

# POPULAR MECHANICS

WRITTEN SO YOU CAN UNDERSTAND IT

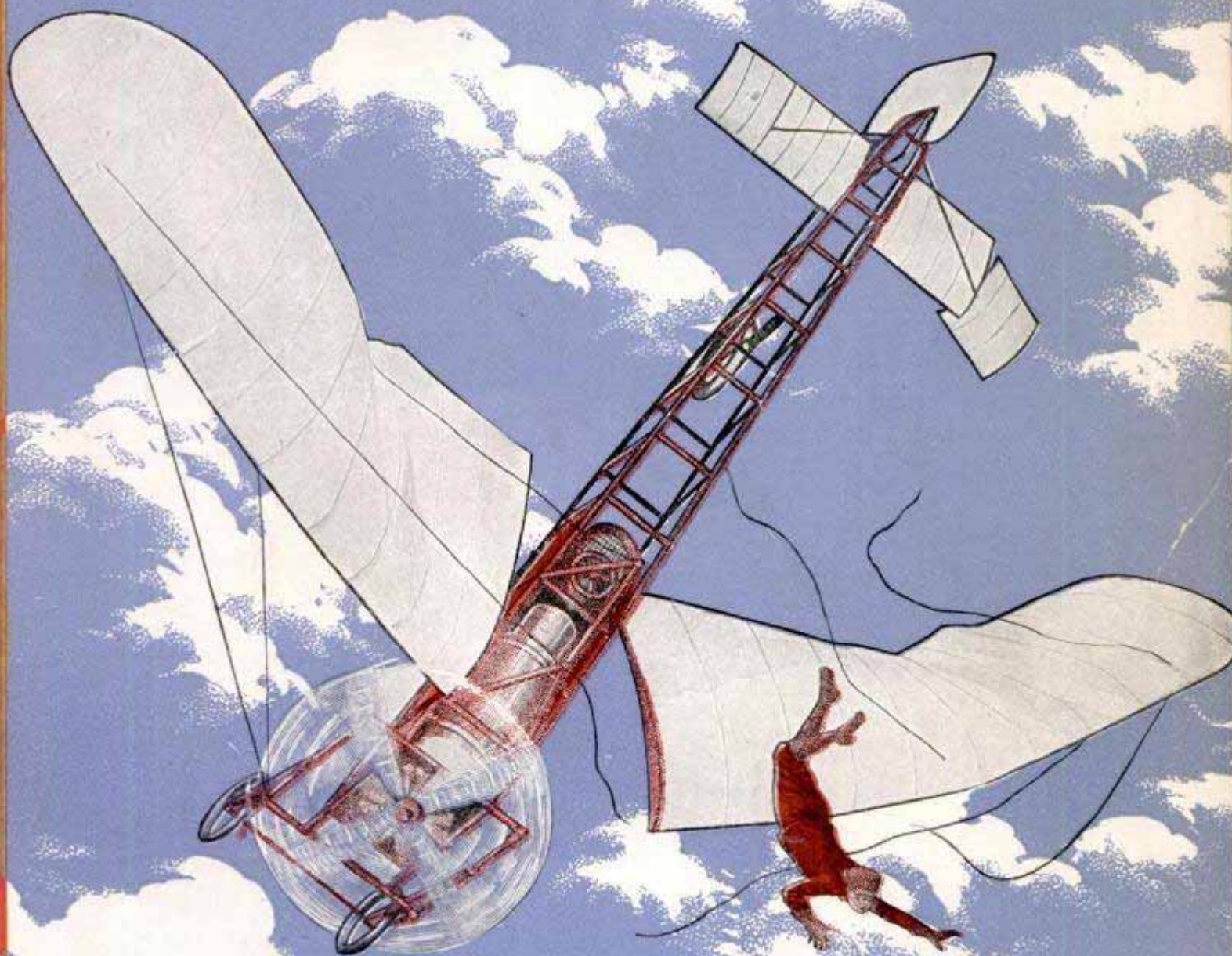

# After the Shop Toil

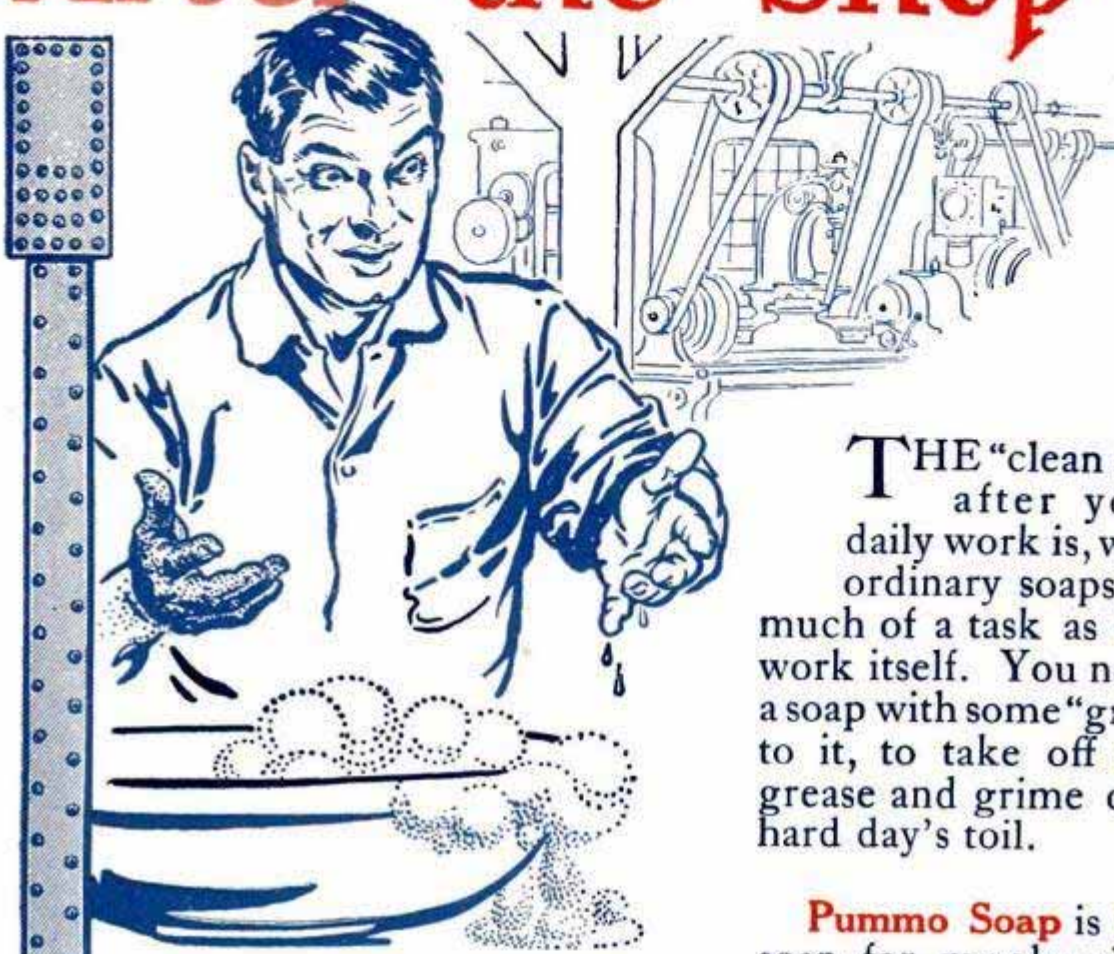

THE "clean up" after your daily work is, with ordinary soaps, as much of a task as the work itself. You need a soap with some "grip" to it, to take off the grease and grime of a hard day's toil.

**Pummo Soap** is the soap for mechanics.

It is made from vegetable oils and glycerine, with just enough finely powdered Italian pumice added to produce a gentle friction. It cleans like a flash, and yet leaves the skin soft and white.

You will be delighted with **Pummo Soap**. We know that if you once try it, you will always have it in your home and at the shop.

**Pummo Soap** is the greatest value you ever saw for **5c.** At grocers and druggists.

If your dealer does not have **Pummo** in stock, write us, giving his name, and we will send you a free sample by return mail.

Made by  
**The N. K. Fairbank Company**  
CHICAGO





SHAM BATTLE AT NAVAL TRAINING STATION

# Trained Men Win

Did you ever watch a young man who has had Navy training? Notice how straight he stands; how firm his step; how sure his action; how straight he looks you in the eye.

Talk with him and see how quick are his decisions, how clear his thinking, and how direct he gets to the point. Notice his politeness and yet his self-reliance.

That's what Navy training means. Those are the qualities it brings out in a man. It does a great deal more for him, too. It gives him good wages and enables him to save them. It can teach him a trade. And it broadens his mind by travel.

Find out about these things. Every young man should know them. "The Making of a Man-O'-Warsman" is an illustrated booklet which tells in a readable way what life in the Navy really is. Send for a copy **now**. You'll forget it if you wait until tomorrow.

---

ADDRESS DESK 69

---

**Bureau of Navigation** Navy Department  
WASHINGTON, D. C.

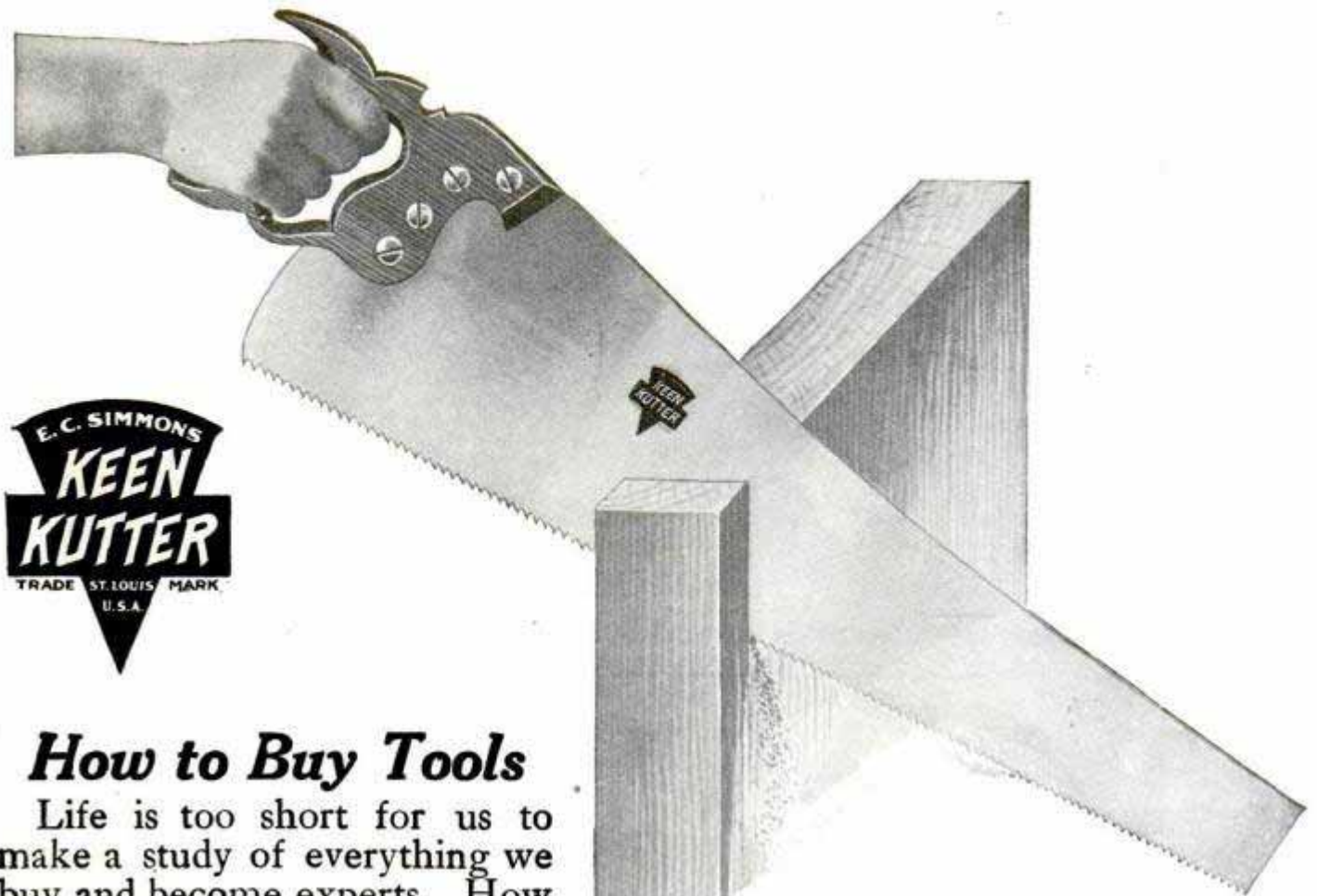

## How to Buy Tools

Life is too short for us to make a study of everything we buy and become experts. How many, for instance, could select the best from a large collection of tools if none of them had any identifying mark?

Who can look through the polished surface and determine the quality of the steel and the fineness of temper. As a matter of fact, the most expert craftsman cannot judge tools by looking at them. There is, however, a certain amount of risk in buying any article of tempered steel that is not protected by a guarantee.

It was to remove every element of risk that the famous line of Keen Kutter Tools were put on the market over forty years ago.

This name covers a complete line of tools and cutlery, and each article is stamped with the trademark, which is the maker's

promise of perfect quality. Each tool, whether it be a can-opener or a cross-cut saw, when once stamped with this name and trademark, does its share in maintaining the reputation that has been won for perfect quality.

Every Keen Kutter tool is put to more rigid tests than those of ordinary uses before leaving the factory. This is the reason that the Keen Kutter guarantee is the broadest one ever made. Every dealer is instructed to refund the money for any article stamped with the Keen Kutter trademark that shows any imperfection in quality of steel, temper, adjustment, balance, or if their work should be unsatisfactory in any respect. You are to be the judge. You are the one to be satisfied.

Sold for over forty years under this famous motto :

*"The Recollection of Quality Remains Long After the Price is Forgotten."*

Trademark Registered —E. C. SIMMONS

If not at your dealer's, write us.

**SIMMONS HARDWARE COMPANY, Inc.**

St. Louis and New York, U. S. A.

Please Mention Popular Mechanics

# POPULAR MECHANICS MAGAZINE

H. H. WINDSOR, EDITOR, 225 Washington St., CHICAGO, U. S. A.

Copyrighted, 1911, by H. H. Windsor.

Exchange Editors are at liberty to quote from these pages by giving the usual credit.

## Contents for March, 1911

Machine Enables Scientist to Read Character.....	309	Two Remarkable 98-Foot Motorboats.....	352
Quadriplane Makes Many Short Flights.....	310	Mechanical Feeder for Geese.....	354
Solidified Gasoline for Automobiles.....	310	Device Tests Engine Cylinders.....	354
New Insulating Bricks Float.....	310	An Electrically Operated Lift Bridge for Canals.....	355
An Electric Mouse Trap.....	310	Coaching the Driver of a Racing Car.....	355
A Mighty Shadow.....	311	Motorist's Repair Couch.....	356
The Largest Valves in the World.....	312	Safety Finger-Nail Cutter.....	356
Army Will Use Wireless at Western Posts.....	312	Botanical Garden in Alps.....	356
Motor Sleigh for Russian Emperor.....	312	Portable Asphalt Plant.....	356
Great Britain's New Battleship Cruisers.....	313	Six-Bladed Motorboat Propeller.....	357
Hide of Huge Elephant.....	314	Real Sanitary Milk Can.....	357
Canaries Act as Mine-Gas Detectors.....	315	Explosion of 17 Tons of Dynamite at Sea.....	358
Spare-Part Outfit for Aeroplanes.....	315	Rapid Unloader for Railroad Cars.....	358
Radium Reduced to \$75,000 a Gram.....	315	Suction Turbines Serve as Air Propellers.....	359
Fighting Arctic Perils with an Improvised Stem Shovel.....	316	Altitude Rule and Aeroplane Rag Level.....	360
An Electrical Recording Tablet.....	319	Eliminating the Flicker in Moving Pictures.....	360
Interesting Ideas from the Paris Automobile Exhibit.....	320	An Ornate Royal Sleigh.....	360
A Serviceable Traveling Hoist for Garages.....	322	Raising Angora Goats in the Southwest.....	361
Piece of Broken Wheel Wrecks Car Interior.....	322	Harem Skirt to Crowd Out Hobble.....	363
Walking-Stick Weapons Carried by Parisians.....	322	Servia Has Novel Way of Disinfecting Visitors.....	363
Beehive Used as Chicken Incubator.....	323	Determining the Rate of Soil Evaporation.....	364
Useful Contest Idea for Aeroplanes.....	323	Concrete Snow Sheds in Cascade Mountains.....	364
Observation Tower for Military Operations.....	323	Erecting Overhead Equipment on Electric Road.....	364
Bridge is Wrecked by Automobile.....	324	Liverpool Clock Rivals Big Ben.....	365
Concrete and Mortar from Volcanic Deposits.....	324	Voisin's New Tailless Biplane.....	366
Austrian Motor Hunting Car.....	324	Shot Getting the Better of Armor Plate.....	366
Red-Cross Car a School for First-Aid Work.....	325	Band Stops Playing While Crossing Bridge.....	366
Uncle Sam's Greatest Warship Launched.....	327	Germany Preparing South Pole Expedition.....	366
Hobbled Ostriches.....	328	Combined Traction Engine and Steam Shovel.....	367
Selden Patent Claims Set Aside.....	328	Carry Board-Gauge Cars on Narrow Tracks.....	367
Business Men's Court for New York.....	328	Canning Music for the Mechanical Piano.....	368
Inventions in Telephony and Telegraphy.....	329	Another "Largest" Liner Started.....	371
Five-Wheeled Auto Has Flexible Traction.....	331	Gastronomic Feat of a Boa Constrictor.....	371
Ingenious Way of Gaining Dance Partners.....	332	A New Form of Propeller.....	372
Aero Wireless Operated over Wide Radius.....	332	Big War Fund Regarded as Peace Guarantee.....	372
Use of Light in Making Night Excavations.....	332	Harvesting Sugar Cane by Machinery.....	372
Photography an Aid to Sculptors.....	333	Steam Speed Boat Makes 39 Miles an Hour.....	373
British Three-Wheeled Motor Car.....	334	Locating Blown Fuses.....	373
To Restrict Carrying of Matches.....	334	Gaming Implements Used for Clock Face.....	374
New York Explosion Not Due to Acetylene.....	335	Electric Meters Installed on Porches.....	374
Death Spread over Wide Radius by Aero Bomb.....	335	Novelties in London Shops.....	374
The Fall That Killed Hoxsey.....	335	Rome's New Zoological Garden.....	375
Raising the "Maine," by Col. William M. Black.....	338	Improved Color-Vision Testing Lantern.....	375
McCurdy Makes Record Oversea Flight.....	340	Electric Mixer Blends Liquids Quickly.....	376
Successful Rescue of Sunken Submarine.....	341	Ingenious Power-Operated Section Car.....	376
Aeroplane Proves Itself a Naval Aid.....	342	The Kingdom of Dust, by J. Gordon Ogden, Ph.D.....	377
Comment and Review, by H. H. Windsor.....	346	Yokes for Convicts to Prevent Escape.....	380
Fitting a Propeller at Sea.....	348	Wrecking Crane with Unusually Long Jib.....	381
Mme. Curie Rejected for Coherer Inventor.....	348	Bleriot Offers Bargain Rates to Pupils.....	381
55-Story Skyscraper for New York.....	348	Concrete Residence of Dr. M. E. Stephenson, Boston.....	382
Electrical Magic Surpasses Legerdemain.....	349	Traveling Concrete Plant Used on Aqueduct.....	383
Wrecked Explorers Walk 1,100 Miles.....	350	How to Make a Hall Tree.....	384
Motor and Propeller to Give Stability.....	350	An X-Ray Eye.....	385
German Aeronauts Lose Their Lives.....	350	Another Trans-Andean Railroad.....	385
City Held Responsible for Typhoid.....	350	Teakettle with Lid on Side.....	385
Oil Concrete the Latest in Road Making.....	351	Windows for Umbrellas.....	385
Boys Fly 250 Feet with a Home-Made Glider.....	351	Device Inserts Cuff Links.....	386
		Auto-Trucks for Aeroplanes.....	386

[Continued on Page 6]

### ISSUED MONTHLY

### SUBSCRIPTION:

SINGLE COPY, 15 CENTS

In United States, and its possessions, and Mexico, per year, postpaid	\$1.50
To Canada	1.75
To all other countries in the Postal Union	2.00

All subscriptions are discontinued at expiration. Please examine the date printed on your wrapper.

Entered as Second Class Matter Sept. 15, 1903, at the Postoffice at Chicago, Illinois, under Act of March 3rd, 1879.  
Published monthly by POPULAR MECHANICS CO.

The attention of prospective advertisers is called to the policy of this magazine in accordance with which the publisher waives all claim for payment of any advertisement appearing in any issue where the number of copies actually printed and circulated is less than the number printed on the front cover page.

This One



BA8X-Z59-SG29

## Contents—Continued

Varnish for Reflecting Surfaces.....	386		
Combined Motor Tractor and Winch.....	387		
Freight Car for Auto Transportation.....	388		
Machine Scours and Dips Flat Pottery.....	388		
Pumping Water 2,200 Feet in One Lift.....	388		
Instruments Exercise Eye Muscles.....	389		
Electric Apartment House.....	389		
Metal Forms for Concrete Houses.....	390		
Surface, Frazil and Anchor Ice.....	390		
Novel Cross-Arms for Transmission Poles.....	391		
Repair Link for Chains.....	391		
Improved Alarm Clock.....	392		
Lunch Car for Those Who Ride in Day Coaches.....	392		
Ingenious French Sop.....	392		
Novel Spiral Strop for Safety-Razor Blades.....	392		
Novel Spark Plugs for Explosion Engines.....	393		
Machine Makes Opaque Paper Transparent.....	393		
Electric Heater Attached to Faucet.....	393		
A Novel Engine Jack.....	394		
France Fixes Weight of the Carat.....	394		
Clean Your Silverware by Electricity.....	394		
Model Shows Watch Escapement.....	395		
Switch Gives Control of Substation Lines.....	395		
Agricultural Tractor Has 12-Foot Wheels.....	395		
Cane as a Preventive of Intoxication.....	396		
Conservation in American Oil Fields.....	396		
May Cross Mediterranean in Aeroplane.....	396		
Evolution of the Tooth Extractor.....	396		
Sand-Blast Barrel for Small Castings.....	397		
Twenty Years of Railroad Development.....	397		
British Motorcycle Ideas for 1911.....	398		
Women Competing for Aerial Honors.....	399		
Electrical Laboratory for the Public.....	399		
International Directory of Foreign Commerce.....	400		
Bureau of Classification for Aerial Craft.....	401		
Delivering Oil in Rural Portugal.....	401		
An Ironclad Telephone for Coal Mines.....	401		
Garter Stiletto Woman's Newest Protector.....	402		
Shortening the Trans-Siberian Railroad.....	402		
Moving Pictures Made Outdoors at Night.....	402		
Rack That Displays and Stores Magazines.....	404		
Record Life of Electric-Sign Lamps.....	404		
New Safety Device for Railroads.....	405		
Making a Piano Mover of an Ordinary Auto.....	405		
Network of Lightning Flashes.....	405		
The Making of Arts-Crafts Lamps.....	406		
Edible Clay Useful in Many Fields.....	407		
Over a Ton of Scale from Two Boilers.....	407		
Automobiles as Election Booths.....	407		
A New Process for Removing Stumps.....	408		
German Musician Invents Music Writer.....	410		
Bridge Evolution Shown in Bethlehem, Pa.....	411		
Back-Rest for Cyclists and Motorcyclists.....	411		
Science and Mechanics in the Middle Ages.....	412		
Aerial Motor Competitive Exhibition.....	412		
Recovering Torpedoes by Electromagnets.....	412		
Colossal Indian Statue Built of Concrete.....	413		
Pay-Within Cars.....	414		
American Museum of Safety.....	415		
Railroad Auto-Car Uses Kerosene Fuel.....	416		
French Military Tandem Monoplane.....	416		
International Boundary Freaks in Vermont.....	416		
Apparatus Exterminates Field Mice and Moles.....	417		
Guard and Protector for Electric Lamps.....	418		
Aerotechnical Institute in France.....	418		
Dog Hospital in Old Street Cars.....	418		
A Unique Concrete Foot-Bridge.....	419		
An Ingenious Hydraulic Dredge Installation.....	420		
Automatic Supervision of Telephone Service.....	420		
Paris Canal Projected for Two Purposes.....	421		
Missionary's Flag-Cane.....	421		
Knee Braces for a Baby Llama.....	421		
Variable Speed Motor.....	421		
Ice-House Made of Freight-Car Doors.....	422		
Hand-Washer for Linen Articles.....	422		
Ship Propulsion by Means of Action of Waves.....	422		
"Looping the Loop" on a Ball.....	422		
Six-Wheel Trucks for Narrow-Gauge Cars.....	423		
Automobile Gun Carriage Tested in Germany.....	424		
Navy Effectively Guards Atlantic Coast.....	424		
Six-Room Apartment on a Private Trolley Car.....	425		
Holding Back a Great Lake with Earth.....	426		
Berlin's Aviation Field.....	427		
Vacuum Cleaner Routs Carpet Prejudices.....	427		
Development of the Scuttle Dash on Autos.....	428		
Supreme Court May Have Palace of Justice.....	428		
\$50,000 Paid for a Famous Violin.....	428		
		<b>SHOP NOTES</b>	
		Wood Box in the Wall of a House.....	429
		Finding Loose Bearings in Automobile Engines.....	429
		Attachment Plug Made from Lamp and Socket Parts.....	430
		Tool for Finding the Center of Shafts.....	430
		A Chicken House.....	430
		Portable Gas Heater for a Steam Furnace.....	431
		Pincushion and Spool-Holder.....	431
		Removing a Stubborn Nut.....	431
		Electric Connections for a Dining-Room Table.....	432
		A Shaft's Speed Determined Without a Speed Indicator.....	432
		Aeroplane Steering Wheel.....	432
		Sign Painter's Shelf for a Ladder.....	433
		Heating Two Offices with One Stove.....	433
		A Gasket Cutter.....	433
		How to Weigh an Automobile.....	434
		To See Bearings in Fine Die-Cutting.....	434
		Preventing a Bottle from Tipping Over.....	435
		Planing the Edges of a Board Square.....	435
		Keeping Drinking Water Clean for Chickens.....	435
		A Steam-Gauge Alarm.....	436
		Marking Iron in a Structural Shop.....	436
		A Window Sash Stop.....	436
		Correct Way to Use a Die.....	436
		Fastening a Hasp from the Inside of a Door.....	437
		Turnbuckles for Aeroplane Bracing.....	437
		To Make an Electric Gas-Lighter.....	437
		Forcing Lubrication by Centrifugal Force.....	438
		Preventing Rats from Gnawing through a Door.....	438
		Raising Inverted Motors.....	439
		A Rural Mail-Box Post.....	440
		Holding a Hot Cutting Chisel on a Handle.....	440
		Foot Support for Ladders.....	440
		How to Repair a Canvas Canoe.....	440
		Removing a Tight Wood Screw.....	441
		Heating Water in a Church Baptistery.....	441
		A Home-Made Lawn Sprinkler.....	441
		A Cellar for Cold Storage.....	442
		Emergency Repair on a Broken Cylinder Head.....	442
		How to Harden and Temper a Lathe Tool.....	442
		Treating a Cracked Hoof.....	443
		A Steel Scraper.....	443
		Keeping Paint from Running Down a Brush Handle.....	443
		Doubling the Lift of the Suction Pump.....	444
		A Pipe-Cleaner That is Clean.....	444
		Cranking a New Automobile Engine.....	444
		Adjustable Level Fastenings for a Straightedge.....	444
		To Get a Natural View from a Photograph.....	445
		Locking Flat-Head Screws.....	445
		How to Make a Pair of Shoe Trees.....	445
		Making Brass Castings a Bronze Color.....	445
		Rubber-Hose Holder for Barrels.....	445
		A Safety Whistle.....	446
		Measuring Gasoline in a Tank.....	446
		Air Blasts Across Spark Gaps.....	446
		Nailing Warped Boards.....	447
		Gauge and Vent for a Funnel.....	447
		An Eye Shade.....	447
		How to Make a Double Trouser Hanger.....	447
		Holding Dipper on a Vessel Rim.....	448
		Etching on Glass.....	448
		Turning Large Screws with a Small Screwdriver.....	448
		<b>AMATEUR MECHANICS</b>	
		Hand Sled Made of Pipe and Fittings.....	449
		Bent-Iron Pipe Rack.....	449
		Emergency Magnifying Glass.....	449
		Home-Made Electric Clock.....	450
		Method of Joining Boards.....	450
		How to Lay Out a Sundial.....	450
		Toy Gun for Throwing Cardboard Squares.....	453
		Photographic Developing Tray.....	453
		Rubber Bands in Kite-Balancing Strings.....	454
		An Aid in Sketching.....	454
		How to Make Miniature Electric Lamp Sockets.....	454
		Wood-Working for Beginners.....	455
		The Walking Cork.....	458
		A Revolving Teeter Board.....	459
		Home-Made Pot Covers.....	459
		Interesting Patents, Practical or Unique.....	460
		Books, Jokes.....	462

# What I value most in Everyman's Car \$450 *The Brush Runabout* By "Everyman"



"I used to think of the automobile as the enemy of the horse," said **the physician**. "But I ruined a lame horse responding to an urgent call and was induced to buy a Brush Runabout. I find that I can see twice as many patients in a day and make twice as good time in urgent cases. The car doesn't catch cold and go lame, and I consider it my horse's best friend."

"I value my Brush because it will go where a horse wouldn't, and will do exactly what it is told," said **the contractor**. "No matter what the road or traffic conditions are, I get from one job to another, and the Brush will stand without hitching."

"We use six Brushes," said **the Secretary of the Telephone Company**, "because our repair men and solicitors cover twice as much territory as they did with the horse and buggy, and at less cost."

"And I doubled my business with one," declared **the wholesale drug salesman**. "First the manager couldn't see it. I asked if, in case I bought the car myself, he would continue my horse and buggy allowance. He said, 'Sure'; and the saving paid for the car in eighteen months."

"I hardly know what I most value," mused **the farmer**. "I don't know whether it is the ease of getting in and out of town with the butter and eggs, the getting of repairs or supplies on short notice, the children's going to school in it, or whether it is because we can hitch up with a turn of the crank and run to church Sunday morning and spend the afternoon at my brother's, fifteen miles down the creek."

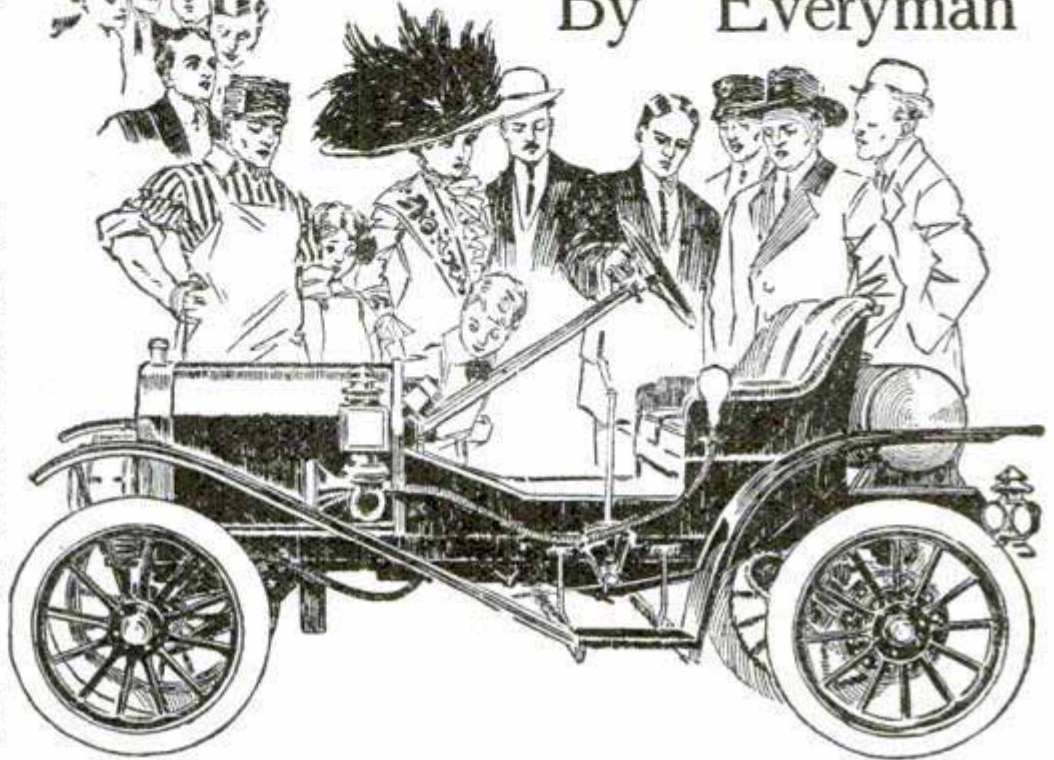

"Well," said **the commuter**, "I decided to quit the street cars and railroad trains and get some pleasant relaxation by running in and out from the office to my little place in the country. I got all this with my Brush Runabout and astonished myself by saving money over the street car and railroad fare."

"I think I have you all beat," said **the manufacturer** of a high-priced touring car. "I make automobiles, but I employ the Brush Runabout at my factory running between departments and carrying men to and fro."

"And you get to love a car when it goes along without trouble like the Brush," added **Louie Abernathy**, the nine-year-old rough-rider who went to New York to meet Roosevelt, and then rode 2,500 miles back to Oklahoma in a Brush, after taking three lessons in driving.

We have thousands of letters from which these Brush expressions are faithfully adapted. They are not overdrawn; if anything, they are underdrawn.

The Brush Runabout is truly Everyman's Car.

Let us send you literature illustrating and describing the car. Just say, "Send books."

## BRUSH RUNABOUT COMPANY

*Licensed under Selden Patents*

386 RHODE ISLAND AVENUE

DETROIT, MICH.

*Please Mention Popular Mechanics*



## YOUR START IN LIFE

Do you realize the vast importance of this—"Your Start in Life?" To be successful you must make a good start, in the right way.

The field of drawing offers an unusual opportunity. Many of the world's greatest engineers began their successful careers as draftsmen.

You have the same chance to-day. You can become a skilled draftsman—hold a good, clean, congenial position at good pay. Home Study will do it, with the aid of the new enlarged *Four Volume Edition*

## CYCLOPEDIA of DRAWING

A complete, comprehensive treatise embodying 1680 pages of practical instructions on Machine Design, Lettering, Blue Printing, The Orders of Architecture, and Sheet Metal Pattern Drafting.

The books also contain 1200 illustrations, plates, tables, diagrams, etc., supplemented with a series of practical test questions. The pages are 7 x 10 inches in size, printed in large clear type on special paper; beautifully bound in half morocco.

These books are compiled from the instruction papers of the American School and to acquaint the public with the superiority of the School's instruction methods. We will place these books in your home absolutely free of charge for five days.

### EXAMINE AT OUR EXPENSE

Fill in and mail the coupon. The books will be sent you free. Carefully examine the books. Compare them with similar works. If you do not find them superior to all others, if you are not satisfied, notify us to send for them. If you keep the books send \$2.00 within five days and \$2.00 a month until you have paid the special introductory price \$9.80. The regular list price of this set is \$20.00. Order now—this offer will not last long.

### IMPORTANT SUBJECTS COVERED:

Sheet Metal Pattern Drafting; Tinsmithing; Architectural Sheet Metal Work; Skylights; Cornices; Roofing, etc.; Practical Problems; Tables; Mechanical, Architectural, Perspective, Isometric and Freehand Drawing; Blue Printing; Mechanical and Architectural lettering; Rendering in Pen and Ink and Water Colors; Water Color Hints for Draftsmen; Shades and Shadows; The Tuscan, Doric, Ionic, Corinthian and Composite Styles of Roman Architecture; Shop Drawings; Machine Drawing; Machine Design, etc.

### FREE OFFER COUPON

American School of Correspondence,  
Chicago, U. S. A.

Please send set Cyclopedic of Drawing for five days' free examination. I will send \$2 within 5 days and \$2 a month until I have paid \$9.80; otherwise I will notify you and hold the books subject to your order. Title not to pass until fully paid. POP. MECH. 3-11

NAME.....

ADDRESS.....

OCCUPATION.....

EMPLOYER.....

## SOMETHING NEW

# Lithographic Models

OF SIX SUBJECTS

*Wireless Telegraph—Motor Car  
Gas Engine—Dynamo  
Steam Turbine and Steam Engine*

Size 8 x 14 inches

50c each <sup>Complete</sup> <sub>et of Six</sub> \$2.50 postpaid

THESE models are of great value as a means of graphically showing all the interrelated parts of the above named mechanisms by virtue of their construction, which is similar to that of educational manikins of the human body and organs, with which nearly everyone is familiar. Beginning with the outermost or surface parts of the gas engine, for example, these are all differently colored and numbered to correspond to a printed key of names which comes with each model. By means of their hinge-like attachment, they may then be lifted, thereby disclosing to view the layer of parts next underneath, exactly as they would be in the engine itself, and so on until the innermost construction is shown. We are sole agents in this country.

ADDRESS

**POPULAR MECHANICS CO.**  
225 Washington Street, CHICAGO

WHEN YOU WANT ANYTHING AND DON'T  
KNOW WHERE TO FIND IT  
WRITE BUREAU OF INFORMATION,  
POPULAR MECHANICS CHICAGO

## MONTHLY CASH PRIZES

Until further notice in this magazine the Editor of Popular Mechanics will pay two cash prizes each month for the best original contributions to it.

### SHOP NOTES DEPARTMENT

\$10 for the Best Contribution  
\$5 for the Second Best

THIS IS IN ADDITION to our usual rates for such contributed articles.

Quality, not length counts.

Checks will be sent on the last day of each month for the prize articles received during that month. Publication in the magazine will follow in about two months.

### PRIZES AWARDED FOR JANUARY, 1911

- First Prize—F. B. HAYS, St. Louis, Mo..... \$10  
"An Air Hoist"
- Second Prize—GEORGE NEUFELD, Philadelphia, Pa.... \$5  
"Blacksmith's Parallel Tong"

### EXTRA AWARD

On account of there being four contributions this month, each of which deserved second prize, we have made an EXTRA AWARD of four additional second prizes, as follows:

- HENRY C. WOOD, Toronto, Canada..... \$5  
"Joint for Aeroplane Construction"
- C. M. GRAHAM, Oskaloosa, Iowa..... \$5  
"Weight on a Belt Shifter"
- HAROLD M. ILG, Lowell, Mass..... \$5  
"Raising a Countershaft"
- C. S. ENRIGHT, Cle Elum, Wash..... \$5  
"Filling Container from Gasoline Storage Tank by Air Pressure"

All accepted contributions to our departments, "SHOP NOTES" and "AMATEUR MECHANICS," are paid for immediately; checks for prize awards are sent at the end of each month.

Address, EDITOR POPULAR MECHANICS  
225 Washington St., Chicago



# CASSELL'S CYCLOPÆDIA OF MECHANICS

## A GOLD MINE OF MECHANICAL REFERENCE

6,500 ILLUSTRATIONS 30,000 INDEXED ARTICLES

### FIVE HANDSOME VOLUMES

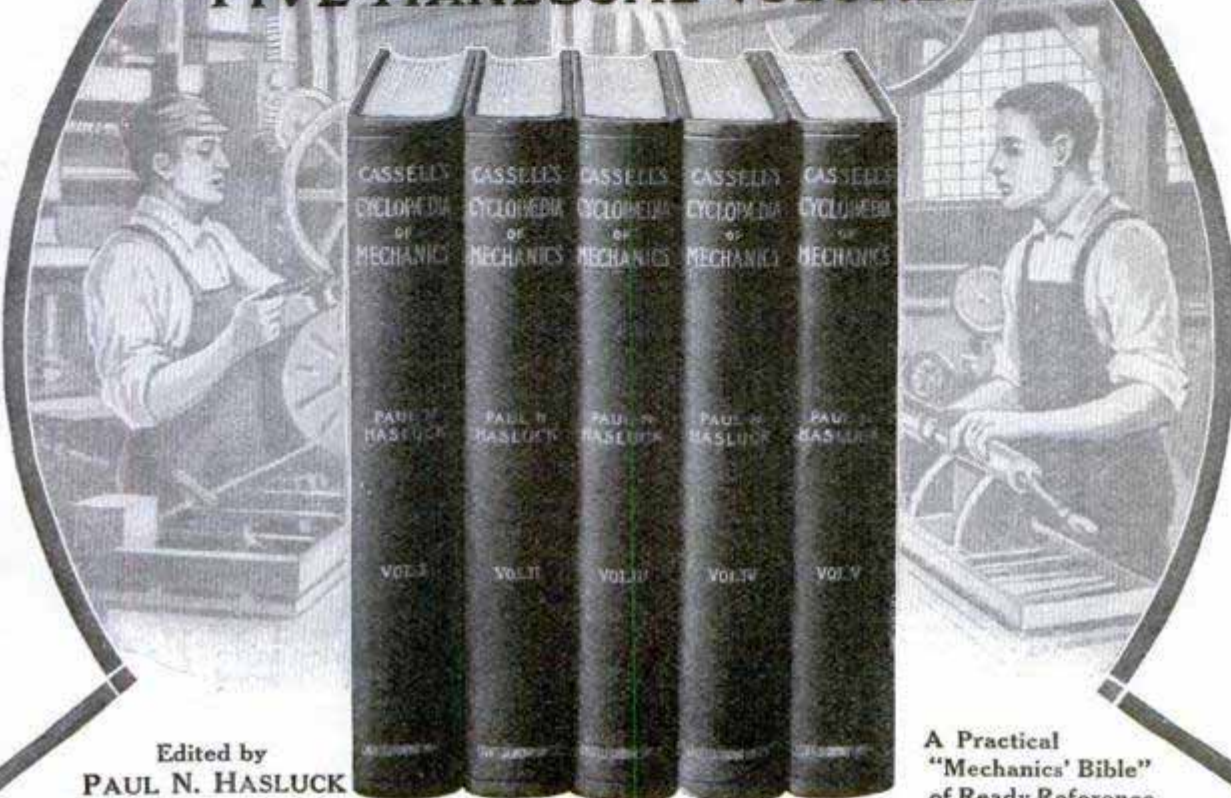

Edited by  
PAUL N. HASLUCK

A Practical  
"Mechanics' Bible"  
of Ready Reference

## Examine This Famous Mechanical Library in Your Home Free

Cassell's Cyclopaedia of Mechanics is an authoritative work, well printed and handsomely bound in five volumes. Written by a staff of skillful and talented mechanical and technical writers, under the direct editorship of Paul N. Hasluck, the foremost living writer on mechanical subjects—every paragraph the paid contribution of an expert. The work is practical from cover to cover, constituting a thoroughly trustworthy reference library and key to up-to-date workshop practice, full of plainly worded and well illustrated articles of interest to all who want a receipt, employ a mechanical process, or stand in need of an item of information concerning mechanical and practical matters. This great work fulfills a long felt want among practical mechanics as well as amateurs and beginners. Students who have previously found that there is nothing to be learned from the compilations of untried and possibly impracticable suggestions and receipts will find Cassell's Cyclopaedia of Mechanics thoroughly dependable and practicable. The work contains over 6,500 illustrations and 30,000 separately indexed articles; over 2,500,000 words. The five volumes number 1760 pages in all, each volume measuring 7½x10½ inches, strongly bound in stout extra durable cloth binding with lettering in gold. The type is large, clear and easy to read. So vast in fact is the scope of the work that only a leisurely examination can do it justice. That is why we make you this out-and-out offer to place it **free** in your home—we know you will find it the best and most valuable mechanical library for you.

### Examine This Great Set of Books at Our Expense

paper and printing and the wonderful fund of information it contains. We want you to EXAMINE it thoroughly, for we know you will be quickly impressed with its great practical value. We want you to ENJOY the finest mechanical library ever offered to discriminating professional or amateur mechanics. The price of this complete work in five volumes as above described is \$18. Just mail us the coupon opposite (send no money) and you will receive the set, carriage paid. Examine it five days. If, at the end of that time, you do not want it, notify us and hold subject to our order. If you keep it, pay us \$2.00 within five days and the balance \$2 a month until paid.

We want you to SEE this famous five volume work for we know you will be pleased with its binding,

and we want you to ENJOY the finest mechanical library ever offered to discriminating professional or amateur mechanics. The price of this complete work in five volumes as above described is \$18. Just mail us the coupon opposite (send no money) and you will receive the set, carriage paid. Examine it five days. If, at the end of that time, you do not want it, notify us and hold subject to our order. If you keep it, pay us \$2.00 within five days and the balance \$2 a month until paid.

**Cassell & Company**  
(Est. 1848) 43-45 E. 19th St., New York

P.M.  
3-11

CASSELL & COMPANY  
43-45 E. 19th St.  
New York

Sign and mail this coupon today

Gentlemen:—  
Kindly send me, carriage prepaid, for free examination, one complete set of Cassell's Cyclopaedia of Mechanics, in five volumes. It is understood that I may examine the work five days, and if I do not wish to keep it I agree to notify you and ho'd, subject to your order. If I keep it, I agree to pay you \$2 within five days and the balance of \$16 in monthly installments of \$2 until settled in full.

NAME.....  
ADDRESS.....  
REFERENCES.....

Send this coupon or a copy of it.

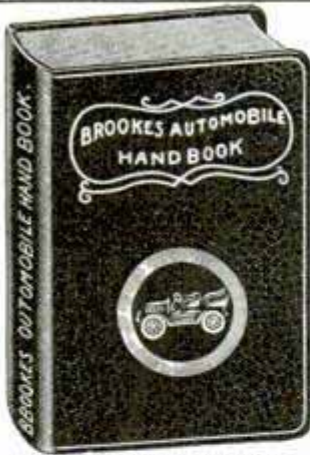

**THE AUTOMOBILE HANDBOOK**  
By L. Elliott Brookes, assisted by other well-known experts. Revised and enlarged 1911 Edition—The largest and most practical work published. Used by all up-to-date automobile schools as their every-day text-book. 16mo, over 650 pages and over 320 illustrations. Full Leather Limp, Round Corners, Red Edges. Size, 4½ x 6½. Price, \$2.00

## Just from the Press

1911 EDITIONS

*"No obsolete methods." No "Musty" rules from bygone authorities.*

**M**OST complete and up-to-date works ever issued on the operation, care and repair of automobiles. No experiments suggested whatsoever. The practical text pertains to present day methods—methods which produce a maximum result. Every essential point is thoroughly covered. These points easily place the books in a class by themselves. They are a complete course of instruction for the owner, operator, mechanic or student. They cover the subject thoroughly, are well illustrated and printed in large, readable type. The bindings are in full leather, stamped in gold, round corners, red edges, specially made in pocket size so they can be "on the job" at all times.

*Sent prepaid on receipt of price to any address. If both volumes are ordered at one time, price \$3.00. Sold by booksellers generally, or sent prepaid upon receipt of price.*

**FREDERICK J. DRAKE & COMPANY, Publishers**  
1325 N. Michigan Avenue CHICAGO, U. S. A.

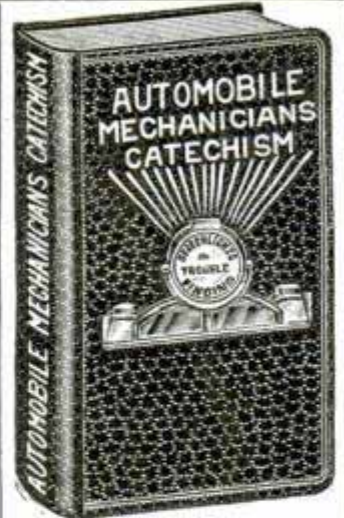

**The Automobile Mechanician's Catechism**  
Over 400 Questions and Answers. Illustrated with 3 large folding charts with all parts fully and correctly numbered. By Calvin F. Swingle, M. E. Pocket Edition, 16mo, Full Leather, Round Corners, Red Edges. Stamped in gold, over 100 pages. Size 4½ x 6½. Price, \$1.25.

We have for sale a limited number of complete files of

### Popular Mechanics for 1909

These consist of the 12 issues of the magazine and a complete index suitable for binding.

Price \$1.25 postpaid

POPULAR MECHANICS, 225 Washington St., CHICAGO

Two Excellent Books for Those Who Like to Make Things

### Amateur Mechanics Nos. 1 and 2

PRICE 25 CENTS EACH POSTPAID

Popular Mechanics Book Department 225 Washington St. CHICAGO

## LEARN TO RUN & REPAIR AUTOMOBILES. YOU CAN





**It's Easy  
WITH DYKE'S NEW SYSTEM**

I Will Teach You Right in Your Own Home, during spare time and quicker and more thorough than you could learn in years around a car—Because: in addition to Dyke's New Revised Home Study Course of 29 complete Instructions (or 12 Books) and 120 Charts, we include absolutely free several

**Working Models**

of parts of the Automobile (see Illustrations) for you to actually see the principle, construction and practice valve setting—timing ignition—setting the magneto, etc. Barney Oldfield says—"A person surely can learn with your system."

If Others Can Learn, You Can—We will send you testimonials from hundreds.

Ten Dollars Covers All—Others charge \$20 to \$40—and not near so complete—We send on approval—everything goes at one time—Diploma when you finish.

**FREE:** 24 Page Book—"How to get into the Auto Business"

**Don't Miss It! Write Today!**

DYKE'S COR'P. SCHOOL MOTORING,  
Box 1 —3947 Washington, ST. LOUIS



**MANIKIN  
OF AN  
AUTOMOBILE  
TAKE IT APART.**

SEE HOW AN AUTO IS CONSTRUCTED.

# PUBLICATION DATE CHANGED

POPULAR MECHANICS  
MAGAZINE will be  
on sale at news stands  
and in the hands of mail  
subscribers on the 20th  
of month previous to  
date of issue instead of  
the 17th as heretofore.

# HOW TO RUN AN AUTO

**Every Owner, Operator, Repairman and Intending Purchaser Should Have a Copy**

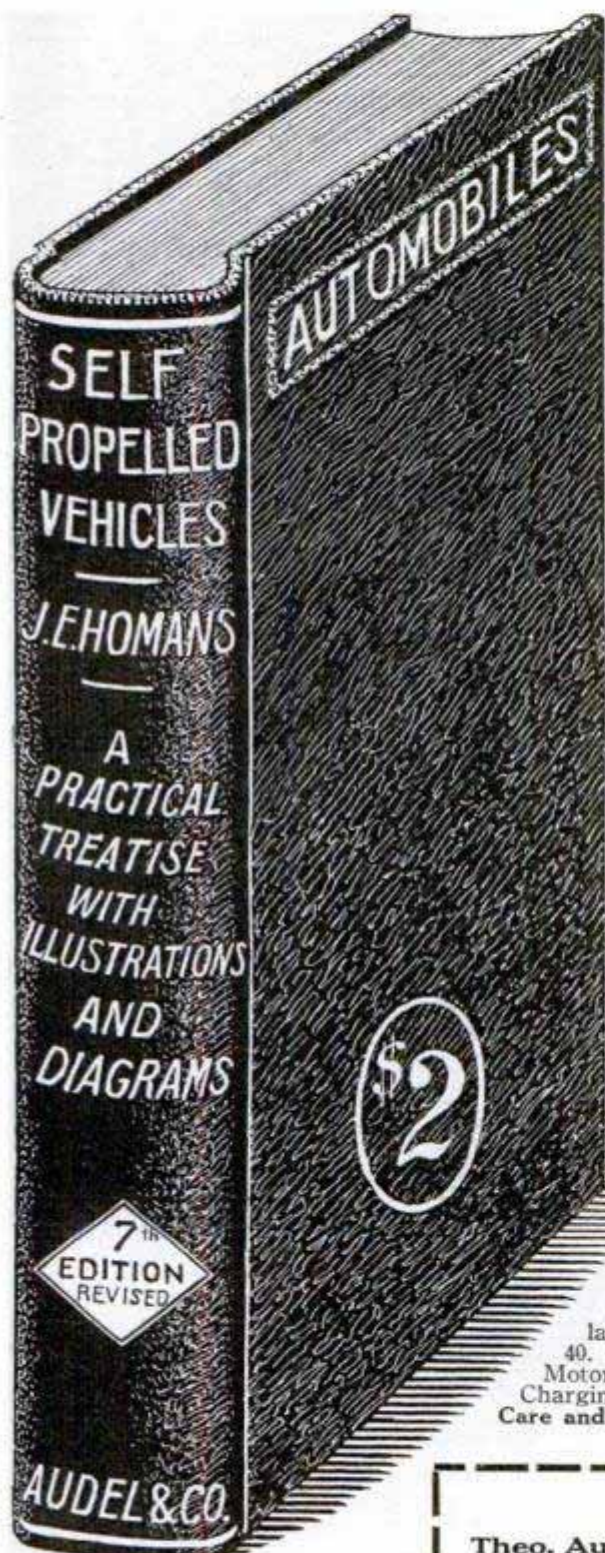

**T**HIS up-to-date Edition tells in plain words how to keep your car in good running condition.

It is a good investment, highly approved by manufacturers, and operators everywhere. By its use you will learn how to set magnetos, time the valves, adjust the carburetters, etc., also how to make your own repairs.

It contains many "Shop Kinks" and "pointers" relating to one, two, four and six cylinder cars. It describes in detail the various types of ignition and wiring systems. It tells how to get the mileage out of your tires.

The book is a useful cyclopedia of automobile operation in one handsome volume of 675 pages, 400 illustrations with ready reference Index. Price \$2.00 postpaid to any address.

## Table of Contents

1. Brief History of Self-Propelled Vehicles.
2. Make-up of a Motor Carriage.
3. Compensation and Compensating Devices.
4. The Driving Gear, Methods of Power, Transmissions.
5. Steering a Motor Vehicle.
6. Combined Steering and Driving.
7. Motor Vehicle Supports.
8. Motor Carriage Wheels, Requirements, Types.
9. Solid Rubber Tires: Theory and Construction.
10. Pneumatic Tires: Advantages, Construction and Types.
11. Tire Troubles.
12. Tires: Care and Repair.
13. Types and Merits of Automobiles.
14. Theory of Gas Engines.
15. Parts of a Gas Engine.
16. Four Cycle Gas Engine.
17. Two Cycle Gas Engine.
18. Compression and Expansion.
19. Gas Engine Operation and Efficiency, Combustion.
20. Exhaust of a Gas Engine.
21. Water-Cooling System.
22. Air-Cooling System.
23. Power Elements of a Gas Engine.
24. All About Carburetters.
25. All About Ignition: High and Low Tension Systems, Wiring, Etc.
26. Balancing Gasoline Engines.
27. Governing and Control, Various Methods.
28. Clutches and Transmissions.
29. Transmissions: Principles and Construction.
30. Operation of Brakes.
31. Ball and Roller Bearing: Theory and Use.
32. Oils, Lubricants and Lubricators.
33. Practical Operation of Engines.
34. How to Operate Motor Cycles.
35. Operation of Steam Engines for Automobiles.
36. Boilers and Flash Generators.
37. Burners and Regulators.
38. Automatic Regulating Devices.
39. All About Steam Cars.
40. Electric Vehicles.
41. Principles of Electricity.
42. Dynamos and Motors: Operation and Construction.
43. All About Storage Batteries, Charging, Etc.
44. Methods of Circuit Changing.
45. Automobile Running, Care and Repair, with Words of Caution.

### NO MONEY IN ADVANCE REQUIRED

Theo. Audel & Co., 63 Fifth Ave., New York

Kindly mail me copy of Homans' Automobiles, and, if found satisfactory, I will immediately remit you \$2.00, or return the book to you.

NAME.....

OCCUPATION.....

ADDRESS..... (Mech. P.M.)

### ORDER NOW ON APPROVAL

The only way the practical merit of this Manual can be given is by an examination of the book itself, which we will submit for examination, to be paid for or returned, after looking it over. Upon receipt of the following agreement, the book will be forwarded.

# YOU NEED THIS NEW CREATION

## WEBSTER'S NEW INTERNATIONAL DICTIONARY - THE MERRIAM WEBSTER

**Because** it is the *only new* unabridged dictionary in many years. Gives just the accurate, up-to-date information you so often wish. A single volume containing the *pith* and *essence* of an authoritative library of the world's thought, action, and culture.

**Because** your needs demand the *highest editorial scholarship*. Editor in chief W. T. Harris, Ph. D., LL. D., former U. S. Com. of Education. Special editors of the highest scholarship in every department.

**Because** over *400,000 Words* are defined. More than ever before appeared between two covers. *2700 Pages. 6000 Illustrations.* Cost nearly half a million dollars. The type matter is equal to that of a 15-volume encyclopedia.

*"The most remarkable single volume ever published."*

**Covers every field of knowledge including:**

- |                 |             |                      |
|-----------------|-------------|----------------------|
| Agriculture     | Forestry    | Mythology            |
| Abbreviations   | Geography   | Nautical and Naval   |
| Architecture    | Geology     | Terms                |
| Art             | Golf        | Philippine Islands   |
| Astronomy       | Heraldry    | Words                |
| Bacteriology    | Law         | Philosophy           |
| Biology         | Mathematics | Physics              |
| Botany          | Mechanics   | Religious            |
| Chemistry       | Medicine    | Terms                |
| Christian Names | Meteorology | Scripture            |
| Economics       | Military    | Names                |
| Electricity     | Terms       | Synonyms             |
| Fiction         | Mineralogy  | Zoology              |
| Foreign Phrases | Mining      | Words used in Trades |
|                 | Music       |                      |

**Because** it is the *only* dictionary with the new time-saving divided page. *"A stroke of genius."*

**Because** the New International has been *tested, approved, and accepted* by leaders in the world's activities.

**Because** to-day you must keep abreast of the times. To *Know* means to *Win Success*. Let us tell you about this supreme authority for all who use English. Look for the circular trade-mark and our name on the title-page.

**G. & C. MERRIAM CO.,**  
SPRINGFIELD, MASS., U. S. A.

For over 68 years publishers of authoritative dictionaries.

**WRITE** for specimens of the new divided page, illustrations, etc. If you mention

Popular Mechanics we will send FREE a set of pocket maps.

Name .....

Address .....

**GET THE BEST**



### UNITARIANISM

The Religion of Common Sense.  
Look into it, Acquire it, Assist it.

Free Literature: Address  
"Associate Department"  
25 Beacon Street, Boston, Mass.

*The Best Book For Beginners*

**A Practical Course in Mechanical Drawing**  
By Wm. F. Willard  
**POPULAR MECHANICS BOOK DEPT.**  
225 Washington Street, Chicago.

Price 50c Postpaid

### COMPLETE FILES OF

## Popular Mechanics Magazine

FOR 1910

Consisting of the twelve issues of the magazine and a very complete index. Suitable for binding. Supply limited.

May be had while they last at the price of \$1.50 postpaid.

Popular Mechanics Co. 225 Washington St. CHICAGO

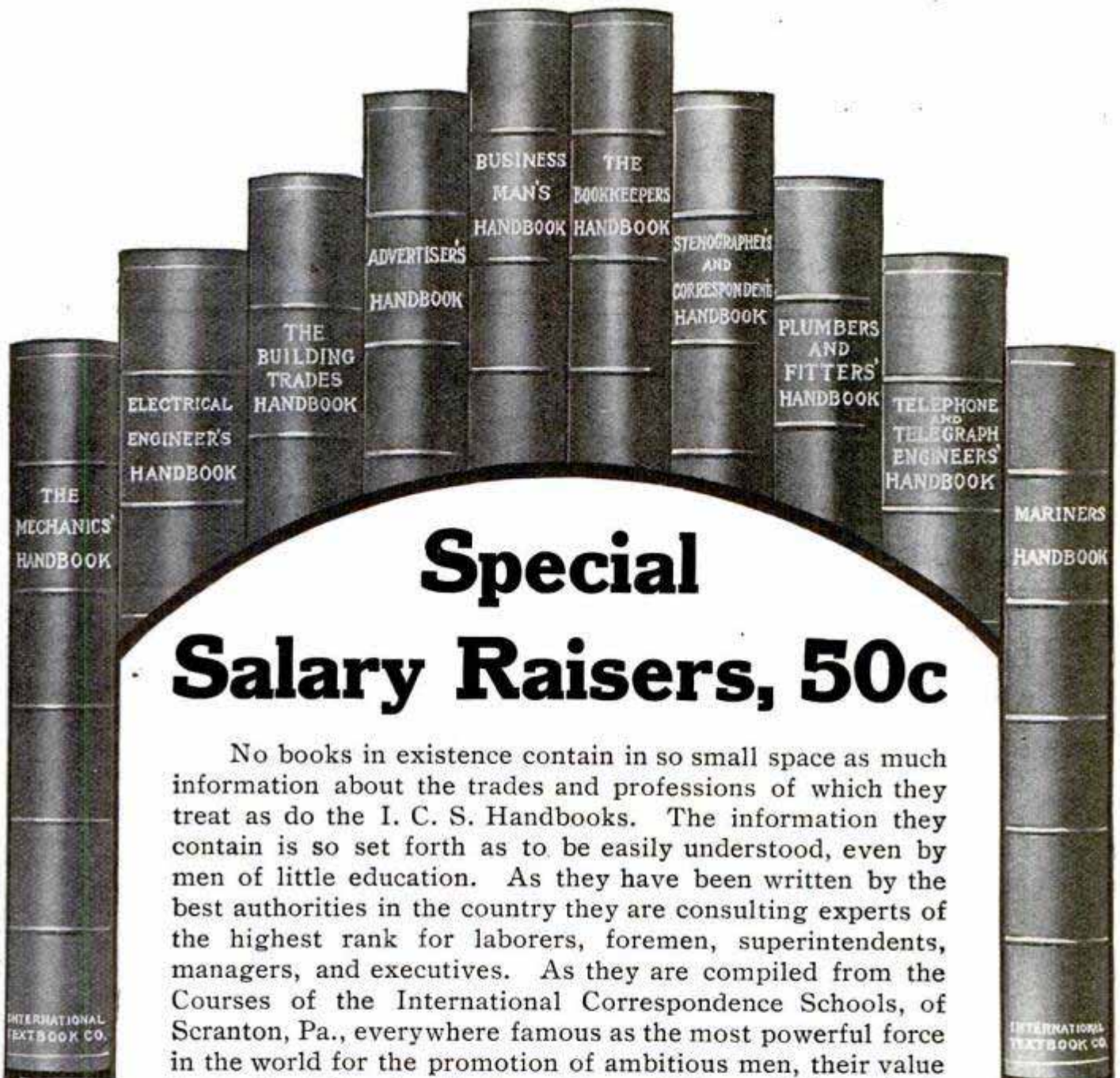

## Special Salary Raisers, 50c

No books in existence contain in so small space as much information about the trades and professions of which they treat as do the I. C. S. Handbooks. The information they contain is so set forth as to be easily understood, even by men of little education. As they have been written by the best authorities in the country they are consulting experts of the highest rank for laborers, foremen, superintendents, managers, and executives. As they are compiled from the Courses of the International Correspondence Schools, of Scranton, Pa., everywhere famous as the most powerful force in the world for the promotion of ambitious men, their value to employes in subordinate positions will be quickly realized. They are an indispensable help to quicker work that will

command advancement. Every important item is indexed with all the initial letters under which it is likely to be sought. They are printed on high-grade book paper in clear type, and durably and handsomely bound in cloth with gilt titles. They contain on an average 364 pages and 175 illustrations and are regularly sold for \$1.25.

**Special Offer:** To better introduce the value of I. C. S. Textbooks and I. C. S. Training we will sell these books for a limited time to those sending to us this coupon and 50 cents.

### International Textbook Co.

Box 872-P, SCRANTON, PA.

I enclose \$\_\_\_\_\_ for which please send me the books before which I have marked X.

- |   |   |
|---|---|
| <input type="checkbox"/> Mechanics' Handbook    | <input type="checkbox"/> Advertiser's Handbook  |
| <input type="checkbox"/> Elect. Eng. Handbook   | <input type="checkbox"/> Business Handbook      |
| <input type="checkbox"/> Bldg. Trades Handbook  | <input type="checkbox"/> Bookk'per's Handbook   |
| <input type="checkbox"/> Plumb. & Fit. Handbook | <input type="checkbox"/> Sten. & Corr. Handbook |
| <input type="checkbox"/> Tel. & Tel. Handbook   | <input type="checkbox"/> Mariners' Handbook     |

Name \_\_\_\_\_

St. and No. \_\_\_\_\_

City \_\_\_\_\_ State \_\_\_\_\_

## Tackling the Smoke Problem

By  
JOHN C. MILLER, M. E.

## The Manufacture of Electricity

By  
W. L. ABBOTT

## The Testing of Aerial Propellers

By  
C. E. LARARD and R. O. BOSWALL

## What Causes Boiler Explosions?

By  
M. KENNETT

These are four out of over fifty important articles of timely interest—all with full and accurate illustrations—which make the current number of

# Shop Notes Quarterly

worth a hundred times what it costs to the **man who does things**. Besides the half hundred of special articles and reviews there are hundreds of other items of value and interest to workers in all the useful callings as well as to all who keep in touch with modern progress.

**Shop Notes Quarterly** is the largest publication in the world devoted exclusively to Mechanics, Science and Practical Knowledge. 210 pages of reading matter—with complete alphabetical Reference Index.

---

**\$1.00 a Year—Ask the Newsdealer—25 Cents a Copy**

---

**POPULAR MECHANICS CO.** 225 Washington Street  
CHICAGO, ILLINOIS

# A Perfect Memory The Key to Success

You can have a perfect memory—if you want it—because a perfect memory, like perfect health, can be acquired. My home course of Memory Training will give you a perfect memory so that you can instantly command any thought, idea or argument.

## My Course Is Not a Theory

but an absolutely scientific course of memory training—the result of years of intimate contact with thousands of students in schools and colleges by one of America's foremost educators.

## Thousands of Successful Men Can Tell You What My Memory Training Has Done For Them

Every one, at times, realizes how embarrassing, how fatal it is not to be able to make an extemporaneous speech. The employer addressing his employees—the secret society man at his lodge—the working man at his union—the woman at her club. So few people possess this talent—yet it can be easily acquired.

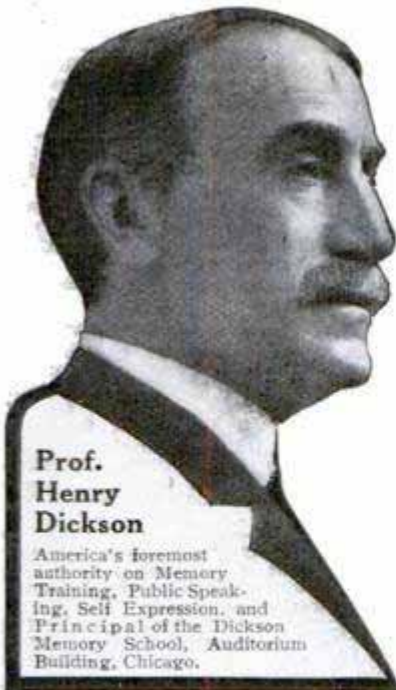

Prof.  
Henry  
Dickson

America's foremost authority on Memory Training, Public Speaking, Self Expression, and Principal of the Dickson Memory School, Auditorium Building, Chicago.

## Dickson's How to Speak in Public

De luxe edition, handsomely illustrated, richly bound. Is full of carefully selected material exactly suited to meet the needs of the man or woman who desires to be a successful public speaker.

Success in Life depends on what you say and how you say it. This book of mine on Public Speaking and Self Expression is based on my 30 years of success as an instructor in Public Speaking in Chicago University, University of Notre Dame, and other well known schools. Taken in connection with my memory training, you can obtain a far better and more useful education than is afforded by many of the best universities. The price

of this 1911 de luxe edition is \$2.00. I will, however, present a copy absolutely free to every student who enrolls for my course of memory training within ten days after reading this offer.

*The ability to think on your feet, to focus your mind instantly and voice your thoughts unhesitatingly, interestingly, makes you a leader of men and it's worth while.*

## You Can Have This Training

No matter where you live, what your vocation, or what your age, my course will make you infinitely more successful.

Only ten minutes a day—no tedious lessons, only a simple method which teaches you—

How to remember names and faces of people you meet. How to focus your mind instantly on the points of a business proposition. How to commit a speech or toast to memory quickly, and deliver it unhesitatingly. How to converse at social gatherings in a natural, interesting way that wins friends. How to overcome self-consciousness, bashfulness. How to control your mind. How to memorize for studies, examinations, etc.

The Dickson System of Memory Training has been highly recommended by such notables as Elbert Hubbard, Prof. David Swing, Dr. Latson and thousands of others.

The fame of this unique and successful system has spread over the entire country, and its successful graduates fill every walk in business, political and professional activity.

While the weakest memories can be strengthened—many of the most intellectual men of the day have availed themselves of memory training.

**Fill Out and Mail Coupon Today If  
You Would Be Successful**

Prof. Henry Dickson, Principal, Dickson Memory School  
705 Auditorium Building, Chicago, Ill.

Send me free booklet "How to Remember," also full particulars how to obtain a free copy of "Dickson's How to Speak in Public."

NAME.....

STREET.....

CITY..... STATE.....

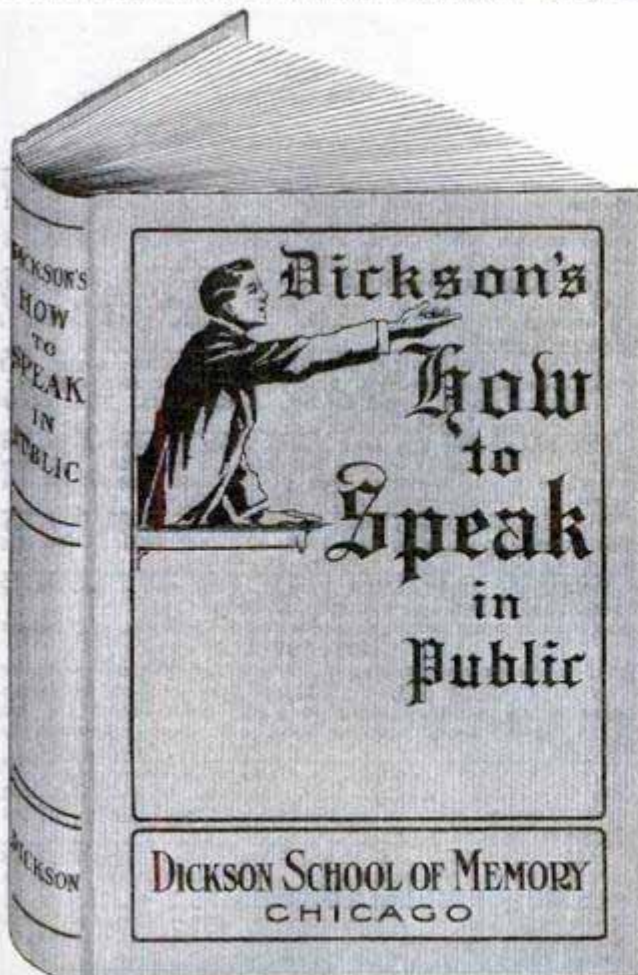

# Classified Advertisements

Advertisements in this section, 10 cents per word, each insertion payable in advance. To insure ads being inserted under proper classified head in the April issue, copy must reach this office not later than March 1st.

*Popular Mechanics Magazine, Chicago.*

Gentlemen: Owing to our inability to fill the orders now on hand, we wish to discontinue our ad in your publication for the month of February. Our advertising has been productive of such excellent results that we cannot handle the work now on hand.

We will write you further in regard to future advertising.

THE ELGIN WHEEL & ENGINE CO.,

Elgin, Ill.

## AUTOMOBILES

WE OFFER OUR PAIGE-DETROIT automobile for \$468, costing eight hundred dollars, new last August, 3 cylinder, 2 cycle, 25 horse power, 2 passenger, racy design, positively like new. Hultz & Co., Streator, Ill.

FIVE PASSENGER REO TOURING CAR. Storage Battery Generator, light, fine set tools, extra tires, in fine shape, climb any hill or go in any sand, for sale cheap or exchange for Diamond Rings. Dr. Edmundoz, Moffitt, Fla.

FOR-SALE: Rambler, 2 cylinder touring car, \$300. Pope Toledo, 4 cylinder touring car, \$600. Oldsmobile, 4 cylinder Roadster, \$800. Longest Bros. Co., Louisville, Ky.

SALE OR TRADE Holsman 4 passenger; good order, \$150.00. Box 233, Royersford, Penna.

RUNNING GEAR COMPLETE with tires, body, etc. (Shaft drive.) Excellent condition, \$85.00. Geo. E. Buss, New Philadelphia, Ohio.

EXTRA LIGHT WEIGHT RUNABOUT, just the thing for light delivery, \$85.00. Write L. C. Bell, 1001 Kansas Ave., Atchison, Kans.

WHITE STEAMER, five passenger, best equipment, fine running order. Charles G. Pape, Fort Wayne, Ind.

OLDS RUNABOUT EXCELLENT CONDITION, leather top, good tires, \$85.00. Indian Motorcycle, \$80.00. G. Wills, Canal Dover, Ohio.

FOR SALE—A new 12 H. P. Holdsmen delivery wagon. Price \$500.00. "Mail Order" Garage, 3 Fox St., Bridgeport, Conn.

ORIENT RUNABOUT, good shape, \$90. Box 327, Cornell, Ill.

FOR SALE—Slightly used 1910 Pierce four, in fine condition, \$235.00. Ernest Stroup, Spencer, Ohio.

KNOX LIGHT DELIVERY, O. K. throughout, \$350.00. Box 79, Beavertown, Pa.

STEAM CAR OWNERS, Myers Kerosene Burner, something new, write for circular. 729 W. Colfax Ave., Denver, Colo.

CLOSING OUT SALE—\$3,500 "Thomas Flyer," \$850; \$2,500 Winton, \$500; \$1,000 Cadillac, \$200. All fine condition. Scrivens, Ashtabula, Ohio.

16 H. P. TWO CYLINDER Haynes Runabout; excellent condition—leather top—extra tires—\$225.00. John Breslawsky, Passaic, N. J.

OLDS RUNABOUT; 10-hp. auto engine and accessories; 4-hp. engine, coil, carburetor, radiator, etc., \$35.00. Zoller Bros., Muncie, Ind.

AUTOMOBILES at very lowest prices. List and catalogue for stamp. Rubel Co., Louisville, Ky.

FOR SALE OREOLE RUNABOUT, good condition, E. C. Neyhart, Greentown, Ind.

TOURING CAR—5 Passenger; 22-hp. Shaft Drive, 34-inch wheels. Tires good. 164-inch wheel base. Photo. Price \$350. Fred Zoll, Findlay, Ohio.

AUTOMOBILE INSTRUCTION, four weeks' course covering shop and road work—provision for out-of-town men. Send for booklet P. M. West Side Y. M. C. A. Automobile School, 318 West 57th St., New York City, N. Y.

AUTOMOBILES—Over Four Hundred Bargains \$95.00 upward. All guaranteed. Freight prepaid. Write now for Latest Illustrated Bulletin. Motor Car Exchange, Dept. C-215, West 125th St., New York City.

"CADILLAC"—5 PASSENGER Touring Car. Top, windshield, lamps, etc. Ready to run. Photo. Price \$400. Jackson's Garage, Findlay, Ohio.

"MAXWELL" RUNABOUT. Good as new. Double seat rear, detachable, 2 or 4 passenger. 14 hp. Tires good. New paint. Guaranteed. Photo. Price \$450. Fred Zoll, Findlay, Ohio.

BUICK "MODEL F." 5-Passenger Touring Car. 24 hp. Full lamp equipment. Top, tools, \$50 speedometer. Tires good. Photo. Price \$500. F. J. Collingwood, Findlay, Ohio.

AUTOMOBILES EXPLAINED so you can understand running and repair. "Homans' Automobiles"—the book that tells you how to remedy trouble, all about carburetors, ignition, lubrication, tires and engine troubles. Highly endorsed. Order today—price \$2 post-paid. Theo. Audel Co., Publishers, 63 Fifth Ave., New York.

AUTOMOBILE BARGAINS—Get our list before placing your order. We will surprise you, 50 bargains from \$100.00 up. Box 275, Burlington, Wis.

DON'T FAIL TO READ the story of Daimler, the Father of the Automobile, in the current number of Shop Notes Quarterly. There is no fiction in Shop Notes Quarterly, but many readers find it more interesting than any other magazine.

"THE HOW AND WHY of the Automobile."—A 200 page book of practical information for seekers after the fundamental facts regarding the gasoline engine and its application to the motor car. Interesting and instructive to both the beginner and the expert. Bound in full cloth—250 illustrations. Price \$1.00 postpaid. Popular Mechanics Book Dept., 225 Washington St., Chicago.

## AUTO SUPPLIES

MULTIPLE JET CARBURETOR for Automobile and Marine engines. Satisfaction guaranteed or your money refunded. Prices, 1 1/4 in. 2 Jet, \$15; 1 1/2 in. 3 Jet, \$20; 1 3/4 in. 4 Jet, \$25. 1 1/2 in. size is a cluster of three carburetors; one set for low speeds, one set for medium speed, and one set for high speed. Simplest, easiest regulated, by far the most powerful. Is economical, and uses low grade gasoline. Easiest to start of all makes of carburetors. Liberal discount to agents, dealers, supply houses and garages. Multiple Jet Carburetor Co., Dayton, Ohio.

STARTS MOTOR FIRST TURN any temperature without raising hood. For automobile, marine or stationary. Within everyone's reach, \$1.00 brings drawing and complete information. Denton, 507 Orange St., Newark, New Jersey.

SPARK PLUGS. TRY A SET of our mica noncarbonizing spark plugs. Regular price \$1.50. Sent postpaid 75 cents each. Spher Mfg. Co., Toledo, Ohio.

\$85.00 TAKES A BRAND new 16 HP. two cylinder opposed automobile motor with carburetor and timer. Badger Motor Co., Milwaukee, Wis.

GUARANTEED new Wizard Magneto, \$17. Denton, 507 Orange, Newark, New Jersey.

FOR SALE—4 Cyl. Air Cooled 20 h. p. auto engine with timer and carburetor, \$75.00. Planetary transmission 20 h. p. with two chains, \$30.00. Box 34, La Salle, Illinois.

FOR SALE—8 hp. Single Cylinder Cadillac Engine and Transmission and coil, good condition. Price \$40. R. Roth, 1423 North Ave., Bridgeport, Conn.

PITS VIM IN YOUR MOTOR, Wizard Carbon Remover, quickest, best; formula \$1.00. Denton, 507 Orange St., Newark, New Jersey.

BLITZ POCKET SPARKER INSTANTLY lights acetylene lanterns, matches unnecessary, 25 cents. G. Wesley, Aurora, Ill.

16 H. P. OPPOSED ENGINE, \$70. Buick radiator, \$25. R. B. Rodgers, 215 W. Florida St., San Antonio, Tex.

GOING TO BUILD AN AUTO? Steam or gasoline? If so, send for list telling us what you need. J. L. Lucas & Son, 3 Fox St., Bridgeport, Conn.

1910—10 H. P. Brush motor complete \$65.00. Box No. 275, Burlington, Wis.

CHASSIS, INCLUDING NEW TWO-CYLINDER engine, transmission, carburetor, coil, timer, wheels, tires, \$125. Small expense necessary to make fine roadster. New four-cylinder air-cooled engine, \$50. Tires, auto supplies. Must be sold. Write for prices. Scrivens, Ashtabula, Ohio.

FOR SALE LOCOMOBILE, 16 and 20 inch, Gasoline Burners, \$8.00 each, 1 Whitney 10-hp. Steam Engine, \$35.00, 1 Mason 4 1/2-hp. Steam Engine, \$15.00. R. Roth, 1423 North Ave., Bridgeport, Conn.

STEAM AUTOMOBILE ENGINES, BOILERS; parts of Prescotts, Locomobiles, Mobiles, Stantons, or other steamers; for sale at reasonable prices. Send for list. State wants. E. L. Marshall, 34 Vernon Ave., Lake View, N. J.

FOR SALE—One gas tank which holds carbonated gas enough to inflate from eighty to one hundred 4 inch tires. Mounted on two wheel truck. Original cost \$45.00, will take \$25.00. Robt. Holmes & Bros., Hazel St., Danville, Ill.

FOR SALE—National 60-gal. gasoline tank mounted on wheels, with pump and register, cost \$250, will take \$125. Robt. Holmes & Bros., Hazel St., Danville, Ill.

STEAM AUTO BOILERS Bought, Sold and Repaired. J. L. Lucas, No. 2 Fox St., Bridgeport, Conn.

## MOTORCYCLES

MOTORCYCLES ALL MAKES, Prices low, oldest Motorcycle dealer in the south. Established 1896. Send stamps for Catalog. R. L. Davis, the Motorcycle Man, 911 West Broadway, Louisville, Ky.

ACCOUNT OVER STOCK, we now offer until sold new Dow Coils for single cylinder, \$3.50; double, \$4.00. Hundreds of other bargains in our catalogue. Write to-day. Motorcycle Equipment Co., Hammondport, N. Y.

YALE MOTORCYCLES SELL, Rider agents, big money demonstrating. Show them that's all. Any thing of value taken as part pay. English Motor Co., New Castle, Pa.

FOR SALE—R. S. Thor, Racycle, Harley Davidson, Excelsior and other motorcycles. G. H. W., Rm. 18, McAndy Bldg., Canton, O.

PIERCE FOUR CYLINDER MOTORCYCLES scarcely used and in first class condition, for sale at very low prices. Wm. B. Colburn, 18 Hanover St., Buffalo, N. Y.



1910 INDIAN \$130. Harley Davidson \$140. Both practically new. Geo. Buss, New Philadelphia, Ohio.

FOR SALE—2½ belt drive Thor equipped motorcycle; run 1,500 miles. \$135. E. Thompson, Casselton, N. D.

FOR SALE—1910 2½ Indian. Practically new. Price reasonable. William Leffer, Tiffin, Ohio.

FOR SALE—1910 model Yale Motorcycle, write, Wm. G. Lattinbach, Mendota, Ill.

WANTED—Motorcycle. C. A. Hall, Covert, Kans.

YOU CAN GET a better motorcycle and save money if you get our large illustrated catalogue of ninety motorcycles for your selection. Every machine in stock guaranteed. Prices very low during winter, enclose three cents, stamps. Rubel Co., Louisville, Ky.

FOR SALE—4 H. P.—1910—Indian factory Guaranteed until July. Address: L. V. Davis, Lestershire, N. Y.

\$125, CASH, takes my new 3½ Reliance. Particulars for red stamp. Harry Fesenfeld, Black Earth, Wisconsin.

CASH for used motorcycles. Rubel Co., Louisville, Ky.

MOTOR CYCLES—Enormous variety of American and Imported makes—Indians, Marsh's, \$35.00. Hundreds of other bargains. Shipped freight prepaid. Write now. Large illustrated bulletin free. Motorcycle Exchange, 215 West 125th St., New York City.

MOTORCYCLES, \$50 UP. Indians, Royals, Thors, Harley Davidsens, Excelsiors, Wagners, etc.; every one guaranteed; send for bargain list and large motorcycle supply catalogue, repairs, etc. F. B. Widmayer Co., 2312 Broadway, New York City.

60 SECOND HAND MOTORCYCLES, 3 tricars, all bargains. Model Motorcycle Garage, 318-20 W. 48th St., New York.

MOTORCYCLES \$35 UP. All makes. Send today for bargain list. Shaw Mfg. Co., Dept. 39, Galesburg, Kansas.

"CONSTRUCTION, MANAGEMENT & CARE of Motorcycles," new enlarged fourth edition just off the press. Most complete work on Motorcycles ever published. Detail motor drawings, Two-Speed, etc. Prepaid for 25c stamps or silver. Keller & Risque, St. Paul, Minn.

DON'T BUY A BICYCLE Motor Attachment until you get our catalog and prices. Shaw Mfg. Co., Dept. 27, Galesburg, Kans.

SHOP NOTES QUARTERLY—Published four times a year—is full of good reading for motorists. It is the biggest magazine in the world devoted to mechanics, science and practical knowledge. Sold by all newsdealers. 25 cents a copy, \$1.00 a year.

WANTED—Motorcycles of any make. Several Wagners wanted. Give description and lowest price for yours. Shaw Mfg. Co., Dept. 28, Galesburg, Kans.

### AERONAUTICS

LEARN AVIATION by taking up a Correspondence Course in The American School of Aviation. A thorough grounding in the principles of Aeronautics without troublesome formulae and calculations. Especially suited for the mechanician. Send for particulars to M. K. Kasmar, Secretary, 1952 North Ave., Chicago.

EVERYTHING FOR MODEL AEROPLANES. The most complete catalogue published, mailed free, 5 cents for postage. Complete parcel of materials to build a "Demoiselle" model 1/12 full size, including plan and instruction, \$1.25. Postage 36c. A. Melcombe, Castle Rd., Bedford, England.

AVIATION DIRECTORY. Quarterly Industrial Number. Information and Addresses; 7 divisions, 41 classifications; Aeroplanes, Motors, Propellers, Parts and Supplies, Manufacturers, etc., 25 cents. L. M. Allison, Lawrence, Kansas.

HYDROGEN-TIGHT GAS-BAGS and portable generators a specialty 33 years. For sale, 2 captive balloon outfits complete, best known system. Latest 7-hp. airship. Unused Wittman glider, cheap. Efficient, gas-light always-working captive balloons are most profitable, successful, attractive novelties before the public today. Carl E. Myers, Balloon Farm, Frankfurt, N. Y.

WANTED 20 H. P. AERO ENGINE, must be in good condition; any make. Give cash price. A. B. Ferguson, 327 Fifth St., Metropolis, Ill.

"BOY AVIATORS' SERIES." Six thrilling Airship Books for young Americans. New, exciting, and absorbing. Send for Vol. 1, and you will quickly want the others. Postpaid 50c. At all bookstores. Our immense catalogue free. Hurst & Co., 395 Broadway, New York.

MODEL AEROPLANES guaranteed to fly, 15 styles \$1.00 to \$6.00. Special 18 inch model flying 100 feet prepaid for \$1.00. Satisfaction guaranteed. Write for free catalogue. Aero-flyer Company, Medford, Massachusetts.

BUILD AN AEROPLANE. Send us \$1.00 and we will mail you blueprints and full directions for building a 3-ft. model Antoinette or 2-ft. Bleriot monoplane, or 3-ft. model Wright biplane. Or blueprints and directions for a 20-ft. Glider. Chicago Aeronautic Supply Co., Room 11, 6030 South Park Ave., Chicago, Ill.

PERFECT LIGHT WOODEN MODEL AEROPLANE propellers 8 inch 50c. Postage 5c; each additional inch 10c. Patterson Merrill, 9621 Charles St., Chicago.

HEADQUARTERS—AIRCRAFT SUPPLIES—Big machines and models. Wood, wheels, rubber bands, propellers. Renton's Chicago Aero Works, 49 Wabash Ave., Chicago. Flights furnished. Aviators taught.

AERO ENGINE with Bosch magneto, for sale. Dr. O'Neill, Ridgewood, N. J.

BLERIOT MONOPLANE, Guaranteed Flyer 25c. Antoinette, two foot, six inch propeller Thrust bearing. Rubbers. Mailed KD to assemble 50c coin. Salesmen wanted. Roberts, 344 Cumberland, Brooklyn, N. Y.

AEROPLANE MOTORS, ALIGHTING GEARS, ribs, cloth, in fact, complete illustrated catalogue of material for building any type of flying machine. We have the largest stock and can make prompter shipments than any aero supply house in America. Also manufacture "Gray Eagle Bi-planes," 40 horse power, \$2,000.00, tuition included. Built especially for exhibition use. Aviators can earn \$500.00 to \$2,000.00 per day. Enclose 10c in stamps for large catalogue. Rubel Co., Louisville, Ky.

PROPELLERS FOR MODELS; light smooth aluminum blades, variable pitch, steel shaft accurately and securely attached; patent allowed. 3½ in. 15c, 5 in. 26c, 6 in. 25c, 8 in. 35c, 10 in. 50c. Post-paid. Low quantity prices. Jersey Skeeter Aeroplanes 25c. Flying Squirrel Aeroplanes 15c. Danielson, 1931 Broadway, N. Y.

AERO SUPPLIES; plain and formed wood; aeroplane and balloon cloth; propellers, motors, books and drawings. Machine built to specifications. First aero supply house in America. Largest stock, lowest prices. Large catalogue 10c. Aeronautic Supply Co., 3932 Olive St., St. Louis.

"VEHICLES OF THE AIR," the newest and only up-to-date contribution to the literature of aeronautics, contains large working plans of all successful modern flying machines. This book of 500 pages, 140 half-tone photographs and 139 drawings is the only book published containing every known fact of this interesting subject. Size, 9x5½ inches. Price \$2.50 net, postage 25 cents extra. Popular Mechanics Book Dept., 225 Washington St., Chicago.

WORKING DRAWINGS OF THE "DEMOISELLE." Santos-Dumont's remarkable Monoplane, offered to the public for the first time. The set comprises seven large blue prints, showing every detail of construction, accompanied by a description of how to build. The machine is unencumbered by patent rights, the famous aviator placing his invention at the disposal of the world. Price \$2.00 postpaid. Popular Mechanics Co., 225 Washington St., Chicago, Ill.

### BOOKS AND PERIODICALS

TWENTIETH Century Book of 10,000 selected Scientific, Chemical, Technological and Practical Recipes and Processes, including hundreds of so-called Trade Secrets for Every Business. The most complete Book of Recipes published. It covers every branch of useful arts and tells thousands of ways of making money, a book everyone should have. (Cloth binding, 800 pages (6x9½), price \$5.00 express prepaid. Satisfaction guaranteed or money refunded. Books for the Skilled Tradesman and Experimenters. Catalogues free. Clarence Hardage, Book-Monger & Publisher, Syracuse, N. Y.

BEFORE BUYING BOOKS ELSEWHERE get our list. Any book in print. State subject wanted. Antlers, 322 Royal St., New Orleans, La.

NATURAL HISTORY FOR SALE, 6 vol., new. All about birds and animals. Need money and will sell at half price. Enos Bates, 58 Shukert Bldg., Omaha, Neb.

ROADMAN'S GUIDE will show you how to get on easy street. Money-making schemes. Write for circular. Standard Pub. Co., Crothersville, Ind.

DO YOU WANT MONEY? If so, our great book, entitled, "500 Successful Money Making Formulas and Trade Secrets," will tell you how to get it. Price 25 cents postpaid. E. W. Lundy & Son, Oradell, N. J.

SATISFACTION OR YOUR MONEY BACK. I sell all standard mechanical, electrical, agricultural and scientific books at or below publisher's prices. Renting and exchange department. Lists free. Cecil Lutes, Noxen, Pa.

READ MY NEW BOOK on cement, stone, iron and wood; fiber concrete. The poor man's gold mine. Price fifty cents. Peter De Linde, Zion City, Ill.

"EXTENDED VISION" or "Looking Beyond This World." Delightful book on Heaven; needed in every home death has entered. Price \$2.00. Dr. Tabor Thompson, 526 Spruce St., Philadelphia.

"KEEN KNOWLEDGE," Annual subscription 25c. Palmland, Floral Park, N. Y.

MAGAZINES FREE—Youth's Companion free 3 weeks; every one sending 2c for Bargain Catalog. Newspapers and Magazines. Foster News Co., Minneapolis, Minn.

A \$2 MONEY ORDER OBTAINS a Webster's Illustrated Dictionary, 1911 Edition. Send for circular. F. O. Martin, 12 Minetta St., New York City.

LEARN VENTRILOQUISM—64 page book containing complete instructions 10c. A. Crosby, Merrimac, Mass.

"YOUR LATENT FORCES" How to use them, 120 pages, 25c. "Personal Magnetism," 146 pages of valuable advice, insuring success in life, 30c. Catalogues free. August Martens, Popular Bookseller, Burlington, Iowa.

EASY LANDSCAPE DRAWING, Book 20c. Address: Parsons, Publisher, Keokuk, Iowa.

PERSONAL MAGNETISM Wins. 148 pages, 30c. "Hypnotic Wonders" Free. Popular Institute, 29 Randolph, Chicago.

SWEDENBORG'S "Heaven and Hell." Fifteen cents. 400 pages. Pastor Landenberger, Windsor Place, St. Louis, Mo.

**WONDERFUL BOOK ON HYPNOTISM.** Personal Magnetism and other Occult sciences sent free to anyone. Send your address today. M. D. Betts, Sta. 65, Jackson, Mich.

"**METAL SPINNING**" is the name of the only book published on this interesting art. A concise working manual both for those who desire to spin metal as an art recreation and to follow this work as a trade. 80 pages, 33 illustrations. Price, 25 cents postpaid. Popular Mechanics Book Dept., 225 Washington St., Chicago.

**GAS FOR POWER** is taking the place of steam for reasons of economy. Learn all about this great change by reading our new non-technical book on this subject, written by a first class authority for the practical man. 192 pages, profusely illustrated, cloth binding. Price \$1.00 postpaid. Popular Mechanics Book Dept., 225 Washington St., Chicago.

**ENGINEERS' questions and answers for license**, by Hobson, for twenty-five cents, postpaid. Send stamps. Reilly's Book Store, Philadelphia, Pa.

**BOYS' BOOK ON GAS ENGINES**—By F. L. Faurete. Every boy should know about the gas engine, because of the very important place it holds in the power world. Here is a book written so boys can readily understand it. Price 25 cents postpaid. Popular Mechanics Book Dept., 225 Washington St., Chicago.

### EDUCATIONAL AND INSTRUCTION

**MOTION PICTURE PLAYS WANTED.** You can write them. We teach you how by mail. Experience unnecessary. Writers earn \$50 a week. Demand increasing. For particulars address, Associated Motion Picture Schools, 112 Clark Street, Chicago, Ill.

**PHOTOGRAPHY EASILY TAUGHT** by my "One Man Method" system. Write for particulars to L. Magill, 220 West 128 St., New York City.

**TOUCH TYPEWRITING EASILY ACQUIRED.** So simple a child can learn. A complete home instructor. Write to Mayer & Miller Co., Publishers, 351 Dearborn St., Chicago, Ill.

**FORMULAS** 25c. Book 1,000 Formulas \$1.25. Forbes Agency, (Cambridge B) Boston, Mass.

**LEARN DRAFTING.** Constant demand for practical men. I give individual instructions by mail. Positions secured for students. Instruments furnished free. G. W. Clair, Box 718, Pittsburg, Pa.

**SEND FIFTY CENTS** for 120 lessons in Business Writing—By America's Foremost Penman and Teacher. Francis B. Courtney, Box 129, Cedar Rapids, Iowa.

**I. C. S. AND A. S. C. SETS.** Cyclopedias, scholarships at bargain prices. New and second-hand volumes on wireless, aeronautics, shop practice, etc. Get my prices before buying. George F. Williams, Box 408, New Orleans, La.

**WITHOUT KNOWING SHORTHAND** you can write 100 words a minute and increase your income—treble your dispatch of business—save your time. Let me explain to you fully how with my new method. Abbreviated Longhand, any longhand writer can easily become the equal of the average professional stenographer—in a few short evenings—at merely nominal cost. Sample Lesson 20c, and full particulars free. Write to-day. A. B. Weaver, Court Reporter, Dept. C, Buffalo, N. Y.

**LEARN TO CARVE** beautiful flowers, etc., on cardboard. A money-making home employment. Information free. A. W. Dakin, Syracuse, N. Y.

**I TEACH UNTIL PROFICIENT**—Logarithms, \$3; Trigonometry, \$5; Latitude, 50c; Longitude, \$2.50; Azimuth, \$2.50; Lunar-distances, \$5. Cpt. C. Nielsen, Willits, Cal., E. Box 448.

\$200 to \$600 MONTHLY easily made fitting eyeglasses. Short, easy mail course. Diploma. Special reduced tuition fee. Big demand for opticians. Best and easiest money-making business. Quick sales. Tremendous profits. We assist you to start. Write today for free "Booklet 4." Tells how. National Optical College, St. Louis, Mo.

**EDUCATION?** Learn typewriting. See what I say under "Typewriters." Atchison.

**BEST SHORTHAND BOOK** for home study. Thousands of successful stenographers learned from it; so can you! Pitman system complete, cloth bound, handy size, finest engraving; specially arranged for self-instruction. Price \$1. Every book contains coupon entitling the purchaser to receive one month's practical instructions by mail. Lessons given by the author, Eldon Moran, our best known American Shorthand Instructor. Students are introduced and correspond with each other. The time to begin is Now. Young pupils succeed well. Book well worth \$1; besides, mail lessons worth \$2 will be received without extra cost. Book and lessons sent immediately on receipt of order. Address Popular Mechanics Book Dept., 225 Washington St., Chicago.

**SHOP NOTES QUARTERLY**, published four times a year by the Popular Mechanics Company, may be called a "Post-Graduate Course" for craftsmen and mechanics, and for all men who have to do with the industrial and practical side of modern progress. Ask your newsdealer to let you look over a copy of this progressive periodical. \$1.00 a year—25 cents a copy.

**TEN ORE SPECIMENS**—Gold, silver, copper, iron, lead, zinc, tin, nickel, graphite, sulphur. Also mineral booklet, 25c. McLaughlin, Sharpville, Pa.

### CAMERAS AND PHOTO SUPPLIES

**KODAK FILMS DEVELOPED**, 10c per roll, any size. Prompt attention given mail orders. Prints 2¼ x 3¼ to 3¼ x 4¼, 3c; 4 x 5 to 3¼ x 5½, 4c. J. M. Manning, 1062 Third Ave., New York City.

**SEVEN PERFECT 5x7 ENLARGEMENTS** from one or more good Brownie or other small films, prepaid, for \$1.00. C. B. Strable, 315 S. E. 14th Ave. Minneapolis, Minn.

**CONVERTIBLE 5x7 FOSO Anastigmat F. 6**, mounted, fine Shutter, price \$10.00. R. M. Wiltbank, Keeseville, N. Y.

**FOR SALE**—Tested formulas for flashlight sheets, powders or ribbons. Also any other recipe (especially medical ones) you want 25c each. Augustine Campbell, Chatham, Ontario.

**FOR SALE**—A new Anso Camera No. 7, size 4x5, including case and dry-plate attachment. Lester Rose, Greenup, Ill.

**CAMERAS, LENSES, EVERYTHING PHOTOGRAPHIC.** Get bargain list and save money. Willoughby, 814 Broadway, New York.

**BETTER GET OUR CATALOG**—Cameras, supplies, developing, enlarging. Valuable exposure, meter included, ten cents. Calendar free. Rex Bromide Co., Dept. A, Lincoln Park Station, Chicago.

**TWO 6¼x8½ CAMERAS** for sale or trade for smaller camera. Butts, Oxford, New York.

### PICTURES AND POSTCARDS

**NEW MEXICO POST CARDS.** Indian, Mexican, Cow Boy and Albuquerque views, all made from original photos and colored true to nature. 12 for 25c., 50 for \$1.00, postage paid. The Bennett Indian Trading Co., Albuquerque, New Mex. Est. 1882.

**THE LATEST PICTURE HITS.** "My Champagne Girl" and "La Belle Danseuse." 15 cents each, or the Two sent complete with 100 other Catchy art ideas for only 25c. Union Art Co., Dept. 4, 131 Grant Ave., Jersey City, N. J.

**PHOTO POST CARDS**, beautiful design, copied from any photograph, any number, 5c each, 50c a doz. Visiting cards with your own photo, actual photographs, printed with name and address complete, latest style. 50 cards for 50c. Myland, 2121 N. Front, Philadelphia, Pa.

**DETROIT, THE BEAUTIFUL**—100 different colored views One Dollar. 12 Sample Cards 15c. Michigan Novelty Co., Detroit.

**15 HIGH GRADE Valentine**, best wishes and birthday cards for only 10c. German American Post Card Co., Dept. 50, Burlington, Iowa.

**AVIATION POSTCARDS**—Bleriot, Antoinette, Curtiss, Wright flyers on the wing; San Francisco meet, 10c, 3 for 25c. Beautiful colored San Francisco views, 35 for 50c. Bender, 2231 O'Farrell St., San Francisco, California.

**SEND 25c FOR 35 POSTCARDS**—Easter, Birthday, Comic, Greetings, or assorted, your choice. Star Mfg. Co., Norton, Kan.

**FUN!** Not a sentence read by others during two years (unsealed) Post Card Corresponding! (Offered Reward!) Original Method. Use any ink. Complete Directions (makes each couple's messages different), \$1.00. To introduce, 50c gets everything! Verne Michener, 1120B, Main St., Kansas City, Mo.

**CORRESPONDENCE CLUB:** Exchange post-cards with people everywhere, names and 10 beautiful post-cards 10 cents. C. C. Club, Dept. A, Kansas City, Mo.

**DECORATE YOUR "DEN"** with "Art Gems." 3 bewitching poses 25c, 6 for 50c. One 6¼x8½ photograph free with every order for six. All real photographs. Money back if not pleased. Art Photo Co., 1403 P. M., Grand Rapids, Mich.

**"STAGE BEAUTY POSES."** Send stamp for profusely illustrated sheets and our free "Salome Nymphs" offer. Gordon Art Co., Dept. P, New York City.

**10 BEAUTIFUL POST-CARDS**—Birthday, Easter, Comic or assorted 10 cents. Knox Specialty Co., Galesburg, Ill.

**18 COLORED POST-CARDS** 10 cents. R. H. Kimball, Goffs Falls, N. H.

**50 POST CARDS** showing trip around the world, 42c postpaid. Econo Co., Box 321, Charlotte, N. C.

**SEND 15c STAMPS** for twenty-two beautiful views of Beautiful Montana. Ye Novelty Shop, Hamilton, Montana.

**EXCHANGE POSTALS.** 350 guaranteed names from 50 countries only one dime. Eugene Lee, Jordan, N. Y.

**MAPLE VALLEY CARD EXCHANGE:** a business exchange. Correspond, buying, selling, exchanging, receiving, etc; both for profit and pleasure. Membership 25c a year, send stamps, age and birth. Box 1183, Pittsfield, Mass.

**25 BEAUTIFUL POSTCARDS**, all holiday or assorted, 25c. Worth 60c. Baker & Co., 2126 Harrison St., Chicago.

**FIFTY HANDSOME POST CARDS** with years subscription to popular and well-known magazine, 40c. Welland Sales Company, 423—M Powers Bldg., Rochester, New York.

**YOUR NAME ON POSTAL EXCHANGE** list free for the names of five dealers handling postals. Dealers wanted in all parts of the world. The Emco Co., Hamilton, Ohio.

**POST CARDS—BIRTHDAY, ST. PATRICKS,** Comics, April Fool, Easter. Suggestions, all 1c each. Beautiful premium with \$1 order. C. F. Packard, Lewiston, Maine.

**YOU'LL GET CARDS** from everywhere. Membership 10c. Idaho Card Exchange, Dept. K, Box 906, Boise, Idaho.

**5 HIGH ART PICTURES**, Smallest Bible on Earth, all 10c (worth 35c) to introduce catalogue. Simons Art Shop, Sidney, N. Y.

**VISIT CALIFORNIA BY POST CARD.** We mail 25 of the most beautiful views of California on receipts of 25c. Each order includes a pretty souvenir. Don't miss this! So. Calif. Post Card Co., Box 174 San Diego, Cal.

**IF YOU REALLY WANT** to exchange post cards, try our splendid club. Lists circulate in many countries. Membership 10c. Halcyon Club, Box 133, Erie, Pa.

### TRADE SCHOOLS

**WANTED—Men** by large Contracting Co. \$20,000.00 contract work going. Can learn automobiles, electricity, plumbing, brick-laying trade in few months. No apprentices or helpers work and no expense. Catalogue free. United Trade School Contracting Co., Los Angeles.

**AUTOMOBILE SCHOOL**—Learn the automobile business, repairing and driving, in which you can earn good wages and have healthful and pleasant work. We give a thorough and practical course in road work and repairing. For full particulars address Academy of Automobile Engineering, 1420 Michigan Ave., Dept. "A," Chicago, Ill.

**PLUMBING, ELECTRICITY, BRICKLAYING** or Mechanical Drafting, taught by expert workmen. Short time and small cost. Positions always open. Catalogue free. Write today. Coyne National Trade Schools, 80 E. Illinois St., Chicago.

**AUTOMOBILE SCHOOL.** You learn with your hands under the supervision of the best instructors obtainable at the Chicago School of Motoring. Write for particulars. F. E. Edwards, Inst., Dept. "B," 1619 Michigan Ave., Chicago, Ill.

### BUSINESS OPPORTUNITIES

**WELDING AND BRAZING REPAIR BUSINESS** for broken parts of Automobiles and Machinery in general. An exceptional opportunity is afforded to an intelligent man with slight knowledge of mechanics to start in the above business, ought to have as capital \$300.00 to make a success of same. Anyone having the above qualifications will learn something to his advantage by writing for fuller particulars to Walter Macleod & Co., Cincinnati, Ohio.

**BE YOUR OWN BOSS**—Make big money at home in spare time. French Dyeing and Cleaning; start small; increase from profits; particulars free. Lorraine System, 306 Journal Bldg., Boston, Mass.

**NEW! MAIL ORDER Knock Down Furniture Business** started on few dollars. Make \$50.00 a week. Complete instructions, including full set of improved detail drawings—\$1.00. Latest designs. Easy to make by our method 400% profit. K-D Furniture Co., Box 347, Sacramento, Cal.

**KEY TO SUCCESS** in the Mail Order Business. Just the book to be welcomed by every live, wide awake person in the land. Brimming over with new ideas, new thoughts, new ways of making money. Only 10c in silver. Postpaid. K. Keller, 26 Leonard St., Jersey City, N. J.

**I WILL START YOU** earning \$100 monthly, selling health hair insoles by mail. Guaranteed to keep the feet warm. Sample pair with instructions, etc., 10c; state size wanted. Crest Insole Co., Dept. M. Atlantic City, N. J.

**BUILD A BUSINESS** of your own and be independent for life. Best paying business on earth. Few dollars starts you. Write for particulars. Frank Mielke, Oldtown, Me.

**PERMANENT SUBSTANTIAL INCOME.** Build one up for yourself. Exclusive territory given agents with some capital sell "Sanapan" Odorless, Non-poisonous, Deodorizing Disinfectant. Half cost others. Experience preferred. Eugene Fisher, Nashville, Tenn.

**MAKE YOUR SPARE MOMENTS PROFITABLE.** Learn to Repair Sewing Machines at home. Easy to learn with my improved instruction course. Leroy Brown, 1216 Madison St., Baltimore, Md.

**CONDUCT A "CANDY KITCHEN."** Clear \$20 daily. Small capital required. Send for particulars. Kennon and Co., 148 West Ontario St., Dept. A, Chicago.

**M. O. SCHEMES**—Tucker's Magazine contains more Original M. O. Schemes than any other magazine published. All written by experts. Two copies by return mail for 10c. Tucker's Magazine of Schemes, Box 98, Roanoke, Alabama.

**MINIATURE RAILROAD.** Armitage-Herschell make, good condition. Engine and ten coaches. A money maker. Price \$365.00. W. Robb, Canal Dover, Ohio.

**MAKE MONEY.** LEARN HOW to Metalize Flowers, Leaves, etc.; Renew Dry Batteries; Transfer Photos to Watch Dials. Formulas 10c, 3 for 25c. Mail Order Bureau, Box 283, Scranton, Pa.

**RAISE GINSENG**—\$1 per square ft. of ground. \$25,000 on ½ A. Grows anywhere; ½ city lot a bonanza. 10c brings booklet. Sheboygan Ginseng Gardens, Sheboygan, Wis.

**START A HIGH GRADE Dry Battery Factory** with small capital. 30 Amperes 1½ volts., guaranteed to hold up with my formula. Ted. Glass, Chief Dry Battery Co., Denver, Colo.

**I HAVE AN ARTICLE** to manufacture at home that beats them all. 4c brings particulars. P. Benson, Stewartville, Minn.

**\$25 WEEKLY** anyone can make painting solarprints. Instructions for preparing and painting enlargements from any Kodak Photo in oil or watercolor 25c. Eastern Supply, Everett, Mass.

**MEN, WOMEN,** Russell's Original Dairy Cream Crisp. Home candy-making, \$5, \$10, a day. Testimonials. Special Free Offer. Charles Russell, 716 Clyborn St., Milwaukee, Wis., 30 years candy expert.

**I MAKE \$50.00 A WEEK.** So can you. Work Light and Pleasant. Particulars for stamp. Dr. Mack, St. Stephens Church, Va.

**THE BEST CUT** and engraving course for 25c, regular price \$5.00. Herman Becker, 32 7th St., N. Y.

**MONEY.** Make a fortune in a short time. More than 300 plans and secrets. Formulas 25 cents. C. K. Shannon, Cassity, W. Va.

**FOR SALE:** Controlling interest, well known Automobile Co. Inc. Laws, Mass. D. G. Wyman, Orange, Mass.

**BIG MONEY AT HOME.** Send stamp for Particulars. Clark, 270 Laurel Ave., Lakewood, N. J.

**5c A WORD** gets your ad in 100 magazines; list and sample magazine free. Crescent Syndicate, St. Louis.

**I MADE \$50,000** in five years with a small mail order business; began with \$5. Send for free booklet. Tells how. Heacock, 5074, Lockport, N. Y.

**AN exceptional opportunity.** See "Books." Lundy & Son.

**PROVIDENCE MANUFACTURER WANTS** twenty-five wide awake, energetic sales agents to sell 3,500 guaranteed articles from samples and catalogs. We want to hear from applicants having good personal selling ability who can produce profitable results from the start. Here is an exceptional opportunity for those with the right kind of push. Address: Sales Manager, A. W. Holmes & Co., Providence, R. I.

**MAIL DEALERS AND ALL** interested in the Mail Order Business should send for our booklet of "Leader Advertisements." This book will be the foundation of several fortunes during 1911. Will send copy of "Leader Advertisement" and other valuable information which should save you hundreds of dollars, upon receipt of ten cents. Mail Dealers Supply House, 341 Dearborn St., Chicago.

**BIG PROFITS:** Open a dyeing and cleaning establishment, splendid field, very little capital needed. We tell you how. Write for booklet. Ben-Vonde System, Dept. C. Staunton, Va.

**INCREASE YOUR INCOME.** "The Money Makers Manual" contains a valuable collection of formulas, plans, schemes; how to make good money during your sparetime. Send 15-2c stamps now and turn your sparetime into cash. Albany Supply House, 4322 N. Albany Ave., Chicago.

**BE A HANDCUFF KING;** make big money on the stage; all Vaudeville circuits pay from \$50.00 per week up. I teach everything in this line. For particulars address, Box 902, Springfield, Mass.

**HAVE YOU ANYTHING TO ADVERTISE?** Our Rate Book tells you all about Advertising Mediums, Rates, Circulation, Closing Dates, etc.; sent for 10c; worth dollars. Folder free. Correspondence Invited. Dearborn Advertising Agency, 455 Franklin Bldg., Chicago.

**START IN THE MAIL ORDER** book business! We can show you a proposition enabling you to make 88c profit on a dollar, yet give your customers \$3.00 value. Send 10c for dollar sample and full particulars. Morgan Co., 3455 N. Hamilton, Chicago.

**LIVE MEN IN EACH COMMUNITY** to own and operate combined local and mail-order business; new, permanent demands, no canvassing. Profits are \$50 each week. Address: L. J. Mortenson, 1417 Chatham St., Racine, Wis.

**DANDY HOME BUSINESS.** Sell your ideas, formulas and knowledge by mail. Some make \$1000 monthly. Instructive booklet for stamp. Information System, 237, Marietta, Ohio.

**BARGAIN PAYING MAIL-ORDER BUSINESS.** Successful plan and samples 30c. Popular Science Institute, Fairbank's Building, Chicago.

**EARN \$6 DAILY MAKING MIRRORS.** Dime brings sample and first lesson. P. Harkness, East Lynn, Ill.

**MAKE MIRRORS AT HOME,** coin money during idle moments. Complete instruction 50c. H. Clark, 2019 N. Carlisle St., Philadelphia.

**\$ MAKE \$ MORE \$ MONEY.** \$ Send stamp at once for a valuable collection of Dollar Getting Secrets; start a profitable business of your own and Increase Present Income. Be. Money Back Store, Baltimore.

**DON'T MISS ADVERTISEMENT** "Valuable Trade Secrets" in Miscellaneous Column.

**START A MAIL ORDER BUSINESS** of your own. Be your own boss. I made \$25,000 in two years with small capital to start. My booklet "Money Making Opportunities in the Mail Order Business" sent free. Address McKean, Dept. 356, No. 2232 Eighth Ave., New York.

**PATENTS PROMPTLY OBTAINED.** My free booklet will help you to fortune. Read pages 11 and 12 before applying for patent. Write today. Dean Swift, Washington, D. C.

**LEARN THE TRUTH** about Mail Order Business before buying "outfits." Important information and particulars for starting free. Mail Order Library, P. M. Tompkinsville, New York City.

**SUCCESS** depends upon the profitable investment of surplus funds. Our free booklet "D" explains how you can learn to do it. Financial Guardian, 81 New St., New York City.

**INVENTORS: ADDRESSES OF MANUFACTURERS** in any line—30, 10c; 100, 25c. Obed Billman, Cleveland, Ohio.

**MAKE MIRRORS AT HOME.** Big profits with little outlay. One 18x36-in. mirror costs \$2 to \$5. You can silver a glass this size for 20c. Send \$1 in stamps or money order and we will send you explicit directions how to do it; also how to emboss, grind, foil, gold leaf, frost, chip and make imitation stained glass. How to transfer photos on glass, bore holes in glass and cut skylights. George L. Patterson & Co., Dept. 3, Brookville, Ky.

**WE START YOU** in a permanent business with us and furnish everything. We have now easy selling plans and seasonable leaders in the Mail Order line to keep our factories busy. No canvassing. Small capital. You pay us out of the business. Large profits. Spare time only required. Personal assistance. Write today for plans, positive proof and sworn statements. J. M. Pease Mfg. Co., 1017 Pease Bldg., Buffalo, N. Y.

**START LEGITIMATE MAIL-ORDER** Mercantile business; possibilities unlimited, conducted by anyone. We print catalogs, supply merchandise at wholesale. Booklet and sample catalog free. Central Supply Co., Kansas City, Mo.

**PLEASANT HOME WORK.** \$40.00 a month earned in spare time. No peddling. Write Now! Blye & Co., Dept. 31, Terre Haute, Ind.

**I WILL START YOU** earning \$4 daily at home in spare time, silvering mirrors; no capital; send for free instructive booklet, giving plans of operation. G. F. Redmond, Dept. 306, Boston, Mass.

**LIVE MEN:** If you are making less than \$25 weekly, send your address quick. If you have a horse and buggy or bicycle you can use, all the better. We teach you. You can start right where you live. You owe it to yourself to investigate this opportunity and let us prove that we can better your condition. The Thomas Company, 962 Third St., Dayton, Ohio.

**FORM A CORPORATION**—Congress Law for D. C. and all States; cheap. Raise money easily; advice free. U. S. Legal Corporation, Washington, D. C. Representing \$1,225,000,000.

**START A MIRROR FACTORY.** We teach and trust you; 10c brings sample lesson; \$25 daily easily. Hullinger's Mirror School, 2, Francesville, Ind.

**YOU CAN START** Mail Order Business in your own home. Big profits. Everything furnished. Free booklet tells how. W. P. Foote, Box 254, Muskegon, Mich.

**HOW TO JUDGE** a patent. An "eye opener" for inventors. Sent free. Obed Billman, Cleveland, Ohio.

**POSITIVELY BEST RIBBONS**, three, \$1.10. See what I say under "Typewriters." Atchison.

#### AGENTS WANTED

**EARN THIS SUIT** in One Hour! Your profit for an hour or two as the representative of our great tailoring house pays for a special made-to-measure suit for you—the handsomest, the most stylish and the most durable ever made. Just show two or three of your friends the samples of our fine wool suitings, take two or three orders and you have earned the suit. You can't fail to get orders. Our 60 beautiful samples create a sensation wherever shown. No one ever saw such materials at the price before. You take no risk. Everything is shipped on approval, subject to 24 hours' examination. Customers try goods on and must be satisfied with style, fit and quality before paying. We pay express on everything! You can undersell everybody. Get clothes for your friends at less cost than they pay anywhere else and make wholesaler's, jobber's and retail dealer's profits. That means the swellest, cleanest and nicest business in America! A Big Business that more than doubles your earnings. We want you to represent us now. Don't wait until somebody else takes this great business. No experience necessary. We furnish you our portfolio with 60 samples of the latest weaves, fabrics and colors, absolutely free. Do you want this swell made-to-order suit and this remarkably easy money-making business that will make you rich? A postal or letter mailed to us at once gives you swell clothes and a big business. Write us now. A postal card will do. Or tell your friends about it. Paragon Tailoring Company, Dept. 11, Chicago, Ill.

**AGENTS!** Wild with excitement! Do you blame them? Everybody eager to buy our beautiful artistic air brush design show cards. Agents making \$75 per week. Cards printed in colors, size 11x14, 350 varieties. No talking—simply show the show cards to storekeepers—the cards speak for themselves. Big profits, something new. Tide just setting in. The show cards are great, you'll say so, you can't help it. Wake right up, no time to argue. Do it now, send this very minute a letter or postal for free catalog and sample. Popular Show Card Co., Desk A, 1235 Michigan Ave., Chicago.

**AGENTS—POSITIVELY GREATEST MONEY** making proposition out. Manufacture rapid-selling food products at home on \$5. capital, 100 lbs. material costs \$2.07, wholesales to stores for \$18.75; 800% gross profit. Simplest thing known, all to gain, no chance to lose. Process and full particulars ready to start immediately, postpaid anywhere except California, 25c. coin or 2c stamps. Get busy. Brown's Delicacy Supply, 316 So. Figueroa St., Los Angeles, Cal.

**\$\$\$ SPARE TIME \$\$\$** Earn \$10.00 to \$15.00 a week during spare time. You can do it. Start a Mail Order Business right from your own home, city, town or rural district. We, as manufacturers, have new easy selling plans for you as our Mail Order Dealer to co-operate with us and keep our factories busy. We carry the stock, seasonable leaders, no canvassing. Small Capital. You pay us out of the business. Large profits. Experience not necessary. Do not work and slave for others, helping them to build fortunes but get wise, make it yourself. We show you how. Write me today for Free Plans, positive proof and sworn statement. J. M. Pease, Pres., J. M. Pease Mfg. Company, Dept. A, Pease Bldg., Buffalo, N. Y.

**WANT A SWELL SUIT?** Show our samples to three of your friends, take two orders easy and make profit enough to get a swell stunning tailored suit free. No trouble, simply show our new up-to-date samples. Everybody surprised, prices so low, styles so beautiful, orders come easy. We take all the risk and guarantee perfect fit or no sale. We pay the express, \$5 a day. Our new agents are making and wearing the swellest clothes besides; old agents after one season make twice as much. Banner agents have a snap. We want a few more hustling agents, willing to dress swell and make \$5.00 a day and up. No money or experience needed. Write quick before we fill your territory and we will send you free a complete outfit to start at once—beautiful samples, latest styles in colors, everything you need to take orders, all fully explained. We will make you even one beautiful suit at a special inside wholesale price as a sample. It's a wonderful opportunity, so write at once or tell some friend who would be happy to get this grand easy money-making chance. Banner Tailoring Co., Dept. 658, Chicago, Ill.

**FELLOWMEN**—Positively only perfect Incandescent Lamps and Burners. Burns Kerosene and air instead of money. Burns with or without mantle. Sold under a strict guarantee. Agents wanted everywhere. Exclusive territory. Positively as represented or money refunded. We want reputation. Write at once. American Light Co., Birmingham, Ala.

**AGENTS WANTED**—Live men to sell the Isograph. The drawing instrument that makes experts of novices. Sells on demonstration. See advertisement on page 114. Send for particulars immediately. Isograph Co., 145 E. 23rd St., New York.

**AGENTS—NEW INVENTION.** Revolving rubber heels—Any one can put on instantly. Heels never run over—never slip—half the price—three times the wear of any other. Sell for 1/2c pair; 200% profit. Sell like wild-fire—every one wants them. Lambert Rubber Co., 1270 Washington Blvd., Chicago.

**AGENTS WANTED** to sell rich looking imported 36x68 rugs at \$1 each. R. H. Carter, Milan, Tenn., sold 115 in 4 days. His profit, \$31. You can do as well. Write for sample offer and unique selling plan. Exclusive territory. L. Condon, Rug Importer, Stonington, Maine.

**WANTED—GENERAL SALES AGENTS** wanted in every county to sell personally, appoint local salesmen, to handle our patented bath necessities. Over 260,000 sold in 1910. Quick sales—at extraordinary profits the year round. Our extensive advertising does one-half the work. If your territory is open it means a permanent income to you providing you can qualify. Give full particulars and references first letter. The Progress Company, 995—210 Monroe St., Chicago.

**AGENTS** for fast selling self-cleaning curry comb and currying scraper. Big money; exclusive territory; \$5.00 per day and up to workers. Berentson & Homan, 502 North Union St., Chicago.

**HIGH GRADE SALESMAN** or City Representatives for the most remarkable Instantaneous Calculator ever devised—New Idea—Bound to Revolutionize all present methods. Calculations so marvelous business Firms buy instantly and set aside expensive machines. Sells for \$5.00. Multiplication, Division, Fractions, Decimals, Discounts, Percentages, Pay-Rolls, Interest, Inventory, Etc., handled in one-fourth usual time. Fractions easy as whole numbers. Handsome Profits for Capable Salesman. Write for particulars. Instantaneous Calculator Co., Detroit.

**BE YOUR OWN BOSS.** Start Selling "Modern-Make-Milwaukee" Specialties. 100% profit. We manufacture and advertise, you sell them. Our agents become independent and own their business. Represent us exclusively. Territory going fast. Write for exclusive proposition. "Cat. P." Modern Specialties Mfg. Co., Milwaukee, Wis.

**WANTED**—One live man in each town to take orders for men's made-to-measure clothes. No money required. Latest styles and lowest prices. You can build up a permanent business and make a splendid salary each day. We pay express, ship subject to examination and guarantee fit. Send your name quick for agency and free samples. Regal Tailoring Co., Dept. 578, Chicago.

**AGENTS:** Will mail our \$1. UKO Safety Razor with 12 superior Blades. Elegant case. Words often mislead. Try it yourself. Send 60c in stamps. Will refund if desired. Splendid proposition. Write at once. The Utility Co., 631 W. 44th St. New York City.

**KEENEDGE** razor hone; latest discovery; razorhoning impossible; all shavers will buy; 100% profit. Sample 25c. Particulars free. Ideal Mfg. Co., Toledo, Ohio.

**AGENTS**—Biggest money-maker known. The new Canchester Incandescent Kerosene Lamp revolutionizes old lighting methods. Burns air, not money. Six times brighter than electricity, gas or acetylene at 1-10th cost. Burns with or without mantle. Burner fits any lamp. Saves 75% oil. No trimming wicks. Showing means selling. Territory going fast. Write today. Handsome outfit furnished. Canchester Light Co., Dept. P. M. 3, 26 State St., Chicago.

**YOU CAN MAKE \$\$\$\$** as our general or local agent. Household necessity; saves 80 per cent; permanent business; exclusive territory; salary or commission; free sample; credit. J. Pitkin, Newark, N. Y.

**AGENTS:** You can positively make \$30 to \$75 a week. New Patented article. Low priced. No competition. Sells in every home. No experience needed. Write for terms. Suction Cleaner Co., 162 Milton St., Dayton, Ohio.

**LEARY AND MUNRO SAY:** Don't kick about your position. Be our representative. Our agents are making big money, you can do the same. Write 1219 Fillmore St., San Francisco, California.

**AGENT WANTED**—\$5 to \$25 day selling our automobile specialty; send for free particulars today. Philip O'Donnell Co., Birch St., Stoughton, Mass.

**A BUSINESS FOR YOU** in your own community. Secure Aladdin Lamp Agency. Produces highest grade modern white light from kerosene (coal oil). No odor, danger, smoke, noise. Simple, clean, durable, reliable, portable. Brighter than electricity. Only successful mantle oil lamp. Guaranteed. Inexperienced men make big money. Ask nearest office for particulars. Mantle Lamp Company of America, Dept. 367, Chicago; Portland, Ore.; Waterbury, Conn.; Montreal, Winnipeg, Can.

**"TOUR UNITED STATES"**—"Trip around world." 50 water color post cards in attractive boxes. Both sets 25c. Big profits. Secor Company, 502 West 122 Street, New York.

**(CELLULOSIA)**—Door plates, new, lettering pure gold. Send for sample case. Nothing invested, 100 per cent profit, sell to every house. Public demand them. LaFontaine, Inventor and manufacturer, Sherburne, N. Y.

**AGENTS**—Either sex; Magic Post Cards; mysterious, fascinating; gets the cash; speak quick; free sample and particulars. State managers wanted. K. C. Post Card Co., Holden, Mo.

**BOY AND GIRL AGENTS**—Sell 24 packages post cards at 10c each and receive a complete camera free. Write today. C. W. Feaster Co., Dept. 13, Windsor, Mo.

**AGENTS**—Improved specialty for automobile owners; quick seller; big profits; illustrated booklets free; write today. The Chaddock Specialty Co., Box 388, Polo, Ill.

**AGENTS**: Send for free booklet, inside information on the agency business. Filled with money making plans. Pointers and experience of thousands of successful agents. Address: J. M. Finch, 1162 3rd St., Dayton, Ohio.

**AGENTS**—Over 500% profit. Gold sign letters; sell everywhere; sample free. Johnston Co., Quincy, Ill.

**THEIR BIG MONEY** in the mail order business. Publish a mail order magazine of your own at a very little cost. For particulars address. Publisher, 247 West 139 St., N. Y. C.

**AGENTS—BOTH SEXES**—We control a specialty never placed on market before. Not for sale in stores. Particulars free, sample 15c. LeRoy Specialty Co., 76 Park Place, Room 52, New York.

**AGENTS**—Make \$8.00 daily selling our specialties. New Jersey Home Supply Co., Boonton, N. J.

**AGENTS**—Sell our Accident policy. Pay \$1000. death and \$5. weekly benefit for \$1. yearly. Easy seller. \$103,000 deposited with Pennsylvania Insurance Commissioner, Commercial Registry Co., Newark, N. J.

**SELL EAGLE BRAND MENDING TISSUES**. Greatest Labor Saving Invention. 500 per cent profit. Three samples for dime. Eagle Rubber Company, 213 East Tenth St., New York.

**REPRESENTATIVES** Mail Order Houses wanted handle Hygienic Hosiery. Made Rights and Lefts to fit the feet. Relieve bunions and corns. Write for particulars. Direct Hosiery Co., 11 South St., Boston, Mass.

**AGENTS**—Portable Fountain Bath Apparatus. Gives plain and electrical baths. Patented 1910. Money maker. Partner wanted to manage plant and mail order business. G. W. Walters, Patentee—Proprietor Electric Bath Co., Findlay, O.

**AGENTS**—Don't overlook this. Ten new, fast selling household articles, just added to our present large line, they are winners, big money makers, write for full particulars. Dexter Supply Co., 334 Dearborn St., Chicago.

**BOYS: SELL 30 PACKAGES** of Tiger Blue, 10c. for a Hamilton Rifle. Send 3c for package and full instructions. American Pharmacal Co., Box 52 Z, Evansville, Ind.

**SHAVEZY RAZOR GUARD** Makes the Old-Style Razor Safe. Every man a purchaser. Easy sales. Big profits. Sample prepaid 50c. Particulars free. Write today. Shavezy Co., Dept. P, Baynes St., Buffalo, N. Y.

**SMALLEST ALARM CLOCK** and Bible in world, 10c each, prepaid. W. H. Garner, A. 119 South Lafayette St., Evansville, Ind.

**AGENTS** earn \$25 to \$50 weekly selling our latest styles beautiful braided wists, and dresses, Mexican drawn work, petticoats, various embroideries. Catalogue free. National Imp. Co., Desk 27, 699 Bway, N. Y.

**WE HAVE THE GOODS** that people want. Liberal commissions to agents. Write us today. E. L. Shepard, 308 Racine St., Delavan, Wis.

**AGENTS**—Stamp names and addresses on key checks, name plates, watchfobs, hotel and baggage checks. We supply blank stock and stamping outfits. Sample free. Hart Manufacturing Co., 80 Guernsey St., Brooklyn, N. Y.

**MAKE \$60 TO \$100** weekly selling our small bottling outfit for saloons. New article, easy seller, large demand. Nothing like it. Write now for free information. Simplex Mfg. Co., Dept., Kewanee, Ill.

**"EXTENDED VISION"** Delightful \$2.00 book on Heaven. Sells in every home visited by death. Agents sample and instructions, \$1.25. Big profit, quick sales. G. Tabor Thompson, D. D., 526 Spruce St., Philadelphia.

**FREE GOLD SAMPLE** goes with first letter. Something entirely new. Every firm wants it. Orders \$1.00 to \$100.00. Nice pleasant business. Write today. Metallic Mfg. Co., 406 N. Clark, Chicago.

**AGENTS**, a check protector that fits on the tip of your pen holder. Sells on sight for 35c. Over 100% profit. Sample and prices mailed for 20c. H. Bassett, 5921 Indiana Ave., Chicago.

**AGENTS**—\$50 to \$75 every week selling our new invention. Every home needs, wants and will buy. Write National Stovepipe Holder Co., 101 Main St., Ottawa, O.

**WEAR THIS STYLISH SUIT!** The man who is admired is the well-dressed man whose clothes are fashionable, and are 1911 styles. You will be that man in your neighborhood! An all-wool, tailor-made suit of flashy 1911 Broadway clothes awaits the first man in your neighborhood who answers this spring announcement. 1911 styles are just in. You get this Suit—the swellest, classiest, snappiest style we ever created—and better your appearance! This is our idea: We want one man as our representative in your neighborhood. You've got a lot of friends. They wear clothes. It is the easiest thing in the world to get them to order their clothes from you. Prices \$7.50 and up. Those orders mean a big business that more than doubles your salary, and the work is the easiest, cleanest, nicest occupation in the world. New representatives make \$5 to \$10 a day. You simply take the order and measurements and mail them to us. We make the clothes, ship them on approval to your friend and hand you the profit money. A Regular Cinch! That's the beauty of being in business for yourself. Sit right down now; write us a postal or a letter for the free outfit to representatives. And you get the swellest suit of fashionable tailor-made, all-wool, 1911 clothes ever worn in your neighborhood. If your personal appearance and a big business is worth a postal or a 2c stamp to you, then act now—write us today. Address American Woolen Mills Co., Dep. 468, Chicago, Ill.

**AGENTS**—You can make \$10.00 a day selling our new high grade original Air Brush Design Show Cards to storekeepers. 350 varieties. Catalog and sample free. Peoples Show Card Concern, 711 W. Madison St., Chicago, Ill.

**WANTED STATE AGENTS**, must be good in figures, to handle Severance's Rapid Calculator. D. N. Severance, Ft. Worth, Tex.

**MINIATURE ALARM CLOCKS, TELEPHONES**, and bibles; smallest in the world; thousands sold. Each 10c. Dozen 75c. Globe Novelty Co., 17 Leavenworth, Omaha, Neb.

**BE A CHEWING GUM MANUFACTURER** at your home, no machinery necessary, 500 per cent profit, big demand. Particulars free. Jensen & Schwarz, 1913 Welton St., Denver, Colo.

**AN ADDING MACHINE** costs \$300. Just think—we will mail a sample of our Lightning Multiplier, with special terms to agents, for 10c. Simplicity Co., 420 Ashton, Grand Rapids, Mich.

**WANTED: HUSTLING AGENTS** for our household specialties. Crescent Mfg. Co., Erie, Pa.

**SELF-THREADING NEEDLES**, 10c a paper. Agents wanted; samples and terms free. Ladies' Art Co., Dept. 41, St. Louis, Mo.

**WE WANT AN AGENT** in every factory. Easy work—Good money. C. T. Johnstone, Dept. O, Rochester, N. Y.

**COLODRIAN WATER PEN!** Guaranteed to write perfectly with water. Agents wanted. Sample 10c. Chas. Hicks, Waterford, N. Y.

**MAKE \$6 A DAY**—Exclusive household specialties; samples furnished. Meissner & Co., West Allis, Wis.

**\$100 MONTHLY** and expenses to trustworthy men and women to travel and distribute samples; big manufacturer. Steady work. S. Scheffer, Treas., M. N. 125, Chicago.

**\$25 WEEKLY** and expenses to men and women to collect names, distribute samples and advertise. Steady work. C. H. Emery, M. H. 25, Chicago, Ill.

**BIG MAIL FREE**—20c registers your name in our Big Mailing Directory in 100 magazines. Secor, Publisher, 504 West 122 Street, New York.

**MONEY for you!** See "Books," Lundy & Son.

**TELEPHONES**—at ½ the usual price. Agents make big money. Telephone Sales Co., Kilbourn, Wis.

**BULLY! GREAT! IMMENSE!** That's what all our agents say after selling our attractive 1911 Combination packages of soap and toilet articles with valuable premiums. 100% to 300% profit. One Michigan agent made \$65 in 47 hours; another \$21 in 8 hours; another \$22.50 in 10 hours. Act now—not tomorrow. Davis Soap Co., 80 Union Park Court, Chicago.

**WANTED LIVE WIRE REPRESENTATIVES** for high-grade patented article. Greatest fall and holiday specialty. Also standard seller to barbers, hotels, hairdressers, best homes. Write for special fall offer. Give full particulars first letter, stating territory desired. Sanitax Co., 2309 Wabash Ave., Chicago.

**BIG MAIL ORDER** and Agents specialty. Perfumed "Victoria" Laundry Gloss saves hard rubbing of clothes and prevents the iron from sticking. A boon to agents. A blessing to the housewife. Nickle for 10c sample with terms. Fred. Sander, Malden, Mass.

**AGENTS**—Ladies or Gents; get on the ground floor; selling our latest and best 25c Pie Crimper, Trimmer and Sealer, ever made; 150 per cent profit; carry dozen in pocket or purse. Circulars free. Stange Mfg. Co., 22 Green St., Yates Center, Kansas.

**ACTIVE MEN OR WOMEN** to work individually or organize and direct selling crews on patented gas cooking appliance. Saves fifty per cent. Exclusive territory and 100% profit. A. F. Decker, Sales Manager, 37 E. 28th St., N. Y.

**AGENTS**—Sell Addison wonderful improved gasoline system lamps. No smoke. No smell. No dirt. Simple, instantaneous, big profits. Addison Light Co., 107 W. Michigan St., Chicago.

**\$10 PER DAY**—Legitimate substitute slot machine; sells like wildfire. \$1.00 sample free, secure territory now. Sidney Game Co., Sidney, N. Y.

**AGENTS**—\$1.00 hourly. One handed flour sifter. Just patented. Only one in the world. Sample free to workers. Ebright Mfg. Co., B 307, Columbus, Ohio.

**LIVE WIRE SALESMEN**, sell our own make brushes for every household use. Write for particulars, territory and the eight advantages of our proposition. 125% profit. Capitol Brush Co., Hartford, Conn.

**AGENTS MAKE BIG MONEY**—Big pay, no experience, no capital required. 5,000 new art specialties, photo pillow tops 25c, portraits 30c, bromides 25c. New 1911 catalog and samples free. Write Daniel H. Ritter Co., Madison St., Chicago, Ill.

**GET OUR AGENTS' PRICES.** Business and calling cards. Electric Pocket Flash Lights. Household Specialties. Send 6c postage. Lartz, 1947 Orchard, Chicago.

**\$3.00 RAZORS, WITH STRAP,** mug, and brush, \$1.20. Agents wanted. Vox Company, Atchison, Kansas.

**COLLECT NAMES,** information, etc., for business concerns. Steady, profitable home business. Instructive booklet for stamp. Information System, 238, Marietta, Ohio.

**SEND YOUR ADDRESS** and we will mail catalog of 750 quick-selling, guaranteed goods. Over 3,500 articles shown in our four beautiful catalogs. \$500.00 prize contest this month. A. W. Holmes & Co., 151 Broad St., Providence, R. I.

**WE ARE GETTING OUT** several new, original money makers for Agents and Canvassers. Postal brings particulars. Falls City Supply Co., Dept. M, Louisville, Ky.

**AGENTS WANTED** for "Sander" Vacuum Cleaner. Works like a carpet sweeper. Revolving of wheels does the pumping. Powerful. Catalogue free. Fred. Sander, Malden, Mass.

**KEROSENE MANTLE LAMPS**—America's largest variety; repeat order quality; our burner guaranteed best on the market. Gullford Co., Seville, Ohio.

**ESTABLISH BUSINESS, CONTROL TERRITORY!** Handsome new electric gas-light line. Kerosene mantle lamps. Automobile head-light burners. All 100 candle power. Sell on sight. Special campaign offers. Your chance. Webster Spec. Mfg. Co., Waterbury, Conn.

**AGENTS**—Sell the Pinless Clothes Line. A labor-saving invention; sells on sight; write quick; exclusive territory; \$25 to \$75 weekly; freight prepaid; sample 25c. Pinless Clothes Line Co., 558 Lumber Exchange, Portland, Oregon.

**BECOME A MANUFACTURER'S AGENT.** We manufacture hosiery which outwears 3 of the ordinary kind, replaced free when hole appears. Easy sales; large profits. First reply obtains agency your city. Triplewear Mills, Dept. D, 724 Girard Ave., Philadelphia, Pa.

**PATENTS PROMPTLY OBTAINED.** My free booklet will help you to fortune. Read pages 11 and 12 before applying for patent. Write today. Dean Swift, Washington, D. C.

**FIGS AND FORTUNES**—Is a booklet giving facts on Fig growing near San Antonio. Free. Agents wanted. C. B. Watters & Co., San Antonio, Tex.

**USEFULTES** 3c. Stewart, San Jose, Cal.

**BOKARA DIAMONDS, AGENTS, EVERYONE**—Wanted to wear and sell these famous gems. Big profits. Sample offer and catalogue. Free. Northwestern Jewelry Co., 55 Northwestern Bldg., Chicago.

**GERMAN SILVER KEY CHECKS**—Steel letters for marking same, key rings, etc.; over 30 styles. Agents wanted. Sample marked with your name and address, and key ring, 15c. Pease, Die Maker, Winchester, N. H.

**AGENTS**—\$50 weekly; we manufacture the best needle case made; a wonderful seller; 200 to 500 per cent profit; talking unnecessary; our copyrighted "Trust Scheme" Envelopes do the work; general agents can make over \$100 weekly; send 10c for a 25c sample containing 115 needles; particulars free; buy direct from the factory at wholesale. Paty Needle Co., 102 Union Sq., Somerville, Mass.

**AGENTS**—WE MANUFACTURE GLASS PAPER. Plain glass windows made to look like real stain glass; something new; easily applied; big money maker; two sample sheets of paper, with catalogue in colors and discount sheet, for 10c. S. H. Parrish & Co., 216 S. Clark St., Chicago.

**AGENTS**—100% profit. Combination monkey-wrench, plumber's pliers, 15 tools combined. Lightning seller. Sample free. Forshoe Company, Box 1335, Dayton, Ohio.

**ONE MILLION AGENTS WANTED,** fast seller costing 5c, selling 50c. Every firm needs. Orders to \$50. Postal brings samples. Embossed Co., 2497 Milwaukee Ave., Chicago.

**I WILL START YOU** earning \$4 daily at home in spare time, silvering mirrors; no capital; send for free instructive booklet, giving plans of operation. G. F. Redmond, Dept. 306, Boston, Mass.

**AGENTS**—Portraits, 35c; frames, 15c; sheet pictures, 1c; stereoscopes, 25c; views, 1c. 30 days' credit. Samples and Catalog free. Consolidated Portrait, Dept. 1198, 1027 W. Adams St., Chicago.

**AGENTS**—HANDKERCHIEFS, DRESS GOODS, Carleton made \$8 one afternoon; Mrs. Bosworth made \$25 in 2 days. No experience needed. Free samples. Credit. Freeprot Manufacturing Company, 59 Main St., Brooklyn, N. Y.

**WIDOWS, Ladies, Men.** New. Interesting. Profitable, easy work. Spare time or permanent. Sell our useful specialties. Our original selling plan will double your sales. Particulars and \$2.00 premium offer free. Fair Mfg. Co., HF51, Racine, Wis.

**AEROPLANES, DYNAMOS, ELECTRIC FANS.** Picture Machines, Mechanical Toys, at half price. Catalogs, 300 illustrations with your name on. Samples and particulars free. Murphy Company, Norwalk, Conn.

**AGENTS** make big money selling our new gold letters for office windows, store fronts and glass signs. Any one can put them on. Write today for free sample and full particulars. Metallic Sign Letter Co., 406 N. Clark St., Chicago.

**MEDALLIONS SELL AT SIGHT.** 300 per cent to 500 per cent profit. Make up your own goods and be independent. "It's easy." Catalog free. Fred Resag Co., 1205 W. Randolph St., Chicago.

**WANTED**—A Man or Woman to act as our Information Reporter. All or spare time. No experience necessary. \$50 to \$300 per month. Nothing to sell. Send stamp for particulars. Sales-Association, 601 Association Bldg., Indianapolis, Ind.

**AGENTS**—\$5 daily selling our Handy Tool, 12 articles in one. Lightning seller. Sample free. Thomas Mfg. Company, 462 Third St., Dayton, Ohio.

**AGENTS**—Sell our Yankee Self-Wringing Mop and make \$4.00 to \$10.00 daily; we also manufacture 500 other fast sellers; particulars free. Scheff Co., 1637 Wells St., Chicago.

**AGENTS**—\$1.00 hourly. One handed flour sifter. Just patented. Only one in the world. Sample free. Forshee Mfg. Co., B, 1535, Dayton, Ohio.

**BIG MONEY MAKERS**—Send for illustrated circular of the finest salted peanut vending machine in the country. Simplex Company, Victor Bldg., Washington, D. C.

**AGENTS**—\$75 monthly. Combination Rolling Pin. Nine articles combined. Lightning seller. Sample free. Forshee Mfg. Co., Box 535, Dayton, Ohio.

**PERFECTION POCKET ADDING MACHINE.** Lightning seller. Agents wanted. Cincinnati Specialty Mfg. Co., Dept. R, Cincinnati, Ohio.

## HELP WANTED

**WE WANT "I CAN" and "I WILL" men** for permanent positions in our regular organization. If you desire to earn more than a mere living, to hold a position of responsibility and to win rapid advancement we will train you during your spare time until you are an expert and qualified to fill the positions we have for real men. We will explain our offer in detail to any one whose letter indicates that he is ambitious to succeed. Address Stace, Burroughs & Co., (Manufacturers' Representatives), 310 Michigan Ave., Offices 726, Chicago.

**\$3,000 to \$10,000 YEARLY** in the Real Estate business, without capital; we will teach you the business by mail, appoint you Special Representative in your locality, of leading real estate company, list with you readily salable properties, co-operate with and assist you to permanent success; a thorough commercial law course free to representatives. If you are honest and ambitious, our free 62-page book will surely interest you. Address International Realty Corp., Dept. 1334, Chicago, Ill. (Successor to The Cross Co. and H. W. Cross & Co.)

**DON'T YOU WANT TO MAKE Yourself a Real Estate Broker?** We will make it easy for you without capital. You can be independent of bosses and have your own office instead of a job—swing big deals and make big commissions instead of working at details on a salary. Write today for booklet "P." No financial backing needed. U. S. Real Estate Institute, 500 Fifth Ave., New York.

**CARPENTERS, WOOD-WORKERS,** men handy with tools; to manufacture Favorite See-Saws at home. W. B. Thomas, 421 E. 41st St., Chicago, Ill.

**WANTED: EXPERIENCED SALESMAN** to sell E. M. F. and Flanders Automobiles at first class garage. Carry complete line of supplies. The Glass Block Garage, Norwalk, O.

**WANTED**—One woman each town having kitchen utensils and store. Make \$10 week. Enclose stamp. Geo. Heinemann, Rogers Park, Ill.

**MEN WANTED,** age 18-35, for firemen \$100 monthly, and brakemen \$80 on all railroads. Experience unnecessary; no strike. Positions guaranteed competent men. Promotion. Railroad Employing Headquarters—over 400 men sent to positions monthly. State age; send stamp. Railway Association, Dept. 89, 227 Monroe Street, Brooklyn, N. Y.

**COLLECT NAMES,** information, etc., for business concerns. Steady, profitable home business. Instructive booklet for stamp. Information System, 239, Marietta, Ohio.

**WANTED**—Wage earners—learn to make best Hand Cleaner on market; at home in spare time; \$15 to \$40 week. G. Monroe, Jamestown, N. Y.

**WANTED ONE THOUSAND CHAUFFEURS** and repair men. Our demand for automobile engineers exceeds the supply. Calls for men of intelligence and mechanical bent capable of commanding \$100.00 to \$150.00 per month upon graduation. Resident course \$20.00 to \$60.00. Home Correspondence course completed by practical road and shop work at this school, highly successful. Look this up. Auto Schools of America, Dept. T, 1600 Michigan Ave., Chicago.

**WANTED—GOOD ABLE-BODIED MEN** as Interurban Motor-men, Conductors. \$65 to \$90 per month. New lines under construction. New positions opening up. Experience unnecessary. Enclose stamp for map new traction lines. I. Railway C. I., No. 16, Indianapolis, Ind.

**WANTED, AGENTS, MACHINISTS, ATTENTION!** Increase salary, new revised Saunders' Hand Book of Practical Mechanics. Best ever ready reference. Thousands in use. Postpaid \$1.00 cloth; \$1.25, \$1.50 leather flap. Big profits. E. H. Saunders, 216 Purchase St., Boston, Mass.

**WE START YOU** in a permanent business with us and furnish everything. We have new easy selling plans and seasonable leaders in the Mail Order line to keep our factories busy. No canvassing. Small capital. You pay us out of the business. Large profits. Spare time only required. Personal assistance. Write today for plans, positive proof and sworn statements. J. M. Pease Mfg. Co., 1018 Pease Bldg., Buffalo, N. Y.

**LIVE MEN IN EACH COMMUNITY** to own and operate a business in his home. Profits are \$200 each week. Money comes in every day and all yours. Brand new business. No canvassing. No capital. Particulars free. Frank C. Voorhies, Desk C. R., Omaha, Neb.

**I WILL START YOU** earning \$4 daily at home in spare time, silvering mirrors; no capital; send for free instructive booklet, giving plans of operation. G. F. Redmond, Dept. 306, Boston, Mass.

EXPERIENCED OR SUCCESSFUL SALESMEN to sell gasoline lighting systems suitable for any place or purpose; attractive proposition. Write for catalogue. Doud Lighting Co., 216 N. Jefferson St., Chicago, Ill. Dept. A.

PLUMBING, ELECTRICITY, BRICKLAYING or Mechanical Draughting, taught by expert workmen. Short time and small cost. Positions always open. Catalogue free. Write today. Coyne National Trade Schools, 80 E. Illinois St., Chicago.

I WILL START YOU in the Mirror Business. Best paying trade of today. Famous French method. \$5 to \$12 daily. Let me prove it. Free particulars. Corey, Dept. 30, Omaha, Neb.

#### WANTED

WILL PAY CASH for second-hand 20 H. P. Gas engine. Must be in good running order. A. B. Ferguson, 327 Fifth St., Metropolis, Ill.

WANTED second-hand photographers' tent. Claud Britton, Clinton, Montana.

WANTED—First class Barnes No. 5 Screw cutting foot power lathe. Lowest price. 3950 N. Ashland, Chicago.

WANTED—Second-Handed Crank Case for a 5x5 Wayne Engine. F. E. Knothe, Sherburn, Minn.

WANTED SECOND-HAND GASOLINE RANGE and cooking utensils suitable for an up to date Grille. Address: Miller of Alexandria Bay, N. Y.

CANE MILL Wanted—Box 78, Christianburg, Ohio.

WANTED SOLID TIRED, small auto chassis, 293 Kempton, Ind.

#### SALE OR EXCHANGE

20 BOOKS & I. C. S. lessons on Steam Engineering; value \$25. Will exchange for tools, machinery, Auto attachments, etc. Write, B. W. Snyder, Box 291, St. John, Kansas.

WE EXCHANGE ANYTHING you require for whatever you don't need. Large bargain list for stamp. Jenkins Exchange, Chicago, Ill.

\$500. STEREOPTICON OUTFIT. Will sell, or exchange for good upright piano. Nelson Ross, Troy, N. Y.

WILL EXCHANGE \$113. I. C. S. Complete Electrical Engineering Course, for Oldsmobile, stationary gasoline engine or No. 5 Oliver typewriter. Cash, \$75. Arthur Ripley, Middleboro, Mass.

#### FOR SALE

FOR SALE: Thirty-five picture machines, ten microscopes, three gum machines, punching bag, hat-blowing-machine, all Mills machines. No trades. Robert More, Bridgeton, N. J.

LARGE PORTABLE VACUUM CLEANER, guaranteed running order; quick sale. \$500.00. Investigate. Springfield Rug Co., Springfield, Ohio.

FOR SALE—Flint Lock Musket 40 inch Barrel, ¼ inch Bore, \$9.00. Percussion Lock Musket 40 inch Barrel, 58 Calibre with Bayonet, \$4.50. J. J. Davenport, Newfoundland, N. J.

TIME CLOCKS—New and secondhand; ribbons and supplies for all machines, guaranteed right. Time Register & Supply Co., No. 9, Church St., New York.

COMPLETE I. C. S. Electrical Engineering Course, with 9 volume reference library, new books, never used. Will make big sacrifice. R. E. Johnson, 801 E. Franklin St., Lima, O.

FOR SALE—New Raymond Brick and Tile plant. Big demand. No competition. L. N. Cook, Ontario, Oregon.

STODDARD'S LECTURES—10 Volumes. Illustrated. Price \$20.00. Charles F. Wheeler, 331 Locust St., Topeka, Kan.

THREE PLASTER MODELS. Color Guard 12 ft. high, including Bag, Infantryman 6 ft. Sailor 6 ft. \$100. for the three. Alex. McDonald Co., Trenton, N. J.

FOUR 36x4 TIRES and tubes new \$100.; also auto parts. Chas. Burlington, New Woodstock, N. Y.

ORIENT BUCKBOARD, \$35; Motorcycle Engine, \$20. George French, Melrose Highlands, Mass.

PAIR AUTOMATIC PIN SETTERS. Slightly used. Cost \$150. Fit any alley. Will sell for \$75. Fred Crowe, Johnsonburg, Penn.

FOR SALE—Moving picture film 1c foot. H. Davis, Watertown, Wis.

PUTNEY'S LAW LIBRARY, twelve volumes, new, at half price. Harry L. Lowden, Pittsfield, Mass.

POPCORN Crispette outfit. 1122 Oak, Elmira, N. Y.

ENGINEERS' TRANSITS, LEVELS and telescope compasses. John Burnett, Ludlow, Ky.

16-FT. LAUNCH, 4x5 Century Camera and outfit, 10-hp. Stationary Gasoline Engine, in good shape. Richard Zimmermann, Waupun, Wis.

FINE SPANISH MAUSER, big revolver, Sabre, dynamo, blue vitriol, cheap. O'Grady, Sisseton, S. D.

FOR SALE—VACUUM CLEANER, nearly new, run by gasoline engine; for price and description write Frank H. Porter, 603 West Bluff St., Janesville, Wis.

REAL BARGAINS—BICYCLES, MOTOR CYCLES, Marine and Stationary Engines, furniture, pianos and musical instruments, typewriters, sewing machines, etc. Write for list. Atlantic Supply Co., Long Branch, N. J.

FREE BOOKS—All about patents and their cost. Shepherd & Campbell, 500B Victor Bldg., Washington, D. C.

"TEXTIGUM" TYPEWRITER COVERS, fine, 50c. See what I say under "Typewriters." Atchison.

#### MACHINERY AND TOOLS FOR SALE

GAS ENGINES, DYNAMOS and switch boards, new and used, all sizes in stock. Write for list. Independent Electric Machinery Co., Kansas City, Mo.

IGNITING DYNAMOS. Start and run your engine with a Sypher Igniting Dynamo. No batteries required. Price \$20.00. Send for catalog. Sypher Mfg. Co., Toledo, Ohio.

3½ HORSE POWER GASOLINE ENGINE, with all fittings, coil, batteries, ready to run fine shape for Printing Press & Outfit or Diamond Ring. Dr. Edmundoz, Moffitt, Fla.

\$1.50 WILL BUY CASTINGS and all material for a neatly designed automatic steam engine of 1/16 H. P. Engine has governor and rotary valve. Blue prints and instruction sheets 25c. Complete engine \$6. Elgin Wheel & Engine Co., Elgin, Ill.

FOR SALE—25 H. P. Fairbanks Morse gasoline engine complete. Practically new. Will sell cheap to quick buyer. Chas. J. Koehler, Box 474, Dayton, Ohio.

BURNERS FOR SALE—Ten "Ferguson" Burners with attachments complete. Manufactured by the Railways Materials Co. Very little used. Excellent condition. Price low. Address: Silica Stone Works, Planebrook, Pa.

17 H. P. GAS OR GASOLINE engine for sale. Fairbanks make, self starter. Michigan City Paper Box Co., Michigan City, Ind.

FOR SALE—One 5 H. P., 220 volt, 60 cycle, 2 phase. A. C. motor, 1,200 R. P. M. Box 3, Girard, Kansas.

ELECTRIC SOLDERING IRONS. Write for particulars; free trial 30 days. State voltage and class of work; written guarantee with every iron. Nilson-Dillenbeck Co., 135 Adams St., Chicago, Ill.

FOR SALE—Fox 3½ H. P. Gasoline Engine Complete, 1910 Model. H. C. Newman, No. 10 Olive St., Norwalk, Ohio.

25 H. P. OLDS GASOLINE ENGINE, good condition; ½ h. p. Roth 110 D. C. motor, new; 5 h. p. 110 D. C. starting box, new. J. G. Jessup, Clay Center, Neb.

MECHANICS—We are now manufacturing a complete line of tool cases from \$5.00 up, send for catalogue. H. L. Depoy, Muncie, Ind.

BLUEPRINTS successful Light Farm Tractor truck; fits any make engine, \$1. Parts furnished. Castings, 5½c lb. Kean Bros., Stanley, N. Y.

THE JOHNSON Marine Reverse Gear—The Gear of Quality. Send for Cat. No. 9. The Carlyle Johnson Machine Co., Manchester, Conn.

FOR SALE—Patterns for 4x4 Marine engine. Also one finished engine. Sues, 4520 Adams St., Chicago.

½ H. P. GAS OR GASOLINE engine for household use, castings or complete engine; full size working blue prints 50c. Commercial Motor Agency, 6412 Greenwood Av., Chicago.

FOR SALE—PLATING DYNAMO, TANKS, soft metal gas furnace, polishing jacks, lathes, guards, etc. Silversmiths balances, spoon punches and anvils. J. C. Barrett Company, Hartford, Conn.

FOR SALE—Seneca Falls "Victor" Scroll Saw; new; very cheap. Thos. Knapp, 1241 State St., Chicago.

ONE 6" AND ONE 8" improved Ericson Hot Air-Pumping Engine for farm water supply. Lucas & Son, Bridgeport, Conn.

PULLEYS, GEARS, SPROCKETS, Shafting Hangers, see page 134. W. A. Jones Foundry & Machine Co., Chicago.

ELEC MOTORS, 3, 5, 8 and 10 Horse; 50, 60, 70 and 90 Dollars; also a 150 Light Dynamo, \$95. American Fixture & Mfg. Co., Troy, Ohio.

FULL LINE OF GAS and gasoline engines in both used and new. All sizes in stock for immediate delivery. New line of Hopper-cooled "Chicago" engines at popular prices. High-grade outfits only. Colborne Mfg. Co., 410 W. Indiana St., Chicago.

MODEL ELECTRIC ELEVATOR. Boys, build one with controller. Blueprints and directions, 20 cents (coin). Cheaply made. Motor suitable for model locomotive, etc. L. King, Tomah, Wis.

SIX HORSE POWER GRAY Stationary Engine, Convertible into Marine. Six months old, good condition. Price \$75.00. Cherry Cheer Co., Sidney, Ohio.

MAGNETO SPARK, FROM BATTERY, new coil, no adjusting or platinum screws, big gasoline and battery saver, \$10 per coil. Cameron Electric Co., 90 Pleasant, Easthampton, Mass.

IRON PLANER and Sullivan Diamond Core Drill. Flanders, Knoxville, Iowa.

ONE MARTIN AIR PUMP, \$10; one brass rotary circulating pump, \$3. John J. Horn, 418 Woodward Ave., New Haven, Conn.

TWO CYCLE, TWO CYLINDER, 3½x3½ inch Marine Gasoline engines, 16 hp, at \$94.00, complete. Castings and drawings of same for sale. Richards' Iron Works, Manitowoc, Wis.

FOR SALE—Three small dynamos, two 1½ hp. oil engines, one 8-hp. gasoline engine, six 24 inch hand saws. Geo. J. Adams, 39 South St., New York.

MACHINERY—SECOND-HAND Iron-Working Machinery, Wood-Working Machinery, Gas and Gasoline Engines, Stationary Engines. Write us for what you want in the Machinery line. We can furnish it. Cincinnati Machinery Co., 307 Johnston Bldg., Cincinnati, Ohio.

FOR SALE—Rebuilt: Throttling, Automatic and Corliss Engines, Boilers, Pumps, Heaters, Machine Tools, Tanks, Saw Mills, and general machinery, at bargain prices. Let us know your wants. The Randle Machinery Co., 1761 Powers St., Cincinnati, Ohio.

**ELECTRIC MOTOR**—3 hp. 2 phase, 550 volts, 133 cycles. Stanley make. W. G. Snyder, 37 State St., North Adams, Mass.

**FOR SALE**—Engine lathe, swings 9½ in., takes 25 in. between centers. Complete with full set change gears to cut all size threads, 3 to 40 in.; price only \$43.50. Address L. F. Grammes & Sons, Allentown, Pa.

**FOR SALE**—Gasoline Engines, automobiles, marine and stationary, also castings. Second hand ones taken in exchange and for sale. Apply with stamps. B. W. Richardson, R. No. 36, Peoria, Ill.

**GASOLINE ENGINES**—Horizontal, 1½ hp. \$40.00; 2¼ hp. \$50.00. Cincinnati Machinery Co., 307 Johnston Bldg., Cincinnati, Ohio.

**LATHES**—Send for free circular showing bargains on small Screw Cutting Engine Lathes. S. B. Machine Tool Co., Dept. L, South Bend, Ind.

**PATTERN-MAKERS!**—A book devoted to the principles of pattern and core making and molding. Written by G. H. Willard, a practical pattern maker of years experience. This book, just published, treats the subject in a much more simple, direct and effective manner than most books along this line. 224 pages, 312 illustrations. Price \$1.00 postpaid. Popular Mechanics Book Dept., 225 Washington St., Chicago.

**LITHOGRAPHIC MODELS**—Series of 6 subjects—Wireless Telegraph—Motor Car—Dynamo—Steam Engine—Steam Turbine—Gas Engine—Size 8x14 inches—All the parts of those mechanisms are shown and numbered to correspond to printed keys of names. Price per set of 6—\$2.50 or 50c each postpaid. Popular Mechanics Book Dept., 225 Washington St., Chicago.

### MANUFACTURING MACHINERY

**GOVERNMENT PROTECTION.** Protect your ideas with Christoph Patented Caveat Date Sheets. By using these Patented Priority Date Sheets, the Government acts as your Notary Public and gives you a date on your Invention for the price of a two cent stamp. By using these Sheets you avoid disclosing your Invention to your friends or a Notary Public; many ideas have been stolen in just this manner. A date on your invention is absolutely necessary, the Patent Office demands it, you must prove priority. The cheapest and best protection on earth for the inventor. Christoph Patented Caveat Date Sheets, with full instructions, 3 for \$1.00, Chicago Model Supply Co., 1638 Clybourn Ave., Chicago.

**IRON, BRASS AND ALUMINUM CASTINGS.** Metal Specialties. Patterns, Models, Polishing, Plating and Japanning. North Chicago Tool Works, North Chicago, Ill.

### BOATS, LAUNCHES AND STEAMBOAT MACHINERY

**FOR SALE CHEAP.** CANADIAN REGISTERED passenger Steamer, 200 gross tons. Rating 90. New Scotch boiler. Hull in good repair. Can be seen at Sandusky. Address Capt. J. W. Post, Chatham, Ont., or Sandusky, Ohio.

**THE BEST 20-FOOT** motor boat ever offered for \$275.00. Write now for descriptive booklet. Rice Brothers Company, Dept. F, East Boothbay, Maine, U. S. A.

**FOR SALE CHEAP**—Motor boat outfit including 8 hp. Rochester engine. J. Moore, Kendall, N. Y.

**\$5,000 SEAGOING CRUISING YACHT**—\$2,900.00. Building—Modern Yacht Co., Bath, Maine.

**FISHING SCHOONER** for sale, 60x19x8; also Auxiliary yacht, 38½x10x4. R. T. Potter, Lewes, Delaware.

### PATENTS FOR SALE

**FOR SALE OR ON ROYALTY** U. S. Patent 929439. Improved window guard and armrest combined. It relieves a person of the uncomfortable position of resting the arms on the window sill. Can be manufactured very cheap. Jacob Huberlin, 327 West 17th St., New York.

**FOR SALE PATENT** No. 966486. Telephone Duplicating Tablet or Ticket Holder. Can be attached or detached instantly on any telephone. Holds ticket firmly, allowing one hand free for handling the receiver. The duplicated one absolutely like the original copies. R. W. Tolley, Clarendon, Texas.

**FOR SALE—PATENT RIGHTS** on wireless instrument, transmits and registers messages in English or Morse, patents pending, practical, cheap; particulars. W. B. Whidden, Waukegan, Ill.

**CAPITALIST** to take patent on the walking machine and manufacture or idea for sale for 25 thousand. Koppel, 2555 Salmon, Philadelphia, Pa.

**NON-SKIDDING DEVICE** for vehicles, easily applied, cheaply manufactured, outright cheaply. F. E. Knights, Troy, Pa.

**PATENT ON QUICK SELLING;** low priced, household article and outfit. Write for particulars, Neal Otterren, Sherman Street, Grand Rapids, Mich.

**NOTICE TO MANUFACTURERS** of steam specialties: for sale U. S. patent No. 912604. Double valve gauge cock; for particulars write. Jos. Olsson, 1026 33rd St., Milwaukee, Wis.

**UNITED STATES AND CANADIAN PATENTS,** of Fruit Jar Clamps for sale, or Royalty. The best known. Elias Smith, Skinnners Eddy, Pa.

**FOR SALE—PATENT** No. 946,566, Jan. 18, 1910, Garden Hoe. Address: J. H. Shaw, Florence, Kansas.

**FOR SALE—PATENT** No. 961061. Rotary currying Brush. Address: J. W. Adler, Williamstown, Ohio.

**FOR SALE PATENTS**—The Wells Butter Worker, France, Belgium. Ella Wells, Shelbyville, Ky.

**FOR SALE**—Patent No. 968,607. Pneumatic pad for horse collars. For particulars address W. Skillman, Springfield, S. Dak.

### PATENTS

**HOOD ENGINEERING CO.**, machine designers and devisors. Thorough practical opinions with suggestions for improvement furnished for \$5.00 with sketch. 1810½ Main St., Dallas, Texas.

**DRAWINGS** for manufacturing. Inventions developed. E. J. Paque, No. 503 Johnston Bldg., Cincinnati.

**INVENTORS.** Let me help you. Valuable advice about Patents free. Have you a useful invention? I will help you sell same, no advance fee charged. Inventors Adviser, Post Office Box 108, Washington, D. C.

**WE SELL PATENTS.** Established ten years. To buy or having one to sell write Charles A. Scott Co., 1096 Granite Bldg., Rochester, N. Y.

**PATENTS**—Our advanced methods save you 80% of your money. "How to succeed as an Inventor" sent free. Inventors and Investors Corporation, Philadelphia, Pa.

**MODELS MADE,** experimental work, moderate prices. Atlas Model Works, 1569 Clybourn Ave., Chicago.

**INVENTORS OUR SPECIALTY** is Models, Ludlow Model Works, Ludlow, Ky.

**FREE!** Blue book and patent guide. Howe & Co., 800 6th St., Washington, D. C.

**MODELS** made for inventors. Low prices. Howard Merryman, Towson, Md.

**"PATENT NON-SENSE,"** or "How to Judge a Patent." Free. Obed Billman, Cleveland, Ohio.

### PATENT ATTORNEYS

**PATENTS PROCURED** and positively sold if the idea has merit; all countries; satisfied clients my best references; send sketch; book free. H. Sanders, 115 Dearborn St., Chicago.

**PATENTS SECURED** throughout the world. Egerton R. Case, Patent Expert, Dept. Q, Temple Bldg., Toronto. Write for free Patent Booklet.

**PATENTS SECURED** and sold. No attorneys' fee until patent allowed. Free books. Fuller & Fuller, Washington, D. C.

**IMPORTANT NOTICE**—Read my page ad on page 118 Advertising Section, of this magazine, relative to patents, trademarks, etc. Special offers contained in the ad. E. E. Vrooman, Patent Lawyer, Washington, D. C.

**PATENTS**—Books, 100 mechanical movements, perpetual motions, 50 illustrations. Mailed free. F. Dietrich & Co., Patent Lawyers, Washington, D. C.

**PATENT OFFICE DRAWINGS.** Catalogue illustrations. Mechanical Drafting and Designing. Adolph C. Kaiser, 348 Tremont Building, Boston, Mass.

**\$15 FILES YOUR IDEA** in patent office, under my "No fee-in-advance Plan," and you make and sell under "Patent Applied For." Send sketch for free report. Books free. Obed Billman, Main Office, Cleveland, Ohio.

**IMPORTANT PATENTS.** For \$1 I can send copy of almost any important U. S. patent in print and give much information concerning that art. Edward W. Byrn, Patent Attorney, 627 F St., N. W., Washington, D. C.

**PATENTS—HERBERT JENNER,** patent attorney and mechanical expert, 608 F. St., Washington, D. C., established 1883. I make a free examination and report if a patent can be had and exactly what it will cost. Send for circular.

**PATENTS THAT PROTECT** and pay. Advice and books free. Rates reasonable—Highest references; Best results. Watson E. Coleman, Patent Lawyer, 622 F. St., N. W., Washington, D. C.

**C. L. PARKER,** Patent Attorney, Ex-examiner U. S. Patent Office, 910 G. St., Washington, D. C. Inventor's handbook "Protecting, Exploiting and Selling Inventions" sent free upon request.

**FREE BOOKS**—All about patents and their cost. Shepherd & Campbell, 500B Victor Bldg., Washington, D. C.

**PATENTS PROMPTLY OBTAINED.** My free booklet will help you to fortune. Read pages 11 and 12 before applying for patent. Write today. Dean Swift, Washington, D. C.

### REAL ESTATE, FARM LANDS

**FREE. A CALIFORNIA HOME SITE** in Los Angeles vicinity. To advertise and develop our holdings, we will, as special offer, give to the first responsible applicant replying to this from your locality, and properly qualifying with us, a full sized lot in new townsite tract, being settled on our properties. This is your opportunity to secure what is rapidly becoming beyond the means of most: A Homesite in the famous Los Angeles section; the most attractive and rapidly increasing community in the world. Write before others and be convinced to your profit. Syndicate Sales and Development Co. Lock Box 1302, Los Angeles, Cal.

**FLORIDA INFORMATION GALORE.** Post yourself before coming or investing. Learn more about Florida in few days than you could in many months. Save time and big postage cost. Get deluge of maps, illustrations, pamphlets, reliable information. Send 25c today, and we'll furnish your name to dozens Boards of Trade, Land Companies, Colonization Managers, Development Companies, Real Estate Dealers, etc., all anxious to send, free, valuable information. Values rapidly advancing; wonderful opportunities for all. Florida Information Service, No. 4 Hyde Park Place, Tampa, Fla.

**FREE homesteads,** in mountain rain belt; rich, level land; shallow water; plenty of timber; near railroad town; the last chance of the homesteader; send quarter for full information. Mosquero Land Co., Desk C, Mosquero, N. M.



**KANKAKEE VALLEY KORN LAND**—Fifty improved farms within one hundred miles of Chicago; forty to six hundred forty acres each; Fifty to One Hundred Dollars per acre. Want city income property anywhere. Special—Farm of 160 acres, all level black loam prairie, well drained, first class buildings, one half mile from Bass Lake summer resort and railroad station, school, r f d; price for a quick deal, \$90 per acre. Robert D. Peters, owner. Knox, Indiana.

**640 ACRE WYOMING STOCK RANCH**, 60 acres alfalfa, 140 a. more virgin plow land, balance hilly pasture, well improved, gravity water works, \$13,800. Would take unincumbered interest paying real estate part payment. W. E. Bramel, owner, Sundance, Wyoming.

**"40-ROOM" MANSION**, cost \$40,000, 20 years ago. Own gas and water works. Steam-heat, 9 fireplaces, 7 bathrooms, complete modern improvements throughout. For sale at half value, with 9 acres lawn, park, fruit; New outbuildings. Model health home, best air, no mosquitoes, very accessible. Write for photos and facts, or call, C. E. Myers, Frankfort, N. Y.

**IF YOU ARE THINKING** of going back to the soil, write me. I have the Soil, Climate, Rainfall and Railroad. Cheap. Lock Box 113, Caro, Tex.

**GARY, INDIANA**. LOTS I have them, near Broadway, \$10. down, \$5 per month. No interest. W. J. Schroeder, Ridge Road, Gary, Indiana.

**\$10 DOWN, \$5 MONTHLY**, buys 40 acres oak farming land. \$6 per acre. Bargain. Thorlands Burham, Monteer, Mo.

**GOVERNMENT FARMS FREE**—Official 112-page book "Vacant Government Lands" describes every acre in every county in U. S. How secured free. 1911 diagrams and tables. All about irrigated farms. Price 25c postpaid. Webb Pub. Co., Dept. 385, St. Paul, Minn.

**BEST FARM LAND**, well located at low price, map free. Address Owner, 221 Throop Street, Chicago.

**SELL YOUR PROPERTY**. New plan. Write for particulars. C. C. Shepard, Minneapolis, Minn.

### BLACKSMITHS

**BLACKSMITHS**. There is a great demand for good steel workers and at big salaries. Buy Toy's Modern Methods, welding new steels solid and doing all hard jobs easy; forging and tempering all tools to a standard by colored charts. All for \$1. Send for samples free. W. M. Toy, Sidney, Ohio.

### CEMENT

**IF YOU WANT** the best information on cement and concrete constructions, subscribe for Concrete, leading cement and concrete monthly. Sample copy, 10 cents. Yearly subscription, \$1.00. Concrete, 135 Newberry Bldg., Detroit, Mich.

### DOGS, POULTRY AND LIVE STOCK

**BARRED PLYMOUTH ROCKS**. Prize and cup winners. Great winter layers. Eggs, \$2.50 per fifteen. Winfred Eldridge, Plymouth, Wis.

**INDIAN RUNNER DUCK** eggs and drakes. Marian Holt, Savannah, Missouri.

**SINGLE COMB BLACK MINORCAS**, best of all layers. Charles G. Pape, Box E-74, Fort Wayne, Ind.

**200-EGG INCUBATOR** costs only \$3; new method; uses hen and hen heat; agents wanted; free catalog. Natural Hen Incubator Co., Sta. H., Dept. 27, Los Angeles, Cal.

### GAMES AND ENTERTAINMENTS

**VENTRILOQUISM EASILY LEARNED**—Do you wish to be popular? Then master this art. Complete book of twelve lessons mailed for 50 cents, stamps or coin. Fred T. Darvill, Portage, Wis.

**ENTERTAIN WITH MAGIC**. Popular and fascinating. Clever tricks with cards, coins, etc., easily learned by anyone. With a few tricks in your pocket you can always respond when asked to entertain. Catalogue of practical tricks, and a clever card trick, for six cents in stamps. Donald Holmes, Box 324, Kansas City, Mo.

**MAGIC**, magazine of wonder. World's most fascinating periodical. Forty pages filled with sparkling pictures, conjuring tricks and magical entertaining news. \$1 a year; sample copy, 10c. F. T. Singleton, 3625 Thompson Ave., Kansas City, Mo.

**MAGIC TAUGHT BY MAIL**—Prospectus, catalog, 10 cents. National Magic School, 1193 Broadway, New York.

**EWING'S CABINET MAGICAL TRICKS**, contains apparatus to perform seven good tricks including the wonderful "Magic Coiner." 35c postpaid. Percy Ewing, Decatur, Ill.

**MILLION DOLLAR MYSTERY**, greatest pack of mind reading cards, absolutely new, 10c. Misto, 751 6th Ave., N. Y.

**FIVE GOOD TRICKS**, 10c. Walter H. Lycke, Omaha, Nebraska.

**GENUINE HAIR MUSTACHES**, real hair on gauze, 35c. Catalogue Theatrical Wigs free. Percy Ewing, Decatur, Ill.

**THREE GOOD TRICKS**, 10 cents. Bamberg, 1193 Broadway, New York.

**LEARN VENTRILOQUISM**—64-page book containing complete instructions, 10c. A. Crosby, Merrimac, Mass.

**MOVING PICTURE MACHINE**, 35c. Prepaid. Turns with crank. Extra pictures, 5c. Bunch Mfg. Co., Marshall, Mo.

**ENTERTAIN YOUR FRIENDS!** Send 5 cents for pack magic cards and catalog tricks. For 10c we send 8 plays and catalog stage make-ups. Bates Play Magic Co., Dept. 21, Melrose, Mass.

**PLAYS, VAUDEVILLE** Sketches, Monologues, Dialogues, Speakers, Minstrel Material, Jokes, Recitations, Tableaux, Drills, Musical Pieces, Entertainments for all Occasions, Make Up Goods, Large Catalog free. T. S. Denison & Co., Dept. 11, Chicago.

### STEEL STAMPS, STENCILS, DIES, ETC.

**\$1.00 TO \$5 A WEEK** (not a day) spare time; write now. Williams, Back Bay, P. O. Box 122, Boston, Mass.

**STEEL LETTERS, STAMPS**, rolls, stencils cut for all purposes. J. O. Gagnon, Attleboro, Mass.

### FOR THE HOME

**STENCILS FOR HOME DECORATION**. A special offer. Two beautiful rose designs, one grape and two others, for wall decoration, cut from heavy oiled paper; 60 cents coin; instructions with each order. H. F. Williams, 6 Union St., LeRoy, N. Y.

**TOILET PREPARATIONS** at Bargain Prices. Beautify your skin with Epidermic Cream; keeps skin soft and youthful; 2 oz. jar 50c. Astringent Lotion; whitens and refines the skin, 4 oz. bottle 50c. Hand Lotion; Keeps hands soft and white, 4 oz. bottle 35c. Shampoo makes hair soft and fluffy, pint bottle 50c. Hair Tonic; Promotes growth, stops falling hair, 6 oz. bottle 50c. Any of the above sent on receipt of price. Address Mrs. Mary Waugeman, 3025 N. Spaulding Ave., Chicago.

**BUY LEATHER TABLE COVERS** from tannery, all colors, 18c square foot. Suede Leather Co., 5641 Bloyd St., Phila., Pa.

**WONDERFUL ADJUSTABLE FIRE BACK**, extends from 4x14 to 6½x19. Price \$1.00. Muskogee Stove Repair Co., Muskogee, Okla.

**A HEALTHY HOME** is what you want. Meier Trap Keeps Water, Sewer Gas, out of Cellar and Cistern. Anyone can attach. Guaranteed. Write Meier Trap Factory, Upper Sandusky, O.

**HONEY—GATHERED BY BEES**: Is rich and delicious. Family packages, 1½ lb. Write for particulars. Address Pike, St. Charles, Illinois.

**PEERLESS DRAFT REGULATOR** puts on draft while you sleep; cheap and reliable. Omar K. Landis, 423 Charlotte St., Lancaster, Pa.

**HAND VACUUM Cleaner** \$7.00. Photo. Butts, Oxford, New York.

**PINLESS CLOTHES LINE GUARANTEED**. Clothes cannot blow off. Saves time; cannot rust; saves money; lasts a lifetime; no trouble. 25 feet \$1, prepaid anywhere. 50 feet \$2, prepaid. Agents wanted everywhere. Pinless Clothes Line Co., 560 Lumber Exchange, Portland, Oregon.

**MAGIC CLEANER**—Make it yourself, costs only a few cents; removes spots, stains, grease, etc., from garments and furniture. Cannot injure the choicest fabric. Saves dollars. No home will be without it after first trial. Send 10 cents for receipt. Address Mrs. Coventry, 5971 Maple Ave., St. Louis, Mo.

**MAKE YOUR OWN MISSION FURNITURE** at the minimum of expense. Our 2 books "Mission Furniture, How to Make It," Parts 1 and 2, tell in plain, simple language just how to make 50 different pieces. Full dimensioned working drawings and half tones of finished articles. Price 25 cents each or 50 cents for the two volumes, postpaid. Popular Mechanics Book Dept., 225

### MUSIC

**SEND 25C FOR 5** popular piano pieces: Cakewalk, song, two-step, waltz, march. Louis C. Haley Music Co., Madison, Wis.

**SHEET MUSIC**—Latest popular songs 15c each. Write for circular. Jersey Music Company, 2903 Westfield Ave., Camden, N. J.

**WORDS SET TO MUSIC**. Piano accompaniment arranged for your melody if desired. Fuller, Box 2635, Sta. J, Phila.

**IF YOU WANT** the latest music and a better assortment for less money than elsewhere, write today for catalog. Sample's Music House, 204 West Ave., Norwalk, Conn.

### FOR MEN

**SUSPENDERS, GARTERS, SOCKS; GUYOT SUSPENDERS** are better liked and better known than any other. Better liked because of their surpassing quality and durability, better known because always made with the same excellence since 1848—and every wearer is always a talking advertiser. Made in France, direct to you for 50 cents. Garters, Socks, these are the best 25 cent value ever offered—They are our leaders—Mail \$1.00 for these three attractive articles postpaid. Grasp this advantage. It will delight you or money refunded. In silk, \$2.00. T. S. Todd & Co., 40 Broadway, New York.

**THE SHAVEZY GUARD** makes your old-style razor safe. Fits any razor. Gives perfect safety from cuts. Prepaid 50c. 3 for \$1.00. Agents wanted. Shavezy Co., Dept. M, Baynes St., Buffalo, N. Y.

**SAFETY RAZOR BLADES SHARPENED**. Better than new, 25c dozen. Satisfaction Guaranteed. Johnson's Pharmacy, Providence, Rhode Island.

**GENTLEMEN**—\$5.00 razor for \$1.95. Send stamp for particulars. Crown Mgr., Box 195, Larimer, Penna.

**FREE, UPON REQUEST**, Self Shavers. Guide and price list. Vincent Rendine, Connellsville, Pennsylvania.

**OUR FINE SAFETY RAZOR** perfect in operation, price 25c, worth dollars. Norman Peel, London, Ontario.

**FOR SALE**—30,000 pound best leaf tobacco, mail stamps for samples. Anton Wavrin, Franklin, Ky.

**SAFETY RAZOR BLADES** sterilized and sharpened better than new; 2 cents each. Five years' success. Send for blade box and circular. Electro Stropping Co., 134 Shelby St., Detroit, Mich.

## PRINTING

**YOUR RETURN CARD** on 50 good grade No. 6% envelopes for 25c, silver. Karl M. Dickson, Covington, Virginia.

**TWO HUNDRED STICKERS**, your name and address or any fifteen words, 20c. Stamps taken. Starnaman, Printer, Berlin, Ont., Canada.

**GUMMED LABELS**, 1,000, 50c; 3,000, \$1.00. Printed two colors. MacTaggart, Printer, 1233 Arch, Philadelphia, Penna.

**MAIL ORDER MEN** get your envelopes at \$1.00 per 1,000. Omega Press, Shawmut, Mass.

**PRINTING PRESS** 11x17 inches. Cheap. G. Wills, Canal Dover, Ohio.

100 6% white envelopes printed and sent postpaid, 32c. Oral Gamage, Macomb, Ill.

200 Printed Envelopes & Note-hds. prepaid, \$1.00. Box 104, Boothwyn, Pa.

**FIFTY HIGH-GRADE VISITING CARDS** with name in old English and leatherette case, 25c, postpaid; 20 cards, 10c coin. The Beebe Press, Dept. O, Lynn, Mass.

**"NEARGRAVURE" PRINTED STATIONARY**—Fac-simile embossed. Samples 4c. Sollday's, Knox, Indiana.

100 NAME CARDS, 50c; superior: 1000 business cards, \$2. General Printing, 5213 Carpenter St., Chicago.

## DIAMONDS, WATCHES AND JEWELRY

**WALTHAM WATCH. BIG PRICE CUT.** 20 year gold filled case, \$12.00 in all retail stores. Our special price, \$9.75. Sent on approval, express prepaid. Darling, Graves Company, 212 Union St., Providence, R. I.

**SEVEN-IN-ONE** New Novelty in jewelry. Scarf pin each day of week. Seven Superb imported stones, match any color tie. Agents wanted. Exclusive territory. Investigate. Weeks, 3344 Boston, Mass.

**DIAMOND WORTH** \$25.00 for \$19.75. Lady's or gentleman's 14K gold ring. Each diamond selected for whiteness and brilliancy. Written guarantee with each stone. Sent on approval, express prepaid. Darling, Graves Company, Importer, 212 Union St., Providence, R. I.

## RARE COINS AND STAMPS

**FREE**—8 unused stamps for names, addresses, 3 collectors, 2c postage. Utica Stamp Co., Utica, N. Y.

**STAMPS ON APPROVAL**, References. L. Barrows, Box 12, Hartford, Conn.

**STAMPS**—105 China, etc., stamp dictionary and list, 2c. C. Bullard Co., Sta. A, Boston.

**FOREIGN STAMPS** 250 MIXED, 10c. 250 old United States 10c. Kleinman, 3645 Marshall, Phila., Pa.

**OLD COINS WANTED**—Highest prices Paid. Latest Buying Catalog 10c. Michigan Coin Co., Detroit.

**STAMPS** 100 ALL DIFFERENT, FREE. Postage 2c. Mention paper. Quaker Stamp Co., Toledo, Ohio.

**FREE** 500 MIXED STAMPS. 3c postage. Edw. Keating, Boone, Iowa.

**ANNUAL COIN CLEARANCE SALE**—Three dollar gold pieces \$4.25. Gold dollars \$2.20. Columbian 1892 1/2 dollars 65c. Early 1/2 dollars Liberty head 65c. Liberty head 1/4 dollars 34c. Isabella 1893 1/4 dollar 55c. 20c pieces 28c. 10 different small war cents 45c. 10 different large war cents 45c. All in good shape. New January 50-page selling catalogue just out, free. William Hesslein, 674 Elm St., New Haven, Conn.

**STAMPS**—200 ALL DIFFERENT, 10c. Coins—10 all different, 15c. Large U. S. cents, 5c. F. L. Toupal Co., Chicago Heights, Illinois.

**COLLECTORS—CATALOG FREE!** Powell Stamp Co., Storm Lake, Iowa.

**\$7.75 PAID FOR RARE DATE** 1853 Quarters, \$20.00 for a Half-Dollar. We pay a cash premium on hundreds of coins. Keep all money coined before 1880, and send 10 cents at once for our New Illustrated Coin Value Book; size 4x7. It may mean your fortune. C. F. Clarke Co., Coin Dealers, Dept. 14, Le Roy, N. Y.

## TELEGRAPHY

**TELEGRAPHY**, both Morse and Wireless, taught quickly. Also Station Agency Work, R. R. Dispatcher's and Western Union wires, and complete wireless station in school. Big demand for operators. Living expenses earned. Correspondence courses if desired. Catalogs free. Dodge's Institute, 15th St., Valparaiso, Ind. Est. 1874.

**TELEGRAPHY TAUGHT** in the shortest possible time. The Omnigraph Automatic Transmitter combined with standard key and sounder. Sends you telegraph messages at any speed just as an expert operator would. Five styles, \$2 up; circular free. Omnigraph Mfg. Co., 41 G. Cortlandt St., New York.

## TYPEWRITERS

**REMINGTON** \$18.75. This is your opportunity. Write at once for the most interesting proposition ever made. We are the final word. Standard Typewriter Exchange, 23 Park Row, New York.

**GENUINE TYPEWRITER BARGAINS**, no matter what make, will quote you lower prices and easiest terms. Write for big bargain list and illustrated catalogue. L. J. Peabody, 264 Minor Building, opposite Postoffice, Boston, Mass.

**REMINGTON TYPEWRITER** CHEAP. Perfect condition. Would ship on approval. Frank Paine, Route 5, Rosedale, Kan.

**TWENTY REMINGTON** No. 6 \$100.00 typewriters, now \$27.50. Hurry. Vox Company, Atchison, Kans.

**BENNETT** \$18.00 TYPEWRITER. Special offer. Investigate. Local and traveling representatives wanted; live men average \$150.00 month. Welland Sales Company, 249 Bear Bldg., Albany, New York.

**UNDERWOODS**, Remingtons and all other machines, 30 to 50% less than mfrs. prices. We rent them anywhere, and allow six months' rental to apply toward the purchase price. Write for catalogue and net prices. Typewriter Sales Co., 171 Broadway, New York.

**TYPEWRITERS**—Real Remingtons, \$12.00; Calligraphs, \$6.00; Hammonds, Densmores, \$10.00; Smith Premiers, \$15.00; Oliver's, Underwoods, \$25.00. 15 days' trial and year's guarantee. Harlem Typewriter Exchange, Dept. 87, 217 West 125th St., N. Y. C.

**I WANT TO CORRESPOND** with persons who are about to buy a high-grade typewriter, and object to paying the high prices generally asked by manufacturers and dealers. Any make on approval. Catalogue, bargain list and valuable information sent free. A. E. Atchison, 4127 West 21st St., Chicago.

**COMPETITORS "BEATEN TO A FRAZZLE"**—Excellent rebuilt Remington's, Smith's, \$18-\$25; Underwood's, Oliver's, \$33; others cheaper; guaranteed; sent on approval; supply limited, write quick. Consolidated Typewriter Exchange, 245 Broadway, New York.

**TYPEWRITERS**—Every kind on the market, write today for best bargain you ever secured. Shipped anywhere on approval. \$6.00 up. Fletcher Typewriter Co., 207 N. 7th St., St. Louis, Mo.

## WIRELESS

**COMPLETE LONG DISTANCE WIRELESS** Receiving Set, with 1000 ohm receiver \$5.95. 1000 ohm double-pole receivers \$1.75. All kinds and parts of wireless apparatus. Send stamp for circulars. Dept. T, Alden Wireless Co., Campello, Mass.

**THE MURDOCK CIRCUIT DETECTOR** affords reliable tests of complete or short circuits in tuners, condensers, coils, and all wireless circuits. Description in Bulletin No. 8. Write. Wm. J. Murdock Co., 10 Carter St., Chelsea, Mass.

**"MAKING WIRELESS OUTFITS"**—A concise and simple explanation of the construction and use of simple and inexpensive wireless equipments, for sending and receiving up to 100 miles, giving full details and drawings of apparatus, diagrams of circuits and tables. By Newton Harrison, E. E. 12mo. Price 25 cents, postpaid. Popular Mechanics Book Dept., 225 Washington St., Chicago.

## MISCELLANEOUS

**CHARLES R. M.** Telegraph quick. Mother prostrated. W. R. M.

**MODEL SURVEYING OUTFITS COMPLETE** including engineer's transit, level, tripod, levelling rod, plus, tape and other equipment, also simple manual of surveying. Outfit will teach you the business and do all kinds of surveying. Price \$8.50. Model Instrument Co., 831 Waukesha St., Butte, Mont.

**BOOK OF BLUE PRINTS**. Electrical diagrams from the simplest bell burglar alarm and annunciator circuits to the most complicated forms of motor, generator and general power-board wiring; price 60c currency or money order. Hansen Engineering Co. (not inc.), 158 N. Humphrey Ave., Oak Park, Ill.

**INSTANTANEOUS FRACTION CALCULATOR**. Handles halves, thirds, fourths, fifths, sixths, eighths, ninths, twelfths and sixteenths instantly. Cloth bound One Dollar. The Instantaneous Calculator Co., Detroit.

**PLAYED OUT** dry cell batteries perfectly renewed; half cent each; complete directions easily followed; 25 cents. Standard Mfg. Co., 391 North Second St., Philadelphia, Pa.

**WRITE TODAY**, for free booklet explaining our plan of furnishing legal advice, medical advice, mechanical advice and the best advice and information on any subject in which you may be interested. National Bureau of Advice, 41 Jackson Blvd., Chicago.

**3,000 FORMULAS**, Recipes and Money-Making Secrets, 368 page cloth bound volume 25c prepaid. Catalogue of Mechanical Books free. Clarence Hardage, Syracuse, N. Y.

**DON'T OVERLOOK THIS**—For \$1.00 we will teach you to transfer photos to china, watch cases, pearl and all metals. Guarantee success. William Coffman & Son, Warsaw, Ohio.

**"THE AD WRITERS' ASSISTANT"**—Book containing 350 phrases, headlines, suggestions, interesting opening chapters, each illustrated with appropriate cut, mailed, 25 cents. Cuts supplied. F. S. Alles, Drexel Building, Philadelphia.

**50c BRINGS 5 FORMULAS** and full instructions for metalizing, mounting and coloring flowers, insects, etc., for jewelry. Easy home work. Big profits. P. Benson, Stewartville, Minn.

**HECTOGRAPHs**, best improved, letter size, including ink, \$1.50 or \$10 per dozen. Filling 50 cents per pound; ink 15 cents for one bottle; \$1 per dozen. C. Barriomp, 1931 Broadway, N. Y.

**METALIZE FLOWERS**, a very pleasant and paying pastime, three 2c stamps brings full instruction. Koenig, 362 West 36th St., N. Y. C.

**INTERESTED IN GASOLINE ENGINES?** Send 50c for booklet, "How to Run and Install Gasoline Engines," and a year's subscription to Gas Energy, 28 Murray St., New York.

**TRANSFER PHOTOS TO WATCH CASES**, chinaware, sofa pillows, etc. New process. Very profitable. 25c brings full instructions. P. Benson, Stewartville, Minn.

**TYPEWRITTEN NAMES FURNISHED**. Any kind of Business, Two Fifty per Thousand. Reliable Name Supply Co., Detroit.

**IMPROVED PRIVATE FORMULAS** for anything, 25c each. Just name it. Seckay Laboratory, 700 L St., Sacramento, Cal.

**YOUR FORMULAS, RECIPES, CORRESPONDENCE, ETC.,** are safe if our System of Secret Writing is used. Sample writing and particulars free. Secretary, Box M359, Eflingham, Kan.

**VANISHING, SYMPATHETIC, LUMINOUS, and Invisible Inks;** formulas for preparing them and many others, 25c silver. George Piner, Big Springs, Texas.

**PROSPEROUS CALIFORNIA FARMERS' ADDRESSES** copied from original letters. 100, 25 cents; 500, One Dollar. Barstow Company, Box 18, Oakland, Cal.

**RUBBER STAMP MAKING OUTFITS.** S. A. Brown, Buffalo, N. Y.

**MAKE PURE VINEGAR** by our process for 5 cents per gallon. Will preserve pickles. No chemicals. Strictly pure. Not injurious. Formula 50 cents. William Coffman & Son, Warsaw, O.

**CAMDEN WOOLLENS—Ladies' and gents' suitings** direct from factory; write for samples. F. A. Packard, Mgr. Retail Dept., Box M, Camden, Me.

**TRANSLATIONS, GERMAN, FRENCH, SPANISH.** Circulars, pamphlets, manuscripts, articles, or books. Correct and fluent. P. Kaufmann, North Tonawanda, N. Y.

**500 SELECT FORMULAS (Book Form) and 5 Money Making Schemes.** 25c. Globe Co., 17 Leavenworth, Omaha, Neb.

**CORRECT FORMULAS FOR ANYTHING** 50c. Dry battery renewal, disinfecting powder, hand cleaning soap, etc. Malalane Company, 1411 Longfellow Ave., New York.

**BLUE PRINT PLAN** for a summer cottage or camp. 25c. Box 42, Holyoke, Mass.

**FORMULA** for repairing aluminum, 25c; cracks or sand holes permanently repaired. A. R. Sisson, Marshall, Ill.

**TEN RECIPES** for making finest candies, 10c (coin). W. Phillips, Clemmons, N. C.

**FORMULAS—15c each.** "Chemist," 125 Bloomfield St., Hoboken, N. J.

**TRICKS, JOKERS, PUZZLES, ILLUSIONS, Novelties—Magic Pocket Trick Free.** Illustrated Catalog included. Sent 6c stamps. Magic Dept., 10-270 West 39th St., New York.

**A PIANO IS GIVEN** for the sale of 90 of our Vacuum Cleaners. An organ for the sale of 30, etc. Bonn & Company, Guernsey, Iowa.

**2,000 SECRET FORMULAS, \$1.** Prepaid, Griffin Mfg. Co., 1000 Kearny Ave., Arlington, New Jersey.

**BLUE PRINTS** 2c square foot or fraction. Any quantity. Orders filled same day received. Power Wallace Company, 1219 Arch, Philadelphia.

**FORMULAS CORRECT,** for anything desired 15c (stamps). Demmy Co., 868 Fort St., E. Detroit, Mich.

**MAKE A PERFECT IMITATION** of marble on anything. 25c brings full instructions. G. L. Silver, 11 Isabella St., Ogdensburg, N. Y.

**BROTHER—Accidentally discovered root** will cure tobacco habit. Gladly send particulars. F. Stokes, Mohawk, Florida.

**VALUABLE TRADE SECRETS,** offered by retired Chemist not to be had elsewhere; Lightning Paint Remover, Maple Flavor, Butter Color, Liquid Sulphur, Bismuth Harmless Hair Dye, besides 2,500 other formulas, shop secrets, result of twenty years conscientious collecting. Worth many times the price asked; \$1.00—stamps. Write today. Supply limited. Liscomb Miller, Evak Chemical Company, Marietta, Georgia.

**FOUNTAIN PEN FOR \$1.00.** Limited number good pens to close out. Write quick. K. W. Henry, Charlotte, N. C.

**"TEXTIGUM" TYPEWRITER COVERS,** fine, 50c. See what I say under "Typewriters." Atchison.

**TATTOOING OUTFITS;** send stamp for price list. Blata and May, Buffalo, N. Y.

**LATEST RAT-TRAP.** Gets them all. No cruelty. Sample, 25c. Zerbey, Sacramento, Penn.

**ANYBODY CAN MAKE GOOD CUTS** with my simple zinc etching process; price, \$1; specimens and particulars for stamp. T. M. Day, Box M, Windfall, Ind.

**HANDCUFFS, LEGIRONS, NIPPERS,** etc., repairs, keys, handcuffs, \$2.50 pair up. Frank Widmayer, 2312 Broadway, New York City.

**LIQUOR HABIT—Guaranteed lifelong home cure,** 3 days. Absolutely best. Book mailed free. E. R. Woods, 534 Sixth Ave., New York, N. Y.

**8,500 NAMES,** residents of smaller towns, for sale. Lynn Kepler, Cambridge City, Ind.

**I WILL START YOU** earning \$4 daily at home in spare time, silvering mirrors; no capital; send for free instruction booklet, giving plans of operation. G. F. Redmond, Dept. 306, Boston, Mass.

**MOTION PICTURE MACHINES,** Film Views, Magic Lanterns, Slides, and similar Wonders For Sale. Catalogue Free. We also Buy Magic Machines, Films, Slides, etc. Harbach & Co., 809 Filbert St., Philadelphia, Pa.

**TOBACCO CAUSES CHRONIC IRRITATION** of brain and nerve cells. Ni-Ko heals this irritation. You won't want tobacco any more. You will feel so good. Write, today. King Ni-Ko, 7, Wichita, Kans.

**HOW to get a Hektograph** that will make 150 copies in 10 minutes; letter size, \$2.00. Write for circular. Heyer Duplicator Co., 84 La Salle St., Chicago.

**500 MONEY MAKING FORMULAS** and Digest, publishing monthly 100 Money Makers, one year for 25c. Trial 6 months, 10c. Digest, Grand Rapids, Mich.

**"PATENT SENSE AND NON-SENSE,"** or "Good and Bad Patents," compared. Free. Obed Billman, Cleveland, Ohio.

**YOUR AD** in over fifty magazines 3 months, 5 cents per word. A. S. Mankin & Co., Alexandria, Va.

## TOO LATE TO CLASSIFY

**FOR SALE.** Large, fine Engineer transit complete, \$98.00. One Astronomical telescope complete \$145.00. One 14" Engineer's level, like new, \$52.50. W. F. Sprengnether, 622 Locust St., St. Louis, Mo.

**POSITIVELY BEST RIBBONS,** three, \$1.10. See what I say under "Typewriters." Atchison.

**169% PROFIT—\$5 to \$6** worth of rope, better, stronger than factory made, from 40c ball of binding twine or from scrap twine free; low priced hand machine, only one in market, never sold before; speedy, simple; weighs 5 lbs., makes rope or wire cables, clothes line, halter ties, any length or thickness; loops or splices; finishes with selvage end. Farmers, mines, factories, boats, liverys, saddlers, stores buy quick. Hurry for territory. Chicago Appliance Factories, Dept. A-21, Quincy St., Chicago.

**BECOME A MANUFACTURER'S AGENT;** we manufacture stove pipe thimbles, stove pipe reducers, match safes, metal bag holders for grain bags, metal push-pin hangers (see display adv. this issue, page 156), and other hardware specialties; liberal discounts. Niagara Metalware Mfg. Co., Buffalo, N. Y.

**AGENTS WANTED** in every shop, office, etc., to sell watches on easy terms. Sample watch with attractive proposition sent to responsible parties. The Heeley Co., Box 32, No. Attleboro, Mass.

**AGENTS—VICTOR SUCTION CLEANER** sells quick—cleans quick. Best low-priced suction cleaner made. One person operates it. Runs on casters. Write for our liberal terms and special offer. Victor Suction Cleaner Co., 226 High Ave., Cleveland, Ohio.

**AGENTS: IMMENSE PROFITS.** Vacuum Cleaners. Everybody delighted—must have one—sample to workers—a postal to us should mean a fortune to you. Aerio Vacuum Co., E 1950, Cincinnati, Ohio.

**HOLSMAN HIGH WHEEL RUNABOUT,** 1910 Model, 4 cylinder, 26 H. P., cheap. H. P. Finks, Ft. Smith, Ark.

**WALTHAM BUCKBOARD.** Some new tires. \$50.00. Ralph Cowles, Canton, Conn.

**THE LARGEST CATALOGUE OF MOTORCYCLES** and accessories ever issued for 10 cts. (coin). It's worth \$10 to \$50 to the interested buyer. Wolke Cycle Co., Louisville, Ky.

**TANDEM ATTACHMENTS** for loop frame Indians, cheap, write for particulars. Mitchell Plumbing Co., Springfield, Ohio.

**THE NEWEST IDEAS** in postcards. Easter, St. Patrick's, Birthday, Greetings, 100 postpaid. 45c: 1,000, \$3.50. Samples, 10c. Stanley, Cornhill, Boston.

**POST CARDS,** wholesale, 90c—1,000 up. Catalogue, 20 assorted, 10c. Vern Co., 66 Decatur St., Brooklyn, N. Y.

**50 ASSORTED HIGH-GRADE** sample post cards. 20c. P. Fitzgerald, 110 Fulton St., Brooklyn, N. Y.

**WANTED—RAILWAY MAIL CLERKS,** City Carriers, Post-office Clerks, Government Stenographers and Bookkeepers. Thousands of appointments coming. Average salary about \$1,100. No "layoffs," short hours. Rapid promotion (Postmaster General Hitchcock commenced as clerk). Annual vacations. Common education sufficient. City and country residents stand same chance for immediate appointment. Political influence not needed. Send your name immediately for schedule showing places of spring examinations. Free coaching. Franklin Institute, Dep't G, 21, Rochester, N. Y.

**SCRANTON MECHANICAL DRAWING COURSE;** 5x7 Isostigmat Lens, with Automatic Shutter. Wanted: Small back geared Lathe. 281, Haines Falls, N. Y.

**WANTED—RAILWAY MAIL CLERKS;** City Carriers; Post-office Clerks; Government Stenographers and Bookkeepers. Thousands of appointments coming. Average salary about \$1,100. No "layoffs." Short hours. Annual vacations. Common education sufficient. Political influence not needed. Send your name immediately for schedule showing places of Spring Examinations. Free coaching. Franklin Institute, Dep't G, 84, Rochester, N. Y.

**BURROWES COMBINATION BILLIARD** and Pool Table with Folding Stand. Write Charles B. Reid, Springfield, Ohio.

**YOU ARE WANTED** for Government Position, \$80.00 month. Write for list of positions open. Franklin Institute, Dep't G, 84, Rochester, N. Y.

**FOR SALE—"PATENT** No. 894397 Railway Switch Mechanism." R. D. Koog, P. O. Box 65, Del Rio, Texas.

**RAILWAY MAIL CLERKS WANTED—Average salary \$1,100.** Alternate weeks off with full pay.—No "layoffs." Common education sufficient. Preparation free for coming examinations in your section. Franklin Institute, Dep't G, 21, Rochester, N. Y.

**4—13' 4" DIA. x 11' 9" long** scotch marine boilers, allowed 200 lbs. working pressure by U. S. Inspt. Other boilers and engines. J. D. Mitchell, 36 Commercial Bank Bldg., Cleveland, O.

**TURN YOUR SPARE TIME** into money, something new, a money maker. Particulars for stamp. Western Supply Co., Buena Vista, Colo.

**YOU ARE WANTED** for Government Position, \$80.00 month. Write for list of positions open. Franklin Institute, Dep't G, 21, Rochester, N. Y.

**MANY GOVERNMENT POSITIONS ARE OPEN.** Spring examinations everywhere. Large salaries. Short hours. Annual vacations. Write for list of positions. Franklin Institute, Dep't G, 21, Rochester, N. Y.

**VENTRILOQUIST'S INTERESTING BOOKLET FREE!** Send stamp. Instructor Bailey, 771 Iglehart, St. Paul, Minnesota.

**YOU ARE WANTED** for government positions. \$80.00 month. Annual vacations. Short hours. No "layoffs." Common education sufficient. Over 12,000 appointments coming this year. Influence unnecessary. Send postal immediately for list of positions open. Franklin Institute, Dep't G, 21, Rochester, N. Y.

**SLIDING FURNITURE SHOES**

replacing castors. Save Carpets. Polished Floors. Slide like a flat-iron. Sell quickly on Demonstration.

**AGENTS WRITE QUICK**

**FAIR MFG. CO., FM67, 5th St., RACINE, WIS.**

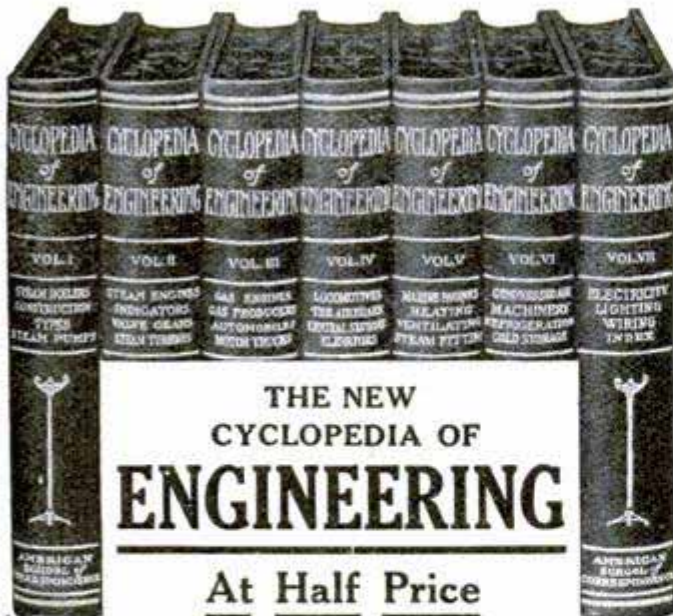

THE NEW  
CYCLOPEDIA OF  
**ENGINEERING**

At Half Price

Every Engineer must read if he would progress—the biggest men in the field can't go around telling what they know—but they can write it. And you can read it—in our New Cyclopedia of Engineering—the most valuable set of books on this subject ever offered to Engineers. This Cyclopedia has just been revised—it's right up to the minute.

These books cover every subject you are likely to meet in practical engineering. They are interestingly written by well-known authorities and are not only valuable for studying, but also as permanent reference books.

The seven books contain 3,200 pages, size 7x10 inches, and over 2,500 illustrations, full page plates, diagrams, etc. The regular price of these books is \$36.00, but as a special introductory offer we have put the price at \$18.80.

**\$2.00 Down \$2.00 a Month**

Shipped express prepaid so you can examine them before paying a cent

This price and these terms make it easy for any engineer to secure the valuable set of books. Read the brief description below and see what you will get when you mail the coupon.

**Our Protective Guarantee**

Send for the Cyclopedia of Engineering, examine it carefully and if, at the end of five days, you see that you need it, send us your first \$2.00 and \$2.00 each month thereafter until the total, \$18.80, has been paid. If the books are not satisfactory—don't send us a cent—we will pay all charges. Use this coupon. We absolutely protect you against loss. Signing the coupon does not obligate you in any way.

**READ THIS SYNOPSIS**

Construction of Boilers—Boiler Accessories—Fuel Economizers—Mechanical Stokers—Steam Pumps—Steam Engines—Indicators—Valve Gears—Steam Turbines—Gas and Oil Engines—Fuels—Automobiles—Carbureters—Locomotive Boilers and Engines—The Air Brake—Single-Phase Electric Railway—Elevators—Marine Boilers—Marine Engines—Heating and Ventilating—Compressed Air—Transmission—Absorption and Compression Refrigeration—Ammonia Machines—Direct Current Dynamos and Motors—Management of Dynamos and Motors—Electric Wiring—Electric Lighting, etc.

For a short time we will include, as a monthly supplement, for one year, the TECHNICAL WORLD MAGAZINE. This is a regular \$1.50 monthly, full of Twentieth Century Scientific facts, written in popular form.

**FREE EXAMINATION COUPON**

**American School of Correspondence**  
CHICAGO, U. S. A.

Please send set Cyclopedia of Engineering for 5 days' free examination. Also Technical World for 1 year. I will send \$2.00 within 5 days and \$2.00 a month until I have paid \$18.80; or notify you to send for the books. Title not to pass until fully paid. POP. MECH. 3-'11

NAME ..  
ADDRESS ..  
OCCUPATION ..  
EMPLOYER ..

Please Mention Popular Mechanics

**Boston Garter**

*Velvet Grip*

Fits smoothly and keeps up the sock with neatness and security. It is comfortable because its wearer doesn't feel it.

The Boston Garter keeps its strength and excels in wear-value Fully guaranteed—a new pair free if you find an imperfection Easy to buy because all dealers have it.

See that Boston Garter is stamped on the clasp.

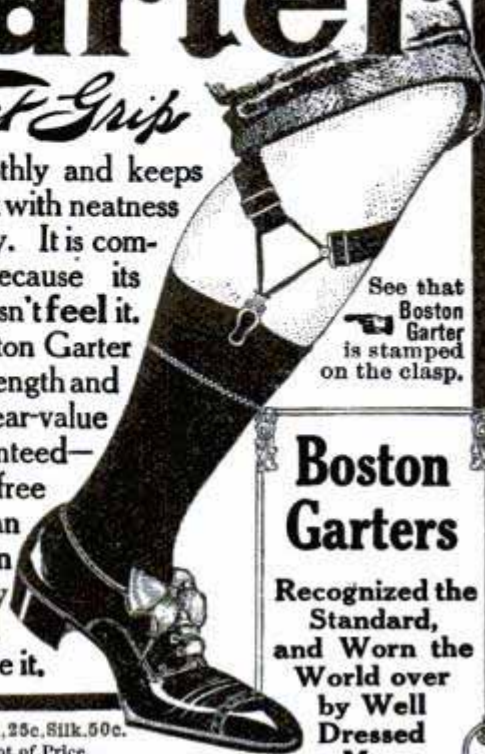

**Boston Garters**

Recognized the Standard, and Worn the World over by Well Dressed Men.

Sample Pair, Cotton, 25c, Silk, 50c.

Mailed on Receipt of Price.

**GEORGE FROST CO., MAKERS**  
Boston, U.S.A.

**ENGINEERS, DRAFTSMEN**

and all others who have lettering to do need a good system of easy lettering.

HERE IT IS

**CONTENTS:**

- BLOCK LETTERS: Heavy, Outline, Condensed, Expanded, Fancy, Shaded and Italics.
- GOthic: Condensed, Expanded, Italics.
- ROMAN: Fancy, Italics.
- SCRIPT: MODERN ARCHITECTURAL



A new edition has just been issued with a supplement containing 8 new alphabets

Well printed on good paper and handsomely bound in cloth. Sent postpaid on receipt of 55 cents.

**Spon & Chamberlain,** 123 P. M. Liberty St. NEW YORK, U.S.A.

WHEN YOU WANT ANYTHING AND DON'T KNOW WHERE TO FIND IT—WRITE BUREAU OF INFORMATION, POPULAR MECHANICS, CHICAGO

**HYPNOTISM!**

Wonderful science easily mastered by anyone. Send address for free book and other literature.

**M. D. BETTS, Dept. 65, JACKSON, MICH.**

# UNCLE SAM WANTS YOU



**Railway Mail Clerks—Internal Revenue Employees—Custom House Examiners and Clerks—City Carriers—Postoffice Clerks**  
**Over 15,000 positions will be filled during 1911**  
**\$800 to \$1800 a Year for LIFE**

No "layoffs" without pay, because of strikes, financial flurries or the whims of some petty boss. Excellent opportunities for quick advancement to Higher Government Positions. If you want immediate appointment, send **TODAY** for our schedule showing dates and locations of the Spring examinations. Any delay means the loss of just so much time in preparing yourself for examination.

**We Prepare Candidates Free**

**SEND COUPON BELOW**

**FRANKLIN INSTITUTE**

Dept. G 110, ROCHESTER, N. Y.

The coupon, filled out as directed, entitles the sender to a free copy of our book, "Government Positions and How to Obtain Them," and to consideration for Free Coaching for the examination here checked.

**COUPON**

- |   |   |
|---|---|
| .... Railway Mail Clerk (\$800 to \$1400) | .... Customs Positions (\$600 to \$1500)                      |
| .... Postoffice Clerk (\$600 to \$1200)   | .... Internal Revenue (\$700 to \$1800)                       |
| .... Postoffice Carrier (\$600 to \$1200) | .... Stenographer (\$800 to \$1500)                           |
| .... Rural Mail Carrier (\$500 to \$ 900) | .... Clerk in the Departments at Washington (\$500 to \$1500) |
| .... Bookkeeper (\$900 to \$1800)         |   |

Name .....

Address ..... G 110

*Use this before you lose it. Write plainly.*

## LEARN JEWELERS' ENGRAVING

A high-salaried and easily learned trade, taught thoroughly by mail. We will teach the beginner better engraving than he can gain in years of rigid apprenticeship. We will also improve the skill of any engraver. Send for our catalog. **The Engraving School, Dept. 112, Page Building, Chicago Ill.**

**WHEN YOU WANT ANYTHING AND DON'T KNOW WHERE TO FIND IT—WRITE BUREAU OF INFORMATION, POPULAR MECHANICS, CHICAGO**

## Come into the Automobile Business



### \$25 to \$50 a Week

Become a chauffeur and earn a big salary and all expenses. Work easy, hours short and pay big. Driving a fine car is a perpetual vacation—you go everywhere—see everything and all in the most pleasant company.

Our course trains you at home in your spare time—no other instruction like it. Mechanical experience unnecessary. If you can read and write you can succeed. Let us prove this to you.

Write for free illustrated booklet, giving sample papers, charts, diagrams and letters from leading Auto makers who endorse our course.

Here is a great opportunity for You. Let us tell you about it and how you can qualify for an attractive position at a large salary.

**THE PRACTICAL AUTO SCHOOL**  
 Coffee Exchange Building, 68 Beaver St., NEW YORK

*Auto salesmen make \$3000 to \$8000 a year. Booklet on salesmanship free to Students.*

## Young Men and Women Wanted EVERYWHERE IN BUSINESS OFFICES

Business houses need more trained help. Good salaries, short hours and certain promotion. I can prepare you by mail in a few hours' study weekly to accept a good position, and after graduating, will assist you in obtaining one. I am associate author of text books now used by the best commercial schools, an experienced accountant, and have been a commercial teacher 44 years. References: any bank or business house in Rochester. Send for FREE BOOK.

L. L. WILLIAMS, 25 Y. M. C. A. Bldg., ROCHESTER, N. Y.

## LEARN WATCHMAKING AT HOME



You can learn by our modern and original system of instruction every part of the Watchmaker's Trade at home as good or better than at a shop. You can earn money while learning and secure a well paying position or start in business after completing our course of instruction. Good watchmakers are always in demand and earn from \$20 to \$35 per week. For particulars apply to the **WISCONSIN SCHOOL OF WATCHMAKING**, Enterprise Bldg., MILWAUKEE, WIS.

## Teach Yourself Arithmetic



with a set of **ARITHMETIC HELP**. Any and all examples and problems in arithmetic, from the easiest to the hardest, are worked out and explained so anyone can understand. For the student or business man. Easy and simple; 2 volumes, 630 pages; over 200 illustrations and color plates; bound in red silk cloth. Most complete ever published. A \$2 bill brings a set prepaid anywhere. Send for a set. If not pleased, return at our expense and get your money back. Order today. **STANDARD SALES CO., 23 Fifth Ave., CHICAGO**



## THIS MAN

and a thousand others have secured good positions as Traveling Salesmen through our Free Employment Bureau recently, and earn from \$1,000 to \$5,000 a year. There are hundreds of other such positions now open. No experience needed to get one of them. We will assist you to secure a position where you can get Practical Experience as a Salesman, and earn \$100 a month or more, while you are learning. Write today for our free book, "A Knight of the Grip," and list of good openings, also testimonials from hundreds of men we have recently placed in good positions. Address nearest office,

Dept. 116, National Salesmen's Training Ass'n. Chicago New York Kansas City Seattle New Orleans

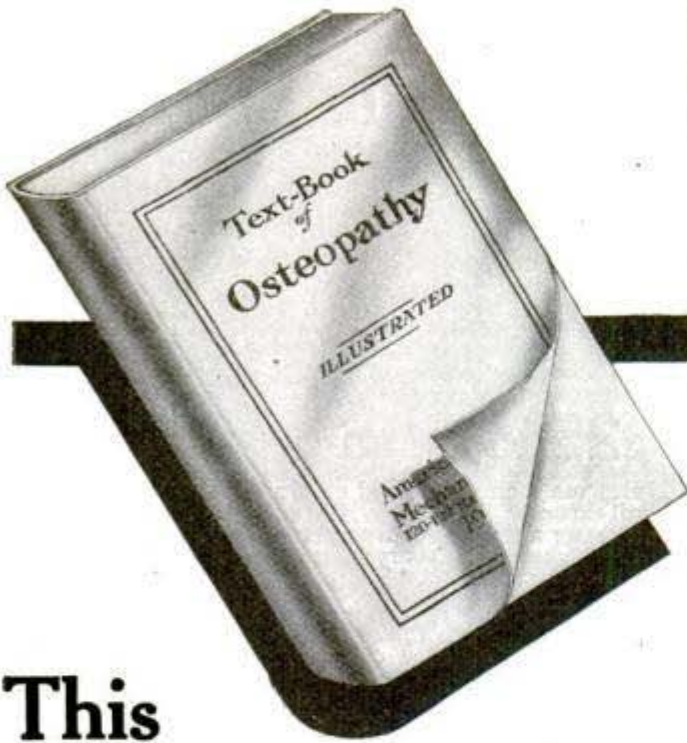

# This Authoritative Book on the Science of OSTEOPATHY ABSOLUTELY FREE

More than 90 pages (profusely illustrated) containing complete and authoritative information, concerning the theory and practice of Osteopathy, together with a full explanation of the profit and honor that comes to Practitioners of the Science of Mechano-Therapy (Drugless Healing); a Science far simpler and more comprehensive than Osteopathy—sent Absolutely Free to readers of "Popular Mechanics."

The possession of this remarkable book has opened the door of Opportunity to an army of ambitious men and women who desired to become Practitioners in the Science of Drugless Healing.

Thousands of successful Practitioners all over the civilized world attest to the ability of the American College of Mechano-Therapy, to educate men and women in class or by correspondence in this highly profitable and honorable profession. Eighteen millions of people in the United States to-day call in a Drugless Healer when they are sick.

Many of our graduates are averaging from \$10 to \$30 per day—and become proficient through studying only in their spare time in their own home.

The expert Practitioner in this Art and Science occupies an enviable position in the social and professional world—he is an expert in his knowledge of the Natural Laws of Drugless Healing.

The object of the College, in presenting you with this free text book on Osteopathy, is to enable us to more clearly define—to give you a more thorough understanding—of the Science of Mechano-Therapy (Drugless Healing). We gladly take the loss entailed by this presentation.

Send us two 2-cent stamps to cover postage. Fill in the coupon below carefully, and we will send you this book immediately, with our compliments. Address

**AMERICAN COLLEGE OF MECHANO-THERAPY**  
Dept 431. 120-122 Randolph Street Chicago, Ill.

CLIP THE COUPON NOW

American College of Mechano-Therapy,  
Dept. 431, Chicago, Ill.

To the Dean:—Please send me, with your compliments, your large text book on Osteopathy, together with complete information regarding your course in the Science of Mechano-Therapy.

My Name is.....

My Address is.....

City..... State.....

The filling out of this COUPON entails no obligation whatsoever.

Please Mention Popular Mechanics

## HIGH SALARIES FOR FAST TYPEWRITERS

If you want more salary, get more speed. Study Tulloss Touch Typewriting. Brings certain increase. Send to-day for **72-Page FREE BOOK**

and make the big pay-envelope your own. Fit yourself for the expert's position—the expert's pay. Spare time study. No interference with regular work. The book describes our Course in detail, gives complete outline of the lessons. In addition, contains many new ideas and valuable suggestions as to the gaining of high speed. Every page full of interest to the live stenographer. One reader writes: "Helped me more toward real touch writing than an entire business college course." Any stenographer could well afford to pay for a copy. Surely you will not lose this opportunity to get one free. **WRITE FOR YOURS TO-DAY.**

**THE TULLOSS SCHOOL OF TOUCH TYPEWRITING**  
103 College Hill, SPRINGFIELD, OHIO

## Do You Want to Double Your Income?

The very day you write as you will be well on the road to doubling your income. Let that day be TO-DAY — you may not again see this ad.

We will prepare you and obtain for you a money-making opportunity with which you can add \$500 to \$5000 a year to your income. It can be handled during spare time or as an exclusive business.

We can help you better yourself, no matter what your occupation or business.

A POSTAL WILL BRING PLAN

**COLLEGE OF INVESTMENTS**  
500-509 Parkway Bldg. PHILADA., PA.

## Government Positions

**45,837 Appointments** were made to Civil Service places during the past year. Excellent opportunities for young people. Each year we instruct by mail thousands of persons who pass these examinations, and a large share of them receive appointments to life positions at \$840 to \$1,500 a year. If you desire a position of this kind, write for our Civil Service Announcement, containing full information about all government examinations and questions recently used by the Civil Service Commission.

**COLUMBIAN CORRESPONDENCE COLLEGE, WASHINGTON, D. C.**

## SECURE A HIGH SALARIED GOVERNMENT POSITION

by passing the Civil Service examination. We prepare you so thoroughly that you have no difficulty. Nearly 50,000 appointments to positions paying high wages made last year. Fine opportunity now. We also prepare students for Teachers' and College Entrance Exams. Rapid, Practical methods—Low cost. Write today for Catalog and Full Particulars.

**BALFOUR JOHNSTONE SCHOOL**  
Dept. 13, Schiller Bldg. CHICAGO, ILL.

## CORNET FREE!

We guarantee to teach you to play by mail and will give you a Beautiful Cornet or any Band Instrument absolutely FREE. You pay weekly as lessons are taken. Instrument is sent with first lesson. Write today for our booklet and wonderful tuition offer.

**INTERNATIONAL CORNET SCHOOL**  
440 Musical Hall, Boston, Mass.

## WANTED MEN

Prepare as **Firemen, Brakemen, Electric Motormen, Colored Train Porters.** Hundreds put to work; \$65 to \$150 a month. No experience necessary. **500 More Wanted.** Enclose stamp for Application Blank and Book. State position wanted.

**I. RAILWAY C. I., DEPT. 35,**  
INDIANAPOLIS, INDIANA.

# LEARN TO REPAIR AND RUN AUTOMOBILES

## EARN BIG MONEY IN AUTOMOBILE BUSINESS



as a chauffeur, repairman, salesman. Work pleasant. Big demand for trained men. Fine chances for starting automobile liveries, agencies, taxicab and repair companies. Learn the automobile—every part, and its mechanical operation thoroughly and practically in a few weeks. Write today for our interesting free book and learn about the tremendous opportunities everywhere in this new business and our excellent course of training.

**KANSAS CITY AUTOMOBILE SCHOOL**  
(Conducted by CLIFF HOGAN)  
(Largest and Best Equipped Automobile School in America)  
2139 E. 15th Street, Kansas City, Mo.

# LEARN THE AUTOMOBILE BUSINESS



**Earn a Splendid Salary**



The Chauffeur travels just as far as the owner, sees all the scenes and is paid well for it. Demonstrators, Inspectors, Testers, Repairmen and Assemblers have pleasant employment at good salaries. All are in great demand because of the rapid growth of the automobile business and lack of skilled men. Our correspondence course covers mechanism, operation and repairing and equips you to fill any of these positions. You study in your spare time.

Rates Reasonable. Write Today for Particulars.  
**CLEVELAND AUTOMOBILE SCHOOL**  
2167 E. 9th St., CLEVELAND, O.

# Study Law at Home!



Hon. David J. Brewer  
Late Vice-President.

The Law is the best paying profession—puts you in touch with more business chances—brings better fees—gives you greater power in your community. If you want to be master of your own career, study law.

Preparation for the bar examination of any state by mail. Personal instruction under Judge Wm. Macon Coleman, A. M., Ph. D. Dean, former Attorney General of North Carolina.

Our founders include the late David J. Brewer, U. S. Supreme Court; Senator Chauncey M. Depew; Hon. Martin A. Knapp, Chairman, Interstate Commerce Commission. Write for catalog Intercontinental University, 1410 H. St., N.W., Washington, D. C.



**I TEACH BY MAIL**  
WRITE FOR MY FREE BOOK  
"How to Become a Good Penman"  
and beautiful specimens. Your name elegantly written on a card if you enclose stamp. Write today. Address F. W. TAMBLYN, 418 Meyer Bldg., Kansas City, Mo.



## LEARN CHIROPRACTIC

The new method of drugless healing  
**EARN \$50 TO \$100 PER WEEK**

Our free book tells how you can learn to detect disease and remove the cause by Howard's method of Spinal Adjustment. Positively the most simple, direct, advanced and scientific method of drugless healing. Based on unerring natural laws. Anyone can understand it; learned in spare time. Improve your social prominence and financial standing. Start now on the road to honor and success. Write for free book and special scholarship offer.  
**NATIONAL SCHOOL OF CHIROPRACTIC**  
806 Wendell Building CHICAGO, ILL.



## ALWAYS ON THE JOB

# The Complete Cyclopedia of Civil Engineering

is always on the job. It contains more up-to-date, accurate, money saving information on reinforced concrete, irrigation, water supply and water power development than you can get in any other book or set of books. It is especially adapted

## For Home Study and Self Improvement

It goes straight to the point, uses plain English. From it you can learn the first principles of plane surveying or solution of the most abstruse problems in strains and stresses. Bound in half morocco, 3,908 pages, 7 x 10 inches. 3,000 full page plates, folding maps, diagrams, etc., carefully indexed so you can turn at once to the topic you want.

### IMPORTANT SUBJECTS COVERED

Plane Surveying—Mechanical Drawing—Plotting and Topography—Steel Construction—Railroad Engineering—Statics—Strength of Materials—Roof Trusses and Mill Building Construction—Cost Analysis in Relation to Engineering—Masonry—Bridge Engineering—Practical Problems in Construction—Hydraulics—House Drainage and Sanitation—River and Harbor Improvements—Irrigation Engineering.

## Examine These Books Free of Charge

If you will send us your name and address on coupon below, we will send you a complete set of these books by prepaid express. You can keep them in your home five days. Examine them carefully, apply the information they will give you, to your daily needs. If you think they will help you in your work, send us \$2.00, then \$2.00 every thirty days until the special price of \$24.00 has been paid. The regular price is \$48.00. If the books are not what you want, advise us. We will have them returned at our expense.

## Special Offer if You Mail Coupon Promptly

For a short time we will include, as a monthly supplement, free of charge for one year the TECHNICAL WORLD MAGAZINE. This is a regular \$1.50 monthly, full of Twentieth Century Scientific facts, written in popular form. Also contains the latest discussion on timely topics in invention, discovery, industry, etc. The magazine will be mailed immediately upon receipt of coupon.

### SPECIAL PREPAID OFFER COUPON

AMERICAN SCHOOL OF CORRESPONDENCE, Chicago, U. S. A.:

Please send set Cyclopedia of Civil Engineering for 5 days' free examination. Also Technical World for 1 year. I will send \$2 within 5 days and \$2 a month until I have paid \$24.00, otherwise I will notify you and hold the books subject to your order. Title not to pass until fully paid.

NAME.....  
ADDRESS.....  
OCCUPATION.....  
EMPLOYER.....

POP. MECH. 3-11

Please Mention Popular Mechanics

## BE YOUR OWN BOSS

Come to the Coyne National Trade Schools  
**LEARN A GOOD TRADE**

and earn \$5 to \$8 a day at

**Plumbing, Bricklaying, Mechanical Drafting  
Electrical Work or Painting and Decorating**

or set up in

**BUSINESS FOR YOURSELF**



HOME OF THE SCHOOLS

The trades that pay \$5 to \$8 a day. Men always in demand. Graduates never looking for work. Most thorough, practical Trade School in the world. No books but tools in teaching. Individual instruction. Expense very small. Your success assured. Thousands of graduates at work in every state making big money.

Write me today for large illustrated Book giving full particulars

—**LESLIE L. COOKE, President**—

**COYNE NATIONAL TRADE SCHOOLS**  
73 E. Illinois St. CHICAGO, ILL.



## Learn Engraving

by mail. Catalog and first lesson FREE.  
Easily Learned. **BIG SALARIES**  
ESTABLISHED 22 YEARS

**Rees Engraving School** Dept. M, Granite Bldg.,  
ROCHESTER, N. Y.



**LEARN PIANO TUNING AT HOME** by the aid of the TUNE-A-PHONE. A Profession that can be converted into money at any time or place in the civilized world at an hour's notice. Earn \$5.00 to \$15.00 per day. Valuable illustrated book FREE. Write **NILES BRYANT SCHOOL OF PIANO TUNING, 31 Music Hall, Battle Creek, Mich.**

## BOOKS THAT REALLY TEACH



you the things you want to know, and in a simple, practical way that you can understand.

Our illustrated catalogue, which will be sent you free upon request, tells all about the Practical Mechanical Books for Home Study that we publish. No matter what your ambition or desire for knowledge may be, we publish books written by authorities in their different lines that will give you just the mechanical training and information that you want and need. Write today for this up-to-date and complete illustrated catalogue and popular price list. It is free.

**FREDERICK J. DRAKE & CO.**

PUBLISHERS OF SELF-EDUCATIONAL BOOKS, 1327 MICHIGAN AVENUE, CHICAGO

## SHORTHAND IN 30 DAYS

## Learn a Good Paying Profession



IF YOU will give us part of your spare time for 30 days, we will positively teach you the **Boyd Syllabic System of Shorthand**. It is a wonderful new method, easy to learn, simple, only nine characters, no words to memorize; yet so simple and complete that it puts the entire English language at your command in 30 days.

Anybody can learn it and become an expert stenographer. We have graduates earning high salaries everywhere. Write for Testimonials & Free Book.

**CHICAGO CORRESPONDENCE SCHOOLS**  
969 Chicago Opera House Block, Chicago, Illinois.

## ART STUDENTS

## Want To Make \$100?



Cash art assignments are given in every issue of the **Students Art Magazine**

also lessons in Designing, Illustrating, Cartooning, Lettering and Chalk-Talking. Students' work published. Articles by and about leading artists. Especially valuable to Art Students of all correspondence schools. You get experience doing commercial art work. Only \$1 for 12 months. Money back if not satisfied. Send subscription today to **Students Art Magazine, Dept. 115 Kalamazoo, Mich.**

## STUDY LAW at Home

Become  
a Lawyer

# LAW

Legal  
Diploma

We make your home a university. Leading Correspondence Law Course in America—recognized by resident colleges. New text, specially prepared by 20 Deans and Univ. law school teachers. We guarantee to coach free any graduate failing to pass bar examination. Special Business Law Course. "Legally-trained men always succeed." Over 10,000 students enrolled. Begin now. Easy terms. Catalog and Particulars Free. **La Salle Extension University, Box 1193, Chicago, Ill.**

## YOU CAN BE A SALESMAN

Earn While You Learn. We have Salesman's Positions Open in which you can secure Practical Training and earn good money while studying our course. Men equipped with our system of Practical Training earn from \$1,200 to \$10,000 per year. Positions now open. Address our nearest office.

The Practical School of Salesmanship  
Box 15, Cleveland, O. Box 15, Ft. Worth, Tex. Box 15, New York

## STAMMER NO MORE

I can cure you. Reputation world-wide. Established 16 years. Trial lesson explaining Home Instruction, with 200-page book, FREE. Answer at once. **George Andrew Lewis, 178 Adelaide Street, Detroit, Mich.**



## HYPNOTISM

Learned at home; small cost; 2c stamp for particulars.

**O. A. SMITH, Room B 57, 823 Bigelow St., Peoria, Ill.**

## LEARN WATCHMAKING

Engraving and Jewelry Repairing. Practical specialists in charge of all instruction. Students trained for the best paying positions. Earn while learning. Our school is endorsed and recommended by leading jewelers. A few months will make you an expert. Positions secured for graduates. Demand for watchmakers greater than the supply. Write for free catalog.

**CHICAGO SCHOOL OF WATCHMAKING**  
Dept. 20, Bush Temple, CHICAGO



# Own a Jewelry Store!

We Furnish  
Everything!

Get Into Business  
for Yourself!

Here is a big opportunity for one influential man in every town.

During the next year we are going to establish a number of men in this best of all businesses.

These men we are going to make our partners.

By our system these men will soon become moneyed men in their community.

For these men we do much and we demand much in return. Not in money, but in brains, business ability and in character.

We are always on the lookout for the unusual men. For these men we do great things. Their opportunities are circumscribed only by their own ability to grow. Quick action is necessary. We can make arrangements with but one man in your town in this matter. If you are interested write us at once. Address

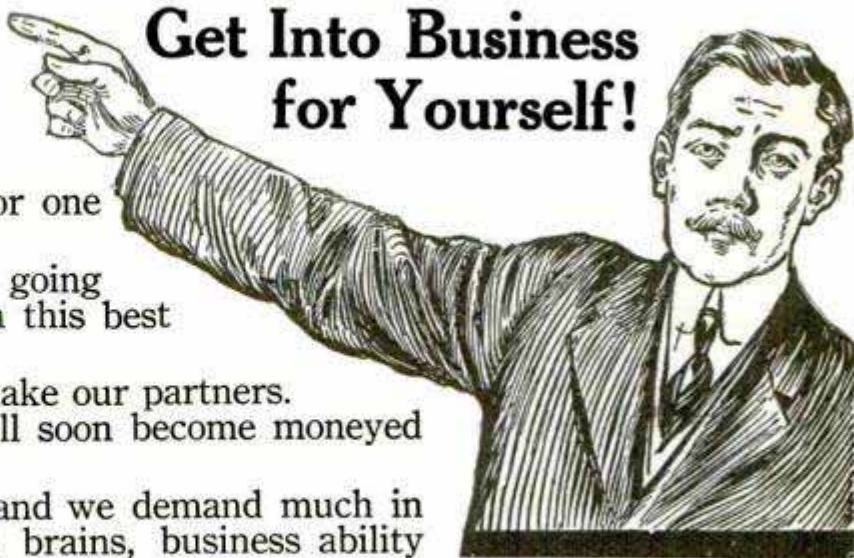

**C. F. ELMORE, Financial Director**

90 Wabash Avenue

Department 141

CHICAGO, ILL.



## COPY THIS SKETCH

and let me see what you can do with it. You can earn \$20.00 to \$125.00 or more per week, as Illustrator or cartoonist. My practical system of personal individual lessons by mail will develop your talent. Fifteen years successful work for newspapers and magazines qualifies me to teach you. Send me your sketch of President Taft with 6c. in stamps and I will send you a test lesson plate, also collection of drawings showing possibilities for YOU.

**THE LANDON SCHOOL** OF ILLUSTRATING  
and CARTOONING  
1438 Schofield Building, Cleveland, Ohio.



## LEARN WATCHMAKING

Watchmaking pays and you can earn while you learn. Write for FREE BOOK, "How to be a Watchmaker." Postal brings it.

Stone's School of Watchmaking  
912 Globe Bldg. St. Paul, Minn.

## LEARN TO WRITE IF YOU ARE EARNING ADVERTISEMENTS LESS THAN \$25 a WEEK

we can positively show you by mail how to increase your salary. Send for beautiful prospectus, mailed FREE.

PAGE-DAVIS SCHOOL, Dept. 112, CHICAGO, ILL.



## STAMMER

My book "How to Stop Stammering"—a treatise on "Scientific Talking"—direct to the point.

Write M. L. HATFIELD, 1462 Grove St., OAKLAND, CALIF.



## I TEACH SIGN PAINTING

SHOW CARD WRITING or LETTERING by mail and guarantee success. Only field not overcrowded. My instruction is unequalled because practical, personal and thorough. Easy terms. Write for large catalogue.

CHAS. J. STRONG, Founder

**DETROIT SCHOOL OF LETTERING**  
DEPARTMENT PM. DETROIT, MICH.

"Oldest and Largest School of its Kind"

## \$2,500 to \$10,000 a Year Made By Plumbers

Here's a trade that will make you independent. Shorter Hours, Bigger Pay—*demand always great*. Our practical methods—teaching by actual work at all phases of trade, with expert plumbers as instructors—enables you to do the work of a skilled plumber in a remarkably short time.

Many of our students are successfully established in the plumbing business for themselves—it takes but little capital and master-plumbers can make from \$2,500 to \$10,000 a year. This is your opportunity—don't neglect it!

Graduates of our school have no trouble in securing good positions at highest pay anywhere in this country. Our new booklet showing many illustrations of our school and students at work and giving full detailed information regarding our course, rates, etc., is FREE. Write for it today. It may be the first step to such prosperity as you had not dreamed of before.

Saint Louis Trades School,  
4430 Olive St., St. Louis, Mo.

## Learn Plumbing

Please Mention Popular Mechanics

# CAN YOU DRAW?



We will turn your talent into money. Our Graduates are filling HIGH SALARIED POSITIONS.

We will open to you one of the most profitable and delightful fields of human endeavor—THE BROAD FIELD OF ART where the demand always exceeds the supply.

## Earn \$25 to \$100 per Week

In easy, fascinating work. Splendid Opportunities await our students, because our twelve years of successful teaching enable us to offer **Many Special Advantages** which fit them for large pecuniary profit.

**Individual Home Instruction**  
by Expert Faculty. Superior Equipment.

### Financial Returns Guaranteed

Complete Courses in Commercial, Fashion, Book, Magazine, Advertisement Illustrating; Newspaper, Cartooning, Lettering, Designing, Show Card, Photo Retouching, Architectural Perspective, Normal, Color, General Drawing, etc.

#### ARTISTS' FREE OUTFIT

of Fine Instruments and Supplies to each Student. Write Today for particulars and Handsome Art Book free.

### SCHOOL OF APPLIED ART

**F175 Fine Arts Building**  
**Battle Creek, Michigan.**

Our own Fire-proof Building.



# Learn to be An Auto Expert



Six weeks spent at this great automobile school—the largest in the world—will double or treble your present earning ability. We make you a **practical** man able to run and repair quickly **any** make of automobile and prepared to take a position as soon as you leave school.

### No Books Used—No Tools to Buy

(No Correspondence Course)

Only Automobile school in the world fully equipped to teach every branch of the business. Chauffeurs earn \$60 to \$150 a month; demonstrators, \$25 to \$40 a week; repairmen, \$20 to \$50 a week; salesmen, \$40 to \$150 a week. We can make you a practical man able to earn these salaries. Low tuition; good board and room near school cheap. You should have our new big **FREE** Illustrated Catalog. Write for it now.

Address **AUTOMOBILE TRAINING SCHOOL**  
15,000 Square Feet of Floor Space  
1131 Locust Street KANSAS CITY, MO.



## \$25 to \$50 a Week IS PAID GOOD PORTRAIT ARTISTS

I teach you at home by my original system. Earn money while learning and get a well paying position or start in business for yourself after getting diploma. I correct your work personally. Send for my free book.

**L. T. KUNDE, Head Master**

KUNDE SCHOOL OF PORTRAITURE, Dept. A, Cawker Bldg., Milwaukee, Wis.



## ARITHMETIC SELF-TAUGHT

A plain, easily-understood volume for all who have not had the opportunity of learning this subject thoroughly, or who have forgotten what they once learned. **257 Pages. Requires no teacher.** This great little book sent postpaid for **60 CENTS**. Stamps accepted, leather binding \$1.

**GEO. A. ZELLAR BOOK CO.**  
Est. 1876, 4462 W. Belle Place, ST. LOUIS, MO.

SPANGENBERG'S  
PRACTICAL  
ARITHMETIC  
Self-Taught

## LEARN MUSIC BY MAIL



By the wonderful Simplex copy-righted system anyone of ordinary intelligence can quickly learn to play piano or organ

### WITHOUT A TEACHER

You need not know the first principles of music. By no other method can you learn music so quickly and thoroughly as by the Simplex System. The study is easy and fascinating. By our system you can study during spare time in your home and quickly become a capable musician, playing popular, sacred or classical selections. Delighted students in every state and territory. Some of our students, after six or eight lessons, begin playing piano or organ in church or Sunday school. Others write that after one lesson they are able to play a waltz from memory. If you wish to become a skilled musician, write at once for our free book.

Address  
**Simplex School of Music**  
Conservatory 672, Kansas City, Mo.

**THIS FREE BOOK TELLS HOW**

## Learn Watch Repairing

Be a watchmaker—you can learn this profitable trade by correspondence in a few weeks in your own home by the DeSelms Chart System. After you complete the course you will know a watch from A to Z. You will know just what the matter is and how to repair one. When you graduate you will be a practical watchmaker and repairer and competent to fill any position. Positions for our graduates.

Ask for our Free Book. It explains our system and terms.  
**THE DeSELMS WATCH SCHOOL**  
23 Perry St. ATTICA, INDIANA



## VENTRILOQUISM

**LEARNED BY ANY MAN OR BOY AT HOME SMALL COST**

Send today 2c stamp for particulars and proof.  
**O. A. SMITH, Room D 3, 823 Bigelow St., PEORIA, ILL.**

## MUSIC LESSONS FREE AT YOUR HOME

Write Today for our Booklet. It tells how to learn to play Piano, Organ, Violin, Mandolin, etc. Beginners or advanced pupils.  
**American School of Music, 50 Lakeside Bldg. Chicago, Ill.**



## DO YOU LIKE TO DRAW?

**That's all we want to know**

Now we will not give you any grand prize—or a lot of free stuff if you answer this ad. Nor do we claim to make you rich in a week. But if you are anxious to develop your talent with a successful cartoonist, so you can make money, send a copy of this picture with 6c. in stamps for portfolio of cartoons and sample lesson plate, and let us explain.  
**The W. L. Evans School of Cartooning**  
321 Kingmoore Bldg., Cleveland, O.

## I TEACH Penmanship BY MAIL

I won the World's First Prize for best course in Penmanship. Under my guidance you can become an expert penman. Am placing many of my students as instructors in commercial colleges at high salaries. If you wish to become a better penman, write me. I will send you Free one of my Favorite pens and a copy of the Ransomian Journal.  
**C. W. Ransom, 718 Reliance Bldg., Kansas City, Mo.**



# Let Me Show You How to Earn \$3,000 to \$10,000 a Year in the Real Estate Business



## NO CAPITAL NECESSARY

If you are ambitious to better your condition—if you want to establish yourself in a splendid paying business requiring no capital—send me your name and address and I will mail you—free—a valuable **62-page prospectus** explaining our system of money-making, without interfering with your present occupation. We have perfected a thoroughly practical, scientific method of teaching by mail the

## Real Estate, Brokerage and Insurance Business

Under our plan, we teach these big money-making branches to one able, ambitious and energetic person in each community. When you are thoroughly qualified to make a success of the business, we appoint you

### Special Representative

This gives you a chance to identify yourself with the oldest and largest Co-operative Real Estate and Brokerage Company in America. By our system you can—if you will—be making money in a few weeks without conflicting in any way with your regular work. Our Co-operative Department will give you more choice, salable property to handle than any other concern in the world. So the sooner you investigate our plan, the sooner you will get your name on your own real estate signs and be ready for business.

### Valuable Commercial Law Course Free

To each of our representatives we also give a thorough course in commercial law without cost. This instruction is indispensable to any man who wants to make his way in the business world. We teach you, free, everything you need to know to successfully meet legal problems that may arise in any business transaction. And we also furnish you free legal advice whenever you require it.

### Send for This Book Now

Our Big 62-Page Free Prospectus will prove of great interest and real value to anyone, but is of vital importance to office employees, salesmen, agents, clerks, solicitors and others who are ambitious to enter the realms of better things in business. This book is an inspiration to the indifferent, a spur to the laggard, and a stimulus to the ambitious. It deals with the great problems of business, and points the only sure way to the complete mastery of Real Estate, Brokerage and Insurance, three of the most profitable branches of modern business, which have made many millionaires and brought great prosperity to tens of thousands of active, energetic men all over the land.

### MAIL THE COUPON TODAY

Don't procrastinate. Act! Anything that is worth doing is worth doing promptly. Resolve to send for this big free prospectus, and send for it right now while the matter is before you. "I'll do it tomorrow," has been the grave of countless good intentions. "I'll do it today," is the solid rock on which to build the only enduring success. Just clip the coupon, fill it out, sign and send it today. By return mail you will receive free the invaluable book, which to thousands of ambitious men has proved the key that opens the door of great achievements in business.

**INTERNATIONAL REALTY CORPORATION**  
Successor to THE CROSS COMPANY & H. W. CROSS & CO.  
1336 Manhattan Building CHICAGO

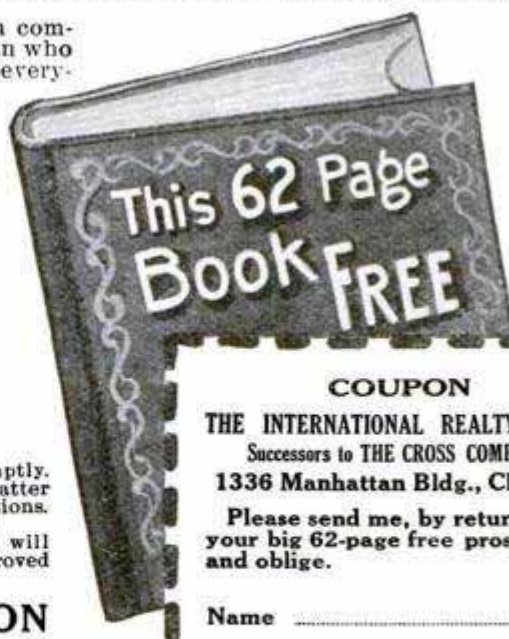

#### COUPON

THE INTERNATIONAL REALTY CORP.  
Successors to THE CROSS COMPANY  
1336 Manhattan Bldg., Chicago

Please send me, by return mail, your big 62-page free prospectus, and oblige.

Name .....

Address .....

# If I Will Agree

To Get You A Position  
Paying Good Wages

When You Graduate From My School of

## Telegraphy

Will You Come?

My graduates are given immediate employment by Railroads, Telegraph and Wireless Companies, because my school is recognized as the only one graduating thoroughly practical operators. Demand exceeds supply. If you want

## Good Wages, Easy Work and a Bright Future

write today. I offer you advantages unequalled anywhere

1. Oldest, Largest and most Successful Telegraph School in the World. 2. Expert Instructors. 3. Best Equipment — (we occupy exclusively two large modern buildings with R. R. train and Western Union wires and complete wireless station installed.) 4. Low Rates. 5. Easy Payments. 6. Living expenses earned while learning. Correspondence courses if desired. *New Course in Railway Accounting* makes my graduates proficient station agents. May be taken alone if desired. Write me today for illustrated descriptive catalog and interesting testimonials.

GEO. M. DODGE, Pres.

DODGE INSTITUTE OF TELEGRAPHY, 8th Street VALPARAISO, IND.

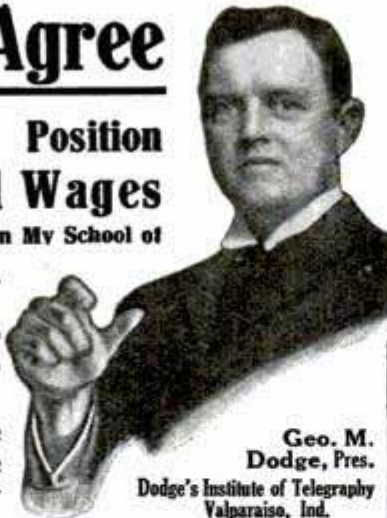

Geo. M. Dodge, Pres.  
Dodge's Institute of Telegraphy  
Valparaiso, Ind.



## Learn Photography, Photo-Engraving or 3-Color Work

Engravers and 3-Color Operators Earn \$20 to \$50 Per Week. Only college in the world where these paying professions are taught successfully. Established 17 years. Endorsed by International Association of Photo-Engravers and Photographers' Association of Illinois. Terms easy; living inexpensive. Graduates assisted in securing good positions. Write for catalog, and specify course in which you are interested. Illinois College of Photography or } 999 Wabash Av. Bissell College of Photo-Engraving } Effingham, Ill. L. B. BISSELL, Pres.

## Draws Dandy Pay Job a cinch

Are you Ambitious?—Want to "get Ahead?"

IF SO, You can become an Automobile Expert like the man at the wheel above. Such Experts earn \$35 to \$50 per week, and are never out of a job. In a few weeks' time we can train you, and assist you to better your position. Small down payment starts you. Valuable model of automobile free to every student. Write us for free samples of lessons, etc.

BUFFALO AUTOMOBILE SCHOOL  
12 (The auto school that comes to you.) CENTAUR BUILDING, . . . BUFFALO, N. Y.

## Great Eastern Trade School

TEACHES PRACTICAL  
PLUMBING, BRICKLAYING or PLASTERING  
IN A FEW MONTHS

No age limit—You can enter at any time. Day and Night Classes—Positions Secured. No Books—Tools take their places.

WRITE NOW FOR FREE CATALOG  
44-48 East 32nd Street, NEW YORK CITY

## New York Electrical School

Offers to men and boys a theoretical and practical course in applied electricity without limit as to time. Instruction individual, day and night school, equipment complete and up-to-date. Students learn by doing, and by practical application are fitted to enter all fields of electrical industry fully qualified. School open all year. Write for free prospectus. 44 West Seventeenth St., NEW YORK

## IF YOU STAMMER

Attend no other school until you hear from me. Largest stammering school in the world curing by the improved natural method. No sing-singing or time-beating methods. Beautiful 88 page book and special rates sent free.

Lee Wells Millard, President, NORTH-WESTERN SCHOOL FOR STAMMERS, Inc., 917 First St., Milwaukee, Wis.

## LEARN WATCHMAKING

refined, profitable labor—Competent men always in demand. We teach it thoroughly in as many months as it formerly took years. Does away with tedious apprenticeship. Money earned while studying. Positions secured. Send for catalog

St. Louis Watchmaking School, St. Louis, Mo.

## Highland Park College

DES MOINES, IOWA

Enter Any Time

2000 Students Annually

One of the most completely equipped ENGINEERING SCHOOLS in the country

Students may enter any time, and their term is 12 weeks from the day they enter.

Mention course in which you are interested. Address,  
O. H. LONGWELL, President, Des Moines, Ia.

## COURSES OFFERED

1. CIVIL, ELECTRICAL AND MECHANICAL ENGINEERING COURSES. Standard courses are offered in Civil, Electrical and Mechanical Engineering. Special opportunity is offered for making up work or for taking a complete course preparatory to the standard Engineering Courses. Shop work from the beginning comes in preparatory courses. See our new Engineering Catalogue.

2. SHORT COURSES

- 1. One Year Electrical Engineering Course
- 2. One Year Telephone Engineering Course
- 3. One Year Steam Engineering Course
- 4. One Year Machinists' and Automobile Course
- 5. One Year Course in Mechanical Drawing

Just a fair common school education is all that is required for entrance to these courses. These courses are very practical and are intended for those who have but limited education and do not see their way clear to take a complete Engineering Course. The Machinists' Course is especially practical. The machine shop is the most complete to be found in connection with any Engineering School in the United States.

## SPECIAL COURSES

1. TRACTION ENGINEERING. This is the most complete course in Traction Engineering offered by any Engineering School in the country. It may be completed in three months. Students are taught how to make all repairs on engines as well as to handle them. Four traction engines used for experimental purposes.

2. GASOLINE AND AUTOMOBILE COURSES. These courses may be completed in three months. They are exceedingly practical. Complete Chauffeur practice. Just a fair common school education is all that is necessary to enter.

3. FARM BLACKSMITHING, FARM CARPENTRY.

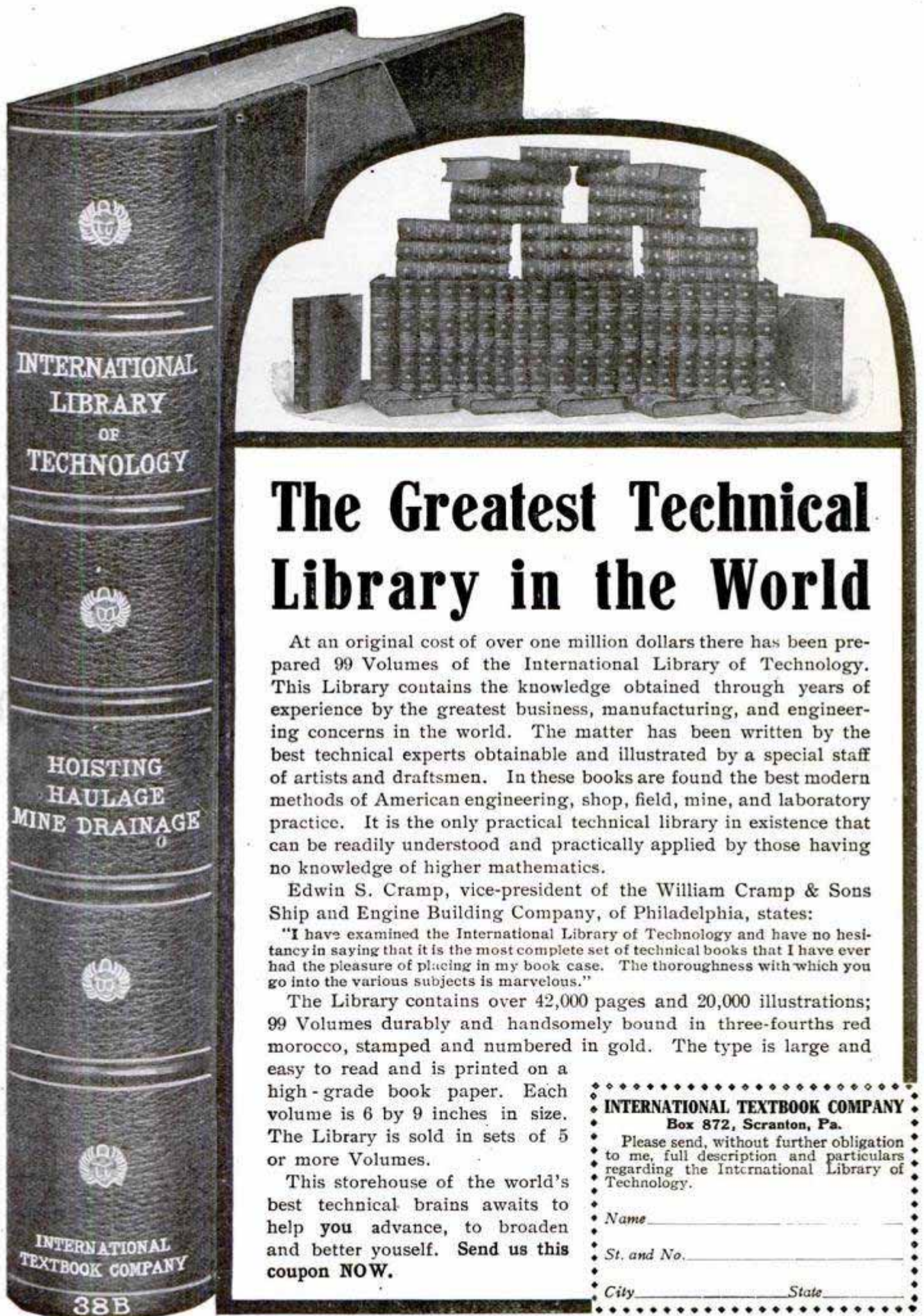

## The Greatest Technical Library in the World

At an original cost of over one million dollars there has been prepared 99 Volumes of the International Library of Technology. This Library contains the knowledge obtained through years of experience by the greatest business, manufacturing, and engineering concerns in the world. The matter has been written by the best technical experts obtainable and illustrated by a special staff of artists and draftsmen. In these books are found the best modern methods of American engineering, shop, field, mine, and laboratory practice. It is the only practical technical library in existence that can be readily understood and practically applied by those having no knowledge of higher mathematics.

Edwin S. Cramp, vice-president of the William Cramp & Sons Ship and Engine Building Company, of Philadelphia, states:

"I have examined the International Library of Technology and have no hesitancy in saying that it is the most complete set of technical books that I have ever had the pleasure of placing in my book case. The thoroughness with which you go into the various subjects is marvelous."

The Library contains over 42,000 pages and 20,000 illustrations; 99 Volumes durably and handsomely bound in three-fourths red morocco, stamped and numbered in gold. The type is large and easy to read and is printed on a high-grade book paper. Each volume is 6 by 9 inches in size. The Library is sold in sets of 5 or more Volumes.

This storehouse of the world's best technical brains awaits to help you advance, to broaden and better yourself. Send us this coupon NOW.

INTERNATIONAL TEXTBOOK COMPANY  
Box 872, Scranton, Pa.

Please send, without further obligation to me, full description and particulars regarding the International Library of Technology.

Name \_\_\_\_\_

St. and No. \_\_\_\_\_

City \_\_\_\_\_ State \_\_\_\_\_



Portable Reading Lamp

JUST PUBLISHED

# Arts-Crafts Lamps

## How To Make Them

By JOHN D. ADAMS

### 16 Beautiful Designs, 25 Cents

AS FOLLOWS:

Two Light Portable—Portable Reading—Four Light Chandelier—Reading Lamp—Dining Room Dome—Porch or Den Lantern—Four Light Chain Hung Chandelier—One Light Portable—Lantern—Drop Light—One Light Bracket—Piano Lamp—Wall Lamp—Electric Candle Sconce—Newel Post Lamp—Chain Hung One Light Bracket.

**Plain Instructions—Dimensioned Detail Drawings and Illustrations of Each Finished Design**

A handy little working manual of 96 pages, printed on the best quality of book paper and handsomely bound in cloth. Supplied by your newsdealer or may be ordered direct from the publisher

**POPULAR MECHANICS BOOK DEPARTMENT, 225 Washington St., CHICAGO**

## READ THIS WONDERFUL STORY

128 Pages.  
Bound in Cloth.  
Illustrated.

# HEAT

Price  
Post-  
paid, **25c**

By **J. GORDON OGDEN, Ph. D., Professor of Physics, Fifth Ave. High School, Pittsburg**

*Thoroughly Understandable — Instructive — Immensely Interesting*

This book consists of a series of articles, each complete in itself, yet all pertaining to heat and its relation to modern mechanics.

**F**EW people realize that fire is the most remarkable and valuable discovery ever made by man. Prior to this, man was brother to the brute, but with the coming of fire, came all the wonderful development that has enabled man to assert and defend his claim as lord of creation. We are only in the infancy of high temperature development, yet read of the harnessing of intense heat to the wheels of progress; the contrivances whereby we are able to emulate the volcano in our laboratories so far as heat is concerned and weld steel rails in the street where they lie; the discovery of uses of rare metals in industrial lines by aid of heat. Investigation of the realm of low temperatures also discloses some wonderful facts. All these, and many other phases of this interesting subject are treated as shown by the following list of chapters:

1—Nature of Heat and How It Is Measured. 2—How Low Temperatures Are Produced. 3—Some Effects of Low Temperature Upon Matter. 4—The Production and Uses of High Temperature. 5—High Temperatures and the Rare Metals. 6—How Heat Travels. 7—How Heat is Measured. 8—Expansion and Contraction. 9—Energy and Fuels. 10—The Manufacture of Artificial Ice. 11—Steam Boilers and Engines.

**POPULAR MECHANICS BOOK DEPARTMENT, 225 Washington St., CHICAGO**

# The Sebastian

15-Inch Standard High Grade  
Low Price ENGINE LATHE

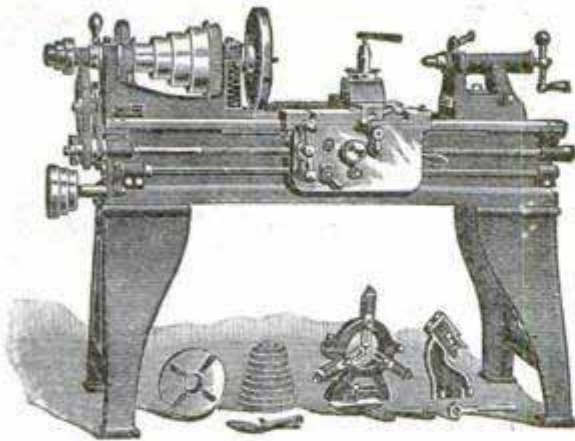

Automobile Builders, Garages, Repair Shops and General Jobbing Shops find this the Ideal Lathe for their work. Our Catalogue of Lathes and Tools Mailed FREE on request.

**THE SEBASTIAN LATHE CO.,** 107 Culvert Street, CINCINNATI, O.

## ANTI-NICOTINE

"Get the Pleasure Without the Poison"  
(Trade Mark Reg.)

**40c 3 FOR \$1.00**



## PIPE

THE PIPE THEY LET YOU SMOKE AT HOME

Looks and colors like meerschaum. Absorbs the nicotine and keeps on tasting sweet. You never had such an enjoyable smoke. Sent prepaid anywhere. Money back if not satisfactory.

Order 3 or More Today  
**H. MENGES, The Smokers' Friend**  
605 N. 7th St. ST. LOUIS, MO.

FREE UPON REQUEST

OUR

Valuable 96-Page Catalogue

OF THE

## Best Mechanical Books

It is well worth having and keeping for reference.

Popular Mechanics Book Dept.

225 Washington Street, Chicago

# REVERSIBLE "Linene"

## LINENE COLLARS

have a dull lustre and look just like linen, but are so cheap that they can be thrown away when soiled. They may be reversed and worn both sides.

10 for 25 cents at the stores

By mail 30 cents, or sample 6 cents in U. S. stamps.

Give Size and Style.

**REVERSIBLE COLLAR CO.**

Department U BOSTON, MASS.



## 127 KINDS IRON PUZZLES

Sample, secret key and 36 page book of cuts of all 10c, 3 leaders 25c  
**WESTERN PUZZLE WORKS**  
St. Paul, Minn.

# 9,059-Word Business Book Free

Simply send us a postal and ask for our free illustrated 9,059-word Business Booklet, which tells how priceless Business Experience, squeezed from the lives of 112 big, broad, brainy business men, may be made yours — yours to boost your salary, to increase your profits. This free booklet deals with

- How to manage a business
- How to sell goods
- How to get money by mail
- How to buy at rock-bottom
- How to collect money
- How to stop cost leaks
- How to train and handle men
- How to get and hold a position
- How to advertise a business
- How to devise office methods

Sending for this free book binds you to nothing, involves you in no obligation; yet it may be the means of starting you on a broader career. Surely you will not deny yourself this privilege, when it involves only the risk of a postal—a penny! Simply say, "Send on your 9,059-word Booklet." Send to **SYSTEM, Dept. 81-3, 151-153 Wabash Avenue, Chicago**

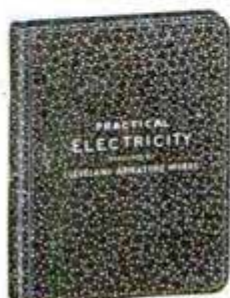

# A SCHOOL WITHIN ITSELF

There are XX chapters in all, XIX carrying you from the fundamental principles of electricity on through the various branches to a point where the careful student comprehends the complete designing, care and operation of a dynamo or motor, and one chapter on electric automobiles, outlining their construction, care and operation, and all about storage batteries and how to handle them. Each subject is carefully written and to the point. After a student studies a subject, he is questioned on that subject in such a manner as to bring clearly to his mind the points he needs to know regarding same. The book contains a dictionary defining 1500 Electrical Words, enabling the reader to ascertain the meaning of any electrical word, term or phrase used in this book, as well as hundreds of others in common use. All required tables necessary in the study are in it.

**\$2.00 PER COPY—FIFTH EDITION—26,000 COPIES SOLD.**

The offer we make of refunding money if book is not satisfactory upon examination is AN UNUSUAL ONE in connection with the sale of a book. But we have no fear of its return. Your decision will be what thousands of others have been. Money would not buy it if it could not be duplicated. We could print testimonials by the hundreds. It is best to order and be your own judge of its merits.

**CLEVELAND ARMATURE WORKS, Cleveland, Ohio**

Armatures and Fields Wound — Commutators Filled  
**AMERICA'S GREATEST REPAIR WORKS.**

# From Dinner Pail to Draughting Table



ONE YEAR AGO a young man in an Iowa town was working as a machinist's helper at \$1.75 a day. Now he is a Draughtsman in the offices of a large manufacturing concern at a salary of **\$1200.00 a year.**

## Every Young Man

with ambition and grit, every young man who wants to *really count* for something in the business world, who wants to be *more* than a mere cog in a big machine, can rise step by step until he *gets the position he wants*; can do it easily and without privation or sacrifice. It isn't hard to climb up higher if you once get started right. It isn't hard to learn what you need to know in order to fill a *good* position. It isn't hard to get in a class of *successful* men, of men who work with their heads instead of their hands.

### Sign the Coupon

and send it back. Find out what we can do for YOU. It costs you *nothing* to get this information and it may mean *everything* to you—*better position, bigger pay, more money to spend for the good things of life*—**REAL SUCCESS**

**American School of Correspondence**  
CHICAGO, U. S. A.

### Opportunity Coupon

American School of Correspondence, Chicago, U. S. A.

Please send me your Bulletin and advise me how I can qualify for the position marked "X." Pop. Mech 3 '11

- |                           |                          |
|---------------------------|--------------------------|
| ... Book-keeper           | ... Draughtsman          |
| ... Stenographer          | ... Architect            |
| ... Accountant            | ... Civil Engineer       |
| ... Cost Accountant       | ... Automobile Operator  |
| ... Systematizer          | ... Electrical Engineer  |
| ... Cert'f'd Public Acc't | ... Mechanical Engineer  |
| ... Auditor               | ... Moving Picture Op'r  |
| ... Business Manager      | ... Steam Engineer       |
| ... Commercial Law        | ... Fire Insurance Eng'r |
| ... College Preparatory   | ... Reclamation Engineer |

NAME .....

ADDRESS .....

**This  
Coupon  
Did  
It**

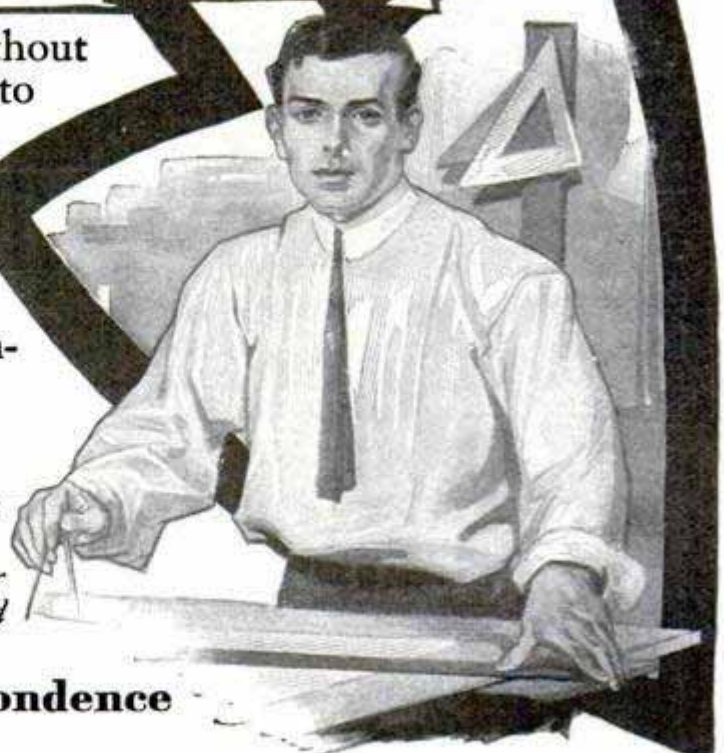



# Popular Mechanics Magazine

WRITTEN SO YOU CAN UNDERSTAND IT

Vol. 15

MARCH, 1911

No. 3

## MACHINE ENABLES SCIENTIST TO READ CHARACTER

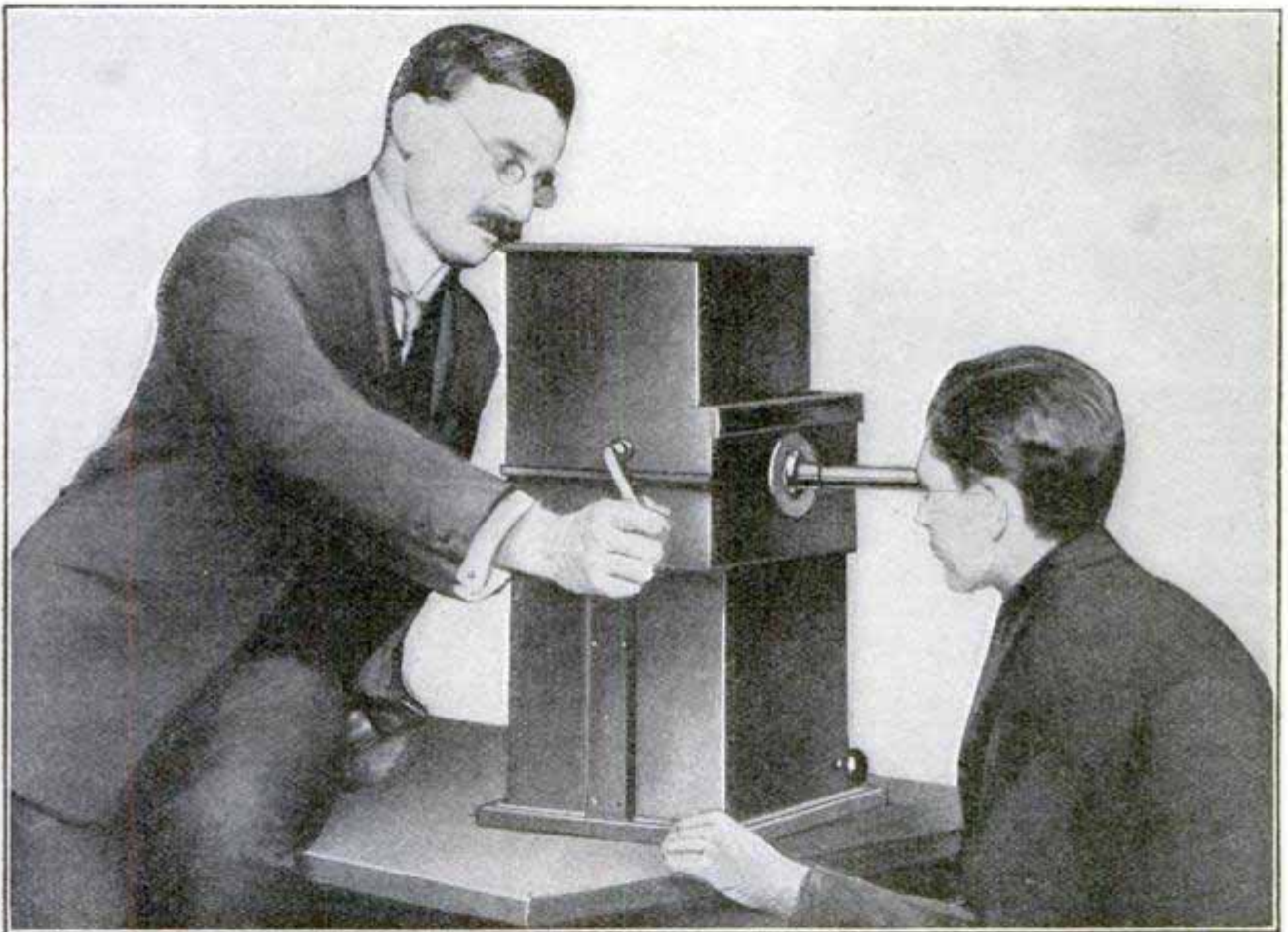

English Scientist Determining Character of Youth with "Perseveration" Machine

**N**OW that machines have been made to tell whether or not a person is lying, the world will not be startled by the announcement that an English scientist has perfected an apparatus with which he proposes to read character. His machine is an appliance to test people for what he terms "perseveration." This quality, in its varying degrees, exercises a powerful influence on character and is said to be relatively low in brilliant persons and high in pro-

found thinkers. Maniacs have small, and melancholics a high degree of "perseveration."

The mechanism determines the grade of each patient by presenting colors to the eye intermittently until the observer ceases to distinguish what he calls a "flicker" in the subject. Then he stops the machine, counts the number of crank revolutions on his color-showing apparatus and deduces the "perseveration."

## QUADRUPLANE MAKES MANY SHORT FLIGHTS

Several hundred short flights, none of which have been more than a mile

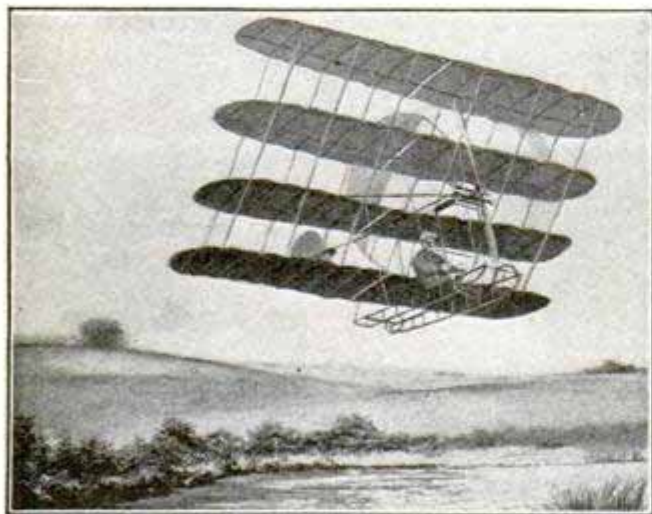

Kentucky Quadruplane in Flight

in length, have been made with this curious quadruplane among the mountains of Carter County, Kentucky. The inventor is M. B. Sellers, who has been experimenting with this type of machine several years.

The four supporting planes are placed one above the other in step formation, the upper plane being in advance. It is claimed to be one of the largest aeroplanes in the world and the total weight, including the operator, is only 250 lb. The first model, complete with engine, propeller, etc., only weighed 78 lb., but the weight of the later models has been increased. The planes have a spread of 20 ft., and the total sustaining surface is 250 sq. ft. The speed attained in the short flights, with a 5-hp. 2-cylinder French motor, direct-connected to the propeller, has been about 26 miles an hour.

## SOLIDIFIED GASOLINE FOR AUTOMOBILES

A chemist of Birmingham, Eng., according to reports sent by the United States consul in that city, has invented a means of converting gasoline into a stiff, white jelly, in which condition it can be used as fuel for automobiles.

The conversion is effected by adding  $1\frac{3}{4}$  per cent of soapstone and alcohol.

The inventor claims an economy of 30 per cent for the jelly as compared to gasoline in its natural state, also that more solidified gasoline than liquid gasoline can be carried in the same space. A block or cube of solidified gasoline, when being vaporized either in a hot pipe or in the ordinary way, does not cause liquefaction of the mass, the heat simply causing a slow formation of vapor which is consumed in the engine.

## NEW INSULATING BRICKS FLOAT

A new insulating lining brick, designed for use where absolute freedom from dampness is necessary, is so waterproofed and burned that 45 per cent of the volume is confined air. Its specific gravity is only 0.90, although its ultimate strength in compression is claimed to be 750 lb. per square inch. The bricks float in water and are claimed to be moistureproof.

## AN ELECTRIC MOUSE TRAP

A mouse trap that electrocutes its victims has recently been invented for use in houses where electricity is used for lighting. The trap is simply a box in which two copper plates are set. The bait is put behind the forward plate and the current turned on. When the

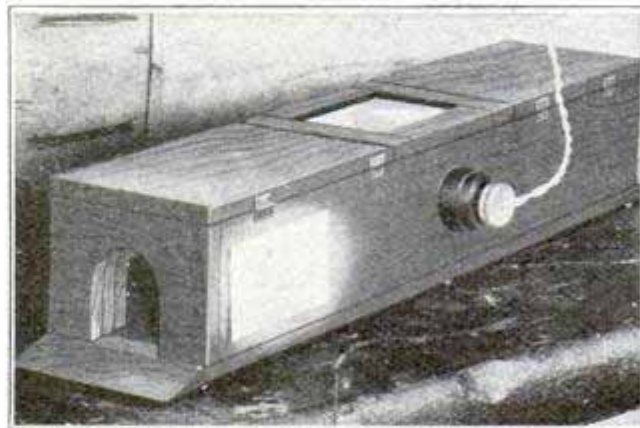

New Mouse Trap That Electrocutes Its Captives

mouse attempts to reach the bait, it has to stand on both plates and is instantly killed.



#### A MIGHTY SHADOW

**T**HIS remarkable photograph was taken at noon from the visitors' gallery of the Metropolitan Building, New York, after a heavy snowstorm. The shadow was cast by the tower of that skyscraper, and it extends from the corner of Madison Ave. and 23rd St. to Broadway and 26th St., a distance of about five blocks. Fifth Ave. may be seen in the middle foreground.

## THE LARGEST VALVES IN THE WORLD

The three huge gate valves constructed to control the water used to

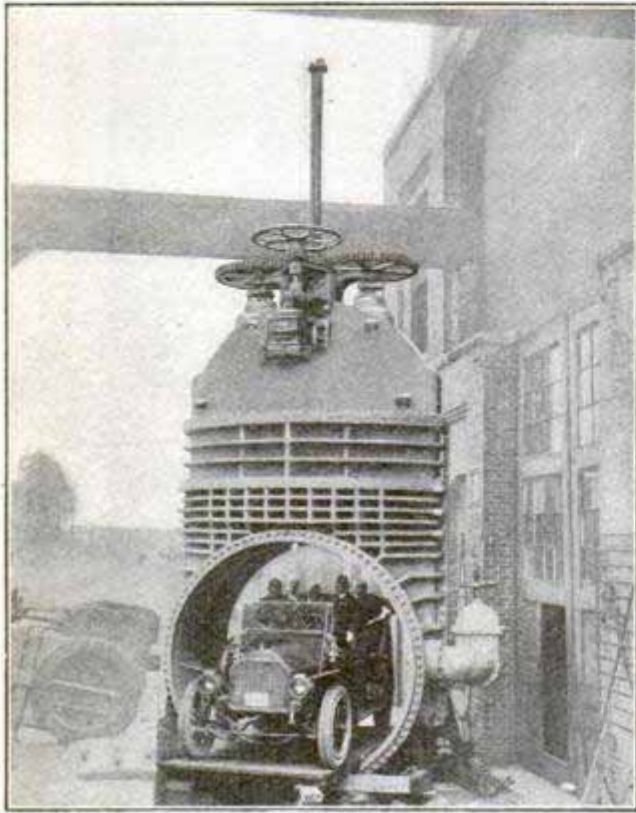

**Touring Car Passing Through Waterway of Huge Valve**  
drive the 12,000-hp. turbines of the Ontario Power Company at Niagara Falls, are undoubtedly the largest in the world. They have a waterway diameter of 9 ft., weigh 130,000 lb. each, and in actual operation each will be under a pressure of more than 550,000 lb.

Two flat cars were required for the transportation of each valve. The overall height of the valves is 30 ft. 3 in.; the width, 11 ft., and the total thickness over the flanges is 6 ft. 8 in. The body is of cast iron and the gate of cast steel.

The raising of the valve gate is accomplished by means of two tobironze spindles, 12 ft. 3 in. long, and 4½ in. in diameter, with threads having a 2-in. pitch. These spindles are operated through gearing by a 15-hp. motor, the operation of completely opening or shutting requiring three minutes. A 14-in. bypass valve is provided for relieving the water pressure when opening or closing the valve.

## ARMY WILL USE WIRELESS AT WESTERN POSTS

Wireless telegraph is to be the means of communication between army posts in the West, according to the latest plans of the War Department. Orders have been issued from Washington to the commanding general of the department of the Missouri, at Omaha, to discontinue the use of commercial telegraph lines for the transaction of government business between Omaha, Ft. Leavenworth and Ft. Riley, Kans. Stations are also being installed at Cheyenne, Denver and other important military posts in the West.

## MOTOR SLEIGH FOR RUSSIAN EMPEROR

The motor sleigh for the Emperor of Russia received the highest awards of the French Automobile Club, the gold medal of the French Touring Club, and the gold medal of the Imperial Russian Automobile Club.

The machine may be used either as a wheeled vehicle or as a sleigh, the front wheels being carried on boat-like runners when used as the latter. The drive wheels, which have dual tires, are shod with anti-skid chains,

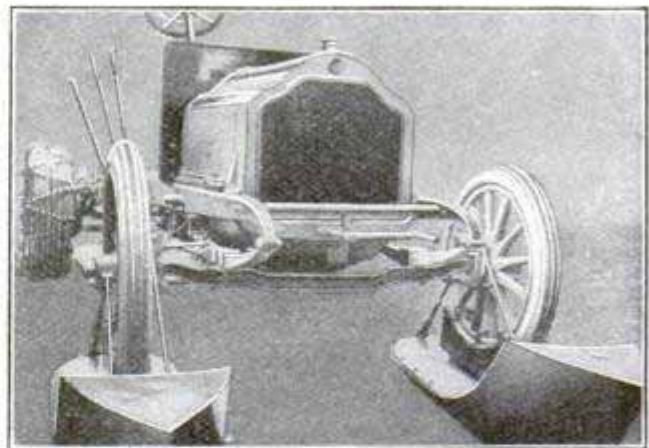

The Czar's Motor Sleigh

and inside of the wheels are emergency runners to keep the wheels from sinking too deep into the loose snow.

⌈The first financial failure on record of a concern engaged in the exploitation of aviation occurred in Paris recently.

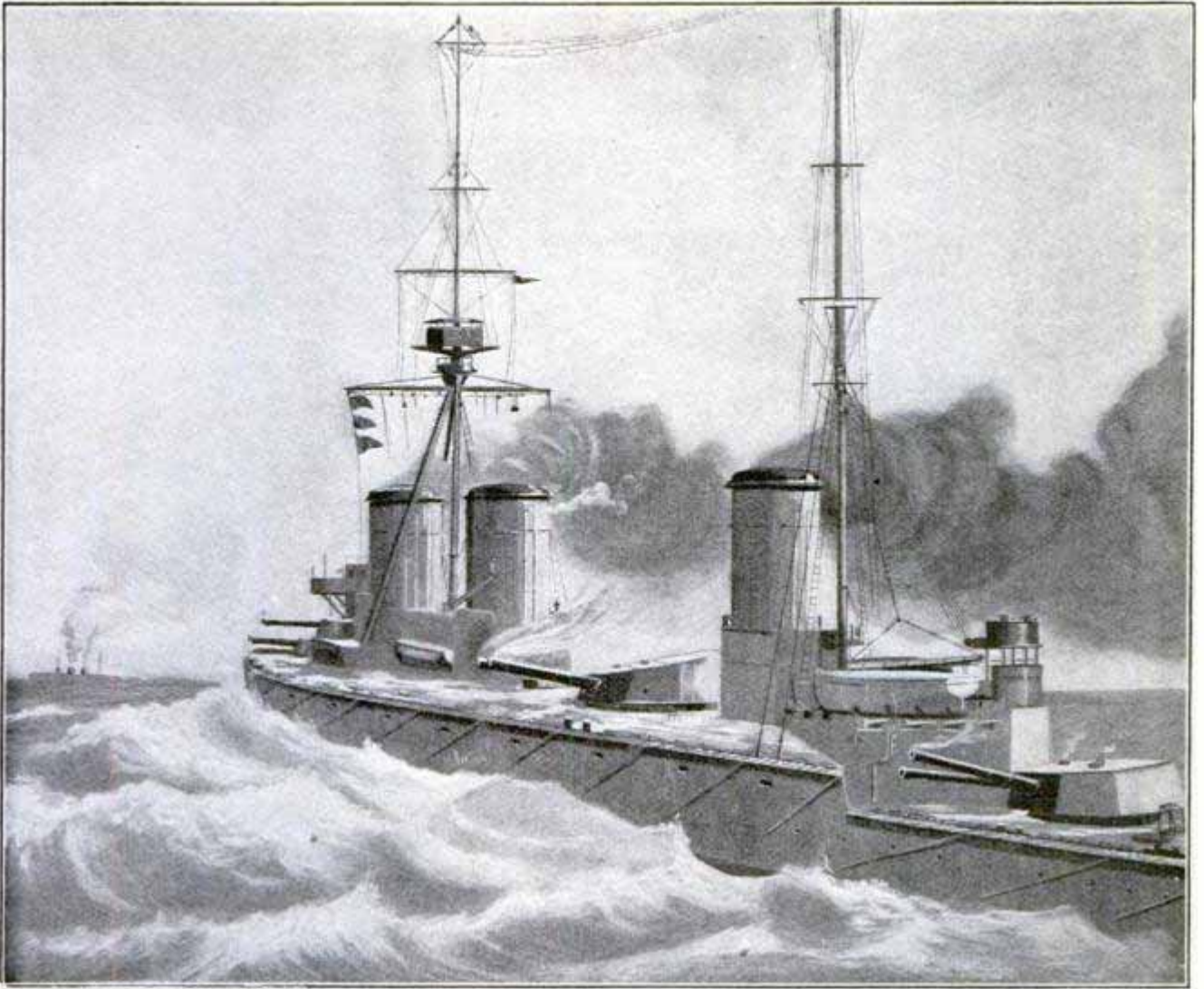

Courtesy the Sphere, London

Newest Type of Fighting Machine.—Designed to Strike Heavy Blows and Run. Every Possible Piece of Superstructure Has Been Dispensed With

## GREAT BRITAIN'S NEW BATTLESHIP-CRUISERS

Great Britain's "Princess Royal" type of battleship-cruisers, now under construction, present as great a revolution in sea fighting machines as did the first "Dreadnought."

Driven at a speed of 30 knots (approximately  $34\frac{1}{2}$  miles an hour) and provided with a main battery of eight 13.5-in. guns, these wonderful fighting machines could, it is said, meet and severely punish the most powerful British battleship now in commission without much risk of being harmed in return. To make the point still clearer, the battleship-cruiser, driven at high speed by its turbines, could maneuver at a distance of from 500 to 900 yd. beyond the effective range of the 12-in. guns of the present dreadnoughts and hurl her own projectiles home.

The eight 13.5-in. guns of the battleship-cruisers are on the center line, and can be fired on either broadside, while four may fire ahead, and two astern. The bridge and superstructure have nearly disappeared on these ships, and only a single tripod mast and a light mast to carry the wireless aerials and signals are in evidence. The big-gun barbettes instead of being round, have a series of angles to throw off the enemy's shells.

☞ Experiments now being made at Johns Hopkins University on the analysis of the fundamental tones and partials that make up every musical sound are expected to lead to a method for determining the value of violins and similar instruments by their tone.

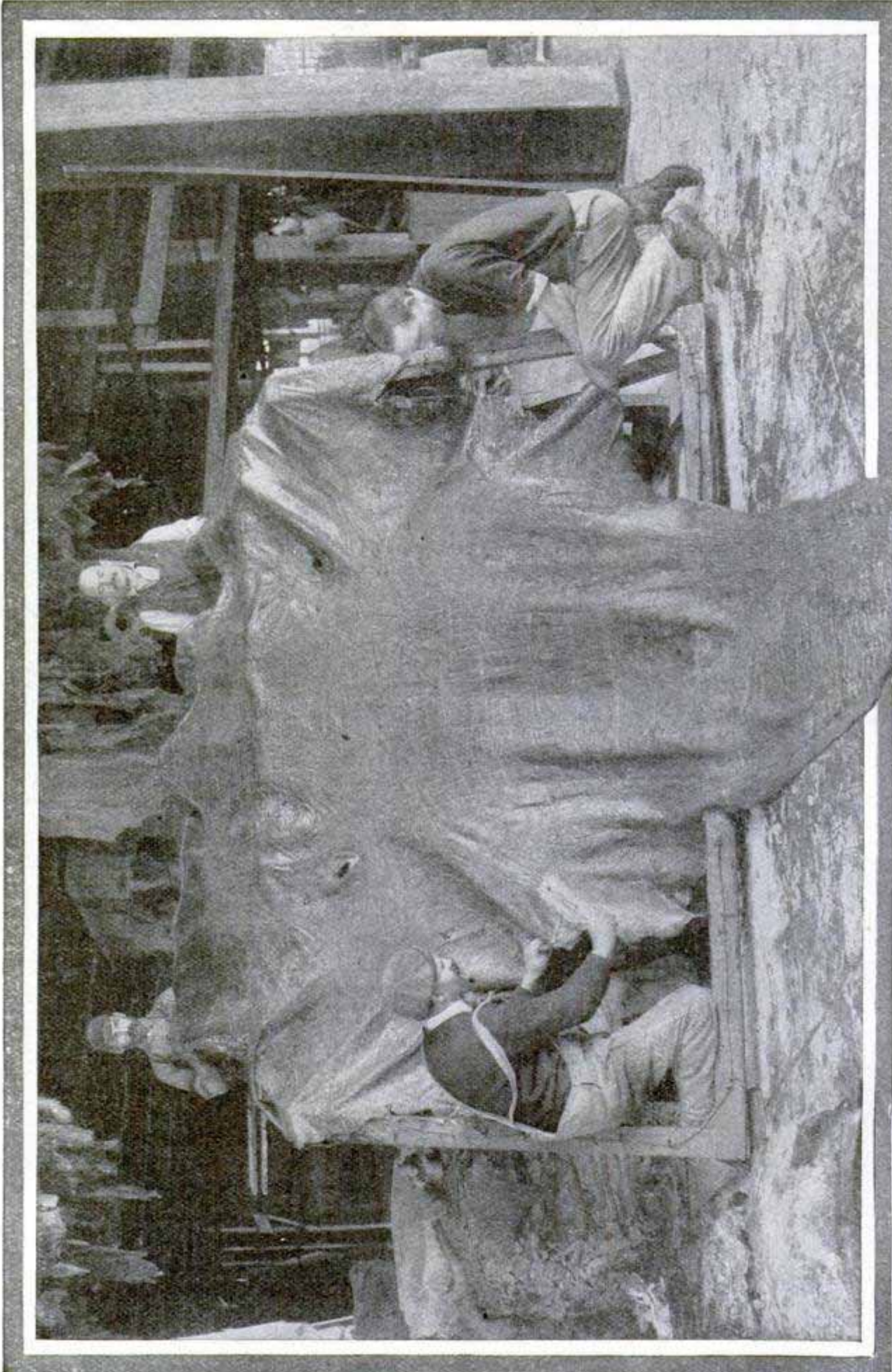

SMITHSONIAN INSTITUTE TAXIDERMISTS PREPARING HIDE OF HUGE

ELEPHANT SHOT BY COL. ROOSEVELT IN AFRICA

## CANARIES ACT AS MINE-GAS DETECTORS

Caged canaries played a prominent part in the attempts made to reach the men suffocated by the explosion which occurred in a coal mine a few miles from Manchester, Eng., recently. Picked men from all the pits in Lancashire were rushed to the Pretoria pit, and gang after gang attempted to penetrate the passages and galleries. At the head of each gang or relief team were six men equipped with breathing helmets whose duty was to repair the broken ventilation doors so as to restore the thorough ventilation of the pit, and to report the first indications of gas. Their lamps, of course, gave them an idea as to the condition of the air, but in addition they carried canaries in cages, as these birds show signs of distress at the first presence of gas.

The Pretoria-pit disaster was the worst in England in many years, some 360 miners, among whom were many boys, being killed. The mine was one of the best equipped in Great Britain, the coal being mined by electric cutters instead of by blasting or shot-firing.

## SPARE-PART OUTFIT FOR AEROPLANES

Just as the automobilist carries spare tires, spark-plugs, bolts and nuts, split pins, and other parts to make replacements when breakages occur in the use of the machine, so the airman today provides himself with an assortment of "spares." He does not carry these on his aeroplane, however, although the time may come when it will be possible to reduce their number to such an extent that they will not be a prohibitive burden even for heavier-than-air flying-machines. The French manufacturers of the Bleriot monoplanes now supply spare parts for their machines put up in neat arrangement in a wooden chest, with locks and suitable handles to facilitate handling in shipping by rail and boat. As exhibited

at the recent French aerial exhibition in Paris, the case contains two extra propellers, a pair of landing wheels and

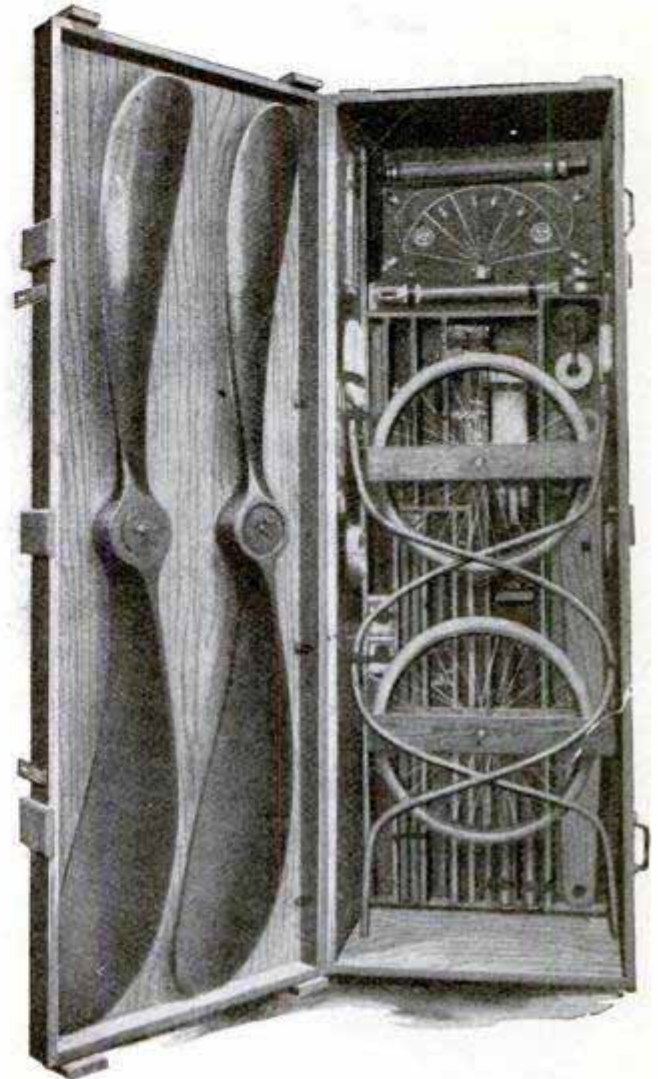

An Emergency Set for Airmen

two pieces of bent bamboo used to support the tail, finished parts for the frame, stranded steel cable in coils, and a multiplicity of small metal parts for different parts of the framework.

## RADIUM REDUCED TO \$75,000 A GRAM

Radium in "bulk" can now be bought comparatively cheap. The Austrian Ministry of Work recently sold Sir Ernest Cassel a gram of the precious stuff, for presentation to the English Radium Institute, for £15,000 (nearly \$75,000), "a price specially reduced on account of the large quantity purchased."

The radium will be used for cancer research.



That Night the Tide Reached the Schooner and Slowly She Slipped from the Sand

## FIGHTING ARCTIC PERILS WITH AN IMPROVISED STEAM SHOVEL

The remarkable story of how a resourceful skipper, applying his slight knowledge of mechanics, saved his ship after she had been thrown high and dry on the Alaskan Coast

By J. E. BECHDOLT

**P**ITTING natural forces against natural forces, boosting a little now and then with an improvised "steam shovel," when nature seemed to lag a bit behind, Capt. E. D. Hoffman overcame obstacles created by the Arctic seas and gales, and brought his schooner the "P. J. Abler" into Seattle after the vessel had been wrecked, piled high and dry on the beach at Goodnews Bay, Alaska, and locked securely up for the winter by the Arctic ice pack.

A mariner whose experience was gathered in more years than he cares to admit, with a spirit of adventure which had made him a soldier of fortune in many lands and carried him through many tight places, Captain Hoffman also possesses a knowledge of mechanics that stood him in good stead when he found himself, after a heavy

storm, securely beached on the Alaskan coast a few months ago. It required 21 days to extricate his ship from her perilous state, but the task was accomplished in a manner so novel that but for photographs of the various stages of the work, even the doughty captain's word might naturally be doubted.

The "Abler" sailed north from Seattle on Sept. 22, on her third voyage of the season, with government school supplies for Hooper Bay, Kodiak and Goodnews Bay. The last of the load was discharged at Goodnews Bay, near the mouth of the Kuskokwin River in Bering Sea. While the schooner lay at anchor in the bay on Nov. 1, a terrific gale blew up out of the North, and sweeping down Bering Sea struck the poorly sheltered harbor with spiteful violence. The "Abler" had been anchored under the shelter of the one



large hill, but no anchor made could withstand the strain put upon it by the gale.

The force of the wind was so great that a pile of 6 by 8-in. timbers which had been neatly piled, was scattered high in the air, many pieces being found at a distance of 600 ft. from their original location.

During the night, the "Abler" dragged anchor and was swept across the harbor to the southern side where she was driven on the sandy shore.

During the following day, the surges continued to lash the beach and when the storm had subsided, the schooner, which had offered a barrier to the shifting sands, was almost buried under tons of sand and gravel. On the side of the boat nearest the water the crew could stand on firm ground and look down into the hull.

Captain Hoffman saw at a glance that the schooner was being buried deeper with every passing hour, and he knew that a way had

to be found to dig out the vessel if he ever hoped to sail her again. To do this work by hand would take so long



Digging the Schooner Out of the Sands  
—Note Improved Steam Shovel at Right



Capt. E. D.  
Hoffman



Improved Steam Shovel at Work

that before it could be completed the Arctic ice pack would have locked the Bering Sea as far south as Unimak Pass and made navigation impossible. With the material at hand the shipwrecked men must extricate their schooner, and that very quickly.

All hands discussed the situation. Edward Adam Born, owner of the "Abler," who was acting as chief engineer, made the suggestion which led to Captain Hoffman's invention. The owner thought that a scoop might be rigged by which the men could dig out the sand in large quantities. Then the captain startled them by announcing that he had a steam shovel to do the work.

The men were put to work at once, rigging up the captain's "steam shovel." A gasoline "drum" was

sawed in two parts diagonally, making of each half a scoop shaped very much like that which a grocer uses to scoop sugar. The "Abler" has a gasoline-driven winch at the bow which was used for handling heavy cargo and lifting anchors. On the winding drum of this winch Captain Hoffman coiled a long cable. The free end of the cable was strung through a block at the head of the foremast, along the mainmast head through another block, and thus to the aftermast where the line came down to a block rigged at the end of the spanker boom, which was swung out astern.

The free end of this cable was then made fast to the scoop which had been rigged with handles so that a man could guide it. The scoop was dragged to the forward end of the schooner and the winch started. With a sailor to guide it, this power shovel made short work of the heavily packed sand. In ten days the schooner had been uncovered and stood, clean to the keel, at the head of a little canal leading down to the water.

However, the tide did not reach the schooner until 20 days after she stranded. While the steam shovel work was in progress, the storm was followed by intense cold. The Bering Sea ice pack, driven by the squall, reached Goodnews Bay within a couple of days after the blow, and by the time the schooner was uncovered, the bay was frozen hard to a depth of several feet.

While part of the schooner's crew was making ready for sea, others, under direction of Captain Hoffman, were preparing for an overland retreat. They traded with the natives for five good sledge dogs, a sledge and outfit for the trail. Captain Hoffman planned, if driven to it, to desert the ship and travel with the crew from Goodnews Bay to Togiak, inland to Lake Iliamna, across the lake and into Iliamna Bay in Cook Inlet, out of the reach of the Arctic ice, and a point of call for a steamer.

Until Nov. 21 the "Abler" lay on the beach and the waters of Goodnews Bay

continued frozen fast. The thermometer registered far below zero, varying occasionally as the winds blew with the frozen breath of the North. All but the captain had abandoned any idea of sailing back to Seattle and were bending their energies toward preparations for the trail.

Captain Hoffman was figuring on just one chance, that occasional miracle of the arctic, the "chinook," a south wind which sometimes blows in the heart of winter, bringing warm weather and melting the snow even at Dawson City, in the heart of the Klondike.

Luck favored the skipper. On the morning of Nov. 21 he came on deck and sniffed the air.

"We put to sea tonight," he announced to his incredulous shipmates.

Before noon the wind was blowing steadily from the south, a soft, balmy breeze. By afternoon the mercury in the thermometer had climbed out of hiding and registered 46 degrees above zero. The ice broke up quickly. That night the tide reached the schooner and slowly she slipped from the sand. She was hauled into deep water and anchored.

Next morning another difficulty confronted the "Abler." While the schooner was on dry land the propeller shaft had frozen tight in the sleeve. There was not a moment to lose, for at any time the Arctic ice pack might again close in. It was impossible to get at the frozen part, so Captain Hoffman rigged a chain lever around the shaft, put a long stout wooden lever into that and fastened the upper end to the spanker boom, giving him a double leverage on the shaft. This leverage was enough to either break the shaft or turn it over. Fortunately it turned.

The "Abler" got out of the ice under power and once her nose was in Bering Sea the wind favored her. She made the run from Goodnews Bay to Seattle in 18 days, logging about 200 miles a day under sail.

---

CA blacksmith in Los Angeles recently broke his neck while trying to button on his collar.

## AN ELECTRICAL RECORDING TARGET

An automatic electrical recording target, developed especially for indoor shooting with miniature rifles, has recently been introduced by an English firm. It consists of two principal parts, a recording or object target, and a reproducer or indicator target.

The object target contains a roll of paper, which is perforated by the rifle bullet. The position of the hit is recorded electrically on the reproducer target by means of a small white disk moving behind a transparent facsimile of the object target.

The motion of the disk is effected in the following manner: When the shot is fired, a small hole, E (see bottom right-hand cut), is made in the paper roll. The electric current is then switched on. This causes the paper to unwind from roller A, around speed roller B, and on to receiving roller C. In this move-

ment, the hole passes under a row of electrical contact fingers, D. One or more of the fingers will thus pass through the hole and establish another circuit which stops the mechanism, and at the same time causes an instrument in the reproducer target to

move the small white disk up or down a distance corresponding to the vertical position of the bullet hole. The horizontal displacement of the hole is simultaneously transmitted either mechanically (by means of a cord or belt) or electrically to the reproducer target. Thus the final position of

the white disk behind the transparent reproducer target indicates the exact position of the bullet hole in the object target. It will be obvious that it does not matter whether the object target be fixed or moving, for the relative position of the actual and indicator targets is always the same.

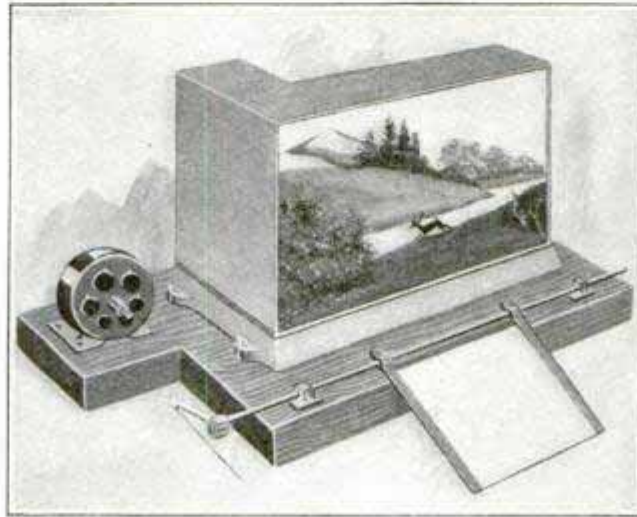

**RECORDING OR OBJECT TARGET**  
Shown adapted for use as moving target. Bull's-eye is folded down

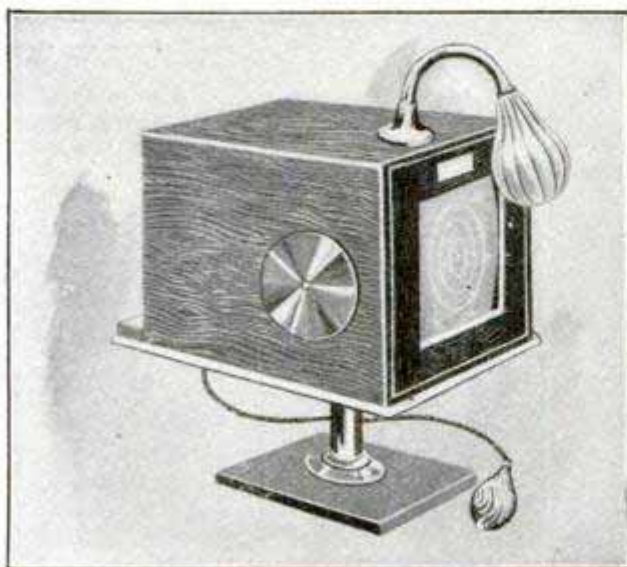

**REPRODUCER OR INDICATOR TARGET**  
Target is transparent, and small white disk behind it shows position of hit

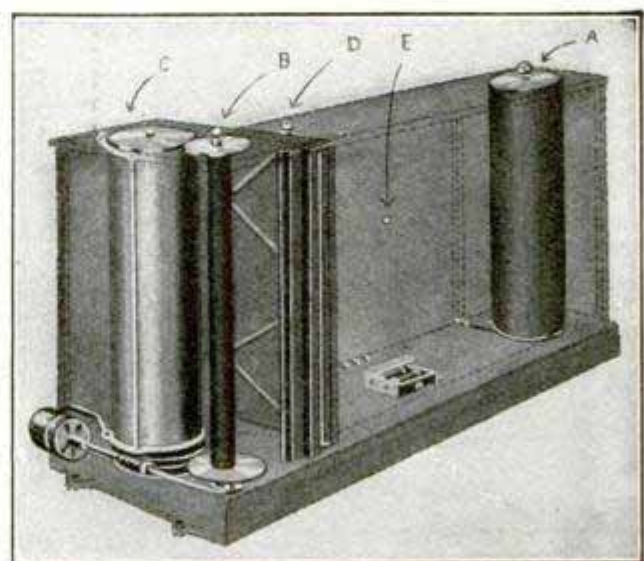

**PAPER ROLL MECHANISM**  
Shows interior of the recording or object target and movable paper roll

## Some of the Most Interesting Ideas Which Were

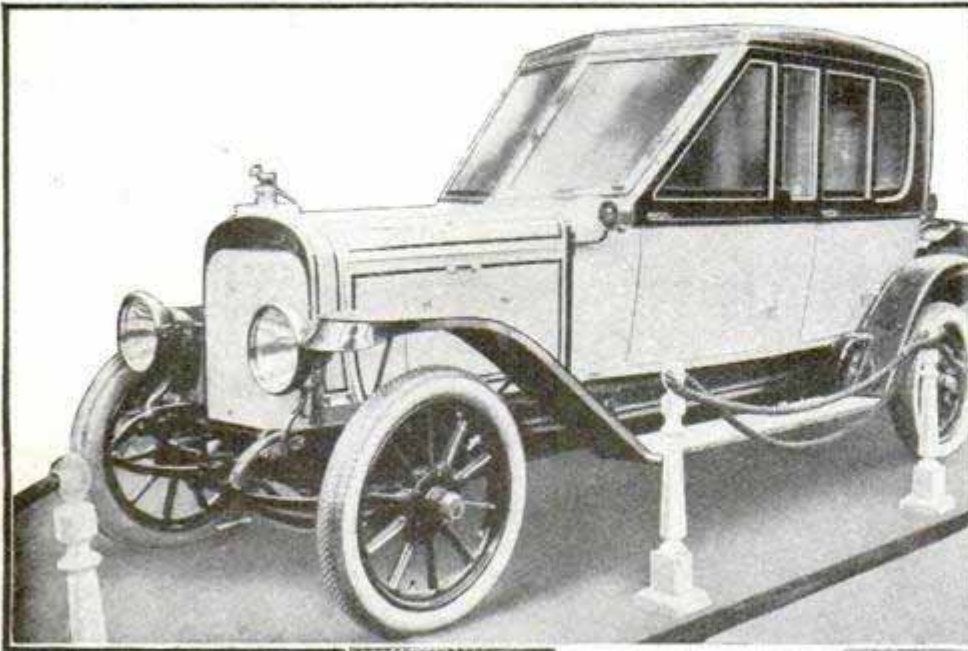

A touring car with sloping front panels completely inclosing the chauffeur without carrying the body too far forward. This design gives the whole a graceful appearance, and decreases wind resistance.

Automobile equipped with front-wheel hub brakes. The chauffeur controls the brakes by means of a foot lever. The value of the front-wheel brake is still undetermined.

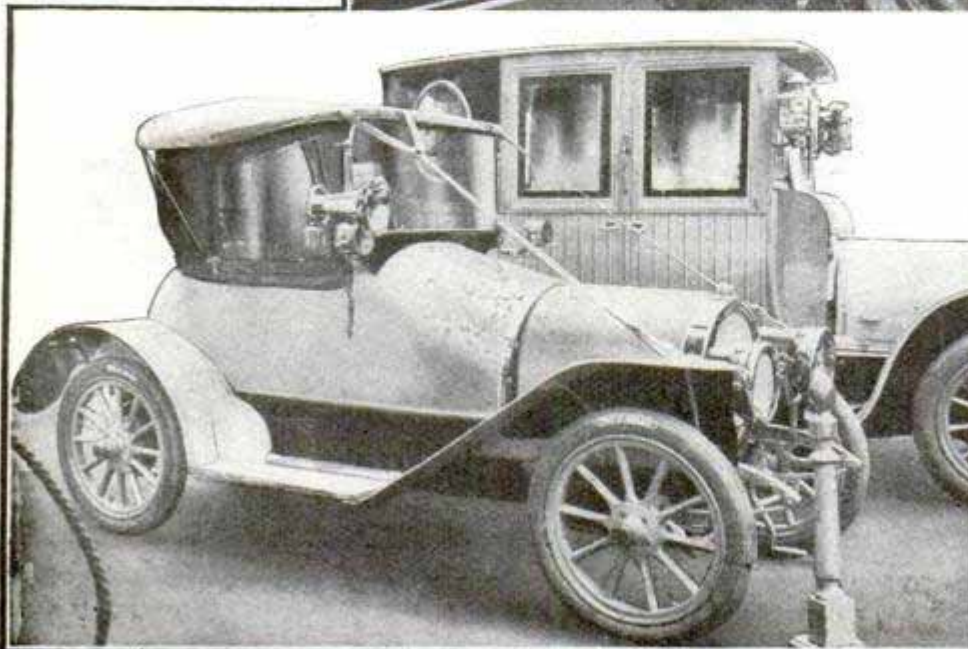
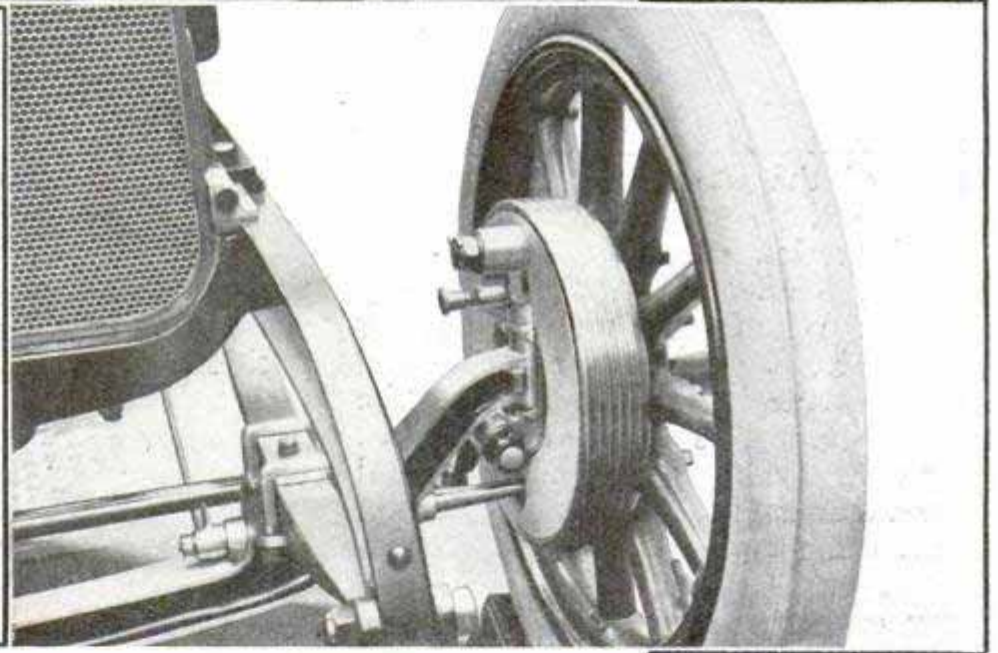

Gentleman's roadster, provided with completely enclosed, collapsible hood. The body of the car has a scuttle dash, the inner end of which carries the windshield supporting the top.

## Displayed at the Recent Automobile Exhibit in Paris

Submarine type of body in which two persons can sit absolutely at ease even when running at 50 miles an hour. Pilot house has large, curved front window and oval windows in sides.

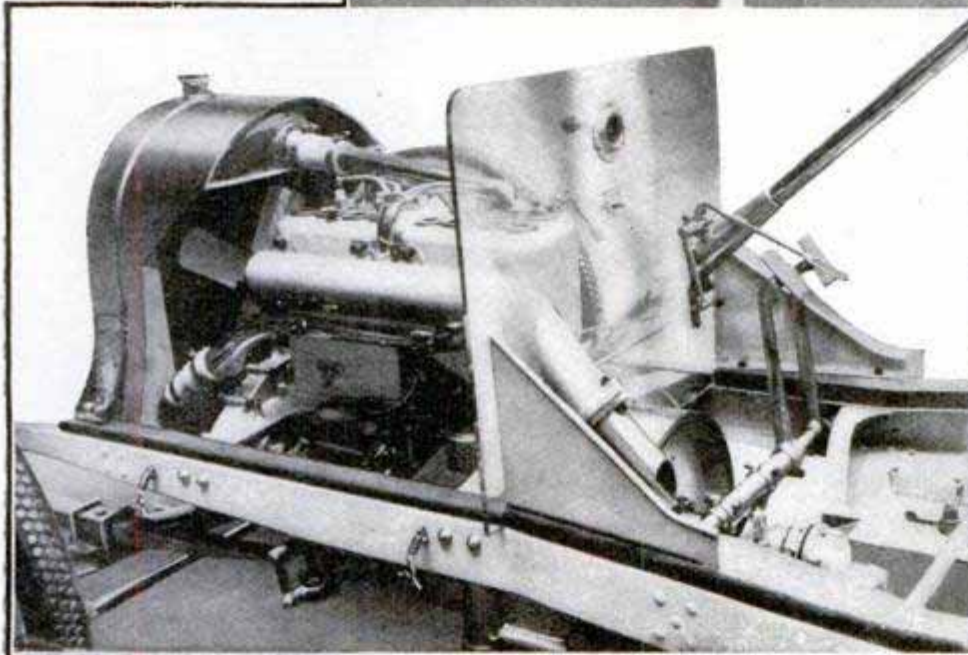
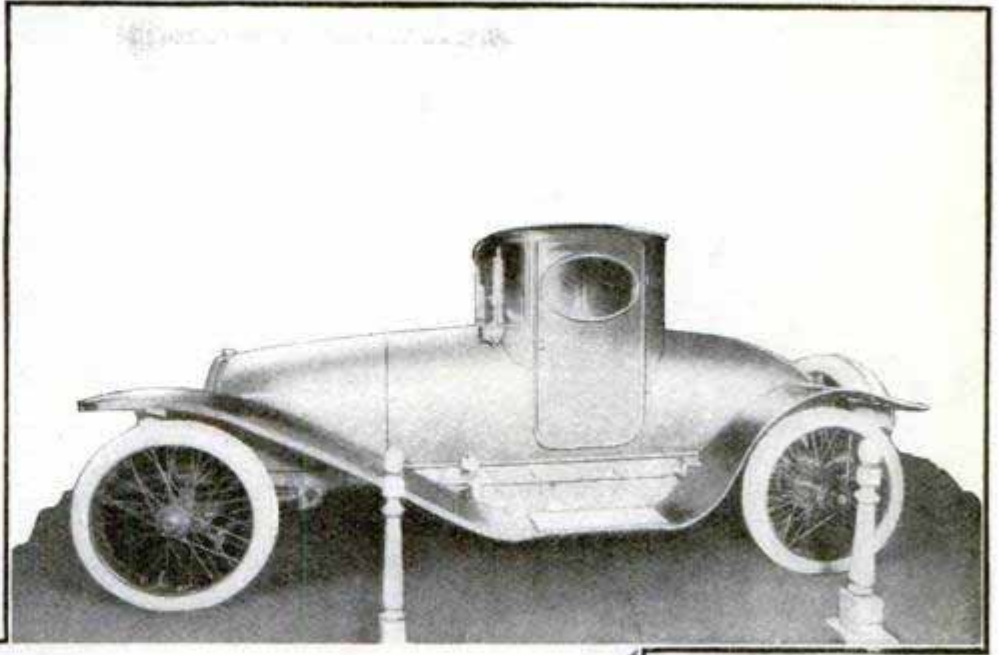

Motor of 4-cylinder, 24-hp. type with glass dash through which the driver may glance at mechanism at any time. Bonnet is removed to show side view of engine.

The body of this double compartment automobile is patterned after the stage coaches which were once the principal means of travel in Europe. Coaches of like shape are still used in Spain.

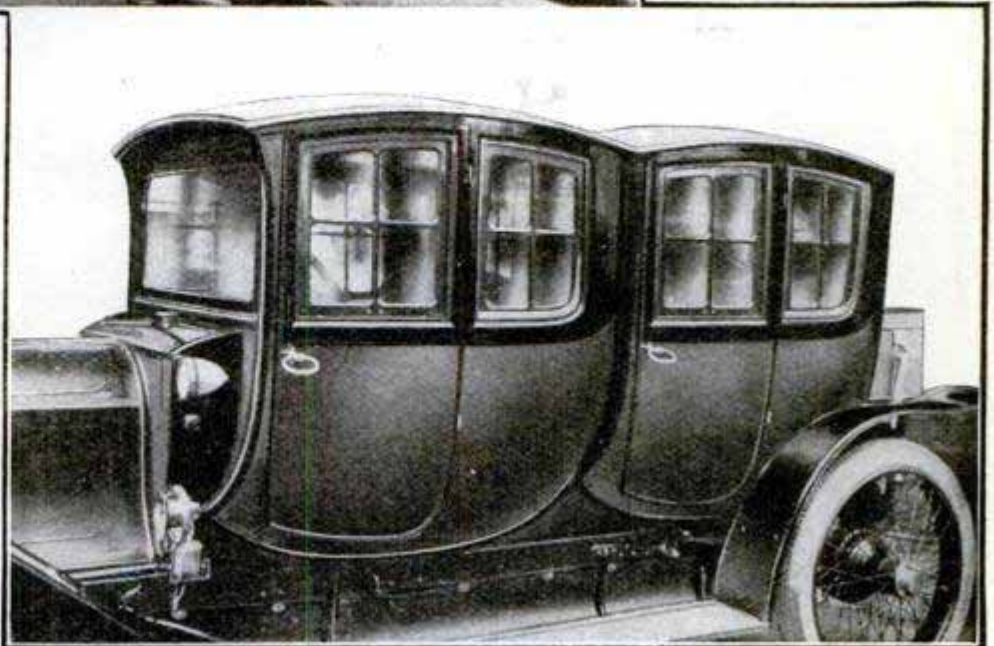

### A SERVICEABLE TRAVELING HOIST FOR GARAGES

Traveling hoists of this type are now included in the general equipment of garages. It is surprising what number

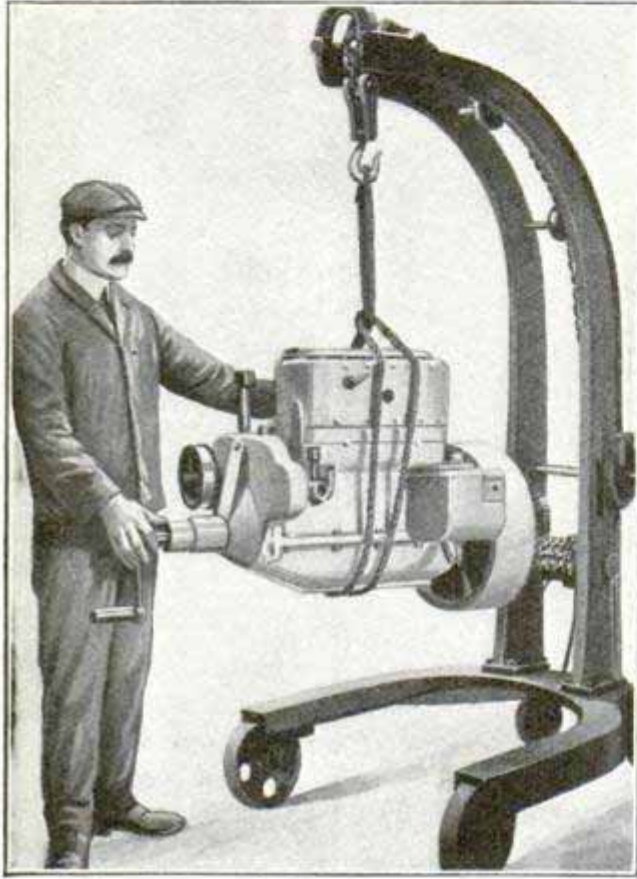

Portable Garage Hoist

of tasks they can be made to perform, such as lifting out and transporting motors from place to place, and raising one side or end of an automobile. The U-shaped truck makes possible the handling of objects in awkward places.

### PIECE OF BROKEN WHEEL WRECKS CAR INTERIOR

A section of a broken car wheel partially wrecked the interior of a passenger car on a Long Island railroad recently, when the wheel broke while the car was in motion. The jagged piece of steel which came into the car was about one-third of the wheel, and tore its way through the car floor directly under the seat of a woman passenger. She was hurled over the seats in front of her, half the length of the car, striking against an iron post, breaking her ankle. The section of the wheel tore up the flooring and the seats in the immediate vicinity and struck the roof, wrecking the whole rear section of the car.

### WALKING-STICK WEAPONS CARRIED BY PARISIANS

Sword canes have been in existence for many years, but the makers of weapons in Paris have extended the idea to include daggers, bayonets, revolvers and guns, all hidden in harmless-looking walking sticks.

The gun cane is provided with a metal stock for steadying it when shooting, while the revolver cane has a dagger attachment, to be used should the bullets fail. The mechanism of the cane and bayonet combination is such that a single movement brings the weapon out of the head of the stick.



The Cane Bayonet at Head of Stick

French Walking-Stick Gun

Revolver, Dagger and Cane Combination

### BEEHIVE USED AS CHICKEN INCUBATOR

Finding that the temperature in a beehive was exactly the same as that required for hatching eggs, an American living in Rome conceived the idea of letting his bees do the hatching. He built a rectangular frame, provided it with a linen bottom, placed 20 eggs, protected by a perforated cover, spread over and around them, in the box, and placed the whole in the highest section of the hive. In course of time, 18 of the eggs were successfully hatched, without in any way preventing the bees from following their normal pursuits.

Repeated experiments proved that a dozen eggs at a time can be successfully hatched in this manner, and that in the course of a season one hive could produce more than 80 chickens.

### USEFUL CONTEST IDEA FOR AEROPLANES

The Marquis de Dion, who is noted for his work in connection with the development of the internal-combustion engine, has recommended a "greatest difference" competition for aeroplanes. This means the award of a prize for the aeroplane that can fly the fastest and also the slowest, the winner being the airman who can show the greatest ratio of his fastest and slowest average speeds over a given distance. The idea has been approved by the French aeronautic authorities and a race along these lines will be included in some competitions in France next season.

### OBSERVATION TOWER FOR MILITARY OPERATIONS

German military experts have recently devised a number of different portable observation towers that can be carried by troops and set up for use in a few minutes. The latest tower consists of a heavy base which contains numbers of parts which are fitted together automatically to make the

pedestal on which the observation platform is placed, and which can be raised or lowered at will. This platform is made of a size sufficient to accommodate eight persons and can be elevated 150 ft. above the level of the ground

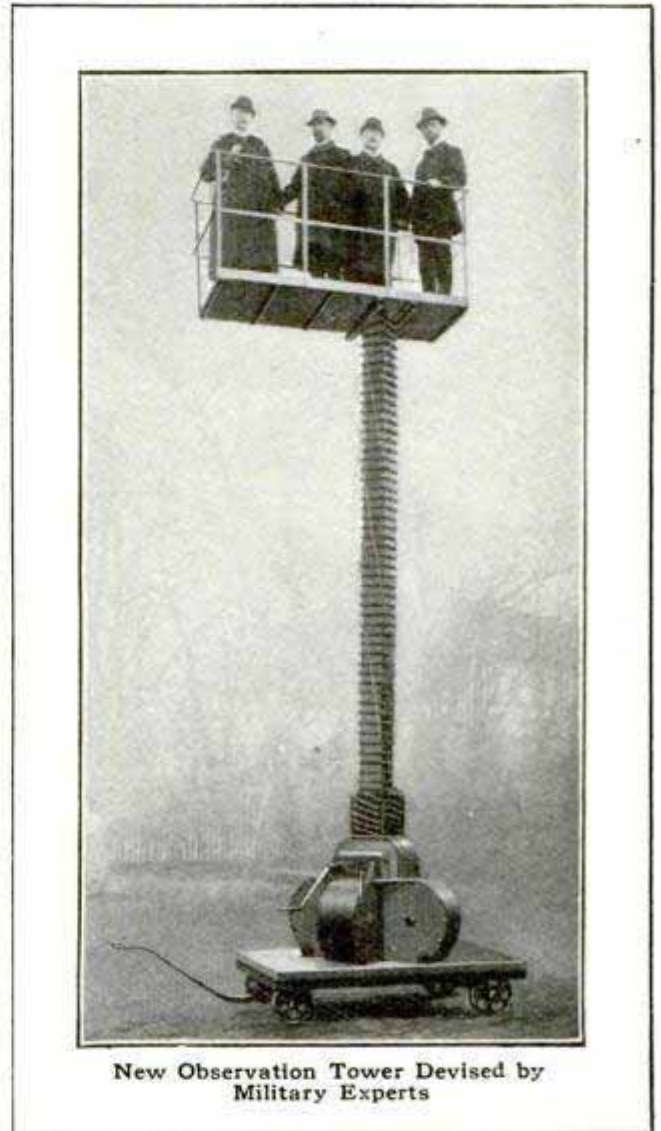

New Observation Tower Devised by Military Experts

on which the base rests. The platform is fitted with steel sides or shields that can be raised to a height of 5 ft. 6 in. to protect the persons using it.

☞ Special street cars during rush hours for "ladies only" are being considered by the town council of Melfort, Sask.

☞ A lawyer of Sterling, Ill., recently recovered \$10 damages from the telephone company of his town because the company failed to put his office address in the telephone directory, as well as the address of his residence.

### BRIDGE IS WRECKED BY AUTOMOBILE

Struck by a heavy automobile bus late one night, this bridge, over the



Bridge Wrecked in Remarkable Manner

Naugatuck River above Thomaston, Conn., collapsed two days later when the machine was pulled out. There is

a rather sharp turn at one end of the bridge, and the car, either from skidding or unskilled guidance, collided with an end post of the bridge, forcing the support off the bridge seat. The bridge was of the double-parabolic type, with an 85-ft. span.

### CONCRETE AND MORTAR FROM VOLCANIC DEPOSITS

Owing to the high cost of transportation, a new mortar and cement has been developed locally for building the Los Angeles Aqueduct. This is made from tufa, a volcanic deposit consisting principally of silica, alumina, lime and magnesia, and occurring in the vicinity of the work in great quantities.

It was found that tufa from the Mojave Desert, when finely ground and blended with slaked lime, forms a mortar which becomes hard when set in water. Tufa cement, made by mixing ground tufa with Portland cement, when mixed with standard sand in the proportion of 3 to 1, develops as much strength in 28 days as the standard sand briquettes made with standard cement in the same ratio.

### AUSTRIAN MOTOR HUNTING CAR

One of the latest types of automobiles constructed in Europe is this Aus-

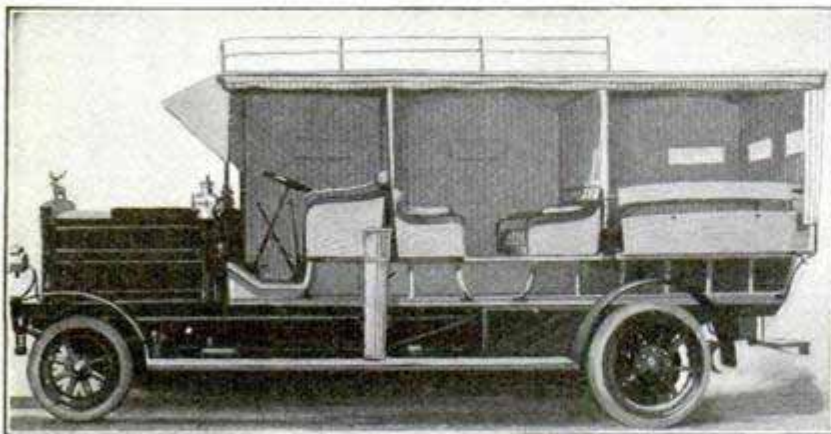

Austrian Hunting Automobile Carries 14 Persons

trian motor hunting car. It has separate compartments for the sportsmen

and professional hunters, a rifle stand for 12 rifles, storage room for 4,000 cartridges, the hunting breakfast, camp-stools, knapsacks, etc., and accommodation for the hounds. The car is expected to carry 14 persons, this number including six sportsmen, six huntsmen, a valet and the driver. Storm curtains, provided with celluloid windows, protect the occupants from wind and rain. Speaking tubes leading from the sportsmen's compartment afford ready communication with the driver and hunters.



## RED CROSS CAR A SCHOOL FOR FIRST-AID WORK

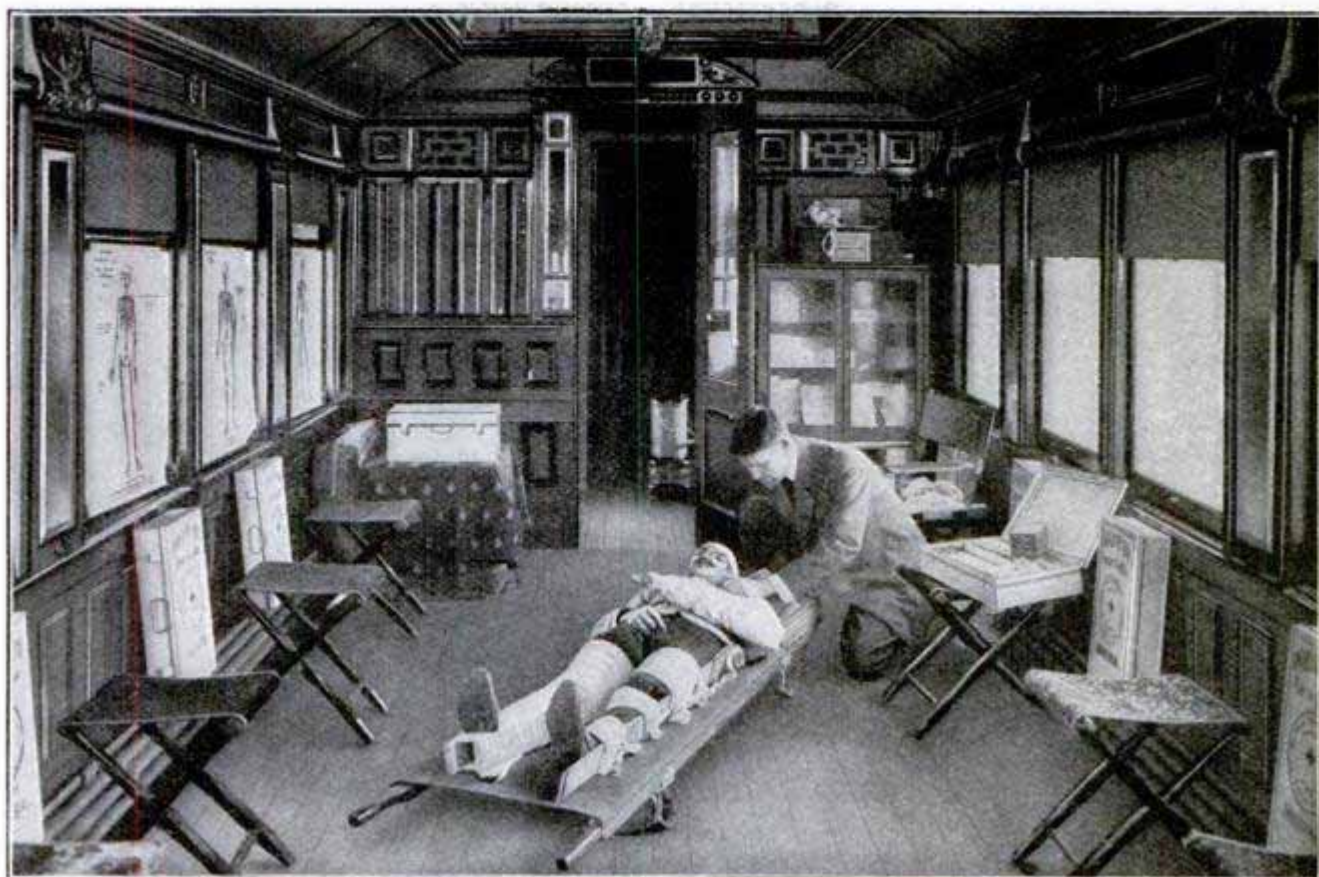

Practical Demonstration of First-Aid Work in the Red Cross Society's Traveling School. The Rectangular Boxes on the Sides Contain Modern First-Aid Outfits

A nation-wide campaign of education in the principles of first-aid work has been inaugurated by the American Red Cross Society and is being carried out with unusual thoroughness. Instruction is carried right into the railroad shops and factories by experts who are traveling through the country on a special car fitted up by the society with every known appliance for rendering immediate relief to the maimed and injured.

The car is a complete hospital and lecture room. Instruction is given in the use of the simple devices carried in first-aid boxes, and practical demonstrations of the various types of dressing are made.

The Red Cross car is under the charge of experts and the railroad companies think so well of the plan that no charge is being made for transportation.

The car is of the ordinary Pullman type but has been entirely remodeled, every up-to-date appliance known to

science for the relief of the injured being installed in the various compartments. Folding chairs are provided so that one of the larger compartments may be turned into a lecture room.

The car is run into the railroad shops for the lectures and demonstrations and is also taken over the factory sidings for the benefit of the workers in industrial plants. There is no time limit on the visit of the car to any particular place, the officials in charge being imbued with a desire to give thorough instruction and to remain in a place until the object of the tour is accomplished.

¶ Captain E. S. Grogan, the African explorer, electioneered by wireless during the recent election campaign in England. He was on his way home from East Africa during the struggle, but wireless telegrams were received from him every day and posted up in his constituency.

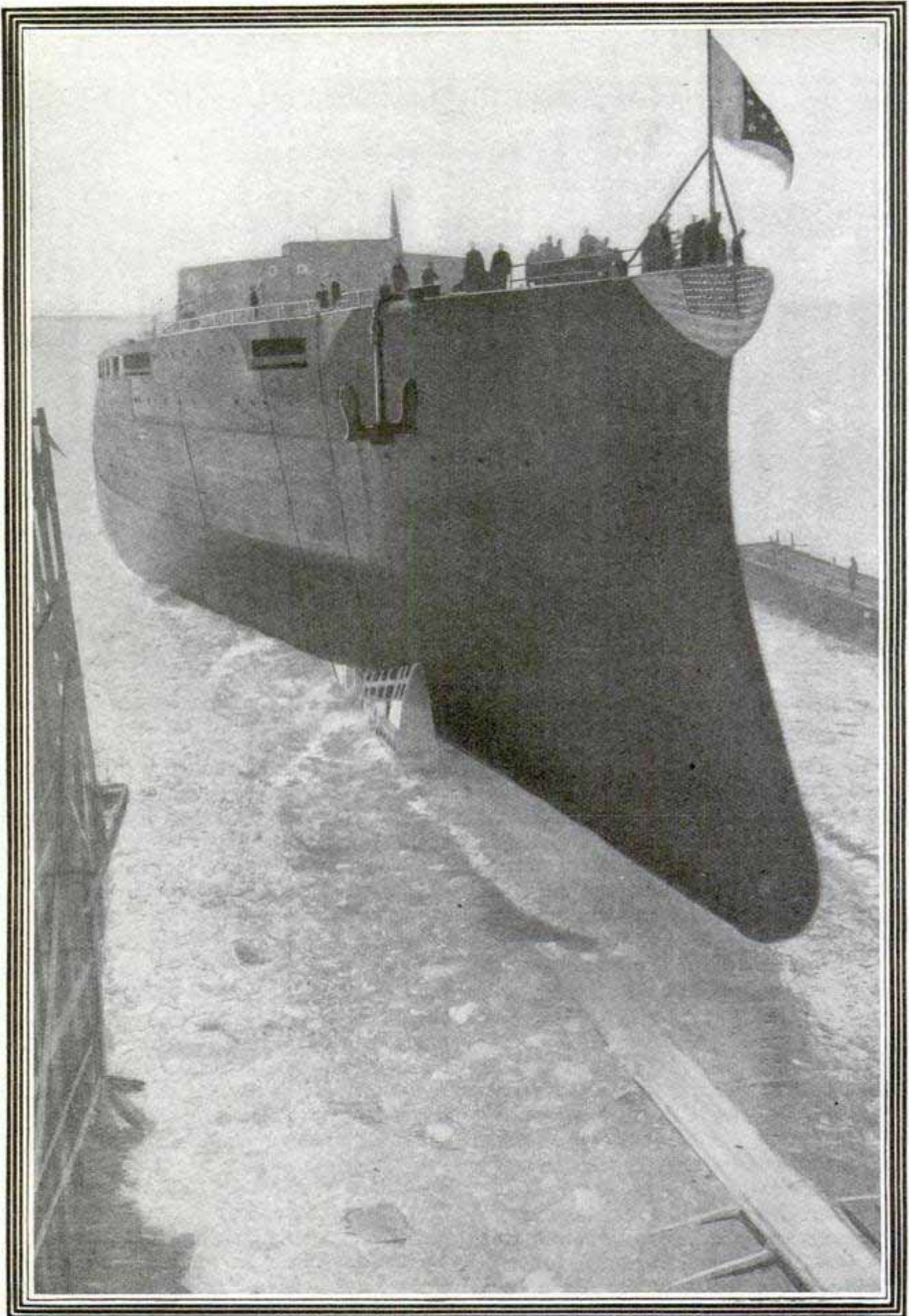

The Great Battleship "Arkansas" as She Slid from the Launching Ways

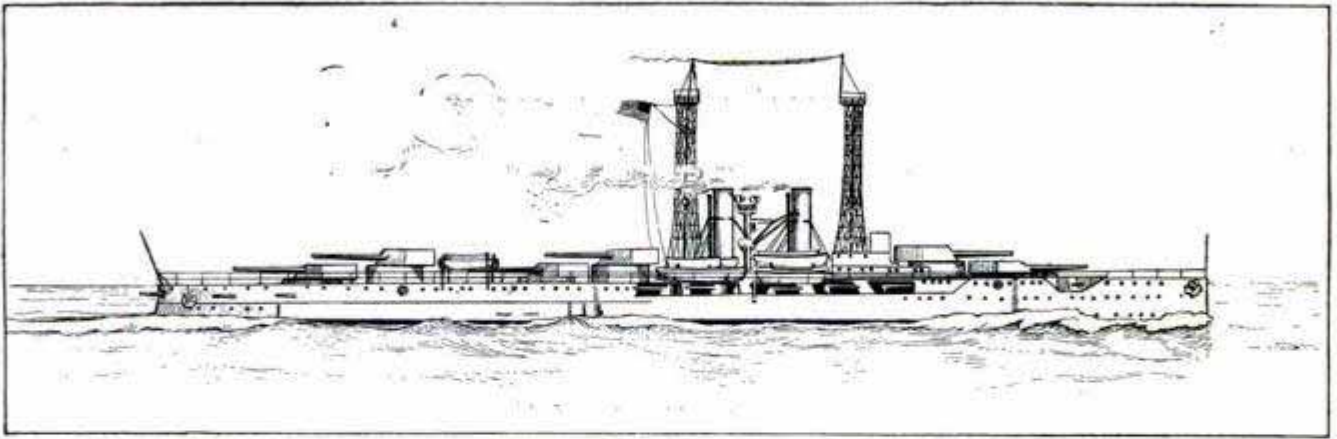

As the "Arkansas" Will Look When Completed, Showing Position of Main Battery Guns

## UNCLE SAM'S GREATEST WARSHIP LAUNCHED

Destined to be the biggest battleship afloat, for a year or two at least, the great hull of the "Arkansas" was successfully launched at Camden, N. J., on Jan. 14. The big man-of-war will be of 26,000 tons' displacement, and the construction work alone will cost the government \$4,675,000. The ship will have the heaviest armament of any vessel in the navy, the main battery being equipped with twelve 12-in. guns and two submerged torpedo tubes. The main feature of the secondary battery will be twenty-one 5-in. rapid-firing guns. The "Arkansas" must be completed within the next 11 months to comply with the terms of the contract. On her trials she must have a speed of not less than  $20\frac{1}{2}$  knots (23.6 miles per hour) and both coal and fuel oil will be used. The ship is 554 ft. long at the waterline and her extreme breadth at the same point is  $93\frac{25}{8}$  in.

The "Arkansas" will be equipped with the new military fire-control masts which have become a feature in the navy since these masts withstood the test of gun fire on the monitor "Florida" several years ago. By carrying the supply of oil for fuel, the vessel may increase her speed in an emergency by flushing her coal with oil or by using oil for increasing her cruising radius. The total estimated cost is \$10,000,000.

The crew of the vessel will include 1,030 men and 86 officers, exceeding by 200 the men carried by the largest battleships now in commission.

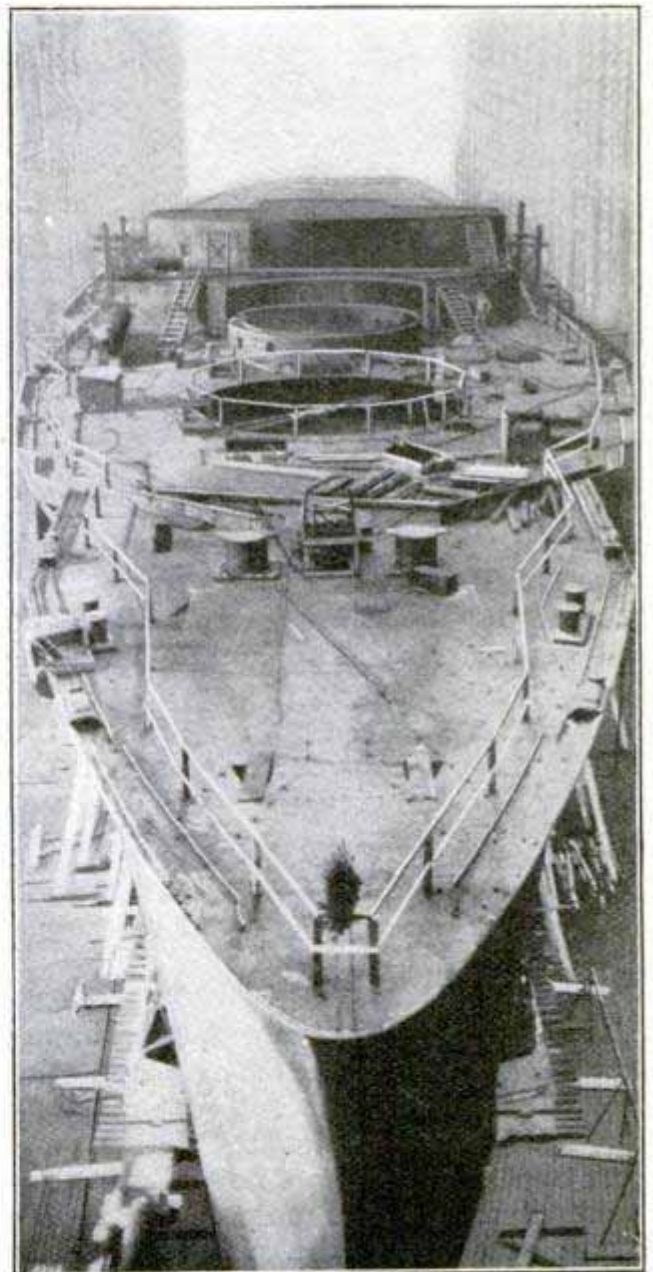

The Deck of the New Battleship as It Looked During Construction. Note Bases for Forward Turrets

### HOBbled OSTRICHES

A hobble of the same type as that recently designed for use in conjunc-

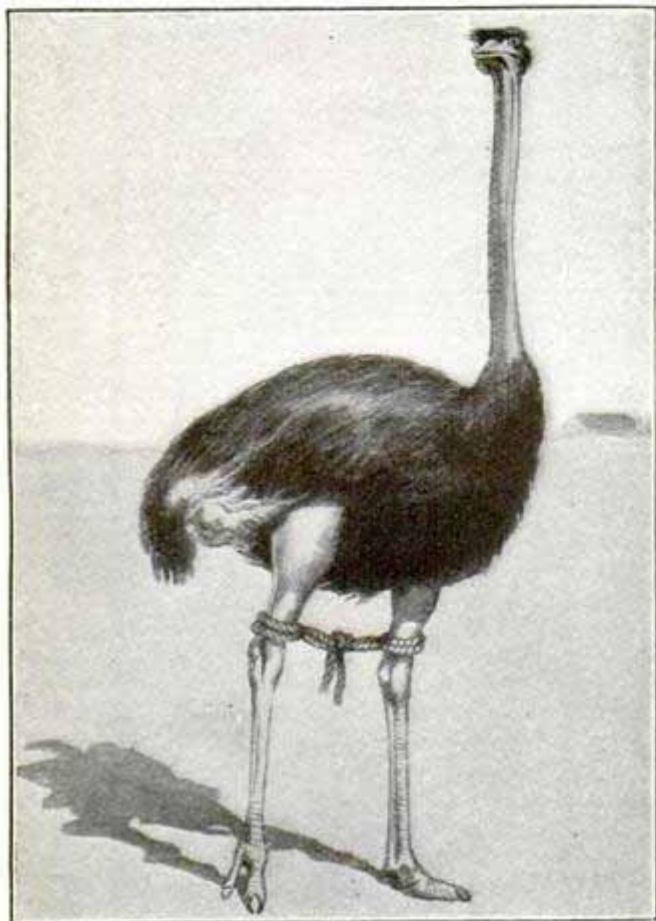

The Hobble Prevents the Ostrich from Running Away

tion with the hobble skirt, although crude and totally lacking in elasticity, is used for hobbling ostriches in the Soudan, Africa. The hobble for feminine wear has as its purpose the confining of the stride so that the knees will not bag the front of the skirt. The hobbles for ostriches prevent the big birds from running away.

### SELDEN PATENT CLAIMS SET ASIDE

The independent automobile manufacturers won a victory, when the United States Circuit Court of Appeals in New York decided that the engine used by them was not an infringement of the Selden patent. This decision sets aside the claim that the Selden patent covered the engines used on all motor vehicles. The case was brought by the Association of

Licensed Automobile Manufacturers, representing 80 per cent of the manufacturers in the country, against the independent manufacturers, — those who had not troubled themselves to obtain a license from the owners of the Selden patent. The decision of the Circuit Court of Appeals reverses a decision of the United States Circuit Court.

The Selden patent was granted George B. Selden, Nov. 5, 1895, although application therefor had been filed May 8, 1879. It covers an engine of the explosion or internal-combustion type adapted to the propulsion of ordinary vehicles. Persons who desired to manufacture automobile engines were required to obtain a license from the Selden interests, so broad were the claims allowed under the original patent. Independent manufacturers asserted their belief that the Selden patent did not cover their engines, and it was to curb the activities of this group that the Association of Licensed Automobile Manufacturers began proceedings in the United States courts, alleging infringement. The case is now to be taken to the Supreme Court of the United States for final decision.

### BUSINESS MEN'S COURT FOR NEW YORK

The New York Chamber of Commerce has decided to establish a commercial court by means of which business men who are members may settle all disputes among themselves. By virtue of a prior agreement to be entered into by both parties of the controversy, the commercial court's judgment will be as effective as that of the Supreme Court.

The main reason for the establishment of such a court is to avoid the delays which often extend over years in the law courts.

CA windmill-operated electric generator produces current for electrically lighting a church near Bilston, England.



Photo by Harris and Ewing

THE MULTIPLEX TELEPHONE INVENTED BY MAJOR SQUIER, U. S. A.

1, Battery Telephone; 2, Transformer Connecting Generator with Line; 3, Microphone Transmitter; 4, Transformer Connecting Receiver with Line; 5, Variometer for Tuning Receiver; 6, Variable Condenser for Tuning Receiver; 7, Audion Detector.

## INVENTIONS IN TELEPHONY AND TELEGRAPHY

The discovery by Maj. George O. Squier, Signal Corps, U. S. A., of a method of sending many telephone messages over a single wire, all at the same time and without the slightest interference, is, according to many authorities on the subject of telephony, the greatest advance made in electrical communication since the invention of the Bell telephone. The underlying principle of this invention is the application of the methods of wireless telegraphy to the existing form of telephone apparatus.

By employing an electrical current which changes in direction many thousands of times in a second, electrical waves are set up in the ether surrounding the wire, and are guided through to their destination by—but not in—the wire, so that the system may be described as wire-

less telephony guided by a single wire. The number of direction changes of the current per second is called the "frequency" of the circuit. Major Squier has found that many currents of different frequencies may be sent—or guided—over the same wire without interfering with each other. At the other end of the wire these currents are picked off by instruments—called

"detectors"—similar to those employed in wireless telegraphy, and each of these detectors is absolutely unaffected by any other current except the one that is "tuned," as it is called, to the frequency of the current which it is designed to pick up.

It is further reported that telegraph messages, transmitted with the usual form of key and received by the ordinary sounder, may also be sent simultane-



Photo by Harris &amp; Ewing

Maj. George Owen Squier, Inventor of the Multiplex Telephone

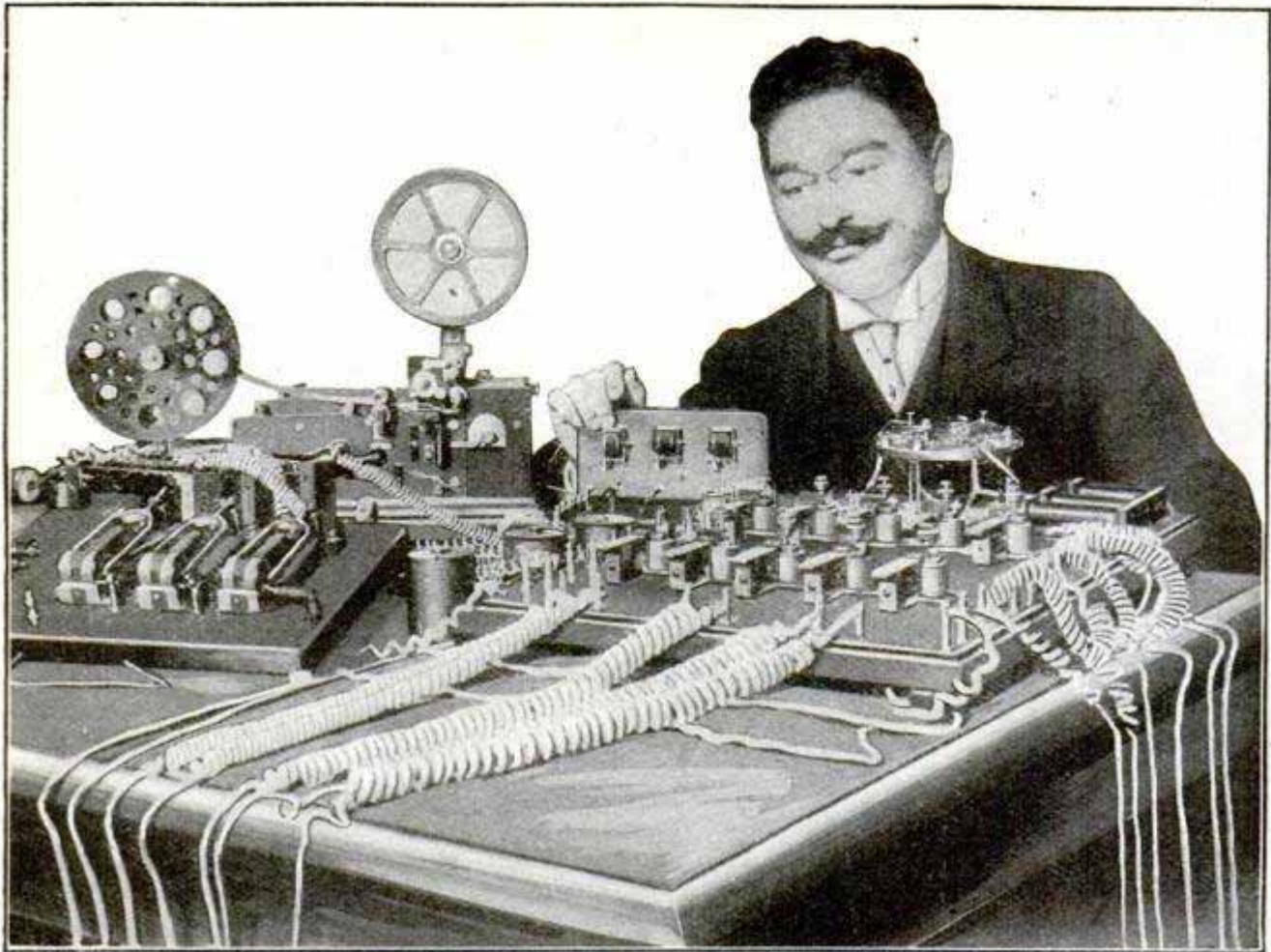

Corrado Andriani, the Italian Inventor, and His New Multiplex Telegraph

ously over the same line, using the same method of selection and separation as with the telephone messages.

The importance of Major Squier's invention, which, although patented, is given freely to the people of the United States, is hard to determine at this

time, but its possibilities seem to be almost limitless.

Major George O. Squier is the chief assistant to Gen. James Allen, chief signal officer of the army. He is a graduate of Johns Hopkins University, where he studied under Professor Row-



The Two Receiving Stations of the Perry System—The Inventor is Seen Standing



One of the Transmitting Stations

land, inventor of a multiplex system of telegraphy. He is also well known in the field of aeronautics.

Following closely on the announcement of Major Squier's multiplex system of telephony and telegraphy, Frank L. Perry, an electrical man of Chicago, claims to have performed two years ago the feat of transmitting a telephonic message in one direction over a single wire, while another to-and-fro conversation was being held at the same time over the same wire. Mr. Perry's claims are corroborated by written statements from several well-known men, including Bion J. Arnold, a prominent engineer of Chicago. Mr. Perry is of the opinion that his invention will first find its greatest utility in the duplexing of lines longer than those found within city limits.

From Italy comes the report that Corrado Andrini has designed a multiplex telegraph that will send from 10 to 15 messages simultaneously over the same wire. This apparatus, which was finally perfected by Luis Maino, chief of the technical department of the Italian government telegraph service, was successfully demonstrated last December in the presence of several well-known scientists.

The Andrini telegraph is said to be comparatively simple and inexpensive, and to be supplemental to the telegraph systems already in use. It enables a single line to handle up to 500 telegrams an hour. Whether it will prove more acceptable to the telegraph companies than the now practically discarded Rowland multiplex system, remains to be seen.

## FIVE-WHEELED AUTO HAS FLEXIBLE TRACTION

A curious automobile, for which much is claimed by its builders, has five wheels, four of which are of the ordinary horse-vehicle type, while the fifth is an adjustable, flexible drive-wheel. This traction wheel is claimed to cushion the automobile in a manner superior to rubber tires, the elasticity or easy riding qualities being under control of the operator, who adjusts it to suit the load or number of passengers by means of a lever in the same manner that he controls the speed.

Another important feature claimed by the inventor is the elimination of compensating gears and complicated mechanism, thus reducing the cost of output. The method of adjustability and flexibility are shown, the fifth wheel being supported by a shaft attached to a hanger. Two coil springs, adjusted by turnbuckles and provided with block and tackle

leading to the control lever or levers, hold the wheel against the running surface, the operator controlling the force exerted by the springs to suit conditions of road and load. Hanging drive-wheels of the same type are used for driving motor sleighs.

CA naval constructor of the Japanese Navy is reported to have invented an aeroplane which will be able to alight on the water and rise therefrom.

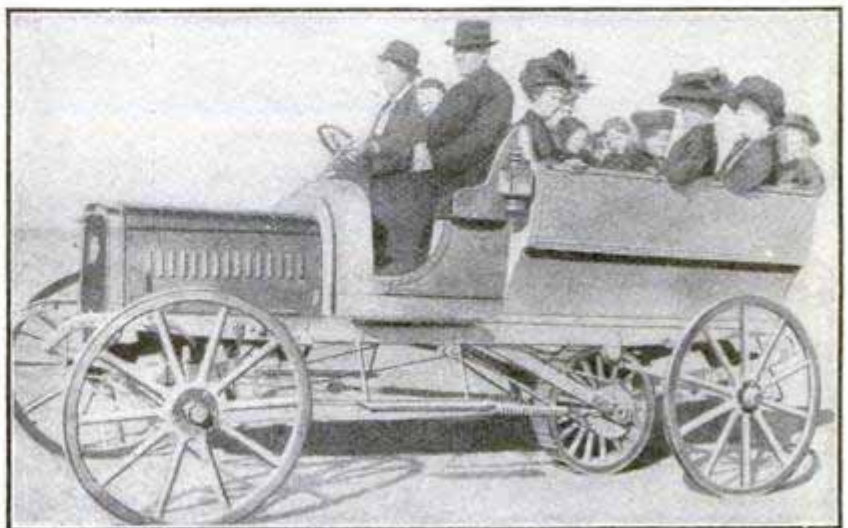

Motor Sleigh Idea Adapted to the Automobile

## INGENIOUS WAY OF GAINING DANCE PARTNERS

A novel cotillion figure in which toy balloons play a prominent part is be-



Courtesy Illustrated London News  
Bursting a Balloon Secures a Partner

ing enthusiastically received in London. Each lady carries a toy balloon which must be exploded by stamping, jumping or falling upon it by the man who wishes to become her partner. When it happens that several men desire the same lady, a friendly contest ensues, often with laughable results.

## AERO WIRELESS OPERATED OVER WIDE RADIUS

Henry Farman has successfully used wireless telegraph apparatus from an aeroplane over a radius of six miles. This feat was accomplished in France after many experiments. Farman believes he will eventually be able to extend the radius to 60 miles. The military possibilities of this accomplishment are almost limitless. An aero scout equipped with wireless could furnish information that would be invaluable. Even with a radius of six miles, his messages could be relayed by the ordinary field wireless equipment a distance of at least 30 miles to the commanding general, who would thus be enabled to plan his movements with accurate information of the enemy's position a day in advance.

The officers of the United States army were the first to experiment with wireless in aeroplanes successfully, but they have been hampered in their work through the lack of aerial craft and funds to perfect the apparatus.

## USE OF LIGHT IN MAKING NIGHT EXCAVATIONS

Night excavation work as efficient as that done in daylight is now possible by the use of an electric headlight on derrick-operated bucket outfits. The first really successful test of the scheme was made during the rush work on the Evanston channel of the Chicago Drainage Canal. The light used was of the locomotive head-lamp type, of 3,000 cp. This was backed with an 18-in. reflector, 3 in. deep, which focused the light into a slightly divergent beam directly under the boom from which the bucket was hung. When it was necessary to obtain great diffusion of light, the reflector was put out of focus by advancing the arc a fraction of an inch, projecting the light over a large area. The lamp was



Excavation Bucket Used at Night with the Aid of Electric Light. Photograph Made 150 Ft. from Bucket, During Chicago Drainage Canal Work.

mounted on the turntable of the derrick crane and was rotated with it so that it followed the bucket in all positions.



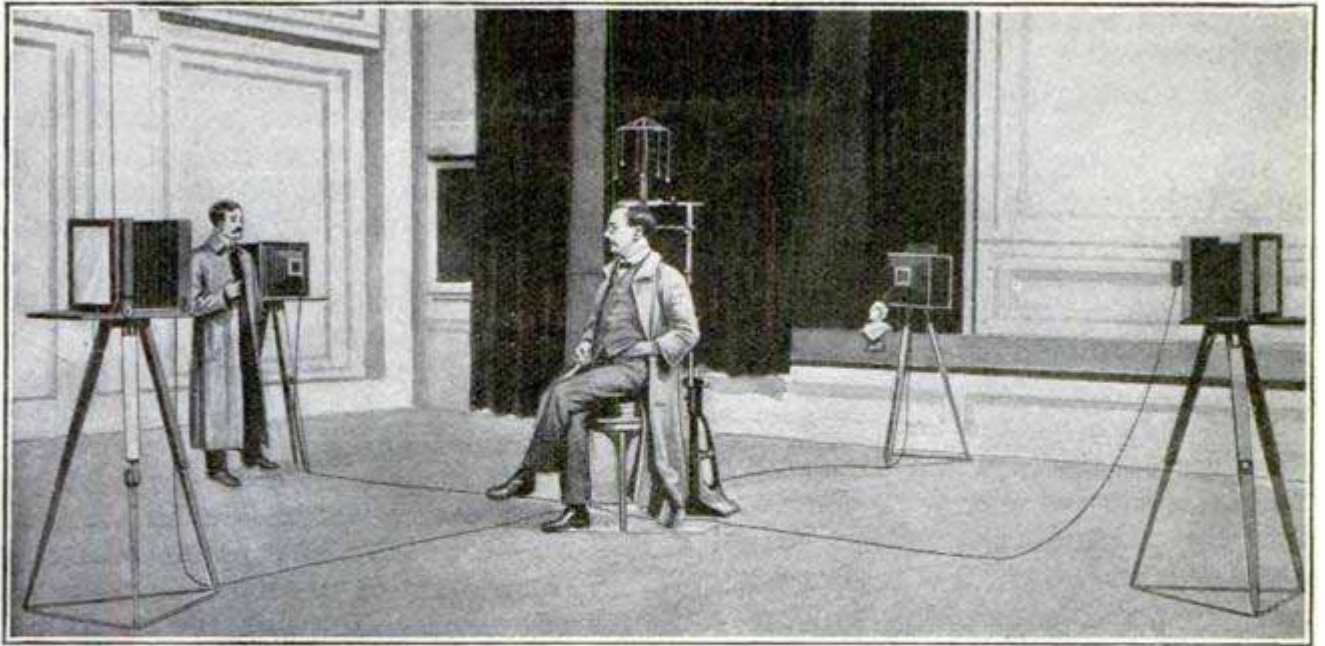

Making the Four Photographs Simultaneously

## PHOTOGRAPHY AN AID TO SCULPTORS

The idea of using photographs to facilitate the work of the sculptor is not new, it being attempted 40 or 50 years ago with 24 cameras placed in a circle. The idea did not then, however, meet with the success expected.

A French sculptor has now devised a simple method by means of which more or less finished working models can be made. By means of four photographs taken simultaneously from all four sides, and a modeling stand of special construction, he can work out

the dominant characteristics of face and figure required for the working model. One of the illustrations shows the arrangement of the four cameras, how they may be snapped at the same time, and the weighted strings suspended over the head of the model in order to determine the different planes the photographs represent, giving reference data for the later operations.

The finished photographs are placed

in frames on the modeling stand. This stand has a square metal base, provided in the center with a vertical rod serving as an axis for the sculpture. The four sides of the base have grooves in which the vertical wooden frames for the photographs slide. On two adjacent sides of the stand are fixed jointed arms provided with long, sliding, pointed rods which can be adjusted at different angles.

In using the apparatus, two photographs, one full face and the other in

profile, are successively inserted in the frames, and slid in front of the arm supporting the pointed rod. Selecting some point, the nose for instance, the pointed rod is brought in contact with it, the inclination of the

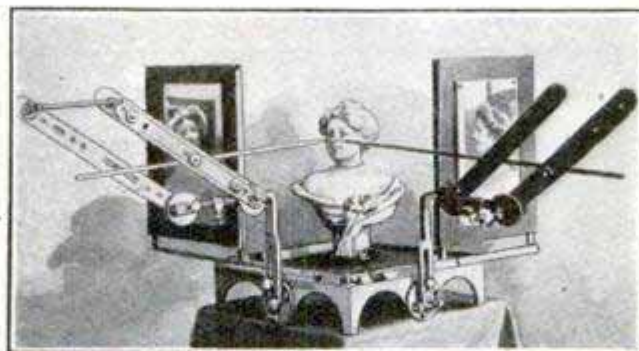

The Modeling Stand

rod is fixed by means of a setscrew, and the rod drawn back. The sculptor then repeats this performance with the profile photograph, the photographs are moved to one side, and the rods pushed forward again. Where

they meet is the point of the nose of the future bust.

The next operation is to surround the vertical rod in the center of the stand with the plastic material and to model the nose to the point indicated, after which the rods are withdrawn, the photographs again swung to the same position as before, and a new point determined and modeled, this operation being repeated until all the points shown by the two photographs are incorporated. Then the same operation is carried out with the two remaining photographs until a model is obtained on which the sculptor needs only to put the finishing touches and impress the personal factor of his talent.

## TO RESTRICT CARRYING OF MATCHES

Congress has been asked to enact national legislation to prohibit the transportation of white and yellow phosphorus matches in the United States. These are types of the variety commonly referred to as parlor matches. A penalty of \$1,000 fine and imprisonment for three years, or either, is attached to the proposed law. To prevent any concern from acquiring a monopoly of other processes of making matches, the bill in Congress proposes to give any person the right to manufacture matches, under any patent process, through the medium of a license issued by the judge of a United States circuit court, to whom

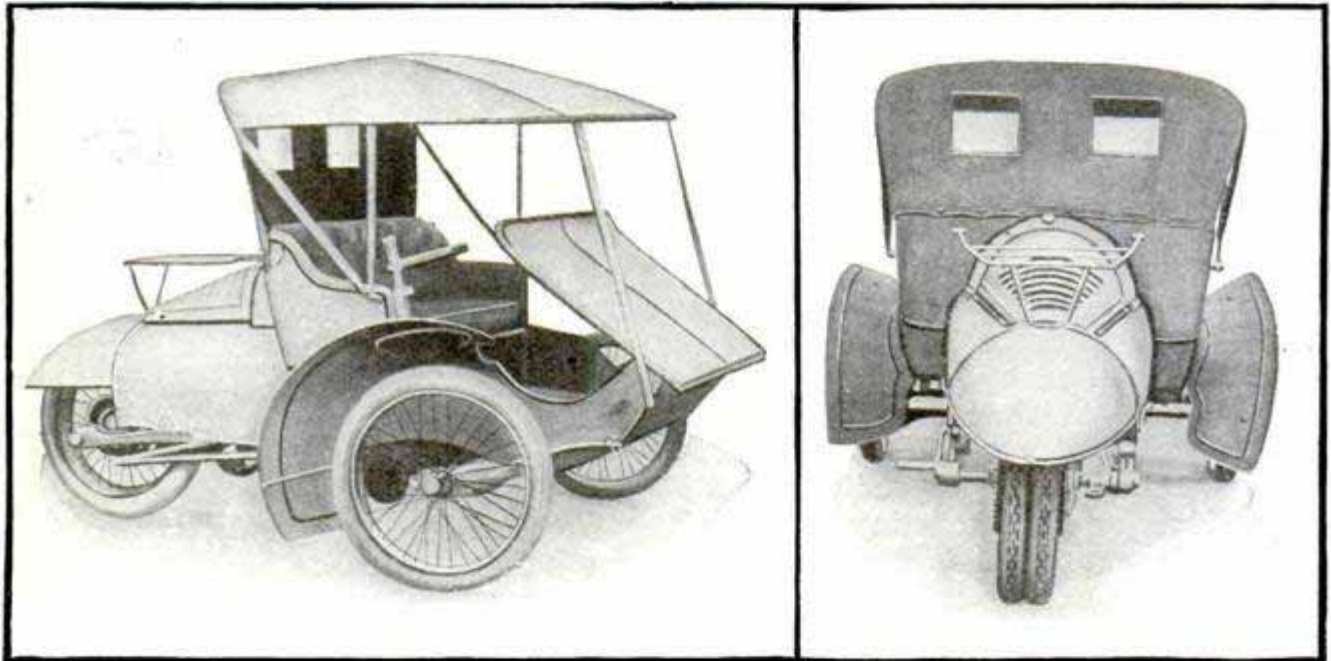

Novel Three-Wheeled Motor Car

Curious Appearance from the Rear

### BRITISH THREE-WHEELED MOTOR CAR

A novel three-wheeled automobile or motorette, with a curiously designed body, is being demonstrated in London. The single rear wheel, which is the drive wheel, carries twin 26-in. tires. The car has a sloping dash and hood, which, when not required, are thrown back out of the way. Behind the seat, the body slopes away to a point and forms the bonnet, which, when removed, gives access to the engine.

the prospective manufacturer is authorized to apply. The owner of the patent is required by the law proposed to supply licenses to persons thus authorized to use them.

Ⓒ No appreciable wear is noticeable on a stairway in a section of the Paris subway where carborundum crystals were mixed with the concrete of which the stairs were made. More than 14,000,000 people passed up and down the stairs during the time observations were taken.

## NEW YORK EXPLOSION NOT DUE TO ACETYLENE

The explosion which occurred at the Grand Central Station, New York, on Dec. 19, killing 10 persons and injuring many others, was not caused by acetylene gas as was stated in reports sent out from New York immediately following the disaster. It is unfortunate that these reports received such credence for, unless contradicted, they tend to cast a shadow on an important and useful industry. It is hoped that the refutation will be as widespread as the original reports. Commercial acetylene is handled in tanks which make explosion impossible, and almost all automobiles have substituted these tanks for the old fashioned wet generators. The coroner's jury which investigated the New York explosion declared that acetylene was not responsible, but that the disaster was due to some other cause.

## DEATH SPREAD OVER WIDE RADIUS BY AERO BOMB

Practical experiments in bomb-dropping and scouting with aeroplanes were carried on in connection with the aviation meeting at San Francisco recently. Lieut. M. S. Crissy of the Coast Artillery Corps, as a passenger in Parmalee's Wright machine, dropped a shrapnel shell from a height of 475 ft. Examination of the spot after the explosion of the shell showed it to have a destructive radius of 70 yd. Later on the same day Lieut. John C. Walker, 8th U. S. Infantry, made a flight with Walter Brookins and from an elevation of 1,000 ft. took photographs of the aviation field and army camp connected therewith, which, when developed, showed the camp and its surroundings in a manner that would have been valuable in time of war.

☉ Captain Bellanger of the French army aerial corps has established a new speed record by flying a distance of 100 miles across country in 70 min.

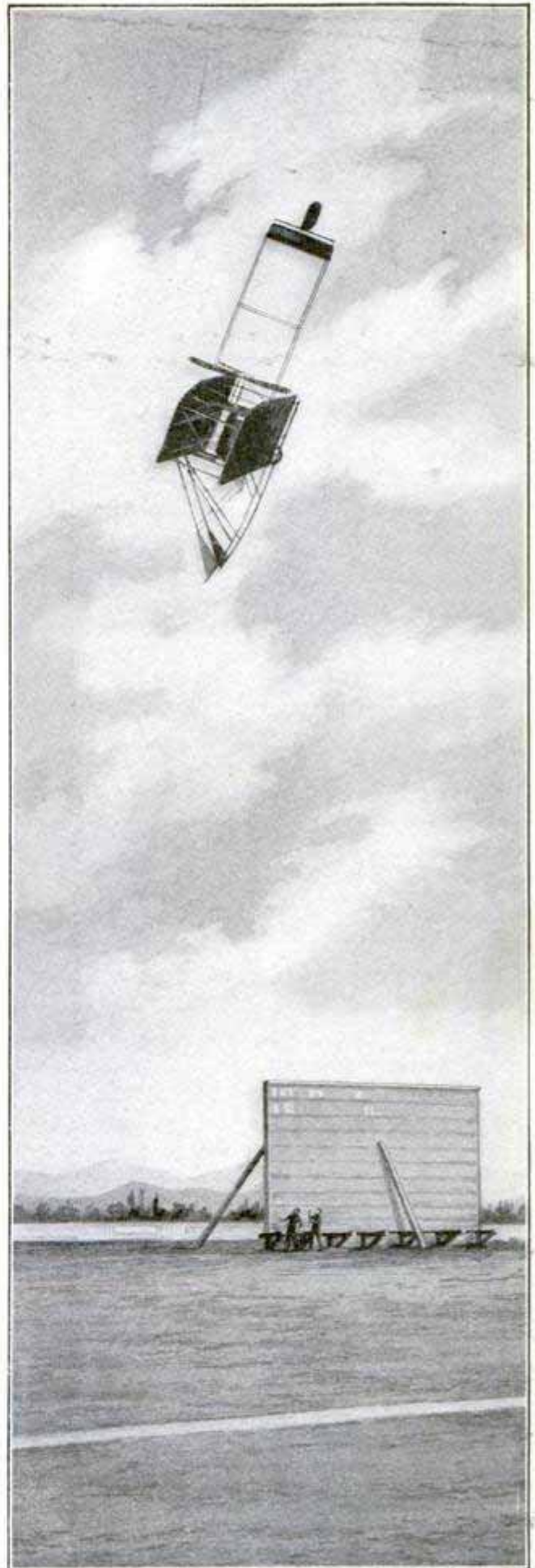

**THE FALL THAT KILLED HOXSEY**  
When Arch. Hoxsey was killed at Los Angeles his plunge was in plain sight of thousands of spectators. The machine came down at incredible speed.

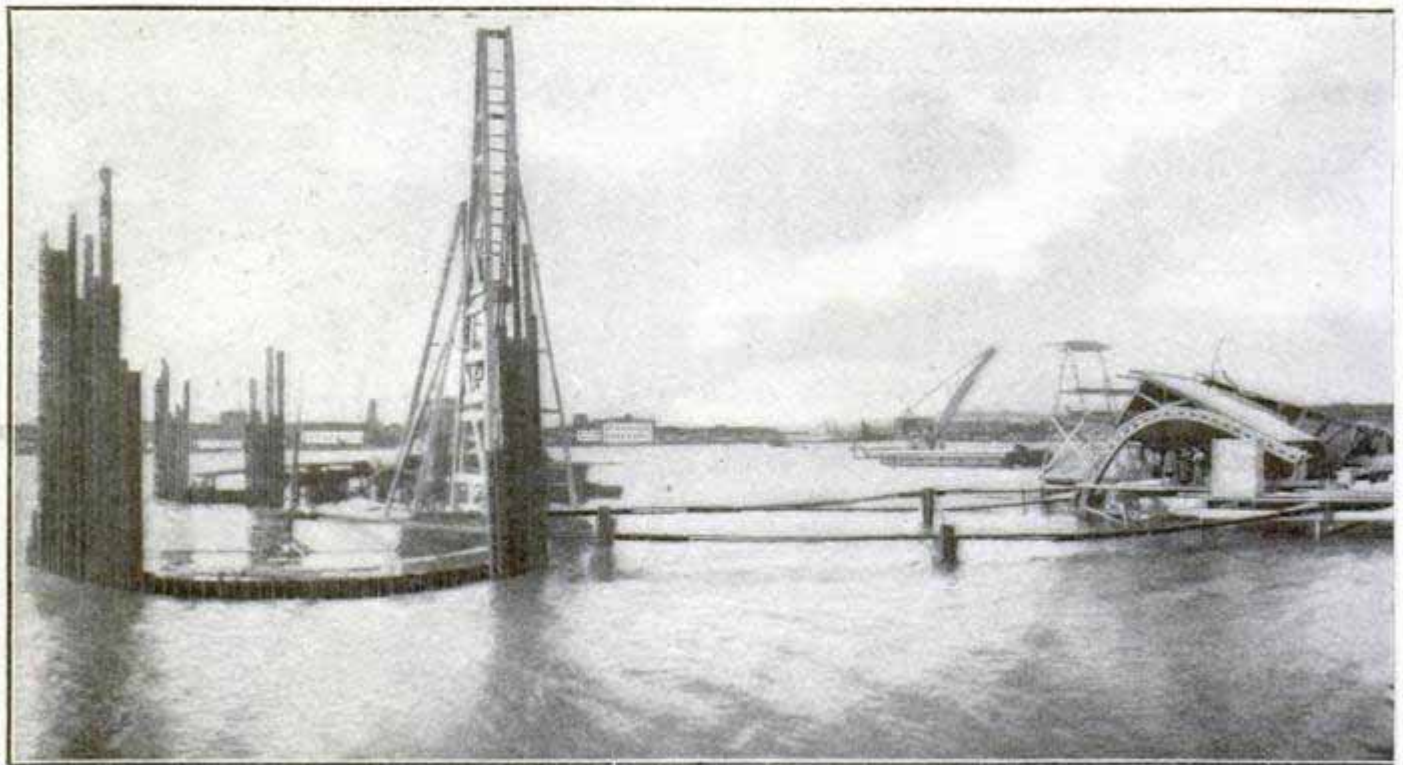

Panoramic View Showing Progress of Work of Raising

## RAISING THE "MAINE"

By COLONEL WILLIAM M. BLACK

*Corps of Engineers, United States Army—In charge of Salvage Operations  
on Historic Battleship in Havana Harbor*

**D**ELVING below the ocean floor in the harbor of Havana scores of busy workmen are unmasking the hulk of the battleship "Maine" at the behest of the American people that they may learn from the bones of the ship the secret of its dissolution 13 years ago. Since the evening of Feb. 15, 1898, the metal mast and twisted iron and steel that a terrific explosion forced over the superstructure have formed the most conspicuous objects in the water roadway to the Cuban capital. For more than 12 years the American people have permitted the ship and the dead within her to lie at the harbor bottom. Appeals to Congress met response last summer in an appropriation placed at the disposal of the Secretary of War for the raising of the ship. With the Chief of Engineers of the Army he was directed to use all dispatch in beginning operations to the end that the bodies remaining in the hulk might be properly interred at the Arlington National Cemetery, that the mast might be re-erected over the

graves of the men who lost their lives, and that a final and complete examination of the wreck might be made to determine definitely the nature of the explosion.

A board of three engineer officers, Col. W. M. Black, Lieut.-Col. M. M. Patrick and Capt. Harley B. Ferguson, was appointed to carry out the will of Congress. In preparing plans for the work, the board had in mind the various considerations expressed in the speeches in Congress and upon which action by that body was taken.

From the nature of the case any conclusions reached as to the cause of the explosion, based on an examination of the ship, must probably be derived from the positions in which the plates and beams now lie in the wreck, and the direction in which each is bent. To obtain this evidence, and to have it convincing when found, it is necessary that the examination of the broken parts be made as they lie, without a change or a possibility of a change due to the prior operations.

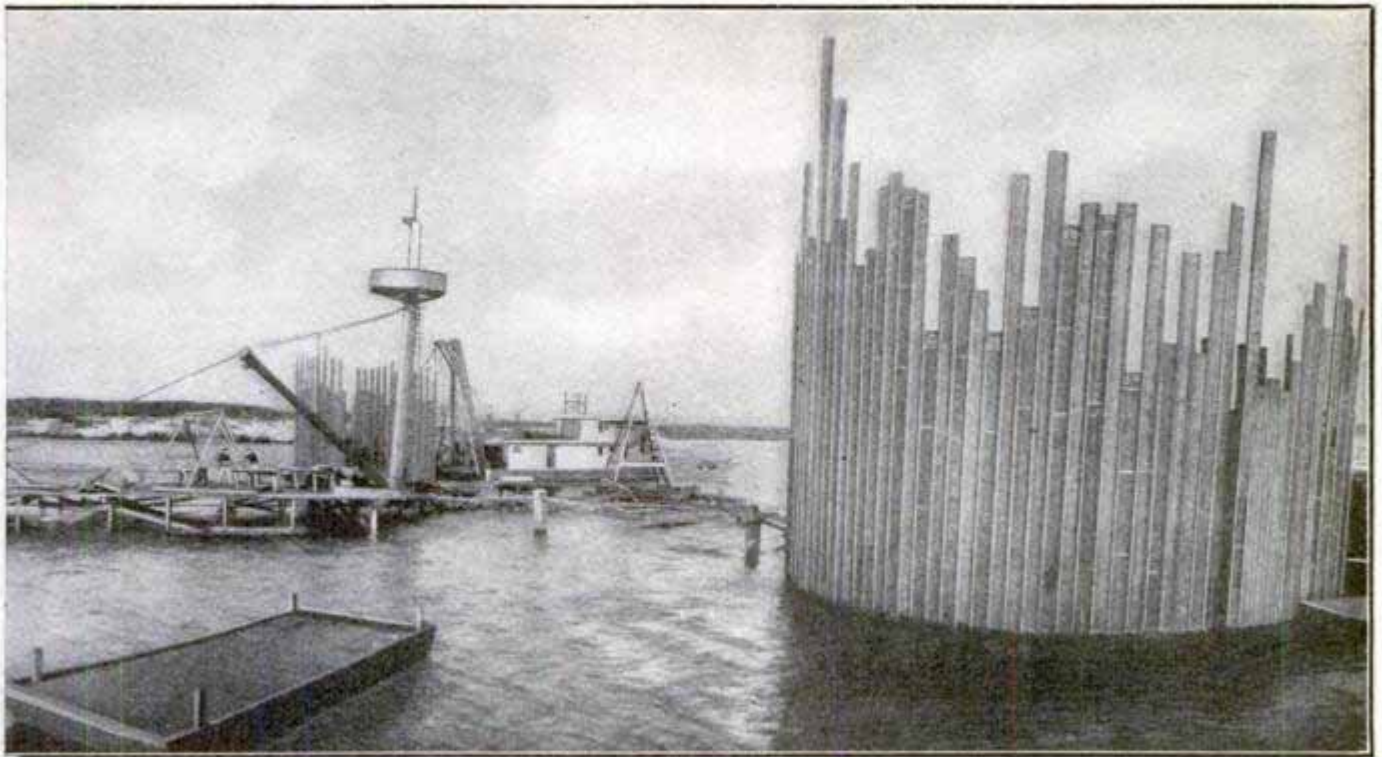

"Maine," and Two of Cylinders in Course of Construction

The forward part of the hull is known to be badly shattered and the metal has been subject to corrosion for more than 12 years. It is evident then that the hull must not be touched before the examination, and therefore, that the only possible course to follow is to build a cofferdam around the wreck, remove the water within the dam, and expose the broken parts.

The inner part of Havana Harbor is sheltered from the sea, and the strongest winds do not cause waves of more than 2 ft. in height. The mean range of tide is about 1 ft. and the

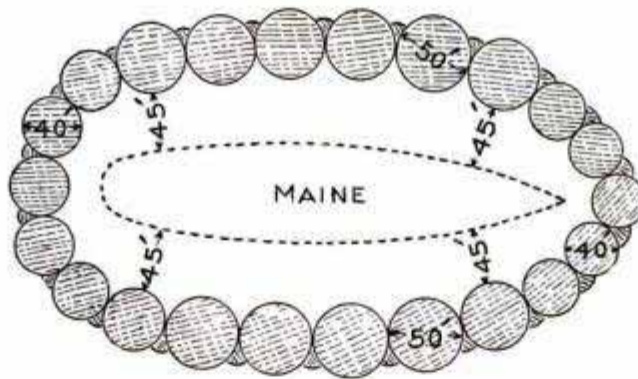

Plan of Cofferdam Being Built Around the Sunken Ship

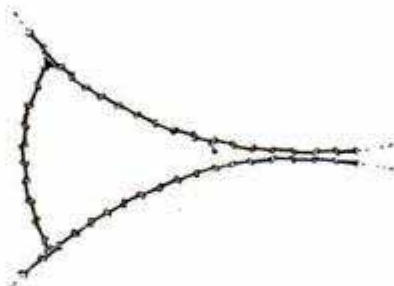

How Separate Steel Piles Are Connected to Form Strengthening Arcs

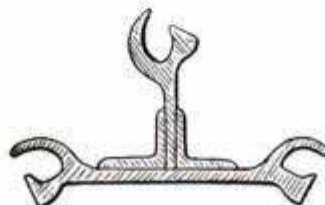

And Special Plate Made to Form Junction Between Cylinders and Arcs

extreme observed range but slightly over 2 ft. The wreck lies in from 30 to 37 ft. of water, and a comparison of harbor charts shows that the presence of the wreck has caused no appreciable change in the harbor bottom in her vicinity. Borings around the wreck show that rock is found at a depth of about 100 ft. and that this is overlaid with clay. For the upper 18 ft. this clay is reddish in color, contains an admixture of coral sand, and is soft. At a depth of 55 ft. blue clay is found, gradually increasing in stiffness with increasing

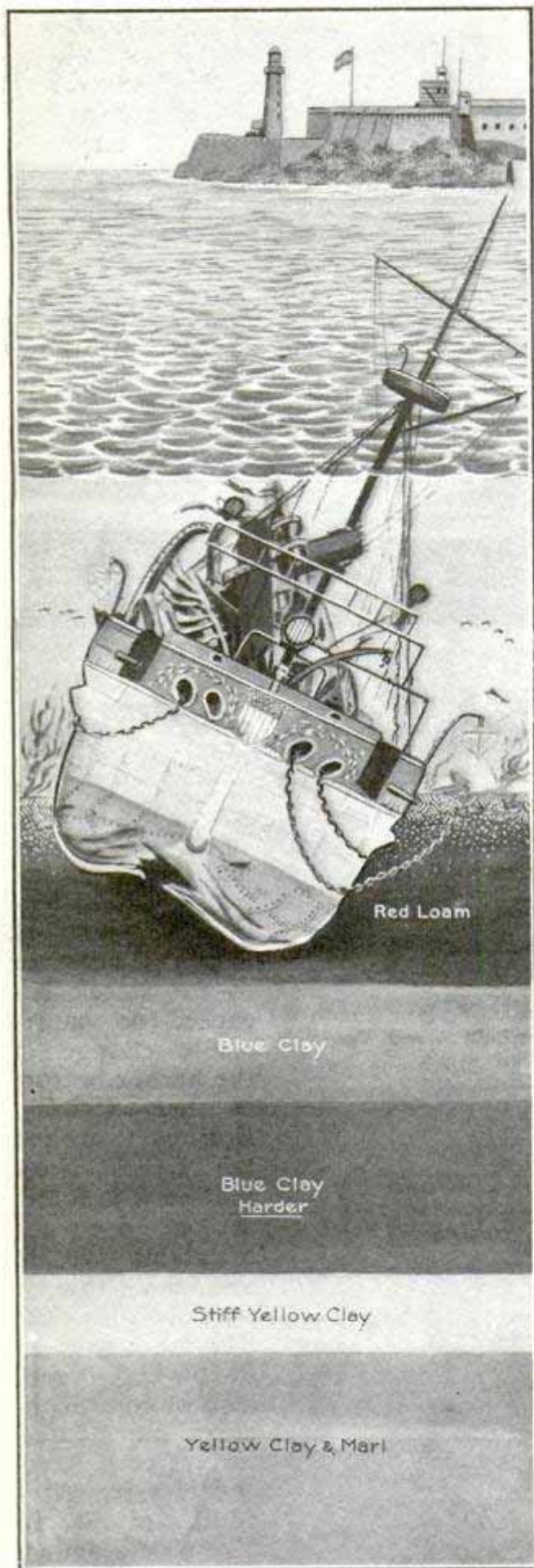

Sectional View Showing Strata under Havana Harbor and Position of "Maine" in Red Loam

depth. Earlier work in the harbor has shown that heavy objects, such as chains, anchors, etc., dropped on the bottom sank in the mud to a depth of from 8 to 10 ft. but failed to move further.

Rough observations made in the after part of the wreck of the "Maine" showed that at the stern, the keel lies at about that depth in the mud, and that there has been but little or no downward movement since the ship sank.

The cofferdam to be used will enclose the area occupied by the hull and the attached wreckage, with sufficient space in addition to admit of the construction which may be required to insure the stability of the wreck during the examination, and to remove it later. It is being so made as to be easily removable, and, if practicable, with such salvage as would make a partial return of the money expended for its construction.

Many types of dams were investigated. It was found that a cofferdam of interlocking steel sheet piling, with the clay of the harbor bottom for filling, best fulfilled the conditions, and that the full strength of the piling could be best utilized by making the dam of a series of cylinders. These cylinders are being placed tangent to each other around the periphery of an ellipse of sufficient size—each cylinder having stability sufficient to enable it to resist the pressure of the mud and water from the outside independently.

Calculations showed that under the most severe assumptions, a cylinder 50 ft. in diameter, with the piles driven to a depth of 70 ft. below the surface and filled with the harbor clay, would have the requisite stability. The cofferdam now being constructed thus is of elliptical form and is made up of 20 cylinders, each 50 ft. in diameter, set tangent to each other. The major and minor axes of the ellipse drawn through the center are 409 ft. and 220 ft. long, respectively, and the clear space between the wreck and the dam has a width of 20 ft. at the bow, 14 ft. at the stern, and 55 ft. amidships on both

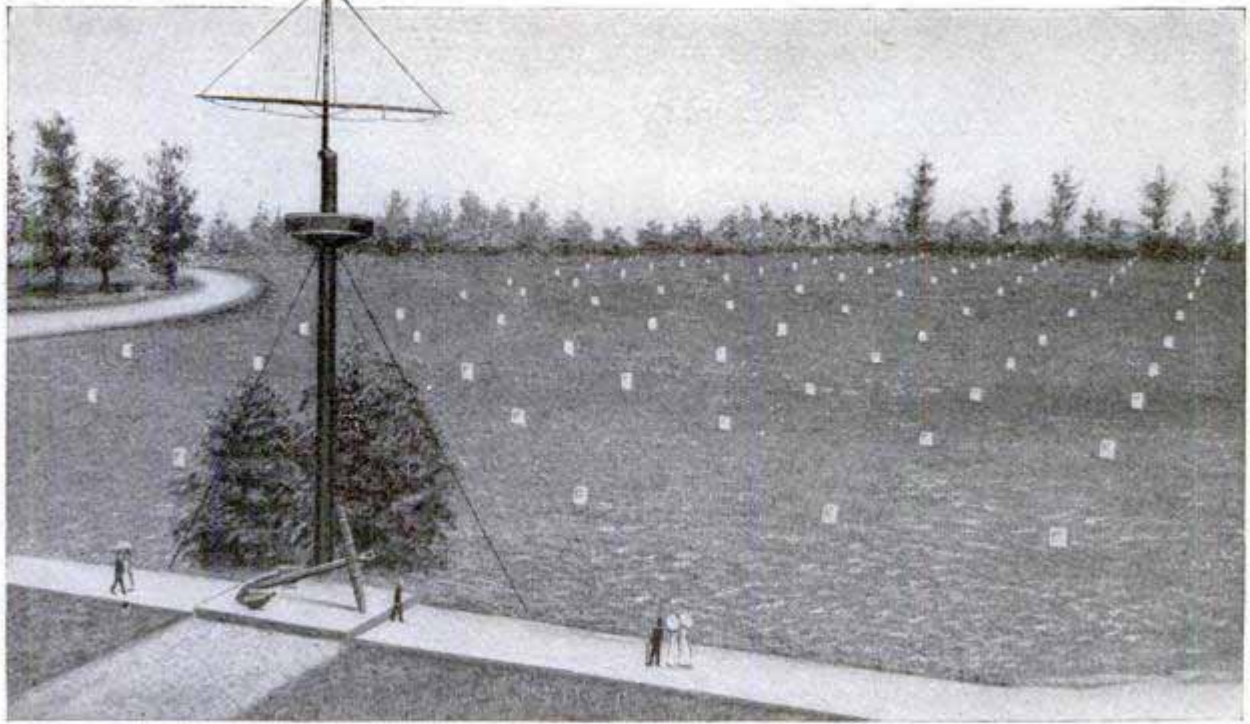

As the Mast of the "Maine" Will Appear When Placed in Arlington Cemetery, Marking the Graves of Sailors That Lost Their Lives in the Explosion

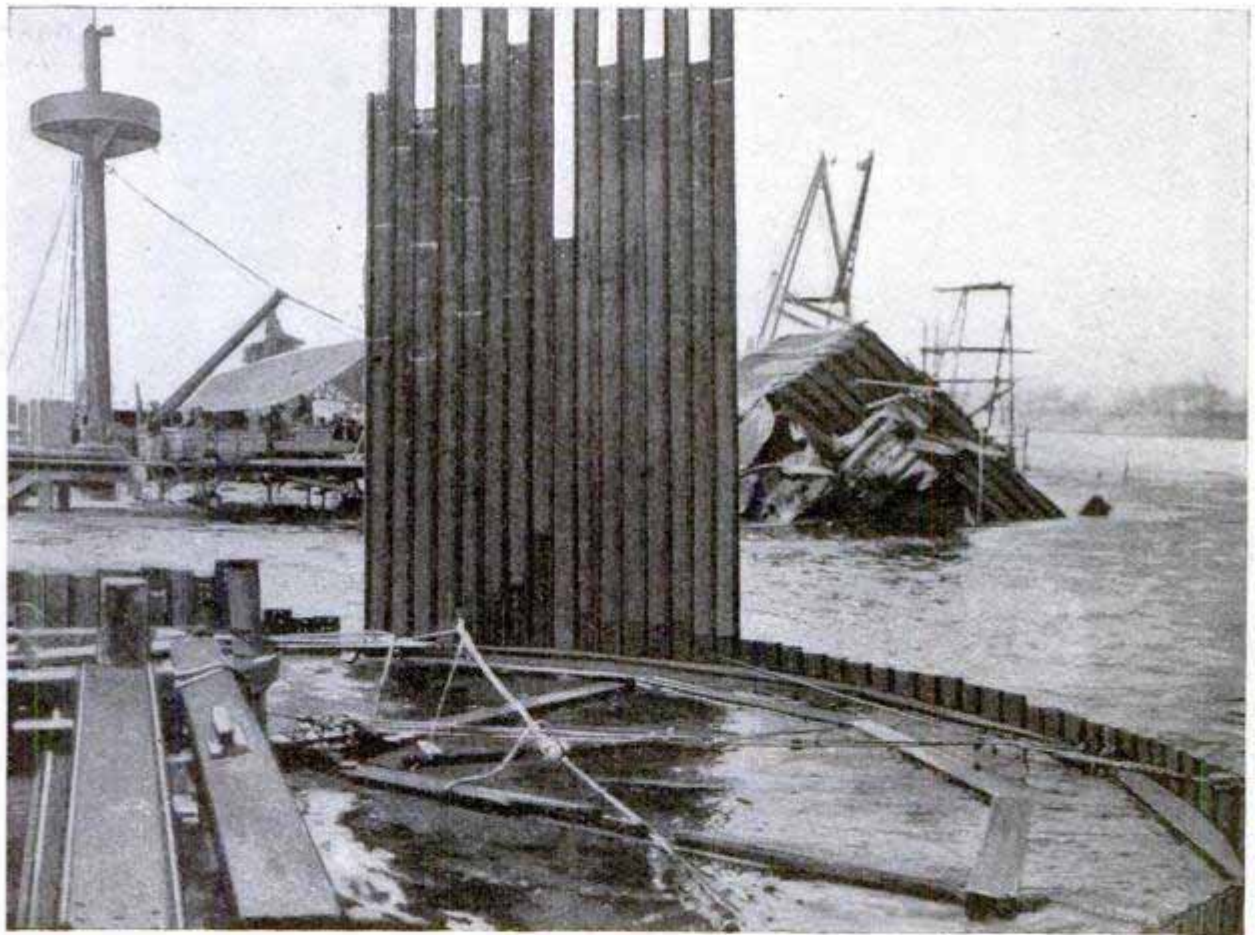

One of the Sheet Piling Cylinders being Placed around the Hulk of the "Maine." The Wreck in Rear

sides. To make the cylinders stable and the dam watertight, short arcs of circles formed of the same sheet piling connect adjacent cylinders around the outside, between "three-way piece"

piles set in each cylinder. The cylinders and the sectors around the outside are to be filled with clay dredged from the harbor bottom.

The Cuban government is assisting

the United States in this work most cordially. A wharf of sufficient size, conveniently located in Casa Blanca, just beneath the walls of the Cabaña Fortress, has been set aside for the work. To place the cylinders, ordinary round piles are driven at the axis of each. Around this central pile is floated a templet of wood, made in sections for ease of removal. The sheet piles are shipped in lengths of 25, 35, 40 and 50 ft. and are bored and provided with fish plates and bolts for assembling into lengths of 75 ft. The piles for a complete cylinder are set

up around a templet and then driven to the required depth.

After any remains of the dead found in the wreck have been removed and the necessary examination has been made, the actual removal of the wreck will be begun by whatever method is found most economical and advantageous. It now seems probable that this will be to sever the shattered portion of the hull from the after part; to build a bulkhead across the cut section; to remove the shattered parts piecemeal and finally to float the unbroken end away from Havana.

### McCURDY MAKES RECORD OVERSEA FLIGHT

A leak in the lubricating mechanism of his Curtiss biplane marred the attempted oversea flight of J. A. D. McCurdy from Key West, Florida, to Havana, Cuba, on Jan. 30. After beating the world's record for flying over the ocean and making 96 miles at the rate of 50 miles an hour, McCurdy was forced to descend into the sea within 10 miles of Havana.

The course between Key West and Havana was marked by vessels of the Atlantic torpedo boat flotilla which were stationed at intervals 10 miles apart for the entire distance. The weather was ideal for the attempt, there being no wind. He was within sight of his goal when he noticed that the oil had been exhausted through leakage and that the engine was showing the

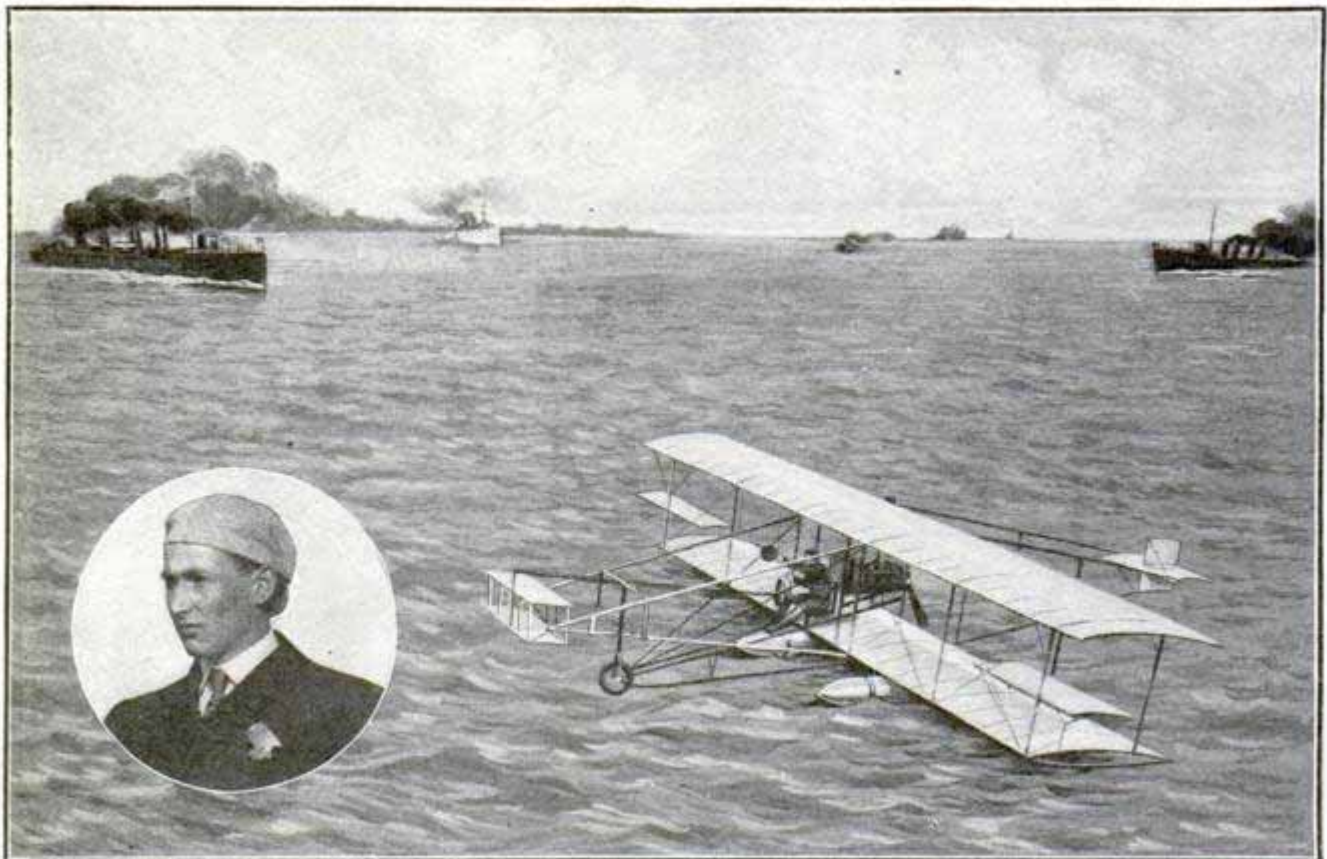

J. A. D. McCurdy in His Biplane Alighting on the Water 10 Miles from Havana, Torpedo Boats Coming to His Rescue



effects of lack of lubricant. He stopped the engine and descended immediately. His machine was equipped with pontoons and rested lightly on the surface of the water, there being no sea running. The torpedo boats "Terry" and "Paulding," the latter being the last in the line of boats, hurried to his assistance. He was about equidistant from both when he came down. McCurdy and his machine were placed aboard the boats, the "Terry" taking the machine and the "Paulding" the airman into Havana. The prize of \$8,000 was awarded him on the ground that the airman had practically accomplished his task and established a new record for flying over sea, the English channel flights being about one-sixth the length of the Key West-Havana course.

#### SUCCESSFUL RESCUE OF SUNKEN SUBMARINE

A submarine telephone set and the German rescue ship "Vulcan" proved the efficiency of such emergency apparatus when the German submarine "U.3" sank in the harbor at Kiel. As soon as the accident occurred, the crew of the submarine released a spherical buoy containing telephone apparatus, which shot to the surface, uncoiling the wires as it rose. By means of this telephone the exact position of the submarine and the conditions within it were communicated to the surface, and the "Vulcan" immediately ordered to the scene. The bow of the submarine was lifted sufficiently for the 30 members of the crew to escape through the torpedo discharge tube. Only 27 men left the vessel, however, the captain and his two lieutenants deciding to remain in the conning tower until the vessel was again master of itself, a decision which resulted in their death. The conning tower was still under water, the vessel not yet having been fully raised when a ventilator gave way, permitting the water to rush in, isolating the tower and cutting off the oxygen upon which the three officers were dependent.



## AEROPLANE PROVES ITSELF A NAVAL AID

The aviation experts of the naval service believe that by the remarkable performances of Glenn Curtiss and Eugene B. Ely in California, during the latter part of January, they have successfully refuted the criticisms of

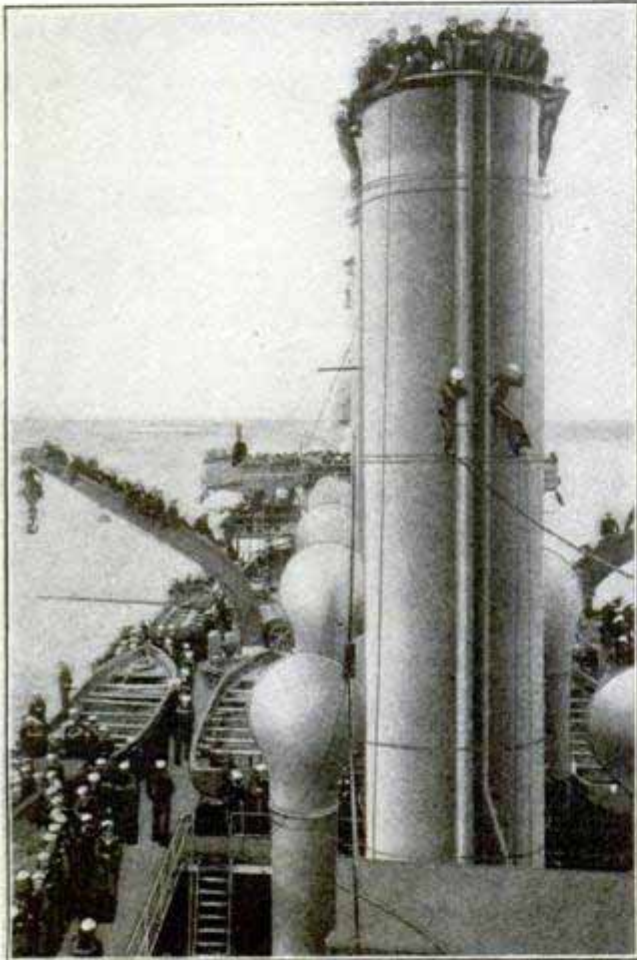

Crew of "Pennsylvania" Climbed Even to the Tops of the Funnels to Witness Ely's Feat

those who have failed to see the adaptability of the aeroplane in naval warfare. With a Curtiss type of biplane, Ely flew from the shore to the deck of the armored cruiser "Pennsylvania," in San Francisco Bay, where he alighted without accident and then flew from the ship to the shore. Curtiss, with his hydroplane attachment, after several trials, succeeded in ascending in his machine from the surface of the water, returning to the water, and rising again into the air.

There has always been a question as to the ability of the airman to return to the deck of a warship after once going into the air. If it was found he

could not do so, then, the value of the aeroplane to the battle fleet commander was very slight. The thing was done under ideal conditions with ease and all risk to the machine and the operator was reduced to a minimum. A platform, 130 ft. long and 50 ft. wide, was constructed on the after deck of the "Pennsylvania." Across this platform were stretched pieces of rope a foot or two apart, to either end of which were attached bags filled with 100 lb. of sand. The under part of the running gear of the aeroplane was fitted with hooks, the idea being that the hooks would engage the ropes as the machine was guided along the platform, and the weight pulling against the machine would gradually bring it to a stop without straining the frame. This theory worked perfectly in practice. Ely lowered the machine to the platform so that it glided onto the platform about 40 ft. from the end. It was moving rapidly when it alighted on the ship but was stopped within 25 ft. by the gradually accumulating weight of the sand bags. The launching of the machine was accomplished in the same manner as the launching from the deck of the scout cruiser "Birmingham" in Hampton Roads.

The Curtiss hydroplane tests took place at San Diego and were the result of a series of experiments Curtiss began more than a year ago. The aeroplane in this instance was equipped with pontoons instead of runners. The machine was run on the water for a short distance at a high rate of speed before being directed into the air. The tests were highly successful and demonstrated the ability of such a machine to be launched from the sea itself. In both these tests the airmen waited several days for the most favorable moment for their work. Whether the feats can be accomplished under the average conditions of weather and sea remains to be demonstrated and on this depends the practical value of heavier-than-air machines in naval warfare.

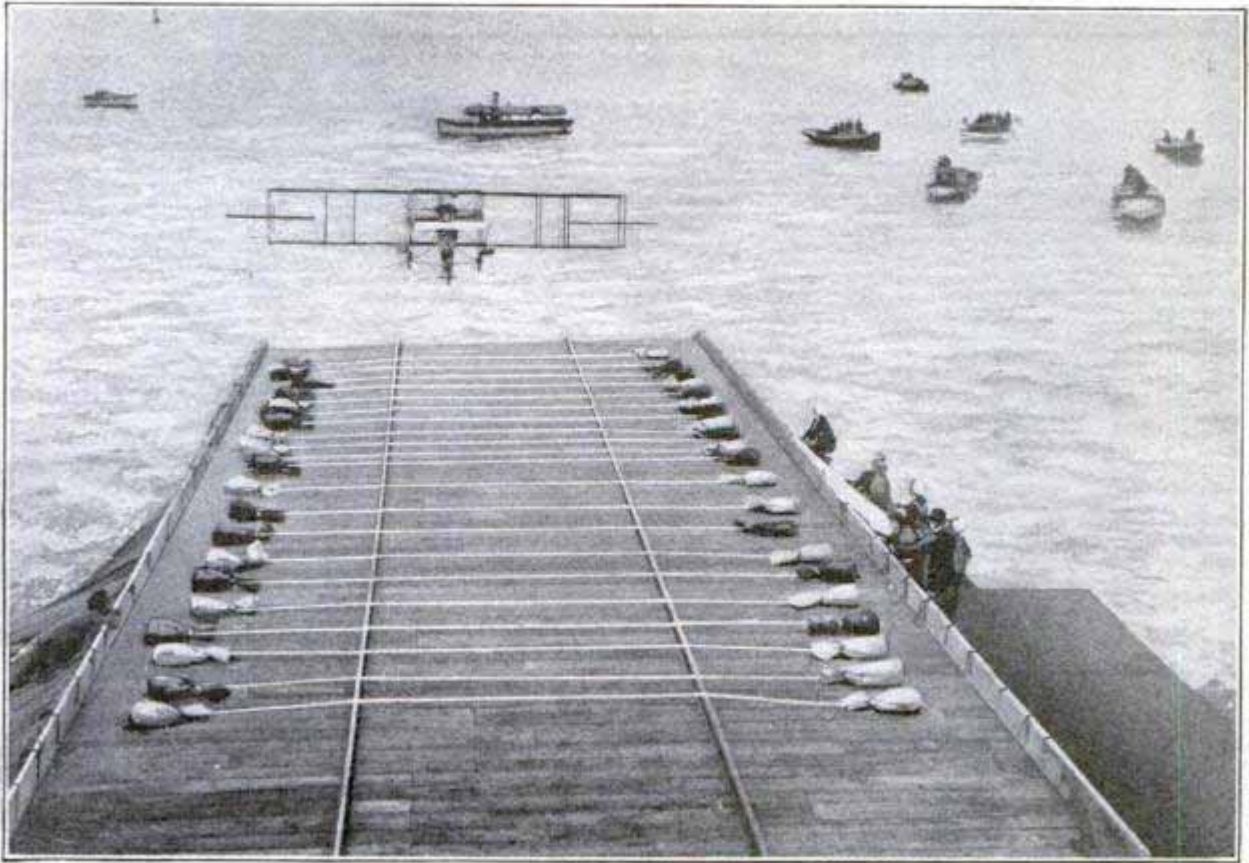

Platform Built on the Deck of the Armored Cruiser "Pennsylvania" to Receive Ely's Aeroplane. Note the Ropes Stretched Across the Platform with Sand Bags at Either End Which Hooks on the Aeroplane Picked Up, the Gradually Increasing Weight Bringing the Machine to a Stop within 25 Feet.

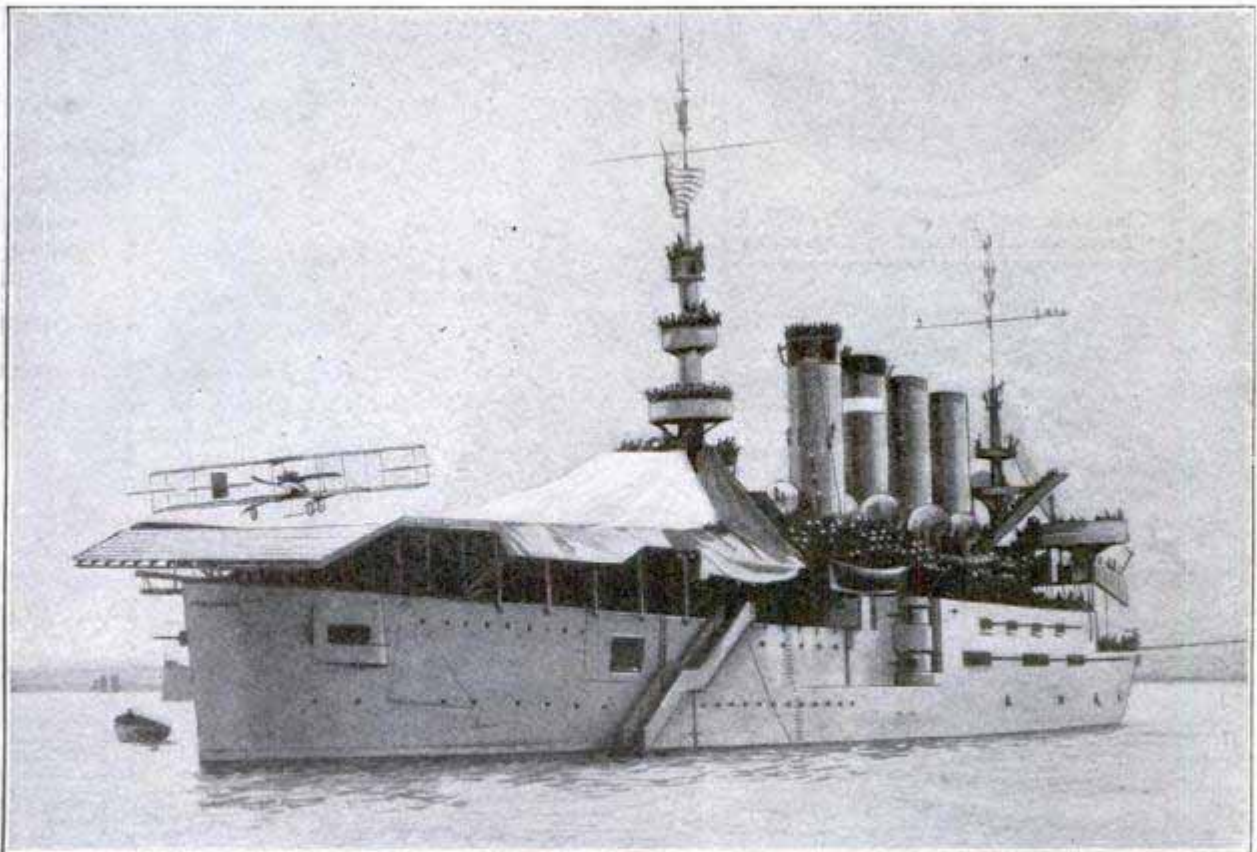

Eugene B. Ely Alighting on the Deck of the Armored Cruiser "Pennsylvania" in San Francisco Bay, January 18. The Photograph Was Made Just As the Aeroplane Started to Drop to the Deck. The Machine Was Launched from This Platform on the Return Trip to the Aviation Field.

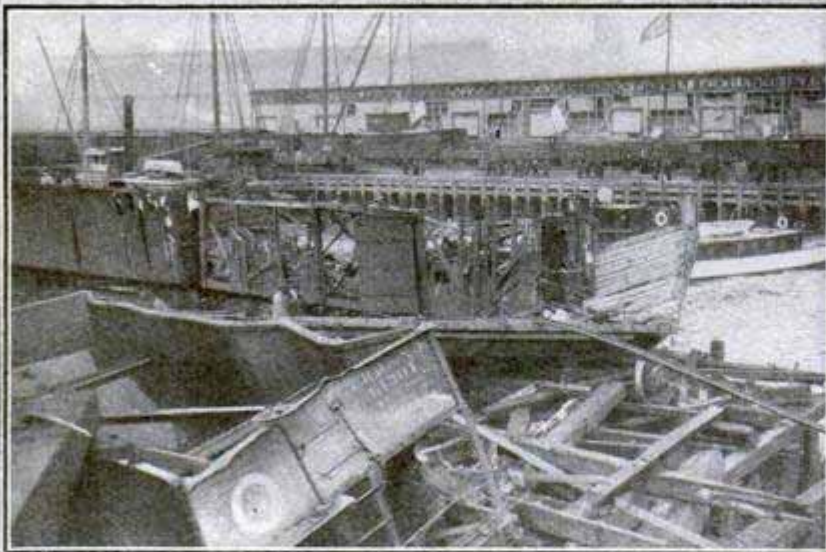

View of the Wrecked Pier and Cars—Note Damage on Opposite Sheds

SHOCK CAUSED \$1,000,000 DAMAGE

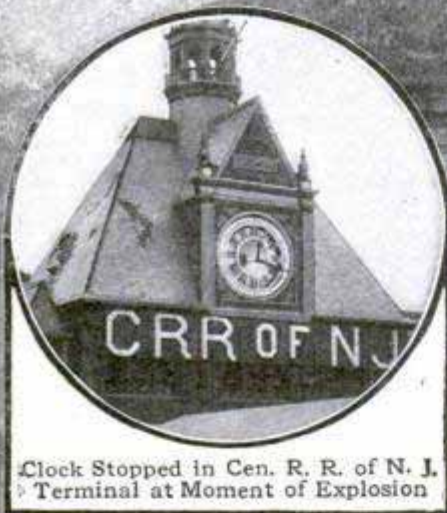

Clock Stopped in Cen. R. R. of N. J. Terminal at Moment of Explosion

Captain of Tugboat Half-Mile away Killed

Railroad Terminal Damaged  
All Windows Broken  
Structure Severely Shaken

Sheds Wrecked

Dotted Outlines Show Positions of Two Dynamite Lighters before Explosion - They were Blown to Pieces

Lower New York Skyscrapers Trembled - People Panic - Stricken \$50,000 Loss in Plate Glass

Steel Barkentine "Ingrid" Members of Crew Killed Ship Stripped of Rigging

Boats of Lighter  
Washed Away  
300 ft. away

EFFECT OF EXPLOSION OF 25 TONS OF DYNA



Searching through Wreckage for Bodies of Crew of "Ingrid"

NORTHPORT 40 MILES AWAY  
Shaken By Earth Tremors

LONG ISLAND SOUND

WITHIN FIVE MILE RADIUS

#### AN ARTIFICIAL EARTHQUAKE

New York really experienced an earthquake, although an artificial one. All the deaths and the great damage in the immediate vicinity of the dynamite were caused by the direct force of the explosion, but the rocking of the New York skyscrapers was due to the earth vibrations sent radiating from the spot where the dynamite let go. The windows that showered glass into New York's streets were not blown out by a rush of air, but shaken out by the tremors of the earth.

When dynamite explodes, it is the expansion of gases which causes the great damage, but the inrush of air to fill the vacuum created by the explosion may also do damage. As often as not this inrush may be held responsible for the shattering of plate-glass windows.

The distance a dynamite explosion may be felt depends upon the nature of the strata of the earth in the vicinity. Northport, 40 miles down Long Island, trembled with the shock, yet Bayonne, hardly two miles distant, did not feel the slightest tremor. Rock is the best conductor of earth waves, and conditions may be such that the vibrations may pass under one community without shaking it, and be felt in another several miles beyond.

It is difficult to say under what conditions dynamite will or will not explode. Hudson Maxim says that although a carload of dynamite would be almost certain to explode if set on fire, sometimes even such a quantity will completely burn up without detonating, while, at other times, a single stick will explode when ignited.

At the rate at which explosives are being used at the Panama Canal, 25 short tons of dynamite, the amount exploded at Jersey City, would excavate 140,000 cu. yd. of rock. If this rock were to be piled straight up on a city building lot measuring 150 by 50 ft., it would tower to a height exceeding 500 ft. Such is the disruptive power of 25 tons of dynamite.

BROOKLYN

MITE AT JERSEY CITY PIER ON FEBRUARY 1

## COMMENT AND REVIEW

**M**UCKRAKING has had a rude awakening. The law, which it so loudly called down upon a big corporation, has at last been invoked by the victim and the accusing magazine loses no time in begging for mercy, and pleading to be let off with a retraction. After all the abuse, vilification, and certainly no small amount of falsehood which magazine writers and publishers have for several years heaped upon the Standard Oil Company, that corporation would have been amply justified in pushing its suit, even with the full knowledge that to do so might mean confiscation of the magazine. Perhaps the lesson will be taken to heart by other muckrakers whom immunity thus far has emboldened to write, regardless of all sense of fairness and frequently of fact. Have you ever considered the

*The  
Penalty of  
Muckraking*

why of the muckraker? It seems to me like this:

When Rome was fighting its wars of conquest, building its empire and framing its wonderful code of laws, the minds of the people were occupied in the doing of real things. Then the people profited by public contests of strength and skill, and physical manhood was glorified. But later on, with surrounding nations subjected, and surfeited with conquest, the appetite for blood led to the institution of those revolting dramas where blindfolded gladiators fought to the death, and helpless maidens were fed alive to wild beasts, or served as living torches. All these for the entertainment of the masses. It was a legalized concession to a perverted public taste, as ignoble, beastly and degenerating as it was cruel and wicked.

For the past fifteen years we have had what is known as yellow journalism. For a time this was confined to the daily press. A depraved public appetite for the sensational was thus created and nurtured. The simple, straightforward, accurate telling of an event ceased to satisfy. A perverted taste demanded a highly flavored and sensational style in which extravagant statement, suspicion, accusation and innuendo were employed to make a startling condition, quite regardless of truth or of what the effect might be on the innocent subject of the attack.

The magazine disease started with Lawson's "Frenzied Finance," which, while paying off some old personal scores, nevertheless resulted in enormous good. The financial success which accrued to its publisher made other publishers jealous and eager, but what began with an ostensible effort to right real wrongs speedily degenerated into a wild scramble after imaginary evils. The extent to which this was carried is fairly illustrated in the case of an honored man now on the Supreme Bench of the United States, who was ridiculed and impugned because he was an attendant upon a Sunday school! Facts only half stated, or expressed in language which made white appear black, suggestions conveying an impression directly opposite to the truth became a fine art with the muckraker.

In the mad rush for circulation in order to command a large volume of advertising at high rates, many of the magazines put the yellow slide in their spot light. Some things were exposed which doubtless needed publicity, but in doing it the temptation could not be resisted to paint the picture in vivid colors, and as competition rapidly developed, publishers became more and more insistent for

"hot stuff" in an effort to outdo their competitors and satisfy a growing but wholly abnormal appetite for sensationalism. Soon the fairly moderate style of these articles began to fall flat on an unnatural mental taste, and publishers demanded of the writers more highly seasoned and sensational stories in order to keep up the pace, and eventually the moderate and possibly well meant and honest effort to correct existing wrongs—some of which are admitted—was entirely lost sight of in the mad race to see who could put out yellow magazinism in the ultimate. Thus degenerated the standard of so many of our monthlies. Then what happened?

As Rome came at last to weary of the weekly public murders through mere monotony of repetition, so the American public at last grew tired of mudslinging because of its commonness. They were surfeited. Their mental digestion was impaired; the food no longer produced the healthy red corpuscles which gave strength to mind and imagination. Their brain cells were clogged with poisonous matter; the whole mental system was run down. It became a case of "the day after" with an unwholesome, dark brown taste in the mouth. The substantial, sanely entertaining, instructive, beautiful and healthful articles of fiction, travel, biography and the like, seemed tame after the long mental debauch. And today both publisher and reader of the yellow magazines are wondering, the one why his sales are falling off, and the other why the magazine is no longer so interesting as it used to be. Yellow leaves fall from withered branches.

Another phase of this back-firing of the engine is seen in the frenzied, artificial methods to hold and bolster up circulation by means of premiums to secure subscribers, and in the cut rates where a combination of publishers offer a group of magazines at half, or less, the regular advertised price. On top of this, a further big reduction to subscription agencies through which the cut rates are handled, has cut down the net price to the publisher, until in some cases he is receiving less than one-third his subscription price, or about one-half the cost of the white paper alone. The magazines which today are making any money on their circulation can be counted, doubtless, on the fingers of one hand. Who pays the freight did you say? The advertiser. This method of keeping the patient alive with oxygen or injections of nitro-glycerine must soon fail for reasons which are self-evident. But we digress.

Muckraking has had its fling; it has seen its balmy days, and now must come the sobering up, and nursing back to health of vitiated mental appetites. The eyes of the readers have been color blinded until everything looks yellow, or if seen in any other hue, appears unnatural. It will take time, yet it will come, but in the process of recuperation some magazines, the worst offenders, are sure to pay the penalty of excesses: Some will struggle through to health again, and some whose vitality is at low ebb will not survive, but out of it will come a chastened, enlightened class of publishers and a return to that high standard of real literature which only a few magazines have steadily maintained through these weary years of husk eating and reveling with the swine.

H. H. WINDSOR.

### FITTING A PROPELLER AT SEA

The steamship "Taiwan" was recently refitted with a new propeller in an open roadstead by loading down the bow of the ship with over 1,200 tons of ballast so as to raise up the

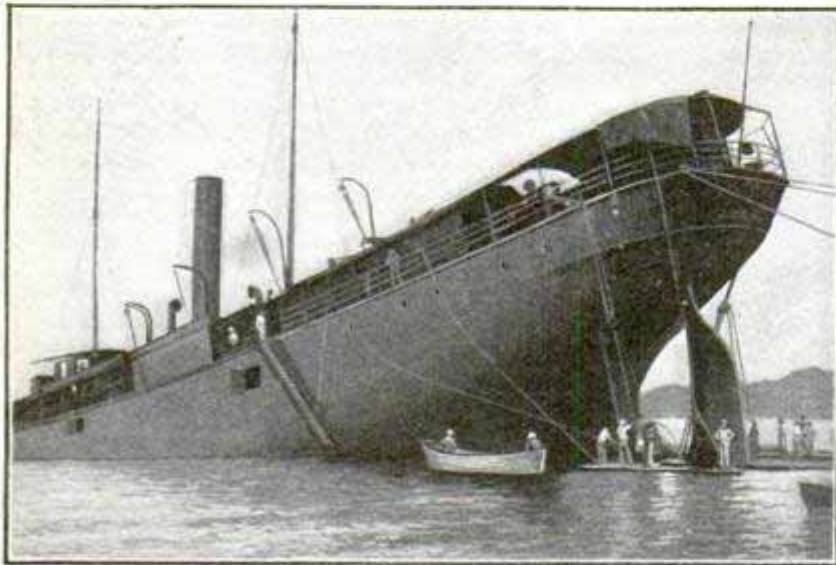

Steamer Fitted with New Propeller in Open Roadstead

stern tube clear out of the water. The vessel, which is 271.3 ft. long and has a gross tonnage of 1,743 tons, lost her propeller in mid-ocean when on a voyage from Mauritius to Hong-kong. She was sailed some 600 miles to Mahé Island in the Seychelles, and as no dock was available, she had to be tipped in the manner stated while the broken end of the propeller shaft was pushed out through the stern tube, a new shaft inserted, and a new propeller put on and fixed.

The illustration shows the ship with her stern out of the water and the repair work practically completed.

CA mouse caught in the generator switches of a Delaware electric lighting plant, caused a short circuit which cut off the current, and consequently the light, from three cities.

CA special train carrying J. Pierpont Morgan and party from Washington to New York made the record time of 3 hours and 56 minutes for the trip which usually takes 6 hours.

### MME. CURIE REJECTED FOR COHERER INVENTOR

Mme. Marie Curie, who is given equal credit with her husband for the discovery of radium, has been defeated for admission to membership of the French Academy of Sciences by M. Edouard Branly, the inventor of the coherer for wireless telegraphy. The vote, taken Jan. 23, stood 28 for Mme. Curie to 30 for M. Branly. The woman scientist's name headed the list of six candidates that was presented, only one of which was to be chosen.

The Branly coherer was so important a factor in the development and perfection of the wireless telegraph apparatus that Marconi selected him as the man to whom he sent the first message by wireless from England to France. The announcement was made after the vote had been taken that the vote did not reflect the attitude of the academy toward the admission of women in any sense, and that the election was based solely on the merits of the claims of the two candidates for recognition by the foremost body of scientists in France.

### 55-STORY SKYSCRAPER FOR NEW YORK

Enlarged plans for the proposed Woolworth Building in lower New York provide for a structure 750 ft. high, 50 ft. higher than the Metropolitan Tower. The main building will have 30 stories and above this will rise a tower about 80 to 85 ft. square, containing about 25 stories, making 55 in all. This skyscraper will be exceeded in height only by the Eiffel Tower which is 985 ft. high, and will cost \$12,000,000. It will cover a total area of 39,500 sq. ft. The original plans provided for a structure 625 ft. high.



## ELECTRICAL MAGIC SURPASSES LEGERDEMAIN

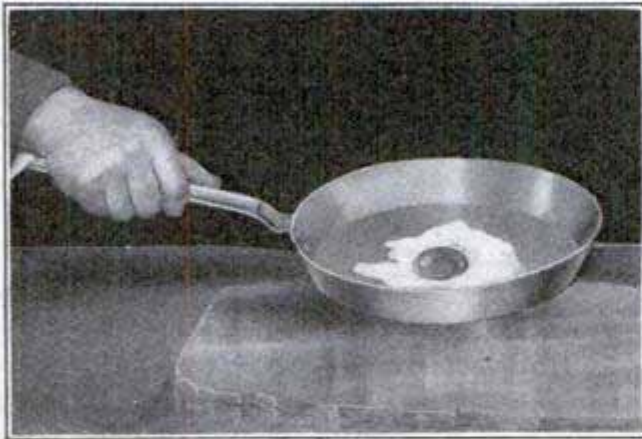

Frying an Egg on Ice



Lighting a Lamp by Wireless

Can eggs be fried on ice? Is it possible to take an ordinary frying pan, hold it over a cake of ice, break an egg into it and fry the egg to a turn without a fire, simply holding the pan in the hand?

It can be done. This and other spectacular tricks of a similar nature were performed at a recent electrical show in Chicago. Many skeptics lost their money betting against it. They felt the cold pan, broke the egg into it, held the pan over the ice themselves, and then burnt their fingers while the egg was frying to find out if the pan was really hot.

An oven of slate with an aluminum base was placed on the marble slab forming the top of the table whereon the ice had reposed for the previous experiment. It was just a simple oven, no fire, no coils, no wires, only slate and aluminum. In the oven were placed the lumps of dough for making biscuits. The oven door was closed and the operator stood, watch in hand, checking off the minutes. Presently he opened the door, and there were the

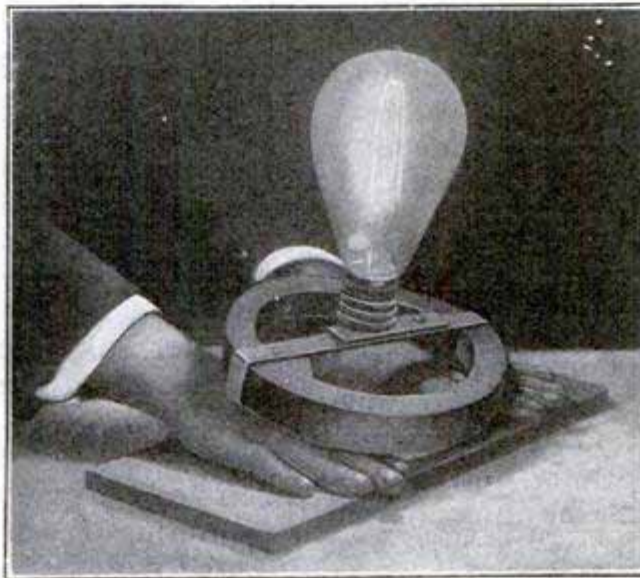

Lighting the Lamp Through the Hands—The Base is Simply a Coil of Wire

## THREE STARTLING EXPERIMENTS

biscuits, baked to an appetizing light brown.

A tungsten lamp, screwed into a socket attached to a simple coil of wire, was placed with the coil immersed in an iron pan partly filled with water. It was set on a slate slab which was placed on the table. Immediately the lamp lighted. A spectator suggested that there was

some mystery connected with the pan. He was invited to place his hands palms downward on the slate. He did so, and the coil, with the lamp attached, was placed on the backs of his hands. The lamp immediately began to glow.

A hollow copper ball, floating in a jar of water, whirled around furiously when the jar was stood on the table. A simple apparatus, consisting of a frame and four pivoted aluminum disks, was put on the slab. The disks whizzed around at a tremendous rate.

Two plates, one a heavy disk of metal and the other a tin dinner plate, were put on the table. The table did not move a bit, but the plates sprang

several feet in the air and dropped on the floor.

It all was done by wireless. Under the table was a powerful electromagnet. When the operator turned on the electric current, which was the ordinary alternating current from the

city mains, a powerful alternating magnetic field permeated everything in the vicinity. In any metal part nearby, it set up induced electric currents, which caused the performances. There was no trickery. Any electrical enthusiast can do the same things.

### WRECKED EXPLORERS WALK 1,100 MILES

A scientific expedition, consisting of 14 men, headed by Prof. J. I. MacConn, of the Canadian geological survey, arrived safely at Winnipeg, Manitoba, the latter part of January after a journey on foot of 1,100 miles in a temperature averaging 60 deg. below zero. Their vessel, the Arctic schooner "Jeanne," in command of Capt. Howard Bartlett, was driven ashore and pounded to pieces in the northwest region of Hudson Bay, and the expedition landed safely, although both lifeboats were smashed. With the aid of Eskimos the expedition tramped 100 miles to Fullerton. Then the party journeyed to Fort Churchill, 500 miles south, on a whaling vessel, where clothing and provisions were obtained. The long march from Fort Churchill to Gimli was started on Dec. 8, with Indians as guides. That no lives were lost on the long tramp is regarded as a great achievement.

### MOTOR AND PROPELLER TO GIVE STABILITY

M. Bouchaud-Praceiq, a French chemical engineer, claims to have discovered the solution of automatic stability for aeroplanes. It is simply this: Make the motor revolve in a direction opposite to that of the propeller, and if the gyroscopic effects of the oppositely revolving masses are equal, the result will, it is said, be perfect automatic stability.

The experiments were made with a motor-driven propeller apparatus supported on a board which was suspended by strings.

The Ligez motor, which was recently demonstrated with success at Issy-les-Moulineaux, acts on a similar principle, and the aeroplane to which it was fitted was enabled to perform with apparently perfect safety some extraordinary evolutions in the air.

### GERMAN AERONAUTS LOSE THEIR LIVES

Sixteen days after its disappearance after an ascent from Schmargendorf, the German balloon "Hildebrandt" was found in a lake in Pomerania province, Prussia, with the bodies of Dr. Roehrs, the pilot, and a companion. The balloon ascended Dec. 29, equipped for a 48-hr. voyage. Nothing was heard from it and it was supposed to have been lost in the Baltic, as an airship resembling it was reported to have been sighted passing over Höganäs, Sweden, on the evening of Jan. 4. The remains of the aeronauts were discovered in the car of the balloon when the balloon was found in Pomerania.

### CITY HELD RESPONSIBLE FOR TYPHOID

Although the relations of a city to its citizens are such that damages resulting from the construction and operation of public works cannot ordinarily be obtained, the supreme court of Minnesota has laid responsibility for typhoid deaths upon the city authorities of Mankato.

The complainant charged the city with negligently allowing its water supply to become polluted with sewage. The court ruled that the municipality was liable in its private or corporate capacity for this negligence.

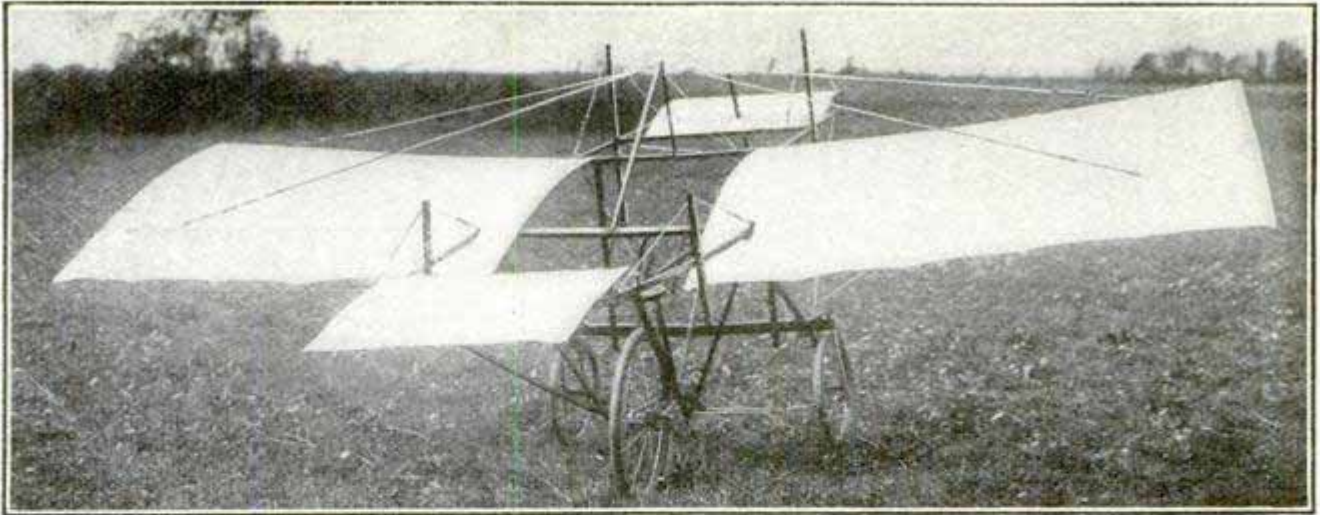

Rear View of Successful Glider of Original Design Built by Two 16-Year-Old Boys

### OIL CONCRETE, THE LATEST IN ROAD MAKING

The latest material in road construction is "oil concrete," which has been used to a depth of 5 in. over a telford foundation on a short experimental road near Harrisburg, Pa. The concrete takes its name from the fact that 15 per cent of oil is added to the ordinary concrete which is used for the upper layer. A thin coating of finely crushed stone was used as a top dressing, and the road was sprinkled daily with water for seven days before it was opened to traffic.

☐ A new foot-warmer for motorists utilizes the heat of both the exhaust gases and the circulation water.

### BOYS FLY 250 FEET WITH A HOME-MADE GLIDER

Flying 250 ft. from a 28-ft. embankment in a glider of their own make is the feat recently accomplished by James M. Fitzwilliams and Edgar A. Clark, two 16-years-old boys of Buffalo, N. Y.

The machine is the result of much experimentation and study, and was built only after several smaller models had been made and tried out.

The glider weighs about 55 lb., and the wings, which are curved and slant upward a little from the center to the tip, measure 16 ft. by 4 ft. 8 in. A rear plane or tail is intended to steady the machine in flight and to do the lateral steering.

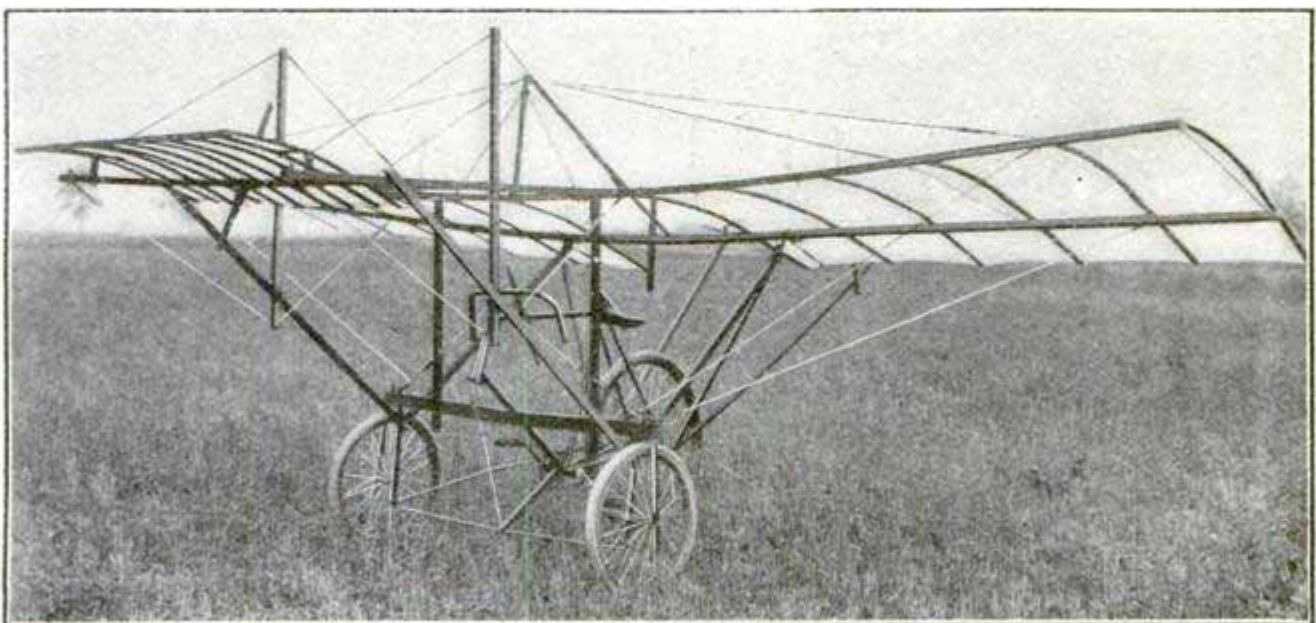

The Boys Flew 250 Ft. with This Machine after Pedaling It along the Ground

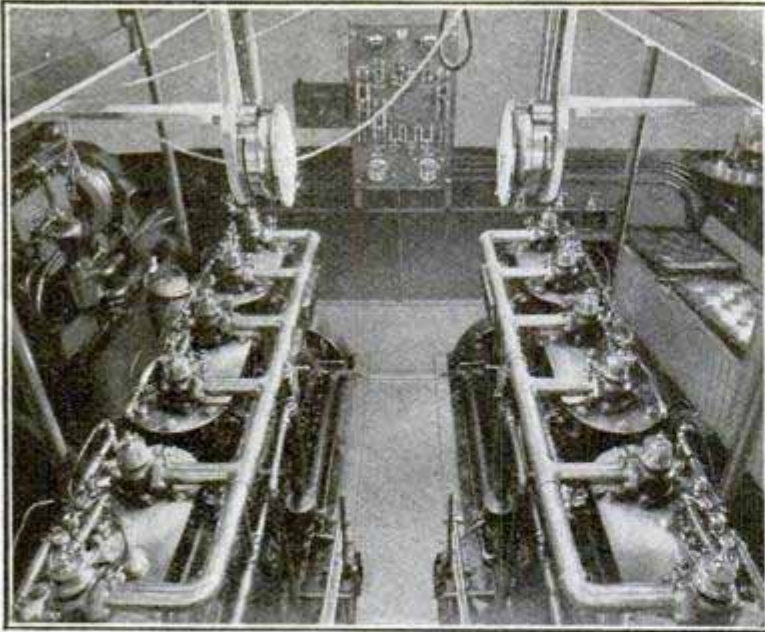

Twin 75-Hp. Engines

Probably more interest was evinced in the building of the twin-screw motorboats "Ethel May II" and "Paula" than in any other orders placed by New Yorkers last year. The two pleasure vessels are "sisters," with the exception that the "Ethel May II" was subsequently equipped with bulwarks, and are owned by Albert E. Smith and J. Stuart Blackton.

The requirements of the owners

were that the boats should be of flush-deck type, 98 ft. long overall, with a beam of 16 ft., a draft of 4½ ft., full headroom below deck, and an overall height from waterline to top of cabin-house that would be well within the clearances required for the Erie Canal. These specifications enable the boats to make the inland-waterway trip from New York to the St. Lawrence River and the Great Lakes.

## TWO REMARKABLE 98-FOOT MOTORBOATS



Galley Equipped with Coal Range



Owner's Bathroom



Dining Saloon above Deck

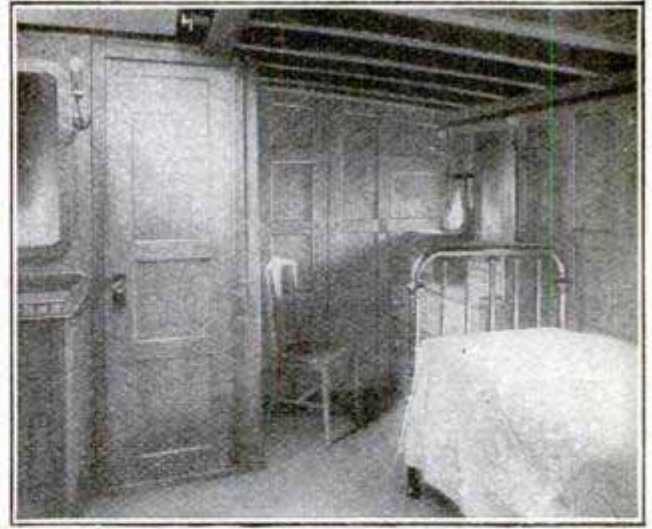

One Side of Owner's Stateroom

The motor equipment of each vessel consists of two 75-hp., six-cylinder engines. The exhaust is carried out to the side, and the stack is used as a ventilator for the engine room.

The design of the boats being the same, the description of the accommodations of one suffices for the other. The owner's quarters are located aft of the engine room and are 14 ft. wide, the full inside width of the boat, with a fore-and-aft measurement of 11 ft. In these quarters are two single brass bedsteads, two chiffoniers, two large hanging lockers and, on the port side forward, a large bathroom with porcelain tub, lavatory, etc. Hot and cold water are available throughout, flowing by gravity to all basins and to the bathtub. The fresh water is carried

in tanks of 600-gal. capacity, located under the cabin floor, from which it is pumped by electricity to an auxiliary tank on the cabin roof. The bathtub is emptied by means of an electric pump, and connection to the sea is made so that, by simply pressing an electric button, salt water may be obtained for the bath, if desired.

The main saloon, aft of the owner's quarters, is finished in dark mahogany and is the full width of the vessel. The stationary furniture consists of a desk and bookcase, mantelpiece and lockers, all of mahogany.

Aft of the main saloon are three single staterooms, provided with single berths, lockers and drawers, and full-length dressers and bureaus. The owner's stateroom provides comfort-

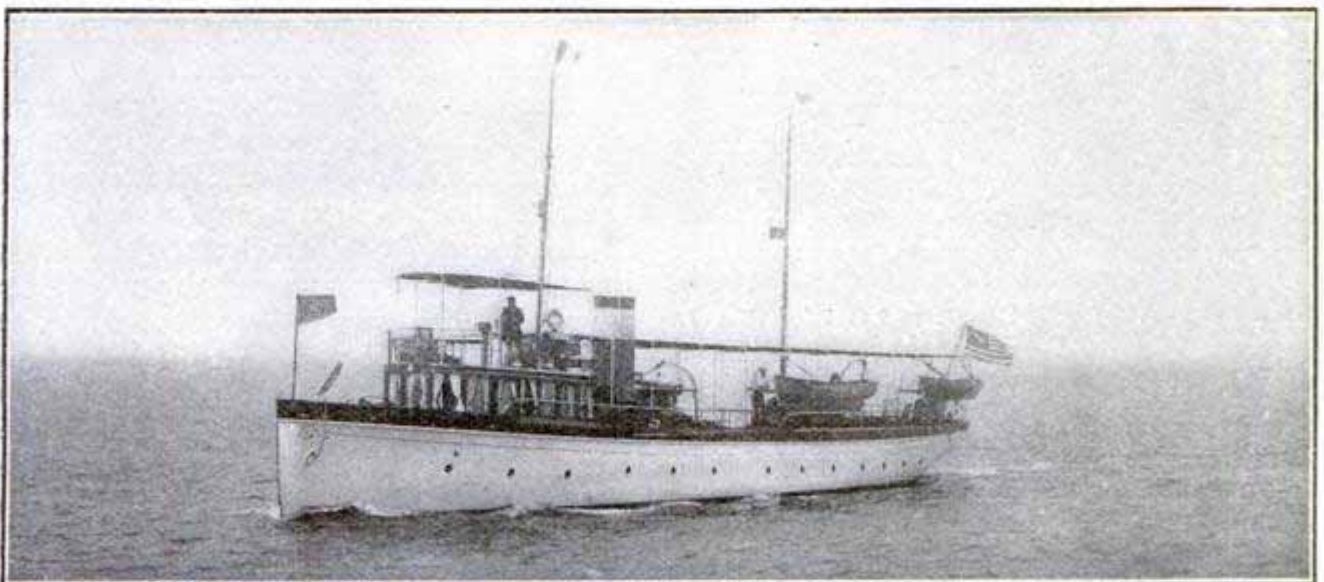

The "Ethel May II"—A Large Motorboat with the Comforts of a Home

able sleeping accommodations for two, and the main saloon for two. The dining saloon is forward on deck and is unusually spacious. A large round table built of mahogany and provided with extension leaves seats a company of 12 very comfortably.

The galley, adjacent to the dining room but below deck, is 15 ft. in width, and 5 ft. fore and aft. It is equipped with a four-hole coal range, large porcelain sink, hot-water boiler, a storeroom for dry groceries and fresh vegetables, an ice box having a capacity of 400 lb. of ice, and the usual equipment of cupboards and lockers.

The crew's quarters are forward under the dining saloon and in the forepeak of the vessel, affording a single stateroom for the captain and four berths for the crew.

The engine room is of unusual size, and affords ample room for the engineer to inspect all the moving parts of the engines. A berth for the engineer is provided in the engine room. An auxiliary electric-light plant, operated by an 8-hp. gasoline engine, is direct-connected with the bilge pump, fire pump and air compressor. The vessel is, of course, electrically lighted, and the windlass on the forward deck is driven through spur gears by a 4-hp. electric motor.

The small-boat equipment is out of the ordinary. Each motorboat has a 14-ft. rowing dingy and a 16-ft., 5-hp. motor tender carried on davits on the port side, and a 20-ft., 40-hp. express tender carried on the starboard side. These express tenders have a speed of 25 miles an hour.

### MECHANICAL FEEDER FOR GEESE

In France the geese which are intended to supply the main ingredient of the delicacy "pâté de fois gras aux truffes" (goose-liver paste with truffles), are kept confined in narrow cages. The slightest movement is thus prevented, and food is forced down their throats, often with nothing more than a tube and stick, in order to produce an extraordinary development of the liver.

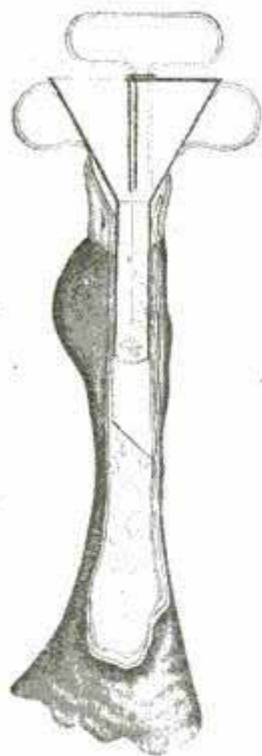

The drawing illustrates a newly devised instrument for this mechanical treatment, which in a measure alleviates the inhumanity of the forced feeding, in that it does not injure the throat or prevent breathing. It consists of a funnel of galvanized iron, provided

with a piston which cannot protrude beyond the end of the tube. At the lower end of the galvanized iron tubing is a section of rubber tubing.

### DEVICE TESTS ENGINE CYLINDERS

When an automobile engine has four or more cylinders, it is highly important that the power of one cylinder should correspond with that of the other cylinders, or smooth running is impossible. Careful tests are made and indicator diagrams taken when the engine is turned out, and an English firm has now placed on the market an engine-testing device which indicates the compression of each cylinder while the automobile is in actual use.

The indicator is attached to the dashboard of the car among the usual array of indicating devices, and each cylinder is connected up to it by a pipe provided with a special valve. Under ordinary running conditions, the indicator and pipes are shut off from the engine, but by turning a valve, shutting off the spark and allowing the engine to run by momentum, the compression of each cylinder can be tested

in a few seconds. Should there be a leaky valve, or any other cause of loss of pressure in the cylinder under test, it is at once shown on the indicator, the pressure generated by the explosion also being shown. Thus the maximum pressure in each cylinder can be compared with that in any of the others. Also, when the operator is giving the engine a little less or a little more air, or advancing the spark, the indicator shows, by the rise or fall of pressure, the exact moment when the adjustments are perfect.

### AN ELECTRICALLY OPERATED LIFT BRIDGE FOR CANALS

A novel lift bridge, probably the prototype of many others to be used in a like connection, has recently been built over the Miama & Lake Erie Canal, in Cincinnati, at a cost of nearly \$50,000. The bridge is of steel, with concrete foundations for its piers, and weighs 400,000 lb. The lift is 8 ft., which is sufficient to permit the passage of the ordinary type of canal boat. A solitary watchman is the only operator needed, and owing to the use of counterbalancing weights in the piers

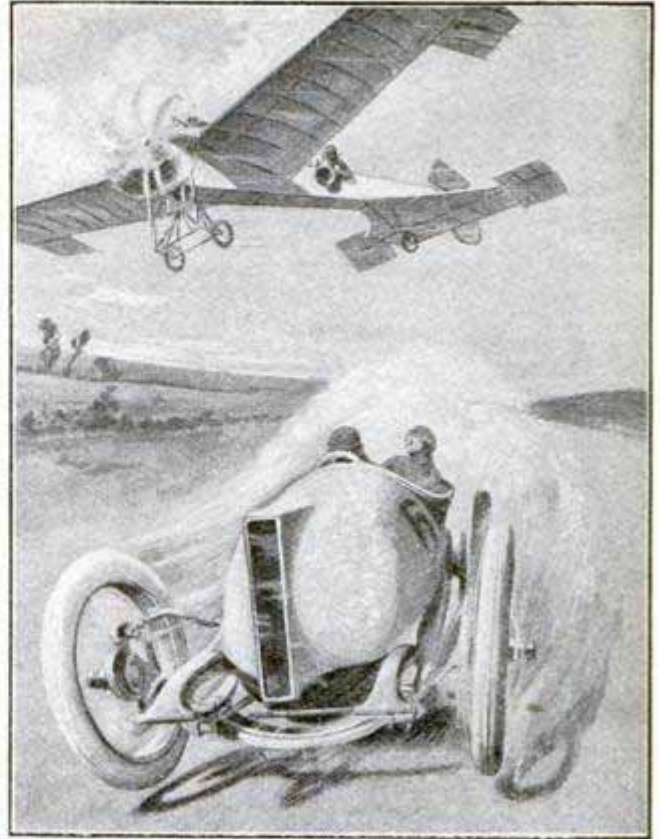

#### COACHING THE DRIVER OF A RACING CAR

The Motor, London suggests that in future automobile races an airman in a fast aeroplane could rise and ascertain the relative positions of rival motor cars and then descend and inform the automobile driver.

at both sides, the elevating is performed by a small electric motor, or may be done manually when required.

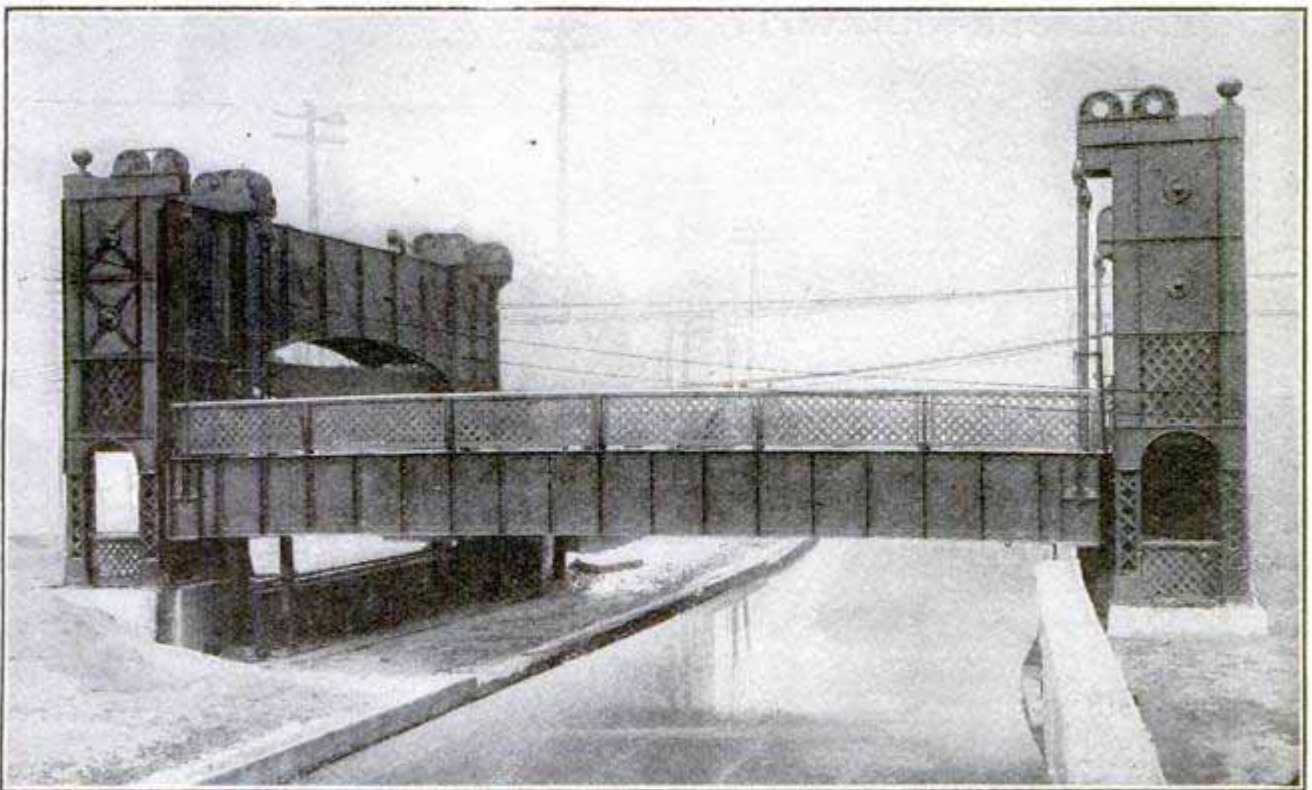

Lift Bridge over Canal in Cincinnati

**MOTORISTS' REPAIR COUCH**

With this ingenious couch, the repairman finding it necessary to work under an automobile in a garage may easily pull himself in and out, he is kept from contact with the cold and

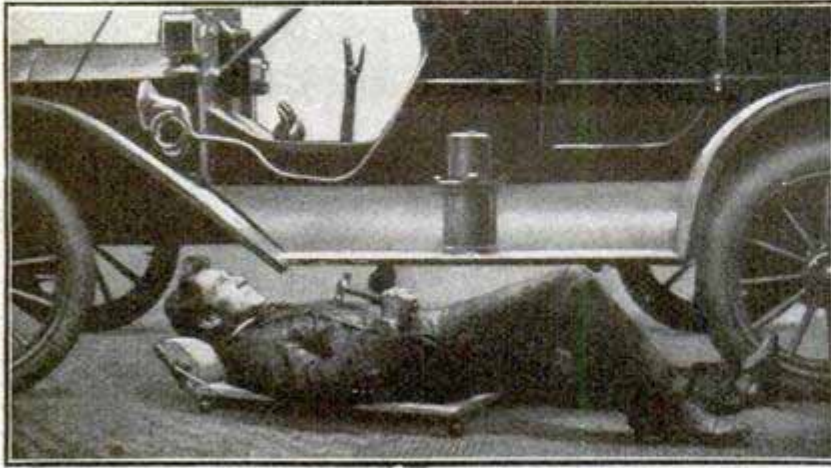

Repair Couch in Use

dirty floor, and his head is supported in a comparatively comfortable position by the adjustable head rest. Work under a car cannot, at best, be other than irksome, and if the work takes any length of time, a support for the head is necessary, otherwise the neck soon becomes cramped.

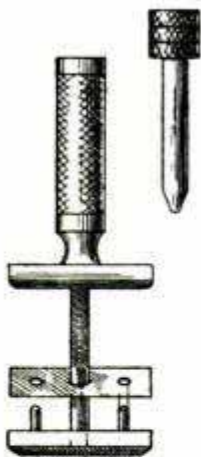
**SAFETY FINGER-NAIL CUTTER**

This ingenious little instrument, constructed on the lines of the safety razor, has been invented by a Frenchman as a safety finger-nail cutter. The drawing shows the simple way of inserting the blade, which is held securely by screwing down the handle of the device.

The edge of the blade projects four hundredths of an inch beyond the guard.

Sound lumber, 25 years old, has been conclusively proved by German government investigators to be materially stronger than new stock.

**BOTANICAL GARDEN IN ALPS**

Situated at an altitude of 7,200 ft. on Little St. Bernard Mountain, in the Alps, is a botanical garden which has just reached its completion after 18 years of work. The idea was conceived about 1880 by

Abbé Chanoux, for 50 years rector of the hospice on the pass over the mountain, and the garden has been named "Chanousia" in his honor.

The Chanousia garden may well claim to be a living museum of the mountain flora of the world, for in it can be seen more than 2,000 thriving species representing the whole Alpine region, the Dalmatian,

Balkan, Carpathian and Caucasian mountains, the northern highlands of Europe, the Himalayas, and the mountain ranges of Canada, America and Japan.

The ground occupied by the garden was donated by the little community of La Thuile, in which it is situated, and is surrounded by a retaining wall more than 2,000 ft. long. The different soil conditions under which the specimens thrive have been faithfully imitated. There are terraces of earth and sand, little lakes and marshes, caves, crevices, grottoes, etc.

**PORTABLE ASPHALT PLANT**

This portable one-car asphalt plant is claimed to have a capacity of 1,800 sq. yd. of 2-in. topping or 4,000 sq. yd. of 1-in. binder in 10 hours. The overall length of the equipment is 67 ft., and the trucks are of 100 tons' capacity.

The hot sand tank, screen mixer and mixer engine, hoisting engine and elevator engine are all on a sliding platform, which is extended by means of two large screws, so that teams can drive under it to receive loads. The hot sand tank is raised when in operation by means of hand screws, one at each



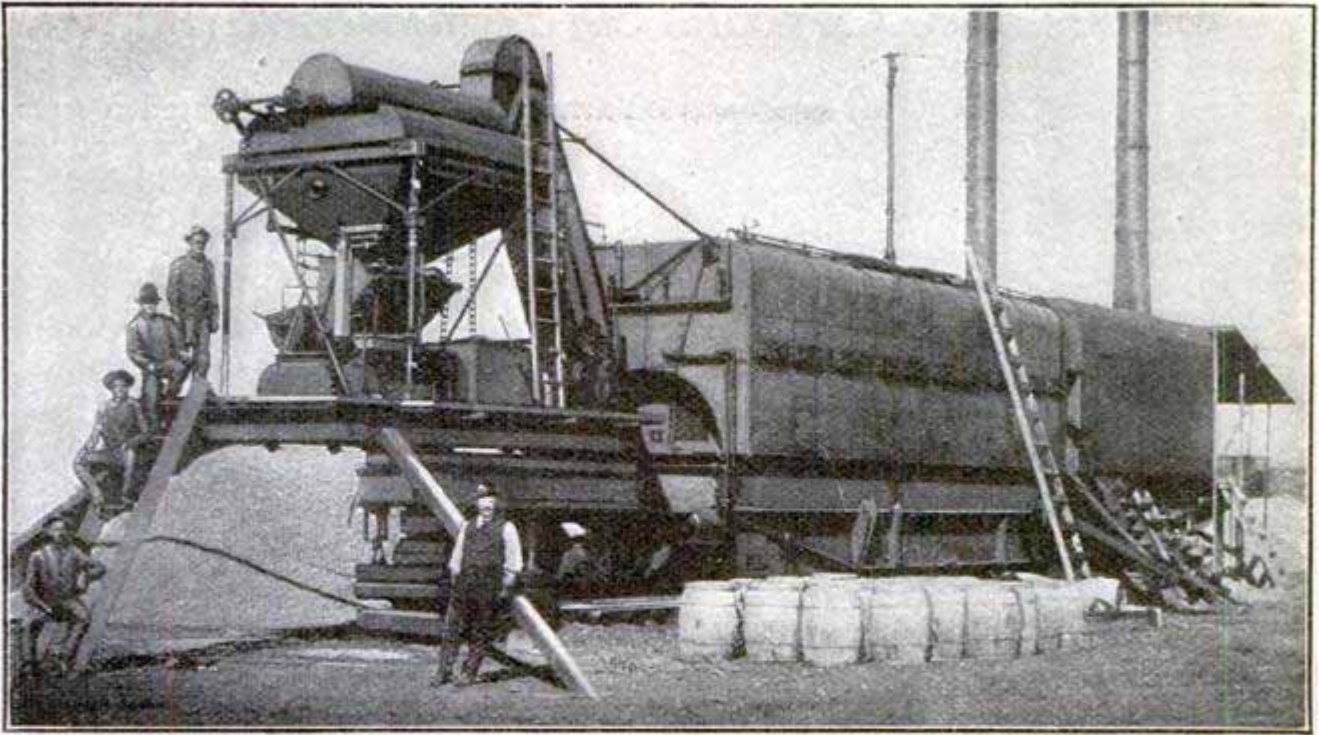

Huge Portable Asphalt Plant in Operation

corner, and lowered when the plant is to be transported, which makes the removal of the tank unnecessary during passage.

The engines required for the operation of the plant are direct connected with steel pinions and gears, no belting being used. The asphalt is heated with steam provided by a 125-hp. marine boiler. The plant is equipped with two independent tanks, each having a melting capacity of 712 cu. ft. The condensed steam from the tanks is returned to the boiler by means of a hot water pump, working automatically. The sand drum is 28 ft. long by 5½ ft. in diameter.

### SIX-BLADED MOTORBOAT PROPELLER

A new speed propeller, for which much is claimed, has six blades so arranged as to form a perfect screw. It is so designed that each blade in every revolution gets solid water regardless of the speed, the blades being in sections of two with a difference of 4 in. in diameter of each section, the rear pair of blades being the largest. Tested on a 26-ft. motorboat equipped

with a 10-hp. engine, this propeller is claimed to have added three miles an hour to the speed, at the same time doing away with much of the jarring

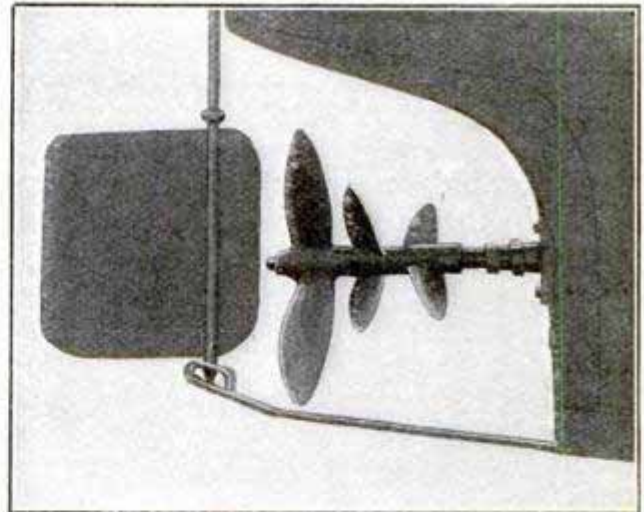

Propeller with Three Pairs of Blades

and shaking which is so usual in small motorboats.

### REAL SANITARY MILK CAN

The sanitary inspector of Saloniki, Turkey, has introduced a milk can which is fitted with valves allowing liquid to be poured out, but not in, after the can has been officially inspected and sealed. This is to prevent adulteration and fraud.

## EXPLOSION OF 17 TONS OF DYNAMITE AT SEA

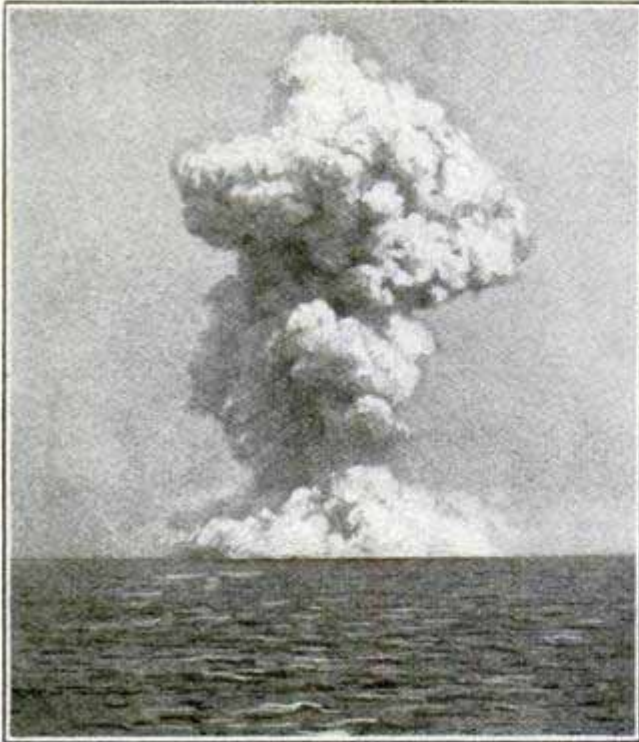

Blowing Up a Shipload of Dynamite

The explosion of 17 tons of dynamite off the coast of England, near

Yarmouth, recently presented a spectacle that gave onlookers an opportunity of learning what would happen if all the magazines on a big man-of-war were to blow up at once. In this instance, the dynamite was exploded deliberately for the purpose of ridding the seas of a water-logged ship, the "Mystery," the hold of which contained the explosive. The "Mystery" collided with another vessel and a hole was stove in her side that caused water to flow in and made her a dangerous derelict. It was decided to blow up the ship and cargo. Fuses were fixed, electric wires attached, and the crew embarked in a small boat. When a mile from the ship, the circuit was closed and the big charge was exploded. The explosion threw a huge column of water hundreds of feet into the air, of such volume that the boat was completely obscured. Nothing remained of the "Mystery" but bits of wreckage.

## RAPID UNLOADER FOR RAILROAD CARS

The rapid unloaders or loaders shown in this illustration are designed

shoveled from a railroad car into a wagon. The device is a steel box of

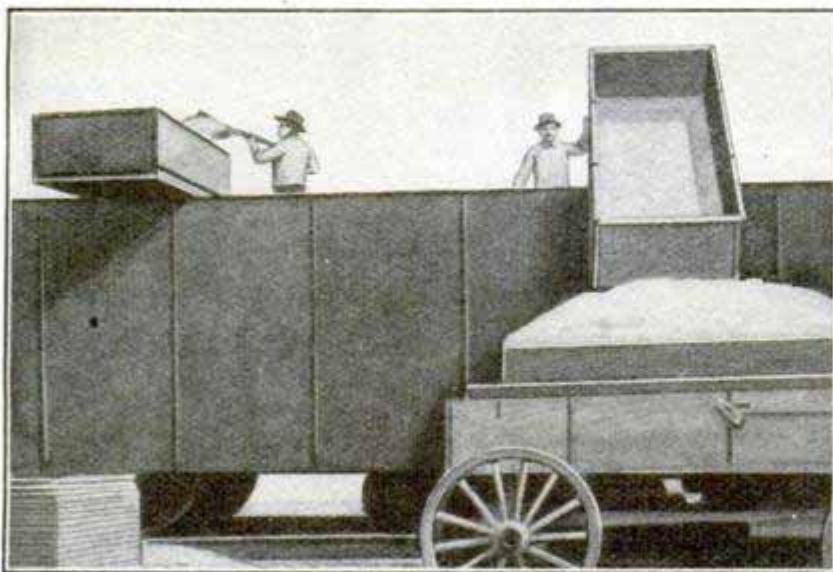

From Car to Boxes to Wagon

to facilitate the handling of coal, sand and other like material that has to be

tilted, by two brackets, one on each side, against the inside of the car.

$1\frac{1}{2}$ -yd. capacity, placed on top of a car, centering on the edge. The inner half is supported by a rail that lies across the car, one end of the rail having a  $\frac{1}{2}$ -in. plate that hooks over the edge of the car under the box. The other end of the rail is held down by a chain. At the inner end of the box is another chain which keeps it from tilting while being loaded, and likewise regulates the elevation of the box while discharging. The box is kept from sliding off the car, when

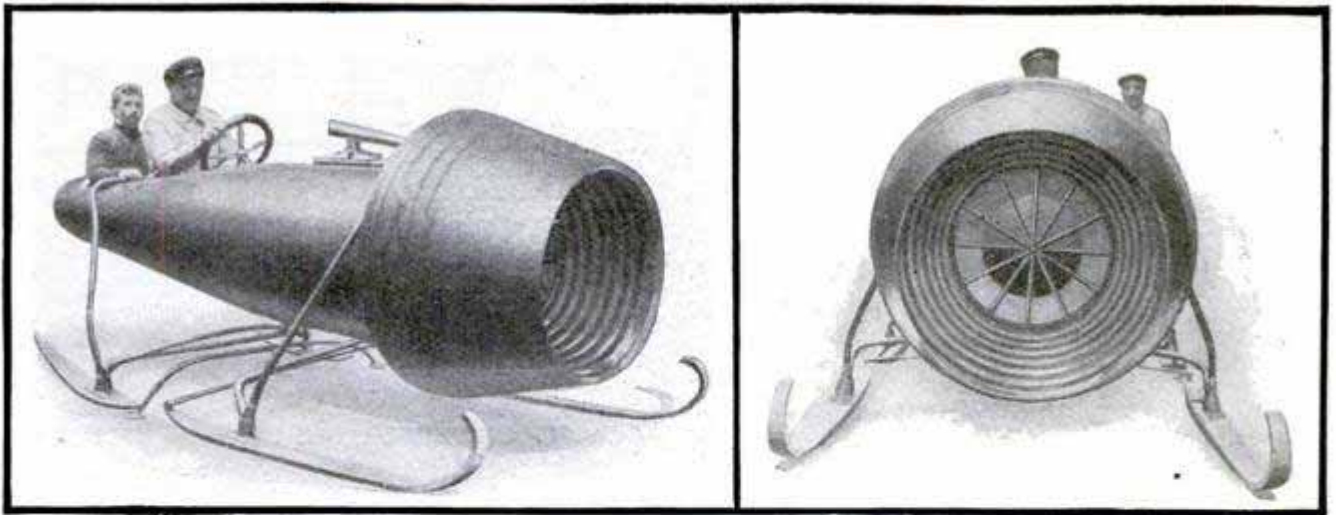

Sleigh Driven by Suction Turbine

## SUCTION TURBINES SERVE AS AIR PROPELLERS

### Motor Sleigh Propelled by Suction Turbine

The motor sleigh for the Grand Duke Cyril of Russia is provided with a power plant of the same type used by M. Coanda in his wooden aeroplane. It has a cigar-shaped hull carried on four runners. The suction turbine, which is mounted in front and driven by a 40-hp. motor, is expected to give the sleigh a speed of 50 miles an hour. Steering is accomplished by causing either end of a curved bar to bear on the ice or snow, the sleigh turning on this as a pivot. The sleigh was baptized by priests of the Russian Church.

### Wooden Aeroplane with Suction Turbine

The Coanda aeroplane, exhibited at the last aero show in Paris, has several radically new features, chief among them being the method of propulsion and material used in its construction.

Aside from the ribs, and the uprights between the planes, this aeroplane is made entirely of wood. The body is long and fish-like, and the cone mounted on the forward end incloses a suction turbine, which takes the place of the ordinary aeroplane propeller, and forces the machine forward by drawing in and forcing back the air.

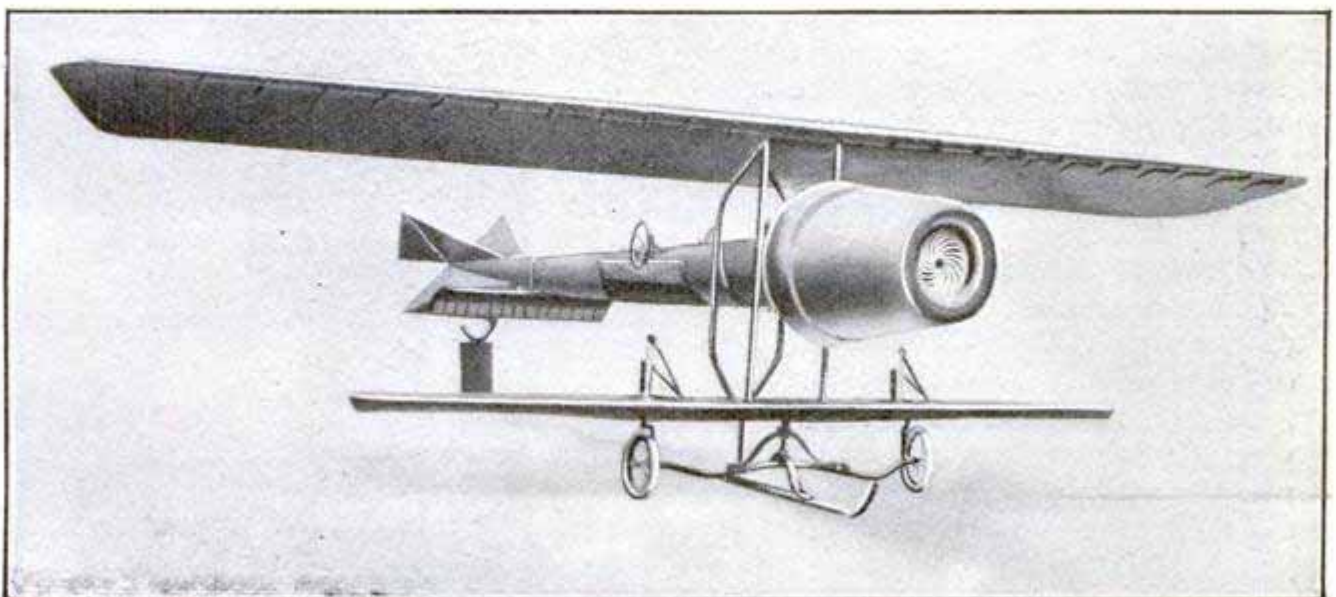

Suction Turbine Drives Wooden Aeroplane

## ALTITUDE RULE AND AERO-PLANE RAG LEVEL

Two interesting devices used by the Wrights, one on the ground and the other on the machine, are a simple altitude rule and an ordinary rag.

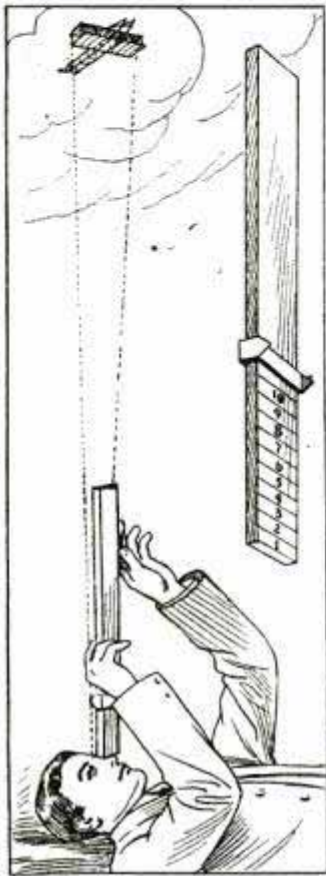

The altitude rule, which, while not absolutely accurate, is close enough for ordinary purposes, consists of an ordinary yardstick on which is a slide having two raised points exactly 1 in. apart. By placing the end of the rule to the eye when one of the Wright machines is directly overhead, and moving the slide until the ends of the wings are

sighted just between the two points, the user can determine the approximate altitude. The planes of the standard Wright machine are about 40 ft. wide, and multiplying this number by the number of inches the pointer is away from the eye gives the altitude. The accuracy of the device depends upon sighting properly and having the aeroplane directly overhead. For very high altitudes, the pointers are set  $\frac{1}{2}$  in. apart, and the number of inches multiplied by 80.

The rag spoken of hangs from the front frame, and, although hardly more than a strip of tape, fulfills the purpose desired as well as the most expensive instrument that could be designed. If the rag points up, the operator knows his machine is going down, and if it points down, he knows it is going up. If it flutters out straight behind, the machine is keeping an even keel, but if it points to the side, the

operator knows he is "skidding," and the machine must be brought back to balance by the use of the wing tips.

## ELIMINATING THE FLICKER IN MOVING PICTURES

Flicker in moving pictures is said to be practically eliminated by a cinematograph which employs two projection lenses, converging on a common center, and used simultaneously with two identical films. Shutters are contrived so as to project the picture from one part of the apparatus while the picture from the other is being cut off.

## AN ORNATE ROYAL SLEIGH

One of the oldest sleighs in existence is a much decorated vehicle used by Louis XI of France, which is now to be seen in the palace of Versailles. This sleigh is believed to be more than 450 years old and is regarded as a fine specimen of the vehicles of its age. It is highly ornamental, no part of it being left without some form of carving or other decoration. It is provided with comfortable seats for two persons, in the body, with steps and seats for footmen and attendants at the back and sides. On the high dash,



Ornate Sleigh Once Used by King Louis XI of France which reaches a peak, is found the crown of France supported by cupids.

Electric locomotives probably will be used for towing ships through the Panama Canal.

# RAISING ANGORA GOATS IN THE SOUTHWEST

By C. L. EDHOLM

Two  
Kids  
of  
the  
Ranch



One of the ways in which the semi-arid tracts of this continent can be profitably utilized is in the raising of angora goats, an infant industry which has tremendous possibilities. In Arizona and other parts of the Southwest, ranchers are making a good living from land which is worthless for agricultural purposes, and in other cases the homesteaders are making their herds do the work of clearing the land of brush for later farming operations. The angora, like the goat tribe generally, can pick up a living where other animals would starve. It feeds on the dry brush of the desert, and by reason of its agility finds pasturage in spots which would be too rugged for cattle or sheep. In the mountains of Arizona, angora goats may be seen feeding along the sides of high cliffs which at first glance appear absolutely

inaccessible to any creature without wings.

The chief source of profit from the angora goat is its long, silky hair which commands a price of from 30 to 40 cents per pound. Each animal yields 3 lb. of hair a clipping, and the herds are sheared twice a year.

As an addition to our meat supply, the angora goat appears to have a great future, as the flesh is said to be better than mutton; in fact, the Mexicans will not eat mutton when they can get goat flesh. The tallow and hides also find a ready sale, the latter being in great demand for making certain fancy varieties of leather goods.

As a milk producer, the angora goat surpasses the cow both in quality and proportionate quantity, and in the making of fine cheese such as is imported from Germany and Switzerland,



New-Born Angora Kid—"Funny as a Goat"



Angora Goats Feeding on Alligator Juniper Tree in Gila National Forest, New Mexico

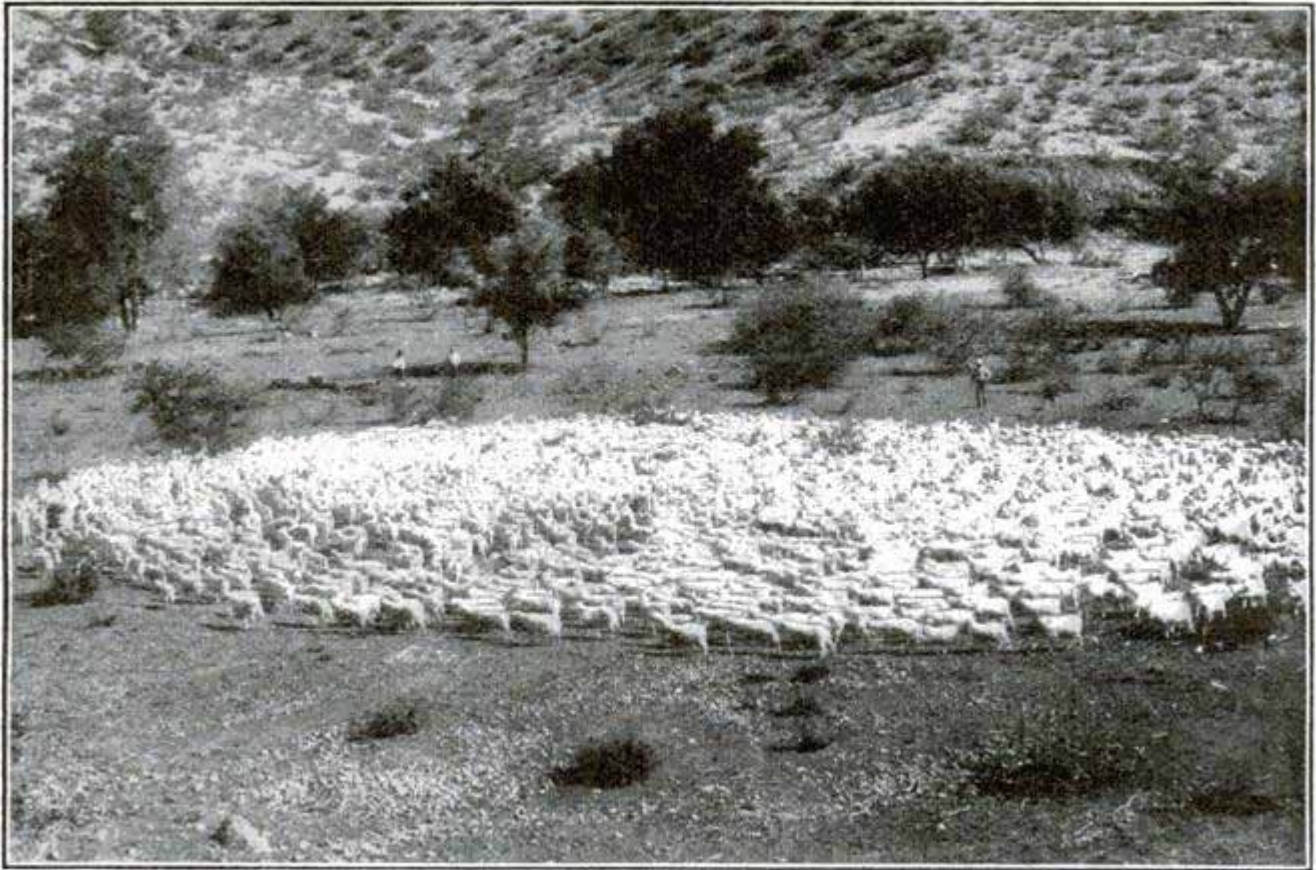

Goats "Wheeling." As They Will Not Stand Still the Only Way to Keep Them Bunched is to Keep Them in Motion about a Central Point. Note Barren Soil on Which They are Grazing

the goat milk would be superior to cow's milk. The average yield is about two quarts or more a day. In those parts of the Southwest frequented by consumptives, the goat's milk is in great demand as it is very rich and nourishing and quite easily assimilated. Indeed, the prejudice against ordinary goat's milk is accounted for by the ragged-looking animals seen browsing around in the vicinity of cities. It would never occur to anyone who has seen one of the beautiful, silky-haired angoras, to feel at all squeamish about partaking of its flesh and milk.

In view of the constantly increasing price of beef and wool, the importance of the angora can hardly be overestimated. With the decrease of the rich pasturage required for cattle, the price of beef is not likely to be reduced, and it seems as if the goat meat might compete with it in the market, as there are almost limitless areas of rugged country upon which such herds could be profitably raised.

The problem of cheap clothing,

which at the same time does not mean inferior material, may be partly solved by the more extensive raising of the angora.

The increase of the herds is very rapid, being estimated at 120 per cent per year, and the animals mature very early. As the rams are kept separate from the herd except for a brief period every year, the bearing season is over in a few weeks during the spring, at which time the herds are kept in corrals so that the young can be given proper care and attention.

The new-born angora kid is one of the most comical little creatures ever brought by the stork, as it stands with its long wobbly legs well braced in four directions to keep from falling and calls to its mamma. Even at birth it has a coat of the long, silky, white hair which distinguishes the breed.

The value of the goat in clearing overgrown farms, or arable land which merely needs to have the brush removed, has already been noted. One illustration shows the energetic man-

ner in which the goats are attacking a scrub juniper, and is an earnest of how thoroughly they would clean out any smaller brush or weeds. This is a matter that means dollars and cents to the rancher in the western country where labor is costly.

The angoras are exceedingly restless and when it is desired to "bunch" them for any purpose, they will not

stand still, so the rancher adopts the maneuver known as "wheeling." The goats are kept constantly in motion around a central point or pivot. One of the illustrations shows them in the act of circling round and round in this manner.

The angora was introduced from Turkey into this country in 1849, by Dr. J. B. Davis, of Columbus, S. C.

## HAREM SKIRT TO CROWD OUT HOBBLE

The old philosopher whose wisdom found expression in the saw that history repeats itself, as well as the gentleman who announced that events of human life move in cycles, need no more fitting proof than is given in the ever-changing styles of woman's costume. Years ago the world was startled by the introduction of "bloomers." The form and style of feminine habiliments have compressed themselves from the crinoline to the hobble skirt since then, and now comes a Paris manufacturer of women's apparel who announces the fact that he has at last an opportunity to introduce his "harem" skirt, which is nothing more nor less than a pair of bloomers which fit close at the ankle instead of just below the knee. He calls it a divided skirt that fits tightly at each ankle and it is referred to as the natural successor of the hobble skirt, which this Paris dressmaker believes has had its day. No petticoats will be worn with this new garment.

## SERVIA HAS NOVEL WAY OF DISINFECTING VISITORS

Because of the prevalence of cholera in many parts of Europe, extraordinary measures are being taken to protect the health of the people. The government health authorities of Servia and Roumania have adopted the expedient of meeting all travelers at the borders and subjecting them to rigid inspection. In some instances inspectors



Courtesy of the Graphic  
Servian Health Inspectors Meeting and Disinfecting Visitors as a Precaution against Cholera

armed with tanks full of disinfectants spray peasants with the contents of their tanks. In the case of a person who has been exposed to cholera, the suspect is required to remove his clothing, which is placed in an oven and baked, and then the man is sprayed with disinfectant.

☞ Horse tramways will disappear in London before the close of 1912, states an English authority on traffic; the horse-drawn omnibuses and the hansoms before the close of 1913; and all four-wheeled horse-drawn vehicles before 1921.

## DETERMINING THE RATE OF SOIL EVAPORATION

The effect on evaporation of a layer of dry, granular soil when placed above

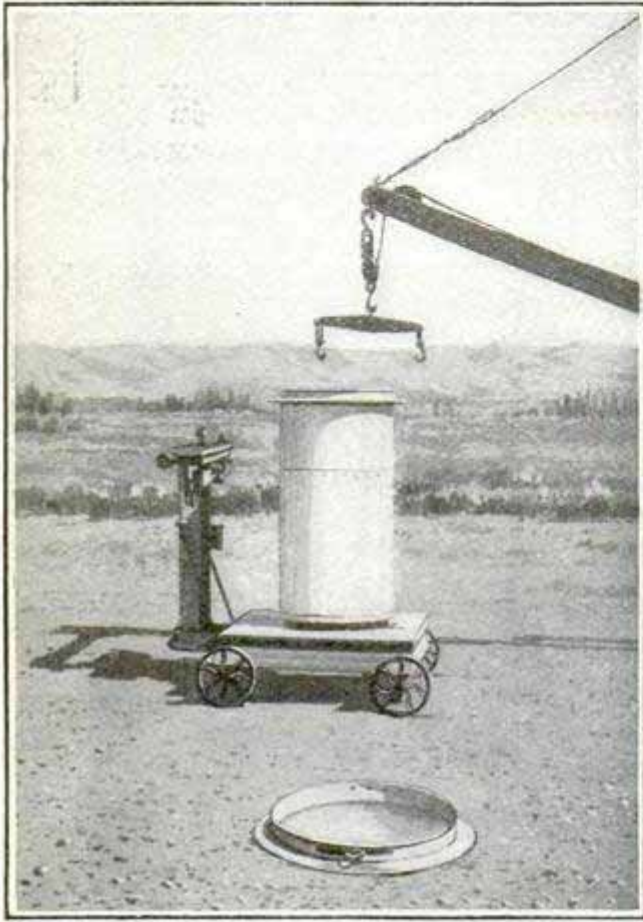

Tank Used in Determining Effect of Mulch in Preventing Evaporation

moist soil, has been tested by a number of experiments with tanks of the kind shown in the accompanying illus-

tration. The tanks, which are water-jacketed and hold about 1,500 lb. of soil, were placed in the open under normal conditions of sunshine, wind and temperature, and weighed at stated intervals.

In one series of experiments the soil received an irrigation of 6 in. over the surface. In the tank in which the soil had not been provided with the layer of dry, granular soil, more than one-third of the water evaporated in 32 days, while less than one per cent was evaporated in the tank protected by a 9-in. mulch.

The result of the series of experiments has led authorities to conclude that the western orchard owners can prevent the greater part of the evaporation losses by cultivating the orchards to a depth of at least 6 in. soon after each irrigation.

## CONCRETE SNOW SHEDS IN CASCADE MOUNTAINS

On account of the danger of destruction by forest fires of the great wooden snow sheds in the mountains of the west, the Great Northern Railroad decided to construct them of reinforced concrete. About 4,000 ft. of concrete sheds are now being built just west of what is known as the "long tunnel" in the Cascade Mountains, where snow slides are unusually severe.

## ERECTING OVERHEAD EQUIPMENT ON ELECTRIC ROAD

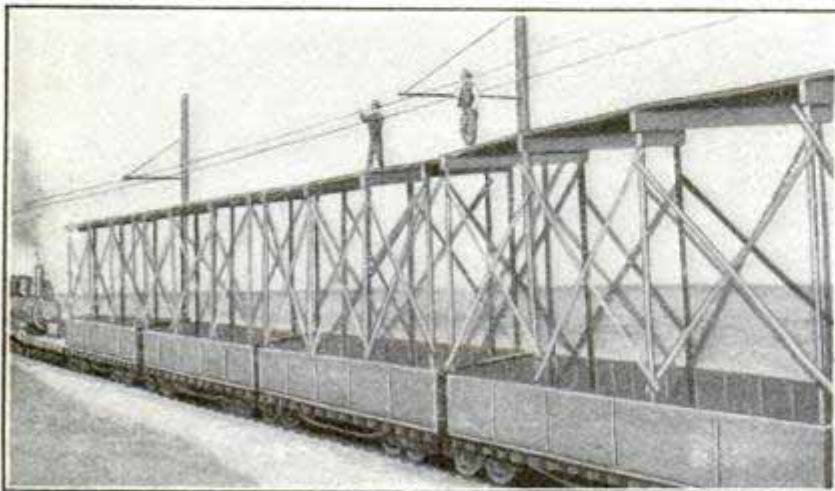

Construction Train for Overhead Construction on Electric Railroad

Some quick work was accomplished in erecting the overhead equipment for the Rock Island-Monmouth division of the Rock Island-Southern Railway Company, in Illinois. The illustration shows the construction train working on the overhead equipment. This train consisted of four cars on which temporary elevated trestles were erected, together with a



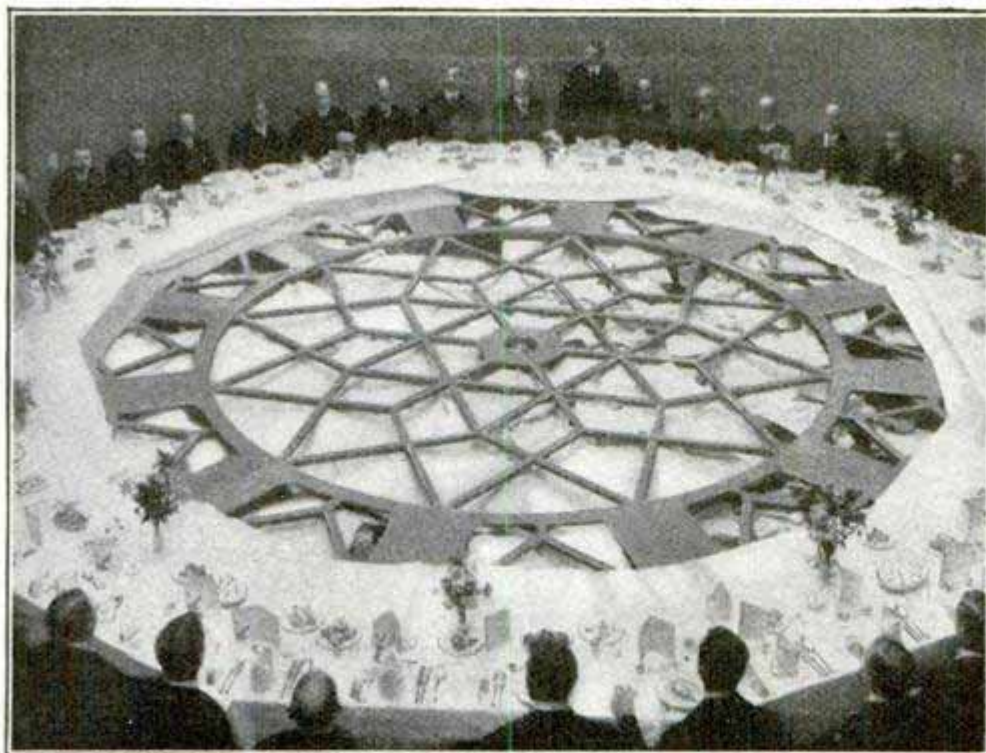

Banquet of 50 Covers, in the Free Trades Hall, Leicester, England, around the Dial of the Electric Clock for the Liver Building, Liverpool



One of the Minute Hands, Showing Comparative Size of 6-ft. Man.

car fitted with a derrick and donkey engine for handling the mast arms, etc. These latter were installed, on stretches of the work, at the rate of 40 in nine hours. When this number of arms had been installed, the cars were coupled together, the hangers for the messenger and trolley wire put in place, and the wires strung. The stringing and clipping of the wire were done at the rate of  $3\frac{1}{2}$  miles a day.

### LIVERPOOL CLOCK RIVALS BIG BEN

With a dial 2 ft. bigger in diameter than that of the famous Big Ben which booms its deep-toned bass from the clock tower of the British Houses of Parliament, the giant electric clock now being erected in the Liver Building at Liverpool, England, sets a new English record in the building of mammoth public timepieces.

The remarkable photographs reproduced herewith not only show the huge proportion of the great dial, but also indicate in a most graphical manner the keen publicity instinct of the makers of this all-British clock.

The clock will occupy a position 220

ft. above the ground. The four dials are each 25 ft. in diameter, and the minute hands are 14 ft. long. Some idea of the size of one of the minute hands will be gained from the illustration, and from the fact that the free end of the hand will move at the rate of more than  $15\frac{1}{2}$  in. a minute, or more than a fourth of an inch a second, which is quite a visible motion, if one is close enough to the hand to observe it.

The driving mechanism of the clock is constructed on the principle known as the "waiting train" movement. This permits the timekeeping element to be mechanically independent of the hand-driving element, and thus prevents any disturbance by wind, rain, snow, etc., of the time accuracy of the clock. It is also unnecessary to ascend the clock tower for the purpose of winding. Regulation is controlled electrically from the Greenwich Observatory, which is the great timekeeper for the British Islands and near-by parts of Europe.

☞ Seven billion lemons were grown in Spain and the Italian provinces of Calabria and Sicily in the last two years.

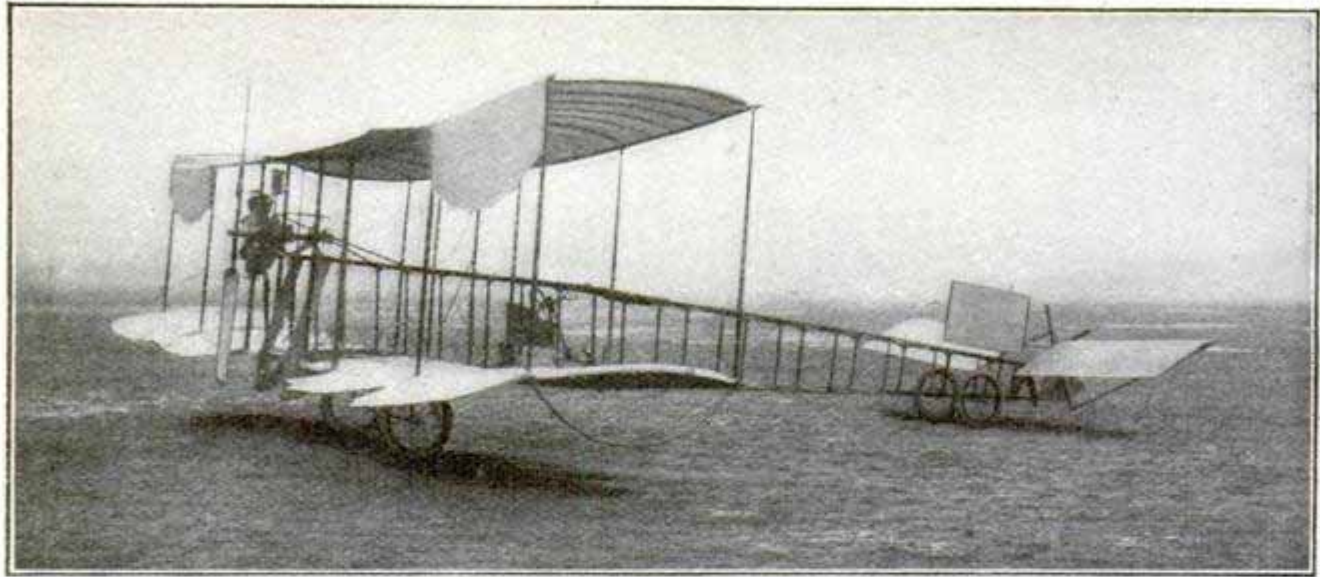

VOISIN'S NEW TAILLESS BIPLANE

The horizontal and vertical rudders are placed about 32 ft. in front of the two main planes, and the operator's seat is 6½ ft. in front of the planes. The rotary motor is placed at the rear, half way between the planes.

### SHOT GETTING THE BETTER OF ARMOR PLATE

The shot appears to be getting the better of the armor in the never-ending contest between the two, according to Rear Admiral Mason, chief of the naval ordnance bureau. He says that the conditions and outlook with regard to armor-piercing projectiles, formerly unsatisfactory, have improved very much during the past year. The quality of the shells supplied by certain firms is better and the outlook is more satisfactory than for several years past, though the lack of an adequate supply of large caliber shells continues to be a matter of serious concern. On the other hand, the advance in armor has not been entirely satisfactory so far as thick plates are concerned, and certain new processes, while giving promise of ultimate improvement, have failed to lend themselves to the installation of the armor on shipboard. In the meantime the older processes are being left behind. But thin plates have shown marked improvement and the hardening methods limited to 2-in. plates have gradually been extended to plates up to 4 in., and it is possible they may be definitely extended and thus solve the problems existing with regard to thick plates.

### BAND STOPS PLAYING WHILE CROSSING BRIDGE

Because the tread of the musicians and the musical vibrations would cause the bridge to shake with such force that it would be unsafe, the band, at the recent dedication of the mammoth McKinley traction system bridge across the Mississippi river at St. Louis, went across the structure carefully and quietly. The leader of the band 15 years before had, at a similar ceremony, unknowingly led his organization, the men marching to the beat of the drum, upon a bridge and caused it to rock alarmingly.

### GERMANY PREPARING SOUTH POLE EXPEDITION

The proposed German South-Pole expedition under Lieut. Fillchner has taken on the character of a great national undertaking, as the Kaiser, Prince Henry of Prussia, the imperial government, army, navy and leading German scientific bodies are all actively and officially identified with it. Much of the money required for outfitting the expedition was raised by public lottery and private subscriptions.

The expedition will sail in the late spring.

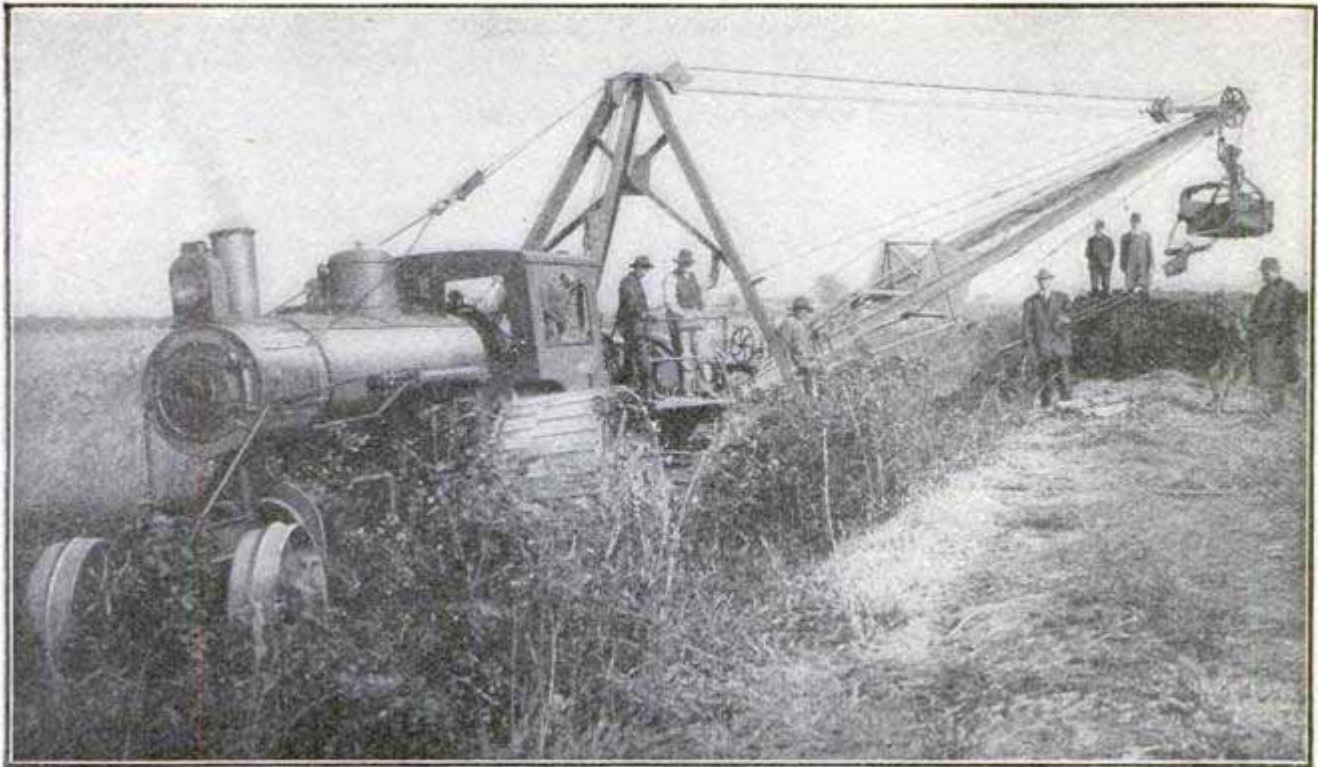

A Steam Shovel and Traction Engine Arrangement That Will Go Almost Any Place

### COMBINED TRACTION ENGINE AND STEAM SHOVEL

One of the latest things in excavating machinery is the combined traction engine and steam shovel shown herewith. This outfit requires no rails on which to run and can be moved from place to place by its own power without the heavy expense of disassembling the engine part.

Several of these outfits are now doing good work in this country. They are especially useful for digging drainage and irrigation ditches, excavating in gravel pits, and for other similar purposes.

### CARRY BROAD-GAUGE CARS ON NARROW TRACKS

An interesting system by which the freight cars of standard-gauge railways may be transported over narrow-gauge lines, thus making possible the delivery of loads in an unbroken condition, is being utilized on the Leek and Manifold-Valley Light Railway in England. The standard-gauge cars are run onto the low-built transportation cars or trucks in the manner shown in the accompanying illustrations, and locked in position. The railway upon which the transporter cars run has a gauge of but  $2\frac{1}{2}$  ft.

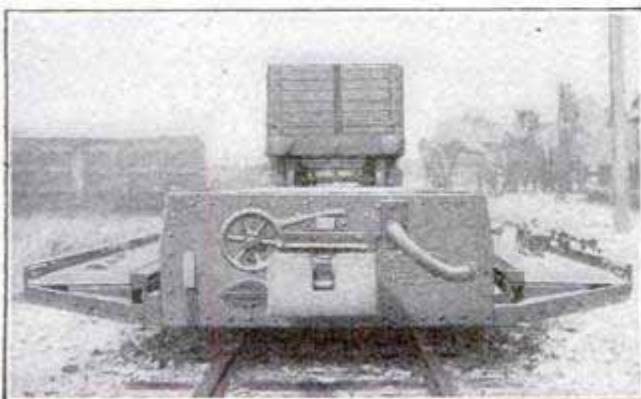

Transporter Car Ready to Take Standard-Gauge Car

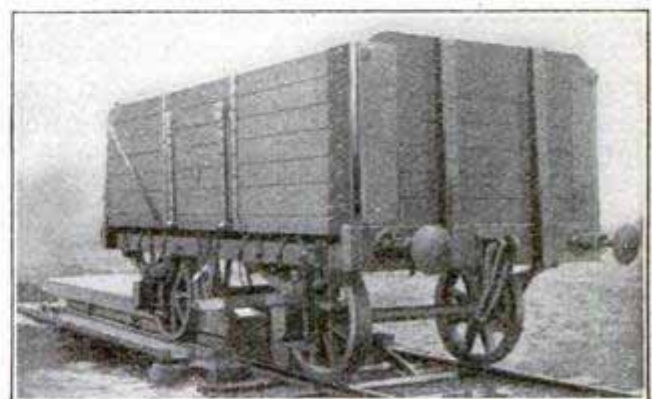

Running English Broad-Gauge Freight Car onto Narrow-Gauge Transporter

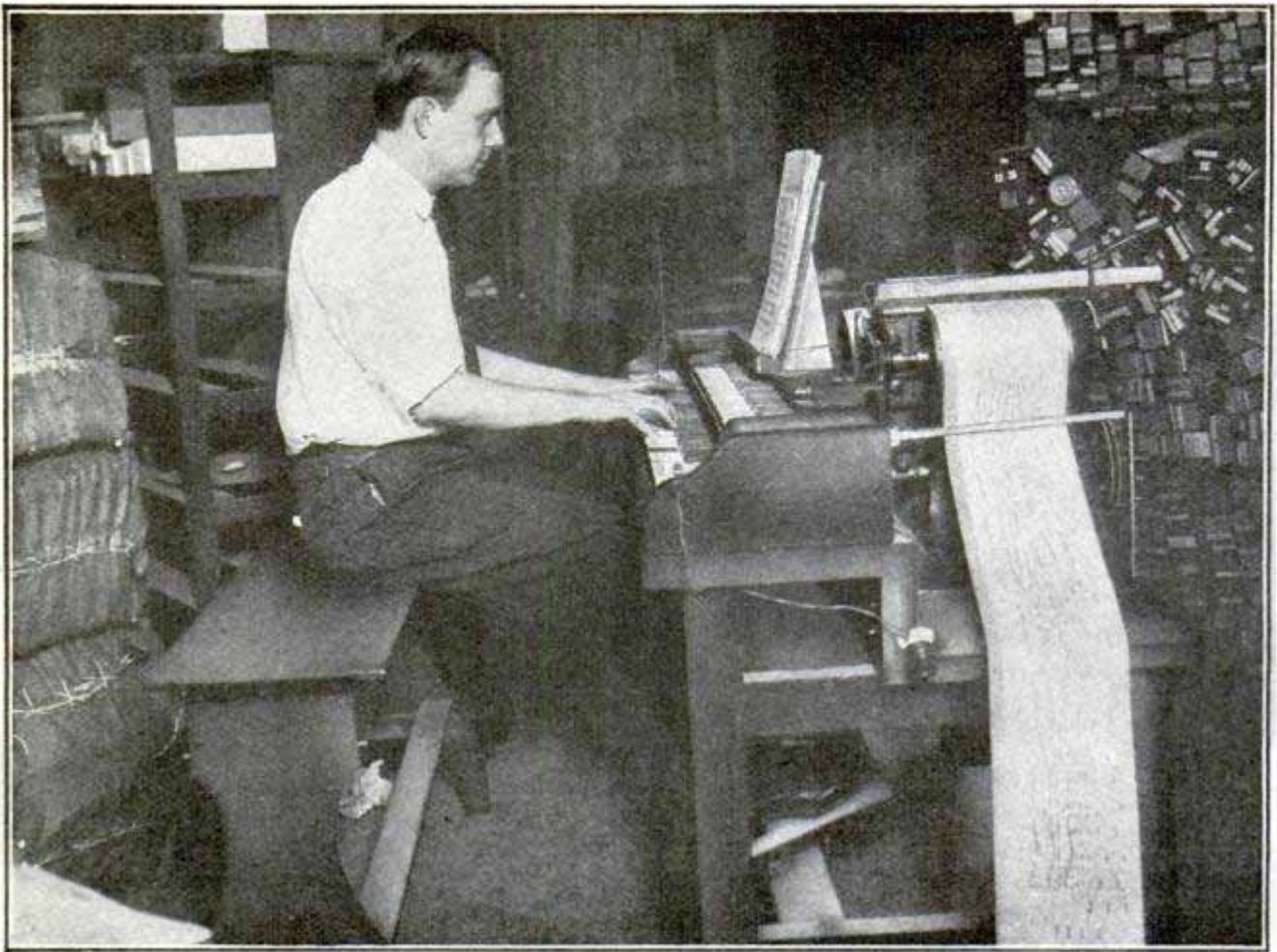

Musician Arranging Music from the Orchestral Score, Using an Arranging Machine

## CANNING MUSIC FOR THE MECHANICAL PIANO

By L. E. CROZIER

The music roll used in mechanical pianos is a familiar object to most persons, but its manufacture involves far more than a simple translation of a music score into perforations in a piece of paper, as on first thought might appear to be all that is required. Except in the case of certain classics, the music of which is full enough without any doctoring, a piece to be played on a mechanical piano must be edited and elaborated by an expert, for otherwise it would sound pitifully thin and tinny when played by an unthinking and unfeeling piece of mechanism.

There are many varieties of mechanical piano players. In a typical kind there is a tracker-board containing longitudinal slots under each of which is a pneumatic tube leading to

and controlling the action of a lever or "finger" which terminates in a leather-covered hammer for operating one of the keys of the piano. The music roll contains perforations corresponding to the notes to be played, and when one of these perforations comes opposite one of the slots or holes in the tracker-board, a free passage is made for a draft of air which operates the finger, and thus the note is played. The air draft is created by the action of the performer's feet on a pair of bellows, or by an electric motor. The note is held until the perforation is passed, the length of time depending on the size and shape of the hole.

It can be readily seen that the man to whom is entrusted the editing of

the music for the mechanical piano, must have as thorough a knowledge of harmony and composition as the original composer, if he is to give anything like a just interpretation of the latter to his audience. He must also thoroughly understand the needs of his instrument, for he is its soul. Preferably, also; he must be master of several other instruments, for often he does his arranging not from the piano-forte, but from the orchestral score. The work offers to a competent musician with a mechanical turn the same opportunity as the editorial department of a musical publishing house.

Seated at an arranging machine with a keyboard like a piano, the musician applies by a touch of his foot to a treadle, the power of an electric motor. This sets in motion a drum at the back which revolves with clicks like a stock ticker, but carries an 8-in. paper in place of the ribbon.

He plays the music just as he would on an ordinary piano, only more slowly, choosing his notes, and insert-

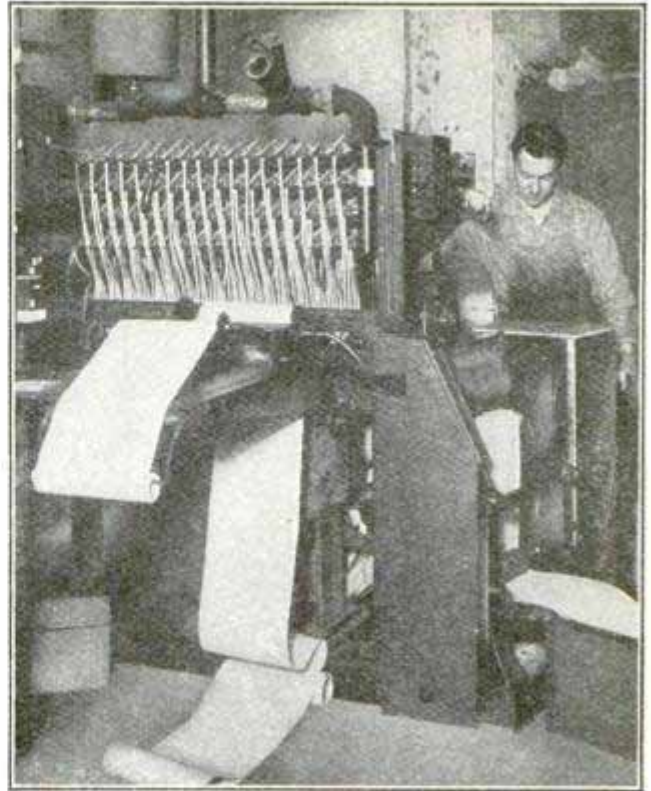

The Machine Which Changes the 88-Note to the 65-Note Master

ing others as he goes. If he wishes to record a half-note, for instance, he presses his finger on the key and

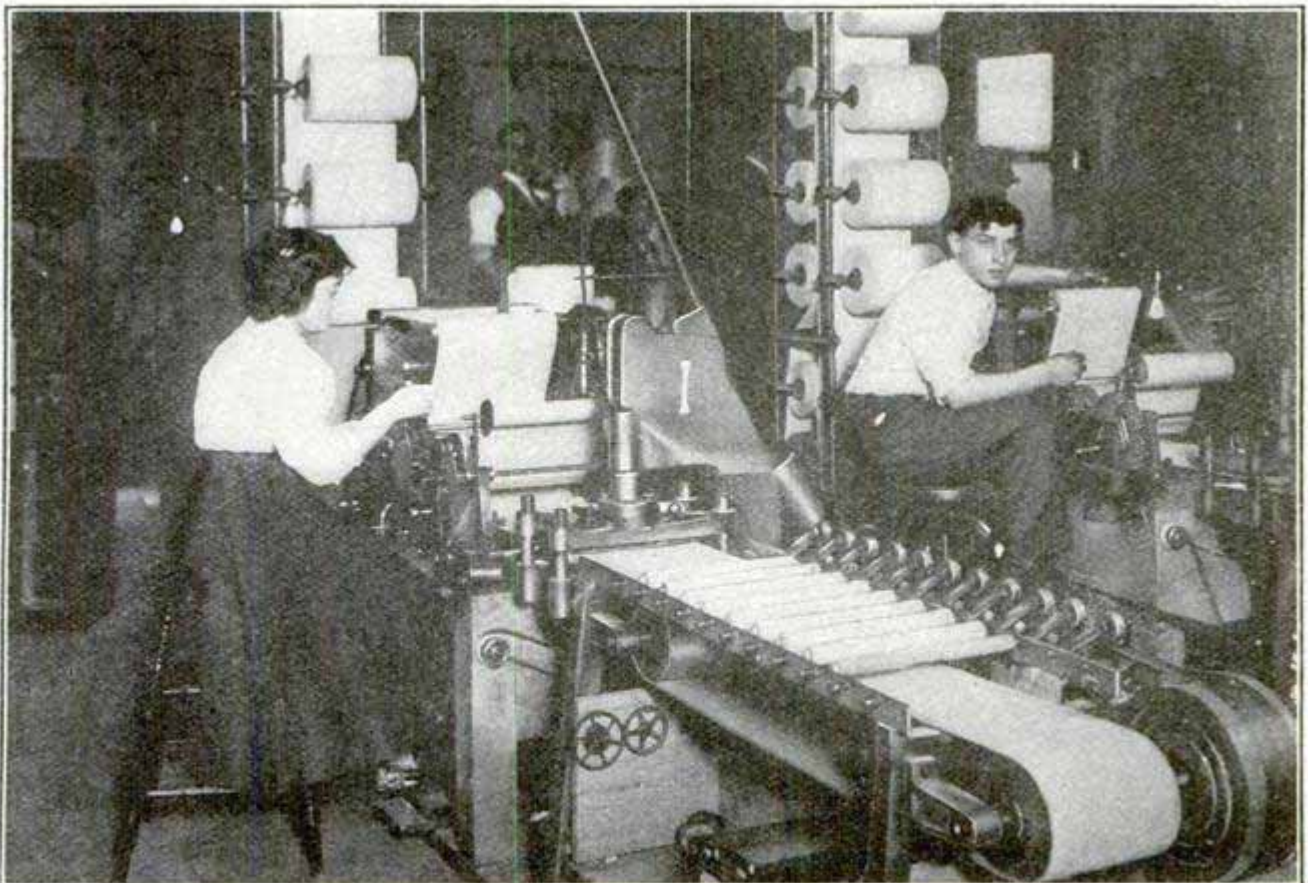

The Machine Which Changes the Punches of the Master Roll to Slits, at the Same Time Punching and Winding Up Ten Other Rolls

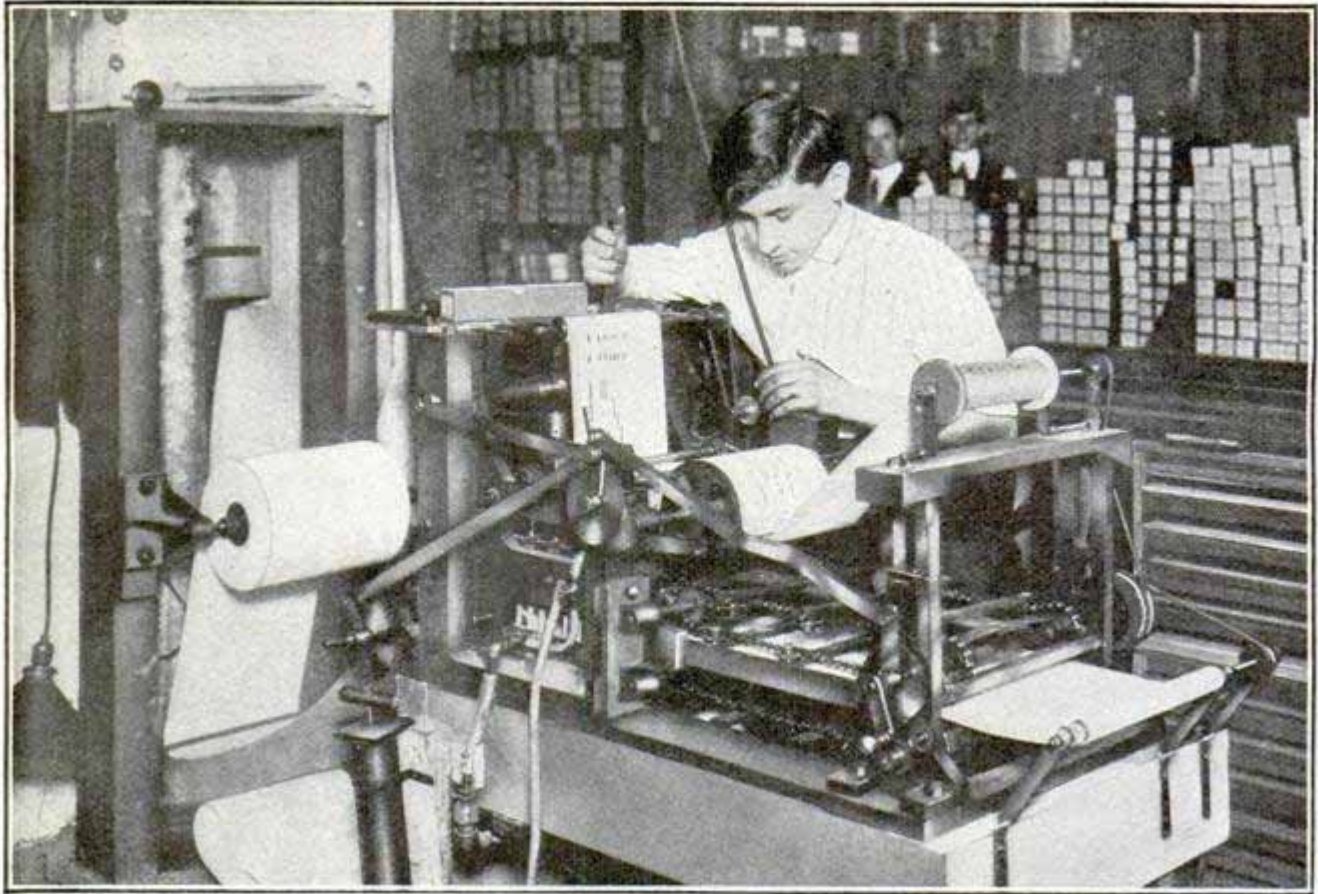

The Machine Which Uses the Narrow Master of the Arranging Machine to Produce a Wide Heavy Master for Reproduction, and a Thin Test Roll

counts eight clicks. There is no other sound, but on the paper appears a vertical row of eight perforations.

This narrow "master," as the paper roll is called, is then run over the tracker-board of a machine which also

responds with punches instead of notes. It perforates two rolls, one a heavy paper, used for reproduction, and the other a thin test roll. The latter is tried on the piano and corrected by the musician.

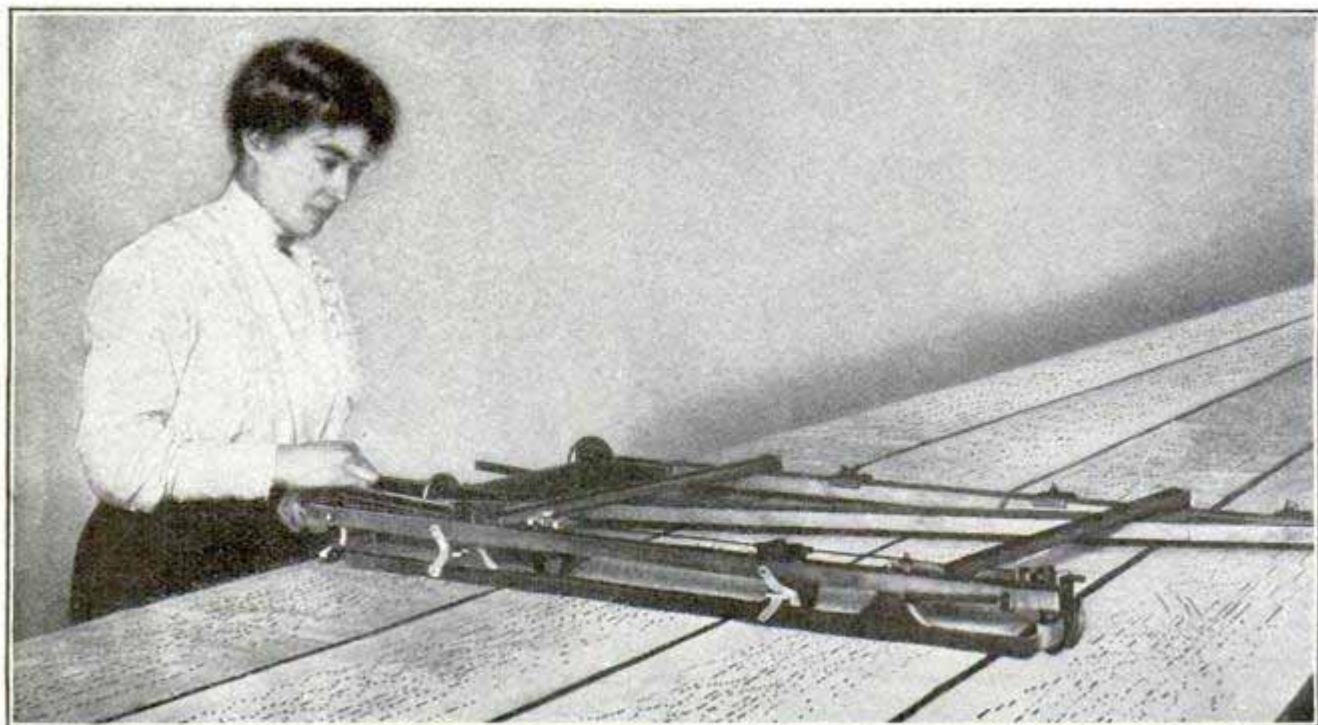

The Marking Table, Where Expression Lines and Printed Directions are Put On

From this the heavy master, too thick for the tracker-board of the piano, is corrected by hand. Its extra perforations are pasted over, and missing ones inserted with a mallet and punch. It is then run through a machine which changes the round perforations of the master to slits where necessary, at the same time reproducing the corrected master upon ten other strips of paper. Each of these strips unwinds from its own large roll, and rewinds, its perforations complete, upon the familiar black spool which is inserted in the piano.

There is also a machine which changes the 88-note master which has previously been edited by hand by the musician, to a 65-note master. This is then reproduced by a machine which perforates and rewinds ten rolls at once.

All the rolls then go to the marking

table where they are spread out two at a time and the dotted expression lines put on by a semi-automatic marking machine. Words in regard to expression are printed by hand by means of rubber stamps. The guide for this marking is a perforated roll, marked by hand by the musician. The rolls are then rewound by means of a hand reel, and carried to the inspection tables, where they are checked over for blemishes. They are then spooled, labeled, tested and boxed, and stored on shelves (called "bins") to await shipment.

Perforated music is not a special invention for the mechanical piano, however. It has for many years been used by the humble hand-organ, and the early patents are all held by Italians. By recent legislation the composer whose music is adopted for the mechanical piano is entitled to royalty.

### ANOTHER "LARGEST" LINER STARTED

The huge White Star liners "Olympic" and "Titanic," which will succeed the "Lusitania" and "Mauretania," before the year is out, as the largest ships in service, will hold this distinction for only a short period, and then will be superseded by the "Europa" of the Hamburg-American line.

The "Europa," the keel of which has already been laid, is a 50,000-ton ship, 900 ft. long, with a beam of 96 ft. She will have nine decks above the water line, and will accommodate 4,250 passengers. Just what the accommodation features will be, and to what extent they will be worked out, has not been fully announced as yet, but they will include many of the things featured as unique in the planning of the "Olympic" and "Titanic," along with others never before attempted.

It required 123,754,000 cross ties, valued at \$60,321,000, to make repairs and build new railroads in the United States during the past year.

### GASTRONOMIC FEAT OF A BOA CONSTRICTOR

By reason of their peculiar anatomical formation snakes are able to devour other animals much larger in

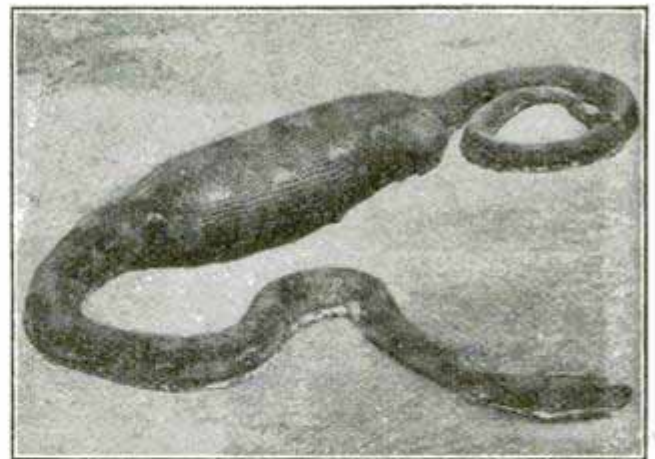

Boa Constrictor after Having Swallowed a Full-Grown Pig

circumference than themselves. Recently in India a huge boa constrictor was made to act as model for the accompanying photograph showing one of these gastronomic feats. A full-grown pig was given to the snake and the boa swallowed the animal with ease.

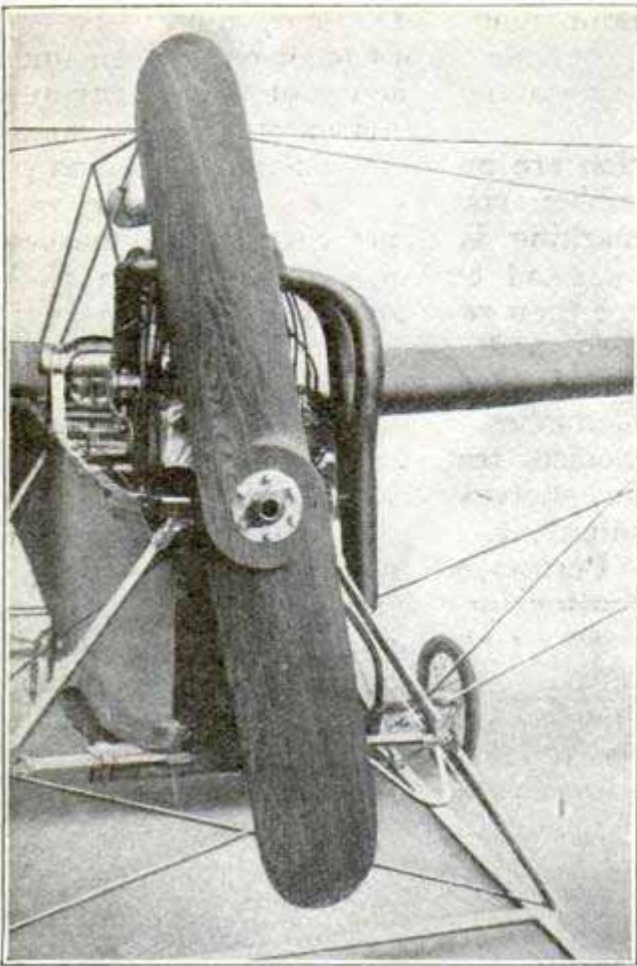

#### A NEW FORM OF PROPELLER

The air is attacked at the center instead of at the ends of the blade, as in the usual design. Though it is only 6½ ft. long, it has given as good results as an 8-ft. propeller of the ordinary type. It was made in France and is known as the "Rip."

#### BIG WAR FUND REGARDED AS PEACE GUARANTEE

The statesmen of Germany believe their war chest of \$30,000,000 in cash that has been idle 40 years, is the greatest factor for peace in the empire. The money is part of the indemnity paid by France at the conclusion of the Franco-Prussian war. It is packed in 1,200 chests and numerous bags. Each chest contains 100,000 marks and the bags 1,000 marks each. The chests and bags are each sealed with three seals and the vault in which they are stored is divided into three chambers, each of which has a different seal. The seals are inspected three times daily by three different officials, and the ministry of war has agents who make monthly and quarterly inspections. Several attempts to invest the money

have been resisted by statesmen who argued that the money provided Germany with a fund with which to commence war at any time without recourse to money lenders, and thereby gave the nation a feeling of security, while it had a deterrent effect upon any enemy.

#### HARVESTING SUGAR CANE BY MACHINERY

The sugar-cane industry will be practically the last of the great agricultural departments of this country to have its harvesting entirely done by machinery, if the cane harvester successfully demonstrated at New Orleans a few weeks ago proves to be reliable and efficient under protracted tests on a large scale.

This machine, which was drawn by four mules and is operated by a 6-hp. gasoline engine, cuts, tops and gathers the cane and dumps it onto the carts or wagons.

The machine has long arms which reach out and gather the stalks. The cutting and topping are done by revolving disk cutters. The leafless canes are then loaded by an elevator device into the carts which follow the machine.

It is claimed that one machine will cut ten acres of cane, weighing about 200 tons, in a day, at a cost of about \$7.50. Cutting the same amount by hand, it is said, costs about \$150. An increase in yield of about 12 per cent is also claimed for machine-cut cane,

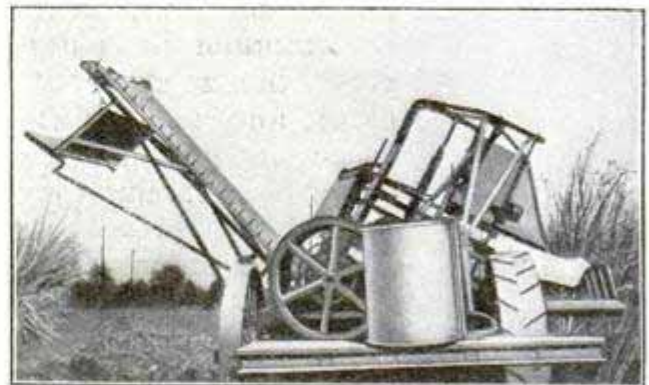

Cuts 10 Acres of Sugar Cane a Day

by reason of the machine saving more of the bottom of the stalks than is possible with hand cutting.



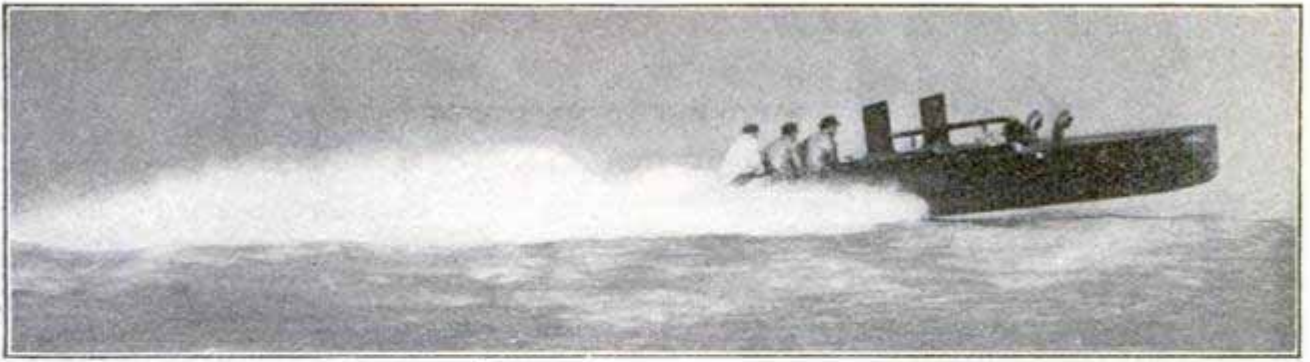

Unique Steam Speed Boat Going 35 Miles an Hour

## STEAM SPEED BOAT MAKES 39 MILES AN HOUR

"Cero II" is a wonderful little speed boat that has made a mile, unofficially, in 1:32, which figures out at a speed of a fraction over 39 miles an hour. But 31 ft. 5 in. in length, with a beam of 4½ ft., she is driven by an automobile steam engine of the compound marine type, which develops between 125 and 150 hp. The weight of the bare hull is but 639 lb., while the machinery weighs, 2,100 lb.

The "Cero II," which is owned by a Cleveland (Ohio) man, is almost straight along her keel and has a broad, flat stern. She appears perfectly flat-sided with no sheer to speak of when at rest, and up to 15 miles an hour just wallows along. At 20 miles an hour her nose begins to rise from the water, and at 25 miles, she shows a little more hull, but it is not until she passes these speeds that her design begins to prove itself. At 33 miles an

hour the nose is about as high as it can rise, and at still higher speeds it drops slightly closer to the water again.

Steam is supplied to the engine by two generators of the endless coil type, placed over burners of the Bunsen type. The generators are aft of the engine, and have individual stacks, which carry away the exhaust and provide extra draft.

### LOCATING BLOWN FUSES

It is sometimes a matter of time and trouble to locate a blown electric fuse in a bank of fuses. An English type of fuse has one end somewhat resembling a shooting target, in full view of the inspector. When the fuse blows, the central black disk or bull's eye, as it may be called, falls out of place and is caught in a recess in the "target," where it may easily be seen. Thus the blown fuse is immediately indicated.

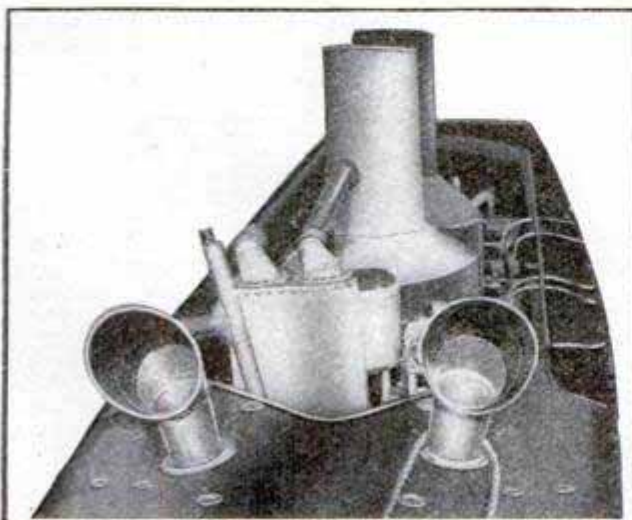

Front View of the "Cero's" Power Plant

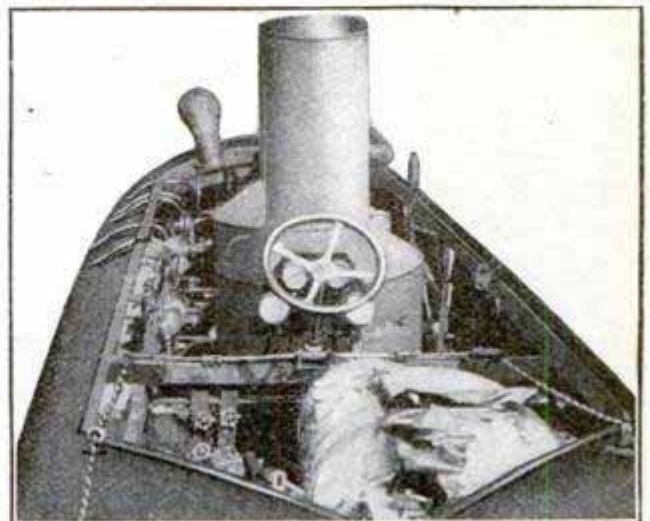

As Viewed from the Rear

### GAMING IMPLEMENTS USED FOR CLOCK FACE

The "Gamester's Clock" would be an appropriate name for a timepiece

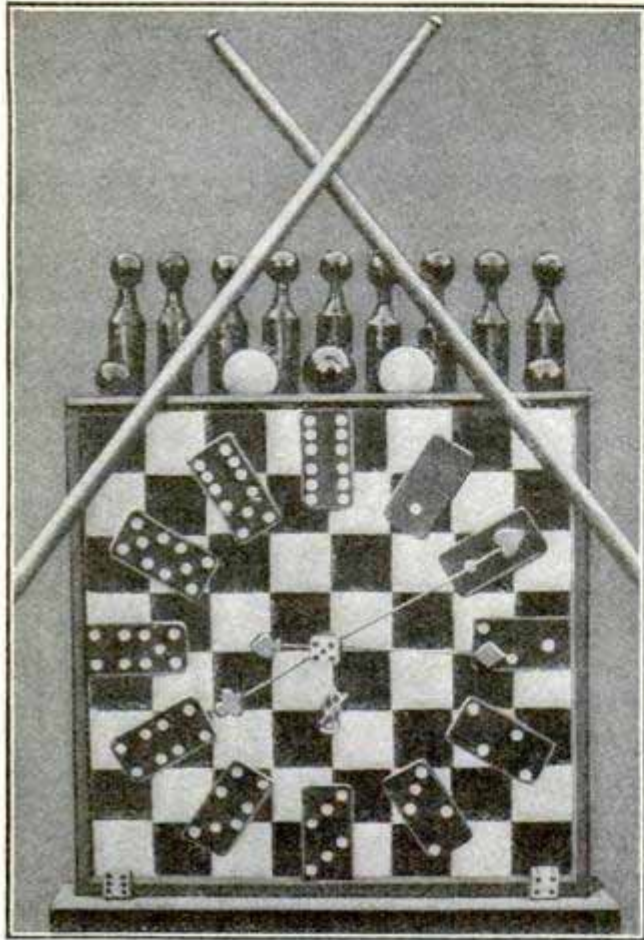

The Gamester's Clock

that has just been constructed, which appears to have been made with all the implements for gaming that could be secured. A checkerboard furnishes it with a face, the numbers on which are made with dominoes of appropriate denomination. The minute hand is tipped with the figure of a "heart" and at its short end has a "club." A "diamond" serves to point the hours for

the hour hand, while a "spade" forms the butt of this hand. The hands are fastened to the clock with a dice, while the top is ornamented with a row of tenpins and billiard balls. Over the top a pair of short billiard cues are crossed.

### ELECTRIC METERS INSTALLED ON PORCHES

The manager of an electric-light plant in a small city has had the majority of residence meters installed outside, usually on the rear porches, but sometimes on the front. They are placed where rain and snow will not interfere with them, and are practically moisture-proof, having protecting glass covers.

The advisability of outside meters was impressed upon this manager through his own experience in reading meters. The time spent in cleaning his feet, waiting for the door to be opened, passing through the house, and possibly climbing to the attic, he considers absolutely unnecessary, to say nothing of the second calls required when the first finds no one at home.

### NOVELTIES IN LONDON SHOPS

A few of the many novelties displayed in London shops to tempt buyers are shown in these illustrations. They include a special chafing dish arrangement for poaching or steaming eggs, a sterling silver twin sauce tureen, a telephone cigar-lighter novelty, and a flower bowl provided with a pedestal with a net for the arrangement of the flowers.

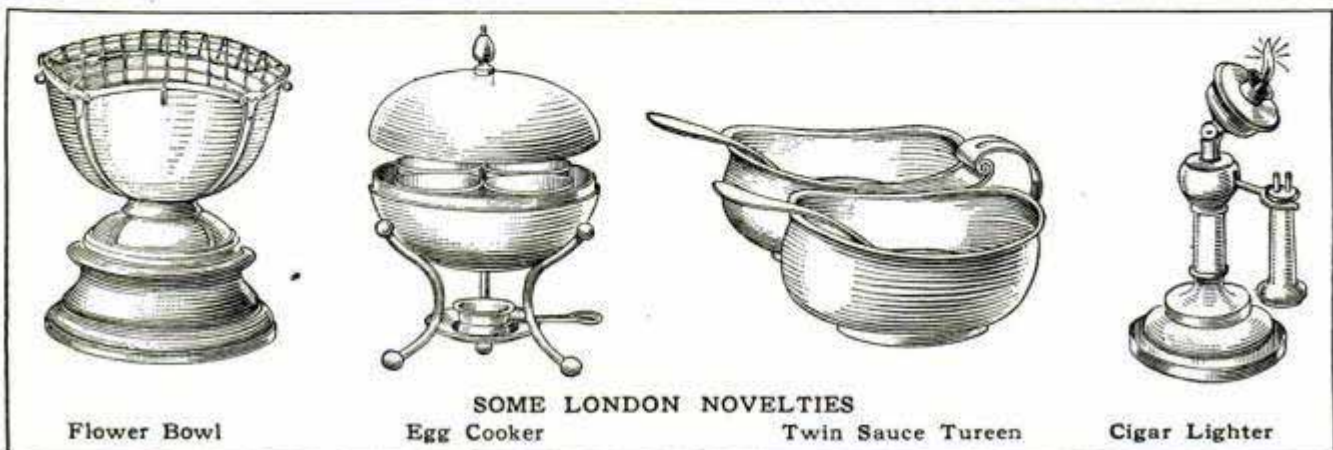

Flower Bowl

Egg Cooker

Twin Sauce Tureen

Cigar Lighter

SOME LONDON NOVELTIES

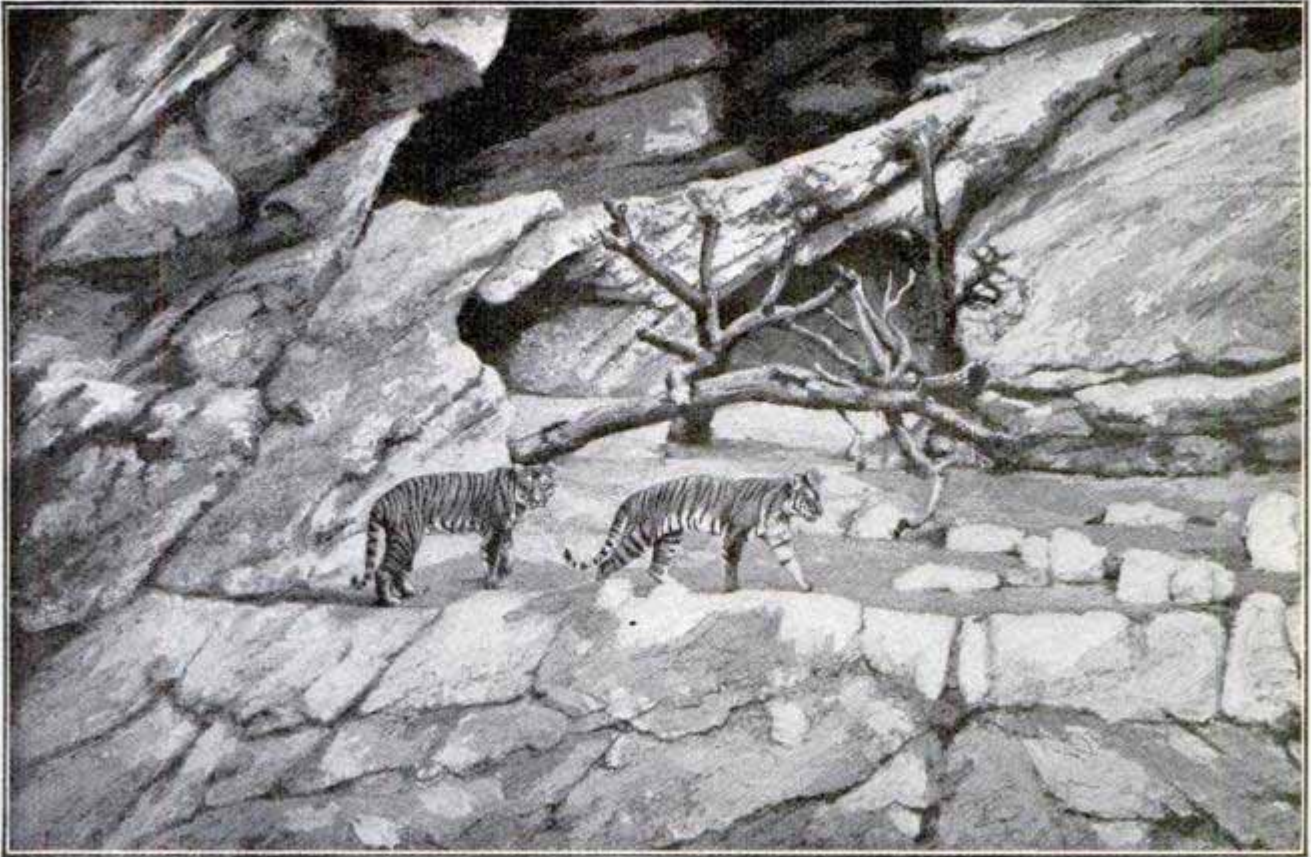

ROME'S NEW ZOOLOGICAL GARDEN

**T**HE conception of a great zoological garden in which lions, tigers, and other wild animals are free to wander about without being separated from the spectators by the bars of cages, has been realized in the new zoological garden at Rome. Deep and wide trenches safeguard the spectators from attack, and the animals have a greater and more natural environment to prowls about in.

### IMPROVED COLOR-VISION TESTING LANTERN

Experiments have developed the fact that, owing to the disks moving in a regular sequence, the colors in the vision-testing lantern used by the government railways of New South Wales, could be learned by persons with a defective color sense. Consequently, the examiner-engineer of the railways mentioned devised a second disk, which, used in conjunction with the old, makes possible various combinations at the will of the examiner.

The disks are rotated by means of handles at the side of the lantern, pointers indicating the numbers of the lights shown. The original numbers are retained, so that no alteration has been necessary in the method of keeping the records.

It is remarkable how a candidate in whom a defective color has been clearly demonstrated, even a defective sense of

red, can be tutored to deceive an examiner, when the old type of testing lanterns are used.

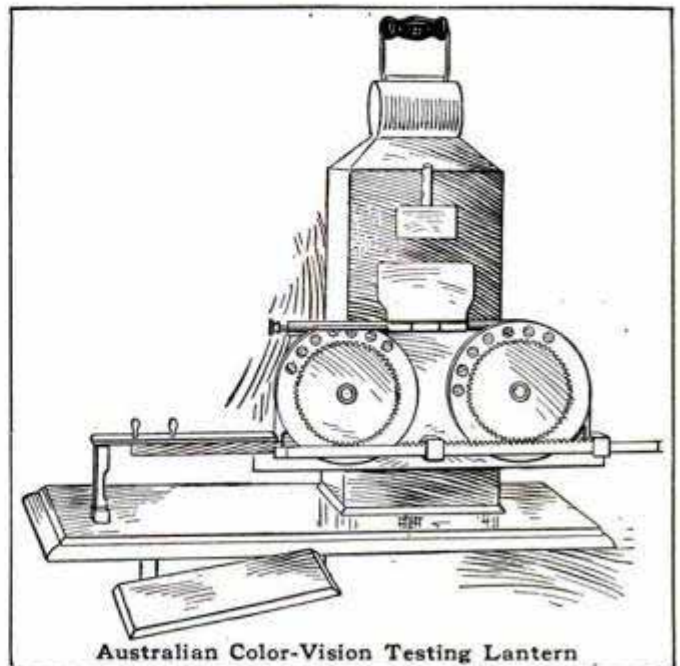

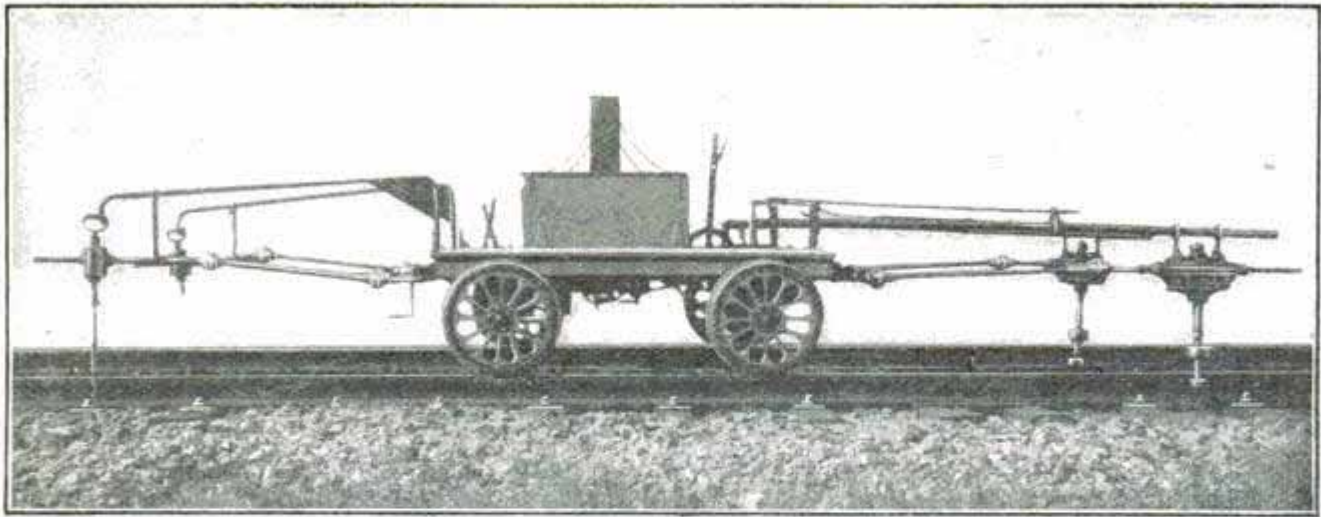

A Useful Car that Drills Holes in Rails and Drives Spikes

### ELECTRIC MIXER BLENDS LIQUIDS QUICKLY

Ordinarily, two minutes or more are required to properly mix a beverage and even then the result is not always satisfactory, but with this electric machine the mixing is done in from 10 to 20 seconds, the flavors are thoroughly blended and the customers are saved a considerable wait.

The electric mixer is designed for soda-water fountains and bars, and consists of a 1/12-hp. motor, attached to a standard and operating a vertical shaft, at the bottom of which is a so-called applicator in the form of a button, so shaped as to set the contents of the mixing glass in motion. The ingredients of the beverage are placed in a mixing



glass, which is adjusted in a holder. The operator then presses down the machine until the button is about 3 in. from the bottom of the glass, when the motor starts automatically. Raising the machine automatically stops the motor, which is claimed to have a maximum speed of 10,000 revolutions per minute. The motor is direct connected to the mixing shaft, and the operation is simple.

### INGENIOUS POWER-OPERATED SECTION CAR

This ingenious little self-propelled section car has a gasoline engine powerful enough to permit of its pulling two or three push cars loaded with section men and supplies, as well as providing power for the operation of tools when stationary.

The accompanying illustration shows the car equipped for boring holes and driving screw spikes. The cranes extending from the drilling end of the car hold up the drills when they are not in operation, while those extending from the spike-driving end hold up the spike drivers at all times. In driving the spikes, all the operators have to do is to exert a downward pressure on the cranes and keep the drivers from slipping off the heads of the spikes.

In connection with a small auxiliary air compressor or electric generator, the engine may be used to operate riveting and other like tools at a distance.

☐ In plowing a prairie of five square miles with a 12-in. plow, the man behind the handles would have to walk a distance of 26,400 miles, or a distance equal to the circumference of the earth at the equator plus that of a journey between New York City and Houston, Texas.

# The Kingdom of Dust

By J. Gordon Ogden, Ph. D.

THIS is the first of a series of articles by Dr. Ogden, who is professor of physics at the Fifth Avenue High School, Pittsburg, Pa. In every home, in every office, in every shop or factory, the fight against Dust is never-ending. Dr. Ogden illuminates this subject in a manner which brings a realization of its infinite importance.

## 1—A Boundless Domain

VAST is the kingdom of dust! Unlike terrestrial kingdoms, it knows no limits. No oceans mark its boundaries, no mountains hem it in. No parallels of latitude and longitude define its boundless area, nor can the farthestmost stars in the infinitudes of space serve other than as twinkling outposts of a kingdom as vast as the universe itself. And what shall we say as to the component subjects of this kingdom? In number, form and variety, they transcend all conceptions of the human mind. In shape, they comprise every possible form. In position, they include every substance that is material. In condition, they are solid, liquid, vaporous and gaseous.

They are with us in the quiet seclusion of our homes, in the busy streets and marts of commerce, on the sunlit crests of the snowy Himalayas, out on the silent prairies, mingled with the desert's shifting sands, amid the ice of the frozen Arctic. They fall as ambassadors from space on the clouds of canvas—the wings of the flying ships, thousands of miles from land. They come to us enshrined in the beautiful snow crystals, and every drop of rain carries with it from the upper reaches of the atmosphere some of these tiny subjects of the mighty kingdom of dust.

Dust would not be possible were it not for the fact that matter is almost infinitely divisible. A coin that is worn smooth in the course of years of

passing from hand to hand is a good illustration of this fact. The wearing away was not done by any one hand, but by the touch of many. Every time a finger was placed upon it, no matter how slight the pressure, tiny particles of gold, or silver, or copper, as the case might be, were removed. No scales used by man could possibly weigh one of these tiny metallic particles of dust, nor could it be seen with the most powerful microscope. Nevertheless, it has length, breadth and thickness, and the removal of it, and of countless others, made the coin smooth and worn.

One sometimes sees an old piano whose ivory keys have deep grooves worn in them by fingers that have long since become subjects of the kingdom of dust. As in the case of the coin, every time the hard ivory was touched, no matter how light the touch, small particles were dislodged to become errant soldiers in the great dust army.

Absolutely pure water will not permit an electrical current to traverse it. If a grain of salt be added to a hundred tons of perfectly pure water, the water becomes at once a conductor of electricity. It is supposed that the solitary grain of salt is divided into an almost infinite number of parts, and that each of these tiny motes of salt acts as a ferry by means of which the electric charge is enabled to cross the water. How extremely minute, then, must be these particles of salt,

when a single grain will supply ferry service for a hundred tons of water, every cubic inch of which must neces-

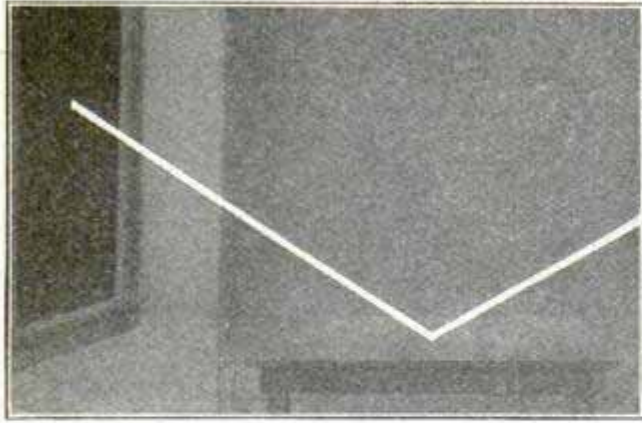

Beam of Sunlight in Darkened Room—The Reflection of the Light from the Dust Particles Makes It Visible to the Eye

sarily contain hundreds of millions of salt particles.

A single grain of musk will perfume a room for years, penetrating every portion of it, and yet not lose sensibly in weight. As it is supposed that the sense of smell owes its inception to the bombardment of the olfactory nerve by small particles of the substance that gives rise to the perfume, we may gather some notion of the extreme minuteness of these particles.

It has been estimated that an average puff of smoke from a cigarette contains about four thousand millions of particles of dust.

A single grain of indigo will give color to a ton of water; of course, every drop of this water must contain an immense number of ultra-microscopic particles of indigo. A few grains of fluorescein, a substance derived from coal tar, will produce a distinct fluorescence, shining with a yellowish green light when strongly illuminated, in a hundred tons of water. To produce this result, the fluorescein must be divided into countless billions of particles.

Professor Warburg of Berlin is to be credited with an excellent illustration of the divisibility of matter. He succeeded in weighing the invisible layer of vapor which condenses on a dry plate in a moderately damp room, and calculated that the film of water dust thus deposited was 500,000 times

thinner than the thinnest writing paper.

The process of division into extremely small particles of matter goes on right under our eyes when we see a match flaming or a candle burning. Some of the carbon of each passes off into the atmosphere in particles so small that they will remain suspended for hours and even days before they finally settle down on the floor or other resting place.

The ordinary incandescent electric-light bulb contains only about a millionth of an equal volume of the air such as we breathe. And yet the bulb is "full" of air, as the one-millionth that is left in the bulb after exhaustion by the vacuum pump, occupies every part of it, and the tiny molecules are constantly whizzing to and fro in countless hordes—untold billions.

Still another, and even more amazing, illustration of the extreme divisibility of matter is shown in the case of the sodium coloration of a flame by the addition of a minute quantity of common table salt. A millionth part of a milligram ( $1/65$  grain) of salt, will be amply sufficient to give a distinctly yellow coloration to a flame. To do this, this millionth of a milligram must have been vaporized into a gas containing trillions of particles of sodium.

Down at the bottom of the sea, under three miles of water, there lies a dust so fine that when it is rubbed be-

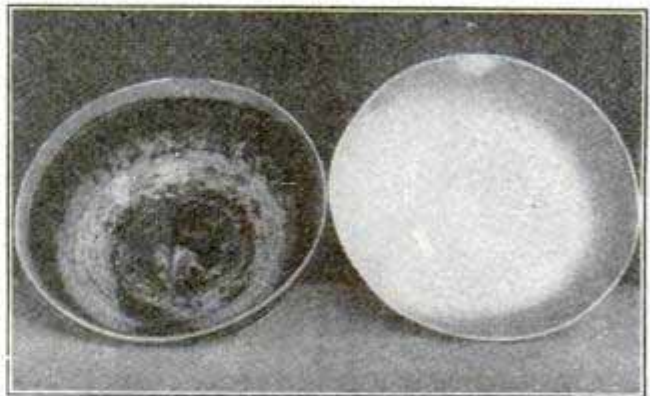

Dust in Porcelain Dish after Evaporating Snow, and Clean Dish to Show Contrast

tween the fingers it enters the pores of the skin. This dust is the remains of the shells of plants and animals,

such as Diatoms and Polycystines. It is estimated that one cubic inch of the ooze that covers the ocean floor contains the remains of forty thousand millions of organisms, each as distinct in its individuality as is an elephant, and possessing a structure that is as perfect, so far as its use is concerned, as is the structure of the human body.

Every conceivable substance enters into the composition of dust. In street dust may be found bits of iron and steel from the tires of wagons, horseshoes, and the nails of our own shoes; bits of leather from harness, fragments of wood, cotton, silk, stone, gold, silver, clothing, wool, hair, animal excreta, various ores, tin, paper, clay, sand, molds, bacteria—in fact, everything under the sun.

Sometimes this dust is so abundant that it fills our nostrils and irritates the delicate mucous membrane, so that we are forced to withdraw from its vicinity. At other times the dust is so imperceptible that we are almost certain there is none present. And yet the air is always full of it, as may be observed quite readily by noting the enormous number of dust motes in a sunbeam passing through a darkened room. Even in the quietest, cleanest room of our home, the sunbeam reveals the unnumbered myriads of everything material that is constantly floating in the atmosphere.



Dust Particles from Pittsburg Schoolroom

Some of the dust finally subsides after floating for days or even months, and settles on the top of books, the mantel

shelf, picture frames, chairs and other objects in the room, as the careful housewife is ready to testify.



From Actual Photograph Showing Peculiar Movement of Dust in Air

A room left undisturbed for weeks at a time may appear to be free from dust, but let a beam of sunlight pass through it, and at once the multitudes of dancing, quivering, irregularly-shaped particles flash into view. Every breath we take entombs thousands of these particles, even under conditions where every precaution is taken to lessen their number.

The amount of dust that falls is enormous. It has been calculated that in February, 1891, the amount of dust that fell on the house tops of the city of London amounted to six tons per square mile. It is not improbable, as will be shown, that this quantity, enormous as it is, is equaled or exceeded in many of our American cities, where coal, especially soft coal, is used as a fuel. Chicago, St. Louis, New York, Philadelphia, Cincinnati, New Orleans and Pittsburg are dust-mantled cities. Millions of dollars are spent annually as a ransom to this mighty kingdom of dust, in order that its unwelcome ambassadors may take wings and fly away from our carpets, our curtains, our books, our windows and our streets. Unfortunately, they do not fly far, but settle down comfortably after a stirring seance with the dust cloth, broom or other cleansing agent. The fight against dust is a continuous one, and must be fought over and over again, the next hour or

day or month, depending upon the energy of the dust fighter.

Careful investigation has shown that even in the comparatively pure air of the country districts, remote from furnace and smokestack, there are over a thousand motes of dust in every cubic inch of air. A good, heavy fall of rain washes the atmosphere quite thoroughly, and for a few hours after this purification the atmosphere is comparatively free from dust. Falling snow acts in a like manner, and the beautiful white crystals always contain dust particles, gathered up in their descent through the air. If the fall be heavy enough, the atmosphere gets a thorough scrubbing. If freshly fallen snow be melted and evaporated, there is always an appreciable quantity of insoluble, residual matter. If snow is allowed to remain for a day or two on the roof, the heavy, black deposit of soot, so familiar to the dwellers in our large cities, is very much in evidence.

The writer recently gathered a quan-

tity of snow three days after it had fallen, on the roof of the Fifth Avenue High School, Pittsburg. The snow was melted and the water evaporated. The quantity of snow taken weighed 52 oz. and covered an area of exactly 2 sq. ft. After evaporation, the residue weighed a trifle over six grains. A chemical analysis proved this residue to be principally carbon, with a slight trace of iron.

Three grains to the square foot may seem to be rather insignificant; but when we consider the total amount to a square mile, the dust deposit becomes quite impressive, being about 12,000 lb., or six tons. This means that during the winter months, at least, about 60 tons of dust fall monthly on the streets, house tops, and in the homes in every square mile of the Pittsburg district. No wonder that Pittsburg has acquired somewhat of a reputation among its envious rivals for its dust and dirt. It is certainly not spotlessly clean.

Of such is the Kingdom of Dust!



Siamese Convict Wearing Queer Neckyoke

### YOKES FOR CONVICTS TO PREVENT ESCAPE

Though city dwellers are not so familiar with the device, every stock farmer has at one time or another been compelled to use a long yoke or hobble on some one of his herd of cattle or horses that made a practice of jumping the pasture fence, straying on a neighbor's property, or running away. This form of contrivance has been used for centuries in the Orient to prevent prisoners from getting away from their guards on the way from court to prison. In China the yoke is a heavy wooden wheel, the wearing of which sometimes constitutes the punishment meted out by the magistrate, the convict being sentenced to wear the yoke for a term of days or weeks. In Siam, a much longer form of yoke is used, the principle being about the same as applied to cattle in this country. If he attempt to escape by running, the poles are so long that they trip him.



## WRECKING CRANE WITH UNUSUALLY LONG JIB

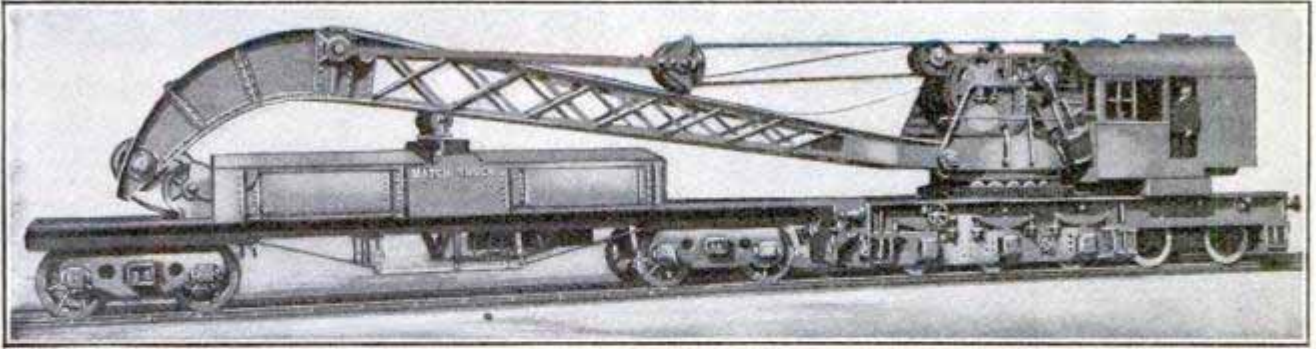

Powerful Railroad Wrecking Crane Which Has Radius of 40 Feet

The wrecking crane shown in the accompanying illustrations is one of the most powerful and practical ever supplied to a British railroad. It has an unusually long and high jib, of the lattice type, curved in form. The lifting power is 36 tons at a radius of 20 ft., and lighter loads up to a radius of 40 ft.

The conditions the builders of the crane were compelled to meet were, according to the Engineer, London, somewhat difficult. In the first place, it had to be constructed to clear the ordinary English railway loading-gauge, and a further limitation was met with in the specified condition that the load on any pair of wheels should not exceed 14 tons when the crane was

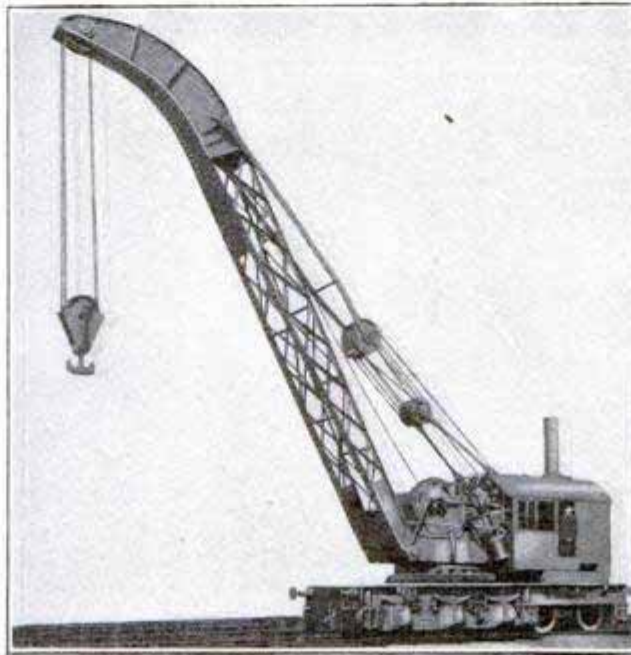

Crane in Operating Position

traveling with a train. These requirements were solved by arranging the crane with a large portable balance weight at the tail end. This weight can be moved in and out to suit different conditions of load, and can also be detached and lifted by the crane itself, onto the truck which carries the forward end of the

jib while in transit.

¶ During the five years from 1905 to 1910 the United States sold goods to China in proportions, which, if evenly distributed among the 400,000,000 people, would have given each man, woman and child .06 of a cent's worth of American supplies.

## BLERIOT OFFERS BARGAIN RATES TO PUPILS

While the art of aviation is comparatively new and all schools that teach it are of recent foundation, there has nevertheless been a sufficient number of the latter started to cause the founders to offer inducements to students. In France, where there are more aviation schools than elsewhere, Louis

Bleriot and his partner, LeBlanc, have taken the lead by offering the first ten students to matriculate for the next year greatly reduced rates. This is indeed a sign of the times. Bleriot offers his first ten pupils a full course for \$160. Bargain prices at all the other aviation schools are now in order.

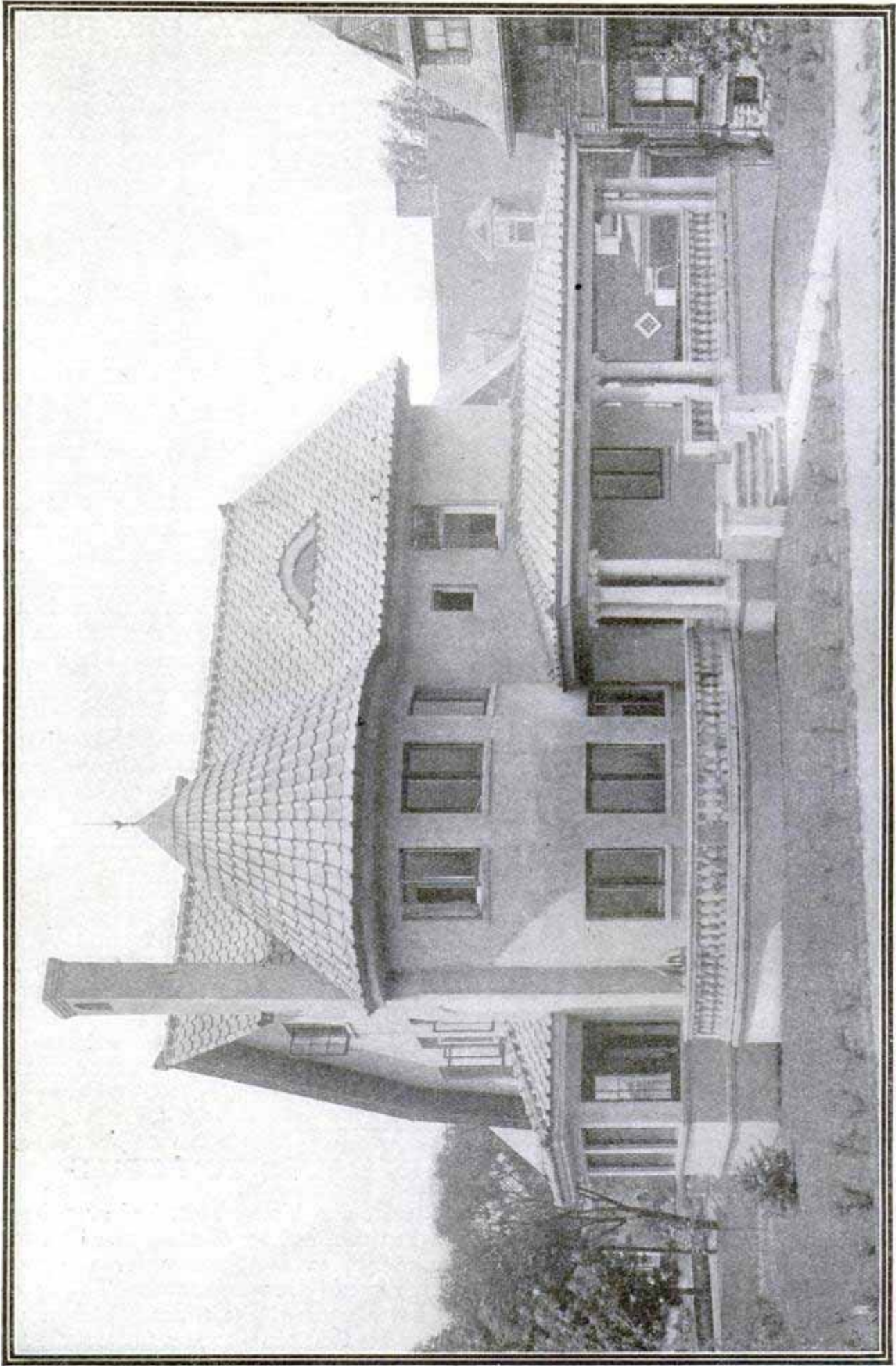

CONCRETE RESIDENCE OF DR. M. E. STEPHENSON, BOSTON, MASS. Built Without the Use of Forms or Molds. It Has 12 Rooms and Cost \$11,000

## TRAVELING CONCRETE PLANT USED ON AQUEDUCT

A traveling concrete plant, embodying several novel features, has been used on the Esopus cut-and-cover section of the Catskill aqueduct, which will furnish New York with its water supply. The portable plant is entirely self-contained, consisting of a mixer, crusher, storehouse, and conveying machinery for delivering the concrete to the side wall and arch forms.

The plant, which has built 60 ft. of aqueduct arch in a day, consists of a four-story framework of steel and a steel transporting bridge, 140 ft. long, one end of which is pivoted to the main structure, while the other is supported by steel saddles resting upon the arch of the completed aqueduct. A gravity mixer is mounted on one end of the plant and delivers concrete into buckets, which are picked up by an electrically operated traveler, running on the lower flanges of the I-beams extending the length of the bridge. This traveler carries the buckets of concrete out on the bridge and dumps them directly into the forms. The main structure

the loading platform where the buckets are filled from the gravity mixer. The second floor carries the lower hopper of the mixer, and a 75-hp. electric motor,

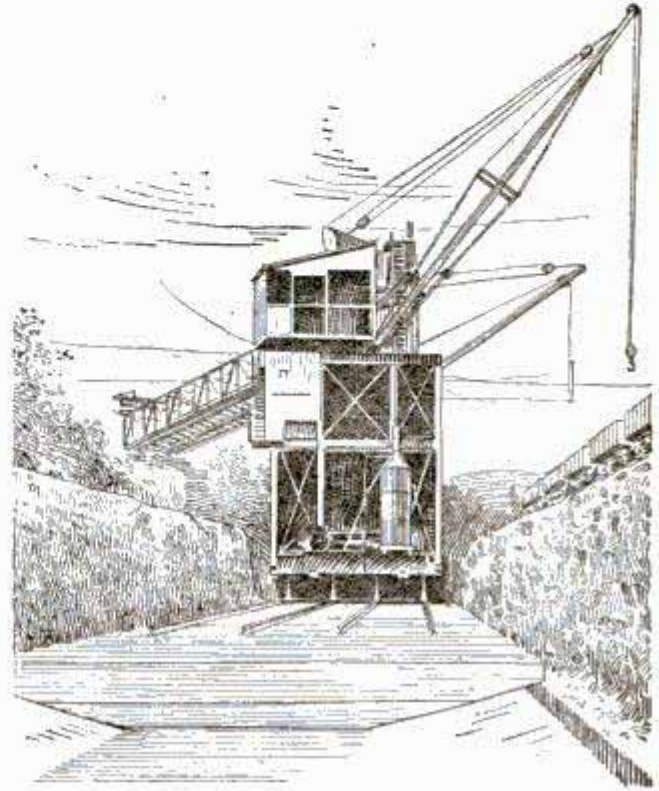

Main Section of Traveling Plant Shown Just as it Was Rounding a Curve

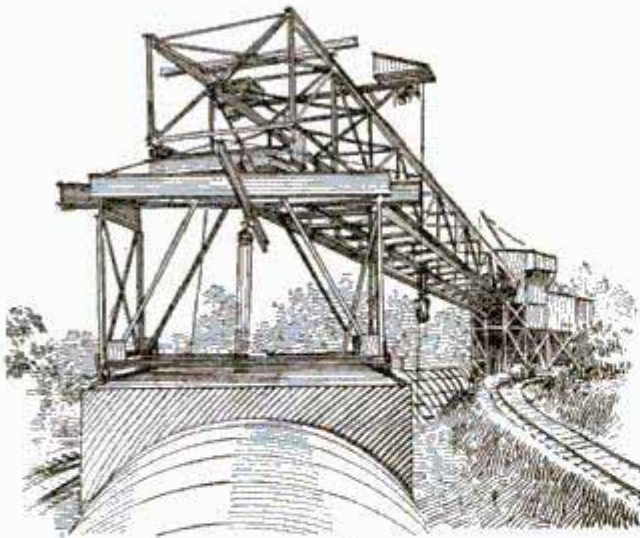

Dumping End of Bridge Supported by Saddles on Completed Aqueduct Arch

is mounted on a car which runs along tracks in the trench as the work progresses, the ties being shaped to fit the finished invert upon which they are placed.

On the first floor of the four-story framework is a gyratory crusher and

which furnishes power for operating the elevator, sand roll, derricks, crushers and screens. The sand roll and the intermediate hoppers of the mixer are on the third floor, while the top floor is given over to a gyratory crusher, the top hoppers of the mixer, the sand and storage bins, and two derricks.

At a rate of 60 ft. per day, the work required of the plant was the mixing and placing of about 171 cu. yd. of concrete daily, and the taking down, moving and setting up of 60 lineal feet of steel forms.

☞Yeast, either dry as sold in stores, or fluid as it comes from the breweries, is said by Dr. Plantier, of Paris, to be a remarkable remedy for burns. It should be diluted with boiled, luke-warm water, and applied as soon as possible after the accident.

## HOW TO MAKE A HALL TREE

When making the hall tree shown in the accompanying illustration use

First square up all the posts and bevel them at the tops as shown. Then cut

the mortises, making them  $\frac{1}{2}$  in. wide and  $\frac{7}{8}$  in. deep. Cut the tenons on the braces to fit these mortises. Be careful to get the distance between the shoulders of the braces all of the same length. A good way to do this is to place them all side by side on a flat surface with the ends square and lay them all out at once. The top arms can be made in the same manner. The tenons should fit good and tight in all the posts.

The parts can now be glued and clamped together. When they are dry, scrape all the surplus glue from about the joints and go over the whole with fine sandpaper, removing all rough spots. Apply the finish you like best or the one that will



Hall Tree Complete

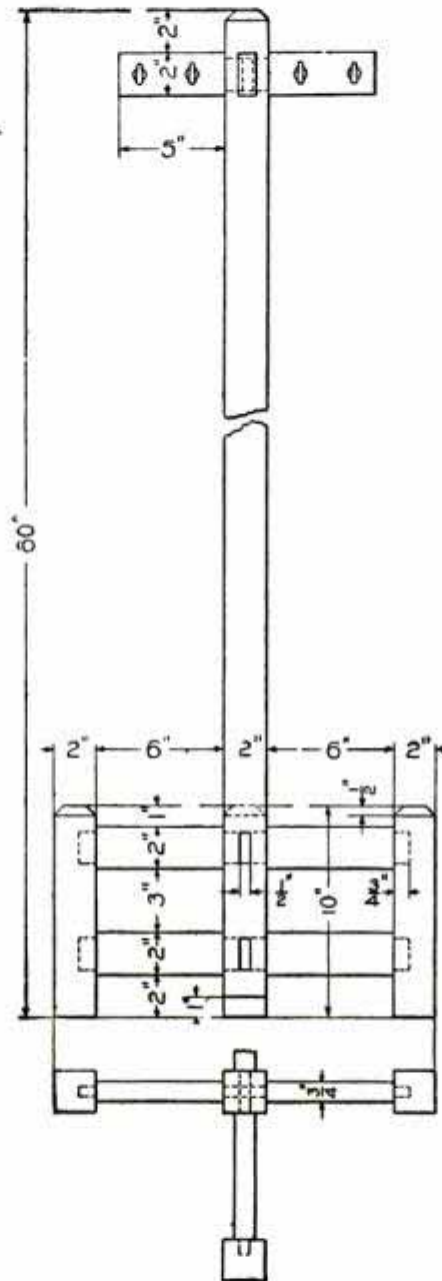

Details of Construction

quarter-sawed oak if possible, as this wood is the most suitable for finishing in the different mission stains. This is a very useful and attractive piece of mission furniture and is also very easy to construct. The stock can be purchased ready cut to length, mill-planed and sandpapered on four sides as given in the following list:

- 1 post, 2 by 2 by 59 in.
- 4 posts, 2 by 2 by 10 in.
- 8 braces,  $\frac{3}{8}$  by 2 by  $7\frac{1}{2}$  in.
- 4 arms,  $\frac{3}{8}$  by 2 by  $5\frac{3}{4}$  in.

match your other furniture. Purchase a few hooks at a hardware store and fasten in the upper arms as shown, and the hall tree is complete.

ⒸA Swedish army officer has constructed an aerial torpedo propelled by a compressed-air motor. It is claimed to have an initial velocity of 984 ft. per second, and a maximum range of over 14,000 ft. Its charge consists of about 5 lb. of explosive.

### AN X-RAY EYE

Dr. Rosig, of the Institute of Technology of St. Petersburg, Russia, has announced the discovery of an electroscopic apparatus which will give the user what might be termed an X-ray eye. He modestly claims the invention one of the most remarkable ever made by a scientist, and, according to reports, insists that it can be used to see through walls, to watch theater performances from the exterior of the building, etc.

### ANOTHER TRANS-ANDEAN RAILROAD

Another trans-Andean railroad has been authorized by the Argentine Republic, the appropriation for construction being about \$8,000,000. The new road will connect the northern part of the Argentine Republic with Chili, while the original trans-Andean route links Buenos Ayres and Valparaiso.

### TEAKETTLE WITH LID ON SIDE

A new teakettle introduced in England has its lid hinged and located in the top near the side, instead of being set under the handle in the usual manner. The person filling the kettle can lift it by the handle and hold back the cover with the fingers of the same hand, while the other hand is used to

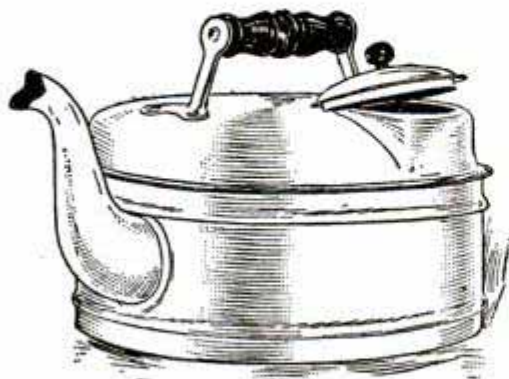

New Position for Teakettle Lid

operate the water tap. With the lid in the new position, all danger of having the hands scalded by escaping steam is removed.

### WINDOWS FOR UMBRELLAS

Windows or portholes for umbrellas have been placed on the market by a concern which believes there is suf-



The Umbrella Portholes in Use

ficient reason for such an innovation to make it popular. The windows are of isinglass, and are sold either separate or attached to a new or old umbrella. Their purpose, of course, is to enable the user to see ahead when holding an umbrella as a protection against a driving rain.

CA simple transformer, which can be connected to any lamp socket on an alternating-current circuit, has been devised for giving low voltages for operating electrical toys for the enterprising "young hopeful" who is studying electricity. Ten different voltages are provided by this apparatus, and these may be used singly or two or more at a time.

### DEVICE INSERTS CUFF LINKS

An invention for buttoning the cuff when links are used is shown in the accompanying drawing. One of the buttons is held in one end of the "linker," which is inserted and then pulled through the buttonholes.

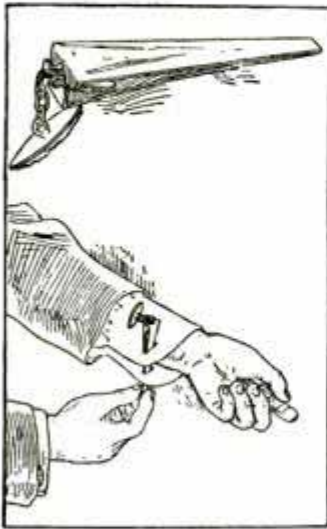

☐ In an action recently brought in London, England, for wire-

less patent infringement, a wireless apparatus was fitted up in the court room and connected to an antenna attached to the flagpole of the building.

### AUTO-TRUCKS FOR AEROPLANES

A British automobile concern has built a truck and trailer especially for the transportation of aeroplanes. The body of the auto-truck proper is arranged as three boxes, two long, narrow ones on each side and a larger one in the center, all three being used for the storing of aeroplane parts. The rear end of the trailer runs on two wheels and the forward end is attached by means of a ring to the back of the

truck proper. The trailer is so constructed that the aeroplane can be easily run up on it.

### VARNISH FOR REFLECTING SURFACES

Metal mirrors, especially those of silver, used as reflectors for search-lights, lighthouses, etc., oxidize very rapidly and must be frequently polished with great care. At each repolishing, however, the reflecting power is lowered, and the operation must be repeated at shorter and shorter intervals.

To remedy this, an inventor has evolved a peculiar varnish, which, adhering to the metal reflectors as a hard, infinitely thin, invisible film, preserves the polish and reflecting power almost indefinitely. The inventor claims the varnish to be absolutely harmless, non-deteriorating and so impervious to water that the surface to which it has been applied can be washed with plain water and dried with chamois without fear of subsequent oxidation.

This varnish is applied in the same manner as ordinary varnish, simply taking care that no air bubbles are allowed to form.

☐ A company with a capital of \$10,000,000 and plantations aggregating 450,000 acres has been formed for the purpose of growing cotton in Chosen (Korea).

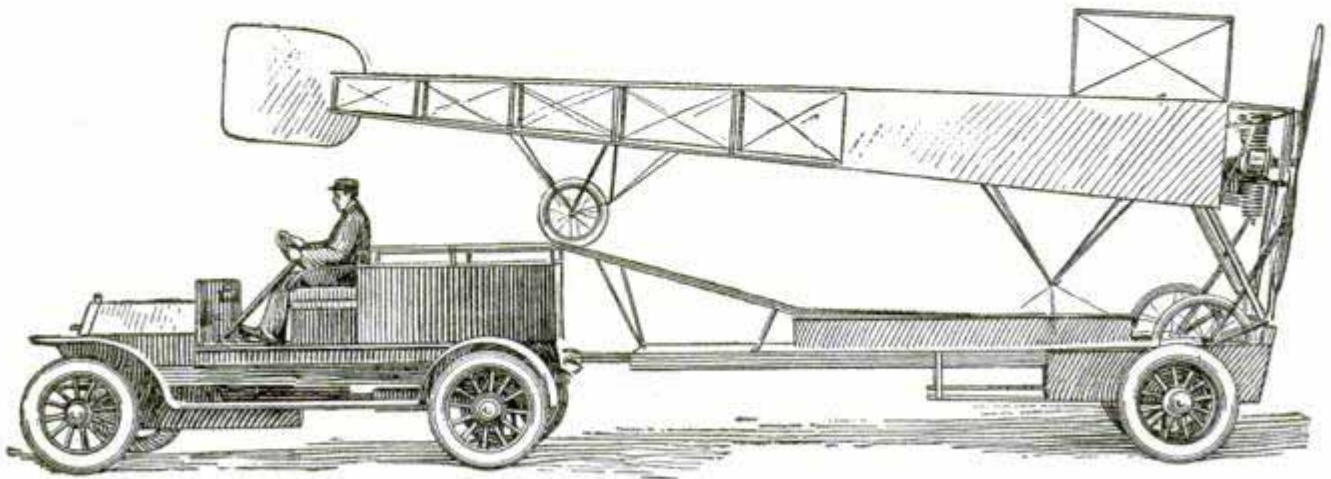

Transporting Aeroplanes by Auto-Truck

## COMBINED MOTOR TRACTOR AND WINCH

An ingenious combined motor tractor and winch is being used by the French in agricultural work. The machine is

rious double-ended affair. The cable is wound up at a speed of 2 to 3 ft. per second. In heavy plowing, to a depth

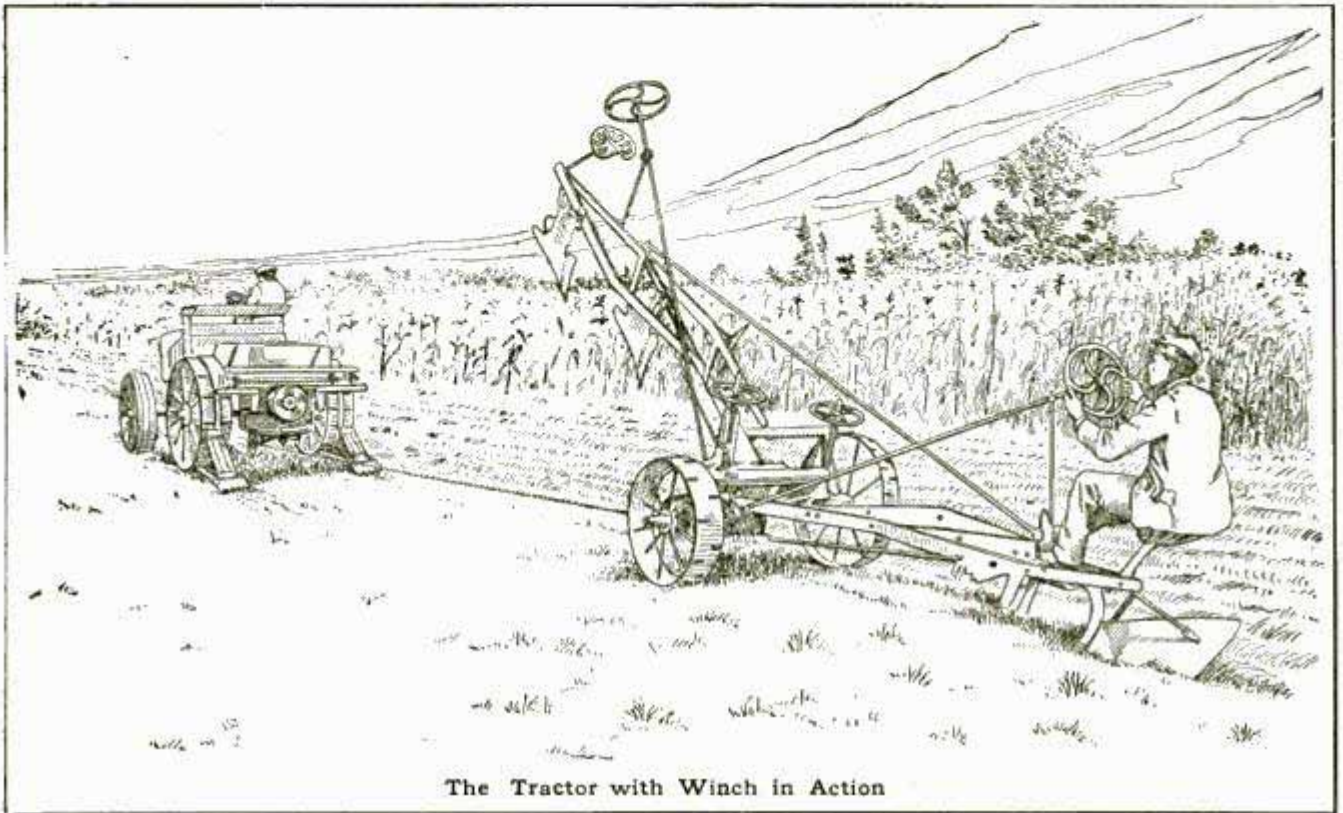

The Tractor with Winch in Action

provided with a 25-hp. engine, which drives either the rear wheels, a horizontal winch for pulling a plow or cultivator, or a pulley for the transmission of power to stationary machines.

In tilling the soil, the motor tractor is run forward the length of its cable, at the other end of which is a plow or cultivator. Then the automatically operated braces or spurs provided on the rear wheels are pressed into the ground to prevent the tractor from sliding backward, and the tilling implement is hauled up to the tractor by cable. It is this automatic wedging to the ground that constitutes the main feature of the machine. As long as the engine is thrown onto the rear wheels, the braces are kept suspended by springs, but the moment the tractor stops, they automatically drop down under the wheels and the teeth enter the ground.

One of the illustrations shows the tractor in action. The tilling implement at the end of the cable is a cu-

of about 10 in., as many as seven acres have been tilled in 10 hours, the gasoline consumption for this amount of work being about 22 gal. Plowing to a depth of only 6 in., two or three acres have been added to this record.

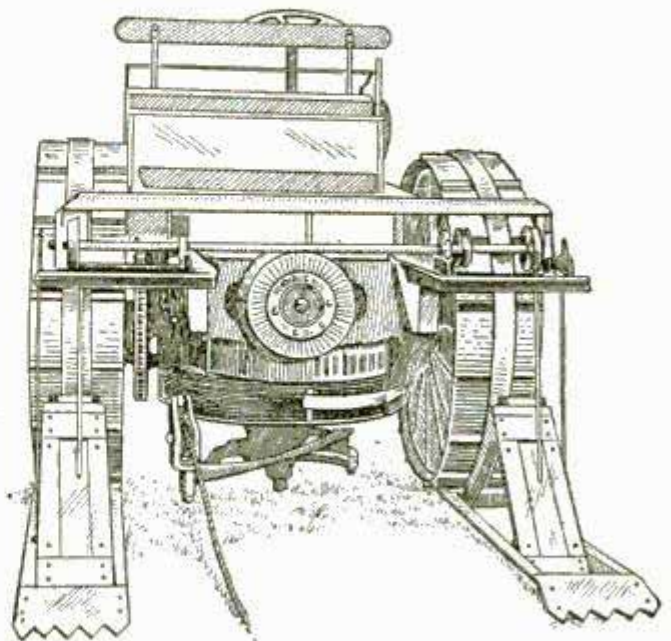

Braces Used While Hauling with Cable

### FREIGHT CAR FOR AUTO TRANSPORTATION

Some time ago a British end-door car for automobile transportation was illustrated in this magazine. This end-

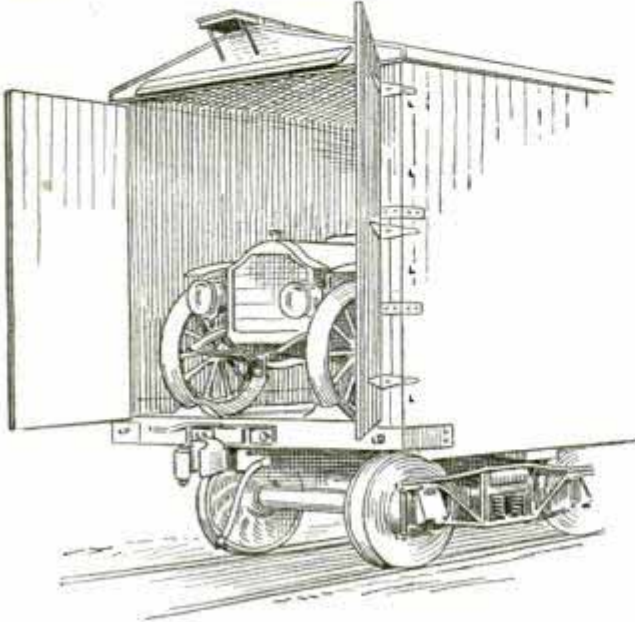

Car for Transporting Automobiles

door car was constructed for the same purpose, and is part of the new rolling stock of the Chicago, Burlington & Quincy Railroad. The length of the car is 40 ft.

### MACHINE SCOURS AND DIPS FLAT POTTERY

A machine that supersedes the hand-to-hand method of scouring and dipping plates and other flat pieces of pot-

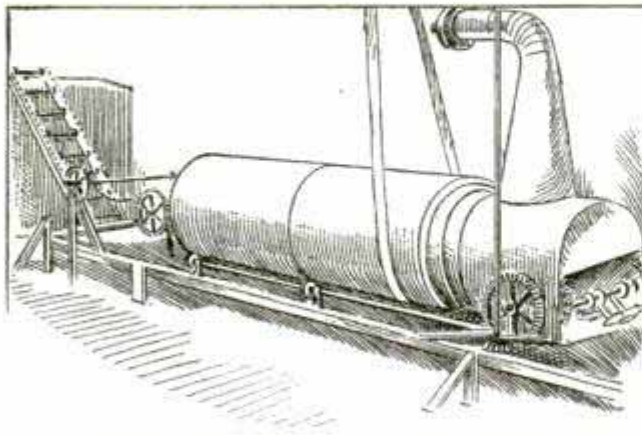

Machine That Scours and Dips Plates

ter's ware is being used in the domestic potteries at Sebring, Ohio.

The machine comprises a cylinder or drum and glazing reservoir through

which the plates are carried by an endless chain studded with spring clips. An operator feeds the plates to the chain, and as they pass through the cylinder the latter is revolved at a high speed, which causes the sand and other substances to be dashed against the ware, cleaning it in a manner said to be impossible by the hand method. The endless chain with its load of plates drops downward on emerging from the left end of the cylinder and passes through a reservoir containing the glazing liquid. The chain then continues its course and the ware is removed dry and ready for the glost kiln men.

### PUMPING WATER 2,200 FEET IN ONE LIFT

A Corliss pumping engine has recently been installed in an American mine, 2,200 ft. below the surface, to pump out the mine water in one straight lift. This may not seem to be anything remarkable, but the enormous "head" of 2,200 ft. introduces some very important engineering considerations. Thus, in this particular instance, the pressure against which the engine has to operate in order just to lift the water this height is 955 lb. per square inch, or between two and three times the pressure of the steam in an ordinary high-pressure steam boiler. The pipes must be designed not only to withstand this enormous pressure, but also to resist the impact or inertia effects of the great column of water when it is suddenly started or stopped. This "water ram," as it is called, may be noted by the very audible rap which occurs when a water faucet is very suddenly turned off.

It is said that the pumping engine noted above is the deepest mine pump in the world.

¶The Spanish Aero Club of Catalonia is arranging for an aeroplane flight across the Pyrenees between the cities of Perpignan in France and Barcelona in Spain. The maximum height of the Pyrenees on this line is about 3,000 ft.



## INSTRUMENTS EXERCISE EYE MUSCLES

Two instruments for correcting discrepancies of sight are shown in the accompanying drawings. One is a bar reading device for forcing binocular vision, and the other, called an amblyoscope, stimulates and exercises the fusion faculty. The former is a bent bar fastened to a head band, the bar being set midway between the eyes. The suppression of either eye at once becomes apparent to the patient because of interference by the rod, thus forcing binocular vision. If both eyes are used simultaneously, the fields overlap and the patient reads behind the bar without difficulty.

The amblyoscope is the instrument commonly used for the treatment of squint, where education of the fusion sense is desired. It consists of two tubes, each provided with a mirror and joined together by a hinge. Pictures on transparent slides are placed in the grooves at the ends of the tubes and viewed by means of transmitted light. A set of slides, one bearing the picture of a bird, and the other of a cage, is, according to an article on squinting in the *Optical Journal*, of considerable value because it gives the child the idea of a game devised merely for his amusement. The slide showing the cage is put in the tube before the child's fixing eye, and the screen showing the bird before the squinting eye. The patient is then told what to look for, and

tubes and about 4 ft. distant, and, after the patient has seen the cage, the lamp before the fixing eye is moved further



Bar Forces Binocular Vision

away and the one before the squinting eye drawn nearer. As a result, the child loses sight of the cage but sees the bird. Then the child is allowed to grasp the instrument, and, assisted by the hands of the physician, is taught to vary the angle so as to make the bird go in and out of the cage. After a period of this treatment the eyes often follow the objects and maintain fusion of the pictures.



An Instrument That Stimulates the Fusion Faculty

at first sees only the cage. Two electric lamps are arranged in line with the

## ELECTRIC APARTMENT HOUSE

A New York apartment house, now in course of construction, will be equipped with a grill, dishwashers, ranges, washing machines, irons, clothes dryers, garbage incinerator and refrigerating plant, all individually operated by electricity. It goes without saying that the lighting is also electric. Gas and coal are not needed at all in the apartments, and it is probable that neither will be used even for minor operations.

## METAL FORMS FOR CONCRETE HOUSES

Several concrete houses at Virginia Highlands, across the Potomac River from Washington, have been con-

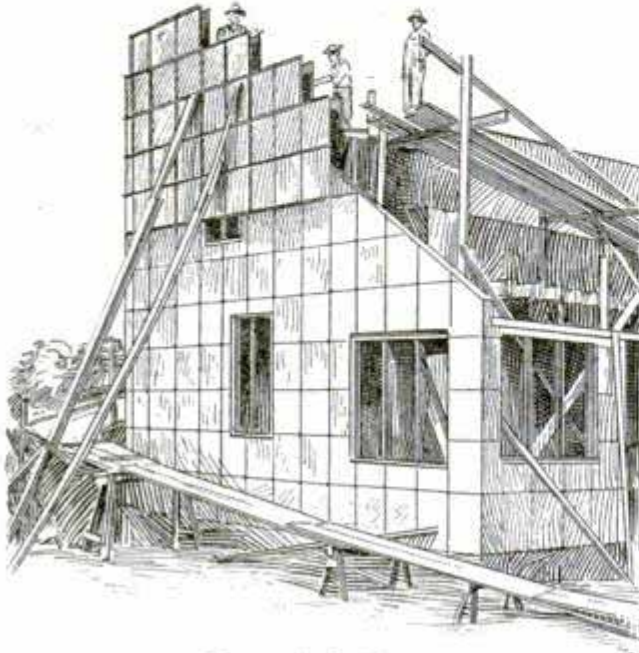

Forms in Position

structed with metal molds. The wall forms consisted of panels of No. 12 gauge sheet steel, 24 in. square, flanged

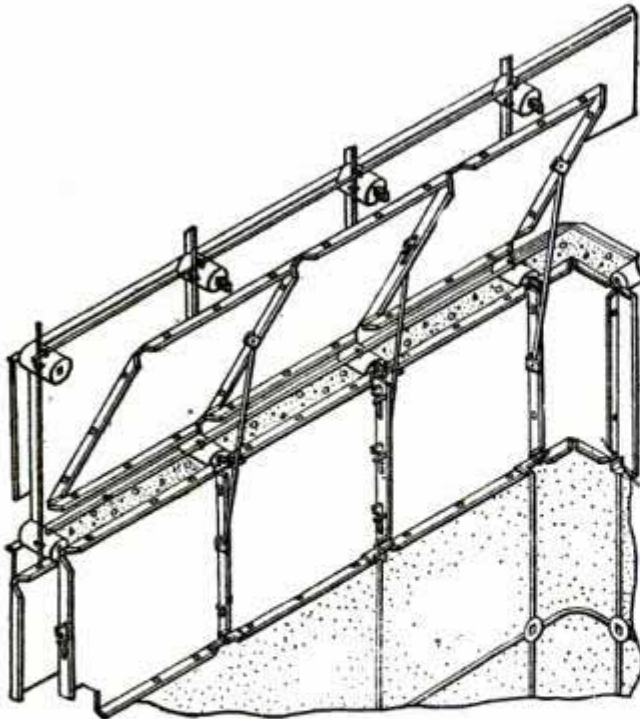

Method of Form Assembling and Bracing

on all sides by a right-angled bend of the sheet. They were used in sets of two tiers each, connected together by light rods. To obtain the required

wall thickness, a pipe or circular spacing block of the proper length was placed between the inside and outside forms at the meeting point of four panels. The entire form has 10 different parts.

Before using, the forms were cleaned and greased. The same forms were also used for the floor construction. Bent panels were used at the corners.

## SURFACE, FRAZIL AND ANCHOR ICE

Investigation of the formation and physical properties of the different varieties of river and pond ice, by Prof. H. T. Barnes, of McGill University, Montreal, who has been studying the subject for years, has provided information, much of which is of interest to the public at large.

The position of the first crystals of surface ice is along the surface of the water, but as ice formation proceeds further on account of heat conduction, the crystals become arranged with their principal axes at right angles to the water surface. Previous experiments indicate that an ice crystal conducts heat best in the direction of the principal axis. The difference between "conduction ice" and "conglomerate ice" (ice formed by the freezing together of irregular masses) is great when considered with reference to their power of disintegration. Salt-water ice is a notable example, and the masses of such ice, not being regular in crystalline structure, take an exceptionally long time to melt.

Whenever a river flows too swiftly for surface ice to form into a sheet, it remains disintegrated in small crystals and is carried down by the current. On account of the smallness of these crystals, they have little buoyancy and are easily swept under. This kind of ice is called "frazil," and often becomes very troublesome. It is swept by currents under surface ice formed in the quieter parts of a river

and floats up to the under side, where it freezes together, building down great hanging dams that become as impervious to water as so much rock. The natural river channel is thus restricted, causing winter and spring floods.

The ice that forms on the bed of a river not frozen over is called "anchor ice" in this country, and "bottom ice" or "ground ice" in Europe. It forms on the surface of objects immersed in water which is slightly supercooled and flowing too fast to freeze over. On clear cold nights it is found growing more rapidly than on cloudy ones, and it also forms faster on dark rocks than on light-colored ones. Terrestrial radiation is therefore responsible for much of the anchor ice, and in addition vast quantities of frazil crystals are frozen to it after having been carried down by the currents. When the water is above the freezing point, anchor ice cannot form, and it has never been observed to form on the bottom under surface ice. Whenever it forms previous to surface ice, it is dislodged as soon as the cover forms, and rises up to become attached to the under side of the surface sheet. The sun exerts a powerful influence against anchor ice. It is a common sight along the St. Lawrence River on a clear cold morning to see great masses rising from the bottom after the sun's rays have penetrated the water.

### NOVEL CROSS-ARMS FOR TRANSMISSION POLES

The cross-arms used on the 60,000-volt transmission line connecting Cannon Falls with Mankato, Minn., are of a novel "wishbone" construction which does away with the use of braces or gains, reduces the required height of poles, the number of bolts, and the tree trimming.

The "wishbone" cross-arm consists of two steel angle-sections, bent and bolted together, making an angle of 60 deg. between legs. The ends of the arms are bent into horizontal position, and the insulator pins are bolted to the

flat web surfaces. The arms are bolted to the pole at points two-thirds of the distance from the crotch or single-

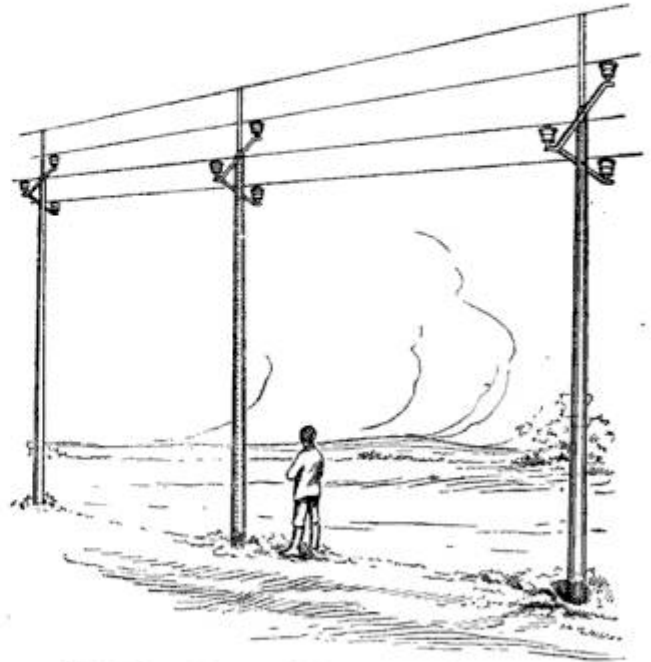

Wishbone Form of Cross-Arm Construction

wire side, the moment of the single wire on the long arm balancing the moment of the two wires at the ends of the short arms.

### REPAIR LINK FOR CHAINS

To repair a broken chain without the aid of a forge and blacksmith's tools would be difficult were it not for the several kinds of repair links, one of the simplest of which is this patent French link. The two halves of the link are pierced at the middle, and through them is inserted a threaded

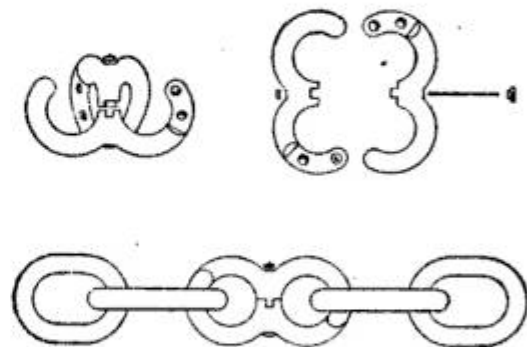

Simplifies Chain Repairing

bolt, around which they pivot. At one end of each half are two pins and at the other end two holes, the pins at the end of one half engaging with the holes in the end of the other.

### IMPROVED ALARM CLOCK

The special feature of this alarm clock is its shape, which is a decided departure from ordinary alarm-clock practice. The common cylindrical case gives way to a shape suggestive of the regular clock, which gives the whole a much richer and more solid appearance. The alarm repeats every 15 seconds for 12 minutes.

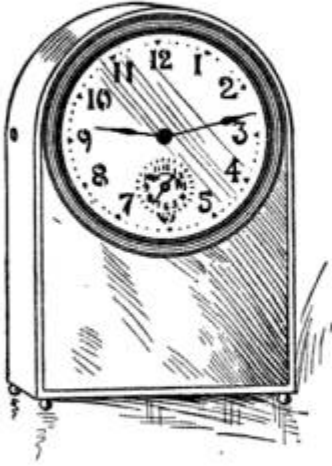

### LUNCH CAR FOR THOSE WHO RIDE IN DAY COACHES

The quick lunch on wheels is what the Southern Pacific Railroad Company calls its new form of restaurant cars designed for day-coach travelers who do not care to patronize the expensive diners or risk their digestion in the hurried bolting of meals at the meal stations. The new cars reproduce within the dimensions of an ordinary railroad car the important features of the dairy lunch room of the business districts of large cities. The railroad officials were impelled to provide the patrons of the day coaches and the tourist cars with a more economical way of getting their meals on account of the fact that the dining cars and station restaurants provide facilities for the feeding of but 30 per cent of the people who travel over the road.

The interior arrangement of the car resembles an ordinary city quick-lunch counter. On one side of the car a range has been installed to cook what are known as "short orders," and on shelves built in the car and on the counter that runs almost its entire length, are displayed the eatables usually found in lunch rooms.

In front of the counter are comfortable revolving arm-chairs something like the chairs used in the dining saloons on steamships. The lunch-car experiment is to rest on the results obtained from the two cars the railroad company has designed. It is estimated that this road has 14,000 people to feed daily. The ordinary provision for supplying food to the traveling public barely covers the necessities of the people who ride in the Pullman coaches.

### INGENIOUS FRENCH SOP

Sopping up spilled liquids with a sponge or rag is not difficult, but



squeezing it out again with the hands is a task so uncongenial that a French concern has devised a sponge squeezer. The sponge is provided with a handle having a protecting shield. The liquid is squeezed out of the sponge by pressing it against a concave sieve set in the top of the cup, provided as a receiving receptacle.

### NOVEL SPIRAL STROPPER FOR SAFETY-RAZOR BLADES

The spiral stropper for safety-razor blades, shown in the accompanying illustration, has recently been put on the market by an American manufacturer. The blade is slipped into a slotted center portion and made rigid, and the device is then run forward and backward on any hard level surface. The stropping leather is secured to the

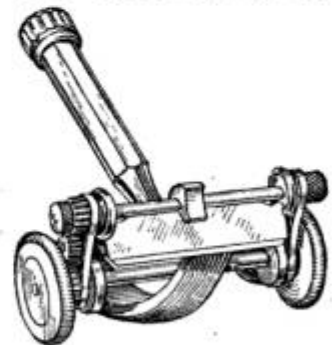

spiral shown in the picture, and the gears cause the blade automatically to reverse as the direction of motion of the stropper is changed. The action of the device gives that drawing motion of the strop over the edge of the blade which is so necessary in putting a fine keen edge on a razor blade.

### NOVEL SPARK PLUGS FOR EXPLOSION ENGINES

An air-cooled spark plug, for air-cooled internal-combustion engines, is a recent invention. Cooling is accomplished by means of flanges which are molded on to the body of the plug.

A "dumpy" plug, used where long plugs are undesirable for constructional

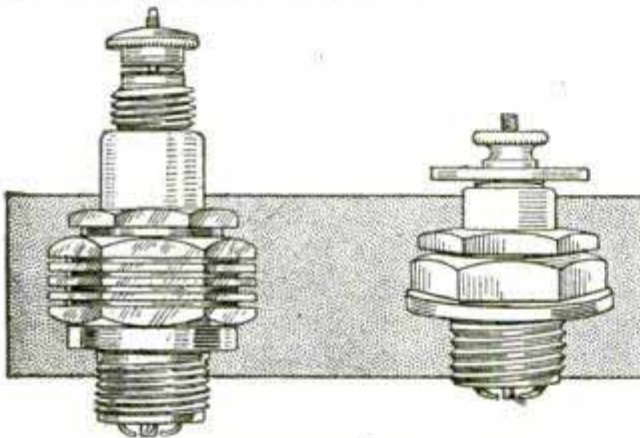

Air-Cooled Plug and "Dumpy" Plug

reasons in certain designs of engines, has been recently introduced by an English firm. The full height from the base of the thread to the top of the terminal is but an inch. The plug is especially useful on engines where the tank comes low down over the valve caps.

### MACHINE MAKES OPAQUE PAPER TRANSPARENT

A machine that makes possible the production of blueprints without the necessity of making tracings of original pencil or pen drawings, is shown in the accompanying illustration. The machine is composed of a series of electrically warmed rolls; a chemical bath, also electrically warmed; a series of traveling tapes and a pair of rolls for drying purposes.

The operation consists of turning on the electric current, which warms the rolls and bath; inserting the drawings and turning the crank which runs the

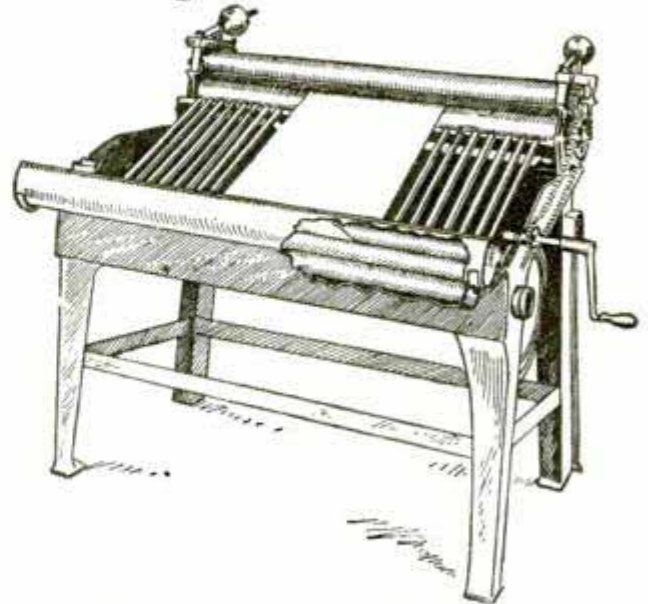

Preparing Drawings for Blueprinting

drawings through the rolls. As the paper passes through them, the chemical is pressed into it and it is then conveyed by traveling tapes to the drier rolls, where the surplus chemical is absorbed.

It is claimed that the machine makes any white paper, no matter how heavy or opaque, sufficiently transparent to blueprint through quickly.

### ELECTRIC HEATER ATTACHED TO FAUCET

A French instantaneous water heater for direct attachment to the faucet is shown in this drawing. It consists of a brass tube containing a coiled glass tube wound with fine nickel-steel wire. The water is heated while passing through this tube, which projects through the lower end of the protecting brass tube. Connection with the electric current is by means of a flexible wire.

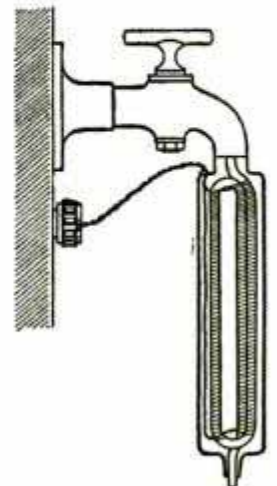

### A NOVEL ENGINE JACK

A novel adaptation of a jack for turning or "barring over" a heavy fly-



wheel is shown in the accompanying illustration. This jack may be operated with either steam or compressed air, and will turn the flywheel quite rapidly through any angle required, or as slowly as

desired through distances down to as little as  $\frac{1}{8}$  in., thus saving time and labor as well as the patience of the engineer.

For turning over an engine, as for checking or setting valves and valve gears, trying clearance, taking up connecting-rod bearings or the like, as well as for making an examination of the rotating parts of dynamos and motors, this little jack would prove useful. Although developed originally for use with Corliss and blowing engines, its range is limited only by the ingenuity of the person using it.

### FRANCE FIXES WEIGHT OF THE CARAT

The weight of the carat in France will, in the future, be 200 milligrams (3.0864 grains), a ruling on this matter having been made in response to appeals from jewelers throughout the world. It is expected that this weight will be adopted by all countries. Heretofore there has been much confusion resulting from the variation in different countries in the exact weight of the carat. As everyone knows, this is the term employed to designate the unit of mass in precious stones and gold. The variations have been slight, but the weights of many stones are slight, so that the difference of a

fraction of a milligram made quite a substantial difference in the prices of those articles which usually are sold by their weight. The need of the change is found in the fact that while a carat weighed 205.1 milligrams (3.1651 grains) in Amsterdam, where it was lightest, it was officially rated at 207 milligrams (3.1944 grains) in Venice, where it was heaviest.

### CLEAN YOUR SILVERWARE BY ELECTRICITY

Cleaning the silverware once a week is one of the disagreeable duties of the industrious housewife. The ordinary method employing polishing paste and "elbow grease" is laborious and also injurious to the ware, as every time a certain amount of silver is removed in the operation. The up-to-date housewife, therefore, will readily appreciate the advantages of a simple electrical process which not only obviates the necessity for manual exertion but also removes the tarnish without the loss of even a particle of the precious metal.

The apparatus consists of a pan made of sheet zinc, with a wire grat-

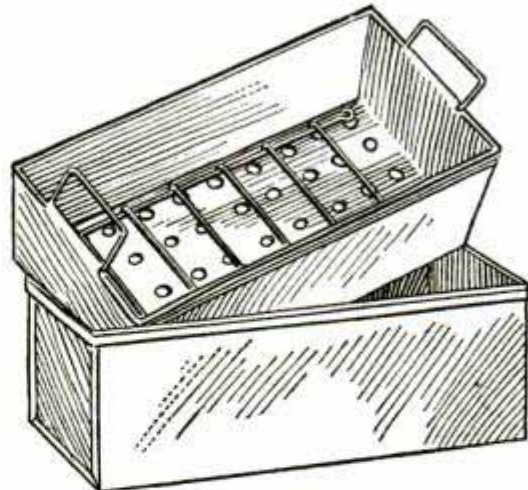

Silver-Cleaning Apparatus

ing of another metal, preferably tin, attached to the bottom by solder, substantially as shown in the illustration. The solution used in the pan may be made in any kitchen, for it comprises only ordinary baking soda and table salt dissolved in hot water. No ex-

ternal source of electricity is needed, as the dissimilar metals of the apparatus set up a feeble electric current which removes the tarnish by taking away from it everything but the silver which is left as a bright deposit on the ware. The apparatus is the patented invention of two University of Wisconsin engineers, and is already being used to a considerable extent.

### MODEL SHOWS WATCH ESCAPEMENT

With the aid of this huge escapement model, standing over 6 ft. high and composed of over 300 pieces, students in a watch making school grasp and master the laws governing the escapement action of a watch. The model amplifies the escapement about 100 times, the escapement wheel being more than 2 ft. in diameter, with the pallet stones, pallet, fork and roller tables, both double and single, designed in proportion.



### SWITCH GIVES CONTROL OF SUBSTATION LINES

A switch which, placed on a pole or in a farm house, will give remote control of substation lines to the operator at the regular office, may, according to "Telephony," revolutionize the rural telephone business.

Among the advantages the new switch makes possible is the extension of a party line without overburdening it. For instance, if five or six miles more of wire and seven or eight additional stations to a 15-party line are joined up, under the present system, many difficulties present themselves.

But by the use of this switch, these additional stations are connected to the main line or the exchange only

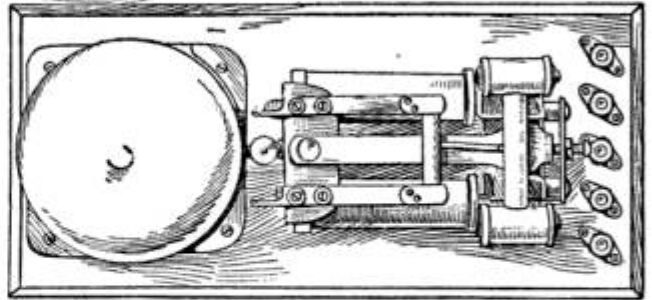

Switch That May Revolutionize Rural Telephone Business

when one of them desires to talk beyond his own little territory. And in addition to this advantage, the switch can be used for instantly connecting two farmers' lines, extending across country toward each other from two different exchanges, into a toll circuit whenever subscribers in either exchange wish to talk across. Normally, each circuit is kept separate.

### AGRICULTURAL TRACTOR HAS 12-FOOT WHEELS

The largest wheels ever used on an agricultural traction engine were built by a firm in Leeds, England, for ex-

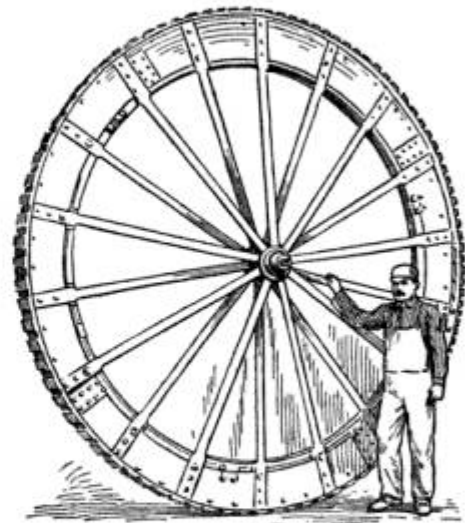

One of the Large Tractor Wheels of English Tractor experimental purposes. The giant wheels are 12 ft. in diameter, with a bearing surface 18 in. wide. The wheels were designed for use on soft soil.

## CANE AS A PREVENTIVE OF INTOXICATION

According to a French authority, this remarkable drinking cane is designed especially for those who find it

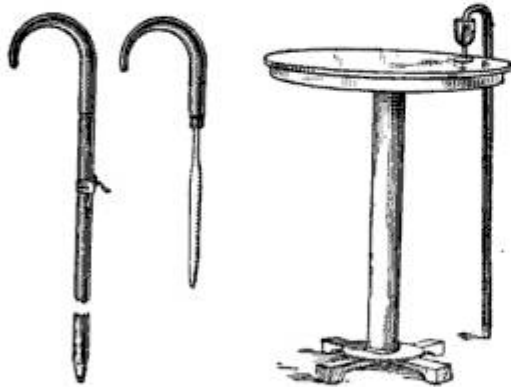

Cane That Drinks When Owner is Indisposed

necessary to seem to drink heartily of intoxicants for reasons of sociability. But it may also be found serviceable for the person who has imbibed to satiety and wishes surreptitiously to provide something for the morning.

The handle is perforated at the end, and running through both handle and stick is a rubber tubing, forming a siphon. By raising and lowering the lever shown part way down the cane air is expelled and the siphon begins to act, rapidly emptying the glass. The capacity of the cane is several glasses. It may be relieved of its contents by giving the screw-tip a few turns.

The French concern advertising the cane recommends it to relieve drummers and others of part, at least, of the heavy drinking, which is incident upon their business visits.

## CONSERVATION IN AMERICAN OIL FIELDS

The conservation wave has reached the American oil fields. Too many wells have been abandoned before being exhausted. The trouble has been that the heavy paraffins have congealed and sealed up the pores in the oil-bearing strata. Two methods of removing this paraffin have been proposed, and in both the agency is heat. In one method, the heated exhaust gases from a special kind of internal-

combustion engine are used to melt the wax and renew the flow of the oil. In the other, an electric heater and pump are used. The ultimate object, however, is the same in both cases, to conserve the supply of natural oils, if it can be done—profitably.

## MAY CROSS MEDITERRANEAN IN AEROPLANE

The possibility of crossing the Mediterranean in an aeroplane from Marseilles to Algiers, a distance of about 500 miles, is being seriously considered in France. The flight would not be sustained, but would include a landing on one of the Balearic Islands, which are about midway. Tabuteau's record of about 290 miles, covered in a trifle over six hours of uninterrupted flight, furnishes the basis for the calculations.

## EVOLUTION OF THE TOOTH EXTRACTOR

The evolution of the dentists' most feared tool, from the crude implement of centuries ago to one of the many types of extractors of modern dentistry, is here shown. The implement at the left is a cant hook with which dentists of the sixteenth century pried loose the teeth of what might well be designated the victim. The implement in the center is a turn-key type used

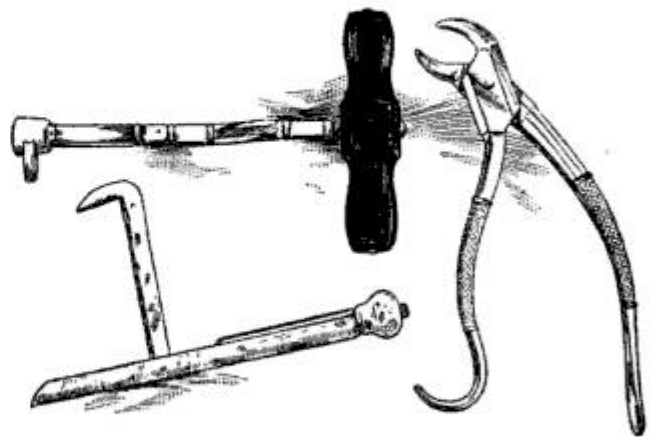

Cant-Hook Extractor of Sixteenth Century—Turn-Key Extractor of a Hundred Years Ago—Scientific Modern Forceps

during the early years of the last century, while the remaining one is typical of the scientific forceps of today.



## SAND-BLAST BARREL FOR SMALL CASTINGS

A sand-blast tumbling barrel which will clean a large number of small cast-iron or brass castings at one charge has been placed on the market by a New Haven, Conn., concern. With the ordinary form of sand-blast, it has been necessary to handle each casting separately, which has made the process, especially with cheap cast-iron goods, too expensive.

The outer shell of the barrel is made of cast-iron, and the inner is of perforated sheet steel. Between this lining and the outer shell are a series of

tem prevents dust or sand from escaping.

The time required for each charge varies with the nature of the castings being blasted. One of the illustrations shows a charge of food-choppers, every portion of which, inside and out, was cleaned in 20 min. Ordinary small hardware castings have been finished in five minutes.

The barrel rests upon roller bearings, and is revolved slowly, as all that is required is to bring every portion under the blast.

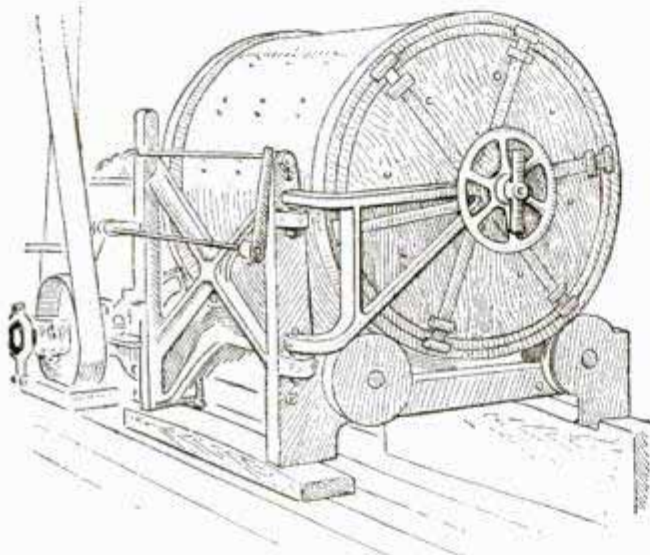

Exterior of Sand-Blast Barrel

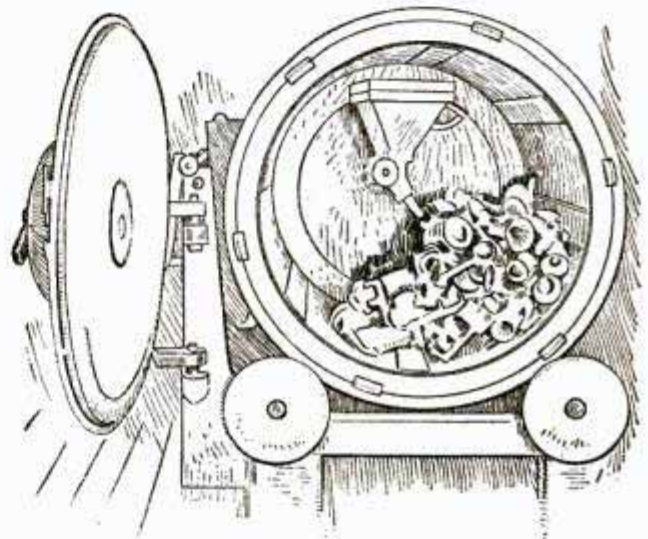

Interior, with a Charge of Food-Choppers

buckets, which, with the hopper, form the important features of the barrel.

In beginning the operation, two or three shovels of sand are thrown on top of the articles to be blasted, then the door is closed, the barrel started revolving, and the blast turned on. The sand, blown among the tumbling castings, drops through the perforations of the inner lining, and is picked up, elevated, and dropped into the hopper. It then falls from the hopper into the air-blast issuing from the four nozzles arranged in a row at the bottom of the hopper, thus forming the sand-blast.

The blast has a pressure of about 50 lb. per square inch, and the sand is used over and over again, the buckets continually elevating and feeding it to the blast. An ingenious exhaust sys-

## TWENTY YEARS OF RAILROAD DEVELOPMENT

In twenty years, the miles of line in this country have increased 52.7 per cent; the miles of track, 73.5 per cent; the net capital, 63.3 per cent; the number of passengers carried, 86.5 per cent; the number of locomotives, 97 per cent; the number of employes, 116.2 per cent; the number of freight cars, 154.6 per cent; the wages of employes, 157.4 per cent; and the number of tons of freight carried, 175.3 per cent. A recent estimate gave the net capital of railroads in the United States as \$14,000,000,000—14 billions of dollars—and the number of tons of freight carried per year as 1,500,000,000.

## BRITISH MOTORCYCLE IDEAS FOR 1911

Many striking novelties in motorcycle ideas appeared at the recent show in London, several of which are shown in the accompanying illustrations.

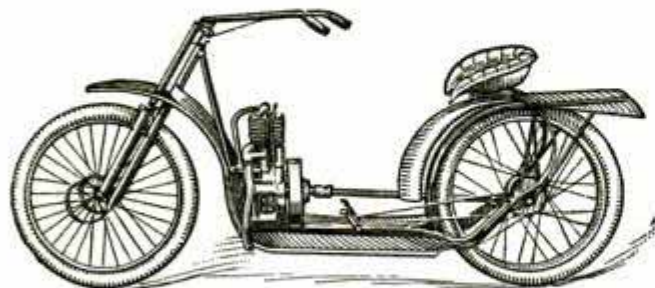

Motorcycle with Bucket Seat, Shaft and Worm Drive, and Pressed Steel Frame

The motorcycle provided with shaft and worm drive has many features. The frame is of pressed steel, and is supplemented by light tubular extensions, which support the footboards and front guards. The 4-hp. engine is set athwart the frame, with the magneto placed on one side and the carburetor on the other. The flywheel is on the same side as the shaft. The novel feature of the drive, a shaft with a universal joint, is the worm and worm wheel employed. The worm is underneath, so that it obtains thorough lubrication. The seat is of the aluminum pan type and is well upholstered. An aluminum gasoline tank is curved to form the forward portion of the rear mudguard.

The motor-tricycle, which is made by the same concern, is provided with a frame similar to the one described, the only exception being that the tubu-

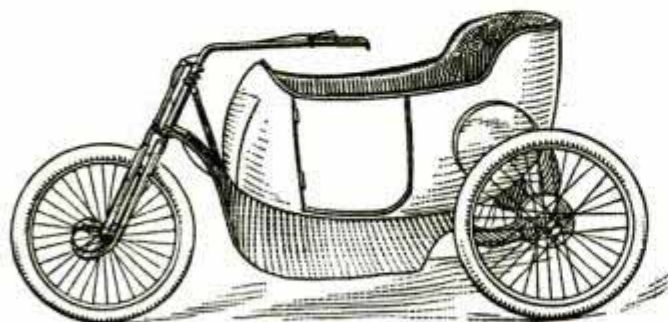

Motor-Tricycle Novelty

lar extensions are spread at the rear to stay the driving axle. The steering is by a tiller. The body is of the automobile type, well upholstered,

with side doors. The back of the body is high.

An ingenious little power plant attached to the wheel it drives has been designed to convert the ordinary bicycle into a power-driven machine. This model made its appearance last year, but was almost immediately withdrawn for modification, so that the cost of production could be reduced sufficiently to make the attachment practical. The illustration shows the modified design. The engine is of the two-cylinder, horizontal-opposed type. The magneto is placed above the engine, with its armature vertical. The location of the carburetor is clearly shown. The method of attachment is

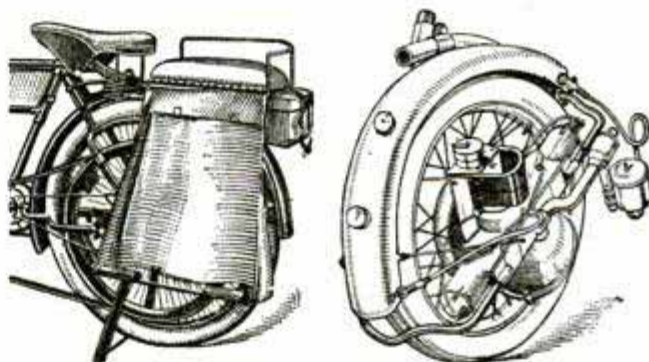

Passenger Seat for Women

Power-Driven Wheel for Bicycles

by a double-knuckle joint. The drive to the wheel is through a reduction gear, a jaw clutch and a bevel. The weight of the wheel and motor, which is substituted for the ordinary bicycle wheel, is but 30 lb. The mudguard is in the form of a tank, containing the gasoline and lubricating oil.

Among the devices for carrying a passenger on the rear carrier of a motorcycle was a padded side-seat for women. A brass rail is provided as a back support. A double rest accommodates the feet, and a leather shield prevents the dress from coming into contact with the wheel.

Shipbuilders of the United States are to construct the two large cruisers which the Cuban congress has ordered for the navy of the island republic.

## WOMEN COMPETING FOR AERIAL HONORS



Mlle. Dutrieu, Who Holds the Duration Flight Record for Women



Mlle. Marvingt

France has a number of aviation enthusiasts among the fair sex and recently several records were established by feminine operators. Mlle. Marvingt set the pace for her sisters in aeroplaning by remaining in the air 53 min. in her Antoinette monoplane at Mourmelon during a heavy gale and while the weather was intensely cold. It was thought she had won the duration prize offered women

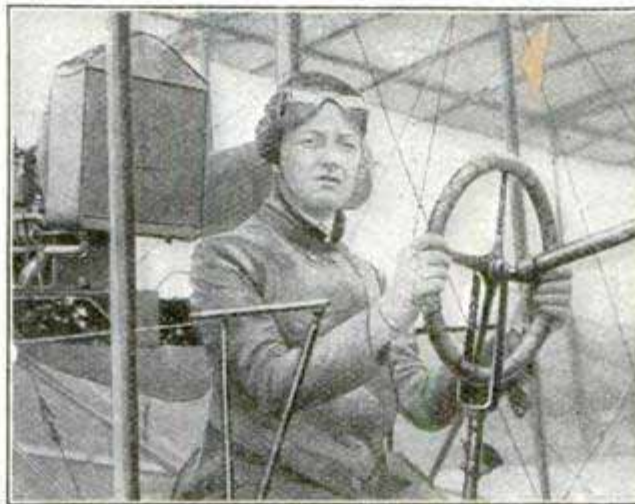

Mrs. Bessica Raiche, First American Airwoman

by a French woman's journal, but her feat simply served to inspire others to similar attempts. A day or two later Mlle. Dutrieu, in a Farman biplane, remained in the air 1 hr. 9 min., covering 60.8 kilometers ( $37\frac{3}{4}$  miles). America has its airwomen also. Only recently the Aeronautic Society awarded a medal to Mrs. Bessica Raiche, the first woman aeroplane pilot in America.

## ELECTRICAL LABORATORY FOR THE PUBLIC

**A**N electrical laboratory for the education and use of the general public has been founded in Brussels by Prof. R. Goldschmidt, who realizes the difficulty of acquiring an exact understanding of an experiment except by making the experiment personally.

His idea, therefore, in founding the laboratory, was to provide the public with means of becoming familiar with the phenomena and applications of electricity. At first, he had in mind the

organization of a sort of museum of electrical inventions and discoveries, something on the order of arts and crafts or industrial museums; but the limitations of such an institution soon became clear to him. What, in his opinion, needed demonstration was not the manner of making an experiment, but the experiment itself. Consequently, the dominant feature of the laboratory is the provision of means by which the visitor can, without the aid of a teacher,

master the experiments. This is done by confronting him at the same time with the problem and its solution.

The main difficulty was the devising of the experimental apparatus, and in this Professor Goldschmidt proved himself an inventor as well as a scientist. He has conceived and constructed most of the apparatus to the smallest detail with a view to their simplicity, solidity and reliability.

On the ground floor of the laboratory is installed equipment for fundamental experiments, which require no complicated apparatus. The public is first introduced to the natural magnetic stone, then to the properties of magnets and electro-magnets. Then follows the explanation of electric motors, and from the familiar electrifying of glass or wax by rubbing, the student proceeds to the action of the Wimshurst machine, which, in its effect, is equivalent to the induction coil, studied in another section. In this department the phenomena of electric discharges through different mediums (cathode rays, radioactivity, etc.) are studied.

On the next floor are found apparatus serving to demonstrate the theoretic principles of electricity, and for the study of induction, alternating currents, and the methods of measuring electric forces.

In the above mentioned sections, each apparatus is enclosed in a glass cage, so that the experimenter can only touch the parts necessary to start and conduct an experiment. To do this, he has only to follow the instructions in a booklet or guide, which is given him as soon as he enters the laboratory. Instructions are also hung up in front of each apparatus.

If, for instance, the experimenter wishes to demonstrate the difference in conductivity of a metal wire at different temperatures, or, in other words, the influence of heat on the resistance of conductors, he goes to the apparatus reserved for this experiment, and presses a button. This action makes a little bell ring, and then he presses a lever, which lights a flame that slowly heats a spiral of steel wire connecting

the bell with the battery that actuates it. As the wire becomes hotter, the ringing of the bell grows weaker. By means of another lever, the experimenter may introduce into the current and under the flame a coil of nickeline or a filament of metallic oxide, thus demonstrating that the resistance of nickeline is not influenced by heat, while in the filament the resistance diminishes as the temperature rises. The same simple and practical methods are followed in all the experiments in the two sections just described. The visitor can, alone and unassisted, except for the guide book, which covers over 300 experiments, study the phenomena which interest him.

---

### INTERNATIONAL DIRECTORY OF FOREIGN COMMERCE

The Bureau of Manufactures of the Department of Commerce and Labor announces, after four years of investigation and compilation, the completion of an international trade and business directory that contains the names and addresses of 125,000 commercial concerns in foreign countries engaged in foreign trade. The names are classified according to the nature of the business, the city, and the country, and represent the result of careful investigation by consular officers and special commercial agents of the government. The officials in charge of the book do not claim to have secured the names of all of the foreign firms engaged in the various branches of trade, but they do believe they have compiled a representative list. The book is printed on stout paper and is substantially bound. It will be for sale in the same way that other public documents are sold, through the Superintendent of Public Documents. No copies have been printed for free distribution.

---

¶In England a medical man may obtain a license for his automobile at a reduced rate, but if he does he cannot carry a passenger, except a chauffeur.

## BUREAU OF CLASSIFICATION FOR AERIAL CRAFT

Basil Zaharof, the engineer who endowed a chair of aerial locomotion at the Sorbonne, Paris, has now donated \$10,000 for the establishment of an aerial bureau of classification. Its purpose is for the listing of both heavier-than-air and lighter-than-air machines, and especially for their classification from the point of view of safety. The classification is to be periodically revised, and will provide a means by which all who contemplate aerial flight may receive unprejudiced information as to the degrees of chance taken in using the different types of machine.

## DELIVERING OIL IN RURAL PORTUGAL

Americans have grown so used to seeing everyday commodities handled and transported in bulk for economy's sake that primitive methods in the civilized but older and slower countries of Europe are curiosities to all but the experienced traveler. Even in London it is possible to see the milk retailer carry his milk in a couple of cans hanging from a yoke about his shoulders. The illustration shows the

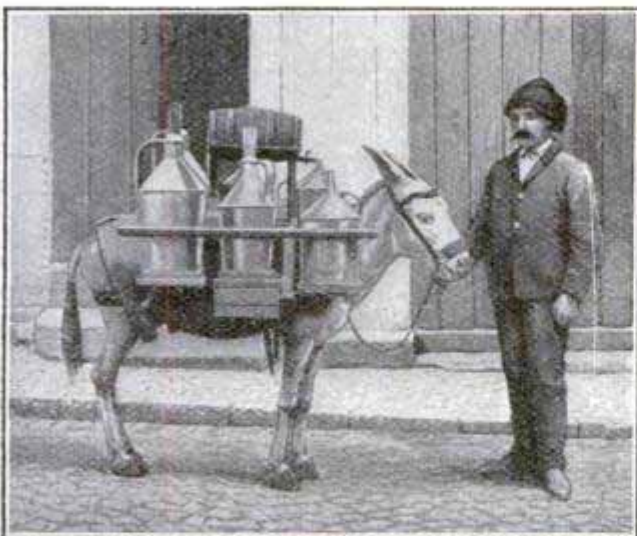

Oil Delivery in Rural Portugal

method commonly used in rural Portugal for distributing kerosene oil from door to door.

## AN IRONCLAD TELEPHONE FOR COAL MINES

The telephone instrument shown herewith is specially designed for use in mines and is proof against moisture,



A Telephone 12,000 Feet from Daylight

gases, fumes and even explosions, any of which would soon put the ordinary commercial telephone out of commission. The inner parts of the instrument are protected by two iron doors, only one of which is opened when the wire is being used.

Mine telephones are used not only for transacting business from instructions given at the surface, but also for locating blazes in the mine, calling medical assistance, etc. Disasters like that at the Cherry mine would be impossible if telephones were installed in mines, and this fact is fast being recognized by the state legislative bodies.

The photograph from which the accompanying illustration was made was taken by flashlight some 12,000 ft. from the surface down a four-per-cent grade in a Pennsylvania mine.

## GARTER STILETTO WOMAN'S NEWEST PROTECTOR

Deprived of pockets in which she might carry firearms, and public senti-

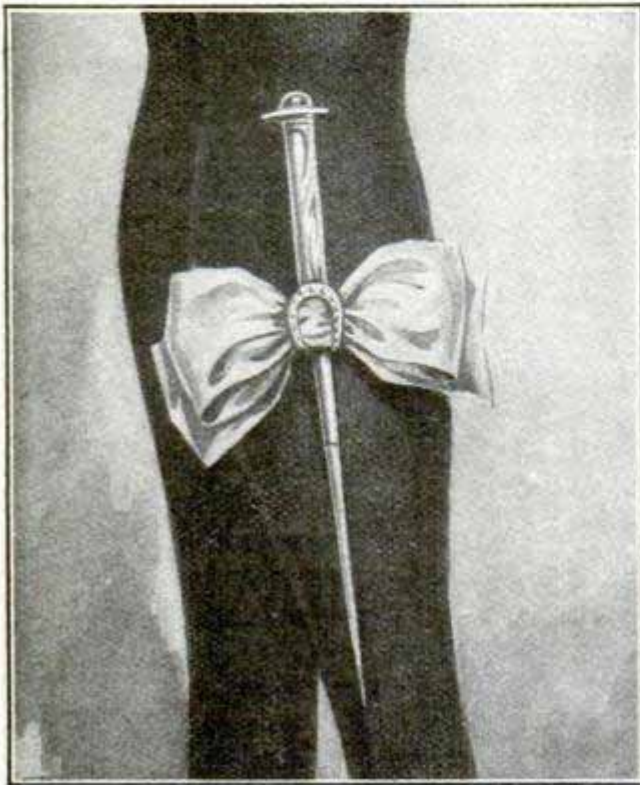

The New Garter Stiletto, Snugly Sheathed, but Always Ready for Use

ment imposing on her the use of more subtle weapons than a club or sword stick, which she would find hard to conceal, modern invention has added

another weapon to the hatpin for women of fashion. The device is the garter stiletto, a long, sharp, vicious weapon that fits snugly in a sheath attached to the garter. The slender steel blade is so thin and so narrow that it would not attract more attention than a hatpin and could be wielded with more deadly effect, in case of necessity.

## SHORTENING THE TRANS- SIBERIAN RAILROAD

The many improvements being made and about to be made on the trans-Siberian railroad will place this line in first-rate condition for heavier traffic and shorten the route considerably. Steep grades and sharp curves are being reduced, and one section has been shortened 99 miles by complete rebuilding. A 994-mile road, on which work has already commenced, will connect Peking with the trans-Siberian road at a point south of Lake Baikal. When this line is finished, the distance between Paris and Peking will be but 6,307 miles, instead of the 7,456 miles by way of Karbin and Mukden. The journey will take 9½ days, instead of 14 days, as at present.

## MOVING PICTURES MADE OUTDOORS AT NIGHT

It has been left to the enterprise of a body of men eager to advertise their city to overcome the darkness of night as an obstacle to the making of motion pictures. Those who viewed moving pictures of the "Priests of Pallas" night parade held in Kansas City, Mo., last year, in their appreciation of the beautiful floats, doubtless overlooked the extreme difficulties that were overcome in preparing them for the screen. Moving pictures made at night mark a wonderful advance in the photographic art. It has been comparatively easy, after the sun has set, to make photographs by the use of flash-light apparatus, but in all such

photography, the subjects must remain still, and, as a rule, the results are not perfect by any means. The production of artificial light of sufficient power to cause the perfect imprint of the image on the sensitized plate is not new, but the making of a perfect moving picture which shows a number of objects in every detail is distinctly new.

The enterprising men in charge of the Kansas City festival wanted pictures of the parade and appealed to a moving-picture man to make them. He cogitated over the subject many weeks and finally agreed. To accomplish his purpose he erected a platform

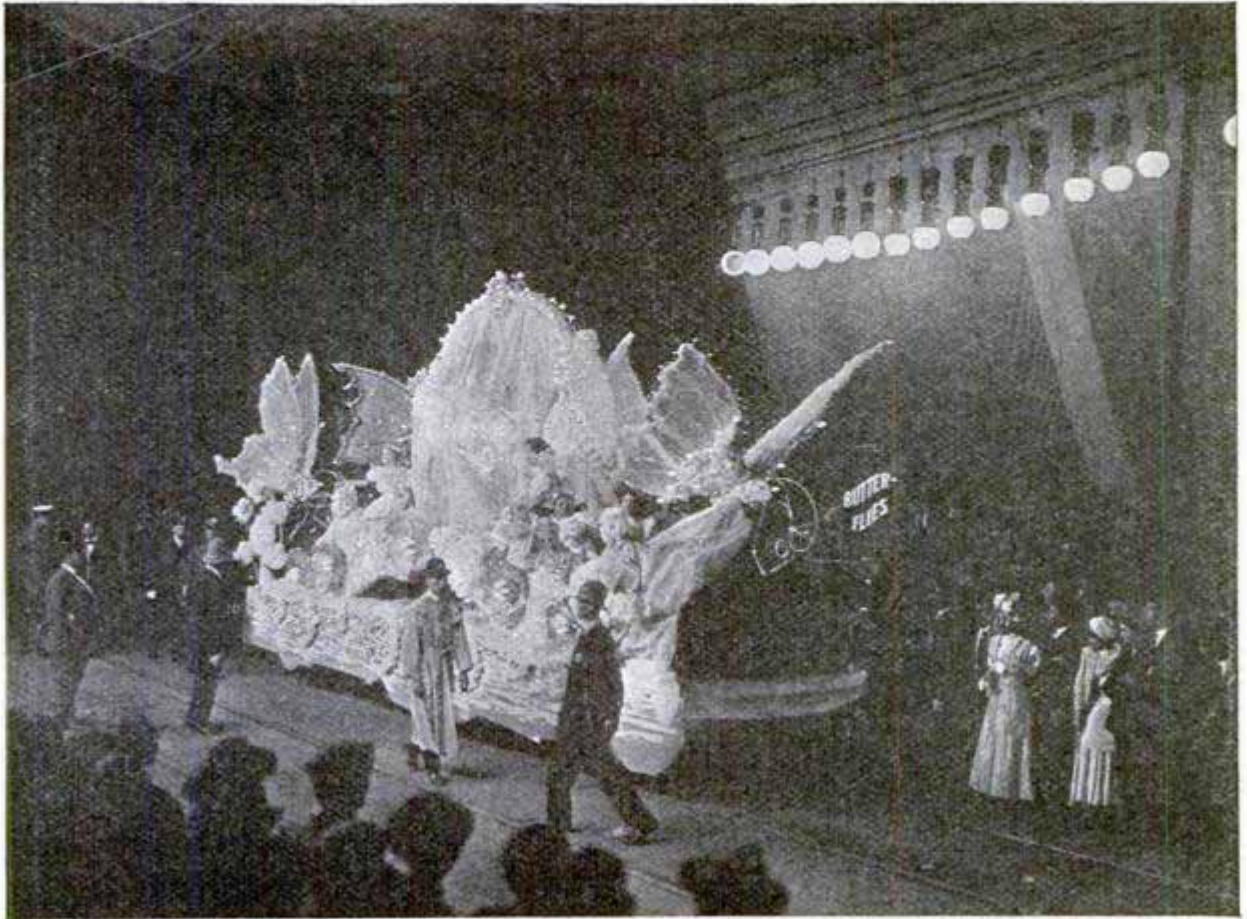

One of the Floats in the Kansas City "Priests of Pallas" Parade Photographed at Night

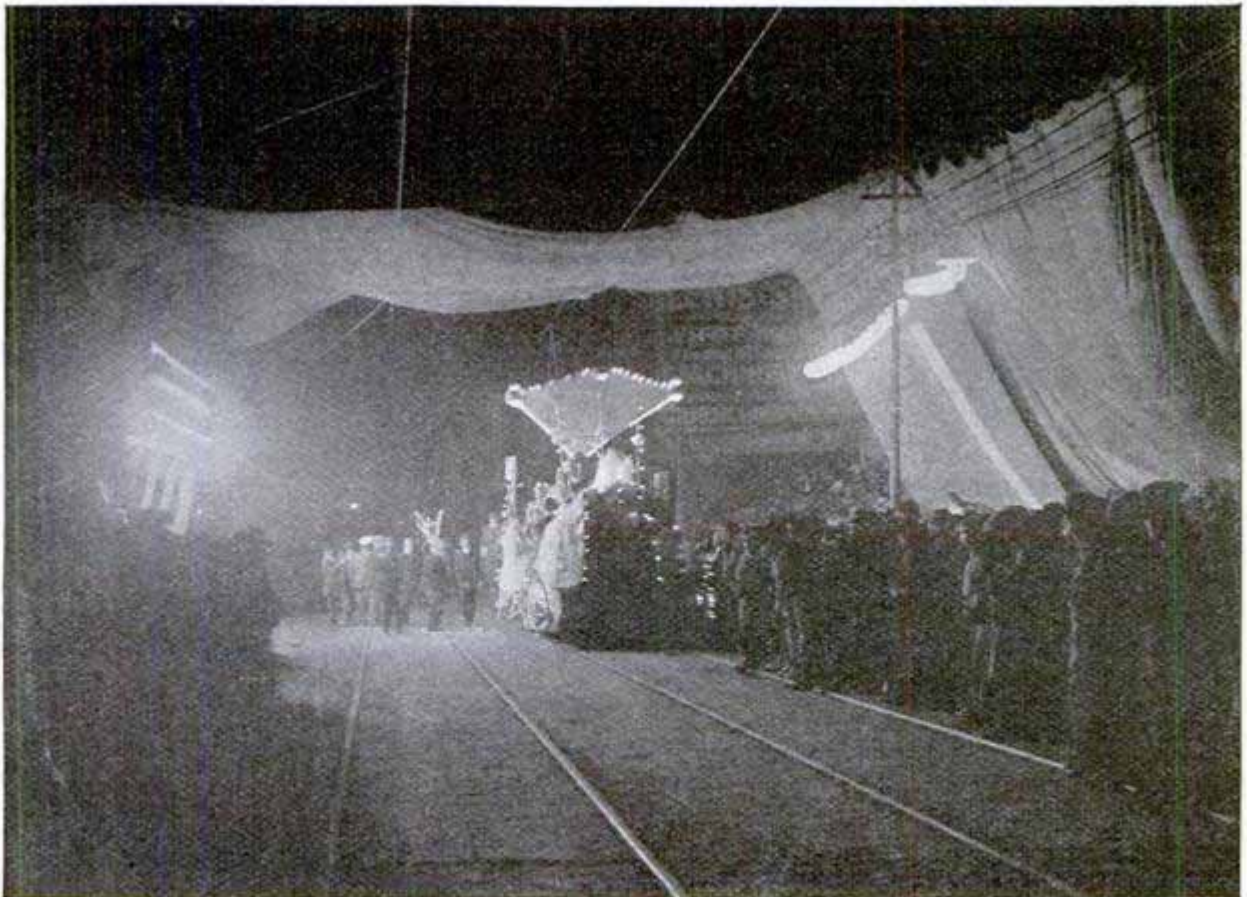

Arrangement of Light by Which Moving Pictures were Made at Night

about 20 ft. high on one side of a street through which the parade was to pass. On this were strung 60 arc lamps in two rows, backed by a monster sheet-tin reflector. The reflector was 70 ft. long and 6 ft. high. On the opposite side of the street was another embankment of light almost as powerful, so that for a distance of about 100 ft. the street was brilliantly illuminated. The machines were started as soon as darkness settled over the city and a film 600 ft. long was made of the parade. The results were highly satis-

factory, the film showing clearly every feature of the parade.

But moving pictures were not all that resulted from the light arrangement. The newspapers of Kansas City sent their photographers to the scene and the next day every paper in the city had snapshots of the night parade that were as good as similar pictures made in daylight. The cinematograph film depicting the parade is private property, but efforts are being made to have it shown in motion-picture theaters throughout the country.

### RACK THAT DISPLAYS AND STORES MAGAZINES

A magazine display rack has lately been put on the market that is regarded by newsdealers as supplying

or news stand. The stands are really a series of shelves with partitions the size of magazines. Across each section of shelves is run a rod of oxidized steel and each of the pockets made by the partitions will hold from 15 to 25 magazines. The steel rod across the sections holds the magazines upright in the pocket, and at the same time permits the display of the entire cover. When one copy is sold another takes its place at the front of the section automatically. The racks that have so far been made have been equipped with pockets the size of the standard magazines, 12 in. by 16 in. and other pockets for the larger publications. The racks are mounted on rollers and can be readily moved.



New Magazine Rack for Newsdealers

a need that has hitherto baffled their ingenuity. By means of this rack from 50 to 70 different publications can be displayed in compact form. The racks are of different sizes, but even the largest is not too bulky for the small store

### RECORD LIFE OF ELECTRIC-SIGN LAMPS

An electric sign installed in Minneapolis on Feb. 2, 1909, has 154 lamps, out of which only one has had to be replaced up to the present time, thus giving the remaining 153 lamps an effective life, up to date, of 3,500 hours each, with the probability yet of materially improving this record performance. The electric lamps are low-voltage tungstens, and their ruggedness is further emphasized by the fact that, during a recent repainting of the sign, all of the lamps were removed and replaced by the workmen without a single breakage.



### NEW SAFETY DEVICE FOR RAILROADS

A Boston man has invented a device called a "metregraph" which combines with the usual electric block-signal system for railroads a series of torches, attached to telegraph poles between stations, which are set on fire ahead of the train when the engineer ignores or overlooks danger signals.

### MAKING A PIANO MOVER OF AN ORDINARY AUTO

There have been many combinations of business and pleasure in the operation of an automobile, but few motorists have been able to transport such unwieldy articles as pianos with ordinary touring cars. An enterprising Nebraska man has accomplished this feat. Being a devotee of motoring, and owning a piano establishment which supplied instruments to patrons living at a distance from his place of business, this ingenious merchant devised a two-wheeled truck substantial enough to convey a piano. A long tongue connects the truck to the rear of his automobile. The piano is bound securely to the truck in an upright position. The owner of this unique device has frequently transported pianos far into the country without the slightest difficulty.

### NETWORK OF LIGHTNING FLASHES

One of the most remarkable discharges of lightning ever photographed was recorded by the camera in Win-



Remarkable Photograph of Lightning Made at Winnipeg, Canada

nipeg, Canada, during an unusually heavy electric storm. The picture shows more than a dozen flashes, all of which occurred at once in different sections of the sky. Some of these flashes showed very faintly in the photograph and others were especially vivid. The storm was one of the most severe ever experienced in Canada.

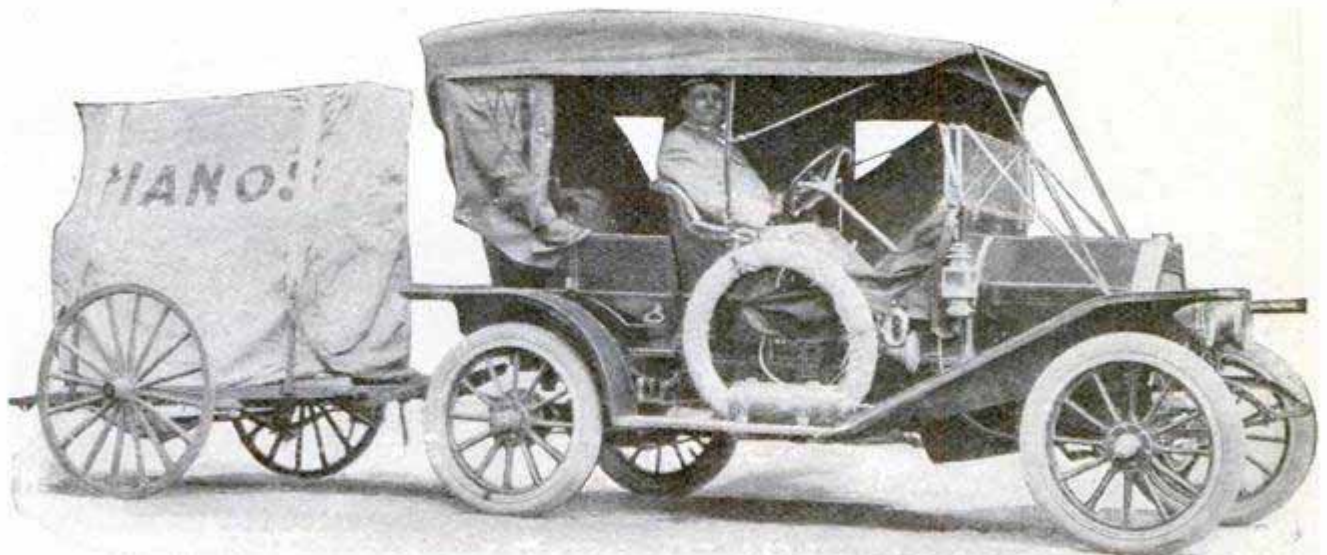

Unique Manner of Moving Pianos with an Automobile

# THE MAKING OF ARTS-CRAFTS LAMPS

By JOHN D. ADAMS

## PART VIII—ONE-LIGHT PORTABLE

**T**HE construction of the shade for this little portable lamp is so simple that it is hardly necessary to give any pattern for the cardboard frame.

tened where they overlap at the corners with paper fasteners. This form of construction, when properly carried out, gives the shade the rigidity of a

cardboard box. While the simple pattern shown may savor somewhat of the sentimental, it is quite attractive when the cross lines are painted black on a heavy drawing paper and the heart is colored an appropriate shade of red. Cardboard of about  $\frac{1}{16}$  in. in thickness will be found amply heavy. After binding the edges with passe-partout tape, the entire frame should be painted a dull black.

The construction of the stand should commence with the baseboard, which, after having been trimmed off squarely and to size, should be uniformly beveled on all four edges. A  $\frac{1}{4}$ -in. block is then to be fastened on the under side at each corner. The four square uprights are now to be planed smoothly and cut to exactly the same length. Two blocks measuring  $2\frac{1}{2}$  in. square are now to be gotten out, and

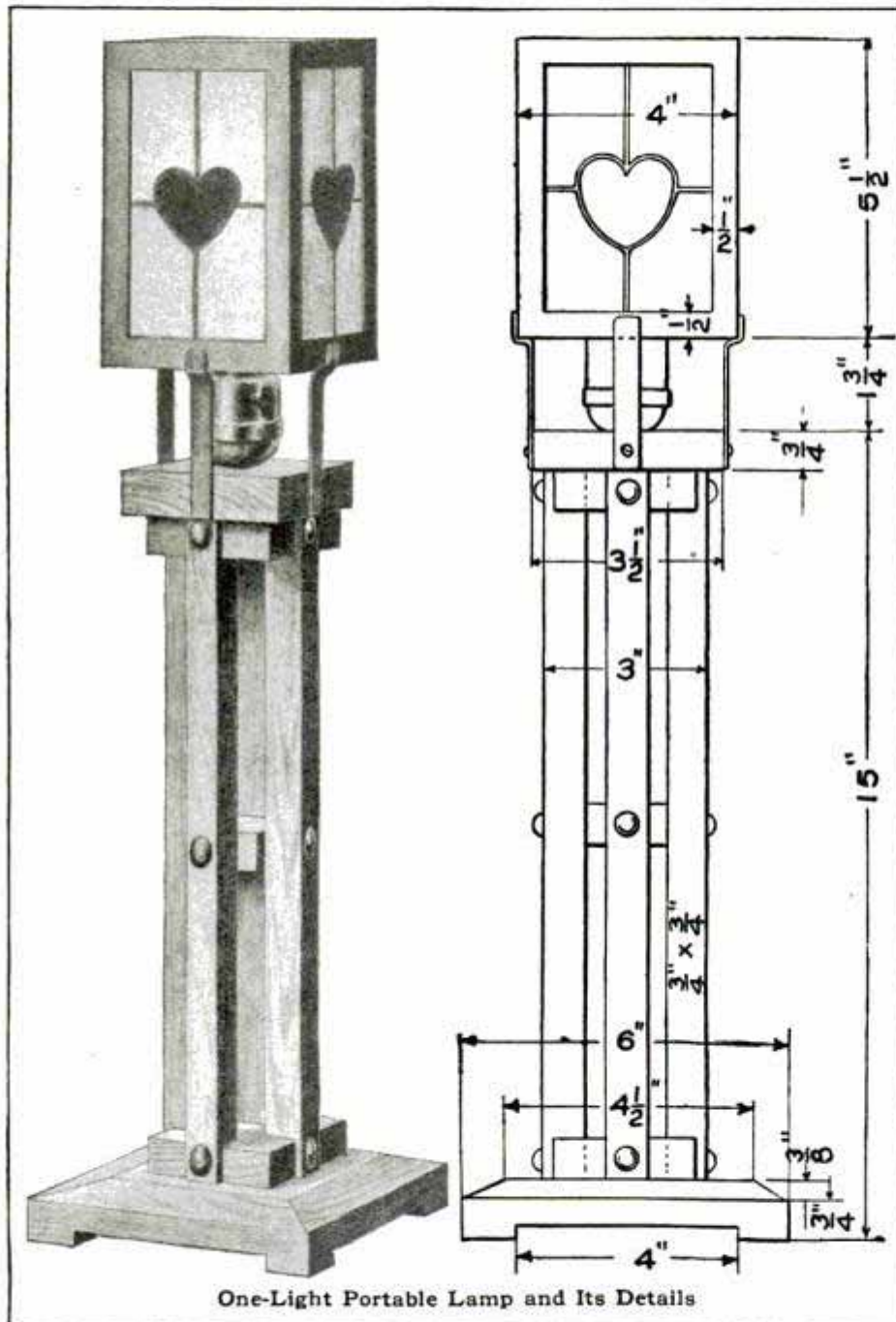

One-Light Portable Lamp and Its Details

All that is necessary is to lay out the four sides in a row on a sheet of cardboard, allowing an extra strip of  $\frac{1}{2}$  in. at the top and bottom. After the shade is bent into the square form, these stiffening strips are bent inward and fas-

tened where they overlap at the corners with paper fasteners. This form of construction, when properly carried out, gives the shade the rigidity of a cardboard box. While the simple pattern shown may savor somewhat of the sentimental, it is quite attractive when the cross lines are painted black on a heavy drawing paper and the heart is colored an appropriate shade of red. Cardboard of about  $\frac{1}{16}$  in. in thickness will be found amply heavy. After binding the edges with passe-partout tape, the entire frame should be painted a dull black.

should be prepared and receive a hole in its center for the cord to pass through. The putting together may now be proceeded with. The two top blocks should be first glued together, and then the lower notched block fastened to the base. Place two diametrically opposite vertical sticks in position and secure them to the blocks with glue and a nail at each end. Place the small center block in position and then the remaining two verticals. To cover the nail heads, procure a dozen upholsterer's nails with large brass or copper heads and drive them in as shown. The projection on the end of the socket should be tightly fitted into the top block, and the cord passed downward through the base and out at one side. Prepare four strips of brass, or galvanized iron painted a dull black, and after bending their upper ends so as to support the shade, fasten them on to the top block with screws.

### EDIBLE CLAY USEFUL IN MANY FIELDS

No mention of the edible clay deposits of the United States is found in the list of natural resources of America. At least it is not called by that name and yet there are great beds of the clay lying from 10 to 30 ft. below the surface of the earth in the Carolinas and in Tennessee. And it is really edible. Hundreds of the class known as "poor whites," that are found in such numbers in the backwoods and mountain districts of the South, are habitual users of this delicacy. It is pure white and free from grit and is found in great abundance.

There are other uses to which the edible clay is put, however, that make it a valuable commodity. The sheen on playing cards, visiting cards and high grades of paper is supplied by the use of the clay, and wallpaper manufacturers use quantities of it in mixing colors for their product. The most important use to which it is put is in the manufacture of porcelain and other kinds of pottery.

### OVER A TON OF SCALE FROM TWO BOILERS

Everybody knows that certain waters will cause scale to be deposited

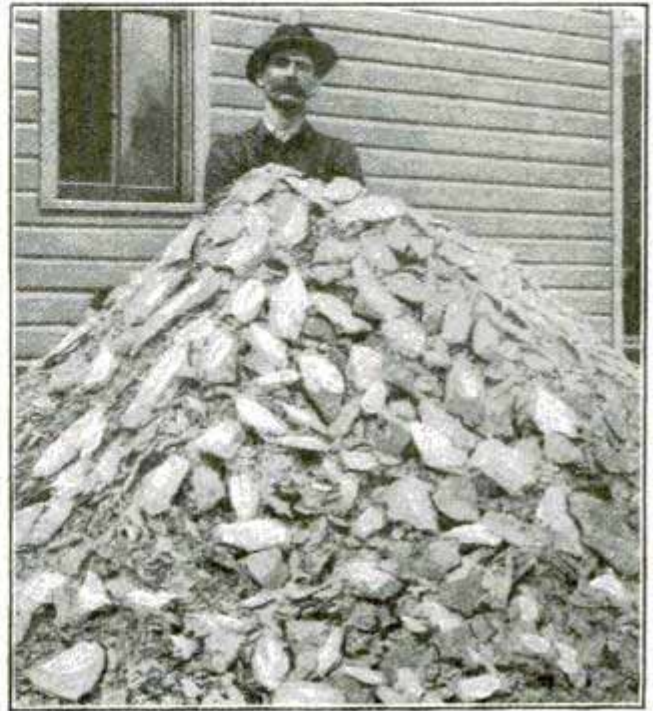

Boiler Scale Removed from Two Boilers

in teakettles, steam boilers and the like. A large amount of money, probably several million dollars annually, is lost by the lack of efficiency caused by such scale deposits. That these are sometimes greater than may be imagined is shown by the accompanying illustration which is reproduced from a photograph of a pile of 2,100 lb. of scale removed from two boilers in an electric-light plant in Wisconsin. A special form of fire-tube cleaner was employed for this purpose.

### AUTOMOBILES AS ELECTION BOOTHS

The extensive use to which automobiles were put in the recent election in England in carrying voters to and from the polls has led to the belief that in the near future automobile voting booths will be utilized in scattered sections. Instead of the voters having to travel to the polls, the booths, conducted by election officers, will travel to the voters.



Preparing for a Char-Pit Demonstration—The Stump Was Removed at a Cost of 25 Cents

## A NEW PROCESS FOR REMOVING STUMPS

**BY TURNING THEM TO CHARCOAL THE LAND IS NOT ONLY CLEARED ECONOMICALLY, BUT IS ENRICHED**

For years the development of the western slope of the Cascade Mountains, and of many other heavily timbered districts in the United States, has been retarded by the difficulty of clearing logged-off land and making it ready for farming. Theoretically the land should be of greater value with the trees removed than as a field for logging operations, no matter how great the timber wealth might be. That, for years, has been the answer of the timber owners to those who contended that the forests should be protected for future generations. But the cost of removing the stumps has been so great that the land converted to agricultural purposes following the course of the logger has been a very limited proportion of the whole.

But a new process has been discovered and is receiving its try-out in

Western Washington. Instead of dynamiting the heavy stumps to get them out of the ground, or of using donkey engines to loosen their grip on the soil, the plan is to turn them into charcoal in the ground, thus enriching the soil, cutting to a minimum the labor required to clear a tract of logged-over land, and reducing to perhaps \$20 an acre the present almost prohibitive cost of from \$70 to \$150 for preparing the logged-off land for the farmer.

Hundreds of thousands of acres lying between the summit of the Rocky Mountains and the Pacific Ocean are awaiting agricultural development. Reforestation is one problem that must be solved, as now there is no comprehensive movement to promote a second growth of timber on lands suitable for forests but not agriculture.

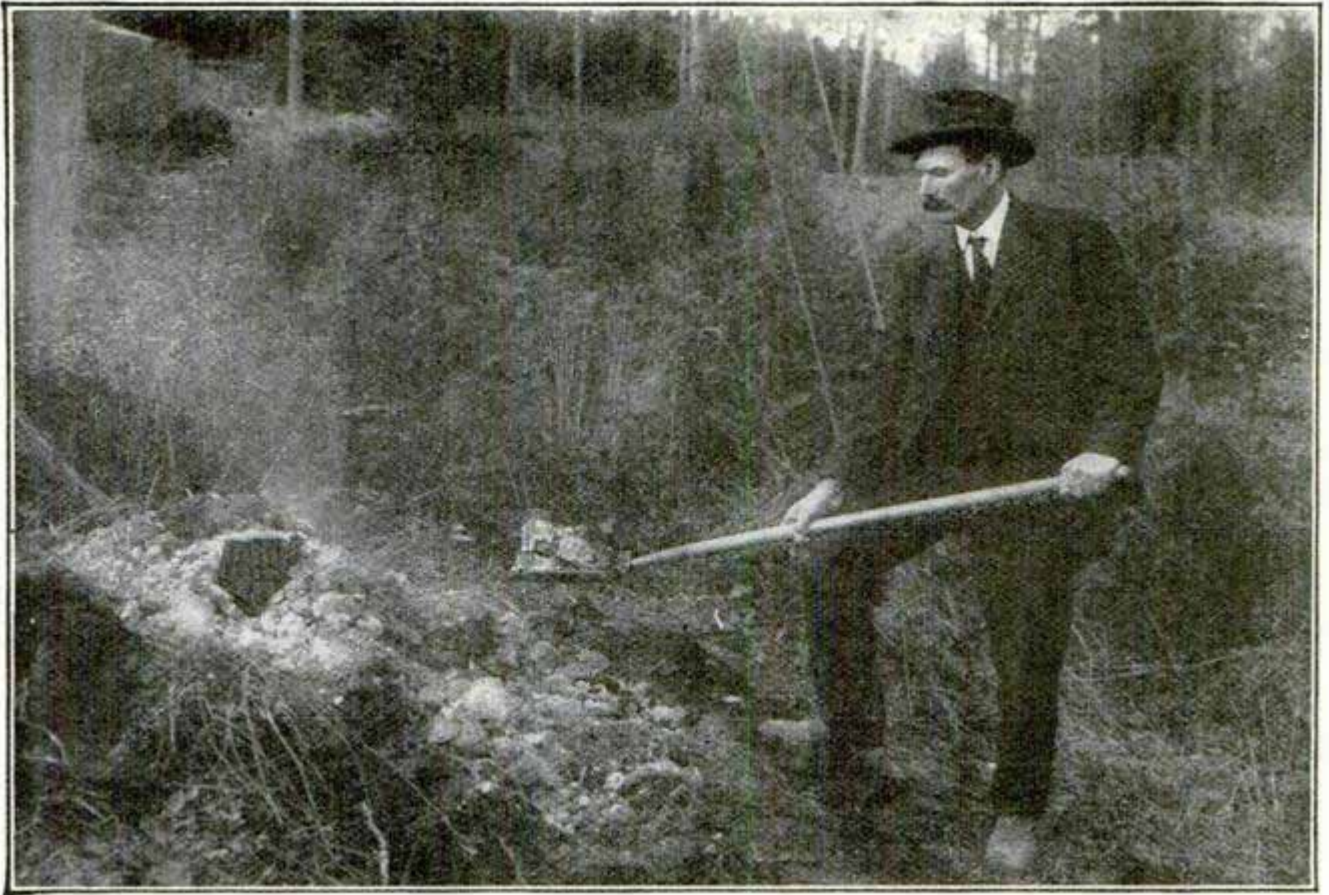

Showing How Soil is Burned to Charcoal by Char-Pit Process

For the immediate future the development of the agricultural areas means much more than reforestation, as years will be required to bring a second crop of fir, cedar and pine to marketable size.

The Oregon & Washington Railway has taken up the logged-off land problem and is doing all in its power to promote to a successful fruition the experiments in the charcoal or "char-pit" process of clearing land as carried



Burning Out a Low Stump

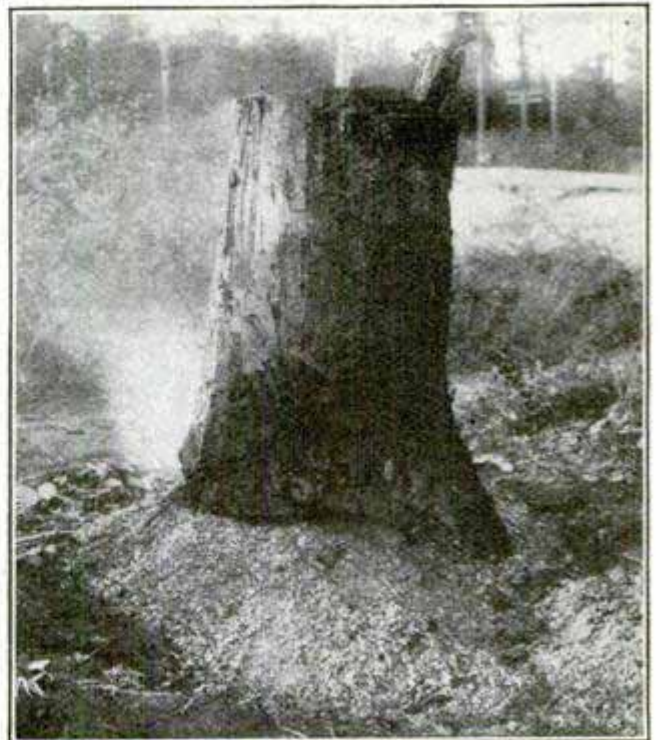

Char-Pit Process Experiment Where Soil is Sandy

on by Harry Thompson, federal expert on farm management, and Prof. W. H. Sparks, of the Washington State College, at Pullman. Prof. Sparks has been making demonstrations at several points in Eastern and Western Washington. He finds that stumps may be removed at a cost as low as 25 cents apiece. Furthermore, the work can be done by inexperienced hands and without costly apparatus. Describing the process Prof. Sparks says:

"The charcoaling or char-pitting is begun by removing the bark from the stump in the spring or early summer to allow the outside of the stump to become thoroughly dry. Often it is well to dig a trench around the stump, or to level the ground about it. Then a ring of wood is stood or piled closely about the old tree base, to a height of 2 ft., and a foot in thickness. Dry rotten wood or bark such as is found in abundance on any new land will answer the purpose.

"This is then completely covered with sod, to a depth of several inches, except a small space on the side against which the wind is blowing. Where no sod is to be found, the wood can first

be covered with a layer of bark, small brush or fern, to keep the loose earth from sifting through.

"Fine kindling is placed in the open space, and fire started and allowed to burn openly until the ring of wood is well afire around the stump. Then a piece of bark or a bunch of fern or grass is thrown over the hole, and the sod covering is complete.

"The stump must now be closely watched and the fire not allowed to burn through the covering, more sod being added as needed. The whole secret of burning the stump completely is to keep the covering intact. If the roots are kept from the air and are recovered as soon as the earth caves, they will burn out completely.

"This method is very economical for large stumps. Small stumps can be grubbed or pulled out to better advantage. The large stumps have been burned out to a depth of 15 ft. While the process is not rapid, work can be carried on by the farmer in connection with his farming, with little additional expense."

In one experiment, 125 stumps, some as large as 3 ft. in diameter, were burned out in four days.

## GERMAN MUSICIAN INVENTS MUSIC WRITER



The "Kromarograph," a Music-Recording Machine Invented by a German Composer

A German musician has devised a machine he calls a "kromarograph" which, it is claimed, records each note sounded on a piano and thus serves the purpose of a typewriter, or "music-writer," for the composer. The machine is for the same purpose as the "musicograph" invented by an Italian which the composer, Mascagni, is reported to have used. The German appliance is somewhat larger and is operated by electricity. A roll of paper is placed in



Unique View of Bethlehem, Pa., Showing Evolution of Bridge Construction

the machine and the composer sits at the piano and plays the composition he wishes to record. The record of the notes is carried to the machine and every tone is faithfully registered on the paper. With this device a musician need not trust to his memory to reproduce a musical phrase or complete work, but can instantly record it as he plays it.

### BRIDGE EVOLUTION SHOWN IN BETHLEHEM, PA.

A remarkable view of Bethlehem, Pa., from the banks of the Monocacy River, shows three bridges that depict plainly the evolution in bridge building in this country from the earliest days of the republic to the present time. One of these structures, a covered wooden bridge, is 94 years old and is still in excellent condition. The steel railroad bridge which spans the river but 200 ft. below the wooden bridge was built in 1908, replacing an iron bridge that was constructed in 1885. In the middle distance is seen a new concrete viaduct which has replaced what was known as the old Broad Street bridge in the heart of Bethlehem. Thus the view over the city shows the ancient wooden, the later

form of iron and steel and the modern concrete bridges all within a range of half a mile.

### BACK-REST FOR CYCLISTS AND MOTORCYCLISTS

An ingenious back-rest for motorcyclists is fastened to the handlebars

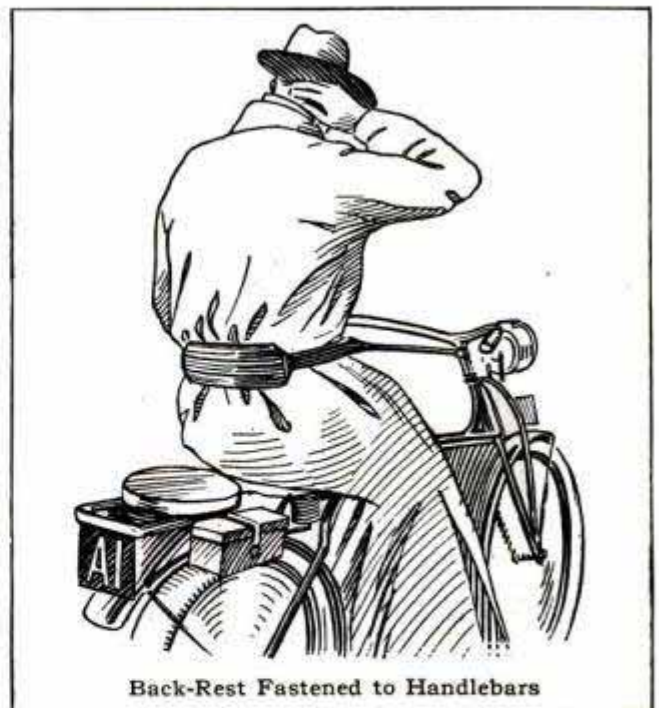

Back-Rest Fastened to Handlebars

or steering column of the machine. This was one of the novelties displayed at a recent automobile show in London, England.

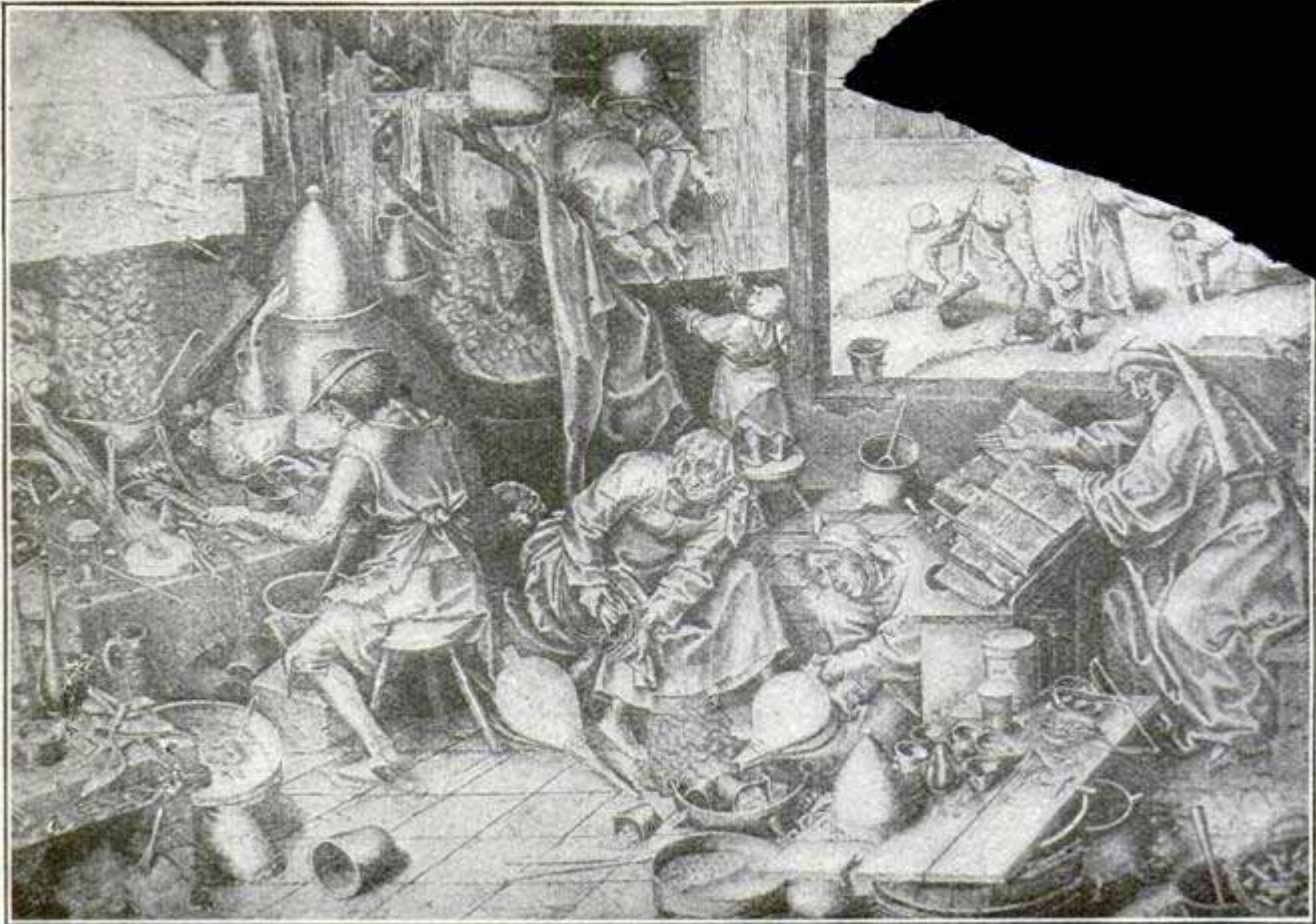

#### SCIENCE AND MECHANICS IN THE MIDDLE AGES

NO. 1.—THE ALCHEMISTS—One of the most fascinating pursuits of the middle ages was that of the alchemists, who sought to find the means of transmuting baser metals into gold. The accompanying illustration is a reproduction of a woodcut of an alchemist's home as it appeared to an artist of the sixteenth century.

#### AERIAL MOTOR COMPETITIVE EXHIBITION

A competitive exhibition of aerial motors is to be held in Paris in July under the auspices of the National Aerial League of France. The motors are to be divided into three classes, the first being for motors of 35 hp. or less; the second, for motors of more than 35 hp. but less than 70 hp.; and the third, for motors of 70 hp. or more.

The motors will be officially tested under full power, on two consecutive days, for a period of five hours each day. The engine weighing least per horsepower in each class will receive a prize of \$1,000, and the one of the three prize-winners weighing least per horsepower will receive an additional \$1,000.

#### RECOVERING TORPEDOES BY ELECTROMAGNETS

The use of electric lifting magnets in recovering kegs of nails from a sunken barge in the Mississippi River, has suggested the use of such magnets for the recovery of torpedoes fired in practice.

Through some fault of the controlling mechanism, torpedoes often sink to the bottom after their energy is expended, which results in considerable loss, as they are virtually small submarines with self-contained power plants, steering mechanisms, etc. The points where they are lost are to be marked by buoys and the ability of the electromagnets will be given a thorough test in attempting to recover them.



## COLOSSAL INDIAN STATUE BUILT OF CONCRETE

The world's biggest Indian now stands with arms folded on a high bluff overlooking the Rock River near Oregon, Ill., visible for miles around. In solemn, silent dignity the massive form rears itself boldly against the skyline from almost every point of the compass, its height of 48 ft. added to an 18-ft. base and the 250-ft. eminence on which it stands giving it an altitude of more than 300 ft. above the surrounding country. The Indian is made of concrete and marks an epoch in statue building, as it is not only a work of art but an example of mechanical genius and engineering skill. It is the work of one of the greatest of the latter-day school of sculptors, Lorado Taft. Mr. Taft conceived the idea of placing the heroic figure of the Indian on the Rock River bluff several years ago and spent much time in working out the plans for the work. The erection of a big statue was not so great a task, but the molding of one in concrete of such size presented a problem of no mean proportions.

Mr. Taft has a summer home at "Eagles' Nest Camp," a colony of Chicago literary and artistic people, near Oregon, Ill., and the unusual natural advantages of the site for such a statue suggested themselves to the sculptor and his friends with added force each summer they spent in their charming sylvan retreat. A 6-ft. model of the statue was first made by Mr. Taft and then he and his assistants set about making the mold and laying the foundations for the big work. They found the job fraught with difficulties. The body of the statue had to be molded where it was destined to stand forever and the erection of the forms for this body occupied much of Mr. Taft's time during the summer and fall. A frame the shape of the figure without the head was made with timber and wire netting, the whole being covered with burlap when the proper proportions were made. This finished, the

whole thing was covered with plaster of paris to a thickness of about 3 in.

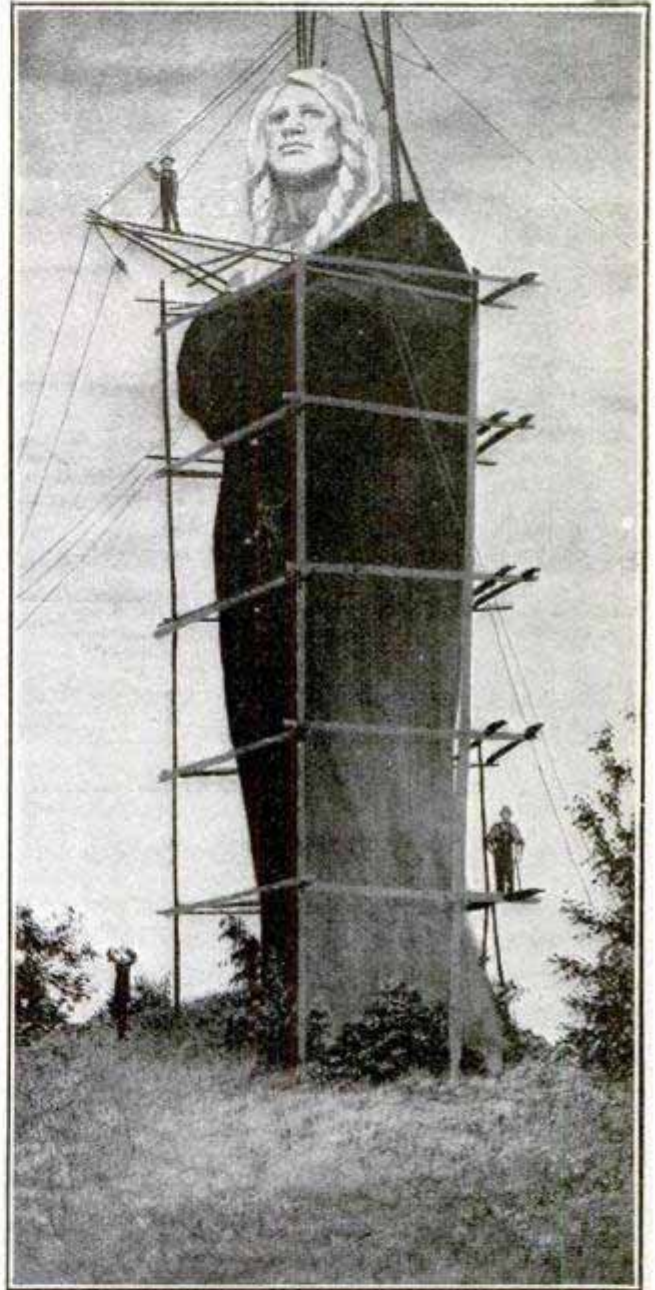

Appearance of the Taft Indian Statue Encased in Mold

Ten tons of plaster were required to make the mold and heavy timbers were used to support it. Concrete was poured into the plaster mold and thus the statue was cast. The mold for the head was made separate from the body.

The foundations for the statue extend 30 ft. below the surface, exclusive

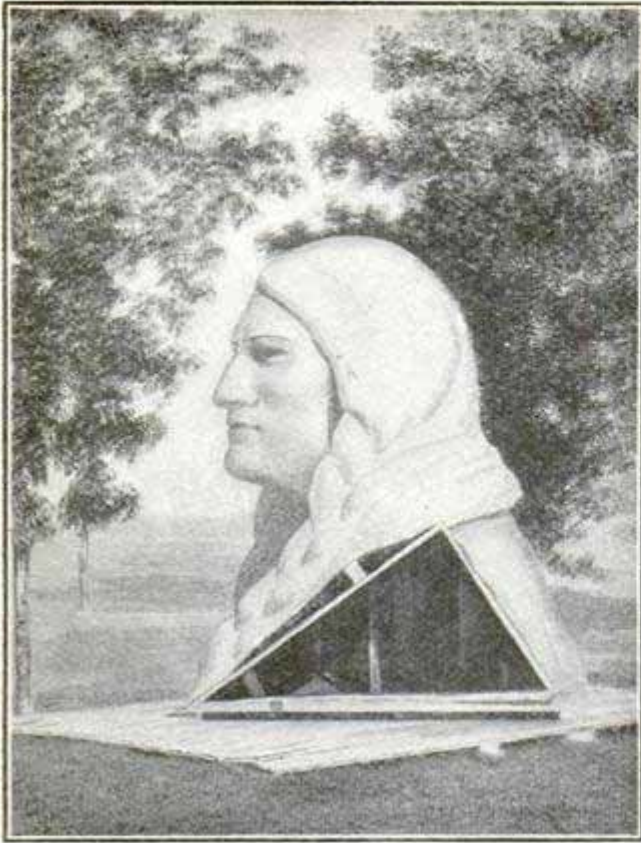

Black Hawk's Head Ready to be Placed on Concrete Block

of the base, which is 18 ft. square and stands 18 ft. above ground. From the

bottom of the foundation to the top of the statue, steel rods were run to reinforce the concrete. The total weight of the statue is estimated at 536,770 lb. and 2,275 cu. ft. of concrete were used to make it. Engineers were consulted in the building of the huge figure, so that every precaution should be taken to insure its standing unscathed by the elements. These have estimated that the wind pressure against the statue would be 28,980 lb. and, with these figures, they devised construction of a character that the wind pressure necessary to overturn it must be 673,785 ft. lb. The total resistance to wind pressure acting through the center of gravity through the 18-ft. base is 4,830,390 ft. lb.

Mr. Taft disclaims having attempted to reproduce the form and features of any individual model, aiming rather at an ideal type, although the statue is more or less a portrait of the late "Black Hawk," a famous chieftain of the Sac and Fox tribe. The attitude of the big, blanket-draped figure is contemplative.

### NEW PAY-WITHIN CARS

The latest development in street-car construction is the "pay-within" car. This type of car has a single closed compartment from end to end. The conductor stands on an elevated posi-

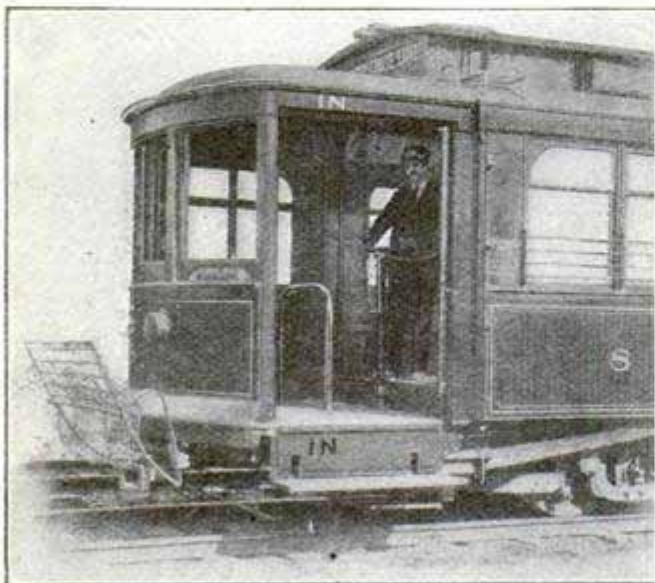

Rear End of Car, Showing Sliding Door Open, Step Down, and Conductor on Elevated Floor of Car

tion near the entrance, at the rear of the car, and controls by means of pneumatic or hand-operated devices the opening and closing of the rear door and the operation of the disappearing or folding steps. He collects the fares as the passengers pass by him. The motorman similarly controls the exit door and steps at the front end of the car. The car is absolutely closed against passengers boarding or alighting while it is in motion. In the typical car there are no bulkheads or partitions separating the end platforms from the elevated floor of the car, but the main features of the invention may be applied to any car without removing the bulkheads. The pneumatically operated type of door operates by sliding, while the hand-operated door folds. The closing of the entrance doors operates a buzzer at the motorman's end of the car, signifying that all is clear and that he can go ahead.

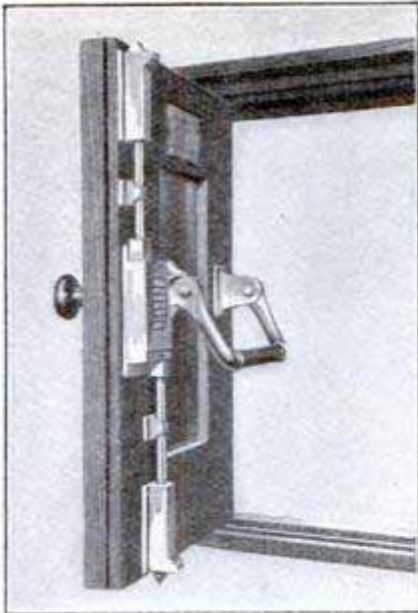

Model of unlocking device for emergency exit doors of theaters and other public places where fire may make rapid exit necessary. On pressing the bar, the door is instantly unlocked.

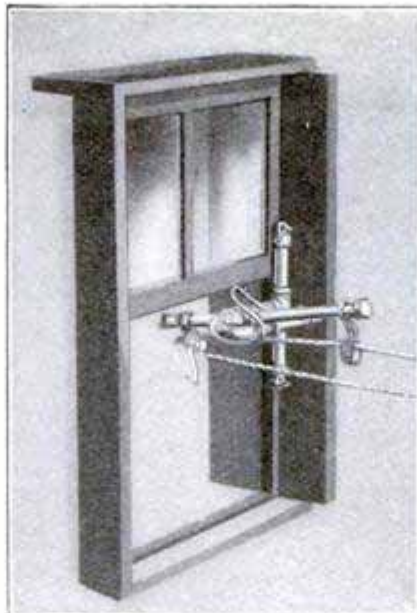

Safety clothes-line apparatus—The clothes can be hung inside the window and when the line is full, the horizontal tube, with pulley attached, is swung upright shifting the line clear from the window.

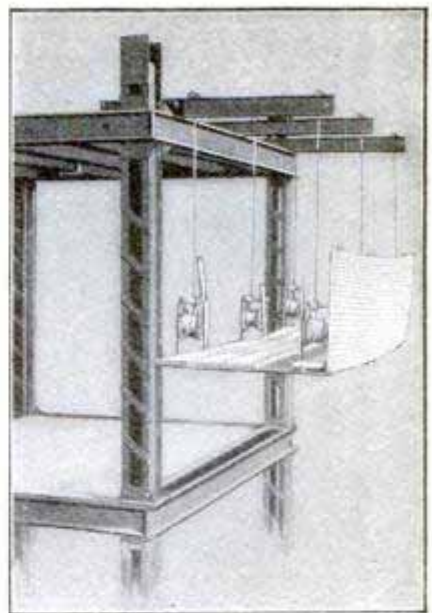

Safety scaffolding clutch which works from protective clutch ratchets suspended by chains from steel beams. A net on its outer edge to keep material from falling on passers-by and injuring them.

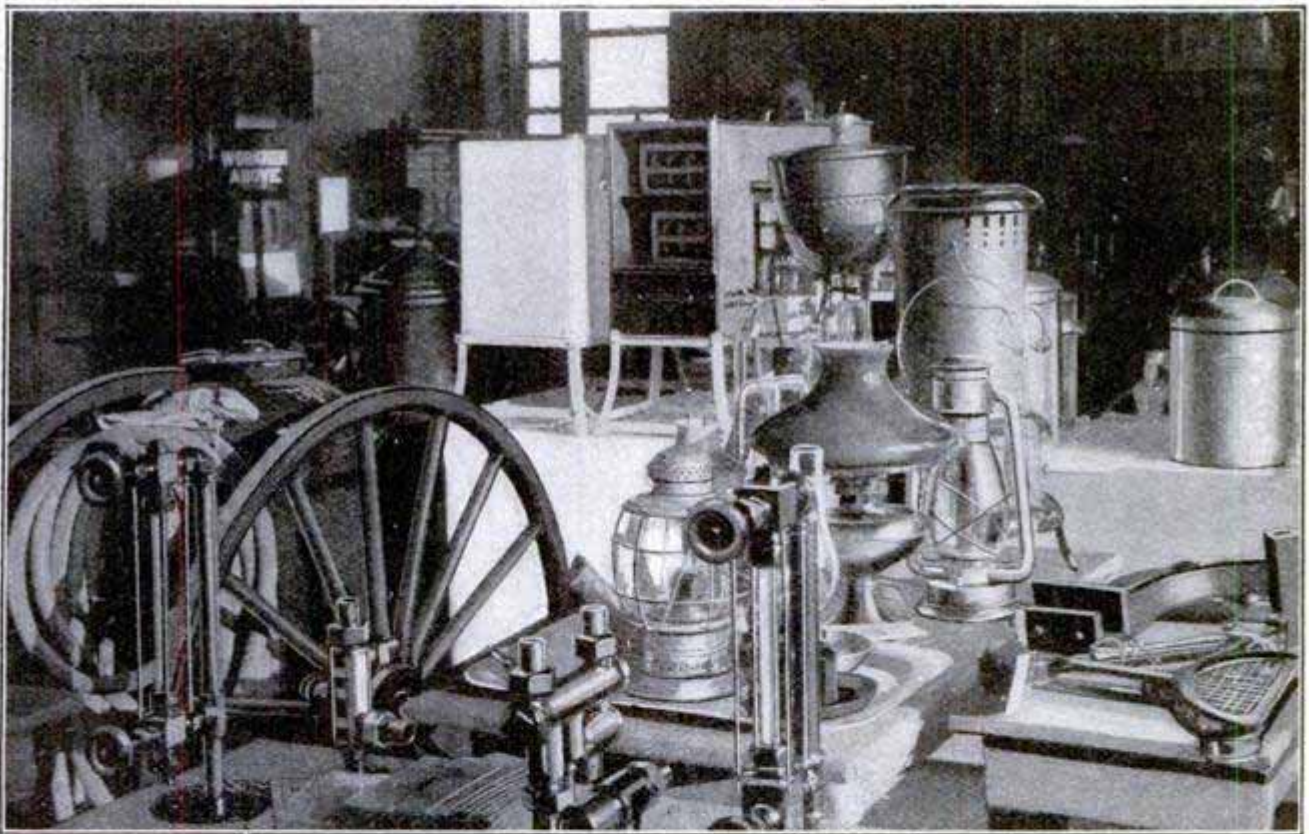

Scene in one corner of the safety device museum, showing safety lamps, lanterns, valves, fire apparatus, apparatus-guards for circular saws, milk-sterilizing apparatus, etc.

#### AMERICAN MUSEUM OF SAFETY

CONSERVATION of the lives of workingmen is the object of the American Museum of Safety which was formally opened in New York recently. Hundreds of models of safety devices for all trades and lines of work are here exhibited. The directors of the museum are planning to erect a building especially adapted for the display of appliances for preventing the soldiers of the great American army of industry from being killed or injured.

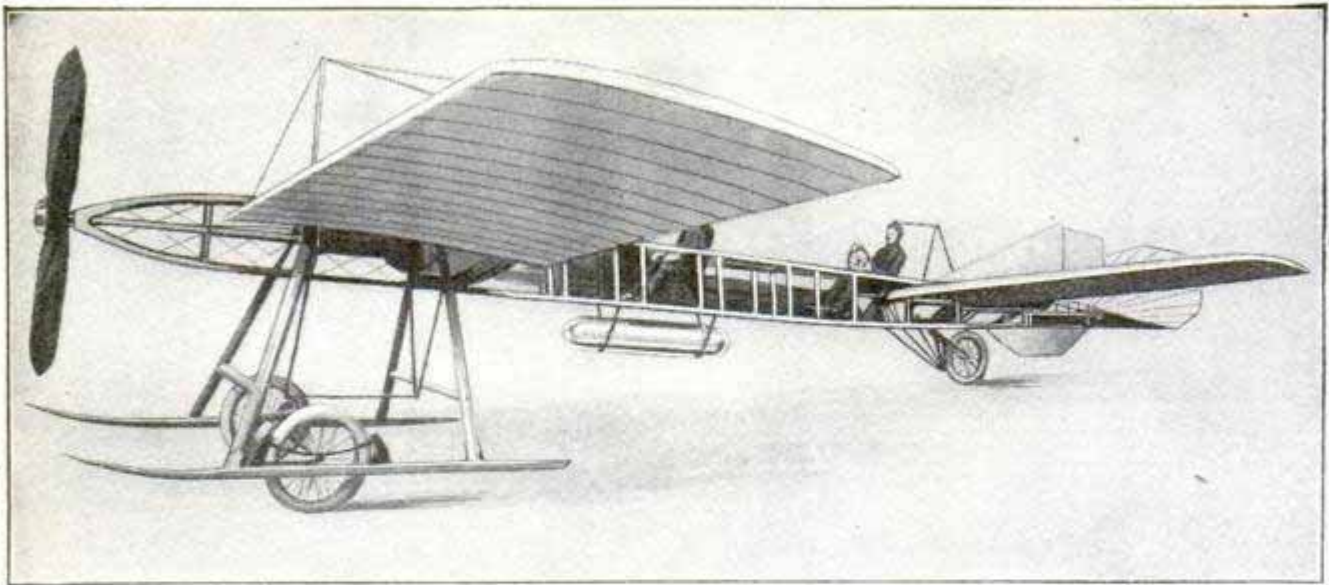

Tandem Monoplane for Military Service

### RAILROAD AUTO-CAR USES KEROSENE FUEL

This railroad inspection car, used on a railroad system in England, has several interesting features, among which is the use of kerosene instead of gasoline as fuel. The engine, which is mounted under the central seat, is of a four-cylinder vertical type, developing 20 hp. The carburetor is arranged to work with both gasoline and kerosene, the former being used for starting purposes only.

The car can be driven from either end, the controls being arranged in duplicate. There is also a horn at each end, but the lamps have to be changed. The seats, which accom-

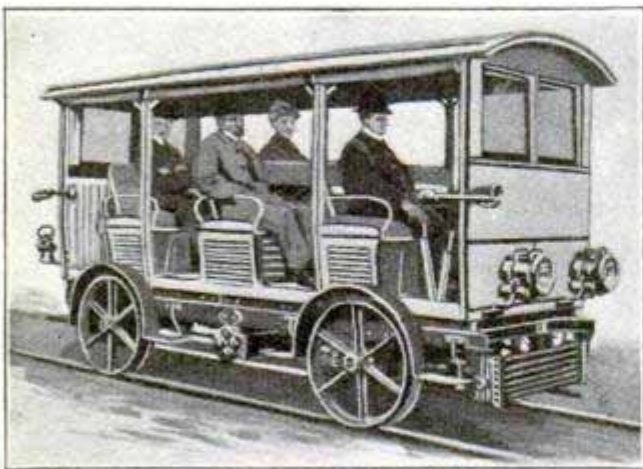

Kerosene-Driven Railroad Inspection Car

modate nine passengers, have reversible backs. The speed is from 12 to 50 miles an hour.

### FRENCH MILITARY TANDEM MONOPLANE

The tandem monoplane designed by M. Clerget, presumably for the French army, weighs 1,430 lb. and is to carry three men. The forward seat is for the mechanic in charge of the motor, the middle one for the officer making observations, and the rear seat for the airman operating the machine.

The machine is provided with a 200-hp. motor. The forward wings have a span of 32 ft., and the rear wings a span of 22 ft. The elevating plane and rudder are disposed at the rear end of the frame. The framework is of wood, rectangular in shape and tapering toward each end. The fuel and oil tank, suspended underneath, has a capacity of 66 gal.

### INTERNATIONAL BOUNDARY FREAKS IN VERMONT

Officials of the United States and the Dominion of Canada feel satisfied that as the result of work recently completed no jesting vandal can steal the international boundary line and move it backward and forward. It is only recently, however, that the section of the dividing line between part of the state of Vermont and the province of Quebec attained this state of permanence. The old form of iron interna-



The Store at Morse's Line, Vt., Half in Canada and Half in the United States

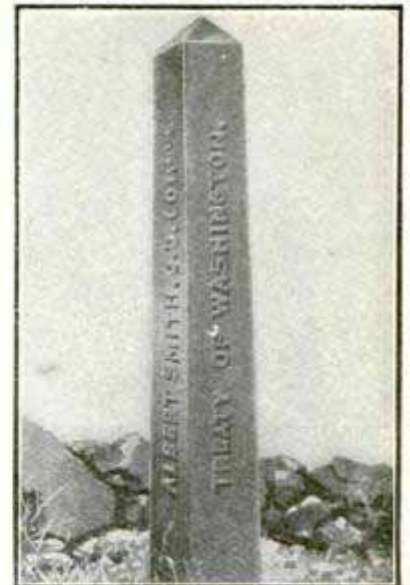

One of the International Boundary Posts

tional boundary posts were not set very deeply in the ground, and it was a common thing to find them misplaced. This sort of thing was most annoying and the two governments decided to stop it by putting in new posts with foundations that extended 5 and 6 ft. below the surface. The new posts are also of iron and are set in cement so firmly that even an earthquake would not budge them.

Some strange conditions are found in Vermont and Quebec along the boundary. There are several buildings that lie on both sides of the "line." One of these at Beebe, Vt., contains two postoffices. Should a letter be mailed at the Vermont office, in the front room, destined for the Quebec office in the back room, it would be necessary to send it 157 miles to another Vermont office before it could be sent into Canada. The house of a physician at Derby Line, Vt., lies across the border with the kitchen in one country and the parlor in another so that every time the cook serves tea in the front room she is compelled to go into a foreign land to do it. One of the most unique international business establishments is located at Morse's Line, Vt. One of the boundary posts is directly in front of this establishment, the "line" running through the center of the store, the post being placed at the edge of the

porch in front of the store. Thus one side of the store is in Canada and the other in the United States.

### APPARATUS EXTERMINATES FIELD MICE AND MOLES

A light portable apparatus for the extermination of field mice and ground moles is used very effectively in France. The body is

a cylindrical receptacle with a conical bottom forming a grate. Straw and a little sulphur is burned on the grate, and the fumes and smoke rise to the top of the cylinder, where they are caught by a crank-operated fan and forced through a hose. The nozzle of the hose is inserted in the tunnels made by the animals, and the crank turned by the operator. Only a few seconds are required for the operation at each hole, a shield near the nozzle forming an air-tight covering for the hole.

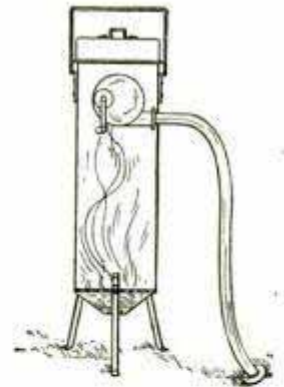

¶The common council of Toledo, Ohio, has passed an ordinance that all explosion engines operating within the city limits must be provided with mufflers.

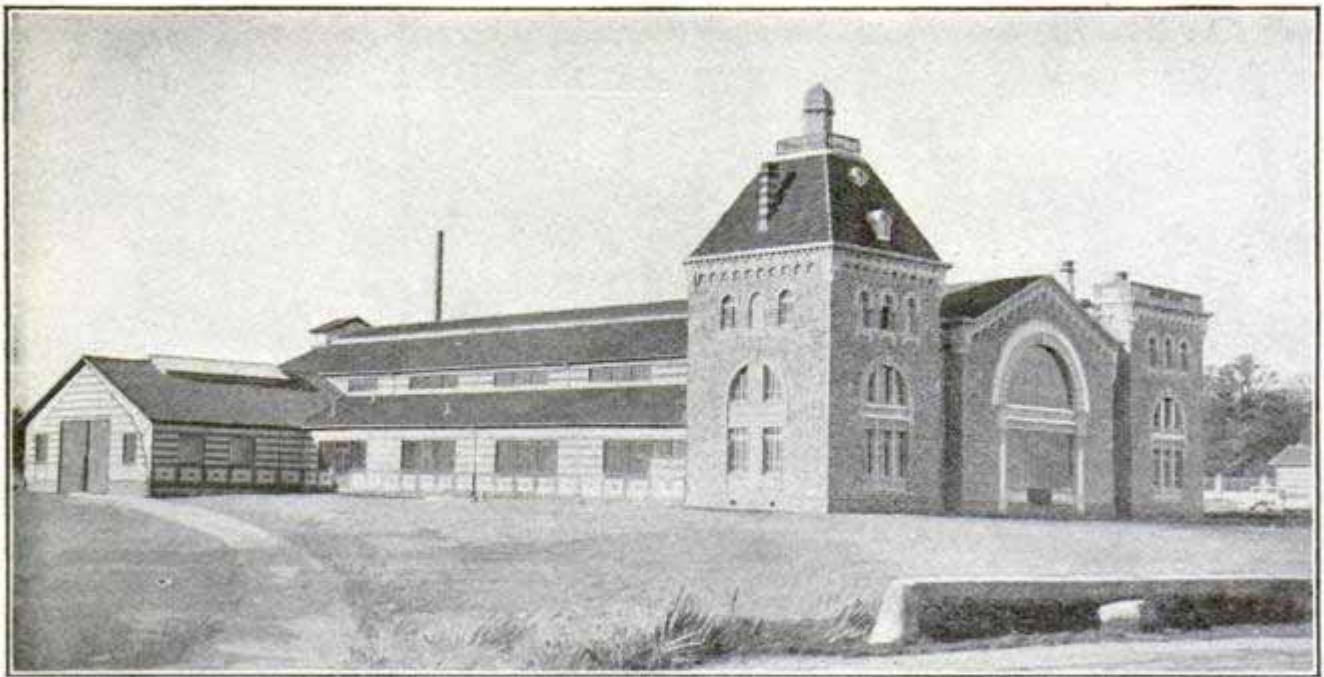

Erected near Paris for Aerial Experiments

### GUARD AND PROTECTOR FOR ELECTRIC LAMPS

Much annoyance has been caused by breakage or theft of electric lamps accessibly located in public places. Every time a lamp is broken or stolen there is inflicted a loss which means more than the money required for replacement; danger to life or limb or to property may often result.



The lamp guard shown herewith locks with a key, without which the guard and lamp cannot be removed. The lock is said to be proof against picking.

In the illustration, the key, which may be worn on an ordinary key ring or chain, is shown ready for insertion.

⌈The "E" string of a violin belonging to the captain of an Atlantic liner saved the life of one of the passengers on the ship when catgut ligaments in the surgeon's kit were found to be defective and the passenger's life depended upon the proper uniting of the wound made in connection with an operation for appendicitis.

### AEROTECHNICAL INSTITUTE IN FRANCE

The aerotechnical institute at St. Cyr, near Paris, erected at a cost of about \$100,000, is the finest establishment yet conceived for study and experimental work in aero-dynamics and flight. The studies and experiments are pursued under the control of a committee of scientists, technical aeronautic engineers, and practical airmen. The money for the erection of the institute was donated by M. Deutsch.

### DOG HOSPITAL IN OLD STREET CARS

The proverb of the ill wind is exemplified in the manner in which a Chicago man has evolved a haven for aristocratic dogs from a graveyard for street cars. This man has created a dog's paradise in that section of the big western city known as Ravenswood, using six worn-out street cars that not alone furnish the dogs a most comfortable place in which to take the rest cure, but also provide the owner and manager of the place with a most unique home. The cars used for the purpose are all of the stove-heated type and are practically impervious to the elements. The place covers two



Old Street Cars Used as Dog Sanatorium

and one-half acres and there are ample yards in which the canine society favorites can take the air. Steel fencing, once used for a similar purpose in a Chicago municipal office, forms the partitions between the yards and a barrier against too free access to the place itself. These fences are of steel wire of the finest type and afford thorough protection to the occupants of the unique houses.

The manager of the place has some of the finest dogs in Chicago on his list of boarders. He makes a specialty of

carrying for high-bred dogs during the absence of their owners in the summer and has also a hospital attached to the place where he treats dogs for all sorts of diseases. He lives in one of the cars which has been fitted up in a most convenient and comfortable style.

#### A UNIQUE CONCRETE FOOTBRIDGE

The use of reinforced concrete for light construction work of considerable proportions is exemplified by the

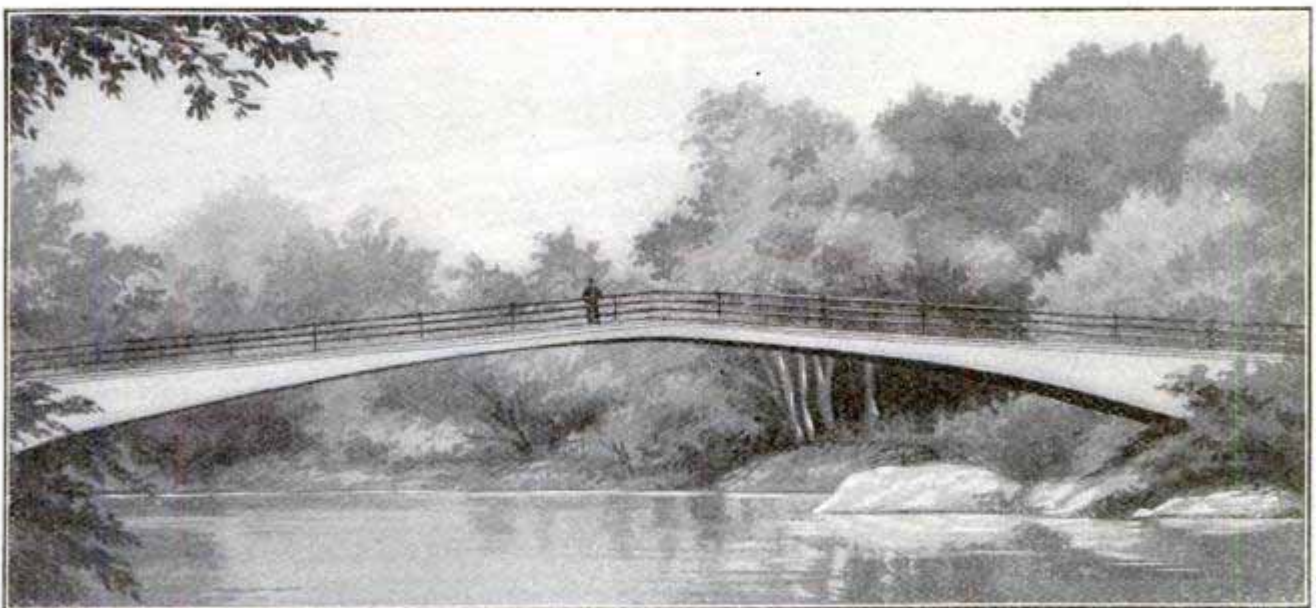

Concrete Footbridge at Stockbridge, Mass.

unique and artistic footbridge recently erected over the Housatonic River at Stockbridge, Mass. This bridge has a clear span of 100 ft. in length, with a rise of only 10 ft. The width of the bridge is 7 ft. 6 in. The arch is 7 in. thick at the crown and is reinforced with 7-in. I-beams. The bridge successfully withstood a test load of 25 tons at the center, before it was opened to the public.

centrifugal pump started. As each incoming breaker sends a quantity of water into the hole, there is no lack of water, and each incoming tide washes up sufficient sand to fill the hole left by the last dredging. Were it not for this fact, it would have been impossible for the dredge to be built in this position and kept supplied with sand. At low tide the pump has to be stopped, as no water reaches the hole.

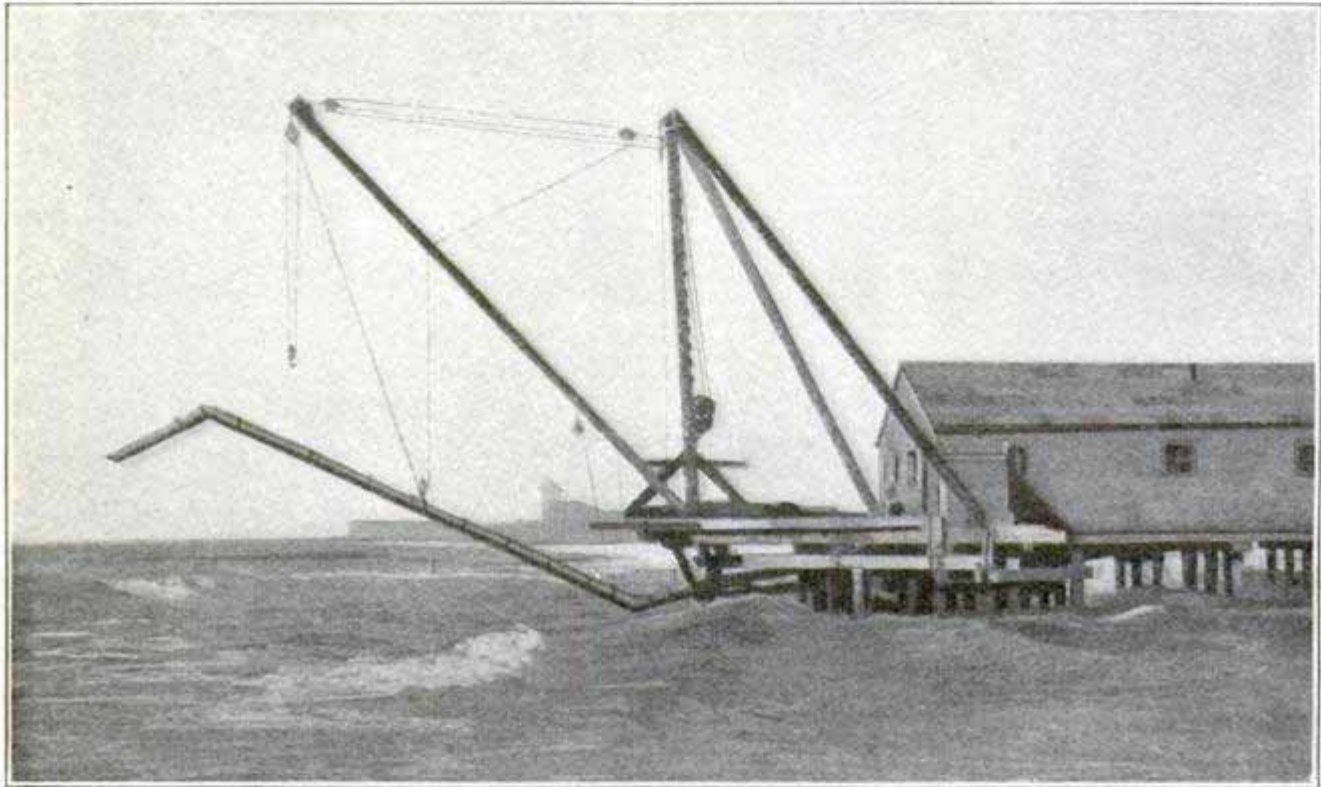

Sucking Up Sand at Far Rockaway, Rhode Island

### AN INGENUOUS HYDRAULIC-DREDGE INSTALLATION

Erected on piles driven deep into the sand on the beach at Far Rockaway, Long Island, is a large suction dredge, which is being used to fill in the swampy land in the vicinity. The sand is drawn directly from the beach and forced through a pipe line about two miles long to the swampy land.

The most interesting feature of this particular dredger installation is that no matter how steadily the sand is sucked away, there is no perceptible lessening of the supply and the holes from which it is taken never grow beyond a certain size. As the tide recedes, a hole is dug in the sand, the long pipe lowered into it, and the large

### AUTOMATIC SUPERVISION OF TELEPHONE SERVICE

A new telephone apparatus being introduced by an American manufacturer is stated to accomplish most completely the requirements for automatic supervision of telephone service. This is a form of local-battery telephone in which the act of removing the receiver from the hook switch automatically signals the exchange, and the restoring of the receiver to the hook automatically gives the clearing-out signal, in this way obviating the necessity for the operator to listen and thus ascertain when the circuit is idle. This convenient apparatus can be adapted for use on either individual or party lines, as desired.



## PARIS CANAL PROJECTED FOR TWO PURPOSES

The idea of converting Paris into a seaport, advocated for many years by prominent French engineers without receiving the smallest public support, has been revived as a means of protecting the city from the floods which have ravaged it during the past two or three years.

The conversion of the Seine into a canal from Paris to Rouen would, it is believed, take care of the surplus water as well as provide a waterway for the passage of ships of heavy tonnage. The other scheme for the relief of flood-stricken Paris is a canal connecting the Marne and the Seine, to the north of Paris. If it is found that the cost of deepening the Seine will not be much more than the estimated cost of the Marne-Seine canal, the scheme may be carried through.

## MISSIONARY'S FLAG-CANE

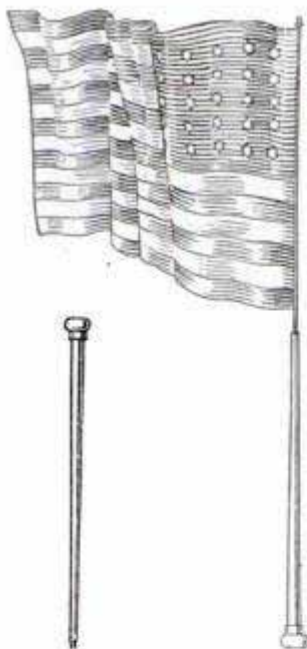

The desire of a missionary to Persia to carry both an American flag and a substantial cane about with him in his walks led to the invention of this novel walking stick. The flag is  $2\frac{1}{2}$  ft. long by 2 ft. wide, and the cane is solid enough to provide an excellent support in walking, and a means of defense should such be necessary.

One of the odd industries of the United States is the manufacture of a special kind of wire for keys for sardine cans. These keys are made in Norway, in which country no less than 25,000,000 were turned out in 1910.

## KNEE BRACES FOR A BABY LLAMA

In an attempt to cure a bad case of knock-knees, a unique mechanical experiment is being performed upon a



Correcting a Case of Knock-Knees

valuable two-months-old baby llama at the Cincinnati zoological garden. He persists in rubbing his fore knees together. Various ways to correct the fault were tried, but not until the steel forms with their straps were made and applied was any success noted. The little fellow now walks and frisks about with the braces on without having his knees bother him. The mechanical device will be continued until he has outgrown the fault.

## VARIABLE SPEED MOTOR

An English inventor claims to have devised an aeroplane engine (working on the same principle as the Gnome rotary motor) which can be started slowly and run at almost any speed. It is said that such an engine would remove the necessity for vol-planing when descending quickly from great heights.

## ICE HOUSE MADE OF FREIGHT-CAR DOORS

This ice house is unique because it was built of discarded freight-car doors, about 150 of which were used. Sections of box-car bodies were util-

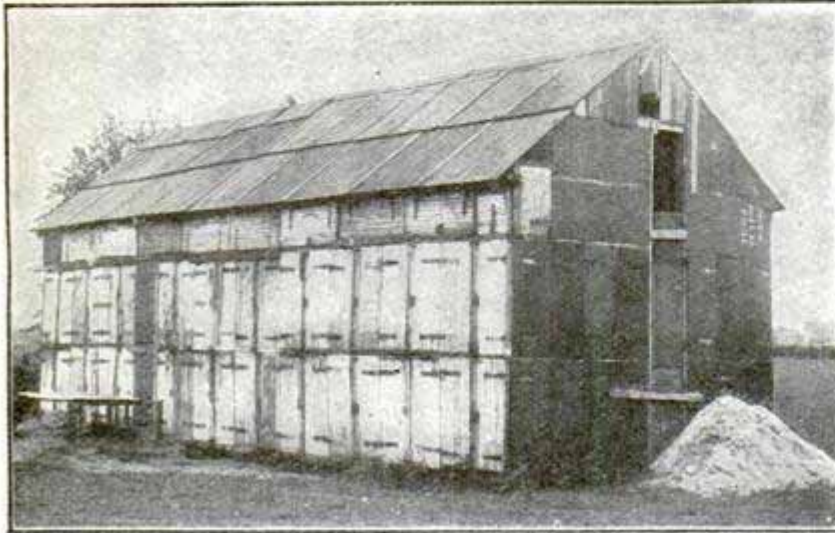

Novel Use Made of Freight-Car Doors

ized for roofing and also for boarding up the ends of the building under the roof. The ice house is located in New York state.

## HAND-WASHER FOR LINEN ARTICLES

This little French device, consisting of two grooved wooden rollers fastened

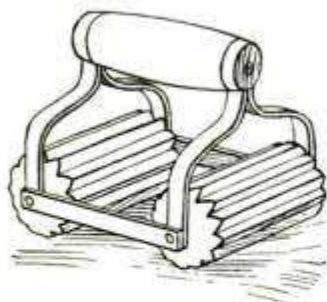

to a suitable handle, is used in place of a brush or hand-rubbing in washing linen. The article to be washed is first soaked in

soapsuds and then placed on an inclined board. The washer is then rolled over it under slight pressure to work the suds through the fabric.

It is estimated that the farmers of the state of Iowa alone use every year \$1,400,000 worth of new fence posts, which cost about \$600,000 to set in the ground.

## SHIP PROPULSION BY MEANS OF ACTION OF WAVES

A Brooklyn inventor is attempting to convince marine engineers of the practicability of his plan of propelling vessels across the ocean by means of wave power. His idea is to place water tanks fore and aft and locate a piston rod provided with a series of cogwheels in the center of the vessel. His belief is that the weight of the water stored in the tanks will, applied by means of the rise and fall of the hull, be sufficient to operate the machinery.

"When a wave strikes the vessel fore or aft," says the inventor, "tons of force would be thrown upon the operating machinery from one series of tanks, and the machinery would also be simultaneously affected by the suction of the receding waters in the tanks at the other end of the vessel. It would not, therefore, affect the power of propulsion if the tides were adverse to the course of the ship."

## "LOOPING THE LOOP" ON A BALL

This new "thriller," devised by a Frenchman, is of a kind that seems almost impossible. The nicety of calculation involved is much greater than that of the "loop the loop" automobile, because this ball, with a woman seated on the outside of it, not only describes a loop, but must land with the woman uppermost on the pivot provided to receive it.

The ball is made of willow, which is the only wood sufficiently elastic to withstand the shock. On one side of it is a chair-like support for the woman, and on the other a hole. Launched from the scaffolding, it takes an upward curve and describes a loop, then lands upon the pivot shown at the

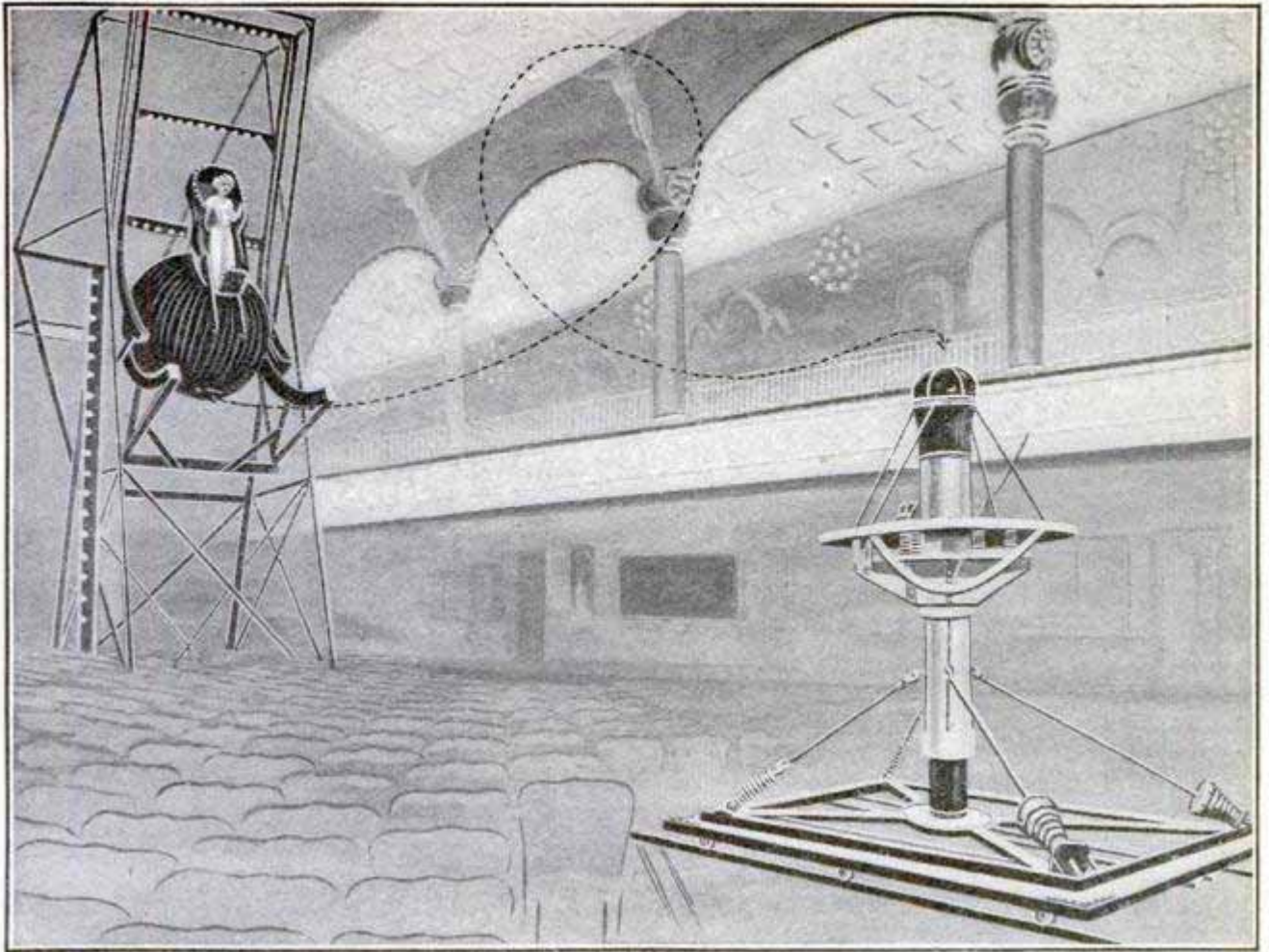

The Latest French "Thriller"—Socket in Ball Must Land on Pivot

right of the illustration, in the same manner as would an apple if allowed to drop on an upturned spike, only that the ball is already provided with a hole for the pivot to enter.

The pivot is provided with shock-absorbing springs, and, to further diminish the shock, the whole glides on a track. The inventor claims there is no possibility of accident.

### SIX-WHEEL TRUCKS FOR NARROW-GAUGE CARS

The new train, consisting of four cars, for the president of the Argentine Republic is mounted on six-wheel trucks of an interesting design. The government railways of this South American republic have a gauge of but 3 ft. 3 $\frac{3}{8}$  in., and the trucks hitherto used on the regulation rolling stock are of the four-wheel type.

The special six-wheel trucks are of the same type, using spring-link

suspended equalizing bars, journal springs, solid forged side frames, etc. The side frames or wheel pieces, 11 ft. 1 in. in length, are said to be excel-

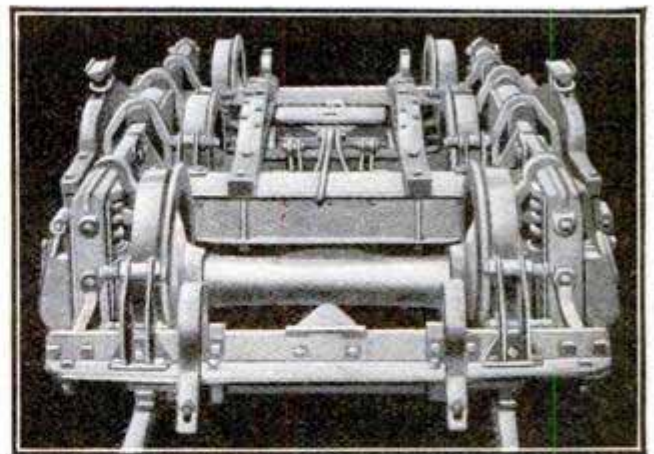

Trucks for Argentine Republic Presidential Car

lent examples of the solid forging process and its unlimited possibilities in truck designing.

Electric street cars and telephones are being introduced in Lebanon, Syria.

## AUTOMOBILE GUN CARRIAGE TESTED IN GERMANY

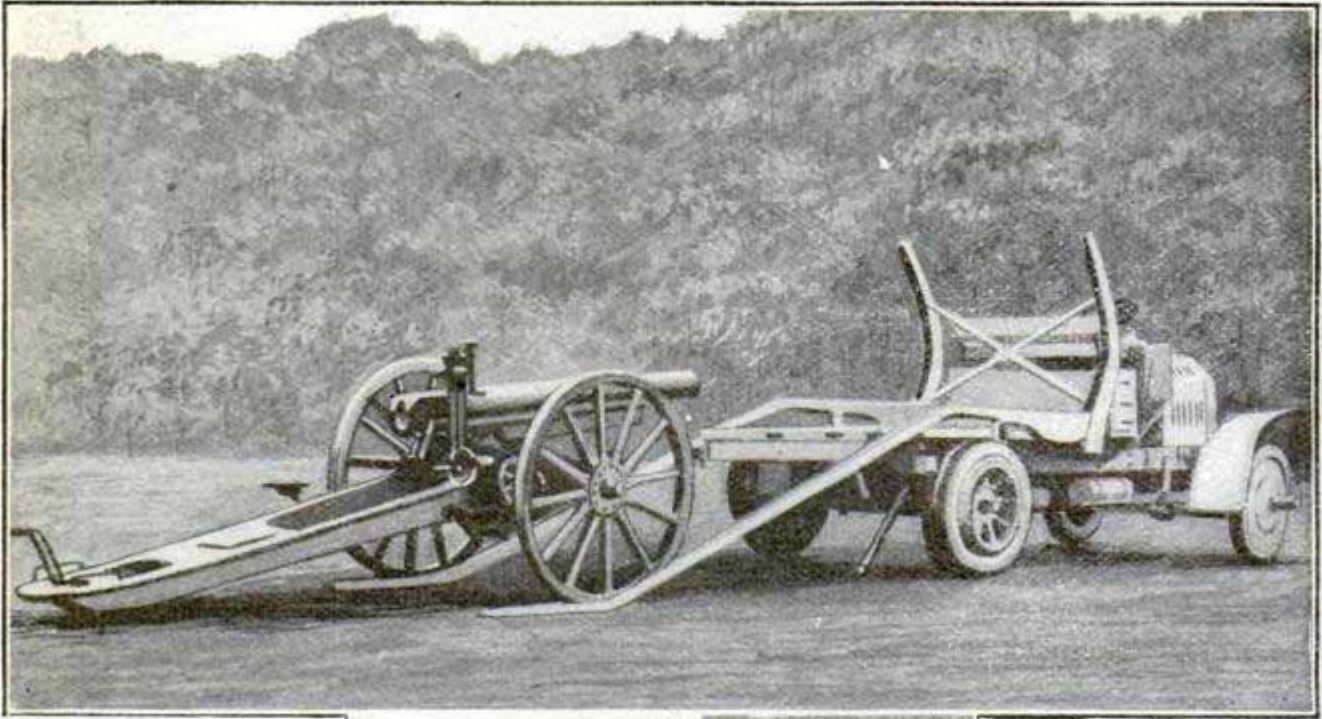

New Military Motor Design  
lery, Showing Manner of

A new motor car for light artillery, which permits the use of motor traction with any type of field gun, has been successfully tested by the German military authorities. Grooved runners are lowered from the rear of the car to permit the gun being taken off to any part of the field by hand. When not in action, the gun is rolled onto the platform over the grooved runners, and these latter are

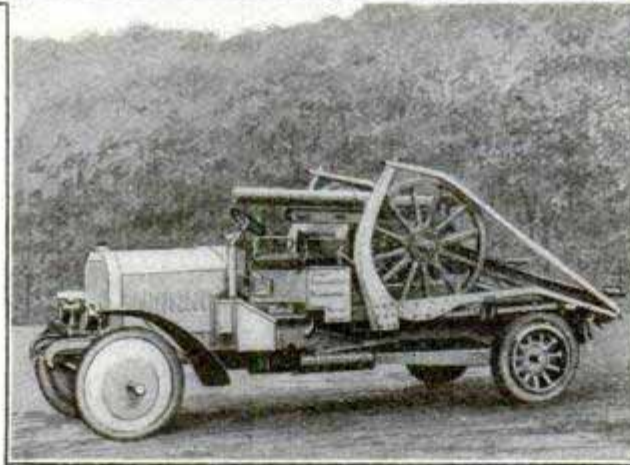

Courtesy of the London Illustrated News  
Gun Secured on Motor Truck

ed to Transport Field Artil-  
Running Gun onto Truck

raised and fitted over the wheels in such a manner that when they are secured to the body of the car, the gun is held firmly in place and can be moved at high speed. This car is to be used as a platform for the gun while in

action. Military men regard it as one of the most practical applications of motor traction to artillery that has yet been devised, and it is thought this method will be generally adopted.

## NAVY EFFECTIVELY GUARDS ATLANTIC COAST

The efficiency of the United States Navy was put to a most severe test, through which it came with entire success, on the recent return of the battleships from their European tour. The cruiser divisions under Admiral Staunton, which had remained in waters of

the United States, were notified that the battleships would attempt to land a force of men in the United States at some point between Charleston, S. C., and St. Augustine, Fla. Rear Admiral Schroeder, commanding the battleships, was directed to use his best efforts to

effect the landing, the strip of coast given him for the purpose offering a radius of several hundred miles. Admiral Staunton sailed from Hampton Roads with his fleet of cruisers on Jan. 4, and on the morning of Jan. 8 discovered his enemy in the Atlantic, 1,380 miles off St. Augustine. The cruisers were kept in continual communication with their commander by means of wireless and assembled at the call of the vessel which discovered the "enemy" as a defending fleet would have assembled to repel an attack. Admiral Schroeder did not know he had been discovered until Admiral Staunton's entire fleet was lined up to oppose him. The feat of the cruisers is regarded as one of the most important demonstrations of naval efficiency of the year.

### SIX-ROOM APARTMENT ON A PRIVATE TROLLEY CAR

The development of electric traction has given rise to the increased use of private trolley cars that are becoming more and more luxurious and complete. The finest example of this type in the country is believed to be the car just turned out by a Cleveland concern for the head of a New York State traction company. The fortunate occupant of this car is provided with a complete six-room apartment consisting of parlor, dining room, smoking room, kitchen, toilet room and a retiring room, which is provided with a couch

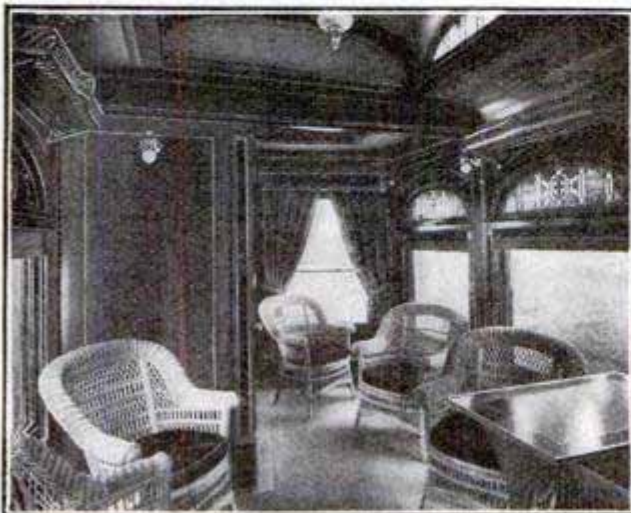

End of the Parlor Compartment on Private Trolley Car Showing Motorman's Cab and Observatory Window

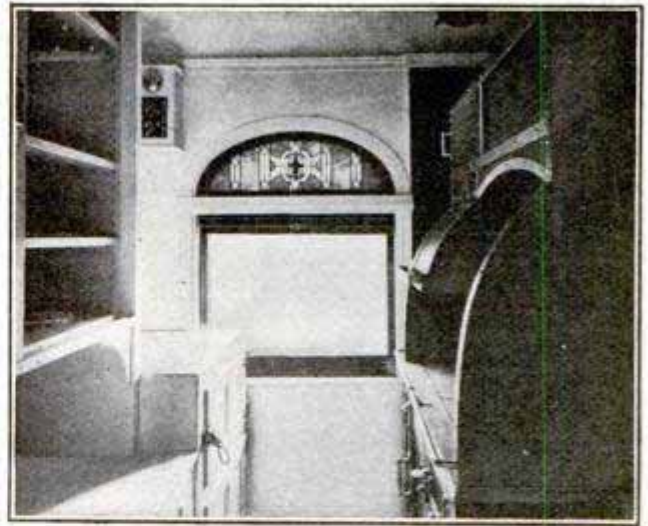

Kitchen Built in Private Trolley Car Showing Range, Refrigerator and Shelves for Dishes

and lavatory and can be used for sleeping. The car is 54 ft. long over the vestibules, and has an inside width of 7 ft. 5 $\frac{3}{4}$  in. At one end is the smoking compartment and at the other, the parlor. These two, with the dining room, which occupies the center of the car, extend across the entire width of the car. The cabs for the motorman at either end of the car are just large enough to accommodate the man and controller. The entrances to the car are through these cabs. The space at the two ends not used for the cab is provided with observation windows. Between the dining compartment and the smoking room is located the kitchen, which is provided with a buffet range, a sink and a refrigerator. Between the dining room and parlor is the retiring and toilet rooms. A narrow corridor at the side connects the dining room with the two end compartments. The entire car is finished in hard wood. The smoking and dining rooms are furnished in mission style and the parlor compartment has wicker furniture. The lighting scheme is worked out with handsome fixtures in keeping with the other furnishings in the rooms.

☞The Federal government is experimenting in the culture of cork trees on the old military reservation at Brownsville, Texas, recently abandoned by the War Department.

## HOLDING BACK A GREAT LAKE WITH EARTH

The big Belle Fourche irrigation dam in South Dakota, which is the largest earth embankment in the world, is nearing completion. Construction of the project was authorized by Congress on May 10, 1904, at a cost of \$5,000,000.

From an engineering standpoint, the Belle Fourche project is one of the most interesting which the government has yet undertaken. Its principal structure is the earthen dam. This wonderful dike which closes the lowest depressions in the rim of a natural basin, is 6,200 ft. long, 20 ft. wide on top, and 115 ft. high in the highest place. The inside face of this structure, which has a slope of 2 to 1, will be protected from wave and ice action by 2 ft. of screened gravel on which will be placed concrete blocks each 4 by 6 ft., and 8 in. thick. The cubical contents of this dike will be 42,700,000 cu. ft., or about half of the famous pyramid of Cheops.

The reservoir created by this dam will cover about 9,000 acres, and will

be the largest lake in the state. It will receive water through an inlet canal  $6\frac{1}{2}$  miles long, 40 ft. wide on the bottom, and capable of carrying the entire flow of Belle Fourche River. When the distribution system of the project is completed, 600 miles of canals and laterals will carry the waters over 100,000 acres of land. About 30,000 acres already are receiving water.

In connection with the project is a diversion dam of concrete weir type, having a height of 23 ft. The length of its masonry crest is 400 ft. The diversion dam is located about two miles below the main project.

The Belle Fourche irrigation project covers a territory of 150,000 acres, of which 100,000 acres will be irrigated in the Belle Fourche Valley. This tract lies on both sides of the river, begins two miles east of the town of Belle Fourche and extends eastward for 40 miles. Within the area are included 50,000 acres of public land, 45,000 acres of private land and 5,000 acres owned by the state of South Dakota. Owing

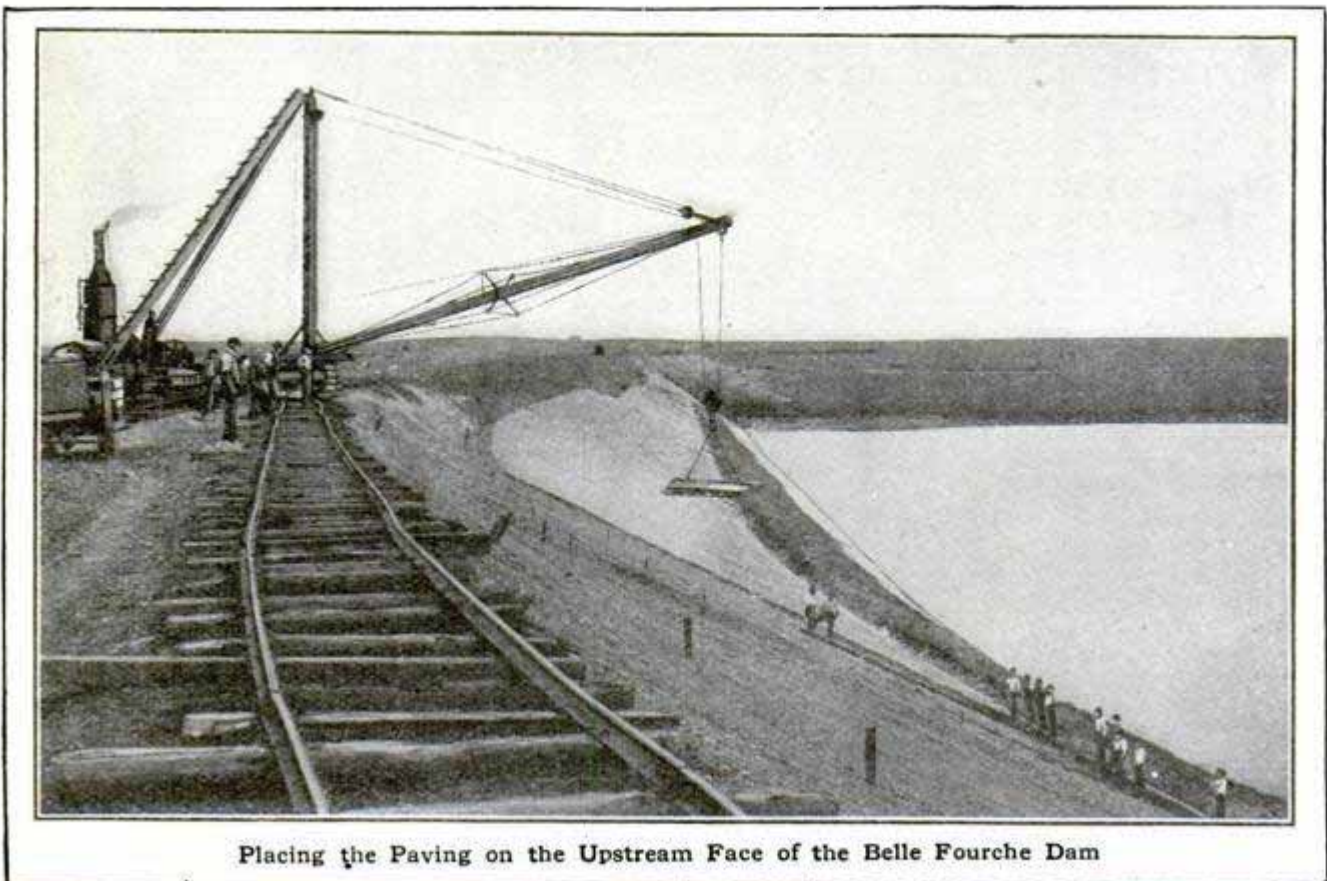

Placing the Paving on the Upstream Face of the Belle Fourche Dam

to the rolling character of the region, however, much of the land included between the main canals lies above the ditch, so that it is possible to irrigate only 100,000 acres. The lands have, where possible, been so divided that

## VACUUM CLEANER ROUTS CARPET PREJUDICES

The vacuum cleaner has removed the prejudice of many people who oppose carpets on hygienic grounds, as well

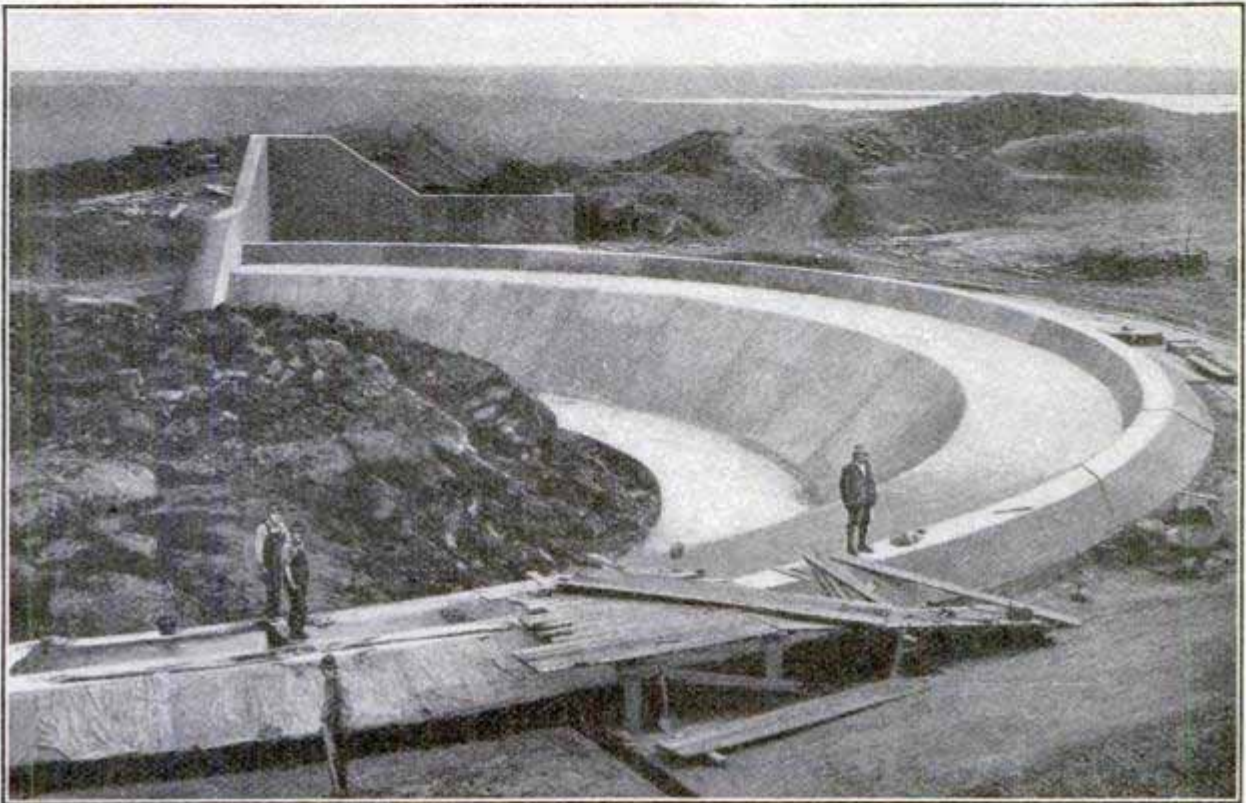

Spillway at Head of Waste Channel, North End of Belle Fourche Dam

each farm unit will contain a portion of dry pasture land as well as irrigated land. Twelve thousand acres in the project are now being supplied with water, the irrigated area is being increased as fast as the canals are completed, and 42,000 acres of irrigable land will be covered with water for 1911 spring crops.

### BERLIN'S AVIATION FIELD

A new aviation company has purchased the Johannisthal aviation field at Berlin from the Prussian government and will transform it into one of the best arranged fields of the kind in any part of the world. The extent of the field is 741 acres. Trees will be transplanted all around its border, and the grandstands and other seats will be removed from the open field to the edge of the bordering fringe of trees, which will afford considerable protection against the sun.

as the dust and dirt that hides in them. The result is that carpets and rugs are again becoming popular with that class of citizens who did not view with pleasure cold bare floors. This significant fact dealers in floor coverings have discovered through the increased volume of their business. The opposition to the use of carpets was largely based on their germ-collecting capacity. The use of the vacuum cleaner has entirely eliminated this danger and today the carpet is practically as safe, so far as general health is concerned, as the polished hardwood floor, provided, of course, it be subjected to frequent cleansing with the vacuum machine.

Interior decorators are again figuring the floor into the color scheme of the rooms and they welcome its return to a status that will permit the application of more color than is usually found in hardwood.

## DEVELOPMENT OF THE SCUTTLE DASH ON AUTOS

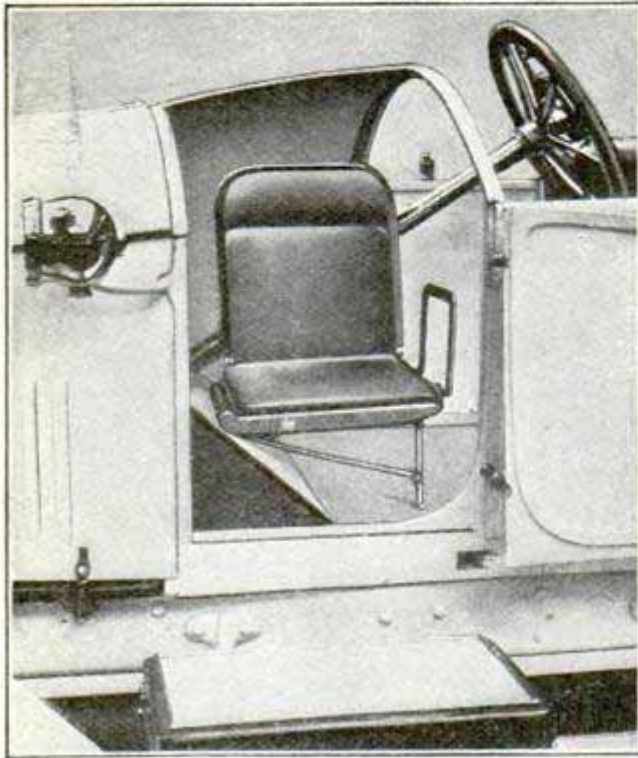

The space which is ordinarily waste room on automobiles having the new expanded scuttle dash is utilized by one French motor concern as a space for the chauffeur when he is not driving the car.

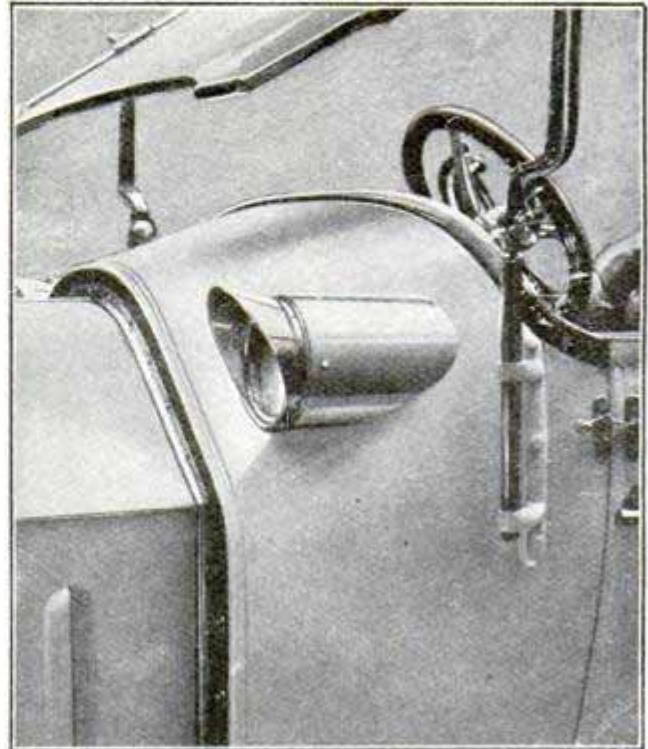

Another European manufacturer has introduced a novel lamp arrangement on the dash. The fixture is thus made part of the body and will not become loose. It also puts the control of the lights at the driver's hand.

### SUPREME COURT MAY HAVE PALACE OF JUSTICE

Plans for the construction of a palace of justice to house the Supreme Court of the United States on the plot of ground just north of the Library of Congress at Washington, are being given serious consideration. The recent hearing of the tobacco-trust case in the present Supreme Court room of the Capitol building called attention to the small quarters the court occupies. There were more than 700 lawyers in attendance and there was not room in the court room to accommodate them.

The proposed building, for which plans have been drawn, is to be on an artistic scale equal to that of the Library of Congress, and is designed to house not only the Supreme Court, but also the arbitration court, if such be formed.

### \$50,000 PAID FOR A FAMOUS VIOLIN

It is reported that Kubelik, the great violinist, has purchased the celebrated "Emperor" violin for \$50,000. This instrument, which has thus sold for about 100 times its weight in gold, is the most famous violin made by Antonio Stradivari, who lived from 1649 to 1737 in Cremona, Italy. The prices of the best violins of Stradivari and Guarneri del Gesù range from \$1,000 to \$2,500, although several have changed hands recently at a much higher price. A few years ago one was sold at Stuttgart for \$10,250, a figure which was considered remarkable at that time.

Indications point to the repeal of the law which prohibits the running of automobiles on public roads in Prince Edward Island.



# SHOP NOTES

## Wood Box in the Wall of a House

In planning a house or remodeling the kitchen, provision should be made for storing a liberal quantity of stove wood, heater chunks or coal, so as to avoid going out in the rain or snow to the wood shed for the house supply, which in a protracted cold spell must be replenished often. The sketch shows how a built-in wood box may be arranged to load from the outside and emptied from the inside. A spring lock or hasp on the kitchen side keeps the box closed against entry from the outside. This box insures a lasting supply of dry wood, as it may be built as large

as one's needs demand.—Contributed by Victor Labadie, Dallas, Texas.

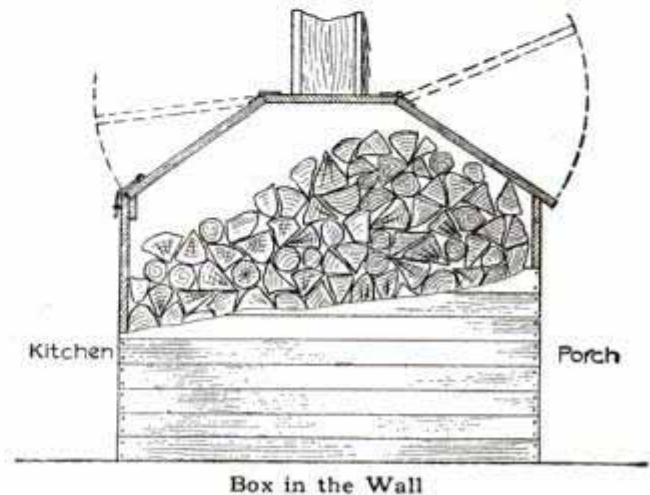

## Finding Loose Bearings in Automobile Engines

The usual method of finding "play" in connecting-rod bearings on automobile engines is to remove the lower half of the crank case, open the cylinder relief cocks and "feel" the connecting rods either by hand or a pry-bar. Often the play is so small that the hands fail to locate it, in which case the pry-bar

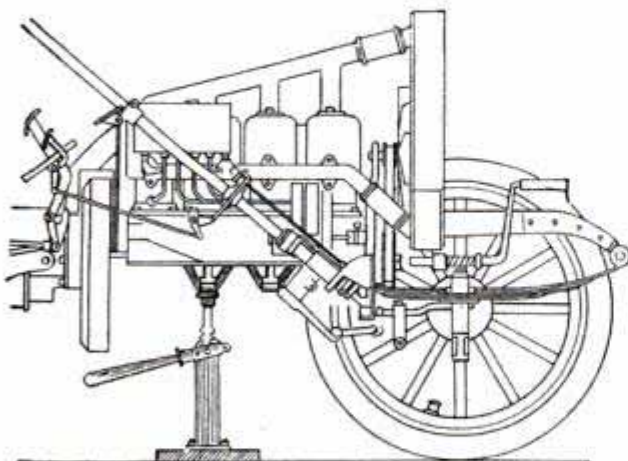

Jack under Crank Bearing

is used. Very often no leverage can be had on the pry-bar, then this method is not positive.

When there is any uncertainty about the pound or looseness of a rod or main bearing, a heavy pry-bar with exceptionally good leverage must be used to "feel" the crankshaft in its bearings. It is very inconvenient, however, to work such a bar up and down beneath a car.

The best method I have found is shown in the sketch. Run the car over a pit, if possible, although the bare floor will do. Raise the car by means of a jack to suit the conditions for testing. If the rod bearings are to be tried, run a jack head against the lower half of the connecting-rod bearing and work the jack handle up and down. The smallest amount of play can be detected in this way, especially on the main bearings, where the pressure of the jack is applied on the crankshaft against the weight of the car and "play."—Contributed by L. A. Prince, Cincinnati, O.

CA good slate-colored paint for a roof is made from white lead, lampblack and yellow ochre.

### Attachment Plug Made from Lamp and Socket Parts

The accompanying illustration shows the parts that are used from an electric lamp socket and the metal base of a tungsten lamp to make an electric plug.

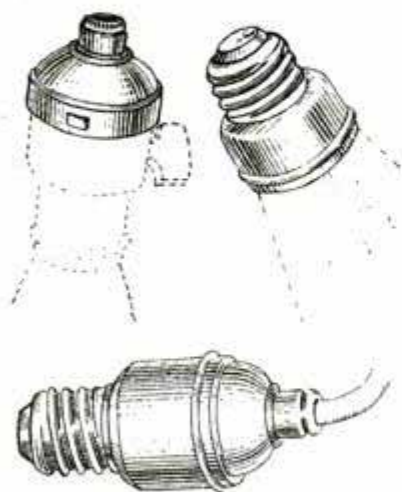

The glass is broken away from the metal base of a discarded globe and the cap from a socket will fit snugly in the place of the glass. The wires are soldered to the places where the filament connections of the lamp were attached. The finished plug will have as good an appearance as one purchased from an electric supply house.—Contributed by Lee Kirtledge, Jackson, Mich.

### Tool for Finding the Center of Shafts

The center of a shaft, a round casting or a large round object may be easily found with the tool shown in the illustration. To make it, nail together two pieces of board, A and B, so that they form a right angle, and fasten a long piece, C, so that one of its edges

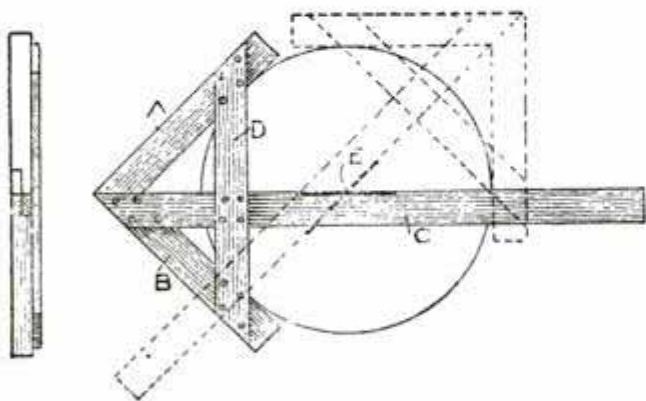

Finding the Center of a Shaft

bisects this right angle, a brace, D, being nailed over the three pieces to insure rigidity.

Lay the device on the end of the round object with the right angle drawn closely to the circumference and then draw a line along the edge of the long piece C. Move it to another position and draw another line. The intersection, E, of these two lines will be the center of the object.—Contributed by Walter Johnson, St. Paul, Minn.

### A Chicken House

The owner and designer of the chicken house shown in the sketch has had remarkably good returns from his poultry, getting plenty of eggs at a time when other chicken keepers in the neighborhood were buying from the grocer, and he ascribes much of his success to the novel features contained in his device.

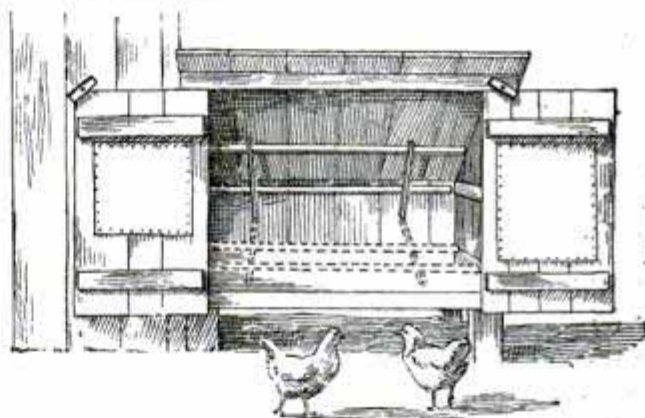

Sanitary Chicken House

The house has a southern exposure, and the two doors which form the front can be thrown wide open so that the interior gets a sun bath every day. In addition to the frequent coats of white-wash, lime is sprinkled on the floor, which is easily kept clean. The doors are fitted with windows, unglazed, but screened with ordinary burlap, which allows sufficient ventilation and still keeps out objectionable drafts.

The most novel feature of the device is the roost, which is fastened by hinges to the rear wall and can be raised to the roof and hung on a hook, thus making it easy to clean the floor. At night the roost is let down and rests on two iron feet, and these, together with the roost, are covered with crude oil which does not need renewing very often. As

a result of this cleanliness, exposure to the sun and treatment with oil, there is not a resting place in the chicken house for the insect pests which make hens unhealthy and disinclined to lay, and the cost and care are practically no greater than with the old-fashioned house.—Contributed by C. L. Edholm, Los Angeles, Cal.

### Portable Gas Heater for a Steam Furnace

Often in the fall and winter months and even early in the spring, it is desirable to have heat in the house for a short time only—just enough to drive off the chill. It is inconvenient and wasteful to build in the furnace a coal fire large enough to generate steam, for when the rooms are warmed, the surplus heat is allowed to escape through the smoke pipe. The sketch shows an inexpensive and easily constructed gas heater which I have made and used with much satisfaction. A piece of pipe shaped like a horseshoe, with about twelve 2-ft. burners, is inserted in the upper small door of the furnace and supported on the ledge of the small door in the rear. Rubber tubing is attached to the stop-cock and connected with the nearest gas-pipe. After allowing a gallon or so of water to enter the boiler, ignite the heater. Because the burners are in close contact with the boiler, steam is generated quickly and the house becomes warm at trifling expense. Where it is desired to start a coal fire, the heater may be removed instantly and hung on the wall for future use. Of course, with

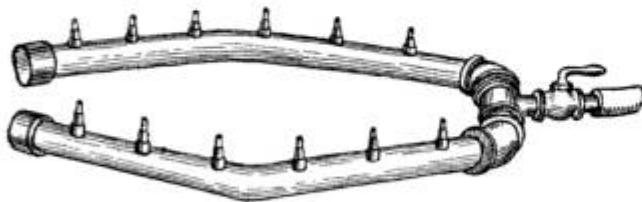

A Temporary Heater

some furnaces, the heater must be shaped a little differently, and the number of burners depends upon the amount of steam needed.—Contributed by G. H. Hill, Montclair, N. J.

### Pincushion and Spool-Holder

An ornamental as well as a useful article for the sewing room is shown in the sketch. When made up and finished in the wood the same as the other furnishings of the room, it will have a neat appearance.

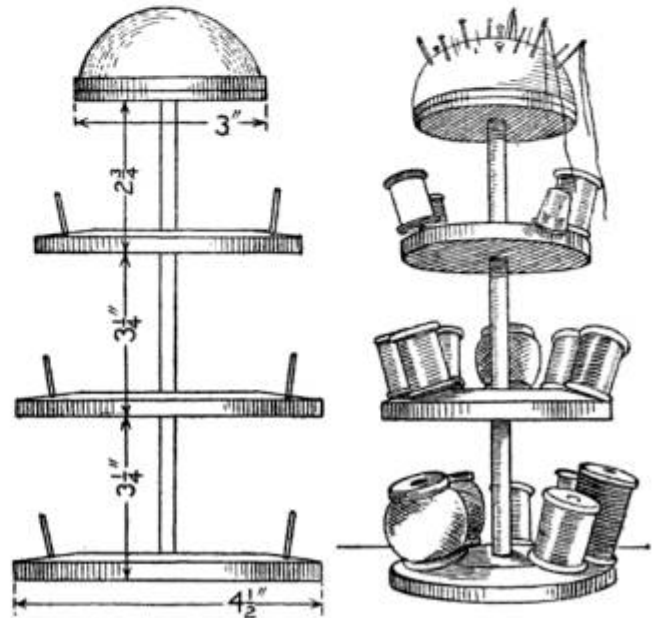

Spool and Needle Holder

The center post is made of a  $\frac{7}{16}$ -in. dowel which is glued into the mortise of the base. The small pins are made of  $\frac{1}{4}$ -in. dowels and six or eight are set into each block. The cushion block is made of two thin pieces, the cushion being made over one and this nailed or screwed to the other before gluing it to the center post.—Contributed by Mrs. Carrie E. Dilly, South Haven, Michigan.

### Removing a Stubborn Nut

Heat an open-end wrench that fits the nut and while hot place it on the nut and allow it to remain for two or three minutes, says the American Machinist. The heat will cause the nut to expand and it can be taken off with ease. A heated wrench gives much better results than a blow torch, as the torch will heat the nut and bolt at the same time, where the hot wrench only heats the nut. Any nut which resists the hot wrench will probably have to be split to take it off.

### Electric Connections for a Dining-Room Table

The many electric devices for cooking a hasty meal have brought about conditions that must be considered when wiring for the electric current in

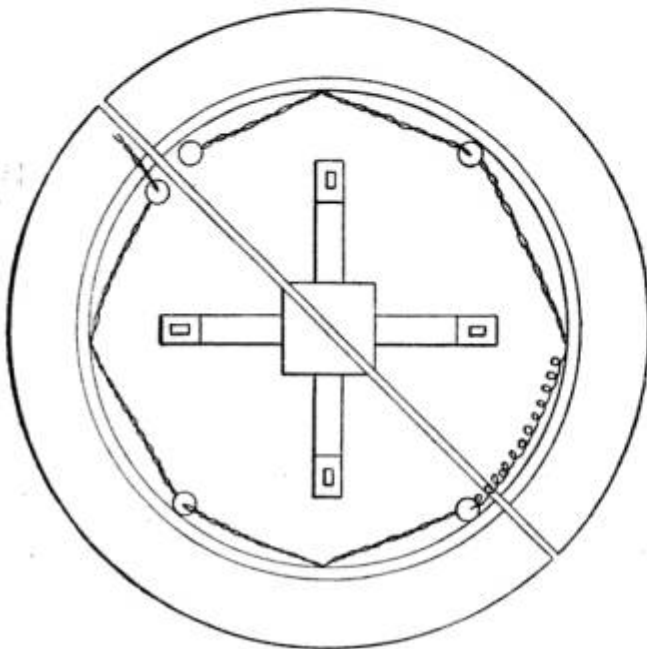

Showing the Wire Connections

order to have the connections near where the utensils are to be used. One family, desiring to have several small heating devices on the dining room table, "electrified" the table top as shown in the sketch.

The electrical equipment of the dining room consisted of the lights, a fan and three practical heating appliances,—a toaster, a coffee percolator and a chafing dish. When the owner of the house first purchased the appliances, he used them on extension cords which were plugged into the lighting fixtures, but he thought this method could be improved upon, so he called in an electrician and had the table wired as shown. A plug was set in the floor under the table and connected in the basement with the main feed wires. The connection between the plug and the tap under the apron of the table is a silk-covered flexible lamp cord of ample capacity to carry the current.

The wiring on the table top was made so that the extension could be drawn out without disturbing the circuit.

The electrical equipment is used at almost every meal. Toast and coffee are made for breakfast; luncheon dishes are frequently prepared in the chafing dish; the after dinner coffee is always made electrically, and frequently little suppers of oysters, rarebits and lobster are given. For formal dinners, a decorative lighting outfit of miniature lamps is used effectively.

### A Shaft's Speed Determined without a Speed Indicator

Having occasion to find the revolutions of a high-speed shaft, and no speed indicator at hand, I used the following method:

I moved the point of a lead pencil along the rotating shaft for a period of 10 seconds, then stopped the shaft and counted the spiral pencil marks. This number I multiplied by 6 which gave me the number of revolutions per minute.

Be sure to keep the pencil moving parallel with the shaft so the mark will be spiral and not one over the other.—Contributed by C. R. Poole, Los Angeles, Cal.

### Aeroplane Steering Wheel

The accompanying illustration shows a simple construction of an aeroplane steering wheel. A 12-in. wheel is made of three pieces of oak,  $\frac{3}{8}$  in. thick and 19 in. square, glued together with the

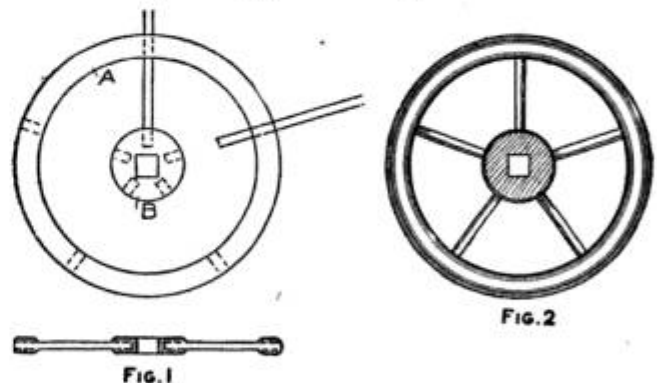

Wheel Made of Wood

grains of adjacent boards crossing at right angles. The rim A, Fig. 1, is sawed from these boards, and holes

bored through for the spokes. The spokes are made of hickory,  $\frac{3}{8}$  in. in diameter. They are fastened with brads and glue. The completed wheel is shown in Fig. 2.—Contributed by F. W. Stromer, Gig Harbor, Wash.

**Sign Painters' Shelf for a Ladder**

I recently saw a sign painter using the device shown in the illustration to hold his materials while working on a ladder. The bottom of the box was placed far enough up to permit an iron clamp to be placed underneath and against the end piece. This clamp fastened the box securely against one of the uprights of the ladder. The box

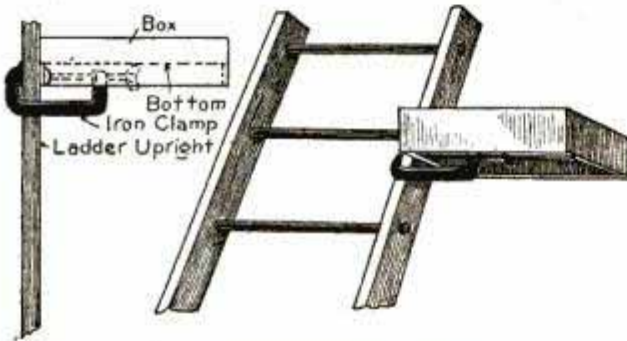

Sign Painters' Ladder Bracket

can be placed on either side.—Contributed by J. M. Kane, Doylestown, Pa.

**Heating Two Offices with One Stove**

In many business places which include a private office and a general waiting room, it is a problem to heat both these rooms effectively with one stove, at the least expense.

The accompanying sketch shows a simple method which has proven satisfactory. Make a connection from any kind of stove through the wall or partition behind the stove with sheet iron, A, Fig. 1. Insert the box-like form from the adjoining room so as to be able to have a turned-back edge (D, Fig. 2) left in the room to be heated, through which to drive nails to hold it in place. Bend and trim the sheet iron at B, Fig. 1, to fit the stove.

The heat is regulated in the inner office by a sliding lift door (C, Fig. 2),

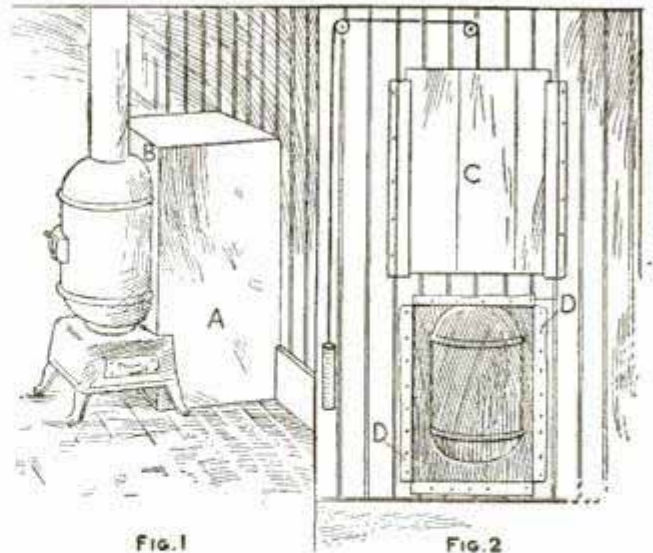

Heat Box on the Stove

which slides in grooves at each side. The door can be raised with a cord and weight, or by having a cord run to some convenient place in the office.—Contributed by Dr. D. D. Smith, Sandusky, O.

**A Gasket Cutter**

The detailed sketch shows an inexpensively made gasket cutter that may be used extensively in many shops. The tool may be of any size and proportion consistent with strength requirements. With the shank fitted to a drill press in the shop, or in a hand brace, it will quickly pay for the trivial expense of its manufacture, both in speed and the quality of work it will do.

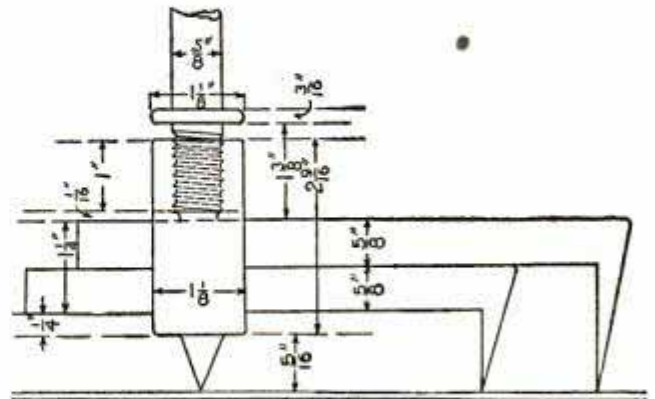

Details of Gasket Cutter

This tool can be used to cut gaskets from almost any material with the exception of metals.—Contributed by F. W. Bently, Jr., Huron, S. Dak.

## How to Weigh an Automobile

The best way to ascertain the weight of a car is to take it to the public weigh scales and, if possible, place it so that the four wheels rest on the scales as shown in Fig. 1.

the combined weight obtained by weighing the car as shown in Figs. 2 and 3 should give the total weight obtained by the method used in Fig. 1 to within a few pounds, but the weight

carried on each of the four wheels is by no means one-fourth of the combined weight. The reason of this is that different bodies are of different weights, and the position of the body and seating capacity has a bearing on the amount of weight thrown on the front and rear wheels. Take, for instance, seven-seated limousine and two-seated runabout bodies that are used on the same chassis. The tires that are just large enough for the latter will be quite inadequate for the former, but the cost of upkeep on the runabout will be decreased if it

is fitted with tires that are large enough for the limousine, although if detachable rims are fitted, a tire of smaller section could be used if desired. However, the cost of the rims would not compensate for the difference in price of the two tires.

## To See Bearings in Fine Die-Cutting

I am a die-maker on watch work, the finest class of work known, and our dies have to be absolutely in perfect alignment. It has been the general custom heretofore to use Prussian blue to enable the cutter to see the bearings. Recently, however, one of our men discovered a new kink which has, with us, superseded the old method. Having a gas flame burning low and red,

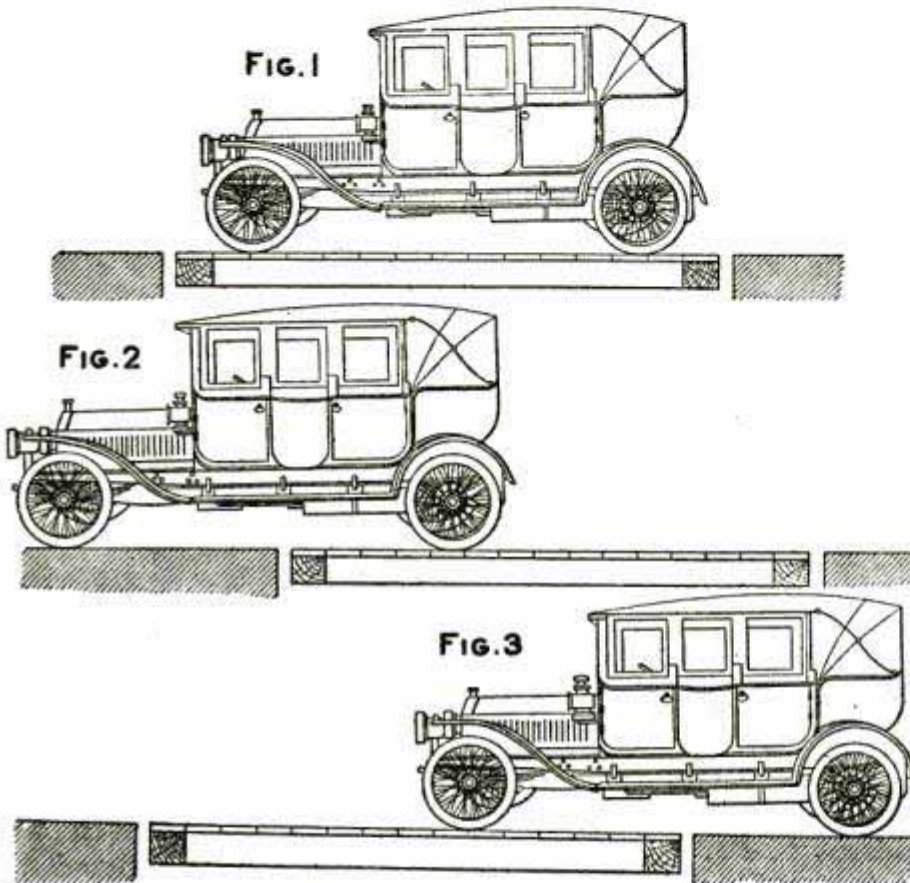

Three Positions in Weighing

Sometimes this is not possible, owing to the great length of the wheelbase and the shortness of the scales, says the Automobile. In any case, the car should be fully equipped with all accessories—spare tires, full tanks, water, oil and gasoline, and each seat that can be occupied filled with a passenger, for reasons that will be made clear. Of course, if the car can be weighed on the scales with both front and rear wheels resting on the bridge, to obtain the total weight it is only necessary to add 150 lb. average for the number of passengers the car will carry, but this does not give the weight per axle or per wheel—the important point in determining the proper size of tires.

It can first of all be assumed that

he accidentally stuck the punch into the flame and thereby got a fine black coating on it. He tried that with the intricate cut he had in hand, and since then we have never used anything else. It is the best thing ever discovered for this purpose, for with it one can find bearings which could never be found any other way. Simply turn the gas down low without any blue flame, turn the punch around a few times, and you get a thin, fine black coating which will show the bright at the slightest touch, and give you every bearing perfectly.—Contributed by J. L. Van La Walker, Springfield, Ill.

### Preventing a Bottle from Tipping Over

The bottoms of bottles or small vials commonly used for holding medicines, extracts or chemicals are so small compared with their weight that they are liable to be overturned and the contents spilled.



A simple expedient to make them more secure is shown in the sketch. The device consists of several pieces of tin about 2 in. long bent at right angles with a pair of pliers. Place

three of them on a round vial at equal distances apart and use four on a square or rectangular-shaped bottle. Bind them tightly with a thread or twine as shown. This will make a base that is secure, and the bottle or vial will slide on a surface before it will tip over.—Contributed by C. S. Browne, Lowell, Massachusetts.

### Planing the Edges of a Board Square

A time-saving method of planing the edge of a board square is to place a perfectly square block of wood on the bottom of the plane near the left side for a guide and holding it with the left hand, as shown in the sketch. This forms a vertical surface true with the

surface of the board and holds the edge of the plane-iron at right angles. A little practice in holding the guide un-

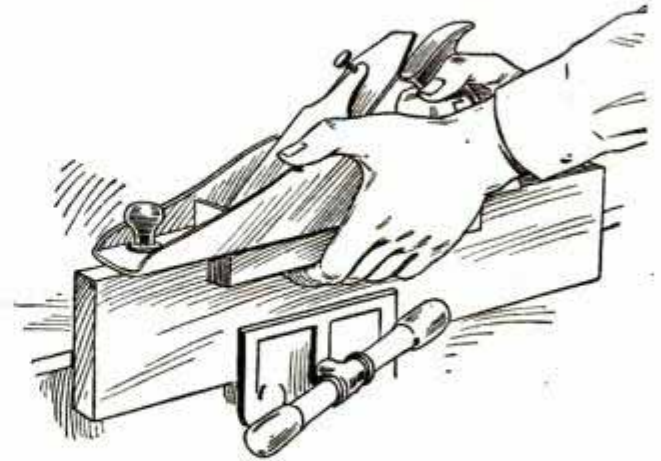

Holding Block on Plane

der the plane will enable one to plane the edge of a board perfectly true.—Contributed by J. J. O'Brien, Buffalo, New York.

### Keeping Drinking Water Clean for Chickens

Cut several lengths of No. 9 wire about 24 in. long and secure them to a board in such a way as to form a circle of radiating wires from a center point similar to the spokes of a wheel. Melt some lead and pour it into the center, and when cold the wires will be fastened

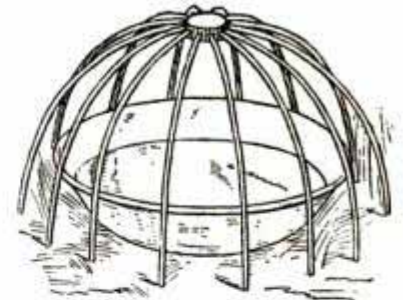

together. Bend the wires in a shape similar to the ribs of an umbrella and set the device over the pan of water, as shown in the sketch. The wires will prevent the fowls from stepping into the pan and give them plenty of room for their heads, when they want to drink.—Contributed by Otto J. Kling, Youngstown, Ohio.

Best results are obtained from hose nozzles made from 6 to 10 times the hose diameter in length, with the hole at the end one-third the hose diameter.

### A Steam-Gauge Alarm

On low-pressure boilers where the attendant is required to do other work away from the boiler room, the electric alarm attachment for the steam gauge shown in the accompanying sketch

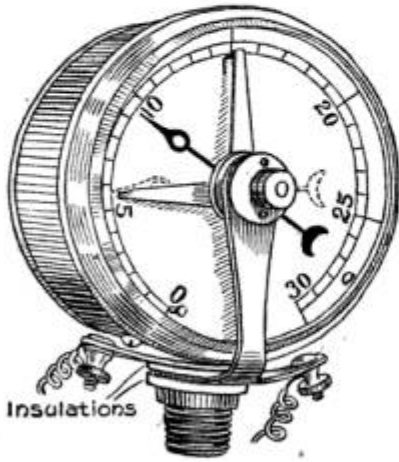

will prove quite valuable. The ordinary alarm attachments provide only for the ringing of the bell when the pressure is either too high or too

low. The one shown not only gives an alarm under either of these extreme conditions, but can be set at any desired pressure instantly. The one shown in the sketch is set for giving the alarm when the high pressure reaches 15 lb. and the low pressure drops to almost 5 lb.

The position of the pointer shown by the dotted lines makes the contact for closing the electric circuit. The thumbnuts for setting the contact points are attached to a piece of brass extending over the edge and glass face of the steam gauge. The glass, being a non-conductor of electricity, provides a way to hold the contact points clear of the metal of the steam gauge. A hole is drilled through the glass in the center for the stems of the thumbnuts. The parts are insulated on the stem as shown.—Contributed by Herman Oenning, Chicago.

### Marking Iron in a Structural Shop

The following method of marking iron will be found very valuable in locating material, saving the fitter's time and saving crane service.

Instruct the layout men to mark all iron as near to the right as possible. The fitter, knowing that all the iron is marked at the right end, can place

it in position for assembling on the skids, thus saving the time it takes to check up and turn some pieces end for end. As all structural shop men know, a fitter will get his iron on the skids, then, after the crane has gone to some other work, he will check up his work and find some of it must be turned. This means a loss of time waiting for the return of the crane. The layer-out must stand while looking at the iron in the same relative position as when looking at the drawing, in order to locate the right end.—Contributed by Edwin J. Knapp, Cleveland, O.

### A Window Sash Stop

The accompanying illustration shows a small device to take the place of an ordinary window stop. It is made of

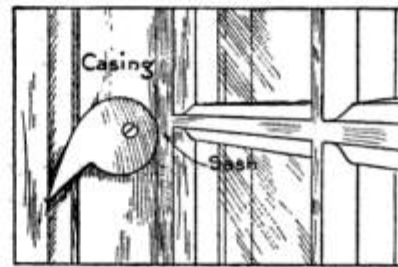

soft wood cut out with a knife. If a more substantial stop is wanted, it may be made of

metal. When two are placed, one on each side of the window casing, one as shown and the other turned over in a reversed position, they will hold the sash immovable.—Contributed by Lily M. Norrell, Blythe, Ga.

### Correct Way to Use a Die

There is a right and a wrong way to use dies as with everything else. You have perhaps noticed that a die seems to work harder and to dig up the threads more at one time than at another. This refers to the round solid type that is split on one side and has a round countersunk hole on each side of the split

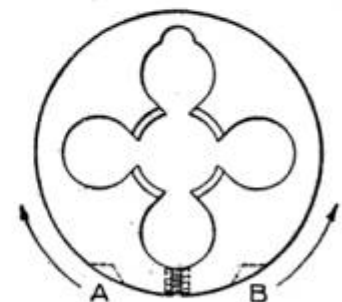



to receive the driving screw from the die stock. If the screw is put in hole A when run on the work and in hole B when backing off, a big difference will be observed. A moment's thought will convince you that this is the logical way, as the natural drag of the die will keep the side opposite the screw from pulling in on the work, and the position of the screw keeps its own side from crowding.—Contributed by D. A. Hampson, Middletown, N. Y.

### Fastening a Hasp from the Inside of a Door

A good way to fasten a hasp or latch to a door and make it impossible to be removed when locked is shown in the sketch here-

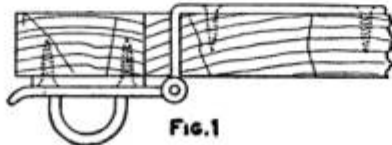

Fig. 1

with. A narrow slot is cut through the door about  $\frac{1}{4}$  in. from the edge and the tongue of the hasp in-

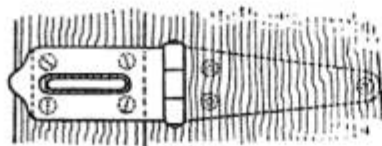

Fig. 2

serted as far as it will go. It is then bent around as shown in Fig. 1 and fastened with screws from the inside. All the screw heads are on the inside or covered as shown in Fig. 2. It cannot be taken from its place but by removing the padlock.—Contributed by Chas. Homewood, Waterloo, Iowa.

### Turnbuckles for Aeroplane Bracing

While building a helicopter I needed a lot of small, light turnbuckles, says a correspondent of Scientific American, and not being able to obtain anything suitable, I made them out of bolts and wire as illustrated in the sketch. They were made of No. 14 soft steel wire and an ordinary  $\frac{3}{16}$ -in. stove bolt. This



Wire and Stove-Bolt Turnbuckle

turnbuckle will easily stand a strain of 200 lb.

### To Make an Electric Gas-Lighter

The electric gas-lighters now on the market are generally high-priced, but here is one that can be easily made at little or no cost. An insulated wire, B, is brought from the battery and wound around the fixture, the end being brought up and bent over the tip, as shown in the diagram. The wire may be held in place at the top of the tip by tape, but care must be taken to keep it well insulated from the fixture.

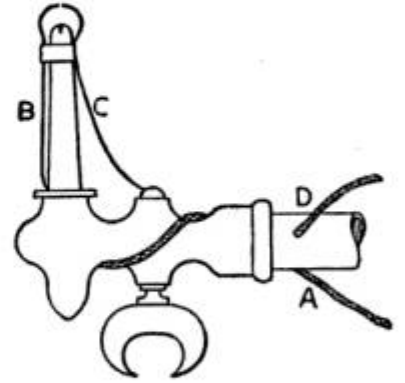

The screw which holds the key in place turns every time the gas is turned on or off. In the slot of this screw is soldered a piece of heavy copper or brass wire, C, which is bent over so as to come in contact with B when the gas is turned on. The contact should be broken just before the gas is turned full on, so that when the gas is burning the two wires are a little distance apart. If these two wires were kept in contact, the battery would soon run down. To complete the arrangement, a wire is grounded on the gas pipe somewhere near the battery. This should be soldered to the pipe to make a good connection.

Electric lighters like this have been in use by the writer for more than six months and give good satisfaction. If the flame is arranged to burn across the plane of the two wires, they will not burn or become coated with soot, although that can be easily wiped off.—Contributed by George Heimroth, Brooklyn, N. Y.

Ⓒ When laying out six holes or dividing a circumference or circle into six equal parts, the straight-line distance is half the diameter—that is, the dividers should be set to the radius of the circle.

## Forcing Lubrication by Centrifugal Force

If the ordinary oil or grease cup is used on a loose pulley, it will not allow the grease to feed on the shaft when the wheel is in motion. This is due to the centrifugal force which tends to keep the oil pressed against the top or cover of the cup.

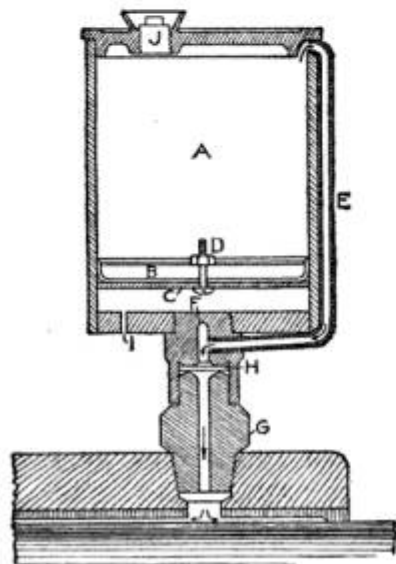

If a small pail is filled with water and swung in a circle in any plane, not a drop of the liquid will be spilled, provided the velocity exceeds a certain value. The oil in the

ordinary oil cup acts the same way when the cup is rapidly rotated. In the accompanying sketch a cup is shown which I have made to use the same force (centrifugal force) to force the oil into the bearing.

The cup is made of any straight-bored cup with a tight-fitting cover, but instead of feeding from the bottom it feeds through a separate pipe, E, whose upper end is attached as near the top as possible. This pipe leads around the cup and into the plug F, which screws into the bottom of the cup. The plug F is blind on the cup side and screws into the plug G, which in turn fits into the hub of the pulley to be oiled. Between the plugs F and G is fitted a diaphragm, H, which is made of sheet lead or soft copper and has a very small hole in its center.

The cup is fitted with a piston, B, which is also made of lead. A cup leather is used over the lead to make it oil-tight and a plate, C, bolted on with a stove bolt, D, whose upper end projects sufficiently to form a stop against the cover of the cup to protect the leather.

The action is simple, as the centrifugal force tends to throw the oil and the piston to the top of the cup. The oil exerts pressure on account of its own centrifugal force, but, as it cannot get away all at once, the pressure of the piston also helps to force it in the course taken by the arrows and then through the hole in the diaphragm H, and on the bearing to be oiled. The size of the hole in the diaphragm varies with the conditions of the pulley to be oiled. High-speed pulleys will naturally have a higher pressure on the oil, therefore they need a smaller aperture to obtain the necessary flow of oil. It is necessary to have a vent, I, in the bottom of the cup to relieve the vacuum under the piston.

This cup has the advantage of feeding only when the pulley is in motion, the only time it needs oiling.—Contributed by L. S. Bunker, Vallejo, Cal.

## Preventing Rats from Gnawing through a Door

Rats and mice usually gnaw a hole through a door at one of the lower corners, as the angle of the crack allows space for breaking away the wood. The rodents can be prevented from gnawing

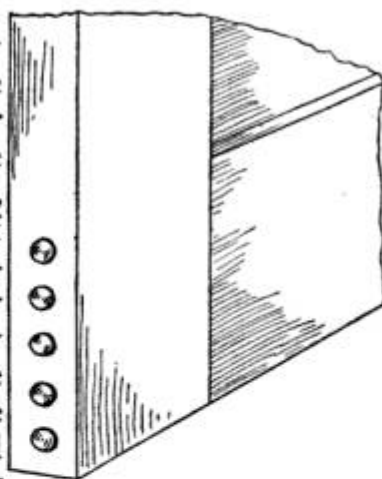

by driving several finishing nails into the wood, as shown in the sketch.—Contributed by W. E. Cleveland, Chicago, Ill.

☞The motorist having need for a funnel when on the road can use the horn as a substitute. It requires but a minute's time to remove the horn from the car, disconnect it and take out the reed.

## Raising Inverted Motors

Under certain conditions the method shown in the illustration will be found excellent for raising a motor to its intended place on a ceiling, says *Electrical World*. The tackle is arranged as shown in Fig. 1. The motor is raised with two ropes, each of which passes through a bedplate bolt hole and over the motor, and is fastened to the eyebolt in the top. The two holes used for the ropes are the ones at diagonally opposite corners. After being made fast to the motor, the ropes are run

can be removed when the motor is in place. When the motor is drawn up against the stringer pieces, two bolts are inserted in the open holes and the nuts are set tightly. The hoisting ropes are pulled out and the other two bolts inserted.

When using this method, it is not necessary to cut large holes in the floor. The stringer pieces through which the holes are bored for the motor supporting bolts are bolted to the beams. Each hole should be  $\frac{1}{8}$  in. greater in diam-

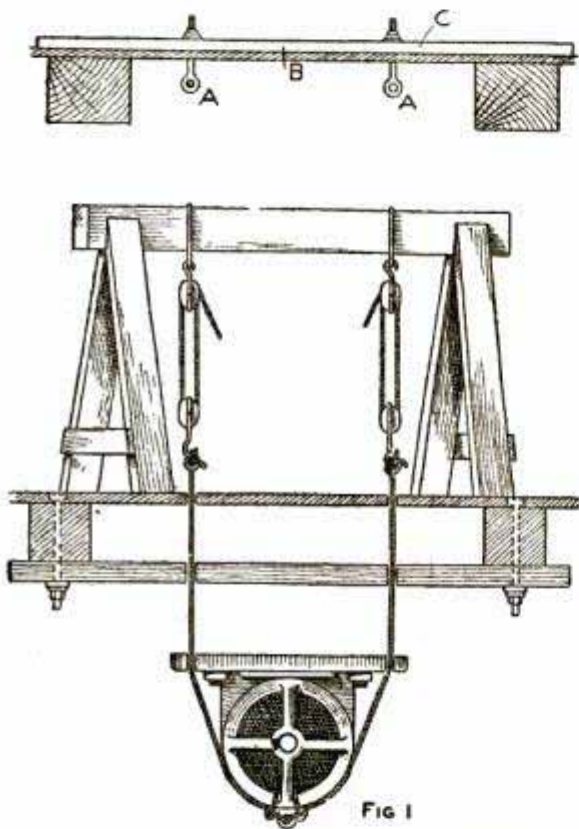

FIG 1

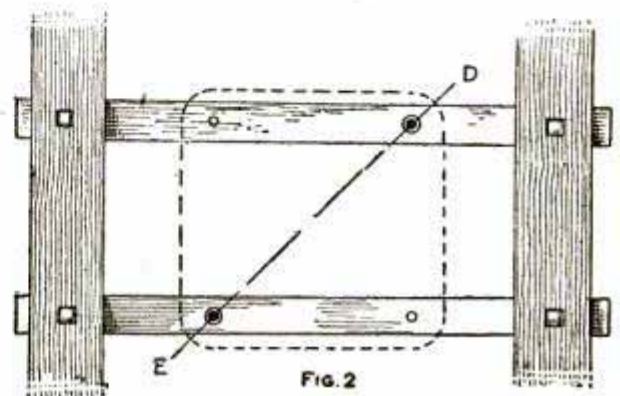

FIG. 2

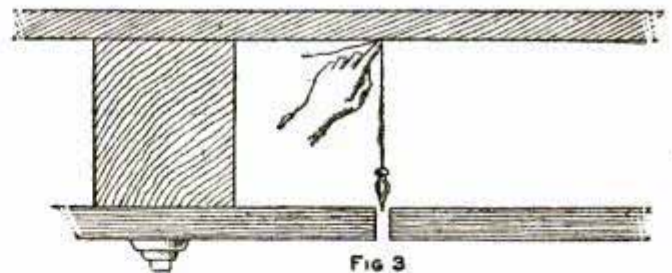

FIG 3

Hoisting an Inverted Motor into Place

through two of the four holes which have been bored through the stringer pieces for the bolts to hold the motor. The ropes are then run through two holes accurately located in the floor above. The plan of the motor base with the diagonal holes located on the line ED is shown in Fig. 2.

The hoist is arranged so that it is directly over the two holes in the floor through which the hoisting ropes pass. Instead of using a horse to support the tackle, it is sometimes best to arrange temporary eyebolts in the floor next above, as shown at A, A. These bolts

eter than the diameter of the supporting bolts. A long bit can be used for boring the two holes for the hoisting ropes through the stringer pieces and the floor. If such a bit is not at hand, the locations of the floor holes can be accurately determined with a plumb bob, as shown in Fig. 3. The floor holes should be large enough to prevent the rope from binding in them.

Iron will show red at 1,000 to 1,300 deg. F., according to the light, and at 700 deg. in the dark.

### A Rural Mail-Box Post

The accompanying sketch shows a rural mail-box post I made, which rests on the ground instead of being set in a hole.

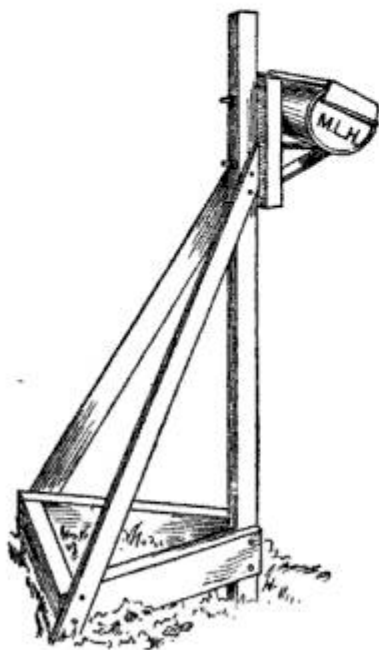

I have moved twice since this post was made and it was easy to place on a load with the household goods.

The post is made of 2-in. by 4-in. material, each piece of the triangle being 2 ft. long and the upright 4½ ft.

high. The braces are ⅝-in. by 2½-in. material, 46 in. long. The block, to which the box is attached, is bolted to the upright so it can be raised or lowered to suit the convenience of the carrier.—Contributed by O. H. Albaugh, Chesterland, Ohio.

### Holding a Hot Cutting Chisel on a Handle

The wood handle of a hot cutting chisel burns from the intense heat and in time the head will become so loose from the shrinking wood that it will slip off when struck a glancing blow. The illustration shows a little device that will hold the chisel and handle together,

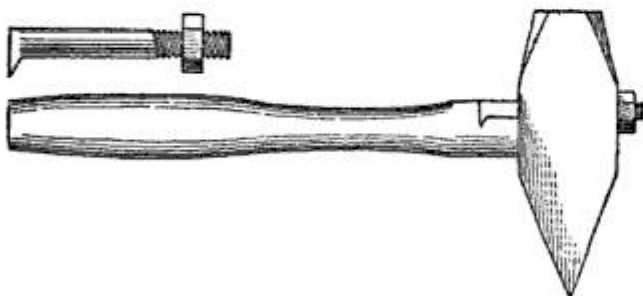

Bolt for Holding Hammer on Handle

no matter how the wood is charred or shrunk. The method of construction

is obvious and does not need further explanation.—Contributed by Walter W. White, Denver, Colo.

### Foot Support for Ladders

Painters and others who work on ladders know how exhausting it is to stand on a rung for any length of time without tiring the feet. One painter overcame this difficulty by making a pair of supports to fit on the soles of his shoes as shown in the sketch. They were made of hardwood, each having two metal clamps screwed to the sides. A strap passes under the support and through the clamps to hold the support against the sole of the shoe.

The device will be a little troublesome when used the first time, but the wearer will soon learn to lift his foot a little higher in climbing a ladder. They will prevent the feet from slip-

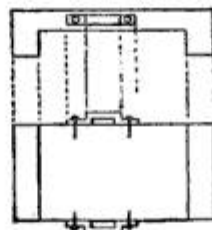

Fig. 1

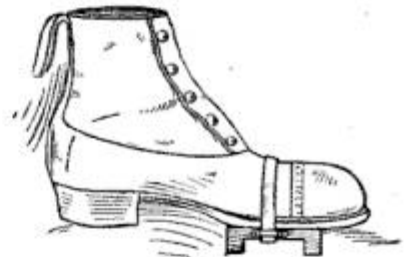

Fig. 2

Support on Shoe

ping on the rungs, but the main advantage is the way they rest the feet and limbs, as the weight of the body is supported on a much larger area of the shoe sole.—Contributed by James E. Noble, Toronto, Canada.

### How to Repair a Canvas Canoe

A good repair job on a modern canvas canoe is sometimes hard to make as it usually leaves a bulge in the canvas over the repaired spot. The exact method of procedure depends on the nature of the hole.

If the defect is only through the canvas, it may be repaired in this way: Pull the canvas loose from the wood for about 2 in. all around the hole and apply a little thick shellac. Next slip a piece of good silk under the hole and

see that it is placed smooth. As soon as the shellac becomes sticky, push the canvas down on the silk as smooth as possible. When the shellac is dry, fill up the crack between the edges of the canvas with a good grade of thick waterproof glue or white lead. When dry, sandpaper and paint. This makes a repair that can hardly be detected.

If the wood is broken, it must be repaired first with either a piece of wood or a thin piece of sheet copper placed over the hole between the wood and the canvas. The space between the copper and the ribs should be filled with wax or some like substance. When this is done, proceed as previously described.—Contributed by L. C. Helm, E. Lansing, Mich.

### Removing a Tight Wood Screw

A screw that has been in the wood for some time is difficult to remove. The more you try to turn it with a screwdriver the worse it gets, and the head is liable to be damaged. Much time and trouble can be saved by heating a rod to a cherry red and placing the end of it on the screw head. Keep it there until the screw has become heated. Allow the screw to cool and then remove with a screwdriver. The expansion of the metal caused by the heat makes the hole larger, and when the screw has cooled and contracted to its normal size, it can be easily removed.—Contributed by Horace A. Person, Washington, D. C.

### Heating Water in a Church Baptistry

There were no arrangements made for heating the water in the baptistry of our church, so the following plan was tried out and worked just as efficiently as a high-priced plant. A water coil heater, E, was made of pipe and fittings and connected to the water-main pipe A and the pipe for emptying the baptistry B, by two pieces of hose, C and D.

After the fire in the furnace burned to coals, the heater E was put in through the door as shown. The water

was allowed to run slowly from the main A and through the coil. Starting this heating device early in the day, the

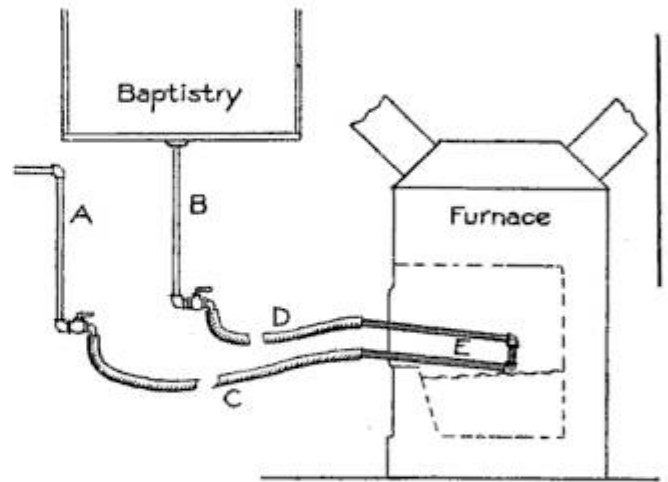

Diagram of Connections

baptistry would be full of warm water for the evening service.—Contributed by Frank H. Morse, Maplewood, Mo.

### A Home-Made Lawn Sprinkler

An inexpensive and easily constructed lawn sprinkler is shown in the

accompanying sketch. Secure a piece of 1-in. pipe, about 2 ft. long, and thread it at both ends. On one end screw a cap, as shown, and on the other end, a pipe tee which is tapped to receive a hose connection. Drill a number of 1/8-in. holes slanting upwards, in the pipe, as shown.

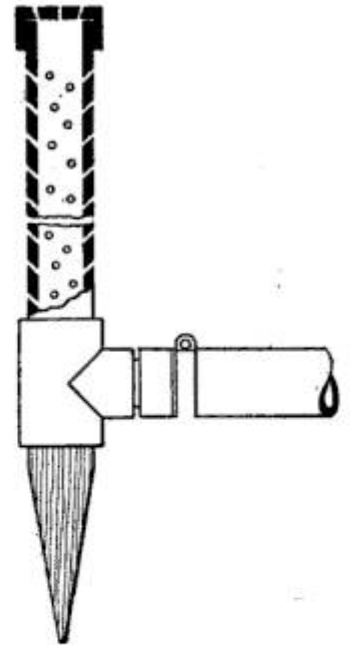

A sharp pin, made of wood and fastened in the tee, serves to hold the pipe upright in the ground. This sprinkler will give as good service as any you can buy and costs less. It is also durable as there is nothing about it that can get out of order.—Contributed by C. C. Brabant, Alpena, Michigan.

### A Cellar for Cold Storage

When keeping my dahlia roots in my home cellar which contains a hot-air furnace for heating the house, I lost

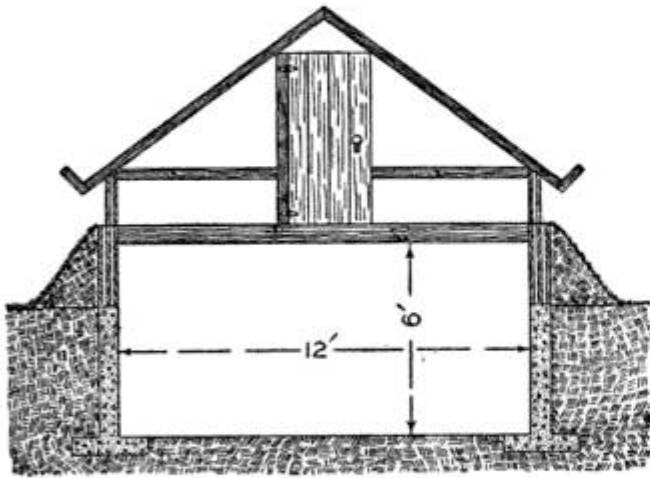

Sectional View of Cellar

many roots by drying and I was forced to get them outside, says a correspondent of Country Gentleman. I designed a cellar for keeping the roots as well as to furnish a place in which to work on sunny spring days. The roof is made of glass which covers the greenhouse part, this being set over a cellar dug in the earth.

The floor was put in loosely with the supposition that the warm air from the cellar would keep the greenhouse from freezing, but instead it helped the cellar to freeze. A small oil stove was sufficient to keep the temperature right during cold snaps in the spring. Such a cellar must be provided with proper drainage in localities where it is necessary.

### Emergency Repair on a Broken Cylinder Head

In case of a broken cylinder head, the following method of emergency repair has by actual test proven satisfactory, although at first sight it is seemingly impractical. Take a piece of tin and cut it the same size as the cylinder head and punch holes for the stud bolts. Fit a piece of hard wood, 3 or 4 in. thick, on the head of the cylinder, allowing 2 or 3 in. to project all around, to prevent the bolts from splitting out. Bore

holes for the stud bolts, marking their positions from the broken pieces of the cylinder head. Make new stud bolts long enough to extend through the packing tin and the wood, with nuts and wide washers. Pack carefully between the tin and the cylinder with any good sheet packing and use care in tightening up the nuts evenly all around. I have seen a locomotive use this repair on one cylinder doing heavy work for more than one week, or until permanent repairs could be made.—Contributed by D. Bittenbender, Northwestern, Cal.

### How to Harden and Temper a Lathe Tool

Many persons can forge a perfect lathe tool but, for some reason, have trouble when they undertake to temper it. I have many times noticed lathe tools with the cutting edge nicked or broken about  $\frac{1}{2}$  in. from this edge.

An inside boring tool is shown in Fig. 1. When hardening this tool, it is not good practice to hold it as indicated by the dotted line C while in the cooling bath. Heat it to the hardening temper up to this line, and plunge the entire tool, cutting edge down, in the bath. This will prevent breaking off the short end. Polish the tool as far back as the line C. Heat a pair of tongs to almost white heat, and place the tool between the jaws, as shown by the dotted line B. The size of the

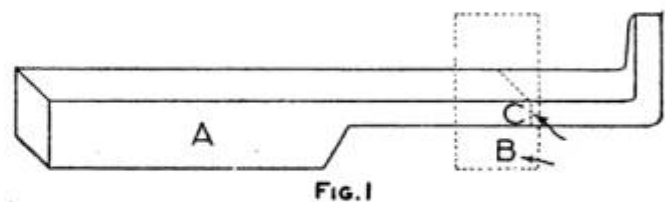

FIG. 1

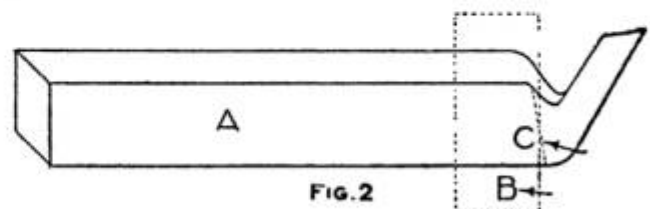

FIG. 2

Tempering Lathe Tools

tongs will, of course, depend on the size of the tool. The hot tongs will

cause the temper to be drawn even, and the tool will be soft enough to file a short distance back from the cutting edge.

In most cases the temper should be drawn to a light blue and cooled in a bath of clear cold water with a quantity of salt added to make a brine. In Fig. 2 is illustrated the same method applied to a diamond-point tool.—Contributed by J. N. Bagley, Webber, Kansas.

### Treating a Cracked Hoof

The proper place to stop the movement of a cracked hoof is at the top of the crack where the new horn is being formed at the coronary band, says the American Blacksmith. The thing to



do is to cut a groove down through the horn on each side of the crack and about  $\frac{5}{8}$  to  $\frac{3}{4}$  in. from it, at the top, and coming to a point about  $\frac{1}{2}$  in. down the hoof. This will form a V-shaped line with the crack in the middle, as shown in the sketch. Clamp the V-shaped part of the hoof about half way up and draw a hot iron deeply across the top of the V, just above the horn.

Any flat, ordinary or bar shoe will do, if the bottom of the hoof is properly leveled. A clamp or two may be put in below the V. If the horn is kept at work, it will not grow together again. The object is to keep the part where the new horn is being formed from moving, and by practically isolating it from the other part of the hoof, nature is given a chance to do the work under most favorable circumstances

### A Steel Scraper

The steel scrapers shown in the accompanying illustration are made of stout pieces of clockspring, inserted in slots sawn in short wooden handles. They are handy for removing dirt and grease from machinery or old paint

from uneven surfaces. The scraper blade is secured by wiring the handle or using a ferrule. Scrapers of various

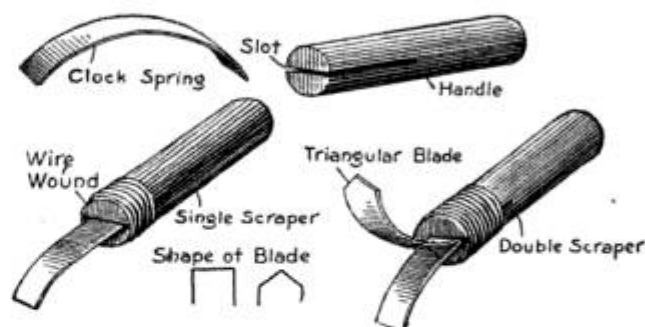

Parts of the Scrapers

degrees of strength and flexibility can be fashioned from different sizes of springs. The double scraper has a triangular-edged blade added for use on carved or indented surfaces.—Contributed by James M. Kane, Doylestown, Pa.

### Keeping Paint from Running Down a Brush Handle

When painting a ceiling or overhead work the paint will run down through the bristles of the brush and onto the handle, making it disagreeable for the workman. I made an attachment as shown in the sketch for catching and holding any surplus color coming from the brush. The attachment is made of tin, funnel-shaped and nailed at the top edge of the metal around the handle. If tight joints are desired, they may be soldered. The paint caught in this cup will run back into the brush when it is held with the handle up.—Contributed by Ben Hemerka, Shamokin, Pa.

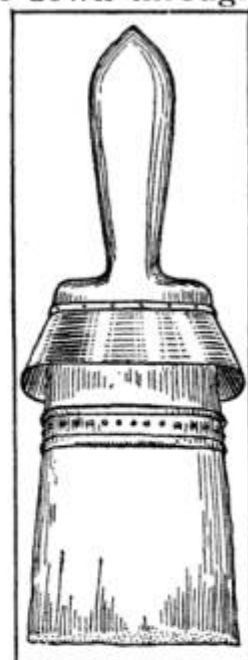

Work being turned on a lathe should never be allowed to "squeak" on the centers.

### Doubling the Lift of the Suction Pump

It is well known that the height through which the ordinary suction pump will lift water is never much over 30 ft., and indeed rarely exceeds 25 ft. after some service, although the theoretical distance is nearly 34 ft. It is therefore somewhat of a novelty to find a suction pump having an effective lift of over 50 ft.

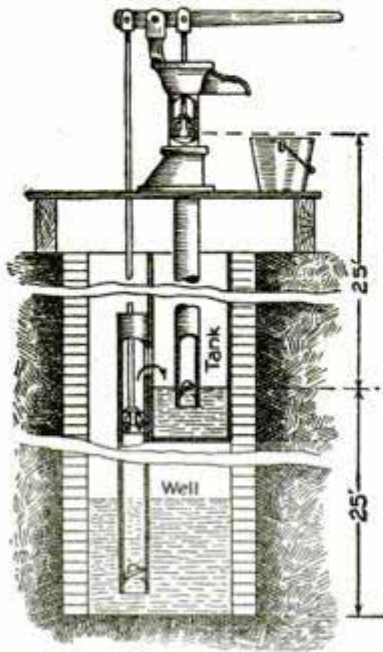

Such a pump was described in a recent issue of *Practical Engineer*. The explanation, however, is simple. Instead of using one suction barrel, two are employed in this case, the piston rods being attached one on each side of the pivot of the pump handle. The pump to the left elevates the water from the well about 25 ft., and discharges into a tank supplying the other pump, the water thus being relayed to the surface in two stages. It is obvious that the pumps must work at the same rates in order to obtain the best effect from the apparatus.

### A Pipe-Cleaner That Is Clean

An ordinary bicycle foot-pump makes an effective pipe-cleaner and can be used without soiling the hands during the operation. Unscrew the stem of the pipe and insert in its place the nipple on the end of the pump hose. Then simply press down the plunger of the pump a few times, and all the accumulated "nicotine" and tobacco will be forced through the bowl of the pipe, rendering it sweet and clean.

The bicycle pump may also be used

to clean the tubes of a gas stove, by attaching it to one of the tubes or at the top of the burner with a section of small rubber hose. The air pressure will force out all the sediment from inside the burner and pipes.—Contributed by A. A. Houghton, Northville, Mich.

### Cranking a New Automobile Engine

Engines on large automobiles when new or just after taking up the bearings are hard to crank by one man. In such a case, instead of wasting strength by trying it alone, loop a rope over the starting crank and get as many persons as required to give the first quick turn. When a magneto is the only means provided for furnishing the spark, this method is especially adapted, as the position may be advanced to where a good spark can be obtained at a slow speed and yet without fear of having a "kick back." The latter, if sufficiently violent, will simply pull the rope out of the hands.—Contributed by M. R. Wells, Cleveland, O.

### Adjustable Level Fastenings for a Straightedge

The illustration shows a convenient level attachment for a straightedge. Setting the ends of the level to an angle with the straightedge by the bolts, an accurate grade can be secured for ditching and the laying of drain tile.

The straightedge should be carefully jointed on the lower edge and the bolts

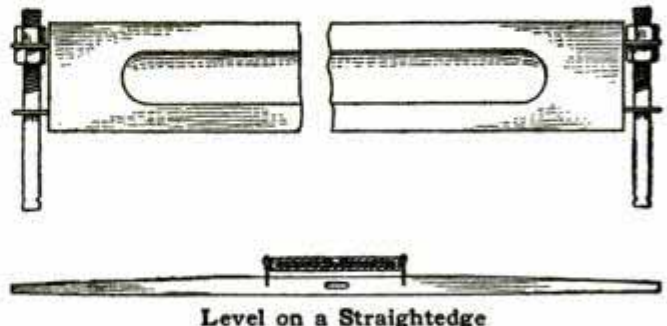

Level on a Straightedge

fastened to its side with nails or screws in the notches. Screw eyes are used in the ends of the level for the adjusting bolts and nuts.—Contributed by Geo. H. Sogle, Riverside, Wash.



### To Get a Natural View from a Photograph

In photographs, half-tone prints, etc., the pictured objects appear flat when viewed with the naked eye in the open light. To bring out the perspective and to have the objects appear in their natural positions, the same as when viewed through a large magnifying glass, a simple arrangement may be used. Take a piece of moderately stiff dark paper, say 12 in. square, and make it into the form of a cylinder having a diameter of about 2 in. View the picture through this cylinder, holding it up to one eye while the other is kept closed.—Contributed by L. Bogia, Philadelphia.

### Locking Flat-Head Screws

After having considerable trouble with some flat-head screws coming loose on an automobile, I tried with success the following method of fasten-



ing them. Each screw was turned up tightly and then the

position of the slot marked with a small sharp chisel. The screw was then removed and a small notch cut in the face of the countersunk hole. The screw was then replaced and part of the head driven down into the notch as shown in the sketch. This effectually locks the screw.—Contributed by Harry G. Fesenfeld, Black Earth, Wis.

### How to Make a Pair of Shoe Trees

Obtain some soft pine blocks about 3½ in. long and 2 in. thick, cut them to the desired shape and sandpaper the surfaces smooth. In the center of the rear end of these blocks bore a ¼-in. hole, 1 in. deep, and glue a piece of reed or cane of the same diameter in it, making the whole thing some 2 in. longer than the shoe. Insert the block in the toe of the shoe and bend the reed into a bow with the free end pressing

against the inside of the heel. It is obvious that the extra length of the

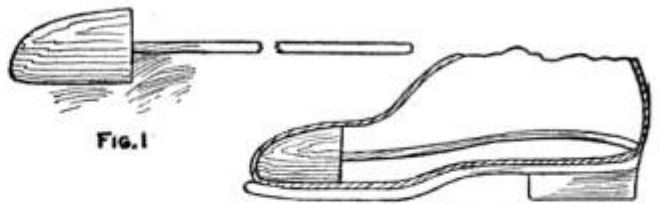

FIG. 1

FIG. 2

Tree in the Shoe

reed will make the trees adjustable to the different sizes of shoes.—Contributed by Katharine D. Morse, Syracuse, N. Y.

### Making Brass Castings a Bronze Color

Dissolve 1 lb. of sal ammoniac in about ½ gal. of water. Thoroughly cleanse and remove all grease from the casting and heat it until the metal becomes red. Then plunge it into the solution and remove it quickly so that it will cool in the air. The surface will take on a light golden color.—Contributed by Peter Matik, Everson, Pa.

### Rubber-Hose Holder for Barrels

The end of an ordinary rubber hose will not stay in a barrel or trough if there is much pressure on the water running through it. The hose will have a tendency to straighten out under the pressure and fall from the barrel and wet things generally, besides wasting the water. In Fig. 1 is shown an attachment for a barrel, and in Fig. 2, the way it is used for holding the end of a hose. It is made of a strip of iron,

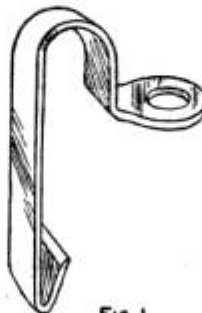

FIG. 1

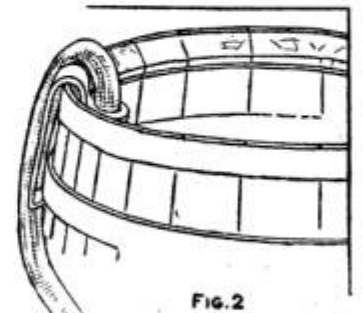

FIG. 2

Holder Attached to a Barrel

bent and sharpened at the bottom so it can be slipped under a hoop, and an opening made at the top to admit the hose.

### A Safety Whistle

While visiting a small plant located in the country, I noticed the device shown in the accompanying sketch and questioned the engineer, who also acted

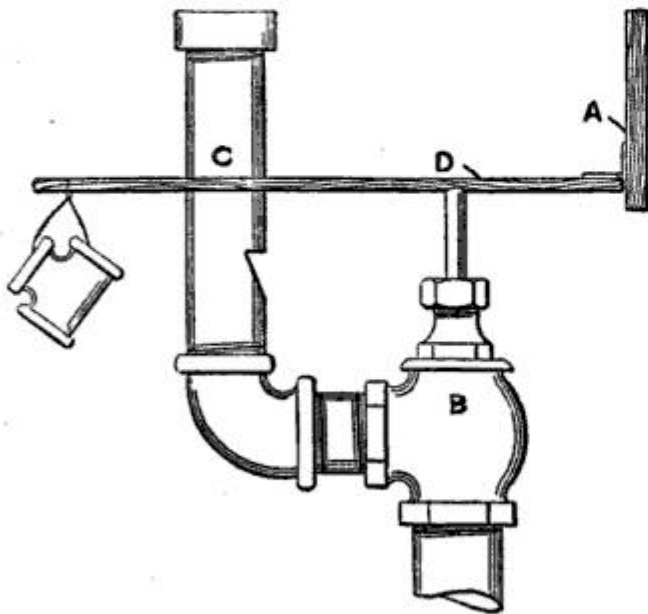

Valve and Whistle

as fireman, concerning it, says a correspondent of Power. He stated that when the old safety valve gave out after 60 years' use on various boilers, his employer would not purchase another, as there was no compulsory boiler inspection at the time. He therefore became apprehensive as he was often obliged to leave the boiler room after making a new fire, and as a result frequently stopped work in another part of the building and waited for the crash.

Becoming tired of this he made the alarm shown in the sketch, and attached it to the boiler. The piece of plank, A, is nailed to the rafters above and to this is hinged the stick D, about 4 ft. long. The angle valve B has the thread filed off the stem and the wheel removed, the upper part of the stem bearing on the stick D, while C is a whistle made from a piece of pipe. The tee hung at the end of the stick serves as a weight for varying the pressure at which the whistle will blow. All the fittings and pipe are  $\frac{1}{2}$  in.

With this device installed, when the pressure reaches the safety limit, the whistle blows and the engineer hurries to the boiler room and checks the fire.

### Measuring Gasoline in a Tank

The use of a small glass tube will be found a simple and accurate method of determining the depth of gasoline contained in the tank of either an automobile or a launch. The tube should be about  $\frac{1}{4}$  in. in diameter and long enough to project a few inches above the top of the tank.

Insert the tube carefully in the tank and when it touches the bottom, place the thumb firmly over the top of the tube and withdraw it. The depth of the gasoline will be clearly indicated by the gasoline in the tube.—Contributed by D. F. Southgate, Rochester, New York.

### Air Blasts Across Spark Gaps

An air blast across the spark-gap of a wireless instrument is said to materially increase the efficiency of the transmitter. The spark-gap is kept cool and at a practically uniform resistance, which allows the transmitter to be used indefinitely without the spark varying in pitch. Gases formed by the oxidation of the metal by the air, and which allow brush discharges of lower potential to pass and give varying and rough notes in the spark are dispersed.

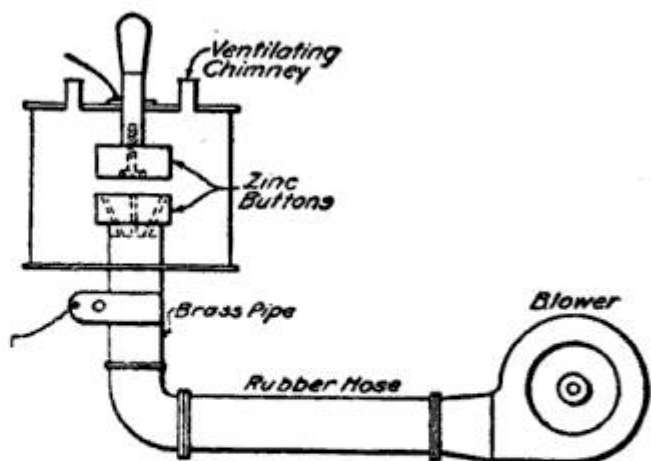

Diagram of Spark-Gap Air Blast

One means of providing an air blast is shown in the illustration. The gap proper consists of two zinc disks. The lower disk has a shoulder turned with a slight taper so that it will fit snugly into a piece of  $\frac{5}{8}$ -in. brass pipe about 6 in. in length. Six holes are drilled

through the disk, these converging within the shoulder to form a passage for the air. A shoulder and length of rubber hose lead from the brass pipe to the blower. The blower starts automatically with the starting of the transmitting motor-generator set, and is placed outside the operating room so that its noise will not interfere with the receiving of signals.

### Nailing Warped Boards

A great deal of trouble has been experienced by every carpenter in nailing baseboards that are warped and

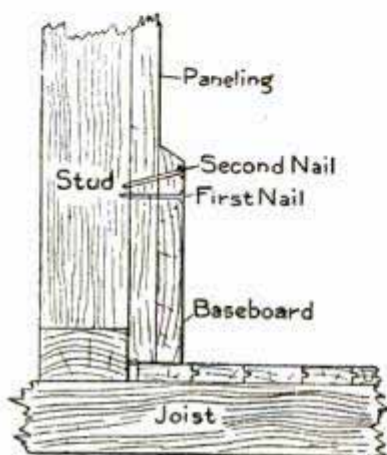

springy against panels, as the boards are sure to jump apart when the nail that has drawn them together is "set." This trouble can be avoided by driving a

nail home straight through the two boards at right angles to their surfaces and tapping it until the boards are drawn tightly together, then, before setting this nail, drive another home close to the other at an angle of about 60 deg. to the face of the board. Both nails can be set without danger of the boards springing apart.—Contributed by L. M. Hodges, San Jose, Cal.

### Gauge and Vent for a Funnel

In pouring liquids into barrels or receptacles where the contents cannot be seen, the attachment for an ordinary funnel as shown in the sketch will prove advantageous. The small tube vents the receptacle being filled, and when full the wire indicator will rise. The tube is made of tin and soldered into the funnel. A stiff wire with a cork attached to the lower end is placed inside the tube. The cork is made smaller

in diameter than the hole of the tube. When the level of the liquid strikes

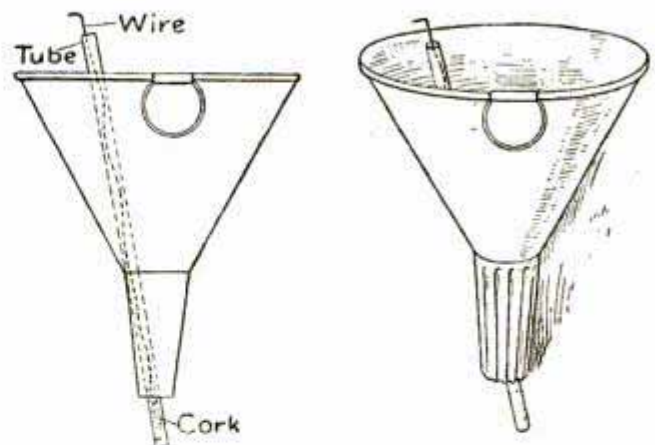

FIG. 1

FIG. 2

Tube inside of Funnel

the end of the tube, the cork will float and carry the wire up, thus indicating that the receptacle is full.

### An Eye Shade

The eyes may be protected from the blinding glare of a light by taking a piece of paper (8 by 11 in. is a good size), folding it in the center, inserting a rubber band in the crease and adjusting the rubber over the head with the paper hanging over the eyes.—Contributed by A. S. Allen, La Belle, Mo.

### How to Make a Double Trouser Hanger

The hanger is made of a piece of heavy iron wire bent as shown in Fig. 1. The length of the wire used for each hanger is about 43 in. One pair of

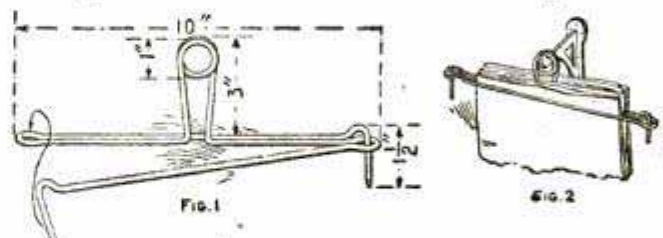

FIG. 1

FIG. 2

Made of Wire

trousers can be clamped on each side of the hanger. The arrow shows the way the hook is inserted in the hole. The hanger in use is shown in Fig. 2.—Contributed by K. Kuga, Hoquiam, Washington.

### Holding Dipper on a Vessel Rim

The person who handles paint, soft tar or oil in barrels, usually puts the dipper to drain on a board or on the

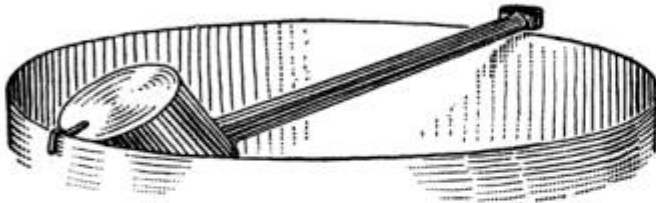

Hook on Dipper Bottom

edge of the barrel so that the liquid will get on the side of the barrel and on the floor. This is a nuisance, which can be avoided by simply soldering a hook on the bottom of the dipper. It can then be hung on the inside of the barrel as shown.—Contributed by W. A. Jaquythe, Richmond, Cal.

### Etching on Glass

A very easy and cheap formula for etching on glass, given by Pottery and Glass, is as follows: Barium sulphate, 3 oz.; ammonia fluoride, 1 oz. To the foregoing is to be added enough sulphuric acid to decompose the ammonia fluoride and make a mixture of semi-fluid consistency. It must be prepared in a leaden vessel and kept in bottles coated inside with a thick layer of paraffin, beeswax or gutta percha, and closed with rubber stoppers. The mixture can be used for printing with rubber letters for stencils, and be thinned so as to use with a common pen. The fumes are poisonous, and contact with the flesh should be avoided.

All glass, even the hardest, may be etched, but highly alkaline glass offers the greatest resistance to the influence of acids. Hydrofluoric acid develops in gaseous form from fluorspar, when the latter, in finely pulverized form, is wetted with strongly concentrated sulphuric acid.

For this purpose, vessels made of materials not affected by the acid are used, such as lead, platinum, rubber and gutta percha. The etching is accomplished by coating the glass surface with beeswax, paraffin or other suit-

able resistant, and then tracing the design desired, whether letters, figures or scrolls, by means of a stencil. A suitable pencil is used to remove the resistant, while the acid etches only the uncovered part of the glass. For lettering, an oiled paper, such as used in stenciling match designs, makes as good a pattern as sheet steel, and is more readily and cheaply prepared.

For rapid work, the following formula will be found of service:

	No. 1	
Fluor-Ammonia.....	1 lb.	
Hydrofluoric Acid.....	0.5 "	
Sulphuric Acid.....	0.1 "	
Ammonia.....	0.1 "	
Water.....	0.1 "	
	No. 2	
Fluor Soda.....	1 lb.	
Sulphuric Acid.....	0.2 "	
Water.....	4 "	
	No. 3	
Carbonate Ammonia.....	2 lb.	
Sulphate Ammonia.....	1 "	
Hydrofluoric Acid.....	1 "	
Water.....	1 "	

Such baths produce in five to twenty minutes, according to the purity and strength of the materials used, a silky frosting or matt etching. Before frosting, the glass should be cauterized for one minute by immersion in diluted hydrofluoric acid, rinsed in warm water and then put into the frosting bath.

### Turning Large Screws with a Small Screwdriver

While driving a number of large screws with a small screwdriver, as nothing in proportion to the size of the screws was at hand, I found it hard to turn the screws after they were about half way in and was unable to turn them without splitting or spoiling the heads.

After spoiling several screws, I tried striking them a light blow with a hammer when unable to turn them farther and found that they could be turned easily. This did not injure the holding quality to any extent. These screws were placed in soft wood, but when striking them in hard wood there is some danger of splitting the wood. Experience will teach about how heavy a blow to strike.—Contributed by Felix Herz, Goldfield, Colo.

# AMATEUR MECHANICS

## Hand Sled Made of Pipe and Fittings

The accompanying sketch shows how an ordinary hand sled can be made of  $\frac{3}{4}$ -in. pipe and fittings. Each runner is made of one piece of pipe bent to the proper shape. This can be accomplished by filling the pipe with melted rosin or lead, then bending in the shape desired, and afterward removing the rosin or lead by heat. Each joint is turned up tightly and well pinned or brazed. One of the top crosspieces will need to have right-hand and left-hand threads or to be fitted with a union. Also, one of the top pieces connecting the rear part to the front part of each runner must be fitted in the same way. The top is fastened to the two crosspieces.

Such a hand sled can be made in a few hours' time and when complete is

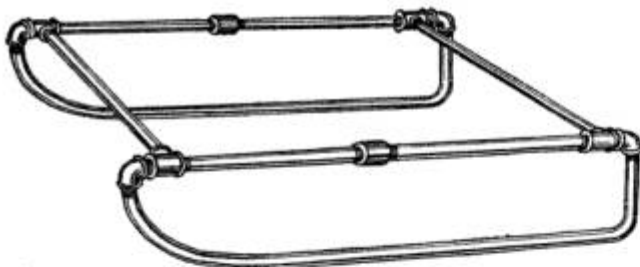

Parts Made of Pipe Fittings

much better than a wood sled.—Contributed by James E. Noble, Toronto, Ontario.

## Bent-Iron Pipe Rack

Strips of soft iron,  $\frac{1}{4}$  or  $\frac{3}{16}$  in. in width and  $\frac{1}{32}$  in. thick, are used in making the pipe rack shown in Fig. 1. This material can be obtained from any local hardware dealer who carries bar iron in stock.

Draw a sketch of the design full size on paper, then run a string over each part, which when straightened out will give the length. The scrolls are bent

with a pair of round-nose pliers. These with a pair of flat-nose pliers

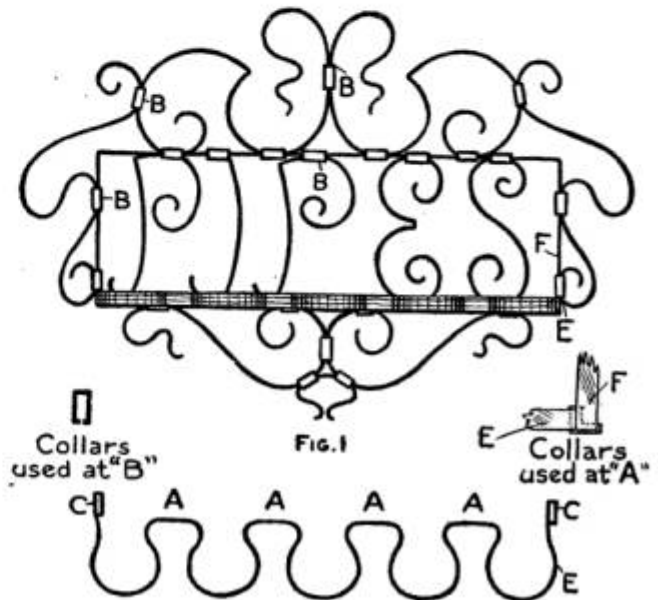

Fig. 2

Design of a Rack

are all the tools necessary. The part for holding the pipes is shown in Fig. 2. The end elevation at E and F shows how the rack is fastened to the main frame of the back.—Contributed by J. W. Vener, Boston, Mass.

## Emergency Magnifying Glass

When in need of a microscope for the study of botany, one may be made in the following manner: Bend a small wire or the stem of a leaf so as to form a small loop not larger than the ordinary drop of water. When this is done place a drop of clear water in the loop and the microscope is complete.



Loop Enclosing a Drop of Water

This temporary device will prove valuable where a strong magnifying glass is not at hand.—Contributed by Arthur E. Joerin, Paris, France.

### Home-Made Electric Clock

The clock illustrated herewith is driven by means of electromagnets acting directly on the pendulum bob. Unlike most clocks, the pendulum swings

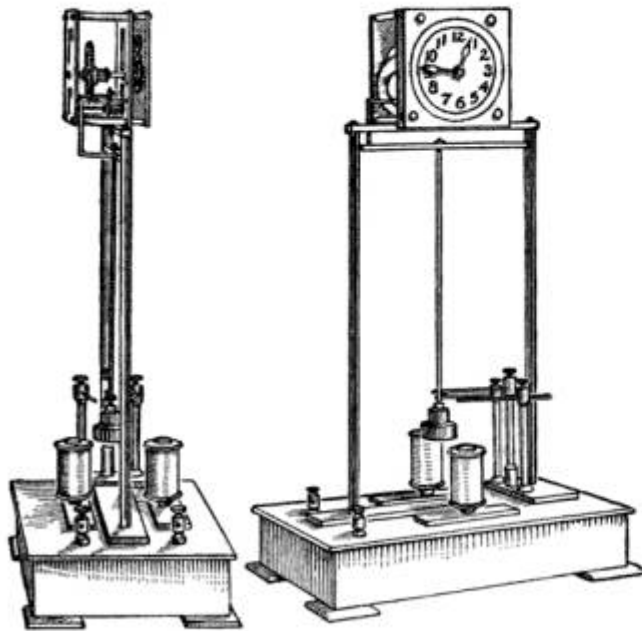

Magnetic Clock

forward and backward instead of laterally. The construction is very simple, and the result is not only novel but well worth while, because one does not have to bother about winding a clock, such as this one, says the *Scientific American*.

The clock is mounted on a wooden base measuring  $3\frac{3}{4}$  by  $6\frac{1}{2}$  in., by  $1\frac{5}{16}$  in. thick. Secured centrally on this base is a  $\frac{1}{8}$  by  $\frac{3}{4}$ -in. bar, 6 in. long and at each side of this,  $\frac{5}{16}$  in. away, is an electromagnet,  $\frac{3}{4}$  in. in diameter and  $1\frac{7}{16}$  in. high. Two uprights,  $7\frac{1}{2}$  in. high and  $\frac{1}{4}$  in. in diameter, are secured in the base bar, and are connected at the top by a brass yoke piece on which the clock frame is supported. Just below the yoke piece a hole is drilled in each upright to receive the pivot pins of the crosspiece secured to the upper end of the pendulum rod. The pendulum bob at the lower end is adjusted to swing just clear of the electromagnets. Mounted at the right-hand side of the base are three tall binding-posts, the center one being  $2\frac{3}{4}$  in. high, and the other two  $2\frac{5}{8}$  in. high. Each is fitted with a piece of copper wire pro-

vided with a small brass spring tip. These springs lie in the plane of the pendulum, which serves to swing the central tip first against one and then against the other of the side tips, thereby closing the circuit of first one magnet and then the other. Each magnet attracts the pendulum until its circuit is broken by release of the center tip, and on the return swing of the pendulum the circuit of the other magnet is similarly closed. Thus the pendulum is kept in motion by the alternate magnetic impulses. The clock train is taken from a standard clock and the motion of the pendulum is imparted to the escape wheel by means of a pawl, bearing on the latter, which is lifted at each forward stroke of the pendulum by an arm projecting forward from the pivotal end of the pendulum rod.

### Method of Joining Boards

The amateur wood-worker often has trouble in joining two boards together so that they will fit square and tight. The accompanying sketch shows a simple and effective method of doing this. Secure a board, A, about 12 in. wide that is perfectly flat.

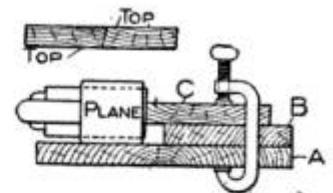

Fasten another board, B, about 6 in. wide, to the first one with screws or glue. Now place the board to be joined, C, on the board B, letting it extend over the inside edge about 1 in. and fastening it to the others with clamps at each end. Lay the plane on its side and plane the edge straight. Place the second board in the clamps in the same manner as the first, only have the opposite side up. If the cutting edge of the blade is not vertical, the boards planed in this manner will fit as shown in the upper sketch. In using this method, first-class joints can be made without much trouble.—Contributed by V. Metzsch, Chicago.

## How to Lay Out a Sundial

The sundial is an instrument for measuring time by using the shadow of the sun. They were quite common in ancient times before clocks and watches were invented. At the present time they are used more as an ornamentation than as a means of measuring time, although they are quite accurate if properly constructed. There are several different designs of sundials, but the most common, and the one we shall describe in this article, is the horizontal dial. It consists of a flat circular table, placed firmly on a solid pedestal and having a triangular plate of metal, Fig. 1, called the gnomon, rising from its center and inclined toward the meridian line of the dial at an angle equal to the latitude of the place where the dial is to be used. The shadow of the edge of the triangular plate moves around the northern part of the dial from morning to afternoon, and thus supplies a rough measurement of the hour of the day.

The style or gnomon, as it always equals the latitude of the place, can be laid out as follows: Draw a line AB, Fig. 1, 5 in. long and at the one end erect a perpendicular BC, the height of which is taken from table No. 1. It may be necessary to interpolate for a given latitude, as for example, lat.  $41^{\circ}-30'$ . From table No. 1 lat.  $42^{\circ}$  is 4.5 in. and for lat.  $40^{\circ}$ , the next smallest, it is 4.2 in. Their difference is .3 in. for  $2^{\circ}$ , and for  $1^{\circ}$  it would be .15 in. For  $30'$  it would be  $\frac{1}{2}$  of  $1^{\circ}$  or .075 in. All added to the lesser or  $40^{\circ}$ , we have  $4.2 + .15 + .075$  in. = 4.42 in. as the height of the line BC for lat.  $41^{\circ}-30'$ . If you have a table of natural functions, the height

of the line BC, or the style, is the base (5 in. in this case) times the tangent of the degree of latitude. Draw the line AD, and the angle BAD is the correct angle for the style for the given

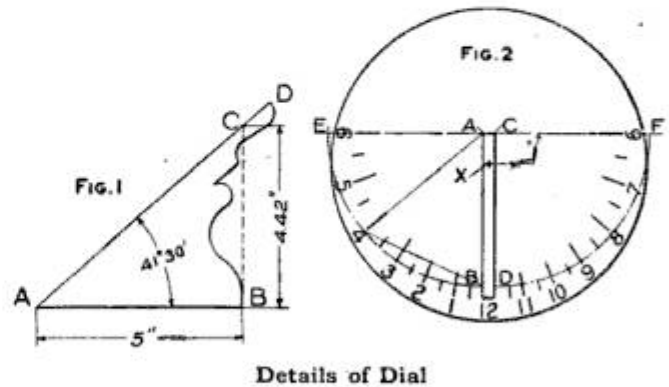

latitude. Its thickness, if of metal, may be conveniently from  $\frac{1}{8}$  to  $\frac{1}{4}$  in.; or if of stone, an inch or two, or more, according to the size of the dial. Usually for neatness of appearance the back of the style is hollowed as shown. The upper edges which cast the shadows must be sharp and straight, and for this size dial (10 in. in diameter) they should be about  $7\frac{1}{2}$  in. long.

To lay out the hour circle, draw two parallel lines AB and CD, Fig. 2, which will represent the base in length and thickness. Draw two semi-circles, using the points A and C as centers, with a radius of 5 in. The points of intersection with the lines AB and CD will be the 12-o'clock marks. A line EF drawn through the points A and C, and perpendicular to the base or style, and intersecting the semi-circles, gives the 6-o'clock points. The point marked X is to be used as the center of the dial. The intermediate hour and half-hour lines can be plotted by using table No. 2 for given lati-

TABLE NO. 1.  
Height of stile in inches for a 5 in.  
base, for various latitudes

Latitude	Height	Latitude	Height
$25^{\circ}$	233	$42^{\circ}$	450
$26^{\circ}$	244	$44^{\circ}$	483
$27^{\circ}$	255	$46^{\circ}$	518
$28^{\circ}$	266	$48^{\circ}$	555
$30^{\circ}$	289	$50^{\circ}$	596
$32^{\circ}$	312	$52^{\circ}$	640
$34^{\circ}$	337	$54^{\circ}$	688
$36^{\circ}$	363	$56^{\circ}$	741
$38^{\circ}$	391	$58^{\circ}$	800
$40^{\circ}$	420	$60^{\circ}$	866

tudes, placing them to the right or left of the 12-o'clock points. For latitudes not given, interpolate in the same manner as for the height of the style. The

the correct time for longitude 75° New York, 90° Chicago, 105° Denver and 120° for San Francisco. Ascertain in degrees of longitude how far your dial

is east or west of the nearest standard meridian and divide this by 15, reducing the answer to minutes and seconds, which will be the correction in minutes and seconds of time. If the dial is east of the meridian chosen, then the watch is slower; if west, it will be faster. This correction can be added to the values in table No. 3, making each value slower when it is east of the standard meridian

TABLE No. 2.  
Chords in inches for a 10 in. circle Sundial.

Latitude	HOURS OF DAY										
	12-30	1	1-30	2	2-30	3	3-30	4	4-30	5	5-30
	11-30	11	10-30	10	9-30	9	8-30	8	7-30	7	6-30
25°	.28	.56	.87	1.19	1.57	1.99	2.49	3.11	3.87	4.82	5.93
30°	.33	.66	1.02	1.40	1.82	2.30	2.85	3.49	4.26	5.14	6.10
35°	.38	.76	1.16	1.59	2.06	2.57	3.16	3.81	4.55	5.37	6.23
40°	.42	.85	1.30	1.77	2.27	2.82	3.42	4.07	4.79	5.55	6.32
45°	.46	.94	1.42	1.93	2.46	3.03	3.64	4.29	4.97	5.68	6.39
50°	.50	1.01	1.53	2.06	2.68	3.21	3.82	4.46	5.12	5.79	6.46
55°	.54	1.08	1.63	2.19	2.77	3.37	3.98	4.60	5.24	5.87	6.49
60°	.57	1.14	1.71	2.30	2.89	3.49	4.10	4.72	5.34	5.93	6.52

¼-hour and the 5 and 10-minute divisions may be spaced with the eye or they may be computed.

When placing the dial in position, care must be taken to get it perfectly level and have the style at right angles to the dial face, with its sloping side pointing to the North Pole. An ordinary compass, after allowing for the declination, will enable one to set the dial, or it may be set by placing it as near north and south as one may judge and comparing with a watch set at standard time. The dial time and the watch time should agree after the watch has been corrected for the equation of time from table No. 3, and for the difference between standard and local time, changing the position of the dial until an agreement is reached. Sun time and standard time agree only four times a year, April 16, June 15, Sept. 2 and Dec. 25, and on these dates the dial needs no correction. The corrections for the various days of the month can be taken from Table 3. The + means that the clock is faster, and the - means that the dial is faster than the sun. Still another correction must be made which is constant for each given locality. Standard time is

and faster when it is west.

The style or gnomon with its base can be made in cement and set on a cement pedestal which has sufficient base placed in the ground to make it solid.

The design of the sundial is left to the ingenuity of the maker.—Contributed by J. E. Mitchell, Sioux City, Iowa.

TABLE No. 3  
Corrections in minutes to change Sun time to local mean time,—add those marked +, subtract those marked —, from Sundial time.

Day of month	1	10	20	30
January	+3	+7	+11	+13
February	+14	+14	+14	
March	+13	+11	+8	+5
April	+4	+2	-1	-3
May	-3	-4	-4	-3
June	-3	-1	+1	+3
July	+3	+5	+6	+6
August	+6	+5	+3	+1
September	+0	-3	-6	-10
October	-10	-13	-15	-16
November	-16	-16	-14	-11
December	-11	-7	-3	+2



### Toy Gun for Throwing Cardboard Squares

The parts of the gun are attached to a thin piece of wood 1 in. wide and 5 in. long. It is best to use a piece of wood cut from the side or cover of a cigar box. A rectangular hole  $\frac{3}{16}$  in. wide and 1 in. long is cut in the wood longitudinally along its axis and  $1\frac{3}{8}$  in. from one end, as shown at A, Fig. 1. A small notch is made with the point of a knife blade at B and notches are cut in the end of the wood as shown at C. Rubber bands are fastened in these notches as shown in Fig. 2. The trigger, whose dimensions are given in Fig. 3, is fastened in the hole A, Fig. 1, by driving a pin through the wood. The assembled parts are shown in Fig. 4.

Place the cardboard square in the nick B, attach the rubber bands and pull the trigger. The top rubber band will fly off and drive the cardboard

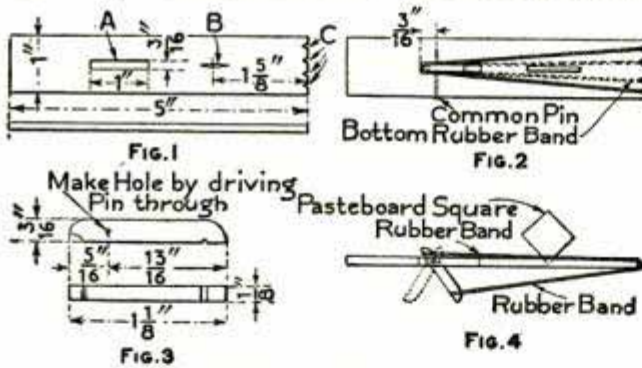

Details of Toy Gun

square 75 ft. or more. The cardboard should be about  $\frac{1}{2}$  in. square. These can be cut from any old pasteboard box.—Contributed by Elmer A. Vanderslice, Phoenixville, Pa.

### Photographic Developing Tray

Plates developed in an ordinary tray must be removed from the bath occasionally for examination. The film when in a chemical-soaked condition is easily damaged. The tray illustrated herewith was made for the purpose of developing plates without having to take hold of them until the bath had completed its work, the examination being made through the plate and the bottom of the tray.

A pocket is provided for the liquid developer in one end of the tray when it



FIG. 1

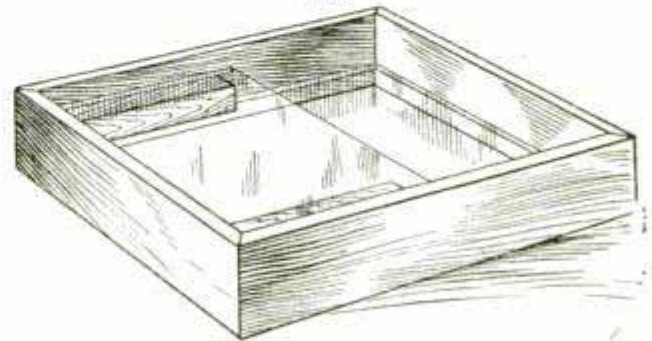

FIG. 2

Developing Tray with Glass Bottom

is turned up in a vertical position. A tray for developing 5 by 7-in. plates should be made 8 in. square inside. The side pieces with the grooves for the glass are shown in Fig. 1. Two of each of these pieces are made with mitered ends. The short groove shown in the top piece of the illustration is for inserting the plate covering on the pocket end of the tray.

Two blocks, one-half the length of the side pieces, are put in between the glass plates to hold the plate being developed from dropping down when the tray is tipped up in a vertical position. The glass bottom of the tray is  $8\frac{1}{2}$  in. square, which allows  $\frac{1}{4}$  in. on all edges to set in the grooves of the side pieces. The wood pieces should be well soaked in hot paraffin, and the mitered corners well glued and nailed.—Contributed by J. A. Simonis, Fostoria, Ohio.

☞ A good filler used as a putty on iron castings may be made as follows: Take, by weight, 3 parts of stiff keg lead, 5 parts of black filler, 2 parts of whiting, 5 parts of pulverized silica and make into a paste with a mixture of one part each of coach japan, rubbing varnish and turpentine.

### Rubber Bands in Kite Balancing Strings

Kite flyers will find it to their advantage to place rubber bands of suit-

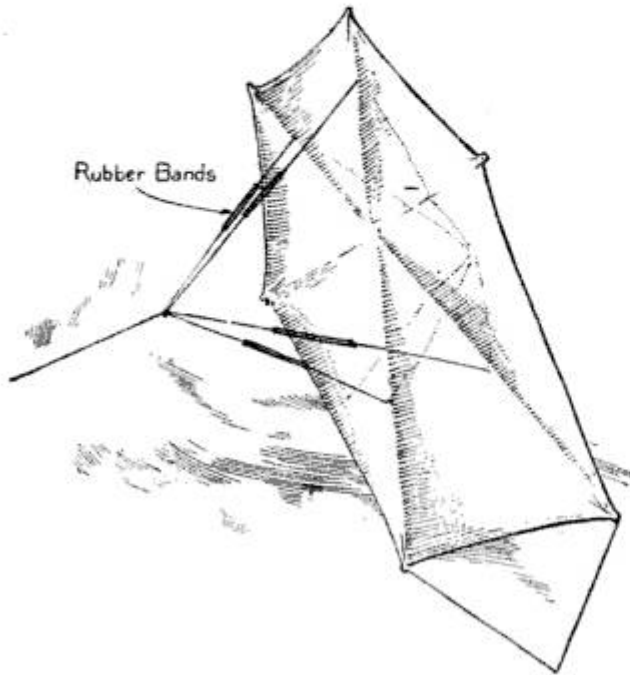

Bands in String

able size in the balancing strings to the kite, as shown in the illustration. This will prevent a "break-away" and also make the right pull, if only two bands are put in the lower strings.—Contributed by Thos. DeLoof, Grand Rapids, Michigan.

### An Aid in Sketching

Sketching requires some little training, but with the apparatus here illustrated an inexperienced person can

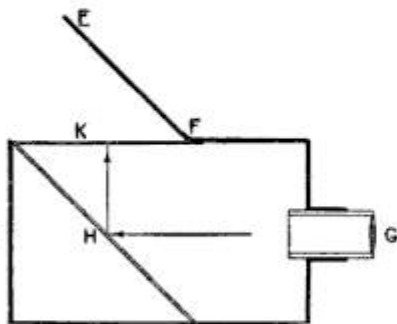

obtain excellent results. The apparatus is made of a box 8 in. deep, 8 in. wide and about 1 ft. long. A double

convex lens, G, is fitted in a brass tube which should have a sliding fit in another shorter and larger tube fastened to the end of the box. A mirror, H, is set at an angle of 45 deg.

in the opposite end of the box. This reflects the rays of light passing through the lens to the surface K, which may be either of ground or plain glass. The lid or cover E F protects the glass and keeps the strong light out when sketching. The inside of the box and brass tube are painted a dull black.

In use, the device is set with the lens tube directed toward the scene to be painted or sketched and the lens focused so the reflected picture will be seen in sharp detail on the glass. Select your colors and put them on the respective colors depicted on the glass. If you wish to make a pencil drawing, all you have to do is to fill in the lines in the picture on the ground glass. If a plain glass is used, place tracing paper on its surface, and the picture can be drawn as described.

### How to Make Miniature Electric Lamp Sockets

A socket for a miniature lamp can be made as shown in the sketch. A brass spring wire is wound around the base of the threads on the lamp and an eye turned on each end to receive a screw and a binding-post, as shown in Fig. 1. A piece of metal, preferably copper, is attached to a wood base as shown in Fig. 2 and the coil-spring socket fastened across it in the opposite direction. Bend the wire so that the spring presses the lamp against the metal. If the wire fits the lamp loosely, remove the lamp and press the sides of the coil closer together. The metal parts can

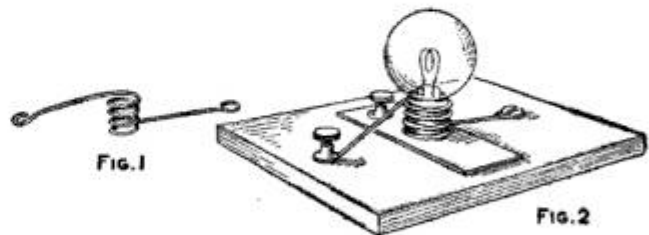

Wire Socket

be attached to any smooth surface of wood without making a regular base.—Contributed by Abner B. Shaw, No. Dartmouth, Mass.

## Wood-Working for Beginners

## Making a Taboret—Typical Form for the Method of Laying Out and Working a Dado—Vertical and Horizontal Paring

By IRA S. GRIFFITH

## CHAPTER XII

Referring to the working drawing, Fig. 69, make out a stock bill of material needed. If possible, use chestnut for this piece. It is easily worked, being soft wood, and takes a fine finish, owing to its open grain.

The top and shelf are octagonal. To make them, square up the two pieces to size in the usual manner. After this has been done so that the two pieces are of the same size as well as square, draw the diagonals, the lines of which extend from corner to corner across the board—or at least draw enough so that they shall cross and indicate the center of the boards. With the rule measure accurately from each of the four corners each way, along the edge and end, a distance equal to one-half a diagonal. Connect these points as shown in the top view of the working drawing. The eight sides should be of the same length. Saw off the corners and plane to the lines.

Square up the four legs to width, and if rough stock, to thickness. Since the top end is to be rounded, it is necessary to square only one end of each piece. Before rounding the tops or shaping the sides of the legs, it is advisable to lay off and cut the dados, the grooves into which the shelves are to be fitted. To lay these out, place all four pieces on the bench side by side, face edges up, squared ends evened, and measure and mark with a knife point the locations of the sides of the dados. Separate the pieces, after having squared knife lines across the edges, and carry these knife lines across each of the face sides. Carry these lines across the second edges also. Set the gauge for the required depth and gauge between the knife lines on the two edges.

Before cutting the dados, it is well to be sure that none of them will be

too wide. To do this, place the legs in the positions they are to occupy relative to one another in the finished piece, then mark with corresponding

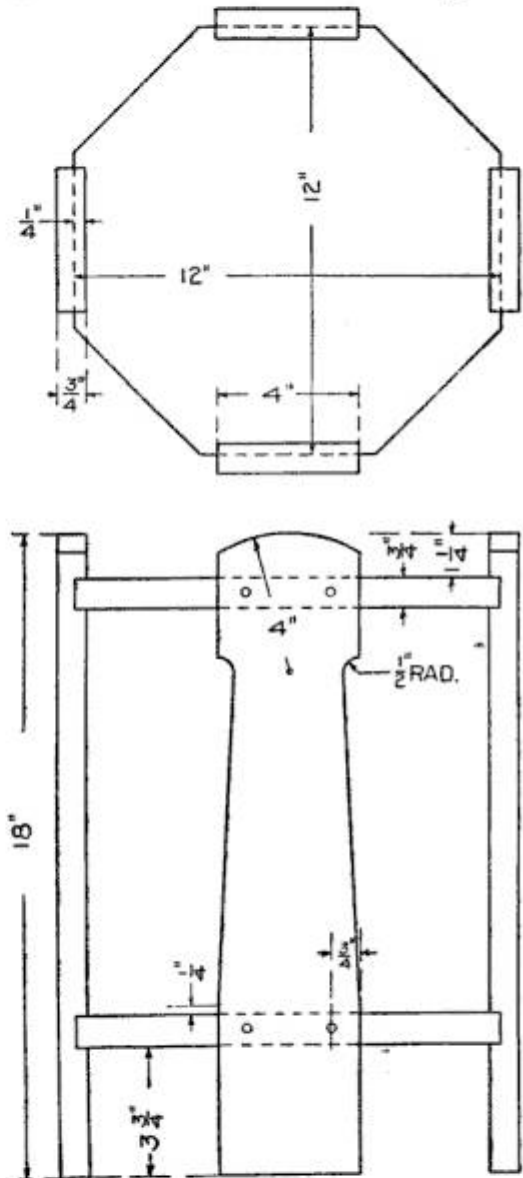

Fig. 69—Details of Taboret

figures or letters the edges of the shelves and the dados into which they are to fit. Test each dado by superimposing its shelf edge upon it. If the surface planing of the shelves was carefully done, all joints ought to answer the test. Should there be any variation, care should be taken to move only the lines representing the lower edges of the dado. In marking the corresponding members of a joint,

Roman numerals should be cut with a chisel in the edge of the shelf deep enough to be visible even after the

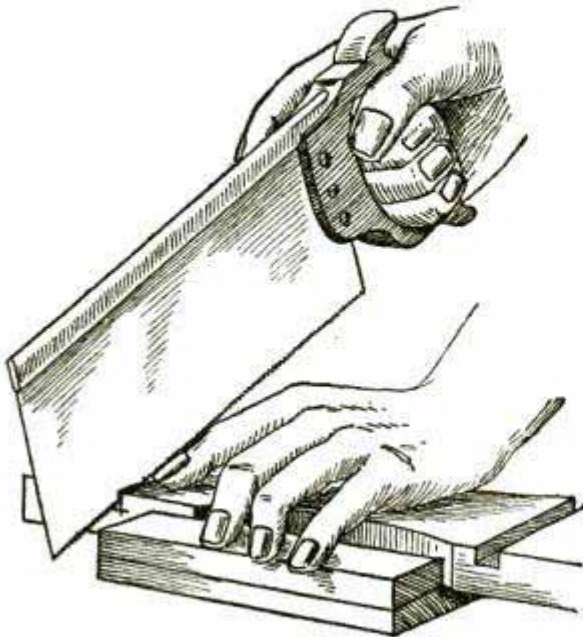

Fig. 70—Sawing Dado



Fig. 71—Chisel

stain and filler have been applied. The dado should be marked lightly with pencil until the groove is cut, after which the Roman numeral should be chiseled in the bottom of the dado. The finish of stain and filler should be applied before the members are assembled. Time is saved and a better finish obtained by this method of procedure.

The best way for the beginner to work the dado is as follows: Take a tenon saw, Fig. 70, and saw about 1/16 in. inside and parallel to the lines that represent the sides of the dados. In using this saw, the cut may be begun on the arris near to or away from the worker. If it is begun on the near arris, the handle should be held lower than the point where the cutting is to begin and be raised gradually as the teeth progress across the surface of the board. If the cut is begun on the far side, the handle should be held high in starting and be lowered gradually as the cutting proceeds. The saw

blade should have the constant guidance of either the thumb or forefinger of the left hand. The strokes should be short and easy at first. As the sawing proceeds gradually increase the number of teeth used, but continue the slow regular strokes. Saw only to the gauge lines, watching both edges while nearing the lines.

Having sawed the sides of all the dados, the next step is to chisel to depth. Figure 71 shows the chisel used for paring. Fasten the work so as to leave both hands free to hold the chisel. Both hands should at all times be kept back of the cutting edge or serious accidents may occur. "Rough out" the waste material in the dado, cutting as much material at each stroke as may be removed by tapping the end of the chisel with the palm of the hand. On hard wood a mallet should be used. Incline the cutting edge of the chisel upward to allow for slanting grain in the wood, Fig. 72-A. Rough out a little over half way across the dado, holding the bevel side of the chisel up. Next, hold the chisel as in

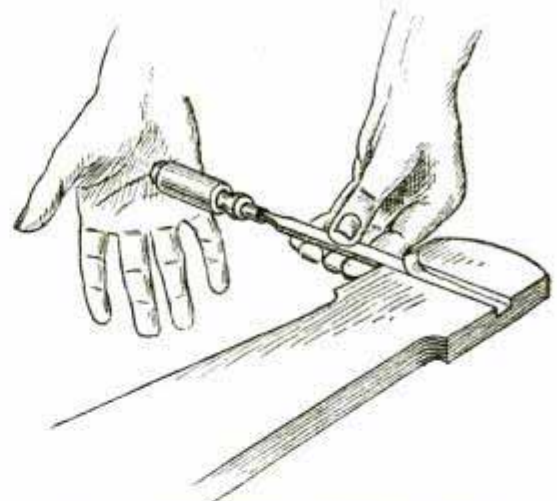

Fig. 72A—Removing Waste Material



Fig. 72B—Finishing with a Paring Cut

Fig. 72-B, move the handle laterally, at the same time forcing the edge into the wood. This lateral movement is

to give a shearing cut. Pare off very thin shavings while nearing the gauge line at the bottom of the dado and on the final cut place the cutting edge exactly in the gauge line. Finish the second side by cutting in a similar manner. A block into which has been driven a nail to the proper depth will indicate whether the proper depth has been obtained or not, Fig. 73.

The next step is to pare the sides of the dados. Hold the chisel as in Fig. 74, the left hand resting on the

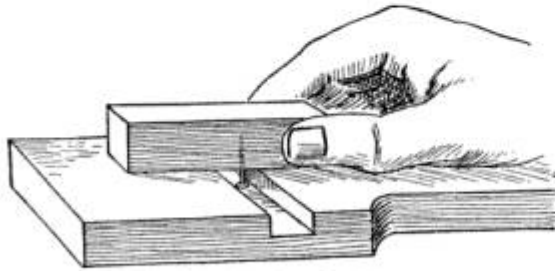

Fig. 73—Testing for Depth

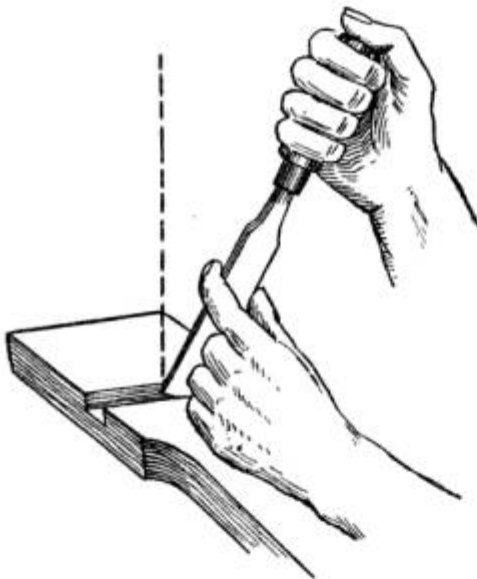

Fig. 74—Paring the Sides

wood to hold it down and the fingers helping to guide the chisel edge. Only a very small part of the cutting edge of the chisel is used, the hardness of the wood and the strength of the worker determining how much. The chisel handle is inclined toward the worker at the start and is gradually worked forward vertically as the pressure is applied. It is very important that the worker stand so as to look along the line he is cutting, otherwise he cannot sight the chisel plumb. The sides of the dado will therefore not be perpendicular. The larger

part of the blade, which is not used for cutting, is to be held against the perpendicular side of the dado already cut so as to aid in guiding the chisel.

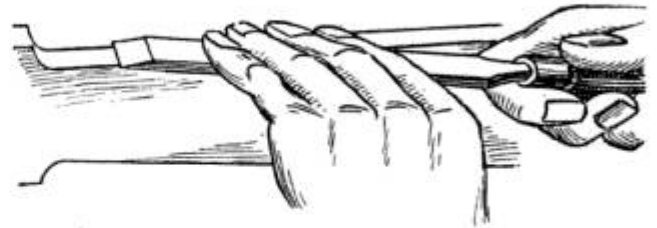

Fig. 75—Paring the Edges

The sides of the legs and the top ends should now be worked to shape. Place the four legs on the bench, side by side, and even the squared ends by means of the try-square. Measure from the squared end of one of them 14 in. and at this point square a light pencil line across the edges of all. Separate the pieces and carry this line across the faces of each piece, using try-square and sharp pencil. This line gives the location of the points from which the arcs are drawn for curved top and sides. The drawing shows the radii. An easy way to make the curves at the side of the leg is to place two pieces together edge to edge in the vise and bore a 1-in. hole, thus making an arc of  $\frac{1}{2}$ -in. radius on each piece. Rip parallel to the straight lines and close to them and pare the edges as in Fig. 75. The top curves may be finished by sawing parallel to the line with the turning saw, Fig. 76, and finished with a spokeshave, Fig. 77. Either of these tools

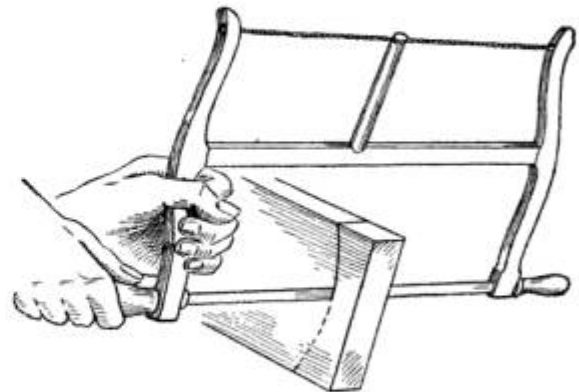

Fig. 76—Sawing the Curve

may be pushed or pulled, whichever is most convenient. On a curve crossing the grain as does this, carpenters

frequently use a plane instead of the spokeshave.

The parts of the taboret may be fastened together by means of round-

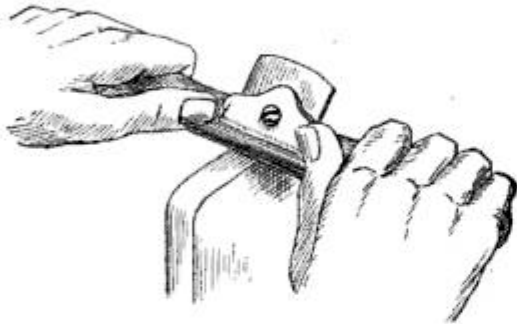

Fig. 77—Finishing with Spokeshave



Fig. 78

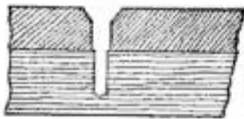

Fig. 79—Countersunk Hole and a Countersink



headed screws. It will be necessary to locate by accurate measurement the places on the legs where holes are to be bored. Holes, somewhat smaller, just large enough to receive the core of the screw, will need to be bored in the shelf edges. Their locations are



Screwdriver Bit



Screwdriver



Gimlet Bit  
Fig. 80

to be determined by superimposing the legs and marking through the holes

already made in the legs. Screws, like nails, are designated by the number of wire gauge from which they are made and the length in inches. Figure 78 shows a wire gauge for screws. It must not be confused with the wire gauge for nails. The gauge is slipped over the screw just below the head. Flat-headed screws must have the holes countersunk. A countersunk hole and a countersink for making it are shown in Fig. 79. With a dark finish use blued screws; with a light finish use brass screws. The screwdriver bit will be found helpful in putting in these screws (Fig. 80). The gimlet bit (Fig. 80) will be needed for boring the smaller holes.

While it may be advisable to leave the surface planing of the legs until the last thing before sandpapering, staining and filling, it is absolutely necessary to have the surfaces of the shelves smoothed of their mill-marks before the dadoes are cut and fitted.

*(To be Continued.)*

### The Walking Cork

This is a simple device which is not a trick, but its effect is rather comical. Procure an ordinary cork and stick two pins into one end. Then two knives of equal weight must be stuck into opposite sides of the cork as shown in the sketch.

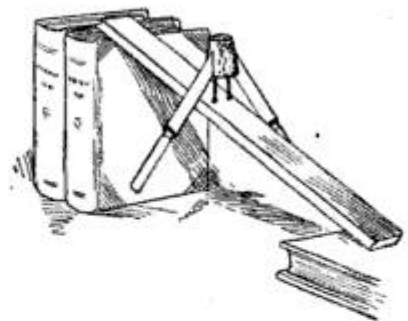

A flat rule is arranged as a sloping platform with a fairly high support at one end and a slightly lower support at the other. Two piles of books will serve for these supports quite well.

The cork is set up on its pins on the rule and then started on its journey with a slight rocking movement. It will now proceed to walk the whole length of the rule, first on one pin and then on the other.

## A Revolving Teeter Board

The accompanying sketch shows the details of a revolving teeter board for the children's playground that can be constructed in a few hours. Secure a post, not less than 4 in. square and of the length given in the drawing, and round the corners of one end for a ring. This ring can be made of 1-in. strap iron and it should be shrunk on the post. Bore a  $\frac{3}{4}$ -in. hole in the end of the post for the center pin to rest in. Make three washers 3 in. in diameter and  $\frac{1}{4}$  in. thick and drill  $\frac{3}{4}$ -in. holes through their centers. Drill and counter-sink two smaller holes for 2-in. wood screws in each washer. Fasten one of these washers to the top of the post as shown. The post is now ready to be set in the ground. Coarse gravel should be packed tightly about it to make it solid. Concrete is much better if it can be secured.

To make the swivel you will need two  $\frac{1}{4}$  by 5 by 8-in. plates, rounded at the top as shown, and two wood blocks, A and B, each  $3\frac{1}{2}$  by 5 by 10 in. Drill the lower ends of the plates for four  $2\frac{1}{2}$ -in. lag screws and the upper ends for a  $\frac{5}{8}$ -in. bolt. Fasten the plates to the block B, then drill a  $\frac{3}{4}$ -in. hole as shown and fasten the two remaining washers to the block, one on each side and central with the hole. Bore a  $\frac{5}{8}$ -in. hole lengthwise through the block A for the  $\frac{5}{8}$ -in. rocker bolt. This bolt should be  $11\frac{1}{2}$  in. long.

The teeter board is made of a 2 by 12-in. plank about 12 ft. long. It should be slightly tapered from the center to the ends. Two styles of hand holds are shown, but the one on the left is the one most generally used. The handles are rounded at the ends and

are fastened to the board with lag screws or bolts. The block A is fastened to the board with lag screws and should be a working fit between the

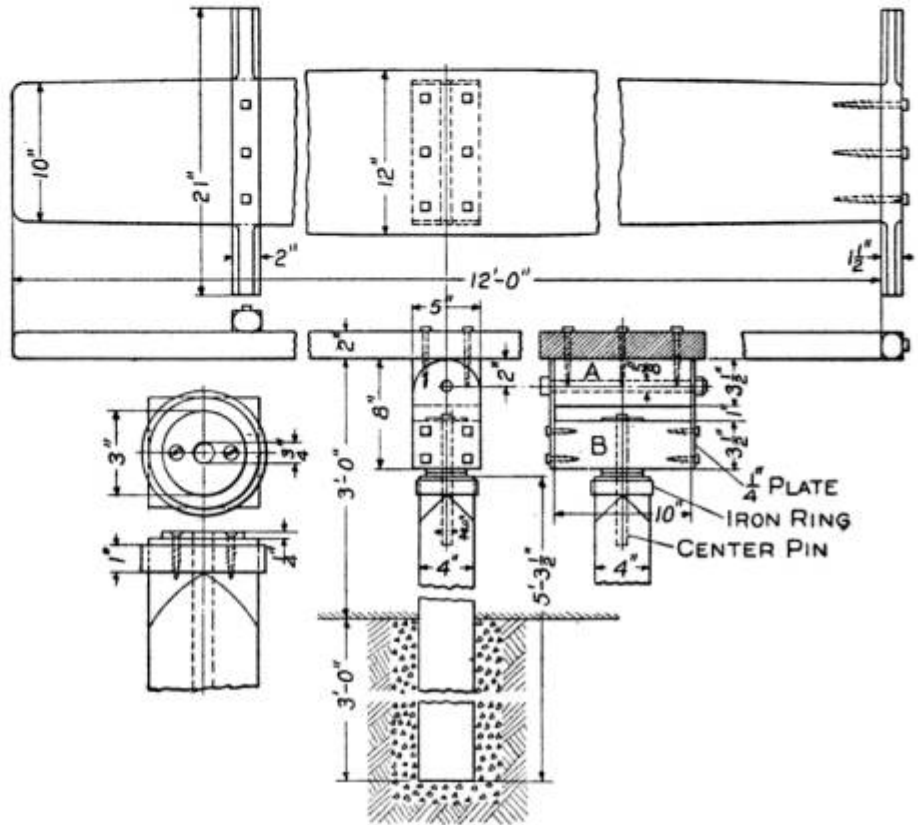

Details of Teeter Board

two plates where it is held by means of the  $\frac{5}{8}$ -in. bolt. The center pin is  $\frac{3}{4}$  in. in diameter and about 9 in. long.—Contributed by W. H. Dreier, Jr., Camden, N. J.

## Home-Made Pot Covers

Empty thread spools and the tins used as extra inside covers in lard cans are usually thrown away, but these can be put to good use as kettle covers, if they are made up as follows:

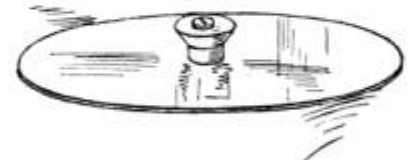

Saw the spool in half as shown, make a hole in the center of the tin and run a screw or nail through the spool and the tin; then flatten its end on the under side. This will make an excellent cover for a pot.—Contributed by Maurice Baudier, New Orleans, La.

## INTERESTING PATENTS,

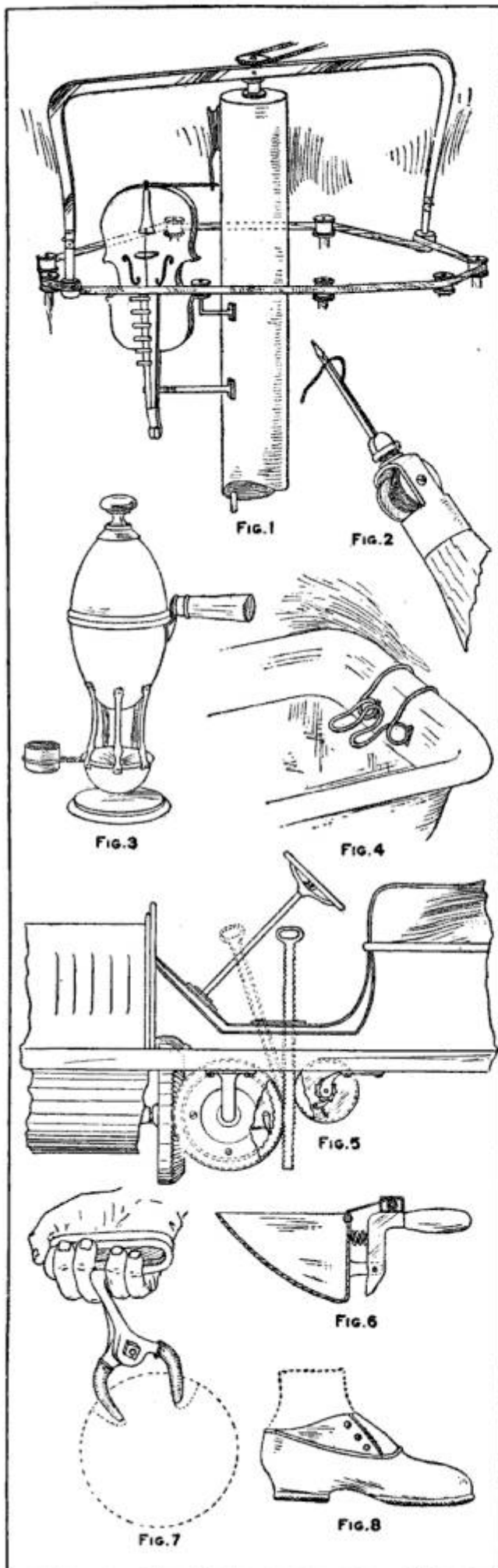

**BOW FOR SELF-PLAYING VIOLINS**—A revolving bow for the mechanical playing of a violin is shown in Fig. 1. The support holding the revolving band is mounted on the standard to which the violin is attached, and is revolved by means of a chain drive.



**LOCK-STITCH SEWING AWL**—Figure 2 illustrates an awl especially designed for the use of farmers in the repairing of shoes, harness, belts, carpets, rugs, etc. The reel carrying the thread is just back of the needle head. The operation is simple. After the thread has been forced through the leather, the reel is released and the thread drawn out to twice the length required for the stitch. The needle is then withdrawn, the end of the thread being held firmly in the left hand, only enough being drawn back to allow the starting of a new stitch. The needle is forced through again at the desired distance, allowing the reel to turn, then, with finger firmly pressed against the reel, is drawn part way back, forming a loop through which the end of the thread is passed. The stitch is completed by pulling it well into the leather, the reel being prevented from turning by placing the finger against it.



**INDIVIDUAL EGG BOILER**—The ingenious egg boiler shown in Fig. 3 is a French invention, consisting of an egg-shaped receptacle into which an egg and a small quantity of water are placed. The water is measured by the little cup shown in the holder extending from the base of the boiler. A sponge, dipped in alcohol, and placed in the cup under the egg container, furnishes the heat. The quantities of water and alcohol are so proportioned that when the alcohol is consumed and the flame goes out, all the water is vaporized and a medium-boiled egg results.



**HEAD-REST FOR BATHTUBS**—Figure 4 is a head-support which hooks over the rim at the back of a bathtub. The device is made of one piece of wire, having its ends bent into supporting hooks and its intermediate portion shaped to form a series of loops for supporting the head. A wash cloth may be placed over the loops to make the rest more comfortable.



**AUTOMOBILE ENGINE STARTER**—A method of starting an automobile engine without having to leave the driving seat is shown in Fig. 5. Between a rotatory member in operative connection with a power shaft and a second rotatory member mounted adjacent, is a toothed starting bar, the drawing upward of which causes the first mentioned rotatory member to turn the shaft, thus starting the engine.



**WEIGHING SCOOP**—Figure 6 is a scoop designed to weigh the material it handles. The operation is clearly shown in the illustration, the scoop proper being attached to the handle by means of a spiral spring and a pivoted connection. A measuring tape extends from a spring reel on the top of the handle to the top of the inner wall of the scoop. The extent to which this measuring tape is drawn out by the movement of the scoop under its load is supposed to show the exact weight of the load, the measuring tape being marked off in ounces and pounds.



**BOWLING-BALL GRIP**—Figure 7 is a bowling-ball grip, somewhat similar to ice tongs in operation, by which bowlers may launch the heavy balls down a bowling alley. Releasing the pressure of the fingers against the smaller of the loops allows the ball to slip free.



## PRACTICAL OR UNIQUE

**RUBBERS PROVIDED WITH HALF TOPS—**

A rubber designed to protect the lower half of a shoe top in front is shown in Fig. 8. The appearance of this rubber is sufficiently similar to the buttoned oxford to be called an "oxford rubber."



**POWER-OPERATED HANDSAW—**Figure 9 is a power-driven handsaw. The eccentrically mounted driving mechanism is located in the body portion between the parallel guideways which are provided to carry the extensions of the saw frame.



**TELEGRAPH-SENDING APPARATUS—**This curious apparatus (Fig. 10) is designed to simplify the action of sending in telegraphy. It is attached by pivotal supporting screws to an ordinary telegraph key, and sends dots by a single movement in one direction, and dashes by a single movement in the other direction.



**"SAFE" FIRE ESCAPE—**Figure 11 is an Ohio inventor's idea of an effective fire escape, and comprises an inclined track and a carriage resembling a safe. The track, which is nothing more or less than a specially constructed ladder, is raised against the wall under the window from which the occupants of a burning building are attempting to escape. The carriage, which is constructed to withstand the flames that might engulf it while passing a lower window, is then hauled to the top of the ladder or track by means of the tackle provided, and the escaping persons enter by climbing into it through the back.

**INGENIOUS TOOL CARRIER AND CHEST—**

A novel method of nesting and carrying carpenters' tools is shown in Fig. 12. It consists of a miter box, a tool chest, and a multi-part tool-holding device, the parts of the latter being pivotally connected with the miter box and chest. The bit stock is utilized as a handle for carrying the whole.



**BICYCLE BOAT—**Figure 13 is a bicycle boat, consisting of a vessel of the row-boat type provided with a pedal-driven propeller. Part of a bicycle frame, with saddle, is mounted in the center of the boat. The bicycle handle is utilized to turn a rudder, located directly underneath.



**PISTOL PADLOCK—**A novelty in locking devices is the pistol padlock shown in Fig. 14. The action of pulling the trigger releases the spring and throws the hasp back.



**INDIVIDUAL TWINE HOLDER—**Figure 15 is a small twine holder adapted to attachment to the belt or waist of the user. The casing contains a reel, which is easily removed, when run bare, for the insertion of a loaded reel. The holder is made of aluminum.



**MEDICATED POULTRY ROOST—**The tubular legs and cross-bars of this poultry roost (Fig. 16) are filled with wicking, which absorbs the insect-destroying fluid fed to it from the tanks. The legs and cross-bars are provided with perforations for the escape of the fluid.



**PLOW ATTACHMENT—**Figure 17 is an attachment for plows which crumbles the soil after it has been turned over. The extra blade with its trailing rods is secured to the bottom of the mold board of the plow.

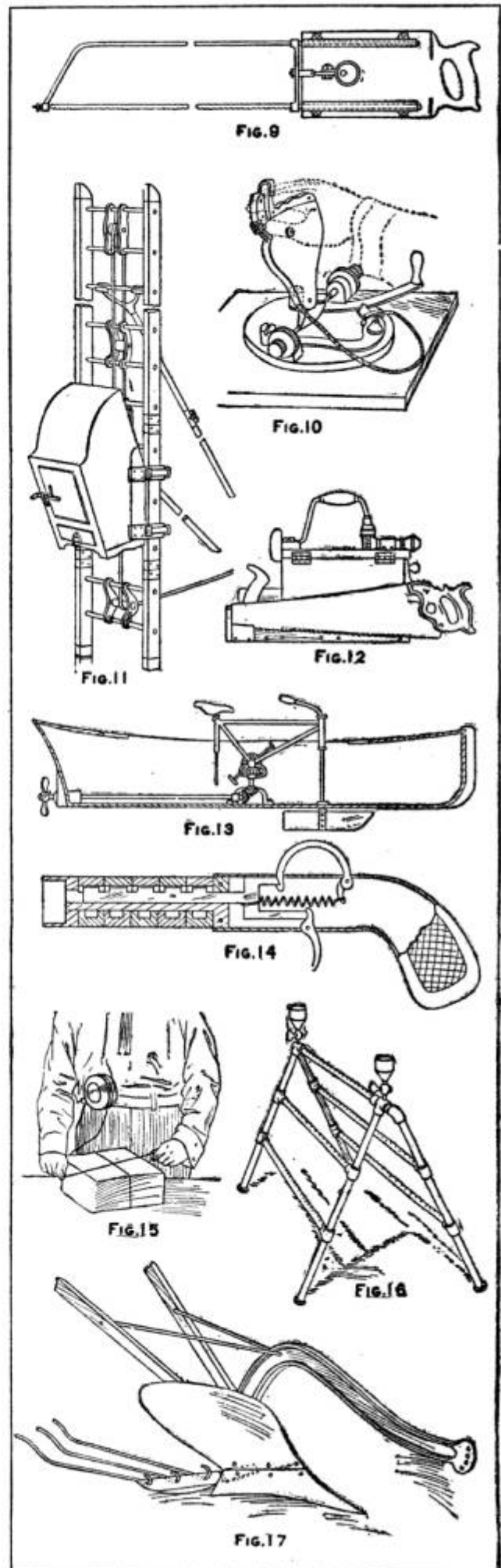

THE ship was sinking. A great panic was imminent. "What shall we do?" cried the terrified passengers.

"Send for the barber," remarked the professional humorist. "He's the only man on board who can razor."

With justifiable rage they hurled him into the angry sea.—Philadelphia Record.

◆ ◆ ◆

Percival (politely): Chicken croquette, please.  
The Waiter (lustily): Fowl ball!

◆ ◆ ◆

In a small western town there was an operator that stuttered, and a new subscriber called up one day and said:

"C-c-c-Cent-t-t-ral, wh-wh-wh-what t-t-t-time i-i-is it?"

Central answered him back like this:

"I-i-it i-i-is f-f-five th-th-thirty."

The subscriber said, "J-j-just f-f-or th-th-that, I am going to h-h-have my ph-ph-phone t-t-t-taken out."

◆ ◆ ◆

"Speaking of farms," a Dakotan said, the other day, "we have some right sizable farms out in Dakota. Yes, sir, I've seen a man on one of our big farms start out in the spring and plow a straight furrow till fall. Then he turned around and harvested back."

"Wonderful," said I.

"On our Dakota farms," he went on, "it's the usual thing to send young married couples out to milk the cows. Their children bring back the milk."

"Wonderful," I replied.

"Once," he said, "I saw a Dakota farmer's family prostrated with grief. The women were weeping, the dogs were barking, the children were squalling, and the tears ran down the farmer's cheeks as he hitched up his twenty-mule team and drove off."

"Where was he going?" I asked.

"He was going half-way across the farm to feed the pigs," said the Dakotan.

"Did he ever get back?" I asked.

"It isn't time for him yet."

◆ ◆ ◆

The Teacher—"Willie, can you tell what steam is?"  
Willie—"Sure—it's water gone crazy with the heat."—News.

"Did you see the janitor?" asked Mrs. Shivvers.  
"Yes," replied her husband. "I told him that it was as cold in our flat as at the north pole."

"What did he say?"

"He merely looked supercilious and asked for my proofs."—Washington Star.

◆ ◆ ◆

New Reporter—The auto turned terrapin, and—  
City Editor—You mean turned turtle.  
New Reporter—Well, it was a high priced machine.  
—Judge.

◆ ◆ ◆

A newly made magistrate was gravely absorbed in a formidable document. Raising his keen eyes, he said to the man who stood patiently awaiting the award of justice:

"Officer, what is this man charged with?"

"Bigotry, your worship. He's got three wives."

The new J. P. rested his elbows on the desk and placed his finger tips together. "Officer," he said, somewhat sternly, "what is the use of all this education, all these evening schools, all the technical classes, and what not? Please remember, in any future like case, that a man who has married three wives has not committed bigotry, but trigonometry. Proceed."—St. Paul Dispatch.

◆ ◆ ◆

Captain Thomas S. Baldwin, who landed the other day with Clifford B. Harmon in the balloon "New York" in an out-of-the-way corner of Ohio, has a dry wit. He is as fond of exercising it as he is flying around Hempstead plains in his Red Devil.

"Oh, Captain Baldwin," said a dear old lady recently, pointing to the propeller of the gallant captain's aeroplane, "what's that flapper for?"

"That flapper, madam," gravely replied the captain, "is to scare the birds away when I am flying."—Cleveland Leader.

◆ ◆ ◆

"The edge on a razor," said the garrulous barber, "improves by laying it aside for a time." "That being the case," rejoined the victim in the chair, "I'd advise you to lay aside the one you are using for about 2,000 years."

## NEW BOOKS

Any Book Mentioned or Reviewed Here May Be Ordered Direct from the Publishers or Through Popular Mechanics Book Dept., 225 Washington Street, Chicago

**ELECTRICIANS' OPERATING AND TESTING MANUAL**—By Henry C. Horstmann and Victor H. Tausley. A handbook for men in charge of electrical apparatus, repair men, trouble men, lamp trimmers and electricians generally. 359 pages, illustrated, flexible leather, \$1.50. Frederick J. Drake Co., Chicago.

**COMPOSITION AND HEAT TREATMENT OF STEEL**—By E. F. Lake. A practical book, and especially valuable at this time, to users as well as makers of steel, by reason of recent developments in this most important industry. 246 pages, 6x9. Illustrated, \$2.50. McGraw-Hill Book Company, New York.

**THE YOUNG ELECTRICIAN**—By Hammond Hall. Intended to "afford instructive amusement to intelligent boys," this book admirably fulfills its purpose. 289 pages, 12mo, cloth, \$1.50. Illustrated. The Macmillan Company, New York.

**WELDING: THEORY, PRACTICE, APPARATUS AND TESTS**—By Richard N. Hart, B. S. This is the first attempt to present under one cover all the available data on a most important subject. Beginning with the subject of metals generally, the book takes up in their order electric, hot-flame and thermal welding, including new brazing methods and solders, and giving due consideration to the working properties of all the commercial metals. 181 pages, 6x9, cloth, \$2.50. Illustrated. McGraw-Hill Book Company, New York.

**THE SHEET JOBBING AND PLATE ROLLER'S ASSISTANT**—By C. H. Kaufman. 363 pages, 5½x8½, cloth, \$5.00. In this, the third edition, the tables are based on 40 instead of 40.80 lb. per square foot of one inch thick. The West Virginia Printing Company, Wheeling, W. Va.

**MECHANICAL DRAWING FOR PLUMBERS**—By R. M. Starbuck. 111 pages, 6x9, illustrated, cloth, \$1.50. A re-publication in book form of Mr. Starbuck's series of articles on this subject in the Plumbers' Trade Journal. The Norman W. Henley Publishing Company, New York.

**A TEXT-BOOK OF ELEMENTARY FOUNDRY PRACTICE**—By William Allyn Richards, B. S. 121 pages, 6x8½, illustrated, cloth, \$1.50. This book is intended for the use of students in colleges and secondary schools, but the principles of the molder's craft are so plainly stated that it may safely be recommended also for those who hope to master them without the aid of an instructor. The Macmillan Company, New York.

**STANDARD PRACTICAL PLUMBING**—By R. M. Starbuck. 406 pages, 6x9, illustrated, cloth, \$3.00. The thirty chapters and the alphabetical index of this volume constitute a handy reference on all subjects connected with the plumber's craft—drainage and venting, ventilation, hot and cold water supply and circulation, etc. It has been prepared, evidently, by a practical man for practical use. The Norman W. Henley Publishing Company, New York.

# Help for HOME-BUILDERS!

Full Particulars and Valuable Books—FREE

We have revolutionized the building material business by our system of selling Millwork and Lumber **direct to the actual user**, who saves all the middle dealers' profits and secures a guarantee of quality that means satisfaction or money back.

With our vastly enlarged and improved facilities we have doubled our stock of materials and can ship to any point in the United States within 48 hours after receipt of orders.

We saved our customers over a million dollars last year. Three great banks endorse us.

Lumber and Millwork for this House  
Plan Book 10c **\$698**

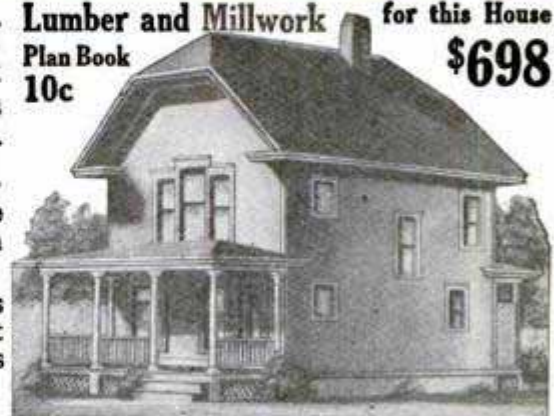

Lumber and Millwork for this 8-Room Stucco House, \$1,634

## 5,000 Building Material Bargains Including Doors, Windows, Mouldings, Stairs, Porches, Flooring, Finish and LUMBER

Get our prices on everything you need to build a new house or modernize an old one. Our Grand Free Building Material Catalog offers 5,000 Bargains—the very latest designs in Millwork, approved by best architects.



Head Blocks, 4c

## We Save You 50 Per Cent

We offer the lowest prices ever known on everything needed to build complete and beautiful homes of the most modern types—even to the mantels and hardware. No local lumber yard or planing mill can begin to offer such a wonderful variety. Everything up to official grades of Sash and Door Manufacturers' Association.

## Quality, Safe Delivery and Satisfaction Guaranteed

We ship everywhere under an absolute guarantee of quality, safe delivery and satisfaction. Money refunded and freight paid both ways if goods are not as represented.

### Send Coupon or Postal

for Free Books and let us help you build at a big saving.

## Gordon-Van Tine Co.

2526 Case Street Davenport, Iowa



Flight of Stairs, Complete and ready to put together. **\$23.93**

We offer a splendid variety of Stair Material in Oak and Yellow Pine. Our designs admit of many variations. Our prices save you from \$60 to \$125 on a complete flight of stairs. See Catalog for latest stair designs.

Estimates FREE **FREE BOOKS**

Gordon-Van Tine Co. 2526 Case St. Davenport, Iowa



Lumber and Millwork for this 7-Room House, \$1,057

**Plan Book FREE**  
Over 50 complete designs for beautiful, practical, economical homes. The only Plan Book that keeps cost within estimates. Enclose 10c for postage and mailing.



Strong Door, 77c



Lumber and Millwork for this 5-Room Bungalow, \$946

(103)

Please send the FREE BOOKS checked below, to

Name \_\_\_\_\_

Address \_\_\_\_\_

Occupation \_\_\_\_\_

Millwork  Lumber  Roofing  Plan Book

If you wish the PLAN BOOK, enclose 10c for postage and mailing.

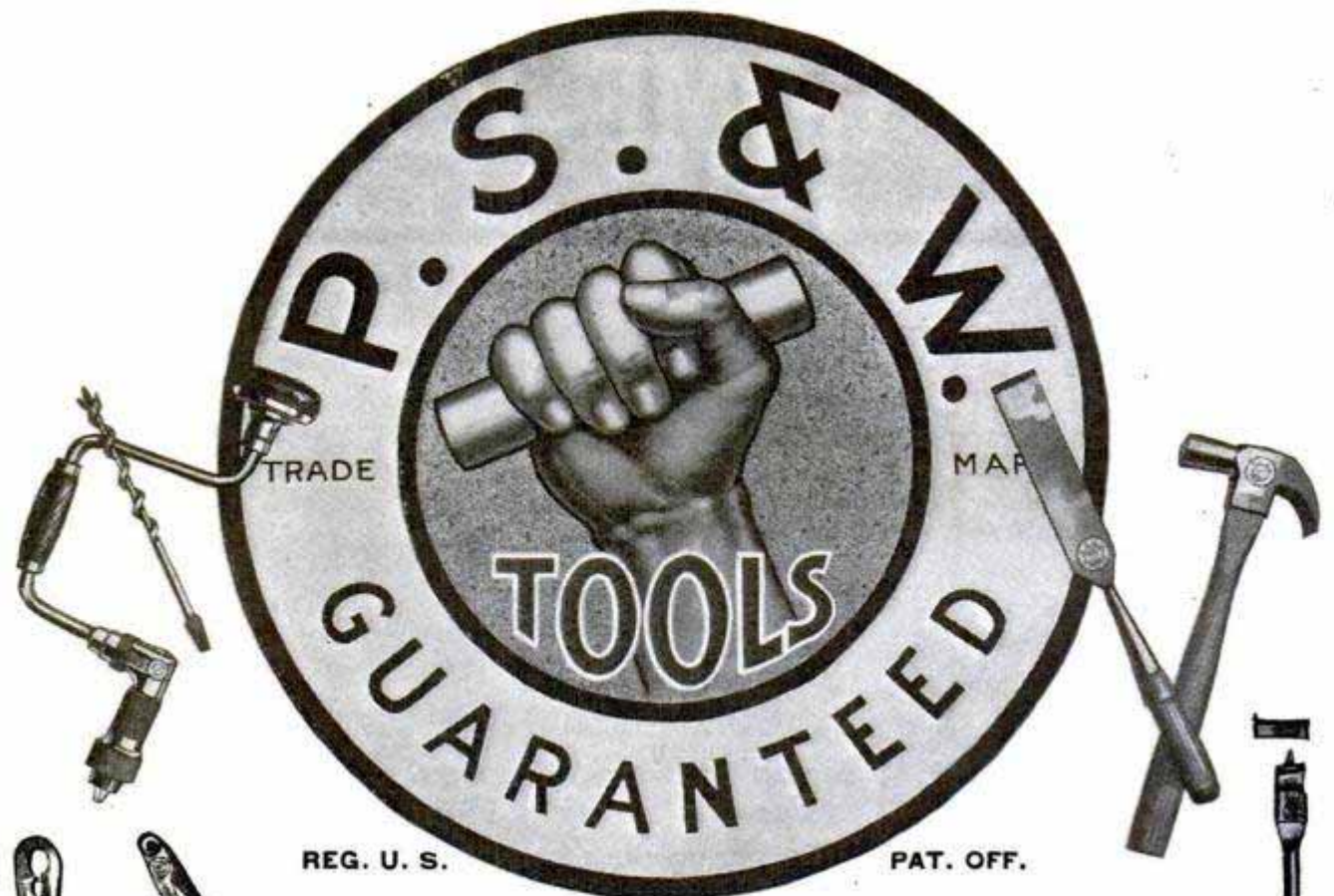

## The MARK of the MAKER

takes the responsibility off your  
shoulders and puts it on ours.

Every item in our four large lines of Guaranteed Hand Tools for Carpenters, Machinists, Electricians and Tinsmiths has to meet the most rigid testing before we are willing to send it out of our factory stamped with that brand.

If our goods were not fully up to the most exacting requirements of the trade and the consumer, we couldn't afford to advertise them to expert mechanics all over the world, and send thousands of buyers to *you*, looking for the MARK of the MAKER.

We quicken the demand and guarantee the quality—you share in the profits.

If you haven't heard of our Mechanics' Handy List, a handy reference book and tool catalog widely advertised to mechanics, send for a copy.

**The Peck, Stow & Wilcox Co.**

**MFR'S** Mechanics' Hand Tools, Tinsmiths' Machines, Builders' & Gen. Hardware

Address Correspondence to 20 Murray Street  
NEW YORK CITY

Established 1819

Five Large Factories

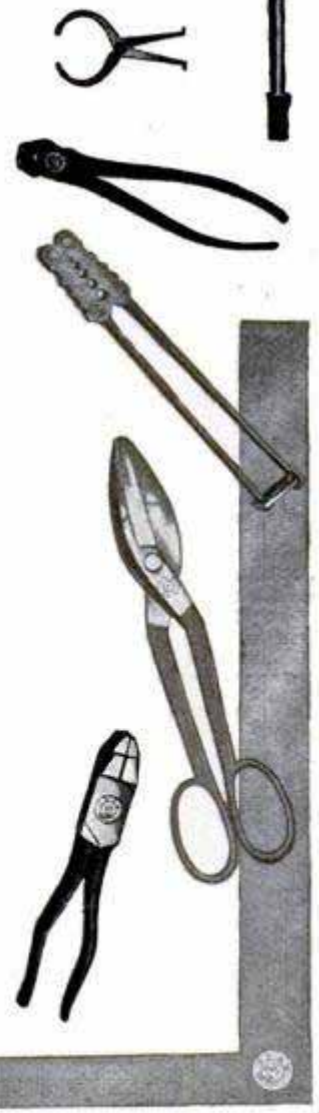



# The Beginning of His Success

Success has dawned for many a man with the marking of the I. C. S. coupon. It was a simple act—an act that placed him under no obligation—but it proved to be the beginning of a career.

Trained men are in demand everywhere. There is not an important labor-employing concern in the world that has not openings for men prepared to make good in positions.

Draftsmen are wanted. Can you trace out a machine or a building? Foremen and Superintendents are wanted. Can you plan and direct work? Chemists are wanted. Can you make an analysis or build up a useful compound? Trained Electricians are wanted. Would it be safe to turn you loose in an electric plant? Civil, Mechanical, and Mining Engineers are wanted. What does that mean to you? Advertising men are wanted. Can you write a business-pulling ad? The Civil Service needs men. Are you prepared to pass a Civil Service examination?

No matter where you live, how little spare time you have, how limited your education (provided you can read and write), nor how small your means, the I. C. S. will go to you and train you in your own home for mastery of the trade or profession you like.

The marking and mailing of an I. C. S. coupon has been the beginning of success for thousands. Why not find out about the I. C. S. plan? It will place you under no obligation whatever but will bring to you a full explanation of the I. C. S. salary-raising system that has been used by thousands to change poor jobs into good positions and "wages" into salaries.

**Mark and Mail the Coupon NOW.**

## International Correspondence Schools

Box 872, Scranton, Pa.

Please explain, without further obligation on my part, how I can qualify for a larger salary and advancement to the position, trade, or profession before which I have marked X.

Electrical Engineering  
Electric Lighting  
Electric Railways  
Electrician  
Electric Car Running  
Dynamo Foreman  
Dynamo Tender  
Wireman  
Mining Engineer  
Telephone Expert  
Civil Engineer  
Automobile Running:

Mechanical Engineer  
Mechanical Draftsman  
R. R. Constructing  
Concrete Construction  
Architect  
Contracting & Building  
Architectural Draftsman  
Plumbing & Heating  
Chemist  
Bookkeeper  
Advertising Man  
Civil Service Exams.

Name \_\_\_\_\_

St. & No. \_\_\_\_\_

City \_\_\_\_\_ State \_\_\_\_\_

Present Occupation \_\_\_\_\_

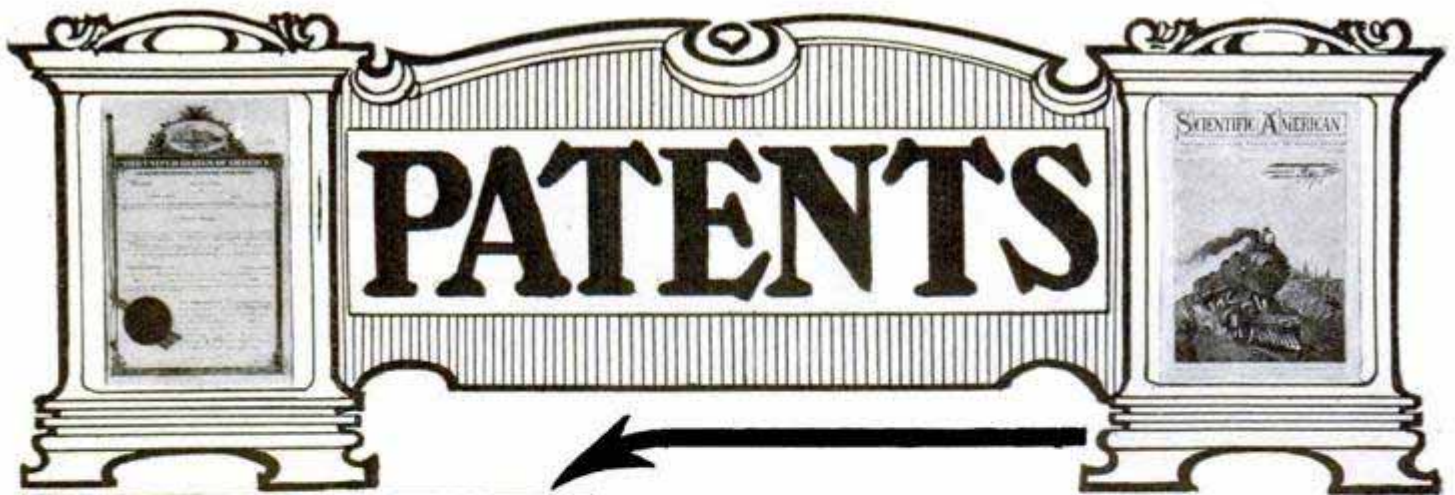

NEW YORK OFFICE, 359 BROADWAY

**F**OR SIXTY-FIVE YEARS the firm of MUNN & CO. has conducted the largest patent practice in the country. We file thousands of applications for patents every year. Our system is so perfected that every case receives the best of attention and is prepared by experts who have had special training in handling every class of invention.

☞ **SEND SKETCH.** If you will send us a sketch, no matter how crude, we will give you a fair and candid opinion as to whether it is probable a patent can be obtained. All matters of this kind are strictly confidential and the description and sketches will be dated and placed in our secret archives for future reference. This service and our Hand Book on Patents are free if you will write us at once.

☞ **QUALITY.** The quality of our work has given us an unrivalled reputation among Patent attorneys and we are the recognized American attorneys for many leading Foreign Patent Solicitors. Our staff consists largely of Examiners from the United States Patent Office, who are therefore familiar with the latest procedure and the best practice. Our draftsmen are all expert mechanical constructors who are able to show the invention in operative form.

☞ **FREE NOTICE.** All patents secured through our house receive a free notice in the **SCIENTIFIC AMERICAN**. No better or more economical method of introducing your invention to the attention of the public could be devised.

☞ **OUR OFFICES.** Our Washington office is located in our own building, near the Patent Office. This permits of our attorneys making special oral arguments with the Patent Office Examiners—an advantage not enjoyed by local attorneys.

☞ We are prepared to conduct Interference Proceedings, Infringement Suits, give Validity Opinions, draw up contracts and attend to all branches of legal work connected with Patents, Trade Marks, etc.

☞ We do not offer prizes or other specious inducements, but rely upon our recognized reputation of over half a century. Our fees are as low as is consistent with good work.

**MUNN & CO., Attorneys**

359 Broadway, New York, N. Y.

**WASHINGTON OFFICE**  
625 F Street, N. W.  
Washington, D. C.



WASHINGTON OFFICE



**6 MONTHS**

**FREE TRIAL**



**10 Tools  
in One**

We want every shop, factory, and tool-user to prove by 6 months' Free Trial, on your own tools, how this grinder saves time, and money, makes work easier, saves and makes money. We will send this Mechanics Special on 6 months' Free Trial, and then, if you wish, send it back at our expense.

# Luther Diamond Tool Grinder

**Genuine Carborundum Wheels  
Will Not Draw Temper**

The genuine Carborundum Wheels on this grinder cut hardest steel, as emery does soft copper, and does not draw temper—no water cooling necessary. You can do work in two minutes on this grinder that would take a half hour on the grindstone. With this grinder it is quick and easy work to keep tools bright and keen-edged, which means faster, easier general work.

**25 Times  
Faster Than  
Grindstones  
6 Times  
Faster Than  
Emery  
Hand and  
Foot Power**



Return This Coupon For Six Months' **FREE TRIAL OFFER**

**Built Like a High Grade Lathe**

Special tool holders make it possible for anyone to do difficult grinding, such as twist drills, saws, chisels, etc. 2500 revolutions per minute—steel and malleable construction, enclosed gears, dust proof, bronze bearings in oil bath, machine cut spur gears.

*Elmwood Haynes, Pres. of Haynes Automobile Co., says: "I have found the Mechanics Special a most excellent device." Thousands of users say the same.*

Return this coupon for 6 months' Free Trial Offer—a whole half year of free test. Let us give you full description of the Mechanics Special—full particulars of our liberal offer, and also the wonderful story of the discovery of Carborundum, as it appeared in McClure's Magazine. Returning the coupon puts you under no obligations. It is well worth your while to find out all about the grinder guaranteed for 5 years—that will outlast any number of emery wheels—save tools and make work easier. Return the coupon today.

**Luther Grinder Mfg. Co.**  
68 Madison St., MILWAUKEE, WIS.

**LUTHER GRINDER MFG.CO.**  
68 Madison Street, Milwaukee, Wis.

**COUPON**

Please send me free and prepaid your free Carborundum booklet and Six Months' Free Trial Offer on Mechanics Special Luther Diamond Tool Grinder. This obligates me in no way whatsoever.

NAME .....

ADDRESS .....

DEALER'S NAME .....

DEALER'S ADDRESS .....

# Double the Purchasing Power of Your Money

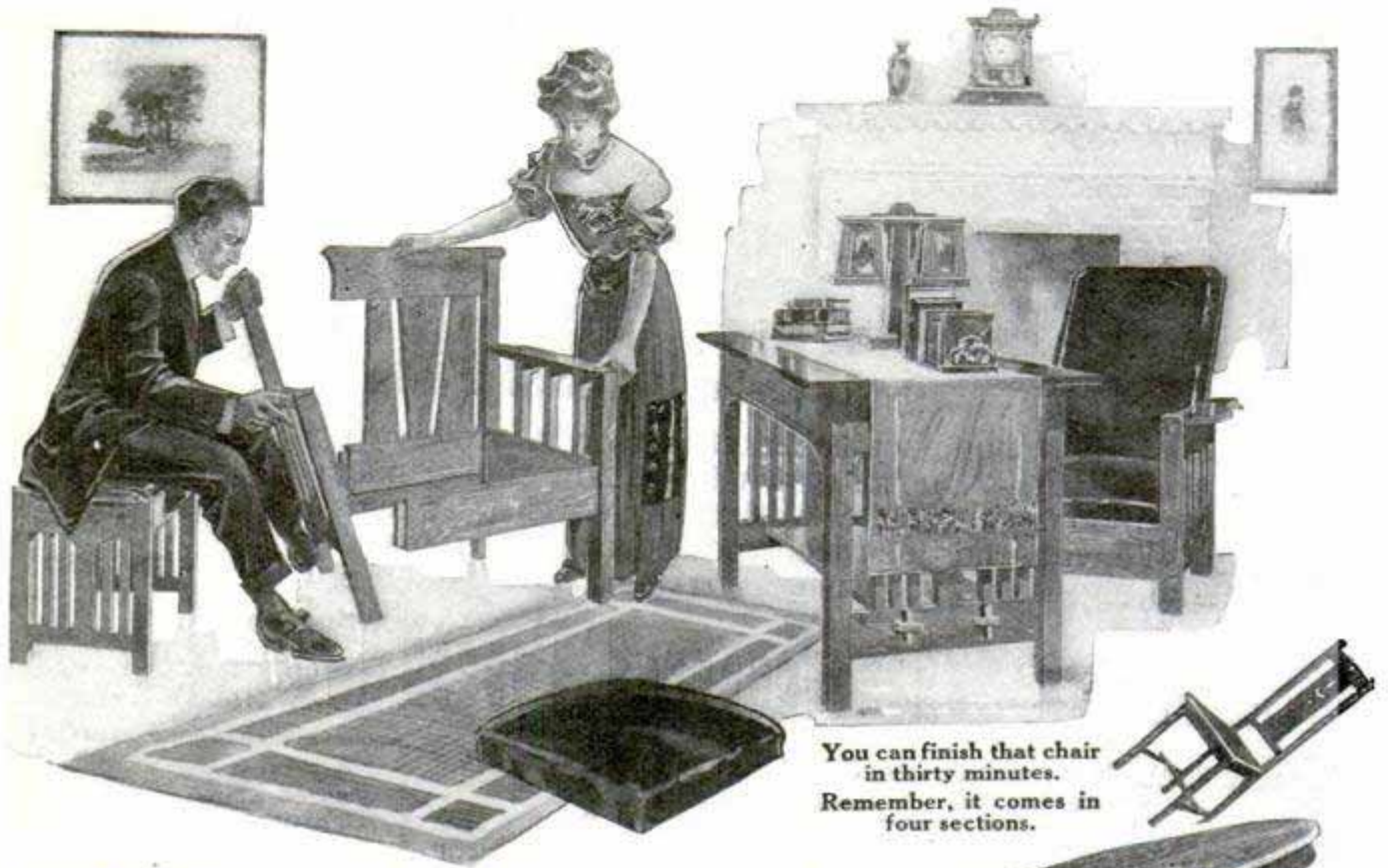

You can finish that chair  
in thirty minutes.  
Remember, it comes in  
four sections.

DO YOU know that home surroundings exert a wonderful influence on domestic happiness—on the development of high ideals—on ultimate success? You do?

DO YOU know that every room in your home can be artistically and elegantly furnished at a price that is ridiculously low? You don't?

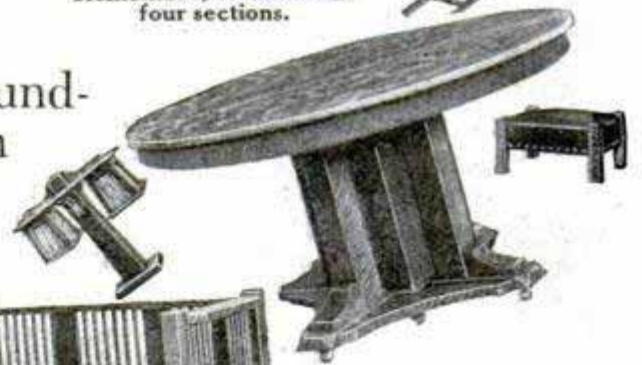
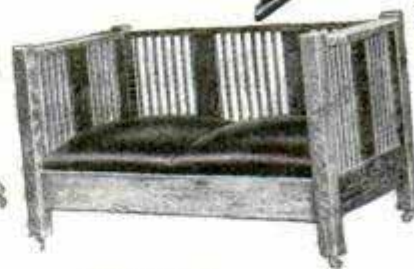
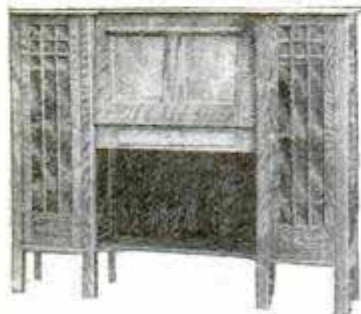

THEN—  
you owe it  
to yourself—  
to your family  
—to investigate this  
proposition. Not know-  
ing means a direct loss to you.

**BROOKS MANUFACTURING CO.** 703 RUST AVENUE  
Saginaw, Mich.



# Make \$1.00 do Exactly the Work of \$2.00

HOW? By having the furniture shipped direct to you from the factory in the natural wood—or stained—and in assembled, easy-to-put-together sections, together with all the materials necessary to give it the proper finish.

An evening at home is ample time to finish all the furniture required in any room.

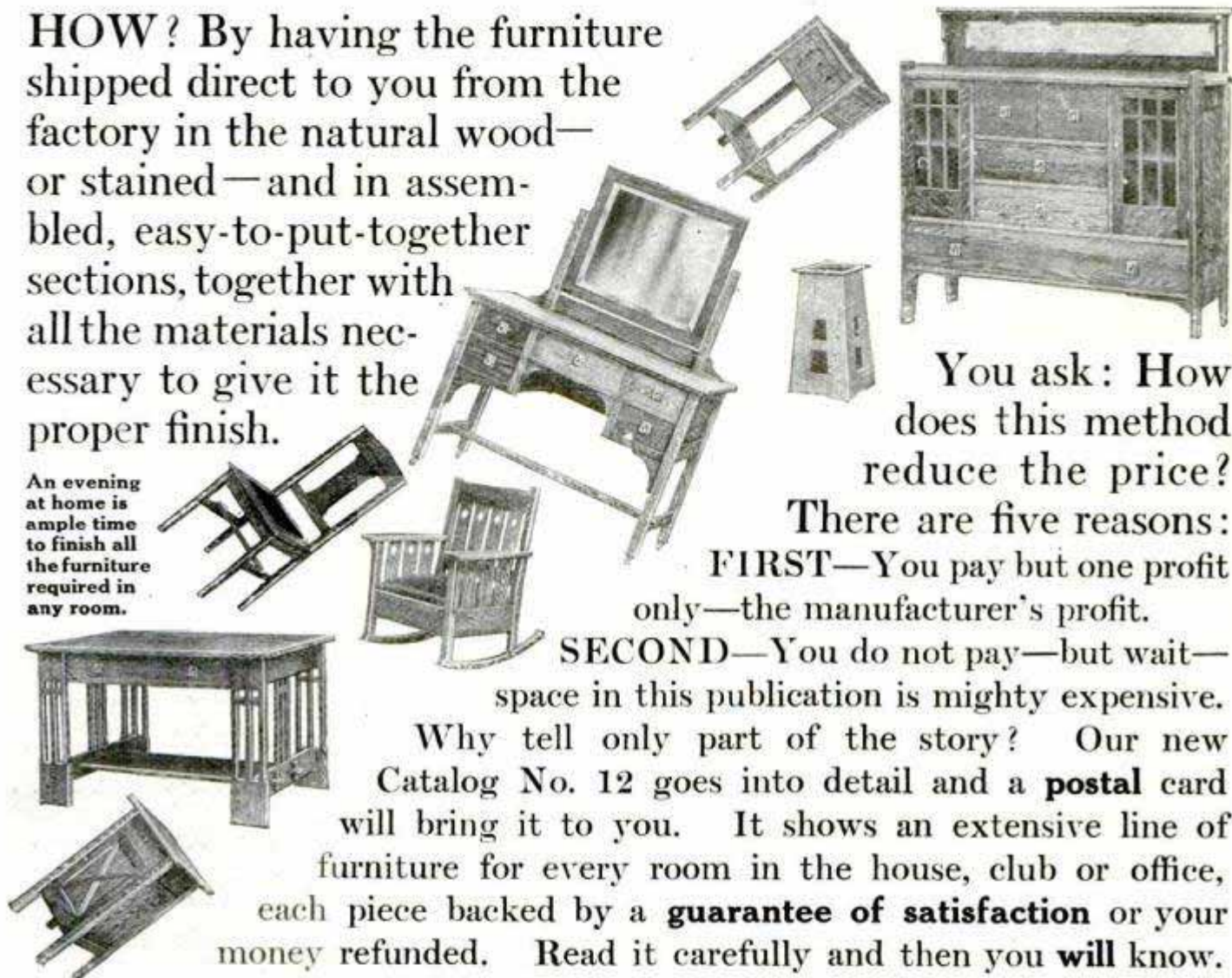

You ask: How does this method reduce the price?

There are five reasons:

**FIRST**—You pay but one profit only—the manufacturer's profit.

**SECOND**—You do not pay—but wait—space in this publication is mighty expensive.

Why tell only part of the story? Our new Catalog No. 12 goes into detail and a **postal** card will bring it to you. It shows an extensive line of furniture for every room in the house, club or office, each piece backed by a **guarantee of satisfaction** or your money refunded. Read it carefully and then you **will** know.

== Send That Postal Now—Right Now ==

## AN IDEA AS TO PRICES

Refer to the illustrations, showing just a few pieces of our extensive line of furniture. Combination Bookcase and Writing Desk—height 50 inches, width 63 inches, \$22.50. Heavy Mission Rocker, \$8.50. 62-inch Settee, \$16.25. 54-inch Extension Dining Table, \$19.50. 48-inch Library Table, \$16.00. Mission Buffet—height 51 inches, length 55 inches, \$22.50. You cannot duplicate any piece for double the price.

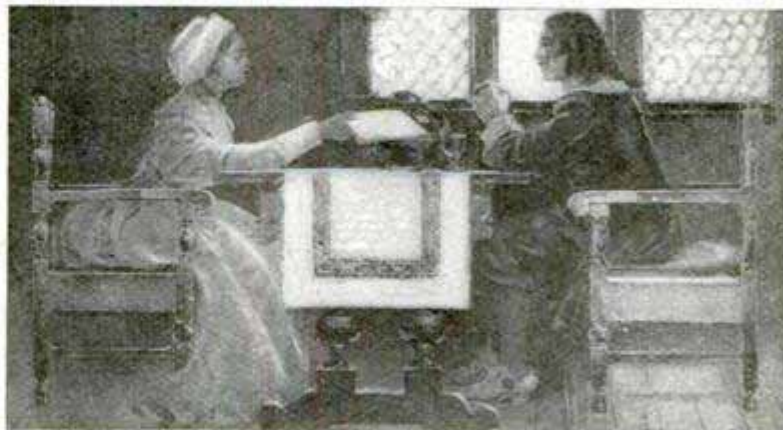

Catalog No. 11 also shows a line of furniture of the Flanders period

**BROOKS MANUFACTURING CO.** 703 RUST AVENUE  
Saginaw, Mich.



# GIBFORD TRADE MARK ZIG ZAG

## AUTOMATIC STROPPER

### Gives a Sharp Blade for Every Shave

Get this remarkable little stropper, and make your daily shave easy — pleasant and economical. No more dull blades; no more expense for buying new ones.

This stropper puts a keen, sharp edge on any make of safety razor blade the natural way. It stropps the blade just as the barber stropps the old-fashioned razor — back and forth on the strop, first on one side of the blade, then on the other. The curve cut strop automatically gives the barber's draw stroke that imparts the final touch of keenness to the blade.

### The Curve Cut Strop Gives the Barber's Stroke



One Model stropps any standard make of safety razor blade

COMPLETE WITH HORSEHIDE STROP  
**\$1.00**

Sold complete with strop by leading druggists, hardware and other dealers everywhere in U. S. for \$1.00. Price in foreign countries \$1.50. If your dealer has not yet put it in stock, it will be sent prepaid from factory, on receipt of price. Send for our free booklet: "No More Dull Blades For Me."

**GIBFORD SPECIALTY CO.**  
63 East Fort St., DETROIT, MICH.

## Vacuum Cleaners!!

### Best By Test

- |  |                          |
|--|--------------------------|
|  | Imperial (Electric) \$45 |
|  | Acme (Hand) 15           |
|  | " (Water Motor) 35       |
- Fully Guaranteed  
Send in your order today

AGENTS WANTED

LIPPINCOTT S. S. & S. Co., Newark, N. J.

Let it not be overlooked or forgotten that President Taft takes a firm stand against the further use of the dangerous and deadly phosphorous match. This match, as he seems to intimate, is not made in heaven. Far from it.—Chicago Tribune.

It was a city man who described the difficulty of keeping up with his multifarious engagements in the following picturesque phrase: "It is very like a celluloid dog trying to chase an asbestos cat through Hades."—London Financial Times.

## Rowboat \$20.00

### MONEY IN BOAT LIVERY!

Can ship in any quantity. Need No Boat House. Never Leak, Rust, Check, Crack or Rot. Absolutely safe. Every boat has water-tight compartments, so cannot sink. 20 different designs. Demonstrator Agents Wanted in Every Community. Write TODAY for FREE Illustrated Catalog and Special Factory Prices. Michigan Steel Boat Co., 156 Bellevue Ave., Detroit, Mich.

## Buy Direct—Save Money—We Pay Freight

Our monthly installment plan of selling direct saves you the dealer's profit and his excessive charges for installation and repairs. You can save at least 1/3 the cost of your furnace. We have been building Jahant Furnaces for over 30 years and guarantee satisfaction

# JAHANT DOWN DRAFT FURNACE

THE BEST HEATING SYSTEM MADE for residences, schools, hotels, churches, etc. It is the most economical furnace too and saves 1/3 to 1/2 the cost of fuel because the patented "Down-Draft System" burns wood, hard or soft coal, and burns it ALL without cinders, clinkers or any waste. Needs less attention, yet heats much better than any other furnace, hot air, steam or hot water heating system. Our plan of monthly payments

### ONLY \$10 DOWN and \$10 A MONTH

makes it easy for any one to have the best heating system made. Every Jahant Furnace is sold with a strong "Guaranty Bond" that allows you 365 DAYS TRIAL. You don't run any risk buying from us. We send complete outfit, furnace, pipes, registers, etc., together with special plans, full directions and all tools for installing. If you can drive a nail you can install a Jahant Furnace without the aid of a tinner.

Write To-Day for Catalog

which explains the Jahant Down-Draft System and tells why it gives more heat at less cost.

THE JAHANT HEATING CO.,

3 Mill Street, Akron, O.



Let Us Put This Piano in Your Parlor  
Not a Dollar To Pay Us!

# SEND NO MONEY

Enjoy This Piano—Take Your  
Own Time—Sent to You  
on 30 Days' Free Trial

Write right now and let us put this piano  
in your parlor — not a dollar to pay us.

Let us send you our big, free, actual photograph, color-illustrated, handsome book, and offers to trust you absolutely with any celebrated and artistic Reed & Sons Piano on as long time as you want, even three years or more, if you are satisfied after 30 Days' Free Trial. Not a cent to pay down—not a dollar for any of our beautiful styles you select from the book we send you on



## REED & SONS PIANOS

Established 1842. Given Highest Award  
at World's Columbian Exposition, 1893

We've sold through dealers, jobbers and agents—for over 68 years—but now we have cut out their big profits and are giving the savings to our customers. We have made our direct-to-you wholesale factory prices so low that you can have a celebrated Reed & Sons Piano, for lifelong service, at a price as low as the price of many "cheap" made pianos—and get the highest artistic quality. Our 25-year guarantee bond goes with every Reed & Sons instrument. Hundreds have had generations of enjoyment from our pianos. So can you on our plan and prove it positively at our risk.

Now Sold Direct to  
You From Factory

Saves you from \$128.00 to \$222.00 on  
price. No Security  
— No Interest to  
Pay—No Col-  
lectors.



### Also Self-Playing Pianos

Reed & Sons Self-Playing Pianos now sold on the most liberal plan. Thousands who "never knew a note" are now enjoying our Self-Players. See our offers and prices all explained in handsomest color-illustrated catalog sent Free.

Take Your Own Time  
—On Trying and Paying—  
We Pay Freight Both Ways.

Take 30 Days' Free Trial in your home with your family and friends to judge the beautiful tone quality—handsome exclusive design and finish—easy action and splendid satisfaction. After a full year's enjoyment send our Reed & Sons Piano or Self-Playing Piano back and we'll pay the freight if not exactly as represented. That's the fairest offer ever made. It means 365 Days' Approval Test, besides 30 Days' Free Trial and 3 years' time to pay if satisfied. When absolutely satisfied you can pay \$1.00 a week, or by the month, or 3 months, or twice a year. We don't care how. Suit your own time. We want you to be happy with one of our pianos or self-playing pianos—prove it at our risk—right now. Write right now—a Postal Today—or the Coupon—For Our Big Book.

REED & SONS PIANO MFG. CO., 253 Wabash Ave., CHICAGO, ILL.

Capital and Resources, \$1,750,000.00—Largest Factory-to-Home Piano Manufacturers in the World.



## Big Book Free

Reed & Sons Piano Mfg. Co.,  
253 Wabash Ave., Chicago, Ill.

Please send me your Big Color Illustrated Piano Book and offer FREE. Everything at your risk.

Name \_\_\_\_\_

Address \_\_\_\_\_

Town \_\_\_\_\_ State \_\_\_\_\_

365 Days Approval Test

# Union Increases Use

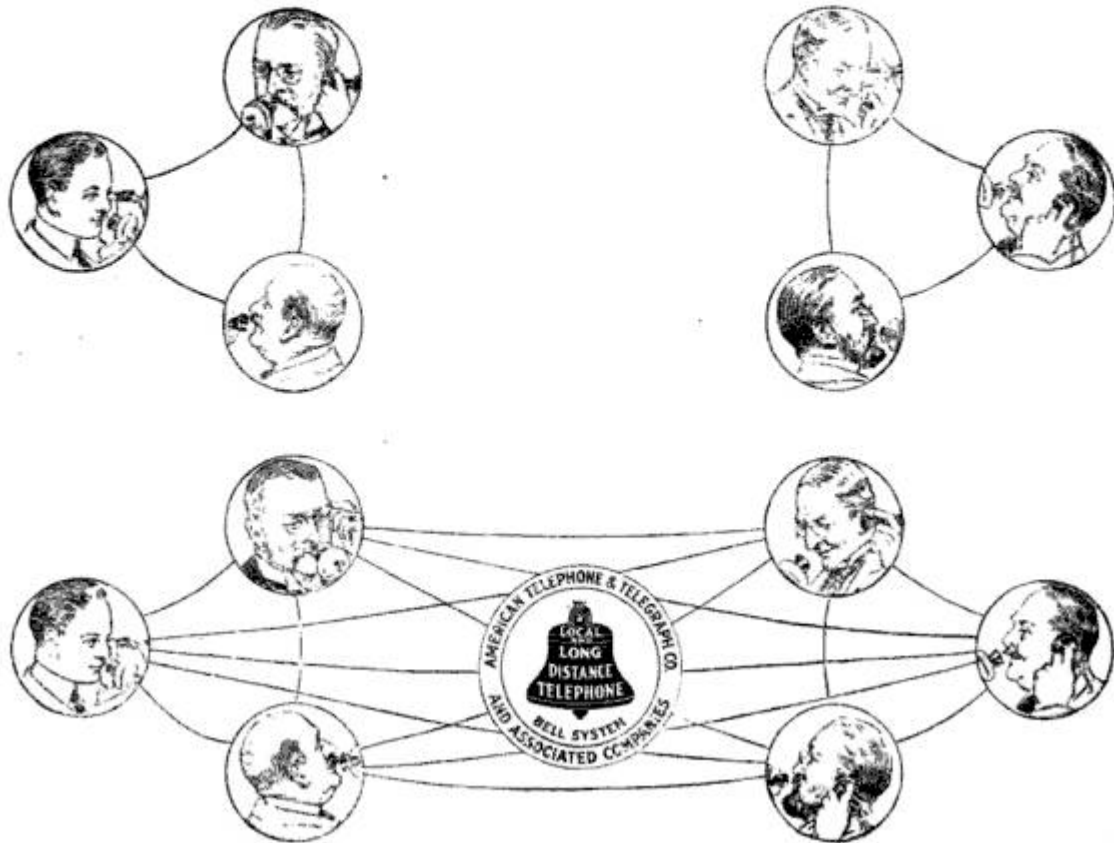

When two groups of telephone subscribers are joined together the usefulness of each telephone is increased.

Take the simplest case — two groups, each with three subscribers. As separate groups there are possible only six combinations—only six lines of communication. Unite these same two groups, and instead of only six, there will be fifteen lines of communication.

No matter how the groups are located or how they are connected by exchanges, combination in-

creases the usefulness of each telephone, it multiplies traffic, it expands trade.

The increase is in accordance with the mathematical rule. If two groups of a thousand each are united, there will be a million more lines of communication.

No one subscriber can use all of these increased possibilities, but each subscriber uses some of them.

Many groups of telephone subscribers have been united in the Bell System to increase the usefulness of each telephone, and meet the public demand for universal service.

**AMERICAN TELEPHONE AND TELEGRAPH COMPANY  
AND ASSOCIATED COMPANIES**

*One Policy*

*One System*

*Universal Service*

*Please Mention Popular Mechanics*

# We Make Your Dreams of Home Come True



We have made the dreams of home come true for over 600,000 people, in every community and in every walk of life; from the humble cottage to the pretentious mansion, from the smallest hamlet to the largest city, the Spiegel, May, Stern Company has been making happy homes for over half a century.

Rich and poor alike have been extended exactly the same terms, exactly the same low prices. There has been no favoritism shown—everybody gets the same liberal, generous treatment. And there isn't any magic about our way of doing business. Just a simple business proposition that has been wonderfully successful and which has built up during the last century the greatest business of its kind in the world.

**Everything Shown in Our Home-Lovers' Bargain Book is an Unusual Bargain—Bought at Tremendous Reduction. No Extra Price if You Wish to Pay as Convenient.**

**3,000 Bargains in Furniture, Carpets, Rugs, Stoves, Ranges, Draperies, Chinaware, Silverware, Sewing Machines, Washing Machines, Lamps, Clocks, Baby Carriages, etc.**

We sell at cash factory prices. No middlemen, no jobbers, no dealers—all these expenses and profits are cut out entirely. We sell from the factory direct to you by means of this catalog only. This is essentially a book of bargains. We are always in the market with plenty of money to take advantage of every possible bargain that is offered. We snap up everything in sight if we can get it at the right price, and we give you the advantage of our quantity-buying, adding only one small profit. We guarantee a saving under prices quoted by any mail order house or by dealers of 15 to 50 per cent. **And if it is not convenient to pay cash you may buy on our liberal open account credit plan at the same prices as if you pay cash.** No other concern in America does that. We are going to prove that to you, as we have to over 600,000 people.

## Cash or Credit—30 Days' Free Trial

Anything shown in this book will be sent to you on 30 days' free trial. **If it's not convenient to pay cash, send the first payment—about 15 cents on each dollar.** Then the goods will be shipped, and you will have them in your home for a month before anything more is due.

If they are not satisfactory—not cheaper than anywhere else—you return them at our expense. Every penny you have paid, including the freight charges, will then be returned to you.

Thus you see the goods before buying them. More than that, you actually use them a month. You have every chance to compare our prices with others. And we leave the decision to you. Isn't that immensely fair?

## Our Guaranteed Saving

There are some things in this book which some mail order houses sell pretty close to our prices. Even on these things, however, we guarantee a saving of at least 15 per cent. Compared with dealers' prices, the saving on most things runs as high as 50 per cent. We also guarantee that.

We send the goods on approval under our guarantee to undersell all other prices—**either cash or credit**—by from 15 to 50 per cent. You can easily tell, when you see the goods, if we do that.

It is on this plan that we have built up this business with its 600,000 customers and its combined capital of \$7,000,000, with its six acres of floor space and its thousands of employes. Let us tell you the story in detail. (86)

**Spiegel, May, Stern Co., 1358 35th St., Chicago**

*Please Mention Popular Mechanics*

## Cut Out the Coupon

**and Get Our Big Free Bargain Book**

Simply give your name and address on the coupon and mail it today. The big Spring Bargain Book or Stove Book, or both, will come by next mail. **Send no money or stamps.**

SPIEGEL, MAY, STERN CO.

1358 35th Street, Chicago

- Mail me the big Spring Bargain Book.  
 Mail me your new Stove Book.

Name .....

Post Office .....

State .....

I am particularly interested in

.....  
 Name article you most desire.

# How Can You Afford to be without A Gasoline Engine When the Price is made so Low <sup>2½ HP</sup> \$69<sup>75</sup>

## You Know the Value of a Gasoline Engine on the Farm

Surely it hasn't been that you doubted the wonderful, many sided utility of this labor saving that you have hesitated. Price has caused thousands to delay—you perhaps. But price cuts no figure now, for the price of the Little Giant 2½ horse power Engine has been tumbled from \$93.25 down to \$69.75. This engine has been on the market for 20 years. Thousands have been sold. Many of these have been used under the most trying conditions—rough handling—over-loading—poor treatment—long continued service. Yet the Little Giant has in every case given absolute satisfaction, and maintained its enviable reputation. It was a big value at the old price. Think what a bargain you secure at the new figure.

## Robs Farm Work of the Drudgery

Let a Little Giant do all the hard work on your farm. Turn over to it all your pumping. Let it run your cream separator, your washing machine. Let it saw your wood, shell your corn, cut your feed, run the fanning mill, blow your forge and sharpen your tools. These are but a few of the tasks that the Little Giant will perform for you. Surely anything that will relieve you of all this work is worth a great deal more than the small price asked.

## LITTLE GIANT Engines are Warranted for 5 Years

We know the Little Giant so well—have seen it so thoroughly tested that we do not feel the slightest hesitancy in attaching this warranty to each engine we sell. We know from past experience that the engine will more than live up to it.

**SIZES AND PRICES—Prices quoted below are for engines 1. o. b. factory, near Chicago**

EF 93200—Size of engine, 2½ h.p.; bore 4 in.; stroke 6 in.; normal speed 400 R. P. M.; piston speed 400 ft. per minute; pulley 6x6 in.; floor space 24x57; height to top of tank 48 in.; approximate shipping weight 550 lbs.  
Price ..... **\$69.75**

EF 93202—Size of engine, 4 h.p.; bore 5 in.; stroke 7½ in.; normal speed 400 R. P. M.; piston speed 500 ft. per minute; pulley 8x6 in.; floor space 26x57; height 52 inches. Approximate shipping weight 750 lbs.  
Price ..... **\$89.50**

## The Biggest Gasoline Engine Value Ever Offered

For many years this successful engine has served as a model for other manufacturers. However, not a single one of their many imitations has approached it in power—in workmanship—in economy or simplicity. Better factory facilities and a big increase in the number of engines built have enabled us to so materially reduce the price. The engine is simply a marvel. It is simple—easy to run—easy to start. It is powerful and will work above its rated power if required to do so. Will run anywhere and the cost of operating is trifling. When developing full power only two and a half pints of gasoline an hour are required. You will own a gasoline engine some day. Why not get one now? You will never be offered a better engine nor will you ever be offered one so good at nearly so low a price. Order from the address nearest you.

ASK FOR A COPY OF OUR GASOLINE ENGINE CATALOGUE

**Montgomery Ward & Co.**  
CHICAGO AND KANSAS CITY

Chicago Avenue Bridge . . Chicago  
19th and Campbell Sts., Kansas City

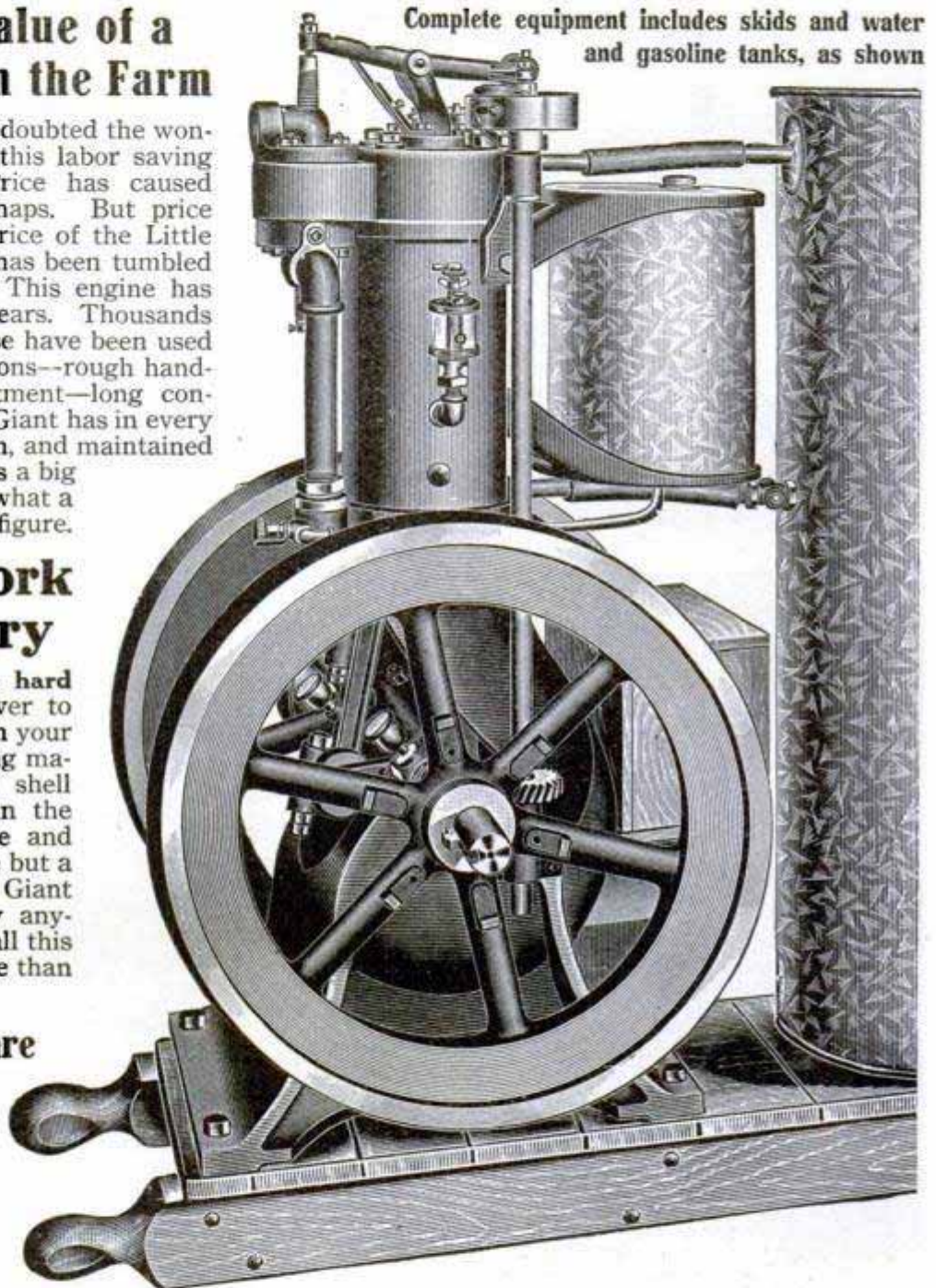

Complete equipment includes skids and water and gasoline tanks, as shown

# The Automobile Hand Book: Technical World Magazine for one year

Both  
only  
\$ **1.50**  
\$ **3.00**  
Value

**The Handbook.** There is in this book more actual, definite, authoritative information concerning every sort of automobile than has ever before been crowded into many volumes. It contains practically the whole world's knowledge about automobiles, boiled down and presented in clear, simple, easily comprehended terms. It tells about gasoline automobiles, steam automobiles, electric automobiles, motor cycles, and every tiny detail of each one of these special types. It is not only valuable, but a positive essential to every owner, manufacturer, salesman, garage man, repair man, chauffeur. It is not only valuable as a reference book in which to look up disputed or puzzling points, but it can also be made the basis of a systematic study of the entire subject.

**The Magazine.** Technical World Magazine believes that the most interesting things are real things; that man's achievements are more interesting than man's imaginings, because they are man's imaginings made real. Technical World Magazine is not a dry journal of scientific lore, but a modern, up-to-date, intensely interesting monthly, full of snap and ginger, and blood-warming tales of the big things that men are doing everywhere. It tells the business man of things on which new businesses will be built; the scientist that on which new scientific investigations may be founded; the explorer of new discoveries; the inventor of new inventions. You need it on your library table to keep you up-to-date, and to keep your family fully informed of the world's progress.

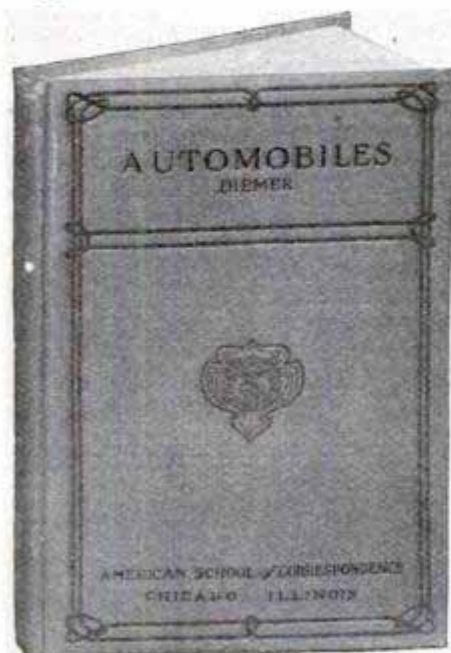

## The Coupon

Technical World Magazine Pop. Mech. 3-11  
58th Street and Drexel Ave.  
Chicago, Ill.

Gentlemen:—Enclosed herewith is \$1.50 for which please send me the Automobile Handbook, and Technical World Magazine, for one year. It is understood that if I am not entirely satisfied, I may return the book and have my subscription to the magazine cancelled, and money refunded.

NAME .....

ADDRESS .....

STATE .....

Send money in the way most convenient

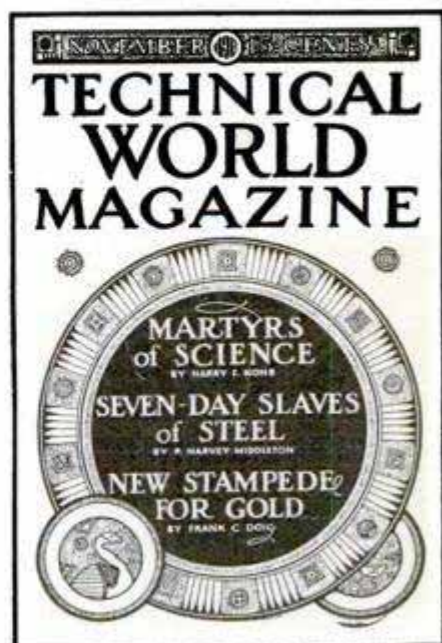

Please Mention Popular Mechanics

**Typewriter Superiority** What is it?  
Merely doing  
the same thing easier, better and longer than the other machine.  
Also some things the other machine will not do at all.

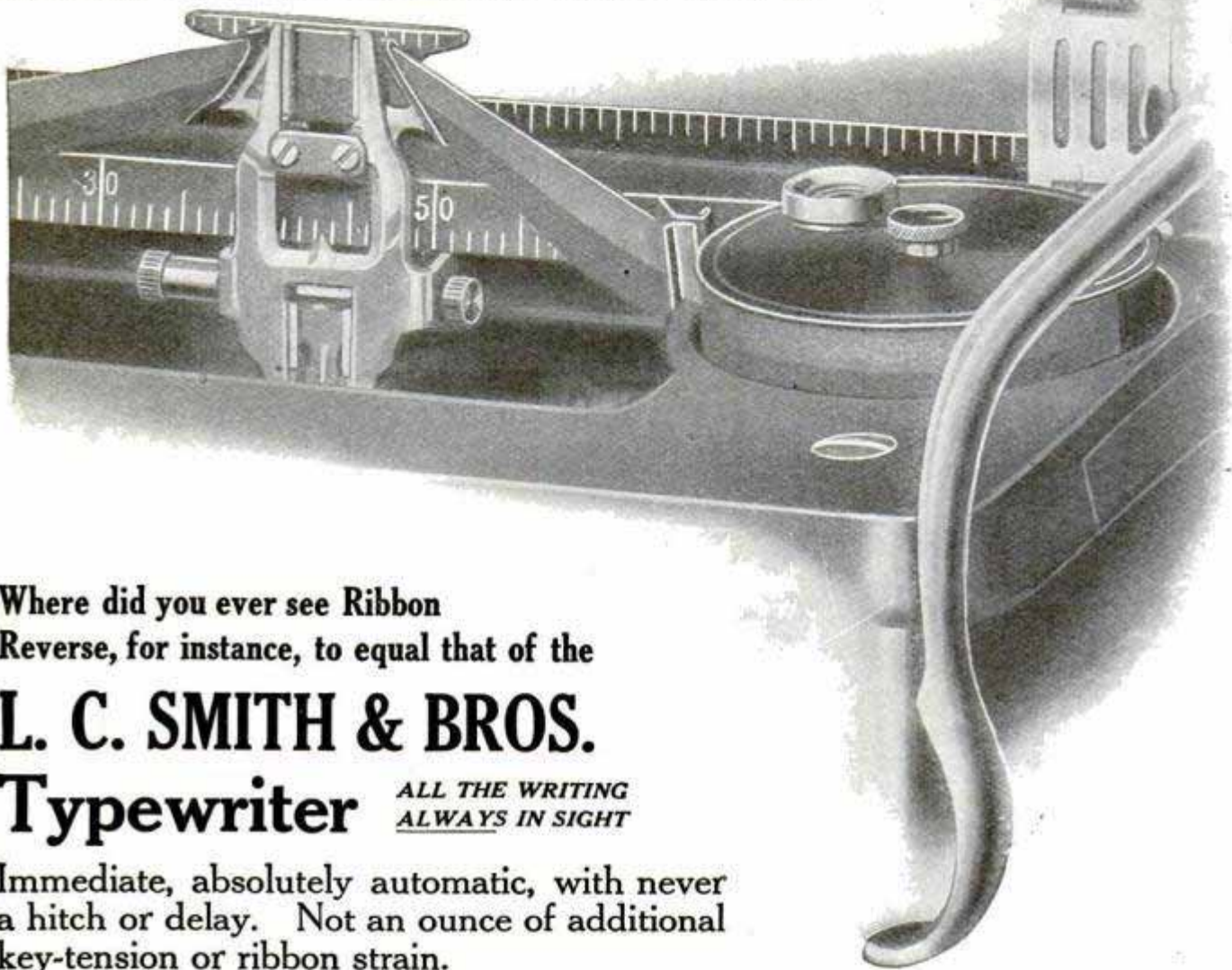

Where did you ever see Ribbon  
Reverse, for instance, to equal that of the

**L. C. SMITH & BROS.**

**Typewriter** *ALL THE WRITING  
ALWAYS IN SIGHT*

Immediate, absolutely automatic, with never  
a hitch or delay. Not an ounce of additional  
key-tension or ribbon strain.

The entire mechanism is that way. Feeds on single stroke of key. Try tabulating a column  
of units—the ribbon *moves!* No pounding in one spot till the ink is all gone and a hole worn  
in the ribbon. And no burrowing to apply a new ribbon. It's an outside operation—a  
matter of a moment. Bichrome and mimeograph features. Everything you could desire,  
and all in the simple, direct fashion of L. C. SMITH & BROS. inbuilt operating devices.

Of course you send for the book. L. C. SMITH & BROS. TYPEWRITER COMPANY, Head Office for Domestic and Foreign Business,  
SYRACUSE, N. Y., U. S. A. **Branches in all large cities.**



**Diamonds on Credit**

20% Down; 10% a Month

Every customer is protected by  
our written guarantee to refund  
his money if his dealer can dupli-  
cate our diamond at our price.

Write for Illustrated Catalog No. 3.

**J. M. LYON & CO.,** 71-73 Nassau St.  
New York City

**IDEAS  
YOUR IDEAS MAY BRING  
YOU A FORTUNE!  
TALENTS**

**H. ELLIS CHANDLEE & CO.**  
55 Bornot Building, WASHINGTON, D. C.

See page 119



The Isograph  
Celluloid, 6 x 6 inches

**USE ISOMETRIC DRAWING**

The Isograph makes it easy. Illustrate your ideas and make your working drawings  
explain themselves. For dimensional or free hand work. Illustrated book of instruc-  
tions quickly teaches the amateur. Invaluable to inventors. Cuts down experi-  
mental work and may save making a model. Its time-saving features are indis-  
pensable to the professional. Every worker in wood or metal needs an Isograph.  
Carpenters, builders and sheet metal workers use it constantly. It explains your  
most complicated ideas.

Postpaid with book of instructions 50c, Money Order or 2c stamps. Send today.  
**THE ISOGRAPH CO., 145 E. 23d St., NEW YORK CITY**

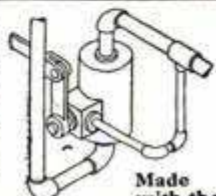

Made  
with the  
Isograph. Gives 3 views in  
one. As good as a photograph.



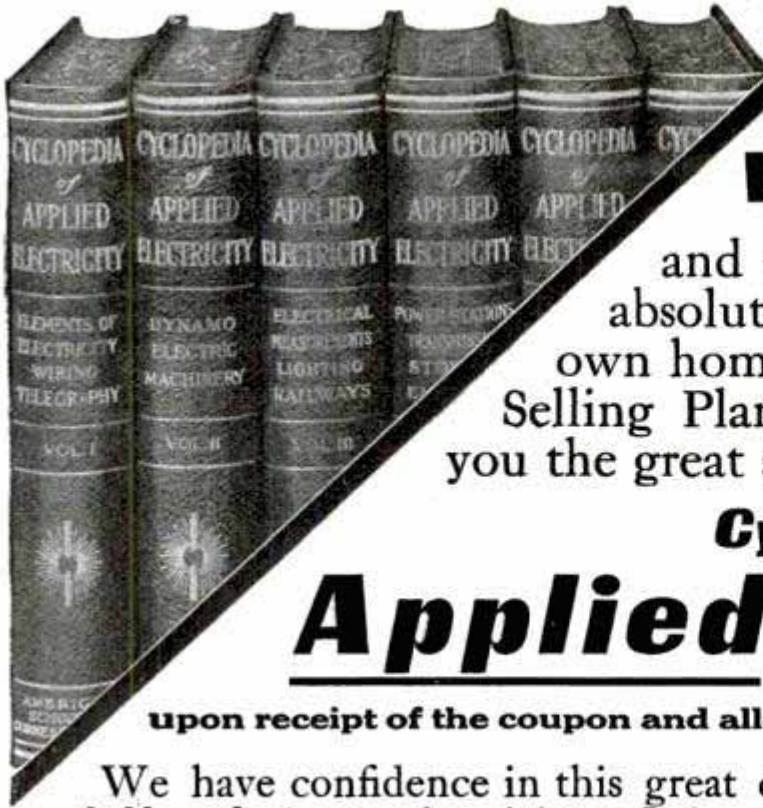

# Here is the Standard Reference Work on Electricity

and we want you to examine it absolutely free of charge in your own home or office. Read our Liberal Selling Plan—it tells how we will send you the great six-volume

## Cyclopedia of Applied Electricity

upon receipt of the coupon and allow you to examine it free of charge.

We have confidence in this great cyclopedia; we know that it is the reliable authority on electricity. It is compiled from the instruction papers of the American School of Correspondence, written by thirty of the world's greatest electrical experts. We want you to endorse our claims and for this reason we make you this free offer.

If you want to be an expert—an authority on everything electrical, you need a work that covers every phase of electrical engineering—a work that will tell you what you want to know in plain English without technical terms and formulas. That is just what you have in this cyclopedia. These books cover every branch of electricity thoroughly, exhaustively, from the elements of electricity to the design and construction of power and central stations. Read "Important Subjects Covered," and then mail the coupon. The six volumes contain 2,896 pages, 7x10 inches in size; 2,000 special illustrations, photographs, plates, diagrams, tables, etc., beautifully bound in half morocco; titles stamped in 23-karat gold.

### This Is Our Liberal Selling Plan

Upon receipt of the coupon the books will be sent you, express prepaid, for 5 days' free examination. If you decide to keep the books, send us your initial payment of \$2.00 within five days and \$2.00 every month until you have paid the special price of \$18.80. The regular price is \$36.00. If, after thoroughly examining the books, you do not see your way clear to keep them, notify us and we will send for them at our expense. Send the coupon today.

#### IMPORTANT SUBJECTS COVERED

Types of Dynamos and Motors; Elevators; Direct-Current Motors; Electrical Measurements; Electric Lighting; Electric Railways; Alternating Current Motors, etc.; Electric Welding; Mercury-Vapor Converter; Management of Dynamos and Motors; Power Stations; Central-Station Engineering; Central-Station Design; Storage Batteries; Power Transmission; Electric Wiring; Electric Telegraph; Wireless Telegraphy; Telephony; Automatic Telephone; Wireless Telephony, etc.

For a short time we will include as a monthly supplement, for one year, the TECHNICAL WORLD MAGAZINE. This is a regular \$1.50 monthly, full of Twentieth Century scientific facts, written in popular form. Also contains the latest discussion on timely topics in invention, discovery, industry, etc.

**AMERICAN SCHOOL OF CORRESPONDENCE**  
CHICAGO, U. S. A.

Pop. Mech.  
3-'11  
A. S. of C.

Please send set Cyclopedia of Applied Electricity for 5 days' free examination, also Technical World for one year. I will send \$2.00 within 5 days and \$2.00 a month until I have paid \$18.80, or notify you and hold the books subject to your order. Title not to pass until fully paid.

NAME .....

ADDRESS .....

OCCUPATION .....

REFERENCES .....

Please Mention Popular Mechanics

# Triple the Purchasing Power of Your Money

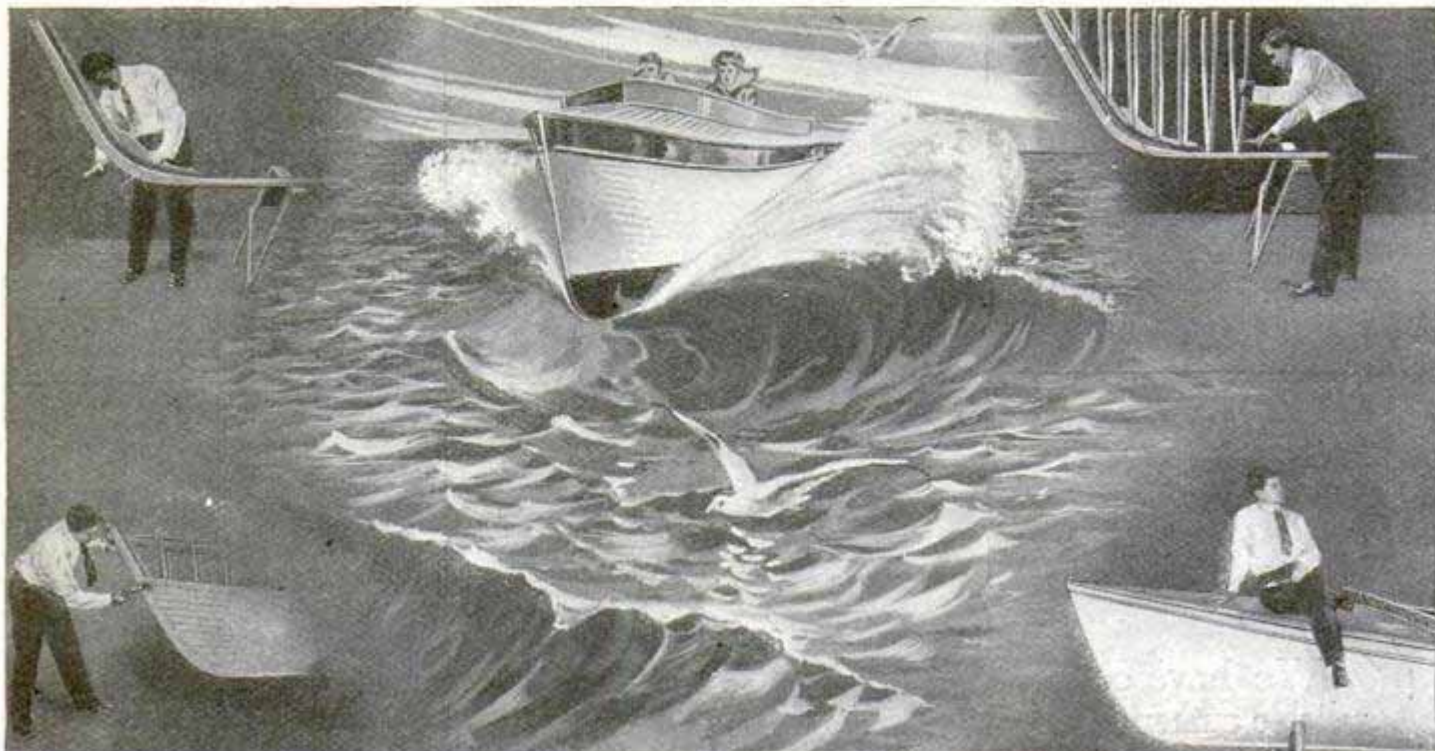

**D**O you know that it is the health-giving pull of Nature that makes every gingery water breeze, every glance at a beautiful lake or river, attract the red-blooded human being, and make him want a boat? It's your duty to yourself—to your family—to respond to this influence.

**AGAIN**—Do you know that by adding a little of your money to a little of your spare time, you can profitably enjoy many a dull hour and own a boat at a ridiculously low cost?

## Make \$1 Do Exactly the Work of \$3

**HOW?** By purchasing the full-sized paper patterns and instructions for a boat, or by purchasing all or part of the material in the knock-down—that is—every piece cut to shape, machined and accurately fitted, so that it will go together but one way only—the right way.

**You ask: Why does this method reduce the price? There are five reasons:**

**FIRST:** You are spending a few pleasant hours instead of money in assembling the boat, which reduces the cost to you over half.

**SECOND:** You do not pay—but wait—space in this publication is mighty expensive. Why tell only part of the story? Our new catalog No. 25 goes into detail, and a **postal card** will bring it to you. It shows an extensive line of boats, from canoes to cabin cruisers—every one backed by a **guarantee of satisfaction** or your money refunded. **Send that postal now—right now.**

**BROOKS MANUFACTURING CO.**

703 RUST AVENUE

SAGINAW, MICH.

## A Quarter of a Million Dollars in Prizes Now Offered for Aeroplane Flights During 1911

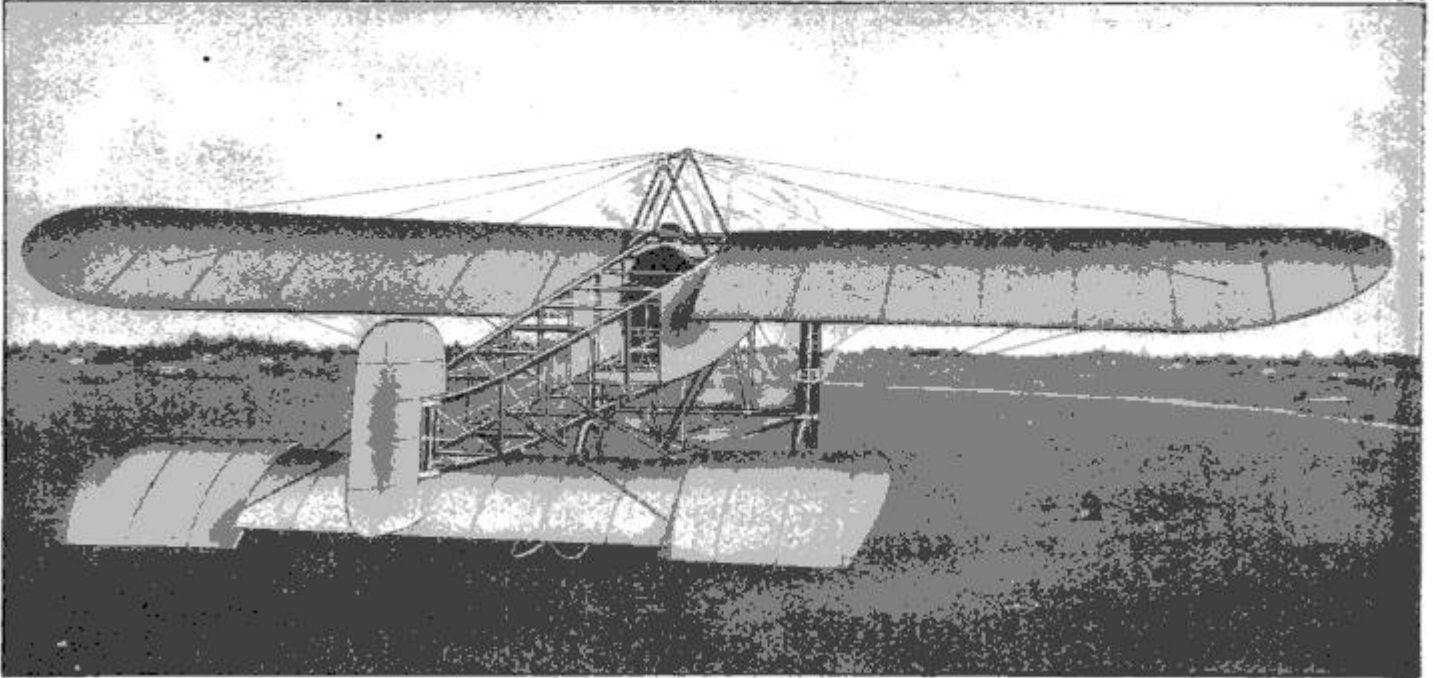

### SEND TODAY FOR AEROPLANE CATALOG No. 1

which shows how, with a little effort on your part, you can own, at a ridiculously low cost, a standard monoplane, of recognized merit, built by the "Brooks" system, embodying strength, simplicity, stability and safety. Double system of guying, together with two independent systems of control.

### A MOST REMARKABLE OPPORTUNITY TO MAKE MONEY

#### THIS SEASON WILL BE THE HARVEST

In addition to prizes, aggregating a quarter of a million, every county fair, every amusement park, will pay mighty well for exhibition flights. We sell outright—you are free to use your aeroplane as you see fit.

You can purchase the plans, specifications, illustrated instructions and patterns, from which you can build an aeroplane, by purchasing the necessary material locally—or

We can also furnish you with all the material shaped ready to fit together, tubing cut to length, and castings in the rough—or

All the material in the knock-down, but accurately fitted prior to shipment, ready to put together according to instructions—or

We will furnish the complete machine without power plant or with same installed ready for flight.

Plans, instructions, etc.,—\$25.00. Material shaped ready to be fitted, including plans, etc.,—\$500.00. We can also furnish at proportionately low prices material in the K. D. accurately fitted ready to assemble, including plans, etc.; completed monoplanes ready for the engine, and completed monoplanes, equipped with power plant including 50 H. P. Motor, ready for flight.

**Immediate delivery guaranteed. Don't fail to send today for Catalog No. 1**

**BROOKS AEROPLANE CO., 703 Rust Ave., Saginaw, Mich.**

→ **Protect Your Idea!** ←

# PATENTS THAT PAY

"My Trade-Mark"

## Special Offer:

Mr. Inventor: I invite you to come to see me, and bring, or send (by registered mail), sketches or photograph or model and description of your idea or invention for FREE examination of U. S. PATENT OFFICE Records and report as to patentability of the same;—to find out as to whether you are entitled to a patent will not cost anything;—then, if your invention is new, upon receiving instructions, I will prepare ALL necessary (application) papers.

DO THIS AND SAVE TIME AND MONEY!

**WRITE NOW!**

### Highest References:

Lincoln National Bank,  
Washington, D. C.

NOTE: When writing these clients send two-cent stamp for reply.

Little Giant Hay Press Co.,  
Alma, Mich. and  
Dallas, Texas.

Gray Lithograph Co.,  
New York City, N. Y.

Farmers Mfg. Co.,  
Norfolk, Va.

New Era Mfg. Co.,  
Fairfield, Iowa.

Bernhard Furst,  
Vienna,  
I. Austria-Hungary.

Otto von Rottenburg,  
Schwindstrasse 20,  
Frankfort a/M.,  
Germany.

H. A. Fonseca,  
Rua Dos Ourives 20,  
Sobrado, Rio de Janeiro,  
Brazil, S. A.

A. J. Corsi,  
Irish Town,  
Gibraltar.

Bell Show Print Co.,  
Sigourney, Ia.

The Camp Conduit Co.,  
Cleveland, O.

The Iowa Mfg. Co.,  
Oskaloosa, Ia.

Sam'l Allen & Son Mfg. Co.,  
Dansville, N. Y.

The Garl Electric Co.,  
Akron, O.

Superior Mfg. Co.,  
Sidney, O.

Tidnam Tel. Pole Co.,  
Oklahoma City, Okla.

Edw. H. Smith,  
Aberdeen, Wash.

C. O. Cracroft,  
Cordova, Alaska.

V. C. de Ybarrondo,  
Los Angeles, Cal.

Wm. H. Garlock,  
Leland Hotel,  
Seattle, Wash.

F. Rutherford,  
Copper Queen Con. Min. Co.,  
Douglas, Arizona.

Gas Range & Heater Co.,  
S. Pasadena, Cal.

Newberg Brick & Tile Co.,  
Portland, Ore.

## INFRINGEMENT, VALIDITY AND INTERFERENCE WORK SOLICITED

I am admitted to practice before the United States Supreme Court and all others

"I want to thank you for the most excellent services you have rendered me in this suit [B. Williams vs. Central Drug Co., U. S. C. C., Northern District of Illinois—E. Div.], and assure you that I appreciate it very much, and if at any time I can secure some business for you, I will be only too glad to do so."  
September 19, 1910.

(Signed) J. THOMPSON, Mgr. Central Drug Co., Sioux City, Iowa.

**FREE: Two Books—61-page "Inventor's Guide" and 64-page "Proof of Fortunes in Patents—What and How to Invent"**

### Foreign Patents a Specialty

If you have a U. S. application write me for excellent literature and terms for promoting your Foreign Patents. Liberal discounts.

### I Advertise My Clients' Patents Free

in a publication having over 2,000,000 circulation. Write for Special Offer. Successful clients in every section of the U. S.



My Office and the Patent Office  
(I give you proof of my location)

Across the street from the U. S. Patent Office

Expert—Prompt Services

**E. E. VROOMAN, Patent Lawyer Wash., D. C.**

Registered Patent Attorney. Patent Litigation

871 F Street, N. W.

**\$217,440.00 \$**  
MADE BY MY CLIENTS \$

**YOU Should Have My FREE BOOK**  
Telling HOW OTHERS will do the  
same IN THE FUTURE. "WHAT and  
HOW to INVENT" BOOK FREE!

"I received ONE HUNDRED DOLLARS (\$100.00) down (in re my Can Righting Machine inventions) and in thirty days NINE HUNDRED DOLLARS (\$900.00), and when my patents are issued ONE THOUSAND DOLLARS (\$1000.00) more. I can conscientiously state to my fellow inventor that he will do the right thing by placing his patent business in Mr. Vrooman's hands for the best iron-clad patents."  
(Signed) WILLIAM C. BRIDGES, Wapello, Iowa.

High-Class Work—Excellent Testimonials



MR. H. ELLIS CHANDLEE

# PATENT

## WHAT YOU INVENT!

# PATENT

**YOUR IDEAS MAY BRING YOU A FORTUNE**

**There is A Constant Demand For Good Inventions.**

One of our clients recently made \$85,000; another \$7,000; another \$5,000; another \$3,400; two others \$1,000 each, and two others \$500.

WRITE FOR

**"OPPORTUNITY"**

A List of Needed Inventions

Also, "U. S. LETTERS PATENT," telling how to obtain a patent.  
"THOUGHTS THAT HAVE PAID," a history of successful inventions.  
"TESTIMONY," giving our testimonial letters from manufacturers and inventors.

Mailed free to any interested person

IF YOU HAVE AN INVENTION send us a rough sketch and description, model or photograph of it, and we will give you our opinion as to its patentability **WITHOUT CHARGE**. If our opinion is favorable, we will issue a contract binding us to **refund every cent of our fee if we fail to obtain a patent.**

This assures you that we will not make application unless the chances of success are good, and that **every effort** will be made to obtain an allowance. We advertise the patents of Our Clients for sale in prominent dailies free of charge.

**"Prompt and Proper Service"**

**H. Ellis Chandlee & Co.**

Suite 55, Bornot Building, WASHINGTON, D. C.

# PATENTS TRADEMARKS AND COPYRIGHTS SECURED OR FEE RETURNED

## SPECIAL OFFER — FREE SEARCH OF PATENT OFFICE RECORDS

Send us a model, photograph or sketch and description of your invention, and we will make a *Free Search of the Patent Office Records* to ascertain if it is patentable. If we report the invention patentable, we will guarantee to obtain a patent or return our fee, and furnish a certificate of patentability backed by a bonded contract to that effect.



**VICTOR BUILDING**

Our new \$150,000 building, opposite the U. S. Patent Office, specially erected by us for our own use, designed and equipped with all modern appliances for our patent business.

**This Certificate of Patentability will protect the inventor and serve as proof of the invention until the case can be filed in the U. S. Patent Office.**

### OBTAINING ASSISTANCE FOR INVENTORS

Our certificate is of great assistance to inventors who require financial aid to obtain patents. It is useless to attempt to interest capital unless evidence is furnished that the invention is patentable. Our certificate gives this necessary assurance.

### OUR FOUR BOOKS MAILED FREE

to any address. Send for these books—the finest publications ever issued for free distribution.

### HOW TO OBTAIN A PATENT

Our illustrated eighty-page Guide Book is an invaluable book of reference for inventors, and contains 100 mechanical movements illustrated and described.

### FORTUNES IN PATENTS

Tells how to invent for profit, and gives history of successful inventions.

### WHAT TO INVENT

Contains a valuable **LIST OF INVENTIONS WANTED** and suggestions concerning profitable fields of invention; also information regarding prizes offered for inventions, among which is

### PRIZE OF ONE MILLION DOLLARS

offered for one invention, and \$10,000 for others.

### PATENTS THAT PAY

Contains fac-similes of unsolicited letters from our clients who have built up profitable enterprises founded upon patents procured by us; also indorsements from prominent inventors, manufacturers, Senators, Congressmen, Governors, etc.

### WE ADVERTISE OUR CLIENTS' INVENTIONS FREE

in a list of Sunday newspapers with two million circulation, in manufacturers' journals and in the *World's Progress*. Sample Copy Free. We also send a **LIST OF PATENT BUYERS**. We not only save you time and money in securing patents, but obtain patents which **PROTECT** the invention and **PAY**. After the patent is granted we assist you **TO SELL YOUR PATENT**.

### FOREIGN PATENTS

WE HAVE DIRECT AGENCIES IN ALL THE PRINCIPAL FOREIGN COUNTRIES and can secure **FOREIGN PATENTS** in the shortest possible **TIME** and at the **LOWEST COST**. We **GUARANTEE TO SECURE THE FOREIGN PATENTS OR RETURN OUR FEES**. Write for our Illustrated Guide Book on Foreign Patents, sent free to any address.

### REFERENCES:

Second National Bank, Washington, D. C.  
R. G. Dun & Co., Washington, D. C.  
National Savings and Trust Co., Washington, D. C.  
Smethport Glass Co., Smethport, Pa.  
Schrade Cutlery Co., Walden, N. Y.  
Clum & Atkinson, Brass Founders, Rochester, N. Y.  
Rochester Rotary Pump Co., Rochester, N. Y.  
Lawrence Mills, Mfrs. Bed Spreads, 51 Brooke Ave., Englewood, N. J.  
The Melvin Gauge and Signal Inst. Co., Scranton, Pa.  
Damon Mfg. Co., Mfrs. "Missing Link" Flour Mill Disintegrators, Bowling Green, Ky.  
Modern Canner Co., Mfrs. Canning Machinery and Canners' Supplies, Bridgeport, Ala.  
M. Winter Lumber Co., Sheboygan, Wis.

C. K. Lassiter, Mechanical Engineer, Schenectady, N. Y.  
Pitner Gasoline Lighting Co., Chicago, Ill.  
Sprout, Wardon & Co., Mfrs. of the Monarch Feed Governor, Muncy, Pa.  
The L. B. Dozier Co., Mfrs. of Plumbing, Heating and Machinery Supplies, Columbia, S. C.  
B. B. Earnshaw & Bro., Mfrs. "Cream Blend" Flour, Washington, D. C.  
A. L. Schultz, Consulting Engineer, Pittsburgh, Pa.  
Arthur H. Swan & Co., Mfrs. of Peel-Blade Tips, 279 Warren St., Roxbury, Pa.  
The H. W. Moore Piano Truck Co., Anderson, Ind.  
The Culver Novelty Co., Mfrs. of Carbureters and Mixers, Culver, Ind.

**VICTOR J. EVANS & CO.,** VICTOR BUILDING  
(Formerly EVANS, WILKENS & CO.) 724-726 9th St., N. W.

Opposite United States Patent Office

WASHINGTON, D. C.

# A Talk to the Inventor



If you have an invention, its worth probably depends upon its having patentable novelty along **certain** lines. **It might be patentable without possessing such value.**

Therefore, before going to expense in perfecting it for sale or manufacture, send me sketch or model and let me make examination of the Patent Office Records, obtain for you copies of the nearest patents, and explain what can probably be covered in a patent.

If prior patents show that a patent on your idea cannot supply what you think would be a safe margin of protection to warrant the outlay of your time and funds, you may be saved great loss.

But if favorable conditions are shown, you will understand its value better than before. **There's a difference** between this and being told simply that your idea is patentable. If in a hurry to get an application on file, tell me what points you wish your patent to cover, and send \$10. If the idea is sufficiently novel, I will then forward the application papers for you to sign, together with copies of the nearest patents and my report. In a simple (one-sheet) case, there would be but \$25 more to pay to file the case in the Patent Office. With remaining fees, total cost of patent is \$65.

Send for my **FREE BOOK**. Tells what you should know before applying for patent.

**H. L. WOODWARD, Registered Attorney**  
9th & G Streets, Opposite U. S. Patent Office WASHINGTON, D. C.

**PATENTS:** For facts about Prize and Reward offers and Inventions that will bring from \$5000 to 10 Million Dollars; and for books of Intense Interest to Inventors, send 8c postage to R. S. & A. B. LACEY, Div. 45 Washington, D. C. Estab. 1869

## A Patent of Quality

is the only kind that will protect your invention and make it salable. You need my free advisory information. Send for it.

GEO. R. HAMLIN, Patent Lawyer  
801-8th Street, N. W. WASHINGTON, D. C.



## PATENT YOUR IDEAS

\$100,000 for one invention; another \$8,500. Book "How to Obtain a Patent" and "What to Invent" sent free. Send rough sketch for free report as to patentability. We advertise your patent for sale at our expense. **PATENT OBTAINED OR FEE RETURNED.**

**CHANDLEE & CHANDLEE, Patent Atty's**

1044 F. Street

WASHINGTON, D. C.

## PATENTS

C. L. PARKER  
Ex-Examiner U. S. Patent Office  
**PATENT LAWYER**  
210 MCGILL BLDG.  
WASHINGTON, D. C.

Patents, Trade Marks, Copyrights, Patent Litigation

Handbook for Inventors, "Protecting, Exploiting and Selling Inventions" sent free upon request.

# SUCCESSFUL PATENTS

## Patents Applied for at Low Rates

Balance payable after patent is allowed. Send sketch or model of invention for free advice as to patentability, practicability and *Commercial Value*. Seventy-two page guide book, "Successful Patents," booklet "Stepping Stones" (containing over 200 inventions wanted), "Recent Successes," and other literature sent free. *My clients' patents advertised and sold free.* Manufacturers constantly write me for patents I procure.

## FEES RETURNED IF NOT SUCCESSFUL

My *personal* services and attention to every case. Highest references. Unexcelled results. Manufacturers represented. Advice costs nothing. No obligation incurred by writing me.

**RICHARD B. OWEN, Dept. 9, WASHINGTON, D. C.**

# PATENTS THAT PROTECT and PAY

Send for FREE 96-page book. Advice free. Terms reasonable. Highest references. Best results.

Send sketch or model for FREE examination and opinion.

Recommended Patent Lawyer in the Bankers' Register and special list of selected lawyers. Also in Martindale's Law Directory, Sharp and Alleman's Directory of Lawyers, The Gast-Paul Directory of Lawyers, and Kime's International Law Directory.

**ALL BUSINESS GIVEN PROMPT AND PROPER ATTENTION**

A large list of strong recommendations furnished free

**WATSON E. COLEMAN, Patent Lawyer, 622 F St., N.W., Washington, D.C.**

## Our 50th Anniversary PATENT

and Trade-Mark Lawyers

We have served faithfully Thousands of Responsible Inventors. IF YOU want the real Truth about Patents write US. Booklet of valuable facts free. MASON, FENWICK & LAWRENCE, 613 F St., WASHINGTON, D. C.

## PATENTS

NEW AND EASY PLAN OF MAKING PAYMENTS

Valuable Book Free Illustrates and describes 100 Mechanical Movements, and contains useful Information for Inventors. MAILED FREE.

**CHAS. E. BROCK, Patent Attorney**

(Twenty-five years' experience)

918 F. STREET

WASHINGTON, D. C.

## "IDEAL" LAWNMOWER GRINDER

"You Grind It As You Find It."

1911 Model now ready. Better than ever before. Ball-bearing Main Shaft and Grinding Wheel. Grinds all makes of Mowers perfectly in 15 minutes, without removing ratchets or wheels. Over 5,000 in use.

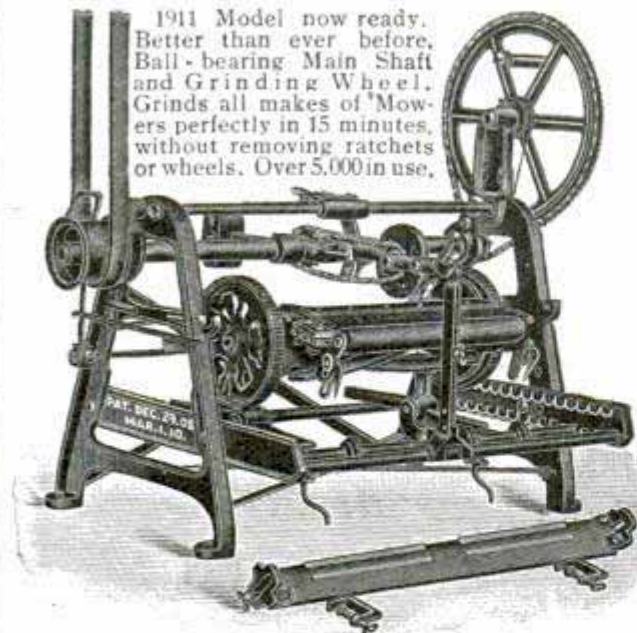

Write Today for full information of this wonderful labor-saver and money-maker. No up-to-date shop complete without it. Will more than pay for itself the first season because it does the work so much quicker and better. Used by U. S. Government and N. Y. City Parks. New Skate Sharpener Attachment for grinding skates. Fully warranted. Write now—TODAY.

**HEATH FDY. & MFG. CO., PLYMOUTH, O.**

## PATENT SECURED OR FEE RETURNED

Free expert search of official records. Send for free handbook.

**MILO B. STEVENS & CO., Attorneys**

ESTABLISHED 1864

854-14th St., WASHINGTON D. C. 370 Monadnock Bldg., CHICAGO

Guaranteed and recommended by the Bankers' Register. Highest rating by Martindale's American Law Directory.

## LANGDON MOORE

Counselor-at-Law and Patent Attorney

Patents, Trade-Marks  
Designs and Copyrights

9th and F Streets, WASHINGTON, D. C.

Formerly Examiner U. S. Patent Office

SEND FOR BOOKLET

Active Powers of Inventive Genius



**INVENTORS** Our Brain Belongs to You. Our Ideas Are Free of Charge.

All we want in return is to build your model, special machinery, dies, tools and jigs to manufacture sheet metal goods, etc. We are expert mechanics, over thirty years experience and have one of the best equipped shops in the country. Ask for Booklet No. 17. Consultation free. Experimental work strictly confidential.

**A. NACKE & SON**

236-242 S. 9th St., Philadelphia, Pa.

## DON'T DISCARD BROKEN PARTS

Have them welded together by the **Oxy-Acetylene Process**. Steel, Cast Iron, Bronze, Copper, Aluminum and all other metals can be welded. Manufacturing quoted on. Welding equipments for repair shops or large plants supplied.

**DAVIS BOURNONVILLE CO.**

105 West Street NEW YORK, N. Y.

Let Us Do Your

Manufacturing

Buying material in large quantities and having a modern factory equipped with the latest machinery enable us to make almost anything in metal or wood at a very low price. Estimates free. We have a complete model and pattern department.

**TINLEY PARK MFG. CO., 14 State Street, CHICAGO**

## Do You Need A Gear



of any description for any purpose? We carry practically all the standard sizes in stock ready for immediate shipment.

We make gears of any style, size or material to order—promptly.

Our new free catalogue contains tables and rules for figuring both spur and bevel gears.

Grant's "Treatise on GEARS"—Price \$1.00 is a valuable reference book for the student and designer.

**Philadelphia GEAR Works, Inc.**  
1120 Vine Street GEO. B. GRANT, PRES. Philadelphia, Pa.



# Make Cement Pipe



Are you looking for a good profitable business that you can carry on as a side line, without a big investment?

## Look at This:

24" vitrified clay pipe costs \$1.25 per foot, or more. The best 24" cement pipe can be made for 35c—85c profit per foot. Other sizes show equal profits. You pay back the investment in machinery in one day. Many miles of sewer and irrigation pipe and drain tile laid last season—Double the amount will be used this year.

## Start now and be in line for Spring business

Over 2000 started last year making cement pipe, brick, sidewalk tile and Miracle Double Air Space Blocks, the only block with which protection is given to the manufacturer, without charge. Small investment only required, and No Previous Experience.

Write now for our big catalog, 128 pages on concrete and concrete machinery, with 500 illustrations. Sent for 24c.



## MARSH CO.

957 Old Colony Bldg., CHICAGO

**THE OLDEST WOMAN**—Believed to be the oldest woman in the world, a peasant living in the village of Pavelsko, Bulgaria, was born, according to the register in the Greek Orthodox Church there, in 1784.

The woman, whose name is Baba Vasilka, has spent 100 years of her life working in the fields. She now

**Rife Automatic Hydraulic Ram** Pumps water by water power. No attention; no expense; 2 feet fall elevates water 50 feet, etc. Guaranteed. Catalogue free. RIFE RAM COMPANY, 2131 Trinity Building, NEW YORK CITY

### AIR GAS! Latest Invention!

Standard Vacuum Gas Machine makes gas automatically! Uses 97% ordinary air! Cheapest, safest, most hygienic for lighting, heating and cooking! All conveniences of city gas, without any of its drawbacks! Non-poisonous, non-asphyxiating, explosive and inodorous! Machine always ready! Gas can be made for 15c per 1000 cu. ft. 25 times cheaper than acetylene! Cheaper than kerosene lamps, electricity or city gas! Saving will pay for the machine in a few months! Agents wanted everywhere in the United States and abroad!

Standard-Gillett Light Co., 108 Michigan St., Chicago, U. S. A.

### Screw Cutting Lathes

Foot or Power, 9 to 13-inch swing  
Cut shows 11-inch lathe, takes 34 inches between centers, complete with foot power or countershaft.

**Price, \$100.00**

Write for catalog showing price of all sizes.

SOUTH BEND MACHINE TOOL CO., 423 Madison St., South Bend, Ind.

## LATHES

9 to 13-inch Swing

List price \$75 and up according to size. When ready to buy send for Lathe Catalog and prices.

**W. F. & John Barnes Co.**  
100 Ruby Street, ROCKFORD, ILL.

# LET THE RED DEVIL WATER MOTOR DO YOUR WORK

**6 inch Motor**  
Improved construction, absolutely perfect, runs your washing machine and a hundred other things. Power for small tools. 1/2 horse power on 3/8-inch pipe, 80 pounds pressure; 1 horse power on 2-inch pipe, 60 pounds pressure. New net price, \$5.00 cash with order.



No. 1492 4-inch Motors for grinding, polishing and buffing. Runs sewing machines, fans, bottle washers, etc. Price with emery, buffing wheel, silver polish and pulley, \$3.00. No. 1493 Motor and pulley only, \$2.50. 3/4-horse power on 80 pounds pressure. Improved construction. Speeds, 3,000 to 5,000 revolutions per minute. Only scientifically and mechanically perfect small water motor manufactured. Patented construction makes it possible. Tremendous output warrants the price. Money back for any reason.

**CATALOGUE AND LARGE SHEET FREE**

## DIVINE WATER MOTOR CO.

Dept. T Utica, New York, U. S. A.

For the name of your local hardware or tool dealer, we will send you free booklet on "Theory and Design of Water Motors."

# Let Us Send You FREE a Hand Book on Concrete Brick and Block Making

This is a standard text book on concrete. It will teach you this leading money making business which is open to small capital. It contains all the latest information on these subjects:

- The field for concrete
- Selecting materials
- Forming the product
- Plant arrangement
- How to estimate
- Weights of materials
- Hints on selling
- Table of compression values
- Various building systems
- Ways of making product
- How to proportion
- Curing — Steam curing
- A waterproof building system illustrated
- Comparative tests
- Profits in concrete



Here is Another Valuable Concrete Book Which is Mailed FREE with the Hand Book

**It Will Show You How to Make \$10 to \$50 Daily With a HELM PRESS**

A wonderful patented invention—Makes concrete with 80,000 pounds pressure—Automatic—No Tamping—Easy Work. Perfect DRY WALL blocks and brick, both made on the one machine. Salable everywhere. Must be used now in place of wood, clay and stone.

**The Helm Dry Wall Building System**

Will get you big business. It saves the builder money as no furring and lathing is required. Endorsed by architects and contractors everywhere. One operator reports \$2430 profit in 90 days. Learn all the details of this profitable business. It is fully explained in the two books.

**SEND FOR THESE FREE BOOKS TODAY**

Merely sign and send the coupon now. No obligation of any sort. Both mailed absolutely free.

Queen City Brick Machine Co.  
323 Bank Bldg.,  
TRAVERSE CITY, MICH.

Queen City Brick Machine Co.  
323 Bank Building,  
Traverse City, Mich.

Please send me free the two books advertised in Pop. Mech.

NAME .....

ADDRESS .....

# CARBORUNDUM

*Will-keep your Razor-Sharp*

Any Man Can Become Expert  
in Honing His Razor



if he uses a Carborundum Hone in a Carborundum Holder.  
The Carborundum Razor Hone is the finest, fastest cutting, most perfectly uniform hone made. The Carborundum Holder allows just enough swing to the hone to keep the razor blade always flat on the surface. It is automatic in action. It can't get wrong.

**ASK YOUR DEALER—OR SEND DIRECT**

No. 103-C—Razor Hone with Holder complete, \$2.75  
Razor Hone without Holder - - 1.00

Carborundum Razor Stropps, the finest, most efficient strop made—46 different styles, 50c to \$2.50.  
No. 440-H is extra value at \$1.00.

**The Carborundum Company,**  
Niagara Falls,  
N. Y.



## For Rapid Pipe Threading

YOU NEED AN

### OSTER MACHINE

It is the most complete and convenient. It has a record of achievements.

Send for Catalogue  
**THE OSTER MFG. CO.**  
2100 East 61st Street  
CLEVELAND, OHIO



lives on an income contributed by her descendants, each of whom—and they number over a hundred—down to her great-great-grandchildren, contributes a small sum for her support. Mme. Vasilka is in full possession of her senses.

Her eldest son is well on in the nineties, and still works in the fields. These cases are remarkable even among the long-lived Bulgarian peasants.—London Daily Mail.



## BLOWERS

for oil and gas forges, melting, brazing blowpipes, gas producers

## VACUUM PUMPS

for vacuum cleaners

Take up their own wear. No springs. Noiseless. Can't get out of order. Send for catalogue No. 22 for blowers and No. 23 for vacuum pumps.

62 P-JOHN ST.  
**LEIMAN BROS. NEW YORK**

WHEN YOU WANT ANYTHING AND DON'T KNOW WHERE TO FIND IT  
WRITE BUREAU OF INFORMATION,  
POPULAR MECHANICS CHICAGO

## BUY A CRESCENT SAW TABLE

and you will get the best machine to be had at the price.

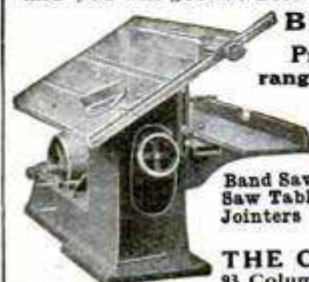

**BUILT IN FIVE SIZES**

Prices range from **\$67.50 to \$187.50**

Send for catalog giving complete description and telling about our fine line of

Band Saws	Borers	Planers and
Saw Tables	Shapers	Matchers
Jointers	Planers	Disk Grinders
Variety Wood-Workers		

**THE CRESCENT MACHINE CO.**  
93 Columbia St. LEE-TONIA, OHIO.

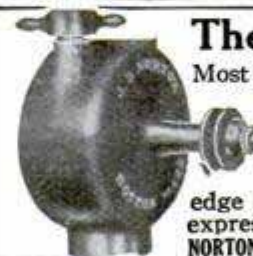

## The Norton "Standard" Water Motor of 1/8 H P.

Most satisfactory power for experimenting purposes, or running light machinery. Perfect in construction; made entirely of brass; runs at a very high speed without vibration. Equipped with pulley and beveled edge grinding wheel. Sent **\$5.00** express paid on receipt of

**NORTON WATER MOTOR CO., Inc., ROSLINDALE, MASS.**



## PUMPS

For city, suburban or farm homes. Any kind of power, except hand. Automatic Controllers, Tanks, Fixtures, Etc.

SEND FOR CATALOGUE NO. 6.

**JARVIS ENGINE AND MACHINE WORKS LANSING, MICH.**

# Eliminate Sagging Bathroom Fixtures

No more "dipping" screws — no loose towel racks or glass holders — no falling cabinets. Here's the **strongest, quickest and most convenient** method of attaching objects to surfaces of building material.

## Star Expansion Bolts

Write for free working samples and Catalogue No. 34 of specialties. Here's an opportunity for a practical demonstration.

WRITE!

**STAR EXPANSION BOLT COMPANY**

CATALOGUE DEPARTMENT 34

147 Cedar Street

NEW YORK



**TRAPS FOR MICROBES**—Like destructive vermin, dangerous microbes will probably in future be caught in traps.

If a current of electricity is passed through water containing the necessary material to render it conductive, oxygen is liberated around one of the wires which lead in the current; certain types of bacteria are so fond of oxygen that they will at once be attracted to the wire where this gas is being generated. Various experiments have been carried out with bacteria in liquids through which an electric current has



### BAR BENDERS

For Concrete Reinforcements

WRITE FOR OUR BENDING TOOL CATALOGUE.

Wallace Supply Co. 124 No. Jefferson St., Chicago  
26 Cortlandt St., New York City

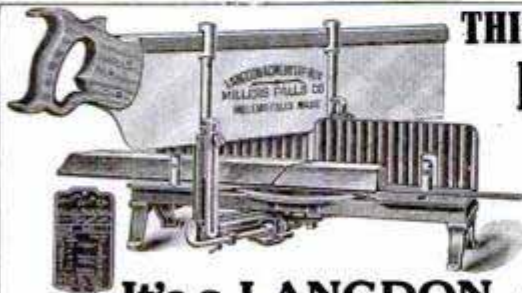

**THIS IS THE MITRE BOX YOU WANT**

**It's a LANGDON ACME**

and is made in three sizes, put up with varying lengths of saws. The advantages over other styles are too numerous to mention in this advertisement, but our pocket catalogue tells the whole story. You can have one of the catalogues by asking for it. It illustrates our full line of tools.

**MILLERS FALLS COMPANY, 28 Warren Street, NEW YORK, N. Y.**

YOU'LL WANT MORE

## "YANKEE" TOOLS

WHEN YOU SEE THE LINE!

35 STYLES

75 SIZES



No. 65



No. 115



No. 44



No. 540

**SEND FOR OUR BOOK OF LABOR SAVERS**

Tells all about them. A postal brings it. Your dealer sells the "YANKEE."

**NORTH BROS. MFG. CO.**  
STATION Q PHILADELPHIA, PA.



Are  
Your  
Tools  
Rusting?

If these tools had been properly cared for; had they been coated when laid away they would have done service for years.

## Household Lubricant

The All-around Oil

in the handy, ever-ready tin oiler, will save tools from rust and ruin.

Preserve Your Tools

with Household Lubricant and they will always be clean and sharp and ready for use.

Sold everywhere

Standard Oil Company  
(Incorporated)

Please Mention Popular Mechanics

B·S

TRADE MARK.



RULES  
WITH  
FIGURED  
GRADUATIONS

EVERY EIGHTH DIVISION  
LINE OF 64<sup>THS</sup> GRADUATIONS  
IS NUMBERED 8, 16, 24, ETC. SO  
THAT READINGS ARE INSTANT-  
LY APPARENT IN 64<sup>THS</sup>.

Catalogue on request  
**BROWN & SHARPE MFG. CO.**  
PROVIDENCE, R.I. U.S.A.

been passed, but a recent investigator, Dr. Charles Ross, has carried the work to a state of refinement which is likely to render it eminently practical. He entices the microbes to the "electrodes" which convey the electric current into a suitable solution, but he makes them traverse a series of tubes before they reach the desired goal, through which it is, apparently, impossible to get back. The vessel into which they have been enticed can be separated from the main vessel and treated with the necessary bactericide to destroy them.



**TOOL CASES** What's your trade?

There's a "Gerstner" Case for every purpose and every one guaranteed. Every up-to-date mechanic should have one. Saves time and tools--there's a place for every one, easily picked out. This one is for machinists. Weighs 14 lbs. and carries a load of 300 lbs. Built right and the price is right. We build Tool Cases and Chests exclusively and ship direct from our factory. Tell us what is wanted

*Gerstner & Sons*

Mfrs. of Mechanics' High Grade Tool Cases  
818 Germantown Street, DAYTON, OHIO

**LUFKIN**

Measuring Tapes



Now made with **Instantaneous Readings**, the big improvement in markings. Saves time and eliminates errors. Send for sample piece of tape and our complete catalog.

**THE LUFKIN RULE CO.**

SAGINAW, MICH.

New York

London, Eng.

Windsor, Can.

# "MORSE"

## TWIST DRILLS



Tool quality is found in its highest development in "Morse" Drills, Reamers, Cutters, Taps, etc., made for and used by men all over the world who know and demand High Quality. *Catalog free.*

### MORSE TWIST DRILL & MACHINE CO.

NEW BEDFORD, MASS., U. S. A.

**MAKING ARTIFICIAL RAIN**—In the town of Irondequoit, bordering Rochester on one side and Lake Ontario on another, more fruit is raised than in any other place of equal size in the United States.

Some say there is not as much produced anywhere else in the world, says the Technical Education and Inventor. Other fruit sections, even the gardens of Long Island, have come to acknowledge Irondequoit's lead.

This pre-eminence of the Irondequoit farmers is partly due to their novel way of watering their farms. The water itself comes from various sources; some from Lake Ontario, some from small ponds on the farms themselves.

Wherever it comes from it is forced to work by elec-



#### Make Your Own Repairs!

Mends Harness, Shoes, Canvas; Myers' Sewing Awl makes lock-stitch like sewing machine. \$1 postpaid. **BIG MONEY FOR AGENTS.**  
C. A. MYERS CO.  
6339 Lexington Ave., Chicago, Ill.

The Awl for All.

ENORMOUS SAVINGS AND BETTER WORK BY USING

### Eclipse Air Brush

A Scientific machine for high class work in applying—Paint, Varnish, Japan, Bronze, Lacquer.

**ONE MAN CAN DO THE WORK OF FOUR**

Write for Booklet and tell us what finishing you do.

**ECLIPSE AIR BRUSH & COMPRESSOR COMPANY**

BLOOMFIELD, N. J.

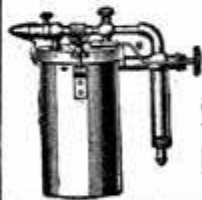

### FOR MENDING HARNESS

shoes, tents, awnings, pulley belts, carpets, saddles, suit cases, buggy tops, dash boards, or any heavy material. **Stewart's Automatic Awl** is the only perfect Sewing Awl.

It takes a wax thread, feeds from spool and does the work of any harness maker machine. It is indispensable for farmers. Agents wanted. Sent prepaid for \$1.25. Send at once for catalog.

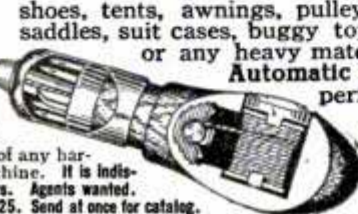

**STEWART-SKINNER CO.**

26 Hermon Street  
Worcester, Mass.

### Keep Your Saw Sharp

THE "SPECIAL" SAW SET



CAN BE USED BY ANYONE, AND SETS A HAND SAW SO THAT IT STAYS SHARP AND RUNS EASY, TRUE AND CLEAN.

Price \$1.00 sent prepaid, or ask your dealer for it

Chas. Morrill, 281 Broadway, New York

### A HANDY HOME BENCH

Once you buy a home bench you'll agree with us that home is hardly complete without it. There are so many uses for it that turn up unexpectedly. Spring is coming now—there will be plenty of tinkering, fixing up, etc. You'll need a bench to work with.

Style here shown has three roomy drawers and a cupboard for tools, etc. Two vises. Solidly and sturdily built and smoothly finished. Made of best maple. Will last for years. Send today for catalog of all styles and prices.

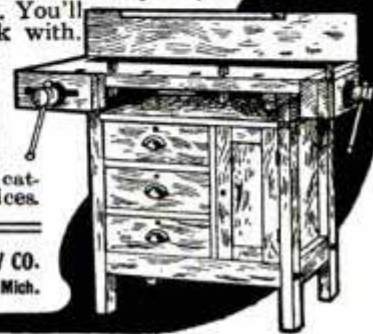

**GRAND RAPIDS HAND SCREW CO.**  
620 N. Front St., Grand Rapids, Mich.

# Murray Style Book

## FREE

**We Want  
Our Big  
1911 Catalog  
in Every Home**



178 pages filled from cover to cover with genuine Buggy, Harness and Saddle bargains; 251 illustrations, many in colors; 138 styles of Vehicles, 74 designs in Harness; the biggest and best book ever printed in this line. Don't miss sending for it!

**Murray Highest Award Buggies Direct from his Factory—Four Weeks Road Trial. Insures Safe Delivery—2 Years' Guarantee.**

Before buying any kind of vehicle, just get the 1911 Murray Style Book and compare Murray Prices with all others. Costs you nothing. You might as well have this book in your home.

**The Wilber H. Murray Mfg. Co.**  
366 E. 5th St.,  
Cincinnati,  
Ohio

Save  
**\$30.00**



Our  
Mechanic's  
Buggy

## From Factory To Horse



### MOTORCYCLISTS

The S-C-R-E-A-M Motorcycle Whistle attached to your exhaust pipe will surely S-C-R-E-A-M riding slow or fast; fits any machine; simply mention model. **\$3.50.** By mail 10c extra

**S-C-R-E-A-M SALES COMPANY**  
2127 Michigan Ave. CHICAGO, ILL



## SCHACHT

### 3 Cars in 1—\$850.00

The Schacht is the greatest under \$1000 car ever put on the market for it not only is a remarkably staunch and speedy roadster, but the addition of a rear seat makes of it a big, roomy family car; or the addition of a box, an up-to-date delivery car.

SEND FOR CATALOG

**THE SCHACHT MOTOR CAR CO.**  
2802 Spring Grove Ave., CINCINNATI, OHIO



## MARVEL

4-5 h. p. using

# CURTISS

LATEST ENGINE

WRITE TODAY FOR CATALOG

**MARVEL MOTORCYCLE CO.**

HAMMONDSPORT, N. Y.

tricity. The farmers tap the wires of the suburban trolleys of the Rochester Railway and Light Company. This current operates the motors which by a 60-lb. pressure force the water through pipes so that it falls like a gentle summer rain.

It is so scattered by this pressure that the air above the fields is full of mist. In winter the greenhouses can be watered the same way.



**Convert Your Bicycle into a Motor-Cycle** using our Attachable Outfit. Fits any wheel. Also Marine and Stationary Motors and Finished Castings. Stamp for catalog. **STEFFEY MFG. CO.**  
Girard Ave. and 30th St., PHILADELPHIA, PA.



### GEER MOTORCYCLES

We Have the Finest Line in the Country

- 5 H.P. Green Egg.....\$225.00
- 4 H.P. Bluebird..... 200.00
- 2 1/2 H.P. Model 4..... 150.00

Discount to Dealers  
Used Motorcycles.....\$40.00

Send for Catalog Immediate Deliveries

**HARRY R. GEER CO., 888 McLaren Ave., ST. LOUIS, MO.**  
Largest Motorcycle Dealers in America

## 30 Days Free Trial



and if we haven't an agent in your city, we will sell you at wholesale agents' price, one

### AMERICAN Motorcycle or Bicycle

and prepay the freight. Write for our introducing offer and catalog, and say whether you want motorcycle or bicycle. Do it now.

**American Motor Cycle Co. 103 American Bldg., Chicago**



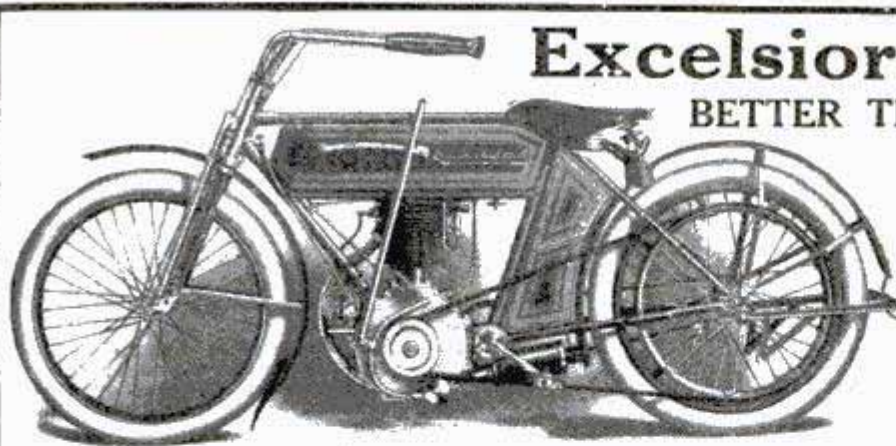

## Excelsior Auto-Cycle

BETTER THAN EVER FOR 1911

The solid foundation of real excellence is retained with refinements in detail that make the

### 1911 EXCELSIOR AUTO-CYCLE

the nearest approach to Mechanical Perfection.

Four Singles and a Twin, all described in catalog D-11.

==== Write for it today. ====

**EXCELSIOR SUPPLY COMPANY** 400 W. Randolph Street  
CHICAGO, ILLINOIS

## A Meco Horn Prepaid to You For \$1.30

This is the identical horn sold all over the country for from \$2.00 to \$3.00. It is finely nicked and made from heavy gauge brass all the way through—large bulb of best quality rubber—length 10 inches, size of bell 3½ inches.

This is only one of hundreds of bargains in our big new catalog.

You can save money by buying your supplies from us. All goods sold under money back guarantee if you are not perfectly satisfied. **At any rate send for our new catalog. IT'S FREE.**



Organized 1904

Incorporated 1910

## MOTORCYCLE EQUIPMENT CO.

1 Lake Street, HAMMONDSPOUT, N. Y.

**THE INK PLANT**—The ink of everyday life may be perhaps described as of mixed animal, vegetable and mineral origin. Sometimes, however, the juice of a plant can be used directly for writing. This is the case with the ink plant, which occurs in South America and New Zealand.

The juice of the plant is red, but it becomes rapidly black on exposure by oxidization. It gives a permanent stain on paper and can be used as ink without further preparation. All the early documents in Spanish South America were written with the juice of the ink plant.—Knowledge.

## Make a Motorcycle of Your Bike



at small cost, by using our Attachable Outfit. It fits any bicycle. Send stamp for catalog. Send 15 cents for "The Motorcycle Manual." It treats of motorcycles; how to get more power, etc.

**SHAW MFG. CO., Dept. B, Galesburg, Kan.**



## 1911 Buggy Book FREE

Send a postal—get the Book—and through it visit with Phelps the biggest factory of its kind in the world. Let him show you in his photographs how a good buggy should be made—what it should be made of. Phelps knows. They're all

### Split Hickory Vehicles

—over 125 styles—every kind—auto seat Buggies, Surreys, Runabouts, etc.—all sold direct to user on 30 Days' Free Road Test—2 Years' Guarantee—at from \$25 to \$75 saving. Don't you want the Book? It will post you on styles and what you ought to pay wherever you buy. A postal gets it.

H. C. Phelps, President,  
**THE OHIO CARRIAGE  
MFG. COMPANY,**  
Station 57, Columbus, O.  
Largest Factory in the World  
Selling Vehicles Direct



## WANTED—RIDER AGENTS IN EACH TOWN

and district to ride and exhibit a sample 1911 Model "Ranger" bicycle furnished by us. Our agents everywhere are making money fast. **Write at once for full particulars and special offer. NO MONEY REQUIRED** until you receive and approve of your bicycle. We ship to anyone, anywhere in the U. S. *without a cent deposit in advance, prepay freight, and allow TEN DAYS' FREE TRIAL* during which time you may ride the bicycle and put it to any test you wish. If you are then not perfectly satisfied or do not wish to keep the bicycle you may ship it back to us at our expense and *you will not be out one cent.*

**LOW FACTORY PRICES** We furnish the highest grade bicycles it is possible to make at one small profit above the actual factory cost. You save \$10 to \$25 middlemen's profits by buying direct of us and have the manufacturer's guarantee behind your bicycle. **DO NOT BUY** a bicycle or a pair of tires from anyone at any price until you receive our catalogues and learn our unheard of factory prices and remarkable special offer.

**YOU WILL BE ASTONISHED** when you receive our beautiful catalogue and study our superb models at the wonderful low prices we can make you. We sell the highest grade bicycles at lower prices than any other factory. We are satisfied with \$1.00 profit above factory cost. **BICYCLE DEALERS**, you can sell our bicycles under your own name plate at double our prices. Orders filled the day received.

**SECOND HAND BICYCLES**—a limited number taken in trade by our Chicago retail stores will be closed out at once, at \$3 to \$8 each. Descriptive bargain list mailed free.

**TIRES, COASTER BRAKE** rear wheels, inner tubes, lamps, cyclometers, parts, repairs and everything in the bicycle line at half usual prices. **DO NOT WAIT**—but write today for our Large Catalogue beautifully illustrated and containing a great fund of interesting matter and useful information. It only costs a postal to get everything. **Write it now.**

**MEAD CYCLE CO. Dept. R108, CHICAGO, ILL.**



## It's Knowledge that Directs

### THE CYCLOPEDIA OF Architecture, Carpentry and Building

is the most exhaustive, comprehensive and authoritative work on the building trades ever published. Covers every branch of building construction, from plans to finishing touches. Contains 4,670 pages, 7x10 inches, printed on special paper, large, clear type.

**Special Features** are: Plans, color plates and photos of buildings completed and in the course of construction. Diagrams and sections showing all details. Over 400 full page plates. 3,000 detail drawings, diagrams, etc. Just the thing for the student. A practical guide for the experienced carpenter and an ever ready reference work for the expert.

#### EXAMINE THESE BOOKS AT OUR EXPENSE

To show you just what the books are and how necessary they are to every man connected with the building trades, owners, real estate agents, etc., we will send a full set, express prepaid, for five days FREE examination. Just fill in and mail the coupon. The books can be returned at our expense if not what you want.

**SPECIAL OFFER:** To introduce our Correspondence Courses, from which the Cyclopaedia is compiled, we offer this set of books at the special price of \$24.00, payable \$2.00 after 5 days and \$2.00 a month. Regular price is \$50.00. This offer is good until July 1st. Order now and save over 50 per cent.

#### IMPORTANT SUBJECTS COVERED

**Reinforced Concrete—Estimating—Contracts and Specifications—The Law of Contracts and Liens—Building Superintendence—Building Materials—Masonry—Carpentry—Stair Building—Hardware—Plastering—Painting—Heating—Ventilation—Wiring for Door Bells—Burglar Alarms—Steel Construction—Elevators—Sheet Metal Pattern Drafting—Mechanical, Architectural, Freehand and Perspective Drawing—Lettering—Blue Printing—Shades and Shadows—The Greek and Roman Orders of Architecture—Rendering in Pen and Ink and Wash—Water Color Hints for Draftsmen.**

Without Extra Cost, we will include for One Year, as a Monthly Supplement, the **TECHNICAL WORLD MAGAZINE**. \$1.50 is the regular price. A thoroughly reliable, clean, up-to-date monthly. Gives you an insight into the real things of life—things that everyone should know. Covers the latest developments in science and discovery in a popular and interesting manner.

### AMERICAN SCHOOL OF CORRESPONDENCE CHICAGO, U. S. A.

#### FREE OFFER COUPON

American School of Correspondence:

Please send set Cyclopaedia of Architecture, Carpentry and Building for 5 days' free examination; also Technical World for 1 year. I will send \$2.00 within 5 days and \$2.00 a month until I have paid \$24.00; otherwise I will notify you and hold the books subject to your order. Title not to pass until fully paid.

NAME .....

ADDRESS .....

OCCUPATION .....

EMPLOYER .....

Pop. Mech., 3-11

Please Mention Popular Mechanics

# HESS FURNACE



No. 48  
"Leader" Hess  
Steel Furnace  
Price \$49

Delivered East of Omaha and  
North of Ohio River  
Pipe and Register Extra

We will deliver a complete heating equipment at your station at factory prices and wait for our pay while you test it during 60 days of winter weather.

The entire outfit **must satisfy you** or you pay nothing. Isn't this worth looking into? Could we offer such liberal terms if we didn't know that the Hess Furnace excels in service, simplicity, efficiency, economy?

We are makers—not dealers—and will save you all middlemen's profits. No room for more details here. Write today for free 48-page booklet which tells all about it.

Your name and address on a post card is sufficient.

HESS, 910 Tacoma Bldg., Chicago

## PURE DRINKING WATER

Typhoid, Malaria, Diphtheria and other dreaded diseases are largely caused by drinking impure water. Our "Seneca" filter will positively remove all germs and other impurities from water, leaving it "Clear as Crystal" and absolutely pure. The "Seneca" filter is on sale at hardware stores generally. If your dealer does not carry it, we will supply you direct. Everyone should have a copy of our Free Booklet, which tells about the diseases caused by drinking impure water and how the "Seneca" syphon and pressure filters remove all impurities.

THE SENECA FILTER CO., DEPARTMENT 11,  
KANSAS CITY, MO.



### Home Ironing Machine

On Easy Payments, 30 Days' Free Trial.

A heated mangle that irons all flat pieces better, easier, and in one-quarter the time. Costs 1c an hour for heat—gas or gasolene. Turned by hand, by power or by motor. "Clean Linen" booklet Free. Ask for it.

Home Ironing Machine,  
G254E Madison St.,  
Chicago

**JAP WOMAN DENTIST**—Jiu-jitsu in the dentist chair is a novelty, but London boasts of it. A Japanese woman has established a dentist's office in London and is said to be attracting many persons who have the toothache and wish to lose the cause. She is said to be clever in using the forceps. But it is her dainti-



## CLASS PINS AND BADGES FOR COLLEGE, SCHOOL, SOCIETY OR LODGE

Either style with any three letters and figures, one or two colors of enamel. Sterling Silver, 25c each, \$2.50 doz.; Silver Plate, 10c each, \$1.00 doz. Catalog free. Special designs also made for any School or Society, at attractive prices. Send idea for estimate. BASTIAN BROS. CO., Dept. 487, ROCHESTER, N. Y.



### BENJAMIN AIR RIFLE FOR MEN AND OLDER BOYS

An air gun that will shoot through half inch pine easily. Many times more powerful than spring guns. Uses compressed air, same as air brakes, rock drills, etc. 15c pays for 1,000 shots (delivered 30c). Practical for small game. 37 inches long. Walnut stock. Nickel barrel. Take down. Sold by dealers everywhere. If your dealer does not carry it, write us. Sent prepaid east of Rocky Mountains on receipt of \$2.50. Pacific Coast and Parcel Post Countries \$3. Circular free. Benjamin Air Rifle & Mfg. Co., 506 N. Broadway, St. Louis, Mo.



## 12 Art Panels 50c. Reproductions of Famous Paintings "Of Woman Beautiful"

Best ever shown in one collection. A full set of 12 in a handsome Art Portfolio, packed flat and safe delivery guaranteed, with 120 life-like miniature illustrations of beautiful art pictures, for only 50c coin, money order or U. S. stamps. Send at once. Money back if not satisfied.

FLORENTINE ART COMPANY  
Dept. U3, 2009 Prairie Ave., CHICAGO, ILL.

FREE Order at once and get "FREE" a beautiful den picture in colors.





## THE "BEST" LIGHT

Makes and burns its own gas. Pure white 500 candle power light, more brilliant than electricity or acetylene, and cheaper than kerosene. Casts no shadow. Costs 2 cents per week per lamp. No dirt, no grease, no odor. Used in every civilized country on earth. Over 20 styles. Every lamp warranted.

Agents wanted.  
Write for catalog.

**THE BEST LIGHT CO.**  
324 E. 5th St., Canton, O.

**Be an Independent Buyer—  
Send Name  
—Book Free**



Send postal for Catalogue No. 473, with special terms and compare Kalamazoo stove and range factory prices with others.

**CASH OR CREDIT**

Either way — you save \$5 to \$40 on any stove in catalogue 473.

**"AND GAS STOVES TOO"**

**A Kalamazoo**  
Direct to You

ness and her cheerfulness that have made her popular. She greets her patients with a smile that makes them forget their trouble, and in a soothing way she says: "I give no pain," as she grasps the tooth, and, with a sudden twist, pulls it out. The success of the Japanese woman in dentistry has encouraged other women to take up the profession. There are comparatively few women dentists in this country, but it is probable that women, observing the success that the Japanese is having, will take up the study.—San Francisco Chronicle.

# PATENTS

**YOUR IDEAS MAY BRING  
YOU A FORTUNE!**

# PATENTS

**H. ELLIS CHANDLEE & CO.**  
55 Bornot Building, WASHINGTON, D. C.  
*See page 119*

Test an **"IMPERIAL"** 30 Days  
In Your Own Home at **OUR RISK**



If it does not prove the best looker, cooker and baker you ever saw, send it back at our expense.

Direct from factory to you at **WHOLESALE PRICE**  
Freight Prepaid.

Has exclusive features not on any other range—such as Stone Oven Bottom, Odor Hood, Oven Thermometer, Ash Sifter, etc., etc.

Easy credit terms if wanted. Write today for Free Catalog and prices.

**THE IMPERIAL STEEL RANGE CO.,** 769 State Street, CLEVELAND, O.

# Sent for 50c



**THIS** handsome rocker will be sent at once to your own home merely on receipt of first payment — 50c. If not the greatest value you ever saw return and get your 50c back. If you like it, pay

## Balance 50c a Month

Rocker is exactly like cut shown above. Beautifully made of especially selected quarter-sawed oak, polished to high piano finish, strongest coil springs to make it comfortable as well as durable, and seat richly upholstered in genuine Nantucket leather. Price \$4.69—sent to you on receipt of 50c cash—balance payable 50c a month.

### Direct-From-Factory Prices On Complete Home Furnishings

We operate 22 big retail stores in the larger cities and have furnished 800,000 homes. All the style, distinction and elegance which marks the best city homes is yours, on terms to suit your convenience. And the prices we quote are so low that only our tremendous business and the fact that we control our own factories make them possible.

## Big Book FREE



"Everything for the Home," a big 200-page book illustrating the latest styles in home furnishings, sent absolutely free. Shows you how you can furnish your home in a way that will be your pride and the admiration of your friends—and do it on our liberal open-account credit plan on payments that you won't miss.

Write today for your free copy—no home lover can afford to be without it.

# HARTMAN FURNITURE & CARPET CO.

230 N Wabash Av., Chicago, Ill.

Largest, oldest and best known home-furnishing concern in the world.

Established 1855—55 years of success.

**22 Great Stores—800,000 Customers**

*Please Mention Popular Mechanics*

# AD-EL-ITE

TRADE MARK

**PAINT AND VARNISH REMOVER  
AND ONE-COAT MISSION FINISHES**

## HAVE A NEW SET



Any of your old furniture, no matter how finished, may be made like new by using our Remover, which is harmless and takes off any number of old, hard coats of paint, varnish, wax, shellac or enamel, and leaves the wood in perfect condition for refinishing with

### ONE-COAT MISSION FINISH

Made in ten beautiful shades producing the old velvety, Mission effect. A stain and finish in one coat.

Dept. 49



Goes about twice as far as ordinary materials. Easily applied. Booklet and samples free.

CHICAGO

**ADAMS & ELTING CO.**

# \$38.95 BUYS THIS COMPLETE BATHROOM OUTFIT

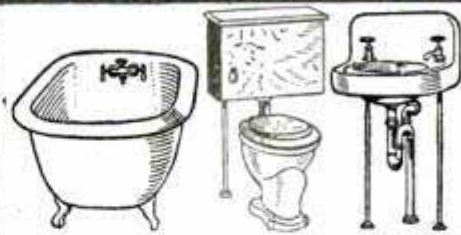

**MODERN BATHROOM FOR EVERY HOME**

## Modern Plumbing at 1/2 Ordinary Cost

Plans and instructions free with every plant.

## Water Supply Outfits

from \$42 upwards.

## Hot Water and Steam Plants

## SAVE \$100 to \$250 on a Heating System



Pumps, Pipe, Valves, Fittings at lowest prices.

Farmers' Tanks for every purpose.

Acetylene Lighting Plants Gas and Electric Fixtures  
All high grade, strictly guaranteed goods.

**BIG CATALOG FREE**—Write to Dept. A.

# M.J. GIBBONS ARCADE DAYTON, O.

**AN EARLY AIRMAN**—In connection with all the early feats that are now making history, in a more or less tragic fashion, does anybody recall the name of John Baptiste Dante, who may have been a late relative of the great Italian poet? He was a mathematician first of all, and he invented wings which were at least good enough to carry him over Lake Trasimene. He had less luck in his second flight, for he fell upon a church and broke his thigh. There was then no such surgical treatment as we have in these days, but the ingenious Dante recovered from his injury and lived to become a professor of mathematics at Venice.—Dundee Advertiser.

## You Can Read or Work All Night

without tiring your eyes by the light of one of these wonderful

### INVERTED TRIUMPH LAMPS

as the pure white and soft steady light is restful and pleasing to the eyes and pronounced by *oculists* to be the nearest approach to daylight of any artificial light, and almost as cheap, as one quart of gasoline lasts 15 to 20 hours, giving light equal to 100 burning candles. Five times as cheap as kerosene. Our HANDY or BONANZA gasoline lighting systems will light your store or home from cellar to garret with pure white gas light at less than 15c per 1000 feet. Better than gas companies charge \$1.00 to \$2.50 a 1000 feet for

Send now for P.O.P. catalog—it's free and tells why.

**Brilliant Gas Lamp Co.,** Dept. 1, 42 State St. CHICAGO, ILL., U.S.A.



## 150 MAGIC TRICKS

64 page book illustrating these easy sleight of hand passes—only 10c.

**WESTERN PUZZLE WORKS, ST. PAUL, MINN.**

## Aladdin MANTLE Lamp BURNS KEROSENE (Coal Oil)



Produces powerful, white, more brilliant light than city gas, gasoline or electricity—simple, noiseless, odorless, clean, safe, durable—complete success—recognized world's standard. Fully Guaranteed.

**T. H. BALL, California, SOLD 850**

On money back guarantee—not one returned, C.E. Kramer made \$700 in 60 days. Complete line of lamps and chandeliers for homes, offices and public places.

Ask nearest office for agency proposition or how to get lamp free  
**MANTLE LAMP CO. OF AMERICA, Dept 525**  
Chicago, Portland, Ore., Waterbury, Conn., Winnipeg, Montreal, Canada.

**A FLOOD OF LIGHT FROM KEROSENE (COAL OIL)**

WROUGHT IRON PICKET FENCE, ORNAMENTAL WOVEN WIRE LAWN FENCE, FARM AND Poultry FENCE, IRON FENCE POSTS, WINDOW GUARDS, RAILINGS, VASES, SETTEES, GRILLES, FIRE ESCAPES, AREA GRATINGS, ETC.

OUR AGENTS IN NEW YORK, BOSTON, PHILADELPHIA, CHICAGO, NEW ORLEANS, PITTSBURG, ATLANTA, DES MOINES, ETC. WILL CONTRACT TO FURNISH AND ERECT FENCE. WRITE OUR FACTORY FOR THEIR ADDRESS.

WRITE OUR FACTORY FOR FREE CATALOGUE. ONE HUNDRED ARTISTIC DESIGNS OF FENCE AND ENTRANCE GATES ALSO LETTERED ARCHES.

WE MAKE SPECIAL DESIGNS FOR PARTICULAR PEOPLE. SUPERIOR QUALITY



**ENTERPRISE FOUNDRY & FENCE CO.,**  
1214 E. 24<sup>TH</sup> ST., - - INDIANAPOLIS, INDIANA.

**THE LIGHTING TRIUMPH OF THE CENTURY**

*Nagel-Chase*

**LIGHTING SYSTEMS**

**OUR** lighting systems represent the greatest progress in gasoline lighting. They are always ready and require no generation, and can be operated as conveniently as electricity by a switch from one point or individually with a chain pull, at one-tenth the cost. Write for catalog and further particulars. Agents wanted everywhere.

**THE NAGEL-CHASE MFG. CO., 151-W. OHIO ST. CHICAGO, ILL., U.S.A.**

**BUY PLUMBING SUPPLIES AT WHOLESALE** Will Save You 30%

Don't pay retail prices. Full stock on hand for prompt shipment. Send for free catalog. B. P. KAROL, 768 to 772 West Harrison St., Chicago

**PRINT FOR YOURSELF**

Excelsior

Cards, circulars, book, newspaper. Press \$5, Larger \$18, Rotary \$60. Save money. Print for others big profit. All easy, rules sent. Write factory for press catalog, TYPE, cards, paper.

**THE PRESS CO., Meriden, Connecticut**

**WANTED**

**THE LIGHT THAT NEVER FAILS**

Has been imitated but never equaled. Burns its own gas and makes more money for agents than any other artificial lighting device on earth. We give exclusive territory and large discounts to good men. For further information and full particulars address Light Dept.

**NATIONAL STAMPING & ELECTRIC WORKS**  
210 So. Jefferson Street, Chicago

**AGENTS**

**A BEACON LAMP BURNER FREE WANTED**

Incandescent, 100 Candle Power. Burns common coal oil. Gives better light than gas, electricity or six ordinary lamps at one-sixth to one-tenth the cost. Fits your old lamp Unequaled for fine sewing or reading.

**COSTS ONLY ONE CENT FOR SIX HOURS**

We want one person in each locality to whom we can refer new customers. Take advantage of our special offer to secure a Beacon Burner FREE. Write today. Agents Wanted. **HOME SUPPLY CO.**  
248 E. C. Life Bldg., Kansas City, Mo.

# Shop, Mill and Factory Supplies

SAVE MONEY BY BUYING YOUR

## Pulleys, Shafting, Hangers, Belting, Gears, Sprocket Wheels, Chain Belt

in fact anything in the line of appliances for transmitting Power, from us.

We are the largest Manufacturers of Pulleys in the United States. No order too small for attention. No order too large to execute.

OUR CATALOGUE A-18 SHOWS OUR COMPLETE LINE

**W. A. Jones Foundry & Machine Co.** MAIL ORDER DEPARTMENT  
1400 North Avenue, CHICAGO, U.S.A.



**WITTE ENGINES**

**GAS - GASOLINE - DISTILLATE**  
Cheapest of all powers. One cent average cost per horse power per hour. Nothing can equal.

**FIVE YEAR GUARANTEE**  
We build all sizes. Hopper jacket or water tank cooling. Inducements to introduce in new localities. Write stating size and style wanted.

**WITTE IRON WORKS CO.**  
1654 Oakland Ave., Kansas City, Mo.

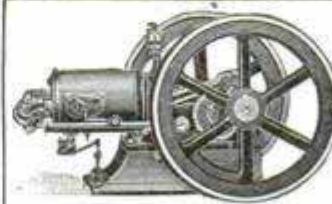

**WHICH WOULD YOU RATHER DO**

Buy a cheap engine and save \$10 to \$50 in first cost, or buy an **ECONOMIZER** and save \$50 to \$500 in running expenses? **Free Trial.**

**H. L. CHAPMAN, Box 595, MARCELLUS, MICHIGAN**

**THE ELECTRICS OF TASTE**—Some time ago it was suggested that wherever a distinctive flavor is formed in the cooking or eating of certain things together, the reason why they seem to improve each

## DON'T BUY A GASOLINE ENGINE

until you investigate "The Master Workman," a two-cylinder gasoline, kerosene or alcohol engine, superior to any one-cylinder engine; revolutionizing power. Its weight and bulk are half that of single cylinder engines, with greater durability. Costs Less to Buy—Less to Run. Quickly, easily started. Vibration practically overcome. Cheaply mounted on any wagon. It is a combination portable, stationary or traction engine. SEND FOR CATALOGUE THIS IS OUR FIFTY-NINTH YEAR. **THE TEMPLE PUMP CO., Mfrs., 431 West 15th St., CHICAGO**

## ELLIS ENGINE USE KEROSENE

### For Farm, Shop and Home

Its success a world beater. Gives more power gallon for gallon. Fuel expense astonishingly low. Runs perfectly on kerosene, gasoline, distillate, any fuel oil. Hundred less parts. Patent throttle gives three engines for the price of one. **Catalog free—tells how.** Force feed lubricator

—perfect oiling. Double duty tank revolutionizes cooling systems. Automobile muffler. Ball bearing governor. Starts instantly, no pre-heating, no crank. **We Pay the Freight**

### Challenges the World

on adaptability to any power purpose. Experience unnecessary. Women can operate. Mounted on skids or trucks. Easily portable. Vibration eliminated. Comes complete, tested, ready to run. Quality high, price low.

**FREE TRIAL**  
No obligation till you are satisfied. **10-year guarantee.** "Engine Facts," our new catalog, free; write postal for it **now.**

**ELLIS ENGINE CO.**  
39 Mullett St.  
DETROIT, MICH.

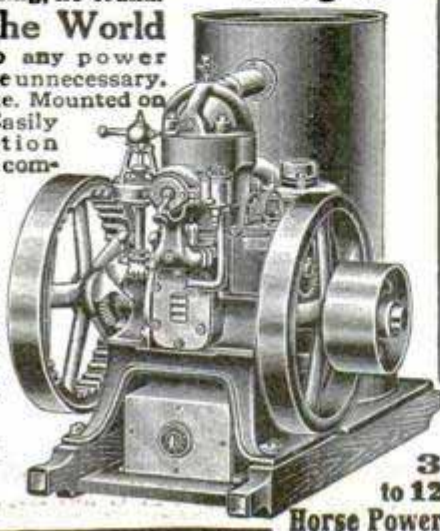

**3 to 12 Horse Power**



## RADIATORS FOR GASOLINE ENGINES

Our radiators will use oil and our New Exhaust Head is equal to a fan. We make Radiators especially for Traction Engines.

Give bore, stroke and number of explosions of your engine and we will give you any desired information regarding cooling.

**LAKE SHORE MFG. CO.**  
112 Dearborn St. CHICAGO, ILL.

## FOOS The Engine of Steady and Reliable Service

Maintaining uniform speed and lowest fuel economy under the most variable conditions of actual work. The Ignition, Counterbalancing and Governing of Foos engines will stand the most rigid technical analysis.

**Sizes 2 to 500 Horsepower**

Quickly convertible from Gas to Gasoline

Types horizontal or vertical. Single or multiple cylinder. For description of many exclusive features of design refer to Catalog 50.

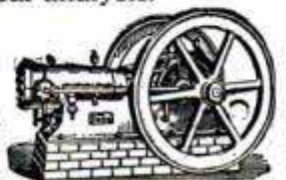

**THE FOOS GAS ENGINE CO., SPRINGFIELD, O.**  
Largest Exclusive Gas Engine Factory in America

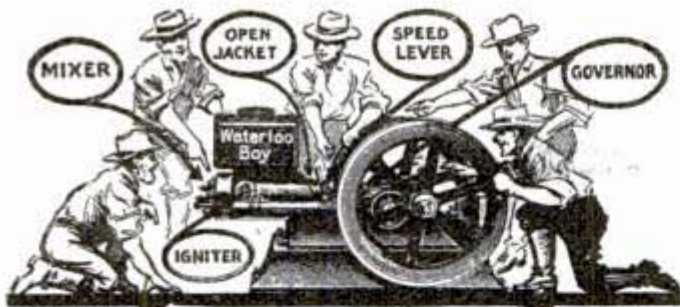

17 YEARS ON THE MARKET

5 YEAR GUARANTEE

## The Waterloo Boy

has all of the good points that go into any gasoline engine besides many exclusive patented features. A few days' trial will enable you to point out the superior points that make the

## Waterloo Boy

the best engine for every conceivable purpose.

We will send to any responsible person a Waterloo Boy on 30 days' free trial, and if it does not do all and more than we claim, if you are not satisfied that it is the best, send it back and we will pay the freight both ways. Can you think of a more liberal proposition than this? Write today for our free catalogue, showing styles and sizes and our free trial offer blank.

Waterloo Gasoline Engine Co.

1021 W. 3rd Ave., WATERLOO, IOWA

YEARLY CAPACITY 15000 ENGINES

30 DAYS FREE TRIAL

## This Engine FREE for 30 DAYS

Test it out and prove to yourself it's the best little all-around gasoline engine ever produced. Adapted for all uses in Shop, Farm and Home. We ship complete ready for use. Simply fill in the gasoline—give it a turn and away it goes.



**THOMPSON GASOLINE ENGINES** are built on correct lines. Let us send you free book and tell you all about our wonderful 30-Day Free Trial Offer. Write today.

J. THOMPSON & SONS MANUFACTURING CO., 22 Oak St., Beloit, Wis.

other is that a certain amount of electrical action is set up between them. Edwin Smith tried numerous experiments along this line, using the two catables as elements in a galvanic battery, instead of the proverbial copper and zinc, to ascertain if a current would be produced. Things generally eaten together, such as raisins and almonds, pepper and salt, tea and sugar and many others, were tried, and in every instance Smith found electrical action taking place and procured a current. He stated as a result of his work

## \$50 TO \$300 SAVED

We are manufacturers, not merchants. Save dealers, jobbers and catalog house profit. I'll save you from \$50 to \$300 on my High Grade Standard Gasoline Engines from 2 to 22-H.-P.—Price direct to you lower than dealers or jobbers have to pay for similar engines in carload lots for spot cash.

## GALLOWAY

Price and quality speak for themselves and you are to be the sole judge. Sell your poorest horse and buy a 5-H.-P. only \$119.50



Direct From My Factory on 30 Days' Free Trial. Satisfaction or money back. Write for special proposition. All you pay me is for raw material, labor and one small profit. Send for my big BOOK FREE.

Wm. Galloway, Pres.  
Wm. Galloway Co.  
1965 Galloway Station  
Waterloo, Iowa



## HERE IT IS!

A Real—Sure Enough—One Horse — Air Cooled — Gasoline Engine Thoroughly Constructed— Completely Endowed.

Guaranteed. Price \$39.25

THE AUTEN MACHINERY CO.  
427-29 W. Randolph St., CHICAGO.

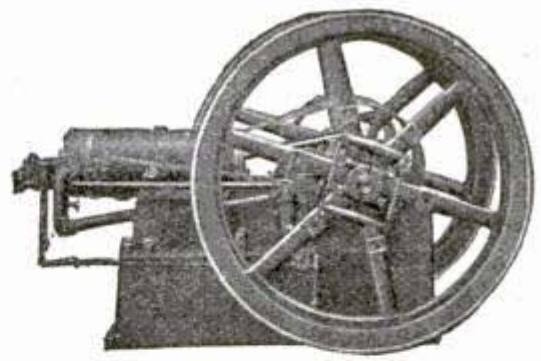

# Maximum Efficiency

When there's work to do you want an engine that will do it—quickly—dependably—cheaply.

You want an engine that takes care of its job and leaves you free to take care of yours—that doesn't make you work double by continually shirking or getting out of order. In short, you want an I H C.

## I H C Gasoline Engines

offer maximum efficiency at a minimum of time, trouble, and fuel.

Their few parts and simple construction make them almost trouble proof.

Their perfect design guarantees smooth and easy running.

Their cylinder construction gives the biggest returns in power from the least gasoline.

Let us prove to you in detail just why these things are so—just why I H C Gasoline Engines offer you the most satisfactory power you can get.

I H C Gasoline Engines are made in all styles and sizes to suit every need; horizontal or vertical, stationary, portable, or traction, air or water cooled. 1 to 45 horse-power.

Write for catalog to

The International Harvester Company of America  
(INCORPORATED)  
16 Harvester Building CHICAGO U S A

# ROBERTS

The Motors That Never Backfire

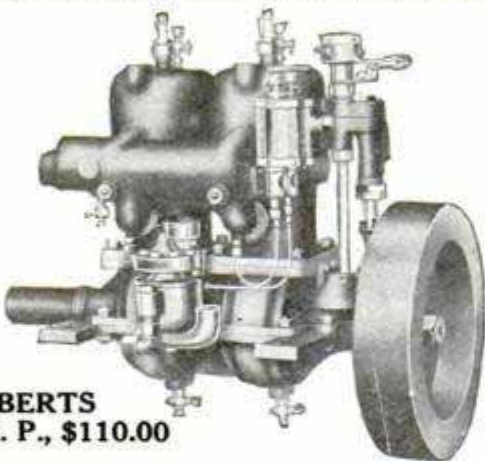

**ROBERTS  
6 H. P., \$110.00**

**A Motor of Highest Quality  
At a Reasonable Price**

**NINE SIZES** 3 to 60 H. P. \$60.00 to \$900.00  
1 to 6 Cylinders

Marine, Auto and Aeroplane Motors and  
Motor Air Compressors

WRITE FOR CATALOGUE

**THE ROBERTS MOTOR COMPANY**  
1419 Columbus Avenue, SANDUSKY, OHIO

**\$40** **2 H.P. COMPLETE**

With fittings, including propeller and shafting, stuffing box, wiring, etc.

**Ready to install in your boat**

## MARINE ENGINE

Used in Government Harbor Service and Chicago Police Boats. High speed, absolute reliability. Extra power and extra wear. Compact, silent running. Low running cost. The perfect two-cycle reversing engine. 2, 3, 4, 6 and 10 H. P. \$40 up 2-year guarantee. A woman or child can run it. Special prices to boat builders and agents. Our engine book contains facts about Marine Engines and illustrates and describes our complete line. Free on request. Northwestern Steel & Iron Wks. 707 Spring St. Eau Claire, Wis.



## Make a Motor Boat of Any Boat in Five Minutes



You can do it with the Waterman Outboard Motor, which you can quickly attach (and detach) to the stern of any skiff, row boat, dinghy, punt, sail boat, and have a good motor boat. It is not a toy, but a reliable 2 H. P. Marine Motor that will drive an 18-foot row boat 7 miles an hour, 4 hours on gallon gasoline. Simplest motor made. Weight 40 lbs. Equipped with Schebler Carburetor. Five years' successful results behind it. Send for Catalog C. Canoe Motors, 1, 2, 3, 4 Cylinders—Catalog K. Standard Type Motors, 1 to 30 H.P.—Catalog A.

**WATERMAN MARINE MOTOR CO.**

1507 Fort Street, West, DETROIT, MICH., U. S. A.

## Boat and Engine Book MAILED FREE

Just like a 30-Footer only smaller Do not think of Buying a Launch or Engine until you see our Handsome Book



**WHICH EXPLAINS FOUR WONDERFUL LAUNCH BARGAINS**

Only \$121 for this

complete 16-ft. Launch—8 H. P., guaranteed self-starting Engine, weedless Wheel and Rudder. Result of 30 years' experience. Money back if not as represented. Write for free catalog today. Special Bargains in Weco reversible, self-starting engines to those building or buying their own hulls. Engine controlled by one lever. Full size Boat Designs furnished free to purchasers of Weco Engines.



C. T. WRIGHT ENGINE CO., 608 Canal St., Greenville, Mich.

that "bitters and sweets, pungents and salts, bitters and acids," appear generally to furnish the elements for true voltaic couples.

Among the other things experimented on are the following, the first mentioned element of the couple taking the place, in each instance, of the attacked element, or zinc: Raw potato and lemon juice, tea and sugar, nutmeg and sugar, horseradish and table salt, onion and beet, vanilla and sugar, starch and iodine.—Pittsburg Dispatch.

## WATKINS' SPECIAL MOTORS

3 H. P. Single Cylinder . . . 30 lbs.  
6 H. P. Double Cylinder . . . 50 lbs.  
12 H. P. Four Cylinder . . . 90 lbs.

**WITHOUT A PEER.**

Especially adapted for CANOES or LIGHT BOATS.

INTERESTING CATALOG ON REQUEST.

**THE WATKINS MOTOR CO.**

837-839 West Sixth Street CINCINNATI, OHIO



# 5 Years' Absolute Guaranty On this Wonderful Detroit Marine Engine

You Are the Only Judge of the engine and its merits. 25,000 satisfied users. Material and workmanship guaranteed for five years.

**Greatest Engine Bargain Ever Offered!**

Fewest moving parts of any practical engine on the market. Nothing complicated or liable to get out of order. Only three moving parts. Extra long plastic white bronze bearings. Vanadium steel crankshaft. Adjustable steel connecting rod. All bearing surfaces ground. French gray iron castings. Water-proof ignition system. Runs at any speed from trolling to racing.



Starts without cranking. Reversible while in motion.

Perfectly counter-balanced. No vibration.

## 30 Days' Trial

Try the engine for 30 days. If you are not fully satisfied, return it and we will promptly refund all money paid us.

Demonstrator Agents wanted in every boating community. Special wholesale price on first outfit sold. Single cylinder, 2-8 h. p. Double cylinder, 8-20 h. p. 4-cylinder, 20-50 h. p. Thoroughly tested before shipment. Comes to you complete with boat fittings and ready to run. Write for free catalog, testimonials and details of the greatest protective guaranty ever offered. Suitable for any boat from canoe to cruiser. Also railroad truck car. All sizes in stock ready to ship. Write today for our wonderful demonstrator offer. [74]

**DETROIT ENGINE WORKS**

1271 Jefferson Avenue, DETROIT, MICH.

# SCRIPPS MOTORS

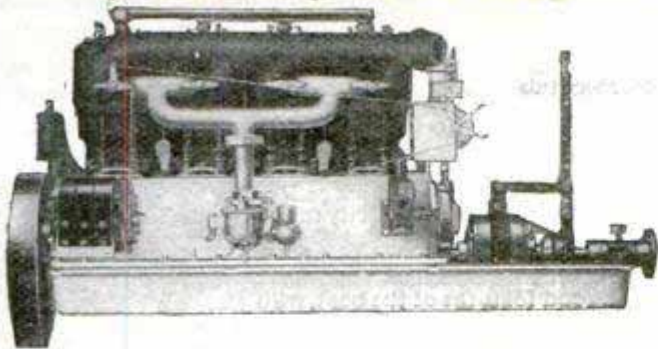

The open water, the blue sky dotted with white clouds overhead, and a comfortable seat in a trim little craft, a few friends for company, and the soft murmur of a smooth sweet-running engine that never stops purring until we reach some shady, quiet woodland spot looking out over the water—

### That's What We're All Waiting For!

The joy of the thing depends on one important point—the engine must be right. The man who makes the mistake of buying a cheap engine loses all the fun—sweating and fuming to get started, perhaps stopping dead in the middle of the trip, and, laboring for hours in the hot sun coaxing the engine to go again, covering his clothes with grease, oil and dirt—these are the things that wipe out the pleasure.

There are a number of good engines on the market. We believe that Scripps Motors are just about the height of mechanical perfection and careful, expert design. We believe we can convince you of the fact if you will investigate.

We feel sure that the Scripps catalogue in your hands will demonstrate to you the justice of our claims. It describes and illustrates our new 1911 Models.

### SCRIPPS MOTOR COMPANY

650 Lincoln Avenue DETROIT, MICH.

# SCRIPPS MOTORS

There is no human head or face that is exactly symmetrical, and celebrated works of art have observed this natural difference between the two sides of the body. The famous Venus of Milo has the left side of her face more developed than the other.—“Cosmos,” Paris.

**FAMOUS MICHIGAN SPEED WHEELS · REVERSE GEARS & MARINE HARDWARE**

**MOTOR BOAT MEN** Send for our large catalog of valuable information on speed wheels, reverse gears and marine hardware. Everything new and up-to-date.

**Prices Right. Satisfaction Guaranteed**  
We carry an immense stock and can make you prompt shipments and save you money. Send for our free catalog today

**MICHIGAN WHEEL COMPANY**  
565 Canal Street, GRAND RAPIDS, MICHIGAN

## BAY STATE MOTORS

“Perfect Simplicity” and “Simple Perfection” are the results, embodied in these Motors, of 15 years devoted to the developing of these essential characteristics, which enable us to put on the market a reliable and economical motor at a reasonable price. Write for catalog, stating size and type (2 or 4 cycle) of motor wanted. We also furnish castings for these motors.

### BAY STATE MOTOR WORKS

Successor to  
**A. J. HOULE MOTOR WORKS**  
580 South East Street, HOLYOKE, MASS.



## “Runs Like A Scared Rabbit”

Writes Cleburne Grady, Montgomery, Ala., who while yet a green hand at motors averaged 12.92 miles per hour on a 8.62 mile river trip.

### Perfection Marine Motor

The “Perfection” is so worthy of the name it needs little attention. Just a regular flow of gasoline and a good spark will keep it working on hard towing, ferrying or pleasure jaunts—and it will last as long as

Write for catalog. **CAILLE PERFECTION MOTOR CO.**, 105 Caille St., Detroit, Mich.  
Send for our Stationary Kerosene Engine Catalog if interested

## Fairbanks-Morse Marine Motors Are Absolutely Guaranteed

by the largest builders of gasoline engines in the world. Equip your boat with a Fairbanks-Morse Engine and be assured of the best design, material, and workmanship.

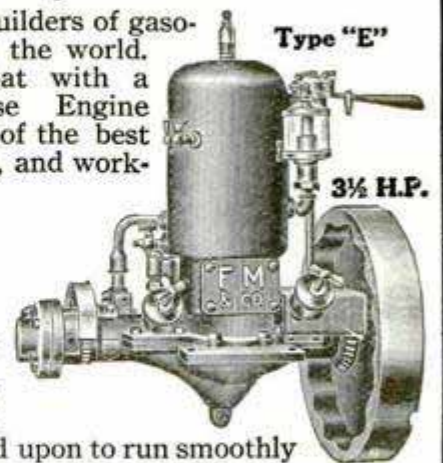

**Starts Easily Without A Crank**

Can be depended upon to run smoothly and to develop *more* than rated horsepower 365 days in the year. If you want an engine for any craft, from power canoe to heavy cabin cruiser, send for our illustrated Catalog No. 449 BZ and list of our 36 branch houses where our motors are carried in stock.

2 cycle 3 1/2 to 24 H. P.; also 4 cycle 4 1/2 to 75 H. P.

### Fairbanks, Morse & Co.

481 Wabash Ave., Chicago 30 Church St., New York

*A very attractive proposition to Agents.*

## Baldrige Reverse Gear

Your Motor Boat Is Not Safe Without This Device

Don't stop your engine. Just move a single lever and boat stops, goes forward, or backward as you please. Nearly 6000 in use. Write for Booklet.

**SMITH & BALDRIDGE MACHINE CO.**  
62 AMSTERDAM AVE., DETROIT, MICHIGAN

**Electric Whistles** and horns for motor boat, automobile, factory and fire alarm use. Searchlights, dynamo and other accessories at low prices. Send for catalogue.

**THE EDGAR MFG. CO.**  
104-5 Hanover St., Boston, Mass., U. S. A.

**OUR O'BRIEN No. 1**

**GRAY MOTORS**

**6 HORSE POWER COMPLETE \$94** Absolutely Guaranteed by a Responsible concern.

1, 2 & 3 Cylinders, 3 to 30 H.P.

Write for complete catalog today—tells all about how these high grade motors are built in the **LARGEST PLANT IN THE WORLD** devoted exclusively to the manufacture of 2-cycle motors. **GRAY MOTOR CO.**, 61 Leib St., Detroit, Mich.

# Six Months to Pay

Sent on Approval



You will be surprised and delighted when you receive your copy of the latest edition of Woolf's Encyclopædia of Bargains—now fresh from the presses.

This book will prove to you that you may be a style leader among your friends—wear clothes of absolutely proper perfection—and pay for them in little sums—just as is most convenient to you.

We allow you six full months, in which to pay for anything you buy of us, and as we are one of the

## Largest Establishment of this kind in the World

we absolutely guarantee perfect satisfaction or your money back. Our buying power is tremendous—we control the output of vast factories. We pay no middleman's profits—no drummers' traveling expense and salaries. No agents. All these savings, we turn over to you in the shape of better clothes for less money—with six months to pay.

### We Ship on Approval

We were the first concern to offer wearing apparel on credit by mail. We are the leaders. We have thousands of satisfied customers all over the country. Others attempt to imitate our methods but they can't imitate our prices nor the quality of our garments. Our transactions are absolutely confidential.

### Send Your Name at Once

We will send you this beautiful Encyclopædia of bargains, together with a personal letter from our President, explaining the methods of confidential dealing by which we have built up the largest business of its kind in the world.

Send for your copy of Book No. 57 at once. Address

**WOOLF'S INCORPORATED**

Dept. 907 Douglas Park Station, Chicago



**4 HP STATIONARY GASOLINE ENGINE** COMPLETE \$76.00

For Farmwork, Irrigation or Pumping, Factory use and Electric Lighting.

3 to 20 h.p.—perfectly governed—guaranteed by a responsible firm. Write for full description.

**GRAY MOTOR CO., 107 Leib St., DETROIT, MICH.**

## Get This Power Boat at Maker's Prices

Buy Direct from Manufacturer and Save Dealers' Profits



This Toppan Power Dory as illustrated above is made of best guaranteed materials and is the standard rough water boat of the world. Safe and reliable—used by U. S. Government in all departments. Send 4c in stamps for catalogue. Ask for prices and facts about Toppan Reversible Motors, built with 2, 3, 5, 8 and 12 Horse Power—and if you want to build your own dory saving exactly HALF, ask for FREE KNOCK-DOWN BOAT QUOTATIONS.

**TOPPAN BOAT MFG. CO.**

3 Haverhill St.

BOSTON, MASS.

# Stop Paying for Marine Engine Experiments

Reputable agents wanted to handle popular-priced marine engine. Absolutely guaranteed for 5 years. Thirty days' trial by the purchaser. Your money promptly refunded, without question, if you are not fully satisfied.

A sure favorite and quick seller. Big returns assured. Simplicity the keynote of construction.

Just the engine you have been looking and waiting for. Combines the good features of the best, with all the bad ones eliminated.

Fool-proof. As near perfect as anything mechanical can be produced.

All sizes in stock from 2 to 50 h. p. Ready to ship on 24 hours' notice if necessary.

Details of the greatest selling plan and agents' money-making proposition ever offered.

Liberal discount, specified territory and absolute protection to accepted agents.

Some very productive territory still open.

Write today for Catalog No. 12

**COLUMBIA ENGINE COMPANY**  
Cor. Jefferson and Bellevue Aves., DETROIT, MICH. [106]

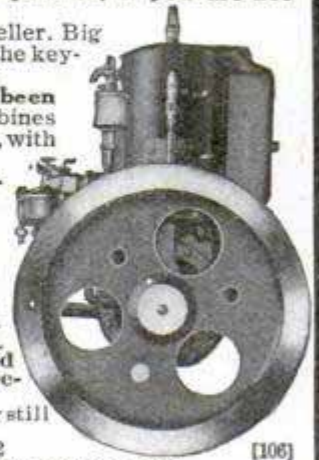

# FERRO



The Engine that Mastered Niagara

Write for free Ferro Book and helpful advice about boats and engines.

THE engine is the deciding factor in buying a motor-boat. We not only furnish the world's standard two-cycle boat-motor, but can help you obtain the best boats built for all purposes.

**The Ferro Machine & F'dry Co.**  
18 Hubbard Ave., Cleveland.  
Agents in Principal Cities and Ports

Here's another chance for Old Dr. Cook. A government engineer has located a mountain within the Arctic circle that is 2,000 ft. higher than McKinley.—Chicago News.

Unquestionably the discovery of a substitute for radium will tend to lower the cost of living; but what is really needed is a cheaper substitute for beefsteak.—Chicago Tribune.

## MODERN ELECTRICS

The greatest, most instructive electrical Magazine printed. Prints more wireless and "How to make things," articles than all electrical magazines combined. Experimental Department, intensely interesting. Wireless contest each month.

SPECIAL OFFER: 6 months for 25c. \$1.00 a year. On all News Stands.

**Modern Electrics Publications, 231 Fulton St., New York**

# NEW WIRELESS WONDER



Aero Field Receiving Outfit. Weight only 4 oz. Receives up to 75 miles. The wireless sensation of the year. Price \$4.00; without phones, \$2.50.

Send 3c for Catalogue

**ETHERIC ELECTRIC CO.** 278 Lenox Ave. Corner 124th St. Salesrooms and Factory 71 Barclay St., NEW YORK, N. Y.

# The "ELECTRO" STATIC MACHINE



Guaranteed to throw a 3-inch spark by merely turning the crank. This machine will give you more amusement than anything you have ever had, and you can perform thousands of experiments with same. Lights Geissler and X-Ray tubes, charges Leyden jars, fires powder, works Wireless Stations, raises a person's hair, etc.

Size 11" x 14". Weight 8 lbs. PRICE \$3.75

Send 4 cent stamp for our great 196-page Electrical Cyclopaedia No. 9 containing hundreds of experiments.

"Everything for the Experimenter"

**THE ELECTRO IMPORTING COMPANY**  
233a Fulton Street NEW YORK CITY



MESCO TRADE MARK MESCO TRADE MARK

## MESCO ELECTRIC TOASTER

Price with Cord  
and Attaching  
Plugs complete.

**\$5.00**

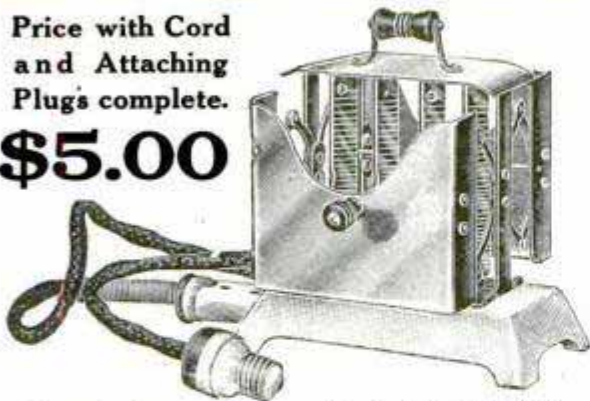

**Low Current Consumption. Mechanical Heat Regulator. Solid Porcelain Base. Highly polished, nickel plated brass. Not the cheapest, but the best.**

The adjustable doors that hold the bread can be placed close to the heat unit for making toast quick and crisp, or they can be withdrawn to the proper distance for making a hard brown toast. If doors are pulled out full distance the toast remains hot, but will not burn. The only Electric Toaster with this essential feature. Can be used on either direct or alternating current. Made for 110 to 120 Volt circuits. Also 220 to 250 Volt. **Ask for Catalog 24P.**

**MANHATTAN ELECTRICAL SUPPLY CO.**  
NEW YORK, 17 Park Place. CHICAGO, 186, 188 Fifth Ave.

MESCO TRADE MARK MESCO TRADE MARK

**FLOWERS WERE ONCE ORDINARY LEAVES**  
—Flowers came into being, according to the botanist, through the gradual adaptation of an ordinary leaf to functions of reproduction. This has been proven not only by direct observations of progressive development, but by the fact that nature sometimes reverses

**ELECTRIC** GOODS FOR EVERYBODY. World's headquarters for Dynamos, Motors, Fans, Toys, Railways, Batteries, Belts, Bells, Pocket Lamps, Telephones, House Lighting Plants, Books. If it's electric we have it. **Undersell all. Fortune for agents. Big Catalogue 4 cents.**  
**OHIO ELECTRIC WORKS, CLEVELAND, OHIO**

**SECONDARY "UNITS" FOR WIRELESS**  
INDUCTION COILS AND TRANSFORMERS; THESE UNITS COST BUT LITTLE MORE THAN WIRE ALONE. SEND 2 CENT STAMP FOR WIRELESS CATALOGUE.

Dawson & Winger Electric Co., 429 Dearborn Street, Chicago

**BIG 200-p ELECTRICAL and WIRELESS CATALOG** Mailed for 4c Stamp

(to cover postage). **60 pages WIRELESS** Instruments for commercial and experimental use. **15 pages Motors and Dynamos** of all sizes. **35 pages Miniature Trains and Imported Electrical TOYS.** **20 pages Telegraph Instruments.** **40 pages Electrical Novelties, etc.** **30 pages general Electrical Supplies.** Get this catalog today—you need it.

**J. J. DUCK, 424-6 St. Clair Street, TOLEDO, OHIO**

**ELECTRICITY**  
VOLTAAMP

The most wonderful and fascinating scientific study of the age. Every Boy, Girl and Grown-up should know about it. The new "VOLTAAMP ELECTRICAL PRODUCTS"—our 112 Page Catalog now ready, the most complete and interesting book ever issued—is full of illustrations and descriptions of the latest Voltaamp Electrical Novelties—Motors, Dynamos, Toys, Machine Models, Telegraph and "Wireless" Instruments, Ruhmkorff Coils, Spark Coils, Geissler Tubes, Switches, Meters, Lamps, Flashlights, Transformers, Tools, etc. The greatest line of Miniature Electric Railways ever shown. Ideal Christmas Gifts. Prices consistently low.

Send for this Catalog—6 cents in stamps or coin, which will be refunded on first order of 50 cents or over. No postals answered.



**VOLTAAMP ELECTRIC MFG. CO., Voltamp Bldg., Baltimore, Md.**

## Bargain Prices on New and Used Electrical Machinery



We Buy, Sell, Rent, Trade and Repair Electrical Machinery. Our Stocks are Large, Prices Low and our Used Machinery is as Good as New. Write for Bargain Booklet Number Twenty. Tell us what you have and what you need. We can interest you.

## SWITCHBOARDS

For POWER or LIGHTING

Whether large or small, Alternating or Direct Current, we do or will build the Switchboard that meets your requirements.



Ask for Switchboard Bulletin Number Twenty-two. It gives prices.

We do not handle novelties or toys.

**The F. BISSELL COMPANY**  
226-230 Huron St. TOLEDO, OHIO

## Holtzer-Cabot Small Motors



1-6 H. P. A. C. Motor

**THE HOLTZER-CABOT ELEC. COMPANY**  
BOSTON Small Motor Specialists CHICAGO

have been developed to meet almost every requirement, and are largely used in all cases where especially difficult conditions are met.

### We can solve your Motor Problems

because of our long experience in this work, because of our large variety of types, and because of our flexible and efficient organization. Write today.

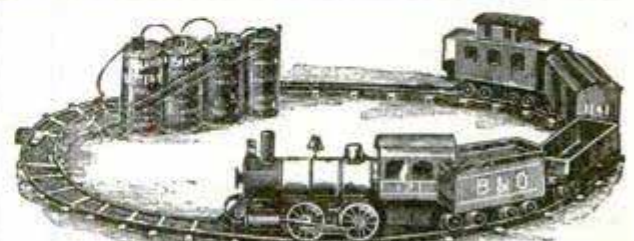

Electrical railways, tracks, switches, trolley cars, dynamos, motors, dynamo castings, gas engine castings, everything for the young electrician. Send for our complete catalog "B."

**The Carlisle & Finch Co.**  
262 E. Clifton Ave. Cincinnati, Ohio

**"THE KNOB DOES IT"** JUST A SIMPLE PRESSURE AND THE PEN FILLS.

Made Right - To Write Right. No More Leakage or Soiled Hands.

Simple, Safe, Secure.

With No. 2 Gold Pen \$2.00  
With No. 4 Gold Pen \$2.50

**"VULCAN" STYLOS**

UNEQUALED FOR FAST WRITING; RULING OR MANIFOLDING.

TWO SIZES—4¼ AND 5½ INCHES  
TWO COLORS—BLACK OR RED \$1.00  
Can be carried in any position.

LARGE SIZE 8 INCHES, BLACK ONLY \$1.25

**"VULCAN" Self-filling FOUNTAIN PENS.**

ANY STYLE SENT POST PAID ON RECEIPT OF PRICE.  
J. C. ULLRICH & CO., 135 Greenwich Street, New York

**Help Yourself to this Typewriter**  
**Use it 10 Days Free**

You will find real pleasure in typewriting your letters, notes, speeches, etc., on the "Wellington." It will save you time and double your writing efficiency. Endorsed by stores, railroads, and professional men everywhere. Over 80,000 in everyday use. The

**Wellington Visible Typewriter**

is not a rebuilt machine. Comes to you direct from factory complete with carrying case, cleaning brushes, etc.

Does work as good as any \$100 machine. Much more simple, and incomparably more durable. "Wellingtons" have been used 7 years without costing one cent for repairs. Machine has 28 keys, 84 characters, weighs 17 lbs., stands 5 in. high.

You can have a "Wellington" for 10-day free trial. Write to-day for particulars.

**THE WILLIAMS MFG. CO., Ltd.,**  
68 RIVER STREET,  
PLATTSBURGH, N. Y.

Price \$60  
Guaranteed 1 year



**LET US GIVE YOU THIS TRANSPARENT CELLULOID TRIANGLE**

It is 4 inch size, 30°+60° angles. Lowest retail price, 25 cents. Absolutely essential to everyone who draws. We make this offer to introduce our new catalogue showing

**SPAULDING'S NEW CARRYING CASES AND COMPLETE OUTFITS**

for designers, architects, engineers and students—compact, durable and convenient. Spaulding's Carrying Cases are made light and strong. They provide well arranged compartments, including space for drawing board and T square. Handled like a suit case; unique, practical, inexpensive. Outfits include all necessary equipment. If you draw, send us five 2-cent stamps to-day to pay postage and get the free triangle and the catalogue.

**SPAULDING PRINT PAPER CO.**  
44 Federal St. BOSTON

**PRICE \$12.00 AT FACTORY**

**This Cabinet** made of Oak, finished golden, 44" long, 24" wide, has drawers, extension slide, roll front, paper cabinet, etc., as shown. We sell it at low price to introduce our **OFFICE FURNITURE**—Desks, Chairs, Tables, Files, Book Cases, etc. ASK FOR PRICES AND CATALOG No. 211.

We make **UPHOLSTERED FURNITURE**—Turkish and Odd Rockers, Parlor and Library Suites, Davenport and Couches in Oak and Mahogany, Flanders, mission and regular. Covered in best leather money will buy—every piece guaranteed. Ask for prices and Catalog No. 411.

**E. H. STAFFORD MFG. CO., 242 Adams St. Chicago, Ill.**

the process and makes flowers revert to the original leaf type.

It is interesting to note that this theory of adaptation was not first formulated by a botanist, but by the great poet Goethe, who expressed it in a literary work published in 1790.

**TYPENITERS ALL MAKES**

All the Standard Machines **SOLD or RENTED ANYWHERE** at 1/4 to 1/2 MFR'S PRICES, allowing **RENTAL TO APPLY ON PRICE.** Shipped with privilege of examination. Write for Illustrated Catalog 980.

**TYPENITERS EMPORIUM, 92-94 Lake St., CHICAGO**



**REBUILT GEM ADDING MACHINES AT \$5 AND \$10**

You can't afford to add up columns of figures with a pencil when you can now buy a rebuilt Gem Adding Machine for \$5 or a better one for \$10. These machines are exactly like the one illustrated. It will do more work than several clerks—do it quickly, and do it right. It is error-proof. These machines are guaranteed to be in perfect working order.

**Satisfaction Guaranteed or Money Refunded in 10 Days**

Firms whose business requires larger, more intricate machines for subtracting, dividing, etc., trade these old Gem machines back to us. We build them over—making them practically new—and sell them at just enough to cover the cost to us.

**In this way you can get an excellent adding machine at a trifling cost**

Send your order with your check today, and if you are not satisfied after ten days trial return the machine and your money will be refunded without question. Order at once—the supply is limited.

**E. JOSEL, Rebuilt Adding Machine Co., 319 Broadway, NEW YORK CITY**

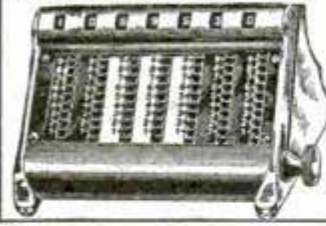

**10 CENTS A DAY** buys the Emerson Typewriter.

Made in our own factory at Woodstock, Ill. \$50 now—later the price will be \$100. The best typewriter made. Entire line visible. Back spacer, tabulator, two-color ribbon, universal keyboard, etc. Agents wanted everywhere. One Emerson machine free for a very small service. No selling necessary.

**To Get One Free** and to learn of our easy terms and full particulars regarding this unprecedented offer, say to us in a letter, "Mail your FREE OFFER."

**The Emerson Typewriter Co., Box 70, Woodstock, Illinois**



**TALENTS**  
**YOUR IDEAS MAY BRING YOU A FORTUNE!**  
**TALENTS**

**H. ELLIS CHANDLEE & CO.**  
55 Bornot Building, WASHINGTON, D. C.  
See page 119

**ALOE'S**  
Our Renowned Double Combination  
**TELESCOPE**

Size 2 in. Object Glass, Length 63 in. Prof. Hicks, of Word and Works Almanac, says they are far superior to others he has examined at twice the price.

CATALOGUES ON APPLICATION



**ASTRONOMICAL TELESCOPES**

Complete with Case, Sun Shade, Sun Glass and Extra Eye Piece for Night Observation. **\$18.00**

One of these superb instruments will give material enjoyment. It will enable you to pick out the smallest Boats on the Horizon, tell the time by a clock at many miles distant, and view the country for fifty miles around. "This telescope" for Astronomical Work is simply unequalled, with its aid the Mountains in the Moon, Jupiter's Moons and Saturn's Rings are clearly discernible.

**A. S. ALOE COMPANY, 515 Olive S., St. Louis, Mo.**

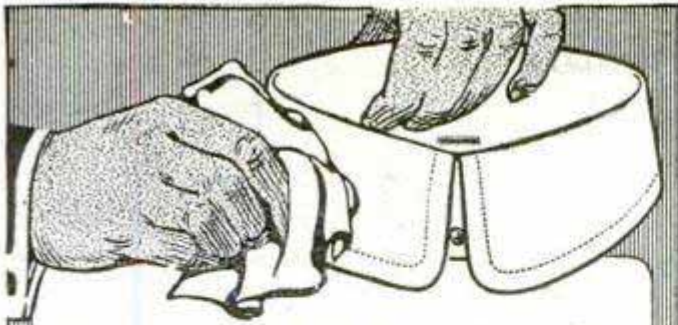

## A Damp Cloth Is Your Laundry

Be certain of always having a clean, smartly styled collar by wearing a Litholin. The most practical for work or play. Permanently clean. Will not spot, fray or discolor. The collar you have always worn—only waterproofed.

### LITHOLIN

#### Waterproofed Linen Collars

Carefully designed and expertly finished. Worn and endorsed by men in every walk of life.

**Collars 25c Each Cuffs 50c a Pair**

At your dealer's, or by mail on receipt of price. Write for booklet.

**FIBERLOID COMPANY**

7 and 9 Waverly Place, New York



**SEASICK SAILORS**—A little while ago the country was amazed at the fatal demonstration of the inability of a large percentage of the sailors of a battleship to swim. The common sense suggestion that men who enlisted to devote several years of their lives to service at sea ought to have been taught swimming was so obvious that it may possibly have induced the



### For real tobacco flavor, not pipe odor, smoke the ABSORBO PIPE

Genuine Imported Vienna Meerschaum

Length of Pipe 5½ inches Absorbs the nicotine like a sponge—ensuring a cool, sweet smoke without injurious after effects. Colors a beautiful rich brown. **Sent prepaid 50 cts.; 3 for \$1.25.** Send for our 200 A List. Money back if not satisfactory.

**SMOKE SHOP SPECIALTIES CO., 296 Main St., Holyoke, Mass.**

## IDEAS YOUR IDEAS MAY BRING YOU A FORTUNE! TALENTS

**H. ELLIS CHANDLEE & CO.**  
55 Borneo Building, WASHINGTON, D. C.

See page 119



### BE YOUR OWN BOSS

#### Make Money Easy

AGENTS wanted in every county to sell the popular Golden Rule Knives with name, address, photo, lodge emblems, etc., on handle. Agents earn \$75 to \$200 a month selling our shears, transparent handled pocket knives and razors. Big profits, quick sales. Exclusive territory. Experience unnecessary. **WE TEACH YOU NOW.**

Write to-day for terms and become one of our successful salesmen.



**GOLDEN RULE CUTLERY CO., 362 Wendell St., Dept. 99, CHICAGO**



## Your Glove For Work or Sport

Hansen, of Milwaukee, makes a glove, gauntlet or mitten to fit every man's individual needs. Hansen's not only fit the hand but fit the work in hand.

Many men look upon gloves as a necessary evil—necessary for protection—evil because they encumber the hand.

Men who wear Hansen's know that gloves can be all comfort—afford perfect protection without being the least hindrance in their work or sport.

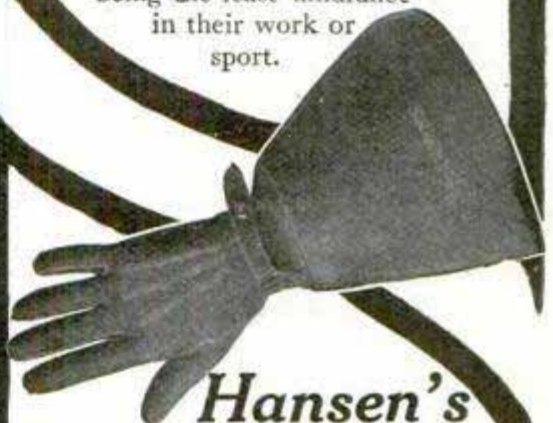

## Hansen's

*"Built Like a Hand"*

warranted never to harden, shrink, shrivel, crack or peel, no matter how often soaked, dried or cleaned.

Made in hundreds of styles for the electrical worker, structural iron worker, teamster, automobilist, locomotive fireman, horseman, hunter, engineer, miner, in short, all classes of workers.

Write today for particulars about the right glove for YOUR purpose, and tell us what your work is or for what purpose you want hand protection. Learn the big value you get in a Hansen.

Ask your dealer to show you the line. We will supply you if he doesn't. Write for catalog anyway.

**O. C. Hansen Mfg. Co.**  
291 Milwaukee Street  
Milwaukee, Wis.



# MEN-GET THIS MONEY \$30,000 IN 9 MONTHS \$13,245 IN 110 DAYS

Amount of orders from R. V. Zimmerman, Ind., farmer (address upon request) for our

## NEW HOME INVENTION

First experience as a general or local agent. Started at home while farming, devoting spare time. M. Stoneman, Neb., artist (address upon request) spare time orders total

**Over \$15,000.00**

One order exceeds \$6,000. "Best thing ever sold. Not one complaint from 2,000 customers." C. A. Korstad, Minn. (address upon request.)

**Orders \$2,212 worth in 2 weeks**

Hundreds enjoying similar prosperity. Agents breaking all records—actually getting rich. Let us refer you to 10 more whose total orders exceed \$51,000; to hundreds like O. Schleicher, Ohio, (minister) whose **First 12 hours work sold 30 Outfits (profit \$81.90).**

A. Wilson, Ky., who ordered \$4,000 worth and sold 102 in 14 days, (profit \$278.40); J. Hart, Texas, \$5,000 worth and sold 16 in 3 hours (profit \$43.68); Reese, Pa. (carpenter) solicited 60 people—sold 55; Beem, Kans., writes: "I averaged \$164.25 weekly for 3 months"; Langley, N. D., sold \$115 worth first day. Why should not Cashman say: "Men who couldn't sell your goods couldn't sell bread in a famine." Reader, these results possible for you at home or traveling all or spare time as exclusive agent for Allen's Wonderful Bath Apparatus.



R.V. Zimmerman



M. Stoneman

We started these men plus hundreds of others. They investigated—accepted—made thousands. Do as they did—make what they made—send postal—get our amazing offer—it's free.



Sectional View

### New—Powerful—Irresistible

Think of it! gives every home a modern bathroom for only \$6.50—abolishes tubs, bowls, buckets, wash rags, sponges. Supplies hot or cold water in any room. No plumbing—no water works—self heating—makes bathing 5-minute operation—easily carried from room to room—child operates easily. Means no more cold rooms, drudgery, lugging water, filling tubs, emptying, cleaning, putting away. No wonder agents without previous experience make small fortunes, buy homes, have an automobile, bank account; average 8 orders to every 10 families. Fascinating, dignified, exciting work. No competition—patent new—field unworked—demand enormous—price insignificant—a demonstrated gigantic success—everything ideal for making money. Don't hesitate—business supplies capital. Be first. Get exclusive rights. Spare time gave Oviatt, Iowa, minister, \$800 in 11 days, \$4,000 to date. Reads like fiction, yet we prove all by affidavits, addresses, any proof you want. Address postal today for full details.

**ALLEN MFG. CO., 3269 Allen Building, TOLEDO, OHIO**

"Lucky I answered ad. It's great. Money coming fast. 17 orders today."—(writes A. L. of Maine.)

**FREE \$13.75 AGENTS' OUTFIT TO ACTIVE AGENTS. CREDIT GIVEN ON SALES**

## Only \$9750 Per Carat for Perfect Cut, Genuine Diamonds



We save you 40%. Learn all about the BASCH plan. Write for catalogue "A," guarantee, money-back contract and prices FREE. Diamonds sent C. O. D. with privilege of examination.

L. BASCH & CO., 272 State St., CHICAGO, ILL.

## FORTUNES MADE



operating the "CIRCLING WAVE" The latest invention and the Catchiest Amusement Riding Device in use. For catalogue, testimonials and price, write

**ARMITAGE & GUINN**  
22 Hill St., Springville, Erie Co., N. Y., U. S. A.



### Every Boy His Own Toymaker

Greatest boys' book ever written. Tells how to make a Steam Engine, Microscope, an Electric Telegraph, Telephone, Magic Lantern, Boats, kites, balloons, electrical and mechanical toys, traps, fishing tackle. 200 illustrations. Price only 10c postpaid, 3 for 25c. Western Puzzle Co., St. Paul, Minn.

naval authorities to give it consideration. But now an even more remarkable oversight is reported. A midshipman, after the usual course and graduation at Annapolis, was assigned to duty on a battleship last July. Since then his sufferings from seasickness have been so frequent and acute that he has asked to be allowed to resign from the navy. Nor is his an isolated case. Nearly a dozen midshipmen and younger ensigns, it is said, have left the navy within the year because of seasickness.

When it is considered that the government has been

## IDEAS YOUR IDEAS MAY BRING YOU A FORTUNE! TALENTS

**H. ELLIS CHANDLEE & CO.**  
55 Bornot Building, WASHINGTON, D. C.  
See page 119

**CACHOO!** Make the whole family and all your friends "just sneeze their heads off" without knowing why, with CACHOO, the new long distance harmless snuff. Sent anywhere for 10c. Catalog included FREE.  
P. T. & N. CO., Department B, Chicago, Ill.



## \$513 Clear Profit in 51 Days from an Investment of \$150



is the result from operating one American Box Ball Alley. Two others cleared over \$2,000.00 first year. Four others over \$1,200.00 in two months. Four others took in \$3,200.00 in nine months. Go in this business yourself. You can start with \$75.00. We let you test it without risking any money. Nearly 7,000 alleys sold to date. More popular today than ever. These alleys pay from \$30.00 to \$75.00 each per week in any town. No gambling device, but the best thing on earth for clean amusement and physical exercise. Patronized by the best people, who form clubs and bring their friends. No expense to install or operate. No special floor required, no pin boy needed. Receipts nearly all profit. We sell only one customer in towns of moderate size. Write for booklet and easy payment plan.

**AMERICAN BOX BALL CO., 722 Van Buren Street, INDIANAPOLIS, IND. (31)**

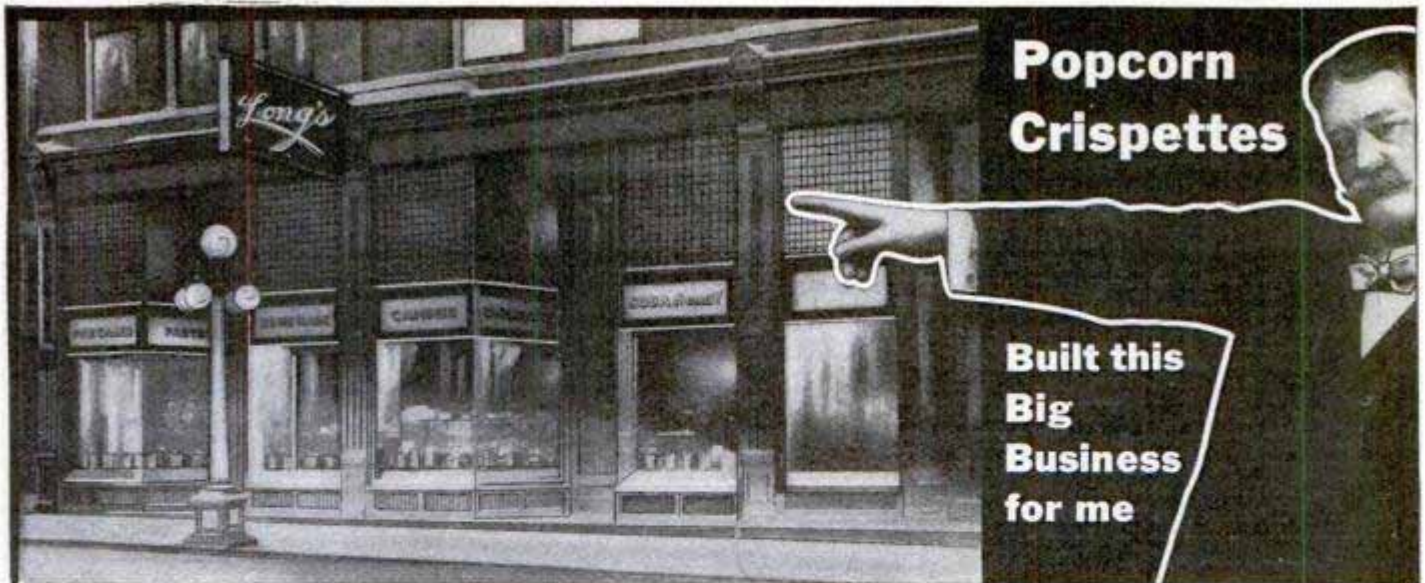

Actual photograph of my big confectionery store, Springfield, Ohio

**I am looking for other men who can make good — who have business aspirations — who are anxious to work for big things.**

What are you going to do during the winter months? Just barely earn a living—keep wishing for something better to turn up. Don't do it.

**Listen!** Take that money you've laid up against the day of opportunity, invest it in a Long Popcorn Crispette Machine and build up a big business the same as I. If I did, you can—that's sure.

You see on this page a picture of my big handsome con-

**Every time you take in a nickel you make three cents profit**

Each day your business will grow—same as mine did. If you make and sell Popcorn Crispettes in your town, you'll have a good thing all to yourself, too: because I furnish a secret formula for making Crispettes, and it's different from anything else. Nobody but you can have it in your town. So you escape competition. People buy and buy and buy Long Popcorn Crispettes because of the taste. They're different from anything ever put out and folks want more and more of them. In the literature I am going to send you, I tell you all about them; about men who have made big money with the machine, and the men tell you how they did it. It's very interesting reading. Why plod along for a few paltry dollars a week—at the bidding of another who is no smarter than you are? **Why let some other fellow cash in on YOUR ability?** Why let the other fellow get the big money while YOU do the hard work that earns it? Is there anything in that? No!—and no man with any spunk and spirit is going to stand it very long. Neither are you. You've got your future to think about. **You have been looking for a good chance and here it is.** To the right man in each community I've got a great proposition to make. Are you one of them? **Success is yours if you go after it.** A splendid opportunity faces you. It may never come your way again.

fectionery store: as fine a store of its kind as you can find anywhere. I built it with Popcorn Crispettes. **I made money because I had what people wanted, and I had it all to myself.** You can do the same.

Somewhere in your town there is a small vacant store—a part of a building—a window—a little nook where the rent isn't high. There you can set up your machine, and make and sell Crispettes.



**W. Z. LONG**  
210 High St., Springfield, O.

**W. Z. LONG**  
Springfield, O.

Please send me full particulars about Crispette machine, and tell me how to start big paying business.

Name.....

Address.....

City.....State.....

to the expense of educating these young men for a service that they cannot fulfill, and that the victims have spent years qualifying for a career they have been forced by physical disability to abandon, it inspires the natural inquiry why, as in the case of sailors who cannot swim, some test is not made to determine their ability to cope with Father Neptune before all this effort, time and expense is wasted? But perhaps this suggestion, remarks the Pittsburg Dispatch, like that of teaching sailors to swim, was so simple as to be overlooked.

**FOOT AGONY** Instantaneous relief for callous, or tender spots on soles. No chemicals. A mechanical device. Material and instructions mailed. 50 cents. Coin, or stamps.  
**C. H. FLATT & CO. 118 Market Street, NEWARK, N. J.**

**WHEN YOU WANT ANYTHING AND DON'T KNOW WHERE TO FIND IT—WRITE BUREAU OF INFORMATION, POPULAR MECHANICS, CHICAGO**

**WHITE VALLEY GEMS** IMPORTED from FRANCE

**SEE THEM BEFORE PAYING!** These Gems are chemical white sapphires. Can't be told from diamonds except by an expert. Stand acid and fire diamond tests. So hard they can't be filed and will cut glass. Brilliance guaranteed 25 years. All mounted in 14K solid gold diamond mountings. Will send you any style ring, pin or stud on approval—all charges prepaid—no money in advance. Write for Free illustrated booklet, special prices and ring measure. **WHITE VALLEY GEM CO., 900 Saks Building, INDIANAPOLIS, IND.**

**DAISY Air Rifle**

The straightest-shooting, most highly perfected air rifle made. Every boy should have one. The **Daisy Special, 1000-shot Magazine Repeater**, is the finest air rifle ever made at any price. Handsome blue barrel, lines like the latest magazine hunting rifle, accurate to a hair; price \$2.50. Buy from your dealer or we will send prepaid on receipt of price. Interesting literature free.

**DAISY MFG. CO., 301 Union St., Plymouth, Mich.**

Other Daisy Models 50c to \$2.00

1000 SHOT DAISY

# Let Me Teach You Art

## 30 Days at My Expense

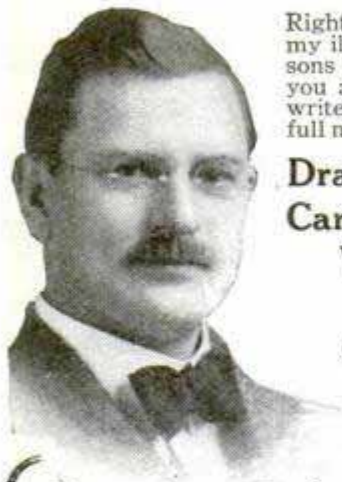

Right in your own home, through my illustrated correspondence lessons and personal criticisms. If you are interested in Art and will write me now, I will give you one full month's instruction in

**Drawing, Illustrating  
Cartooning, Designing  
Water-Color and  
Oil Painting or  
China Decoration**

**at my expense  
without one cent  
of cost to yourself**

I make this special offer in order to introduce my Famous Art Course into every community. If you love the beautiful you possess artistic talent. Let me develop that talent. I can give you a training that may not only better your position socially but may also enable you to **Earn from \$25 to \$50 per week** even more, as an artist, illustrator, designer or cartoonist. Write me today and I will send you my **Free Prospectus** and full particulars as to how you can obtain 30 days' instruction in art at my expense.

**J. Jan Dvorak, Pres., Fine Arts Institute**  
Studio 1193 OMAHA, NEB.

### Your Picture in a Postal Card IN ONE MINUTE



The pictures are developed, toned and finished in a single developing solution. No experience is necessary. Price of machines \$7.50 and \$15.00—circulars describing our machines sent free. We are also headquarters for supplies for all minute picture machines.

**AMERICAN MINUTE PHOTO COMPANY**  
Dept. U, 720-728 W. 12th St., Chicago, Illinois  
The largest manufacturers and distributors of minute picture machines and supplies in the world.



## 500% PROFIT

Operating a **Daydark Photo Post Card Machine**. Three photo postal cards of any object made and delivered on the spot in ten minutes. No experience required—no dark room necessary. All work done in the machine in open day. Establish a profitable business at home by opening a Daydark Postal Parlor. Big money maker on the street, at fairs, etc. Send at once for free catalog and sample post card showing the fine work the machine does.

**Daydark Specialty Co.**

2108 Cass Ave., St. Louis, Mo.



## The Illustrator Magic Lantern

Beautifully nickelled  
Strongly finished  
Lenses the best



Our **Illustrator Lanterns** are used by the leading Lecturers, by the Largest Universities, Colleges, and Schools. Complete Price Lists mailed on application. This lantern accommodates Electric Arc, Incandescent, Lime, and Alco-Radiant Lights.

### POST CARD MAGIC LANTERN

It shows on a screen the image reflected from a post-card or any other picture or flat object. Prices \$4.50, \$13.50, \$25.00, \$60.00.

**WILLIAMS, BROWN & EARLE, Inc.** Dept. 20 913 Chestnut St., Philadelphia, Pa.



## LE PAGE'S LIQUID GLUE

In the tool house on the shelf handy for instant use be sure to have a can of **Le PAGE'S LIQUID GLUE**, the best adhesive made.

It mends things almost as good as new and holds fast. Saves many a long trip and many a delay.

Sold in cans holding  $\frac{1}{2}$  gills, gills,  $\frac{1}{2}$  pints and pints; also in cap sealing bottles and pin sealing tubes, which we recommend for household requirements.

Your dealer sells it. Demand **Le PAGE'S**. Accept no substitute.

*Library slips with every bottle and tube*

**HOW SNAKES CLIMB TREES**—Many have thought that snakes accomplish the feat of climbing by wrapping themselves about the tree and following a spiral course upward. Several years ago two wood-choppers, having felled a large oak tree several feet in diameter and very tall, found in its top two common black snakes. After pondering for some time, the men arrived at the conclusion that one snake had taken hold of the other's tail, and thus by co-operation they had been enabled to clasp the trunk, and by circling about it had ascended to the top.

Whatever probability may have attached to this con-

## Your Opportunity

is knocking—now. For the man who wants a pleasant and a big money making proposition, the photo button business offers great opportunities. The

### Wonder Cannon Camera

has made hundreds independent. It will do the same for you. Complete outfit, \$25.00, including **WONDER CANNON**, tripod and supplies to make 400 finished photo buttons. Write today for **FREE CATALOG**.

**CHICAGO FERROTYPE CO., Dep't. 102, Chicago, Ill.**



**BARODA DIAMONDS.**  
Flash Like Genuine  
ANY STYLE at 1/40 the cost—IN SOLID GOLD RINGS  
Stand acid test and expert examination. We guarantee them. See them first—then pay.  
**Special Offer**—14k Tiffany ring 1 ct. \$5.98. Gents ring 1 ct. \$6.98. 14k Stud 1 ct. \$4.86. Sent C.O.D. for inspection. **Catalog FREE**, shows full line. Patent ring gauge included, 10c. **The Baroda Co., Dept. A5, Leland & Dover Sts., Chicago**

Save Money in Building. Write for Free Booklet and Samples of

# BISHOPRIC WALL BOARD AND SHEATHING



**BISHOPRIC WALL BOARD** is cheaper and better than Lath and Plaster; applied Winter or Summer. YOU can easily nail it to studding. Applied dry it is at once ready for paint, paper or burlap, is clean and sanitary; guaranteed proof against dampness, heat, cold, sound and vermin. Made of kiln-dried dressed lath, imbedded in hot Asphalt Mastic, and surfaced with sized cardboard; is cut at the factory into uniform sheets, 4x4 ft. sq. Price \$2.50 per 100 sq. ft., or \$6.40 per crate of 256 sq. ft. L.o.b. factories, New Orleans, Cincinnati, or Alma, Mich.

The Mastic Wall Board & Roofing Mfg. Co., 60 E. Third St., Cincinnati, Ohio

**BISHOPRIC SHEATHING** saves 75 per cent in material and labor. Same as Wall Board, but cardboard surface of Sheathing is not recommended for decorative purpose; therefore costs less. Quickly nailed to studs with laths and asphalt exposed. Makes smooth, solid job. Does away with building paper. Proof against heat, cold, dampness. Price \$2.35 per square of 100 sq. ft., or \$6 per crate of 256 sq. ft. L.o.b. New Orleans, Cincinnati, or Alma, Mich.

Write for Booklet and Free Samples of Wall Board, Sheathing and Roofing.

Shows weatherboards over Sheathing, lath side exposed; also Bishopric Roofing over Sheathing, smooth side exposed.



## "Hatching Facts" Free

Your address on a postal brings latest edition of "Hatching Facts." It tells how to start right at least expense; how Belle City won World's Championship last season. Write today, but if in a hurry order direct from

this ad. J. V. Rohan, Pres. Belle City Incubator Co.



**\$7.55 Buys Best 140-Egg Incubator**

Double cases all over; best copper tank; nursery, self-regulating. Best 140-chick hot-water brooder, \$4.85. Both ordered together, \$11.50. Freight prepaid (E. of

Rockies). No machines at any price

are better. Satisfaction guaranteed. Write for book today or send price now and save time.

Belle City Incubator Company, Box 164 Racine, Wisconsin



clusion was dispelled by the observation of two naturalists.

A black snake, measuring perhaps a trifle over 6 ft. was found clinging to the side of a small tree, around which it could have wrapped itself nearly twice had it wished to do so. Instead of this the snake passed right and left at short distances, catching the folds along its under parts over and behind slightly projecting rough strips of bark.

As the snake rested only five or six feet off the

**\$7.50 FREIGHT PREPAID FOR 120-EGG INCUBATOR**

**SAFE SURE**

Biggest value of the year. Write for low prices on larger sizes, delivered.

**Famous RELIANCE**

Simplest—surest—safest. Metal-covered; metal legs and lamp. Delivered free east of Missouri River, and north of Tennessee. Prices quoted to points beyond. Write for Free Book.

RELIANCE INCUBATOR CO., Box 589 Freeport, Ill.



## PUNCTURES REPAIRED BICYCLE TIRES FREE

**CLOVERLEAF BRAND FIXITFREE TIRES**, are nearly perfect or we could not afford this guarantee; 99 per cent of the value in a tire cannot be seen, you cannot judge a tire by the look; all look alike except the tread design, which has no value for merit; only fancy. Wearing and puncture resisting qualities are what count. This is the service you are willing to pay for; TROUBLE SAVING, this is what we offer you. On usual guaranty you receive nothing in this direction, but unkept promises and "Hot Air."

**Our Guaranty** covers the unseen, the unknown parts; guarantees you the year's tire service WITHOUT EXTRA COST to you. All punctures and other repairs MADE FREE, or replaced with new tires, without charge, regardless of what or who is at fault. No questions, we simply do it. Local Dealers handling this brand of tires can do the same. **INSURANCE TAG ATTACHED TO EACH TIRE** This special introductory price now. Order early; give size wanted; Catalog Free.

Agents Wanted. **THE VIM** Chicago, Ill. Des Moines, Iowa Minneapolis, Minn.

**CLOVERLEAF BRAND WE PAY EXPRESS \$5.85 PER PAIR FIXIT FREE**

## AGENTS 100% PROFIT



Most perfect and valuable Combination of tools ever invented. Sells at sight to Farmers, Plumbers, Machinists, Automobile Owners, in stores and the home. Made of Drop Forged high grade carbon steel. One agent in Essex County, N. Y., after a 6 days' canvass ordered 100 tools. His profit \$100.00. Big snap for agents. Sample free to workers. **T. THOMAS MFG. CO., 2848 Wayne St., Dayton, Ohio**

## Greider's Fine Catalogue

of purebred poultry, for 1911, over 200 pages, 57 large colored pictures of fowls, calendar for each month, illustrations, descriptions, photos, incubators, brooders, information, and all details concerning the business, where and how to buy fine poultry, eggs for hatching, supplies, etc. at lowest cost, in fact the greatest poultry catalog ever published. Send 15c for this handsome book. **B. H. GREIDER, BOX 2, REEMS, PA.**



## Fairbanks-Morse Gasoline Traction Engines For All Purposes

These engines are proving a big success because of their great power and thorough reliability. Will always develop full horsepower.

Send for Bulletin No. TR449

**Fairbanks, Morse & Co.**

481 Wabash Avenue, Chicago, Ill.

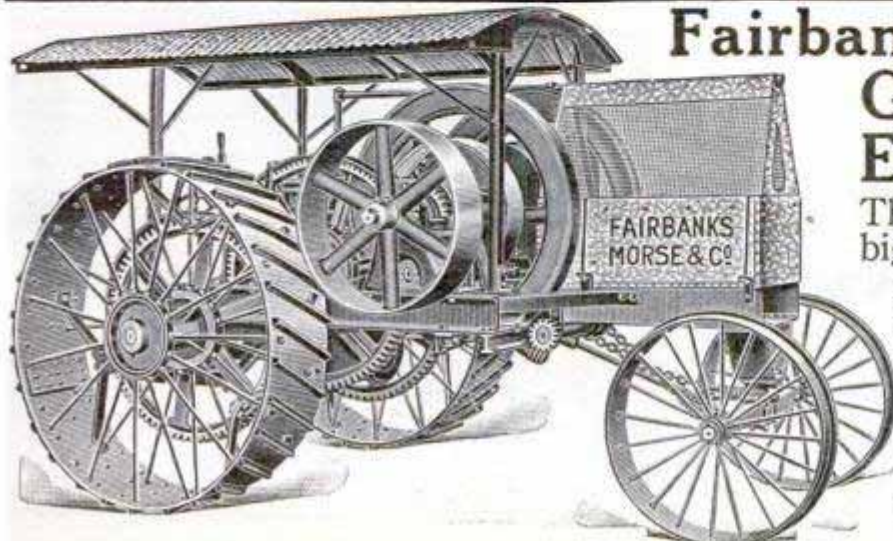

# Send For Our Free Vibrator Book



If you send your name and address we will send you **Free** our Vibrator Book describing the White Cross Electric Vibrator shown here.

*Merely send a Postal Card and our FREE Vibrator Book will be mailed to you.*

This Vibrator is a rubbing machine which draws the blood to any aching part of the body to do its work. This machine rubs much better and much faster than the hands.

While the hands are able to give a few dozen rubs per minute the machine gives several thousand rubs. It rubs hard or gently, just as the operator chooses. The machine can be operated by anyone in his own home.

Send today for the  
**FREE VIBRATOR BOOK**

**Lindstrom-Smith Co.**  
253 La Salle St., Dept. 1193  
**CHICAGO**



## Geisha Diamonds

THE LATEST SCIENTIFIC DISCOVERY

Bright, sparkling, beautiful. For brilliancy they equal the genuine, standing all test and puzzle experts. One twentieth the expense. Sent free with privilege of examination. For particulars, prices, etc., address

**THE R. GREGG MFG. & IMPT. CO.**  
Dept. H, 517 Jackson Blvd., Chicago, Ill.

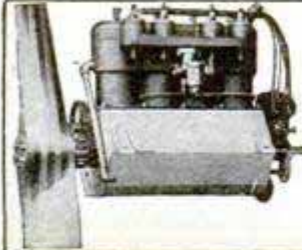

## The AEROMOTOR

The most compact, powerful and light aeronautic power plant built; 4 and 6 cylinders —4-cycle—30 to 75 H. P.

Detroit Aeronautic Construction Co.  
76 Crane Ave., DETROIT, MICH., U. S. A.

ground, one of the naturalists grasped its tail to test its climbing qualities, but so great was the force with which it pulled upward that it proved a difficult task to hold it. Finally, becoming annoyed at this ill treatment, the snake reached down threateningly at the offending hand and losing its hold, fell to the ground.—Harper's Weekly.

## LEARN BY MAIL TO STUFF BIRDS AND ANIMALS

Write for  
**FREE**  
Book  
Today



tan hides, make rugs, etc. Most interesting art in the world. Learn it right at home by mail, in your spare time.

**Get Our Book FREE**

**Taxidermy**

It tells all about our school and how we teach this fine business by mail—and the book is **absolutely FREE**. Make big profits in your spare time. Save your fine trophies. Decorate your home with beautiful specimens. You will be delighted with our beautiful book for it tells you all about taxidermy.

SEND FOR THE FREE BOOK TODAY

**NORTHWESTERN SCHOOL OF TAXIDERM, 1193 Rex Bldg., Omaha, Nebraska.**

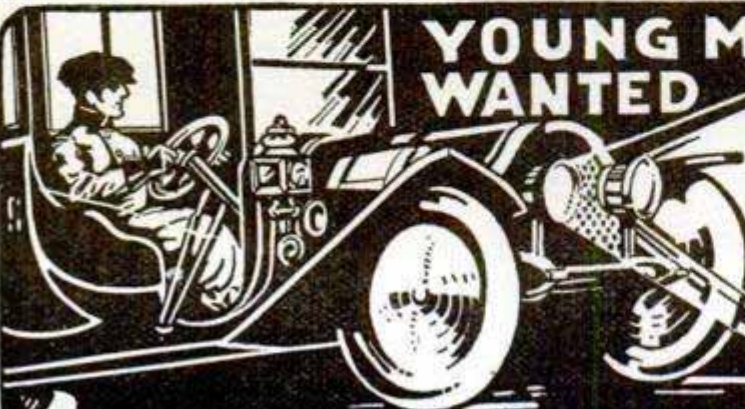

## YOUNG MEN WANTED

## You Can Easily Learn

to be an automobile salesman, chauffeur, demonstrator or repairman. Our home-study course of 10 weeks is **simple, practical and interesting**. No mechanical experience required. Our graduates are everywhere, earning **\$25 to \$50 weekly** in positions we obtained for them. Free model of automobile to every student. Highly endorsed and reasonable.

**SEND FOR FREE LESSON AT ONCE**

A postal will bring it. Chauffeurs and competent men supplied owners and garages.

**Empire Auto Institute**

395 Empire Bldg. Rochester, N. Y.

The Original Auto School

**IN AUTOMOBILE BUSINESS  
NICE WORK-BIG PAY-DANDY JOB**



# EQUIPMENT FOR BUSINESS

WHAT would you think if a man handed you a piece of brown paper with his name written on it, as his business card? You'd be rather non-plussed wouldn't you? At least you would have a serious doubt as to his desirability as a business connection. In other words his equipment for business does have an effect on you. You do judge him by his equipment,—and every man is judging you in the same way. Just remember that!

Just as a card is an advance over a piece of brown paper with written name, so the

## Peerless Patent Book Form Card

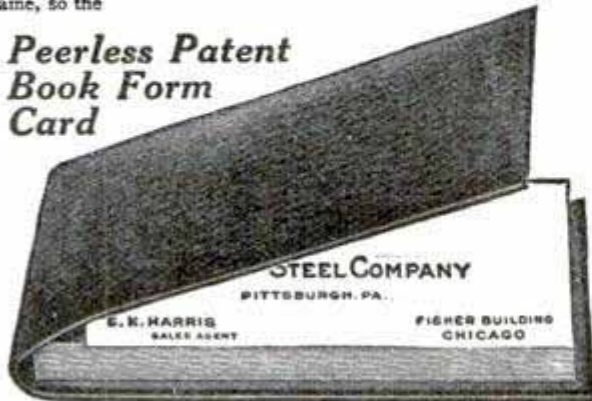

is an advance over the printed, loose, card. You need this peerless card in your business equipment—and you need it because it is the best and cheapest. Cheapest because every card can be used—none to throw away because they have become soiled in the pocket or case—none lost. Every card you pay for is available for the use for which it is intended. Send today for a sample of tab and see what the card is, and how it is detached from the book form with a smooth edge. You will be surprised and pleased.

**The JOHN B. WIGGINS COMPANY**  
Engravers Die Embossers Plate Printers  
17-19 EAST ADAMS STREET CHICAGO  
New York Office, 350 Broadway

**HOURS OF EARLY BIRDS**—An observant Frenchman who has been making notes of the habits of the feathered fraternity has just made a time table of the hours they wake of a morning.

The chaffinch heads the list with 1:30 a. m.; at 2:30 the blackcap hails the morn, while at 3 the quail utters his quaint "Pay tes dettes!" ("Pay thy debts!")

The blackbird does not rise till 4 o'clock, while the tomtit, even more of a stay abed, does not commence his day till 4:30, while the restless sparrow considers the air not sufficiently warmed for his approval till 5:30 a. m.—Gentlewoman.

## WITENITS YOUR IDEAS MAY BRING YOU A FORTUNE! TALENTS

**H. ELLIS CHANDLEE & CO.**  
55 Bornot Building, WASHINGTON, D. C.  
See page 119

# NO MORE BALD HEADS



When our VACUUM CAP is used a few minutes daily. We accept no pay until you have tried the Cap 60 days and are satisfied. The Vacuum Cap is an appliance that draws the blood to the Hair Roots and starts a new healthy crop of hair. It stops Dandruff, stops the hair from falling out. Bought by Doctors and men who

know that it is the only reasonable HAIR GROWER known to science. No Drugs Used. Write for application blank, testimonials, and booklet on "HAIR," sent sealed in plain envelope, FREE.

**THE MODERN VACUUM CAP CO.**  
O. 559 BARCLAY, DENVER, COLO.

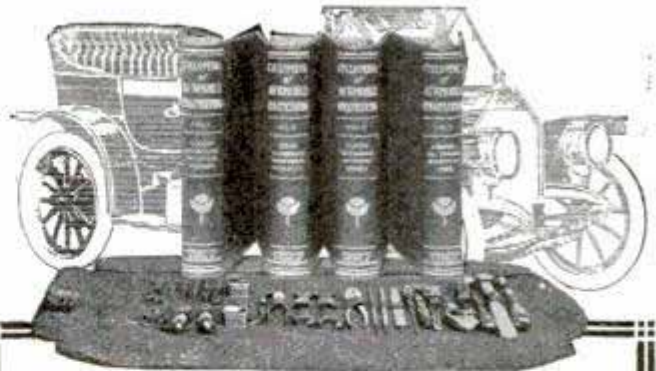

## The Complete Kit

No matter how fine the car you own, or drive, or manufacture; no matter how thoroughly it is equipped, your outfit is not *complete* unless you own the new

## Cyclopedia of Automobile Engineering

Four large, handsome volumes bound in half morocco, 1200 illustrations, full-page plates, diagrams, etc., 1500 pages, 7x10 inches, crammed with interesting and very necessary information concerning automobiles, aeroplanes, and motor boats; knowledge that you've got to get some way or other before you can thoroughly understand or enjoy the automobile "game."

### CONDENSED TABLE OF CONTENTS

**VOL. I—GASOLINE AUTOMOBILES:** Running Gear, Power, Operation, Repair. **AUTOMOBILE MECHANISMS:** Carbureters, Starting Devices, Clutches, Gears, Brakes.

**VOL. II—STEAM AUTOMOBILES:** Flash Boiler, Engines, Operation and Repair. **COMMERCIAL VEHICLES:** Selection, Delivery Trucks, Upkeep, Mileage, Capacity. **TYPES:** Selection, Price, Demonstration, Speed.

**VOL. III—ELECTRIC AUTOMOBILES:** Battery, Motor, Transmission, Control, Tires, Capacity, Driving, Elements of Electricity, Electric Current. **AUTOMOBILE DRIVING:** Starting and Stopping, Gear Changing, Use of Spark and Throttle, Care of Car, Road Repairs.

**VOL. IV—AERIAL NAVIGATION:** Dirigible Balloons, Aeroplanes, Airship Motors. **GAS AND OIL ENGINES:** Ignition, Testing. **MOTOR CYCLES:** Construction, Operation. **MOTOR BOATS:** Types, Engines, Installation.

### Read This Free Examination Offer

You can examine these books for five days in your own home or office, free of all cost. Don't risk missing this offer by stopping to think it over now. Order now and do your careful thinking with the books before you. That costs nothing. Mail the coupon.

### Here's Our Liberal Selling Plan

If you like the books after examination, send us \$2.00; then \$2.00 a month until the special price of \$12.80 is paid. If they are not satisfactory, advise us and we will have the books returned at our expense. Order promptly, and we will include for one year, as a monthly supplement, the **TECHNICAL WORLD MAGAZINE**, a regular \$1.50 monthly, full of interesting scientific topics written in popular form.

### AMERICAN SCHOOL OF CORRESPONDENCE CHICAGO, U. S. A.

#### FREE EXAMINATION COUPON

#### American School of Correspondence:

Please send set Cyclopedia of Automobile Engineering for 5 days' free examination; also Technical World for 1 year. I will send \$2.00 within 5 days and \$2.00 a month until I have paid \$12.80; or notify you and hold the books subject to your order. Title not to pass until fully paid. Pop. Mechs. 3-11

NAME .....

ADDRESS .....

OCCUPATION .....

EMPLOYER .....



**BUY AT Wholesale Prices FROM THIS Big Catalogue**

By our system of giving New York wholesale prices and *paying the freight* on most of the goods we sell, we save you 30 to 40 per cent. on every purchase.

Bear in mind that we supply everything needed about the home, farm or factory. After you once have our catalogue of 75,000 articles, you need not go out of the house to buy most of the articles you need.

Our goods are all reliable and we guarantee satisfaction or *money back*.

Our customers are all over the world. They are satisfied because we give a square deal and save them money. We want their trade *not only for to-day, but next year, and for years to come.*

We have been in business since 1816 and a great many of our customers have been buying from us for a generation. Doesn't that record invite your confidence and your trade?

Get our catalogue and send us a trial order. We know that the quality, the low prices, and the *Free Delivery* will hold you as a customer ever after.

*If it's Sugar you want or Harness—Clothing or Tools—we can supply you.*

Just drop a postal card for the catalogue—it's free—you ought not to be without it.

**WHITE, VAN GLAHN & CO., 30 Barclay St. NEW YORK CITY**

Oldest Mail Order House in America. Est. 1816

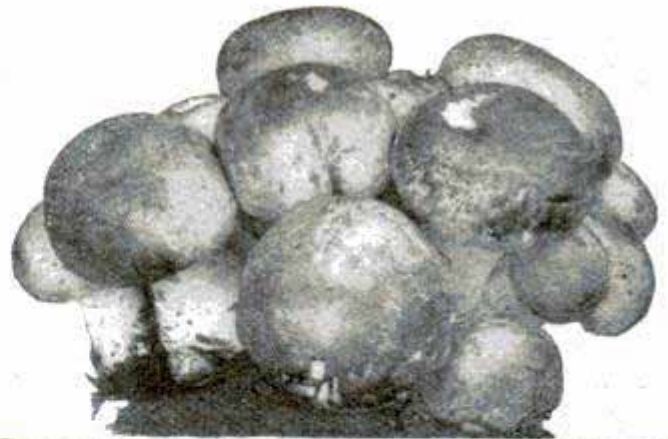

## Grow Mushrooms

For Big and Quick Profits

Small Capital to Start. A Safe Business

I am the largest grower in America. Ten years experience enables me to give practical instruction in the business worth many dollars to you.

No matter what your occupation is or where you are located, here is an opportunity to acquire a thorough knowledge of this paying business.

Send for Free Book giving particulars and information, how to start, cost, etc. Address

**JACKSON MUSHROOM FARM**  
6014 N. Western Avenue CHICAGO, ILL.

## ACME GEMS

SENT ON APPROVAL FROM OUR GEM MINES



Diamond cut, purest white, sparkling like a Diamond. Stands acid, file or Diamond tests. Cuts glass. Genuine white Topaz. Superior to imitation Diamonds. **Gems from \$1.50 upwards.** See them before paying. All goods sent on approval. Write for free booklet and ring measure.

**ACME GEM COMPANY, 305 Barclay Block, Denver, Colo.**

## WONDER LAMP

The United Factories of 818 Wyandotte St., Kansas City, Mo., is making an offer to send a lamp free to one person in each locality to whom they can refer new customers and who will show and recommend this marvelous, new, incandescent 100 candle power oil lamp. Simply send name and nearest express office.

**FREE**

A man whose trousers were stolen from a Pullman car has been awarded damages in the sum of \$439.50, which is doubtless all the trousers were worth, but sets a ridiculously low estimate on the amount of "mental anguish."  
—Kansas City Star.

## Musselman Coaster Brake



"The Armless Wonder"—smallest, lightest, simplest and strongest bicycle brake made. The original Armless Automatic Brake, imitated by many—equalled by none. Weighs 25 ounces. Sold by all high-class dealers, or write us, giving dealer's name, and we will advise you and send you booklet, "The Major's Story," FREE. Also made for Motorcycles.

**The Miami Cycle & Mfg. Co.** Licensed Coaster Brake Mfrs. 32 Grand Ave. Middletown, O.



# \$1.00 A MONTH

**BUYS THIS SEWING MACHINE**

We will sell you a high-grade, drop-head, Sew Easy Sewing Machine for \$1.00 a month. We guarantee each machine for Ten years. We ship direct from the factory. We do not sell to stores and we have no agents. We can save you fully one-half. You get the machine at once and use it while you are paying for it and it only costs you about 3 cents a day. We have many special features in our machine such as short needles which don't break easily. Our shuttles hold half again as much thread as the old spring tension shuttle.

**FACTORY PRICES** **SAVE FULLY ONE HALF**

We can't tell all the good points in this advertisement, and we couldn't afford to send you a machine on the small dollar a month plan unless we gave big value and low prices. We want you to write us today saying: "Please send me circulars and full particulars about your 'dollar a month' Sewing Machine offer." Write Today. Address

**SHEFFIELD MFG. CO., Dept. 90, 1421 Olive Street, ST. LOUIS. MO.**

# A \$3.00 Exerciser for \$1.00

Prof. Anthony Barker's **HERKULES MUSCLE-BUILDER** (Trade Mark)

Steel Spring Exerciser for Men, Women and Children  
(Two Exercisers in One)

**Price \$1.00** The Best Exerciser on the Market at Anywhere Near the Price

Every person—man, woman and child—needs an exerciser. A good exerciser is just as important in life as good books. Perhaps it is of more importance, for whereas good books assist materially in developing the brain and mental faculties, a good exerciser will just as materially assist in the development of the physical powers and consequently the health, which is our choicest possession.

There are as many different exercisers on the market as there are fish in the sea. A great many of these are almost worthless and are put together absolutely regardless of the requirements of the people for whom they are intended. I would not offer the Herkules to the public if I did not know that it is all I represent it to be and the BEST EXERCISER that can be had at the price.

### THE HERKULES WILL LAST

It is not made of cheap rubber and cloth to wear out in a few days or a few weeks' time, but is built from the very best of steel and is exceptionally durable. It is never in the way, because, when not in use, it can be lifted from its hook and placed in a small drawer or box.

### THE HERKULES IS VERSATILE

It will develop a strong neck, broad, powerful shoulders, strong back and stomach, well shaped legs, and gain great strength in your arms, wrists and hands.

### COURSE OF INSTRUCTION FREE WITH EVERY ORDER FOR A HERKULES

I include a complete chart of instructions, giving every exercise necessary for a thorough development of the entire body. In getting up this chart I have used the knowledge which I have acquired in my many years' experience of building perfect men and women. I am operating the largest school of physical culture in New York City, in which hundreds of pupils are constantly enrolled. If you will follow the lessons which I give in the chart you cannot fail to obtain satisfactory results.

**NOTICE** As Professor Barker does not employ agents, it is necessary to obtain the complete outfit, consisting of the Muscle Builder, Two Charts of Instructions, Three Separate Handles and Two Screw Attachments to send \$1.00 to

**PROF. ANTHONY BARKER**

640 Barker Bldg., 110 W. 42nd St., New York, N. Y.

Individual Instructions for Health and Strength at my select Gymnasium or by mail. Particulars on request.

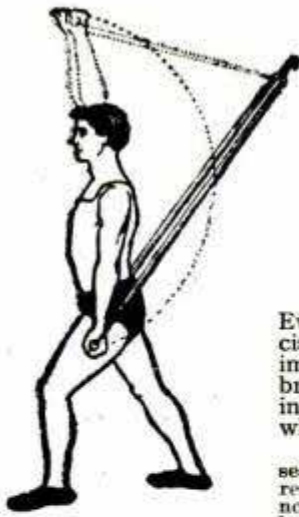

Shoulder Exercise

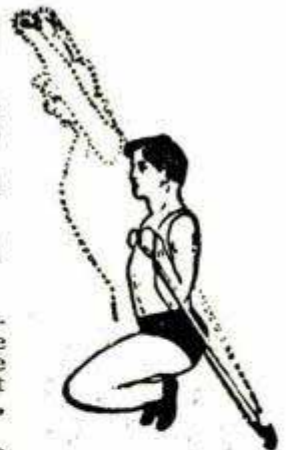

Leg Muscles

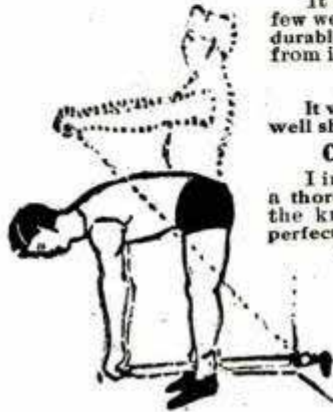

Spine and Stomach

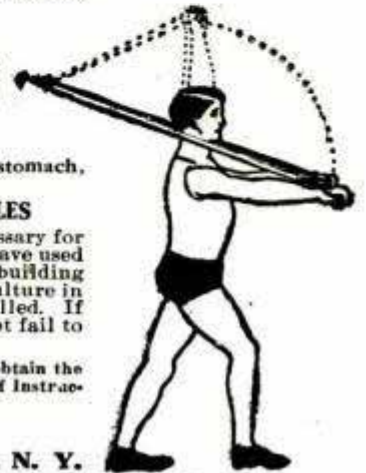

Chest Exercise

**PROFIT IN COPPER CENTS**—In spite of the fact that the government coined 146,000,000 one-cent pieces last year the demand for coin of that denomination continues to increase, and plans have been made to turn out another 100,000,000 within the next twelve months.

## "Caldwell Special"

60 Days Trial FREE

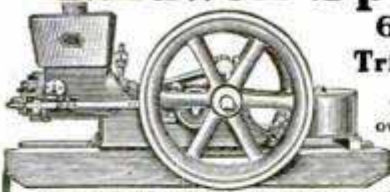

Prove it on your own premises that it saves time, saves labor and makes money.

The "Caldwell Special" is as clean cut as a race horse. Built right—works right. Simply built—always gives full H. P. Costs little to run—big profit producer to pump water, run cream separator, shred or grind corn and a dozen other things.

Write any or all the 8 Banks of Waterloo as to our responsibility. Sixty day Trial Free. We prove it to you on your own premises at our expense that you cannot afford to do without a "Caldwell Special."

**CALDWELL-HOLLOWELL MFG. CO.**  
514 Commerce St., WATERLOO, IOWA.

## "COME-PACKT" FURNITURE

Pedestal Table \$17.75

With 45 inch top, round or square. With 54 inch top, \$21.50. Three leaves, top and pedestal lock included. Dealer's Price \$42.

**QUARTER SAWN WHITE OAK, CHOICE OF 8 FINISHES**  
Shipped in finished sections, saving freight and expensive packing, from factory to you, saving all store expenses and profits.

### New "Big Six" Catalog Mailed Free

Six money saving departments in our big catalog—Quarter Sawn White Oak, Mission Furniture, New "Willow-Weave" Furniture, Mission Lamps and Lighting Fixtures, Cluny Lace Curtains, etc. Write for it today to

**Come-Packt Furniture Co.**

301 Edwin Street,  
Ann Arbor, Mich.



## For Dusty Concrete Floors

**Trus-Con Floor Enamel**, applied with a brush, gives a wear-resisting, tile-like surface to concrete floors—becomes part of the concrete—does not peel or crack off like ordinary paints—stops dusting—easily cleaned by mopping. **Trus-Con Floor Enamel** is furnished in a variety of colors for use in factories, warehouses, hospitals, power plants, hotels, schools, offices, residences, garages, etc.

Tell us condition and size of your floor. Sample, Booklet and Color Card free.

**Trussed Concrete Steel Company**  
46 Trussed Concrete Building Detroit, Michigan

*Trus-Con Wall Finishes for damp-proofing and beautifying concrete, brick and plaster walls. Trus-Con Paste for water-proofing concrete. Trus-Con Sno-wite for enameling interiors.*



WATERPROOF FINISHES  
**TRUS-CON**

# ELGIN WATCHES ON CREDIT



**Special This Month - \$16.50**  
**17-Jewel Genuine ELGIN** IN 20-YEAR GOLD FILLED CASE only **16.50**  
 Sent PREPAID On **Free Trial** at Our Special ROCK BOTTOM WHOLESALE PRICE.

**Let me send you this**  
**Beautiful Genuine 17-Jewel Elgin Watch**  
**Complete in 20-Year Gold Filled Case—**  
**the BIGGEST BARGAIN Ever Offered!**

**NO MONEY DOWN \$2 A Month**  
 \$2.50 After Examination.



**You Assume No Risk Whatever in Dealing With Us** Guaranteed for 20 Years.  
 because before you buy or pay one cent, we place the watch right in your own hands and let it do its own talking. We ask **NO SECURITY** and **NO INTEREST**—just plain honesty among men. Our Elgin Watches are so well known and our CREDIT PLAN so easy, that no matter where you live or how small your wages, **WE WILL TRUST YOU**, so that you and every honest man and woman can own a **DIAMOND** or High-Grade Elgin Watch in a beautiful Guaranteed 25 year Gold Filled Case and wear it while paying for it in such small payments that you never miss the money. **Write today for our Big Free Watch and Jewelry Catalog.** It tells all about our easy credit plan and how we send Elgin 19-Jewel B. W. Raymond and 21 and 23-Jewel Elgin Veritas every where on Free Trial, without security or one cent deposit, positively Guaranteed to Pass Any Railroad Inspection: **HARRIS-GOAR CO. Dept. 59 KANSAS CITY, MO.**

**WATCH AND DIAMOND BOOK FREE**  
 Write For It.

The House that Sells More Elgin Watches than Any Other Firm in the World.



## THE "ADJUSTABLE"

**ERASING SHIELD for DRAFTSMEN**

Slots can be adjusted to any size. You erase only the line you wish to take out. Made of thin German silver plates.

Price 25 cents

**DRAFTSMEN'S SPECIALTY CO.**  
 510 Mass. Bldg., KANSAS CITY, MO.

**DITENTC**  
**YOUR IDEAS MAY BRING YOU A FORTUNE!**  
**TALLENTO**

**H. ELLIS CHANDLEE & CO.**  
 55 Bornot Building, WASHINGTON, D. C.

See page 119

## Rémoh Gems



### Not Imitations

The greatest triumph of the electric furnace—a marvelously reconstructed gem. **Looks like a diamond—wears like a diamond—brilliance guaranteed forever—stands filing, fire and acid like a diamond.** Has no paste, foil or artificial backing. Set only in 14 Karat Solid gold mountings. 1-30th., the cost of diamonds. Guaranteed to contain no glass—**will cut glass.** Sent on approval. Money cheerfully refunded if not perfectly satisfactory. Write today for our De-Luxe Jewel Book—its free for the asking. Address—

**Rémoh Jewelry Co.**  
 429 N Broadway  
 St. Louis, Mo.



There is something mysterious about the disappearance of the one-cent pieces from circulation. They seem to grow scarcer every month, and what becomes of them nobody knows. The government can stand it, however. The coinage of one-cent pieces is exceedingly profitable, an official statement showing that the government reaps a net gain of 87 cents on every dollar's worth of the pieces placed in circulation. Coining like that is making money in the true sense of the term.—New York Mail.

## Too Much Florida Land has been sold

to people who have never seen it. Write Brooksville Board of Trade for **BOOK OF FACTS**, describing different kinds of Florida soil. We have no land to sell but want settlers and investors to develop richest district in Florida, according to State Dept. of Agriculture; not pine land, not sand, but high and rolling with rich dark top soil and clay subsoil. No fertilizer, irrigation or drainage necessary. Raises 80 bu. corn per acre. Best for citrus fruits, truck and staple crops. An industrious man, with \$500 to \$1000 capital can be independent here. 300 ft. above sea; no swamps or marshes. Ideal climate, schools, churches, towns, good roads, all conveniences. Home seekers and investors please investigate. We need you and will help you.

**BOARD OF TRADE, Box 224, BROOKSVILLE, FLA.**

## A Perfect Portable Typewriter for \$18

The **Bennett Portable** is the handiest typewriter in existence. Weighs but 4½ lbs. and slips into your grip or pocket, ready to turn out neat work on train, at hotels or anywhere. High grade construction; made by experts in the Elliott-Fisher Billing Machine Factory. Guaranteed fully. Standard keyboard, 84 Characters. Low priced because simply made of few parts.

### Put the Bennett to a 10 Day Practical Test

You can be business-like in your correspondence no matter where you are. Let us send you catalog, samples of work and our 10 day free trial offer. Send us your request today.

**P. C. Bennett Typewriter Co., 386 Broadway, New York, N.Y.**



Have the Earliest  
and Finest  
**Sweet  
Peas**

In Your  
Town

Also insure early picking of better garden beans and peas than you have ever grown. These are the results of using—

**FARMOGERM**  
High-Bred Nitrogen Gathering Bacteria

Just mix with water and moisten seed or sprinkle over rows. The bacteria increase by millions. Quicker, harder, and larger growth follows because the bacteria furnish the nitrates needed. These and some other crops MUST be inoculated to thrive best. Ask any expert. See our reports from users. Farmogerm comes in small, specially sealed bottles READY FOR USE. Sold by leading seed houses or sent by mail or express paid.

GARDEN SIZE, 50c      ACRE SIZE, \$2.00

Hardy Lawns are started by mixing in some inoculated white clover seed. Our Free Book No. 20 gives full particulars and proofs. Write today. It will enable you to break all records this year.

**EARP-THOMAS FARMOGERM CO., Bloomfield, N. J.**



One of 40 Designs

**A Wing Piano or Player**  
**Piano Shipped Absolutely FREE!**

We, the manufacturers of Wing Pianos for 43 years, will send you a genuine Wing Piano, or Wing Player Piano, tested and guaranteed by us without one penny from you. We will ship the piano free with all freight paid in advance by us. You are not out one cent in money or trouble. This is an offer never equaled before by a big manufacturer. An offer direct from one of the largest manufacturers of pianos in the world. This offer is backed by a forty-year guarantee by the manufacturer. This offer places you in the very same position as if you were a dealer. You buy at exactly the same price as the dealer pays. You do business direct with the factory which has sent out more than 42,000 pianos.

Think of what this offer means! We allow you to keep the genuine Wing piano in your house for four full weeks without paying anybody anything. You play on it. Use it just as if it were your own. Take music lessons on it. Test it in every way. Compare it with any other piano you wish. Decide yourself. There won't be any salesman around to bother you. You may be sure that if you decide to keep the Wing none of the money goes into the salary of salesman. Every cent goes into the piano because you deal with the men who make the piano.

**Did You Ever Have a Piano in Your Home?**

If not, haven't you often—often—wished that you did have one? The delights of sitting before a splendid instrument—the supreme pleasure it gives—is known only to those possessing a good piano. Your opportunity is here now. You may have a piano in your home any time you want it. You may use it for 4 weeks positively without expense to you. After the four weeks' free trial are up make your decision. Either keep the piano or send it back, just as you choose. We ask you not to keep it unless you are fully satisfied—more than satisfied. Unless you are charmed with the delightful tone—the splendid beauty of the Wing Piano—we would rather you would not have it. Because we want every Wing to sell another Wing.

**Have You an Old Organ or Piano?**

If you have an old organ or piano we will allow you a good price in exchange for a Wing Piano. Get our free book which explains all about it.

After the four weeks' free trial are up make your decision. Either keep the piano or send it back, just as you choose. We ask you not to keep it unless you are fully satisfied—more than satisfied. Unless you are charmed with the delightful tone—the splendid beauty of the Wing Piano—we would rather you would not have it. Because we want every Wing to sell another Wing.

If for any reason—any reason whatsoever—you desire to return the piano you are at liberty to do so. Then we will pay the freight back to our factory. You are not out one cent. You have had the use of the Wing Piano for four weeks. Send the free coupon for big piano book. This book tells you all about how to judge any pianos. Don't think of buying a piano until you have read this book.

**Send FREE Coupon NOW**  
**For Big Piano Book**      A book of complete Piano Information

It contains ten tests to apply to every piano. Apply these tests to any piano and you will know absolutely whether that piano is a good piano or not. This book is invaluable to anybody who intends to buy a piano now or in the future.

The New York World says: "A Book of Educational Interest every one should own."

Send this Free Coupon  
**WING & SON** (Estab'd 1868)  
Wing Building  
13th Street and 9th Avenue  
Department 1193  
NEW YORK CITY

**FREE Coupon**  
WING & SON (Est. 1868)  
1193 9th Ave. and 13th St.,  
New York City.

Gentlemen:—With the understanding that I am not buying anything you may send me the 156 p. Piano book containing the piano tests also your free shipment offer on the Wing Piano.

My Name.....  
My Address.....

Please Mention Popular Mechanics

**Inflating Auto Tires Without Effort**

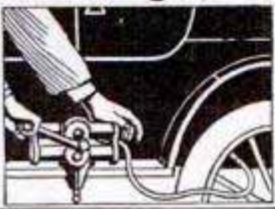

**The Hawthorne Four Cylinder Automobile Hand Air Pump**

This latest departure in Automobile Hand Air Pumps is clamped to the running board when in use and turned with a crank as shown in cut. Does the work quickly and with least possible exertion. Prices and fully illustrated pamphlet on request.

PLEASE MENTION THIS MAGAZINE  
**HAWTHORNE MANUFACTURING CO., Inc.**  
No. 3 Spruce St., Bridgeport, Conn.

The gates for the Panama canal weigh 92 tons each. No chance for the boys to lift them Halloween night.—Los Angeles Times.

Birdmen are not quite up to the standard of harmony adopted by the birds in their nests.—Birmingham Age-Herald.

**Use KEROSENE Engine FREE!**

Amazing "DETROIT" Kerosene Engine shipped on 15 days' FREE Trial, proves kerosene cheapest, safest, most powerful fuel. If satisfied, pay lowest price ever given on reliable farm engine; if not, pay nothing.

**Gasoline Going Up!**

Automobile owners are burning up so much gasoline that the world's supply is running short. Gasoline is 9c to 15c higher than coal oil. Still going up. Two pints of coal oil do work of three pints gasoline. No waste, no evaporation, no explosion from coal oil.

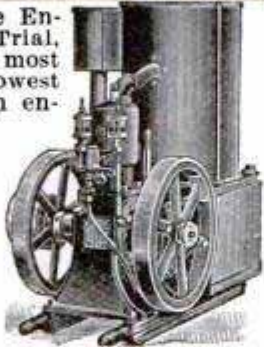

**Amazing "DETROIT"**

The "DETROIT" is the only engine that handles coal oil successfully; uses alcohol, gasoline and benzine, too. Starts without cranking. Basic patent—only three moving parts—no cams—no sprockets—no gears—no valves—the utmost in simplicity, power and strength. Mounted on skids. All sizes, 2 to 20 h.p., in stock ready to ship. Complete engine tested just before crating. Comes all ready to run. Pumps, saws, threshes, churns, separates milk, grinds feed, shells corn, runs home electric-lighting plant. Prices (stripped), \$29.50 up.

Sent any place on 15 days' Free Trial. Don't buy an engine till you investigate amazing, money-saving, power-saving "DETROIT." Thousands in use. Costs only postal to find out. If you are first in your neighborhood to write, we will allow you Special Extra-Low Introductory price. Write!

**DETROIT ENGINE WORKS, 213 Bellevue Ave., DETROIT, MICH.**

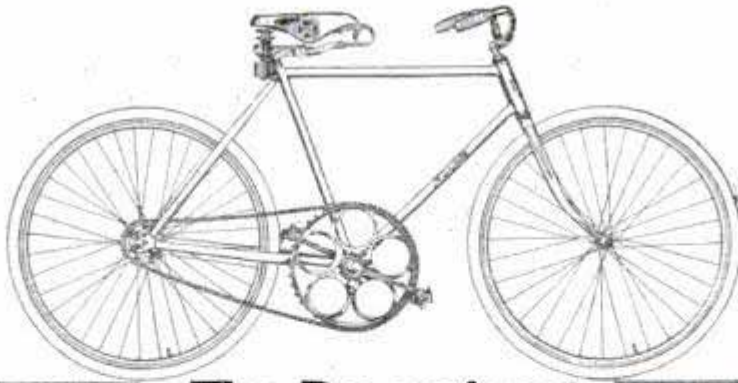

## The Pre-eminent RACYCLE

**T**HE 1911 Racycle scales the heights of bicycling perfection. The evenly balanced crank hanger, which for years has enabled Racyclists to travel farther with less expended energy than any other wheel, is now indestructible. Made with solid tool steel crank shaft and heavy tool steel cones, giving a perfect bearing surface. Guaranteed for three years. The wheel for business or pleasure.

### The World's Best Bicycle

With 27.9% less pressure on crank hanger bearings than any ordinary bicycle, the Racycle is the easiest riding wheel and best hill climber. "The Three Reasons" pamphlet proves this. "Ray" Juveniles are for little people. Pacemaker and Rideabout Models are equipped, without extra charge with our Musselman Armless Coaster Brake — smallest, simplest, lightest and strongest brake made.

1911 Catalog, Pamphlet—"The Three Reasons"—explaining \$10,000 Cash Prize Problem, Racycle Watch Charm and booklet—"The Major's Story"—all mailed for 2c stamp. Sent FREE if you mention Bicycle Dealer in your town.

**THE MIAMI CYCLE & MANUFACTURING CO.**  
32 Grand Ave., Middletown, Ohio, U. S. A.

IT'S ALL IN THE CRANK HANGER



### Send for My New Book "MODERN HOMES"

It contains plans of houses I have actually built and was originally published for the exclusive use of my clients. Has always sold for \$1.00, but in order to interest more people in my plans, I offer it at 50 cents a copy. I have built homes costing from \$900 to

\$200,000 and have many satisfied clients.

Send 50 Cents for the book and get acquainted with me

**CLYDE S. ADAMS, Architect and Civil Engineer**  
1241 Arch Street PHILADELPHIA

## Want Spring Suit?



It will cost you nothing. Everybody needs clothes. Your friend, neighbor or acquaintance will buy of you. Profit on two orders will get you a free suit. The easiest thing in the world.

### BIG OUTFIT FREE

We give you a bigger and better line and make our prices lower than any other house in existence. Our system insures a better fit, better work and better service. No express charges.

### CLOTHING AGENTS

**WANTED**—Now is the time to get in the game. Our men make from \$5 to \$15 a day easy. Take up the clothing business as a side line — it will pay you well. You need no money or experience. We furnish everything to start.

**FREE Complete Sample Outfit** Including big assortment of cloth samples, latest fashions, tape measure, special offer. Write at once before we get someone else in your town. This is a wonderful opportunity to make money and start you in a well paying business.

**THE CAPITOL TAILORS**  
352 Capitol Bldg. CHICAGO

**BEAUTIFYING THE COUNTRY**—In point of variety and scope, the forest work done on the Biltmore estate in North Carolina is remarkable. The forests, which cover 130,000 acres, are made profitable by the production of various forms of material. Four million feet of lumber, 5,000 cords of tannic acid wood and fuel, 1,000 cords of tan bark and several hundred cords of pulp wood are cut every year. At the same time the forest, through wise management, is bettered and is steadily increasing in value. Workmen employed

**PATENTS**  
YOUR IDEAS MAY BRING  
YOU A FORTUNE!  
**PATENTS**

**H. ELLIS CHANDLEE & CO.**  
55 Bornot Building, WASHINGTON, D. C.  
See page 119

## MY GUARANTEE



Prof. Titus in a Powerful  
Leg Exercise

I guarantee that you will derive every benefit from the use of my system and my "Progressive Exerciser." I guarantee that you will be satisfied. If you are not, simply write me so, at which time I will refund every cent you have paid me.

Signed, **PROF. H. W. TITUS.**

My course on physical training as used in connection with the

### "PROGRESSIVE EXERCISER"

has been so universally successful in the regeneration and restoration of bodily health and vigor that, without further reservation, I am able to make the above guarantee.

My Most Recent Book

### The "WHYS" of Exercise

tells all about this wonderful little exerciser. It also tells many truths about exercise which are startling to the average reader, giving as it does the "reasons why" so many systems fail, and proving conclusively that there is but one way to acquire REAL HEALTH AND STRENGTH. With request for my book send 4 cents to cover postage.

My price for machine and complete course of instruction is extremely reasonable  
**PROF. H. W. TITUS,** 302 Titus Building, NEW YORK  
156 East 23rd St.,

## Ten Pinnet—The Big Paying Amusement Business

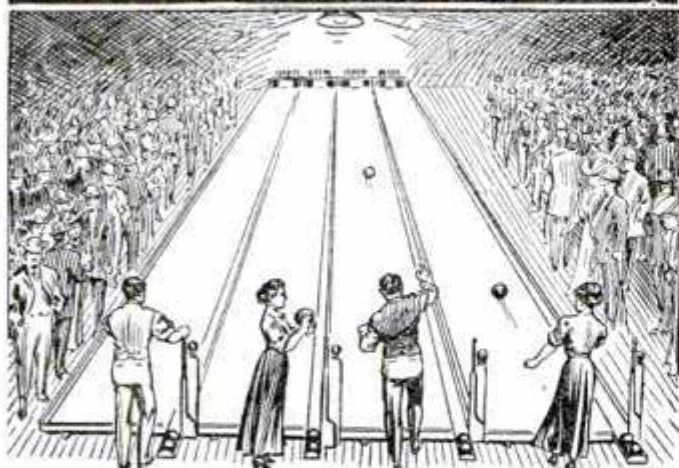

Get into the game with a Ten-Pinnet Outfit now! It is the new sensation. The Ten-Pinnet alley has 10 real tenpins. This bowling game for men and women and the youth—with more excitement than bowling can ever offer. More combination plays can be made. Bowlers of big reputation are taking up Ten-Pinnet. It is a great money-making game, run by itself or in the park, garden, Y. M. C. A., pleasure resort, cafe or pool-room. It is the all-the-year-'round game.

### Get Our Big, Free Ten-Pinnet Book—It Shows You Everything—Tells You How to Start in Ten-Pinnet Business—The Story Complete!

You make more with Ten-Pinnet and it costs you far less than bowling. You don't have to build special foundations for your alleys. You don't have to refinish your alleys. You don't have to pay pin boys. A simple pull of a lever at the players' end sets up the pins and the balls return by gravity. All the profits above rent are yours, no matter how many alleys you run. Write today and let us tell you how to start in the Ten-Pinnet business with as little as \$75. Let your earnings pay the balance. Get in early—before some one else beats you to it. (25)

**TEN-PINNET COMPANY,** 700 Draper Street, INDIANAPOLIS, IND.

along the boundaries of the forest do duty as fire guards. Thus fire protection is secured at least throughout all the accessible parts of the tract. In connection with all lumbering operations, permanent logging roads are built. These minimize the present cost of transportation and will greatly reduce the cost of marketing future crops. Thus the extension of the roads is steadily adding to the investment value of the forest. Moreover, they serve also as a network of fire lines. Forest planting is practiced where fire will not threaten its success.—St. Louis Republic.



**HOW TO ENTERTAIN** Book with 250 Jokes and Riddles, 73 Toasts, 67 Parlor Tricks, 8 Fortune-Telling Secrets, 52 Money-Making Secrets, 22 Funny Readings. All 10c Postpaid.  
**J. C. DORN, 417 Dearborn St., Dept. 26, CHICAGO, ILL.**



### NULITE Gasoline Table Lamp

A beautiful lamp for homes, hotels, offices, stores, banks, cafes. Portable, safe; can be turned upside down or rolled on the floor without danger or affecting the light. 300 c.p. of soft, brilliant light, 1/2c per hour. Also 200 different styles of lamps and systems.

**AGENTS**—We want town, county and traveling salesmen. Best proposition ever offered. Sells everywhere. WRITE FOR SPECIAL OFFER.

**CHICAGO SOLAR LIGHT CO.**  
222 S. Jefferson St. CHICAGO



### BIG MAIL FREE

Your NAME PRINTED in our Mailing Directory and sent to 10,000 firms all over the world so they can send you FREE Samples: Catalogs, Books, Papers, Magazines, etc., etc. Send 20 cents to cover cost of printing your name and you will receive a big mail FREE.

Ingram, Va., Jan. 7, 1910. Mr. Anderson, I have already received more than 2,000 parcels of mail, and still they come, scores of papers, samples, magazines, etc., for which I had often paid 10 to 25 cents each. R. T. James. Send to **ANDERSON, "The Mail Man," Box 5658, JAMESTOWN, N. Y.**

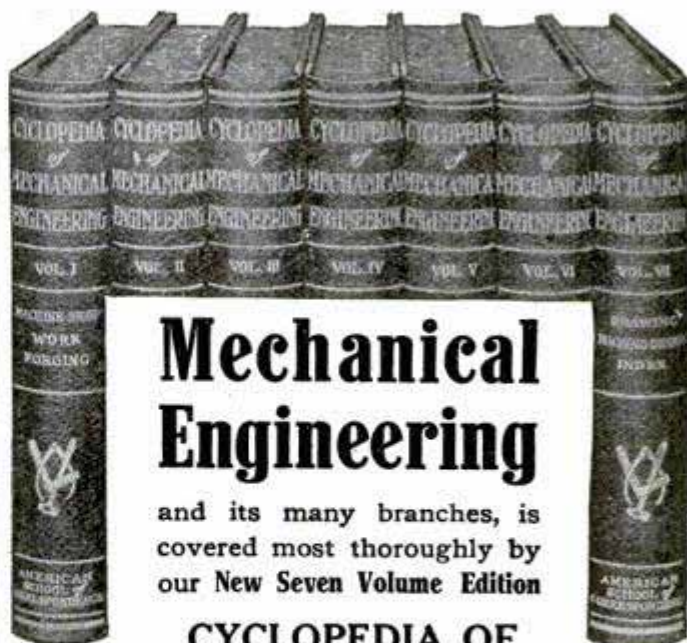

## Mechanical Engineering

and its many branches, is covered most thoroughly by our New Seven Volume Edition

CYCLOPEDIA OF

## Mechanical Engineering and Modern Shop Practice

These seven great volumes contain 2,992 seven by ten inch pages of information which is of vital interest to every progressive mechanic.

In this wonderful work will be found instruction in Machine Shop Work; Assembling of Machinery; Tool Making and Shop Management in such simple and comprehensive form that the student cannot fail to benefit by it. Every detail of mechanical engineering is thoroughly analyzed and treated, rendering the books of unusual value to the experienced mechanic and shop manager, as you will note by reading "Subjects Thoroughly Covered."

The Cyclopaedia is supplemented with a series of practical test questions and includes over 2,000 full-page plates, illustrations, tables, formulas and "shop kinks."

### TO PROVE THEIR VALUE TO YOU

we will send you the complete Cyclopaedia absolutely free for examination—just mail the coupon. Keep the books five days—apply the principles to your work—test every formula. You will agree that they are all we state, and more. Send \$2.00 after examination and \$2.00 a month until you have paid the special price of \$18.80. The regular list price is \$36.00. If the books do not meet with your requirements, advise us and we will remove them at our expense.

### Subjects Thoroughly Covered

Machine Shop Work—Vertical Milling Machine—Motor-driven Shops—Shop Lighting—Forging—Electric Welding—Tool Making—Metallurgy—Manufacture of Iron and Steel—High-Speed Steel—Flaws in Castings—Electric Lifting Magnets—Magnetic Clutches—Making a Machinist—The Ideal Foreman—Pattern Making—Foundry Work—Automatic Coal and Ore Handling Appliances—Machine Parts—Construction of Boilers—Types of Boilers—Boiler Accessories—Steam Pumps—Air Compressors—The Steam Engine—The Steam Turbine—Indicators—Valve Gears—Refrigeration—Gas Producers—Gas Engines—Automobiles—Elevators—Sheet Metal Work—Practical Problems in Mensuration—Mechanical Drawing—Drafting Room Organization—Machine Design.

**SPECIAL OFFER IF YOU MAIL COUPON PROMPTLY** For a short time we will include, as a monthly supplement, for one year, the **TECHNICAL WORLD MAGAZINE**. This is a regular \$1.50 monthly, full of Twentieth Century Scientific Facts, written in popular form. Also contains the latest discussions on timely topics in invention, discovery, industry, etc.

### Free Examination Coupon

**American School of Correspondence, CHICAGO, U. S. A.**

Please send set Cyclopaedia of Mechanical Engineering for 5 days' free examination. Also Technical World for 1 year. I will send \$2 within 5 days and \$2 a month until I have paid \$18.80, or notify you and hold the books subject to your order. Title not to pass until fully paid.

NAME.....

ADDRESS.....

OCCUPATION.....

EMPLOYER.....

# "I Made \$20 Today"

Sold 48 This Week, profit \$88.80,  
Writes M. G. Clark, Mont.

## "WOMEN BUY AT SIGHT"

Vibration Does the Work



"Started yesterday; sold 10, and today 12 more. It's a gold mine. Rush 50 more," writes J. H. Hodson, N. Y. Hundreds of men and women making **\$50 to \$100 a Week**

actually making a week's wages every day. They're banking money, buying homes, automobiles. **New discovery** makes it easy for them—will do the same for you. Tremendous sale of the

### Home Comfort Scrubbing Machine

breaks all records. New, popular, irresistible—double your money every sale. Every housewife a customer. World's greatest labor saving invention. **No more back breaking, floor scrubbing days.** New marvelous machine replaces hands, brushes, rags, buckets for scrubbing. **Vibration does the work.** Scrubs, attacks dirt, dust, grease—works like magic. A God-send to women. **Self feeding, self sudsing.** Turns scrubbing drudgery into neat, easy, quick, pleasant task. **Child can do it the Home Comfort way. Weighs 5 pounds. Sells for \$3.25—lasts for years. Not sold in stores. Home Comfort is truly a never ending household boon.** Pleases, astonishes all. Customers wonder how they ever got along without it.

**Mrs. Harris, Ill., writes:** "Home Comfort has been a God-send. It's so easy to scrub and clean. Really wonderful how quick it works."



**\$3.25**

**Mrs. H. Cole, N. Y., writes:** "I am simply delighted. Robs scrubbing of all its hard work and takes so little time. Can scrub dirtiest floors with scarcely any effort." **C. Barnes, S. C., writes:** "No other invention means so much to the home. I am **booking orders like lightning.** It takes every woman by storm." What woman hasn't been eagerly waiting for the Scrubbing Machine? It's here—perfected—selling like wildfire. Sells for **\$3.25**—banishes forever woman's worst torture. Could anything be more appreciated, popular, irresistible? **Don't delay**—seize this live opportunity. Be first—get exclusive territory—make a fortune. Send today for agency, free sample and credit terms.

**SANITARY SUPPLY CO., Box 228, Sta. F, TOLEDO, OHIO**

# This Kerosene Engine Cuts Your Expenses 75%

**YOU** should not even consider engines that operate on gasoline only. The rapidly rising price of gasoline, now 6 to 16 cents higher than kerosene, absolutely makes operation on this fuel too expensive. The Perfection Kerosene Engine operates on **any** engine fuel. When you purchase it you are on the safe side—proof against all fluctuations of the market. You can always run this engine at a great fuel saving and get the greatest amount of work done. The Perfection **vaporizes its own kerosene** and so makes it as efficient as gasoline—something other engines **cannot** do.

The Perfection is very light, portable, has only three moving parts, runs everything about the place, is lower in price than any other engine of its capacity on the market.

## PERFECTION Kerosene Engine

Sent You on 15 Days Free Trial

See your dealer at once and ask him to let you have a copy of our **Free ENGINE BOOK** which shows the sizes and styles of the "Perfection" and explains this very attractive offer. Your dealer will send any "Perfection" engine to your farm for 15 days and let you return it if you are not satisfied. Ask him about it. If he does not carry the "Perfection" write to us and we will send you our **Free Engine Book** direct.



**CAILLE PERFECTION MOTOR CO.**

205 Second Ave.

DETROIT, MICH.

**CARRYING MONEY**—It is interesting to note the various methods in which men of different nationalities carry their worldly wealth.

The Englishman carries gold, silver and copper all loose in his trousers pocket, pulls out a handful of the mixture in an opulent way and selects the coin he needs.

The American carries his "wad" or "roll" in pretty much the same way, the average man here looking

## LET THIS LITTLE ENGINE DO YOUR WORK! WRITE FOR FREE BOOK

This wonderful little air-cooled engine is a complete portable power plant. Fits any pump. Capacity 800 to 1000 gals. per hour. Runs hand or foot power machines. **Fuller & Johnson FARM PUMP ENGINE** Thousands in use! Owners delighted! Simplest form of gasoline power in existence! Investigate—save money. **FREE!** Postal brings valuable book, giving information of great importance. Send at once. Address—**FULLER & JOHNSON MFG. CO., 3 Partridge St., MADISON, WIS.**



# Ann Arbor

## 3 Room Lighting System for \$14.50

Ann Arbor Lighting Systems are brighter than gas, steadier and clearer than electric light, and cost about one-tenth as much to operate. Each lamp gives 300 to 500 candle power for less than 1/2 cent per hour. Fuel is gasoline; perfectly safe.

**We make Complete Lighting System for Homes, Churches, Stores, Etc.**

Price \$10 up, according to number of lamps desired. We make inverted arcs especially adapted for use in stores, halls, factories, etc.

**We Want Agents** who will push our line. Special terms to those who write early. Catalog and prices on request.

**SUPERIOR MFG. CO.**  
294 Second St., Ann Arbor, Mich.

# \$1.00 DOWN

## BURROWES BILLIARD AND POOL TABLE

\$1 down, balance small amounts monthly, buys any Table \$6 to \$15. Larger Tables \$25, \$35, \$50, \$75, easy terms. All cues, balls, etc., free. The Burrowes Table is high-grade and adapted for the most expert play. Set it on library or dining table, and set it aside when not in use.

**NO RED TAPE**—On receipt of first installment we will ship Table. Play on it one week. If unsatisfactory return it, and we will refund money. Write to-day for catalog.

**E. T. BURROWES COMPANY, 66 Elm St., PORTLAND, ME.**



## A Few Dollars Reserves This Boat For You

A MARVELOUS value in a beautiful classy family launch that will stand the hard knocks, safe as the day is long and built as Shell Lake Boats are always built—this is what we offer just ten readers of this paper. **A Boat You Can Trust.** The key note of this boat in design, construction and motor equipment has been **safety.** She is as good for the novice as for the experienced water man, yet nothing of style has been sacrificed, nothing lacking in class—you will never be ashamed of her no matter what your company. Will carry eight people—all the speed you need. **The Price is a Marvel.**

We will sell just ten of these boats at a price that will astonish you. Send today for full details of construction and our Special Bargain Offer.

### Shell Lake Boat Company

Member National Boat and Engine Company,

Salesrooms: Dept. 14, Shell Lake, Wis.

Chicago Boston New York Detroit Philadelphia Buffalo Seattle



with contempt upon the pocketbook as indicative of a "tight" disposition.

The Frenchman makes use of a leather purse with no distinguishing characteristics. The German uses one gayly embroidered in silks by the fair hand of some Lottchen.

The half-civilized capitalist from some torrid South American city carries his dollars in a belt with cun-

**"MONARCH" Automatic FISH HOOK;** cannot be sprung by weeds or in casting.

Holds fish tighter the more he pulls; fish are caught by even touching the bait. Small size 15c.; large size 20c. Set of 6 hooks \$1.00.

J. GEORGE CO., 36 Pulaski Street, Brooklyn, New York

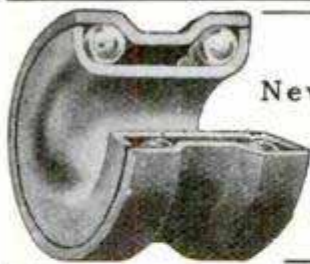

## KNIFE

New Two-piece Multiple Ball Bearing

MADE ONLY BY THE

**KNIFE MFG. CO.**

Sales Office, Drexel Bldg., Philadelphia  
(Send for price list.)

Nothing External Revolves

## DETROIT REVERSE GEAR

Starts—Reverses—Stops INSTANTANEOUSLY

All working parts submerged in oil bath at every revolution.

**The Simplest, Most Reliable, Most Compact** and the Smallest Perfect Marine Reverse Gear ever offered. No outside moving parts to throw the oil or grease, tear the skirts, bruise the hands or catch waste. No noise. Manufactured in sizes for from 2 to 80 H. P. We carry all sizes in stock for immediate shipment. Guaranteed for one year. Write for special prices and free catalog. Valuable information from our Consultation Department FREE to motor boat men.



(40)

Detroit Engine Works, 24 Beaufait Ave., Detroit, Mich.

# STARTLING Watch Offer

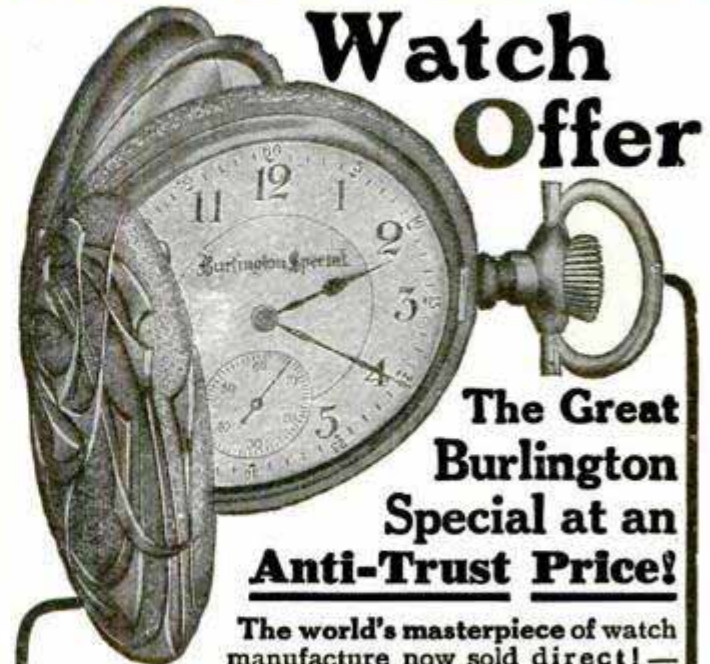

The Great Burlington Special at an **Anti-Trust Price!**

The world's masterpiece of watch manufacture now sold direct!—

The most amazing offer ever made in the whole history of the watch industry—an offer which has absolutely **PARALYZED** competition—the offer of the genuine **Burlington Special** direct to the public at the rock-bottom **ANTI-TRUST PRICE**, without middlemen's profits.

## The Fight is On!

We will not be bound by any system of price-boosting contracts with dealers. We will not submit to any "high profit" selling scheme. We will not be dictated to by ANY Trust.

**NO MATTER WHAT IT COSTS**, we are determined to push our independent line even if we should have to fight a combination of all the Watch Manufacturers of the country!

And so we are making this offer—the most sweeping, astounding offer ever made on a high-grade watch. The famous **BURLINGTON** direct and at the same price **WHOLESALE** Jewelers must pay.

And in order to make the proposition doubly easy for the public we will even allow this rock-bottom price, if desired, on terms of

**\$2.50 a Month** Don't miss this wonderfully liberal offer. Sign and mail coupon now.

Rock-bottom, anti-trust price, whether you buy for cash or time.

**POST YOURSELF!**

Be sure to get posted on watches and watch values, trust-method prices and anti-trust prices before you buy a watch. Learn to judge watch values!

Get the Burlington Watch Company's

**FREE WATCH BOOK**

Read our startling exposure of the amazing conditions which exist in the watch trade today. Read about the anti-trust fight. Read about our great \$1,000.00 Challenge. Learn how you can judge watch values. Send your name and address for this valuable **FREE BOOK** now—TODAY. Sign & mail coupon.

**BURLINGTON WATCH CO.** Dept. 1193

19th & Marshall Blvd., Chicago, Ills.

Please send me, without obligation and prepaid, your free book on watches and a copy of your \$1,000.00 challenge, with full explanations of your cash or swap 2 month offer on the superb **ANTI-TRUST** Burlington Watch.

Name.....  
Address.....  
No letter need sent coupon will do.

## The Latest Thing in Oilstones

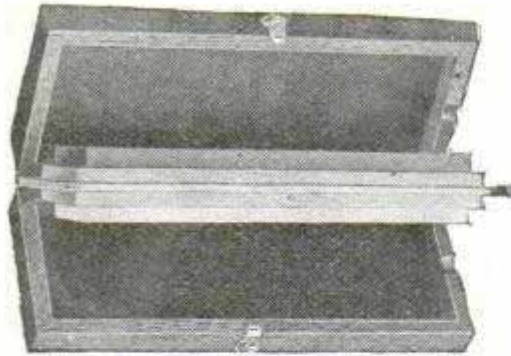

## PIKE REVERSIBLE

The handiest and most economical Oilstone contrivance yet originated. Two of the best Oilstones in the world in one mounting. Either stone ready for use instantly. A time and labor saver to the busy mechanic. You cannot afford to be without it. If your dealer hasn't it, send \$2.00 direct to us and your order will be filled without further cost to you.

**PIKE MFG. CO., PIKE, N. H.**

This Trade Mark is



Your Protection

Send for booklet "Oilstones, How to Select and Use Them." Every mechanic should have a copy.

## THE RIGHT ENGINE FOR YOUR BOAT

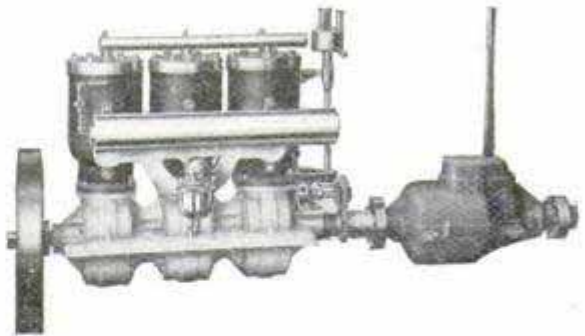

THERE'S a vast difference between *almost* the right motor to fit your hull and exactly the right one.

Our line is so varied that we can give you the engine *exactly* suited to your needs whether you want to run a towing boat or a racer.

**ELBRIDGE MARINE ENGINES** are simple, economical, efficient. They have more power for weight and bulk than any others. Everyone covered by an *unlimited* guarantee.

Our 1911 Catalogue is **FREE**. Send for it.

**ELBRIDGE ENGINE COMPANY**  
62 Culver Road ROCHESTER, N. Y.

ningly devised pockets to balk the gentleman with light fingers. Some of these belts are quite expensive.

The Italian of the poorer classes ties up his little fortune in a gayly-colored handkerchief, secured in many knots, which he secretes in some mysterious manner about his clothes.

A similar course has charms for the Spaniard, while the lower-class Russian exhibits a preference for his boots or the linings of his clothes as a hiding place for his savings.—New York Tribune.

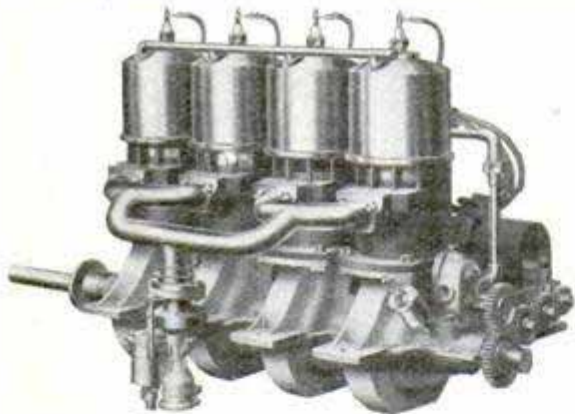

## Are You Interested in Aeronautics?

Every novice Aviation record in America has been made with

## Elbridge Featherweight Engines

Our "AERO SPECIAL" is even lighter, more powerful, and more reliable than the Featherweight. Under every climatic condition and for men in every walk of life, the ELBRIDGE has made good. It's a motor that always "motes."

To insure your successful flight, we will furnish propellers that propel and radiators that radiate. Our new book, "American Amateur Aviation," of vital interest to all who are interested in Aeronautics, sent for six cents postage. Catalogue **Free**.

**ELBRIDGE ENGINE CO.** 62 Culver Road  
ROCHESTER, N. Y.

Trade-Mark U. S. Registered

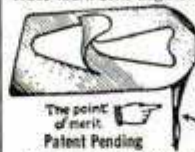

The point of merit  
Patent Pending

## 10 FOR 10 CENTS Nickel-Plated Push-Pin Hanger

Made of tempered steel in one piece. Nothing to lose, bend or break. Push in wood or plaster wall with thumb or tap with small hammer. Will sustain a weight of 25 lbs. For the Home, Office or Factory, also for Schools and Hotels where the unsightly nail is prohibited. For sale at Hardware, Stationery and Photo-Supply Stores. Sample box of 10 sent Prepaid for 10 cents.

Liberal Discount to the Trade. Salesmen Wanted  
Niagara Metalware Mfg. Co., Buffalo, N. Y., Manufacturers of Hardware Specialties

## Clean by Water Power

The PRESTO Vacuum Cleaner uses water power. It takes all the dirt, dust and germs that enter the Cleaner direct to the sewer. The **ONLY** sanitary process. No fine dust or germs return through bags or screens to the air to be inhaled or to settle. No muss. No valves to clog; no motors to repair. The PRESTO stationary Cleaner obviates the most dangerous and unhealthy act in house-cleaning work; emptying bags and boxes of bacteria-laden dust. Costs less than one-half cent per hour to operate.

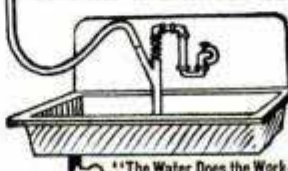

"The Water Does the Work—  
the Air Does the Cleaning"

Guaranteed for **TEN YEARS**. Protected by patents. PRESTO portable Cleaner, complete with 50 feet of one inch vacuum hose, five cleaning tools, ready to connect to hif, only **\$30.00**. We manufacture both the portable and the stationary systems. Write for full particulars.

**PRESTO CLEANER CO.**  
Office 114-116 Colonnade Bldg.

TOLEDO, O.



# Knowledge Will Put YOU in the Spot Light

The fellow that does only what he has to, and spends his spare time in theaters or pool rooms or on the street corner—that fellow does not expect to go very high.

How did your superintendent, or general manager, or foreman, or department chief land the position he holds? By showing knowledge of his work; by proving that he had ability; by getting ready when he was in the same job you now hold.

How can you get into the spot light? How can you mount over the crowd and attract the attention of the "big man"?

By your own efforts properly directed. By being willing to devote to study a part of your spare time. By giving the International Correspondence Schools a chance to direct your efforts and lead you to the front.

Your spare time, if you would but realize it, could be made more profitable than the time sold to your employer.

Mark and mail the coupon to find out all about the I. C. S. plan to put you into the spot light. Doing so will cost you nothing, and will bring to you a full explanation of just what kind of Course you will get, what you will learn, and what has been done by other students of the same Course.

Three hundred I. C. S. students a month write to tell of progress.

Don't wait.

**Mail the coupon NOW.**

## International Correspondence Schools

Box 872, Scranton, Pa.

Please explain, without further obligation on my part, how I can qualify for a larger salary and advancement to the position, trade, or profession before which I have marked X.

Electrical Engineering  
Electric Lighting  
Electric Railways  
Electrician  
Electric Car Running  
Dynamo Foreman  
Dynamo Tender  
Wireman  
Mining Engineer  
Telephone Expert  
Civil Engineer  
Automobile Running

Mechanical Engineer  
Mechanical Draftsman  
R. R. Constructing  
Concrete Construction  
Architect  
Contracting & Building  
Architectural Draftsman  
Plumbing & Heating  
Chemist  
Bookkeeper  
Advertising Man  
Civil Service Exams.

Name \_\_\_\_\_

St. & No. \_\_\_\_\_

City \_\_\_\_\_ State \_\_\_\_\_

Present Occupation \_\_\_\_\_

# Credit Tailors

## This Suit

Perfect Fit  
Guaranteed

**\$16<sup>95</sup>**

Six Months  
to Pay

Others From  
\$12.95 to \$35.00

All-Wool  
Fabrics

The Smartest  
Spring Styles



# Samples Free

Ask us to send you our sample book of all-wool cloth—the newest patterns out. Also the Clement Style Book for Spring, showing what the best-dressed men will wear. Every up-to-date man should see the Clement styles and fabrics before he orders clothes.

We will send with the outfit a tailor's tape, so you can take your own measure. This dealing direct, without a local agent saves you one-third on the price. It enables you to get a \$30 suit for less than \$20.

Clement-made suits costs from \$12.95 to \$35.00. Every fabric is all-wool, acid-tested, London shrunk. The tailoring is perfection, and fit is guaranteed. No man wants anything better.

The suit will be sent on approval, made in any fabric, any style. If not satisfactory, you can return it, and we will pay express both ways.

If you are delighted, pay a little each month for six months. No extra price, no interest, no security, no red tape.

We are making clothes for tens of thousands of particular men. We save them from 30 to 50 per cent on the highest class of tailored clothes. You will wish you had known of us years ago when you find out what clever, all-wool clothes we make for very little money.

Write for the samples and Style Book now. A postal will do. There isn't any place else to get such clothes for so little.

**THE CLEMENT CO.**

3542 Morgan Street (13) CHICAGO

# Anyone Can Enjoy This Delightful Turkish Bath Right At Home—Cost 2 Cents

Every Benefit, Every Luxury of Vapor Bathing  
Within Reach of All—The "Robinson" Thermal  
Bath Cabinet Going Into Countless Homes

You no longer need to go to an expensive hotel or public Turkish Bath when you want to get a fine hot vapor bath, rid the pores of accumulated waste and feel fresh and fit instead of dull and "stale." Just get a "Robinson" Thermal Bath Cabinet. A bath takes only 15 minutes of your time and will cost you only 2 cents. This is a ridiculously small expense as compared with what you have to pay for ordinary Turkish Baths. This "Robinson" bath is fully equal in all respects to any Turkish Bath and far more convenient. Pursued systematically, this home cabinet bath will accomplish wonders in the treatment of La Grippe, Fever, Hard Colds, and Rheumatism. Beware of imitations.

**OUR \$2.00 BOOK SENT FREE.** It represents the best work of some of our greatest minds on a subject of vital welfare to all human beings, "The Philosophy of Health and Beauty" was prepared under the supervision of Prof. Robinson. This offer is for a limited period only. Send today.

**ROBINSON MFG. COMPANY**

172 Snowflake Bldg.

Toledo,  
Ohio



**THE VALUABLE QUEBRACHO TREE**—The most valuable of all Argentina's forest products is the quebracho tree. This is a remarkably strong and lasting timber. It has been used extensively in Argentina for railroad ties and fence posts, for which purposes it has a life of 40 years. But the unique element of the quebracho is the tannin of its bark, and this is shipped all over the world for tanning purposes. Formerly the

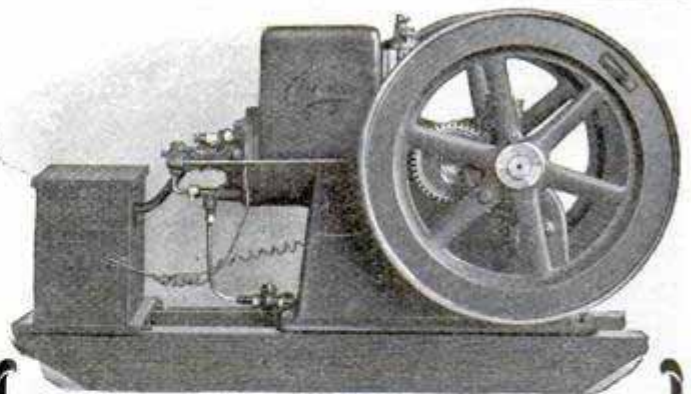

## Get Our Price First

Don't buy until you get our Direct from factory prices and catalog describing our line of high grade

## CHICAGO GASOLINE ENGINES

You want the best at the lowest cost—investigate the construction simplicity, reliability of the "Chicago"—none better. Save 1/3 usual cost. Sold on Free Trial. Five year guarantee. Sizes 1 to 15 h. p. Write to-day.

**COLBORNE MFG. CO.,** 410 Indiana St. CHICAGO, ILL.

# Why Do Men Fail?

☞ THE SUPREME PROBLEM OF LIFE for you is, *how to get money in sufficient quantity to make you independent before your hair turns gray and your eyes grow dim.*

☞ The struggle for money is "the struggle for existence," and a man can scarcely hope to be victorious therein except in the days of his strength and prime.

☞ We are all fighting for money (because money means nearly all that's worth while), but few there be who attain it.

☞ Now why should that be so? *Why are there so many failures?* The answer is simple: The majority are failures because *they do not think right!* They are in a state of discord rather than harmony with the natural Laws that govern money-making and the creation of wealth.

☞ Is that your case? Is your mind negative? If so, you must seek immediate remedy. You must remove the blight of wrong thinking; and for that purpose we strongly recommend to your attention a *splendid little book*, entitled

## "THE LAW OF FINANCIAL SUCCESS"

☞ It is as full of good things as an egg is full of nutriment. It is the essence of money-making boiled down for busy people.

☞ Send for it at once. It only costs ten cents and it will make a new man of you. It will teach you how to be a winner—how to escape the hell of poverty—the worst of all hells.

☞ We honestly declare it is worth no end of money to any man who is desirous of *properly directing* the forces within him for his own enrichment.

☞ If you have the strength and determination to be a winner, get this book. Get it at once. Follow our advice.

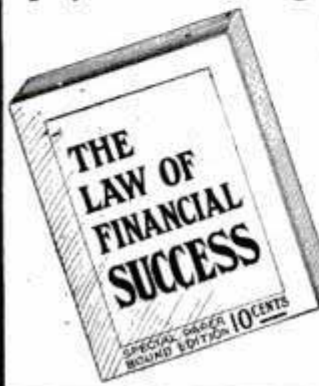

Don't put off till tomorrow what you should do today. Fill in the coupon and the book is yours by the next mail, and it may be the making of you. *If you don't like it your money will be returned; you run no risk.* Special Paper Bound Edition of 16 chapters, 104 pages, only 10 cents. Over 150,000 copies sold.

☞ Don't miss the tide that leads to Fortune.

**THE FIDUCIARY CO.**  
305 TACOMA BUILDING  
CHICAGO, ILL.

WRITE YOUR NAME AND ADDRESS HERE

THE FIDUCIARY COMPANY,

305 Tacoma Bldg., Chicago, Ill.

Gentlemen: For enclosed 10 cents (stamps or coin) send me a copy of your book "The Law of Financial Success."

Name \_\_\_\_\_

Address \_\_\_\_\_

Town \_\_\_\_\_ State \_\_\_\_\_

*Cut out coupon and mail today*

bark itself was exported, but now shipment is principally of quebracho extract.

The center of the quebracho trade, both for logs and extract, is the city of Santa Fe, about 350 miles north of Buenos Aires on the Parana River, a tributary of the Rio de la Plata. During the year 1909, Argentina exported 55,493 tons of quebracho extract, valued at \$4,226,323 Argentine gold (\$1 of which equals \$0.965 United States currency). The principal market for this was the United States, which received 25,693 tons, and Germany 6,265 tons. Shipment of logs for the

### ANY ONE can solder with **TINOL** THE NEW PASTE SOLDER

"Just put it on the spot and heat it." No rosin or acid needed. 50c a can. Self-acting alcohol torch, 50c. Complete soldering outfit, torch and can of Tinol, \$1.00. Trial can Tinol, 25c. At your dealer's, or sent by us post-paid. Money back if not satisfied.

**HESS & SON**  
1217 Filbert St., PHILADELPHIA



### Let SANDOW Run It!

#### Wonderful Work Engine

Farmers and Shop Owners, Stop Sweating! A few dollars gets this grand little work engine, complete and ready to run Cream Separators, Corn Shredders, Grist Mills, Feed Mills, Dynamos, Printing Presses, etc., etc. Gives a lifetime of steady service! All sizes: 2 to 20 h. p. No cranking! No cams! No gears! Only 3 moving parts. Finest construction. Thousands in use. Guaranteed 5 years. Write for Special Introductory Proposition.

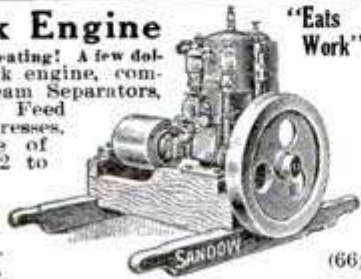

DETROIT MOTOR CAR SUPPLY CO., 2 Canton Ave., Detroit, Mich.

## You Who Drink Unwisely

Why hesitate in taking steps to overcome a false appetite? Over-indulgence in liquor is the result of *constitutional* weakness. Often this is originally induced by wilful drinking. A continued excessive drinking, however, is not a matter of the will, but of the body. It is a physical, not a mental condition—therefore, subject to medical treatment.

### Oppenheimer Treatment

NO HYPODERMIC INJECTIONS

Entirely without harmful after-effects is the Oppenheimer Treatment. Its splendid virtue lies in the fact that it goes direct to the cause. It removes the unnatural craving for liquor by giving perfect physical balance.

#### Administered Through Your Physician

Your own physician administers the Oppenheimer Treatment. It is never put in the hands of the patient. Thus, the utmost in effectiveness is assured and possible misuse obviated.

Nor will the taking of this treatment interfere at all with your business or social duties. It is wonderfully simple, and its benefits are felt within 24 hours.

Absolute professional confidence is observed by the Oppenheimer Institute in all its dealings. Only your physician needs share in the knowledge that you are taking treatment. You should feel no more hesitancy about it than you would in administering to any other bodily ill.

Ask your doctor about the Oppenheimer Treatment. In the meantime, cut out the coupon and send today.

#### COUPON

OPPENHEIMER INSTITUTE, 317 W. 57th St., N. Y. City  
Kindly send me in strictest confidence, and under plain cover, details of the Oppenheimer Treatment.

Name.....  
Address.....

# 16 Square Foot Model Bleriot Monoplane



This model is complete with drawings, instructions, propeller, canvas, wood and wheels all ready to be put together and fly. The planes have a spread of 4 feet and the model in all covers an area of 16 square feet.

We supply everything. Write us your requirements. Our price for full sized Bleriot is **\$500** with out engine or propeller.

**B  
L  
E  
R  
I  
O  
T**

H. G. Carter, designer of this model, is the well known English aviator and has been associated with aerial navigation for over 15 years. He has made 18 parachute descents from balloons, holding the world's record for 3000 feet, made at Blackpool, England, in 1905. Mr. Carter flies a machine of his own construction, having made 27 trial flights and having established an official record of 62 miles in 57 minutes.

**\$2 EACH  
POST  
PAID**

Send us a two dollar bill and we will send you this **LARGE MODEL** ready to be put together.

**\$2 EACH  
POST  
PAID**

**CARTER & SON, Aviators and Manufacturers**  
201 Bennett Bldg., 99 Nassau St., NEW YORK

**M  
O  
N  
O  
P  
L  
A  
N  
E**

## T & M MARINE ENGINES



**Best of All** for speed boats, launches, cabin cruisers and all pleasure or commercial boats up to 65 ft. Right size and type for every craft. Pace-makers for 16 years. Noted for speed, power, endurance, dependability, long service. Quick-reversing.

**START WITHOUT CRANKING**  
2 to 120 H. P.—Single or multiple cylinder—light, medium or heavy duty. Write for catalog and name of nearest dealer.

**TERMAAT & MONAHAN CO.**  
Dept. A, Oshkosh, Wis. Chicago Office, 1205 Michigan Ave.



same year amounted to 294,722 tons, valued at \$4,380,-033 Argentine gold. Great Britain took 151,968 tons, the United States 29,278 tons, and Germany 15,615 tons.—U. S. Consular Report.

A college course which teaches young women Italian architecture, advanced sociology, landscape gardening, counterpoint and what Voltaire called cosmonigology, but omits to teach them how to spell is picturesque but inefficient.—New York Telegraph.

## MODEL AEROPLANE SUPPLIES



Engines,  $\frac{1}{4}$  H. P. Weight, 4 $\frac{1}{2}$  lbs.—1 H. P. 6 $\frac{1}{2}$  lbs. Very strong, powerful and efficient. Complete line of accessories, ball-bearing propeller shafts. Miniature pneumatic tire wheels.

made in six sizes. Turn buckles, metal fittings, propellers, rattan, bamboo, all six sizes of selected woods, finest grade English Rubber strand, etc. CORRECT PRICES, COMPLETE CATALOGUE SENT ON REQUEST  
**THE WHITE AEROPLANE COMPANY, 15 Myrtle Avenue, BROOKLYN, N. Y.**

## Greatest Launch Values Ever Offered



This Handsome, Gracelul, Seaworthy, Speedy Runabout Complete, Only **\$94<sup>50</sup>**

Other similar values in 16-ft., 18-ft., 20-ft., 23-ft., 27-ft. and 30-footers at the same proportionate prices. We are the world's largest power boat manufacturers. Selling direct at Factory Prices, we save you one-half.

Send for Our 1911 Boat Catalog Today—Mailed Absolutely FREE!

It illustrates with full descriptions the famous Detroit Family Launches, Runabouts, Speed Boats, Auto Boats, Speed and Power Canoes, Pullman Cabin Cruisers, fully equipped with berths, galley, etc., for extended cruises. Sixty-four models in all sizes, ready for immediate shipment. All Detroit Boats are equipped with the most efficient, smoothest running, non-complicated marine engine ever built. Starts without cranking—reverses while in motion—has only three moving parts. **GUARANTEED FOR 5 YEARS.** So simplified any child can operate it. Detroit special construction combines more speed with greater seaworthiness than any other boats made. Ask any of our 12,500 satisfied owners. **WE HAVE A NEW CONFIDENTIAL PROPOSITION TO MAKE A LIMITED NUMBER OF MOTORBOAT ENTHUSIASTS TO ACT AS OUR DEMONSTRATING REPRESENTATIVES. WRITE QUICK.**

**DETROIT BOAT CO., 1100 Jefferson Ave., DETROIT, MICH.**

**ON CREDIT**

**BIG BARGAINS IN DIAMONDS AND WATCHES**

Write for our handsome 100-page Catalog, containing over 2,000 illustrations of Diamonds (new exclusive mountings, our own designs), Watches, Artistic Jewelry, Silverware, Novelties. Let us send you a fine Diamond or Watch on approval, all charges prepaid. If satisfactory, keep it and send us one-fifth of the price, balance in eight equal monthly amounts. Great bargains in Watches.

**ON CREDIT**

**DIAMONDS WATCHES**

**LOFTIS BROS. & CO.**

Samuel T. A. Loftis, President

**THE OLD RELIABLE, ORIGINAL DIAMOND AND WATCH CREDIT HOUSE**

DEPT. C 173, 92 TO 98 STATE STREET, CHICAGO, ILL.

Branch Stores: Pittsburg, Pa., and St. Louis, Mo.

**ON CREDIT**

**ON CREDIT**

**ON CREDIT**

**ON CREDIT**

No. 278

No. 256

\$8 Down \$40 a Month

\$9 Down \$4.50 a Month

\$45

**FINANCING AN ENTERPRISE**

These two volumes by Francis Cooper tell how to successfully finance and promote any business enterprise. Written from 15 years practical promoting experience—540 pages. Full information on patents, capitalization, incorporation, prospectus writing, etc.—everything you want to know. Third edition. Endorsed by business men. Bound in Buckram, \$4.00 Prepaid—money back if not satisfied. Descriptive Circular free.

**RONALD PRESS CO., Dept. C, 229 Broadway, New York**

**Best grade cedar canoe for \$20**

We sell direct, saving you \$20 on a canoe. All canoes cedar and copper fastened. We make all sizes and styles, also power canoes. Write for free catalog giving prices with retailer's profit cut out. We are the largest manufacturers of canoes in the world.

**DETROIT BOAT CO., 158 Bellevue Ave., Detroit, Mich.**

### She Did It With JAP-A-LAC

Her bed room radiator didn't match her dainty walls;  
'Twas painted red, just like the radiators in the halls.  
She bought some silver JAP-A-LAC and set to work one night,  
And now you ought to see it—it's an actual delight.

**The Glidden Varnish Company, Cleveland, Ohio  
Toronto, Ont.**

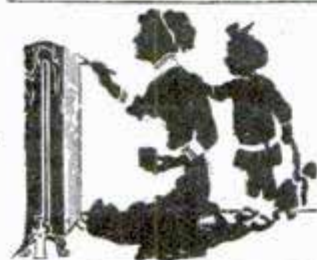

**WHEN YOU WANT ANYTHING AND DON'T KNOW  
WHERE TO FIND IT—WRITE BUREAU OF  
INFORMATION, POPULAR MECHANICS, CHICAGO**

**WHEN YOU WANT ANYTHING AND DON'T KNOW  
WHERE TO FIND IT—WRITE BUREAU OF  
INFORMATION, POPULAR MECHANICS, CHICAGO**



### The American Combined Level and Grade Finder

**Most Practical, Durable and Convenient Instrument Made**

At one glance you can get the true slant on any line or grade either in degrees, inches or percentage, or all at the same time, and will at once give the exact distance needed to plumb up to a true level. The longitudinal recess shown in cut is well worth the low price of the instrument. Write AT ONCE for circular and Testimonials. Special Introductory Price given to First Applicants with privilege of taking Agency. Address **EDWARD HELB, Mfr., Box 75, RAILROAD, PENNA.**

**To Newsdealers:** We believe in "A Square Deal for the Newsdealer." We give no premiums, nor do we offer "special inducements" of any kind whatever to secure subscriptions. This magazine refuses to be clubbed in any manner with any other publication, under any circumstances. We do not allow subscription agencies to offer or accept subscriptions to this magazine at less than the published rate of \$1.50 per year. We employ no solicitors to secure subscriptions. We consistently live up to our belief of "A Square Deal for the Newsdealer."

**POPULAR MECHANICS CO.**

# Time and Its Measurement

By **JAMES ARTHUR**

Reprinted from Popular Mechanics. So far as known is entirely different from anything previously written on the subject. Mr. Arthur is a great authority along this line, having for years made an extensive study of clocks, watches and time-measuring devices.

**Contents:** Chapter 1—Historic Outline. 2—Japanese Clocks. 3—Modern Clocks. 4—Astronomical Foundation of Time

"Written So You Can Understand It." 64 pages. Profusely illustrated. Size 7x10 inches. Printed on coated paper with handsome blue cloth covers. Price \$1.50 Postpaid.

**POPULAR MECHANICS BOOK DEPT., 225 Washington St., CHICAGO**

# Start a New Independent Business

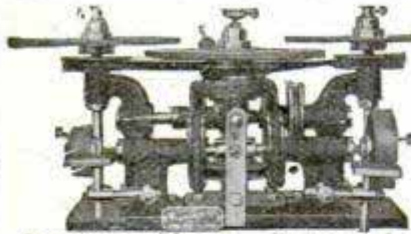

American No. 3. Patented.

## \$5 to \$10 a Day Made Easy

Others are doing it, so can you. With the advent of the Safety Razor—

### A New Industry Has Been Created

The "American" machines are money makers. The only successful machine ever invented. With these machines anyone without previous experience can hone razors, sharpen all kinds of safety razor blades, clippers, scissors, etc.

**NO MAKE BELIEVE, BUT THE REAL THING**

FOR PARTICULARS, ADDRESS MANAGER

**ILLINOIS CUTLERY CO., Dept. 5, 171 Washington St., CHICAGO**

NOTE—We sharpen all kinds of safety razor blades. Razors Honed, 15c.



### \$12 to \$40 A WEEK

can be added to your income in spare time growing mushrooms entire year in cellars, sheds, boxes, etc. Sell like hot cakes 50 cents to \$1.25 per pound.

Free Illustrated Instruction Booklet

**HIRAM BARTON**

Desk 2, 329 W. 48th St., New York



## TRY IT FREE

10 machines in one. Handiest tool on the farm. Has 10 Alectride grinding attachments. Takes rust off tools and sharpens them 25 times faster than sandstone. 8 times as efficient as emery. Does not draw temper. High speed and easy running. Write for free trial. Positively no money down. Send postal for free booklet today. **Harman Supply Co.** 180 Harrison St. Dept. 1193, CHICAGO

## Send for our Catalog of high grade Carpenters' Tools



It will pay you to insist on having "OHIO" TOOLS from your Dealer, as they are tools that will give **continuous satisfaction**. Experienced mechanics have come to regard them as the most satisfactory and economical tools on the market.

We manufacture a complete line of Planes, both iron and wood, Chisels, Drawing Knives, Gouges, Auger Bits, Hand and Bench Screws, Benches, Cement Workers' Tools, Etc.



## OHIO TOOL CO.

(Department 3)

COLUMBUS, O. AUBURN, N. Y.

# NSU

## The Two Speed MOTORCYCLE

Spring Frame, Spring Forks, and a number of other improvements. Write for Proposition "P"

**N. S. U. MOTOR CO.**  
206 W. 76th St., New York City

## Solar—The Quality Lamp

is used on 80 per cent of the quality cars made in America.

It's used because it's the one reliable, dependable lamp—the only lamp that for service and beauty would not cheapen the car itself.

You can have Solars, too, if you insist on them when you buy your car. "If you don't use a Solar we both lose."

**BADGER BRASS MFG. COMPANY**  
Kenosha, Wis. (38) New York City

## Wouldn't You Like To Be In This Party?

Off for an afternoon of pleasure and health. City noise and dust and heat left far behind. Fresh air and sunshine and cool breezes all about. Up the river they go, eat their picnic supper with ravenous appetites, and back again in the cool of the evening—happy, rested and invigorated. Come! Satisfy your longing! Put your vacation money in pleasure that lasts! The cost is less than you have supposed

# Ideal Launches

Just the kind of boat you need. Speedy, safe, dependable, roomy, seaworthy. Beautifully modeled, masterfully built, efficiently powered. Hulls of seasoned white oak and cypress, sheathed inside, handsomely finished with spar varnish and marine enamel. Built right here in the heart of motorboat country. Look at the height of the bows, and the graceful lines! Dry in roughest weather. 16, 18, 20, 26-foot models. Special 16-foot Launch, \$49

Driven at high speed by the famous 2-cycle, non-cranking Gile Engine—positively reversible—controlled by one lever. 3, 5, 6, 10, 15 horsepower. Engines sold separately, if desired.

Take the first step this minute! Sit down now and write us a postal for the handsome FREE catalogue. It gives every detail about these matchless pleasure craft. Sending for it won't put you under any obligation to buy. **GILE BOAT & ENGINE CO., 301 Main St., Ludington, Mich.**

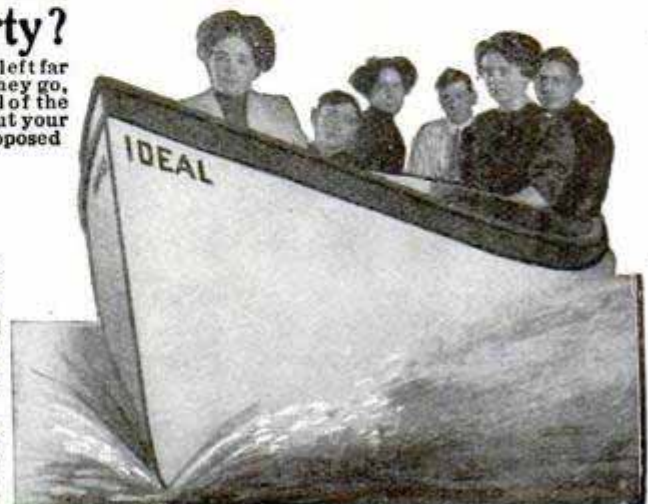



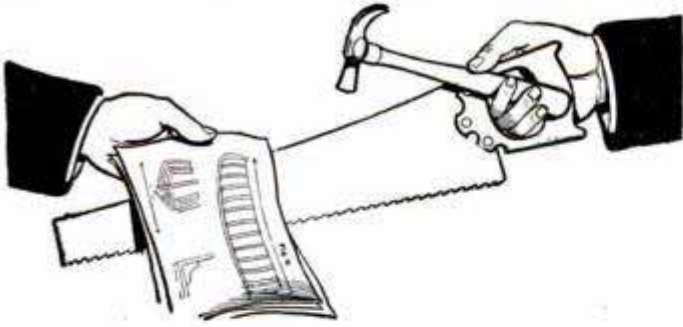

## This Is All You Need To Build Your Own Boat and Save One Half

**J**UST your hands—a hammer—a saw—Pioneer A. B. C. instructions—and with a Pioneer Knocked Down Boat you can build for yourself as satisfactory and seaworthy a motor boat as you could wish, at the same time saving one-half of the ordinary cost. There's no trouble—no waste. Just take our knocked down boat, fit the parts together, nail on the planking, all cut to fit perfectly. It's so simple and easy that the parts almost fall together. And we guarantee you a perfect boat at one-half cost.

### Pioneer Knocked Down Boats

are made of finest material, white oak frames, etc. They are the standard of the world. Each boat is set up and trued at our factory before being taken apart for shipment. Every part from the keel up is accurately true—fitted snugly and balanced exactly. Every individual part is marked to fit the other so that the setting up is as easy as assembling a set of blocks. You simply can't go wrong. It makes no difference if you don't know the first thing about boat building. Your hands—a hammer—a saw and our directions are all that's necessary.

We can give you any sized boat you wish. We give you all the costs and prove to you that our plan will save you at least one-half.

### Write For Free Information

telling the whole story, explaining the simplicity of building your own boat—letters from some thousands of successful amateur boat builders—letters from people who hardly knew what a boat was until they got our simple A. B. C. plans, yet today they are having the best kind of motor sport and in a boat they built themselves. You do the same. Just write for this free book and we'll explain how.

**The Pioneer Boat & Pattern Company**  
Wharf E Bay City, Mich.

## Pioneer Frames



# Learn to Dance

Waltz and Two-Step taught by mail in the privacy of your own home. Wonderful new system for old and young.



**W**E will positively teach you (by mail at your own home) to waltz and two-step smoothly and gracefully in three weeks' time. Try our wonderful system of chart and diagram instructions. Then you will understand at once why the Universal Dancing Academy's method makes young men and young women and older men and older women finished dancers without undergoing the cost and publicity of the ordinary dancing school. Ten minutes a day—practicing all alone in your own home—and you will learn to dance perfectly.

## Become Popular Lead Socially

**I**F you want to keep "in the swim" socially you must know how to dance. Don't let the young folks have all the fun while you sit in a corner and have nothing to do. Don't be a young man standing on the side wall while others become the favorites of the girls. If you are a girl—*don't be a wall flower*. Do you realize that more than one half of all pastime is spent in dancing? Don't lose one half of the pleasure which ought to be yours and which other people from fifteen to sixty years old are enjoying every day.

### You can make money too

**B**ESIDES making you a graceful and polished dancer our course of instruction teaches you how to organize and conduct dancing classes and clubs at big profit to yourself. It also shows you how to give private and public dances which will mean big money for you, and besides make you a social leader of your community.

### First waltz lesson sent free

**W**E will send you the lesson teaching you the waltz step absolutely free. Get these lessons at no cost to you. No obligations. You will see the first day—inside of five minutes—how easy it is to learn the waltz step. We will convince you at once that the Academy's wonderful system will make a finished, graceful dancer out of any man or woman, young or old, in a remarkably short time. If, after learning the waltz step, you want the balance of the lessons, you get the advantage of a special price offer made for introductory purposes on the entire course. No obligations in getting the first waltz lesson free. See coupon.

### Universal Dancing Academy

Dept. 1193  
Bush Temple  
of Music  
Chicago  
Ill.

Universal  
Academy of  
Dancing  
Bush Temple of  
Music, Dept. 1193  
Chicago, Ill.

GENTLEMEN:—Please send me full particulars of your system of dancing instructions and the first lessons in waltzing at no cost and without obligation.

NAME.....

ADDRESS.....

# Get This Course in Physical Culture

For a limited time, to every one sending us \$1.00 for an eight months' subscription to the  
**PHYSICAL CULTURE MAGAZINE**

We'll give a complete course in body building, specially designed for home use by Bernarr Macfadden, the world's greatest authority on health and strength-building. This course calls for no apparatus, and is adapted for use by both men and women. Each lesson is illustrated by a handsome chart, in colors, accompanied by plain and thorough printed description.

March Issue  
 on News-stands NOW



## This Course Is Equal, In Some Respects Superior, To Many Costly Correspondence Courses

In preparing these lessons Bernarr Macfadden has utilized the knowledge which he has gained by a quarter-century's experience in health-building. You reap the benefit of his wide experience, and of his treatment of thousands at his immense Healthatorium, 42d Street and Grand Boulevard, Chicago, Ill. We make this unusual offer because we want to acquaint you with **Physical Culture**—a monthly magazine whose handsomely illustrated pages are brimful of entertaining fiction and useful information for health-seekers and lovers of outdoor life. You'll not try to get along without it once you become a reader. Just send us a dollar bill and say, "Send me **Physical Culture** for eight months and your free course in physical culture at once." We will cheerfully refund your money if you are not satisfied.



Bernarr Macfadden

**PHYSICAL CULTURE PUB. CO., 924 Flatiron Bldg., New York City**

## JUST READY

# HOW TO MAKE A WIRELESS SET

By **ARTHUR MOORE**

A book of 96 pages, bound in cloth, explaining in an understandable manner the construction of an outfit suitable for transmitting four or five miles. This set can be easily constructed at a small cost by any boy of ordinary ability.

*Complete details with illustrations*

**PRICE 25 CENTS POSTPAID**

ORDER OF YOUR NEWSDEALER OR SEND DIRECT TO THE PUBLISHER

**Popular Mechanics Book Dept.** 225 WASHINGTON STREET  
 CHICAGO, ILL.

WHEN YOU WANT ANYTHING AND DON'T  
 KNOW WHERE TO FIND IT  
 WRITE BUREAU OF INFORMATION,  
 POPULAR MECHANICS CHICAGO

WHEN YOU WANT ANYTHING AND DON'T  
 KNOW WHERE TO FIND IT  
 WRITE BUREAU OF INFORMATION,  
 POPULAR MECHANICS CHICAGO



**Magnificent Steel Launch \$96**  
 Complete With Engine, Ready to Run

18-20-23 and 27 ft. boats at proportionate prices. All launches tested and fitted with Detroit two-cycle reversible engines with speed controlling lever—simplest engine made—starts without cranking—has only 3 moving parts—anyone can run it. **The Safe Launch**—absolutely non-sinkable—needs no boathouse. All boats fitted with air-tight compartments—cannot sink, leak or rust. We are sole owners of the patents for the manufacture of rolled steel, lock-seamed steel boats. Orders filled the day they are received. Boats shipped to every part of the world. **Free Catalog. Steel Rowboats, \$20.** (83)  
 MICHIGAN STEEL BOAT CO., 1271 Jefferson Ave., DETROIT, MICH., U. S. A.



Be optimistic —  
Smoke "Velvet"!



"Velvet," a charming pipe tobacco that has that desirable quality of contentment about it that is more often lacking in a pipe tobacco. "Velvet" is Burley leaf. Millions of them hung up for 2 years—they mellow—the harshness disappears—the flavor becomes fragrant—very smooth smoke. Such tobacco *never bites*. "Velvet" is ideal regalement.

10c. at all dealers

SPAULDING & MERRICK  
Chicago, Ill.

*Velvet should be on every dealer's shelf — IF NOT, send us 10c. for the regular tin — sent only in United States.*

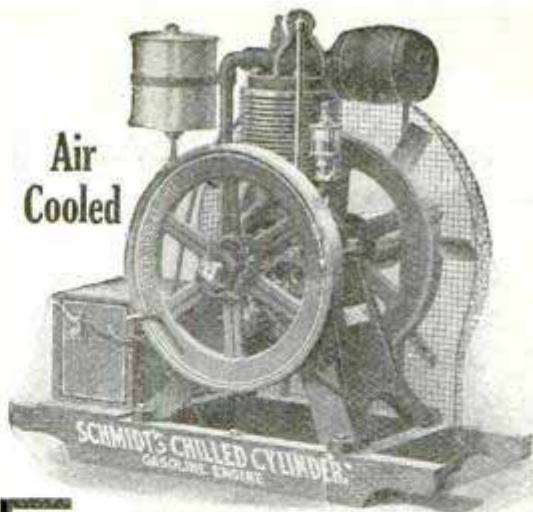

Send the **FREE COUPON** and get Dealer's Price and Easy Payment Terms on the Most Stupendous Gasoline Engine Offer Ever Made

5 Years Guarantee

## This Engine Sent to You **FREE**

Here is the first real free trial offer ever made on a gasoline engine. We will actually send you our marvelous new model 3 h. p. gasoline engine for your free use for 10 days. Ten full days after you get the engine to your own place to set it working. A wonderful new type gasoline engine—the engine that has revolutionized the gasoline industry. Schmidt's Chilled Cylinder Gasoline Engine, the engine that does more kinds of work on the farm than any other engine ever made. **So easy to handle we can trust it to any farmer or shop owner on absolute free trial.** Lightest 3 h. p. Takes up less room.

### Easy Payments

Take long time to pay for this engine if you keep it. If you don't like it send it back at our expense. Try it first free. Then decide for yourself. Make small monthly payments if your prefer.

### Send No Money

Just a request for a free trial brings this engine to you. No advance payments to us, no deposit, no C. O. D. to us, no notes, no mortgages, no security but your own word. 5 years guarantee on this engine. You can save all dealers' and agents' profits on this engine if you write to the engine works direct.

### SHOP ENGINE

This engine is suited to all the needs of a farm or shop. It can't "kick back" because it has our Spark Retarder—the only farm-engine with a Spark Retarder. A woman or a boy can handle this engine.

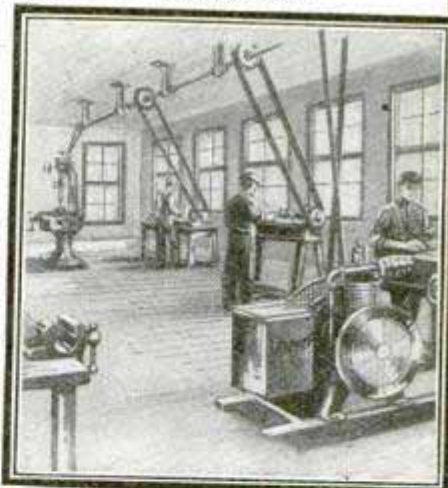

**HOW TO USE POWER** To all who send the free coupon promptly, we will send a very valuable booklet on how to use power on a farm or in a shop. It will tell you the newest things about saving time and labor on a farm that you certainly ought to know.

**FREE COUPON**

Schmidt Bros. Co.  
Eng. Works, Dept. 1193  
Davenport, Iowa

Send Free Coupon

Schmidt Bros. Co.  
Engine Works

Dept. 1193  
Davenport,  
Iowa.

Gentlemen: Without any obligation on me you may send me catalogs and full particulars of your free trial offer, your wholesale price and easy payment terms on Schmidt's Chilled Cylinder Gasoline Engine, also free book "How to Use Power" all free and postpaid.

NAME .....

ADDRESS .....

Please Mention Popular Mechanics

# Mission Furniture

## HOW TO MAKE IT

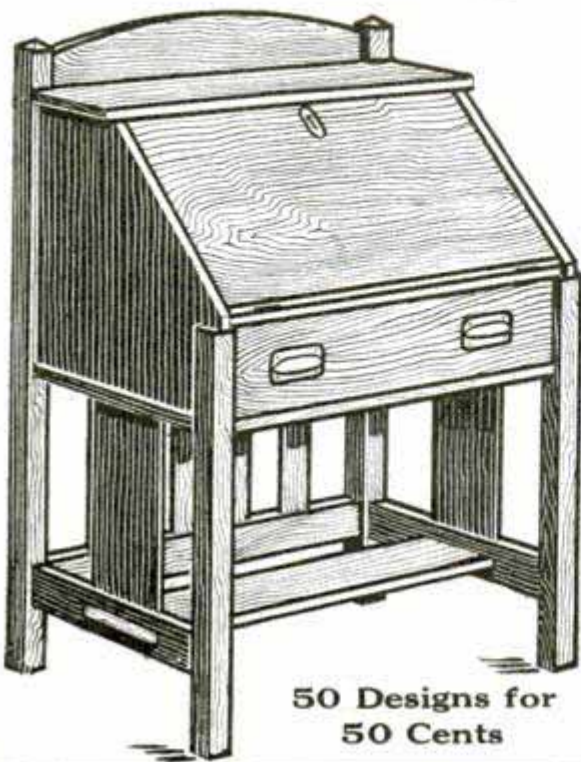

50 Designs for  
50 Cents

### Read What One Man Did

*Hattiesburg Miss  
Aug 19, 1910*

*Popular Mechanics Co.,  
225 Washington St Chicago.  
Sirs*

*Please find enclosed  
25¢ for which send me  
Part Two Mission Furniture  
How to make it, by mail post  
paid I have part 1, and have  
made one pe. of ~~the~~ furniture  
and sold \$400.00 Four hundred  
dollars worth of it and I am  
not a carpenter either but with  
the instructions written so I  
can understand it I have a business  
of my own. Yours truly  
John D. O'Leary*

### TWO VOLUMES

**PART ONE**

**PART TWO**

21 Designs, 96 Pages.

32 Designs, 128 Pages.

Cloth Cover.

**25 Cents Each, Postpaid**

**POPULAR MECHANICS BOOK DEPT.**

225 Washington Street, CHICAGO

*A New Book that is Needed*

# POWER GAS and the GAS PRODUCER

By J. C. MILLER, M. E.

An Authentic Text Book and a Complete Reference Manual Covering Every Detail of Installation and Operation.

**"Written So You Can Understand It"**

**192 Pages Price \$1.00**

**For the Steam User.** This book will enable the Steam User to judge intelligently as to the economy and advisability of changing from Steam to Producer operation.

**For the Steam Engineer.** It will enable the Steam Engineer to understand thoroughly the working of the new system if the change is made, and to handle a plant competently and with confidence.

**Profusely Illustrated. Extra Cloth Binding.**

Sent postpaid to any address by the publishers

**POPULAR MECHANICS CO.**

225 Washington Street, CHICAGO

*A New Book*

# Pattern-Making

By G. H. WILLARD

**With Additional Chapters on  
Core-Making and Molding**

224 Pages, 312 Illustrations, Cloth Cover

Price \$1.00 Postpaid

**"Written So You Can Understand It"**

A book for the man who has to do the work. Written by a practical pattern-maker of many years' experience.

### Chapter Headings

I. Pattern-Making as a Trade. II. The Tools. III. Woods. IV. Joints. V. Turning. VI. Turning (Continued). VII. Turning (Continued). VIII. Turning (Concluded). IX. The Circular Saw. X. The Circular Saw (Continued). XI. Machine Tools. XII. Machine Tools (Continued). XIII. Simple Patterns. XIV. Simple Patterns (Continued). XV. Simple Patterns (Concluded). XVI. Crooked Patterns. XVII. Large Pattern Work. XVIII. Large Pattern Work (Continued). XIX. Crosshead Guide Patterns. XX. Sweep Work. XXI. Pipe Work. XXII. Stove Pattern Work. XXIII. Molding—Machine Work. XXIV. Molding Pattern Work.

### Part II—Core-Making and Molding

Chapter I. Core-Making, Simple and Complex. II. Principles in Molding. III. Loam Patterns and Loam Molds. Every one following this trade, or intending to learn it, should have a copy of this valuable book.

Published by

**POPULAR MECHANICS CO., 225 Washington St., Chicago**



**A DAY PER ACRE**

## Buys a Fruit or Truck Farm in Florida That May Make You a Fortune Right from the Start

We offer you at the rock-bottom price per acre a small farm of from ten to forty acres on one of the richest tracts of land in Florida. This tract is located only a few miles from Tampa, and is crossed by three railroads. Transportation facilities and the comforts and conveniences of a big city are thus almost at your door.

**You can have a money-making farm on this land for the remarkably low terms of \$1.00 an acre per month, which is the same as only three and one-third cents per day.**

If you could but see this land we are offering, we know that you would eventually want to own one of our small farms. **YOU DO NOT NEED MORE THAN TEN ACRES OF THIS LAND TO MAKE A FAIR PROFIT AND ACCUMULATE A BIG BANK ACCOUNT.**

**The soil on our tract** is remarkably fertile. Almost every kind of produce can be raised. Vegetables will grow between the rows of fruit trees, so that almost every square foot of ground may be cultivated.

**The climate of Hillsboro County**, in which both Tampa and our tract are located, is almost perfect. Temperature variations from winter to summer are less near Tampa than at most other Florida points. One of the greatest testimonials to the excellence of the climate of Hillsboro County is that the American Medical Society selected this county out of all America as the site of the organization's proposed Health City.

*Climate and soil combine to produce crops at just the time northern markets are demanding them as winter luxuries. This means higher prices and more profit.*

Every day we receive letters from people who have personally investigated our lands. This was recently written by Mr. L. S. Meyer, 5914 Winchester Ave., Chicago:

"I have just returned from an extensive trip through Florida, and am convinced that your tract is the very best that it is possible to buy.

"While on the property I investigated especially the farms of Mr. E. W. Bearss. What Mr. Bearss is doing is a revelation to me, and proves conclusively that immense crops of vegetables and fruit can be raised on this land when properly developed.

"I am simply astonished at the possibilities of this country, the health and prosperity that await home-seekers here. The fact is **YOU CAN LIVE LIKE A PRINCE IN FLORIDA**, on the same amount of labor that would afford only a bare living elsewhere.

"It is my intention to move my family onto my land in your North Tampa tract within the next few months and immediately develop the same."

[Signed]

L. S. MEYER.

**The advantages of being located near a big metropolitan city like Tampa can hardly be overestimated.** Tampa is now the metropolis of southern Florida. It is already the second largest city in the state and its population is going up by leaps and bounds. Though a comparatively young city, it already boasts of industries whose annual payroll is nineteen million dollars!

You see, then, that there are many reasons why you should invest in a Florida farm on our tract. Our land lies high and dry, while the natural water supply is just enough to keep it properly moist.

These are no idle claims we make for our lands. We guarantee to prove every single statement.

### WRITE FOR OUR FREE BOOK

Send a postal today, and we will forward you our **BIG FREE ILLUSTRATED BOOK**, containing all the proof you need. It proves every claim we have made, and is fully illustrated from photographs actually made on the ground. Twenty pages of reading and illustrations that will make you almost as fully acquainted as though you had personally visited North Tampa.

### JUST SEND THE COUPON

#### NORTH TAMPA LAND COMPANY

Dept. 10, 540 Commercial Nat'l Bk. Bldg., Chicago

Please send without any expense or obligation to me your Free Illustrated Book about your North Tampa Land.

NAME .....

ADDRESS .....

CITY.....STATE.....



# If Your Dealer Doesn't Carry Signal Coat Shirts Send for a Couple at Our Risk

We want you to know the comfort, wear and good looks of Signal Coat Shirts—we want you to realize the advantage of the open front which enables you to slip the shirt on or off like a coat. No tugging over the head.

Ask your dealer to show you this shirt. Note the many points and advantages to be had on no other shirt.

*Extra button at bottom of breast plait, to keep the front smooth, sleeve slit in the side not in seam and reinforced with rip proof band. Two double band collars, band turned, two pockets. Made from fast indigo percales. Seams double sewed.*

If not obtainable in your town, send size and we will express you a couple, charges prepaid. If satisfactory, pay expressman \$1.00 each. (West of Missouri River \$1.25.) If not what you want, return at our expense. Write for folder showing extra styles in neat colored designs for semi-dress at \$1.50, collars to match.

**Hilker-Wiechers Mfg. Company**  
 1256 Mound Avenue  
 Racine, Wisconsin  
 Makers of Signal Overalls



Union Made

## LEARN TO RUN AND REPAIR AUTOMOBILES FOR

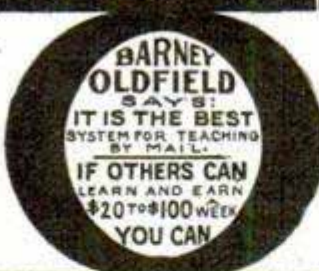

It's easy with Dyke's New System from London—the original and only system—using *real* Working Models. My Home Study Course consists of: 29 Instructions; (12 Books) 120 Charts—and the models—*free*. It costs but \$10—*now*—others charge \$20 to \$80 for less. Everything sent at once—*on approval*—diploma when finished.

Write today and let us show you what hundreds say who are *now* earning big salaries.

Our 24-page Book tells you: "How to get into the Auto Business"—don't miss it—*it's free*.

A. L. DYKE, BOX 1—3947 Washg'n, St. Louis

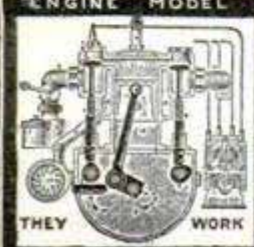

**THE WAY YOU WALK**—There is a new science appearing on the horizon. It has yet no name, but it claims to surpass graphology and chiromancy in delineation of character.

It is based solely on the manner of walking. People who take short, quick steps and whose feet hardly touch the ground are superficial and inconstant.

On the other hand, those of us who take long, regular strides, have well ordered minds.

Thanks to the fashion of 1910, which cuts off more and more of skirt widths, more of us will have to be classed in the first category.

One is obliged to take short, tottering steps, and so the new science will conclude that we are inconstant and superficial.

Let us make the best of it and pray that our feet may be as light as our mentality is supposed to be.—Duluth News-Tribune.

**GENUINE PRECIOUS** and **MOST BRILLIANT** Stones,—cut, look and wear like Diamonds. **NEW DISCOVERY!** Wonderfully Fiery and SPARKLING.



Will send for free examination by Express C. O. D. at following prices:  
 Ladies Tiffany Rings 1/2 ct. Stone, . . . \$5.50 1 ct. Stone, \$ 8.50.  
 Ladies Double Tiffany Rings 2-1/2 ct. Stones, \$8.50 2-1 ct. Stones, \$16.00.  
 Ladies Ear Drops (or Screws) 2-1/2 ct. Stones, \$8.50 2-1 ct. Stones, \$16.00.  
 Gents Heavy Tooth, flat or round Belcher Rings 1/2 ct. Stone, \$9.75, 1 ct. \$13.00, 2 ct. Stone, \$19.50. Studs 1/2 ct. \$4.50, 1 ct. \$7.50, 2 ct. \$13.50.  
 Let us send you one of these surprisingly beautiful stones on approval.  
**E. E. FRETTER & CO. 52 Dearborn Street CHICAGO ILL.**

## Mechanics For Young America

A book which tells how to make scores of articles which delight the heart of the average boy. Price 25 Cents Postpaid

**POPULAR MECHANICS BOOK DEPT.**  
 225 Washington Street, CHICAGO

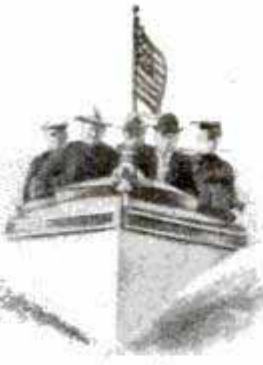

## MULLINS Steel Motor Boats

This year Mullins Steel Motor Boats have established a new record in value for the money. For 1911 you can get 16 and 18 ft. models at \$115 up and 24 and 26 ft. at \$400 up. This is a

### Revolution in Prices!

All the style, all the true worth for which Mullins Steel Boats have been noted are yours to-day in these models—at low cost! *Hulls of steel*, resistant qualities, rigidity and long life such as old-fashioned boats never knew. Metal-covered keel—a boat's back-bone—withstands almost limitless punishment. Like all Mullins Steel Boats, *cannot sink*. Possess all leading features of richest Mullins boats—air-tight compartments, power plant under cover; ONE MAN CONTROL, Silent Under Water Exhaust—and *start like an automobile*. Carry more, with comfort and safety, than any other boats of their size. Catalogue FREE.

THE W. H. MULLINS CO., 151 Franklin St., Salem, Ohio

It is safe to guess that that Chicago woman who declared that men are useless creatures never called on a husband to button her up the back.—Washington Herald.

The oldest organ in use is located on the Island of Gothland, in the Baltic Sea. It dates back a thousand years.—Boston Herald.

Present road to wealth seems to be about 6,000 ft. above ground.—Wall Street Journal.

## Bicycle Agents Wanted! To Ride and Exhibit Wheels.

Remarkable Special Offer to Introduce the Famous "America" Bicycles in Certain Sections of the United States—Big Opportunity to Riders!



All middlemen's profits are knocked off "America" Bicycles to men who will ride and exhibit the biggest value wheel in the world! This special offer applies to territories where we want the "America" well introduced.

**Manufacturer's Factory-to-Rider Prices!** "America Truss Frame Bicycle" and "America Coaster-Brake Diamond Flyer Bicycle" are **guaranteed 10 years!**—twice as long as any other wheel, because built **twice as good**—will last a lifetime! They are shipped on **Free Trial**—completely equipped—**NO EX-**

**TRAS TO BUY!** The "America" is **insured!** (See catalog.) A postal or letter brings you Special Offer and catalog **FREE!** It's a penny well spent. It will save you **dollars** on your wheel.

Write today to

**America Cycle Mfg. Co., Dept. 100**  
319 Michigan Ave. (The Old-Reliable Bicycle House) CHICAGO, ILL.

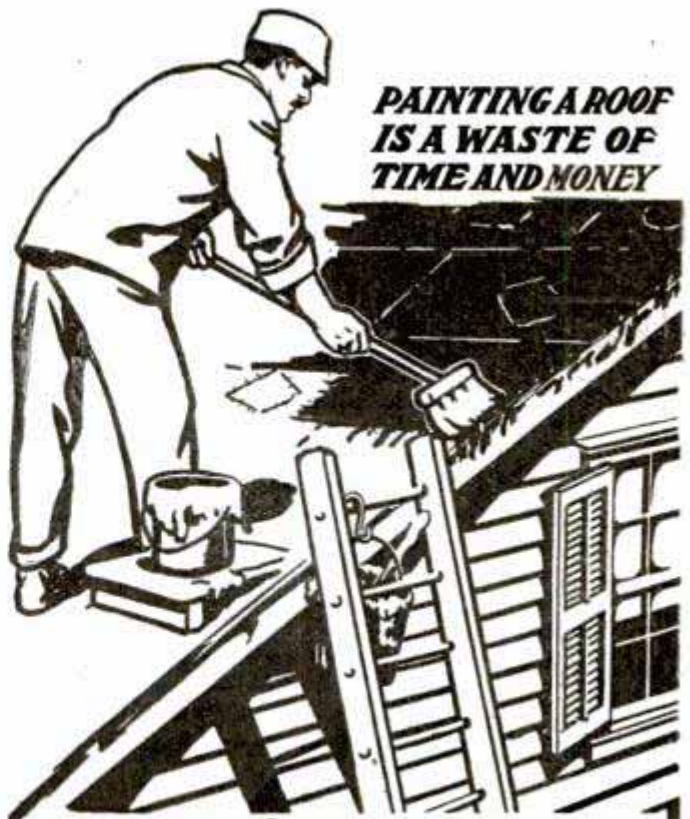

**PAINTING A ROOF  
IS A WASTE OF  
TIME AND MONEY**

# Amatite

## ROOFING

### Needs No Painting

**U**SING Amatite means ending your roofing troubles. It means that after it is once laid on your roof it will need absolutely *no painting or attention*.

Its *real mineral surface* does away with this bother and expense entirely.

And the beauty of it is that Amatite doesn't cost any more than other ready roofings; in fact, less than many.

Amatite comes in convenient rolls ready to be laid on the roof. Anyone can do the job. Liquid cement for the laps and large headed nails are supplied free in the center of each roll.

If you want to know something about the best roofing made and one that needs absolutely no painting, send for a sample and booklet regarding Amatite. Address nearest office.

**BARRETT MANUFACTURING CO.**

New York Chicago Philadelphia  
Boston Cincinnati Minneapolis  
Cleveland Pittsburg New Orleans  
Kansas City St. Louis Seattle



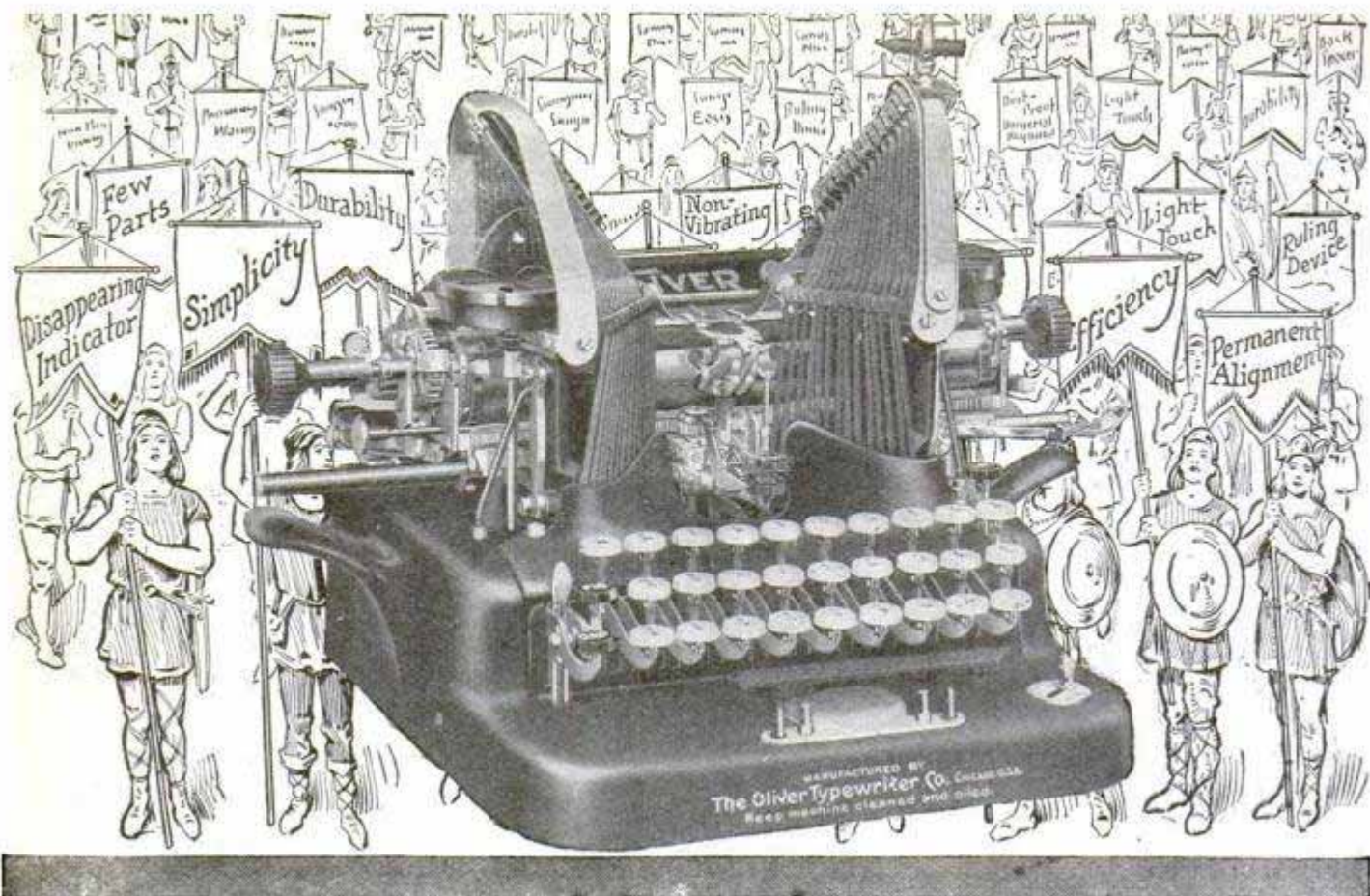

## Backed by a Brilliant Array of

The Oliver Typewriter, which brought about the Era of *Visible Writing*—a *revolutionary improvement*—has persistently carried the standard toward the summit of Highest Efficiency. The many brilliant innovations that have been introduced in rapid succession, overturning typewriter traditions and precedents, have kept the Typewriter world in a ferment since the Oliver entered the field.

"*Visible Writing*," the central thought around which revolve these many startling improvements, encountered tremendous opposition from our staid, conservative rivals.

# The **OLIVER** Typewriter

*The Standard Visible Writer*

They thought to stem the resistless tide of popular approval by condemning it as "unnecessary," "impractical," "visionary." Then—one by one—these "*blind*" manufacturers ran up the flag of *surrender*.

**Today—all standard typewriters are "*Visibles*"!**

Do you wonder that the Oliver has the largest sale of any typewriter in existence?

**Why not buy a typewriter that has—at the Present Time—all these time-saving, result-getting innovations, rather than one that will adopt them later, when forced to change by enlightened public opinion?**

The Oliver Typewriter **17-Cents-a-Day Purchase Plan** is in its way as great an innovation as was that of *Visible Writing*. It extends the *immediate* advantages of the use of *Typewriters* to thousands who must otherwise *wait*. The response of the public to this amazing offer is *phenomenal*. Sales are reaching *stupendous volume*.

*Please Mention Popular Mechanics*



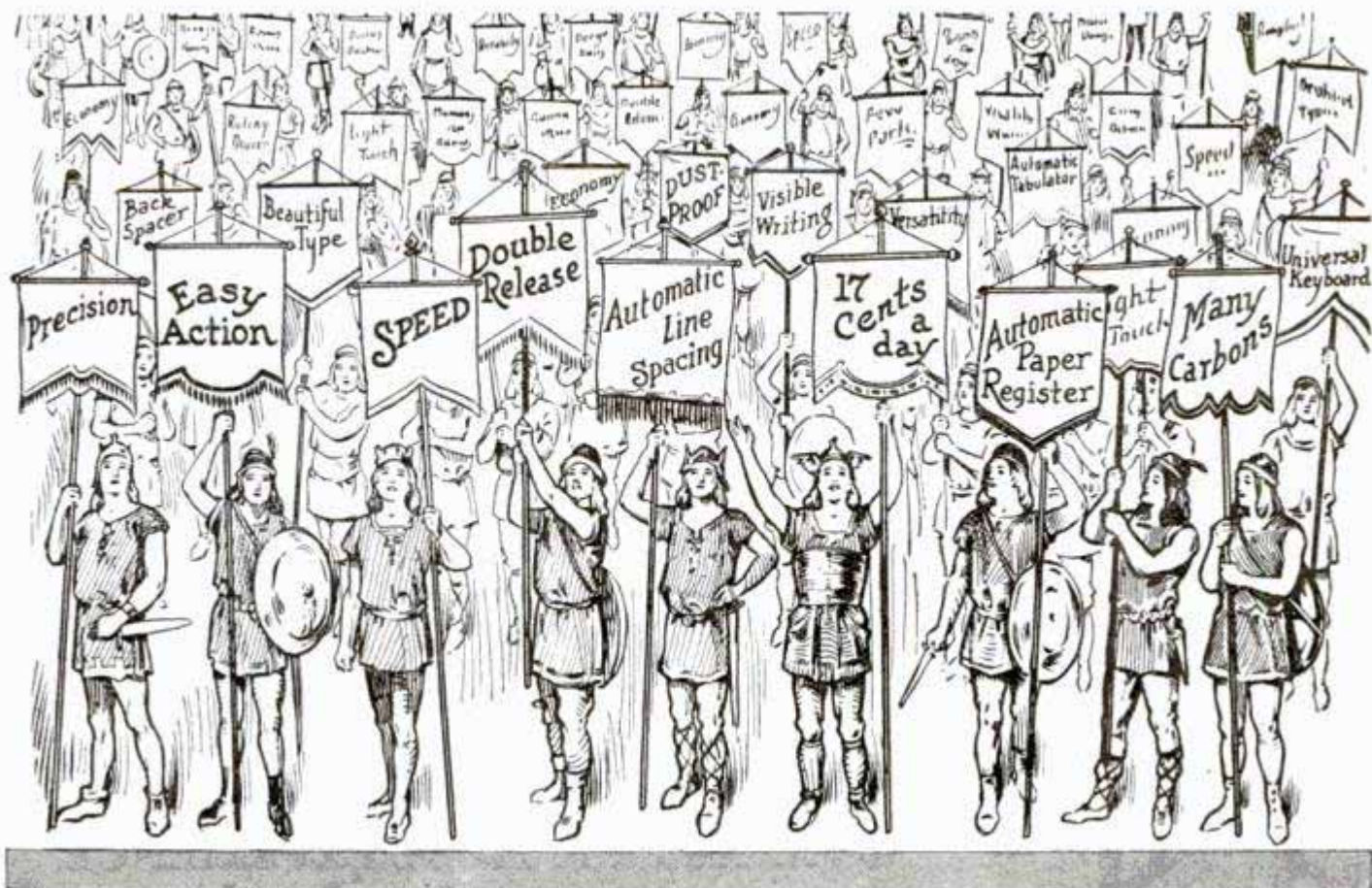

## Oliver Typewriter Features!

The abandonment of *longhand* in favor of clean, beautiful, legible *typewriting* is the next great step in human progress. *The Era of Universal Typewriting is fast becoming a reality!* The Oliver Typewriter is just as indispensable to small merchants, tradesmen, shop and factory owners as to the largest business enterprise. It's an easy way for the merchant and tradesman to *protect* himself against *misunderstandings*, because he keeps a *carbon copy* of every typewritten letter or document. The *legibility* of typewriting prevents mistakes, disputes, delays. Professional people, ministers, authors—all who have to *write*, where typewriting would be more welcome to those who *read it*, owe it to themselves to own Oliver Typewriters.

## Yours for 17 Cents a Day!

This "17-Cents-a-Day" Purchase Plan makes the Oliver Typewriter as easy to own as to rent. It places the machine within easy reach of every home—every individual. A man's "cigar money"—a woman's "pin money" will buy it! Clerks on small salaries can now afford to own Oliver Typewriters. By utilizing spare moments for practice they may fit themselves for more important positions. Schoolboys and schoolgirls can buy Oliver Typewriters, just by saving their pennies.

You can buy the Oliver Typewriter on this plan at the regular catalog price—\$100. A small first payment brings the machine. Then you save 17 cents a day and pay monthly.

And the possession of an Oliver Typewriter enables you to earn money to finish paying for the machine.

*Can you spend 17 Cents a Day to better advantage than in the purchase of this wonderful machine?*

Write for handsome Catalog and 17-Cents-a-Day Purchase Plan. Address—Sales Department

**The Oliver Typewriter Company**  
644 Oliver Typewriter Bldg., Chicago (77)

### Send Coupon or Letter

The Oliver Typewriter Company  
644 Oliver Typewriter Bldg., Chicago

Gentlemen: Please send your Art Catalog and details of "17-Cents-a-Day" offer on the Oliver Typewriter.

Name .....

Address .....

Occupation .....



# CHIEF DRAFTSMAN

Will INSTRUCT PERSONALLY a limited number selected, ambitious men in

## Practical Drafting, Detailing, Designing

### Draftsmen Drawing \$125-\$150 Monthly

Are NOT MADE in Schoolrooms,  
 Are NOT MADE by reading books,  
 Are NOT MADE by making Copies,  
 Are NOT MADE at home drawing pictures  
 from printed book lesson.

### LET ME TELL YOU:

It requires actual, practical, up-to-date  
 DRAFTING-ROOM WORK to train YOU  
 to gain the PRACTICAL EXPERIENCE  
 that your employer will demand of you.



# FREE

This \$13.85  
 DRAWING  
 OUTFIT

and Free Position.

As Chief Draftsman of Engineering firm I know exactly the Quality and Quantity of PRACTICAL training, knowledge and actual up-to-date experience (not school knowledge) you must have, in order to obtain a good position and advance to highest salary.

I give **INSTRUCTION UNTIL COMPETENT** and  
**PLACED in POSITION** at above Salary.

DON'T waste TIME and MONEY trying to learn from books or printed "STUFF" you can only learn on PRACTICAL WORK which I furnish you.

Address **CHIEF DRAFTSMAN**  
**Div. 19, Eng's Equip't Co. (Inc.), Chicago**

# Will You Try Johnson's Wood Dye and Wax at our Expense?

We'll gladly send you samples of all of Johnson's Wood Finishes—together with copy of our beautifully illustrated book by famous experts—printed in five colors—"The Proper Treatment for Floors, Woodwork and Furniture"—absolutely free. This Book tells you how to finish or refinish all woodwork, floors and furniture.

**Read Free Offer Below.**

## Johnson's Prepared Wax

for all woodwork, floors and furniture (including pianos). Anyone can easily use Johnson's Prepared Wax over any finish or on the bare wood for that beautiful, artistic, dull finish so much in vogue. Ask your dealer for sample.



## Johnson's Wood Dye

—not a varnish stain—but a deep-seated Dye which penetrates the wood and fixes a deep, rich, permanent color. Made in 14 artistic shades. Johnson's Wood Dye makes inexpensive softwoods as beautiful and artistic as expensive hard woods. Color plates and directions for use in the booklet.



## Johnson's Kleen Floor

for cleaning all polished floors, stairs, and finished surfaces, keeping them in perfect condition. Apply with a cloth and rub dry—removes all stains and discolorations. After using, give the surface a coat of Johnson's Prepared Wax and the wood will look just like new.



## Johnson's Under-Lac

a thin, elastic spirit finish far superior to varnish or shellac. Not thick or sticky or slow-drying like varnish—neither does it dry too quickly like shellac. Especially good on linoleums and oilcloth, bringing out the pattern and giving a finish as glossy as new. Protects from wear—makes cleaning easy. Dries hard in an hour. Gallons \$2.50—quarts 70c—pints 40c.



## Free Book and Sample Offer

We have sent a liberal supply of Johnson's Wood Finishes—together with a supply of our beautiful Instruction Book by famous experts—illustrated in five colors—to all leading dealers who handle paints, for your use, free. If your dealer hasn't samples and books send us his name, and we'll send you Free—any two of the above finishes, with copy of the Book. All we ask is that you test the samples and ask your dealer to supply your future needs.

Answer this ad and get this 25c book free.



S. C. Johnson & Son, Racine, Wis.  
"The Wood Finishing Authorities"

## Free Coupon

For 25c Book, "The Proper Treatment for Floors, Woodwork and Furniture" FREE and two samples as follows: .....

Name .....

Address .....

Paint Dealer's Name .....

Paint Dealer's Address .....

# \$650

## Buys the Material Needed to Build This Home!

Price Includes Blue Prints; Architect's Specifications; Full Details; Working Plans and Itemized List of Material.

### OUR HOUSE DESIGN NO. 6

This is our leader, the best seller of any house ever designed anywhere, by anybody, at any price. Why? Because it comes nearer to filling the requirements of a home than any house of its size ever built. It is 23 ft. wide and 33 ft. 6 in. long, not including the porch. It has seven rooms, bath, pantry and a large front porch. It is of handsome appearance and symmetrical proportions. It is magnificently lighted and perfectly ventilated. Embodies every modern comfort and convenience. Our extremely low price makes it the best bargain proposition on the market. We cannot recommend this design too highly. Even if you don't need a home, build this house for an investment. You can sell it ten times over before it is finished.



## We Save You Big Money on Lumber and Building Material!

The Chicago House Wrecking Co. is the largest concern in the

world devoted to the sale of Lumber, Plumbing, Heating Apparatus and Building Material direct to the consumer. No one else can make you an offer like the one shown above. We propose to furnish you everything needed for the construction of this building except Plumbing, Heating and Masonry material. Write for exact details of what we furnish. It will be in accordance with our specifications, which are so clear that there will be no possible misunderstanding.

### How We Operate

We purchase at Sheriffs' Sales, Receivers' Sales and Manufacturers' Sales, besides owning outright sawmills and lumber yards. Usually when you purchase your building material for the complete home shown above, elsewhere, it will cost you from 50 to 60 per cent more than we ask for it. By our "direct to you" methods we eliminate several middlemen's profits. We can prove this to you.

### What Our Stock Consists of

We have everything needed in Building Material for a building of any sort. Lumber, Sash, Doors, Millwork, Structural Iron, Pipe, Valves and Fittings, Steel and Prepared Roofing. Our stock includes Dry Goods, Clothing, Furniture, Rugs, Groceries, etc. Machinery, Hardware, Wire Fencing—in fact, anything required to build or equip. Everything for the Home, the Office, the Factory or the Field, besides everything to wear or to eat. Send us your carpenter's or contractor's bill for our low estimate. We will prove our ability to save you money. WRITE US TODAY, giving a complete list of everything you need.

### Free Book of Plans

We publish a handsome, illustrated book containing designs of Houses, Cottages, Bungalows, Barns, etc. We can furnish the material complete for any of these designs. This book is mailed free to those who correctly fill in the coupon below. Even if you have no immediate intention of building, we advise that you obtain a copy of our FREE BOOK OF PLANS. It's a valuable book.

### Our Guarantee

This company has a capital stock and surplus of over \$1,000,000.00. We guarantee absolute satisfaction in every detail. If you buy any material from us not as represented, we will take it back at our freight expense and return your money. We recognize the virtue of a satisfied customer. We will in every instance "Make Good." Thousands of satisfied customers prove this. We refer you to any bank or banker anywhere. Look us up in the Mercantile Agencies. Ask any Express Company. Write to the publisher of this publication. Our responsibility is unquestioned.

## \$2.00 Buys a Complete Set of Blue Prints

tion charges prepaid, for the low cost of \$2.00. This is only a deposit, a guarantee of good faith, and the proposition to you is that after receiving these blue prints, specifications and list of material, if you can place an order with us for complete bill of material, we will credit your account in full for the \$2.00 received, or we will allow you to return these plans, specification and list of materials to us and we will refund \$1.50, thereby making the total cost to you 50 cents.

We send you a set of plans for the house described above, including the necessary specifications and complete list of material, transportation and complete list of material, if you can place an order with us for complete bill of material, we will credit your account in full for the \$2.00 received, or we will allow you to return these plans, specification and list of materials to us and we will refund \$1.50, thereby making the total cost to you 50 cents.

### High Grade Bathroom Outfits!



The price of this Bathroom Outfit \$37.50.

Plumbing material direct to you at Bargain prices. We have everything needed in Plumbing Material. Our prices mean a saving to you of 30 to

60 per cent. Here is an illustration of a bathroom outfit we are selling at \$37.50. Your plumber would ask you about \$60.00 for this same outfit. It is only one of many other complete outfits that we are offering at prices ranging from \$25.00 to \$50.00. Our catalog describes them in detail. Get our prices on Pipe and Fittings. Write us today.

### Hot Air Furnaces!

Don't let the contract for your hot air furnace until you get our figures. We will cut your local dealer's price in half. We can furnish you a complete equipment including pipes, registers, furnace; everything required at a price not much more than what an ordinary heating stove would cost you. Complete hot air heating plants \$48.00 up. Get our heating catalog at once. Tells you all about it. Write us today. We guarantee to save you money. We loan you tools. We make your plans. Every heating plant we sell is backed by our guarantee bond.



### Hot Water Heating Plants!

We guarantee to save you 50 to 75 per cent on a modern hot water heating plant for your home. We make you complete plans and instructions, and help you out every way we possibly can. We loan you tools. Every plant packed by our guarantee bond. We furnish the material; you get the plant installed. Cut out the local dealer's profit and cut the cost in half. Thousands of our plants installed and working perfectly in every part of the country. Write today for our Special Heating Catalog. Tell all about our heating proposition. We can furnish Heating Apparatus for any building, no matter how large. Tell us your needs.



### Water Supply Outfits

Modern Air Pressure Water Supply Systems at prices ranging from \$48 to \$200. They are strictly new, first-class and complete in every detail. It makes no difference whether you live in the

country, you can enjoy every city comfort at little expense. Why not investigate this? We are ready to furnish you with all facts free of charge. All material fully guaranteed. We also have a complete stock of Pipe, Valves and Fittings at 40 to 60 per cent saving. Gasoline engines at low prices.

### Free Publications

Write for our Free Catalog. Fill in the coupon to the right and we will send such literature as best suits your needs. We publish a 1000 page mammoth catalog fully illustrated, giving our business history and showing all the vast lines of merchandise that we have for sale. We buy our goods at Sheriffs', Receivers' and Manufacturers' Sales. Ask for Catalog No. 539 Our Book on Plumbing and Heating Apparatus contains 150 pages of useful information. Our free "Book of Plans" is described elsewhere in this advertisement.

CHICAGO HOUSE WRECKING CO., 35th and Iron Sts., Chicago

### Send Us This Coupon

Chicago House Wrecking Co. 539

I saw this ad in Popular Mechanics

I am interested in \_\_\_\_\_

Name \_\_\_\_\_

Town \_\_\_\_\_

Co. \_\_\_\_\_ State \_\_\_\_\_