

POPULAR MECHANICS

WRITTEN SO YOU CAN UNDERSTAND IT

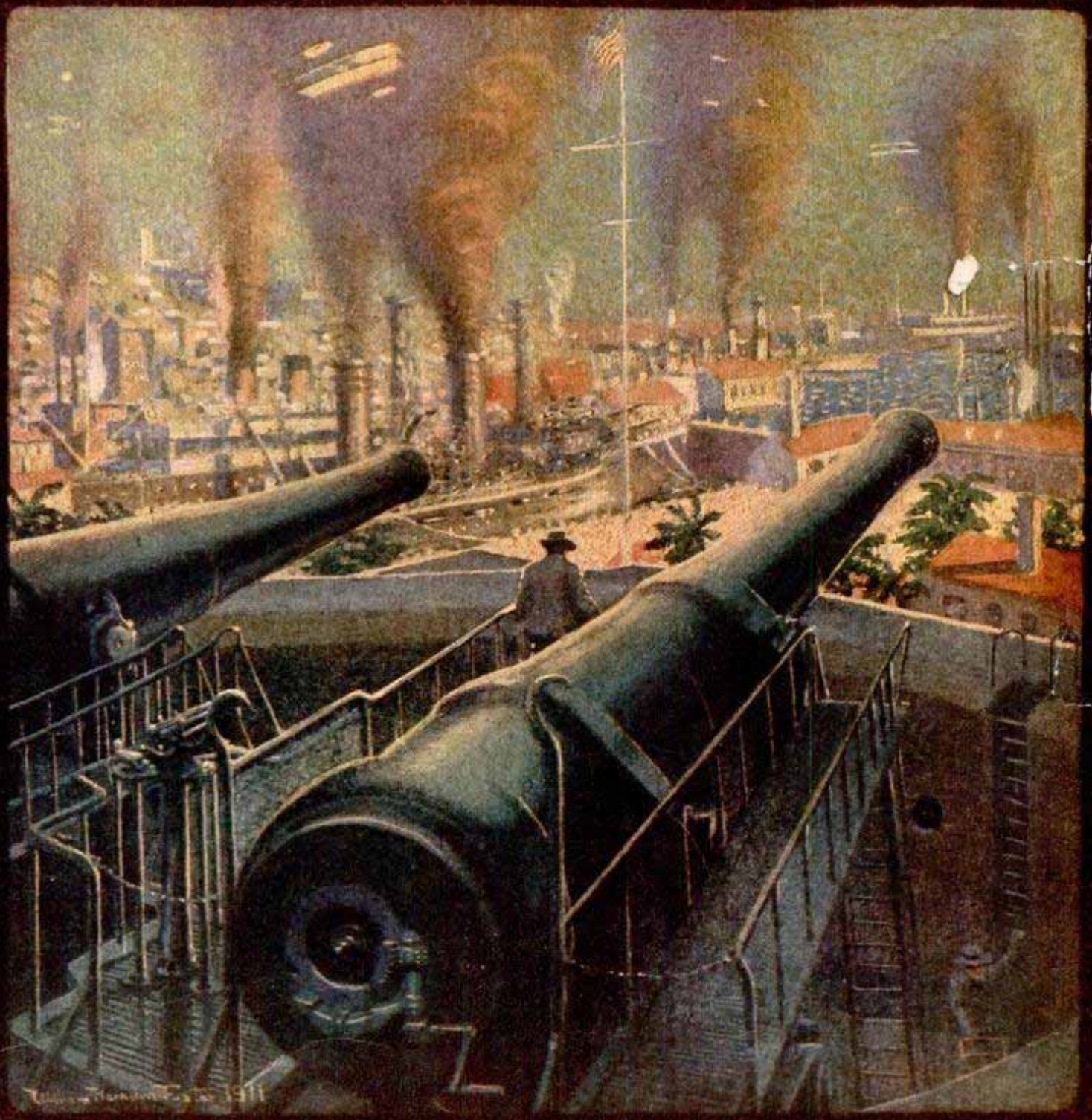

Leaving the Grime Behind



Pummo Soap—

the soap of soaps for the worker.

Vegetable oils, fine Italian pumice and glycerine are the ingredients.

The soap and pumice cleanse thoroughly and quickly, and the glycerine so tempers the action of the pumice that

there is merely a gentle friction which opens the pores of the skin and stimulates the circulation, leaving a feeling of freshness and thorough cleanliness that is positively exhilarating.

Pummo will make the skin cleaner and whiter than any ordinary soap—in half the time. Lathers freely in any kind of water. **Price but 5c**

Pummo will be found specially valuable for the use of mechanics, miners, mill men, farmers, engineers, railroad men.

If your dealer does not have **Pummo** in stock, write us, giving his name, and we will send you a free sample by return mail.



Made by

The N. K. Fairbank Company, Chicago

Trained Men Win

Did you ever watch a young man who has had Navy training? Notice how straight he stands; how firm his step; how sure his action; how straight he looks you in the eye.

Talk with him and see how quick are his decisions, how clear his thinking, and how direct he gets to the point. Notice his politeness and yet his self-reliance.

That's what Navy training means. Those are the qualities it brings out in a man.

It does a great deal more for him, too. It gives him good wages and shows him how to save them. It can teach him a trade. And it broadens his mind by travel.

Find out about these things. Every young man should know them. "The Making of a Man-O'-Warsman" tells in a readable way what the sailor has to do, what he is paid, how he amuses himself, and all the other interesting details of life in the Navy. Send for a copy now. You'll forget it if you wait until tomorrow.

ADDRESS

Bureau of Navigation Desk 69, Navy Dept.
WASHINGTON, D.C.

Tools for Expert Work

Smooth, perfect fitting joints—beautiful cabinet work—work requiring precision and accuracy can only be done with good tools. That means not only good in quality but the most scientific skill in adjustment, “hang,” balance, distribution of weight—just the right temper for hard, durable edges or tough striking surfaces. It is perfection in such details that has made famous the name

KEEN KUTTER

Quality Tools

The only complete line of guaranteed tools under one name and trademark. Guaranteed to give perfect satisfaction, or money refunded.

“The Recollection of Quality Remains Long After the Price is Forgotten.”

Trademark Registered.

If not at your dealer's, write us.

—E. C. SIMMONS.

**SIMMONS HARDWARE
COMPANY, (Inc.),
St. Louis
and
New York,
U. S. A.**

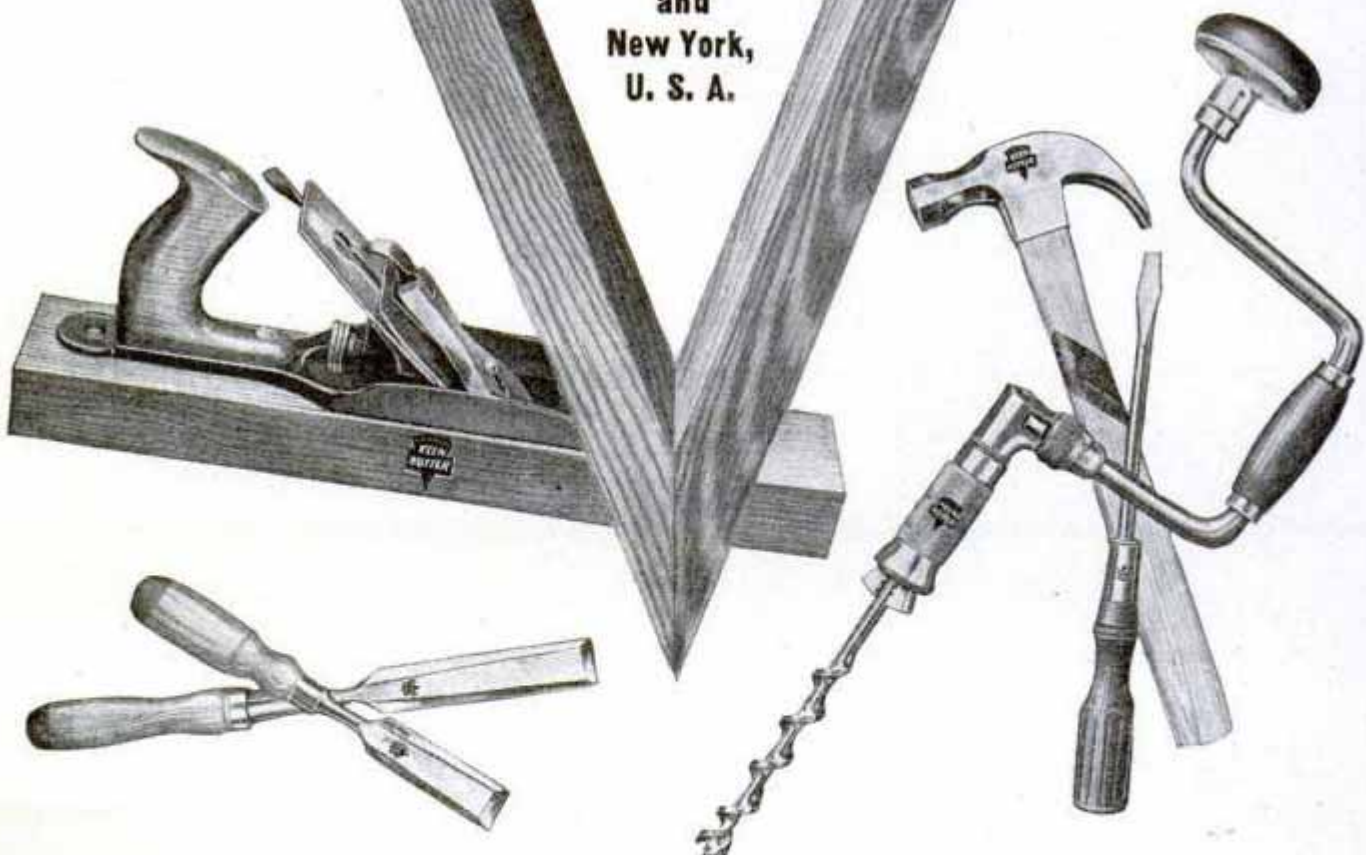

Please Mention Popular Mechanics

POPULAR MECHANICS MAGAZINE

H. H. WINDSOR, EDITOR, 225 Washington St., CHICAGO, U. S. A.

Copyrighted, 1911, by H. H. Windsor.

Exchange Editors are at liberty to quote from these pages by giving the usual credit.

Contents for February, 1911

Non-Sinkable Dory with Food and Water Ports in Bottom.....	155
Runaway Team Snaps Telephone Pole.....	156
Focusing of Binoculars.....	156
Electric Advertising Extraordinary.....	157
Deluge Pipe for Fighting Basement Fires.....	158
Enough Gold to Sink a Ship.....	158
Pioneer Woman Wireless Operator.....	158
French Army Bicycle Made in Two Parts.....	159
Trans-Caspian Railroad Proposed.....	159
The New Vault at the United States Treasury.....	161
The Turned-Up-Trouser Suit for Women.....	162
Alcohol Vapor and Oxygen as Stimulant.....	162
Drinking Water Purified by Chloride of Lime.....	162
Auto Runs 70 Miles with a Milk Can for Radiator.....	163
India to Make Its Own Rails.....	163
Cleopatra "Cat" Chair.....	163
Elephant Saves Hundreds of Lives.....	164
The Fortification of the Panama Canal, by Lieut. Gen. Nelson A. Miles.....	165
No Monopoly of the Atmosphere.....	172
The Length of Flashes for Lighthouses.....	172
Geared Turbines for Steamships.....	173
Multiplane Aeroplane.....	173
Automobile Leads Horses from Pasture.....	173
Reservoir Overflow Will Drive Auxiliary Plant.....	174
Placing a Bridge Draw under Difficulties.....	175
The New Capitol Doors.....	176
Photographs at a Speed of Five Thousand a Second.....	178
Yacht for Prince Built in China.....	178
Spiral Tunnels of the Canadian Pacific.....	179
Memorials for Victims of Aerial Navigation.....	180
Railroad Opened from Hongkong to Canton.....	180
Court Holds That Sawdust Contaminates Stream.....	180
Explosion of Acetylene Causes Devastation.....	181
Millions Lost by Fire in Cincinnati.....	182
Mauretania's Record Christmas Trip.....	183
Fifty-three Airmen Killed during Past Year.....	184
Moisant and Hoxsey Die on the Same Day.....	185
Altitude Record Set at Two Miles.....	186
Moving-Picture Profanity Shocks Lip Readers.....	187
Death Takes Heavy Toll at Fire in Chicago.....	187
Unruly Elephant Killed with Cyanide.....	188
Digging Ditches with Dynamite.....	188
Telephone and Electric Light Guard Tomb.....	188
Comment and Review, by H. H. Windsor.....	189
Colossal Indian Statue Built of Concrete.....	191
Sends Lifeboat over Niagara in Test.....	192
Acrobatics an Adjunct to Skating.....	193
Tug Supplies the "Olympic" with Electric Energy.....	194
Caricaturing the Noted Airmen.....	194
House of Representatives to be Made Smaller.....	195
Mission Car for Southern California.....	197
Water Used as Ship-Rolling Preventive.....	197
Building Charts to Aid Firemen.....	198
Italian Troops Maneuver on Alpine Heights.....	198
Suction Dredger and Well Borer Hunt Treasure.....	200

Boxing Automobiles for Foreign Shipment.....	200
A Universal Calendar for 1911.....	202
Swallow's Nest on Shade of Electric Light.....	203
The Raising of a British Dredger.....	203
A Motorcycle for Women.....	203
Transporting Millions under Guard.....	204
A Pioneer Salt-Works in the West.....	205
New Version of Passion Play in Germany.....	206
Bullet-Shaped Car in New French Biplane.....	207
Making Ships' Reckonings in Fogs.....	207
Breeding Bugs to Destroy Insect Pests.....	208
Apparatus for Testing Batting Strength.....	209
Grain Elevator Moved on Freight Cars.....	210
Fire Train Fights Forest Fires.....	210
How Fireflies Generate Their Light.....	211
Largest Gyratory Ore-Breaker in World.....	211
Compact Wireless Field Set for a Pack Saddle.....	212
Time Clock Blows the Factory Whistle.....	212
Whale Steak is Japanese Delicacy.....	212
Planning a Port for a Great City, by Gardner Mack.....	213
Instruction Car Trains Motormen.....	219
Electrical Phonographic Reproduction.....	220
Seattle Streets Regraded under Difficulties.....	220
Maryland Roads to be Freed of Toll Gates.....	221
Shakespeare's Theater.....	222
Concrete Crib is Floated to Position.....	222
Toys from Scrap Tin.....	222
Why Aeroplanes Fall.....	222
Armored Automobile for Bank Service.....	223
Ingenious Advertising Fountain.....	224
One-Man Coal Mine.....	224
How the American Sailors Impressed an Englishman.....	225
Aeroplane Parachute.....	227
Where Nations Meet.....	228
Concrete Brackets Support Street.....	228
Persian Corn Barn.....	228
The London Motor Show at Olympia.....	229
Electric Heater of Pocket Size.....	230
Compressor Air Taken from Car Roof.....	230
Wireless on an Arctic Outpost.....	230
Buggy Demolished by a Train.....	230
Washed Money Mistaken for Counterfeit.....	231
New Idea in Beam Compasses.....	231
"Sign of the Red Car" is Newest Name Board.....	231
Watch of a Hundred Years Ago.....	232
Cabinet Electric Heater.....	232
Strange History of the Wedding Ring.....	232
Submarine Constructed to Rescue Itself.....	233
Crude-Oil Tire Heater.....	234
Proposed Irish Trans-Atlantic Line.....	234
Fast Locomotive for Heavy Service.....	234
The Making of Arts-Crafts Lamps.....	235
Greatest Steam-Electric Power Plant.....	236
Ratchet Wheel Winds Up Toy Aeroplanes.....	237
Giant Locomotive for Virginia Railway.....	237
How to Make a Wall Case.....	238
Six-Piece Pie-Cutter.....	239

[Continued on Page 6]

ISSUED MONTHLY

SUBSCRIPTION:

SINGLE COPY, 15 CENTS

In United States, and its possessions, and Mexico, per year, postpaid.....	\$1.50
To Canada.....	1.75
To all other countries in the Postal Union.....	2.00
All subscriptions are discontinued at expiration. Please examine the date printed on your wrapper.	

Entered as Second Class Matter Sept. 15, 1903, at the Postoffice at Chicago, Illinois, under Act of March 3rd, 1879.

Published monthly by POPULAR MECHANICS CO.

The attention of prospective advertisers is called to the policy of this magazine in accordance with which the publisher waives all claim for payment of any advertisement appearing in any issue where the number of copies actually printed and circulated is less than the number printed on the front cover page.

This One



Contents—Continued

Postmen Knockers.....	239	Sawing Tubes at an Angle.....	280
French Battery Said to be Most Powerful.....	239	Keeping a Lantern Bail Upright.....	281
Clock Operated by Falling Balls.....	240	Roof Jack for Holding Paint Pots.....	281
Navy to Test Telegraph Typewriting Machine.....	240	Repairing a Pump Jack-Arm.....	281
Moving-Picture Shows for Convicts.....	241	Attaching Crank to a Clock Key.....	282
Wireless Control of Water Craft.....	241	A Simple Door-Opening Device.....	282
Motor-Operated Tillage Machine.....	242	A Center for Turning Large Work.....	282
Utilizing Waste Gas-Engine Heat.....	242	Electric Foot-Warmer.....	282
Moving-Picture Films Are Photographs.....	243	A Silent Ratchet Wrench.....	283
Transmitting the Correct Time by Wireless.....	243	Turning Eccentrics.....	283
The "Duck" Aeroplane.....	243	Forms for Sawing Miters on a Cabinet Bench.....	283
Most Modern System for Fire Protection.....	244	Shutter Speed Tester.....	284
Five Killed in Runaway Accident.....	244	Preventing Work Slipping from a Chuck.....	285
The Vanishing Figure-Heads.....	245	A Home-Made Vulcanizer.....	285
"Visions of the Future" in Electricity.....	247	Home-Made Ratchet Drill.....	286
Old Mexican Ore Mill.....	248	Drapery-Hanging Pole.....	286
The Kentucky River "High Bridge".....	249	An Edge Center for Patternmakers.....	286
French Gun-Automobile.....	249	Drilling Holes Central with a Center Punch	
Five-Year-Old Girl Who Drives an Auto.....	250	Mark.....	287
Steel Smokeless Powder Will Not Corrode.....	250	Hydraulic Oil Pump.....	287
An Electrical Laundry.....	250	Belt Punch Used for a Brush Handle.....	288
Tree Growing Around a Headstone.....	251	An Extemporized Level.....	288
Portable Elevator for Stacking Freight.....	251	How to Harden and Temper a Rock Drill.....	288
Steering-Apparatus Gears of the "Olympic".....	252	Protection for the Eyes from Intense Heat.....	288
Recovering Oil from Waste.....	252	Fastening a Loose Door-Knob.....	289
No More Public Flights by Latham.....	252	New Way of Handling Rubber Rope.....	289
Wind Screens for Motorcycles.....	252	Preventing Plain Rubber Hose from Kinking.....	289
American Naval Progress, by L. William Thavis.....	253	Automatic Porch Light.....	290
Gas-Driven Cargo Ship.....	255	Tool for Boring Large Holes in Boiler Plate.....	290
Hot Coppers for the Crowd.....	255	Elevated Center for Large Radii.....	291
Oil Fire at Bayonne, N. J.....	256	Home-Made Floor Scraper.....	291
Peary's Ship to Join Wrecking Fleet.....	256	Foundation Supports.....	291
Increasing Demand for One-Dollar Bills.....	257	Shaft Hanger Repair.....	291
Bas-Reliefs Made with the Camera.....	257	A Simple Thief Catcher.....	292
Child Swallows Brooch and is Fed Cotton.....	257	Stock Rack for the Shop.....	292
Japanese Modes in Hair-Dressing.....	258	Lining Cement Cisterns with Paraffin.....	292
Airship Shops Employ Most Skillful Artisans.....	260	Binding-Posts Used for Trammel Points.....	292
Testing the Parts of the New Quebec Bridge.....	262	Simple Mottling Process for Tool Steel.....	293
Hopples for the Hobble-Skirted.....	262	Needle for Lacing Bicycle Tires.....	293
Benzine as Automobile Fuel.....	262	Turning "Springy" Stock in a Lathe.....	293
Stenciling with a Paint Sprayer.....	263	A Wood Cutting-Off Tool.....	293
The Tallest Barber Pole.....	263	Coat and Hat Hanger for Campers.....	294
Combined Cutting and Suction Dredger.....	264	Tool for Cutting Tenons.....	294
A Stamp with Every Key Tag.....	264	Cement Concrete Vats and Tanks.....	294
What Airmen Think of Safety Devices.....	264		
Raising Bramah Cattle in Texas.....	264		
Playing Piano under Difficulties.....	265		
To Explore New Guinea in Balloon.....	265		
An Eiffel Tower of Handkerchiefs.....	266		
Cross-Country Telegraph Letters to Europe.....	266		
Customs Inspectors Hold Up Royalty.....	266		
Collapse of Concrete Building.....	267		
Acorn Food Supplies of the California Indians.....	268		
Navy Seeks to Prevent Submarine Disasters.....	269		
Device for Measuring Cylinder Bore.....	269		
Turning Lamp Fork for Automobiles.....	269		
Intrinsic Brilliance of the Sun.....	269		
Climbing Mount Blanc No Easy Task.....	270		
Memphis Plans Protection against Short Weight.....	271		
An Old-Time Boiler.....	271		
Grain in Wood Resembles Head of Animal.....	271		
Reflected Light for Operating Rooms.....	272		
What a 1,200-Lb. Dynamite Blast Looks Like.....	272		
Reservation Indians Use the Automobile.....	273		
If an Airman Dropped a Monkey Wrench.....	273		
Directing the Aim of the Gunners.....	274		
French Biplane on Monoplane Lines.....	274		

SHOP NOTES

Bending Wood.....	275
Cutting Plugs for Filling Screw Holes.....	275
A Paper Drinking Cup.....	275
Hanging Ingrain Paper.....	275
Combination Ladder.....	276
Tool for Cutting Fiber Washers.....	276
Exhaust Cutout for a Motorcycle Engine.....	277
Home-Made Steam Trap.....	277
Roller Bearings for Bureau Drawers.....	277
Rolling a Band-Saw.....	278
Testing an Electric Meter.....	278
Strainer in Oil-Can Spouts.....	278
Remedy for Damp Walls.....	279
How to Fasten Pipe into Hose.....	279
Unloading Device.....	279
Home-Made Instantaneous Water Heater.....	280

AMATEUR MECHANICS

Clay Flower Pots Used for Bird Houses.....	295
How to Make Rope Grills.....	295
A Simple and Effective Filter.....	296
How to Build an Ice-Yacht.....	297
Turning Lights On and Off from Any Number of	
Places.....	300
How to Make an Electric Pendant Switch.....	300
Wood-Working for Beginners.....	301
Viewing a Scene for a Photograph.....	304
Removing a Stamp by Steaming.....	304
Knife Made from a Hack-Saw Blade.....	305
Killing Mice and Rats.....	305
Roller Coaster Illusion Traveling Up an Incline.....	305
Block for Planing Octagonal Wood Pieces.....	305

INTERESTING PATENTS, PRACTICAL OR
UNIQUE

Gas Heater.....	306
Hog Yoke.....	306
Calf Weaner.....	306
Potato Gatherer.....	306
Ingenious Cuspidor.....	306
Automatic Watering Trough.....	306
Shoe-Salesman's Stool.....	306
Apparatus for Filling Trenches.....	306
Saddle-Spring for Motorcycles.....	306
Mouth Gag for Use When Working on Horses'	
Teeth.....	306
Massaging Apparatus.....	307
Button-Hook for Collars.....	307
Electric-Light Bulb.....	307
Tree-Felling Saw.....	307
Automatic Stop for Phonographs.....	307
Automatic Poultry Duster.....	307
Side-Discharge Dump-Wagon.....	307
New Books.....	307
Jokes.....	308

Can you afford to be without

Everyman's \$485 The Brush Runabout Car

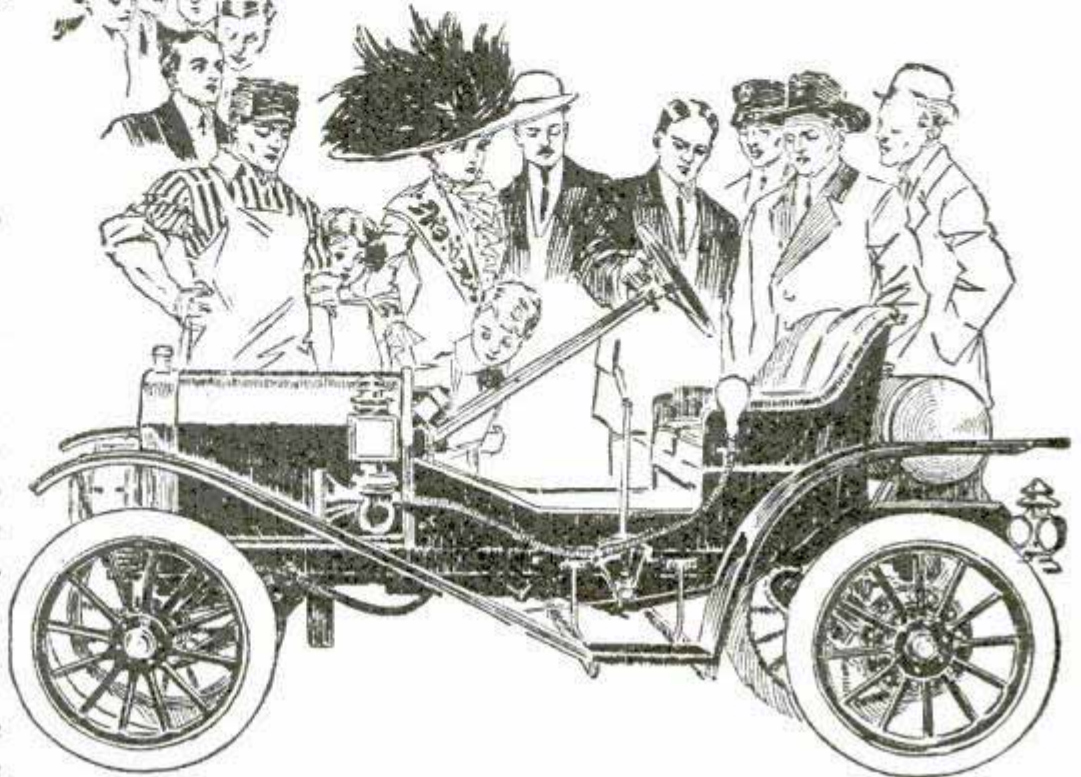

WITHOUT a car, you are paying a penalty in time lost, in energy wasted, in healthful recreation missed. You don't need a big, high-powered, high-priced car—expensive to buy and more expensive to run—to enjoy the convenience, the pleasures of an automobile. The Brush Runabout costs scarcely a cent a mile to run—less than a horse and buggy. It is not only a dependable motor car, but will “earn its keep.” It is not a mere pleasure car; it is a “utility” car—a business asset six days of the week, an economical means of recreation outside of office hours.

The Car for Every Man

The business man—You can get to your office quicker than by street car, cheaper than by train, and the fresh morning air will fit you for the day's work. Then you can keep the car busy all day, calling on customers, delivering goods, running errands.

The salesman—You can make more calls in a day, cover more territory, carry samples easily and comfortably.

The physician—You can make your calls in half the time it now takes; reach your emergency cases quicker, and have more time for study and recreation or for your own family.

The farmer—You can use the Brush in numberless ways—going to town, “getting 'round” the farm, taking produce to market and bringing back the supplies. The women folks can use the car for visiting or shopping, or the children for going to school.

Any man who uses any means of transportation in the performance of his duty—any man who wants to live in the country without being tied to a time table—the Brush is the car you should have.

Proved by Service Tests

Ten thousand Brush owners have proved these qualities in its daily use—have learned the adaptability of EVERYMAN'S CAR for business or pleasure.

Let them tell you what the Brush is doing for them, and how little it costs them. Send a post-card for catalogue.

BRUSH RUNABOUT COMPANY, 286 Rhode Island Avenue
 Division of United States Motor Co. Licensed under Selden Patent,
 DETROIT, MICHIGAN.

Please Mention Popular Mechanics



Would You Pay \$2 a Month for a Better Salary?

—for a chance to show what you're REALLY WORTH. Would you pay \$2 a month for the difference between failure and real achievement, between a common job and a BIG SUCCESS?

Then Sign the Coupon

on this page—sign it without obligating yourself to spend one penny—and let us send you a work that will give you that vitally important knowledge of practical affairs that **COMMANDS** a good salary wherever you are; a work that every railroad employee, every man, in the engineering and construction departments of every industrial enterprise, every foreman, and superintendent in mill and factory, should carefully read and study.

The Cyclopedia of Civil Engineering

is not a collection of theories, but the actual, crystallized, tried and tested experience of the greatest railroad and industrial engineers. It is not a dictionary of disjointed facts, not a dry and technical work, but a clear and simple exposition of every phase of practical engineering. For these eight volumes teach the handling of men as well as the strength of stone and steel; they describe modern feats of irrigation as well as the building of mills and factories; the latest triumphs of cement and concrete construction as well as the laying of tracks of steel over mountain and plain. These eight meaty volumes are handsomely bound in half Morocco and contain 3908 pages, with over 3000 illustrations, folding maps, diagrams, etc.

We want you to at least SEE these books. We want YOU to judge their worth. We want to send them to you at OUR risk, for you to examine at your leisure, and then if you don't believe them to be ACTUALLY WORTH TWICE THE INTRODUCTORY PRICE WE ASK, if you don't believe them to be worth to YOU IN COLD DOLLARS AND CENTS TWELVE TIMES \$2.00 a month, then simply send them back within five days at OUR expense AND THE TRANSACTION WON'T COST YOU ONE PENNY.

For a short time we will include as a monthly supplement, for one year, the **TECHNICAL WORLD MAGAZINE**. This is a regular \$1.50 monthly, full of Twentieth Century Scientific Facts, written in popular form.

Some Important Subjects Covered

- Handling Men
- Figuring Costs
- Strength of Floors
- Strength of Walls
- Strength of Beams
- Roof Trusses
- Roof Coverings
- Ventilation
- Steel Construction
- Masonry
- Plane Surveying
- Mechanical Drawing
- Railroad Engineering
- Building Roadbeds
- Tunnel Construction
- Railroad Finance
- Bridge Building
- River and Harbor Improvements
- Wind Pressure and Snow Loads
- House Drainage and Sanitation
- Cement and Concrete Building
- Water Power and Water Supply
- Irrigation Engineering
- Hauling Power of Locomotives
- Highway Construction

American School of Correspondence CHICAGO, U. S. A.

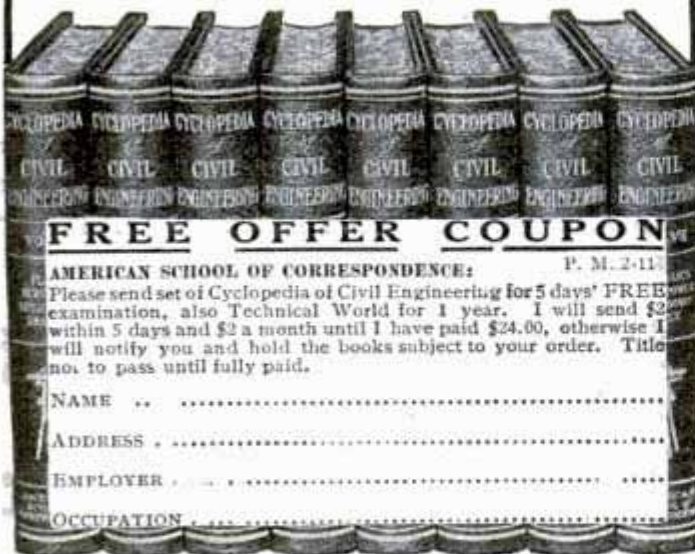

FREE OFFER COUPON

AMERICAN SCHOOL OF CORRESPONDENCE: P. M. 2-114
Please send set of Cyclopedia of Civil Engineering for 5 days' FREE examination, also Technical World for 1 year. I will send \$2 within 5 days and \$2 a month until I have paid \$24.00, otherwise I will notify you and hold the books subject to your order. Title not to pass until fully paid.

NAME ..
ADDRESS ..
EMPLOYER ..
OCCUPATION ..

Please Mention Popular Mechanics

word Business Booklet, which tells how priceless Business Experience, squeezed from the lives of 112 big, broad, brainy business men, may be made yours—yours to boost your salary, to increase your profits. This free booklet deals with

- How to manage a business
- How to sell goods
- How to get money by mail
- How to buy at rock-bottom
- How to collect money
- How to stop cost leaks
- How to train and handle men
- How to get and hold a position
- How to advertise a business
- How to devise office methods

Sending for this free book binds you to nothing, involves you in no obligation; yet it may be the means of starting you on a broader career. Surely you will not deny yourself this privilege, when it involves only the risk of a postal—a penny! Simply say, "Send on your 9,059-word Booklet." Send to **SYSTEM, Dept. 81-2, 151-153 Wabash Avenue, Chicago**

ANTI-NICOTINE PIPE

"Get the Pleasure Without the Poison"
(Trade Mark Reg.)

40c 3 FOR \$ 1.00



PIPE

THE PIPE THEY LET YOU SMOKE AT HOME

Looks and colors like meerschäum. Absorbs the nicotine and keeps on tasting sweet. You never had such an enjoyable smoke. Sent prepaid anywhere. Money back if not satisfactory.

Order 3 or More Today

H. MENGES, The Smokers' Friend
605 N. 7th St. ST. LOUIS, MO.

WHEN YOU WANT ANYTHING AND DON'T KNOW WHERE TO FIND IT
WRITE BUREAU OF INFORMATION, POPULAR MECHANICS CHICAGO

FREE UPON REQUEST

OUR

Valuable 96-Page Catalogue

OF THE

Best Mechanical Books

It is well worth having and keeping for reference.

Popular Mechanics Book Dept.
225 Washington Street, Chicago

COMPLETE FILES OF

Popular Mechanics Magazine

FOR 1910

Consisting of the twelve issues of the magazine and a very complete index. Suitable for binding. Supply limited.

May be had while they last at the price of \$1.50 postpaid.

Popular Mechanics Co. 225 Washington St. CHICAGO



PROF. HENRY DICKSON

Principal Dickson School of Memory. The Largest and Most Successful School of Mental Training in the World

"How to Remember"

A Valuable Book on Memory Training Absolutely Free to Readers of Popular Mechanics

If you want a perfect memory, you can have it; for a perfect memory, like perfect health, can be acquired. Here is a book that tells you exactly how to get it.

The author, Prof. Dickson, is America's foremost authority on mental training. His book is clear, specific and intensely interesting. He explains how you can easily and quickly acquire those retentive and analytical faculties, which contribute so much to all social, political and business success. He offers you a valuable opportunity to investigate the benefit of memory training for yourself—without assuming any risk, obligation or expense.

Simply sign and mail the coupon below—or send a letter or postal—and this book will come forward to you at once, absolutely free and postage prepaid.

Who is Prof. Dickson?

Prof. Dickson is backed by reputation and experience as a teacher, extending over twenty years in the leading Universities and Schools of the day.

Personal contact with thousands of pupils impressed him with the fact that each one was hampered by the same deficiency—a marked absence of proper powers of Attention, Concentration, Retention, Self-Control, Memory, etc. **He was one of the first educators** to discover the universal and primary need of the cultivation of these faculties, preliminary to the attempted acquisition of knowledge. **He was the pioneer** in the application of this newly discovered principle that no matter what course of training the student intended to take up later, these drills of the faculties of memory were absolutely necessary as preliminary training. His students learned so much more easily and so thoroughly retained their acquired knowledge, that his method attracted world-wide attention. The result was the foundation of the Dickson School of Memory.

What Prof. Dickson Has Done

The fame of this school and its unique methods has spread over the country. To date over 40,000 enrollments have been recorded and successful graduates fill every walk of business and professional activity. While the weakest minds can be strengthened, it must not be imagined that this method is applicable only to this class. Many of the most intellectual men of the day have availed themselves of Memory Training. W. T. Harris, former U. S. Commissioner of Education—the late Col. Robert Ingersoll, Mark Twain, and thousands of like minds have testified to the great benefit to be derived from Memory Training.

How He Can Help You

Thousands of successful men in all walks of life gratefully testify that they owe the consummation of their highest ambitions to his teachings, and he surely can help you—no matter who or what or where you are.

- He teaches you
- How to remember names and faces of people you meet.
- How to focus your mind instantly, to use effectively the points of a business proposition.
- How to recall small but vital points of business without burdening the memory.
- How to commit a speech or toast to memory quickly, and deliver it unhesitatingly in public or private.
- How to think on your feet and make an extemporaneous speech.
- How to converse at social gatherings in a natural, interesting way that wins friends.
- How to overcome self-consciousness, bashfulness, etc.
- How to control your thinking faculties.
- How to apply concentration to the subject at hand.
- How to acquire the habit of easy, logical thinking.
- How to memorize for studies, examinations, etc.

Highly recommended by Elbert Hubbard, Prof. David Swing, Dr. Latson, and thousands of others

Fill out coupon, tear out, mail TODAY, or send postal

DICKSON MEMORY SCHOOL
705 Auditorium Building, Chicago, Ill.
Send me free "How to Remember."

NAME _____

STREET _____

CITY _____

STATE _____

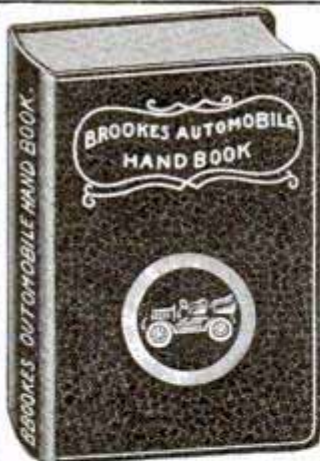

THE AUTOMOBILE HANDBOOK

By L. Elliott Brookes, assisted by other well-known experts. Revised and enlarged 1911 Edition—The largest and most practical work published. Used by all up-to-date automobile schools as their every-day text-book, 16mo, over 650 pages and over 320 illustrations. Full Leather Limp, Round Corners, Red Edges, Size, 4½ x 6½. Price, \$2.00

Just from the Press

1911 EDITIONS

"No obsolete methods." No "Musty" rules from bygone authorities.

MOST complete and up-to-date works ever issued on the operation, care and repair of automobiles. No experiments suggested whatsoever. The practical text pertains to present day methods—methods which produce a maximum result. Every essential point is thoroughly covered. These points easily place the books in a class by themselves. They are a complete course of instruction for the owner, operator, mechanic or student. They cover the subject thoroughly, are well illustrated and printed in large, readable type. The bindings are in full leather, stamped in gold, round corners, red edges, specially made in pocket size so they can be "on the job" at all times.

Sent prepaid on receipt of price to any address. If both volumes are ordered at one time, price \$3.00. Sold by booksellers generally, or sent prepaid upon receipt of price.

FREDERICK J. DRAKE & COMPANY, Publishers
1325 N. Michigan Avenue CHICAGO, U. S. A.

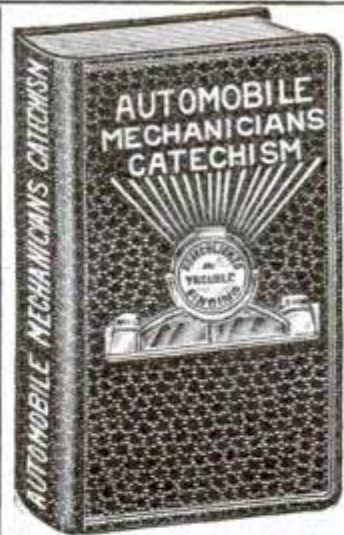

The Automobile Mechanician's Catechism
Over 400 Questions and Answers. Illustrated with 3 large folding charts with all parts fully and correctly numbered. By Calvin F. Swingle, M. E. Pocket Edition, 16mo, Full Leather, Round Corners, Red Edges. Stamped in gold, over 100 pages. Size 4½ x 6½. Price, \$1.25.

The Sebastian

15-Inch Standard High Grade
Low Price ENGINE LATHE

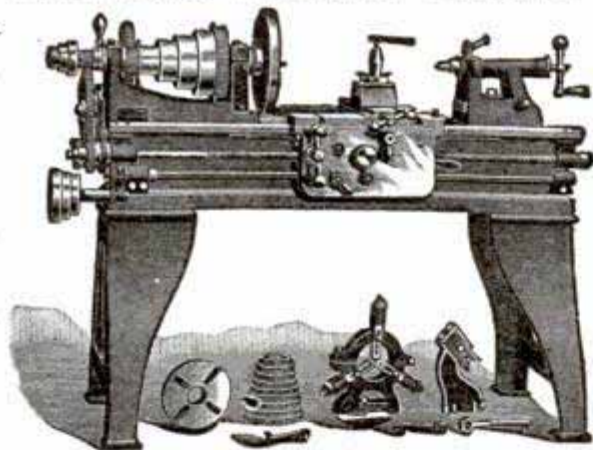

Automobile Builders, Garages, Repair Shops and General Jobbing Shops find this the Ideal Lathe for their work. Our Catalogue of Lathes and Tools Mailed FREE on request.

THE SEBASTIAN LATHE CO., 107 Culvert Street, CINCINNATI, O.

ENGINEERS, DRAFTSMEN

and all others who have lettering to do need a good system of easy lettering.

HERE IT IS

CONTENTS:

BLOCK LETTERS:
Heavy, Outline, Condensed, Expanded, Fancy, Shaded and Italics.
GOTHIC:
Condensed, Expanded, Italics.
ROMAN:
Fancy, Italics.
SCRIPT: MODERN
ARCHITECTURAL



A new edition has just been issued with a supplement containing 8 new alphabets

*Well printed on good paper and handsomely bound in cloth.
Sent postpaid on receipt of 55 cents.*

Spon & Chamberlain, 123 P. M. Liberty St. NEW YORK, U.S.A.



127 KINDS IRON PUZZLES

Sample, secret key and 36 page book of cuts of all 10c, 3 leaders 25c
WESTERN PUZZLE WORKS
St. Paul, Minn.

Two Excellent Books for Those Who Like to Make Things

Amateur Mechanics Nos. 1 and 2

PRICE 25 CENTS EACH POSTPAID

Popular Mechanics Book Department 225 Washington St. CHICAGO



A SCHOOL WITHIN ITSELF

There are XX chapters in all, XIX carrying you from the fundamental principles of electricity on through the various branches to a point where the careful student comprehends the complete designing, care and operation of a dynamo or motor, and one chapter on electric automobiles, outlining their construction, care and operation, and all about storage batteries and how to handle them. Each subject is carefully written and to the point. After a student studies a subject, he is questioned on that subject in such a manner as to bring clearly to his mind the points he needs to know regarding same. The book contains a dictionary defining 1500 Electrical Words, enabling the reader to ascertain the meaning of any electrical word, term or phrase used in this book, as well as hundreds of others in common use. All required tables necessary in the study are in it.

\$2.00 PER COPY—FIFTH EDITION—26,000 COPIES SOLD.

The offer we make of refunding money if book is not satisfactory upon examination is AN UNUSUAL ONE in connection with the sale of a book. But we have no fear of its return. Your decision will be what thousands of others have been. Money would not buy it if it could not be duplicated. We could print testimonials by the hundreds. It is best to order and be your own judge of its merits.

CLEVELAND ARMATURE WORKS, Cleveland, Ohio

Armatures and Fields Wound—Commutators Filed
AMERICA'S GREATEST REPAIR WORKS

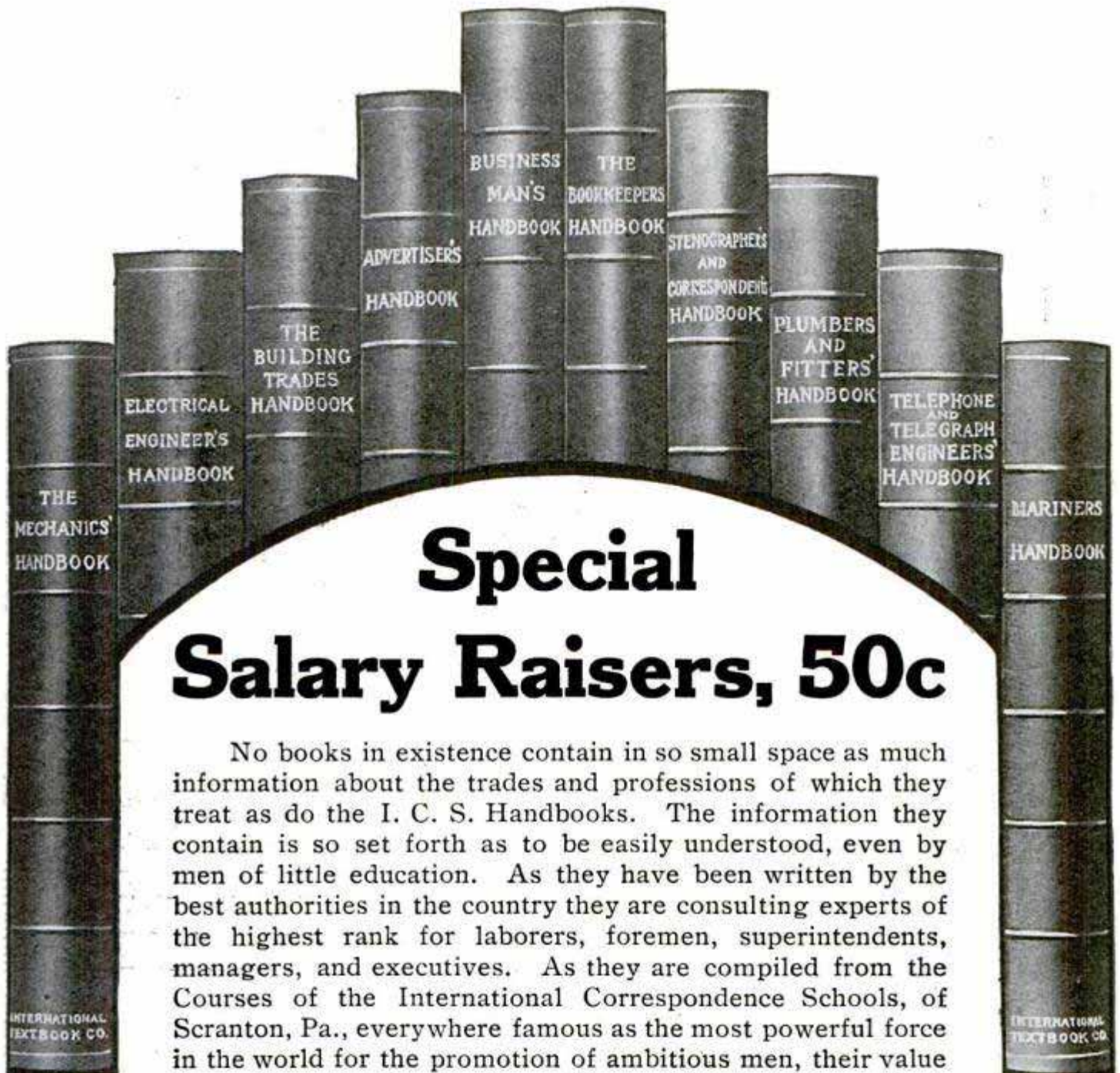

Special Salary Raisers, 50c

No books in existence contain in so small space as much information about the trades and professions of which they treat as do the I. C. S. Handbooks. The information they contain is so set forth as to be easily understood, even by men of little education. As they have been written by the best authorities in the country they are consulting experts of the highest rank for laborers, foremen, superintendents, managers, and executives. As they are compiled from the Courses of the International Correspondence Schools, of Scranton, Pa., everywhere famous as the most powerful force in the world for the promotion of ambitious men, their value to employes in subordinate positions will be quickly realized.

They are an indispensable help to quicker work that will command advancement. Every important item is indexed with all the initial letters under which it is likely to be sought. They are printed on high-grade book paper in clear type, and durably and handsomely bound in cloth with gilt titles. They contain on an average 364 pages and 175 illustrations and are regularly sold for \$1.25.

Special Offer: To better introduce the value of I. C. S. Textbooks and I. C. S. Training we will sell these books for a limited time to those sending to us this coupon and 50 cents.

International Textbook Co.

Box 872-P, SCRANTON, PA.

I enclose \$_____ for which please send me the books before which I have marked X.

- | | |
|---|---|
| <input type="checkbox"/> Mechanics' Handbook | <input type="checkbox"/> Advertiser's Handbook |
| <input type="checkbox"/> Elect. Eng. Handbook | <input type="checkbox"/> Business Handbook |
| <input type="checkbox"/> Bldg. Trades Handbook | <input type="checkbox"/> Bookk'per's Handbook |
| <input type="checkbox"/> Plumb. & Fit. Handbook | <input type="checkbox"/> Sten. & Corr. Handbook |
| <input type="checkbox"/> Tel. & Tel. Handbook | <input type="checkbox"/> Mariners' Handbook |

Name _____

St. and No. _____

City _____ State _____

Publication Date Changed

COMMENCING with this [February] issue, Popular Mechanics Magazine will be on sale at news stands and in the hands of mail subscribers on the 20th of month previous to date of issue instead of the 17th as heretofore.

Popular Mechanics Magazine

READ THIS WONDERFUL STORY

128 Pages.
Bound in Cloth.
Illustrated.

HEAT

Price
Post-
paid, **25c**

By **J. GORDON OGDEN, Ph. D.,** Professor of Physics, Fifth Ave. High School, Pittsburg

Thoroughly Understandable — Instructive — Immensely Interesting

This book consists of a series of articles, each complete in itself, yet all pertaining to heat and its relation to modern mechanics.

FEW people realize that fire is the most remarkable and valuable discovery ever made by man. Prior to this, man was brother to the brute, but with the coming of fire, came all the wonderful development that has enabled man to assert and defend his claim as lord of creation. We are only in the infancy of high temperature development, yet read of the harnessing of intense heat to the wheels of progress; the contrivances whereby we are able to emulate the volcano in our laboratories so far as heat is concerned and weld steel rails in the street where they lie; the discovery of uses of rare metals in industrial lines by aid of heat. Investigation of the realm of low temperatures also discloses some wonderful facts. All these, and many other phases of this interesting subject are treated as shown by the following list of chapters:

1—Nature of Heat and How It Is Measured. 2—How Low Temperatures Are Produced. 3—Some Effects of Low Temperature Upon Matter. 4—The Production and Uses of High Temperature. 5—High Temperatures and the Rare Metals. 6—How Heat Travels. 7—How Heat is Measured. 8—Expansion and Contraction. 9—Energy and Fuels. 10—The Manufacture of Artificial Ice. 11—Steam Boilers and Engines.

POPULAR MECHANICS BOOK DEPARTMENT, 225 Washington St., CHICAGO

25
Fascinating
Volumes
25

The Library of Valuable Knowledge

"The Fairy Tales of Science"

1,000
Unusual
Illustrations
1,000



IN this series of 25 volumes we have successfully met the great demand for a library that will reveal in an interesting and entertaining way the wonders of the universe and the history of man's accomplishment. Eminent scientists have sorted, sifted, and arranged the scientific knowledge of today, and have made some of the most interesting fact-stories that have ever been put into print. The men who prepared these volumes not only knew their subject, but they knew how to present it in a popular and pleasing way. It is just as if you were attending a course of public lectures where a group of eloquent experts were explaining for your benefit the wonderful truths they had learned, making all nature speak to you in a new language and mean something richer and deeper than ever it did before.

Unique—Accurate—Down to Date

Heretofore it has been impossible to get this knowledge in a reliable and accurate shape except from text-books which repel the average busy man or woman. The idea back of **The Library of Valuable Knowledge** is a new and vital one. Becoming absorbed in these volumes, you will find that unconsciously your powers of observation have been quickened and your imagination has been stimulated.

If you will examine "The Story of Electricity," or "The Story of Rapid Transit," for example, you will find that the books have been brought down to date. At the same time, there is no "Sunday newspaper" science here—nothing that has not passed under the eye of an expert and received the stamp of his approval.

"I have not time to go into detail, but suffice it to say that I am so pleased with them that I felt I would be doing you and some more of my thinking friends a great service to let them know about this set, which I think is the finest of its kind that I have ever seen. Those that love nature can scarcely lay one of these books down when once they have begun to read it."

*From a letter to a personal friend of
E. S. CLEM, Instructor in Chemistry,
Fairmont, Minn. High Schools.*

Special Introductory Offer In order to introduce this set of books among people interested in these matters and to promote its sale to them and their friends, we are offering to send the 25 volumes at our own expense for your examination and approval. If they are satisfactory, you may keep them and send us the special, low introductory price in small monthly payments. If they are not, notify us and we shall arrange for their return at no expense whatever to you. Read, fill out, and forward the coupon today, but send no money with it.

THE UNIVERSITY SOCIETY 44-60 E. 23d Street
NEW YORK

25 PROFITABLE 25 FACT-STORIES 25

1. The Story of the Stars
2. The Story of the Solar System
3. The Story of the Eclipses
4. The Story of the Earth
5. The Story of the Earth's Atmosphere
6. The Story of Germ Life
7. The Story of the Plants
8. The Story of Life in the Seas
9. The Story of Animal Life
10. The Story of the Living Machine
11. The Story of a Piece of Coal
12. The Story of a Grain of Wheat
13. The Story of the Cotton Plant
14. The Story of Primitive Man
15. The Story of Extinct Civilizations of the West
16. The Story of Extinct Civilizations of the East
17. The Story of the Alphabet
18. The Story of Geographical Discovery
19. The Story of the Art of Building
20. The Story of Music
21. The Story of Books
22. The Story of Photography
23. The Story of Electricity
24. The Story of Rapid Transit
25. The Story of the Mind

Bound in rich half-leather, dark blue leather backs and linen buckram sides, head-bands and gold backs. Every detail of manufacture will suit the most exacting. Each vol. (7½x5¼) has a complete index.

A mere glance at the authors named below will suffice to convince you of the wealth of learning at your service.

Geo. F. Chambers, F.R.A.S.; Prof. H. G. Seeley, F.R.S.; Douglas Archibald, F.R.M.S.; Prof. H. W. Conn; Grant Allen; Prof. S. J. Hickson; B. Lindsay; Edw. A. Martin, F.G.S.; Hon. W. C. Edgar; Frederick Wilkinson, F.G.S.; Edward Clodd, F.L.S.; Robert Anderson, M.A., F.A.S.; Jos. Jacobs; P. L. Waterhouse, R.I.B.A.; F. J. Crowest; G. B. Rawlings; A. T. Story; John Munro, C.E.; Beckles Wilson; Jas. M. Baldwin, P.L.D., L.L.D., Dr. Sc.

With introduction by William T. Harris, A.M., L.L.D., late U. S. Commissioner of Education, Washington, D. C.

COUPON

CUT THIS COUPON OFF AND MAIL TODAY

The University Society
44-60 E. 23d St., New York

Please send me on APPROVAL, charges prepaid, a set of THE LIBRARY OF VALUABLE KNOWLEDGE, twenty-five beautiful volumes bound in half-leather. If satisfactory, I agree to pay you \$1 promptly and \$2 a month thereafter for eleven months. If not satisfactory, I will notify you. P. M.

NAME

STREET

CITY AND STATE



Portable Reading Lamp

JUST PUBLISHED

Arts-Crafts Lamps

How To Make Them

By JOHN D. ADAMS

16 Beautiful Designs, 25 Cents

AS FOLLOWS:

Two Light Portable—Portable Reading—Four Light Chandelier—Reading Lamp—Dining Room Dome—Porch or Den Lantern—Four Light Chain Hung Chandelier—One Light Portable—Lantern—Drop Light—One Light Bracket—Piano Lamp—Wall Lamp—Electric Candle Sconce—Newel Post Lamp—Chain Hung One Light Bracket.

Plain Instructions—Dimensioned Detail Drawings and Illustrations of Each Finished Design

A handy little working manual of 128 pages, printed on the best quality of book paper and handsomely bound in cloth. Supplied by your newsdealer or may be ordered direct from the publisher

POPULAR MECHANICS BOOK DEPARTMENT, 225 Washington St., CHICAGO

Books for Young and Old Who Like to Make Things

Amateur Mechanics No. 1— 174 Articles
165 Illustrations

Amateur Mechanics No. 2— 193 Articles
196 Illustrations

Mechanics for Young America— 150 Articles
196 Illustrations

These books tell how to make hundreds of different articles of daily use and the directions are "Written So You Can Understand It."

Instructions are given for making such things as Workbench—Wireless Telegraph Outfit—Boats of Various Kinds—Induction Motor—Lantern Slides—Arc Lamp—Motorcycle—Devices for Winter Sports—Electric Locomotive—Aerial Glider—Flash Lamp—Static Electric Machine—Ice Boat—Steam Engine—Bobsled—Induction Coils—Lathe, etc.

Price 25 cents each, postpaid

For sale by all newsdealers or can be ordered direct from the publishers

**Popular Mechanics Book Dept. 225 WASHINGTON ST.
CHICAGO**

Mission Furniture

HOW TO MAKE IT

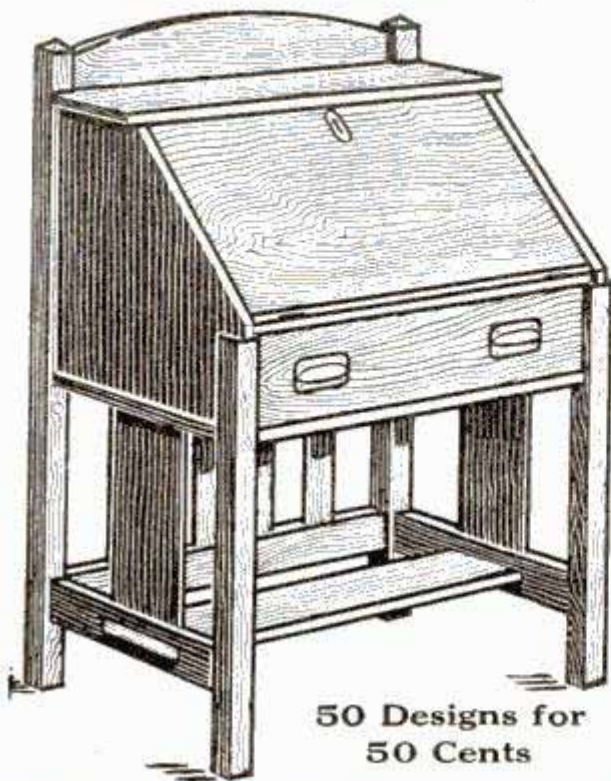

50 Designs for
50 Cents

Read What One Man Did

*Hattiesburg Miss
Aug 19, 1910*

*Popular Mechanics Co.,
225 Washington St Chicago.
Sirs -*

*Please find enclosed
25¢ for which send me
Part Two Mission Furniture
How to make it, by mail post
paid I have part 1, and have
made one pe. of ~~the~~ furniture
and sold \$400.00 Four hundred
dollars worth of it, and I am
not a carpenter either but with
the instructions written so I
can understand it I have a business
of my own, Yours truly
John D. Pleman*

TWO VOLUMES

PART ONE	PART TWO
21 Designs. 96 Pages.	32 Designs. 128 Pages.
Cloth Cover. 25 Cents Each, Postpaid	

POPULAR MECHANICS BOOK DEPT.
225 Washington Street, CHICAGO

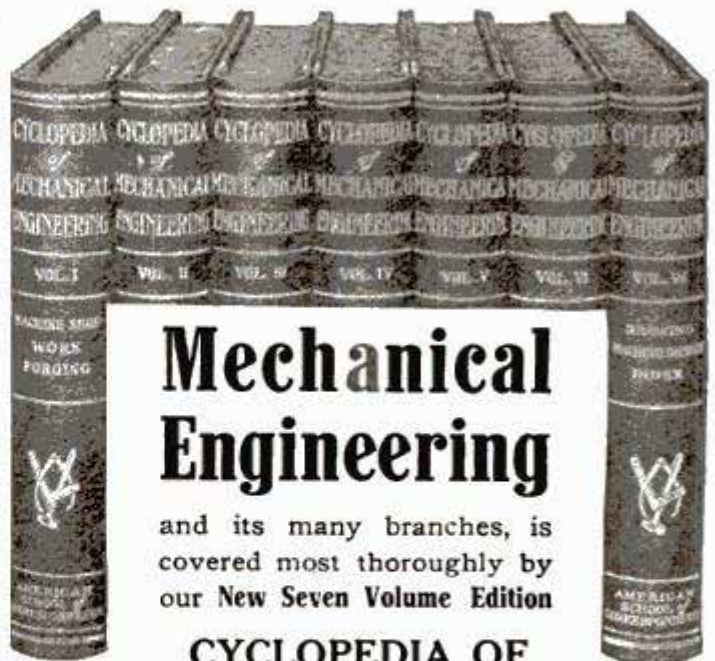

Mechanical Engineering

and its many branches, is covered most thoroughly by our New Seven Volume Edition

CYCLOPEDIA OF

Mechanical Engineering and Modern Shop Practice

These seven great volumes contain 2,992 seven by ten inch pages of information which is of vital interest to every progressive mechanic.

In this wonderful work will be found instruction in Machine Shop Work; Assembling of Machinery; Tool Making and Shop Management in such simple and comprehensive form that the student cannot fail to benefit by it. Every detail of mechanical engineering is thoroughly analyzed and treated, rendering the books of unusual value to the experienced mechanic and shop manager, as you will note by reading "Subjects Thoroughly Covered."

The Cyclopedias are supplemented with a series of practical test questions and includes over 2,000 full-page plates, illustrations, tables, formulas and "shop kinks."

TO PROVE THEIR VALUE

We will send you the complete Cyclopedias absolutely free for examination—just mail the coupon. Keep the books five days—apply the principles to your work—test every formula. You will agree that they are all we state, and more. Send \$2.00 after examination and \$2.00 a month until you have paid the special price of \$18.80. The regular list price is \$36.00. If the books do not meet with your requirements, advise us and we will remove them at our expense.

Subjects Thoroughly Covered

Machine Shop Work—Vertical Milling Machine—Motor-driven Shops—Shop Lighting—Forging—Electric Welding—Tool Making—Metallurgy—Manufacture of Iron and Steel—High-Speed Steel—Flaws in Castings—Electric Lifting Magnets—Magnetic Clutches—Making a Machinist—The Ideal Foreman—Pattern Making—Foundry Work—Automatic Coal and Ore Handling Appliances—Machine Parts—Construction of Boilers—Types of Boilers—Boiler Accessories—Steam Pumps—Air Compressors—The Steam Engine—The Steam Turbine—Indicators—Valve Gears—Refrigeration—Gas Producers—Gas Engines—Automobiles—Elevators—Sheet Metal Work—Practical Problems in Mensuration—Mechanical Drawing—Drafting Room Organization—Machine Design.

SPECIAL OFFER IF YOU MAIL COUPON PROMPTLY For a short time we will include, as a monthly supplement, for one year, the TECHNICAL WORLD MAGAZINE. This is a regular \$1.50 monthly, full of Twentieth Century Scientific Facts, written in popular form. Also contains the latest discussions on timely topics in invention, discovery, industry, etc.

Free Examination Coupon

American School of Correspondence, CHICAGO, U. S. A.

Please send set Cyclopedias of Mechanical Engineering for 5 days' free examination. Also Technical World for 1 year. I will send \$2 within 5 days and \$2 a month until I have paid \$18.80, or notify you and hold the books subject to your order. Title not to pass until fully paid.

NAME.....
ADDRESS.....
OCCUPATION.....
EMPLOYER.....

FIELD FOR DRAFTSMEN

This Page taken from *Popular Mech.* Advertising Section Jan. 1910

Big Demand for Mechanical Draftsmen. Positions Paying \$100 to \$150 Per Month

It is perhaps not known to many Readers of Popular Mechanics, but especially to the ambitious, wide awake, and progressive ones and to the large number of Mechanics reading this paper that there is no better field or opportunity for advancement than there is to the practical and well trained Mechanical Draftsman.

But not that man is wanted who has the largest or most expensive library of technical school books "at home," neither the one that carries along with him under his arm when applying for a position a nicely engraved "beautiful Diploma" on paper (costing \$50 to \$75 per sq. ft.) nor the "would be" Draftsman that can "copy" a nice looking picture from another picture with given dimensions.

No, the demand is for Draftsmen with practical Drafting Room training that can "Do Things," Do it "themselves," and Do it right away "Right."

No Employer cares for your Diploma, neither for your set of nice "Books at Home" in your Book-case. He wants you to "Deliver the Goods" for the money he pays. To Draw \$100—\$150 per month, the average Salary paid to Draftsmen, you must be able to do more than "Only make a Copy" of someone else's drawing. Originality and practical ability is demanded of you and this requires practical training.

The quickest and best way to be trained on practical Drafting Room work and to get the required practical experience is to receive personal and individual Instruction from a High

Grade practical man at the trade, with a reputation as the most experienced man in training men to become COMPETENT and SUCCESSFUL DRAFTSMEN.

An ordinary Draftsman, not even the best Draftsman can teach this trade unless he has many years of experience as an Instructor, and has ability to impart knowledge that is understood and that will stick forever. A special gift that 99 out of 100 do not have.

Mr. P. Dobe, Chief Draftsman of the Engineers Equipment Co. (inc.) Chicago, with 20 years experience in training and handling men has for a good many years given personal individual Instruction by mail with the most deserving success, because his Instruction work consists of actual practical Drafting Room work that gives his personal student and apprentice the required practical experience.

He treats each student personally and gives him individual practical working instruction according to the ability of the student to master the work and to advance. His instruction is not given as patent medicine the same for all alike, and his personal assistance is very valuable to anyone.

Mr. Dobe has been an advertiser in this paper for a good many years and will send his "Successful Draftsmanship" Prospectus, 6x9, also list of 250 open Draftsmen positions and full information free. Anyone earnestly interested should write to him personally, his advertisement appears on last page of this book.

Read it over again *Every Word true*

NOTICE



I accept for instruction only a limited number of desirable and success-promising students, and not, like schools do, anybody and everybody that can pay the price.

Please Mention Popular Mechanics

Read my advertisement on last page

Read my advertisement on last page

Classified Advertisements

Advertisements in this section, 10 cents per word, payable in advance. To insure ads being inserted under proper classified head in the March issue, copy must reach this office not later than February 1st.

Syracuse, N. Y., December 17, 1910.

Popular Mechanics Magazine, Chicago.

Gentlemen: In reply to your letter of recent date regarding my classified advertisement, I wish to say that I inserted the same advertisement in five magazines, and pulled five times as many orders and replies from the Popular Mechanics Magazine as I did from all the rest of the magazines combined. The Popular Mechanics Magazine is a far better advertising medium than the largest New York papers or any other magazine that I have come in contact with. I hope to be in a position to use space elsewhere in the Popular Mechanics Magazine. It is my sincere wish that the year of 1911 contains for you a full measure of prosperity.

Sincerely yours,

CLARENCE A. HARDAGE.

AUTOMOBILES

BUICK MODEL 10, 1910 Roadster with rumble seat. Brand new with regular equipment including magneto. Will sell at agent's price \$800.00. Five Passenger White Steamer, 1907 Model, in good running order with wind shield and full equipment \$490.00. The Osborne & Sexton Mch. Co., Columbus, O.

TOURING CAR—5 Passenger; 22-hp. Shaft Drive, 34-inch wheels. Tires good. 104-inch wheel base. Photo. Price \$350. Fred Zoll, Findlay, Ohio.

AUTOMOBILE INSTRUCTION, four weeks' course covering shop and road work—provision for out-of-town men. Send for booklet P. M. West Side Y. M. C. A. Automobile School, 318 West 57th St., New York City, N. Y.

CRAIG-TOLEDO ROADSTER, with 40-hp. Continental motor, Elsemann magneto, Hoffecker speedometer, clock, 36-in. wheels, Prest-O-Lite tank; 1907 model which sold for \$4,000; price \$600. A. S. Lee, 52 Richmond St., Providence, R. I.

AUTOMOBILES—Over Four Hundred Bargains \$95.00 upward. All guaranteed. Freight prepaid. Write now for Latest Illustrated Bulletin. Motor Car Exchange, Dept. C-215, West 125th St., New York City.

"CADILLAC"—5 PASSENGER Touring Car. Top, windshield, lamps, etc. Ready to run. Photo. Price \$400. Jackson's Garage, Findlay, Ohio.

MAGNETO—Suitable for up to 50 hp. motor. In first class shape. Cheap. Harry Fleishman, Albany, N. Y.

"MAXWELL" RUNABOUT. Good as new. Double seat rear, detachable, 2 or 4 passenger. 14 hp. Tires good. New paint. Guaranteed. Photo. Price \$450. Fred Zoll, Findlay, Ohio.

RUNNING GEAR COMPLETE with tires, body, etc. (Shaft drive.) Excellent condition, \$85.00. Geo. E. Buss, New Philadelphia, Ohio.

FOR SALE or Exchange an Oldsmobile runabout. Harry Felton, Woodbury, Pa.

STEAM CAR Correspondence School. Particulars sent. 520 Fourteenth St., Denver, Colo.

BUICK "MODEL F." 5-Passenger Touring Car. 24 hp. Full lamp equipment. Top, tools, \$50 speedometer. Tires good. Photo. Price \$500. F. J. Collingwood, Findlay, Ohio.

FOR SALE—Waverley Electric Stanhope, in good condition throughout; battery new last spring. A bargain. \$350. A. S. Lee, 52 Richmond St., Providence, R. I.

FOR SALE—Automobile less power plant, also engine and transmission. George C. True, Clinton, Maine.

1906 MODEL FRANKLIN Light Touring car, in excellent condition; new motor, carburetor, etc. Has top, windshield, gas tank, gas and oil lamps, horn and extra tire. Price \$300. Also '09 model M. M. 3½-hp. motorcycle, has Bosch magneto, in perfect shape, a bargain at \$100. Light & Ice Co., Flemingsburg, Ky.

FOR SALE—One 1909 Model O White Steamer; one late 1908 Model L White Steamer. Both cars fully equipped. Cars right. Prices right. You write Parrett Machine Co., Wenona, Ill.

HOLSMAN HIGH-WHEEL RUNABOUTS—1910 Model, top, complete equipment. A 1 condition, \$225. Also 1909 Model, good condition, \$195. H. P. Finks, Ft. Smith, Ark.

AUTOMOBILES at very lowest prices. List and catalogue for stamp. Rubel Co., Louisville, Ky.

NEW YORK MOTOR CAR and Cycle Exchange Touring Car Steamer, White system 1908 Model, perfect condition, sacrifice \$225, cost \$2,000. Write for photograph. Motor Car Exchange, 215 West 125th St., New York City.

AUTOMOBILE BUYERS, don't get stuck. Consult an expert before buying. Arthur E. Pray, 618 Colonial Bldg., Boston, Mass. Telephone, Newton West 184-2.

FOR SALE—Runabout, less motor. M. Chamberlain, Bartley, N. J.

FOR SALE OR EXCHANGE—4 cyl. Mitchell. Want 1910 Motorcycle. L. J. Voorhees, Sonestown, Pa.

REMODELED STEAM LOCOMOBILE in good running condition, tires good, price reasonable. 11 Ernst St., Oneonta, N. Y.
ORIENT AUTO \$75.00. A. Wolke, Louisville, Ky.

AUTOMOBILES EXPLAINED so you can understand running and repair. "Homans' Automobiles"—the book that tells you how to remedy trouble, all about carburetors, ignition, lubrication, tires and engine troubles. Highly endorsed. Order today—price \$2 post-paid. Theo. Audel Co., Publishers, 63 Fifth Ave., New York.

AUTOMOBILE BARGAINS—Get our list before placing your order. We will surprise you, 50 bargains from \$100.00 up. Box 275, Burlington, Wis.

"THE HOW AND WHY of the Automobile."—A 200 page book of practical information for seekers after the fundamental facts regarding the gasoline engine and its application to the motor car. Interesting and instructive to both the beginner and the expert. Bound in full cloth—250 illustrations. Price \$1.00 postpaid. Popular Mechanics Book Dept., 225 Washington St., Chicago.

DON'T FAIL TO READ the story of Daimler, the Father of the Automobile, in the current number of Shop Notes Quarterly. There is no fiction in Shop Notes Quarterly, but many readers find it more interesting than any other magazine.

AUTO SUPPLIES

SAVE THE PIECES—Broken cylinders, crank cases, shafts, gears and housings promptly repaired just like new at one-third the cost and guaranteed. Address Welding Dept., Bertschy Motor Co., Council Bluffs, Iowa.

FOR SALE—One gas tank which holds carbonated gas enough to inflate from eighty to one hundred 4 inch tires. Mounted on two wheel truck. Original cost \$45.00, will take \$25.00. Robt. Holmes & Bros., Hazel St., Danville, Ill.

GOING TO BUILD AN AUTO? Steam or gasoline? If so, send for list telling us what you need. J. L. Lucas & Son, Bridgeport, Conn.

THE CINCH REPAIR KIT—Quickest, easiest and most satisfactory method of patching punctures known. No glue or paste. Retail \$5.00. Agents wanted. Send for sample. Union Mercantile Co., Crawfordsville, Ind.

FOR SALE CHEAP—New 4 cyl. 45 hp. motor, sliding gear transmission, \$200. Wheel, axles, frames, radiators, etc. G. H. W., Rm. 18 McCurdy Bldg., Canton, Ohio.

FOR SALE—National 60-gal. gasoline tank mounted on wheels, with pump and register, cost \$250, will take \$125. Robt. Holmes & Bros., Hazel St., Danville, Ill.

MAKE YOUR TWO CYLINDER four cycle engine run like a four cylinder. New method of wiring, and full instructions for fifty cents. Benton Company, Montclair, N. J.

AUTOMOBILE TIRE PUNCTURE repaired permanently in one minute. Agents wanted. Description free. A. D. Ames Spec. Co., Box O, Kirkman, Iowa.

FOR SALE—Parts of four (4) one ton cars, damaged by fire. Cars were built by the largest Commercial Factory in the world and run only a short time. Parts can be bought reasonable. Write for particulars at once. Tyrone Motor Car Company, Tyrone, Pa.

MOTOR TROUBLE DETECTOR and extensive instructions; distinguish ignition miss from valve or carburetor misses, locate and remedy many other troubles for owner or chauffeur, \$1.50. Agents wanted. Geo. H. Taber Mfg. Co., 14th St., Elmira, N. Y.

AUTOMOBILE STEERING WHEEL LOCK just out. Selling rapidly. Attached in a few minutes. Write for circular. Agents wanted in all cities. Sachs, Landers Mfg. Co., Kohl Bldg., San Francisco, Cal.

PUTS VIM IN YOUR MOTOR! Wizard Carbon Remover; quickest, best; formula, \$1.00. Denton, 507 Orange St., Newark, N. J.

STEAM AUTO BOILERS Bought, Sold and Repaired. J. L. Lucas, No. 2 Fox St., Bridgeport, Conn.

MOTOR CYCLES

YOU CAN GET a better motorcycle and save money if you get our large illustrated catalogue of ninety motorcycles for your selection. Every machine in stock guaranteed. Prices very low during winter, enclose three cents, stamps. Rubel Co., Louisville, Ky.

MOTOR CYCLES—Enormous variety of American and Imported makes—Indians, Marsh's, \$35.00. Hundreds of other bargains. Shipped freight prepaid. Write now. Large illustrated bulletin free. Motorcycle Exchange, 215 West 125th St., New York City.

YALE MOTORCYCLES WIN. Better than ever. Old machines taken in trade on 1911 models. Rider agents wanted. Head light outfit "free" for riders' names. English Motor Co., New Castle, Pa.

MOTORCYCLES, \$50 UP. Indians, Royals, Thors, Harley Davidsons, Excelsiors, Wagners, etc.; every one guaranteed; send for bargain list and large motorcycle supply catalogue, repairs, etc. F. B. Widmayer Co., 2312 Broadway, New York City.

MOTORCYCLE FREE ENGINE PULLEY, fits any motorcycle; working drawings and complete instructions 50c. Andee Cycle Works, 148 W. 37th, New York City.

FOR SALE—'07 Yale Motorcycle \$30. '08 Yale \$65. One Baly Breeze Carburetor \$6. A. Jordan, Athens, Ga.

60 SECOND HAND MOTORCYCLES, 3 triars, all bargains. Model Motorcycle Garage, 318-20 W. 48th St., New York.

1910 INDIAN \$150.00. Harley-Davidson \$150.00. Both practically new. W. Robb, Canal Dover, Ohio.

FOR SALE—1910 Indians, 2½. Wm. Leffler, Tiffin, Ohio.

FOR SALE—Yale Motorcycle \$35.00. T. T. Bouling, Hucking, Georgia.

2 1/4 H. P. INDIAN, all remodeled, first \$40 takes it. T. F. Fiorillo, 192 Davenport Ave., New Haven, Conn.

MOTORCYCLES \$35 UP. All makes. Send today for bargain list. Shaw Mfg. Co., Dept. 30, Galesburg, Kansas.

INDIAN MOTORCYCLE cheap. James H. McClellan, Cynthiana, Ky.

FOR SALE—1910 Yale Motorcycle, like new. A. Maes, 200 N. 11th, Terre Haute, Ind.

THE LARGEST CATALOGUE of Motorcycles, etc., ever issued for 10 cts. (coin). Wolke Cycle Co., Louisville, Ky.

1910 ERIE 3 hp. Motorcycle attachment, complete with frame, \$35. Claude E. Hurd, Box 19, Davison, Mich.

CASH for used motorcycles. Rubel Co., Louisville, Ky.

FOR SALE—New Motorcycle, \$135.00. Herman Kaskel, Spencer, Ohio.

MOTORCYCLE BARGAINS—Twin 6 Reading Standard, \$150, Tandem, \$135. 1910 Merkel Light, like new, \$195. Yale, \$65. John H. Hull, Mt. Hope, Pa.

FOR SALE—6 hp. Three Twin. A. Curpin, Findlay, Ohio.

WANTED—Motorcycle. A. J. Wolke, Louisville, Ky.

"CONSTRUCTION, MANAGEMENT & CARE of Motorcycles," new enlarged fourth edition just off the press. Most complete work on Motorcycles ever published. Detail motor drawings, Two-Speed, etc. Prepaid for 25c stamps or silver. Keller & Risque, St. Paul, Minn.

DON'T BUY A BICYCLE Motor Attachment until you get our catalog and prices. Shaw Mfg. Co., Dept. 27, Galesburg, Kans.

DON'T BUY a single Motorcycle part before you get our free catalog listing all Guaranteed supplies, because it will save you money. Motorcycle Equipment Co., Hammondport, N. Y.

SHOP NOTES QUARTERLY—Published four times a year—is full of good reading for motorists. It is the biggest magazine in the world devoted to mechanics, science and practical knowledge. Sold by all newsdealers. 25 cents a copy, \$1.00 a year.

WANTED—Motorcycles of any make. Several Wagners wanted. Give description and lowest price for yours. Shaw Mfg. Co., Dept. 28, Galesburg, Kans.

AERONAUTICS

TO EXPERIMENTERS OF AERONAUTICS we will send Free of Charge the famous Held handmade, bi-plane, glider model also much valuable information on aeroplanes, prices of models, plans, and instructions. Write and you will benefit. 10c for postage. Held Promoting Company, 817 36th St., Oakland, Cal.

BUILD AN AEROPLANE. Send us \$1.00 and we will mail you blueprints and full directions for building a 3-ft. model Antoinette or 2-ft. Bleriot monoplane, or 3-ft. model Wright biplane. Or blueprints and directions for a 20-ft. Glider. Chicago Aeronautic Supply Co., Room 11, 6030 South Park Ave., Chicago, Ill.

MOTOR FOR SALE—One 35 hp. water cooled motor that has made an 800-lb. aeroplane fly. Gives 260-lb. thrust. Weight 165 lbs. Condition guaranteed OK. Price \$500. Write quick if wanted. Address Box 188, Monett, Mo.

COMPLETE, one man dirigible outfit, including hydrogen generators, Curtiss motor, cost \$1,400. Sacrifice at \$300. L. G. Mecklem, Everson, Wash.

AEROPLANE MOTORS, ALIGHTING GEARS, ribs, cloth, in fact, complete illustrated catalogue of material for building any type of flying machine. We have the largest stock and can make prompter shipments than any aero supply house in America. Also manufacture "Gray Eagle Bi-planes," 40 horse power, \$2,000.00, tuition included. Built especially for exhibition use. Aviators can earn \$500.00 to \$2,000.00 per day. Enclose 10c in stamps for large catalogue. Rubel Co., Louisville, Ky.

WE MANUFACTURE TRUE SCREW PROPELLERS that give results. Model propellers any pitch and diameter, laminated on solid, at 50c per inch. Let us develop your model. A. Booth, 8101 Vincennes Road or 7835 Lowe Ave., Chicago.

NEW CURTISS BIPLANE—How to build and fly it. Completely and clearly explained with minute detail in 8vo, cloth-bound book, 60 illustrations: aviation dictionary and other valuable information. Postpaid \$1. Aero, Printers' Building, St. Louis.

WRIGHT BIPLANE or Santos-Dumont Monoplane. Working drawings and description of either, fifteen cents, both for twenty-five. Hibline, 708 Lafayette Ave., Baltimore, Maryland.

BLUE PRINTS AND WORKING DRAWINGS of Curtiss, Wright, Antoinette, or Bleriot aeroplanes. One dollar. Chicago Aeroplane Mfg. Co., Chicago.

HEADQUARTERS—AIRCRAFT SUPPLIES—Big machines and models Wood, wheels, rubber bands, propellers. Chicago Aero Works, 49 Wabash Ave., Chicago.

FLYING ORNTHOPTER, a real wing-flapping machine, postpaid 25 cents. Send for our complete catalogue of model supplies free on request. The White Aeroplane Co., 15 Myrtle Ave., Brooklyn, N. Y.

AVIATION DIRECTORY. Complete classified directory of all Aeroplanes, Aviation Motors, Supplies and Accessories, Manufacturers. Introductory price, 25 cents. L. M. Allison, Lawrence, Kansas.

RIBS, STRUTS AND SPARS. Laminated to order for Aeroplanes and Gliders. W. C. Durgan, 115 Brown St., Syracuse, N. Y.

AERO, PUBLISHED WEEKLY; \$2 a year, 10 cents a copy. Ten weeks trial, 50 cents. Aero, Printers' Building, St. Louis.

BLERIOT MONOPLANE! Guaranteed flyer. Aluminum, bamboo construction. 25c coin prepaid. Agents. Roberts, 344 Cumberland St., Brooklyn, N. Y.

SEE OUR AD under Patents, Atlas Model Works.

AERO SUPPLIES; plain and formed wood; aeroplane and balloon cloth; propellers, motors, books and drawings. Machine built to specifications. First aero supply house in America. Largest stock, lowest prices. Large catalogue 10c. Aeronautic Supply Co., 3932 Olive St., St. Louis.

MOD. 1911, 20 to 30 hp. Aero Engines. Price \$250. 5 1/2 x 5; weight 120 lbs. Complete Monoplanes, \$1,500. Represented at Philadelphia, St. Louis, Chicago and Paris Aero Shows. Catalogues. Detroit Aeroplane Co., Detroit, Mich.

GUARANTEED FLYING MODELS—Latham or Bleriot Monoplanes. 15 styles \$1.00 to \$6.00. Write for catalogue or send \$1.00 now for 18-inch model flying 100 feet. Satisfaction guaranteed. Aero Flyer Company, Box 53, Medford, Mass.

"THE AERO MANUAL"—Compiled by the staff of "The Motor," London, Eng. The first complete handbook on the subject of mechanically propelled human flight. History of the work of aviators and their successes. Special articles on the dynamics of flight. Of absorbing interest to either the novice or the enthusiast. 156 pages. 150 special illustrations. Price, \$1.00 postpaid. Popular Mechanics Book Dept., 225 Washington St., Chicago, Ill.

"VEHICLES OF THE AIR," the newest and only up-to-date contribution to the literature of aeronautics, contains large working plans of all successful modern flying machines. This book of 500 pages, 140 half-tone photographs and 130 drawings is the only book published containing every known fact of this interesting subject. Size, 9x5 1/4 inches. Price \$2.50 net, postage 25 cents extra. Popular Mechanics Book, Dept., 225 Washington St., Chicago.

WORKING DRAWINGS OF THE "DEMOISELLE," Santos-Dumont's remarkable Monoplane, offered to the public for the first time. The set comprises seven large blue prints, showing every detail of construction, unaccompanied by a description of how to build. The machine is unencumbered by patent rights, the famous aviator placing his invention at the disposal of the world. Price \$2.00 postpaid. Popular Mechanics Co., 225 Washington St., Chicago, Ill.

BOOKS AND PERIODICALS

LEARN TO EARN. Books on Modern Subjects and Trades, that show you how to do things. New, up-to-date, written by authentic authorities and fully illustrated. "Operator's Wireless Telegraph and Telephone Hand-Book;" "Flying Machines, Construction and Operation;" "Electricity Made Simple;" "Electroplating Hand-Book;" "Practical Gas Engine Hand-Book;" "Automobile Motors and Mechanism;" "Automobile Troubles and How to Remedy Them;" "Automobile Driving Self-Taught;" "Boat Building for Amateurs;" "Telegraphy Self-Taught;" "Practical Telephone Hand-Book;" "Elementary Chemistry;" "Modern Blacksmithing;" "Modern Carpentry;" "Bookkeeping Self-Taught." 200 to 400 pages. Cloth bindings, \$1.00 each postpaid. Catalogue free. Clarence Hardage, Book-Monger and Publisher, Syracuse, New York.

BOOKS LOANED FREE—BY MAIL—On many subjects; others rented and sold. Occultism, success, business, health, new thought, etc. For conditions, lists, Weekly Bulletin, full information and impartial advice, address Librarian Oriental Esoteric Society, 119, Washington, D. C.

READ MY NEW BOOK on stone, iron and wood fiber concrete. The poor man's gold mine. Price, fifty cents, postpaid. Peter DeLinde, Zion City, Ill.

PRACTICAL BOOKS for Sale and Exchange. Cecil Lutes, Noxen, Pa.

I. C. S. TEXT-BOOKS bought and sold. Geo. F. Williams, Box 408, New Orleans, La.

"POWER OF PERSONAL INFLUENCE." Your latent forces and how to use them. 120 pages, 25c. "Personal Magnetism," containing valuable advice, insuring success in life. 146 pages, 30c. Both, 50c. Catalogue free. August Martens, Bookseller, Burlington, Iowa.

FOR SALE—Several sets "American Cyclopaedia of the Automobile," 6 massive volumes, 3,000 pages, 600 questions and answers. A school within itself. Bound in Red Art Buchram. Latest edition. Brand new, in original box. Publisher's price, \$28.50. My price, \$8.00. Write for special circular. Address Bruce M. Angle, 1211 East 54th St., Chicago.

WEBSTER'S NEW ILLUSTRATED DICTIONARY, 1911 edition. Send prepaid on receipt of \$2.50. Send for circular. F. O. Martin, 12 Minetta St., New York City.

AUTOMOBILE CATECHISM—Being questions and answers showing how to run an Automobile. Leather binding. Postpaid 50c. Thomson-Pitt Book Co., 947-8th Ave., New York.

SWEDENBORG'S "Heaven and Hell." Fifteen cents. 400 pages. Pastor Landenberger, Windsor Place, St. Louis, Mo.

SEND 25c FOR ROADMANS' GUIDE, gives much information, where to buy supplies, etc., to those wishing to engage in Mail Order Work. Thos. A. Hill, 3300 Quivas, Denver, Colo.

WONDERFUL BOOK ON HYPNOTISM, Personal Magnetism and other Occult sciences sent free to anyone. Send your address today. M. D. Betts, Sta. 65, Jackson, Mich.

GAS FOR POWER is taking the place of steam for reasons of economy. Learn all about this great change by reading our new non-technical book on this subject, written by a first class authority for the practical man. 192 pages, profusely illustrated, cloth binding. Price \$1.00 postpaid. Popular Mechanics Book Dept., 225 Washington St., Chicago.

ENGINEERS' questions and answers for license, by Hobson, for twenty-five cents, postpaid. Send stamps. Reilly's Book Store, Philadelphia, Pa.

BOYS' BOOK ON GAS ENGINES—By F. L. Faurote. Every boy should know about the gas engine, because of the very important place it holds in the power world. Here is a book written so boys can readily understand it. Price 25 cents postpaid. Popular Mechanics Book Dept., 225 Washington St., Chicago.

"METAL SPINNING" is the name of the only book published on this interesting art. A concise working manual both for those who desire to spin metal as an art recreation and to follow this work as a trade. 80 pages, 33 illustrations. Price, 25 cents postpaid. Popular Mechanics Book Dept., 225 Washington St., Chicago.

WITHOUT KNOWING SHORTHAND you can write 100 words a minute and increase your income—treble your dispatch of business—save your time. Let me explain to you fully how with my new method, Abbreviated Longhand, any longhand writer can easily become the equal of the average professional stenographer—in a few short evenings—at merely nominal cost. Sample Lesson 20c, and full particulars free. Write to-day. A. B. Weaver, Court Reporter, Dept. C, Buffalo, N. Y.

DRAFTSMEN'S, BUILDERS' and Foremen's Courses. Maack's Architectural Academy, St. Louis, Mo.

LEARN BOOKKEEPING AT HOME for 50c. Its simplicity shown by practical set of books and business forms. For every entry full and clear explanation. No long study, no high tuition. Price 50c, postpaid, by G. Melville, P. O. Box 531, Syracuse, N. Y.

\$2,500 TO \$5,000 annually can be earned in the Real Estate business without capital. We teach you by mail how to qualify for a good position, or how to start a business of your own. Write today for Book "P." It is free and explains our up-to-date methods. United States Real Estate Institute, 500 Fifth Ave., New York.

LEARN DRAFTING. Constant demand for practical men. I give individual instructions by mail. Positions secured for students. Instruments furnished free. G. W. Clair, Box 718, Pittsburg, Pa.

LEARN TO CARVE beautiful flowers, etc., on cardboard. A money-making home employment. Information free. A. W. Dakin, Syracuse, N. Y.

I TEACH UNTIL PROFICIENT—Logarithms, \$3; Trigonometry, \$5; Latitude, 50c; Longitude, \$2.50; Azimuth, \$2.50; Lunar-distances, \$5. Cpt. C. Nielsen, Wilhite, Cal., E. Box 448.

AMERICA'S FINEST PENMAN will send favorite pen free and special prices for lessons by mail. Francis B. Courtney, Box 129, Cedar Rapids, Iowa.

I. C. S. AND A. S. C. sets, odd volumes, encyclopedias, and all technical works. The best textbooks in the world at lowest prices. Save 75% on an I. C. S. scholarship. Geo. F. Williams, Box 408, New Orleans, La.

TOUCH TYPEWRITING EASILY ACQUIRED. So simple a child can learn. A complete home instructor. Outfit, \$2.00. Mayer & Miller Co., 351 Dearborn St., Chicago, Ill.

THE PITTSBURG ENGINEERING COMPANY, Pittsburg, provides long and short courses in Mechanical and Structural draughting. Positions assured.

\$200 to \$600 MONTHLY easily made fitting eyeglasses. Short, easy mail course. Diploma. Special reduced tuition fee. Big demand for opticians. Best and easiest money-making business. Quick sales. Tremendous profits. We assist you to start. Write today for free "Booklet 4." Tells how. National Optical College, St. Louis, Mo.

EDUCATION? Learn typewriting. See what I say under "Typewriters." Atchison.

BEST SHORTHAND BOOK for home study. Thousands of successful stenographers learned from it; so can you! Pitman system complete, cloth bound, handy size, finest engraving; specially arranged for self-instruction. Price \$1. Every book contains coupon entitling the purchaser to receive one month's practical instructions by mail. Lessons given by the author, Eldon Moran, our best known American Shorthand Instructor. Students are introduced and correspond with each other. The time to begin is now. Young pupils succeed well. Book well worth \$1; besides, mail lessons worth \$2 will be received without extra cost. Book and lessons sent immediately on receipt of order. Address Popular Mechanics Book Dept., 225 Washington St., Chicago.

SHOP NOTES QUARTERLY, published four times a year by the Popular Mechanics Company, may be called a "Post-Graduate Course" for craftsmen and mechanics, and for all men who have to do with the industrial and practical side of modern progress. Ask your newsdealer to let you look over a copy of this progressive periodical. \$1.00 a year—25 cents a copy.

TEN ORE SPECIMENS—Gold, silver, copper, iron, lead, zinc, tin, nickel, graphite, sulphur. Also mineral booklet, 25c. McLaughlin, Sharpville, Pa.

CAMERAS, PHOTO SUPPLIES, ETC.

EURYPLAN THE POPULAR GERMAN LENS. Latest construction. Most luminous. One of the most scientific lenses ever imported. Send for price-list and free sample print. Ralph Harris & Co., 24-28 Bromfield St., Boston, Mass.

DURING JANUARY Dunne's \$1.25 box of 12 colors for coloring Photographs, Lantern Slides, etc., 50 cents. Send stamp for bargain list. Willoughby's Square Deal Bargain House, 814 Broadway, New York.

PHOTOISMS—A magazine that will appeal. Send 25c for 3 mos. subscription or one dollar for a year and a Wager Exposure Scale free. Photoisms, Advertising Dept., 196 Broadway, N. Y.

KODAK FILMS DEVELOPED. 10c per roll, any size. Prompt attention given mail orders. Prints 2¼ x 3¼ x 4¼, 3c; 4 x 5 to 3¼ x 5½, 4c. J. M. Manning, 1062 Third Ave., New York City.

PICTURES AND POST CARDS

PHOTO POST CARDS, beautiful design, copied from any photograph, any number, 5c each, 50c a doz. Visiting cards with your own photo, actual photographs, printed with name and address complete, latest style. 50 cards for 50c. Myland, 2121 N. Front, Philadelphia, Pa.

THE LATEST PICTURE HITS. "My Champagne Girlie" and "La Belle Danseuse." 15c each, or the two complete with 100 other "catchy" art ideas for 25 cents. Union Art Co., D. M., 131 Grant Ave., Jersey City, N. J.

JOIN THE "CURTIS CORRESPONDENCE CLUB," and receive post cards from members everywhere. Largest in existence. Membership 10c. C. C. Club, 3935R Tracy Ave., Kansas City, Missouri.

IF YOU REALLY WANT to exchange post cards, try our splendid club. Lists circulate in many countries. Membership 10c. Halcyon Club, Box 133, Erie, Pa.

SEND 25c COIN OR STAMPS for six beautiful photo post cards. "Pretty girls." Address Notion Store, Box 156, Woodstock, Ill.

SEND 10c AND RECEIVE ten beautiful holiday or assorted post cards postpaid. Micheal Post Card Co., Dept. 54, 2629 Halsted St., Chicago.

FIFTY beautiful post cards 25c. Booth, Box 249, Albany, New York.

MAKE SEASON POST CARDS. Alternate summer and winter scenes on same card. Very novel. Particulars free. P. Benson, Stewartville, Minn.

PORCELAIN MINIATURE COPIED FROM ANY PICTURE. Sepiatone for \$1. Tinted in Water Colors, \$2. Size about 2¼x3 inch oval. Stamp for booklet. Jeffres, 6 E. Lafayette Ave., Baltimore, Md.

POST CARDS, 30 for 25c. Beautiful colored, embossed, Birthday, Valentine, Lincoln and Washington Birthday, St. Patrick, Easter, United States or Foreign Views. Hahn, 254 W. 15th St., New York.

DECORATE YOUR "DEN" with catchy "Stage Beauty" posters in colors. Send stamp for illustrations and free "Salome Nymphs" offer. Gordon Art Co., Dept. P, New York City.

POST CARDS, wholesale, 90c—1,000 up. Catalogue, 20 assorted, 10c. Vern Co., 66 Decatur St., Brooklyn, N. Y.

YOU'LL GET CARDS from everywhere. Membership 10c. Idaho Card Exchange, Dept. K, Box 906, Boise, Idaho.

10 ELEGANT POST CARDS, 10c. The Novelty, Point Pleasant, West Virginia.

SAN FRANCISCO, L. Douglas, 51 Octavia St., on receipt 50c will mail 30 different artistic colored scenes of this modern stately Exposition City.

NAVIGATION

NAUTICAL SCHOOL—Lake and Ocean Navigation Marine Engineering. Make a specialty of preparing young men for original or raise in papers. Special yachting course. Students taught by correspondence. Chicago Nautical School—founded by Lieut. W. J. Wilson, U. S. N.—Masonic Temple, Chicago. Send for circular.

TRADE SCHOOLS

MAACK'S ARCHITECTURAL ACADEMY, St. Louis. Day and evening courses for draftsmen, builders and foremen. Lessons by mail, for home instruction.

GREER COLLEGE OF MOTORING, Aeronautics, and Motor Boat Operation. 15,000 feet of floor space devoted to the Practical Teaching of Automobile Driving and Repairing. Home study courses on the above subjects. Send for our free book—"Motoring." 1457 Wabash Ave., Chicago, Ill.

AUTOMOBILE SCHOOL—Learn the automobile business, repairing and driving, in which you can earn good wages and have healthful and pleasant work. We give a thorough and practical course in road work and repairing. For full particulars address Academy of Automobile Engineering, 1420 Michigan Ave., Dept. "A," Chicago, Ill.

PLUMBING, ELECTRICITY, BRICKLAYING or Mechanical Draughting, taught by expert workmen. Short time and small cost. Positions always open. Catalogue free. Write today. Coyne National Trade Schools, 80 E. Illinois St., Chicago.

AUTOMOBILE SCHOOL. You learn with your hands under the superintendence of the best instructors obtainable at the Chicago School of Motoring. Write for particulars. F. E. Edwards, Inst., Dept. "B," 1619 Michigan Ave., Chicago, Ill.

Purchaser holds land as security. Better than life insurance; costs less; yields more; enjoyed while you live. For particulars write J. P. Welsh, President, 402 World Building, New York City.

MONEY IN ENTERTAINING. A half hour of magic contains instruction and patter for a complete performance. Postpaid 50c. F. C. Hill, Dept. A, 150 Nassau St., New York.

START A MAIL ORDER BUSINESS of your own. Be your own boss. I made \$25,000 in two years with small capital to start. My booklet "Money Making Opportunities in the Mail Order Business" sent free. Address McKean, Dept. 356, No. 2232 Eighth Ave., New York.

PATENTS PROMPTLY OBTAINED. My free booklet will help you to fortune. Read pages 11 and 12 before applying for patent. Write today. Dean Swift, Washington, D. C.

LEARN THE TRUTH about Mail Order Business before buying "outfits." Important information and particulars for starting free. Mail Order Library, P. M. Tompkinsville, New York City.

MANUFACTURERS—I do a general agency, distributing and advertising business over north west. Reliable mail order articles handled. Large mailing list. R. Slater, Hamilton, Mont.; North Yakama, Wash.

FOR SALE—Factory plant, 80 miles west of Chicago. Main building 2 story brick, 30x69 feet; 60 hp. water power; steam heat and power; on "Q" siding; bonus. Price \$6,000 on easy monthly payments. W. J. Parks, La Salle, Ill.

BIG PROFITS—Open a dyeing and cleaning establishment. very little capital needed. We tell you how. Booklet free. Ben-Vonde System, Dept. C, Staunton, Va.

\$ MAKE \$ MORE \$ MONEY \$. Our Dollar Getting Secrets will help anyone, anywhere, to increase their income. Send postal today for free samples. Be. Money Back Store, Baltimore.

CASH FOR YOUR BUSINESS or Real Estate. I bring buyers and sellers together. If you want to buy, sell or exchange a property or business, write me today. Established 1881. Frank P. Cleveland, 1308 Adams Express Building, Chicago, Ill.

SUCCESS depends upon the profitable investment of surplus funds. Our free booklet "D" explains how you can learn to do it. Financial Guardian, 81 New St., New York City.

I MADE \$50,000 in five years with a small mail order business; began with \$5. Send for free booklet. Tells how. Heacock, 5974, Lockport, N. Y.

INCREASE YOUR INCOME. Particulars free. Exchange, 919 Tex. Ave., Shreveport, La.

INVENTORS: ADDRESSES OF MANUFACTURERS in any line—30, 10c; 100, 25c. Obed Billman, Cleveland, Ohio.

MAKE MIRRORS AT HOME. Big profits with little outlay. One 18x36-in. mirror costs \$2 to \$5. You can silver a glass this size for 20c. Send \$1 in stamps or money order and we will send you explicit directions how to do it; also how to emboss, grind, foil, gold leaf, frost, chip and make imitation stained glass. How to transfer photos on glass, bore holes in glass and cut skylights. George L. Patterson & Co., Dept. 3, Brooksville, Ky.

MAKE METAL POLISH. Furniture Polish, Silver Polish, Shoe Polish, Shoe Blacking, etc. Start a business of your own. Small investment—large profit. We supply practical working Formulas (not cheap ones) and complete information for making and marketing. Also, Formulas, Paints, Varnishes, Linseed Substitutes, Turpentine Substitutes, Specialties. For particulars write Canadian Formula Bureau, 69 Adelaide East, Toronto, Canada.

MUSHROOMS—NEW PURE TISSUE culture Summer spawn. Now is the time, plant this new spawn; produces big crop white mushrooms all summer. Four other varieties winter planting, modern plan forcing plants, mushrooms, early quick crop. Book free. Fresh sample brick 35c postpaid. We are originators, order direct from laboratory. Challenge Farm, 6961 Gravois Ave., St. Louis, Mo.

START IN THE MAIL ORDER book business! We can show you a proposition enabling you to make 88c profit on a dollar, yet give your customer \$3.00 value. Send 10c for dollar sample and full particulars. Morgan Co., 3455 N. Hamilton, Chicago.

FOR SALE—Fine \$20,000.00 stock of Hardware, Implements, Paints. Can reduce stock. \$60,000.00 yearly. Best town, North Alabama, seven cotton mills, various industries, fine business territory. In business thirty years, wish to retire. M. A. Collins, Huntsville, Ala.

WE START YOU in a permanent business with us and furnish everything. We have now easy selling plans and seasonable leaders in the Mail Order line to keep our factories busy. No canvassing. Small capital. You pay us out of the business. Large profits. Spare time only required. Personal assistance. Write today for plans, positive proof and sworn statements. J. M. Pease Mfg. Co., 1917 Pease Bldg., Buffalo, N. Y.

MAKE BLACK CARBON ROOF PAINT—No machinery required. Small investment, large profits. Formula and full directions, \$2.00. Canadian Formula Bureau, 69 Adelaide East, Toronto, Canada.

BUILD A BUSINESS of your own and escape salaried drudgery for life. Learn the Collection Business. Limitless field; little competition. Few opportunities so profitable. Send for "Pointers" today. American Collection Service, 101 State St., Detroit, Mich.

START LEGITIMATE MAIL-ORDER Mercantile business; possibilities unlimited, conducted by anyone. We print catalogs, supply merchandise at wholesale. Booklet and sample catalog free. Central Supply Co., Kansas City, Mo.

Terre Haute, Ind.
WANTED FINANCIAL AID. Any amount. Industrial. Vast magnitude. Immense possibilities. Revolutionizes world's greatest industry. Investments guaranteed. Perry, Empire Building, Denver, Colo.

GOOD INCOME FROM SMALL INVESTMENT, dip-plating knives, forks, spoons, etc. Write for particulars. Rogers Metal Co., Kansas City, Mo.

HERE'S YOUR OPPORTUNITY; immense profits are made selling perfumes. Make it yourself. 25c brings formulas and full instructions. Box 33, Dept. C, Quincy, Ill.

DANDY HOME BUSINESS. Sell your ideas, formulas and knowledge by mail. Some make \$1,000 monthly. Instructive booklet for stamp. Information System, 234, Marietta, Ohio.

SEND 20c we will start you in the trust scheme Post Card business; make \$8 and \$10 daily. St. Louis Specialty Co., 2628 N. Jefferson Ave., St. Louis, Mo.

AUTOMOBILE REPAIRMAN with two thousand dollars; money back first year. Box 453, Plant City, Fla.

YOUR OPPORTUNITY FOR 1911 is Gary, Ind. Write me for particulars. W. J. Schroeder, Ridge Road near Broadway, Gary, Ind.

MAKE \$3 DAILY MAKING MIRRORS. Complete guaranteed instructions sent for \$1. Pearl Harkness, East Lynn, Ill.

SUCCESSFUL MAIL ORDER PLAN and 25c sample, 12c. Popular Institutes, Fairbanks Bldg., Chicago.

HERE'S AN OPPORTUNITY to double your present earning capacity. We want one agent in every factory to sell the best known and the best advertised hand soap on the American market. We give exclusive sale and only want ambitious men. For particulars, write today. N. E. Supply Co., 9 Fulton Place, Boston, Mass.

I WILL START YOU earning \$4 daily at home in spare time, silvering mirrors; no capital; send for free instructive booklet, giving plans of operation. G. F. Redmond, Dept. 306, Boston, Mass.

LIVE MEN: If you are making less than \$25 weekly, send your address quick. If you have a horse and buggy or bicycle you can use, all the better. We teach you. You can start right where you live. You owe it to yourself to investigate this opportunity and let us prove that we can better your condition. The Thomas Company, 962 Third St., Dayton, Ohio.

FORM A CORPORATION—Congress Law for D. C. and all States; cheap. Raise money easily; advice free. U. S. Legal Corporation, Washington, D. C. Representing \$1,225,000,000.

CONDUCT A "CANDY KITCHEN." Clear \$20 daily. Small capital required. Send for particulars. Kennon and Co., 148 West Ontario St., Dept. A, Chicago.

SEND 10c (coin preferred) for "Key to Success in the Mail Order Business." Contains much valuable information, where to buy supplies, etc. Thos. A. Hill, 3300 Quivas, Denver, Colo.

START A MIRROR FACTORY. We teach and trust you; 10c brings sample lesson; \$25 daily easily. Hullinger's Mirror School, 2, Francesville, Ind.

YOU CAN START Mail Order Business in your own home. Big profits. Everything furnished. Free booklet tells how. W. P. Foote, Box 254, Muskegon, Mich.

HOW TO JUDGE a patent. An "eye opener" for inventors. Sent free. Obed Billman, Cleveland, Ohio.

OVER 100 MONEY-MAKING formulas 25c. Anchor Supply Co., Desk C, Rockville, R. I.

POSITIVELY BEST RIBBONS, three, \$1.10. See what I say under "Typewriters." Atchison.

WANTED

ONE DOLLAR OFFERED for Popular Mechanics 1906 July—August—September. Write to F. M. MacDesmot, 1407 Eighth St., Oakland, Cal.

MOVING PICTURE MACHINES wanted. Fred L. Smith, Amsterdam, N. Y.

WANTED—Auto engine. 293, Kempton, Indiana.

WANTED—Air Cooled engine. Warner Brothers, Muncie, Ind.

SALE OR EXCHANGE

EXCHANGE PIPE MACHINE, size 2½ to 6 inch for one four inch. G. R. Davis, Hagerstown, Ind.

CADILLAC DELIVERY WAGON—Must dispose of it at once. Have no use for same. Photo on request. F. J. Collingwood, Findlay, Ohio.

WANTED TO EXCHANGE—Orient automobile for 1910 model motorcycle. P. C. Walter, Viola, Wis.

NEW \$250 MOTIOGRAPH PICTURE MACHINE for Billiard Table, diamonds or \$175 cash. J. M. Gordon, Somers, Mont.

WE EXCHANGE ANYTHING you require for whatever you don't need. Large bargain list for stamp. Jenkins Exchange, Chicago, Ill.

AGENTS WANTED

EARN THIS SUIT in One Hour! Your profit for an hour or two as the representative of our great tailoring house pays for a special made-to-measure suit for you—the handsomest, the most stylish and the most durable ever made. Just show two or three of your friends the samples of our fine wool suitings, take two or three orders and you have earned the suit. You can't fail to get orders. Our 60 beautiful samples create a sensation wherever shown. No one ever saw such materials at the price before. You take no risk. Everything is shipped on approval, subject to 24 hours' examination. Customers try goods on and must be satisfied with style, fit and quality before paying. We pay express on everything! You can undersell everybody. Get clothes for your friends at less cost than they pay anywhere else and make wholesaler's, jobber's and retail dealer's profits. That means the swiftest, cleanest and nicest business in America! A Big Business that more than doubles your earnings. We want you to represent us now. Don't wait until somebody else takes this great business. No experience necessary. We furnish you our portfolio with 60 samples of the latest weaves, fabrics and colors, absolutely free. Do you want this swell made-to-order suit and this remarkably easy money-making business that will make you rich? A postal or letter mailed to us at once gives you swell clothes and a big business. Write us now. A postal card will do. Or tell your friends about it. Paragon Tailoring Company, Dept. 11, Chicago, Ill.

"NEVER WET"—Positive waterproof and preservative for boots and shoes. Supersedes rubbers. Dry feet at small cost. Fine polish obtained over it. Satisfaction guaranteed or money refunded. Two sizes: 10c, 25c. Postage free. Write for agency. Dept. B, Providence Oil Co., Providence, R. I.

YOU CAN MAKE a good income acting as agent for Manheim Mendless Hosiery for men and women, bearing a positive six-months' guarantee against holes. Box six pairs, men \$1.00, women \$1.50; assorted colors. Direct from mills to wearer. Write today for terms. Manheim Hosiery Mills Company, Dept. P, Manheim, Pa.

KEROSENE MANTLE LAMPS—America's largest variety; highest quality made; our burner guaranteed best on the market. Guildford Co., Seville, Ohio.

OUR STARTLING NEW INVENTIONS: Saxonia Spark Gas Lighter, cheaper than matches; Vacuum Cleaner, cheaper than brooms; Incandescent Kerosene Mantle Lamps, cheapest and best light known. Quick sales and large profits. U. S. A. Lighting Co., Box G, Springfield, Mass.

WANTED: AGENTS to handle our Automatic Fire Alarm, automatically rings when fire starts in any part of building. Quick seller. Liberal commission. Address, Davis Manufacturing Company, El Campo, Texas.

AGENTS—The latest and best selling book, "John F. Deitz the Defender of Cameron Dam." New book, now ready. Sample and terms, 50c. J. E. Wakefield Co., Box 333, Eau Claire, Wis.

ESTABLISH BUSINESS, CONTROL TERRITORY! Handsome new electric gas-light line. Kerosene mantle lamps. Automobile head-light burners. All 100 candle power. Sell on sight. Special campaign offers. Your chance. Webster Spec. Mfg. Co., Waterbury, Conn.

YOU CAN MAKE MORE money than you ever dreamed possible decorating china, burnt wood, metal, etc., in colors from photographs. Men successful as women. Learned at once, no talent required. Takes like wild-fire everywhere. Send stamp quick for particulars. R. Vallance Co., Elkhart, Ind.

AGENTS—Sell the Pinless Clothes Line. A labor-saving invention; sells on sight; write quick; exclusive territory; \$25 to \$75 weekly; freight prepaid; sample 25c. Pinless Clothes Line Co., 558 Lumber Exchange, Portland, Oregon.

BECOME A MANUFACTURER'S AGENT. We manufacture hosiery which outwears 3 of the ordinary kind, replaced free when hole appears. Easy sales; large profits. First reply obtains agency your city. Triplewear Mills, Dept. D, 724 Girard Ave., Philadelphia.

AGENTS—Millions of households use lamps. Everyone a customer. Our SunRay mantle kerosene burner fits all lamps. Burns with or without mantle. Ten times brighter than gas. Prices defy competition. Particulars free. Simplex Gaslight Co., 20 Park Row, New York.

SIDE LINE SALESMEN to sell high class article to Banks and Merchants as advertising souvenirs. Good men make \$50.00 weekly in commission. Territory open. Sample free. C. Ropp & Sons, 557 Lakeside Building, Chicago, Ill.

THE BEST YET—Agents for our latest automobile specialty, mends tire in one minute, no patch or cement; sells at sight. W. H. Howe, Franklin, N. H.

AN ADDING MACHINE costs \$300. Just think—we will mail a sample of our Lightning Multiplier, with special terms to agents, for 10c. Simplicity Co., 420 Ashton, Grand Rapids, Mich.

\$50 to \$75 PER WEEK, for the agent selling our new invention. Every one needs it and wants it. Big profit. Write today for our proposition. National Stove Pipe Holder Co., 101 Main St., Ottawa, Ohio.

AGENTS—You can make \$10.00 a day selling our new high grade original Air Brush Design Show Cards to storekeepers. 350 varieties. Catalog and sample free. Peoples Show Card Concern, 711 W. Madison St., Chicago, Ill.

MAKE \$60 TO \$100 weekly selling our small, bottling outfit for saloons. New article, easy seller, large demand. Nothing like it. Write now for free information. Simplex Mfg. Co., Dept. L, Kewanee, Ill.

AGENTS WANTED—Rubber stamps and novelties. Send 4 cents for full particulars. A. S. Mankin & Co., Alexandria, Va.

MEN AND WOMEN AGENTS to handle proposition which sells at sight. Two to six in almost every home. Particulars free. Charles Specialty Co., Kanona, Kan.

AGENTS earn \$25 to \$50 weekly selling latest styles beautiful braided waists, Princess dresses, Mexican drawn work, petticoats, various embroideries. Catalogue free. National Imp. Co., Desk 27, 699 Broadway, New York City.

AGENTS—Make \$5 to \$25 per day selling our specialty; particulars free; write today. Henry J. Specialty Co., 87 South 2nd St., Ironton, Ohio.

"PREVENTO"—Every eyeglass wearer buys. Sample and terms 25c. Dissatisfied, money refunded. Samuels, Optician, Wilkes-Barre, Pa.

MAIL ORDER MEN—Ladies' beauty pins are winners, sample doz. 20c, 1 gross 50c; sample doz. scarf pins 25c, 1 gross \$1.75. Johnston Co., Newport, R. I.

BOY AND GIRL AGENTS, sell 24 packages of post cards for us at 10 cents each and receive a beautiful camera absolutely free. Write today. Canon Supply Co., Dept. 36, Canon City, Colorado.

PATENTS PROMPTLY OBTAINED. My free booklet will help you to fortune. Read pages 11 and 12 before applying for patent. Write today. Dean Swift, Washington, D. C.

REPRESENTATIVES WANTED in every state, exclusive territory, profitable seller, practical season specialty. P. C. W. Manufacturing Co., 1 Madison Ave., 3084, New York.

LEARY AND MUNRO SAY: Don't kick about your position. Be our representative. Our agents are making big money, you can do the same. Write 1219 Fillmore St., San Francisco, California.

LARGE CHICAGO HOUSE WANTS REPRESENTATIVE in your locality. Build up your own business; capital required, \$1; ordinary ability and willingness to work. M. G. Good Co., 203 Fifth Ave., Chicago.

WANTED—TEN THOUSAND AGENTS to cover entire country with new proposition. No investment. Fortune if you hurry. Particulars for red stamp. Falls City Supply Co., Dept. M, Louisville, Ky.

FIGS AND FORTUNES—Is a booklet giving facts on Fig growing near San Antonio. Free. Agents wanted. C. B. Watters & Co., San Antonio, Tex.

\$25 WEEKLY and expenses to men and women to collect names, distribute samples and advertise. Steady work. C. H. Emery, M. G. 25, Chicago, Ill.

SMALLEST ALARM CLOCK and Bible in world, 10c each, prepaid. W. H. Garner, A. 119 South Lafayette St., Evansville, Ind.

GENERAL AGENT—Write for special offer, King Menshol Salve. King Mfg. Co., Pittsburg, Pa.

ARE YOU CAPABLE of earning big money? Read Welland Sales Co. ad. under "Typewriters."

AGENTS WANTED to sell our Beautiful Scripture Wall Motives. Frank Shilling Co., Navarre, Ohio.

USEFULTES 3c. Stewart, San Jose, Cal.

AGENTS—DON'T BOTHER WITH CHEAP trashy jewelry and tableware—it injures your reputation. Sell dependable sterling and plated tableware, jewelry, leather goods, and novelties. Watches and diamonds at cut prices. Low prices, big profits. We prepay all express and mail charges. Write now for free catalog of 750 pictures and information about our 3,000 absolutely reliable and fully guaranteed quick selling articles. A. W. Holmes & Co., Desk 21, Providence, R. I.

HERE'S A MONEY GRABBER. Hand machine makes \$5 to \$6 worth of better, stronger rope than factory for 40c, any length or thickness; saves time and money. Absolutely no competition. Farmers, factories, liveries, saddlers, all rope users buy at sight. Absolute control of territory free to high-grade men who can handle agents; 125% profit. Chicago Appliance Factories, 702 A, 21 Quincy St., Chicago.

AGENTS—Biggest money-maker known. The new Canchester Incandescent Kerosene Lamp revolutionizes old lighting methods. Burns air, not money. Six times brighter than electricity, gas or acetylene at 1-10th cost. Burns with or without mantle. Burner fits any lamp. Saves 75% oil. No trimming wicks. Showing means selling. Territory going fast. Write today. Hand-some outfit furnished. Canchester Light Co., Dept. P. M. 2, 26 State St., Chicago.

BULLY! GREAT! IMMENSE! That's what all our agents say after selling our attractive 1911 Combination packages of soap and toilet articles with valuable premiums. 100% to 300% profit. One Michigan agent made \$65 in 47 hours; another \$21 in 8 hours; another \$22.50 in 10 hours. Act now—not tomorrow. Davis Soap Co., 80 Union Park Court, Chicago.

AGENTS WANTED to sell rich-looking imported 36x68 rugs at \$1 each. R. H. Carter, Milan, Tenn., sold 115 in 4 days; his profit \$51; you can do as well. Write for sample offer and unique selling plan; exclusive territory. A. Condon, Rug Importer, Stonington, Maine.

A BUSINESS FOR YOU in your own community. Secure Aladdin Lamp Agency. Produces highest grade modern white light from kerosene (coal oil). No odor, danger, smoke, noise. Simple, clean, durable, reliable, portable. Brighter than electricity. Only successful mantle oil lamp. Guaranteed. Inexperienced men make big money. Ask nearest office for particulars. Mantle Lamp Company of America, Dept. 267, Chicago; Portland, Ore.; Waterbury, Conn.; Montreal, Winnipeg, Can.

and sell these famous gems. Big profits. Sample offer and catalogue. Free. Northwestern Jewelry Co., 55 Northwestern Bldg., Chicago.

AGENTS—In every city and town; best selling automobile specialty; large demand for goods; success assured; start at once. The Chaddock Specialty Co., Polo, Ill.

WE SHOW CONFIDENCE in our goods by giving you free sample before you buy. Eureka Antisplash Waterstrainers are winners for agents—both sexes. Daily profit \$5 upward. Let us prove it. Send 2c stamp (mailing cost). P. Seed Filter Mfg. Co., Reade St., New York.

AGENTS—\$1.00 hourly. One handed flour sifter. Just patented. Only one in the world. Sample free to workers. Ebricht Mfg. Co., B 307, Columbus, Ohio.

AGENTS—Send 10c for handsome sample German silver key check, your name and address stamped thereon. Big commissions for taking orders. Blank stock and stamping outfits supplied. Hart Manufacturing Co., 80 Guernsey St., Brooklyn, N. Y.

DO YOU WRITE LETTERS? We will mail 100 neatly printed envelopes to your address absolutely free. Sample upon request. The Fairplay Supply Company, Dept. 22, Fort Pierre, S. Dak.

LARUES PINE TAR PASTE, and other hand cleaning specialties are big sellers. Write for terms and territory. Sample 10c prepaid. F. C. LaRue Soap Co., 584 Niagara St., Buffalo, N. Y.

GERMAN SILVER KEY CHECKS—Steel letters for marking same, key rings, etc.; over 30 styles. Agents wanted. Sample marked with your name and address, and key ring, 15c. Pease, Die Maker, Winchester, N. H.

AGENTS—Here is corker; only pancake griddle in world that bakes square cakes, turns them, bakes 6 each time; 150 percent profit. Canton Griddle Co., Canton, Ohio.

MAKE 100% PROFIT selling Portable Highchair, weighs 13 oz.; rapid seller. Price, \$1.00. Postal brings particulars. Dept. P, Stork Sales Co., Hamilton, Ohio.

YOU CAN MAKE BIG MONEY selling our Friction Gas Lighters, latest invention. Send for our price, sample 25c. Sheboygan Electric & Machine Co., 210 Engineering Bldg., Milwaukee, Wis.

AGENTS—To sell the "Gem" pocket rule holder in every shop; new invention; just out; sell on sight. New Invention Co., Box 1008, Wilmerding, Pa.

AGENTS—Patent lunch box; folds for the pocket; illustrated circulars; write today. Hawes Mfg. Co., Dept. M, Carthage, N. Y.

COLLECT NAMES, information, etc., for business concerns. Steady, profitable home business. Instructive booklet for stamp. Information System, 235, Marietta, Ohio.

ONE AGENT OR DEALER in every locality to handle best shoe polish ever offered. Sample express paid 50c. Twenty shines. Waterproof. Northern Specialty Mfg. Co., Duluth, Minn.

BOY AND GIRL AGENTS, sell 24 packages of our Post Cards at 10c each and receive a beautiful watch or typewriter free. James E. Spurr & Co., Plymouth, Mass.

SELL EAGLE BRAND MENDING TISSUES. Greatest Labor Saving Invention. 500 per cent profit. Three samples for dime. Eagle Rubber Company, 213 East Tenth St., New York.

AGENTS AVERAGE \$2.00 PER HOUR working for us. Drop postal. The Auto Novelty Co., Harrisburg, Pa.

\$100 WEEKLY—ENGINEERS, FIREMEN, AGENTS save all coal-users half. 4-c water-gas fuel, any stove, furnace, steam-pump without changes. Exclusive field. Kol-Saver, Glen Ellyn, Illinois.

CALLING AND BUSINESS CARDS are the best side line; samples free. Kay, 409 Gold St., Brooklyn, N. Y.

\$100 MONTHLY and expenses to trustworthy men and women to travel and distribute samples; big manufacturer. Steady work. S. Scheffer, Treas., M. M. 125, Chicago.

AGENTS—MAKE MONEY during spare time. Good proposition. Edward Grossman, 247 West 139th St., New York City.

IF IT'S MONEY YOU WANT, send name at once for samples of our quick sellers. Coast Chemical Co., Box 894, Los Angeles, California.

WANTED—RAILWAY MAIL CLERKS, City Carriers, Post-office, Customs, Internal Revenue Employees. Thousands of appointments coming. Average salary about \$1,100. No "layoffs." Short hours. Rapid promotion. (Former Postmaster General, Cortelyou, commenced as a clerk.) Annual vacations. Common education sufficient. City and Country residents stand same chance for immediate appointment. Political influence not needed. Send your name immediately for schedule showing places of coming examinations. Free coaching. Franklin Institute, Dept. F-86, Rochester, N. Y.

AGENTS—\$50 weekly; we manufacture the best needle case made; a wonderful seller; 200 to 500 per cent profit; talking unnecessary; our copyrighted "Trust Scheme" Envelopes do the work; general agents can make over \$100 weekly; send 10c for a 25c sample containing 115 needles; particulars free; buy direct from the factory at wholesale. Paty Needle Co., 102 Union Sq., Somerville, Mass.

your appearance! This is our idea: We want one man as our representative in your neighborhood. You've got a lot of friends. They wear clothes. It is the easiest thing in the world to get them to order their clothes from you. Prices \$7.50 and up. Those orders mean a big business that more than doubles your salary, and the work is the easiest, cleanest, nicest occupation in the world. New representatives make \$5 to \$10 a day. You simply take the order and measurements and mail them to us. We make the clothes, ship them on approval to your friend and hand you the profit money. A Regular Cinch! That's the beauty of being in business for yourself. Sit right down now; write us a postal or a letter for the free outfit to representatives. And you get the swellest suit of fashionable tailor-made, all-wool, 1911 clothes ever worn in your neighborhood. If you personal appearance and a big business is worth a postal or a 2c stamp to you, then act now—write us today. Address American Woolen Mills Co., Dep. 468, Chicago, Ill.

AGENTS WANTED—Daily Expense Record, every family needs one, fifty cents, special inducements to agents, particulars free. Crucknell, 207 Ozark Bldg., St. Louis, Mo.

HERE'S AN OPPORTUNITY to double your present earning capacity. We want one agent in every factory to sell the best known and the best advertised hand soap on the American market. We give exclusive sale and only want ambitious men. For particulars, write today. N. E. Supply Co., 9 Fulton Place, Boston, Mass.

AGENTS MAKE BIG MONEY—Big pay, no experience, no capital required. 5,000 new art specialties, photo pillow tops 25c, portraits 30c, bromides 25c. New 1911 catalog and samples free. Write Daniel H. Ritter Co., Madison St., Chicago, Ill.

AGENTS—WE MANUFACTURE GLASS PAPER. Plain glass windows made to look like real stain glass; something new; easily applied; big money maker; two sample sheets of paper, with catalogue in colors and discount sheet, for 10c. S. H. Parrish & Co., 216 S. Clark St., Chicago.

AGENTS—100% profit. Combination monkey-wrench, plumber's pliers, 15 tools combined. Lightning seller. Sample free. Forsee Company, Box 1335, Dayton, Ohio.

ONE MILLION AGENTS WANTED, fast seller costing 5c, selling 50c. Every firm needs. Orders to \$50. Postal brings samples. Embossed Co., 2497 Milwaukee Ave., Chicago.

I WILL START YOU earning \$4 daily at home in spare time, silvering mirrors; no capital; send for free instructive booklet, giving plans of operation. G. F. Redmond, Dept. 306, Boston, Mass.

500 AGENTS WANTED for fast seller needed in quantity by every firm. Nice pleasant business. Big demand everywhere. Profits large. Samples free. Write quick for particulars. Metallic Mfg. Co., 406 N. Clark St., Chicago.

AGENTS—Portraits, 35c; frames, 15c; sheet pictures, 1c; stereoscopes, 25c; views, 1c. 30 days' credit. Samples and Catalog free. Consolidated Portrait, Dept. 1198, 1027 W. Adams St., Chicago.

AGENTS—HANDKERCHIEFS, DRESS GOODS, Carleton made \$8 one afternoon; Mrs. Bosworth made \$25 in 2 days. No experience needed. Free samples. Credit. Freeport Manufacturing Company, 59 Main St., Brooklyn, N. Y.

WIDOWS, Ladies, Men. New. Interesting. Profitable, easy work. Spare time or permanent. Sell our useful specialties. Our original selling plan will double your sales. Particulars and \$2.00 premium offer free. Fair Mfg. Co., HF51, Racine, Wis.

AEROPLANES, DYNAMOS, ELECTRIC FANS. Picture Machines, Mechanical Toys, at half price. Catalogs, 300 illustrations with your name on. Samples and particulars free. Murphy Company, Norwalk, Conn.

AGENTS make big money selling our new gold letters for office windows, store fronts and glass signs. Any one can put them on. Write today for free sample and full particulars. Metallic Sign Letter Co., 406 N. Clark St., Chicago.

GREAT SELLING LINE of Electrical Specialties including New Electric Auto Horns, Vibrators, etc. Easy sellers. Big profits. Some choice territory still open. Particulars free. Standard Electric Works, 1249 Washington Ave., Racine, Wis.

AGENTS earn from \$3 to \$6 a day selling Victor razors and strops. Fine outfit, goods sell at sight. 100 per cent profit, exclusive territory. We teach how to make sales; earn while you learn. The Victor Manufacturing Co., Dept. P. M., Canton, O.

MEDALLIONS SELL AT SIGHT. 300 per cent to 500 per cent profit. Make up your own goods and be independent. "It's easy." Catalog free. Fred Resag Co., 1205 W. Randolph St., Chicago.

WANTED—A Man or Woman to act as our Information Reporter. All or spare time. No experience necessary. \$50 to \$200 per month. Nothing to sell. Send stamp for particulars. Sales-Association, 601 Association Bldg., Indianapolis, Ind.

AGENTS—\$5 daily selling our Handy Tool, 12 articles in one. Lightning seller. Sample free. Thomas Mfg. Company, 462 Third St., Dayton, Ohio.

AGENTS—Sell our Yankee Self-Wringing Mop and make \$4.00 to \$10.00 daily; we also manufacture 500 other fast sellers; particulars free. Scheff Co., 1637 Wells St., Chicago.

AGENTS—\$1.00 hourly. One handed flour sifter. Just patented. Only one in the world. Sample free. Forshee Mfg. Co., B. 1535, Dayton, Ohio.

BIG MONEY MAKERS—Send for illustrated circular of the finest salted peanut vending machine in the country. Simplex Company, Victor Bldg., Washington, D. C.

AGENTS—\$75 monthly. Combination Rolling Pin. Nine articles combined. Lightning seller. Sample free. Forshee Mfg. Co., Box 535, Dayton, Ohio.

ALUMINUM LACE CURTAIN CLASPS, 5c per doz., 24 sent postpaid 10c silver. Agents wanted. J. L. Lucas & Son, 3 Fox St., Bridgeport, Conn.

PERFECTION POCKET ADDING MACHINE. Lightning seller. Agents wanted. Cincinnati Specialty Mfg. Co., Dept. R., Cincinnati, Ohio.

HELP WANTED

MEN WANTED—As we have established a new factory in Poughkeepsie, N. Y., for the manufacture of automobiles, we are constantly in need of first-class motor assemblers, transmission assemblers, vise hands, milling machine operators, lathe hands and a few good foremen. Steady employment; high class work to good men. F. I. A. T., Poughkeepsie, N. Y.

AVIATORS WANTED. NO LIMIT to salary. Demand far exceeds the supply. Full course by correspondence and post graduate course in assembling and actual flights at our aviation field. We have our own exhibition department and can use competent aviators. Also secure positions outside. Chicago School of Aviation, Chicago, Ill.

WANTED ONE THOUSAND CHAUFFEURS and repair men. Our demand for automobile engineers exceeds the supply. Calls for men of intelligence and mechanical bent capable of commanding \$100.00 to \$150.00 per month upon graduation. Resident course \$20.00 to \$60.00. Home Correspondence course completed by practical road and shop work at this school, highly successful. Look this up. Auto Schools of America, Dept. T, 1600 Michigan Ave., Chicago.

WANTED—RAILWAY MAIL CLERKS, City Carriers, Post-office, Customs, Internal Revenue Employees. Thousands of appointments coming. Average salary about \$1,100. No "layoffs." Short hours. Rapid promotion. (Former Postmaster General Cortelyou commenced as a Clerk.) Annual vacations. Common education sufficient. City and Country residents stand same chance for immediate appointment. Political influence not needed. Send your name immediately for schedule showing places of coming examinations. Free coaching. Franklin Institute, Dept. F-21, Rochester, N. Y.

WANTED AN ENERGETIC MEMBER in every shop—town—country community. To join and work for the grandest, most glorious fraternal order known. Pays benefits for sickness, injury, accident, death. 50c a month and up will carry full membership. Secure members. Easy—pleasant—pays well. Give spare time. Be first from your locality. Send 10c for Official Journal, particulars of membership, great money-making plan. The I-L-U of the World, 625 First National Bank Bldg., Covington, Ky.

WANTED—RAILWAY MAIL CLERKS, City Carriers, Post-office, Customs, Internal Revenue Employees. Average salary about \$1,100. Send your name for schedule showing places of coming examinations. Free coaching. Franklin Institute, Dept. F-21, Rochester, N. Y.

\$3,000 to \$10,000 YEARLY in the Real Estate business, without capital; we will teach you the business by mail, appoint you Special Representative in your locality, of leading real estate company, list with you readily salable properties, co-operate with and assist you to permanent success; a thorough commercial law course free to representatives. If you are honest and ambitious, our free 62-page book will surely interest you. Address International Realty Corp., Dept. 1234, Chicago, Ill. (Successor to The Cross Co. and H. W. Cross & Co.)

WANTED—GOOD ABLE-BODIED MEN as Interurban Motormen, Conductors. \$65 to \$90 per month. New lines under construction. New positions opening up. Experience unnecessary. Enclose stamp for map new traction lines. I. Railway C. I., No. 16, Indianapolis, Ind.

WANTED—RAILWAY MAIL CLERKS, City Carriers, Post-office, Customs, Internal Revenue Employees. Average salary \$1,100. Send for schedule of coming examinations. Free coaching. Franklin Institute, Dept. F-21, Rochester, N. Y.

CHAUFFEUR WANTED in every locality to represent us; liberal inducements. Write secretary Benevolent Chauffeurs League, 103 W. 63rd St., New York City.

SHOWCARD LETTERING—Learned at your own home; small cost. Send for particulars. Commercial School of Lettering, Lockport, N. Y.

MEN OR WOMEN to copy letters at home; \$10 to \$25 week; experience not necessary. Brooks Copying Company, Box 261, Washington, D. C.

SALESMEN TO SELL "The Best Ever" Lady Washington Hulled Beans with Chicken. Galehouse Packing Company, Seattle, Washington.

WANTED—RAILWAY MAIL CLERKS, City Carriers, Post-office, Customs, Internal Revenue Employees. Average salary about \$1,100. Short hours. Annual Vacations. Common education sufficient. Send your name immediately for schedule showing places of coming examinations. Free coaching. Franklin Institute, Dept. F-21, Rochester, N. Y.

COLLECT NAMES, information, etc., for business concerns. Steady, profitable home business. Instructive booklet for stamp. Information System, 236, Marietta, Ohio.

DINING CAR CONDUCTORS—Salary \$75-\$125. Correspondence School Conductors, Imperial Bldg., Chicago.

BIG MONEY WRITING SONGS. Thousands of dollars for anyone who can write successful Words or Music. Past experience unnecessary. We want original song poems, with or without music. Send us your work today, or write for free particulars. H. Kirkus Dugdale Co., Dept. 265, Washington, D. C.

\$1,200 a year salary or commission. Man or woman in every county to manage business with grocery stores. Permanent. No experience necessary. Enclose stamp. The Confecto Mfg. Co., Lima, Ohio.

WANTED, AGENTS, MACHINISTS, ATTENTION! Increase salary, new revised Saunders' Hand Book of Practical Mechanics. Best ever ready reference. Thousands in use. Postpaid \$1.00 cloth; \$1.25, \$1.50 leather flap. Big profits. E. H. Saunders, 216 Purchase St., Boston, Mass.

YOU ARE WANTED for Government position. \$80.00 month. Write for list of positions open. Franklin Institute, Dept. F-21, Rochester, N. Y.

WE START YOU in a permanent business with us and furnish everything. We have new easy selling plans and seasonable leaders in the Mail Order line to keep our factories busy. No canvassing. Small capital. You pay us out of the business. Large profits. Spare time only required. Personal assistance. Write today for plans, positive proof and sworn statements. J. M. Pease Mfg. Co., 1018 Pease Bldg., Buffalo, N. Y.

MEN WANTED, age 18-35, for firemen \$100 monthly, and brakemen \$80 on all railroads. Experience unnecessary; no strike. Positions guaranteed competent men. Promotion. Railroad Employing Headquarters—over 400 men sent to positions monthly. State age; send stamp. Railway Association, Dept. 89, 227 Monroe St., Brooklyn, N. Y.

LIVE MEN IN EACH COMMUNITY to own and operate a business in his home. Profits are \$200 each week. Money comes in every day and all yours. Brand new business. No canvassing. No capital. Particulars free. Frank C. Voorhies, Desk C. R., Omaha, Neb.

I WILL START YOU earning \$4 daily at home in spare time, silvering mirrors; no capital; send for free instructive booklet, giving plans of operation. G. F. Redmond, Dept. 306, Boston, Mass.

EXPERIENCED OR SUCCESSFUL SALESMEN to sell gasoline lighting systems suitable for any place or purpose; attractive proposition. Write for catalogue. Doud Lighting Co., 216 N. Jefferson St., Chicago, Ill. Dept. A.

PLUMBING, ELECTRICITY, BRICKLAYING or Mechanical Draughting, taught by expert workmen. Short time and small cost. Positions always open. Catalogue free. Write today. Coyne National Trade Schools, 80 E. Illinois St., Chicago.

WANTED—MACHINISTS—Floor and Machine hands. None but first-class mechanics wanted. Litchfield Foundry & Machine Co., Litchfield, Ill.

I WILL START YOU in the Mirror Business. Best paying trade of today. Famous French method. \$5 to \$12 daily. Let me prove it. Free particulars. Corey, Dept. 30, Omaha, Neb.

FOR SALE

REAL BARGAINS—BICYCLES, MOTOR CYCLES, Marine and Stationary Engines, furniture, pianos and musical instruments, typewriters, sewing machines, etc. Write for list. Atlantic Supply Co., Long Branch, N. J.

FOR SALE—Model "S" Ford, fully equipped, magneto, tire protectors, extra case, bargain. 18 ft. 3 hp. motor boat. 1—4½x1½, 2 cyl., 2 cycle engine. Thomas K. Smith, Sistersville, West Virginia.

MAKE A MORRIS CHAIR. Send 15 cents and I will mail you a blueprint giving complete details and bill of material. H. E. Mertens, 522 West 136th St., New York.

FOR SALE—Meier trap, keeps back water and sewer gas out of cellar and cistern, guaranteed; write for full particulars. Meier Trap Co., Upper Sandusky, Ohio.

NEW SHOT GUNS shipped from factory. Repeating and double barrel hammerless. Rifled bullet shell; rifle sights; watch. Exchange for Graflex camera. Dan Walters, Rich Hill, Mo.

FOR SALE—Wagon Shop, electric power with machinery, on switch track; on account of sickness. 2652 Elston Ave., Chicago.

GOOD SECOND HAND Printing presses, Cutters, Type, etc. Send 1c for big list. Popular Bargains, Richland, Pa.

1910 MANWELL WITH TOP, windshield, speedometer, \$450. Cadillac with top, \$200; 200 Voltmeter, \$10; 150 Amperemeter, \$10; Rheostat, \$10; Bulldog, goodnatured, \$10; 2 to 4 hp. gasoline engine, \$35 to \$65; one horse boiler, \$10; Flute, \$5; 8 hp. double cylinder marine engine and boiler, \$75. F. J. Rettig, Wabash, Ind.

1910 CHALMERS DEMONSTRATOR. Perfect condition, Mohair top, windshield, lamps, Bosch magneto, speedometer. First check for \$1,000 gets it. F. J. Collingwood, Findlay, Ohio.

PARKER MECHANICAL SHOOTING GALLERY, good order. Also 4 hp. gasoline engine. Box 596, Danville, Ky.

FOR SALE—Mail Order Business. Box 122, Saint Elmo, Ill.

FOR SALE—Twelve Edison batteries, type W. Write F. C. Wilson, Russellville, Ark.

ENGINEERS' TRANSITS, Levels and Telescope Compasses. John Burnett, Ludlow, Ky.

EDISON MOVING PICTURE machine, 1 pin, in A 1 condition with lot of extras for theatre, costing \$350. Sacrifice for \$85. H. C. Wing, Greenfield, Mass.

ACETYLENE BURNERS, \$1.00 per doz., \$10.00 per gross. Box 314, East Chattanooga, Tenn.

FREE BOOKS—All about patents and their cost. Shepherd & Campbell, 500B Victor Bldg., Washington, D. C.

"TEXTIGUM" TYPEWRITER COVERS, fine, 50c. See what I say under "Typewriters." Atchison.

of same for sale. Richards Iron Works, Manitowoc, Wis.

BEFORE YOU BUY, let us know what your power requirements are, as we are sure to have just what you want in our stock of slightly used high grade gasoline engines. Gas Power Engineering Co., Milwaukee, Wis.

FOR SALE—Three small dynamos, two 1½ hp. oil engines, one 8-hp. gasoline engine, six 24 inch band saws. Geo. J. Adams, 39 South St., New York.

ELECTRIC MOTOR—3 hp. 2 phase, 550 volts, 133 cycles, Stanley make. W. G. Snyder, 37 State St., North Adams, Mass.

WE SELL Gas Engine castings. Dimension drawings. 50. Parmelee & Son, St. Johns, Mich.

20 HP. STATIONARY, steam runabout parts, guns. C. Parrish, Wayland, N. Y.

PRINTING PRESS 11x17 inches. Cheap. G. Wills, Canal Dover, Ohio.

WE MANUFACTURE PUNCHES, SHEARS, drill vises, grinders, face chuck and angle plates, center rests, jointers, combination wood workers, belt sanders, felloe rounders, counter shafts, etc. In rebuilt and second hand machinery we have lathes, all sizes, drills, planers, shapers, millers, 300 milling cutters, hangers, band saws, jointers, moulders, other machinery. Specify exact requirements and we will equip your shop. Bicknell, Janesville, Wis.

ICE MACHINES FOR SALE. We offer for prompt shipment two 15 ton Boyle Consolidated vertical twin single acting compression cylinders, steam driven ice machines. Also one 10 ton horizontal Whitehill Corliss driven. These machines taken out on account of insufficient capacity and installation of larger machinery. The Norton Machinery Co., Cincinnati, Ohio.

FOR SALE—Gasoline engine 7 horse power; 15 horse power gasoline engine; 25 horse power gasoline engine; air compressor; 16 inch lathe and shaper. R. Plimmer, 122 Water St., New York.

\$60 ONE I H. P. VERTICAL steam engine and boiler, with all fittings, almost new and in fine working order. A. E. MacCarter, Reading, Pa.

3 H. P. GASOLINE ENGINE, Olds', practically new, for \$90. Write A. N. Morton, 53 Penrose St., E. Cleveland, Ohio.

STEEL PILING—Second-hand Steel Piling. First-class condition. Various lengths. G. D. Smith, 414 Fisher Bldg., Chicago. Send for List Contractors' Equipment.

1 H. P. STATIONARY GASOLINE ENGINE castings, \$16. Blueprints, \$1. 2½ hp. motorcycle engine castings, \$6. Blueprints, 50c. Box 199, San Antonio, Texas.

CASTINGS, \$14.50; assembled drawing, 50c; two hp. marine or stationary gasoline engines. Austin Machine Works, Austin, Illinois.

FOR SALE—A lot of 4x3½ water cooled engines. Price \$28.00 each. Double cylinder, \$56.00 each. Louis Splitt, Manitowoc, Wis.

½ H. P. GASOLINE engine castings with drawings, \$6.00. Stamp for circular. Crown Motor Works, Elgin, Ill.

DITCHING MACHINE, 500 rods daily, \$240. G. H. Cox, Geneva, Ohio.

ONE large double action power press, one single action bench press, one standard four slide wire machine. Good as new, used six weeks. A. M. Suppenter Co., Chillicothe, Ohio.

PULLEYS, GEARS, SPROCKETS, Shafting Hangers, see page 108. W. A. Jones Foundry & Machine Co., Chicago.

MACHINERY—SECOND-HAND Iron-Working Machinery, Wood-Working Machinery, Gas and Gasoline Engines, Stationary Engines. Write us for what you want in the Machinery line. We can furnish it. Cincinnati Machinery Co., 307 Johnston Bldg., Cincinnati, Ohio.

FOR SALE—Rebuilt: Throttling, Automatic and Corliss Engines, Boilers, Pumps, Heaters, Machine Tools, Tanks, Saw Mills, and general machinery, at bargain prices. Let us know your wants. The Randle Machinery Co., 1761 Powers St., Cincinnati, Ohio.

FOR SALE—Engine lathe, swings 9½ in., takes 25 in. between centers. Complete with full set change gears to cut all size threads, 3 to 40 in.; price only \$43.50. Address L. F. Grammes & Sons, Allentown, Pa.

FOR SALE—Gasoline Engines, automobiles, marine and stationary, also castings. Second hand ones taken in exchange and for sale. Apply with stamps. B. W. Richardson, R. No. 36, Peoria, Ill.

MODEL GASOLINE ENGINE CASTINGS, Marine \$8.50, Stationary \$7.50. S. Drago, 3228 Flournoy St., Chicago, Ill.

GASOLINE ENGINES—Horizontal, 1½ hp. \$40.00; 2¼ hp. \$50.00. Cincinnati Machinery Co., 307 Johnston Bldg., Cincinnati, Ohio.

LATHES—Send for free circular showing bargains on small Screw Cutting Engine Lathes. S. B. Machine Tool Co., Dept. L, South Bend, Ind.

PATTERN-MAKERS!—A book devoted to the principles of pattern and core making and molding. Written by G. H. Willard, a practical pattern maker of years experience. This book, just published, treats the subject in a much more simple, direct and effective manner than most books along this line. 224 pages. 312 illustrations. Price \$1.00 postpaid. Popular Mechanics Book Dept., 225 Washington St., Chicago.

cooled, 7½ hp. Blueprints, \$1.50. Arnold & Ruopp Mfg. Co., Marshalltown, Iowa.

MANUFACTURING MACHINERY

DIES, PRESS WORK, fine machine work; inventions developed; long experience; personal attention. Patent Model Works, 612 Queen Anne Ave., Seattle.

WE ARE EXPERTS on Piston Rings for all makes of engines. Let us make your rings. Wheeler Engine Works, Bridgeport, Conn.

IRON, BRASS AND ALUMINUM CASTINGS, Metal Specialties. Patterns, Models, Polishing, Plating and Japanning. North Chicago Tool Works, North Chicago, Ill.

PATENTS FOR SALE

FOR SALE—MANUFACTURERS LISTEN—Electric drop switch, releasable hauler chain, automatic harness hanger, mostly adapted for fire companies. These patents must be sold; for particulars address H. C. Graybill, 108 East 5th Ave., Altoona, Pa.

FOR SALE OR ON ROYALTY—Patent on "Autophotographer." Little machine which operates bulb and shutter automatically, and enables Photographer to take his own picture—article for itself which is connected to camera only by rubber tube—easily carried in pocket. Hubscher, 423 Lexington, New York City.

FOR SALE—U. S. Patent No. 957,308, issued May 10, 1910. Wagon-jack. Can be manufactured at small cost. I wish to sell outright for cash. For particulars write M. G. Colby, Main St. Sta., Franklin, N. H.

FOR SALE—U. S. Patent No. 758,591. The Goundry Concrete Cement Fence Post. Patent applies to cement posts, archways and poles. Valuable to railroads on account of scarcity of lumber. T. A. Haberkorn, 327 Huron St., Toledo, Ohio.

FOR SALE OR EXCHANGE—Valuable patent on electrical device that saves 50% over present methods and can be sold at a profit of 100%, an unlimited demand. Will sell for \$2,000 or equivalent value in trade. E. B. Feaster, Columbus, Neb.

BUY MY PATENT safety elevator and avoid law suits and save a thousand lives annually. Write to owner for particulars. E. J. Mounts, P. O. 179, Denton Co., Krum, Texas.

FOR SALE—Patent No. 957,561, dated May 10, 1910. Quilting Frame. Something every family needs. The handiest frame ever made. Will give a good commission if sold soon. If interested write me. Fred Jakob, Ravenna, Neb.

FOR SALE—Patent No. 988,607. Pneumatic pad for horse collars. For particulars address W. Skillman, Springfield, S. Dak.

NEW INVENTION \$500, worth \$2,000. Elmer Maker, North Swansea, Mass.

PATENTS

WANTED PARTY to take charge of manufacturing and sale of best (Patented) hand tool invented in many years. Sells on sight; for all metal workers, wood workers, farmers, etc. Profit 70%. Address John Holmes, 1117 Avon Court, Rockford, Illinois.

GOVERNMENT PROTECTION. Protect your ideas with Christoph Patented Caveat Date Sheets. By using these Patented Priority Date Sheets, the Government acts as your Notary Public and gives you a date on your Invention for the price of a two cent stamp. By using these Sheets you avoid disclosing your Invention to your friends or a Notary Public; many ideas have been stolen in just this manner. A date on your invention is absolutely necessary, the Patent Office demands it, you must prove priority. The cheapest and best protection on earth for the inventor. Christoph Patented Caveat Date Sheets, with full instructions, 3 for \$1.00. Chicago Model Supply Co., 1638 Clybourn Ave., Chicago.

MODELS MADE, INVENTIONS PERFECTED by first class mechanics. Our long experience in this line will be to your benefit. Moderate prices. Atlas Model Works, 1569 Clybourn Ave., Chicago, Ill.

MODELS made for inventors. Low prices. Howard Merryman, Towson, Md.

PATENTS THAT PROTECT—Careful, honest work in every case; long experience; highest references. A 64-page book sent free. Fitzgerald & Co., Patent lawyers, Dept. 82, Washington, D. C.

"PATENT NON-SENSE," or "How to Judge a Patent." Free. Obed Billman, Cleveland, Ohio.

PATENT ATTORNEYS

\$15 FILES YOUR IDEA in patent office, under my "No fee-in-advance Plan," and you make and sell under "Patent Applied For." Send sketch for free report. Books free. Obed Billman, Main Office, Cleveland, Ohio.

IMPORTANT PATENTS. For \$1 I can send copy of almost any important U. S. patent in print and give much information concerning that art. Edward W. Byrn, Patent Attorney, 627 F St., N. W., Washington, D. C.

PATENTS THAT PROTECT are secured through Pacific Coast Patent Agency, Inc., Dept. D, Stockton, California.

IMPORTANT NOTICE—Read my page ad on page 116 Advertising Section, of this magazine, relative to patents, trademarks, etc. Special offers contained in the ad. E. E. Vrooman, Patent Lawyer, Washington, D. C.

PATENTS—HERBERT JENNER, patent attorney and mechanical expert, 608 F. St., Washington, D. C., established 1883. I make a free examination and report if a patent can be had and exactly what it will cost. Send for circular.

PATENTS THAT PROTECT and pay. Advice and books free. Rates reasonable—Highest references; Best results. Watson E. Coleman, Patent Lawyer, 622 F. St., N. W., Washington, D. C.

C. L. PARKER, Patent Attorney, Ex-examiner U. S. Patent Office, 910 G. St., Washington, D. C. Inventor's handbook "Protecting, Exploiting and Selling Inventions" sent free upon request.

FREE BOOKS—All about patents and their cost. Shepherd & Campbell, 500B Victor Bldg., Washington, D. C.

PATENTS PROMPTLY OBTAINED. My free booklet will help you to fortune. Read pages 11 and 12 before applying for patent. Write today. Dean Swift, Washington, D. C.

BOATS, LAUNCHES AND STEAMBOAT MACHINERY

BUILD YOUR OWN BOAT and save $\frac{1}{2}$ the cost. The greatest proposition ever offered to the boating public. Get our free catalogue. DeFoe Boat & Motor Works, 3125 South St., Bay City, Mich.

REAL ESTATE AND FARM LANDS

"SUNNY ALGOA"—THE ORANGE GARDEN of Texas. Hundreds of enthusiastic non-residents having orchards developed on monthly payments. High class community and land values advancing very rapidly. Write at once for booklet "L." Gulf Coast Development Company, Algoa, Texas.

WASHINGTON APPLE LAND CALLS YOU. One acre this year produced \$3,440. \$15 monthly pays for five acres; finest soil, near railroad. H. B. Snider, 334 Henry Bldg., Seattle, Wash.

HOMES IN BEAUTIFUL OZARKS—Fertile valleys, rich mountain tops, flowing springs, healthful climate, fruit, grain, stock and poultry. Easy terms. Prices right. J. C. Mitchell & Co., Fayetteville, Ark.

90 A. HIGHLY improved, $\frac{1}{2}$ mile Ottawa. 360 a. stock farm, good improvements, 6 miles Ottawa. G. A. Sallee, owner, Ottawa, Kansas.

SOME LITTLE HOME FARMS. Easiest terms. List free. Ike. Riggs, Fayetteville, Ark.

LAST CHANCE AT LARGO, only 147 choice orange, grape fruit and truck farms left; as good as any of the 1,600 farms already sold; the heart of the Pinellas Peninsula, practically a huge island surrounded by the warm waters of the Gulf of Mexico, with the finest climate and conditions for winter vegetables and citrus fruit in America. The big Largo book tells all about it. Free. Send today. Pinellas Groves, Inc., 1136 Steger Bldg., Chicago.

LOTS ON THE BEAUTIFUL Halifax River and the Ocean, in the Townsite of Pelican, near Ormond Beach, Florida. America's famous Winter Resort and Racing Beach, Rich Men's Homes and Orange Groves line its banks. This is an exceptional opportunity for the small investor. Lots 50x100, 75 foot street, 20 foot alley, \$50.00 for inside and \$75.00 for corners. \$5.00 cash and \$5.00 a month. Address Henry C. Paulsen, Colorado Springs, Colo.

GOVERNMENT FARMS FREE—Official 112-page book "Vacant Government Lands" describes every acre in every county in U. S. How secured free. 1910 diagrams and tables. All about irrigated farms. Price 25c postpaid. Webb Pub. Co., Dept. 385, St. Paul, Minn.

CALIFORNIA Irrigated Land: famous Gridley colonies; large and small tracts; easy terms. Improved farms; best home-seekers' proposition. Write for particulars. Gridley Land and Irrigation Co., Gridley, Cal.

80 ACRE FARM CHEAP. 15 in cultivation, balance timber. Small orchard. 4 miles from Prestonia, Mo. Price \$700. Half cash. O. J. Kunz, 3444 Itaska St., St. Louis, Mo.

LOTS IN POE, ALTA, main line on Grand Trunk Pacific, for sale at \$10 down and \$5 per month. Write Walch Land Co., Winnipeg, Canada.

BLACKSMITHS

BLACKSMITHS. There is a great demand for good steel workers and at big salaries. Buy Toy's Modern Methods, welding new steels solid and doing all hard jobs easy; forging and tempering all tools to a standard by colored charts. All for \$1. Send for samples free. W. M. Toy, Sidney, Ohio.

CEMENT

IF YOU WANT the best information on cement and concrete constructions, subscribe for Concrete, leading cement and concrete monthly. Sample copy, 10 cents. Yearly subscription, \$1.00. Concrete, 135 Newberry Bldg., Detroit, Mich.

DOGS, POULTRY AND LIVE STOCK

SINGLE COMB WHITE LEGHORN day old chicks our specialty. Place your orders now for Spring delivery. Hurlhurst Farm and Hatchery, Wilson, N. Y.

WHITE ROCKS, LIGHT BRAHMAS. Eggs for sale. Will N. Cowles, Whitewater, Wis.

200-EGG INCUBATOR costs only \$3; new method; uses hen and hen heat; agents wanted; free catalog. Natural Hen Incubator Co., Sta. H., Dept. 27, Los Angeles, Cal.

GAMES AND ENTERTAINMENTS

EWING'S CABINET OF MAGICAL TRICKS. Contains apparatus to perform 6 good tricks, 25c postpaid. Percy Ewing, Decatur, Ill.

TEN THOUSAND VENTRILOQUISTS WANTED! Learn in few hours! New natural method. Unlimited fun. Interesting information for stamp. W. C. Bailey, 771 Iglehart St., St. Paul, Minn.

WIGS AND MAKE-UP; catalogue free. Percy Ewing, Decatur, Illinois.

153 TRICKS—Every kind joke book, ventriloquism, how to box, how to dance, puzzles, games, toasts. 10 and 25c each. Cat. free. Stoddard Co., Box 373, Pittsburg, Pa., Dept. K.

FREE—25c **MAGIC POCKET TRICK** free. Large illustrated catalog of new tricks, puzzles, jokes, illusions and acts. Send 6c stamp. Magic Company, 10-270 West 39th St., New York.

PLAYS, VAUDEVILLE Sketches, Monologues, Dialogues, Speakers, Minstrel Material, Jokes, Recitations, Tableaux, Drills, Musical Pieces, Entertainments for all Occasions, Make Up Goods, Large Catalog free. T. S. Denison & Co., Dept. 11, Chicago.

ENTERTAIN YOUR FRIENDS! Send 5 cents for pack magic cards and catalog tricks. For 10c we send 8 plays and catalog stage make-ups. Bates Play Magic Co., Dept. 21, Meirose, Mass.

MAGIC TAUGHT BY MAIL—Prospectus, catalog, 10 cents. National Magic School, 1193 Broadway, New York.

THREE GOOD TRICKS, 10 cents. Bamberg, 1193 Broadway, New York.

STEEL STAMPS, STENCILS, DIES, ETC.

STAMPS, STENCILS, SEALS, CHECKS, Punches and Dies. Presswork. Dickey-Grabler Co., Cleveland, Ohio.

FOR THE HOME

PINLESS CLOTHES LINE GUARANTEED. Clothes cannot blow off. Saves time; cannot rust; saves money; lasts a lifetime; no trouble. 25 feet \$1, prepaid anywhere. 50 feet \$2, prepaid. Agents wanted everywhere. Pinless Clothes Line Co., 560 Lumber Exchange, Portland, Oregon.

ELECTRICAL BURGLAR ALARM TRAP, can attach to doors and windows, 30c prepaid. Andee Electric, 148 W. 37th, New York City.

RECIPE FOR HOME-MADE Ice Cream and Sour Cream Salad Dressing. None better. Twenty-five cents. Home Receipt Co., Box 426, Oregon, Ill.

DECORATE YOUR HOME; a rare bargain, two beautiful rose stencil designs, one grape design and two others; cut from oiled stencil board, all for 50 cents coin or money order. H. F. Williams, 6 Union St., Le Roy, New York.

NO EARLY RISING to attend steam furnace. Simple home-made device sets drafts and warms house. Winter morning troubles eliminated. Instructions, 25c. L. Eckart, 712 Coster St., New York City.

COMPLETE ELECTRIC LIGHTING PLANT, suitable for homes, farms, institutes; comprising 2 hp. engine, dynamo, switchboard, storage battery, fixtures and lamps. Capacity, 50 lamps, \$275.00. Dirzuweit Electric Mfg. Co., York, Pa.

CYCLONE DISH AND VEGETABLE washer. Labor saver for women. Washes dishes clean. Absolutely guaranteed. Particulars free. One Minute Washer Co., El Reno, Okla.

MAGIC CLEANER—Make it yourself, costs only a few cents; removes spots, stains, grease, etc., from garments and furniture. Cannot injure the choicest fabric. Saves dollars. No home will be without it after first trial. Send 10 cents for receipt. Address Mrs. Coventry, 5971 Maple Ave., St. Louis, Mo.

MAKE YOUR OWN MISSION FURNITURE at the minimum of expense. Our 2 books "Mission Furniture, How to Make It," Parts 1 and 2, tell in plain, simple language just how to make 50 different pieces. Full dimensioned working drawings and half tones of finished articles. Price 25 cents each or 50 cents for the two volumes, postpaid. Popular Mechanics Book Dept., 225 Washington St., Chicago.

PEERLESS DRAFT REGULATOR puts on draft while you sleep; cheap and reliable. Omar K. Landis, 423 Charlotte St., Lancaster, Pa.

MUSIC

IF YOU WANT the latest music and a better assortment for less money than elsewhere, write today for catalog. Semple's Music House, 204 West Ave., Norwalk, Conn.

Keenedge Co., 827 N. Tacoma, Indianapolis, Ind.

FOR SALE—30,000 pound best leaf tobacco, mail stamps for samples. Anton Wavrin, Franklin, Ky.

SAFETY RAZOR BLADES sterilized and sharpened better than new; 2 cents each. Five years' success. Send for blade box and circular. Electro Stropping Co., 134 Shelby St., Detroit, Mich.

PRINTING

\$150.00 JOB PRINTING OUTFIT, complete; must sell; first \$75.00 get bargain. Holmes, Box 530, South Norwalk, Conn.

PRINTING PRESS, foot-power, new, 7x11 and outfit. \$75 cost \$110. Charles Masten, Frankfort, Ind.

AMATEUR PRINTERS type and supplies. Send for list. 958 W. Harrison St., Chicago, Ill.

25 ENVELOPES, 10c. Eagle Envelope Co., Quincy, Mass.

TYPEWRITER CIRCULAR LETTERS, \$1.50 to \$2.75 the 1,000; 6x9 circulars \$1.25; 5,000 for \$3.50; 5,000 3x6 envelope slips, \$2.00. All other printing as cheap. Elegant set samples free. Good's Printery, Harrisonburg, Va.

FIFTY HIGH-GRADE VISITING CARDS with name in old English and leatherette case, 25c, postpaid; 20 cards, 10c, coln. The Beebe Press, Dept. O, Lynn, Mass.

PRINTING—50 letterheads and 50 envelopes, 50c postpaid. Patterson Press, Beaver Falls, Pa.

100 CARDS 50c; name and address; superior. Card Printery, 5213 Carpenter St., Chicago.

3,000 GUMMED LABELS, 1x2, any wording, one color, 75 cents. Riverside Press, 53 River St., Chicago.

25 VISITING CARDS, 10c; 100, 25c, postpaid. Retter, Box 142-P, Tipppecanoe City, Ohio.

25 GOOD WHITE ENVELOPES neatly printed, 12c; 100, 40c, postpaid. F. Johnson, 625 E. 40th St., Chicago.

RARE COINS AND STAMPS

STAMPS—200 ALL DIFFERENT, 10c. Coins—10 all different, 15c. Large U. S. cents, 5c. F. L. Toupal Co., Chicago Heights, Illinois.

COLLECTORS—CATALOG FREE! Powell Stamp Co., Storm Lake, Iowa.

SPECIAL COIN PACKET—5c silver, 3c silver, 3c nickel, 2c piece, large cent, 1/2 cent, Connecticut Colonial, War cent, Confederate note, Georgia War note. All in good shape, 75c for lot delivered. New 50 page selling catalogue just out. Free. William Hesslein, 674 Elm St., New Haven, Conn.

500 MIXED STAMPS, 20c. L. Barrows, Box 12, Hartford, Conn.

\$7.75 PAID FOR RARE DATE 1853 Quarters, \$20.00 for a Half-Dollar. We pay a cash premium on hundreds of coins. Keep all money coined before 1880, and send 10 cents at once for our New Illustrated Coin Value Book; size 4x7. It may mean your fortune. C. F. Clarke Co., Coin Dealers, Dept. 14, Le Roy, N. Y.

TELEGRAPHY

TELEGRAPHY, both Morse and Wireless, taught quickly. Also Station Agency Work, R. R. Dispatcher's and Western Union wires, and complete wireless station in school. Big demand for operators. Living expenses earned. Correspondence courses if desired. Catalogs free. Dodge's Institute, 15th St., Valparaiso, Ind. Est. 1874.

TELEGRAPHY TAUGHT in the shortest possible time. The Omnigraph Automatic Transmitter combined with standard key and sounder. Sends you telegraph messages at any speed just as an expert operator would. Five styles, \$2 up; circular free. Omnigraph Mfg. Co., 41 G. Cortlandt St., New York.

TYPEWRITERS

UNDERWOODS, Remingtons and all other machines, 30 to 50% less than mfgs. prices. We rent them anywhere, and allow six months' rental to apply toward the purchase price. Write for catalogue and net prices. Typewriter Sales Co., 171 Broadway, New York.

VERY SPECIAL PRICES on Bennett \$18.00 typewriters. Investigate. Few more local and traveling representatives wanted; live men can average \$150.00 month. Welland Sales Co., 249 Bear Bldg., Albany, N. Y.

TO PARTY SENDING me \$1.00 to pay part of the express charges I will send my \$100.00 Remington No. 6 Typewriter C. O. D. \$20.00, giving you the privilege of examination before accepting. Address E. D. Bedal, 3714 Indiana Ave., Chicago, Ill.

TWO OLIVERS: ONE UNDERWOOD nearly new, taken on debt; any reasonable offer takes them. Ayers Investment Co., 202 Sykes Block, Minneapolis, Minn.

REMINGTON TYPEWRITER CHEAP. Perfect condition. Would ship on approval. Frank Paine, Route 5, Rosedale, Kan.

VISIBLE Typewriter, \$5.00. Meier, Russell, Kan.

TYPEWRITERS—Real Remingtons, \$12.00; Caligraphs, \$6.00; Hammonds, Densmores, \$10.00; Smith Premiers, \$15.00; Olivers, Underwoods, \$25.00. 15 days' trial and year's guarantee. Harlem Typewriter Exchange, Dept. 87, 217 West 125th St., N. Y. C.

I WANT TO CORRESPOND with persons who are about to buy a high-grade typewriter, and object to paying the high prices generally asked by manufacturers and dealers. Any make on approval. Catalogue, bargain list and valuable information sent free. A. E. Atchison, 4127 West 21st St., Chicago.

COMPETITORS "BEATEN TO A FRAZZLE"—Excellent rebuilt Remington's, Smith's, \$18-\$25; Underwood's, Oliver's, \$33; others cheaper; guaranteed; sent on approval; supply limited, write quick. Consolidated Typewriter Exchange, 245 Broadway, New York.

TYPEWRITERS—Every kind on the market, write today for best bargain you ever secured. Shipped anywhere on approval. \$6.00 up. Fletcher Typewriter Co., 207 N. 7th St., St. Louis, Mo.

WIRELESS

MURDOCK WIRELESS APPARATUS is known for reliability. We make sets for all purposes, experimental or commercial. Receivers, \$2.70 to \$13. Tuning coils, \$4.00 to \$15. Genuine patented Silicon Detector, \$15. Send for full catalog and prices. Wm. J. Murdock Co., 10 Carter St., Chelsea, Mass.

"MAKING WIRELESS OUTFITS"—A concise and simple explanation of the construction and use of simple and inexpensive wireless equipments, for sending and receiving up to 100 miles, giving full details and drawings of apparatus, diagrams of circuits and tables. By Newton Harrison, E. E. 12mo. Price 25 cents, postpaid. Popular Mechanics Book Dept., 225 Washington St., Chicago.

MISCELLANEOUS

DON'T OVERLOOK THIS—For \$1.00 we will teach you to transfer photos to china, watch cases, pearl and all metals. Guarantee success. William Coffman & Son, Warsaw, Ohio.

THE MURDOCK CIRCUIT DETECTOR is the best device ever offered for testing out all ordinary circuits. Consists of head receiver, battery, test tips. By mail, \$2.50. Write for full description. Wm. J. Murdock Co., 10 Carter St., Chelsea, Mass.

ILLUMINATING PAINT in all colors; the sensation of the hour; formulas for preparing all colors mailed for 25c silver; all other formulas you may want mailed free. Fred Conner, Hagerman, Idaho.

MAKE PURE VINEGAR by our process for 5 cents per gallon. Will preserve pickles. No chemicals. Strictly pure. Not injurious. Formula 50 cents. William Coffman & Son, Warsaw, Ohio.

"HOLEPROOF" your hosiery. Send ten cents in silver and stamped envelope and receive enough to treat a dozen pairs. Simple, efficient process. Marvelous Discovery Company, 217 Fulton St., Brooklyn, N. Y.

\$1,500.00 RHEUMATISM FORMULA, complete with directions, 25c. G. E. Brasington, Druggist, Maiden Rock, Wis.

ANYBODY CAN MAKE GOOD CUTS with my simple zinc etching process; price, \$1; specimens and particulars for stamp. T. M. Day, Box M, Windfall, Ind.

ROSE DEW-DROP PERFUME and Wedding Ring by mail, free to anybody, if you send 10 cents postage. Union Mfg. Co., Dept. 30, Palatine, Ill.

FORMULAS for anything 20c. Malalane Company, 1411 Long-fellow Ave., New York.

SMALLEST BIBLE ON EARTH with catalogue of rare novelties, 12c. W. L. Board Co., 1912-14th St., Washington, D. C.

HANDCUFFS, LEGIRONS, NIPPERS, etc., repairs, keys, handcuffs, \$2.50 pair up. Frank Widmayer, 2312 Broadway, New York City.

LIQUOR HABIT—Guaranteed lifelong home cure, 3 days. Absolutely best. Book mailed free. E. R. Woods, 534 Sixth Ave., New York, N. Y.

FIVE USEFUL, helpful formulas for \$1.25. Worth much more. Box 806, Lubbeck, Texas.

BEST RUBBER STAMP making outfits. S. A. Brown, Buffalo, New York.

"CACHOO" sneeze powder. Sample, 10c. Three, 25c. By Reg. mail, dozen, 80c; hundred, \$5.00. Ewing's, 190 Thatcher Pl., Decatur, Ill.

GET A WATCH or fountain pen free. Particulars for two cent stamp. Box 472, Louisville, Ky.

FORMULAS, anything, 25c each. Forbes Agency, (Cambridge B), Boston, Mass.

ARE YOU AFRAID OF SLIPPING on icy pavements? "The Flat Spring Steel Ice Scraper" will hold you up. Put on in a second; not cumbersome. No screws. No straps. Every pair guaranteed. State width of heel. Send 12c. A. P. Blakemore, 3425 Market St., Philadelphia, Pa.

TRANSFER PHOTOS TO WATCH CASES, chinaware, sofa pillows, etc. New process, very profitable. 25c brings full instructions. P. Benson, Stewartville, Minn.

I HAVE REMOVED MY BUSINESS to St. Joseph, Mo., where I have the utmost facilities for furnishing reliable formulas, 25c each. Homer Cloukey, Technical Expert, Box 407, St. Joseph, Mo.

50c BRINGS 5 FORMULAS and full instructions for metalizing, mounting and coloring flowers, insects, etc., for jewelry. Easy home work. Big profits. P. Benson, Stewartville, Minn.

FREE—Send me 15 cts. and I will send you a nice calf coin purse free, and tell you how you can make lots of money. Lock Box 114, Melrose, Mass.

PHOTOS ON WATCH DIAL, on apples; man in the bottle; transmitting phonograph music to a distance, 25c coin. J. F. Ellioth, Jr., Box 291, Islip, L. I.

YOU NEED ONE of Bell's Handy Boxes—assorted pure Para rubber bands (guaranteed). Prepaid, money back privilege, 17c. Worth more. Order Bell Mfg. Co., 596 Broadway, New York.

MAYLON DETECTIVE SERVICE, perfectly reliable, highest police references. Correspondence Solicited. L. S. May, Chief, 859 Green, Salt Lake, Utah.

BIG PROFITS in tanning hides and skins, 15 receipts and instructions, \$1.00 postpaid. Address Earl Dryer, Dept. 1, Homer, Mich.

SCARF PIN INSURANCE. Pin can't come out. Gold filled. Sample, 10c. Special quantity price. Middleton Jewelry Co., North Attleboro, Mass.

MOVING PICTURE MACHINE, 35c. Prepaid. Turns with crank. Extra pictures, 5c. Bunch Mfg. Co., Marshall, Mo.

8,500 NAMES, residents of smaller towns, for sale. Lynn Kepler, Cambridge City, Ind.

IF YOU WANT a money getting formula, something new, we have it. 12 cents gets it. Francis Co., 239 Third St., Jersey City, N. J.

50 PRINTED ENVELOPES, 20c; 150, 55c; prepaid. Eagle Co., Quincy, Mass.

SEE OUR AD under Patents. Atlas Model Works.

I WILL START YOU earning \$4 daily at home in spare time, silvering mirrors; no capital; send for free instruction booklet, giving plans of operation. G. F. Redmond, Dept. 306, Boston, Mass.

MOTION PICTURE MACHINES, Film Views, Magic Lanterns, Slides, and similar Wonders For Sale. Catalogue Free. We also Buy Magic Machines, Films, Slides, etc. Harbach & Co., 809 Filbert St., Philadelphia, Pa.

TOBACCO CAUSES CHRONIC IRRITATION of brain and nerve cells. Ni-Ko heals this irritation. You won't want tobacco any more. You will feel so good. Write, today. King Ni-Ko, 7, Wichita, Kans.

HOW to get a Hektograph that will make 150 copies in 10 minutes; letter size, \$2.00. Write for circular. Heyer Duplicator Co., 84 La Salle St., Chicago.

TRICKS, JOKERS, PUZZLES, ILLUSIONS, Novelties, Magic Pocket Trick Free. Illustrated Catalog included. Send 4c stamps. Magic Dept., 10-270 West 39th St., New York.

500 MONEY MAKING FORMULAS and Digest, publishing monthly 100 Money Makers, one year for 25c. Trial 6 months, 10c. Digest, Grand Rapids, Mich.

"PATENT SENSE AND NON-SENSE," or "Good and Bad Patents," compared. Free. Obed Billman, Cleveland, Ohio.

YOUR AD in over fifty magazines 3 months, 5 cents per word. A. S. Mankin & Co., Alexandria, Va.

TOO LATE TO CLASSIFY

POSITIVELY BEST RIBBONS, three, \$1.10. See what I say under "Typewriters." Atchison.

Time and Its Measurement

By JAMES ARTHUR

Reprinted from Popular Mechanics. So far as known is entirely different from anything previously written on the subject. Mr. Arthur is a great authority along this line, having for years made an extensive study of clocks, watches and time-measuring devices.

Contents: Chapter 1--Historic Outline. 2--Japanese Clocks. 3--Modern Clocks. 4--Astronomical Foundation of Time.

"Written So You Can Understand It"

64 pages. Profusely illustrated. Size 7x10 in. Printed on coated paper with handsome blue cloth covers.

Price \$1.50 Postpaid

Popular Mechanics Co., 225 Washington St., Chicago



YOU CAN AFFORD

to have clean laundry all the time if you wear collars that equal linen in appearance but cost only 2½ cents apiece. Such are Linene Collars.

Price at the stores 25 cents per box of 10, or by mail 30 Cents in U. S. stamps. SAMPLE BY MAIL for 6 Cents.

State size and style.

REVERSIBLE COLLAR COMPANY,
Department U, BOSTON, MASS.



WHEN YOU WANT ANYTHING AND DON'T
KNOW WHERE TO FIND IT
WRITE BUREAU OF INFORMATION,
POPULAR MECHANICS CHICAGO

MONTHLY CASH PRIZES

Until further notice in this magazine the Editor of Popular Mechanics will pay two cash prizes each month for the best original contributions to its

SHOP NOTES DEPARTMENT

\$10 for the Best Contribution
\$5 for the Second Best

THIS IS IN ADDITION to our usual rates for such contributed articles.

Quality, not length counts. Checks will be sent on the last day of each month for the prize articles received during that month. Publication in the magazine will follow in about two months.

PRIZES AWARDED FOR DECEMBER, 1910

First Prize—ARTHUR D. JOHNSON, Philadelphia, Pa., \$10

"Cutting Threads with a File"

Second Prize—PHILLIP J. DUFF, Montreal, Canada, \$5

"Caliper over Flanges"

EXTRA AWARD

On account of there being five contributions this month, each of which deserved second prize, we have made an EXTRA AWARD of four additional second prizes, as follows:

L. M. EIFEL, Chicago, \$5

"Driving Nails In Brick Walls"

E. E. DOCKER, Berkeley, Cal., \$5

"An Air Check Valve"

F. G. REMPE, Oakland, Cal., \$5

"A Mixing Stick"

F. W. STROMER, Gig Harbor, Washington, \$5

"Fastening Bolts in the End of Bamboo Poles"

All accepted contributions to our departments, "SHOP NOTES" and "AMATEUR MECHANICS," are paid for immediately; checks for prize awards are sent at the end of each month.

Address, EDITOR POPULAR MECHANICS
225 Washington St., Chicago

Smoke Problem

By
JOHN C. MILLER, M. E.

of Electricity

By
W. L. ABBOTT

The Testing of Aerial Propellers

By
C. E. LARARD and R. O. BOSWALL

What Causes Boiler Explosions?

By
M. KENNETT

These are four out of over fifty important articles of timely interest—all with full and accurate illustrations—which make the current number of

Shop Notes Quarterly

worth a hundred times what it costs to the **man who does things**. Besides the half hundred of special articles and reviews there are hundreds of other items of value and interest to workers in all the useful callings as well as to all who keep in touch with modern progress.

Shop Notes Quarterly is the largest publication in the world devoted exclusively to Mechanics, Science and Practical Knowledge. 210 pages of reading matter—with complete alphabetical Reference Index.

\$1.00 a Year—Ask the Newsdealer—25 Cents a Copy

POPULAR MECHANICS CO. 225 Washington Street
CHICAGO, ILLINOIS

A TRAIN LOAD OF BOOKS



One of Chicago's Biggest Bookstores Failed

To close out stock quick we offer it at less than cost of paper. Binding free. We are also now closing out other bankrupt book stocks at **10c to 50c on the dollar**, and publishers' overstocks and regular stock at wholesale and below.

Millions of Books—Thousands of Titles

In our eight years' experience as book brokers we have never before been able to offer such tremendous bargains. Buy now. Buy quick while the stock is complete.

Sample Prices

Famous Pictures, \$12.00. My price, **\$1.50**. **Dante's Inferno**, Dore's Ills., \$6.00. My price, **90c**. **Harper's History of the War with Spain**, \$16.00. My price, **\$2.60**. **Library of Modern Achievements**, 10 vols., \$50.00. My price, **\$7.50**.

American Encyclopaedia Britannica, 12 vols., \$48.00. My price, **\$11.75**. Thousands of other similar bargains.

Fiction—regular stock. Many below wholesale prices. **Shepherd of the Hills**, 38c. **That Printer of Udell's**, 38c. **Calling of Dan Matthews**, 85c. **Uncrowned King**, 54c. Hundreds of others.

Biggest Bargains ever offered in de luxe home library sets. Going at less than cost of binding. Plates, paper, printing, selling expenses, free. **Prices cut 70 to 80 per cent while this stock lasts**. We have a few sets each of

Dickens, Tolstoy, Scott, Burke, Taine, Bronte, Balzac, Ainsworth, Thackeray, Parkman, Dante, Gibbon, Prescott, Dumas, Emerson, Cooper, Green, Hugo, Eliot, Carlyle, Cervantes, Poe, Rawlinson, Plutarch; Shakespeare, De Musset, Hawthorne, Irving, Plato, De Maupassant, Lincoln, Stevenson, Fielding, Kipling, Longfellow, Lossing, De Foe, Wilde, Goethe, Schiller, Macaulay, Burns, Sue, Smollett, Guizot, Lever, Lover, Daudet, Lytton, Moliere, Warren, Gautiere, Austen, Pepys, Bjornson, Ibsen, Voltaire, De Kock, etc.

All Books Shipped on Approval

Ask for our big **Bargain list of books**, select what you think you may want, and we will ship them to you on your agreement to pay for them or return at our expense.

Bargain List—Our Big Bargain List is free. A post card will bring it. **Send the card now**, get the list before the choicest bargains are gone forever.

David B. Clarkson Co., Book Brokers, 211 Clarkson Bldg., Chicago

IT'S UP TO YOU

Whether to fill an ordinary, cheap job, or become an expert chauffeur, salesman or auto repairman at \$25 to \$50 a week. Our students are filling lucrative positions after a few week's home study. You can do it! We guarantee our graduates licenses. All the shop work and road practice you wish. Do not complete payments until you have a paying position satisfactory to you. Low costs. Write at once for our special offer,



PITTSBURGH AUTOMOBILE ACADEMY, INC.
Pittsburgh, Pa.

The Best Book For Beginners

A Practical Course in Mechanical Drawing
Price 50c Postpaid
By **Wm. F. Willard**

POPULAR MECHANICS BOOK DEPT.
225 Washington Street, Chicago

Mechanics For Young America

A book which tells how to make scores of articles which delight the heart of the average boy. Price 25 Cents Postpaid

POPULAR MECHANICS BOOK DEPT.
225 Washington Street, CHICAGO

We have for sale a limited number of complete files of

Popular Mechanics for 1909

These consist of the 12 issues of the magazine and a complete index suitable for binding.

Price \$1.25 postpaid

POPULAR MECHANICS, 225 Washington St., CHICAGO



Napoleon bidding farewell to Josephine—"My destiny and France demand it." This is but one of the hundreds of thrilling illustrations in the *Library of Universal History*. Do YOU know all of this heart-throbbing story—the Imperial Emperor, the loving wife, the inexorable pail of ambition, the breaking heart left behind!

RECEIVERS' SALE!

A \$60 LIBRARY FOR ONLY \$29.50



Wonderful opportunity to get these 15 magnificently bound volumes, comprising the *Library of Universal History*. Absolutely the most startling bargain in a recognized authoritative history. We, as receivers, must dispose of enough sets to pay the obligations of the publishers. For a limited time we will send you a set for free examination without asking you to pay one cent down.

UNION BOOK COMPANY FAILS! HALF PRICE!

Yes, actually less than half price—the greatest opportunity ever offered our readers, an opportunity to secure at less than the publisher's price these 15 beautifully bound volumes of the *Library of Universal History*. This is a brand new, handsome edition, all printed from large, new type, embellished with over 100 double-page maps and plans, 700 full-page illustrations, many of which are in colors, and more than 5,000 pages of solid reading matter, beautifully written.

Books Sent FREE

We will ship the books right to your home, all transportation charges paid by us. You can see the complete set just as it is. You see the books themselves. We want you to sit down in your own home and read these books. Keep them for a week. Begin at the dawn of civilization and thread the paths down to the hour in which you live. Study the lives of Alexander, Caesar, Napoleon, Washington, Lincoln, Bismarck. Analyze the secret of their power and success. Watch the rise, progress and decline of Egypt, Greece and Rome, and on through European and American history right down to the present hour. The past teaches a lesson that every thoughtful American citizen knows applies to our own country today. You should study history — your children should study it.

The late Ex-President Cleveland said: "I am sure this history will find an important place among the publications intended to give wider familiarity with historical literature."

SEND NO MONEY—This Coupon

brings the books to your home FREE. Just send us the coupon—that is all. The books will be sent to your home, transportation charges prepaid. We advise you to send the coupon today, for certainly hundreds will take advantage of this extraordinary offer. Remember, a free examination for a week — books returnable at our expense if you do not wish to keep them. If you do wish to keep them pay only 50c down and then only \$2 a month for 14½ months. Send coupon today. See these books now.

American Underwriters' Corporation,
192 Michigan Ave.,
Dept. 1192, Chicago

American Underwriters' Corp'n Dept. 1192 192 Michigan Ave., Chicago
Without any expense or obligation to me, I will examine the *Library of Universal History* if sent to my home, but charges prepaid. This is positively not an order, but simply a request for an absolutely free examination.

Name.....
Occupation.....
Address.....



PRACTICE DRUGLESS HEALING

Become a Doctor of Mechano-Therapy, the startling new science. Splendid opportunity for men and women to enter uncrowded, highly paid profession. Learn by mail or in class. Short time prepares you. Fine practice—big income quickly acquired. The practice of Mechano-Therapy offers you the opportunity of a lifetime—a chance to climb quickly and easily to prominence—influence. No long years of preparation—just a little time. No long, tedious waits for business. Your services will be in immediate demand at good prices. Best of all, you can make from \$3,000 to \$5,000 a year right from the start.

EIGHTEEN MILLION PEOPLE

in the United States today call in Drugless Healers when sick. As sentiment against drugs grows, this number will increase by thousands. It means a fruitful field for the Mechano-Therapist. What is Mechano-Therapy? Simply scientific drugless healing—just getting into harmony with nature—treating human ailments without ruining the system with poisonous drugs—a science of health, not medicine.

FREE BOOK COUPON

American College of Mechano-Therapy
Dept. 366, Chicago, Ill.

Please send without any cost to me or any obligation on my part, a copy of your free book "How to Become a Mechano-Therapist," testimonials from graduates, proofs, etc.

Name.....
Street.....
City.....State.....



USE THE COUPON

SEND FOR FREE BOOK

Gain Success

You Can If You Will

Achieve your ambition. Down deep in your heart you cherish the conviction that you can do great things. You don't intend to always work for someone else—exist on small income—remain a mere cog in the great wheel of the world's work. Your place is up with the leaders—where you can mingle with your equals—with the wealthy, influential, honored and respected business men and women of the community. When you have completed your course—graduated with honors—received your diploma as an M. T., you can step out from oblivion and assume the place you were born to occupy.

Send Now For Big FREE BOOK

It tells all—explains everything. Anticipates and answers your questions—in a way impossible here. This announcement has stirred you—aroused your ambitions—as it has hundreds of others. For others we have been the guiding star to honor, power and riches; they saw the great opportunity and grasped it. Their thrilling, inspiring messages—their vivid, enthusiastic descriptions of success since their graduation—their praise of our school and methods of instruction, all makes absorbingly interesting reading. The old way of administering drugs is giving away to this wonderful new science. The demand for Mechano-Therapists is far greater than the supply. Millions are sick—willing to pay anything to be cured. Drugs have failed. Faith in them is destroyed. You can cure the sick by Mechano-Therapy—make lots of money. These and many other things are explained in the free book. Send for it today. See for yourself the marvelous possibilities of this remarkable science. Investigate. You owe it to yourself to do that much. Don't put it off one minute. You needn't write a letter or even a card. Just sign the coupon, drop in an envelope and mail now.

AMERICAN COLLEGE OF MECHANO-THERAPY
120-122 Randolph St., Chicago

LEARN MUSIC BY MAIL



By the wonderful Simplex copy-righted system anyone of ordinary intelligence can quickly learn to play piano or organ

WITHOUT A TEACHER

You need not know the first principles of music. By no other method can you learn music so quickly and thoroughly as by the Simplex System. The study is easy and fascinating. By our system you can study during spare time in your home and quickly become a capable musician, playing popular, sacred or classical selections. Delighted students in every state and territory. Some of our students, after six or eight lessons, begin playing piano or organ in church or Sunday school. Others write that after one lesson they are able to play a waltz from memory. If you wish to become a skilled musician, write at once for our free book. Address

Simplex School of Music Conservatory 658, Kansas City, Mo.

THIS FREE BOOK TELLS HOW

STUDY LAW at Home

Become a Lawyer **LAW** Legal Diploma

We make your home a university. Leading Correspondence Law Course in America—recognized by resident colleges. New text, specially prepared by 20 Deans and Univ. law school teachers. We guarantee to coach free any graduate failing to pass bar examination. Special Business Law-Course. "Legally-trained men always succeed." Over 10,000 students enrolled. Begin now. Easy terms. Catalog and Particulars Free.
La Salle Extension University, Box 1192, Chicago, Ill.

Be A Signal Engineer

Signal Engineers and Supervisors receive



\$125.00 to \$350.00

monthly. Other signal positions pay from \$65.00 up. This is Your Opportunity to train yourself in your spare moments for a profession Always Needing a Man Who Knows.

We send the entire course of Self Instruction with Complete Sturdy Practical Working Models upon receipt of the First Payment.

DEPARTMENT OF SIGNALING

UNDER PERSONAL SUPERVISION
S. DEUTSCH, B. S. E. E. and Staff
Manhattan Building, CHICAGO, ILL.

Don't Miss Your Chance. Write for details At Once.



STAMMER

My book "How to Stop Stammering"—a treatise on "Scientific Talking"—direct to the point.

Write M. L. HATFIELD, 1462 Grove St., OAKLAND, CALIF.

LEARN JEWELERS' ENGRAVING

A high-salaried and easily learned trade, taught thoroughly by mail. We will teach the beginner better engraving than he can gain in years of rigid apprenticeship. We will also improve the skill of any engraver. Send for our catalog. The Engraving School, Dept. 112, Page Building, Chicago Ill.

WHEN YOU WANT ANYTHING AND DON'T KNOW WHERE TO FIND IT
WRITE BUREAU OF INFORMATION, CHICAGO
POPULAR MECHANICS



I TEACH BY MAIL

WRITE FOR MY FREE BOOK
"How to Become a Good Penman" and beautiful specimens. Your name elegantly written on a card if you enclose stamp. Write today. Address F. W. TAMBLYN, 418 Meyer Bldg., Kansas City, Mo.

Please Mention Popular Mechanics

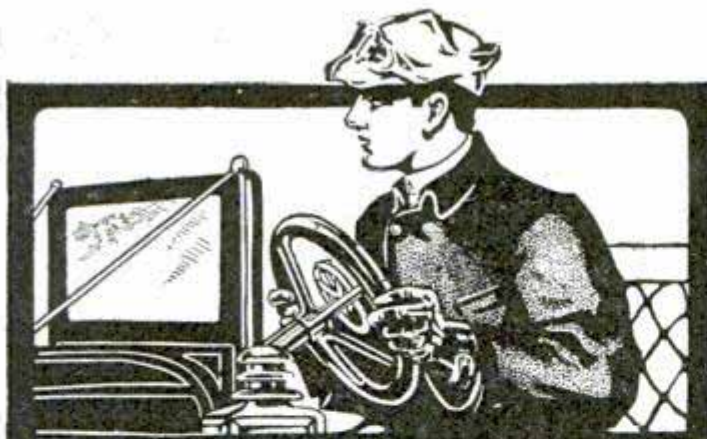

YOUNG MEN WANTED

EARN
\$25.00 to \$50.00 Weekly
IN AUTOMOBILE BUSINESS

Chauffeurs, Automobile Salesmen and Repairmen get big pay for pleasant work because the demand for trained men exceeds supply. We have taught hundreds (without mechanical ability), and we can teach you in ten weeks if you study a few hours a week. It is interesting. Free model of automobile to every student. Our simple mail course guarantees thoro efficiency because it's personal. Ask our graduates who are earning \$25.00 weekly or more in positions we obtained for them.

Send today for first lesson—it's free

Chauffeurs, competent men supplied owners and garages.

Empire Auto Institute, 327 Empire Bldg. ROCHESTER, N. Y.
The Original Automobile School

BE YOUR OWN BOSS

Come to the Coyne National Trade Schools

LEARN A GOOD TRADE

and earn \$5 to \$8 a day at

**Plumbing, Bricklaying, Mechanical Drafting
 Electrical Work or Painting and Decorating**

or set up in

BUSINESS FOR YOURSELF



HOME OF THE SCHOOL

The trades that pay \$5 to \$8 a day. Men always in demand. Graduates never looking for work. Most thorough, practical Trade School in the world. No books but tools in teaching. Individual instruction. Expense very small. Your success assured. Thousands of graduates at work in every state making big money.

Write me today for large illustrated Book giving full particulars

—LESLIE L. COOKE, President—

COYNE NATIONAL TRADE SCHOOLS
 73 E. Illinois St. CHICAGO, ILL.

"HELP WANTED"

-Uncle Sam.

**Railway Mail Clerks
 Internal Revenue Employees
 Custom House Examiners & Clerks
 City Carriers — Postoffice Clerks
 Many Spring Examinations**
 Over 15,000 positions will be filled during 1911.

**\$800⁰⁰ to \$1800⁰⁰ a Year
 for LIFE**

No "layoffs" without pay, because of strikes, financial fluctuations or the whims of some petty boss. Excellent opportunities for quick advancement to Higher Government Positions. If you want immediate appointment, send **TODAY** for our schedule showing locations and dates of the Spring examinations. Any delay means the loss of just so much time in preparing yourself for examination.

SEND COUPON BELOW

FRANKLIN INSTITUTE
 Dept. F 112, ROCHESTER, N. Y.

We Prepare Candidates Free

The coupon, filled out as directed, entitles the sender to a free copy of our book, "Government Positions and How to Obtain Them," and to consideration for Free Coaching for the examination here checked.

COUPON

.... Railway Mail Clerk [\$800 to \$1400] Customs Positions [\$600 to \$1500]
.... Postoffice Clerk [\$600 to \$1200] Internal Revenue [\$700 to \$1800]
.... Postoffice Carrier [\$600 to \$1200] Stenographer [\$600 to \$1500]
.... Rural Mail Carrier [\$500 to \$ 900] Clerk in the Departments at Washington [\$500 to \$1500]
.... Bookkeeper [\$900 to \$1800]	

Name

Address..... F 112

Use this before you lose it. Write plainly.

How to Run an Auto

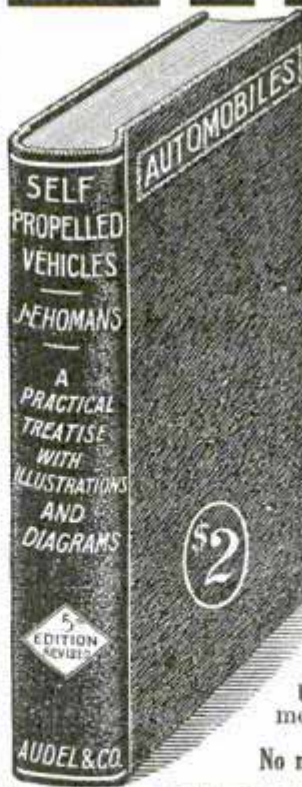

"Homans' Self Propelled Vehicles" gives full details on successful care, handling and how to locate trouble.

Beginning at the first principles necessary to be known, and then forward to the principles used in every part of a Motor Car.

It is a thorough 1910 course in the science of Automobiles, highly approved by manufacturers, owners, operators and repairmen. Contains over 400 illustrations and diagrams, making every detail clear, written in plain language. Handsomely bound.

Price \$2.00 postpaid, or sent Free on Approval

The only way the practical merit of this MANUAL can be given is by an examination of the book itself, which we will submit for examination, to be paid for or returned after looking it over.

Upon receipt of the following agreement, the book will be forwarded:

No money in advance required, sign and return

THEO. AUDEL & CO., 63 Fifth Ave., NEW YORK, N. Y.
 Kindly mail me copy of Homans' Automobiles, and, if found satisfactory, I will immediately remit you \$2, or return the book to you.

NAME.....

OCCUPATION.....

ADDRESS..... (Feb. Pop. Mech.)

CAN YOU DRAW?



We will turn your talent into money. Our Graduates are filling HIGH SALARIED POSITIONS.

We will open to you one of the most profitable and delightful fields of human endeavor—THE BROAD FIELD OF ART where the demand always exceeds the supply.

Earn \$25 to \$100 per Week

in easy, fascinating work. Splendid Opportunities await our students, because our twelve years of successful teaching enable us to offer **Many Special Advantages** which fit them for large pecuniary profit.

Individual Home Instruction

by Expert Faculty. Superior Equipment.

Financial Returns Guaranteed

Complete Courses in Commercial, Fashion, Magazine, Book, Advertisement Illustrating; Newspaper, Cartooning, Lettering, Designing, Show Card, Architectural Perspective, Photo Retouching, Normal, Color, General Drawing, etc.

ARTISTS' FREE OUTFIT

of Fine Instruments and Supplies to each Student. Write Today for particulars and Handsome Art Book free.

SCHOOL OF APPLIED ART Founded 1899

D175 Fine Arts Building
Battle Creek, Michigan

Our Own Fire-proof Building.



SPECIAL RIGHT NOW, COMPLETE COURSE \$10



AUTOMOBILE MECHANICAL MODELS FREE

with DYKE'S HOME STUDY

COURSE OF AUTOMOBILE ENGINEERING

You can learn to be a **Chauffeur or Repairman** with my system. Endorsed by **Barney Oldfield** and 2000 others

THEY WORK



Dyke's Working Models

DO IT NOW

LEARN AUTOMOBILE ENGINEERING

FREE BOOK "How to Get Into the Auto Business" SEND FOR IT TODAY. DON'T MISS IT

DYKE'S COR'SP SCHOOL MOTORING, BOX 1 3947 WASHINGTON, ST. LOUIS
(FIRST AUTO SUPPLY MAN IN AMERICA PUBL R FIRST AUTO BOOK 1)

Home Study LAW DEPARTMENT Intercontinental University



Hon. Martin A. Knapp

Preparation for bar examination of any State by mail. Personal instruction by Judge Wm. Macon Coleman, A. M., Ph. D., Dean. Courses also in Oratory and Argumentation. Founders of this National School include late David J. Brewer, U. S. Supreme Court; Senator Chauncey M. Depew; Edward Everett Hale; Hon. Martin A. Knapp, Chairman Interstate Commerce Commission. Write for Catalogue I. C. U., 1410 H. St., Washington, D. C.

LEARN WATCHMAKING AT HOME



You can learn by our modern and original system of instruction every part of the Watchmaker's Trade at home as good or better than at a shop. You can earn money while learning and secure a well paying position or start in business after completing our course of instruction. Good watchmakers are always in demand and earn from \$20 to \$35 per week. For particulars apply to the **WISCONSIN SCHOOL OF WATCHMAKING** Enterprise Bldg., MILWAUKEE, WIS.

\$2,500 to \$10,000 a Year Made By Plumbers

Here's a trade that will make you independent. Shorter Hours, Bigger Pay—*demand always great*. Our practical methods—teaching by actual work at all phases of trade, with expert plumbers as instructors—enables you to do the work of a skilled plumber in a remarkably short time.

Many of our students are successfully established in the plumbing business for themselves—it takes but little capital and master-plumbers can make from \$2,500 to \$10,000 a year. This is your opportunity—don't neglect it!

Graduates of our school have no trouble in securing good positions at highest pay anywhere in this country. Our new booklet showing many illustrations of our school and students at work and giving full detailed information regarding our course, rates, etc., is **FREE**. Write for it today. It may be the first step to such prosperity as you had not dreamed of before.

Saint Louis Trades School,
4430 Olive St., St. Louis, Mo.



Learn Plumbing

Salesmen Wanted

Trained Salesmen earn from \$1,200.00 to \$10,000.00 a year, and expenses. Hundreds of good positions now open. No experience needed to get one of them. We will assist you to secure a position where you can get Practical Experience as a Salesman and earn \$100 a month or more while you are learning. Write to-day for our free book "A Knight of the Grip," list of good openings, and testimonials from hundreds of men recently placed in good positions.

Address nearest office, Dept. 116

National Salesmen's Training Association

Chicago New York Kansas City Seattle New Orleans



LEARN CHIROPRACTIC

The new method of drugless healing
EARN \$50 TO \$100 PER WEEK

Our free book tells how you can learn to detect disease and remove the cause by Howard's method of Spinal Adjustment. Positively the most simple, direct, advanced and scientific method of drugless healing. Based on unerring natural laws. Anyone can understand it; learned in spare time. Improve your social prominence and financial standing. Start now on the road to honor and success. Write for free book and special scholarship offer.

NATIONAL SCHOOL OF CHIROPRACTIC
806 Wendell Building CHICAGO, ILL.

LEARN TO WRITE ADVERTISEMENTS IF YOU ARE EARNING LESS THAN \$25 a WEEK

we can positively show you by mail how to increase your salary. Send for beautiful prospectus, mailed FREE.

PAGE-DAVIS SCHOOL, Dept. 112, CHICAGO, ILL.

BE AN ACTOR

Actress or Orator

Earn \$25 to \$200 Weekly

Our course in Elocution and Dramatic Art is complete, thorough and comprehensive. It enables you in a short time to qualify for a good paying position on the stage or speaker's platform. Learn by correspondence the most fascinating and best paying profession in the world. Illustrated Book on Dramatic Art, free.

CHICAGO SCHOOL OF ELOCUTION, 162 Grand Opera House, Chicago

Please Mention Popular Mechanics

GRADUATES

Of My School of Telegraphy

Where Wire and Wireless Telegraphy
and Station Agency Work are taught

ALWAYS EARN GOOD WAGES

because they are thoroughly proficient when they finish my course of instruction and are invariably given immediate employment by Railroads, Telegraph and Wireless Companies.

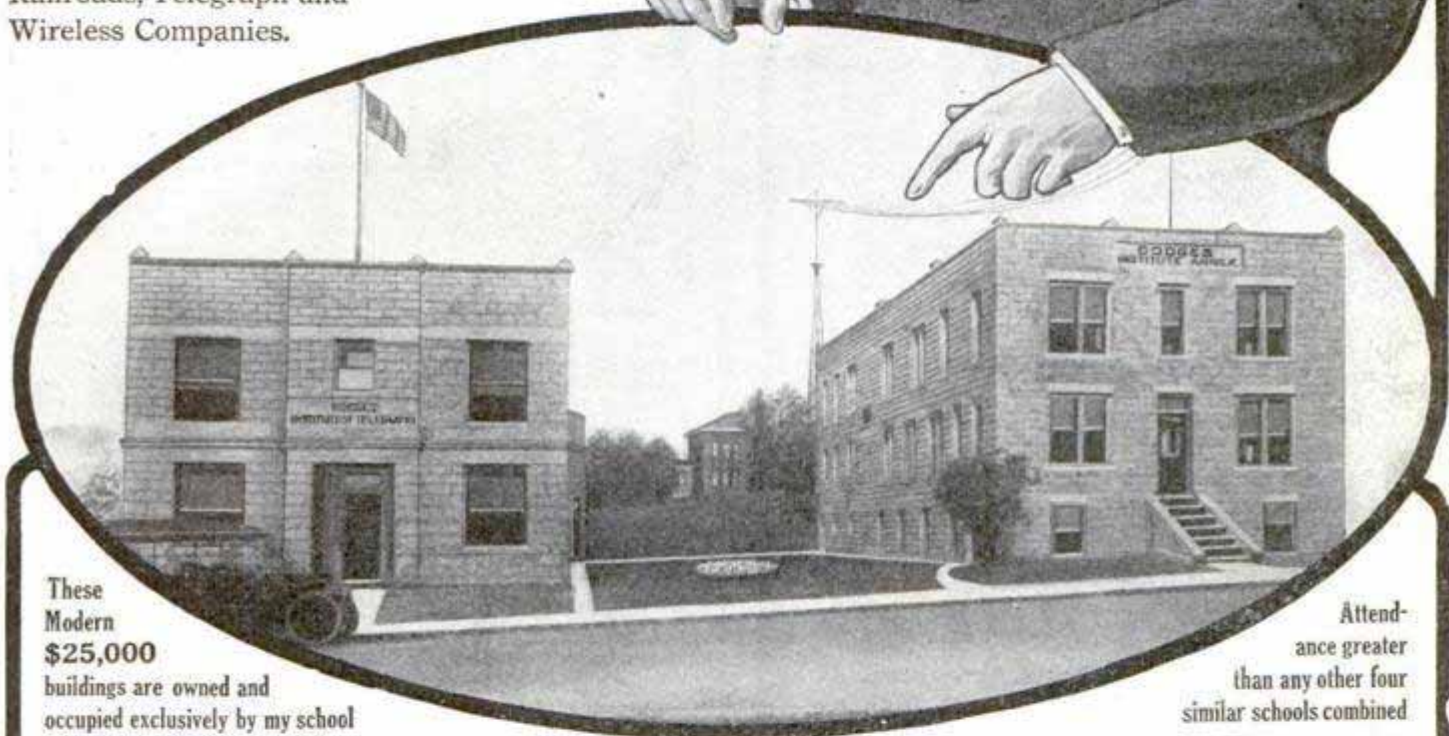
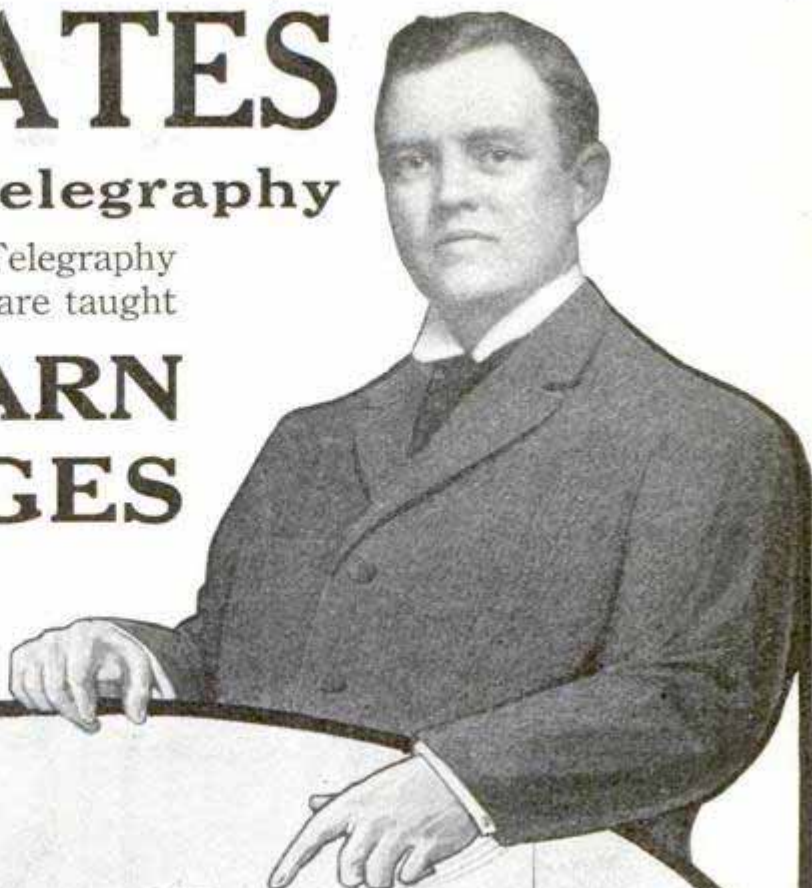

These
Modern
\$25,000
buildings are owned and
occupied exclusively by my school

Attend-
ance greater
than any other four
similar schools combined

The opportunities for rapid advancement are greater now than ever before—because the demand for telegraph operators and agents far exceeds the supply. My Institution is the only one in which students may become entirely qualified.

If You Desire A Good Salary, Easy Work And A Bright Future, Write Me NOW!

I offer the following unequalled advantages:—Most practical and efficient instruction. Best Equipment (Largest and finest buildings of the kind in the world, equipped with R. R. Dispatcher's and Western Union wires, and Complete Wireless Station), Oldest and most successful Telegraph School in the world, Endorsed by Railroad and Western Union Officials. My new Station Agency Department is in charge of a practical, expert railway agent and accountant with many years' experience. Expert instructors in all departments. **Low Rates (Easy Payments).** Living expenses earned while learning. Graduates assisted to good positions. Correspondence courses if desired. **FREE**—Large illustrated catalog and interesting testimonials. **Address me personally today—**

GEO. M. DODGE, President

DODGE'S INSTITUTE OF TELEGRAPHY

8th Street, VALPARAISO, IND.

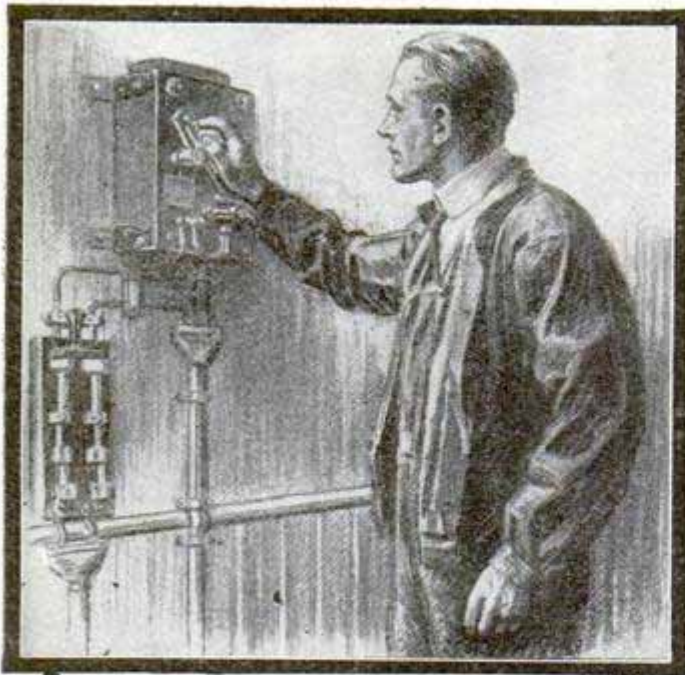

Become An Expert Electrician In Spare Time

Never has there been such a demand for technically trained electrical men as at present. The great expansion of the electrical field in all its branches is responsible for this. The trained electrical man is always sure of a good position at a good salary.

The International Correspondence Schools have made the mastery of any electrical course easy. Any ambitious man can learn *in spare time* to become an expert electrician. *You can.*

Courses cover Electrical Engineering, Lighting and Railways, Interior Wiring, Dynamo Running, Electric Car Running, Heavy Electric Traction, Telephone Engineering and Telegraph Engineering. Everything made clear and simple. Courses conducted by experts. No hurry or delay. The I. C. S. stands by you until you are through.

It costs you nothing and puts you under no obligation to learn *how* the I. C. S. can help you. Simply fill in and mail the attached coupon to-day. Do it *now*.

International Correspondence Schools
Box 872, Scranton, Pa.

Please explain, without further obligation on my part, how I can qualify for a good position in the line of electrical work indicated in the attached coupon:

Position.....

Name.....

Street and No.....

City.....State.....

Please Mention Popular Mechanics

Learn to be An Auto Expert

Six weeks spent at this great automobile school—the largest in the world—will double or treble your present earning ability. We make you a **practical** man able to run and repair quickly **any** make of automobile and prepared to take a position as soon as you leave school.

No Books Used—No Tools to Buy
(No Correspondence Course)

Only Automobile school in the world fully equipped to teach every branch of the business. Chauffeurs earn \$60 to \$150 a month; demonstrators, \$25 to \$40 a week; repairmen, \$20 to \$50 a week; salesmen, \$40 to \$150 a week. We can make you a practical man able to earn these salaries. Low tuition; good board and room near school cheap. You should have our new big **FREE Illustrated Catalog**. Write for it now.

Address **AUTOMOBILE TRAINING SCHOOL**
15,000 Square Feet of Floor Space
1131 Locust Street **KANSAS CITY, MO.**



ART STUDENTS \$100 For You!



If you want to make money, and at the same time get 12 months' practical experience doing Commercial Art Work, you need the Students Art Magazine. It gives Cash Assignments in each issue, advice and easy lessons in Designing, Illustrating, Cartooning, Lettering and Chalk-Talking; articles by and about leading artists. It is an independent "live wire" for Artists and Art Students of all schools, especially valuable to

Art Students of all Correspondence Schools

It publishes and criticises student's work. You need it. \$1 for 12 months and your money back if not entirely satisfied. Write for it now.

Students Art Magazine, Dept. 99 Kalamazoo, Mich

\$25 to \$50 a Week IS PAID GOOD PORTRAIT ARTISTS

I teach you at home by my original system. Earn money while learning and get a well paying position or start in business for yourself after getting diploma. I correct your work personally. Send for my free book.

L. T. KUNDE, Head Master

KUNDE SCHOOL OF PORTRAITURE, Dept. A, Cowker Bldg., Milwaukee, Wis.



MUSIC LESSONS FREE AT YOUR HOME

Write Today for our Booklet. It tells how to learn to play Piano, Organ, Violin, Mandolin, etc. Beginners or advanced pupils. American School of Music, 50 Lakeside Bldg. Chicago, Ill.



VENTRILOQUISM

Send today 2c stamp for particulars and proof. **O. A. SMITH, Room D 2, 823 Bigelow St., PEORIA, ILL.**

LEARNED BY ANY MAN OR BOY AT HOME SMALL COST

LEARN WATCHMAKING

Engraving and Jewelry Repairing. Practical specialists in charge of all instruction. Students trained for the best paying positions. Earn while learning. Our school is endorsed and recommended by leading jewelers. A few months will make you an expert. Positions secured for graduates. Demand for watchmakers greater than the supply. Write for free catalog.

CHICAGO SCHOOL OF WATCHMAKING
Dept. 20, Bush Temple, CHICAGO

Let Me Show You How to Earn \$3,000 to \$10,000 a Year in the Real Estate Business



NO CAPITAL NECESSARY

If you are ambitious to better your condition—if you want to establish yourself in a splendid paying business requiring no capital—send me your name and address and I will mail you—free—a valuable 62-page prospectus explaining our system of money-making, without interfering with your present occupation. We have perfected a thoroughly practical, scientific method of teaching by mail the

Real Estate, Brokerage and Insurance Business

Under our plan, we teach these big money-making branches to one able, ambitious and energetic person in each community. When you are thoroughly qualified to make a success of the business, we appoint you

Special Representative

This gives you a chance to identify yourself with the oldest and largest Co-operative Real Estate and Brokerage Company in America. By our system you can—if you will—be making money in a few weeks without conflicting in any way with your regular work. Our Co-operative Department will give you more choice, salable property to handle than any other concern in the world. So the sooner you investigate our plan, the sooner you will get your name on your own real estate signs and be ready for business.

Valuable Commercial Law Course Free

To each of our representatives we also give a thorough course in commercial law without cost. This instruction is indispensable to any man who wants to make his way in the business world. We teach you, free, everything you need to know to successfully meet legal problems that may arise in any business transaction. And we also furnish you free legal advice whenever you require it.

Send for This Book Now

Our Big 62-Page Free Prospectus will prove of great interest and real value to anyone, but is of vital importance to office employees, salesmen, agents, clerks, solicitors and others who are ambitious to enter the realms of better things in business. This book is an inspiration to the indifferent, a spur to the laggard, and a stimulus to the ambitious. It deals with the great problems of business, and points the only sure way to the complete mastery of Real Estate, Brokerage and Insurance, three of the most profitable branches of modern business, which have made many millionaires and brought great prosperity to tens of thousands of active, energetic men all over the land.

MAIL THE COUPON TODAY

Don't procrastinate. Act! Anything that is worth doing is worth doing promptly. Resolve to send for this big free prospectus, and send for it right now while the matter is before you. "I'll do it tomorrow," has been the grave of countless good intentions. "I'll do it today," is the solid rock on which to build the only enduring success.

Just clip the coupon, fill it out, sign and send it today. By return mail you will receive free the invaluable book, which to thousands of ambitious men has proved the key that opens the door of great achievements in business.

INTERNATIONAL REALTY CORPORATION

Successor to THE CROSS COMPANY & H. W. CROSS & CO.
1236 Manhattan Building CHICAGO

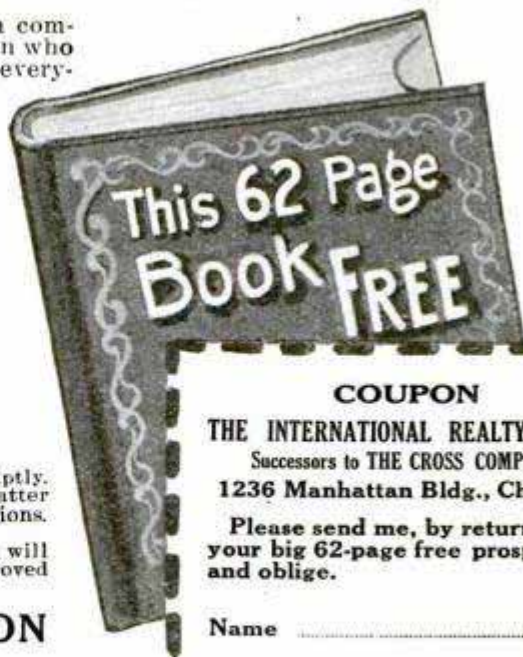

COUPON

THE INTERNATIONAL REALTY CORP.
Successors to THE CROSS COMPANY
1236 Manhattan Bldg., Chicago

Please send me, by return mail,
your big 62-page free prospectus,
and oblige.

Name

Address

Highland Park College

DES MOINES, IOWA



Enter
Any
Time

2000
Students
Annually

One of the most completely
equipped ENGINEERING
SCHOOLS in the country

Students may enter any time,
and their term is 12 weeks
from the day they enter.

Mention course in which you are interested. Address,

O. H. LONGWELL, President, Des Moines, Ia.

COURSES OFFERED
1. CIVIL, ELECTRICAL AND MECHANICAL ENGINEERING COURSES. Standard courses are offered in Civil, Electrical and Mechanical Engineering. Special opportunity is offered for making up work or for taking a complete course preparatory to the standard Engineering Courses. Shop work from the beginning comes in preparatory courses. See our new Engineering Catalogue.

2. SHORT COURSES

1. One Year Electrical Engineering Course
2. One Year Telephone Engineering Course
3. One Year Steam Engineering Course
4. One Year Machinists' and Automobile Course
5. One Year Course in Mechanical Drawing

practical and are intended for those who have but limited education and do not see their way clear to take a complete Engineering Course. The Machinists' Course is especially practical. The machine shop is the most complete to be found in connection with any Engineering School in the United States.

Just a fair common school education is all that is required for entrance to these courses. These courses are very practical and do not see their way clear to take a complete Engineering Course. The machine shop is the most complete to be found in connection with any Engineering School in the United States.

SPECIAL COURSES

1. TRACTION ENGINEERING. This is the most complete course in Traction Engineering offered by any Engineering School in the country. It may be completed in three months. Students are taught how to make all repairs on engines as well as to handle them. Four traction engines used for experimental purposes.

2. GASOLINE AND AUTOMOBILE COURSES. These courses may be completed in three months. They are exceedingly practical. Complete Chauffeur practice. Just a fair common school education is all that is necessary to enter.

3. FARM BLACKSMITHING, FARM CARPENTRY.



Learn Photography, Photo-Engraving or 3-Color Work

Engravers and 3-Color Operators Earn \$20 to \$50 Per Week. Only college in the world where these paying professions are taught successfully. Established 17 years. Endorsed by International Association of Photo-Engravers and Photographers' Association of Illinois. Terms easy; living inexpensive. Graduates assisted in securing good positions. Write for catalog, and specify course in which you are interested.

Illinois College of Photography or } 999 Wabash Av.
Bissell College of Photo-Engraving } Effingham, Ill.
L. B. BISSELL, Pres.



IF YOU STAMMER

Attend no other school until you hear from me. Largest stammering school in the world curing by the improved natural method. No singing or time-beating methods. Beautiful 88 page book and special rates sent free.

Lee Wells Millard, President, NORTH-WESTERN SCHOOL FOR STAMMERERS, Inc., 917 First St., Milwaukee, Wis.



ARITHMETIC SELF-TAUGHT

A plain, easily-understood volume for all who have not had the opportunity of learning this subject thoroughly, or who have forgotten what they once learned. 257 Pages. Requires no teacher. This great little book sent postpaid for 60 CENTS. Stamps accepted, leather binding \$1.

GEO. A. ZELLAR BOOK CO.
Est. 1870, 4462 W. Belle Place, ST. LOUIS, MO.

SPANGENBERG'S
PRACTICAL
ARITHMETIC
Self-Taught



LEARN PIANO TUNING AT HOME by the aid of the TUNE-A-PHONE. A Profession that can be converted into money at any time or place in the civilized world at an hour's notice. Earn \$5.00 to \$15.00 per day. Valuable illustrated book FREE. Write NILES BRYANT SCHOOL OF PIANO TUNING, 31 Music Hall, Battle Creek, Mich.



DO YOU LIKE TO DRAW?

That's all we want to know

Now we will not give you any grand prize—or a lot of free stuff if you answer this ad. Nor do we claim to make you rich in a week. But if you are anxious to develop your talent with a successful cartoonist, so you can make money, send a copy of this picture with 6c. in stamps for portfolio of cartoons and sample lesson plate, and let us explain. The W. L. Evans School of Cartooning 321 Kingmoore Bldg., Cleveland, O.

LEARN WATCHMAKING

refined, profitable labor—Competent men always in demand. We teach it thoroughly in as many months as it formerly took years. Does away with tedious apprenticeship. Money earned while studying. Positions secured. Send for catalog St. Louis Watchmaking School, St. Louis, Mo.

Teach Yourself Arithmetic

with a set of ARITHMETIC HELP. Any and all examples and problems in arithmetic, from the easiest to the hardest, are worked out and explained so anyone can understand. For the student or business man. Easy and simple; 2 volumes, 630 pages; over 200 illustrations and color plates; bound in red silk cloth. Most complete ever published. A \$2 bill brings a set prepaid anywhere. Send for a set. If not pleased, return at our expense and get your money back. Order today. STANDARD SALES CO., 23 Fifth Ave., CHICAGO



HYPNOTISM!

Wonderful science easily mastered by anyone. Send address for free book and other literature.

M. D. BETTS, Dept. 65, JACKSON, MICH.

HYPNOTISM

Learned at home; small cost; 2c stamp for particulars.

O. A. SMITH, Room B 56, 823 Bigelow St., Peoria, Ill.



I TEACH Penmanship BY MAIL

I won the World's First Prize for best course in Penmanship. Under my guidance you can become an expert penman. Am placing many of my students as instructors in commercial colleges at high salaries. If you wish to become a better penman, write me. I will send you Free one of my Favorite pens and a copy of the Ransomian Journal.

C. W. Ransom, 718 Reliance Bldg., Kansas City, Mo.



SHORTHAND IN 30 DAYS

Learn a Good Paying Profession



IF YOU will give us part of your spare time for 30 days, we will positively teach you the **Boyd Syllabic System of Shorthand**. It is a wonderful new method, easy to learn, simple, only nine characters, no words to memorize; yet so simple and complete that it puts the entire English language at your command in 30 days. Anybody can learn it and become an expert stenographer. We have graduates earning high salaries everywhere. Write for Testimonials & Free Book.

CHICAGO CORRESPONDENCE SCHOOLS
969 Chicago Opera House Block, Chicago, Illinois.

COPY THIS SKETCH

and let me see what you can do with it. You can earn \$20.00 to \$125.00 or more per week, as illustrator or cartoonist. My practical system of personal individual lessons by mail will develop your talent. Fifteen years successful work for newspapers and magazines qualifies me to teach you. Send me your sketch of President Taft with 6c. in stamps and I will send you a test lesson plate, also collection of drawings showing possibilities for YOU.

THE LONDON SCHOOL OF ILLUSTRATING AND CARTOONING
1438 Schfield Building, Cleveland, Ohio.



LEARN WATCHMAKING

Watchmaking pays and you can earn while you learn. Write for FREE BOOK, "How to be a Watchmaker." Postal brings it.

Stone's School of Watchmaking
912 Globe Bldg. St. Paul, Minn.



SECURE A HIGH SALARIED GOVERNMENT POSITION

by passing the Civil Service Examination. We prepare you so thoroughly that you have no difficulty. Nearly 50,000 appointments to positions paying high wages made last year. Fine opportunity now. We also prepare students for Teachers' and College Entrance Exams. Rapid, Practical methods—Low cost. Write today for Catalog and Full Particulars.

BALFOUR JOHNSTONE SCHOOL

Dept. 12, Schiller Bldg. CHICAGO, ILL.

BOOKKEEPING TAUGHT BY MAIL

at home—during spare time. New system—very simple—anyone can learn. Few hours each week completes course. Diploma given. Knowledge of bookkeeping necessary to success. Bookkeepers get good pay—have short hours. Special offer to first student in each town. Send for free booklet, "Key to Success." Lincoln Commercial School, 623 Nasby Bldg., Toledo Ohio

LAW Taught You in Your Own Home By Mail
Our successful students are everywhere. Write for details of our complete professional course. Catalog Free!
POTOMAC UNIVERSITY, Div. 20, WASHINGTON, D. C.



I TEACH SIGN PAINTING

SHOW CARD WRITING or LETTFRING by mail and guarantee success. Only field not overcrowded. My instruction is unequalled because practical, personal and thorough. Easy terms. Write for large catalogue.

CHAS. J. STRONG, Founder

DETROIT SCHOOL OF LETTERING
DEPARTMENT PM. DETROIT, MICH.

"Oldest and Largest School of its Kind"



"You Are Making Good"

Don't you want your employer to say this to you? Don't you want him to say: "I've been watching you, young man, and I'm going to give you a raise and a better position"?

That is the kind of *recognition* training wins.

YOU can gain just such advancement with the help of I. C. S., as thousands of others have done. Your employer will be glad to advance you as fast as you show *progress in training*—other employers will want you—there are always big opportunities for the man who is "making good."

Mark the coupon now to show what line you prefer—the one you want as *your* pathway to Success—mail it to-day—costs only postage—and let I. C. S. explain how it comes to you in your own home, *in spare time*, without your giving up your present place or all your recreation, and helps you to become an **EXPERT** in your chosen line.

Don't delay—don't waste any time—don't neglect—for your own sake, **mark the coupon NOW.**

INTERNATIONAL CORRESPONDENCE SCHOOLS,
Box 872 SCRANTON, PA.

Please explain, without further obligation on my part, how I can qualify for the position, trade or profession before which I have marked X.

Automobile Running Mine Superintendent Mine Foreman Plumbing, Steam Fitting Concrete Construction Civil Engineer Textile Manufacturing Stationary Engineer Telephone Expert Mechanical Engineer Mechanical Draftsman Electrical Engineer Electric Lighting Supt. Electric Wireman	Civil Service Architect Chemist Languages— Banking Building Contractor Architectural Draftsman Industrial Designing Commercial Illustrating Window Trimming Show Card Writing Advertising Man Stenographer Bookkeeper	Spanish French German Italian
--	--	--

Name _____

Present Occupation _____

Street and No. _____

City _____ State _____

Please Mention Popular Mechanics

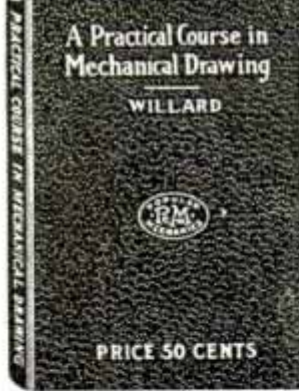

A Practical Course in Mechanical Drawing

By WM. F. WILLARD

(For several years instructor in Mechanical Drawing at Armour Institute of Technology, Chicago)

134 Pages Price 50c Size, 5x7 Inches
131 Illustrations Cloth Cover

A book for individual study, shop classes, trade or high schools, and those who would like to know something of the DRAFTING PROFESSION.

Simple, Rational, Economical, Fresh

CHAPTERS

I. Introductory. II. The Draftsman's Equipment. III. Geometric Exercises with Instruments. IV. Working Drawings. V. Conventions Used in Drafting. VI. Modified Positions of the Object. VII. The Detailed Working Drawing. VIII. Pattern-Workshop Drawings. IX. Penetrations. X. The Isometric Working Drawing. XI. Suggested Course for High Schools—Reference Vocabulary—Definitions of Symbols.

ORDER OF YOUR NEWSDEALER OR DIRECT FROM THE PUBLISHERS

Popular Mechanics Book Dept. 225 Washington Street Chicago

A New Book

Pattern-Making

By G. H. WILLARD

With Additional Chapters on
Core-Making and Molding

224 Pages, 312 Illustrations, Cloth Cover
Price \$1.00 Postpaid

"Written So You Can Understand It"

A book for the man who has to do the work. Written by a practical pattern-maker of many years' experience.

Chapter Headings

I. Pattern-Making as a Trade. II. The Tools. III. Woods. IV. Joints. V. Turning. VI. Turning (Continued). VII. Turning (Continued). VIII. Turning (Concluded). IX. The Circular Saw. X. The Circular Saw (Continued). XI. Machine Tools. XII. Machine Tools (Continued). XIII. Simple Patterns. XIV. Simple Patterns (Continued). XV. Simple Patterns (Concluded). XVI. Crooked Patterns. XVII. Large Pattern Work. XVIII. Large Pattern Work (Continued). XIX. Crosshead Guide Patterns. XX. Sweep Work. XXI. Pipe Work. XXII. Stove Pattern Work. XXIII. Molding—Machine Work. XXIV. Molding Pattern Work.

Part II—Core-Making and Molding

Chapter I. Core-Making, Simple and Complex. II. Principles in Molding. III. Loam Patterns and Loam Molds.

Every one following this trade, or intending to learn it, should have a copy of this valuable book.

Published by

POPULAR MECHANICS CO., 225 Washington St., Chicago

A New Book that is Needed

POWER GAS and the GAS PRODUCER

By J. C. MILLER, M. E.

An Authentic Text Book and a Complete Reference Manual Covering Every Detail of Installation and Operation.

"Written So You Can Understand It"

192 Pages Price \$1.00

For the Steam User. This book will enable the Steam User to judge intelligently as to the economy and advisability of changing from Steam to Producer operation.

For the Steam Engineer. It will enable the Steam Engineer to understand thoroughly the working of the new system if the change is made, and to handle a plant competently and with confidence.

Profusely Illustrated. Extra Cloth Binding.

Sent postpaid to any address by the publishers

POPULAR MECHANICS CO.
225 Washington Street, CHICAGO

Own a Jewelry Store!

**We Furnish
Everything!**

**Get Into Business
for Yourself!**

Here is a big opportunity for one influential man in every town.

During the next year we are going to establish a number of men in this best of all businesses.

These men we are going to make our partners.

By our system these men will soon become moneyed men in their community.

For these men we do much and we demand much in return. Not in money, but in brains, business ability and in character.

We are always on the lookout for the unusual men. For these men we do great things. Their opportunities are circumscribed only by their own ability to grow. Quick action is necessary. We can make arrangements with but one man in your town in this matter. If you are interested write us at once. Address

C. F. ELMORE, Financial Director

90 Wabash Avenue

Department 140

CHICAGO, ILL.

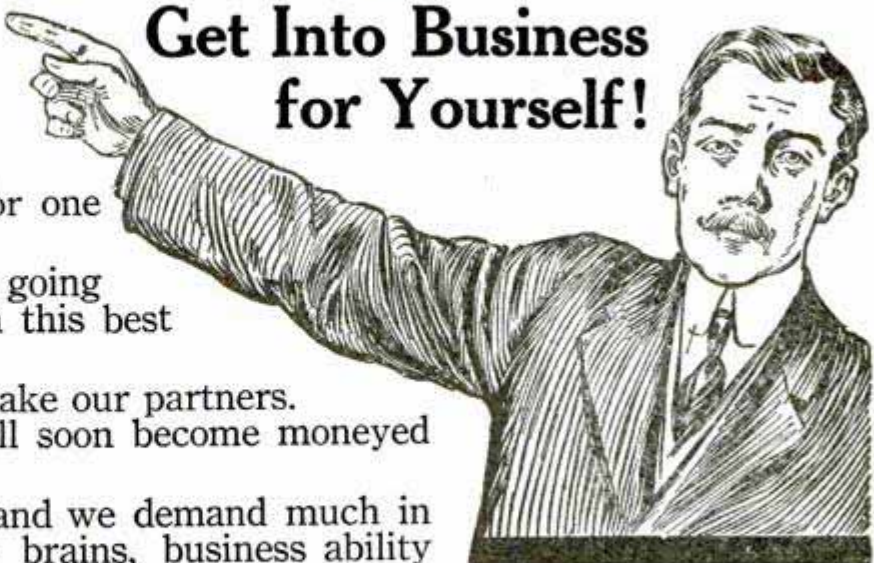

BOOKS THAT REALLY TEACH

you the things you want to know, and in a simple, practical way that you can understand.

Our illustrated catalogue, which will be sent you free upon request, tells all about the Practical Mechanical Books for Home Study that we publish. No matter what your ambition or desire for knowledge may be, we publish books written by authorities in their different lines that will give you just the mechanical training and information that you want and need. Write today for this up-to-date and complete illustrated catalogue and popular price list. It is free.

FREDERICK J. DRAKE & CO.

PUBLISHERS OF SELF-EDUCATIONAL BOOKS, 1327 MICHIGAN AVENUE, CHICAGO



LEARN THE AUTOMOBILE BUSINESS



**Earn a
Splendid
Salary**



The Chauffeur travels just as far as the owner, sees all the scenes and is paid well for it. Demonstrators, Inspectors, Testers, Repairmen and Assemblers have pleasant employment at good salaries. All are in great demand because of the rapid growth of the automobile business and lack of skilled men. Our correspondence course covers mechanism, operation and repairing and equips you to fill any of these positions. You study in your spare time.

Rates Reasonable. Write Today for Particulars.

CLEVELAND AUTOMOBILE SCHOOL
2167 E. 9th St., CLEVELAND, O.

Government Positions

45,837 Appointments were made to Civil Service places during the past year. Excellent opportunities for young people. Each year we instruct by mail thousands of persons who pass these examinations, and a large share of them receive appointments to life positions at \$840 to \$1,500 a year. If you desire a position of this kind, write for our Civil Service Announcement, containing full information about all government examinations and questions recently used by the Civil Service Commission.

COLUMBIAN CORRESPONDENCE COLLEGE, WASHINGTON, D. C.

New York Electrical School

Offers to men and boys a theoretical and practical course in applied electricity without limit as to time. Instruction individual, day and night school, equipment complete and up-to-date. Students learn by doing, and by practical application are fitted to enter all fields of electrical industry fully qualified. School open all year. Write for free prospectus. 44 West Seventeenth St., NEW YORK

Great Eastern Trade School

TEACHES PRACTICAL

PLUMBING, BRICKLAYING or PLASTERING

IN A FEW MONTHS

No age limit—You can enter at any time. Day and Night Classes—Positions Secured. No Books—Tools take their places.

WRITE NOW FOR FREE CATALOG

44-48 East 32nd Street, NEW YORK CITY

Learn the Barber Trade

IT'S EASY! POSITIONS WAITING

The OLD MASTERS now supplanted by the MOLER GRADUATE who is as carefully prepared as a Doctor. Good wages after few weeks. Our manual for home study. Established 1893. 33 branches all leading cities. For information regarding anyone, write Dept. 25.

MOLER SYSTEM OF COLLEGES, Chicago, Ill.



From Dinner Pail to Draughting Table



ONE YEAR AGO a young man in an Iowa town was working as a machinist's helper at \$1.75 a day. Now he is a Draughtsman in the offices of a large manufacturing concern at a salary of

\$1200.00 a year.

Every Young Man

with ambition and grit, every young man who wants to *really count* for something in the business world, who wants to be *more* than a mere cog in a big machine, can rise step by step until he *gets the position he wants*; can do it easily and without privation or sacrifice. It isn't hard to climb up higher if you once get started right. It isn't hard to learn what you need to know in order to fill a *good* position. It isn't hard to get in a class of *successful* men, of men who work with their heads instead of their hands.

Sign the Coupon

and send it back. *Find out* what we can do for YOU. It costs you *nothing* to get this information and it may mean *everything* to you—*better position, bigger pay, more money to spend for the good things of life*—**REAL SUCCESS**

American School of Correspondence
CHICAGO, U. S. A.

Opportunity Coupon

American School of Correspondence, Chicago, U. S. A.

Please send me your Bulletin and advise me how I can qualify for the position marked "X." Pop. Mech 2-'11

- | | |
|---------------------------|--------------------------|
| ... Book-keeper | ... Draughtsman |
| ... Stenographer | ... Architect |
| ... Accountant | ... Civil Engineer |
| ... Cost Accountant | ... Automobile Operator |
| ... Systematizer | ... Electrical Engineer |
| ... Cert'f'd Public Acc't | ... Mechanical Engineer |
| ... Auditor | ... Moving Picture Op'r |
| ... Business Manager | ... Steam Engineer |
| ... Commercial Law | ... Fire Insurance Eng'r |
| ... College Preparatory | ... Reclamation Engineer |

NAME

ADDRESS

**This
Coupon
Did
It**

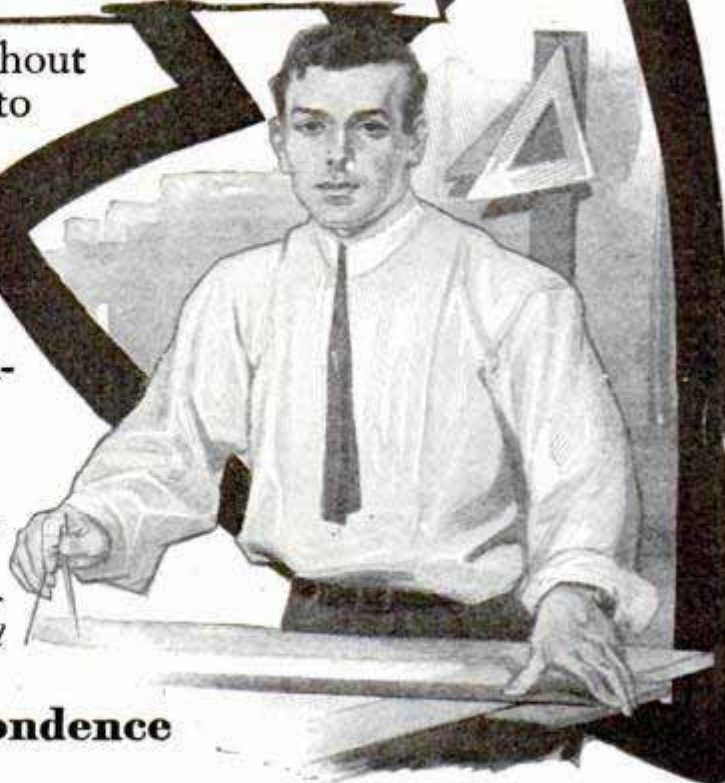

Popular Mechanics Magazine

WRITTEN SO YOU CAN UNDERSTAND IT

Vol. 15

FEBRUARY, 1911

No. 2

NON-SINKABLE DORY WITH FOOD AND WATER PORTS IN BOTTOM

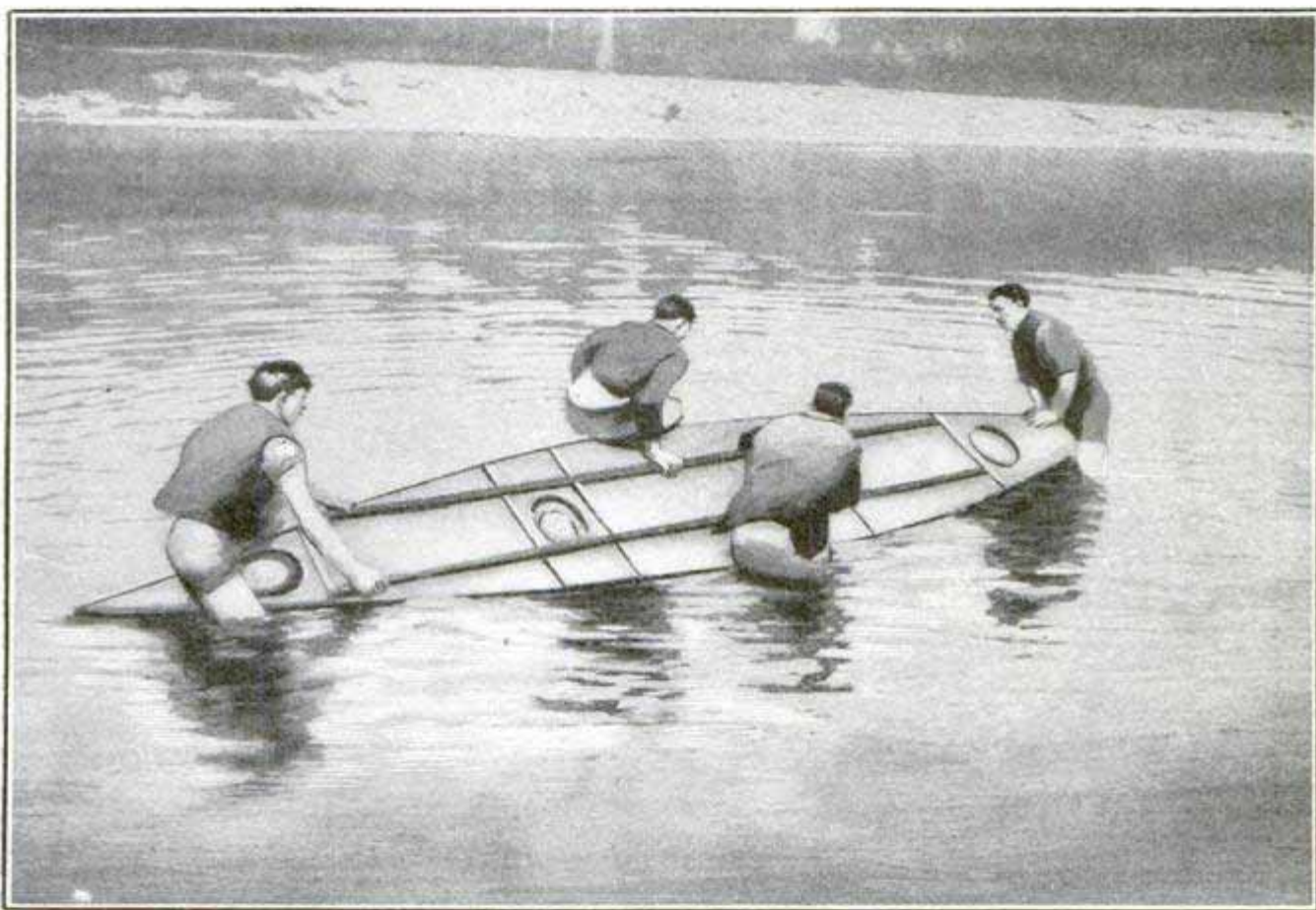

Non-Sinkable Dory Bottom Up, Showing Hand-Holds and Watertight Portholes in Bottom which Give Access to Supply Tanks

THE new non-sinkable fishermen's dories now coming into use on the Newfoundland fishing banks have several ingenious features. Four watertight compartments, located under the bow, stern and cross seats, keep the staunch little craft afloat and provide receptacles for the storage of clothing, food and water.

Watertight portholes in the tops of the seats give access to the interior of the tanks. The bow and stern tanks alone are sufficient to keep the dory

afloat, and at the same time provide receptacles for the storage of a limited supply of dry clothing, while one of the cross-seat tanks is partially filled with food, and the other with water. Most important and ingenious, however, are the portholes which give access to the tanks through the bottom of the boat, should it be capsized. These are set in the flat bottom, as shown in one of the illustrations, and, unless a sea is continually breaking over the little craft, the ports may be

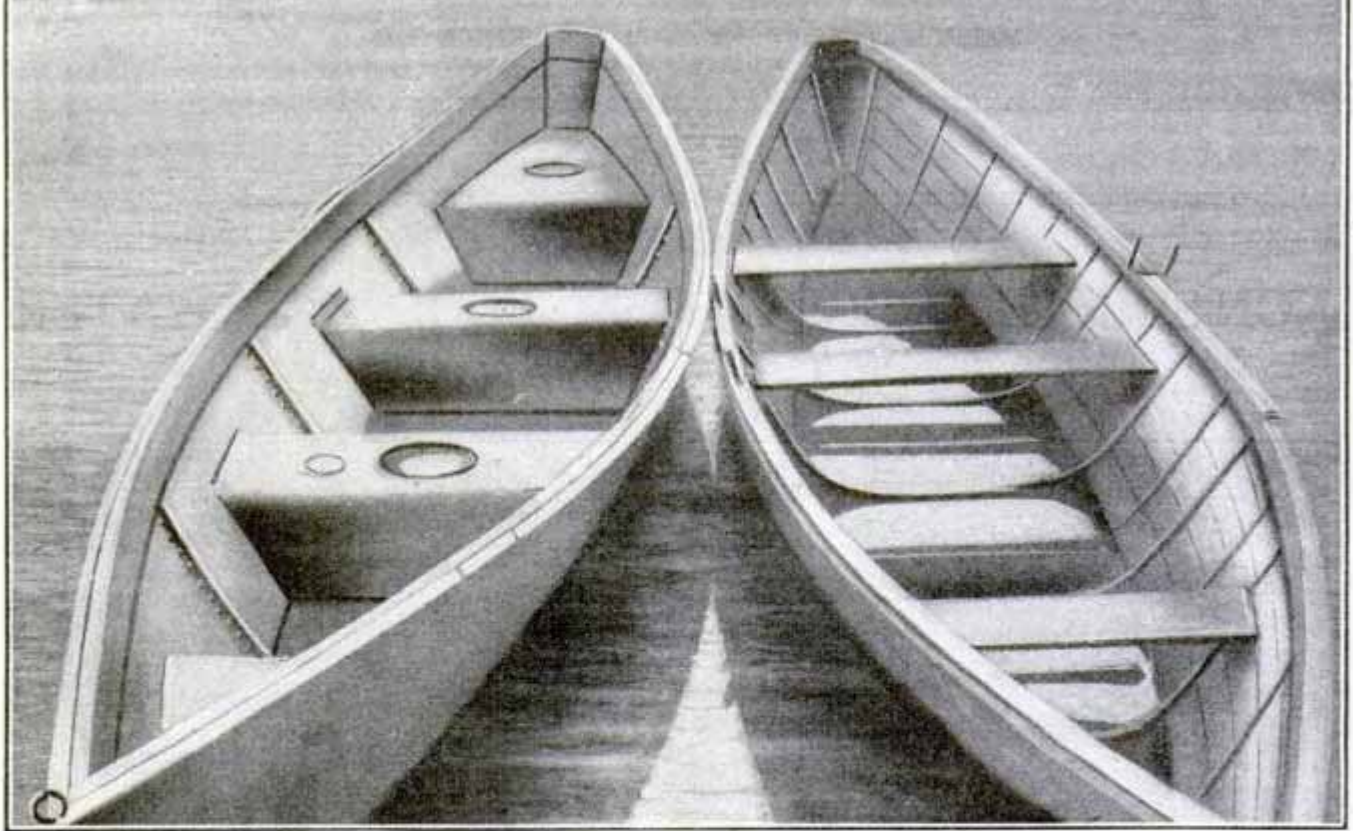

The Non-Sinkable and the Ordinary Fishermen's Dory

unscrewed, one at a time, and the food, water and clothing reached. The two false keels are provided with hand-holds as an aid to the men clinging to the bottom.

RUNAWAY TEAM SNAPS TELEPHONE POLE



A 35-ft., 8-in.-top telephone pole in Metamora, Ill., was snapped off recently by a team of runaway horses without resulting in the slightest injury to the latter. The wagon tongue struck the pole squarely, about 4 ft. above ground, and the horses passed by on either side, the harness breaking and freeing them.

FOCUSING OF BINOCULARS

Most users of opera or field glasses suppose it a matter of indifference whether the tubes are collapsed or extended when placed to the eyes for adjustment. According to the Optician, however, the tubes should always be extended in the first place, then slowly racked in until the moment clear vision is obtained, which, for a normal-sighted person, is the moment when the emergent light takes the form of parallel pencils.

When the tubes are racked out instead of in, the adjustment is liable to be stopped at a point where clear vision is produced by divergent pencils of light falling on the eye. This means that while the muscles of direction of the eyes are adapted for distant vision, the internal muscles of accommodation are adapting themselves for near vision. Although done quite unconsciously, the misuse of the eyes in this way for any considerable period brings on symptoms of ocular strain and theater headache.

ELECTRIC ADVERTISING EXTRAORDINARY

The latest and most wonderful addition to the electric advertising structures that have earned for a part of Broadway, New York City, the name of "The Great White Way," is the 110-ft. tower, built exclusively for electric-sign displays, which has been erected at a cost of \$40,000 on the top of the eight-story Heidelberg Building, at the junction of Broadway, 42nd Street, and Seventh Avenue in the heart of the theater and hotel district.

The tower contains about 120,000 sq. ft. of advertising space, and stands on a trapezoidal base measuring approximately 100 by 86 by 50 by 50 ft. It is formed about what was intended to have been the central shaft of a 30-story office building, as the Heidelberg Building, for special reasons, was limited to eight stories after provision had been made for the larger structure. Nine more stories were added to the skeleton work for the contemplated shaft, and the advertising tower was finished off more or less artistically, with dummy terra-cotta walls and wooden balconies.

The incandescent lamps, wiring and other necessary supplies for the electric signs, as well as the flashers for operating the more pretentious of them, are located in the tower.

The latest reports concerning this unique structure seem to indicate that on the whole the building has not fulfilled the anticipations of its promoters, and it is possible that the tower will be torn down and a more sightly and profitable office building erected in its place.

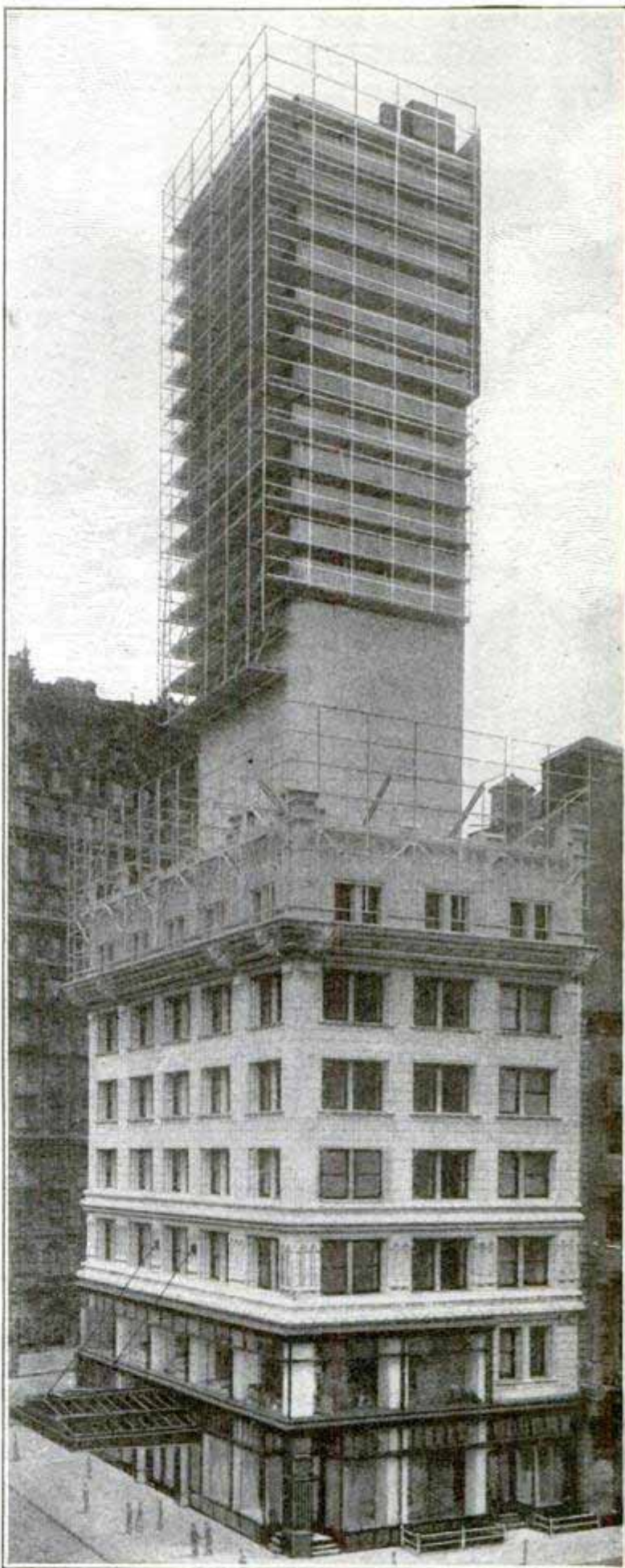

A 110-Foot Tower Built for Electric-Sign Displays

The operation of a special deluge pipe, designed for the fighting of fires



Operating a Deluge Pipe

in basements and under roofs, is here shown. Inserted through a hole made in a roof, or in the floor above a basement, the nozzle is in position to send a stream straight out under the flooring or roof, and the operator, by turning the wheel, can direct this stream in any direction. A set of spikes is provided to hold the pipe in position should it be necessary to leave it unattended.

ENOUGH GOLD TO SINK A SHIP

The expression "enough gold to sink a ship" is often used by many people, few of whom have any conception as to what such a quantity represents. The most extreme case would be that of the "Olympic," the greatest ship in the world. This vessel has a displacement of 66,000 tons, and as a greater volume of the ship is out of the water than is submerged, it would probably take an additional weight of 100,000 tons to sink this vessel in calm water.

What does 100,000 tons of gold

cost? Sixty million dollars! If this sum were in ten-dollar gold pieces, and these were laid flat on the ground and touching, the line would extend 100,000 miles with enough left over to stretch from the surface to the center of the earth. In volume, this gold would occupy nearly 170,000 cu. ft., and cast into a column 10 ft. in diameter would tower almost as high as the Washington Monument.

PIONEER WOMAN WIRELESS OPERATOR

Miss Gaynella Packer, of Jacksonville, Fla., enjoys the distinction of being the first woman to be given the post of wireless operator on board a passenger steamer engaged in ocean traffic. She has been placed in charge of the wireless equipment on one of the Atlantic coast steamship lines. She had been for two years a telegraph operator in Florida and went to New York last year to take music lessons. On the way up the coast she became interested in the wireless and this led her to study the method.



Miss Gaynella Packer, Wireless Operator

FRENCH ARMY BICYCLE MADE IN TWO PARTS

Little or no attention has been given to the ordinary bicycle in military circles in this country, but abroad, where good roads abound and there is much flat and level country, the machine has been regularly adopted in the armies. It is possible that it will eventually

normal position and the corps can mount and pedal away at a rapid rate of speed. Members of the corps have been repeatedly used with great success as couriers for the commanding officers of the outlying sections of contending forces at maneuvers.



Placing the Bicycle in Position as a Pack

be supplanted by the motorcycle, but the fact remains that today, in several of the larger European armies, the cyclist corps is regarded as an important part of the organization, and in France there is an especially efficient corps. The soldiers of the great republic use their wheels for quick marches but are not dependent upon them entirely. A type of bicycle has recently been devised which is so built that the front can be disconnected and the whole made into a compact package to be carried on the back of the soldier. When the necessity arises, the wheels can be quickly assembled in their



View of Soldier with Bicycle on His Back

TRANS-CASPIAN RAILROAD PROPOSED

A group of Russian financiers are endeavoring to promote a trans-Caspian railroad, to connect the lines of Russian and Indian companies. The length of line under discussion would be 1,600 miles, and it would cost about \$100,000,000. An attempt is being made to form an international company, of which Russia and Great Britain will have control. It is estimated that passengers and mails could be carried from London to Bombay in seven or eight days.

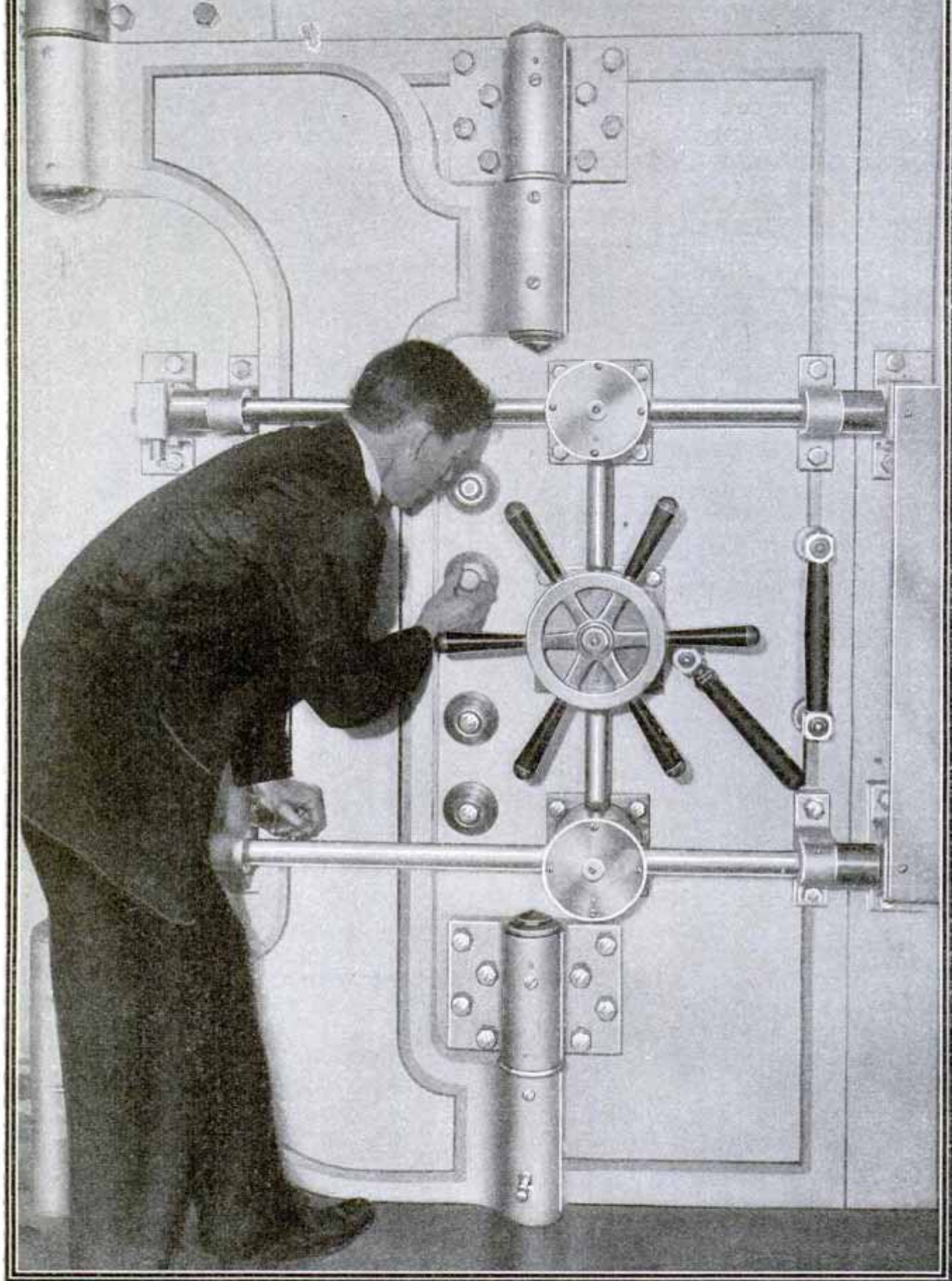

THE STEEL DOOR THAT GUARDS HALF A BILLION DOLLARS

It Has Four Combinations and No One Man Can Open It. Each of Two Trusted Employees of the Treasury Department Knows Two of the Combinations

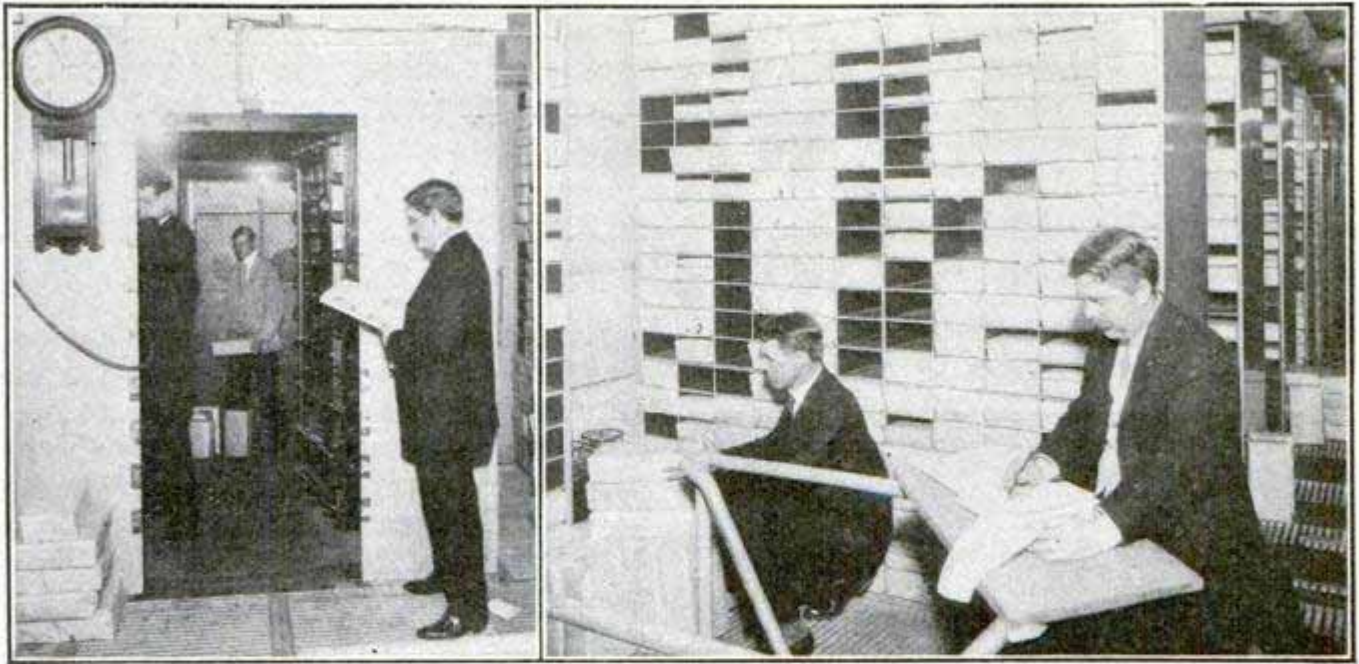

View into Private Elevator to Vault

Interior of New Treasury Vault Showing Packages of Money

THE NEW VAULT AT THE UNITED STATES TREASURY

By WALDON FAWCETT

The United States government is now in possession of the largest and finest safe in the world. It is located deep underground below the United States Treasury building at Washington, and in this huge strong box it is the intention to keep in storage at all times not less than \$500,000,000 in currency. Of course, this new governmental depository of wealth is not a "safe" in the ordinary interpretation of the word, but rather a vault nearly 54 ft. in length, close to 20 ft. wide and about 16 ft. in height.

This new vault, which cost the government more than \$34,000, was made necessary by the passage by Congress a few years ago of what is known as the emergency currency act—a new law which provides that in order to have the means at hand to frustrate future panics, the comptroller of the currency must henceforth keep on hand at all times bank notes or paper money to the value of half of the capital stock of all the United States national banks in existence. This meant the creation of a new reserve reservoir of \$500,000,000 and since the government vaults were already taxed

to their capacity to provide for the keeping of the funds on hand, it was necessary to provide a new treasure house.

The new vault in the sub-basement of the Treasury building is two stories high, and in order to provide storage facilities in the form desired, the entire interior is given over to a series of huge double file cases of sheet steel. These cases are apportioned into pigeonholes—more than 15,000 of them in all—each just large enough to accommodate the standard-size package containing 1,000 sheets of money, each sheet being made up of four bills. Thus each pigeonhole that is filled with one-dollar notes holds \$4,000, whereas, if the denomination be \$10, the contents of the pigeonhole will total \$40,000.

The exterior walls of the new vault are of the heaviest steel construction and the door and the port holes provided for ventilation are closed by heavy steel doors fitted with the latest approved locks of the heaviest and most intricate construction, but the main safeguard for this subterranean wealth lies in an electric protective system that cost \$9,000, and which enmeshes the entire vault in a close-

ence. This system is tested every 15 watchmen.

THE TURNED-UP-TROUSER SUIT FOR WOMEN

Paris, famed for both the beautiful and atrocious in styles for women, has



Very Masculine Parisian Creation for Women

scored again under the latter designation. The latest is a very masculine outfit, designed as a lounging suit, consisting of a fairly lengthy coat and a trouser-skirt with turned up bottoms. The trouser-skirt is really not much fuller than the extreme peg-leg trousers so stylish a few years ago, and especially affected by college men.

ALCOHOL VAPOR AND OXYGEN AS STIMULANT

Attention has been directed by two English physicians to the remarkable stimulating effects on the heart and circulatory system produced by the inhalation of oxygen containing alcohol vapor. Oxygen which had been bubbled through absolute alcohol contained in an ordinary wash-bottle was administered in several cases of illness in which heart failure was a prominent symptom, and the stimulating effect on the heart and circulation was found to be decidedly greater than that produced by oxygen alone. In some of these cases, the administration appeared to have been the cause of the prolongation and saving of life. In cases of pneumonia with heart failure, the mixture was found to be a valuable remedy.

DRINKING WATER PURIFIED BY CHLORIDE OF LIME

A very simple means of purifying drinking water is recommended by the health authorities of Ontario. A teaspoonful of chloride of lime, leveled off by rolling a pencil over it, is mixed with a cup of water, and is then diluted with three cupfuls of water. A teaspoonful of this dilution is used to every two gallons of water to be purified, mixing it thoroughly, which gives between four and five parts of free chlorine in a million parts of water. The health authorities of Ontario say this will destroy in 10 minutes all typhoid and cholera bacilli and dysentery-producing germs, at the same time leaving the water without taste or odor.

Of the 43 types of aeroplanes displayed at the recent exhibition at Paris, only 13 were biplanes.

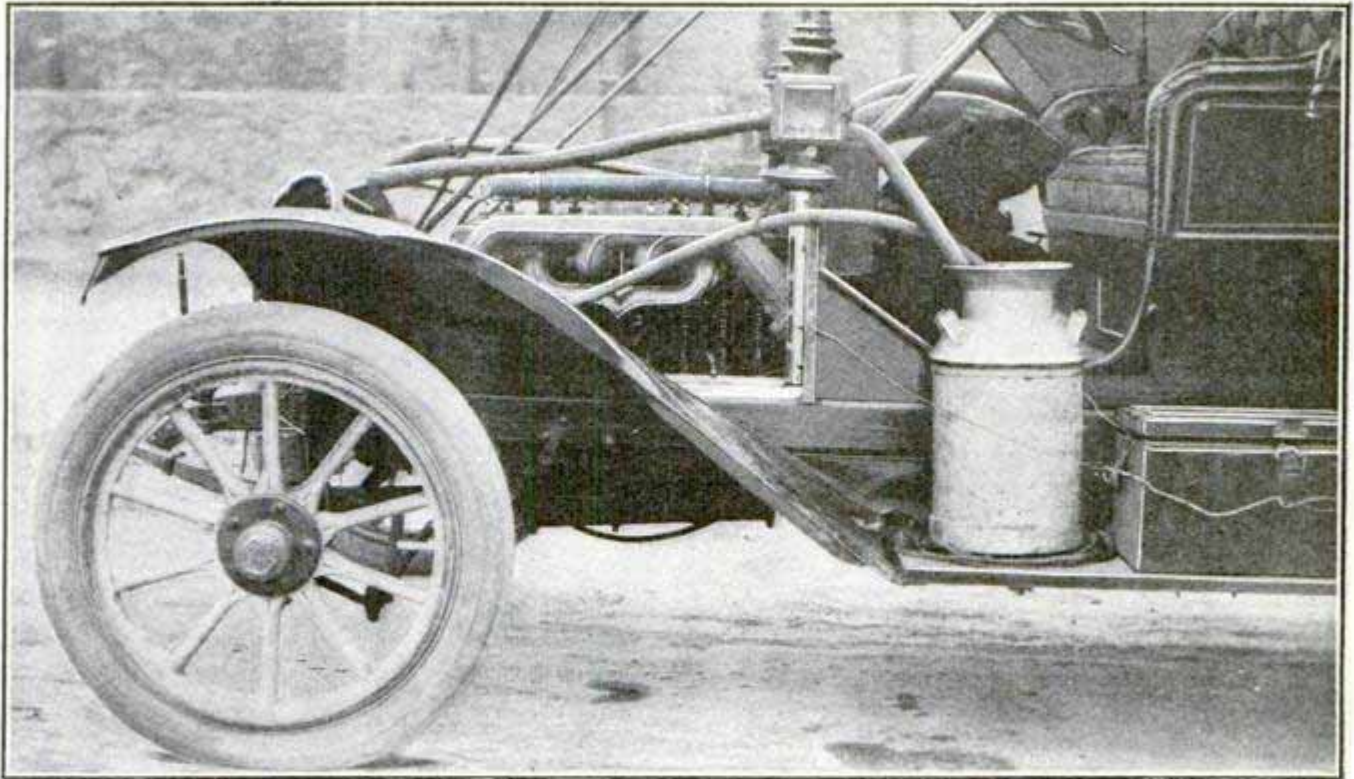

Novel Use for Milk Can in Case of Emergency

AUTO RUNS 70 MILES WITH A MILK CAN FOR RADIATOR

The loss of his radiator did not prevent J. Fred Brown, of Martelle, Iowa, from making a 70-mile run to the factory for repairs. A collision with a switch engine tore the radiator away, destroyed both the lamps and put the hood out of commission, but without damaging the engine. A large milk can, filled with water and secured on one of the steps was made to do duty as a radiator. Circulation for the engine-jacket cooling water was provided by attaching a piece of garden hose to the intake pipe and another to the exhaust and dipping the free ends of the pipes in the water in the can. The novel makeshift acted perfectly and the 70-mile run was made without mishap.

INDIA TO MAKE ITS OWN RAILS

By the first of next year India will be making its own rails, and a short time later the railroads of that country will be utilizing them instead of rails made in England. The huge shops of India's first great steel plant are well under way near Kalimati, on the Ben-

gal-Nagpur Railway, and it is expected that the plant will be ready to turn out pig iron within seven or eight months. The steel rails will follow shortly after.

CLEOPATRA "CAT" CHAIR

The "cat" chair shown in this illustration is one of the "period" novelties produced by a New York furniture house. It is for a Cleopatra period room. The seat, which is the cat's back, is covered with leopard skin. The legs and head are of teak wood.



Novelty Chair

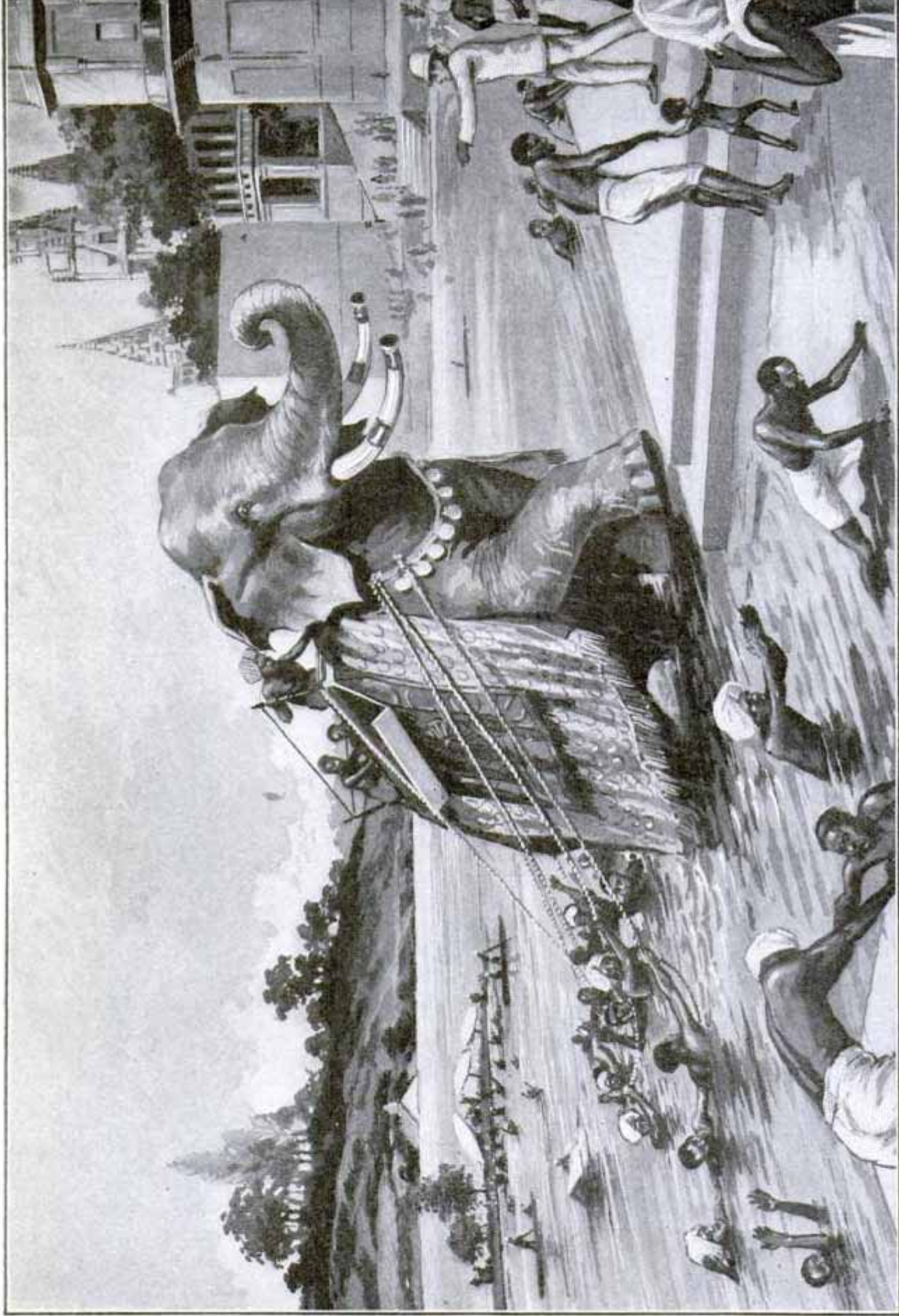

ELEPHANT SAVES HUNDREDS OF LIVES IN THE RIVER GANGES

Hundreds of pilgrims to the sacred waters of the Ganges, in India, owe their lives to an elephant. While the great river was filled with people seeking to cleanse of their sins, the water suddenly rose. More than 200 men, women and children were drowned before help could reach them. An elephant belonging to a rich man in the river bank was driven into the stream with long ropes attached to his harness and the victims of the sudden rising of the tide clung to these ropes and were towed in safety. The elephant and his keeper made repeated trips into the water and pulled ashore all of those who remained above the surface and could not effect their



The Fortification of the Panama Canal

"When other nations cease to increase their armaments by great strides, not only in ships and guns, but in men, in powder, and in aerial fleets, it will be safe for us to lay our Canal at the feet of the World and say 'We have built it for you, and we can trust you to protect it for us'—not before."

By

LIEUT. GEN. NELSON A. MILES

THE government has, during the past hundred years, expended not only hundreds of millions, but billions, of treasure for the welfare of the people and to promote the strength and perpetuity of the nation. The important measures for the improvement of its rivers and harbors, and the construction of its transcontinental railways alone have required great expenditures in money or in land subsidies. These have contributed to the wealth of the nation and given it the best communication and inland commerce of any country in the world. It is now expected that the Panama Canal will promote the nation's ocean com-

merce and merchant marine. It will be of great advantage to the business interests of the Atlantic, Pacific and Gulf coasts, as well as being of great importance to the military and naval departments of the government. Its protection is as important as its completion.

The very important question of defense will demand the serious consideration of the present session of Congress, and it is one that not only interests the people of this generation, but also concerns the future welfare of the nation. At the last session it was pointed out that not only was the defense advisable from a military point of view, but that in the

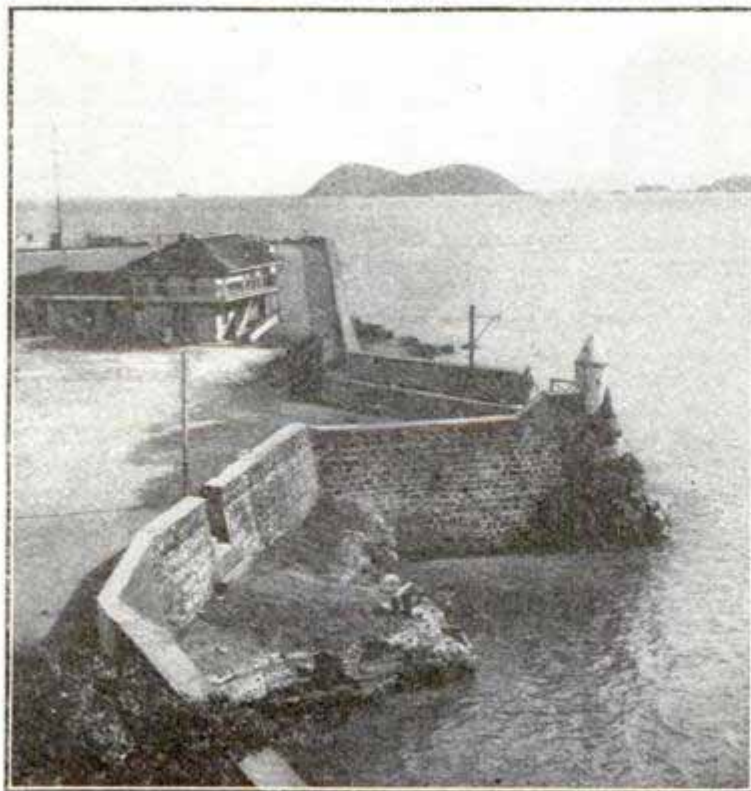

Copyright by Underwood & Underwood
Old Spanish Fort That Now Guards Pacific Entrance to the Canal

the labor and material for their construction was still available in the Zone. Fourteen million dollars was estimated as the cost of the work. No appropriation was made. Now, the subject is presented in a way requiring prompt and decisive measures, for Colonel Goethals has recently reported that he expects the Canal to be completed one year earlier than was at first planned; in December, 1913, instead of January, 1915.

Should we leave the Canal unfortified, and uncovered by treaties with all the great powers, the risk of

its loss through seizure by an enemy would be neither more nor less than the risk of war with a naval power. In such a war it would be decidedly, perhaps im-

peratively, to the advantage of the enemy to seize and hold this important waterway, far more important to us, strategically, than any harbor on our coast. The risk of war may be small, but it is, nevertheless, worthy of our most earnest consideration, to put the matter on its lowest basis, in safeguarding the \$350,000,000 we have put into the Canal. But we have bound that small strip of territory to us by ties far stronger than those of dollars and cents. Into it has gone the best of American energy and genius. At the price of American lives, we have turned the plague district of the western hemisphere into a healthful region. We have picked up the

The Canal will be a monument for all time to the enterprise and patriotism of the people of the great Republic.

Prudence, as well as honor, demands that we give it ample protection. Not to do so would be like building great treasury and sub-treasury buildings for the safekeeping of our national treasure, and neglecting the matter of locks and bolts. To the military mind the importance of maintaining control of the Canal in time of war with a naval power transcends any other consideration. Second only to force in

war comes communication; and when so many channels of communication center at one point, the strategic value of that point becomes most important.

Possessing the Canal, our fleets and transports could move freely from one ocean to the other; losing it, we are, so far as all shipping is concerned, divided,—a most dangerous condition. Either coast is then open to attack without marine support from the other.

The case of the Suez Canal, which is not fortified, is in many ways incomparable to that of the Panama Canal. The Suez was constructed by a private company, at a cost not one fourth that of ours, and at a loss of life far less. The British government later purchased a large amount of the shares; and, while they have not been able to fortify the Canal, it is interesting to note how they

"So let us hope that we will complete our great enterprise, not by the protection of promises, but by the strong, sure hand of government; that we will not leave it for years guarded only by an indulgent Providence as we have in the past left our coast cities; but that we will secure it in our own right and might for the benefit of our people for all time."

Wilson J. Miles

have constantly sought to strengthen their position there. Surrounded by Malta, Cyprus, Aden and Egypt, the Suez Canal is today as completely controlled by Great Britain as if it were under her guns.

The question of our diplomatic right to fortify the Canal is no longer urged. We have now to choose between fortification and an attempt to secure our valuable possession by treaties which such foreign powers

for the doubtful benefit to them of being able to use it in time of war. I say "doubtful benefit," because, as an able soldier, in advocating neutrality, has pointed out, no nation with whom we might be at war, except England, would have any occasion to use it for the passage of war fleets, even if it were neutral.

France, for instance, if victorious on the Atlantic, would hardly send her fleets into the Pacific through the



THE CULEBRA CUT, LOOKING NORTH

"Into the work of building the canal has gone the best of American energy and genius"

"as may be willing to join the United States" in securing the neutrality of the Canal, and "to protect the United States in its ownership, possession, control, sanitation, right to police and to perpetually maintain said Canal." (I quote from a recent Resolution in the House of Representatives). Put it as we will, we really ask the nations to guarantee our possession of the Canal and to relieve us of our burden of holding it—all

Panama Canal, and leave our Atlantic seaboard. Japan, similarly, would not invade the Atlantic even if she had destroyed our Pacific fleet. Nor would either of those nations, if at war with us, find it convenient to use a neutral canal for their merchant ships; for, while their ships might be safe in passing through the Canal, no treaties could insure them protection on the high seas. It would indeed be a brave merchant



Pacific Entrance to the Canal, Showing Rocky Islands

who would send his ships through, and subject them to the danger of capture on seas so near our shores. Therefore, no nation, except England, in case of war with us, would benefit by a neutral canal, so far as the passage of its own ships was concerned. A foreign power would only benefit by the neutrality of the Canal if that power was itself a neutral in a war between the United States and another power. In that case, it could feel a little more certain of passage for its merchant vessels, because as long as the neutrality was respected by both belligerents the Canal could not be damaged or destroyed. Possibly this benefit would not be considered sufficient to weigh against the advantage, in case of war with us, of being able to cripple us by a blow at the Canal.

This, it seems to me, is the real point of the question; that the Canal is vital to us, not to our enemies. It is curious to read in the arguments in favor of neutrality that foreign nations at war with us would not be apt to use the Canal, even if it were neutral. No man can anticipate what the conditions, possibilities and national requirements may be, between two nations involved in a great war; but the point is not what an enemy may do with his own ships,

but how we can prevent the possibility of any enemy closing the Canal to us. We are the divided nation. Ours is the fleet that must have free passage if it is not to be cut in two. France, Germany, Japan, at war with us, might not want to send their own warships through, but it would be vital to them to prevent our doing so. Now, we might be able to insure our "ownership, possession, control," etc., by inducing the world to sign neutrality treaties, so one-sidedly favorable to us.

But, even then, the question arises, "Is this the time in the progress of humanity at which we can trust a most valuable possession into the safekeeping of other nations, other races?" Has that millennium really been reached?

This is the age of the greatest armaments the world has ever known. Is it all meaningless? Germany, for example, will launch in the single year of 1911, more dreadnoughts than we now possess, and four great battleship-cruisers besides. Is it all to keep the peace?

When other nations cease to increase their armaments by great strides, not only in ships and guns, but in men, in powder, and in aerial fleets, it will be safe for us to lay our Canal at the feet of the world and

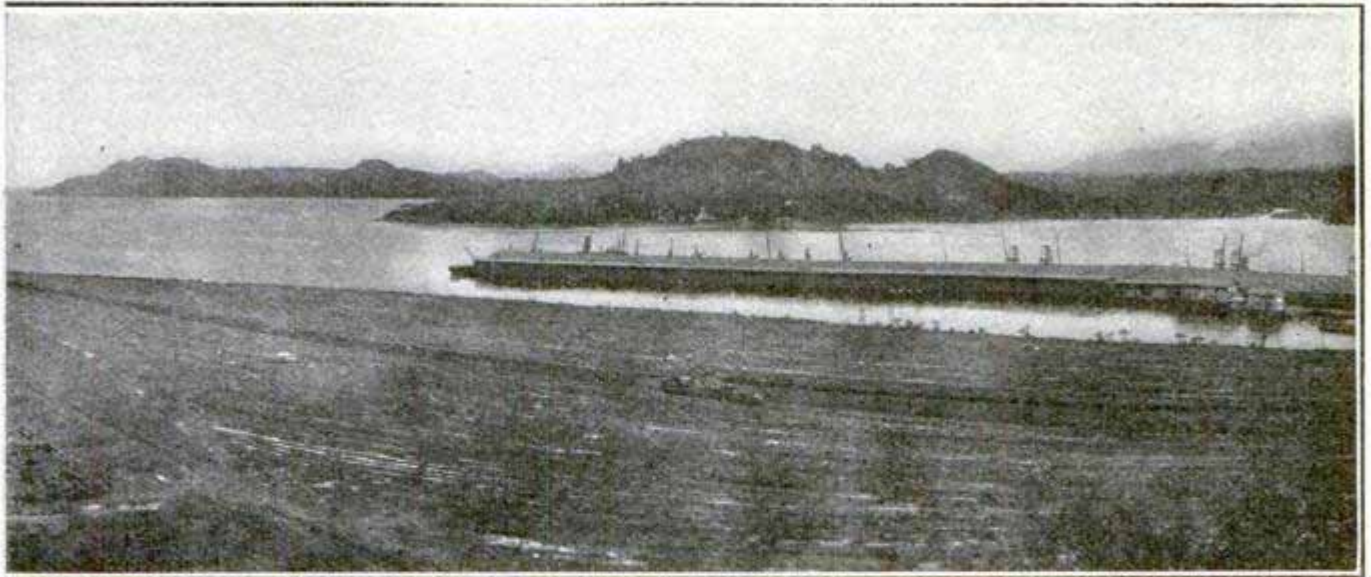

on Which Fortifications could be Placed to Guard the Waterway

say, "We have built it for you, and we can trust you to protect it for us"—not before.

Should we ever again become involved in a war with a first-class naval power, we would at least have the advantage of being nearer the Canal than our enemy. We would probably be able to rush troops down to the Zone, though the operation would indeed be hazardous, and, as an eleventh-hour proceeding, unsatisfactory. England, for example, might be able to intercept our transports in the Gulf by means of cruisers based on Jamaica. But at least the geographical position of the

Canal does not force us to keep there a large garrison capable of defending the Zone irrespective of reinforcements.

Fourteen-inch guns, twelve-inch mortars and concrete emplacements cannot, however, be sent down on a day's notice by fast freight. They cannot even be constructed and mounted within a year's time. The fortifications, at least, we must have.

We do not know what effect aviation will have on fortifications; but we do know that if our own airships and rapid-fire guns can keep the air craft of the enemy at a respectable distance from our heavy guns, these

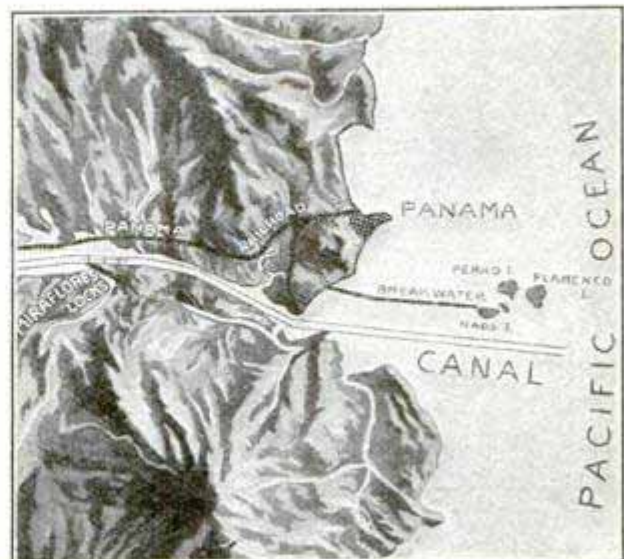
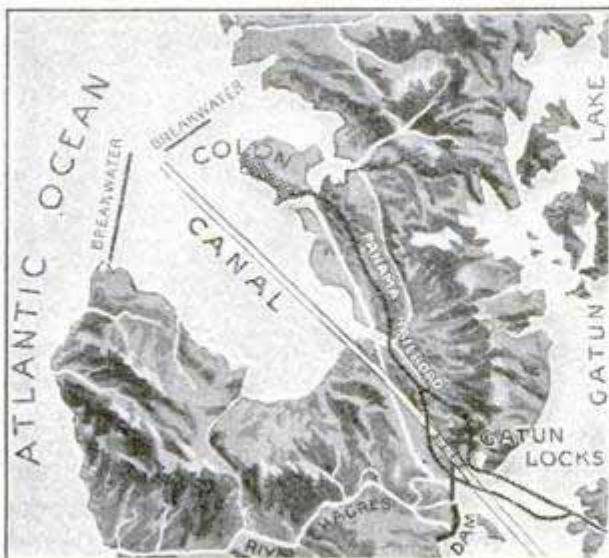

There is a Gooseneck Turn in the Isthmus Where it is Crossed By the Canal. To Go From the Atlantic to the Pacific, Therefore, a Ship's Course will be East

Atlantic Entrance, Showing Headlands

Pacific Entrance, Showing Islands and Headlands

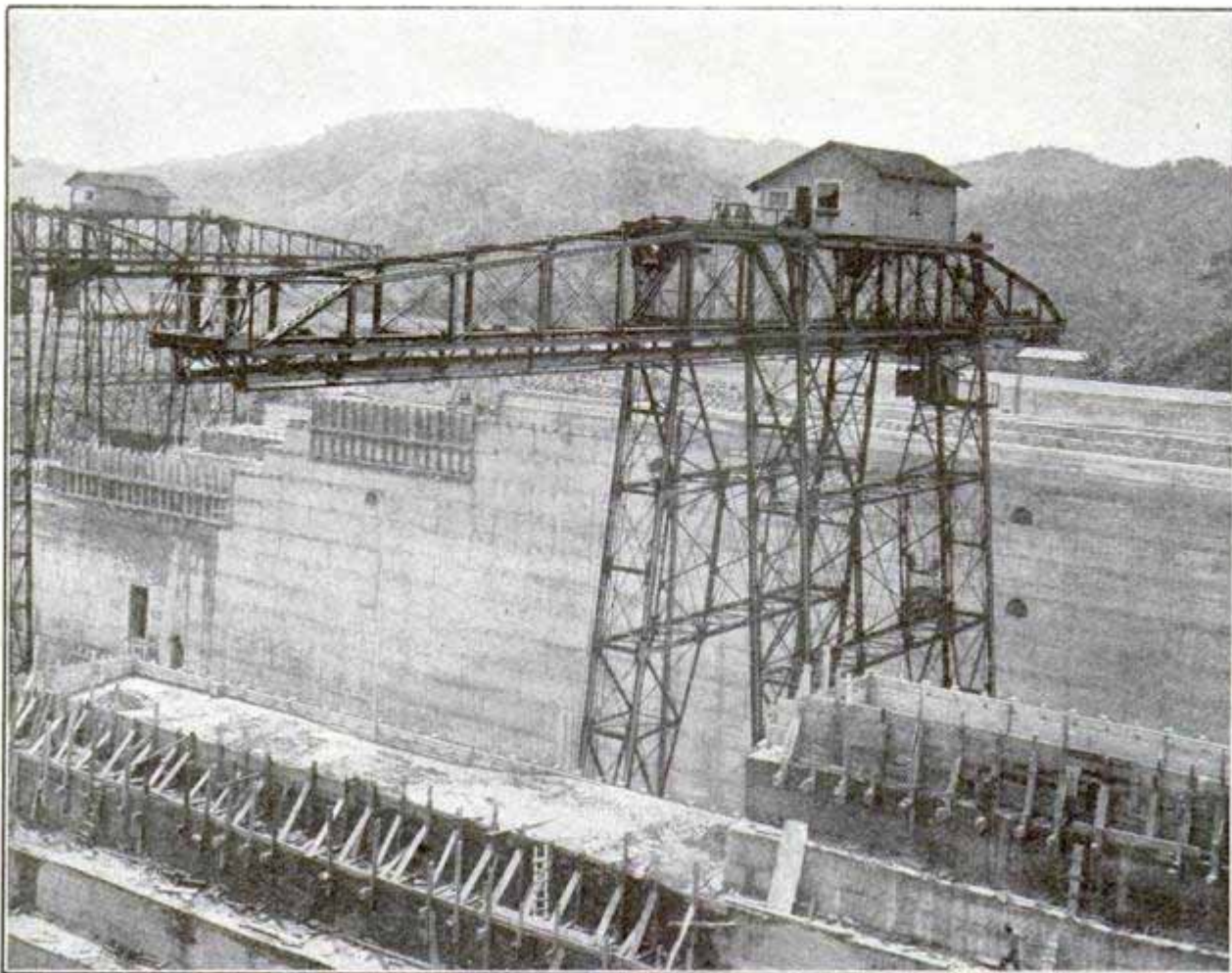

THE CONCRETE HANDLING PLANT, MIRAFLORES LOCKS

"The canal will be a monument for all time to the enterprise of the people of the Republic"

guns, in their turn, will keep the enemy's fleet well outside their range. Our mines, torpedoes and submarines will secure an even larger area of immunity from the enemy's ships. And there is no reason why we should not maintain a more formidable aerial force on the Zone than an enemy could bring there.

The upper slope of a hill is a very good place for seacoast guns. The height slightly increases the range, and, what is of more importance, the field of view. It is also more difficult for a naval gunner to hit a high emplacement than one on sea level. And a small rocky island standing well out above the sea is a most admirable place for a seacoast fort. It is usually difficult, sometimes impossible, to make a landing from small boats on such an island, and a few infantrymen with machine guns could protect the rear of the em-

placements indefinitely. Fortunately for us, both ends of the Canal lie in bays enclosed by such high headlands or rocky islands. Limon Bay, on the Atlantic side, is a body of water stretching nearly four miles inland and enclosed at its entrance by prominent heights. On the Pacific side, the entrance of the Canal, lying in Ancon Harbor, is encircled by a chain of small islands four or five miles away.

An attack on the Canal might have for its object the capture and occupation of the entire Zone, or the damage or destruction of the locks. To resist capture, a strong field force of all arms, infantry, cavalry and field artillery would be necessary; for should the enemy attempt such a measure it would mean a long over-sea transportation and an isolated attack. It would not be undertaken by a weak force. The larger part of our protecting force we might send

down immediately before war was declared; but to leave the mobilization and transportation of the whole of it until the last moment would be an extremely dangerous proceeding. Furthermore, troops that know a country through having marched and maneuvered over it are far more efficient in its defense.

In the case of an attack, the object of which was the destruction or damage of the locks, a mobile force sufficient to protect the coast from landing parties would be necessary. If insufficient force is at hand, to guard against sudden landings, the enemy might seize and destroy the locks and then retreat to their ships. Or they might simply capture the forts from the rear and thus enable their ships to approach near enough to destroy the locks by bombardment. The locks on the Atlantic side, at Gatun, are only $2\frac{1}{2}$ miles

from the coast; those on the Pacific side, at Miraflores, are but 4 miles inland. Our own fleet conducts its battle practice at a range of nearly six miles. It is true that the Canal curves at both ends between the locks and the sea, and that the locks will not be clearly visible from the sea, particularly on the Pacific side; but nevertheless big guns have before this done good shooting against invisible targets. All that would be necessary would be to have an observer posted on a hill top from which both ships and locks could be seen. He might be a man landed from the enemy's ships or a spy. From his post he could signal to the ships whether a shot was high, low, to the right, or left, and in this way put the guns on the target.

At the siege of Port Arthur, the Japanese army reached a point from which a view of a part of the harbor

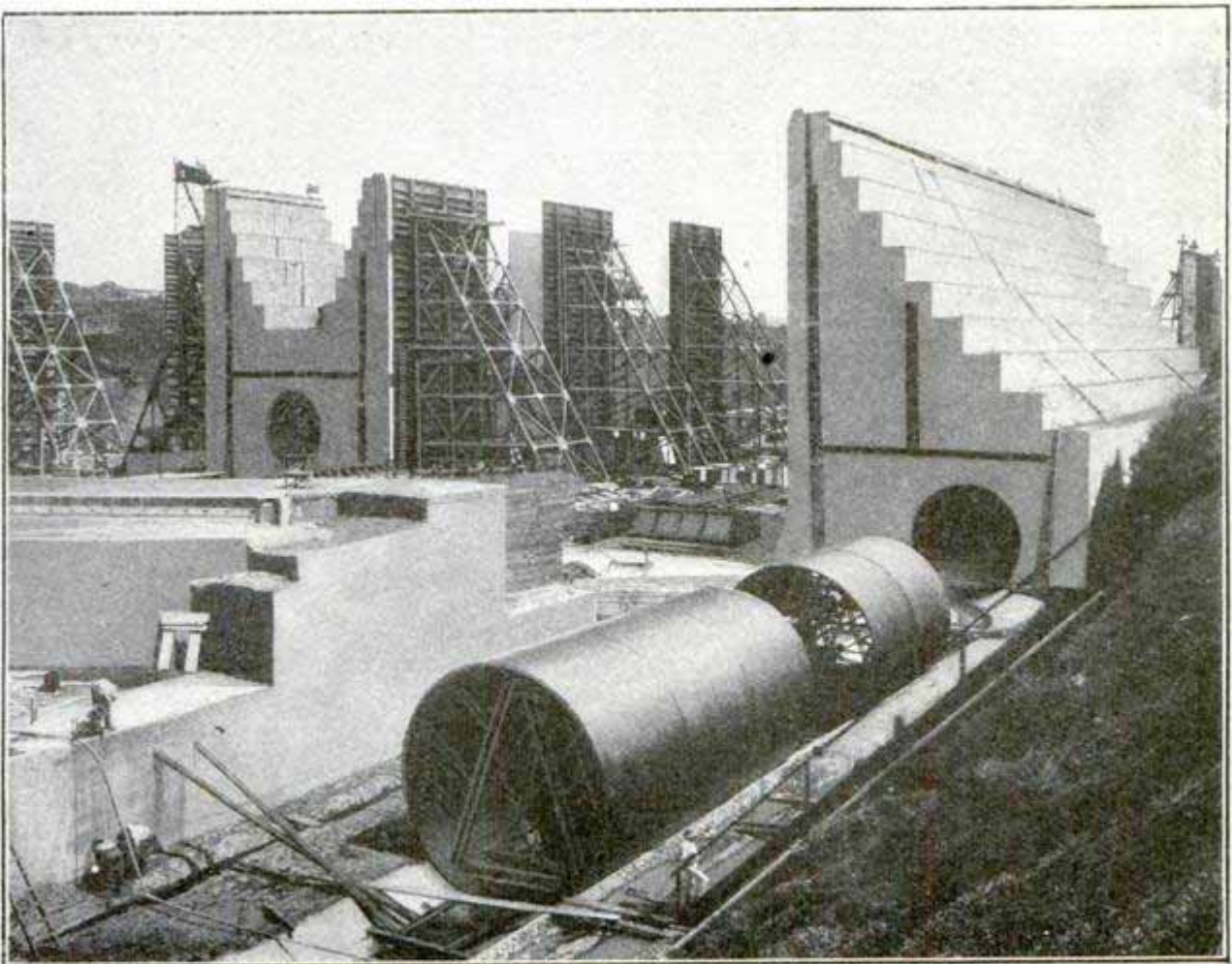

UPPER LOCKS AT GATUN

"Their protection is as important as their completion."

the Russian fleet was for a time successfully bombarded. Some Chinese junks used to fish in that part of the harbor visible to the Japanese, who were then firing their huge 11-in. mortars. If a shot fell short of a Russian ship, a junk would move nearer; if it fell over the ship, the junk would move away. The Japanese trick was discovered, but that method of indirect fire, crude as it seems, might some day be repeated.

There is no chance of such a destruction by bombardment as long as the fortifications are intact, but it must be remembered that a modern fortification is only formidable to the enemy's ships. The great guns are mounted so as to sweep with their fire a certain channel, but they are of themselves powerless against an attack from a land force. So, fortifications involve field troops for their defense. The fortifications of our own coast would be secured by the regular army and other land

necessary mobile force must be constantly maintained there. Nor should we, in considering the security of the Zone, be unmindful that it is unfortunately situated in the heart of the most spontaneously revolutionary district in the world. In fact, it came to us through a revolution. Panama, a state not yet ten years old, is to the north of it. Beyond that is Central America. To the south lie Colombia and Venezuela. A field force appears necessary for police purposes if nothing else.

So, let us hope that we will complete our great enterprise, not by the protection of promises, but by the strong, sure hand of the government: That we will not leave it for years guarded only by an indulgent Providence, as we have in the past left Porto Rico, Hawaii, and, at times, our own coast cities; but that we will secure it in our own right and might for the benefit of our people for all time.

NO MONOPOLY OF THE ATMOSPHERE .

Suit was recently brought against the Lake Shore and South Bend Railroad Company because its 6,600-volt single-phase trolley line affected inductively the telegraph lines of the Postal Telegraph-Cable Co., and the Western Union Telegraph Co., and the signal system of the Lake Shore and Michigan Southern Railroad.

The finding of the court was that the use of the single-phase alternating current on one's own premises does not constitute a nuisance, even though the electricity may escape and interfere with the operation of electrical devices on adjoining property and that the companies bringing suit held no monopoly of the atmosphere.

THE LENGTH OF FLASHES FOR LIGHTHOUSES

It appears from an article by Dr. W. McDougall, in the *Journal of Psychology*, that the flash lights now in use in lighthouses might be visible a greater distance if exposed for a somewhat longer period. His tests were made with a large revolving disk having sectors cut out at its periphery. This was placed in front of a lantern so as to alternately cover and expose a spot of light as it was revolved.

By carrying on a number of experiments with very dim lights he found that, for the dimmest light at all perceptible, a minimum exposure of one-fifth second was required. It seems that one-tenth of a second is the generally accepted minimum exposure.

GEARED TURBINES FOR STEAMSHIPS

Experiments with geared turbines on the British steamer "Vespasian" may have an important effect on the methods of steamship propulsion in the near future. The experiments were to determine whether this means of propulsion would be a saving as regards fuel, weight and space in comparison with the best types of reciprocating engines used in cargo steamers of low speed and great dead-weight capacity. The result of the first test, as attained on an ordinary sea voyage at the ordinary rate of sea travel, gave a decreased steam consumption of 15 per cent.

MULTIPLANE AEROPLANE

An aeroplane of a type that cannot yet be accounted as among those that have achieved practical success, is this curious multiplane, which made its first test flight in France recently. It is one of the largest aeroplanes yet constructed, weighs over 1,700 lb., and is the first to be provided with a closed protecting hood for the operator. The French call the machine the "Phantom Aeroplane."

AUTOMOBILE LEADS HORSES FROM PASTURE

Leading horses from pasture is one of the newest uses to which the automobile has been put by the enterpris-



Using an Automobile in Bringing Horses from the Pasture

ing American farmer. The illustration shows some farmers from Pendleton, Oregon, who prefer using their machine to walking in performing one of their daily chores about the farm. This latest use of the automobile, freakish though it may appear at first blush, is typical of the hustling methods of the up-to-date farmer, to whom the gain of even a few minutes a day in the performance of one of his regular tasks is of the highest importance.

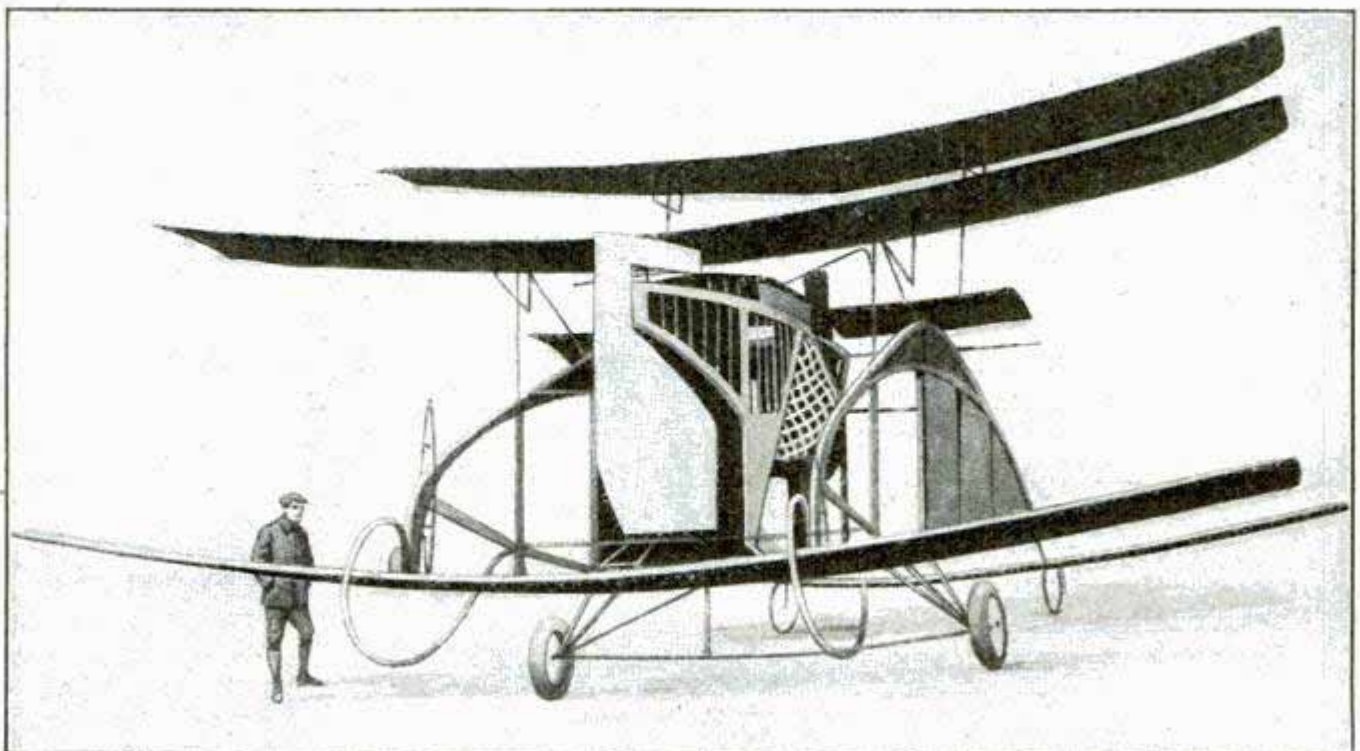

French Multiplane with Protecting Hood for Operator

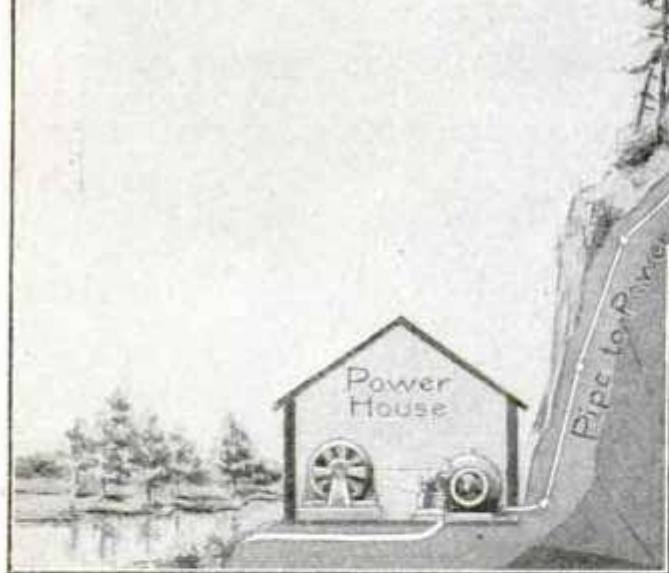

Cross-Section Showing Proposed Auxiliary Power Plant in Seattle, Wash.

RESERVOIR OVERFLOW WILL DRIVE AUXILIARY PLANT

That it is not always a handicap for a city to be built upon hills innumerable is shown by an ingenious plan which the city of Seattle is about to put into effect to provide additional power to its lighting and power plant. The main power plant is located in the Cedar River Valley, near the summit of the Cascade Mountains, 30 miles from Seattle, and it is driven by the water of the Cedar River, which also furnishes Seattle with its drinking water supply.

While this plant furnishes all the power needed at present for street lighting and sale to private subscribers, the lighting department has determined on a small auxiliary plant to help out on the highest load hour and furnish power for any emergency. To drive this plant the overflow of one of the city's big water reservoirs will be utilized.

Volunteer Park is one of Seattle's many view places. It lies at the summit of a range of hills, 400 ft. above Lake Union, a large landlocked body of water in the heart of the city. In the park is one of the city's big water reservoirs fed, by gravity, from Cedar River.

The electrical engineer of the lighting department proposes to utilize the overflow from the big reservoir to drive the power plant which he will erect at the foot of the hill on the shore

of the lake. From about 8 o'clock at night until early morning there is a plentiful overflow from the big reservoirs. The engineer proposes to store up this water, which has hitherto gone to waste in the lake below, in an auxiliary reservoir of about 200,000-cu. ft. capacity which will be built alongside the main basin.

The auxiliary reservoir will be much smaller than the main basin, and the pipe leading from the big reservoir to it will have a valve which will open only into the smaller reservoir. Because the smaller reservoir will be of less depth than the main reservoir, there will always be a sufficient supply of water in the main reservoir to furnish the district it serves. The small power station will contain one dynamo and is expected to develop 2,000 hp. This plant will be operated two hours a day, about sunset, while the city is still selling commercial power and also using current to light the streets. By means of an electric switch the auxiliary plant can be set in motion at any time from the city's central power house, two miles away.

The estimated cost of the auxiliary plant is \$60,000. The University of Washington will co-operate in building the plant, as the hydraulic engineering class of that institution expects to make use of it for experiments in hydraulics.

PLACING A BRIDGE DRAW UNDER DIFFICULTIES

Although many bridge draws have been floated into position on scows, the task involved in placing the huge lift draw of the new Hawthorne Avenue bridge over the

Avenue bridge is 245 ft. long, and weighs 888 tons. It was the last to be built of the six spans of the 1400-ft. bridge, the piers of which are made of concrete. The draw was

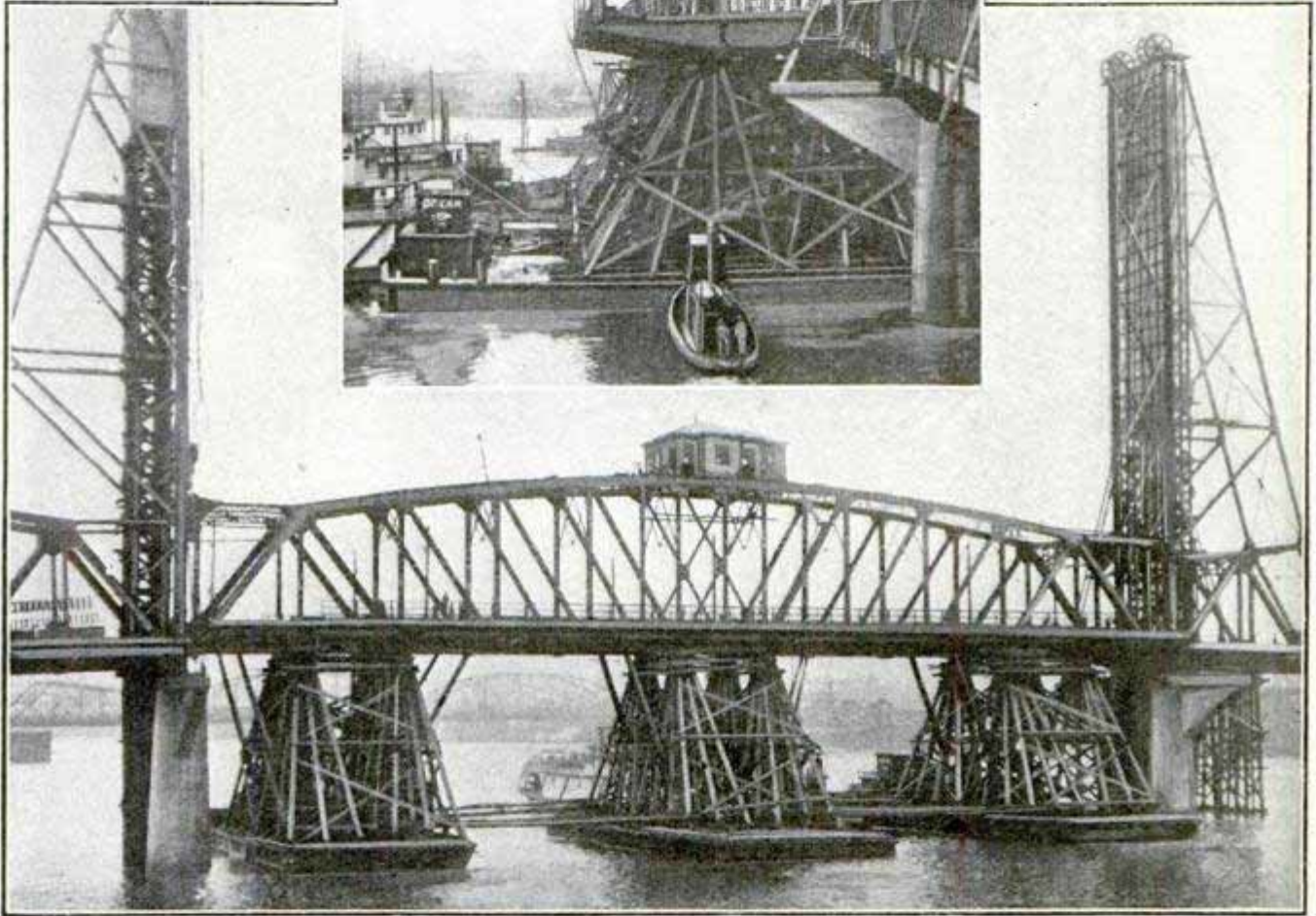

Upper, Sliding the Draw into Place.—Lower, Draw Just After Being Floated into Position on Scows

Willamette River at Portland, Oregon, was noteworthy on account of an unusual combination of unfavorable circumstances. However, notwithstanding the swift current and heavy drift in the river, the occurrence of a freshet just as the last scow was being placed, the height of the bridge above the water, and the size and length of the draw, the whole delicate operation of floating the draw into position was completed in less than two hours without a hitch of any kind.

The draw span of the Hawthorne

constructed on a temporary trestle supported on piles driven into the bed of the river. Three scows, having a lifting buoyancy of about 500 tons each, were used to float the draw span to the bridge site, the draw being supported at a height of 45 ft. above the water by stilts or trestles of heavy timbers resting on the scows. The scows were partially submerged by running water into their holds, and floated one at a time under the draw. The supporting trestles were then removed, one section at a time, and the

stilts were brought up firmly under the steel span by pumping the water out of the holds of the scows. When finally the two end sections of the temporary trestling were removed, the span settled down on the stilts, and the two river steamboats "Sarah Dixon" and "Shaver" took the scows in tow and slowly and steadily moved the whole fabric into place. The draw ends were hooked into the steel superstructure of the bridge, and the hardest part of the task was performed.

The draw is of a type which can be lifted bodily to permit the passage of vessels under it. In order to minimize the effort of moving it, two great counterweights of 422 tons each are provided, one at each end, to balance the dead weight of the structure. These weights are attached to the draw at each end by 96 steel cables, and 21 concrete blocks, each weighing 1,500 lb., were prepared beforehand to be added to the counterweights or span, as required, the idea being to make the span a little heavier than the

weights so that it can be lowered by gravity. Two 125-hp. electric motors, located in a machinery house at the center of the draw, furnish the power for lifting, an operation which takes slightly less than one minute. Provision has also been made for moving the draw by manual power in the event of the electrical apparatus being put out of commission. When lifted to the top, the draw gives a clearance 245 ft. wide and 160 ft. high at mean low water, and about 135 ft. high in time of floods.

The bridge is the fourth one built over the Willamette River. The floor of the bridge is over 60 ft. wide. In the middle there is a 20-ft. roadway for ordinary vehicular traffic; on each side of this is an 11-ft. space for street cars and automobiles, and foot passengers are provided with two 8-ft. sidewalks next to the outermost edges of the bridge. The bridge represents an outlay of \$480,000 by the city, and it is claimed that each of the two contractors lost \$50,000 on the work.

THE NEW CAPITOL DOORS

Representing the apotheosis of America, and containing designs which bring the history of the Nation down to the present time, magnificent bronze doors will soon adorn the west entrances of the United States Senate and House of Representatives. The prize of \$10,000 for the design, offered by Congress seven years ago, has been awarded to Louis Amatois of Washington, D. C. Before being placed into position, the bronze doors will be on exhibition in the Corcoran Gallery of Art for several months.

It is 72 years since the first bronze doors were placed at the eastern portals of the Capitol. They were by Rogers, and are known as the Columbus doors. Afterward the Crawford bronze doors, on which were designs depicting scenes in the history of the Republic, were placed at the Senate and House entrances.

The Amatois doors contain eight panels, surmounted by a large deep transom. In the transom panel is shown an allegorical figure representing America seated in a chariot and drawn by lions—typifying strength—led by a child—symbolizing the superiority of the intellect over brute force. Following the chariot are figures representing a scholar, architecture, literature, painting, music, sculpture, mining, commerce and industry. On one side of the transom is a statuette representing Thomas Jefferson. On the other side another represents Benjamin Franklin. There is a medallion at each corner, and these represent Peabody, the educator-philanthropist; Emerson, the sage, philosopher and thinker; Horace Mann, the educator, and Johns Hopkins, the merchant philanthropist.

Below the transom are panels in re-

lief, four on each side. On these panels are depicted allegorical representations of jurisprudence, science, art, mining, agriculture, electricity, engineering, naval architecture and commerce. On the sides are statuettes of famous Americans. Others are depicted on the corner medallions.

The top panel on the left side represents jurisprudence. The subject is a session of the United States Supreme Court, with John Marshall, as Chief Justice, presiding on the occasion of a famous decision. The science panel shows effigies of the greatest scientific investigators from the time of Hipparchus, the Egyptian astronomer, to Darwin. It includes Alexander Graham Bell, inventor of the telephone, and Morse, inventor of the telegraph. The panel devoted to art shows portrait-like presentments of Homer, Virgil, Dante, Shakespeare, Goethe, Hugo, Palestrina, Beethoven, Rossini. A flying figure typifies genius. In the medallions are representations of Poe, Thornton, Stuart and other men famed for their genius. The fourth panel at the bottom on the left side is symbolical of mining. Brown and James W. Marshall, who discovered gold in California; Alexander W. Holey, the mining engineer; E. B. Chase, A. Hewitt and Clarence King are shown here.

On the right side, the top panel represents agriculture with a harvest scene. The men chosen as typical of the genius which has advanced the science of agriculture are Samuel G. Morton, the ethnologist; and James Wilson, Secretary of the Department of Agriculture. The medallions represent the late Senator Morrill, I. P. Norton and Bussey, the founders of agricultural chemistry. Typical scenes are chosen for the panels representing iron and electricity. Here are found Peter Cooper and H. A. Rowland, one on either side of the panel. There are medallions of Baldwin, the locomotive builder, and Edison, investigator in the realm of electricity.

The laying of railroad tracks, with a great bridge in the background, forms the subject of the panel devoted

to engineering. Among the engineers chosen as typical among those who have accomplished the engineering marvels of the last century are James

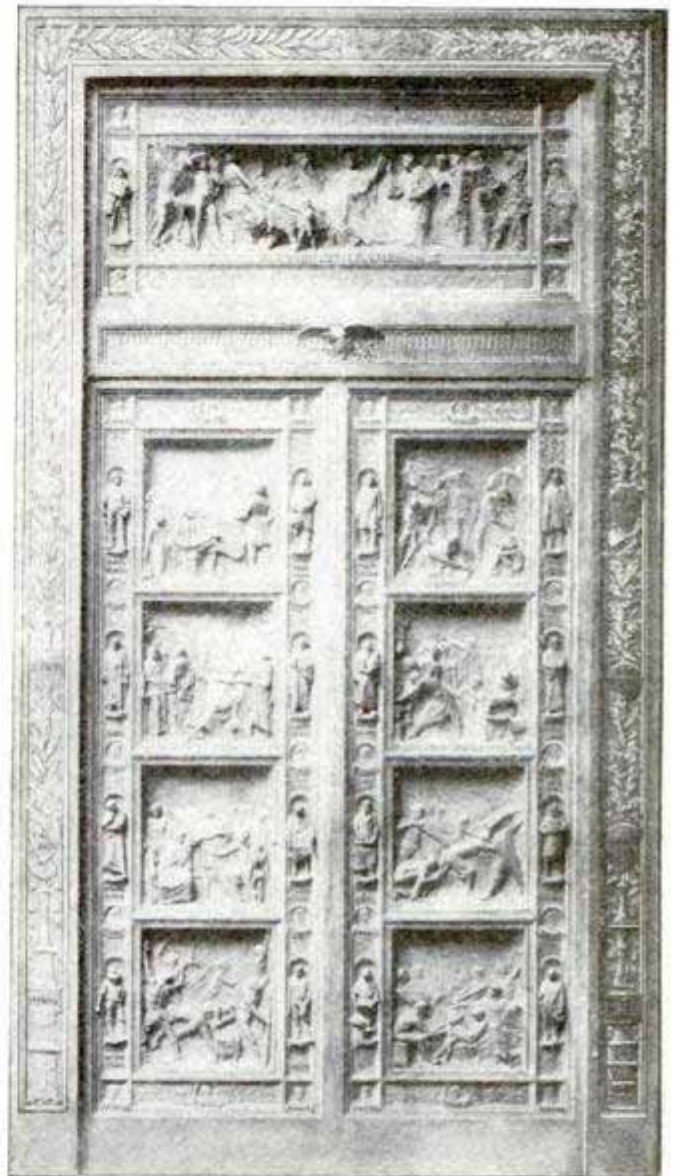

One of the New Bronze Doors for the Capitol

B. Eads, Gen. Thos. L. Casey, the army engineer; Roebling, builder of the Brooklyn bridge, and Stevens of trans-continental railroad fame. For the panel representing naval architecture and commerce the artist chose a figure typifying the former, which is shown in the act of pointing out, on a globe, to another figure, typifying commerce, industries and agriculture, the places where the products of the nation can be marketed. Fulton, Ericsson, Cyrus W. Field, Eli Whitney, Elias Howe, Fremont the Pathfinder and J. Lenthall are the men immortalized in the side figures and medallions. The doors will be set in a frame of bronze.

Sections of two extraordinary moving-picture films, one of a used cartridge being thrown out of the chamber of a revolver, and the other of a bullet approaching and passing through a ball of clay, taken at a speed of 5,000 per second, are shown in the illustration. In the former the cartridge may be seen rising higher and higher into the air, and in the latter the projectile is seen approaching at the right, entering, and coming out on the other side.

It is electricity that has made possible the taking of photographs at this tremendous speed of 5,000 a second. The photographs were taken by a German scientist, the object being illuminated by an electric spark for a period varying between one millionth and one ten-millionth part of a second. The apparatus resembles to some extent a wireless-telegraph outfit. An alternating current, passing through the primary of an induction coil, causes a rapid and regular series of sparks between the electrodes of a spark-gap included in the secondary circuit. These serve to illuminate the moving object while a concave mirror concentrates as much as possible of the light from the spark on a short-focus condensing lens. As the spark lasts less than one millionth of a second, the movement of the film is too insignificant to impair the distinctness of the image.

YACHT FOR PRINCE BUILT IN CHINA

The new yacht for Prince Tsai Hsun, which was built in Shanghai, China, is one of the handsomest vessels in the Orient. She is equipped with two sets of triple-expansion engines, with cylinders 10 in., 16 in., and 26.5 in. in diameter, respectively, by 18-in. stroke, which gives her a speed of 14 knots (16.12 miles an hour). Steam is furnished by two Scotch boilers; indicat-

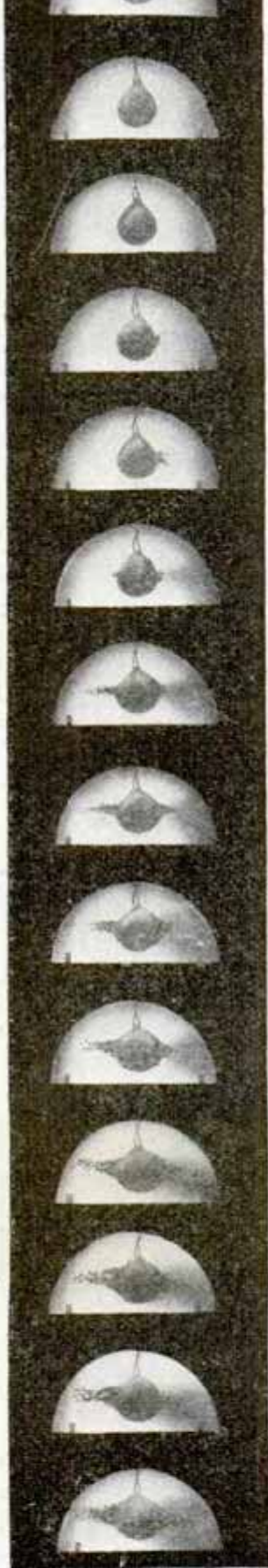

Moving Pictures Made at Speed of 5,000 a Second: Bullet Approaching and Passing through Ball of Clay

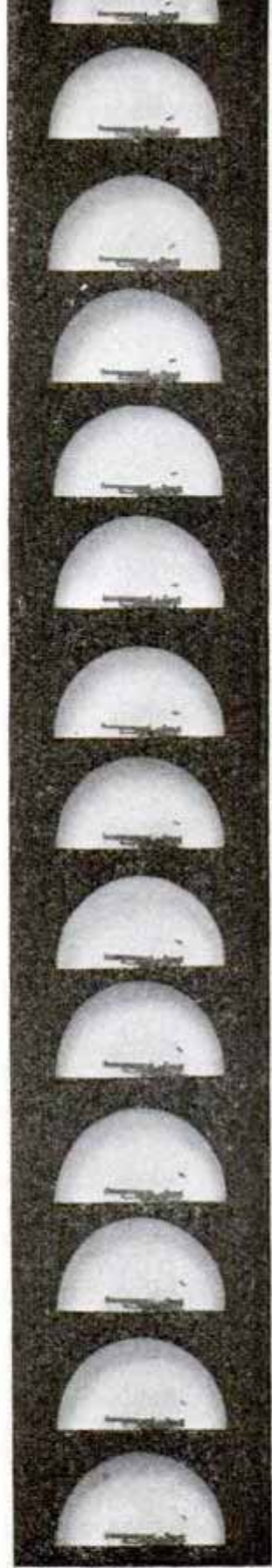

Photographs Taken at Inconceivable Speed: Showing Automatic Discharge of Cartridge from Revolver

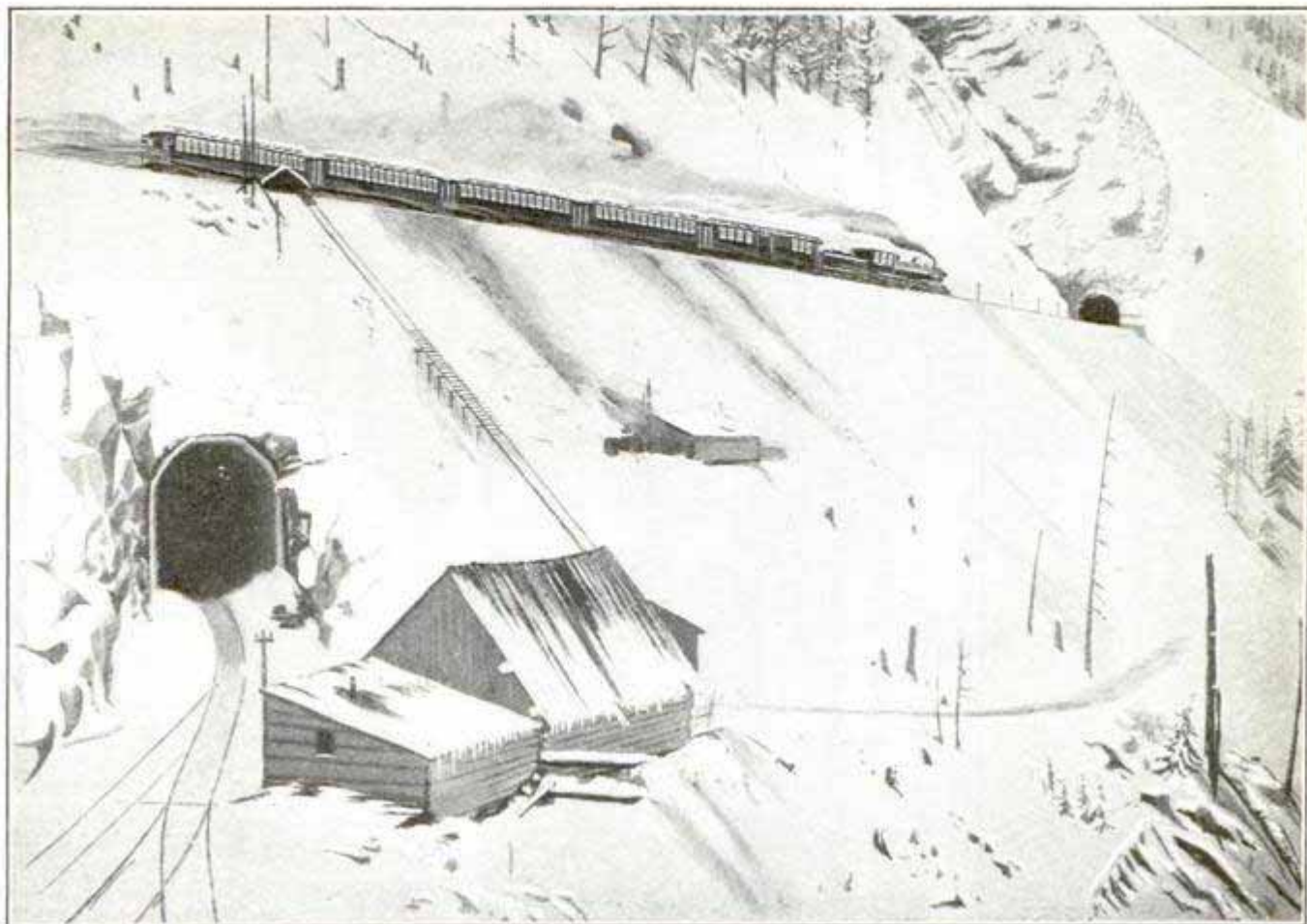

Portals of Spiral Tunnel No. 1, Trains Entering and Emerging Near Same Point, with Difference of 45 Feet in Elevation of Tracks

ing 900 hp. under 180-lb. pressure. The vessel is 150 ft. between perpendiculars, with a breadth of 25 ft. and a molded depth of 12 ft. 6 in. The displacement is 500 tons. The accommodations on board are up to date in every particular, spacious quarters for the prince and his suite being provided. The boat has been christened the "Lien-Chinfollows."

SPIRAL TUNNELS OF THE CANADIAN PACIFIC

The spiral tunnels of the Canadian Pacific Railroad, located between Field and Hector, British Columbia, in the valley of the Kicking Horse River, were the only practical means of reducing the grades. They form one of the most remarkable grade reduction works ever attempted.

The spiral tunnel designated as No. 1 in the diagram is 3,200 ft. long, and turns an angle of about 234 deg., the difference in elevation of its portals being 45 ft. How close these portals

are together is shown in another illustration. Spiral tunnel No. 2 is 2,890 ft. long, turning an angle of about 232 deg., with the difference in elevation of portals about 46 ft.

The tunnels are 5,000 ft. above sea level, and during extremely cold

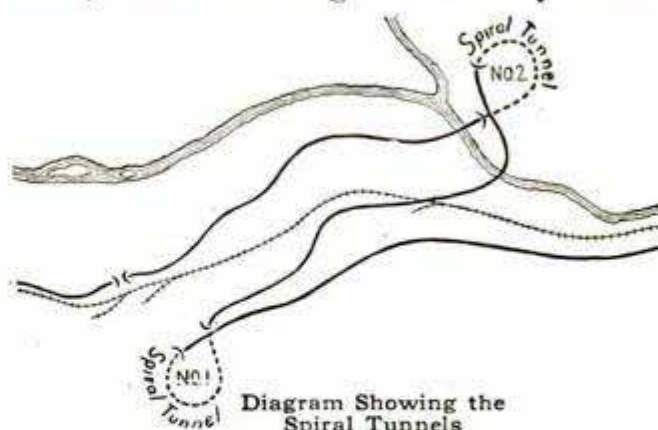
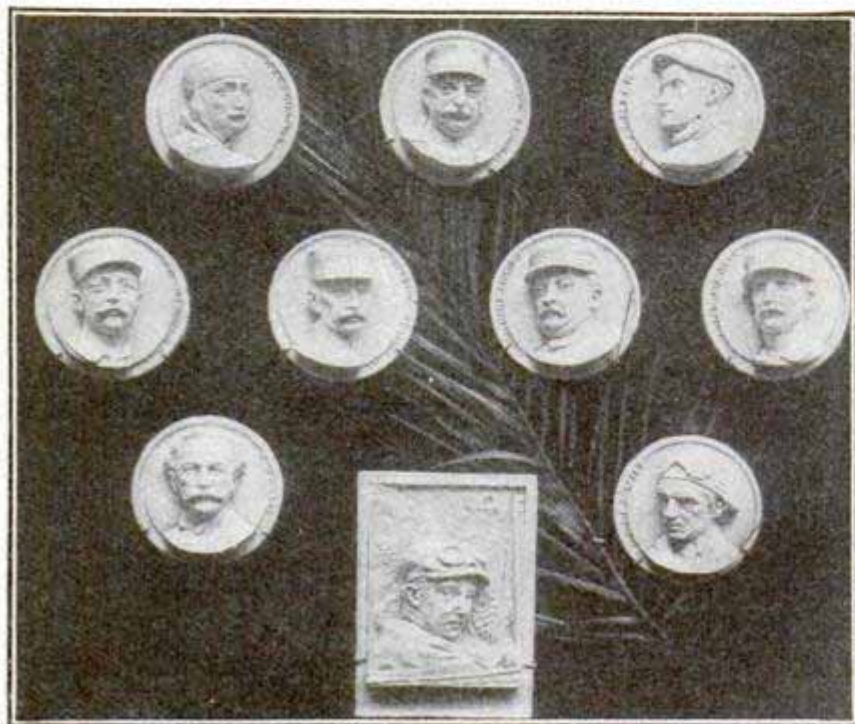

Diagram Showing the Spiral Tunnels

weather much difficulty was experienced with the freezing up of the air supply pipe lines. The drilling throughout almost the entire length of both tunnels was most difficult, as the rock was brittle and in a semi-fractured state, having been distorted by upheaval.

MEMORIALS FOR VICTIMS OF AERIAL NAVIGATION

One of the features of the second annual aeroplane exhibition in Paris was the handsome memorial tablets placed



AIRMEN'S MORTUARY TABLETS AT PARIS SHOW

Delagrange	Captain Ferber	Wachter
Adjutant Vincent	Captain Marchal	Lieutenant Chaure
Severo	Chavez	Adjutant Reaux
		Lefebvre

in a conspicuous place in honor of men who have sacrificed their lives in their efforts to solve the problems of aerial navigation. The tablets were of plaster and each contained a portrait head in bas-relief of the man it was designed to honor. They were placed on a black pall, to the center of which a palm leaf was affixed so that the fronds hung gracefully over the center tablet. In the lower left-hand corner was a tablet containing the inscription which freely translated acclaims:

"Glory to the Fallen
The Achievements of the Dead Mark
the Progress of the Living.
Auguste Comte."

ⒸLieut. Wilhelm Filcher, of the German army, has received \$175,000 in contributions for the fund that will be used by the expedition he proposes to lead into the Antarctic regions next spring.

RAILROAD OPENED FROM HONGKONG TO CANTON

The English section of the Canton-Kowloon Railroad, connecting Hongkong with Canton has just been formally opened. There remains unfinished a few miles of the Chinese section of the road, which has a total length of 111 miles. The English portion, extending from Kowloon, on the mainland opposite the island of Hongkong, to the limits of the British leased territory, is 22 miles long. There is much speculation as to the financial future of this railroad. Heretofore all communication between Hongkong and Canton has been by water. The opening of the railroad is regarded as a great advance. Hongkong is rated as the second port in the world in point of shipping, being the receiving and distributing point for European and American trade with China, and the headquarters of many of the foreign commercial houses. Canton is the most populous province of China, and the city of Canton has many of the richest native manufacturing plants.

COURT HOLDS THAT SAWDUST CONTAMINATES STREAM

Sawdust contaminates water, according to the decision of a Virginia court in the case brought by residents along the banks of a stream to prevent the owners of a sawmill from dumping the dust from their mill into the water. The farmers testified that the sawdust gave the water such a color and offensive odor that the cattle would not drink it. On the strength of this testimony and other facts brought out, the court ordered the sawmill people to make other disposition of their refuse.

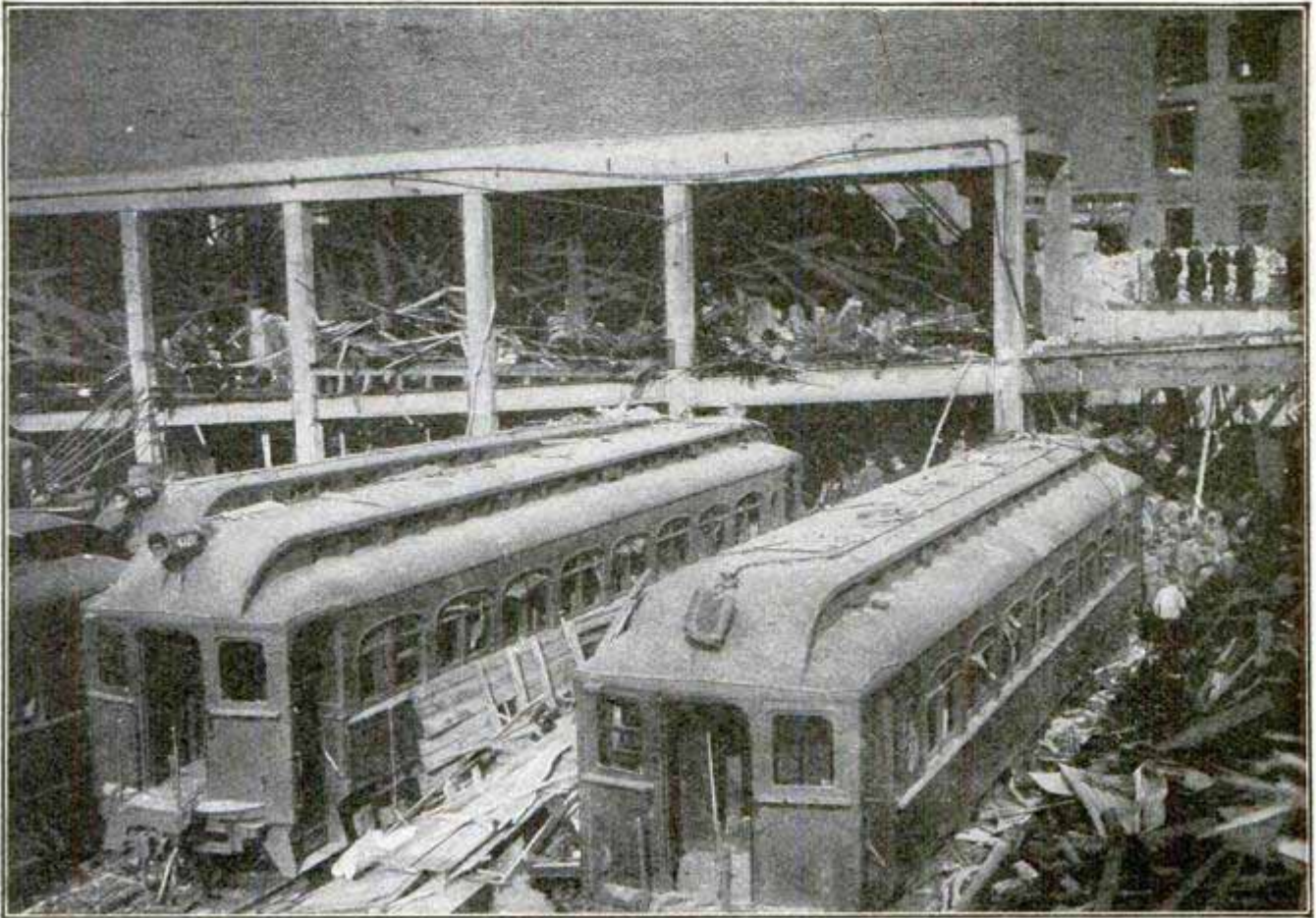

View of the Train Shed, Showing Wreck Caused by Explosion, at Grand Central Station, New York

EXPLOSION OF ACETYLENE CAUSES DEVASTATION

Manhattan Island was shaken to its foundations on the morning of Dec. 19 by the explosion of acetylene gas at the Grand Central terminal yard, which killed ten persons and injured more than 100 and caused damage to property to the extent of thousands of dollars. A large tank used to supply illuminating gas to cars on the railroad

lines using the Grand Central Station is situated 500 ft. from the main power house connected with the station at the corner of 50th Street and Lexington Avenue.

The particular section of the power house at this point is used for storage batteries, and beneath it is a storage track for cars. A train of cars was

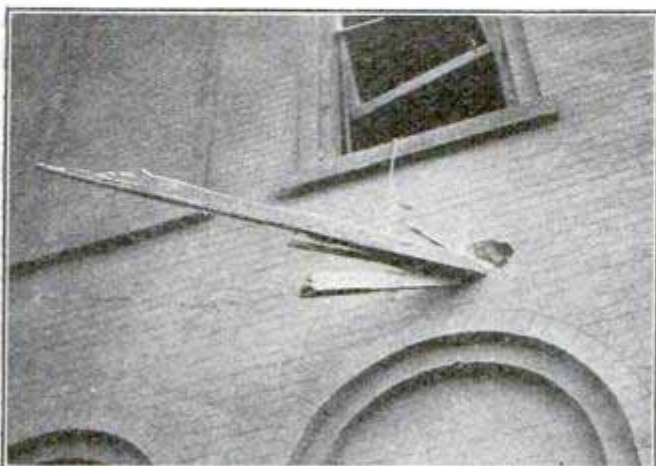

Piece of Timber Driven 300 Ft. and Through a Brick Wall by Force of the Explosion



Automobile Which Was Passing at Time of Explosion on which Street Car Fell, Killing Several People

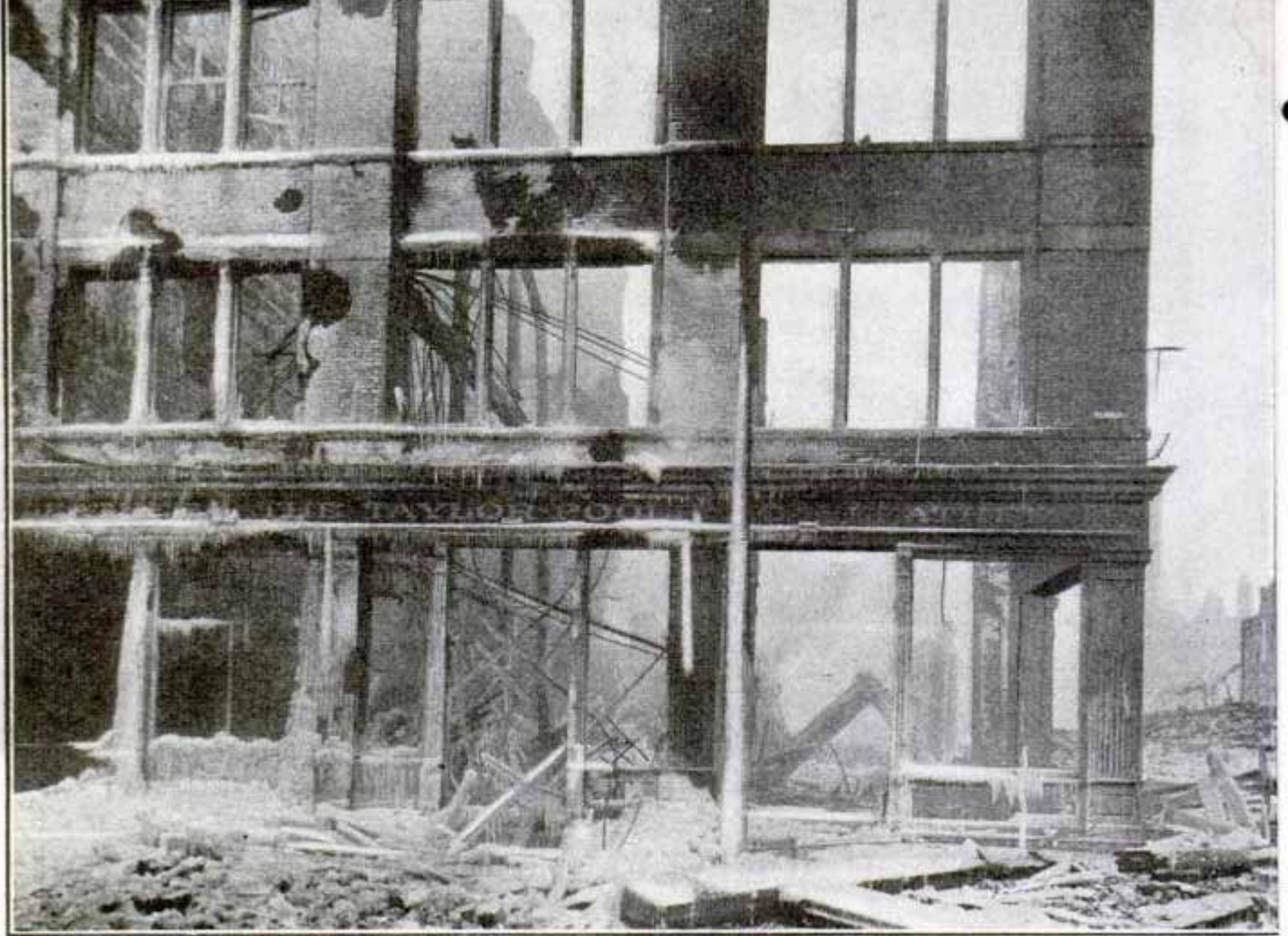

View of the Ruins of Cincinnati Business

run into these storage tracks, and for some reason the motorman could not apply the brakes quick enough, with the result that the cars ran into the bumpers. Debris from the splintered post broke one of the distributing pipes from the gas tank and before the supply was cut off 14,000 cu. ft. of gas escaped. About half an hour after the bumper was wrecked, the explosion occurred in the storage battery house. The north wall of the house was thrown down by the explosion and the easterly part of the house was entirely destroyed. A street car that was passing at the time of the explosion was wrecked and blown over onto an automobile. Houses opposite the wrecked building were badly damaged and buildings within a radius of a quarter of a mile were slightly damaged.

MILLIONS LOST BY FIRE IN CINCINNATI

One of the most destructive fires ever known in Cincinnati occurred December 22nd, when half a dozen big buildings occupying almost an entire block were destroyed with their contents, the damage amounting to \$2,100,000. The loss of human life added to the horror, several firemen and employees of the various business firms whose establishments were wrecked having perished in the flames. The ruins left by the fire showed well the extent of the conflagration and the tremendous damage wrought.

☐The French government has imposed a heavy tax on automatic cigar lighters because they infringe on the state monopoly of matches.

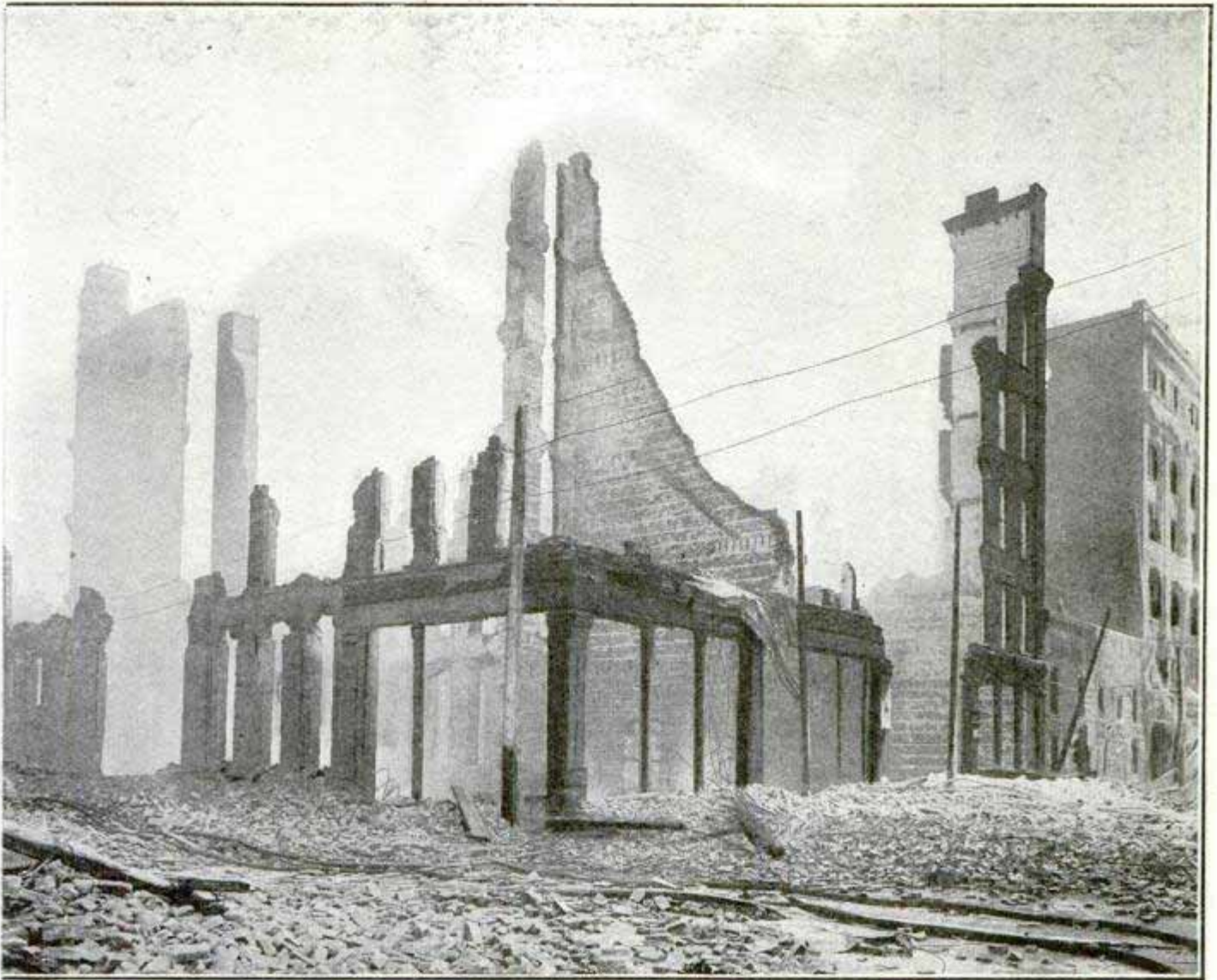

Block, after the \$2,100,000 Fire, December 22nd

"MAURETANIA'S" RECORD CHRISTMAS TRIP

It is not impossible that "seeing America" tours of a fortnight's duration may be started from London shortly, at least one English tourist having visited Manhattan Island, Philadelphia, Washington and Baltimore and returned to London after an absence of just 12 days. This feat was accomplished as a result of the record-breaking round trip of the "Mauretania." The run started Sunday, December 11, and ended Thursday, December 22, the "Mauretania" having made the run to New York, discharged her cargo, taken on a new cargo and passengers and returned to Fishguard between those dates. The big ship remained on this side of the Atlantic less than 36 hours. The London Daily Mail sent a special correspondent with the

ship, who was assigned to visit Washington, Baltimore, Philadelphia and New York and to visit the chief officials at each place. He called on President Taft, Vice-President Sherman, Speaker Cannon, Ambassador Bryce, Mayor Gaynor of New York, saw "The Great White Way" and the Bowery, interviewed an opera singer and "Chuck" Connors and returned to England on the "Mauretania" after having been away from his desk just 12 days.

☪ Cecil Grace, a member of the Royal Aero Club of England, is the first airman to be reported lost. Grace flew from Dover to the Belgian frontier and thence to Calais, Dec. 22, in an effort to win the Baron de Forest prize. He started from Calais for Dover and since then nothing has been heard from him or his machine.



"THE SIRENS OF THE SKY" AND TWO RECENT VICTIMS

Cartoon by John T. McCutcheon in the Chicago Tribune of Jan. 1, Following the Deaths of John B. Moisant and Arch. Hoxsey, Whose Photographs are Shown in Upper and Lower Corners Respectively

FIFTY-THREE AIRMEN KILLED DURING THE YEAR 1910

Fifty-three lives were sacrificed in the progress of aviation in 1910. The fateful figure 13 seemed to exercise an especially baneful influence over those who sought to conquer the air, no less than nine of the fatalities having occurred on the thirteenth day of the month. The first of these was May 13th. Two months later, July 13th, five men lost their lives, and on No-

vember 13th, three more went to their deaths. A recent census of the air taken in France states that November 15th there were 501 men and women devoting their lives to the science of aviation alone. Three years ago there were but four—Wilbur Wright, Orville Wright, Henry Farman and Alberto Santos-Dumont. By an odd trick of fate, all of these four pioneers

are living today and, with the exception of Orville Wright, who was seriously injured in 1908, none of them has been severely hurt, though each has had narrow escapes. All of these pioneers have retired from the business of flying. The Wrights occasionally take a machine out for test, but never fly for exhibition purposes. It is also an odd fact that many of the more famous men who have followed the quartet who first entered the field have also retired. Thus Bleriot, Paulhan, Latham, De Lesseps and several others are giving their attention to the commercial end of the business of aviation rather than to the spectacular or exhibition side of it.

The greatest number of deaths occurred in the last six months of the year, there having been but fourteen before July 1. December was the sinister month.

Of the 53 men who died, 36 were killed in aeroplane accidents and 17 went to their deaths in balloons. But seven of the dead were Americans, the remainder representing France, Germany, Russia, Belgium, Italy, Holland and England. Eleven of them were soldiers experimenting with aeroplanes or balloons for military purposes. The following is believed to be a complete list of those who were killed between Jan. 1 and Dec. 31, 1910:

MOISANT AND HOXSEY DIE THE SAME DAY

The entire world was shocked December 31 by the death of two of the foremost airmen, John B. Moisant and Arch. Hoxsey. Both were Americans and both had won high honors. Moisant was making a final trial for the Michelin annual duration prize at New Orleans and was thrown from his Bleriot machine while making a turn. Hoxsey started out to better the altitude record he made December 26, after having read a press dispatch containing news of Moisant's death, and was returning to earth, having reached a height of about 7,000 ft. He had descended to within a few hundred feet of the ground when something went wrong and his machine came down like a shot. His body was horribly mangled.

Moisant first drew public attention by his plucky flight with a passenger from Paris to London, his fame being further increased when he won the Statue-of-Liberty flight at the last international aviation meet. Hoxsey came into prominence only a few months ago when Col. Theodore Roosevelt made a short flight with him at St. Louis, after Hoxsey had flown from Springfield, Ill., to the St. Louis aviation field.

THE LIST OF MEN WHO SACRIFICED THEIR LIVES DURING THE YEAR 1910, IN THE ADVANCEMENT OF AVIATION AND AERONAUTICS OR THE PURSUIT OF PRIZE MONEY

Jan. 4.	Leon Delagrangé, Bordeaux, France.	Oct. 7.	Captain Mazievitch, St. Petersburg, Russia.
Apr. 2.	Hubert Le Blon, San Sebastian, Spain.	Oct. 9.	Lieutenant Matsievski, St. Petersburg, Russia.
Apr. 4.	Hugo Delbrueck, F. Benduhn, Hein, Stettin, Germany.	Oct. 23.	Captain Madiot, Douai, France.
Apr. 19.	P. Luft, Herr Groupner, Hoecker, Lusschenring, Berlin, Germany.	Oct. 25.	Lieut. Wilhelm Mente, Magdeburg, Germany.
May 13.	Hauvette-Michelin, Lyons, France.	Oct. 26.	Fernand Blanchard, Issy-les-Moulineaux, France.
June 2.	M. Logily, Budapesth, Hungary.	Oct. 27.	Lieut. Jose Saglietti, Rome, Italy.
June 4.	Captain Popoff, Gathina, Russia.	Nov. 2.	M. Peters, Brussels, Belgium.
June 17.	Eugene Speyer, San Francisco, Cal.	Nov. 13.	Two Officers of the German army and one civilian, crew of the German balloon "Saar", Berlin, Germany.
June 18.	Thaddeus Robl, Stettin, Germany.	Nov. 17.	Ralph Johnstone, Denver, Colo.
July 3.	Charles Wachter, Rheims, France.	Dec. 3.	Lieutenant Cammarota and one enlisted soldier, Rome, Italy.
July 12.	Charles Rolls, Bournemouth, England.	Dec. 3.	Walter Archer, Salida, Cal.
July 13.	Oscar Erbsloeh, Herr Toello, Herr Hett, Herr Kronz, Herr Spicke, Cologne, Germany.	Dec. 22.	Cecil Grace, while crossing the English Channel.
July 15.	Daniel Kinet, Ghent, Belgium.	Dec. 26.	Frederick Brown, Havana, Cuba.
Aug. 3.	Nicholas Kinet, Brussels, Belgium.	Dec. 26.	M. Piccolo, Sao Pauli, Brazil.
Aug. 10.	M. De Baeder, Cambrai, France.	Dec. 28.	M. Laffon and M. Paula, Issy-les-Moulineaux, France.
Aug. 12.	Benny Prinz, Asbury Park, N. J.	Dec. 30.	Lieut. de Caumont Buc, France.
Aug. 20.	Marquis P. Vivaldi, Rome, Italy.	Dec. 31.	John B. Moisant, near New Orleans, La., and Arch. Hoxsey, Los Angeles, Cal.
Aug. 27.	Clement Van Maasdyk, Arnheim, Netherlands.		
Sept. 23.	Georges Chavez, Domodosolla, Italy.		
Sept. 25.	Edmond Poillot, Chartres, France.		
Sept. 28.	Ernest Plochmann, Muelhausen, Germany.		
Oct. 1.	Heinrich Haas, Treves, Germany.		

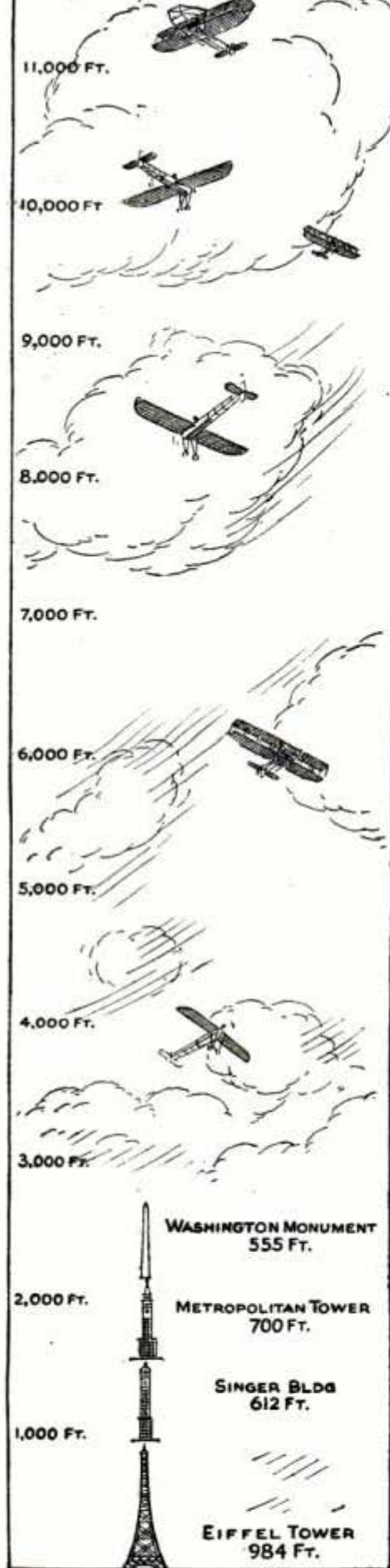

Some Altitude Records of 1910.

11,474 Ft.
Dec. 26

M. Legagneux
10,499 Ft.
Dec. 19

Ralph Johnstone
9,714 Ft.
Oct. 31

Georges Chavez
8,792 Ft.
Sept. 23

Walter Brookins
6,175 Ft.
July 9

Louis Paulhan
4,164 Ft.
Jan. 12

The aeroplane altitude record was set at more than two miles above the earth's surface by Arch. Hoxsey at Los Angeles, Cal., the day after Christmas, when, with his Wright biplane, he climbed to a level of 11,474 ft. This feat brought to a close a year that has been remarkable in the altitudes reached by aviators, if for no other reason. While there were several high flights prior to 1910, when Louis Paulhan reached 4,164 ft., Jan. 12, at Los Angeles, he kindled the ambition to fly highest in the breasts of his brother airmen and, during the 12 months that followed, many attempts were made to reach the higher altitudes with such great success that a height of two or three thousand feet is now considered the ordinary altitude for maneuvering. Walter Brookins twice bettered Paulhan's record, his final mark being 6,175 ft. which he reached at Atlantic City, N. J., July 9. Within a month Drexel made 6,750 ft. at Lanark, England. Then, in September, Leon Morane, in France, raised the record to 8,471 ft., a mark which remained the highest but one week. Then Georges Chavez made his fatal flight across the Alps, attaining an altitude of 8,792 ft. On Oct. 1, M. Wynmalen captured the record with an altitude of 9,121 ft., and on the last day of the international aviation meet at Belmont Park, L. I., the late Ralph Johnstone increased the world's record to 9,714 ft. On Dec. 19, at Pau, France, M. Legagneux flew to a height of 10,499 ft. Then came the final record of Hoxsey at Los Angeles, Dec. 26.

The competition for altitude records has developed a new type of costume for airmen. Even in the summer the atmosphere in the higher levels is cold and biting so that furs must be worn to withstand its rigors. The fur outfit gives the airman the appearance of an Arctic explorer or an Eskimo, the garments being made for comfort without regard to either smartness of cut or fit.



Scene at the Chicago Stockyards Fire, Where Fire Chief and 23 Companions Were Buried beneath Falling Wall

MOVING-PICTURE PROFANITY SHOCKS LIP READERS

Moving-picture profanity is the newest discovery that has been made in connection with the many motion-picture theaters throughout the country, many deaf persons who welcomed the gradual spread of the motion picture having discovered that the actors in certain classes of the silent dramas use unprintable language when they are going through with their parts. To the deaf mutes who read the lips with facility, the language used by the people in the pictures was as plain and distinct as the speaking of actors and actresses on the stage is to the average theater audience. These people have been greatly shocked by what they have seen, and in at least two large cities public protest has been made against the continued appearance of such films.

☞The amount of money already spent for the purchase of construction equipments for the Panama Canal is about \$26,000,000.

DEATH TAKES HEAVY TOLL AT FIRE IN CHICAGO

Twenty-four men were killed and damage to the extent of \$1,000,000 was done by fire in the Chicago stockyards December 22. The dead included the chief and one of the assistant chiefs of the fire department. The fire started in the early morning hours and was considered an insignificant one, although a large portion of the department was turned out to fight it, because of the dangerous location. Lack of a high-pressure water system prevented the firemen from getting control of the flames, which spread to an ammonia tank in one of the packing houses. An explosion occurred which caused an outer wall to fall and bury the fire chief and his companions.

☞Rene Barrier, a French airman traveling with the Moisant aviation exhibition company established a new speed record in Memphis, Dec. 7, when he flew a distance of 16 miles in 10 min., 55 1/5 sec., an average of 87.93 miles per hour.

An elephant which had become dangerous on account of its unruly temper was recently killed in New York

Dynamite is being used extensively in Arkansas, Missouri and Louisiana in the construction of drainage ditches.



"Old Queen" Whose Death Sentence Was Executed with Cyanide of Potassium

by administering cyanide of potassium. The elephant was known as "Old Queen." In her old age she developed a surly disposition, losing all the docility that had characterized her conduct during her previous career. She capped the climax of her wickedness when she killed her keeper and incidentally injured several other attendants. As the elephant was fond of apples, 600 grains of cyanide were placed in a large basket of the fruit and given to her. She ate them voraciously. The poison was effective almost instantly.

Ray Harroun, one of the most famous drivers of racing automobiles in the United States, has announced his retirement. He will take up the manufacture of aeroplanes and engines for aeroplanes.

The auxiliary schooner yacht "Visitor II," belonging to a Pittsburg millionaire, has the honor of being the first vessel to go through the Panama Canal as far as the Gatun locks. The trip was made on November 23.

The usual procedure is to sink holes about 2 ft. apart and 3 ft. deep along the line, and place a dynamite cartridge of about 60 per cent strength in the bottom of each. At the middle of the line, which is usually about 1,000 ft. in length, are placed two or three cartridges, in one of which a blasting cap with fuse attached is inserted. The concussion of the explosion fires the adjacent holes, and the action continues along the entire

line in both directions.

The result is a ditch about 3 ft. deep, 4 ft. wide at the top and 1 ft. wide at the bottom. The earth is blown out well, no ridges of soil are formed along it, and the bottom is loosened, which considerably increases the value for drainage purposes.

TELEPHONE AND ELECTRIC LIGHT GUARD TOMB

The body of Mary Baker G. Eddy, founder of Christian Science, lies in a tomb that is equipped with a complete electric-light and telephone service, probably the first time electricity has been put to such use. The body is watched night and day, and the lights and telephone are for the benefit of the two watchmen who are employed to remain at the tomb. By means of the light all parts of the tomb are visible at any time of the night, and with the telephone the watchmen can summon assistance in case they should need it. The body will later be moved to a mausoleum that is to be constructed for it.

COMMENT AND REVIEW

COMPARED with aviation, the man who makes a parachute jump or stirs ingredients in a factory where nitroglycerine is made, has a safe job with every prospect of dying of old age. In the development of no other modern art has so large a proportion of fatalities occurred, and in few, so many deaths in the same length of time. The story of 1910, with all the glory of its long-distance and altitude records, is dimmed, when one contemplates the fearful price in human life at which it has been purchased.

Fifty-three enthusiastic airmen, more than one for each week in the year, have paid the penalty of their daring.

The closing hours of the year crowned the long roll of sacrifice with the loss of three of our best airmen; men who not only were leaders on this side, but holders of world's records. Johnstone with the high-altitude record at the time of his death, then Moisant, who last October earned the international trophy for speed, and Hoxsey, who carried the altitude record even yet higher. The gloom which this galaxy of death has brought to all interested in aviation is in no degree lessened by the thought that they all perished in exhibition flights, and that their desire to interest and satisfy a gaping throng was the occasion of their death.

The causes in a majority of cases have been so similar as to make evident a condition in construction of aeroplanes which must be corrected before any reasonable degree of safety will be insured. There is, however, some reason to believe that the secret of the chief cause of disaster has been recently discovered, though not yet made public. The principle is so simple that, as is usually the case, the wonder will be it was not observed months ago, and when the time comes to announce it, will be instantly understood. It is devoutly to be hoped that these expectations will be fulfilled, for unless some radical safeguarding can be accomplished in the very near future, the loss of life this year will certainly be appalling on account of the hundreds of planes now building or ordered for early delivery.



WHILE the several express companies in this country continue to charge rates for the most part greatly in excess of what seems necessary to pay good dividends, and while the shippers here writhe and protest without avail, Canada has found a way to regulate matters. The Railway Commission of Canada has taken a hand and quickly adjusted the objectionable rates. The revision was partly based on the finding as to the amount of money actually invested in the business. In the case of one express company capitalized for \$2,000,000, all the money actually invested was \$24,500, the balance of its assets having been taken out of earnings, besides paying large dividends. Another company had \$3,000,000 of stock on an initial investment of only \$212,719. Judge Mabee, Chairman of the Commission, in his ruling said:

"The whole business of express could go on just as it does now without the existence of any express companies at all, by simply substituting railway employes for express employes, and letting the railways take the whole of the toll in the first instance."

That this appears the logical thing to do becomes more apparent when our own express companies attempt to excuse their high rates on the grounds of having to overpay the railroads for hauling their cars. In fact, the express com-

panies admit having become such active bidders against each other, that the railroads are receiving as high as 55 per cent of the gross earnings, leaving only 45 per cent to the express company out of which to render service and pay dividends. In other words, for a package taking a rate of \$1, the railroad gets 55 cents for hauling it in a car, while the express company for 45 cents calls for the package, takes it to the shipping office, enters a record, hauls to train, at destination hauls from train to office or delivers to consignee, and has to stand liable for loss in transit. The very fact that express companies continue to pay big dividends under such conditions is a confession that the rates to shippers are easily 25 per cent too high, which should still leave the railroads a profitable price for simply hauling the car.



THE unusual loss of life to members of fire departments during the month of December centers public attention for a little time, as such disasters do periodically, on the dangerous character of the work. Comparatively little has been done, perhaps little can be done, to safeguard the men engaged in fighting fires. On battleships, the fighting is mostly done behind armor plate defenses; metallic shields are provided for the man working a gatling gun on land; sharpshooters are taught how to construct small earthworks behind which they can fire while lying prone upon the ground; the life-saving crews wear cork jackets, and oxygen helmets protect rescue parties who enter mines, at least against the deadly gases formerly so fatal. The city fireman, however, has scarcely anything to safeguard him in his work. Each large fire differs from every other fire. Even though he is familiar with the construction and arrangement of the building, he can never know what inflammables or explosives have been brought into the place within the few hours previous; or what careless or ignorant employe has moved these danger factors from accustomed places of comparative safety to positions of extreme risk.

In most cities, it is the practice for the men in each fire station to visit the buildings in their immediate district and familiarize themselves with the interior arrangements; but a large fire calls in other companies, often from quite a distance, who are unacquainted with conditions and who must therefore take chances. It is easy for the public to criticise those in command of the men for leading them into what often is called unnecessary danger, yet this can be accounted for. First, the enthusiasm and eagerness, which every true fireman has, to subdue the fire as quickly as possible; then, the insurance companies are not always sparing in their criticism of officers whom they regard as timid, and then there is a certain excitement about a big fire which gets into the blood of even the most seasoned fire-fighter, and makes the thing which the instant seems necessary to do, the one all-important move to make, and so he takes the chances. Around the stoves in the engine houses all over the country one may learn of thrilling escapes by hundreds which never came to public ear only because a floor or wall delayed its falling two or three seconds.

The lesson is plainly the imperative duty — one of life and death to brave men — to maintain a ceaseless, relentless inspection of old buildings and to insist on such construction in new ones as shall reduce the risk to its lowest possible point. Carelessness, favoritism, graft, political pull, when used to pervert safety requirements, should properly be classed among other kinds of homicide and dealt with accordingly by the courts, to guilty owners and inspectors alike.

THE Carnegie fund of \$10,000,000 for preventing war is in many ways the most notable donation ever made. Scores of millions have been given by him and others for libraries, schools, colleges, universities, medical and other research, and for pensions. Many of the most essential discoveries in medicine and the arts, however, have been made by individuals of limited means, and working without financial aid, as for instance, chloroform, vaccination to prevent smallpox, the steam engine, the telephone, the X-ray, and so on.

While \$10,000,000 is a large sum, it is insignificant compared to the cost of war, for our own or any other first-class power would spend as much or more each week during the period of hostilities. And yet it should be large enough to serve the purpose, if money can solve the problem. A much less sum could be depended on to invent and perfect any possible mechanism; to eventually discover an antidote for cancer or tuberculosis.

Just how the desired result is to be obtained there seems as yet to be no settled idea; even Mr. Carnegie himself has not told us; yet such a commission as he has named is certainly resourceful and commanding in its combined abilities. Should the vessels of all navies, all the land defenses, all the munitions of war be suddenly annihilated; all the military forces on land and water lose their training, skill and organization in an instant, would the problem be greatly simplified? Some say yes; others, no. Our boasted civilization itself has complicated the undertaking. A few hundred years ago, wars were started and wars ended at the word of a king or other ruler. Today, no confederation of ruling heads could insure peace, though it would greatly increase its likelihood. We ourselves furnished an illustration of this in the Spanish-American war. President McKinley did all he could to prevent it, but the public were simply obsessed with a desire to fight another people's battle, and they did.

War today rests not with presidents, kings, emperors and czars, but is vested in congresses, parliaments, dumas and the like. This condition renders universal peace more difficult to attain because the executive power is spread out among hundreds of law-makers, with a corresponding increase in the diversity of views held. It is obviously more difficult to bring all these individual minds to work in concert, than to arrange a business agreement between the so-called ruling heads of the United States, England, France, Germany, Austria and Russia. There is also a large element of selfish business interests of a mercenary character to be reckoned with, men who would directly profit from a war in which their own country might engage. That the thing is difficult, however, is no argument against attempting it.

The peace fund at the present moment appears to be chiefly instrumental as providing the movement to which it is dedicated with that power and dignity which inevitably attaches to a vast sum of money. There is a potential energy existent in ten million dollars which commands respect, consideration and attention. The smartest man in the world, with the greatest invention of the age, if clad in rags and dirt, can walk the streets for months and tell his discovery to the winds; but let him appear in perfect dress and riding in an eight-thousand-dollar limousine, and the doors of the private offices of bank presidents swing open at his approach.

The time is not far distant when the cost of the military in peace will bankrupt the leading nations of Europe. Why not then syndicate the armed forces of the world under the authority of an international court, and aside from any question of morals, reduce the cost of keeping peace to one-fourth of what it is at present.

H. H. WINDSOR.

amazing spectacle to the world Jan. 3, when for 10 hours three criminals, believed to be anarchists, successfully defied 1,600 policemen, a section of the fire department, a company of soldiers and a machine gun. The battle which followed an attempt to capture them continued until their refuge fell to ruins from fire, engulfing the men who had been the cause of the fighting.

The first act of the tragedy took place in Houndsditch, Dec. 16, when three policemen were killed and two wounded in an attempt to capture a gang of thieves who had dug a tunnel from one building to another in an attempt to rob a jewelry store. One of the thieves was fatally wounded in the encounter, but the others escaped. The search for these led the police to a house in Sidney street, near the scene of the first crime. Made cautious by the fate of their comrades, the police began operations to capture the crim-

plan to surprise their quarry miscarried and they were met with a deadly pistol fire. The fire department was called out to flood the building with water, but their efforts were ineffective and a company of Scots Guards with a Maxim machine gun was added to the besieging force. All the morning the policemen, soldiers and firemen riddled the place with bullets and flooded it with water. The end came when the building gave way to fire.

Several persons in the crowd of **thousands of** people that had assembled to witness the battle were more or less seriously injured by flying bullets, and five policemen, two firemen and one soldier were wounded. Home Secretary Winston Churchill was in personal charge of the fight and defended his unique course of action with a statement that a big anarchist plot against the crown had been unearthed, in which the three men were concerned.

SENDS LIFEBOAT OVER NIAGARA IN TEST

A new form of lifeboat which has the appearance of a submarine has been invented by James Mitchell of Arrow River, Manitoba. Robert Leach, a resident of the Niagara River frontier, has volunteered to go over

Niagara Falls with the boat and the test is to be made in June, according to present plans. One model of the boat has already been sent over the falls with satisfactory results.

The present Mitchell boat is 25 ft.

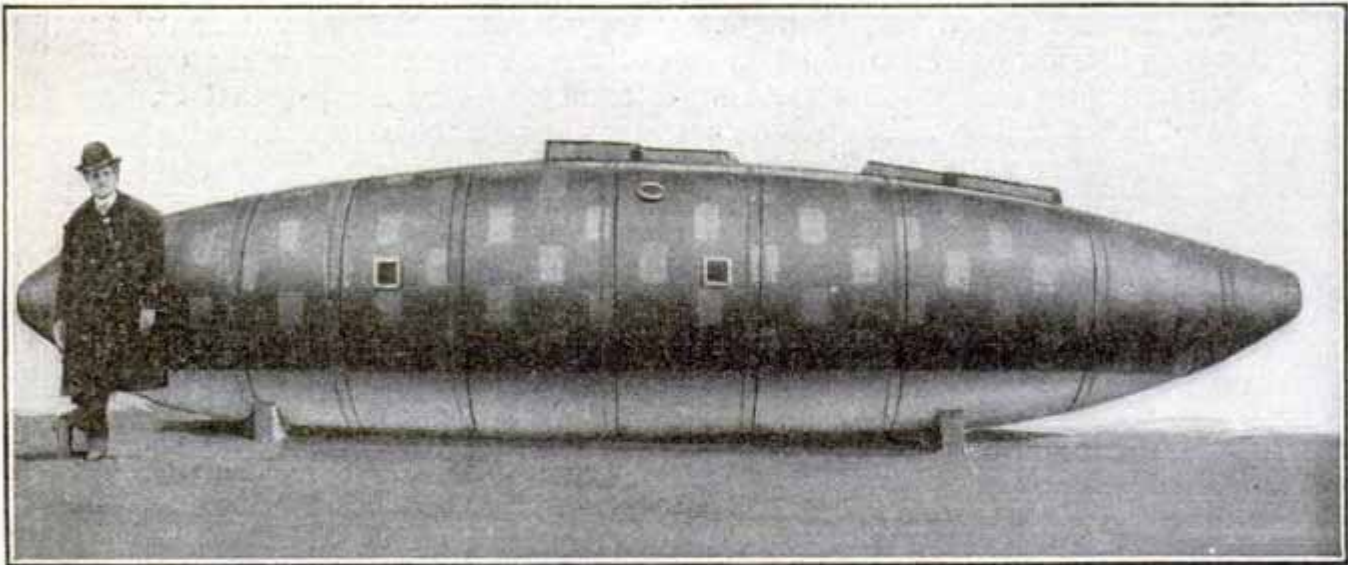

Novel Lifeboat and Robert Leach Who Will Take It Over Niagara Falls on a Test Trip

long and 5 ft. in diameter, and shaped like a cigar. It has two sliding hatches to permit entrance and exit and its carrying capacity depends entirely on the size to which it may be built. The two ends are constructed of solid blocks of wood sheathed with steel, and the bottom also has steel sheathing. It is provided with a port-hole through which passengers can see their position, and is also provided with oar locks so that it can be pro-

pelled by hand. The boat which has been tested was constructed of half-inch pine with ribs of oak placed 3 in. apart. The bottom of the boat is double and, in the space between, water or other form of ballast is carried.

It is the inventor's idea that the boat could be launched from a foundering ship by the very sinking. He has calculated that the boat will be carried down by the suction, but will immediately rise to the surface.

ACROBATICS AN ADJUNCT TO FANCY SKATING

While Holland and the Scandinavian countries are usually suggested when one thinks of skating and winter sports of similar character, there yet remains in the United States a big interest in the

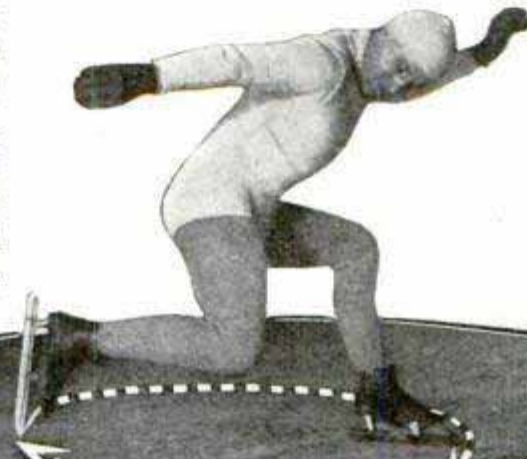

daring and strength as well as acrobatic skill. Norval Baptie, an American who holds a number of speed championships, has lately turned his attention

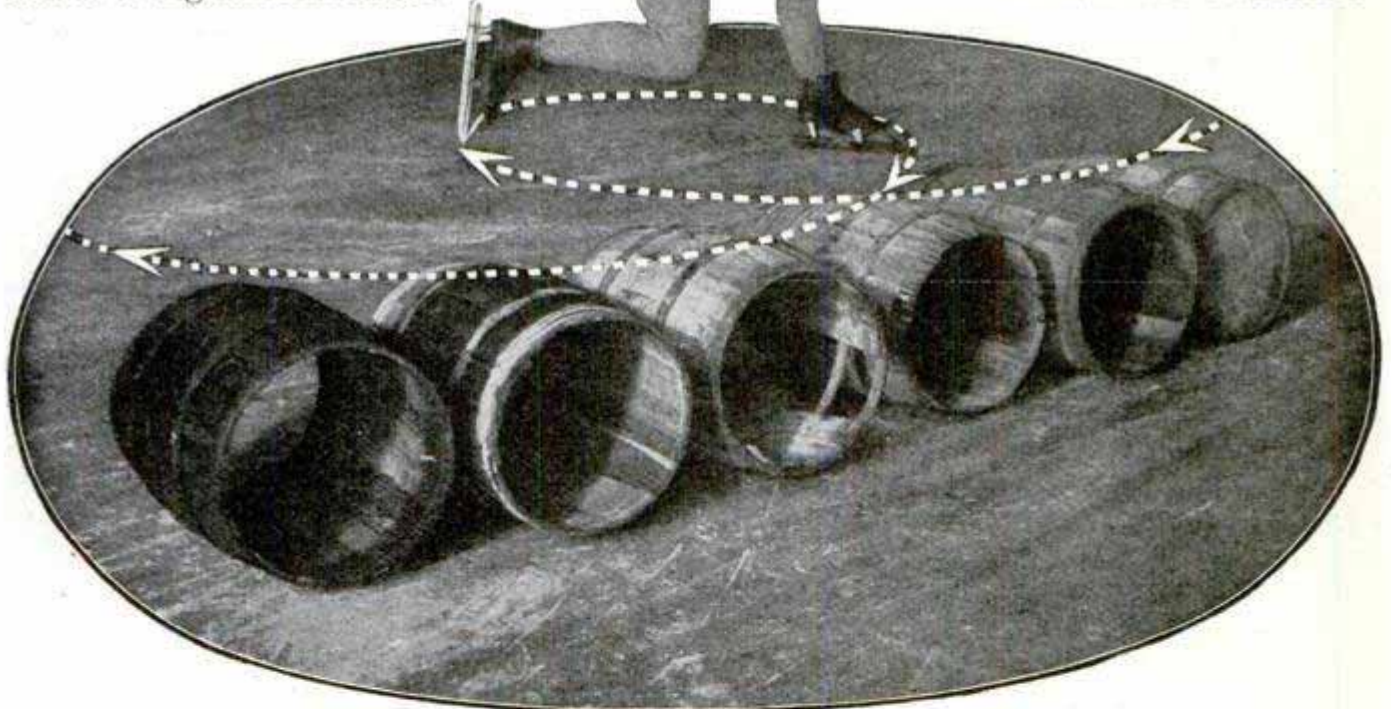

Skater Norval Baptie Describing "Figure 3" over Six Barrels

feats of prowess performed on ice and snow, and for several years past an American skater has held the championship in a number of distance events. The mere skating of races, however, does not seem to appeal to American devotees as much as the development of the art in fantastic forms that frequently call for the display of

to feats of strength and skill. He frequently makes long leaps over obstacles in skating around an indoor ice rink or in the open, but this season has developed something more than a mere leap. Placing six barrels side by side on the ice he leaps backward, using his left foot for the final shove into the air, and while going over the



Archdeacon

Icarus

Latham

Bleriot

Santos-Dumont

FUN WITH THE NOTED

CARICATURES OF THE NOTED AIRMEN

barrels describes what is technically known as a "figure 3." He alights on his left foot on the farther side, facing in the opposite direction from which he started. In performing this feat, a photograph of which was recently made while the skater was in midair, Baptie describes a perfect figure 3 with his body, flying backward and twisting to the right half way over the barrels and then, having completed the twist of his body so that he faces completely about, going forward for the other half of the distance.

TUG SUPPLIES THE "OLYMPIC" WITH ELECTRIC ENERGY

A tug moored alongside the monster "Olympic" generated the necessary electric energy for light and power during her fitting out. The tug was formerly a British gunboat used in Chinese waters, and has engines of 1,500 hp. For the period of service as an electrical plant, the shafting was disconnected from the propeller and coupled up to the dynamos.

One of the curiosities at the Automobile Exhibition in Paris was this amusing panel, bearing caricatures of the foremost French and American airmen.

M. Archdeacon, a well-known French engineer who has taken active interest in aviation from the beginning, is holding Icarus by the wings and introducing him to Latham, who is garbed in the uniform of the aerial corps of the French army, and to Louis Bleriot and Santos-Dumont. The latter's attention is distracted from the introduction by a dragon-fly which persists in stinging him upon the nose. His little monoplane is the "Demoiselle," which is French for dragon-fly.

Archdeacon holds in his other hand a sign that bears the inscription "your forefather." A Greek legend has it that Icarus, a son of Daedalus fled with wings from Crete to escape the resentment of Minos. His flight, being too high, proved fatal to him, for the sun melted the wax which cemented his

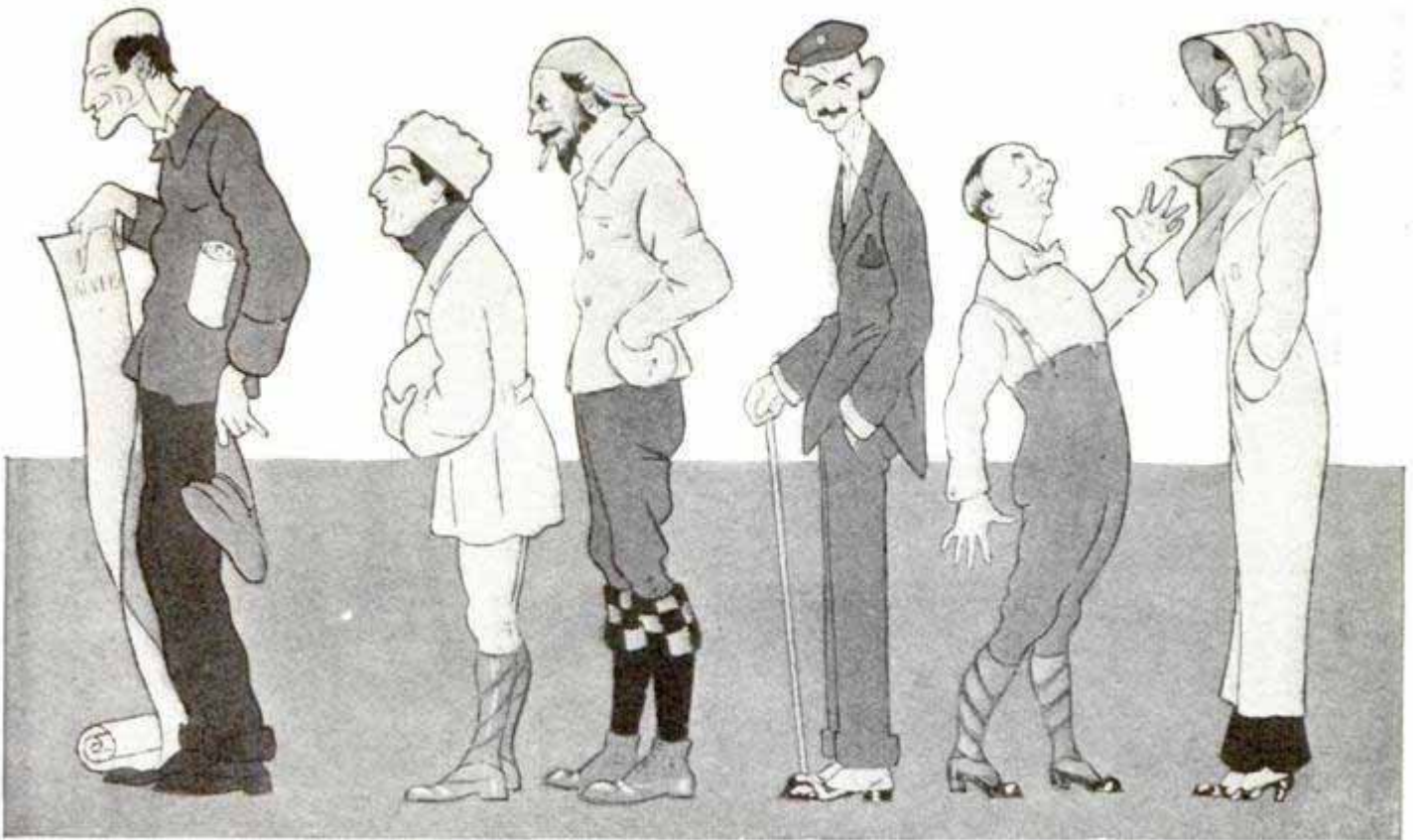

Wilbur Wright
AMERICAN AND FRENCH AIRMEN

Paulhan

Farman

Curtiss

Rougier

Baroness de La Roche

wings and he fell into that part of the Aegean Sea which bears his name.

Wilbur Wright is next in line from Santos-Dumont, at whom he is smiling, for in his hand he holds his patents, while Santos-Dumont gave his

patents to the world. Behind Wright are Paulhan, Farman, Curtiss, Rougier and Baroness de la Roche. Paulhan has made a fortune out of aviation and he is depicted holding a bag of money.

HOUSE OF REPRESENTATIVES TO BE MADE SMALLER

When the 61st Congress adjourns at noon, March 4, workmen will take charge of the hall of the House of Representatives and by the time the members assemble for the opening of the 62d Congress, on the first Monday in December, a complete transformation of the big hall will have been effected. For years members of the House have protested against the effort required of them to make themselves heard in their big place of assembly. Representative Samuel W. McCall, who presented the plan for the re-arrangement of the House which has been adopted, took occasion, in his report, to call attention to the fact that:

"In order to agitate this enormous

volume of air (referring to the dimensions of the hall) many of the members are compelled to make very special effort, and the energy that should be employed in the brain is diverted to the lungs."

In addition to bad acoustic properties, the House has always been poorly ventilated. All these difficulties are to be overcome in the new arrangement, it is promised, which provides for a considerable reduction in size and the doing away with the desks for individual members, substituting a form of bench instead. A wide rail or shelf in front of each bench will give the members a place to rest books and papers while speaking. Though the new House will be only a little larger

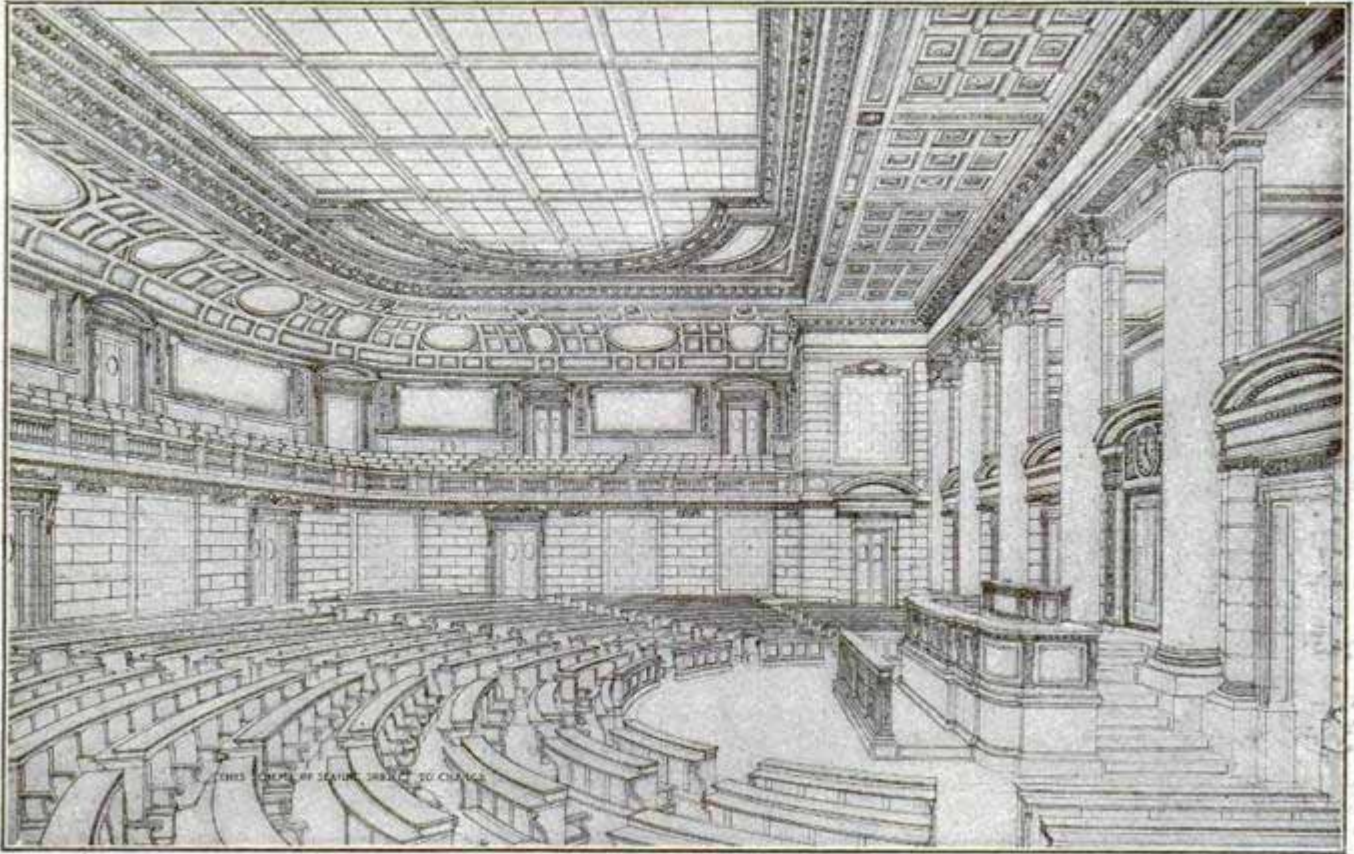

How the House Will Look when Reduced and Reconstructed

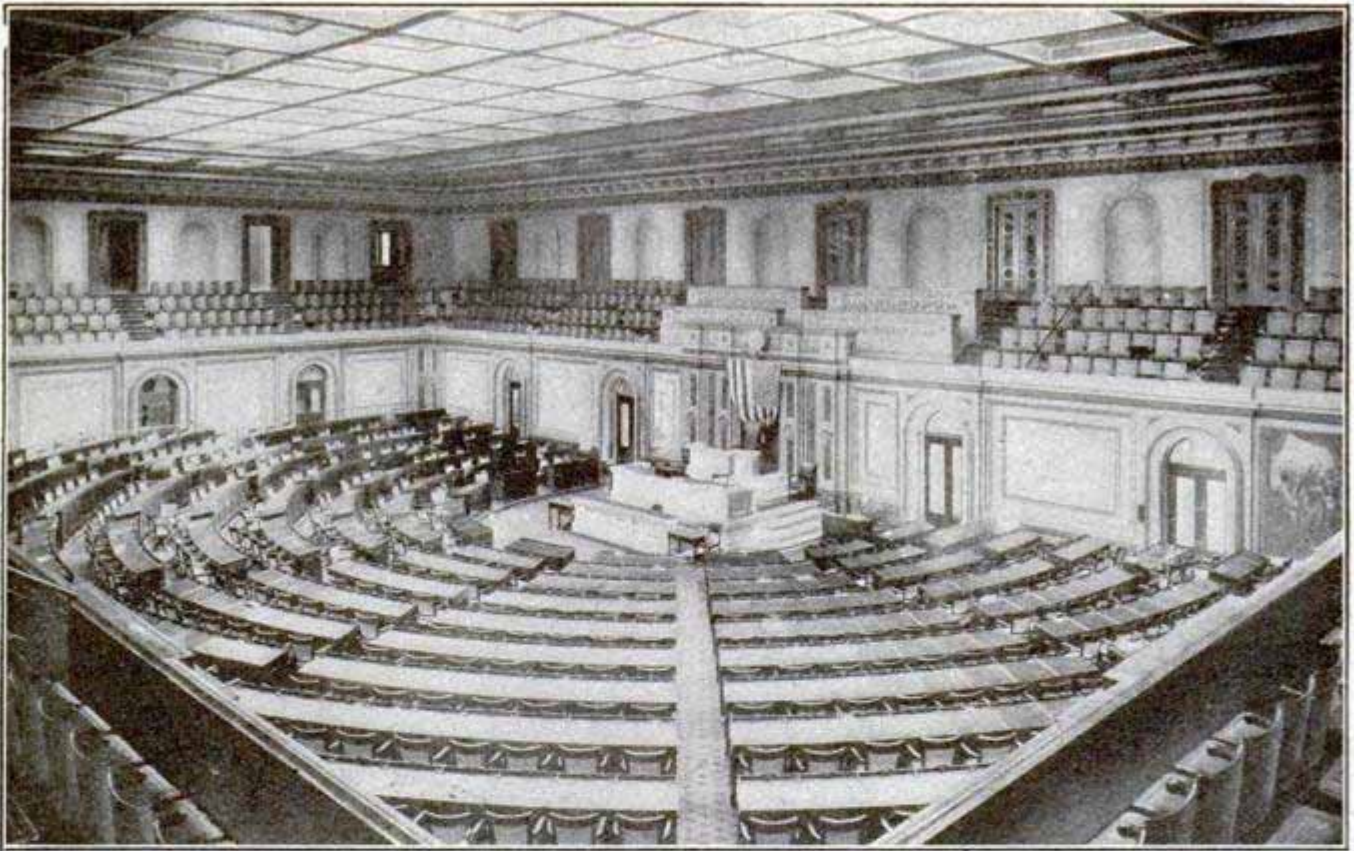

Hall of the House of Representatives at Washington

than the senate chamber, which accommodates 92 members, it will have seats for more than four hundred members. The present membership of the House is 391, but it is expected

that the new census will materially increase it

The floor space of the present House is 109 by 64 ft. The change proposes to reduce it to 61 by 89 ft.



Interior of New Car with Fittings in Mission Style

MISSION CAR FOR SOUTHERN CALIFORNIA

A steel car of unique design to run through the land of the old missions in southern California, has just been completed. It is finished in pearl grey with gilt trimmings, and the interior is paneled with fumed oak and pearl-grey leather. The chairs, parcel racks and beamed ceiling are of dark color and simple design, while the chandeliers are brass reproductions of mission bells, and the lamp brackets at the sides are of stained glass and brass.

The car made its initial trip with a party of newspaper men and magazine correspondents recently.

This car has a length of 76 ft., weighs 133,000 lb., and has a large steel beam running lengthwise under the floor to prevent telescoping. This feature makes the car comparatively safe from accident.

WATER USED AS SHIP-ROLLING PREVENTIVE

An apparatus consisting of U-shaped tanks extending through the hold of a vessel was recently exhibited before the annual convention of the German Marine Engineers' Society in Berlin as a preventive of the excessive rolling of ships in a heavy sea. The U-shaped tanks admit water, which rises and falls as the ship rolls, thus steadying her.

Tests of the apparatus made on two vessels plying between German ports and South America are said to have reduced the rolling from 11 to 2 degrees.

☞ One hundred and thirteen lives were sacrificed during the hunting season of 1910 through hunters mistaking companions or other hunters for deer or other game.

BUILDING CHARTS TO AID FIREMEN

A card index which would, in case of fire, indicate at a glance the nature of a building's interior and its contents,

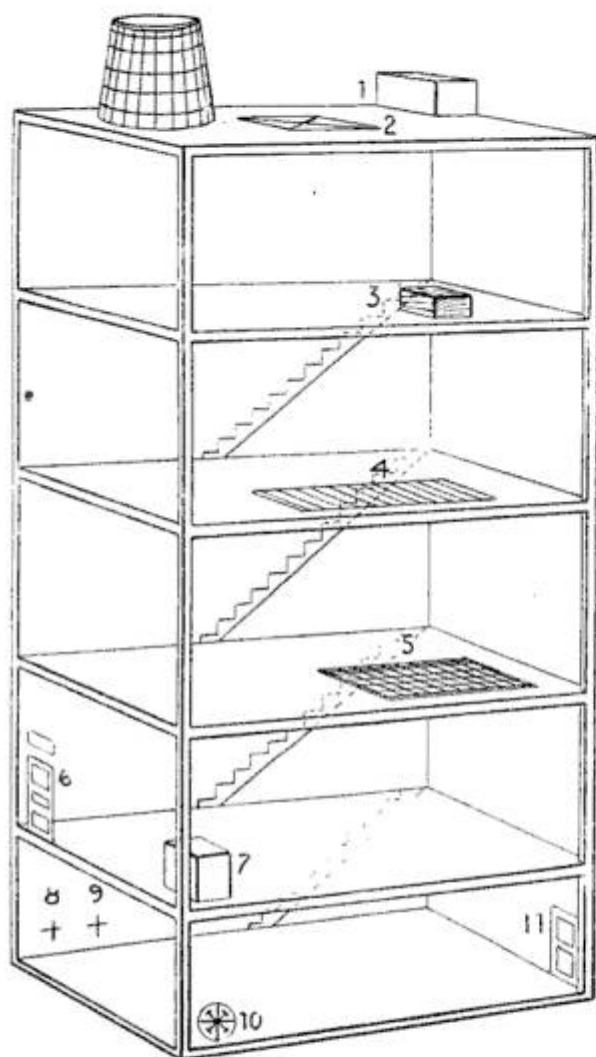

Fire-Fighter's Chart of a Publishing Plant

Key:—Water Tank, 10,000 gal.; 1, Elevator Wheelhouse; 2, Trap Door in Gravel Roof; 3, 100,000 Lb. Lead; 4, Linotypes, value \$50,000; 5, Presses; 6, Front Door; 7, Safe; 8, Gas Cock; 9, Electric Switch; 10, Dynamite, 10 Lb.; 11, Basement Door in Rear.

and particularly the location of dangerous features, such as explosives and heavy weights, is being advocated for Montreal, Canada.

Among the things such a chart might indicate by simple figures and signs are: basement exits, kind of roof, nature of walls, location of heavy weights on roof and upper floors; exact positions of any kind of explosive, of the stairs, elevator shafts, fire escapes, valuable stock, sprinkler valves, main gas cock, and electric light switch. The number of employes on each floor could be given in figures.

If the idea is carried out, four copies of the diagram of each building will be made; one to be placed near the main entrance in a glass-faced holder, and the others to be indexed by the fire department, the building inspector, and the factory inspector. It is further suggested that the charts be revised at least twice each year.

ITALIAN TROOPS MANEUVER ON ALPINE HEIGHTS

Maneuvering above the timber line is one of the unpleasant duties of the officers and men of the Italian army. So much of the northern frontier of Italy lies in the Alps that it is necessary to have a corps of expert mountain climbers attached to the army to provide adequate means of defense. With the idea of giving his troops thorough experience in the art of mountaineering, King Victor Emmanuel has devised a system of Alpine maneuvers. A portion of the army of Italy is sent into the mountains every year to solve a series of military problems. The soldiers carry with them all of the military equipment for use in offensive and defensive tactics that can be safely transported over the difficult passes. Mountain artillery and machine guns are included in these exercises, and the difficulties of long marches in the snow and preparations for going into action, both with artillery and infantry, give the troops an experience which would be extremely valuable should their country be involved in war with one of the powers of northern Europe.

“The Star-Spangled Banner” has at last been adopted as the national anthem by the Navy and is played by all naval bands at the “colors” formation in the morning. Heretofore the salute to the colors prescribed in the regulations consisted of “long rolls” by the drums and “flourishes” with the bugle.



Infantry Defending a Position in the Italian Army Alps Maneuvers, Using Snow as a Shelter



Operating Machine Gun Under Difficulties in Italian Army Maneuvers in the Alps

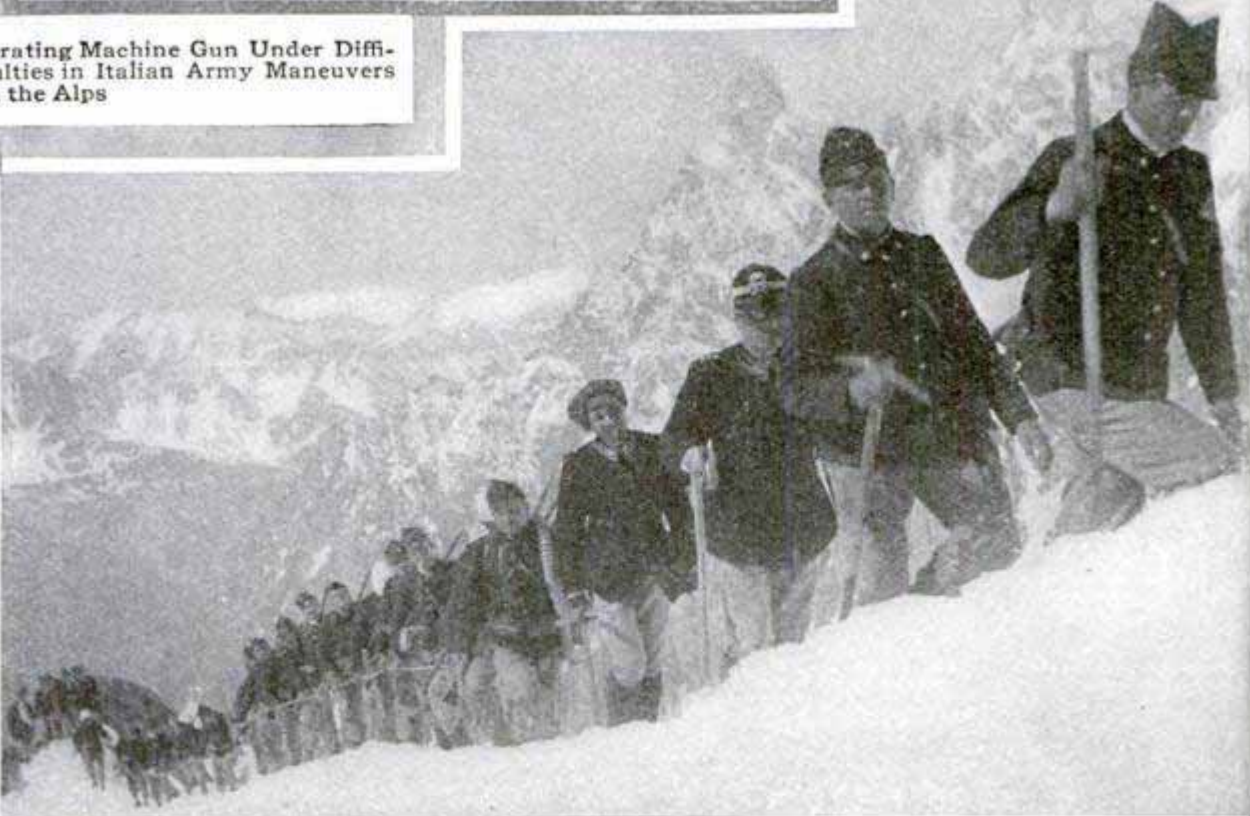

How the Italian Army Maneuvers in the Alps, Battling with Snow and Slippery Trails

The search by a British syndicate for the "Floencia," a ship of the Spanish Armada which went down in Tobermory Bay, Isle of Mull, in

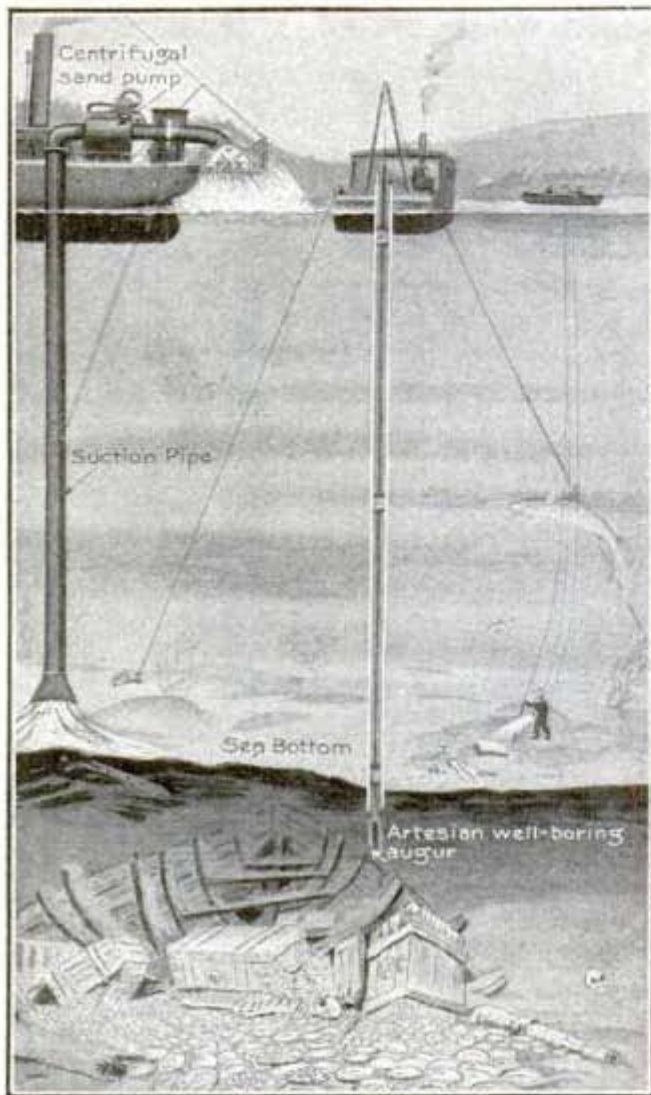

Courtesy Graphic, London

How English Syndicate is Reaching Sunken Treasure

1558, has met with considerable success. This ship is said to have carried 30,000,000 pieces-of-eight as its treasure cargo. A number of these coins have been recovered, along with sword-hilts, scabbards, large quantities of black African oak, muskets, stiletos, and stone and iron shot. A piece-of-eight was a Spanish coin worth \$0.96½ in American money, so that the coins carried by the "Florentina" are worth nearly \$30,000,000, an amount of gold weighing about 50 short tons.

The apparatus used in searching for the treasure is unique, consisting of a specially constructed suction dredger

ing auger penetrates the sea bottom for several feet, and brings up samples, which are examined for treasure. Then the scow supporting the borer is moved to another point, and, if the previous haul of sample bottom reveals treasure, the suction dredger is set to work at that point. The material sucked up by the dredger is discharged into a large sieve with a mesh sufficiently small to retain objects 1/3 in. in diameter.

BOXING AUTOMOBILES FOR FOREIGN SHIPMENT

None of the transatlantic lines carry automobiles uncrated, consequently, the majority of these lines have made special arrangements by means of which passengers who are taking automobiles abroad may avoid petty inconveniences.

One of the big lines has arranged for the necessary boxing at the pier. The tourists are thereby enabled to use their automobile up to the day prior to sailing, when they run them directly to the pier. The boxes are built in such manner that they may be taken apart on arrival abroad and used again for the return shipment.

The method of packing is shown in the accompanying illustrations. In one may be seen the method of blocking the wheels and fastening the vehicle down by means of ropes, while another shows how the weight is taken off the tires by means of supports under the hubs.

Automobiles for Cherbourg and Plymouth are carried in the upper compartments of the liners, and upon arrival at either of these ports are discharged into a special automobile tender. The passenger is thus able to obtain his car within two to four hours after the liner reaches port.

¶The parliament of the Netherlands has adopted a bill granting state protection to foreign patents on payment of a small fee.

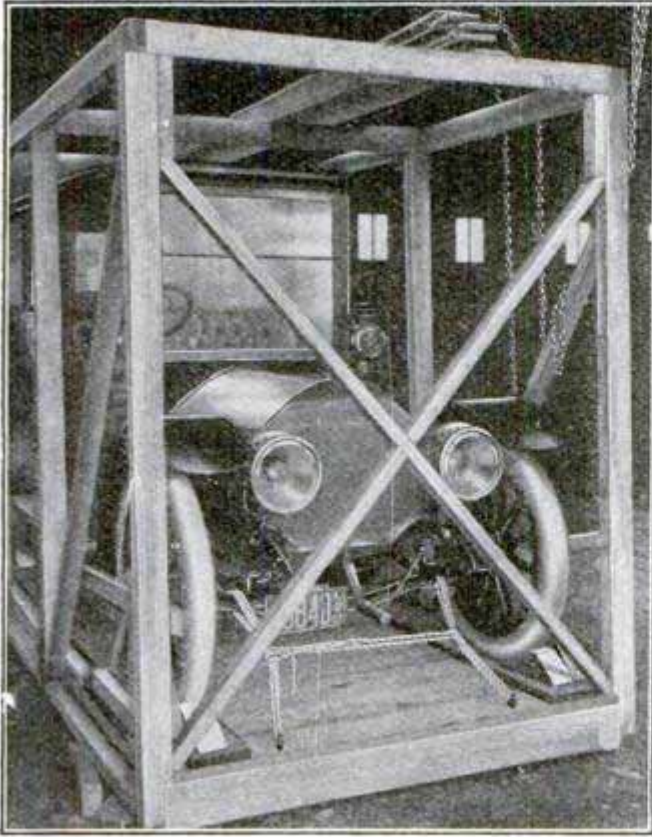

How Forward End is Blocked in the Case

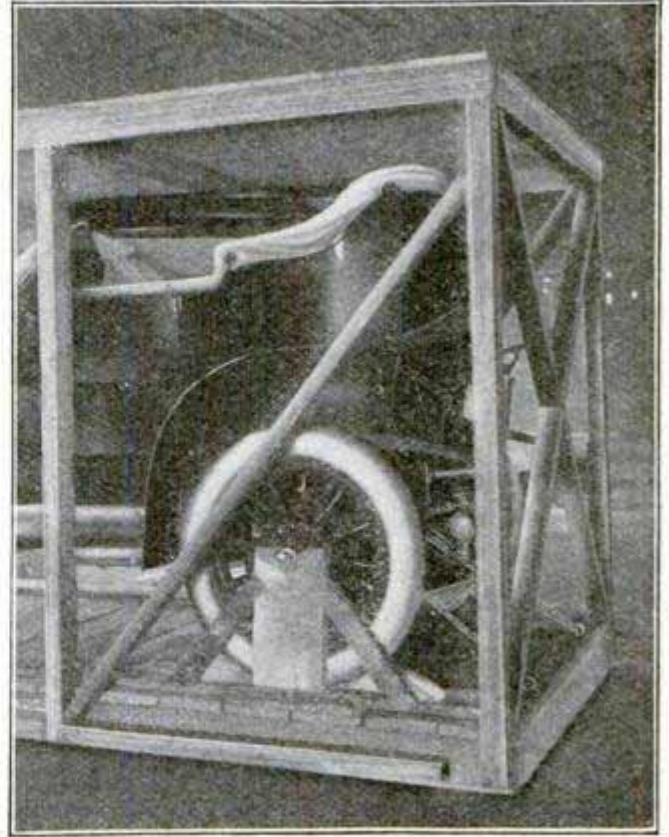

One of Supports Which Lift Weight from Tires

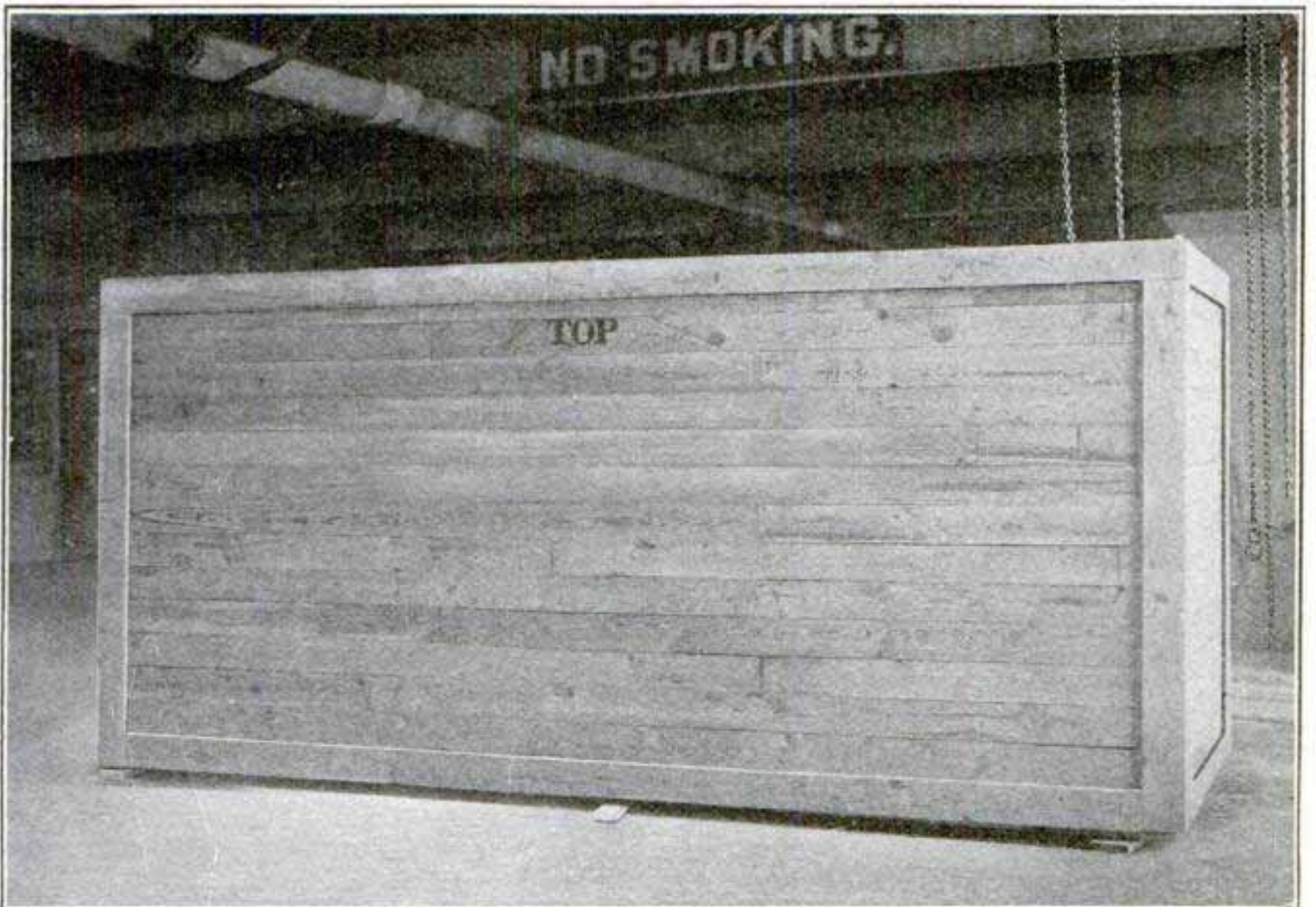

Automobile Completely Boxed for Shipment

HOW A MOTOR CAR IS BOXED FOR FOREIGN SHIPMENT

Oct.			Nov.		Dec.	July	1	2	3	4	5
SUN	MON	TUE	WED	THU	FRI	SAT	1	8	15	22	29
MON	TUE	WED	THU	FRI	SAT	SUN	2	9	16	23	30
TUE	WED	THU	FRI	SAT	SUN	MON	3	10	17	24	31
WED	THU	FRI	SAT	SUN	MON	TUE	4	11	18	25	
THU	FRI	SAT	SUN	MON	TUE	WED	5	12	19	26	
FRI	SAT	SUN	MON	TUE	WED	THU	6	13	20	27	
SAT	SUN	MON	TUE	WED	THU	FRI	7	14	21	28	

A UNIVERSAL CALENDAR FOR 1911

The table given herewith is a universal calendar for the year 1911, and on the same principle a similar table may be made for any year.

In using the table, the day of the week for any date will be found under the month in the same horizontal line. Thus, for January or October, the Sundays will be the 1st, 8th, 15th, 22nd, and 29th. For February the Fridays will be the 3d, 10th, 17th, and 24th, the last figure (31) being omitted as there is no 31st day in February. These numbers, 3, 10, 17, 24, are found horizontally opposite the "Fri." which is vertically under the column at the head of which appears "Feb." for February.

Similarly, given any day of the month by number, the particular day

may be found. Thus, if it is required to find what day of the week July 4 will fall upon, look for the number 4 in the table and follow the horizontal line to the left until the vertical column for July is found. This appears immediately to the left in the next column, and the day is shown to be Tuesday. The number of Sundays or Mondays or any other particular days in any month may also be found.

In using the table it should be remembered:

Thirty days hath September,
 April, June and November.
 All the rest have thirty-one,
 Save February.
 But Leap Year,
 Coming once in four,
 Gives then to February,
 One day more.

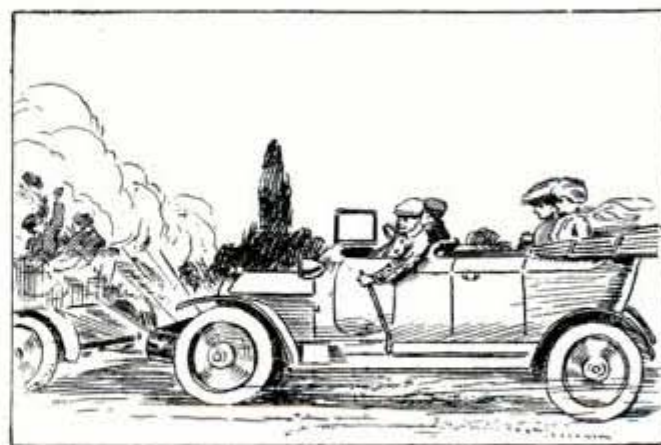
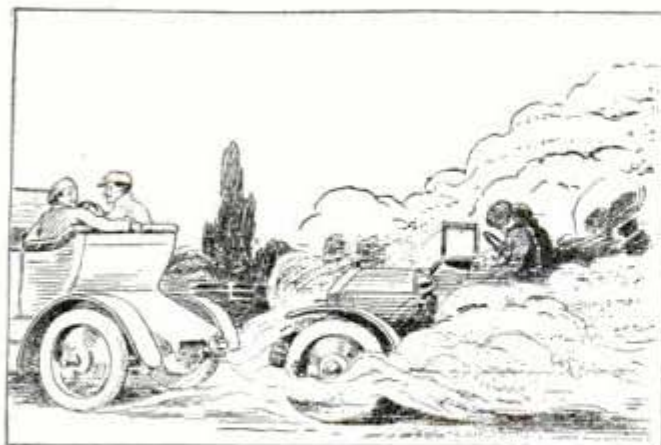

A dust returner, worked by a two-way exhaust pipe, is suggested by the "Motor," London, as a means of retaliating on the offender at the end of every journey

SWALLOW'S NEST ON SHADE OF ELECTRIC LIGHT

A swallow's nest built over the porcelain shade of an electric-light fixture in a modest dwelling at Oberammergau attracted the attention of many of the Americans who attended the Passion Play. The surprise of finding modern electric illumination in the little home of Sebastian Bierling, uncle of the man who took the part of St. John in the play, was in itself great.

The fixture on which the birds had built their nest hung about a foot under the low ceiling of a narrow hall on the second floor. The nest was occupied by three little swallows. The

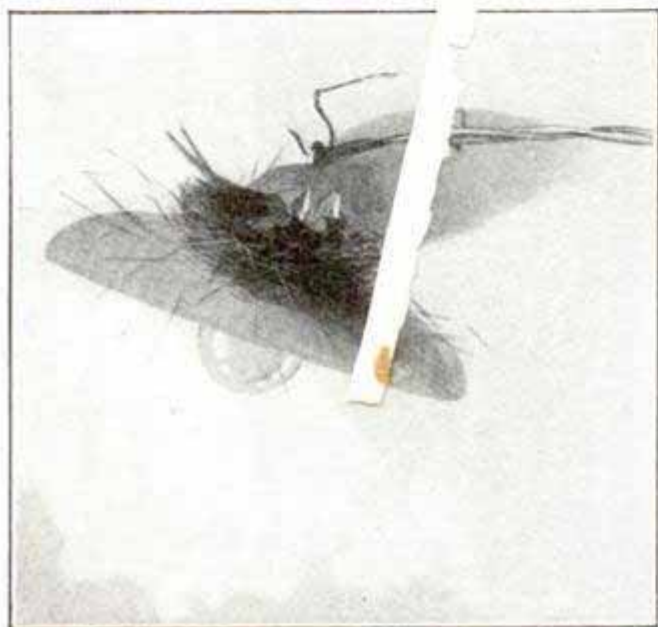

Remarkable Place for a Nest

parent birds flew back and forth from the nest to the street through an open window in the hall.

THE RAISING OF A BRITISH DREDGER

The powerful British dredger "Walter Glynn," which capsized in the Mersey during a heavy gale, was lifted and turned upright at the first salvage attempt. Her position as she lay on her side at low water is shown in the illustration.

Salvage was accomplished by attaching lifting camels (pontoons) of 1,000 tons capacity, made fast to the dredger at low water, so that when the tide

rose they lifted her. Wire cables leading from the shore were employed to

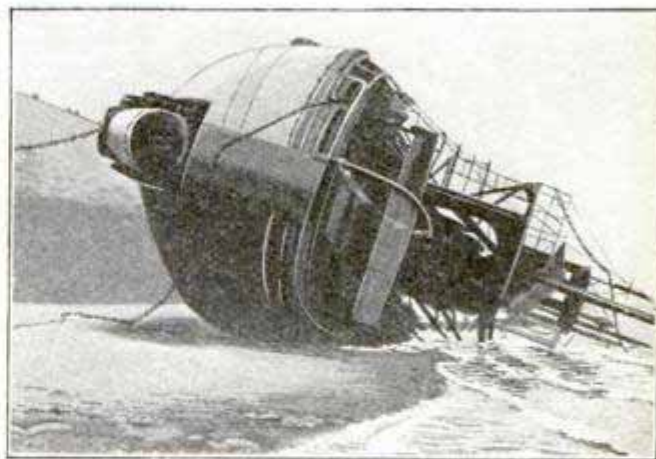

Capsized Dredger at Low Water

pull her onto an even keel. The winches ashore were embedded in concrete to a depth of 14 ft.

After being dismantled as much as possible, the dredger weighed more than 1,500 tons.

A MOTORCYCLE FOR WOMEN

Although motorcycling is almost exclusively a sport or means of transportation for men in America, and young men at that, the makers of motorcycles for women are finding a ready sale in England. The method of inclosing all movable parts on a woman's motorcycle, so that there is no danger of the skirts being caught or spattered with oil, is shown in the accompanying illustration of a popular model.

This machine is of the light-weight type, and is driven by a 1¼-hp. motor,



English Woman's Motorcycle

which is sufficient for ordinary requirements. The heavier machines are, of course, difficult for a woman to handle.

Uncle Sam has just put in commission a huge fort on wheels which is used daily to transport millions in bank notes and stamps from the Bureau of Engraving and Printing to the Treasury Department, where it is stored for safekeeping.

Not only is the big van nearly bomb-proof in itself, but just to make sure that neither thieves nor cranks will ever succeed in accomplishing a hold-up, seven heavily armed guards ride to and fro with the treasure of millions.

figures, the round seal to the right and the number to the left of the face of a paper bill, stamped in blue, are what make the bills legal tender. Hence, when the money passes through the wonderful cutting and stamping machine, which also counts the bills out in lots of 100, it is ready to spend, and anyone who got hold of it would have the real thing.

The van now carries daily to the treasury \$7,000,000 in bank notes, certificates and stamps. Of this amount

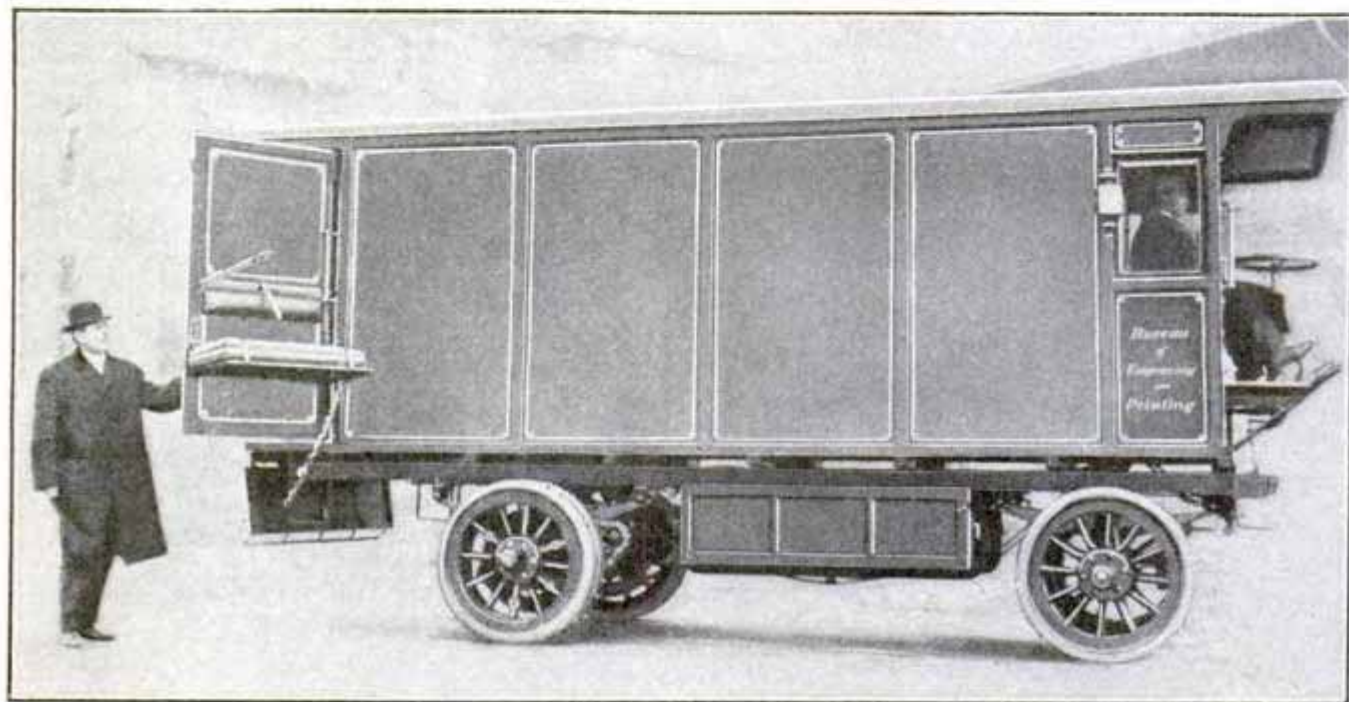

A Huge Fort on Wheels for Uncle Sam's Use

The van is made of hardened steel, with heavy locks and bars. Four of the guards occupy seats on the rear of the wagon, two sit on the seat with the driver, while another follows on horseback. The guards are all former members of the United States army.

All this extra precaution is due to the change in the system of making money. Until recently the money was printed at the Bureau of Engraving and Printing, but sent to the treasury minus the seal and the number so that it was not real money until handled in the treasury. Now one machine does all the work, including the stamping of the seal and number. These

\$3,000,000 is in silver certificates, \$2,000,000 in national bank notes, \$1,500,000 in postage stamps, and \$500,000 in internal-revenue stamps. Returning to the bureau from the treasury, the van carries blank paper for the notes and stamps.

Last year \$12,000,000,000 in stamps and \$3,000,000,000 in certificates were transported from the bureau to the treasury without the loss of one stamp or certificate.

"This is a remarkable record," said Director Ralph, "but there is no telling when the unforeseen may happen. This guard should have been organized years ago."

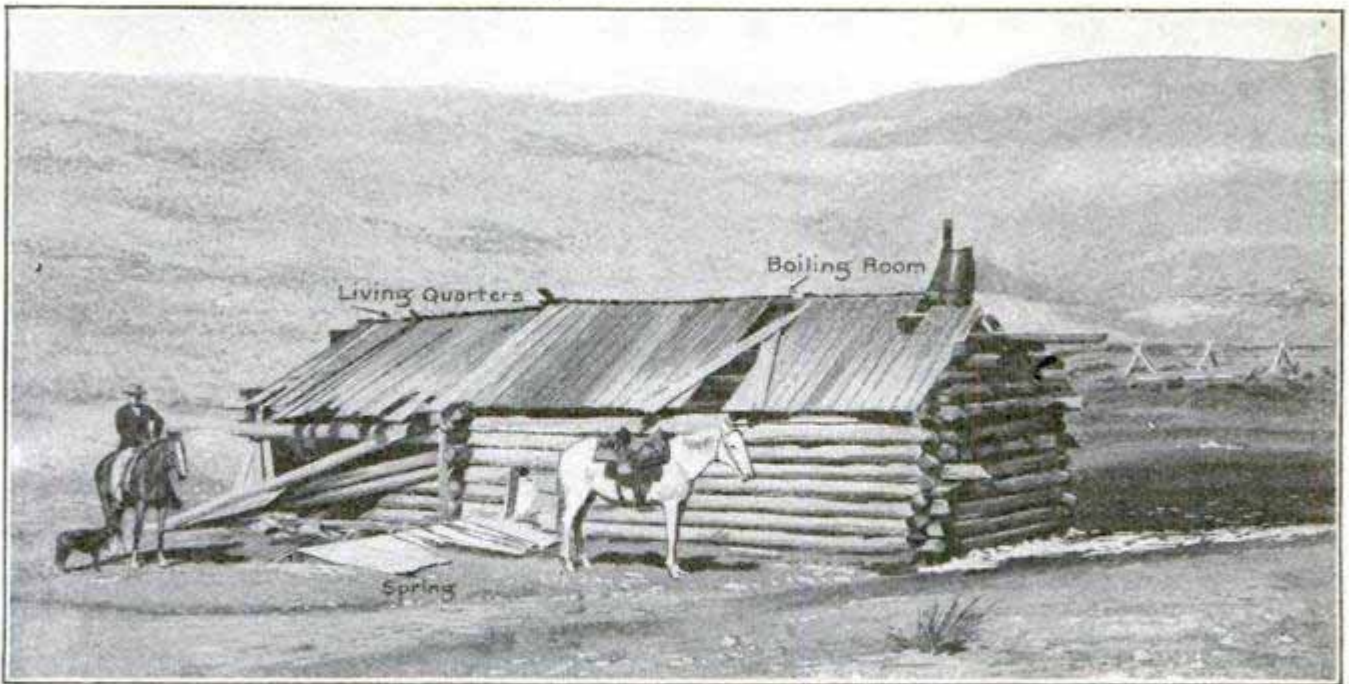

Sam Draney Salt-Works, Tygee Creek, Idaho

A PIONEER SALT-WORKS IN THE WEST

By C. L. BREGER

West of the Salt River Valley, or of Star Valley, as it is locally known, occur some salt-works which up to 40 years ago had the acknowledged reputation of being the finest west of the Mississippi. In those days as much as 200,000 lb. of salt were boiled monthly from a couple of springs in Stump or Smoking Creek, 13 miles northwest of Afton, Wyo. The price in the late sixties was \$1.25 per 100 lb., at the springs. Emigrant trains to the northwest along the Lander route de-

pended upon this region for salt; but the mainsprings of the industry were the Idaho and Montana mining camps. Large amounts of salt were consumed in the chlorination of the precious ores in the day before the cyanide process came into vogue. Ox teams laboriously hauled the salt, breaking trail for scores and hundreds of miles across mountain divides and valley swamps. The ox-pens at some of the springs are standing well-preserved to this day. When, however, railroads came into

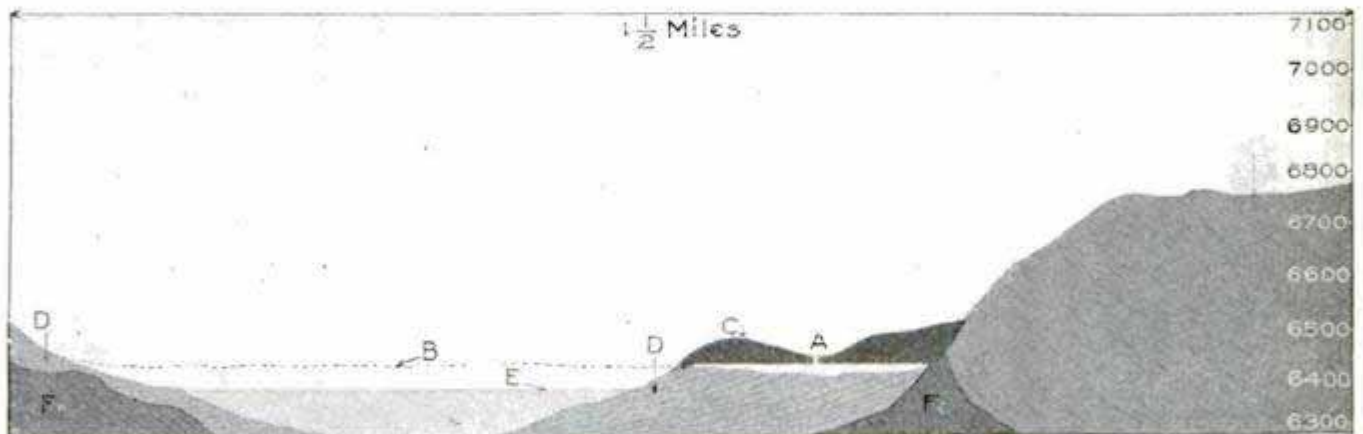

Diagram Showing Occurrence and Origin of Salt at Crow Creek, Near Montpelier, Idaho, at Different Heights above Sea Level, as Shown on Right

- A—Section of rock-salt body covering 113 acres
- B—Supposed level of bottom of Crow Creek valley at time of salt formation
- C—Terrace of red clays washed over salt body
- D—Tertiary gravels, or conglomerates, which once filled Crow Creek valley.
- E—The most recent, or "Quaternary" gravels, and soils, forming present bottom of valley
- F—The older or bedrock formations

the West, the salts of Kansas and of the Great Salt Lake began to be developed, and the northwest found it cheaper to get its salt by railroad. Thus, the Star Valley salt district, now 40 to 65 miles from the nearest railroad point (Montpelier, Idaho; on the Oregon Short Line) has dwindled in importance, until today only the pioneer settlers remember its prestige of by-gone days. Although several additional plants have been built in recent years, all the deposits together now furnish annually only a couple of hundred tons or less, which is consumed by the local ranchmen for table and stock use. The brine springs are still worked as they were worked 50 years ago.

In 1902, in deepening one of the brine springs in Crow Creek Valley, Bannock County, Idaho, 12 miles southwest of Afton, Wyo., the source of the brine was here found to be a body of rock salt which comes up to within 6 ft. of the surface. A shaft about 20 ft. square has penetrated downward through 20 ft. of the rock salt without reaching the bottom, the purity of the salt apparently increasing with the depth.

Analyses of the Crow-Creek rock salt and of the Tygee and Stump-Creek brine, or boiled salts, show a quality far above the average and ranking with the best salts produced anywhere, the degree of purity ranging from 98 to 98.9 per cent.

The Crow-Creek rock salt body covers 113 acres or more. It has been conservatively estimated to contain 74,000,000 cu. ft. of rock salt, from which over 5,000,000 short tons of table salt can be extracted.

One of the illustrations shows the Sam Draney salt-works on Tygee Creek, Bannock County, Idaho, seven miles west of Afton, Wyoming. The salt-works in this region are located in the valley bottoms in barren patches usually recognized by the absence of vegetation, and by the soggyness due to the contained brine. The spring is made by digging a hole about 3 ft. deep, 2 to 4 ft. wide, and 3 or 4 ft. long.

This quickly fills with water so saturated with salt that the brine frequently has a "thick" appearance when dipped up.

Sleeping and living quarters are provided for one to three men, partitioned off from the main cabin or "boiling room." In the old works of 50 years ago there was also a shed for the oxen.

The boiling room usually contains three pans. These are sheet-iron, shovel-shaped troughs, about 10 ft. long, 3 or 4 ft. wide, and 10 in. deep. Each pan rests on a little three-sided stone wall or firebox about 3 ft. high, the front being left open for firing. Wood is used for fuel. The brine is dipped up in pails by hand, and poured into the pans. As the water boils off, the salt or brine is stirred with a shovel, and a common to medium fine-grained product is the result. The salt is not milled, ground or refined. Into one corner of the little cabin there is crowded a storage bin for the salt, and somehow or other room is also made in the opposite corner for an extra or emergency spring, in case of snow or freezing.

NEW VERSION OF PASSION PLAY IN GERMANY

The people of Eisenbach, Saxe-Weimar, Germany, are preparing to give a Protestant version of the Passion Play next summer. The play has been written by Herr Weiser, stage manager of the Grand-Ducal Theater at Weimar, and celebrated actors from all parts of Europe have been engaged to take part in the eight performances that are to be given. Eisenbach is known throughout the world as "The Cradle of the Reformation" as it was here that Luther translated the Bible in 1521.

ⒸThe rocket type of life-saving apparatus, which forms one of the principal means adopted for saving life on the coasts of England, Scotland and Ireland, has saved 9,307 lives on these coasts since 1870.

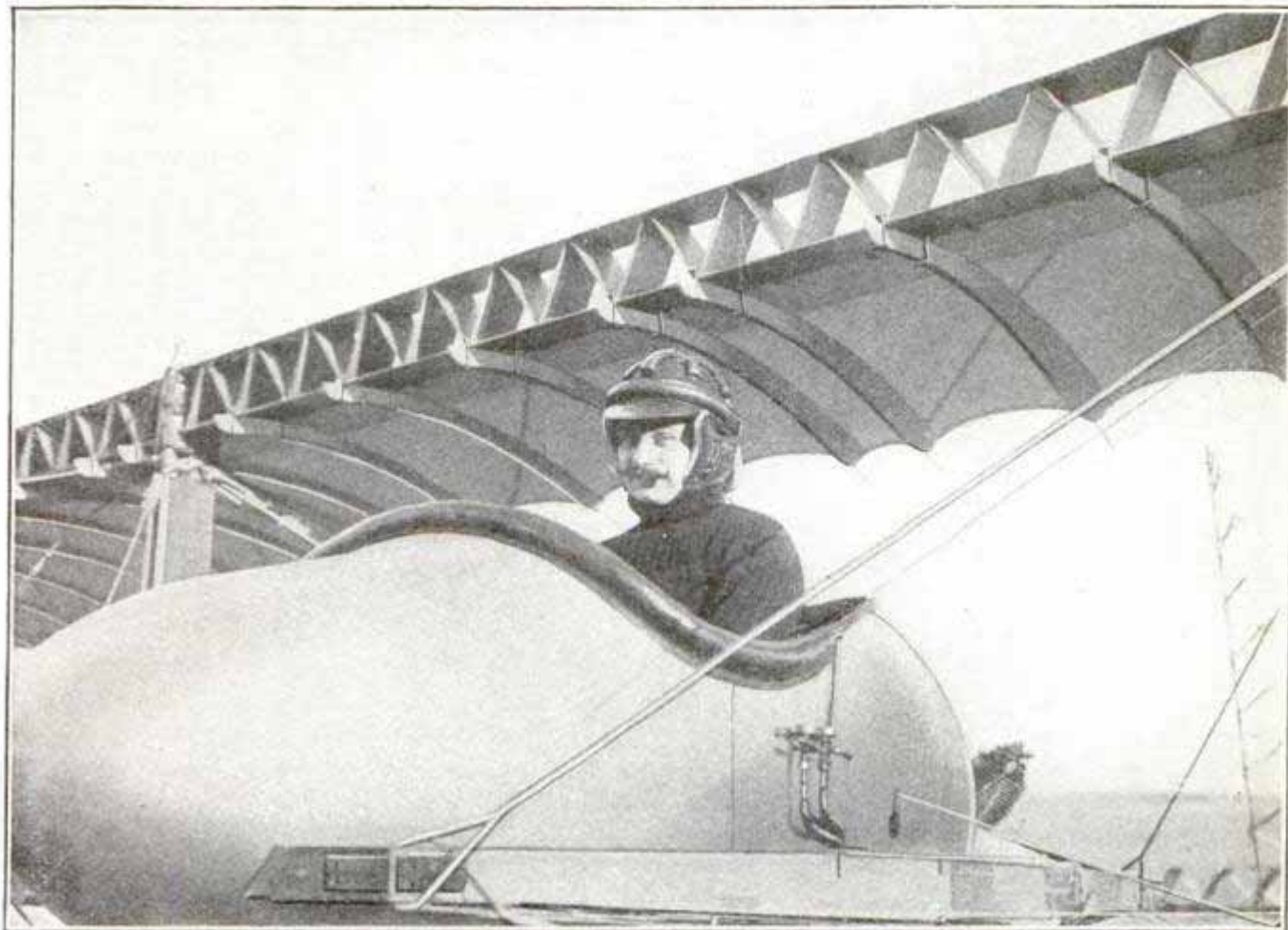

M. Caille, French Airman, in Novel-Shaped Aeroplane Car

BULLET SHAPED CAR

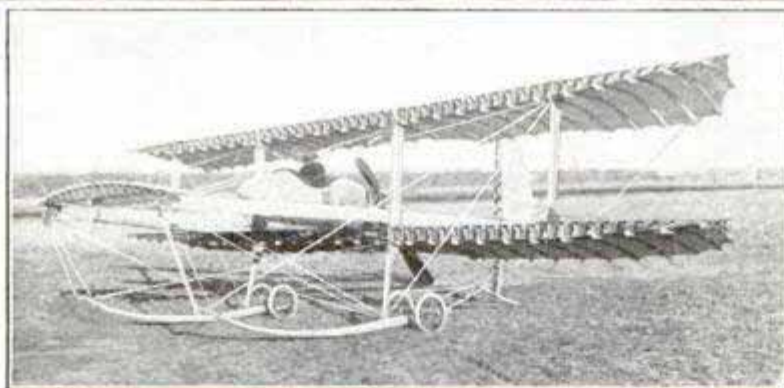

Paulhan's Unique Machine; Showing Position of Operator's Seat

IN NEW FRENCH BIPLANE

European airmen are watching closely the latest product of Louis Paulhan, who has turned manufacturer. The bullet-shaped car, in which the operator sits, is an innovation as well as the latticed girders which

strengthen the planes. The machine was tried out at the St. Cyr aerodrome, near Paris, recently, and was a success. M. Caillé was the first airman to fly with the new aeroplane, which attracted considerable attention.

MAKING SHIPS' RECKONINGS IN FOGS

A device called a "fogometer" has been invented by a Seattle man for assisting mariners in making reckonings near shore in foggy weather. This instrument is used to facilitate certain trigonometrical calculations from data

obtained by sound and wireless signals from the shore, and the run of the vessel on a log-measured course between the times of receipt of the signals. The fact that the wireless messages are practically instantaneous and sound takes about one second to travel 1,100 ft. is the basis of Captain Smith's theory.



The State Insectary at Sacramento, Cal.



Breeding Cage on Right

BREEDING BUGS TO DESTROY INSECT PESTS

In the grounds of the California state capitol, at Sacramento, is an unpretentious looking building, of glass and concrete, commonly known as the "bug house," but officially designated the state insectary. It is maintained by the state, under the direction of the Horticultural Commission, for the purpose of collecting, breeding and distributing beneficial insects to combat insect pests. It is remarkable, not only for the benefits it has conferred upon California farmers, gardeners and fruit growers, but also because it collects, breeds and distributes

of a large inner court surrounded on three sides by glass-walled breeding rooms and storage rooms. On the remaining side are the offices, laboratories, and an educational museum containing exhibits of all beneficial insects and insect pests known in the state. The heating, lighting and ventilating arrangements of the insectary are perfect, so that temperature and other conditions in any apartment can be regulated to suit requirements.

The breeding of beneficial insects is really a less complicated matter than might be supposed. All that is necessary is a few specimens of the insect, and an abundant supply of its appropriate food. Then if the right conditions of heat, light and ventilation are supplied, the enormous reproductive powers of the insects may be trusted to take care of the rest.

The scientists in charge of the insectary keep the eggs, larvæ and matured insects of all known beneficial species of importance in the state in "cold storage," that is to say, at a temperature that will keep them dormant, without

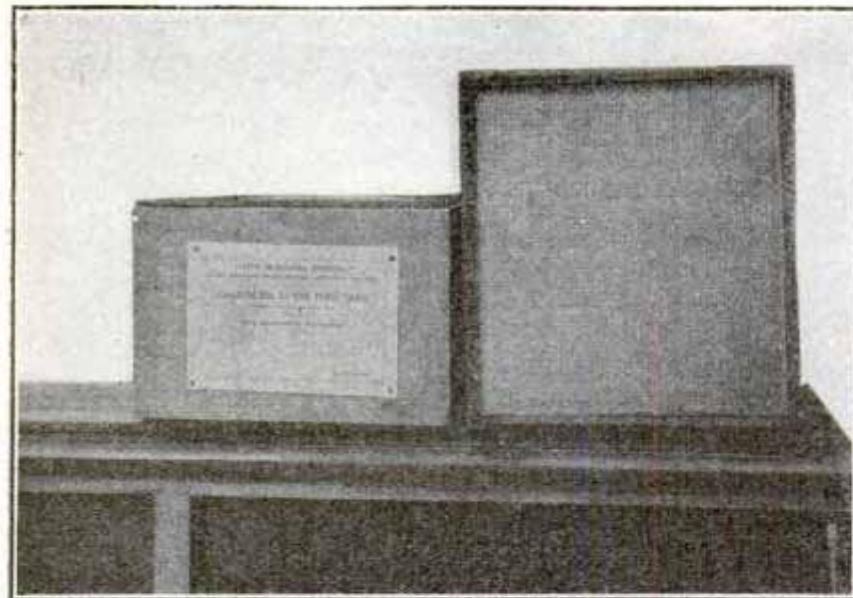

Shipping Cases for Ladybird Beetles—Each Case Contains a Colony of 60,000

beneficial insects upon a scale never attempted anywhere else in the world.

The insectary consists essentially

injuring their vitality. Whenever a serious outbreak of any pest insect is reported in any part of the state,

the first thing necessary at the insectary is to secure pest-infected leaves, twigs or fruit. These are placed in breeding cages along with the beneficial insect known to be the natural enemy of that particular pest, and the temperature regulated to the proper degree for insect development. The beneficial insects at once become active; and, finding an abundance of their appropriate food, they multiply with great rapidity. Within a very few days after receiving notice of the outbreak of the pest, the parasitologists of the insectary are ready to ship colonies numbering thousands of the insect which is best calculated to bring the pest under subjection.

The basic idea of the insectary is that nature never created an insect capable of developing into a pest without creating another insect to act as its check, and preventing it from destroying all before it. This is, in a nutshell, the key to the new science of parasitism—to use “bugs for fighting bugs.” The practical application of this science has enabled those in charge of the California state insectary to subdue the melon aphid, that threatened the entire destruction of the great cantaloupe, watermelon and cucumber-growing industries of the Imperial Valley; the various aphid pests that infested the peach, apricot and apple orchards; the dreaded San Jose scale; the black scale on olive and citrus trees; the cottony cushion scale on citrus trees, the soft brown scale, the brown apricot scale and many other scale insects and plant lice that used to do great damage. There are still many insect pests for which the proper insect antidotes have not been discovered; but the parasitologists of the state insectary are quite convinced that the remedy exists somewhere in nature. To find those remedies that are still missing, California maintains an entomological explorer, who searches the ends of the earth for beneficial insects, so that he may forward them to Sacramento for breeding purposes.

APPARATUS FOR TESTING BATTING STRENGTH

A strength-testing apparatus, in which the striking of a ball on either end of an arm causes the latter to whirl, has been patented by a New York inventor. In making a test of batting strength, the player strikes the lower ball with a bat. The arm thus re-

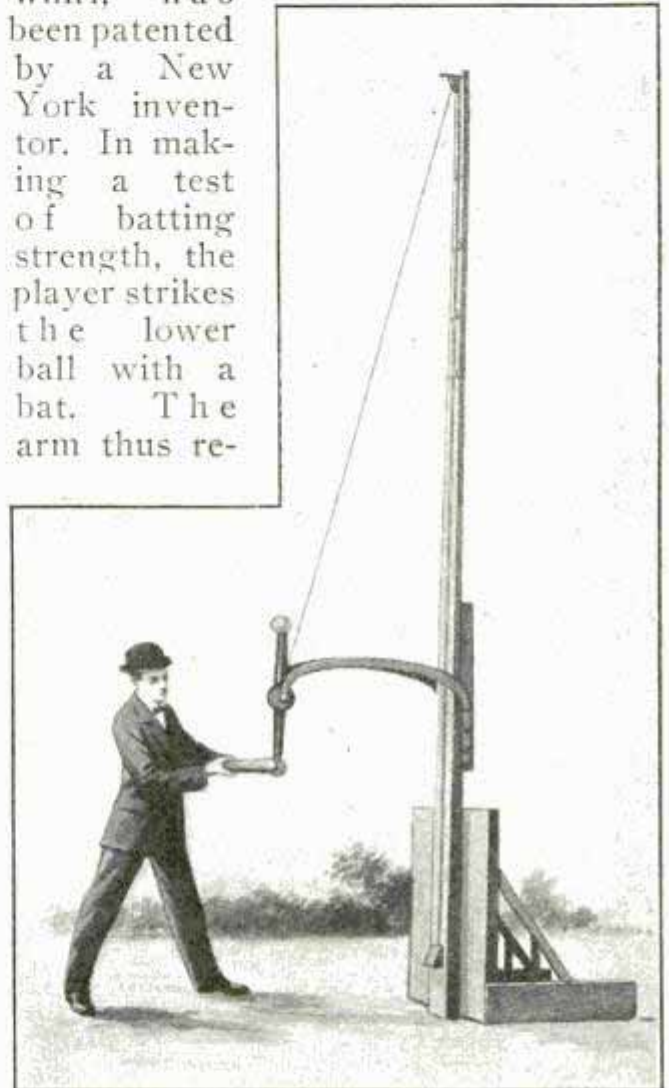

Indicates Batting Strength

volved is provided with a drum which revolves with it and winds up a cable provided with a weight at its end. The weight is drawn up a frame by the cable to a height corresponding to the force of the blow given the ball.

If the weight is lifted to the top of the frame, the play is called a home run, while if it is only lifted opposite one of the spaces indicated by the numerals 1, 2 and 3, the play is called a one, two or three-base hit.

☞ American children received \$6,000,000 worth of toys from Nuremburg, Germany, during the holiday season.

The queerest kind of freight ever carried on the Sante Fe railroad was a grain elevator 175 ft. high, 75 ft.

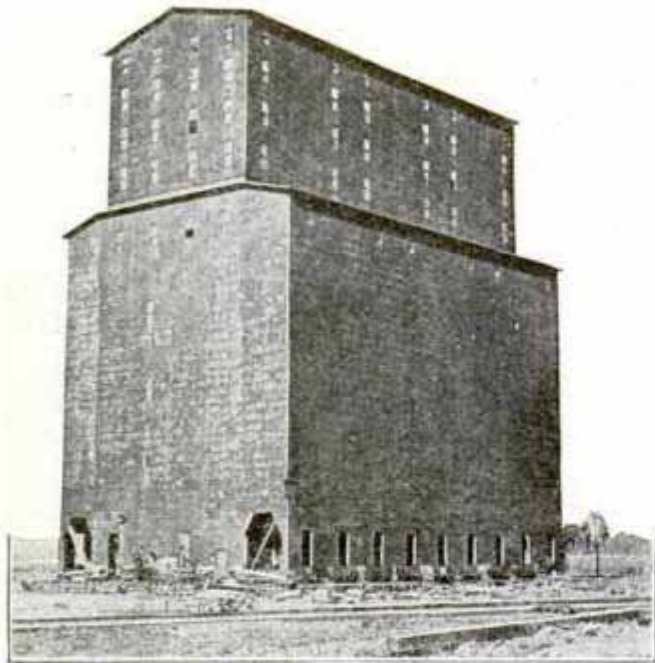

Moving a Grain Elevator

wide and 200 ft. long. After having been moved nearly 500 ft. on rollers, the huge structure was loaded on to trains of flat cars on parallel tracks and hauled from Argentine to near Turner, where it was set upon a new foundation. The trip was made with-

employed was the same as is customary with any other building, with the exception that in order to avoid racking it, tracks were built on cribbing to overcome the inequality of the ground, and the building moved on rollers on these tracks. The structure was completely equipped with elevating machinery with all of the paraphernalia usually found in an elevator.

FIRE TRAIN FIGHTS FOREST FIRES

A unique and unusually efficient train equipment for fighting forest fires was recently devised by the staff of the Ashland division of the Chicago & Northwestern Railroad.

The equipment consists of three tank cars and a steam pump, with an ample supply of 2½-in. fire hose. The tank cars have a capacity of 24,000 gal. each, and are connected with each other by 3-in. hose. A suction hose is also included in the equipment, so that the water supply can be taken from any river, pond or tank.

It is intended that during the months when forest fires are most frequent the



Testing Railroad Forest-Fire Train

train will stand, with tank cars filled, ready to be rushed to any point on the division lines. A locomotive, fired up and ready to be attached at a moment's notice, will be held in the roundhouse for fire duty.

HOW FIREFLIES GENERATE THEIR LIGHT

A study of the luminescence of the firefly, and especially of the chemical problems involved, by F. Alex McDermott, of Washington, D. C., has brought forward several very interesting points.

So far as is now known, says this investigator, two constant chemical factors, water and oxygen, are necessary for the production of light by a living organism. The third necessary factor, the substance oxidized, may be, and probably is, variable. The luminous organ of the firefly consists of two layers of material under the outer transparent covering. The inner of these two layers consists mainly of guanin, a compound similar to uric acid, and this probably serves as a reflector. The outer layer consists of a mass of cells, normally of a pale yellow color. Both layers are penetrated by innumerable minute tracheæ (ducts) which unite in the interior of the insect to form larger passages and run together in the outer layer of yellow cells, forming a network somewhat resembling the finer veining of a leaf.

It is practically certain that in life these passages are filled with air, and it seems probable that the photogenic process is accompanied by the evolution of carbon dioxide and the consumption of the oxygen of the air.

LARGEST GYRATORY ORE-BREAKER IN WORLD

The largest gyratory ore-breaker in the world has been installed at the plant of the Biwabik Mining Company at Biwabik, Minn. This monster breaker can produce a 40-car trainload of crushed ore an hour, crushing pieces

of rock weighing as much as ten tons. It stands 28 ft. high and weighs more than 500,000 lb.

The iron ore properties of the com-

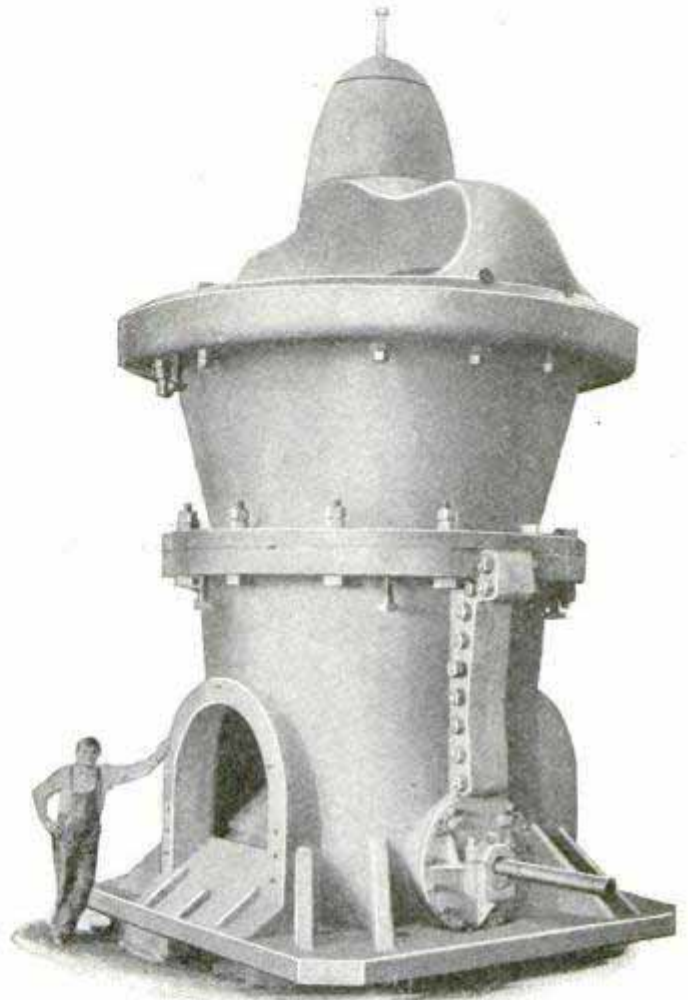

Giant Ore Crusher

pany have been developed on the open pit system, which permits the open blasting of the ore. The ore comes loose in large pieces. Consequently, an exceptionally large crusher was desired. The greater part of the ore is taconite, one of the hardest of iron ores, and its crushing to suitable size for the blast furnaces was difficult.

¶The Navy Department has just let contracts for the construction of six new torpedo boats, which will be the largest and fastest fighting crafts of their kind in existence. The boats will be required to develop a speed of from 25 to 30 knots (about 29 to 35 miles an hour), and their cost will range from \$250,000 to \$325,000 each.

COMPACT WIRELESS FIELD SET FOR PACK SADDLE

A portable wireless field set that is packed on a motorcycle or a horse has

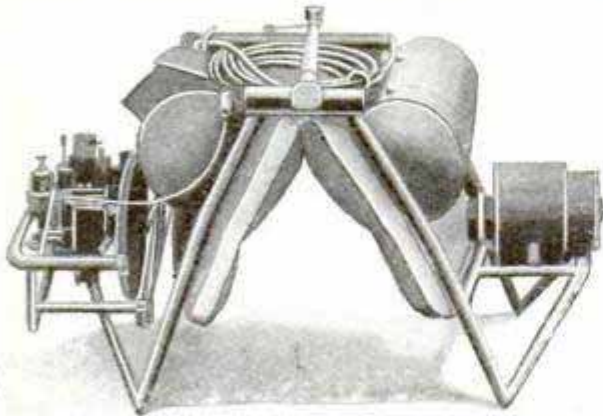

Portable Wireless Field Set as It Is Placed on the Pack Saddle

been given exhaustive tests by the British military authorities. The apparatus is believed to be one of the most compact and serviceable that has yet been devised. It consists of a $2\frac{3}{4}$ -hp. gasoline engine of a special type and a small dynamo with the requisite jointed pole, guy wires, and wireless receiver and transmitter. The engine used in the tests was of a class that has become popular with motor cyclists. For the wireless set, the engine has slightly lower compression and a larger flywheel which also serves as a fan. When the set is mounted on a motorcycle the same engine runs both the wheel and the dynamo. The entire outfit is carried on a pack saddle when horse transportation is used.

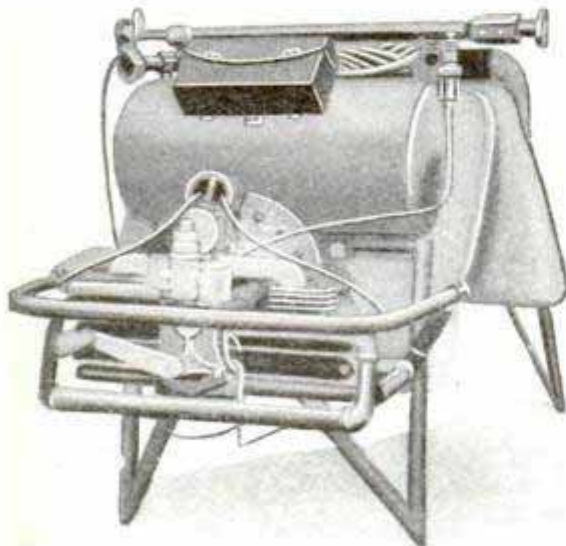

Another View of Portable Wireless Field Set, Showing Arrangement of Engine

The pole used with the experimental set was 60 ft. in length, divided into 5-ft. sections.

TIME CLOCK BLOWS THE FACTORY WHISTLE

An ingenious timekeeper in a Georgia factory, who was also called upon to perform other duties, has invented a scheme for blowing the factory whistle at starting and stopping time, with the aid of the factory time clock. By this method, the whistle is blown at the exact moments when work should begin and end. At first this man was compelled to ring a bell when time was called. Later the whistle was installed. As the timekeeper was also storekeeper, he was frequently busy at other things when the time came for the whistle to be blown. Therefore he rigged up an electric contact system between the clock and the whistle which resulted in the automatic sounding of the whistle.

WHALE STEAK IS JAPANESE DELICACY

So great has become the demand for whale meat in Japan that there is danger of a scarcity of whales in that part of the Pacific in a not far distant future. The Japanese government allows only 30 ships to operate, but the number of whales captured is unrestricted.

The average Japanese now prefers whale steak to beef steak, the best cuts of the former retailing at 12 cents per pound. It is much coarser than beef, and is said to be not unlike venison in taste. It is prepared the same as beef steak, the favorite methods being broiling, frying and baking. The tail is considered a great delicacy.

A report just completed shows that of the 58,977,287 acres of cultivated land in France, wheat alone is grown on 16,310,925 acres. The total of cultivated land does not include the 4,309,087 acres of vineyards.

Planning a Port For a Great City.



By GARDNER MACK

SEIZING as the psychological moment a period of unusual agitation for inland waterways with the advantages to accrue from the opening of the Panama Canal, Chicago has come forward with plans for the improvement of its hitherto undeveloped lake front in an effort to recover from smaller cities its share of the package freight transportation on the greatest of inland seas. The second largest city in the United States and the greatest railroad center of the world, Chicago has 35 miles of frontage on Lake Michigan without a dock, while to the north and east are lands which hold fabulous wealth in minerals, agricultural products, and manufactures together with smaller commercial centers anxious to be contributors to the upbuilding of the big western metropolis.

No less than four plans have been presented involving expendi-

tures of from \$10,000,000 to \$20,000,000 and the immediate accomplishment of tremendous engineering feats. The Chicago Sanitary District, the body formed for the purpose of constructing the famous drainage canal which reversed the flow of the Chicago River and opened a waterway from the Great Lakes to the Gulf of Mexico, is anxious

to have a hand in the improvement and is preparing to ask the legislature for authority to take up the task. There are two other plans that have been presented through private sources and by means of a harbor commission appointed by the mayor in 1908. Out of all of which it would seem that something should be accomplished to return to the city the shipping that has decreased 60 per cent during the past 15 years, and has given rise to much criticism from the business interests of the entire country. Only a wonderful increase in the

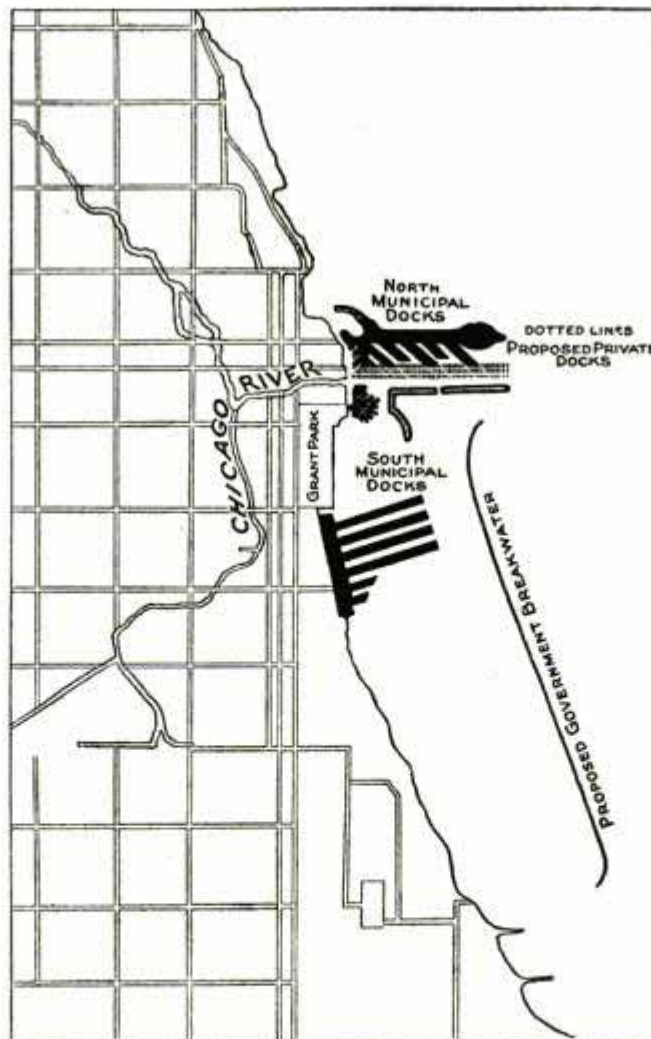

Outline Map of Chicago's Lake Front Showing the Three Definite Plans That Have Been Proposed for the Purpose of Providing a Much Needed Outer Harbor



The Present Appearance of the Lake Front, South of the Mouth

amount of ore shipped to her steel mills by boat has kept her from showing an actual decrease in the total receipts and shipments. As it is, the aggregate has been almost uniform for 13 years past.

Years ago the port of Chicago showed a greater tonnage than was found in the foreign water-borne commerce of the cities of Liverpool and London combined or the cities of New York, Boston and Philadelphia combined. Located near the southern extremity of Lake Michigan the city has been developed with the capital and labor of the entire United States because its geographical position made it the commercial hub of the country.

The federal government years ago built a harbor of refuge and constructed breakwaters to protect the outlets of the Chicago and Calumet Rivers, but the land intended for docks was converted into a park and the harbor is now used for yachts, merchant ships using it only as a refuge.

There is scarcely a business man in the middle west who has not known for 20 years that Chicago needed a real

lake harbor. But not a single individual or commercial body made a forward step toward getting it. The government engineers begged and pleaded to be permitted to do something. The man whose pocket was touched by the failing lake trade cried for help, and the worker whose living depended on the shipping demanded improvement. Nothing was done. All wanted to go forward, to accomplish approximately the same thing, but each remained standing just where he was. And the trade slipped away.

Chicago really has two ports in one—the Chicago River and its branches, and the Calumet River at South Chicago. The use of the rivers is restricted for obvious reasons. The difficulties of navigation in the Chicago River—the port for the package cargo trade—are extreme. This river is divided into three parts. The main stream runs west a little more than a mile, and there divides into the north and south branches.

There are something like 45 draw bridges over the river. Some of these are of the center pier type and some



of the Chicago River, the Yacht Harbor in the Right Foreground

Courtesy of the Chicago Daily News

are bascule bridges—the kind that divide in the middle and lift to either side so that a clear channel is given in the center of the river. A ship of the longest lake type, 600 ft. over all, would have difficulty in passing

through the main river where there are six bridges of different types rather close together. Practically all of the package freight warehouses are on the river banks. Iron ore constitutes the bulk of the Calumet harbor traffic.

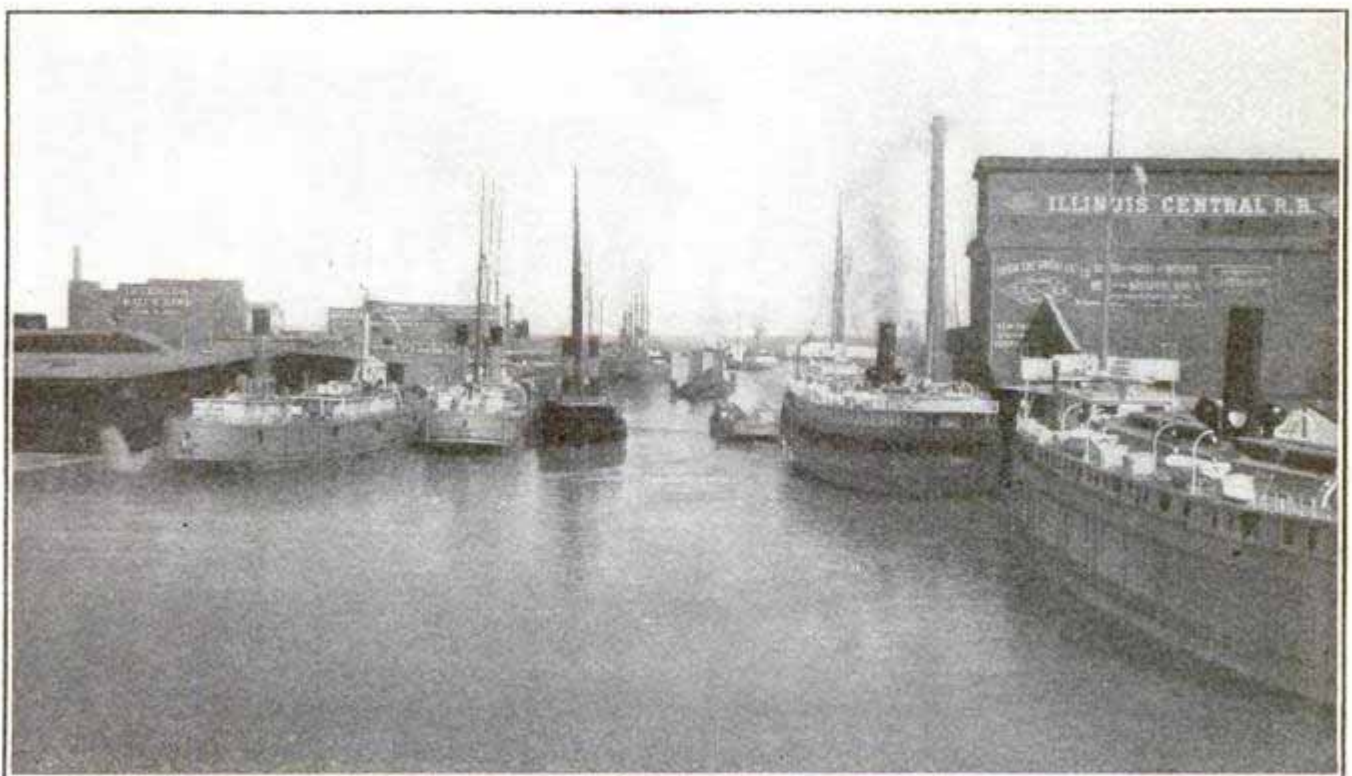

View of the Chicago River Showing Its Crowded Condition and Some of the Difficulties of Navigation



Engineer's Plan for the Proposed Chicago Docks

Contemplation of the Chicago River facilities as they exist today brings to light one of the strongest reasons for the building of a lake harbor, as it was one of the strongest reasons for the construction of the great drainage canal by the Chicago Sanitary District. There is but a small portion of the dock room along the waterfront that does not belong to the railroads. There are 21 trunk lines engaged in carrying freight into and out of Chicago. Between them they transport more than 30,000,000 tons of the principal items of the lake trade every year. And naturally they want to continue to carry it. The great advantage of water transportation over rail is its cheapness. The great advantage of rail transportation over water is speed. But the conditions in Chicago are such that for through freight speed is absolutely impossible. It takes from three to seven days to get a freight car through Chicago.

Therefore, with the railroads controlling all the docking facilities, or practically all of them, and with the railroads dictating the kind and quan-

tity of freight to be loaded and unloaded from them, it is not strange that practically every ship running into Chicago from the lake is owned or controlled by a railroad company, and that there is very little difference between the freight rates by water or by rail. In fact it costs the man who docks and unloads a coal ship in the south branch of the Chicago River ten cents per ton more for his coal than he would be required to pay in Milwaukee for the same service. This increase is ostensibly charged to the difficulty in navigating the south branch and the expensiveness of the progress of a steamer up the river to the point where it docks.

That there is no lack of appreciation of this condition is proven by the fact that the city of Chicago, through a harbor commission, appointed in 1908; the Chicago Sanitary District which is already nationally known as the body of men who successfully accomplished the building of the drainage canal; the Commercial Club, and interests headed by James A. Pugh, have each presented and persistently



to be Constructed and Operated by Private Capital

urged harbor plans. The three first contemplate the construction of docks, warehouses, etc., to be owned and operated by the municipality, and the Pugh plan is a private enterprise.

The report of the harbor commission does not pin itself to any one scheme, favoring rather any plan that will bring about a municipally owned harbor with strong recommendations for development north of the Chicago River mouth. The city of Chicago unfortunately has no money with which to build docks. The Sanitary District has plenty of money for the project, and a plan, but lacks the authority, and, up to date, has not definitely decided on a site. The plan of the Commercial Club contemplates the use of a site north of the river mouth. In the selection of either of these alternatives with the north of the river site, litigation would result that would probably delay the realization of the harbor dreams for a long time. The fourth plan, presented by the Pugh interests, and involving the construction of privately owned docks, is more extensive in that it is complete in de-

tail of warehouses and lighterage facilities, and further than this, these interests controlling the site north of the river mouth by act of the legislature, have a complete set of plans for the work, have the \$20,000,000 necessary to complete it, and announce in very positive terms that operations will begin at once. The Pugh plan does not meet with the approval of many of the commercial interests in Chicago, because it provides for private rather than public ownership of the docks, warehouses, etc. So that there is every reason to believe that litigation would also follow any attempt to construct these docks.

There are, then, three concrete plans for the development of the outer harbor. The plan of the Commercial Club, the plan of the Sanitary District and the plan of the Pugh interests. The first of these contemplates the construction of a long pier projecting into the lake about one mile north of the river mouth, with piers extending therefrom in a southerly direction. Experts have calculated that a pier constructed along the lines suggested

be doubled and tripled by extending the main pier farther and farther into the lake as the commerce of the city grows.

The Sanitary District plan for piers north of the river contemplates the use of land at the river mouth claimed by the Pugh interests. The project calls for an expenditure of \$10,000,000 and the building of six immense piers. These piers would be 1,200 ft. long, the longest in the world, and each of them would accommodate four of the largest steamers in the lake service. There would be two piers built at once with the necessary warehouses and storage places. It is a part of the plan to equip these piers with the most modern devices for loading and unloading vessels. Cargoes would be taken from the holds of the ships and conveyed directly to waiting freight cars, or from the cars directly to the ships, without unnecessary handling. The piers would have three decks to accommodate teams and street railways, steam roads and subways. The cost of handling the cargoes, etc., would be so low as to enable the authorities to charge 25 cents per ton for dockage, which, it is estimated, would not only pay the interest on the investment but would defray the whole cost of construction in a number of years.

The Sanitary District trustees have not yet decided whether they will accept the plan for the construction of the piers north of the river mouth, as described, or at a more southerly point between 12th street and 39th street. The advantage to be gained in the southerly site lies in the fact that it could be reached more directly by the railroads. The construction of the docks north of the river mouth would necessitate lighterage of much of the freight to and from the railroad terminals, the Chicago River being used for this purpose.

The plan of the private interests for which the promoter has engineers' specifications, and the authority from

complete dock and lighterage service. There would be three docks extending 2,700 ft. into Lake Michigan from property now owned by Mr. Pugh north of the mouth of the river. These docks would include a pier for passenger, fruit and cold-storage traffic, a receiving pier, and a dispatching pier. The northernmost of the three piers would be the passenger and cold-storage pier. The northern side of this pier would be on a line with existing street car tracks which could be run to the end of the pier. It would be a structure of three decks with a submarine cold storage plant to occupy the entire bottom of the pier or so much thereof as might be necessary. The first deck would be devoted to the receiving and shipping of fruit, most of which comes to Chicago in the holds of the passenger ships. The second would be the passenger pier. The street cars would have tracks on this deck of the pier. On the third deck there would be an enormous auditorium which it is proposed to use for trade conventions and for amusement enterprises. The auditorium would be built to seat 10,000 people. The second pier would be the receiving pier for shipments from the east. The third or dispatching pier would be the headquarters of the lighterage department as well as the point of loading for east-bound water freight. The lighters to carry freight to and from the railroad terminals are so constructed that they do not need to have bridges opened for them, thus being able to navigate the river at all times.

These, in brief, are the Chicago outer harbor plans. With half of the fresh water area in the world to carry her freight, in the most modern steamships for which the Great Lakes are famous, it remains to be seen whether or not Chicago will stand still for another decade and let the smaller cities on the Great Lakes, that have not her advantages of geographical location or railroad facilities, maintain their supremacy in water-borne traffic.

INSTRUCTION CAR TRAINS MOTORMEN

The school of instruction in which the aspirants for positions as motormen on the electric railways of Detroit are trained, runs back and forth on a 100-ft. stretch of track in one of the car barns.

It is a car, especially equipped with

graduate course. The applicant is first assigned to a car on the line where he is to be employed, and rides in the vestibule, where he can observe the method of operation. After a day or two he manipulates the controller, this apprenticeship continuing for a week

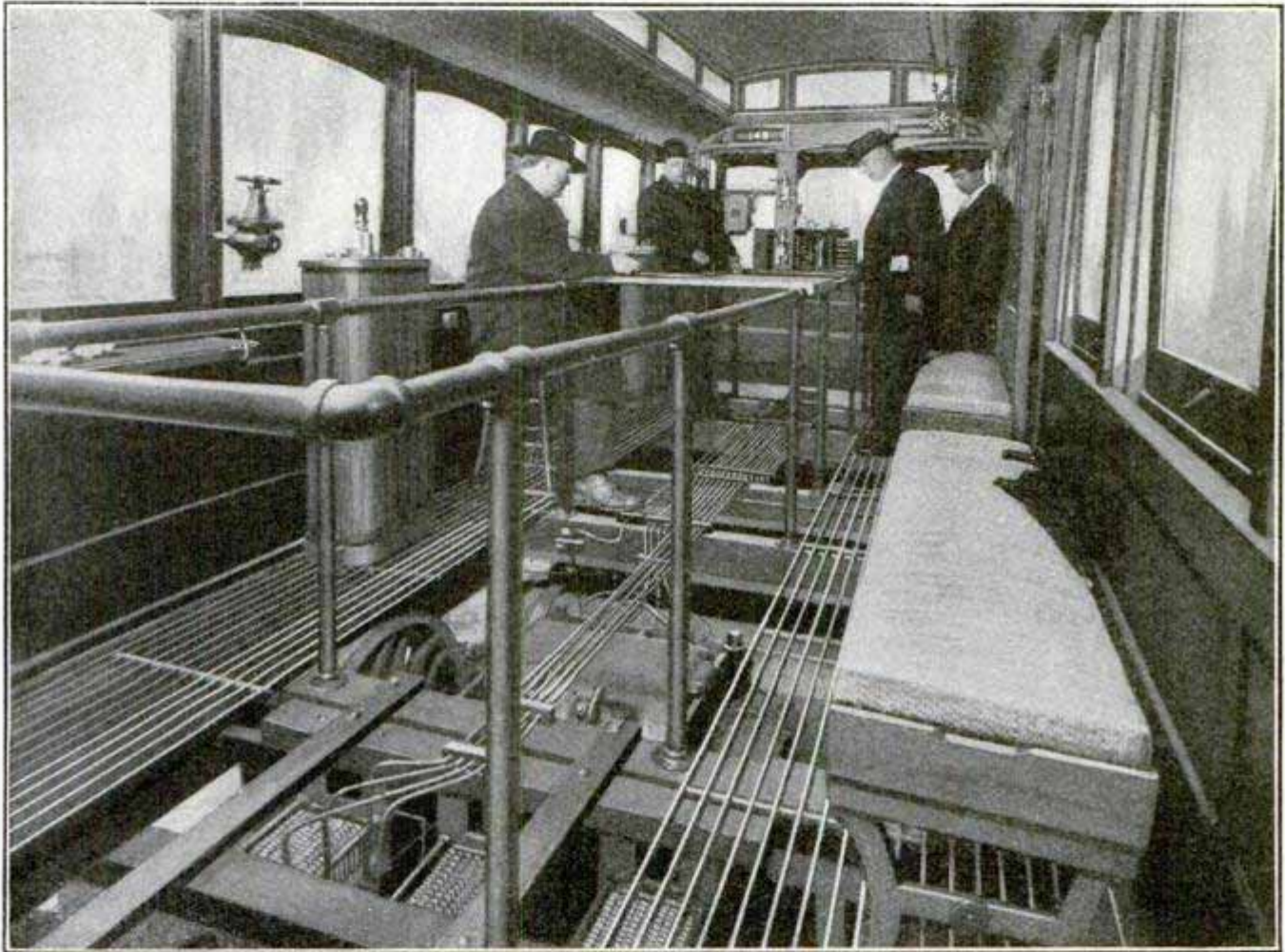

Interior of Car for Instructing Motormen

every type of controller, brake, fuse, brake gauge and trolley guide used on any car in the city or suburban service. An iron grating as a floor reveals all the inner mechanism, and the current is traced from its entrance into the car through the trolley pole to its exit in the rails. Its action at every application along the line is explained, and the use of the ice-cutter, the sand, and the hand and air brakes are clearly demonstrated.

The old system of training motormen, however, is not done away with, the school being more or less of a post-

or 10 days. He thus learns to do certain things to gain certain effects, but why the certain things have these effects he learns during his stay on the instruction car.

—
 (The largest sailing vessel in the world, the five-masted, full-rigged ship "Preussen," was stranded at Dover, Eng., recently. She measures 407 ft. in length, 53 ft. 6 in. beam, 27 ft. 1 in. depth, and has a gross tonnage of 5,081. She belongs to a firm of Hamburg shippers who have a fleet of big sailing vessels.

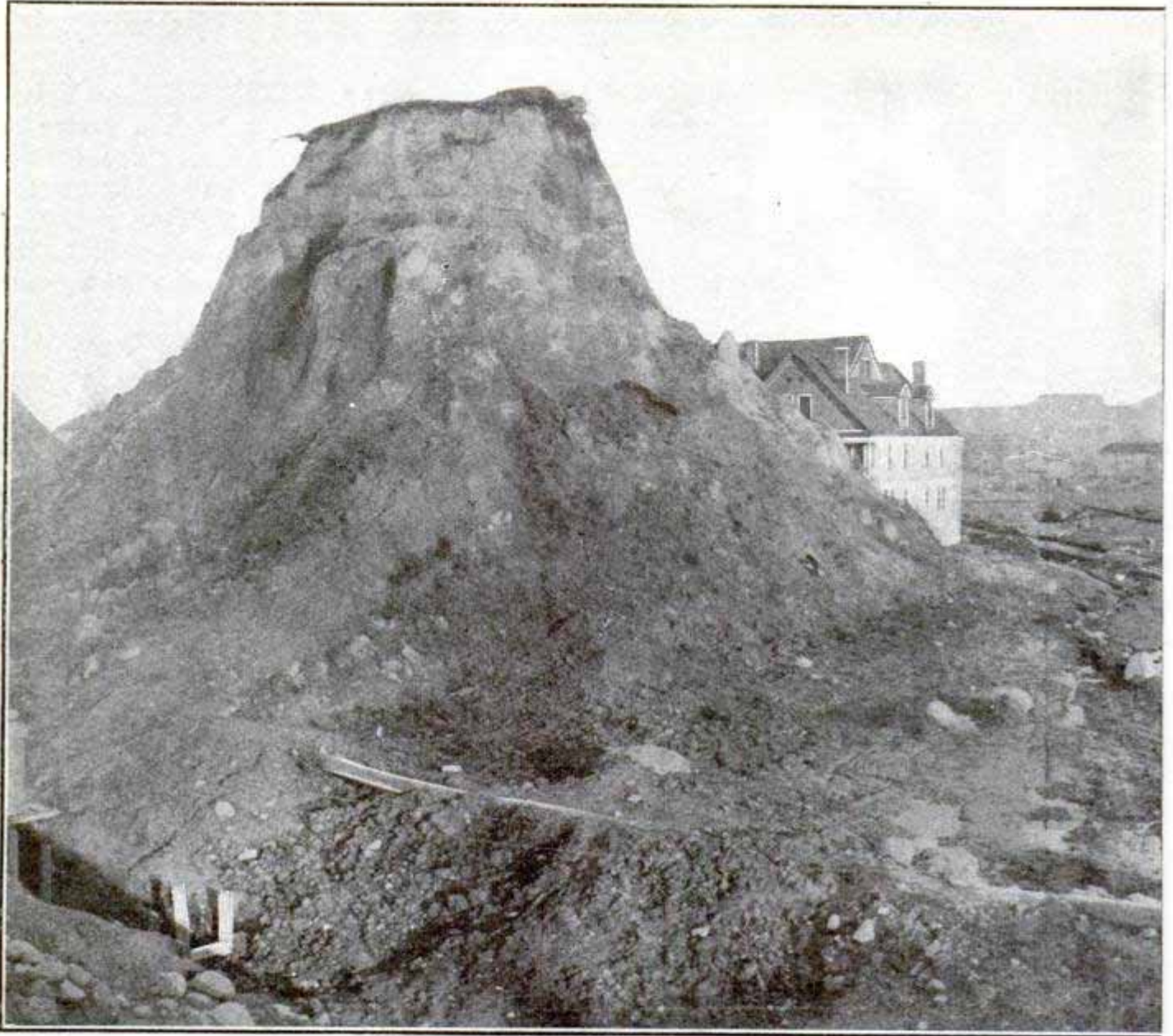

City Lots Left High in the Air in

ELECTRICAL PHONOGRAPHIC REPRODUCTION

A new method of recording and reproducing sound waves is proposed by a German scientist. His record is made in the form of a graphite or lead-pencil line of varying thickness, formed under the control of the sound vibrations on a strip of insulating paper.

The reproduction of the sounds is effected by introducing successive small portions of the pencil line into an electric circuit containing a telephone receiver, the current through which is varied according to the thickness of the line.

SEATTLE STREETS REGRADED UNDER DIFFICULTIES

In the readjustment of the grades in parts of Seattle the engineers in charge were compelled to overcome difficulties not entirely physical. There were many property owners who did not take kindly to the cutting down of the hills and declined at first to permit their property to be touched by the workmen.

The result was that in several places streets were cut to the new levels leaving city lots high in the air. One instance of this kind occurred at what is known as the Denny Hill cut where a plot the size of two city lots was

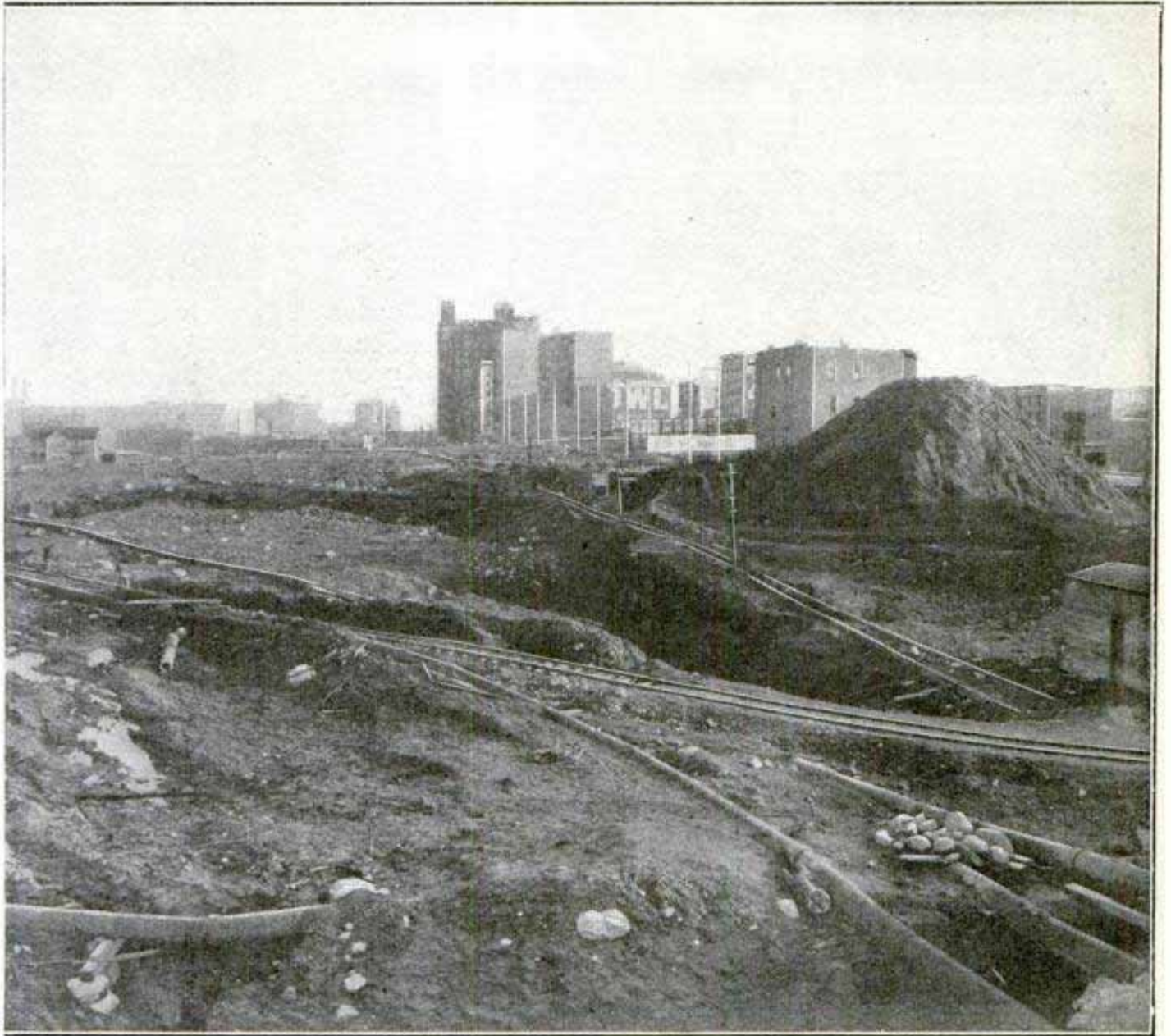

Seattle Regrading Project at Denny Hill

Copyright, 1910, A. H. Cruse

left in the air. This plot has since been graded, the non-resident owners of the property having at last realized the necessity of bringing their real estate down to the common level.

MARYLAND ROADS TO BE FREED OF TOLL GATES

The sum of \$2,000,000 is to be set aside by the state of Maryland to free it of the antiquated toll gates that now obstruct traffic along some of the most important highways of the state, if the plans of Governor Crothers are adopted. The proposal is that the present road improvement fund be increased to double its present propor-

tions and a part of the addition be used to purchase the private pike rights in the various counties. Maryland has some of the most magnificent roads in the country and many of these are over rights of way privately controlled, to traverse which every traveler must pay toll. The progressive citizens of Maryland are anxious to have the toll gates done away with.

☐ In ten years the French manufacturers have exported automobiles to the value of \$161,771,670, the business having grown from a total of \$821,987 in 1899, to \$15,406,418, for the first six months of 1910.

at a recent theatrical exhibition in London was a model of the famous Globe

goes to waste, ingenious use is made of the scrap tin which piles up outside of Puget Sound can-making factories. A shipload of Christmas toys, mostly mechanical flying-machines, steamboats and automobiles, etc., reached Seattle recently as the postscript to the story of a shipload of scrap tin which was dispatched to Germany a couple of years ago. The cans in which the several million sockeye salmon are packed every year are mostly made on the sound and generally in the salmon packing towns. Huge piles of the scrap tin accumulate, but where, a few years ago,

the scrap was hauled off to the most convenient dumping place it is, today, saved and baled and dispatched to Germany. It returns in the shape of all sorts of brightly painted contrivances to gladden the hearts of American children.

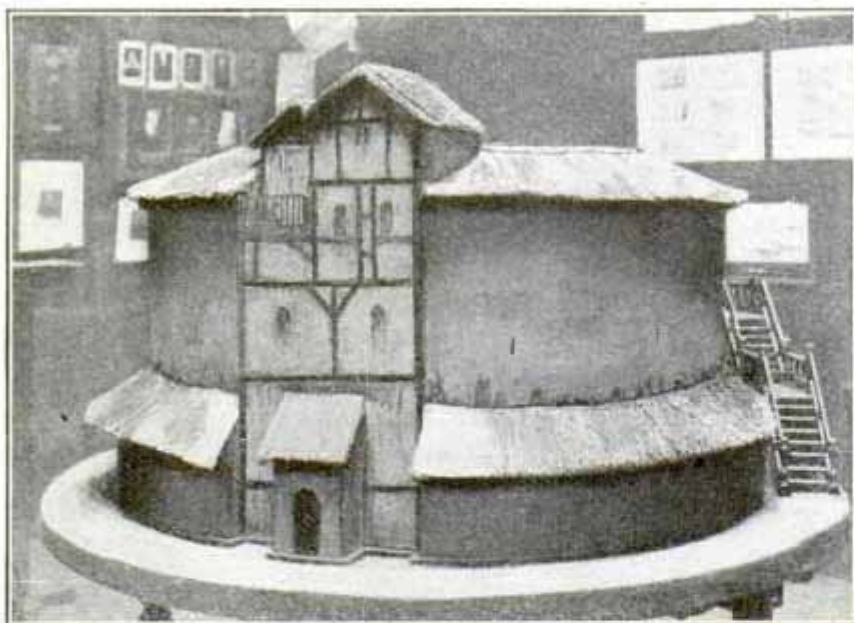

Model of Famous Globe Theater

theater of Shakespeare's time. It was built in 1599 and burned in 1613, the fire being caused by sparks from a cannon used during the production of "King Henry VIII." It was immediately rebuilt, however, and from that time until his death, Shakespeare owned one-fourteenth of it.

Built perfectly round, the central portion was roofless, and was called the pit. Entrance to the pit, which had no seats, was one penny. Seats in the galleries, provided with rude chairs and protected by thatching, cost two pennies.

CONCRETE CRIB IS FLOATED TO POSITION

The reinforced concrete crib, on which the new lighthouse at the entrance of Lloyd Harbor, on Huntington Bay, Long Island, N. Y., is being built, was constructed on shore, launched, and towed a distance of half a mile to the site. The crib is 26 by 30 by 16 ft. in size, and contains four equal bays. The bottom and outer walls are 16 in. thick.

WHY AEROPLANES FALL

The too near approach by the elevating rudders to a vertical position during descent, is stated by a well-known French airman to be one of the most common causes of aeroplane accidents. This authority bases his opinion according to the following line of reasoning:

The longitudinal stability of an aeroplane depends on the dihedral (or two-plane-sided) angle between the equivalent surface of the main supporting planes and that of the tail planes. When this angle opens upward (apex lowermost), the aeroplane has automatic longitudinal stability. A disturbing element, however, is introduced by a third (equivalent) surface, that of the elevating rudder, which forms with the supporting planes an

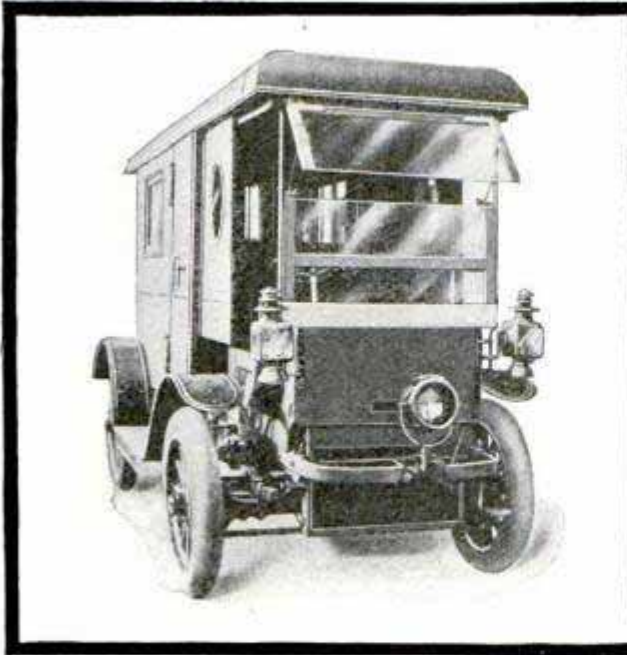

Side View of Banking Automobile

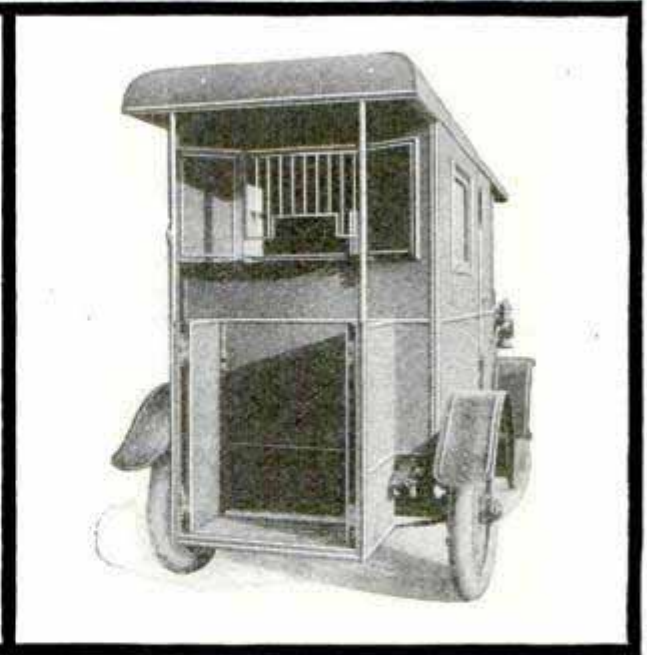

Rear View, Showing Vestibule

angle which may open either upward or downward, according to the position of the rudder. In ascending, this angle is open upward, and the tendency is to increase the longitudinal stability. But when the rudder is reversed for the descent, the angle flattens out to a straight-line position and then becomes downwardly open, like an inverted V, thus causing an upsetting action. This lessens the stability caused by the upwardly open angle between the main planes and the tail, and at a certain critical point will entirely neutralize it, the result being that when this point is passed, the machine will suddenly and unpreventably assume a vertical position and drop headlong to the ground.

As there is no way in which the airman may become apprised of the approach of the danger position, it is suggested he confine the action of the rudder to within certain safe limits.

On the other hand, Louis Bleriot contends that the greatest danger does not lie in the descent in a nearly vertical spiral drop, but that the critical point is reached when the airman must change from an abrupt angle to one more nearly horizontal in order to strike the ground at a tangent, as in the fatal accident to Chavez, who was killed when preparing to alight after his successful trip over the Alps.

ARMORED AUTOMOBILE FOR BANK SERVICE

An armored automobile that may be used for transporting large sums of money through the streets, or may be used as a street bank or pay car, was recently exhibited in New York.

The walls and roof of the car are constructed of steel, hardened insulating material, and hard wood. The body is also fire-proof, and a system of electric alarms are provided as additional burglar protection.

The car is divided into two distinct sections, the front part for the driver, and the rear for the banking operations. The fixtures of the banking room include a large safe, and a desk or counter extending the full width of the car under the cashier's window. The latter contains the money drawers. At the rear of the machine is a vestibule which serves to protect the persons transacting business.

Chinese musical taste seems to find its most perfect form of expression in the bagpipe, rather than any other Occidental musical instrument, and the Chinese people have paid more attention to concerts given by the pipers of the English Highland regiments than to the bands of the other organizations.

INGENIOUS ADVERTISING FOUNTAIN

At a short distance many who visited the Brussels Exposition took this fountain to be nothing more than one



An Advertising Feature of Brussels Exposition

of the decorative units erected to please the eye, but closer inspection would have divulged the fact that it was a clever advertisement.

It was a structure of concrete covered with a coating of patent waterproofing, and its purpose was to demonstrate the efficiency of the latter. So well did it perform this task that it was awarded the Grand Prix for concrete waterproofing materials. The waterproofing substance was applied about 1 in. thick on the concrete surface.

ONE-MAN COAL MINE

Within the corporate limits of Grand Ledge, Michigan, is a coal mine the total operating force of which is one man and a very intelligent horse.

The operating plant is simple, the hoisting apparatus consisting of a drum of the type used by house movers. As the mining progresses, the operator lays tracks for his cars. After mining the coal, he loads it into a car and taps a signal to the horse above. This animal, taught by experience, begins to walk around the drum, and then the operator pulls a wire connecting with the drum and the clutch is thrown. When the car starts up the incline, the operator walks beside it, the wires to the clutch and brake being always at hand. At the top the car rolls out onto a dumping frame, and is ready to be dumped into the wagon of a customer.

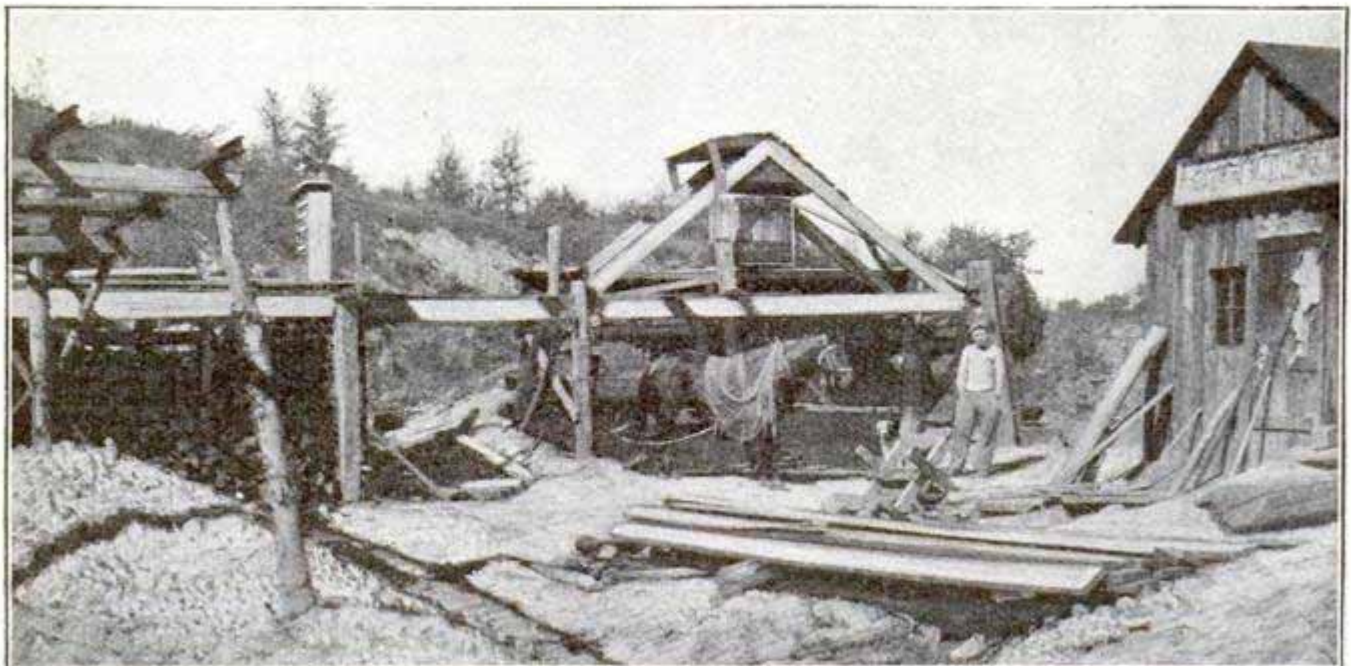

Michigan Coal Mine and Two Operators

HOW THE AMERICAN SAILORS IMPRESSED AN ENGLISHMAN

By PHILIP GIBBS

In the London Graphic

THE recent visit of the Atlantic Fleet to Europe, the largest fleet of American naval vessels which has ever visited foreign ports, was the occasion of marked expressions of good will. The sailors attracted attention everywhere and aroused favorable comment by their appearance and bearing. Officers and sailors were entertained at the Guild Hall by the Lord Mayor. The hall is used only on rare occasions and for events of great importance, so that the reception to the Americans in the historic building was a distinguished attention. Never before have the rank and file of any army or the enlisted men of any navy been entertained there.

"SAY, kin yer tell me the way to the Strand, friend?" It was a question asked in Cannon Street, and just for half a second it struck me as queer that a couple of British blue-jackets should not be able to steer a straight course to the Strand, for, as a rule, they know London pretty well, from Limehouse to Battersea Park Road. Then at the tail-end of half a second I saw that these were not British Bluejackets. Their tailor had stunted them from the knee downwards, and their faces had a foreign cut. I read the name on their caps: "Minnesota," and I knew that the man who questioned me was Cousin Jack.

Since then I have seen hundreds of these American handymen in the streets of London, coming in twos and threes from Fenchurch Street Station, after a journey from Gravesend, where four of their big battleships take up a heap of room in the river. Londoners are taken by surprise as they pass. Like myself, the ordinary citizen imagines for a moment that his own Jack Tars have got a bit of "liberty," and a smile creeps into his eyes and to the corners of his mouth, as it always does when a bluejacket takes the pathway. Then suddenly he turns his head. He, also, notices the skimpy trousers, and the foreign-looking faces, and little things which do not belong to the manners and customs of our Jack. He stares back at them. "Rum looking beggars those Yankee seamen! Smart, but not like our boys, of course."

Apart from prejudice—and, of course, our bluejackets are the best in the

world!—there are differences between the men of the two navies. It does look a bit queer to see an able seaman with a moustache on his upper lip. It is a shock to our traditions. Then their youthfulness is surprising. Most of them look mere boys, rather long and lanky for their age. And their eyes are not in harmony with their calling. There is not so much blue among them all as to make a sailor's pair of breeches. They have dark eyes, very bright and keen, but more like the eyes of the Army than of a Navy that takes the colour of the sea. That also is against the traditions of our service. The marines, too, are very military-looking fellows. When they stride along in their light-blue overcoats they look like men from a new regiment of Territorials who might be sick, and not ashamed, if ever they went to sea. One cannot help noticing those little things, but they are set down without malice.

It is all a question of unfamiliarity. But that is wearing off a little now, for during the last two or three days London has been invaded by these seamen with Red Indian names on their caps. I have seen them in the strangest places and situations. I have seen some of them looking at the ladies' fashions in High Street, Kensington. I saw two of their petty officers in the very thick of the Suffragette raid on the House of Commons. They seemed to be enjoying themselves heartily, though continually surprised that there should be such sport in England. I saw another couple among the Vene-

mic way as they chewed gum incessantly.

I saw more of them when I went to tea with the flag-lieutenant in the Rear-Admiral's flagship, off the Terrace Pier, Gravesend. It was a fine sight, that American battleship, on a grey sullen day, with a red sun gazing in a bleary way through the leaden sky. Vast, grim, melancholy, with guns thrusting out their snouts from bar-bette and gun-port and turret, with three tall funnels, and two high lattice-work masts like gallows—"waste-paper baskets" they are called in Yankee slang—she was not a beauty. The only pretty thing about her was the flag with the Stars and Stripes, which fluttered in an east wind. She had just a little lively colour, too, when a string of signal flags danced a jig for a moment or so, and was answered by other little flags which went up the lines on the "Minnesota's" sister ship lying further down the river. It might have been the Admiral's signal proclaiming the watchword of victory before a great engagement. It looked to me uncommonly like Nelson's last signal before Trafalgar. As a matter of fact, it was an order to let the fires die down.

But if, as I say, the "Minnesota" didn't look beautiful, she looked a very monstrous and impressive death-machine. If these gun-snouts had begun to bark, London would be mourning in its ruins. A crowd of small craft—traders, row-boats, barges—nosed about the battleship, and as far as size went they were like a swarm of water-rats crawling about some gigantic carcass.

Jamming a pot-hat tight on to my head I rowed out in a small boat to the flagship, stepped perilously across six barges, climbed the gangway ladder, saluted the quarter-deck, elbowed my way through a crowd of petty officers and seamen who were engaged in a very earnest argument on some subject of naval philosophy, and looked around for the flag-lieutenant. He was

getting away in a pinnace. The Mayor lifted his cocked hat a score of times. The flag-lieutenant saluted as many times again, with equal courtesy. Two black-gowned gentlemen in white wigs bowed repeatedly as they clung on to a handy rope, and the Mayor's beadle, in a gorgeous livery, looked like the gilded figure of an old man-of-war brought up from Castle's ship-breaking yard, and he was just about as impressive.

The machine—we still call these things ships!—is as much like one of our battleships as one flat-iron is like another. But the men and the manners are different from ours. It is true that the officers have the keen hatchet-face which one sees so often in the British Navy—it is a fine type—but the relations existing between the officers and the men, and the appearance of the men themselves, are surprising to an Englishman who knows something about his Navy. There is not that immeasurable and impassable gulf which exists between our officers and seamen. The American naval lieutenant has an easy-going way with him when he gives an order or enters into amiable conversation with "the boys." And they, seamen and petty officers, have a manner of "liberty, equality and fraternity" when addressing a young gentleman on the quarter-deck which would make a British midshipman go red to the roots of his hair before reporting the matter to his superior officer, and a British lieutenant purple in the face before ordering the immediate arrest of the offenders. It is all a matter of discipline. In our fleet discipline is very hard, very severe, very ruthless, and its laws are as sacred as those of religion. There must be no "answering back" in the British Navy. Instant obedience, absolute submission, machine-like response to the slightest word of command, and profound respect for the very eyebrows of an officer—if he raises them it is "look out for squalls"—are exacted and unquestioned. Disci-

pline extends to every part of the ship. It is the very atmosphere breathed by the men. It grips them in an invisible but iron hand during every hour of the day and night. And it has created the greatest Navy in the world, and the finest seamen.

But on an American battleship life is not so strict. The American sailor confesses himself to be "an independent sort of cuss." Of course, he is willing to obey orders, but he wants to see the sense of them, and, anyhow, he is an American citizen who can appeal to the laws of Congress made specially for his well-being.

"It's like this," said one of the petty officers on the "Minnesota," "we would rather be buried in live ants than work under your style of discipline. I guess we weren't made that way. It's not in our blood, so to speak."

From this petty officer, who twirled a neat little moustache, and chewed

gum all the time, I obtained some interesting information from the point of view of the lower-deck. Undoubtedly, for instance, my first impression of the youthfulness of the American Navy was quite accurate. I was assured that a great number of petty officers are between eighteen and twenty years of age, and it is not uncommon to find ordinary seamen as young as sixteen. Quick promotion seems as much a habit in the Navy as quick luncheons in New York. A sailor may pass through all the grades from ordinary seaman to chief petty officer in the four years of his commission. He may go into the Naval Academy—"it is all laid down by Congress," said my friend—and if he passes his examinations, emerge as an officer with a cocked hat and a command. We don't do that sort of thing in our Navy. Perhaps it is a pity we don't.

AEROPLANE PARACHUTE

An aeroplane which spreads a parachute when falling in somewhat the same manner that a bird spreads its wings is being tried out in France. The parachute is in the form of additional planes or bearing surfaces, which are tucked in when flying, and

drawn out in case of accident. One of the accompanying illustrations shows the parachute planes tucked close against the edges of the upper plane of the aeroplane; in the other, they are stretched out on the supporting frame.

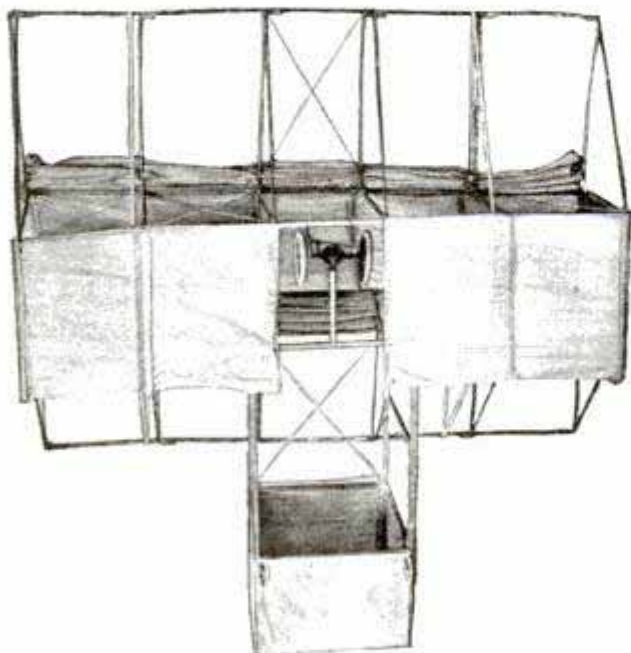

Parachute Planes Closed

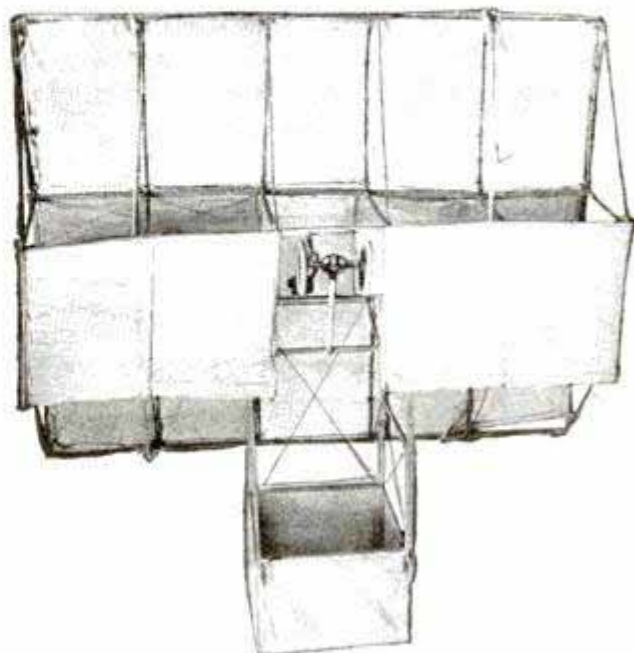

Parachute Planes Stretched Out

WHERE NATIONS MEET

The rulers of three nations could meet by the stones shown in the accompanying illustration and hold a conference, each ruler standing on his own territory.

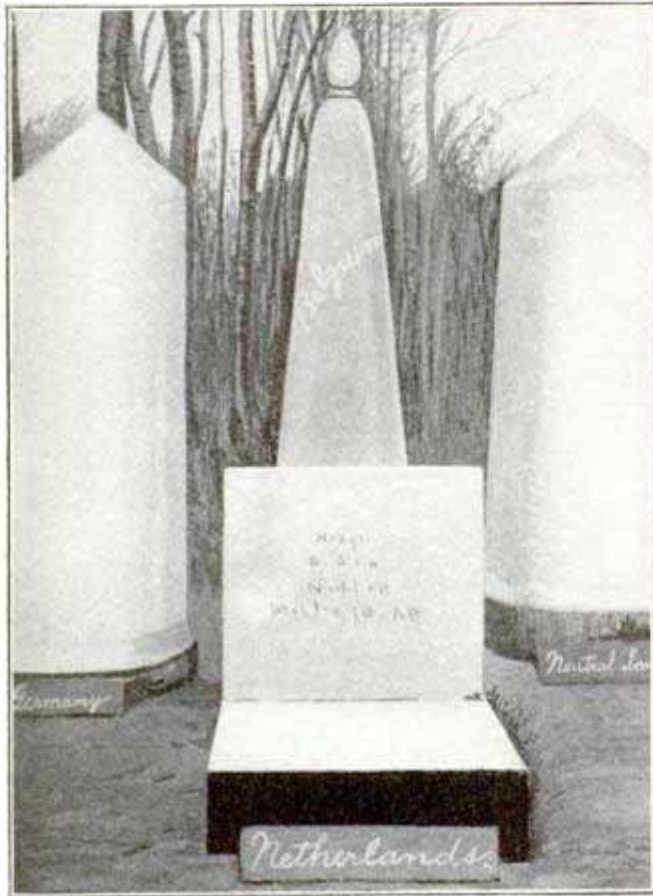

Where Germany, Belgium and Holland Meet

The stone on the left marks the limit of Germany, and the one at the right is on neutral land. The stone in front of the center is in Holland, and the one at the back of the center is in Belgium. A person, starting from the stone marking neutral territory, could visit three nations by taking only a few steps.

CONCRETE BRACKETS SUPPORT STREET

Concrete brackets are used to support a 1,500-ft. section of the Rue de Rome near the Saint Lazare station, Paris, this unique method being adopted through the necessity of utilizing the space under this street as one of the approaches to the station. Supporting columns would have been

in the way, therefore the brackets were decided upon as the only solution.

The wall carrying the brackets rises to a height of 63 ft., and the brackets are spaced 17 ft. apart. The width of the supported section is 23 ft. The pavement was tested with a load of 123 lb. per square foot. As a final and most formidable test, a 33-ton steam roller was made to bump its way over 1-in. wooden planks, nailed transversely to the wooden pavement.

PERSIAN CORN BARN

Although the true home of maize, commonly called corn in this country, is American, it not being known in Europe until after the discovery of the New World, it is now grown in many lands and has many names. The plant bearing the ears, sometimes called gigantic grass, is known to the botanists as *Zea Mays*. In Great Britain the cereal is familiarly known as maize, or Indian corn; in Holland and Hungary it is called Turkish wheat; in Egypt, Syrian dhurra; in the South African colonies, mealies.

The curious structure shown in the illustration is a Persian corn barn. It looks like a giant bird house, and is raised high above the ground as a protection.



Storing Corn in Persia

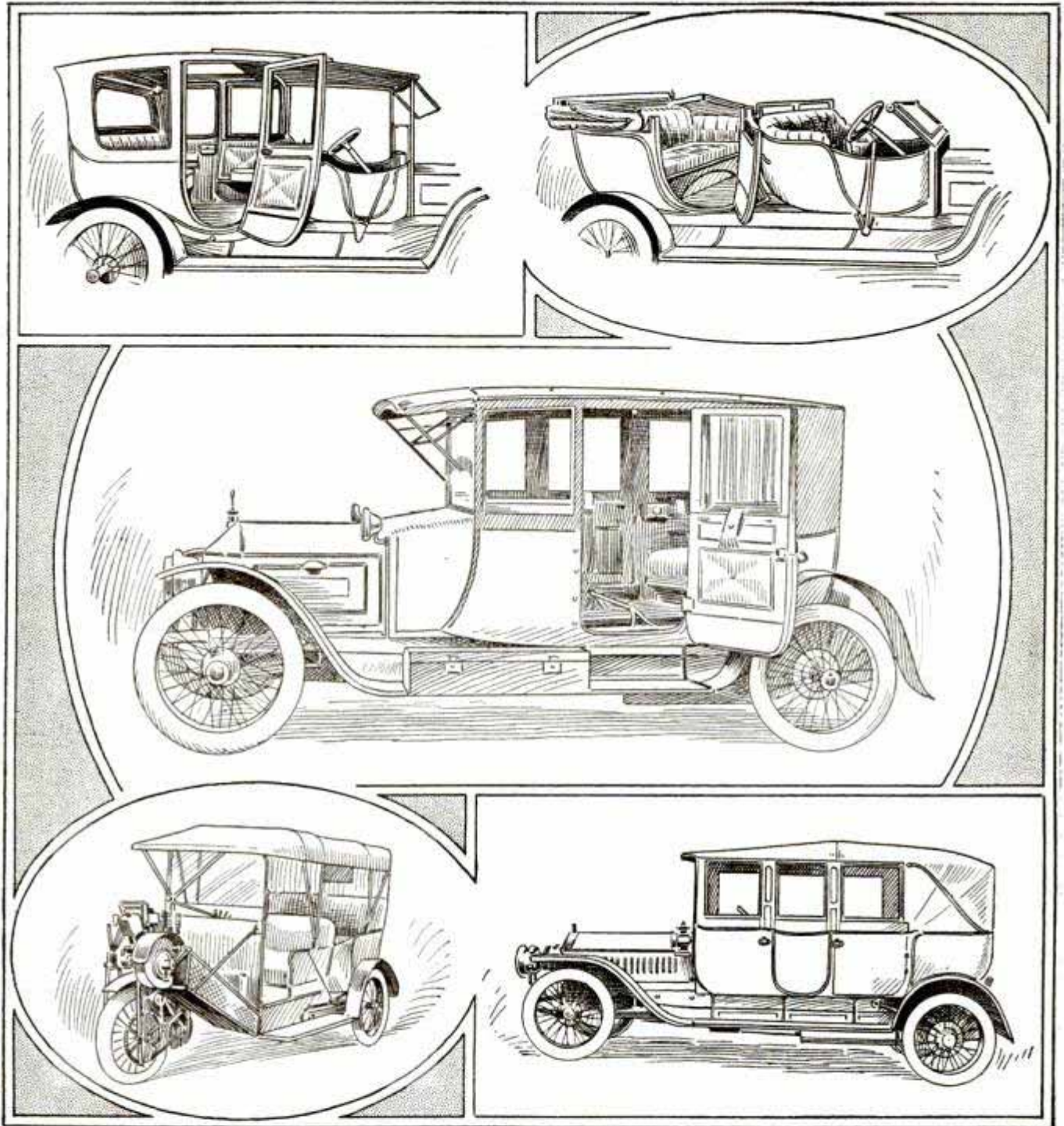

New Design of Limousine Body with Sliding Roof to Improve Ventilation

Two-Purpose Car—Windows on Back of Front Seat and Top Convert Car into Landaulette

A Car of Grace and Beauty—Note Open Body and Foot-Rest

New Three-Wheeled Car Made Up in Touring-Car Fashion—Engine Mounted on Top of Wheel

A Handsome Car of the Landaulette Type—Awarded Grand Prix at Brussels Exhibition

THE LONDON MOTOR SHOW AT OLYMPIA

ALTHOUGH no revolutionary departures in construction or design were shown at the recent London Motor Show, the exhibits emphasized the rapid development of the automobile. New body designs were numerous and the general tendency toward small cars was very noticeable. Most of the cars on exhibit were fitted with motors of between 12 and 15 hp. This low horsepower is favored because it allows the car owner to escape the heavier tax on the higher-powered machines. Other features of the show were: the extension forward of limousine bodies; reduction of noise; application of six-cylinder principle to comparatively small engines; curved wind-shields to deflect draughts over head of driver, and wind-shield in front of back seat; increasing favor of worm-drive back axle; drift toward adoption of a drive giving four speeds as opposed to three; gradual disappearance of chain drive; and increasing use of wire wheels.

ELECTRIC HEATER OF POCKET SIZE



One of the most convenient of water heaters yet invented is so small that it can be conveniently carried in a pocket, yet it will boil a quart of water in three minutes when attached to an ordinary electric-light socket. The cost of bringing a quart of water to the boiling point is only three-tenths of a cent. When not in use it can be instantly detached from the socket. As the diagram shows, it is a small cylinder of perforated metal,

only 5 in. long, by $1\frac{1}{4}$ in. in diameter. It has a capacity of 6 amp., 117 alternating current maximum.

COMPRESSOR AIR TAKEN FROM CAR ROOF

The master mechanic of a Rhode Island trolley company has done away with the troubles arising from the collection of grit and dust on the teeth of the motor pinions and the compressor gears, by placing felt shields on the motor cases and piping the compressor air from the car roof. In the open cars the latter operation has been accomplished by utilizing the spouts designed to carry off water from the eave troughs; while on the closed cars the pipe is carried up back of the controller and through the roof. By this method, clean air for the compressor is secured at all times.

WIRELESS ON AN ARCTIC OUTPOST

Wireless telegraphy already has produced wonderful results in the cause of improved facilities of transportation and communication over land and sea, but of no small value will be the uses which navigators expect to make of it next spring in gathering reliable data about the thickness of the ice floes that annually drift southward in the path of transatlantic steamships, and likewise greatly endanger coast traffic in the vicinity of the Gulf of St. Lawrence and Labrador.

The Secretary of Commerce and Labor has been advised that a wireless station is being erected on the Magdalen Islands. This island group forms an outpost from which early information concerning the probable time when it is safe to resume navigation to and from North Atlantic ports usually is looked for. In the past, when the cables connecting the islands and the mainland have failed to work, it has been impossible for navigators to form a correct judgment of ice conditions.

BUGGY DEMOLISHED BY A TRAIN

It would seem impossible for a vehicle to be smashed as completely as is

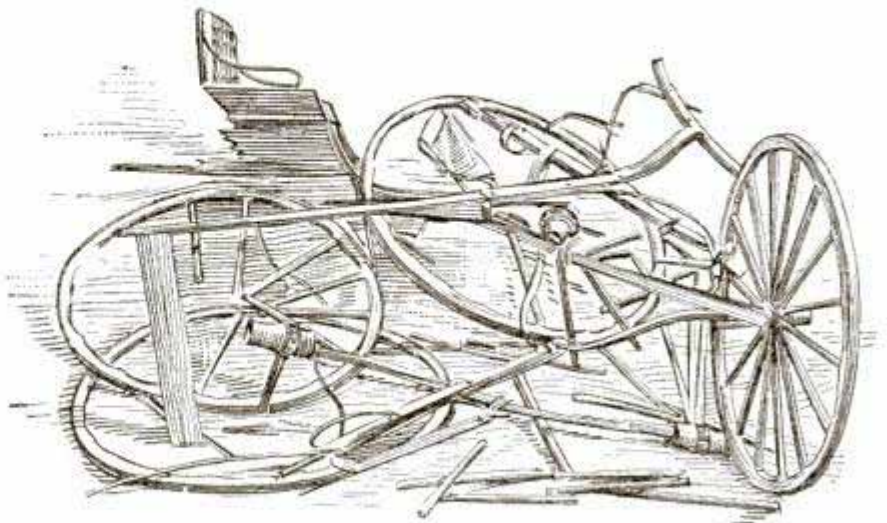

Driver and Horses Escaped Injury

shown in the accompanying illustration without injuring the occupant or the horses, yet such is the fact. Drawn

by a team of horses and occupied by its owner, the vehicle was struck by a train near Victoria, Australia, recently, both the owner and the horses escaping without even slight injuries.

WASHED MONEY MISTAKEN FOR COUNTERFEIT

The Treasury Department has discovered what promises to be a serious defect in the proposed system of "laundering" paper currency. A New York woman washed and ironed a bill, cleaning it so well that a banker to whom it was afterward submitted, pronounced it a counterfeit and sent it to the secret service officials. Chief John E. Wilkie, in order to test the judgment of various persons around his office, placed the "laundered" bill with a number of good counterfeits and requested them to pick out the good bill. In every instance a counterfeit was picked out as the true legal tender. Secret service agents declare that fully 80 per cent of the government's money will be mistaken for counterfeit if the cleaning process is finally approved. The washing makes the sharp lines of the engraving indistinct and gives the note the appearance of a poor imitation.

NEW IDEA IN BEAM COMPASSES

A recent improvement in beam compasses will be of interest to draftsmen. In most instruments of this kind the adjustment for length is obtained by moving a nut along a screw. This nut is often located where it is inconvenient to operate and the setting therefore is rather slow. Besides, the price of the instrument is often prohibitive to a majority of those who work at the drafting table; for while sometimes very badly needed, it is not required often enough to warrant the extra outlay.

In the new compass the point, as shown in the illustration, is set on the outer edge of a milled disk and is consequently eccentric with the end of the beam. The micrometer adjustment

is obtained almost instantly by simply turning the disk, one-half revolution of

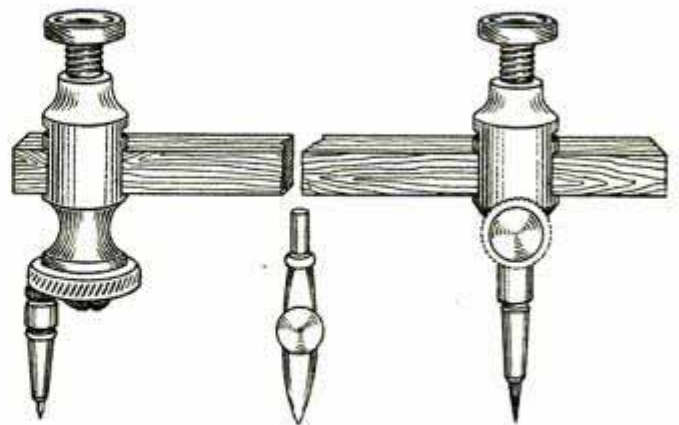

Micrometer Adjustment Trammel Points

which gives the full range of $\frac{1}{2}$ -in. adjustment.

"SIGN OF THE RED CAR" IS NEWEST NAME BOARD

Will the "Sign of the Red Car" displace the "White Horse Tavern" and "Tea Cup Inn?" An enterprising automobile dealer has adopted for his place of business a sign symbolic of his trade. The sign shows the outline of the front of an automobile, with the name

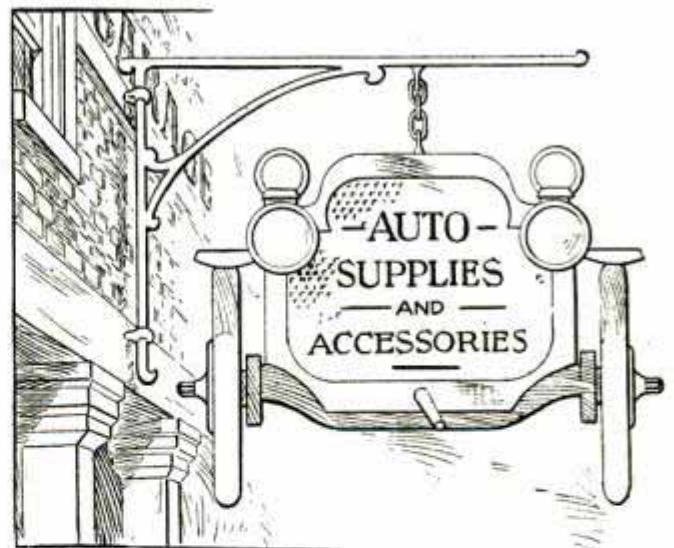

Unique Sign of Auto Supplies' Dealer

of the dealer and his business painted on what would be the radiator front of a real car.

Tests made for recovering cement from apparently empty cement sacks resulted in finding 4,130 lb. of cement in 7,598 bags.

An ingenious musical watch more than a century old is shown in the accompanying illustration.



Clock and Music Box Mechanism

It is a French repeater, made about 1795, and still keeps time with a loss of but one minute a week, repeating the hours and quarters and playing one tune. The case and dial are gold, and the figures and minute marks are enamel.

CABINET ELECTRIC HEATER

An extremely interesting method of housing an electric radiator has been evolved by an electrical supply concern in London, Eng.

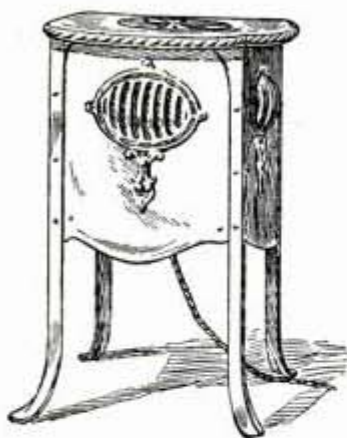

It is called the "cabinet radiator" and is finished in oxidized brass, copper, or silver. The cabinets are from 2 to 3 ft. high,

and are about 16 in. wide.

France has 25 aerodromes at which 35 aviation schools are conducted.

Few people realize that the phrase used in the wedding service incidental to placing the ring on the bride's finger is something more than a form. In ancient days, when the ring first appeared as an adjunct to the wedding service, it meant literally that the groom did endow his wife with all his worldly goods, for the ring usually represented the sum total of these. That was the beginning of the use of the ring at marriages and it has continued to this day. The Egyptians are credited with being the first people to use it. In the old days before the time of mints and coinage, the gold money in Egypt was made in the form of a ring and usually worn on the finger as a convenient method of carrying and safe keeping. The men and women therefore had all their gold, or wealth, made into rings and for the majority of people these rings were no larger than the plain gold bands of today. When the groom placed the ring on the bride's finger, therefore, he meant exactly what the modern service makes him say.

There are many quaint and pretty customs relating to the act of placing the circlet of gold on the woman's finger as she is wedded. It was in 860 A. D. that the first church wedding service was prescribed by Pope Innocent III, and the ring was made a part of it. Then the man repeated the "Gloria" as he placed the ring successively on the thumb, the first, middle and ring fingers of his bride's left hand, leaving it finally on the latter. In the time of Queen Elizabeth, it was customary for the women to wear their wedding rings on their thumbs, the wife removing the ring from her fourth finger immediately after the ceremony. This custom also prevailed in the time of George I.

In the 14th and 15th centuries, the custom of wearing twin or "Gimmel" rings prevailed. These rings had their origin in Rome where they were known as "fide" and were supposed to

symbolize the fidelity and faith of the union. They were two small hoops that fitted one within the other, some of which were constructed with two hands clasped together. The so-called "posey" rings of England originated in Elizabethan days and continued popular to the 18th century, the "posey" being a pretty sentiment engraved on the band. Sometimes the sentiment was lengthened into a verse and then as many as five of these little engraved hoops were used.

Wedding rings were not always made of gold. In the most ancient days of which mention is made of them in history, excepting in the case of the Egyptians, iron was the metal used. And iron continued to be used for many years and by many of the peoples who adopted the custom. In Germany, the custom of making the rings of the grosser metal was revived in 1813 as a result of the action of the women of Prussia in giving their gold rings to be used to defray the expenses of the war of liberation. In this instance the government gave iron rings in exchange for the gold, the new rings being inscribed: "I gave gold for iron." In many old Prussian families the iron rings are preserved as sacred relics and in some of them the greatest honor that can be conferred on a bride today is to be wedded with one of these heirlooms.

SUBMARINE CONSTRUCTED TO RESCUE ITSELF

A submarine which, in case of accident, will drop its keel and rise safely to the surface, so the inventor hopes at

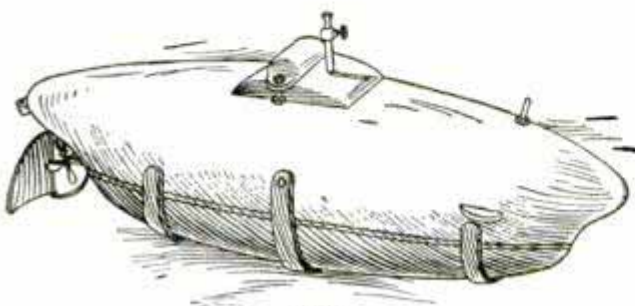

FIG. 1

The Sections of the Submarine Attached

least, has been designed by a French engineer.

The submarine is divided along a horizontal plane into two parts, of

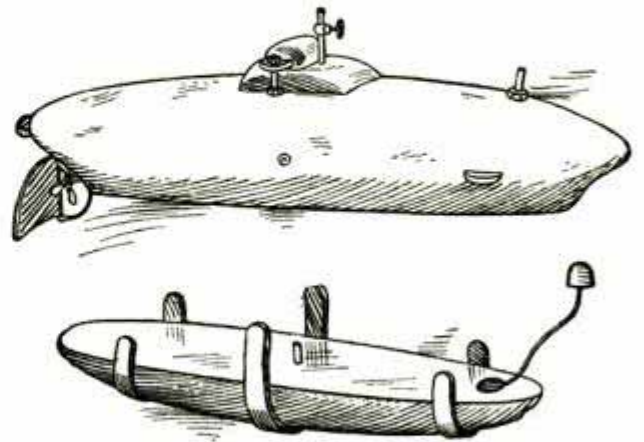

FIG. 2

Submarine with Keel Dropped

which the lower, the water-ballast compartment, can be detached from the upper, which is the submarine proper. In case of an accident, not entirely wrecking or filling the craft with water, it is hoped that by dropping the lower section, the upper, containing the crew, all the machinery, and the fighting mechanisms, would rise.

Metal straps pass around the lower section and hold it fast to the upper by means of threaded rods, operated automatically or by hand from the inside. The tube rising from the center of the lower section has a hermetic contact with a like tube in the upper section, but is not otherwise joined. When the submarine is to be submerged, the ballast compartment is gradually filled with water by means of this tube, the displaced air escaping. When the submarine is to rise, compressed air drives the water out of the ballast compartment. Should the lower section have to be dropped, a float rises to the surface as a means of locating its position.

¶An underground telephone cable is to be laid from Washington to New York, later to be extended as far as Boston, tests of the system having convinced electrical engineers of the superiority of this system over aerial construction.

The use of crude oil instead of the higher priced gasoline in heating the

gether and almost entirely efficient the tire.

PROPOSED IRISH TRANS-ATLANTIC LINE

Plans for a transatlantic line between Galway and Halifax are under consideration. Galway is situated at about the middle of the west coast of Ireland, and vessels starting from there will enter directly upon the Atlantic, with Halifax but 2,196 miles distant. At the rate of speed of the "Lusitania" the voyage between these two ports could be made in 3½ days.

Galway is 126 miles from Dublin, on the main line of the Midland Great Western Railway. An interesting feature of the scheme is to run car ferries across the Irish Sea from Kingstown to Holyhead, whereby boat trains may be sent directly through between London and Galway. The entire journey between these two points would consume but 12 hours, which would mean only four days from London to Canada.

FAST LOCOMOTIVE FOR HEAVY SERVICE

This locomotive, which was built by a German concern and exhibited at the International Exhibition at Brussels, is one of the largest ever turned out in Europe. Although it does not exceed in general dimensions the American locomotives of corresponding types, it is said to be remarkable for its combination of high tractive power and great speed. It hauls a 700-ton train over level track at a speed of 74½ miles an hour, and at a speed of 37½ miles on gradients of 1 ft. in 100 ft.

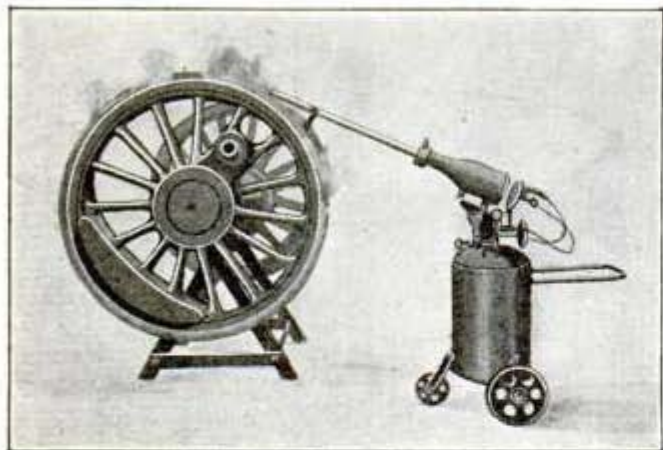

Crude-Oil Tire Heater in Operation

tires of locomotive wheels for removal is possible with the tire-heater shown in the accompanying illustration. It is claimed that 1½ to 2½ gal. of crude oil in this heater will do the work that formerly required from 3 to 4 gal. of gasoline.

The apparatus consists of a 20-gal. tank mounted on wheels, a generator mounted on the top of the tank in such manner that it may be adjusted vertically, and a heating ring which leads from the generator and surrounds the tire. The apparatus is wheeled to any part of the shop and connected with the shop air line. To start the generator, a small piece of waste, saturated with crude oil, is ignited and placed at its entrance. The oil is then turned on and almost immediately the chamber of the generator is heated to a white heat. The spraying of oil into the chamber then continues, and, coming in contact with the heated lining, is at once vaporized and passed into the burner. The gas burns at an intense heat at the

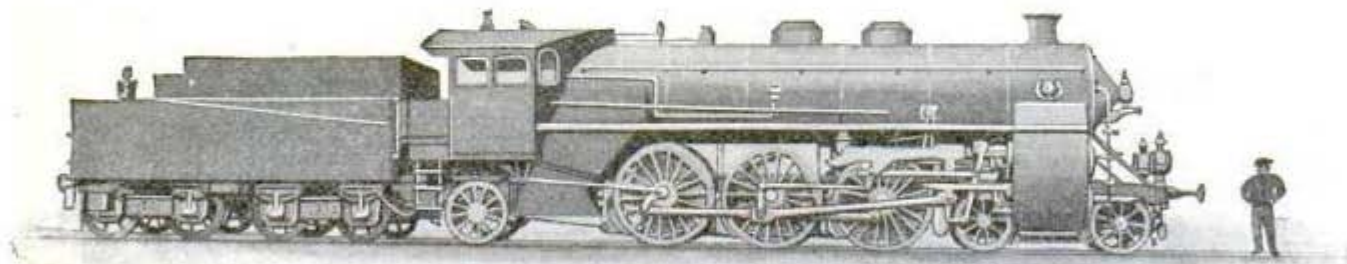

Draws 700-Ton Train 74½ Miles an Hour

THE MAKING OF ARTS-CRAFTS LAMPS

By JOHN D. ADAMS

Part VII—Lantern

ALTHOUGH there is no outward similarity between this lantern and the one described in Part VI, the method of construction is much the same. As previously mentioned, do not attempt to work with too heavy a grade of cardboard, particularly for lanterns. Carefully lay out the pattern for one side on a piece of heavy, flat paper, which should then be cut out with a sharp knife. Mark this off four times on the large sheet of cardboard, thus obtaining the pattern for all four sides in a continuous row as shown. Cut out the various openings with a sharp knife, and then score along the dotted lines for bending.

Do all the knife work from one side and over a hard wood board, in order that sharp, clean-cut edges may be obtained.

When all the cutting has been done, paste the colored paper on what will be the inside, and then carefully bend into shape, connecting the first and last sections by means of the extra strip, using

glue and passe-partout tape. The extra strips at the bottom should now be bent into a horizontal position and a paper fastener put in at each of the four overlapping corners.

The method of laying out the top is very simple. Draw a circle of 9-in. radius and space off four 12-in. chords. Draw a radial line from each of the points on the circumference, and the pattern is ready to cut.

Bend into shape, and make the connection with glue and passe-partout tape as usual. The extra strip at the top of each of the four sides should now be bent into an angle corresponding to the slope of the top, which is then to be placed in position and attached with glue and paper fasteners.

Ordinarily such a lantern is hung high up and is operated by means of a wall switch, so that it will only be necessary to make a small hole in the top and run the cord through, allowing the lantern to hang on top

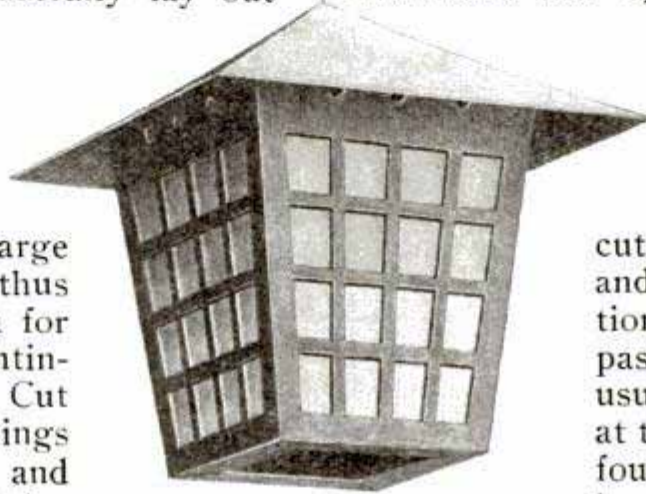

Lantern Complete

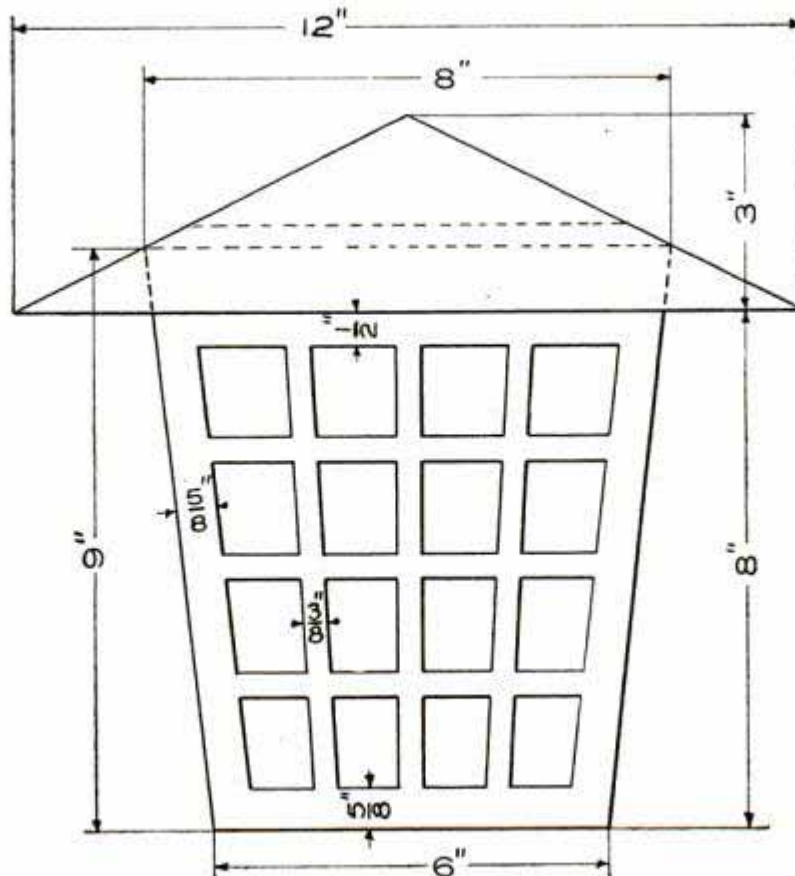

General Dimensions

on and on directly at the lantern, a one structure. But few, even among

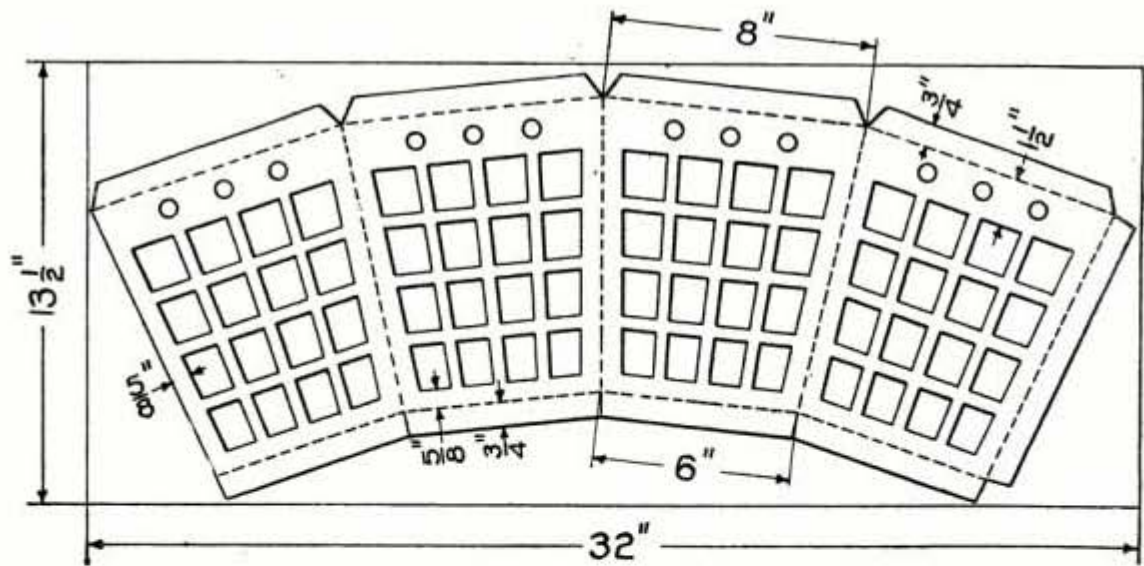

Detail of the Sides

socket operated by a little hanging chain may be used, or else a 1 1/2-in. hole may be cut in the top and the

well informed electrical men, are acquainted with the enormous quantities pertaining to the operation of such a plant.

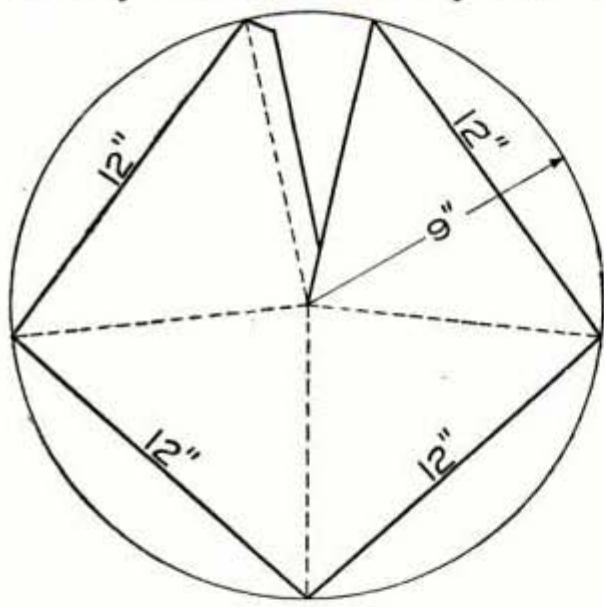

Layout for the Top

shade attached to the socket at a point just below the socket key, by means of four little strips of tin.

At a recent lecture before one of the local branches of The American Institute of Electrical Engineers, W. L. Abbott, chief operating engineer of the Commonwealth Edison Company, gave a most interesting description of this station, from which the following remarkable figures were obtained.

The entire plant of this one of the company's stations, including the coal-storage yard, switch tracks, power house, etc., covers an area of 16 acres. The main building is 475 ft. long by 240 ft. wide. From this rise the five giant smokestacks, each 20 ft. in diameter by 250 ft. high. There are 300 men usually employed in and about the station, of which nearly one-half are employed in operating the machinery and apparatus that handle the coal. No less than 50 huge car-loads of coal are received each day at the station, and such is the efficiency of the methods used in handling it that the unloading cost amounts to the insignificant and altogether wonderful figure of but 2 cents a ton.

GREATEST STEAM-ELECTRIC POWER PLANT

Those versed in the growth and development of the great electric generating stations of these progressive times are doubtless well aware that the Fisk Street Station of the Commonwealth Edison Company, of Chicago, contains the greatest aggregation of

There are 80 boilers in the power house, each of the nominal rating of 500 hp. and developing in the ordinary run about 800 hp. This gives a total

normal horsepower capacity of 64,000. When all of these boilers are working at normal capacity, coal is burned up at the rate of $2\frac{1}{2}$ tons per minute, evaporating 1,700 tons of water, and drawing from the boiler room and discharging from the tops of the stacks 62 tons of air, per minute, or about 25,000 cu. ft. of air per second.

The type of engine used is the Curtis steam turbine, with vertical shaft. The shaft of one of these machines, together with the revolving buckets of the turbine and the rotating field of the electric generator, forms a unit weighing 150,000 lb. This is supported on a steel footstep bearing, 20 in. in diameter and 18 in. high, the bearing being separated from the shoe of the shaft by a lubricating film of oil forced in at a pressure of 750 lb. per square inch. The normal speed is 750 revolutions per minute, and such are the balance and the energy of the moving parts that when once set in motion the shaft with its adhering parts will continue to revolve for several hours before coming to rest. In the event of a short circuit happening, however, the enormous revolving mass would be brought to rest in the fraction of a second.

RATCHET WHEEL WINDS UP TOY AEROPLANES

The tedious operation of winding up a toy aeroplane by turning the propeller

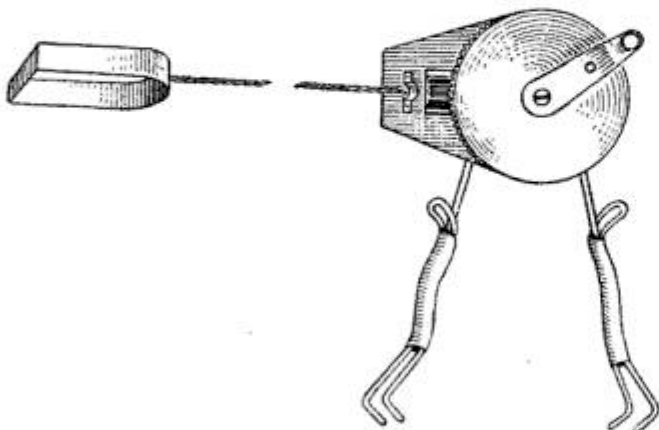

Winder before Attachment to Aeroplane

er a hundred or more times, according to the length of the rubber band used, is obviated by a little device invented in France. It consists of a ratchet

wheel, provided with pincers of spring wire to clutch the mounting of the

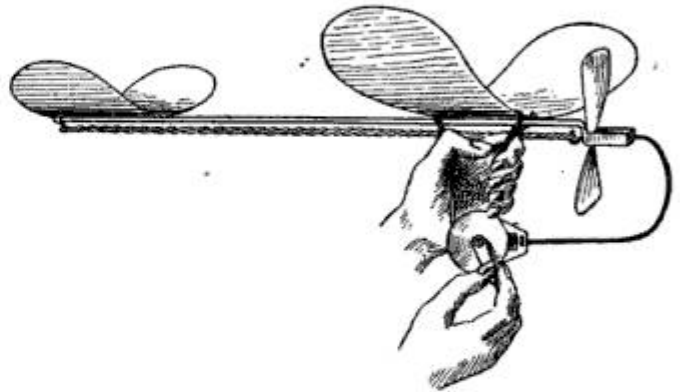

In Position, with Winding Completed

aeroplane, and a clamp attached to the propeller and connected with the ratchet wheel by means of a flexible spring. The rubber band is quickly twisted by turning the crank of the ratchet wheel. By the time it has been twisted sufficiently, the flexible spring connecting the ratchet wheel with the propeller has taken the form of a loop, which is the signal to stop winding.

GIANT LOCOMOTIVE FOR VIRGINIA RAILWAY

A locomotive built under a guarantee to haul a train of 20 cars of 28 tons each, with a caboose, up a 2.07-per cent grade, has just been delivered to the Virginian Railway for use in its freight service. While this is not the largest locomotive ever turned out in America, it is one of the most powerful. The wheel base of the engine and tender is 89 ft. $2\frac{1}{2}$ in. and the total weight of the engine and tender is 625,000 lb. The weight on the 16 drive-wheels, which are 56 in. in diameter, is given as 405,400 lb. The engine is of the Mallet type and is equipped with compound cylinders supplied with steam by boilers having a heating surface of 5,232 sq. ft.

☞ Radium now costs \$900,000 less an ounce than it did a year ago, the latest quotation being \$2,100,000. Radium banks in Paris and London lend the precious stuff at the rate of \$200 per 100 milligrammes to scientists and physicians.

HOW TO MAKE A WALL CASE

The wall case shown in the accompanying picture will serve well as a

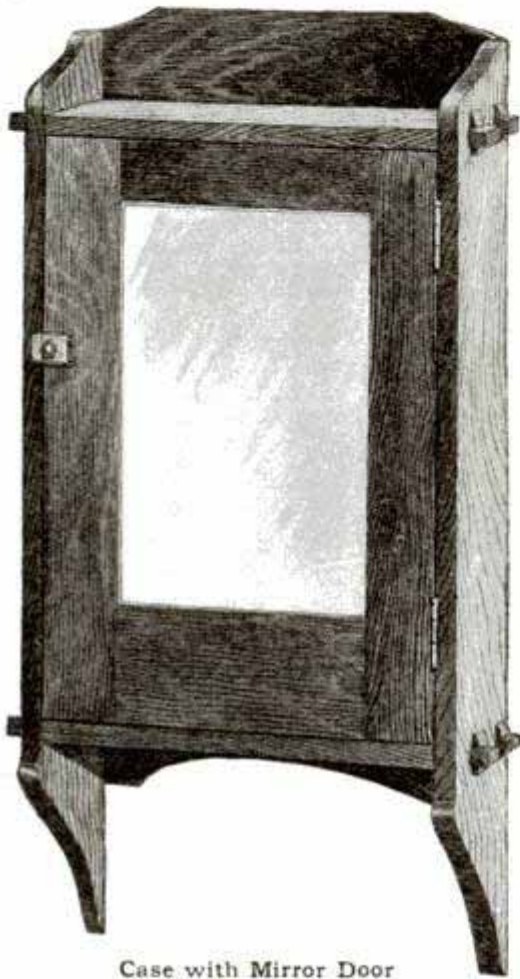

Case with Mirror Door

medicine case. Having a paneled door in which is set a mirror, it serves equally well as a shaving case. It is best made of some hard wood, though a soft wood such as pine or yellow poplar will work up easier and look well finished with three or four coats of white enamel paint.

There will be needed the following pieces:

- 2 sides, $\frac{5}{8}$ by 6 by $32\frac{1}{2}$ in., S-4-S.
- 1 top and 1 bottom, $\frac{5}{8}$ by 6 by 18 in., S-4-S.
- 1 top of back, $\frac{1}{2}$ by 4 by $16\frac{1}{4}$ in., S-2-S.
- 1 bottom of back, $\frac{1}{2}$ by 3 by $16\frac{1}{4}$ in., S-2-S.
- 1 shelf, $\frac{5}{8}$ by 5 by 16 in., S-4-S.
- 1 back, $\frac{1}{4}$ by 16 by 21 in., S-2-S.

DOOR

- 2 stiles, $\frac{5}{8}$ by 3 by $20\frac{1}{2}$ in., S-4-S.
- 1 top rail, $\frac{5}{8}$ by 2 by 11 in., S-4-S.
- 1 bottom rail, $\frac{5}{8}$ by 4 by 11 in., S-4-S.
- 1 backing for door, $\frac{1}{8}$ by 10 by 15 in., S-2-S.

First shape the ends of the two side pieces as shown in the drawing. Next square the top and bottom pieces of the case to size, and lay out and cut the

tenons on the ends. Lay out and cut the mortises in the side pieces, also the groove for the shelf, having first squared the shelf to size. Cut and shape the top and bottom pieces of the back as shown. Cut the rebates in the side pieces into which these pieces are to rest their ends. Cut the rebate for the back. Thoroughly scrape and sandpaper these parts and assemble them. Cut and fit the back in place.

The door is to be made next. Plan the different parts of the door so that the edges may be planed to fit the opening; that is, make the door a good quarter larger at top and bottom than the opening. In cutting the rebate, the easiest way is to use a rabbeting plane and cut the full length of the pieces. By using a tenon on the rails in which one shoulder is as much longer than the other as the rebate is deep, there is no resulting groove showing at the corner.

The wood should be finished before the glass is set; at least, it should be filled, if of hard wood, and one coat of paint put on, if of soft wood which is to be enameled.

In setting the glass, place a thin cushion of putty between the rebate

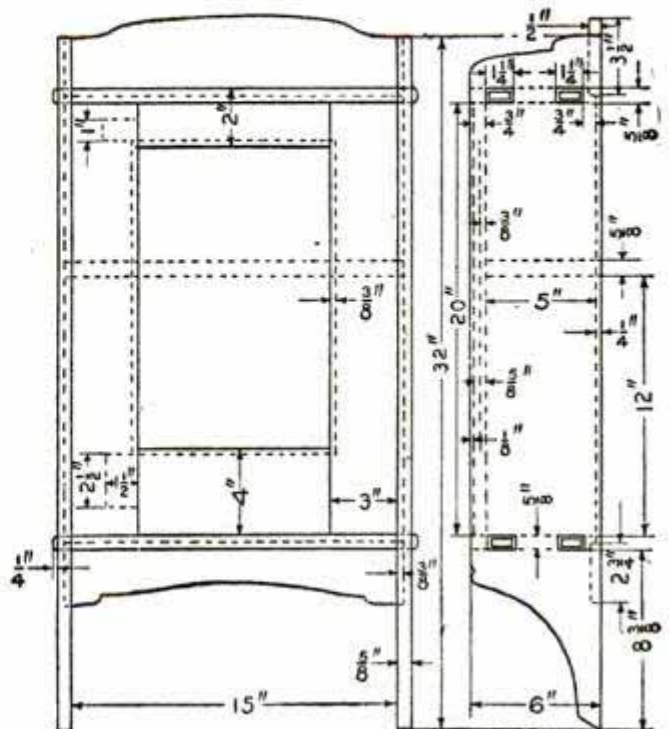

Wall Case Details

and the glass and another thin cushion between the glass and the fillet of wood or the backing which is to protect the back of the glass.

Fit the door, and then put on the hinges and lock. If desired, the tenons may be made keyed as shown in the photograph, instead of through as shown in the drawing.

To finish the case, if of oak, apply a coat of light paste filler, the directions being on the filler can. Next put on a coat of white shellac. When this has hardened, apply two coats of some good varnish. Allow time for each coat to harden and rub the first coats with hair cloth or curled hair, and the last with pulverized pumice and raw linseed oil or crude oil.

If the wood is soft and an enamel white is desired, the enamel is applied not unlike paint. The directions will be found on the cans in which the paint is purchased.

SIX-PIECE PIE-CUTTER

A pie-cutting device, which cuts a whole pie into six pieces at one operation, has been designed for the use of hotels and restaurants. It consists of



Six Pieces at One Cut

a base for the pie to rest upon, and a lever provided with six knives, arranged like the spokes of a wheel.

POSTMEN KNOCKERS

Postmen in some American cities ring the doorbell when delivering letters; in others, they blow a whistle as



Postman with Knocker

they approach the house; but in Kingston, Jamaica, each postman carries a knocker. These knockers are short, knobbed sticks or batons, with which they perform a rat-a-tat-tat on the doors where letters are to be left.

FRENCH BATTERY SAID TO BE MOST POWERFUL

While Edison has been working to perfect the battery for which great claims are made, the French have been far from idle, and today a Paris concern lays claim to the most powerful battery in the world.

According to the figures published by the Edison Storage Battery Company, the type known as A-4 has an output of 13.3 watt hours per pound, and A-6 an output of 16.8 watt hours per pound. The French concern is manufacturing one type of battery which it claims has an output of 17 watt hours per pound, and another with an output of 27.3 watt hours per pound.

Electric street cars and telephones are being introduced in Lebanon, Syria.

This unique clock, operated by falling steel balls, is designed to give the impression of perpetual motion, but it is an impression only, as the balls have to be elevated again by an electric motor.

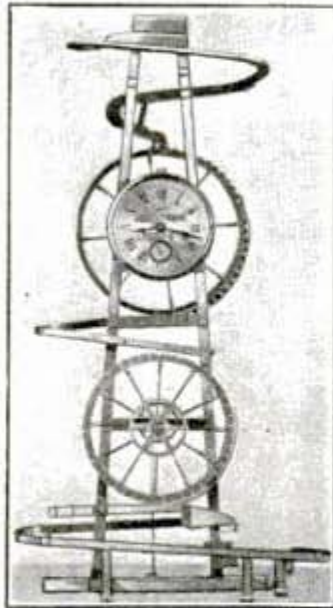

The clock is of the ordinary type with the main wheel and spring removed, the large wheel back of the dial taking their place. This wheel has 60 cups, half of which are continually filled with $\frac{1}{16}$ -in. steel balls, fed to it

by the upper trough. These balls keep the wheel turning. Once each minute, a ball falls from this wheel into the central runway, by which it is conveyed to the lower wheel, causing it to make one revolution. After the ball leaves the lower wheel, it is caught in a receptacle and held until five balls have been accumulated, the weight of this number discharging them into a runway which leads to a second receptacle. This receptacle is in turn weighted down by the balls and comes in contact with the brass frame of the clock, thus closing an electric circuit for three seconds, thereby starting the motor concealed in the box. The motor operates a conveyor chain concealed in the frame tubing, and this returns the balls to the starting place. The lower wheel has nothing to do with the running of the clock, but aids in the impression of perpetual motion.



¶The two destroyers built for the Australian government as part of its contribution to the British navy have been completed and are now under way from England to the antipodes.

Important results are expected in the navy from tests about to be made on the battleship "Nebraska" of the utility of the telegraph-typewriter in the transmission of orders from the fire-control station and conning tower to gun and battery commanders, the engineers and navigators. Recent developments have shown that the noise of the guns makes it almost impossible to hear signals sent on the Morse telegraph instruments and for the same reason, delicate and expensive appliances are necessary to make the telephone available. If the claims of the manufacturers of the telegraph-typewriters are found to be justified by experiments about to be undertaken with these instruments, it is possible the machines may be installed on all the battleships.

The telegraph-typewriter consists of three principal parts: a transmitter, polar relays actuated on the line, and the typewriter or printing device. The typewriter is operated by electrical impulses from a main-line circuit to print letters or other symbols corresponding to those of the transmitting instrument. The polar relays actuated by the impulses over the main-line circuit are of no special kind, any standard polar relay being entirely satisfactory. By a predetermined selection of impulses, certain combinations of three impulses of different polarity sent over the line select and print the exact character desired. The first impulse may be of any polarity, but the second must be different from the first and the third different from the second. There are 36 combinations possible with these three impulses, thus giving 36 different operations of the selecting mechanism. One of these is used for the letter space, one for the carriage return, one for the line space, one for the typewheel shift and one for the typewheel release. This leaves 31 combinations to determine the different positions of the typewheel, the type being carried on a small wheel, as is

the case in several of the typewriting machines now on the market. The impression or print from the wheel is obtained by a hammer which forces the paper against the typewheel, a form of mechanism that has also been in use on commercial typewriters for many years. The use of one of the combinations as a typewheel shift makes it possible to use 62 characters, two for each of the 31 combinations of impulses.

The selection of each individual letter by the machine is an absolutely independent operation, depending in no way upon the selection of the previous letter, as is the case in other machines of this character known as the "step and step" type. The Navy Department has been informed that the machine will work under line conditions even when the Morse might fail and that it is also free from local troubles that result from loss of current. The impulses sent over the wire are received in magnets which constitute the selective device. The printing hammer and the typewheel are controlled by one magnet. No magnet is worked on different current strength and the machine will print under any conditions, provided the proper impulses are received in their proper sequence.

MOVING-PICTURE SHOWS FOR CONVICTS

The inmates of the Federal penitentiary at Leavenworth, Kansas, and the Kansas State penitentiary are to be permitted to attend moving-picture shows. The shows, which will be given inside the penitentiaries, will be of the educational type and, in most instances, will form part of a lecture course. The chaplains of the two institutions believe that bible study will be promoted with the motion pictures. The use of motion pictures in penal institutions was given much attention by the delegates to the international prison congress which met in Washington recently, and the delegates expressed themselves as heartily in favor of the practice.

WIRELESS CONTROL OF WATER CRAFT

A young Australian inventor has given successful demonstrations of a

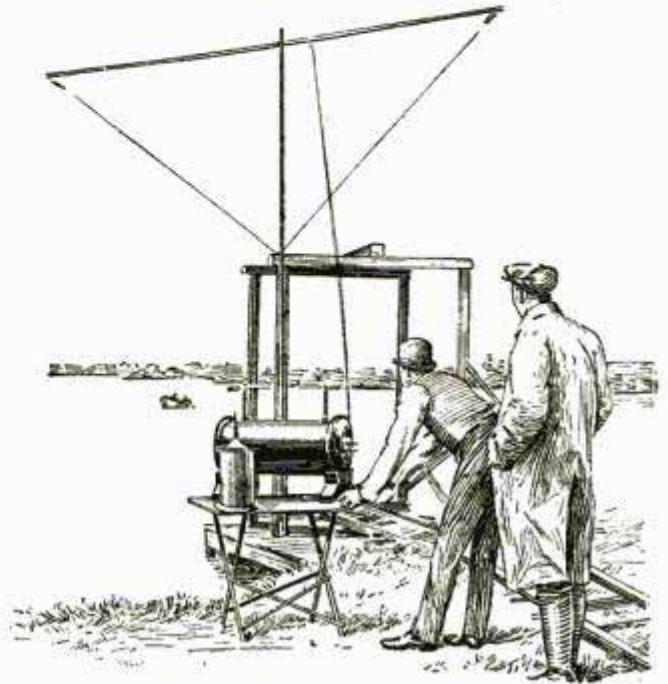

Controlling a Motorboat by Wireless

wireless apparatus for controlling the movement of boats on the water and torpedoes beneath the surface. Such control is not new, several European inventors having constructed apparatus for operating torpedoes, but the

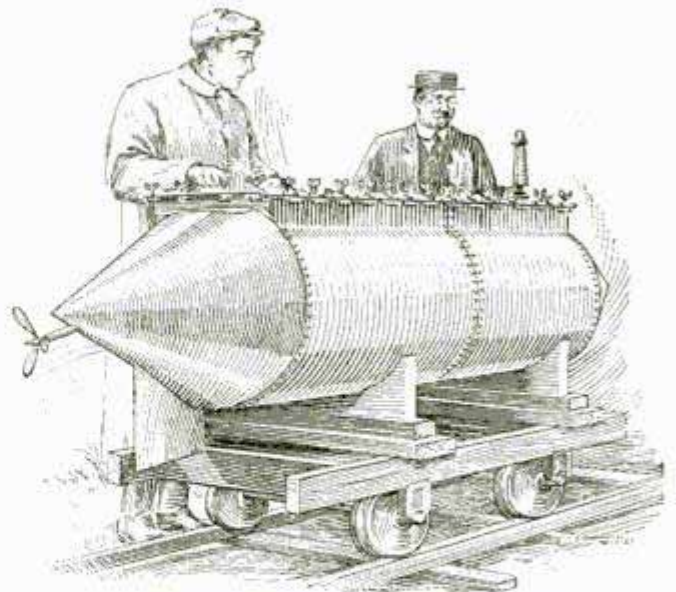

Wireless-Controlled Submersible Torpedo

Australian inventor has worked out what is said to be an improved system.

ⒸA prize for women aviators exclusively has been offered by a Paris ladies' journal, the *Femina*.

MOTOR-OPERATED TILLAGE MACHINE

A tillage machine which will perform the work of a plow, disk harrow and roller, tilling the soil in the same

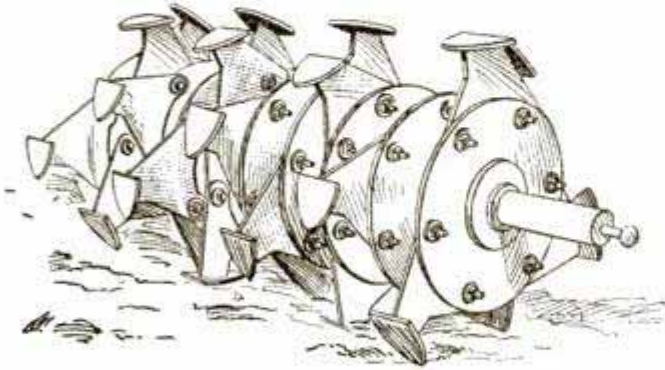

Tilling Mechanism of Hungarian Machine

manner as can be accomplished with a gardener's shovel and hoe, was recently described before the German Agricultural Society at Berlin.

Three strong wheels with broad rims carry a covered platform, upon the front part of which is a 45-hp. gasoline engine, making 500 revolutions per minute. The power is transmitted to the tilling mechanism by means of drive chain. This mechanism, which

is attached to the machine by means of adjustable arms, consists of a cylinder provided with disks. Two lateral sheet-steel knives attached to each one of these disks comprise the "hoe." When lowered to the ground, this mechanism will dig itself into the soil in a manner resembling the action of a paddle-wheel in water, digging up clods and throwing them backward against a guard, where they are crushed, finally reaching the ground again shattered to small pieces or thoroughly pulverized.

The adjustment for deep or shallow tilling is simple, and it is claimed that the machine will work in all kinds and conditions of soil. It leaves the seed bed equally well tilled to its entire depth, with the density of the soil particles increasing from the pulverized top layer down, so as to make the passage from loose to firm soil gradual.

According to a French authority, Germany will add 17 heavy ships to her navy during the next two years and England will turn out 22.

UTILIZING WASTE GAS-ENGINE HEAT

Jacket water and the exhaust are the two sources of great heat waste in

ent engines, but according to Prof. J. T. Faig, of the University of Cincinnati, this waste is generally three times as great as the amount converted into work in the cylinder.

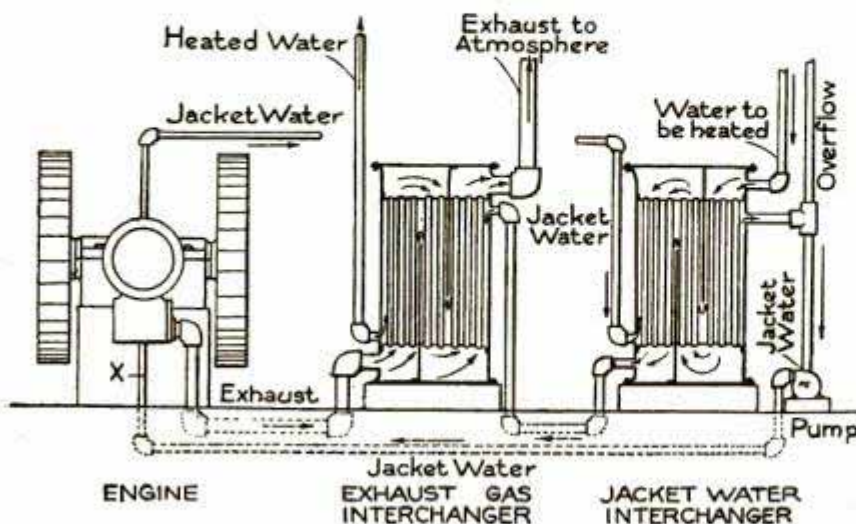

Heating with Waste Heat from Gas Engines

internal combustion engines. The amount of heat so lost varies in differ-

ent engines, but according to Prof. J. T. Faig, of the University of Cincinnati, this waste is generally three times as great as the amount converted into work in the cylinder. How Prof. Faig proposes to save 60 per cent of the total heat in the fuel is shown in the illustration, which is a drawing of an engine provided with two simple heat exchangers, one uses the jacket water and the other the exhaust gases. The jacket water is used over and over again. The water to be heated must have sufficient pressure to overcome friction of passage through the in-

terchangers. The circulation through the exchangers of the jacket water, exhaust gases, and water to be heated, is clearly shown.

MOVING-PICTURE FILMS ARE PHOTOGRAPHS

The decision recently handed down that moving-picture films should be appraised by the customs authorities as photographs and not as manufactured products of celluloid will result in the refund of more than \$300,000 that has been paid in duties, to importers. The customs authorities claimed that under the law they were required to appraise articles of import at the value of the chief material that entered into their manufacture, and as celluloid was the principal part of a moving-picture film, it should be assessed for duty under the head of celluloid. The duty on celluloid is 25 per cent *ad valorem*, (according to their value), plus 65 cents per pound. Photographs are dutiable at 25 per cent *ad valorem*. The difference in the duty on an ordinary roll of film would be about \$3. The moving-picture people fought the payment of the duty and have finally won out.

TRANSMITTING THE CORRECT TIME BY WIRELESS

Wireless apparatus for transmitting the correct time direct from the ob-



Receiving Correct Time by Wireless

servatory to offices, stores and homes on land, and ships at sea, has been devised by two French inventors. Just such a method of correcting clocks and watches was predicted by James Arthur in his series of articles on "Time and Its Measurement," published in this magazine in 1909.

Arrangements are being completed for holding regular motorboat racing regattas on the Nile.

THE "DUCK" AEROPLANE

Louis Paulhan, who is one of the best known of the French airmen, has designed an aeroplane which is called the "Duck" because, like the duck, it is to rise from the water instead of from land in commencing a flight and alight on the water again in making the descent.

Paulhan's invention is a series of three floats, attached as shown in the drawings. They are of a special shape calculated to minimize resistance in leaving the water. Under the force of the aerial propeller the floats are expected to practically climb out of the water.

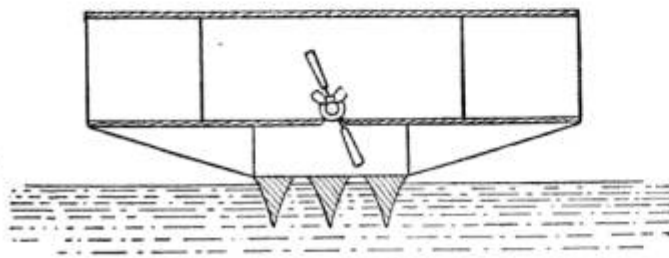

FIG. 1

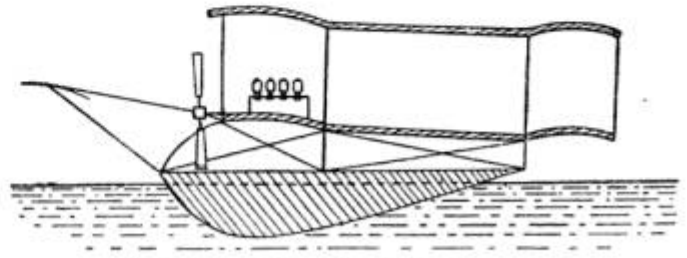

FIG. 2

Front and Side Views of Aeroplane Equipped for Starting from the Water

Three miles of piping that weighs 425 tons and is equipped with 117 hose connections, 24 roof hydrants and 12 flush hydrants, forms the basis of the thoroughly modern fire protection that has been prepared for the new Pennsylvania railroad station in New York, which covers 28 acres of ground. With this equipment it is possible to supply 12 standard fire streams at one time, pouring out 3,000 gal. of water per minute. The water comes from a 20-in. main on Seventh Avenue and a 24-in. main on Ninth Avenue. These two mains were tapped and cross connections were made with the private 12-in. main in 31st Street between the two avenues. The connections were carried directly to two 1,500-gal. pumps, which have a 16-in. suction pipe leading to two storage tanks, which have a capacity of 75,000 gal. The pumps can be operated singly or in battery, and connect with a 12-in. discharge union to the distributing system.

The distributing system comprises two sections. One of these supplies sixteen 4-in. standpipes inside the building and the other forms a 10-in. loop of gridiron shape that encircles the track level between Seventh Avenue and Ninth Avenue. The supply pipes are carried in pipe subways that encircle the building. The pumps are housed in a structure separate from the main building wherein is also the station power plant. All of the pipe is wrought steel. In the station building there are 83 hose connections placed about 80 ft. apart and each is supplied with 100 ft. of 2½-in. linen hose and an 18-in. nozzle having a 1-in. discharge. On the track levels there are 23 hose connections on the train platforms and 12 fire hydrants of the flush type in the yards. Each of the platform connections is equipped with 100 ft. of linen hose. For the roof hydrants there are connections of 100 ft. of rubber-lined hose for each hydrant.

Hand and chemical extinguishers are provided for the corridors in the upper

floors, there being seventy-five 3-gal. extinguishers in the building, besides which there are 33 extinguishers of the non-freezing type on the track level floor. There are also two 500-ft. hose reels, making a total hose equipment in the building of 15,000 ft. Outside the building there are six Siamese hose connections on the four street fronts, connected directly with the standpipes and to which the city fire engines can be attached in case anything goes wrong with the apparatus in the building.

As a further precaution, the building is equipped with a complete fire-alarm system of the most improved type, with gongs in centrally located points. This system operates in connection with the 116 alarm boxes placed in the tunnels. The fire brigade consisting of 25 men divided into three companies, includes a hose wagon company, a chemical engine company and a standpipe company. There are also five men designated to use the hand extinguishers. On the sounding of an alarm from any of the tunnel boxes, the power in the third rails of the tunnel is automatically cut off. This is regarded as the most complete fire-fighting equipment of any large structure in the world, coupled with the fact that the building itself is as near fireproof as it is possible to make it.

FIVE KILLED IN RUNAWAY CAR ACCIDENT

Five people were killed and 25 injured of the 35 passengers on a work car of the United Railways company of Portland, Ore., when the car was uncoupled from the locomotive that had pulled it up Tualatin Hill, October 26, and collided with a flat car. The accident was unique in the history of Pacific Coast railroads, as the car seemed to be in perfect condition before it parted from the locomotive. The brakes failed to hold it and it plunged down the steep grade.

The VANISHING FIGURE-HEADS



By J. E. BECHDOLT

TYPICAL of the romance of the sea and the glamor of the fast disappearing sailing fleet is the figure-head, the carved allegorical figure which a few years ago used to adorn the bow of every ship and which today can scarcely be found in any port. Occasionally in a "bone yard" or on some quiet tidal creek where the

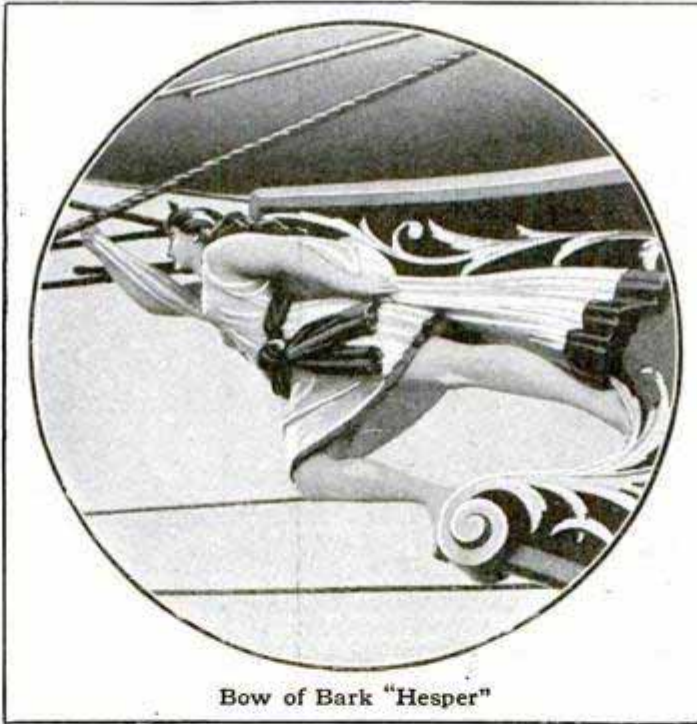

Bow of Bark "Hesper"

old hulks lie rotting out their days, one comes upon a vessel bearing one of these carvings beneath her bowsprit, stiff wooden gods and goddesses, statesmen of days gone by, and occasionally a fantastic gargoyle.

The figure-head has a family tree that goes back to the first venture of man on the

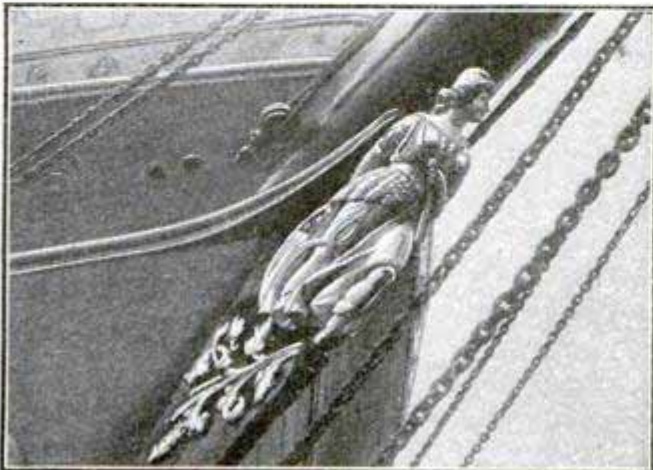

Goddess of Liberty on Ship "America"

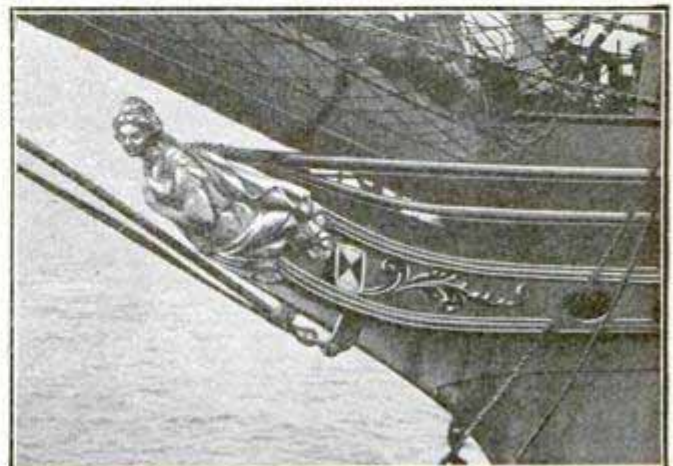

Teutonic Goddess on Bow of Ship "Adolph"

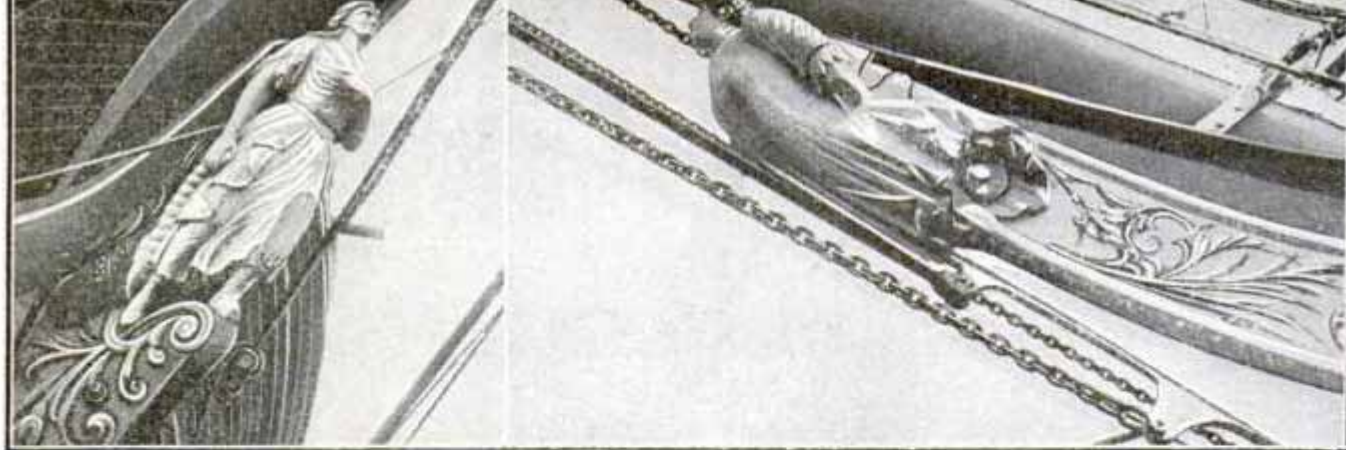

Allegorical Figure-Head on Bow of Ship "Glory of the Seas"

An Ecclesiastical Figure-Head on British Bark "Elginshire"

water. The most primitive tribes adorned the bows of their canoes with birds and beasts rudely daubed, just as the Indians of the Alaska coast do today. These gave to boats an individuality, propitiated the storm gods and brought good fortune to the ventures.

When Jason set out for the golden fleece he cut a bough from the talking oak of Dodona and had fashioned from it a figure of wondrous beauty. Had it not been for the sage advice of this oracle, the "Argo" would have been posted at some mythological Lloyds as one of the ships which never returned.

The Norse rovers fashioned the bows of their vessels into heads of wolves and drag-

ons and savage birds which they brightly gilded and daubed with crude colors. The cruel glaring faces at the beaks of the black fleet of Norway brought terror to many a peaceful farming colony.

In later days when ships put out for trade instead of war, the figure-head grew more peaceable, in sympathy with the vessel's mission.

Ancient Greece furnished all of her gods and goddesses to bless the enterprises of the old square riggers. Statesmen lent their frock-coated dignity to the "apple-bowed" craft. Proud owners in side whiskers and frilled shirts, one hand thrust into the swelling bosom of a wide-collared coat, became trademarks

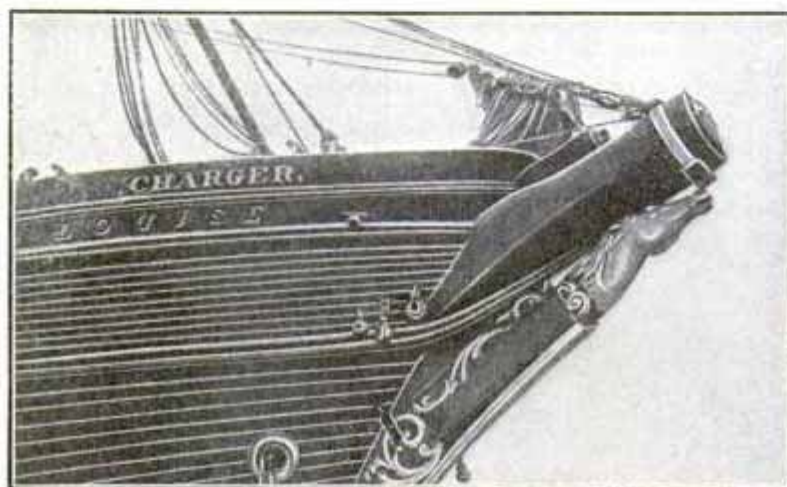

Horse's Head on Bark "Charger." Allegorical Figure-Head Was on This Vessel When Known as "Louise," but Another Was Substituted When Name Was Changed. Sailors Ascribe Change of Figure-Head and Name as Cause of Misfortunes Which Befell the Bark. It is Now Used as a Barge.

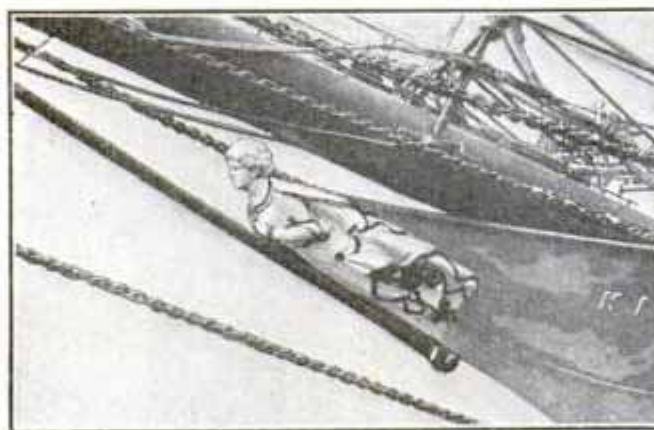

Carved Figure-Head on British Bark "Kidaltan"

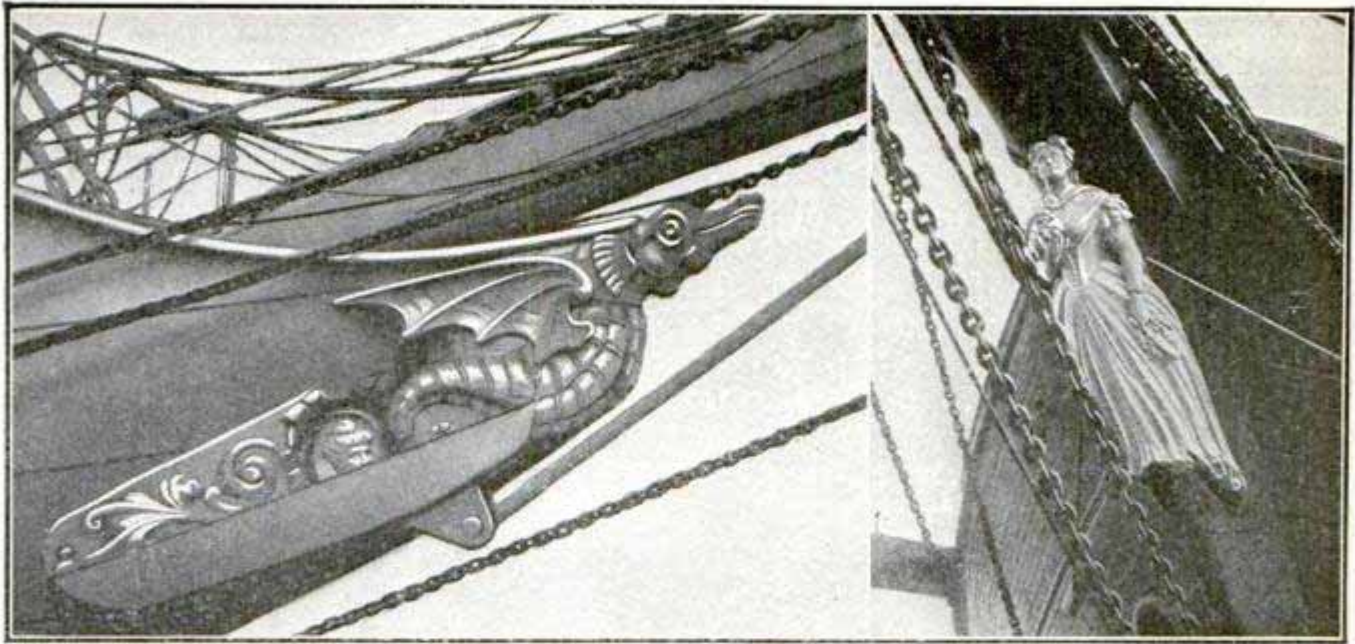

Grotesque Sea Horse at Bow of French Vessel and Graceful Figure-Head on Bow of "Kate Davenport," and Believed to be Portrait of Vessel's Namesake

for the vessels of their lines. Unwinking through the spray, stiff and formal in the hurricane, the effigies of hundreds of stodgy, stay-at-home owners rode triumphant over the waves.

Latter day ingenuity found in zinc a counterfeit for the hand-carved wooden figures and some of the latest of the figure-head family were fashioned from the metal. At about the same time steam became a factor in marine navigation and before the march of this powerful rival to wind, the figure-head shrank from view. Sailing ships had seen their day. New vessels were built with an eye to economy, and a scroll on the bow post succeeded the figure-head. Today even the scroll has disappeared.

The carving of figure-heads has become a lost art. A few years ago one of the last of the craft of carvers had a shop near the waterfront of San Francisco, but in the great earthquake and fire his place disappeared.

What becomes of the old figure-heads, is a question which suggests pleasant speculation. Charles Dickens in "The Old Curiosity Shop" tells of the finish of one which the dwarf, Quilp, used to vent his spleen upon, attacking it with a red-hot poker and burning hideous wounds upon its unresponsive features.

Time has dealt more kindly with a few. Occasionally one is seen in some muddy estuary, staring curiously across a field of potatoes or nosing a crumbling dock where lie the dismantled hulks. There is a whimsical touch of romance in the sight of one of the old forgotten figure-heads adorning a tidal canal and companionship with peaceful horses and cows.

The photographs herewith represent a few of the family yet afloat. Only the Indian, true to the traditions of his forefathers, regardless of steam and power craft has time today to adorn his boat in this way.

"VISIONS OF THE FUTURE" IN ELECTRICITY

In his recent presidential address to the Institution of Electrical Engineers, in London, England, S. Z. de Ferranti, a man whose practical accomplishments have helped to make electrical history, unfolded what he himself

termed "visions of the future," a story of the coming electrical age, when all power for the production of heat, light and mechanical energy will be generated electrically in a few great central stations distributed throughout

coal consumption in England from 150,000,000 long tons annually, to 60,000,000. Electricity would be so cheap that all mechanical operations, all lighting and cooking would be done by it, and the railroads would all be operated by this wonderful agent of our modern civilization. From the by-products, fertilizers would be produced cheaply to increase our crop production, and the light oils producible from the coal would furnish energy for automobiles, etc. Electric smelting would supplant

OLD MEXICAN ORE MILL

In the primitive mining operations in Mexico a stone mill, known as the "arrastre," is used for grinding ore. In the center of a stone-lined pit is a vertical axle from which extend sweeps, driven either by man or beast power, and on the crossarm extending through the axle are large square blocks of stone hung by chains which drag in

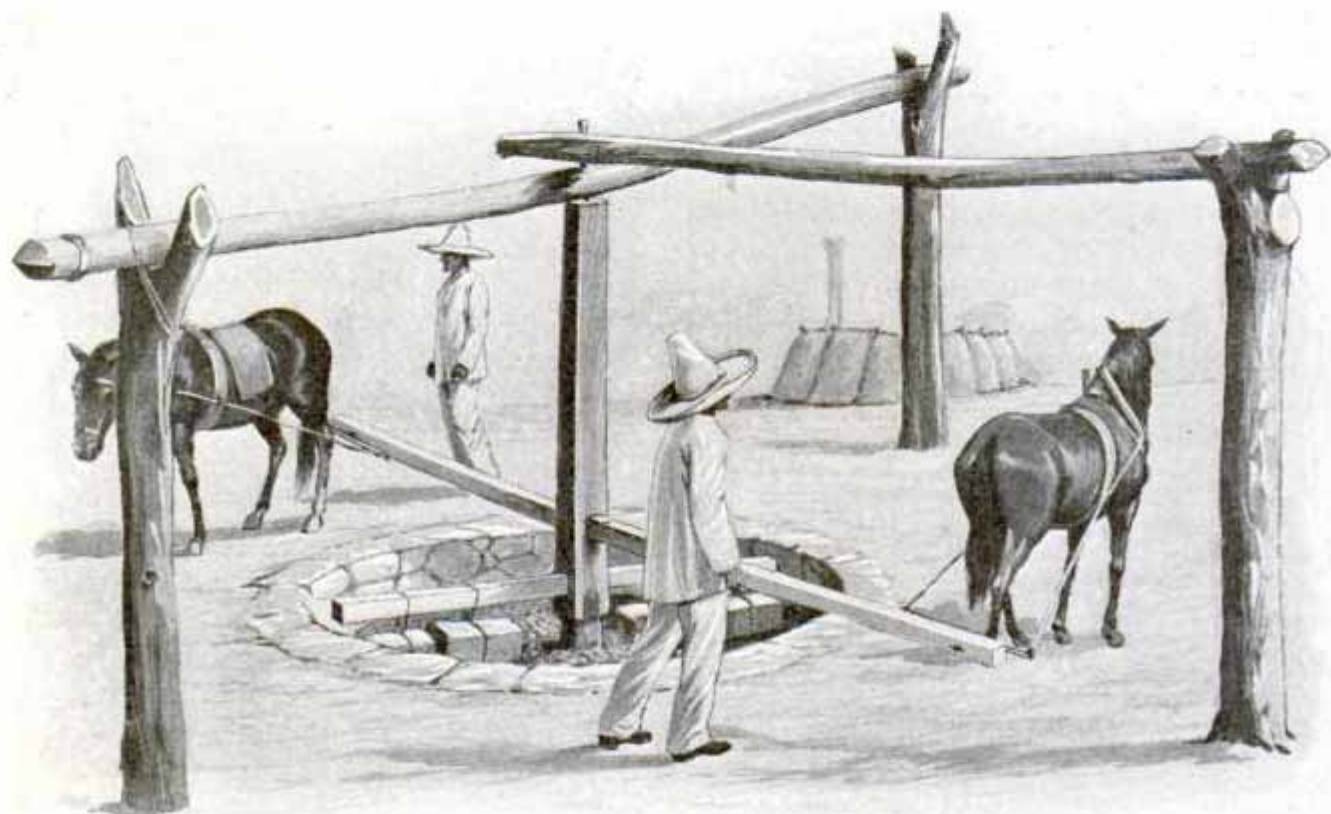

Mexican Ore Crusher

present-day methods, electro-chemical industries would prosper exceedingly, and even the rainfall would be controlled electrically. The banishment of the smoke evil would also tend to increase the productivity of our farms and gardens, and altogether make life a more cheerful prospect.

"Of course, there are many things which at present stand in the way of realizing such a scheme as I have outlined," declared Mr. de Ferranti, "but the more I have considered these ideas in detail, the more certain am I of the fundamental soundness under-

the bottom of the stone-lined pit. They are dragged around the pit and in this manner pulverize the ore. This method is exceedingly slow and has but small capacity, but it grinds the ore very fine and by reason of the absence of any steel grinding surfaces in connection with the ore, leaves it in particularly good condition for treatment metallurgically. Many of the arrastres were in use in the Mexican districts until recently and some of them are still in use, although most of them have been supplanted by modern mills, driven by steam or electric power.

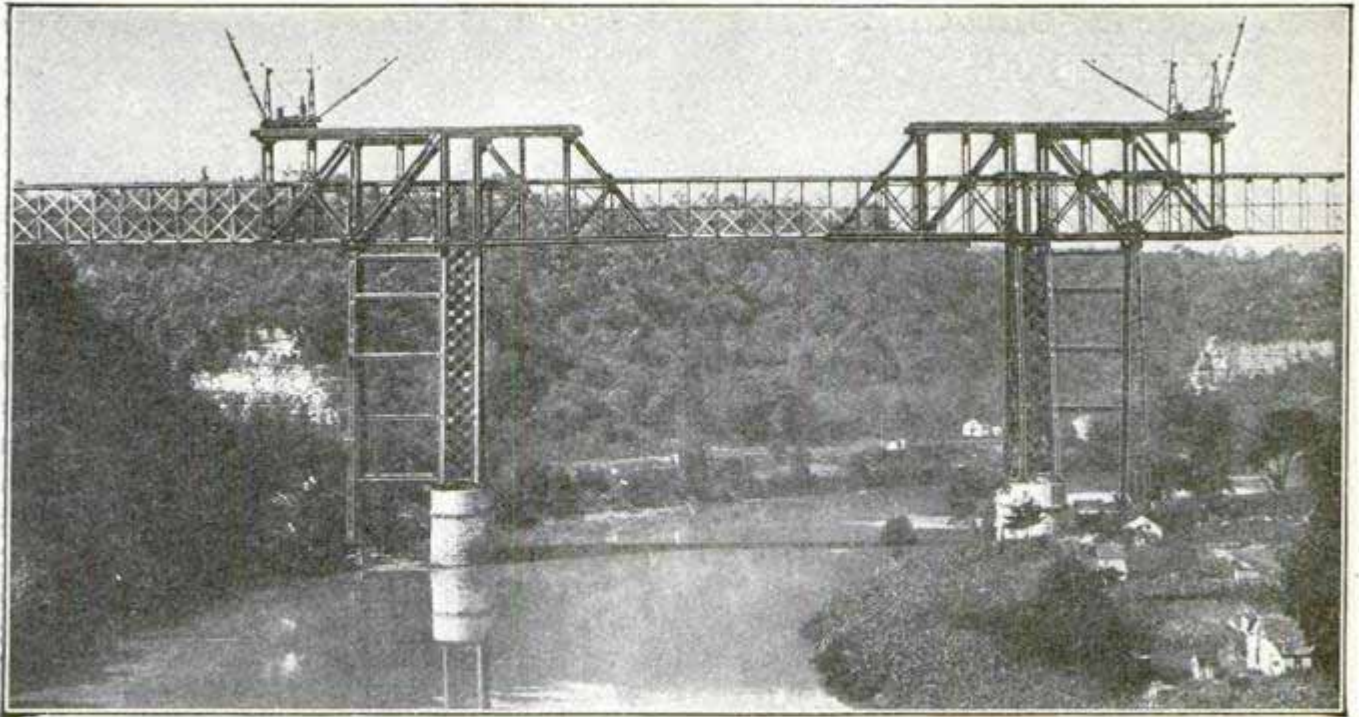

New Bridge Over the Kentucky River

THE KENTUCKY RIVER "HIGH BRIDGE"

The new bridge known as the "High Bridge," spanning the Kentucky River on the Cincinnati Southern Railroad, is claimed to be the highest bridge over a navigable stream in the United States. The height from the water to the top of the rails is 315 ft., and the length is 1,138 ft.

A comparison with the houses near the base of the bridge will give an excellent idea of the massiveness of the pier foundations.

FRENCH GUN-AUTOMOBILE

The automobile carriages and guns designed by French army engineers for warring upon aerial craft have several features claimed to make them superior to the same type of fighting-machines evolved by other powers. The gun itself has more length than other guns mounted on automobiles, and it lies close to the body of the machine when in transit.

Its revolving standard is at the rear of the machine instead of in the middle, and the muzzle may be elevated to a point almost directly overhead. Furthermore, the gun carriage proper can be lifted, at the time of firing, by

means of a system of levers which force two supports against the ground. This minimizes the shock of the discharge, which might otherwise injure the axle of the machine. The gun has a 3-in. bore.

One of the objections that must be considered in the actual use of such guns when the army using them is scattered over the surrounding territory, has been raised by Gen. Nelson A. Miles, U. S. A., retired. He says that the vertical gun as a means of de-

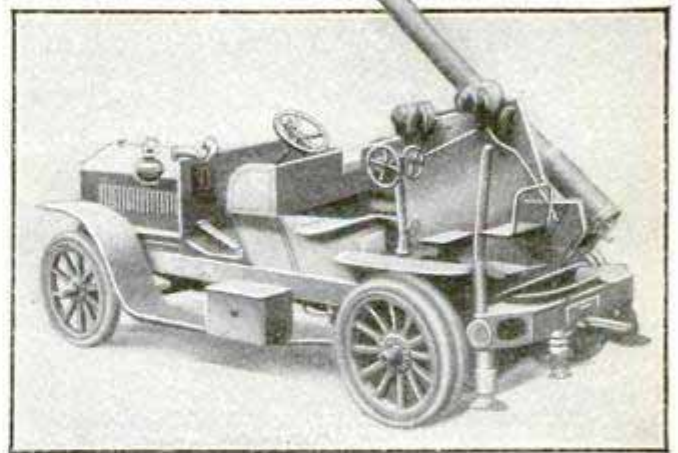

Gun in Position for Firing

fense against an aerial fleet would be as great a danger to the army firing it as to the fleet, for the shots would fall back to earth, while the aerial fleet would have passed out of reach.

The ranks of experienced chauffeurs has recently been increased by the ad-

pose of testing its resistance to rust. At the conclusion of the tests, there appeared to be nothing changed about the

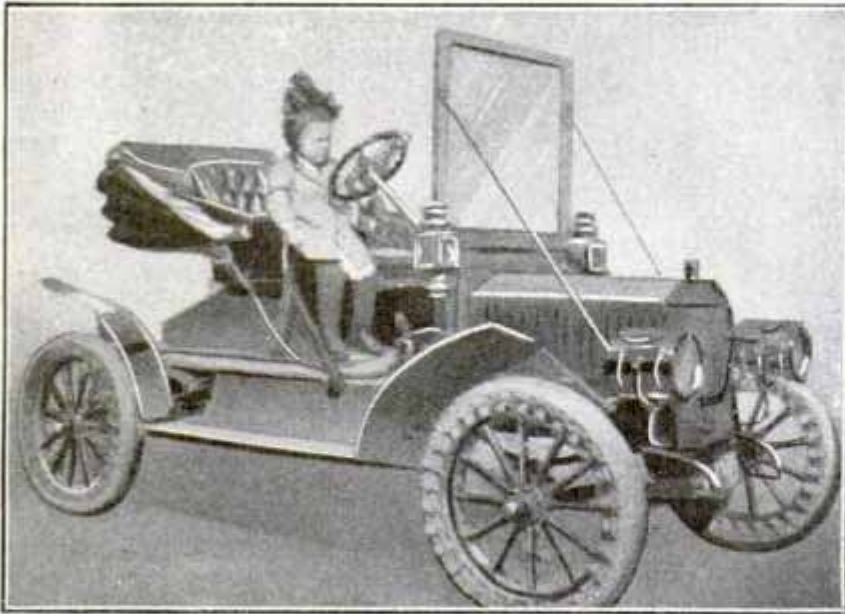

Little Miss Dorothy Schwartz at the Wheel of Her 20-Hp. Runabout

dition of Miss Dorothy Schwartz of Edwardsville, Ill., who was presented with a 20-hp. runabout on her fifth birthday and is a familiar sight in the city in which she lives driving her car. She began to learn the automobile when but three years old, her father allowing her to hold the steering wheel of his machine during their trips together.

STEEL SMOKELESS POWDER WILL NOT CORRODE

A new quality of steel that resists both the corroding influence of smokeless powder and rust, has been manufactured in England and put through a series of the most severe tests.

Five thousand cartridges, containing 43.21 grains, troy, of smokeless powder, were fired through a rifle barrel made of it without showing any effect whatever on the steel. During the intervals between the firing, which covered a

rings for valves and for a variety of other things where non-corrosive and rust-proof qualities are desirable.

AN ELECTRICAL LAUNDRY

The laundry of a Colorado hotel is electrically equipped throughout, even the water being heated and the starch cooked by electricity. The equipment includes motors for driving the machinery, an 85-kw., 250-gal. boiler, generating steam at 80 lb. per square inch, a 20-kw. circulating-type water heater connected to a 600-gal. hot-water tank, and a 6-gal. starch cooker.

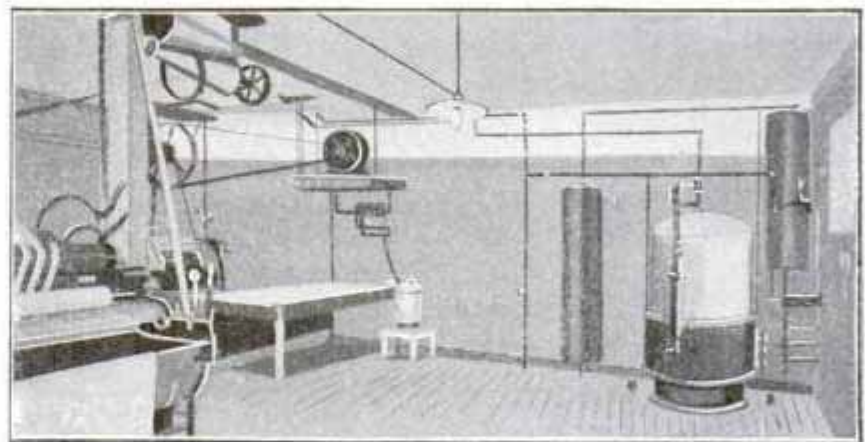

Laundry Relies Upon Electricity

The boiler, which is the large jacketed cylinder at the right of the illustration, supplies steam for heating the rolls of the 60-in. mangle, and the water for the washing machine.

TREE GROWING AROUND A HEADSTONE

The removal of the accumulated rubbish and undergrowth of years from the ancient Mount Ida Cemetery, one of the landmarks of Troy, N. Y., brought to light many curiosities, one of which is shown in the accompanying illustration. Most of the ancient headstones had fallen from lack of care and the ravages of age, but a sturdy elm has enfolded the one in the picture with its protecting roots, and held it straight and firm during all the years that it took the tree to grow from a little sapling to its present commanding size. The stone is a memorial to Thomas G. Perkins and was



Headstone in a Troy, N. Y., Cemetery

erected in 1840, when it was entirely free from the little elm that stood near it. As the tree grew, the roots did not have room to spread without disturbing the stone, and so they gradually surrounded it in the manner shown in the picture.

PORTABLE ELEVATOR FOR STACKING FREIGHT

The accompanying illustration shows the construction and indicates the method of operation of a gasoline-engine-driven portable elevator used at several points on the Pacific coast for piling grain in warehouses.

The elevator rests upon a frame, 8 ft. long by 2 ft. wide, mounted on roller-bearing casters, which enable it to be swung in any direction or to be rolled from place to place as

the stacking progresses and the tiers are completed. The conveyor is operated by

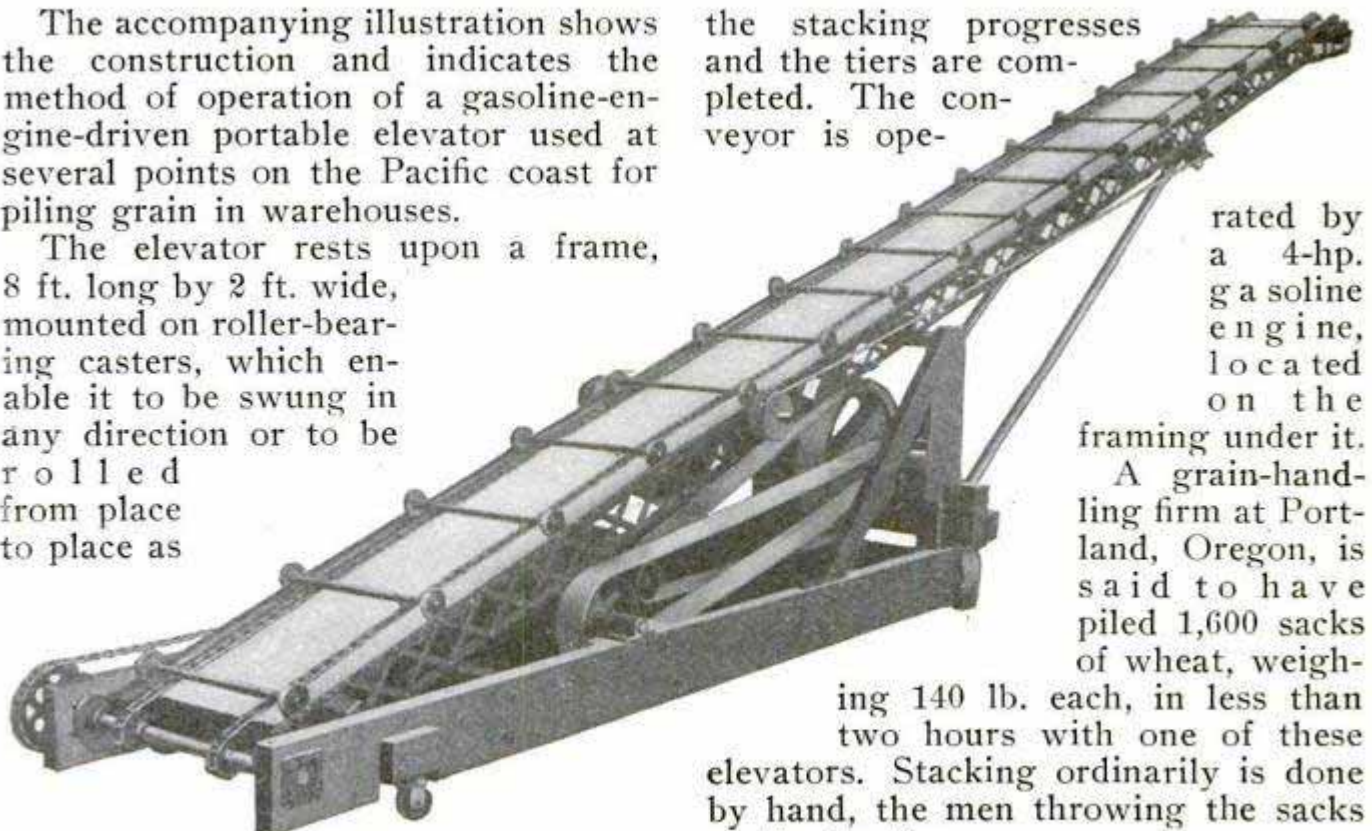

Stacks Freight Rapidly

rated by a 4-hp. gasoline engine, located on the framing under it.

A grain-handling firm at Portland, Oregon, is said to have piled 1,600 sacks of wheat, weighing 140 lb. each, in less than two hours with one of these elevators. Stacking ordinarily is done by hand, the men throwing the sacks up tier by tier.

STEERING-APPARATUS GEARS OF THE "OLYMPIC"

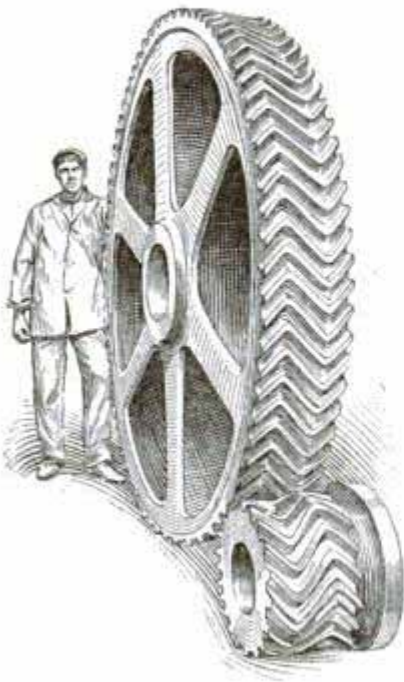

Everything pertaining to the operation of the huge White Star liner "Olympic" is built on a tremendous scale, as is clearly borne out by the accompanying illustrations of the helical gears for her

steering apparatus. Two sets of spur wheels and two sets of bevel wheels are required, the size of the former as compared to the height of a man being clearly shown.

The gears are formed with herring-bone teeth. The ordinary helical gearing when transmitting a load should run with the apexes of the teeth in a forward direction, and this form accomplishes it. The total weight of the two sets of spur and bevel wheels is 15,000 lb.



RECOVERING OIL FROM WASTE

A method, used in France, of recovering oil from waste and restoring the waste itself to its original condition, utilizes a centrifugal separator into which steam is forced under high pressure. The operation is completed in about 15 or 20 minutes. The oily impurities run out at the base of the machine and are afterwards treated in another apparatus to recover the oil.

NO MORE PUBLIC FLIGHTS BY LATHAM

Hubert Latham will fly no more. He is the last of the pioneer bird men to announce his intention of spending the remainder of his days on terra firma. The Wrights, Curtiss, Bleriot, Paulhan, Sommer and the Comte de Lesseps have all given up exhibition work and with the exception of the Wrights, Curtiss and Bleriot, each of these airmen have renounced the pleasures of air flight under all circumstances. The three Americans and Bleriot have not yet declined to fly privately to test new machines or develop new ideas, but none of them will consent to make aerial journeys in public. Each of them, however, is hard at work at aeroplane manufacture, as are their French contemporaries who have retired. The business of running the machines in the air has been given over entirely to the pupils and employes of the pioneers.

WIND SCREENS DESIGNED FOR MOTORCYCLES

Nearly all the important accessories of the automobile are being adapted on a smaller scale for use on the motorcycle, one of the latest being a wind screen. It is suitable for fitting to the handle bars, is made in two pieces, and is adjustable. A wind screen has not been a common sight on motorcycles in the past, but as some means of protection for the face and upper part of the body is as necessary on such machines as on automobiles, the coming year will probably find many of them in use.



AMERICAN NAVAL PROGRESS

By L. WILLIAM THAVIS

ANNOUNCEMENT that the United States government plans the building of two additional dreadnoughts, a collier or two and one gunboat has caused a sudden awakening of the German, Japanese and Chinese governments in naval construction.

Germany has made a decided gain in naval strength over this country, and her navy stands second in tonnage afloat. The Germans have made a decided stride toward equality with the British navy. It is believed by many experts that Germany has already eclipsed us in the actual strength of ships in commission. Statistics as to Germany deal only with vessels in commission or in reserve, while a number of ships out of commission and regarded as obsolete are included in the American statistics.

A surprise to the American naval officers is that Japan has accomplished little in the last year. Her gain in tonnage afloat is so small as to indicate that the navy has actually dropped back slightly. Japan has now suddenly awakened, and efforts are being made to get through a monster program, even larger than Germany's, to obtain one or two battleships of 27,000 tons, mounting 14-in. guns, and to have other battleships and cruisers, authorized last year, enlarged by several thousand tons. Japan is understood recently to have secretly made contracts in England for the first of the 27,000-ton ships, the plans for which call for the mounting of ten 14-in. guns.

France remains in fourth place, just below the United States, but she has lost nearly 50,000 tons afloat, the equivalent of two dreadnoughts. Russia gained little afloat during the last year, and lost as much in building as France did afloat. Italy is in seventh place and Austria last.

The Chinese government has opened negotiations for a further and distinct foreign loan of \$25,000,000 to be used

for the development of her navy. This is the result of the report made by Prince Tsai Hsun, the uncle of the emperor, after his visit to America. It is probable that Americans will receive the largest share of the orders for the construction of the new vessels, as well as the privilege of furnishing one-fourth of the loan.

Naval Constructor Capps has gone to the Philippines on a mission regarded as of great importance to the American navy. He will make a careful examination of the Cavite navy yard in Manila harbor, and the naval station at Olongapo on Subig Bay. Part of the general scheme of naval development in the Pacific is to create an American Gibraltar at Pearl Harbor, Hawaii, which involves the abandonment of the idea of establishing a powerful naval base in the Philippines, and converting the station at Olongapo into a mere repair depot.

There is not water enough at Cavite to enable heavy warships to approach the navy yard there, and it is doubtful if Olongapo can be rendered impregnable. Still, in view of the necessity of making more or less repairs to the American fleet which must be maintained in the Orient, some suitable plant must be maintained at a point nearer to Asia than Hawaii. Hence the necessity for placing the naval station at Olongapo in condition to do that work.

When the work of his mission is completed in the Philippines, Naval Constructor Capps will return to the United States by way of Europe, taking advantage of the opportunity to make a thorough study of recent developments in naval construction in the great navy yards of the European maritime powers. Incidentally, he is also to look into the development of the aeroplane for naval uses in Europe.

The gradual increase in the power of guns constituting the main batteries

gun—that is, a gun 45 times the size of the bore, in this case 45 ft. long—with which the vessels of the "Connecticut" class are armed, and which was at least as powerful as any gun afloat when it was installed on those ships, has been succeeded by the 12-in. 50-caliber gun of the "Arkansas" and "Wyoming," now building. The guns of the "Arkansas" and "Wyoming" will have a muzzle velocity of 2,900 foot-seconds.

The 14-in. 45-caliber gun—52 ft., 8 in. long—which has just been brought out, and with which the two great battleships authorized by the last session of Congress, and the ships that may be authorized this winter, will be fitted, will have a greater accuracy than the 12-in. gun, which it supersedes, and will fire a projectile with much more destructive force. A new type of breech mechanism is being developed for the 14-in. gun, and a form of projectile has been adopted which will give considerably greater range than the old form, together with a marked increase in striking velocity and penetration, especially at long ranges.

At one time it was thought that the 14-in. gun would be the last word in naval ordnance for some time to come. But already there is talk of arming our future dreadnoughts with 16-in. guns. The advocates of the larger guns propose that there shall be at least six, and if possible, eight of them on each vessel, mounted one in a turret, and so arranged as to give unrestricted broadside fire. Such a gun would fire a projectile weighing 2,400 lb.

The steam engineering experts of the navy now have under consideration the question as to whether turbines or reciprocating engines shall be installed in future battleships. The engineers entertain considerable doubt as to the wisdom of installing turbines, in view of the greater cost of operation over reciprocating engines, as originally demonstrated by the comparative cruising of the scout cruisers, and as con-

"North Dakota" with turbines.

Steady and satisfactory improvement in the equipment and efficiency of wireless telegraph installations in the naval establishment is being made. Results of tests during the past several months indicate that 10 or 25-kilowatt sets are better suited for shore stations. Considerable work of an experimental nature has been done at the wireless laboratory at the bureau of standards and at the station at Brant Rock, Mass., where a 100-kilowatt set is installed. These experiments were carried out in connection with the installation on the scout cruisers. The work on the coast stations has been satisfactory as a whole, but many improvements are required, principally in the line of furnishing high-frequency apparatus and more durable masts or towers. It is proposed to use steel towers wherever possible, especially in the tropics.

Plans are being formulated for increasing the power of wireless apparatus at navy yards and stations, and the reduction of the number of unprotected coastwise stations. A modern high-powered station has been installed at Colon and is in excellent condition. This station has given very satisfactory results and is able to communicate with Key West every night in the year except in the summer months, when static conditions make communication in the tropics irregular. Other stations of similar power are to be erected at Key West and on the island of Porto Rico. It is expected that these stations will afford constant communication between the United States and the stations at San Juan, Guantanamo and the Canal Zone.

There has been much difficulty in obtaining a suitable compass for submarines, on which the conditions affect the accuracy of the instrument. It is believed that the difficulties have been overcome by employment of the gyroscopic compass, with which extensive experiments have been conducted. The Germans have used a compass of

this character, and one of them has been obtained by our naval attaché at Berlin.

The gyroscopic compass, if a satisfactory one is devised, would be valuable on battleships and other naval vessels for use during battle and battle exercise. The magnetic compass is not very reliable during an action, owing to the changing magnetic conditions in a ship due to gun fire and injuries sustained. If a gyroscopic compass can be obtained which is accurate within a degree for two or three hours, the

probable length of a naval battle, it would probably prove sufficiently accurate.

Electricity hereafter will be used to do all the cooking for the sailors aboard the new ships of the navy, as thorough tests have shown the superiority of the electric range over the old coal galley, not only in convenience, but in economy as well. In some cases it has been found that electricity can be used for heating purposes with better results than steam coils aboard a battleship.

GAS-DRIVEN CARGO SHIP

An ocean-going producer-gas-driven cargo ship was recently launched at a Tyneside shipyard, and will be used chiefly in carrying coal from ports in South Wales.

The ship, which is called the "Holzapfel I," was built as an experiment. It is 120 ft. long and 22 ft. beam. The gas plant consists of two 100-hp. generators, and two vaporizers and scrubbers. The gas engines are of 180 brake horsepower, having six cylinders of 10 $\frac{3}{4}$ -in. diameter and 10-in stroke, and are intended to run at 450 revolutions per minute.

It is said that the coal consumption in the producer is $\frac{3}{4}$ lb. per indicated horsepower-hour. In other words, when the engines are producing about 200 indicated horsepower at full speed, the ship will use up about 150 lb. of coal per hour for her propulsion. At this rate, one ton of coal would last over 13 hours of continuous running. In an average steam boiler supplying a reciprocating engine, the same amount of coal would last between two and three hours.

ⒸA workman named Hase has the distinction of being the first airship stow-away, having been discovered concealed under the tarpaulin covering the benzine tank of the dirigible "Parseval VI" during the course of a recent voyage near Berlin, Germany.

HOT COPPERS FOR THE CROWD

The throwing of hot pennies to the crowd that gathers in the streets of Beaumaris, Wales, following the hunt procession, is one of the interesting



Courtesy London Illus. News

Feature of the Anglesey Hunt Festivities

features of the famous festivities of the Anglesey hunt. The Lady Patroness of the hunt throws heated coppers up to the value of several English pounds (a pound equals \$5) from the balcony of the Bulkeley Arms.

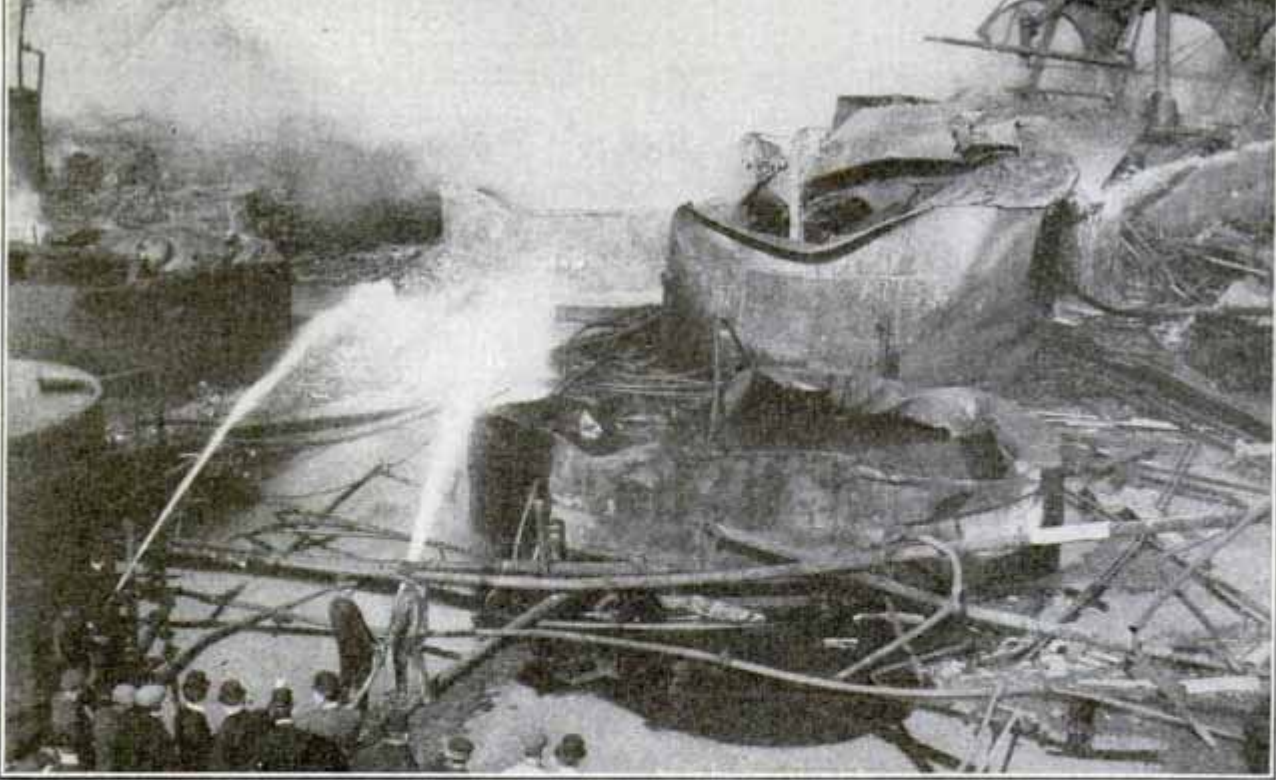

Twisted Pipe Lines and Battered Steel Tanks Were All That Remained When Smoke Was Cleared from the Ruins

OIL FIRE AT BAYONNE, N. J.

THE explosion of one of the tanks of the Tidewater Oil Co. at Bayonne, New Jersey, in November, resulted in the destruction by fire of 17 tanks and many stills, the total damage being \$250,000. Houses four miles distant were shaken by the explosion and nearly all the windows within a radius of two miles were broken. It is said that the flames reached a height of 500 feet.

PEARY'S SHIP TO JOIN WRECKING FLEET

The ship that carried Commander Robert E. Peary to the Arctic regions on his last voyage of discovery is to be reconstructed for use as an adjunct to the fleet of wrecking vessels owned by a salvage company in New York. The vessel, known to fame as the "Roosevelt," was especially constructed to withstand the pressure of icebergs and is considered one of the most substantially-built crafts afloat. While not very pretty to look upon, she is able to combat the tremendous pressures and strains to which a boat can be subjected. Her sidings are 18 in. thick, and, inside, her hull is braced with massive timbers and steel columns. The "Roosevelt" had three masts and was schooner-rigged when she carried

the Arctic explorer and his party. She will hereafter have but two masts, the foremast being replaced with a 100-ft. derrick pole. Two additional boilers will be installed. It is probable that the first work the ship will be used for will be in the second attempt to raise the cruiser "Yankee" which now lies at the bottom of the sea near New Bedford, Mass.

Following the successful use of taxicabs in Singapore, a company is now being organized to operate them in Colombo, on the island of Ceylon.

During the last year there have been 35,396 persons employed by the Panama Canal Commission in actual work on the canal and railroad.

INCREASING DEMAND FOR ONE-DOLLAR BILLS

Greenbacks of denominations of \$20. and more are being fed daily into the macerating machine in the Treasury, in accordance with Secretary MacVeagh's decision to supplant them with one-dollar bills of the same variety. The change is being made at about the rate of \$1,000,000 a day, and the small bills are being sent to the sub-treasuries to meet the demand of the banks all over the country for bills of small denominations. So great has the demand grown for small bills that Treasury Department officials are predicting that within a short time it may be necessary to convert all silver certificates into one-dollar bills. They believe that eventually all the large bills in circulation will be gold certificates.

BAS-RELIEFS MADE WITH THE CAMERA

A photo-chemical process, known as photosculpture, for the production of all kinds of reliefs on gold, silver, ivory, bronze, steel and plaster, has been discovered and put to practical use by a European inventor.

The model has only to pose for a

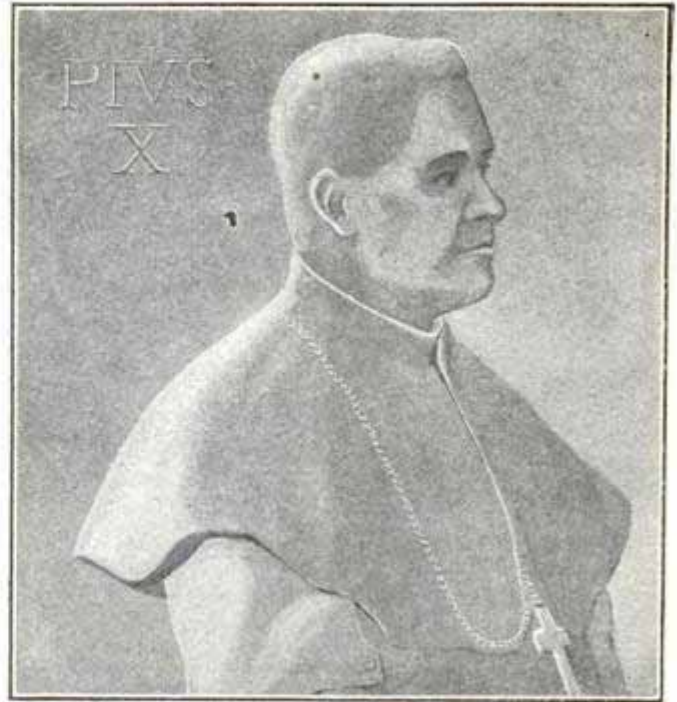

Bas-Relief Made with Apparatus

few seconds, a projection-lantern of a special design being used, so as to light it proportionately to the relief. A second negative is made with the opposite graduation, and with one of the two negatives a diapositive is printed. By superposing this on the other negative, a special plate is obtained, which has transparencies proportionate to the reliefs of the model. Then by printing on gelatine in electric light, a copy of the model is obtained in bas-relief, which can be reproduced in the substances already mentioned.

CHILD SWALLOWS BROOCH AND IS FED COTTON

When a child swallows a brooch, pin or other object which might penetrate the intestines, it should be fed an absorbent cotton sandwich, according to a French physician. In one instance this physician made a child swallow a small quantity of the cotton, partly in milk, and partly with a jam sandwich. A few hours later, when the foreign body, in this case a brooch, was expelled, it was found so well wrapped in the cotton that no damage could possibly have been done by the pin or the pointed projections of the setting.

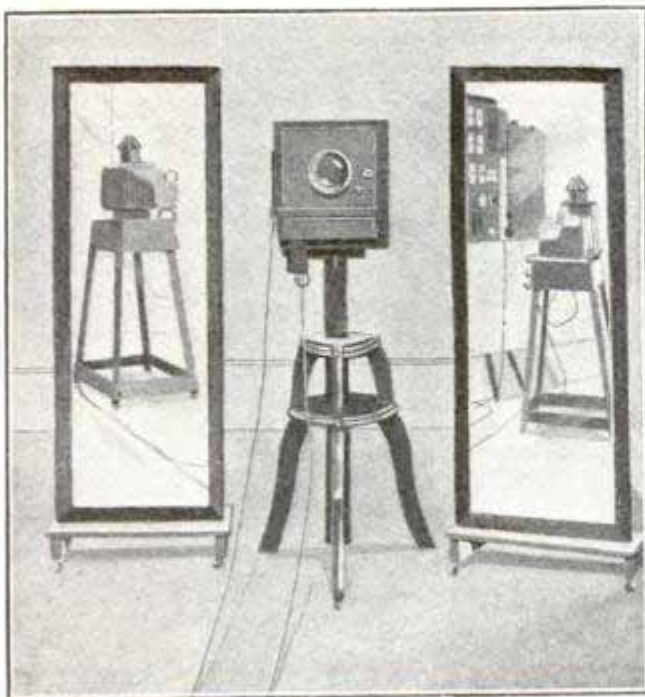

Photosculpture Apparatus—Camera in Center with Projection-Lantern Reflected in the Mirrors



"Tsubushi" for Middle-Aged Woman



"Tenjin" (with drapery) for Middle-Aged Woman



"Mitsu" (three) for Middle-Aged Woman



A Typical Geisha Style



"Shimada" Another Variety for Middle-Aged Woman



"Shimada" for Middle-Aged Woman



"Ohatsu" for Young Miss



"Chigo" for a Girl



"Hiyoshi" for Young Lady



"Shimada" Another Variety for Middle-Aged Woman



"Momare" for Young Miss



"Taka" for Young Lady

JAPANESE WOMEN DRESS THEIR OF WHICH HAVE BEEN



"Taka" Another Variety for Young Miss



"Taka" for Middle-Aged Woman



"Shimada" for Young Lady



"Taka" for Young Miss



"Butterfly" (with ornaments) for Middle-Aged Woman



"Butterfly" (with corals) for Middle-Aged Woman



"Butterfly" (double) for Middle-Aged Woman



"Butterfly" (tied) for Middle-Aged Woman



"Butterfly" (ordinary) for Middle-Aged Woman



"Maru" Another Variety for Newly Wedded Bride

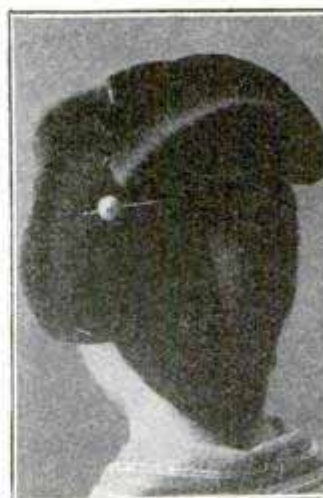

"Maru" for Married Woman



"Maru" (round) for Newly Wedded Bride

HAIR IN RECOGNIZED FORMS, MANY USED FOR AGES

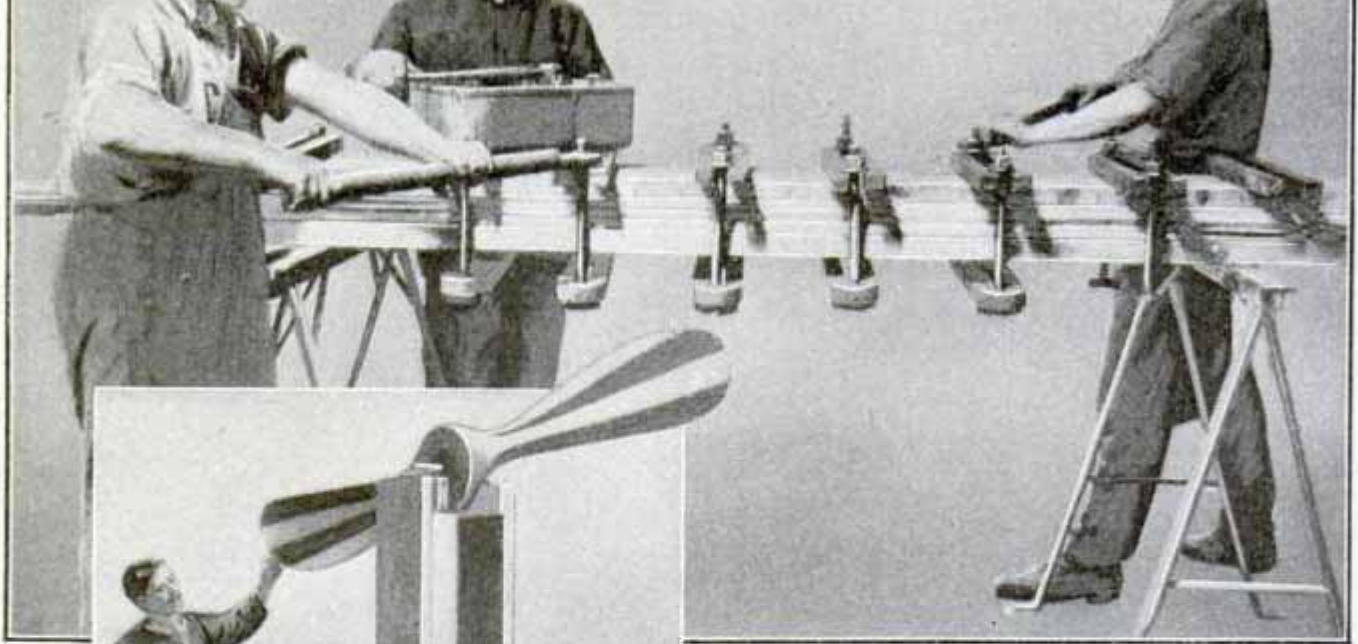

Gluing Together the Sections of Hardwood for the Propeller

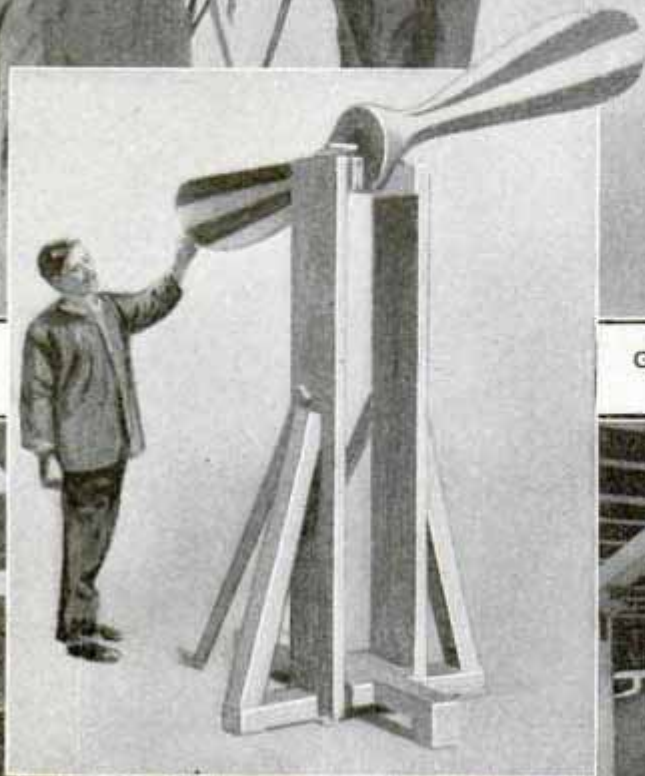

Testing the Balance of a Finished Propeller

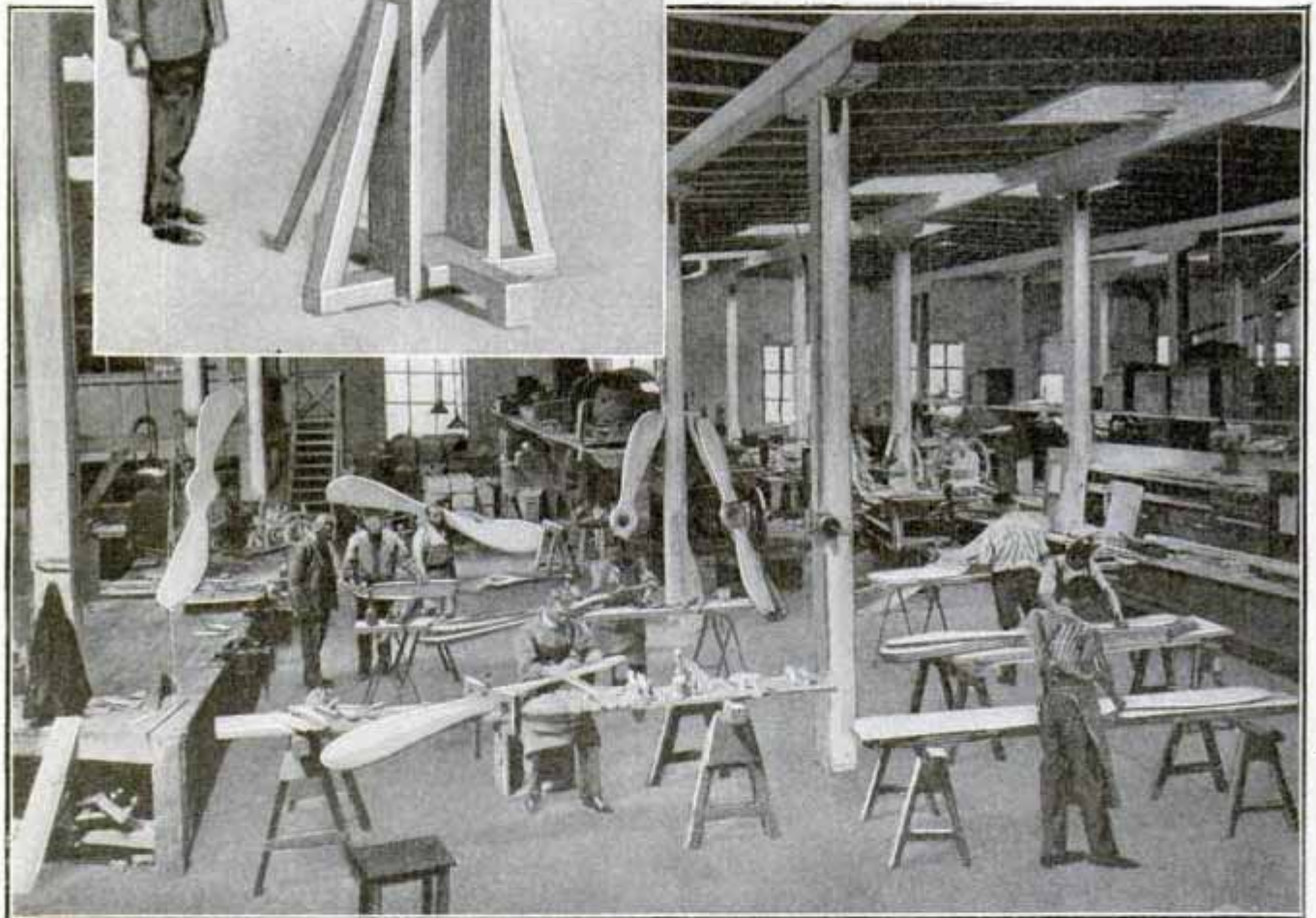

View of the Finishing Room in an Aeroplane Shop

AIRSHIP SHOPS EMPLOY MOST SKILLFUL ARTISANS

THREE years ago, the man who would have described his occupation as a "finisher" for airship propellers would have been greeted with jeers and possibly pointed out as a fit subject for an institution for the feeble minded. Today, the making of aeroplanes employs hundreds of men and has given rise to at least half a dozen new lines of endeavor. The construction of the frail-looking machines that glide so swiftly and gracefully through the air is a delicate operation and calls for the utmost skill.

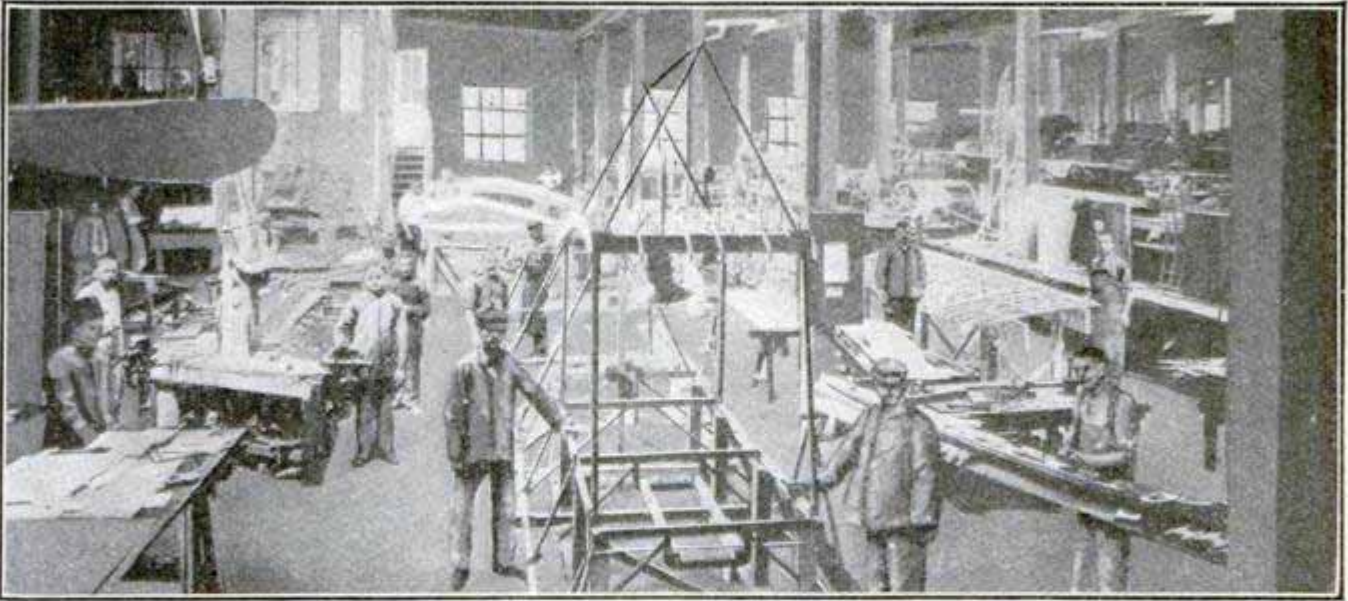

Making Aeroplane Frames



Chiseling the Propeller into Shape from the Rough Glued Sections

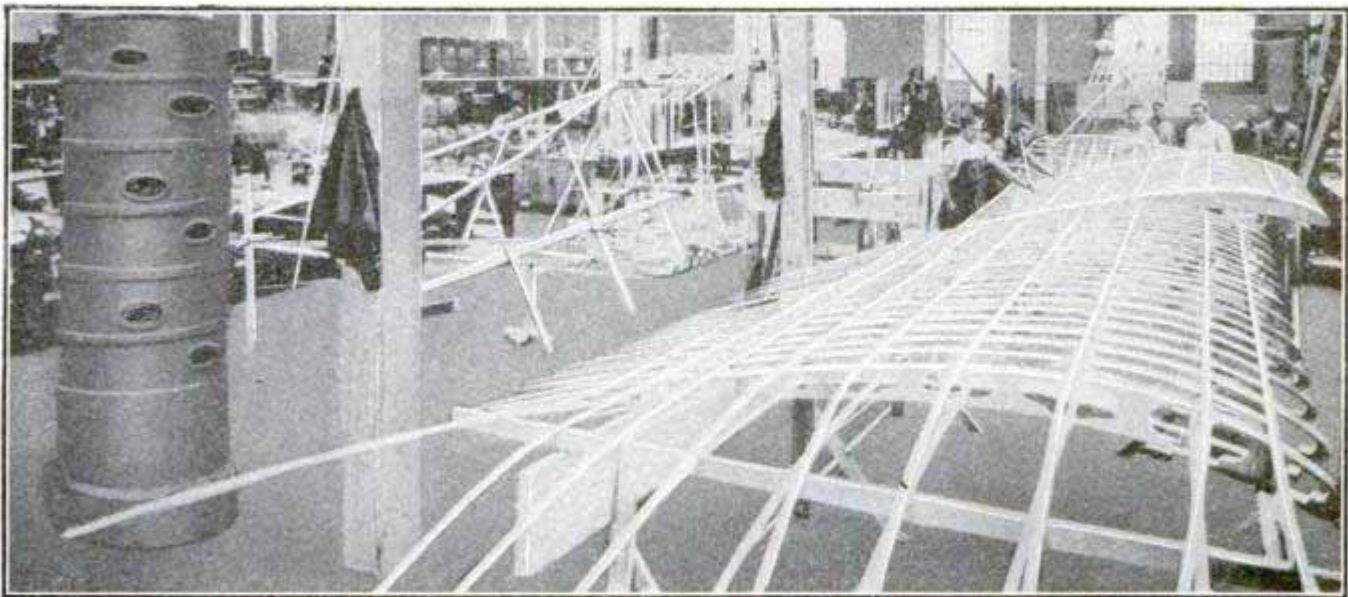

View Showing the Assembling of Frames in Sections

In France, the building of aeroplanes has become a well recognized industry employing hundreds of the most expert mechanics. In England, there are several factories, and here in the United States, at least two big firms and many smaller concerns are engaged in the business, the large returns already received giving promise of increasing profits for the future.

The ultimate strength of some of the principal compression members of the 1,758-ft. span of the New Quebec bridge

of them were built on a reduced scale, had lengths up to about 36 ft., maximum cross-sectional areas of 57 sq. in., and weights of over 10,500 lb. Some sections developed an ultimate strength beyond the 2,800,000-lb. capacity of the testing machine.

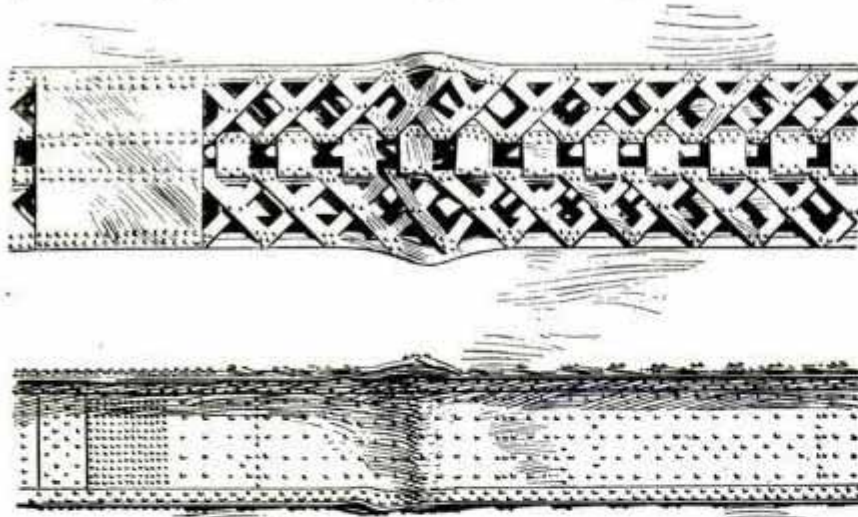

Top and Side View of Model of Quebec Bridge Section Tested to Destruction

was recently tested out at Phoenixville, Pa., by means of nickel-steel models. These models, although most

the center span by the cantilever method, and the failure under destructive pressure is typical.

HOPPLES FOR THE HOBBLE-SKIRTED

The hobble skirt is very much inclined to bag at the knees in somewhat the same manner as do trousers, but,



Horse Harness Idea Adapted to the Hobble-Skirted

whereas the only remedy for the latter is continual pressing, an ingenious European has devised a preventive for the former. This preventive, called a hobble garter, works in exactly the same manner as the more or less well known horse hopple. It effectively checks undue length of stride, thereby saving the front of the hobble skirt from being bagged out of shape by the knees.

BENZINE AS AUTOMOBILE FUEL

Benzine as a fuel for automobiles was recently tested out by the Chicago Motor Club in a 670-mile run from Chicago to Cincinnati and return, the car used being equipped with a carburetor claimed to be adaptable without adjustment to the use of benzine as a fuel. The main reason of the test was to determine the validity of this claim, made by the manufacturers of the carburetor.

The 670 miles were made on an aver-

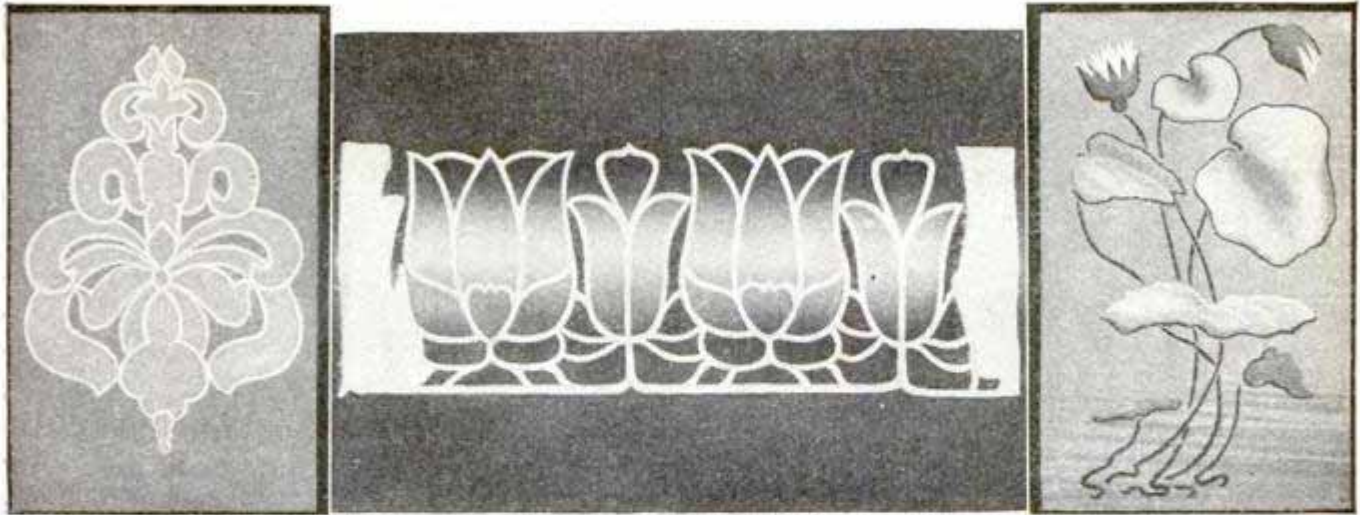

Effects Worked Out with Paint-Spraying Machine

age running schedule of 22 miles an hour. The fuel consumed was 36 gal., which averages 18.6 miles to the gallon. The only trouble experienced in starting the motor was on the morning of the last day of the run, after the car had stood over night in a cold garage. Gasoline was used to prime the cylinders.

Benzine is the commercial name for naphtha, which is a mixture of the lighter and more volatile hydrocarbons passing off in the earlier stages of the distillation of crude petroleum. Naphtha is less expensive than gasoline, and better mileage per gallon and more power are claimed for it, but it does not vaporize as readily as the latter, consequently the starting of a motor on this fuel is more difficult.

STENCILING WITH A PAINT SPRAYER

For stenciling on plaster, paper, cloth or any material where liquid color is used, the paint spray is said to be far superior to the brush in both speed and quality of work accomplished. The modern paint spray is capable of adjustment so fine that paint may be thrown in a line from the smallest stripe to a broad spray for coating surfaces. An idea of the delicate shading made possible by the spray may be gained from the accompanying illustrations.

The possibilities of producing novel

effects are unlimited, according to the *Wall-Paper News*, because stencils not practical to brush are easily sprayed, without injury to the most delicate stencil or mask, such, for instance, as lace stenciling and the use of leaves for stencil or mask-producing effects.

THE TALLEST BARBER POLE

A little 10 by 12-ft. barber shop opposite the railroad station at Guerneville, Cal., is claimed to have the tallest barber pole in the world. It is a telegraph pole, 35 ft. high, painted in the customary barber-pole fashion.

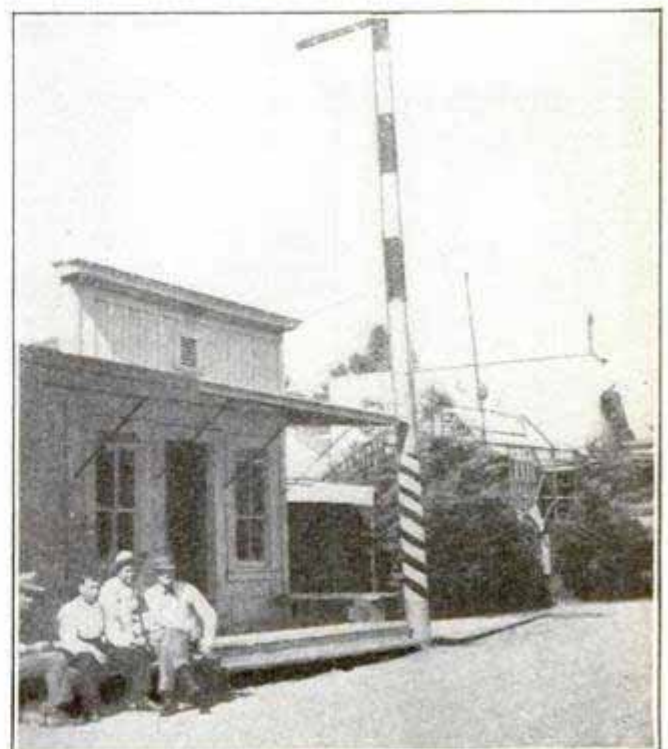

Unique Barber Pole in California

A special suction hopper dredger fitted with a screw cutting apparatus for work in stiff clay has been acquired by the British Admiralty for dredging

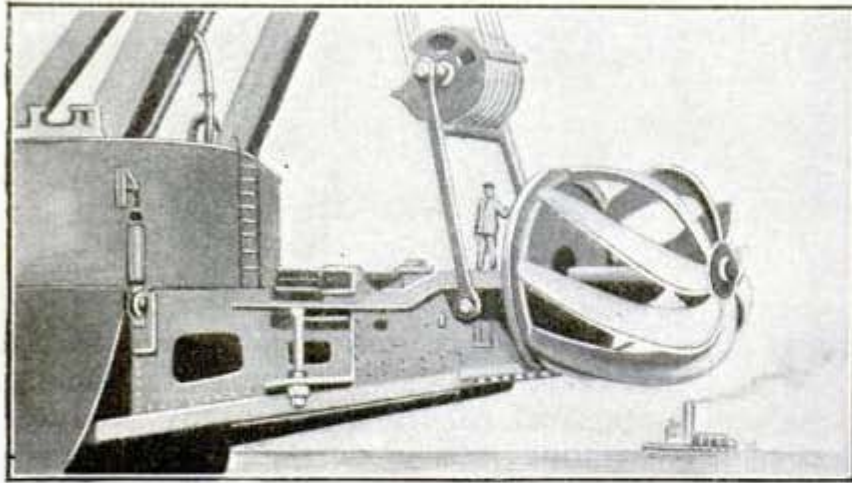

A Dredger Which Cuts and Sucks Up Clay

the berth for the new floating drydock at Portsmouth. The dredger is effective to a depth of 65 ft., and will cut and suck up the clay at the rate of about 100 tons per hour.

A STAMP WITH EVERY KEY TAG

A request on a key tag to return the same through the mails should it be carried away by mistake does not always accomplish the desired result, as it requires the buying and placing of a stamp. To add to the chances of a key and tag being returned, an Indiana hotel man has patented a tag which carries a postage stamp under a little



Key Tag Provided with Return Postage

celluloid disk. The disk, which protects the stamp against wear or defacement, is pulled off and thrown away when the key is deposited in a mail box.

The majority of French aeroplane constructors and practical airmen, according to L'Aero, do not take kindly to the many safety devices, such as parachutes, padded jackets, etc., now being proposed. Instead, they believe that the efforts of constructors and manufacturers should be wholly directed toward strengthening the frameworks, improving wing construction, propellers and motors, and toward the attainment of automatic stability, while reducing as far as possible all resistance-producing parts and weight.

M. Bleriot says in this connection that the loss of life in aviation, while great, is not discouraging in view of the fact that aviation has made such unheard-of progress in such a short time, and warns his countrymen not to desist in their efforts to lead in the conquest of the air.

"If we hesitate," says LeBlanc, the famous French airman, "we will certainly be superseded by the Americans, whose daring is incomparable."

RAISING BRAMAH CATTLE IN TEXAS

The hump-back cattle of India may partially supplant the Durham beef breeds in the coast region bordering the Gulf of Mexico and the Caribbean Sea. Several thousand head of pure-bred and part-bred Bramah, or sacred cattle, are now being successfully raised in the lowlands of southeastern Texas. The introduction of the new stock from India promises to revolutionize the cattle industry in the low coast region of Texas, along the Mexican Gulf, as the sacred cattle are immune from fever and black leg and are not infested with ticks.

The Bramah stock was first brought to the United States by John E. Pierce, veteran owner of a huge ranch near Pierce, Texas. The herd rapidly increased and was interbred with native ranch stock. Last year Mr. Pierce divided his ranch and sold out most of the herd, including full and part-breeds to stockmen in the region. The first lot of Bramah bulls was imported by Mr. Pierce at great expense about ten years ago. The full-bred Bramahs take on flesh rapidly and although they do not show the heavy layers of fat that the best grades of corn-fed beef cattle do, they are good beef cattle; while the half-breeds have proved good milch stock.

While the Bramahs are docile by nature and in India are used as beasts of burden, yet the bulls on the ranch have proved very combative. Bramahs are not troubled by the heat; they are good swimmers and readily cross the most boggy bayous. It is quite probable that the raising of the "sacred stock" will spread throughout the coast country of Texas and Mexico. The introduction of these cattle, although at first only an experiment, has now proved a commercial success.

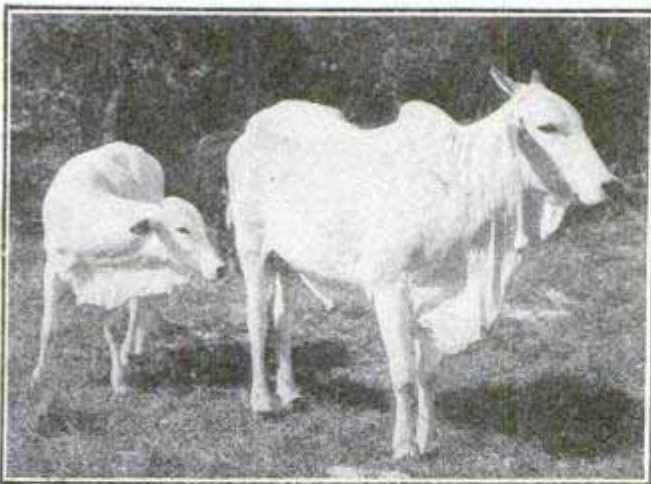

Bramah Cattle, Bull and Cow, at Pierce, Texas

There is but little doubt that the smaller hump-backs from Upper India would thrive on the Mexican plateaus in the higher regions near timberland.

It is estimated that the output of tungsten in Boulder County, Colo., amounted to \$1,000,000 during 1910.

PLAYING PIANO UNDER DIFFICULTIES

One of the novel positions an English pianist takes in rendering popular



Novel Piano Performance

selections for the delight of music hall audiences is shown in the accompanying illustration. Balanced, head down, on a shoulder rest, with his back to the keyboard, he can play several selections without error.

TO EXPLORE NEW GUINEA IN BALLOON

The interior of New Guinea, an island lying just north of Australia, inhabited by one of the most savage tribes of the islands grouped under the title of "Oceania," is to a great extent unknown. Exploration by a small party on foot would be difficult. Therefore, Dr. Wegener, director of the German Meteorological Observatory at Samoa, proposes that a complete survey be made by means of a balloon.

The winds are regular. The plan is to start the balloon from one side and drift over the immense interior to the other side, where a ship would pick up the party and take the balloon back to some other convenient point for another ascent.

This remarkable handkerchief display drew much attention in a Berlin



Unique Display of Handkerchiefs

warehouse. It is a reproduction of the Eiffel tower made up of 120,000 handkerchiefs, and took many days to build.

CROSS-COUNTRY TELEGRAPH LETTERS TO EUROPE

Telegrams sent by ocean steamship is the latest device to extend the time limit under which merchants at interior points may send letters to their European correspondents. One of the telegraph companies has adopted a scheme for the transmission of letters on the day of sailing of steamers from New York so that a correspondent, say in San Francisco, can dictate a letter on the day of sailing of a steamer from New York, send it by telegraph to New York and have it go out on the steamer that day to his European cor-

respondent. This device saves down the time required for the transmission of a letter to Europe six days. The letter is sent at the regular telegraph rates with an addition of five cents for foreign postage. It is addressed in the same manner as other letters are addressed with the addition of the words "care ocean mail."

CUSTOMS INSPECTORS HOLD UP ROYALTY

Europe seethed with gossip and indignant protest recently when two queens, a princess and a prince were detained at Weltenraedt, on the Belgian frontier, a most inconvenient length of time by the Belgian customs officials, who insisted upon subjecting the trunks and hand baggage of the ladies to a search for contraband articles. The party included Queen Alexandra of England, her daughters, the Queen of Norway and Princess Victoria of England, and the Crown Prince of Norway, who were en route on a royal train from Copenhagen to Calais. Despite the protests of the courier of the party who informed the Belgian inspectors of the identity of his charges and of the fact that they were simply passing through King Albert's domain on their way to England, the train was held two or three hours. Help and release came finally when King Albert and the British Ambassador at Brussels were importuned by the very indignant ladies and their outraged attendants.

One of the observations made by Dr. Charles Chree, the English scientist, during his recent investigations in atmospheric electricity, was that it is more dangerous to stand under an oak tree than under a beech. The safest thing to do in an electrical storm, he said, was "to go out upon a golf course and lie down in a bunker—provided other golfers do not go on playing."



The Persons Killed and Injured Were Eating Supper in the Small Wooden Building Adjoining When the Concrete Structure Collapsed

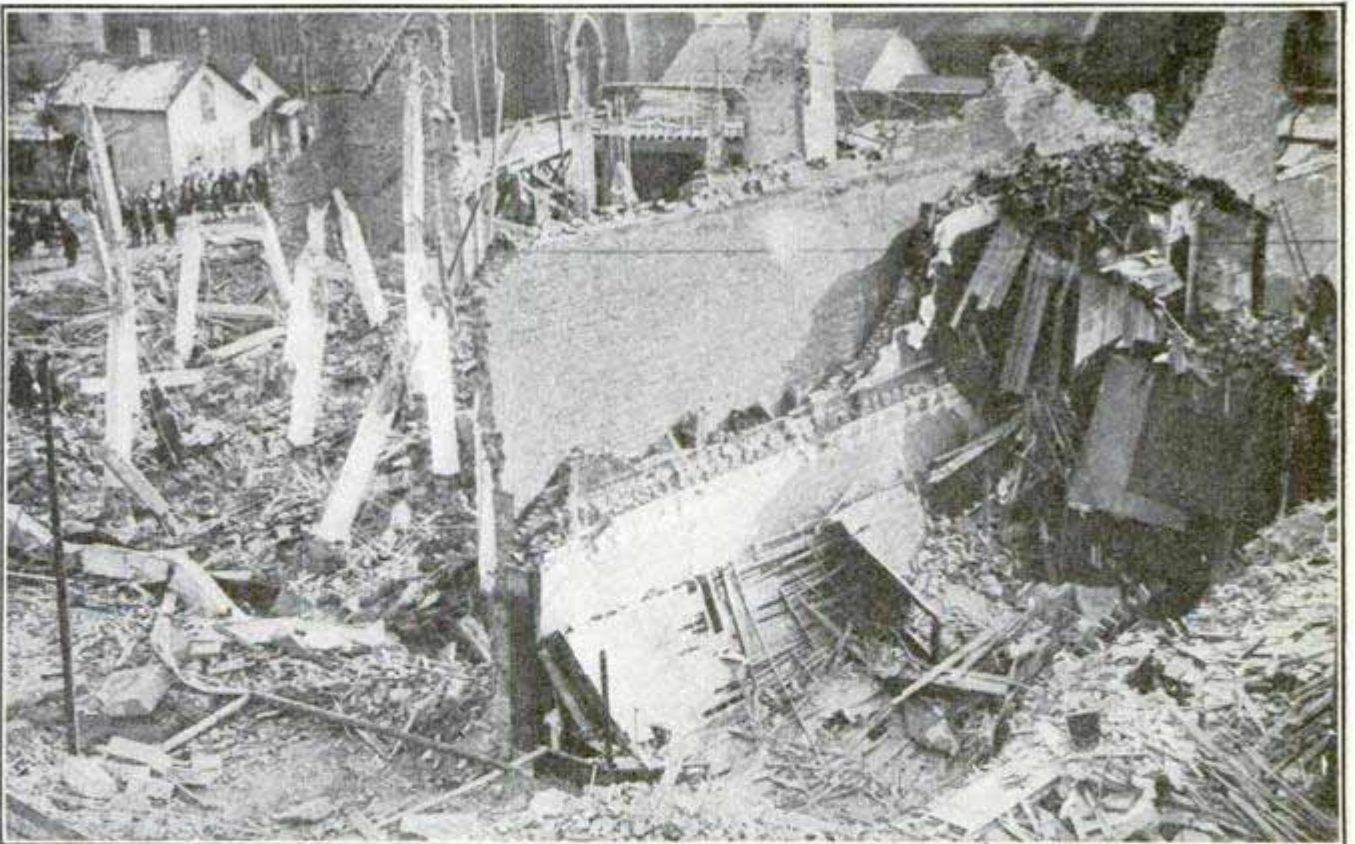

A Few Broken Pillars Were All That Remained of a Four-Story Concrete Building at Cleveland, Following Its Collapse

FAILURE to allow concrete to set properly is said to be responsible for the collapse of a four-story building at Cleveland, O., recently, killing four persons and injuring eight. The wreck is said to be one of the most complete on record, as the entire structure came crumbling down like sand, filling the cellar to the street level, and leaving only a few bare pillars sticking up.

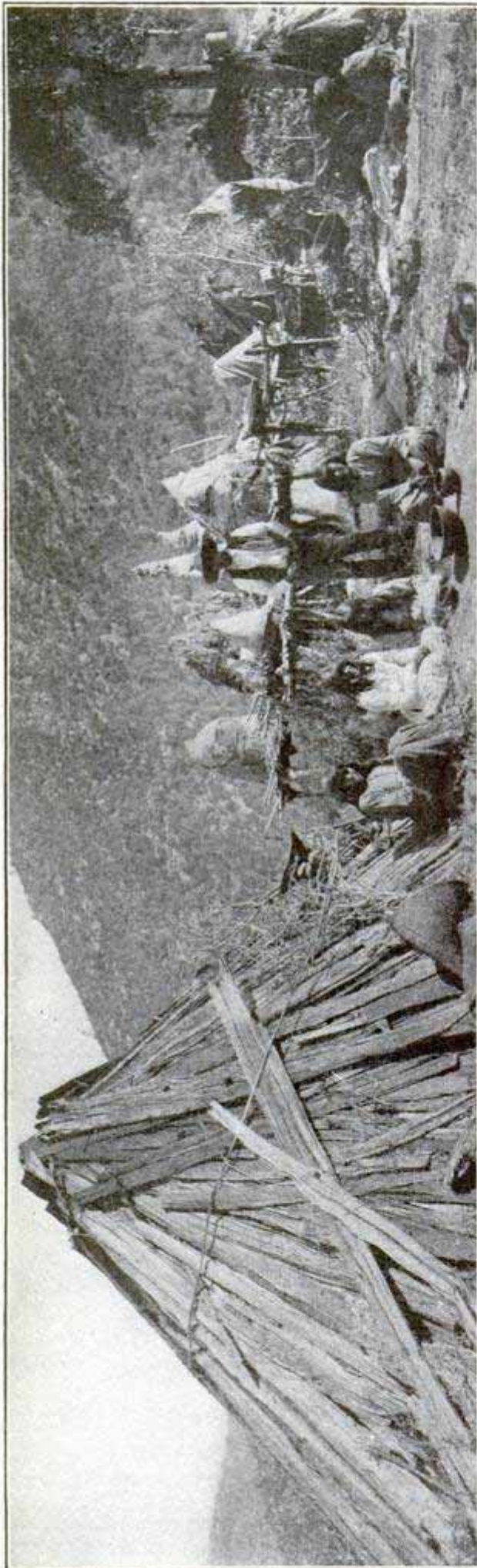

Mono Indian Tepee and Acorn Bins

ACORN FOOD SUPPLIES OF THE CALIFORNIA INDIANS

Among certain tribes of the Mission Indians of California, acorns form a highly important article of diet. These are gathered in the fall, dried thoroughly in the sun, and then stored for winter use in large bins, each holding 10 bu. or more. The bins are of wicker-work, like huge inverted baskets. Usually they are covered with canvas or other material as an added protection from rain and snow, and are placed upon elevated platforms to prevent them from drawing dampness from the ground.

When desired for food purposes the acorn kernels are pounded into a coarse meal. Sometimes this is baked into cakes, but more often it is made into mush, which is prepared in a very curious manner.

It is first mixed with water to a very thin batter, in a tightly woven basket-work bowl, smeared on the outside with the gum of a tree to prevent it from leaking. Into this batter red-hot stones are then dropped, causing it to boil. As soon as the stones become cooled to such an extent as to be of no further use for cooking, they are lifted out by a wooden ladle, and replaced by freshly heated stones. When the mixture has been sufficiently cooked, the bowl is placed on the ground until the mush cools. The entire family then gathers around it to enjoy the feast, the Indians using the palms of their hands to convey the mush to their mouths.

The illustration shows the cedar-bark tepee of a happy family of Mono Indians, in the Fresno Mountains. At the right of the picture may be seen the acorn bins, and at the base of the tepee is a basket such as the squaws use in gathering the acorns. Farther to the right are baskets of various sizes, used by these curious people as cooking utensils.

Paris has an aero club, "Stella," whose active membership is made up exclusively of women.

NAVY SEEKS TO PREVENT SUBMARINE DISASTERS

As a measure of protection for human life in cases of accident in submarine boats, the Navy Department has decided to designate a board to investigate the whole matter. It is believed that the equipment of submarine boats with oxygen helmets and the installation of apparatus capable of generating that life-sustaining fluid on board such vessels would result in the saving of many lives.

Tests made on the submarine boat "Octopus" demonstrated that 14 men could remain confined an entire day without fresh air. By purifying the air with chemicals, such as peroxide of sodium and potassium, it is thought that life might be prolonged perhaps a week.

DEVICE FOR MEASURING CYLINDER BORE

An internal caliper, by which the diameter of a cylinder bore may be quickly and accurately ascertained, regardless of the type of cylinder, and without the trouble of removing the cylinder from its base, has been patented by a London concern. A graduated flexible steel blade slides through a curved socket, one end of the socket being provided with a steel prong. The end of the instru-

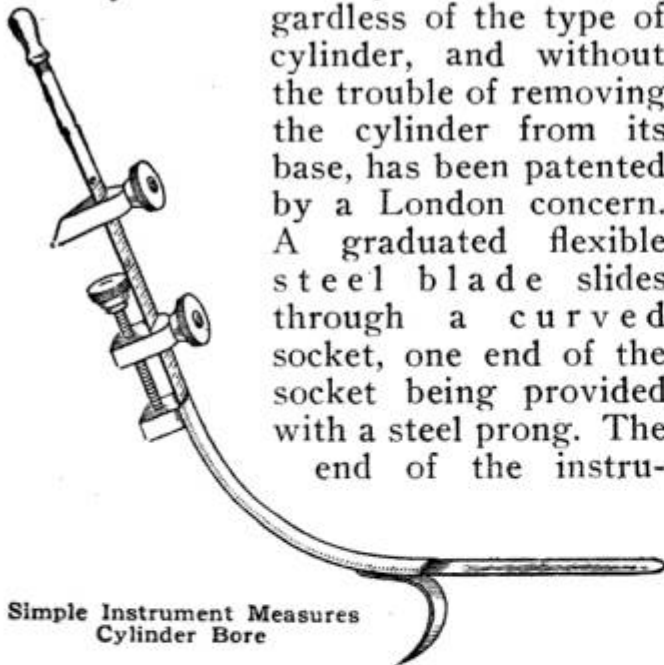

Simple Instrument Measures
Cylinder Bore

ment is inserted through a valve port, and the curved prong pressed against the cylinder wall. The graduated blade is then pushed through the socket until its point is felt to touch the opposite side of the cylinder wall, when the diameter of the cylinder is at once indicated by the scale at the end of the socket.

TURNING LAMP FORK FOR AUTOMOBILES

A lamp fork, adjusted in such manner to the steering knuckle of one of the wheels that the lamp turns auto-

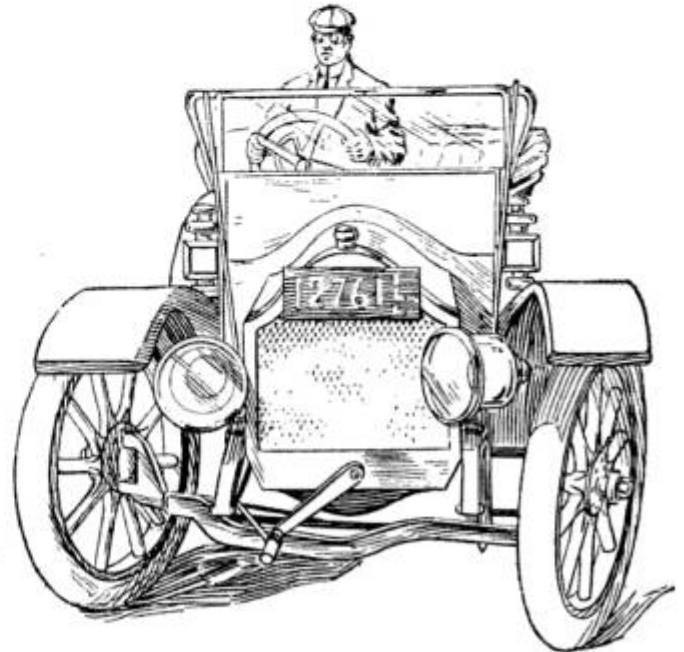

One Lamp Projects Rays Around Turns, While Other
Throws Rays Directly Ahead

matically and projects its light along the road and around turns in advance of the car, is being manufactured by an eastern automobile equipment company.

In a device of somewhat similar design invented a year or two ago, both lamps turned, but in this only one lamp turns, the other continuing to cast its light straight ahead.

INTRINSIC BRILLIANCY OF THE SUN

The intrinsic brilliancy of the sun, deduced by M. C. Nordmann from temperature measurements made by a heterochromatic stellar pyrometer, shows close agreement with the estimate of Müller, arrived at by entirely different methods.

After allowing for the light absorbed in transmission through the atmosphere, Nordmann finds the intrinsic brightness of the sun to be in the neighborhood of 319,000 cp. per square centimeter, which is about 2,072,000 cp. per square inch. Müller's estimate was 301,500 cp. per square centimeter.

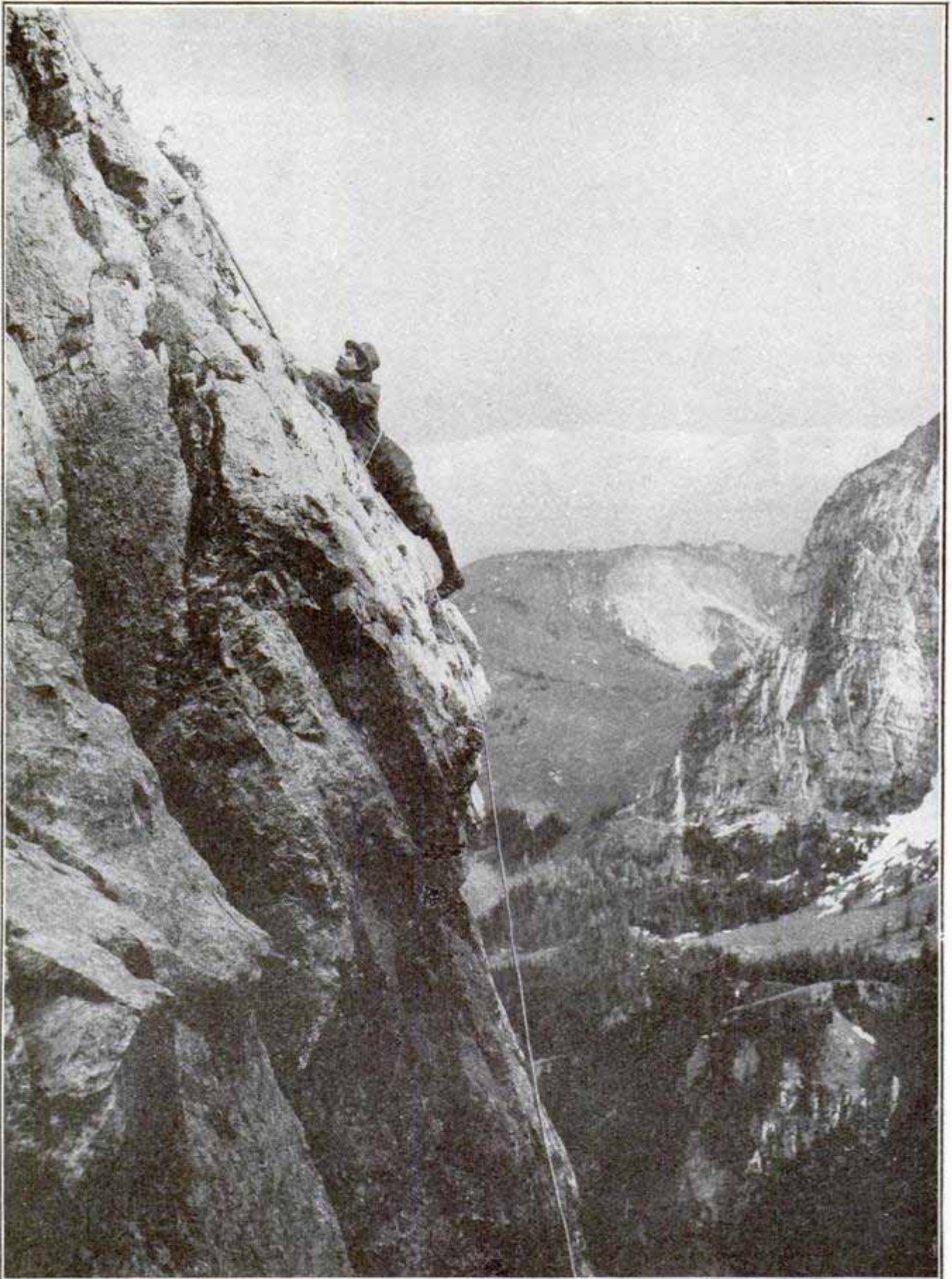

CLIMBING MONT BLANC NO EASY TASK

THE conquest of Mt. Blanc is one of the feats each tourist to the Swiss Alps always has before him. But the task is not easy of accomplishment. To negotiate the steep, rocky slopes requires both fortitude and strength. The climber must possess a steady nerve and have a guide who combines with this quality an unusual strength.

MEMPHIS PLANS PROTECTION AGAINST SHORT WEIGHT

Memphis, Tenn., has adopted an ordinance regarding the weighing of coal, which provides that any consumer can compel a dealer to drive to the public scales to weigh any load of coal he may purchase. An inspector is on duty at the scales and if the weight is found to be short, the dealer is fined. If the weight is correct, the consumer is required to pay the weighing fee and also compensate the coal dealer for the loss of time.

AN OLD-TIME BOILER

Actual examples of old-time boilers are very scarce, and this haystack type, one of the earliest, is now practically extinct, although this one example may still be seen at a colliery at Pelsall, Staffordshire, Eng.

It is composed of 49 irregular-shaped plates of various sizes, arranged in four tiers, with a circular plate at the top. The seams are single-riveted, some of the joints matching each other, while others are staggered. At the bottom of the boiler is a blow-off cock, while the feed pipe is placed 2 ft. from the bottom. A 2½-in. pipe with a pro-

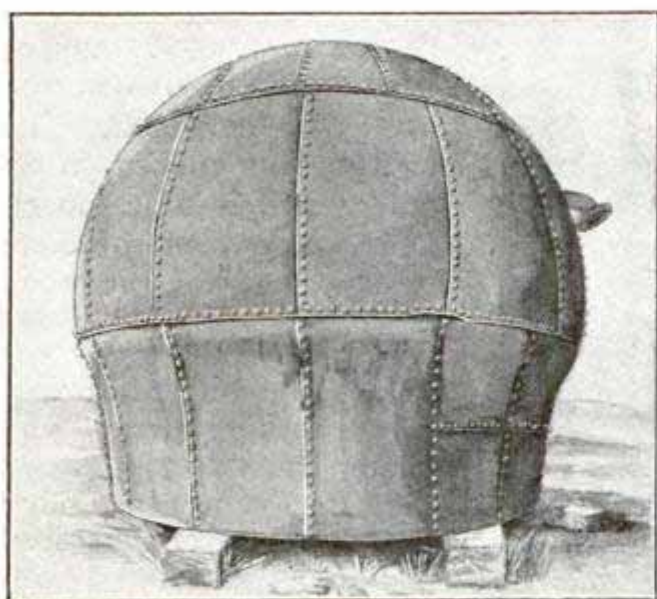

An Old Haystack Boiler

jecting arm, fitted inside the boiler, was probably some portion of the old-time float-and-chain water gauge and feed arrangement.

GRAIN IN WOOD RESEMBLES HEAD OF ANIMAL

At first glance the accompanying illustration might be taken for a like-

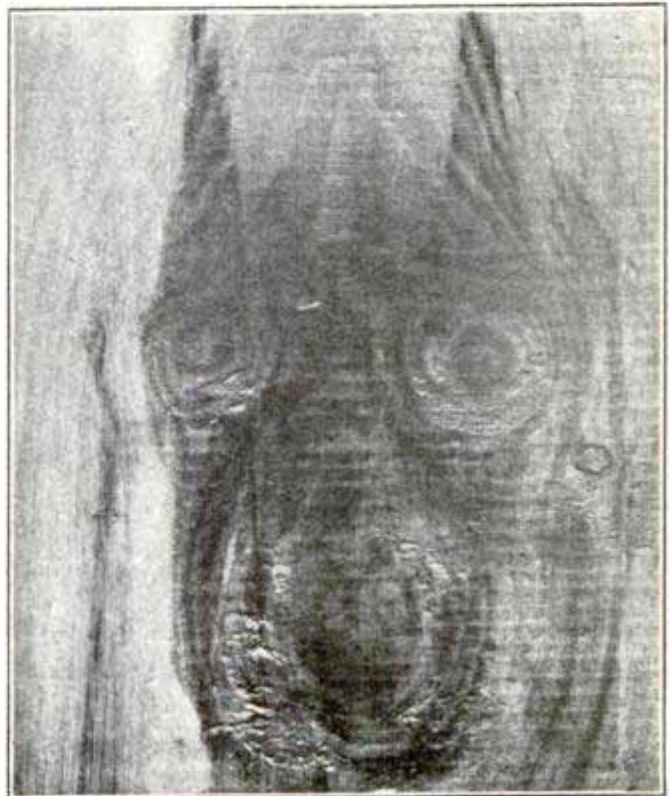

What Is It?

ness of the head of some strange beast. You might delve into all the natural histories published without finding its like, however. As a matter of fact, this is only a section of pine board about 10 in. square, just as it came from the saw in the mill. The eyes and nose of the queer looking object are formed by knots in the board, and the grain of the wood completes the illusion, which is sufficiently good to produce a very realistic effect. A strange feature in connection with this freak is that the reverse side of the board is an exact duplicate, the features appearing equally distinct from either side.

☞The Russian government has ordered the construction of a vessel that has been designed to carry cholera patients from the outlying sections of the Wilna district to the hospitals. Kerosene engines will supply the motive power. The boat will be 42 ft. long and 9 ft. beam.

REFLECTED LIGHT FOR OPERATING ROOMS

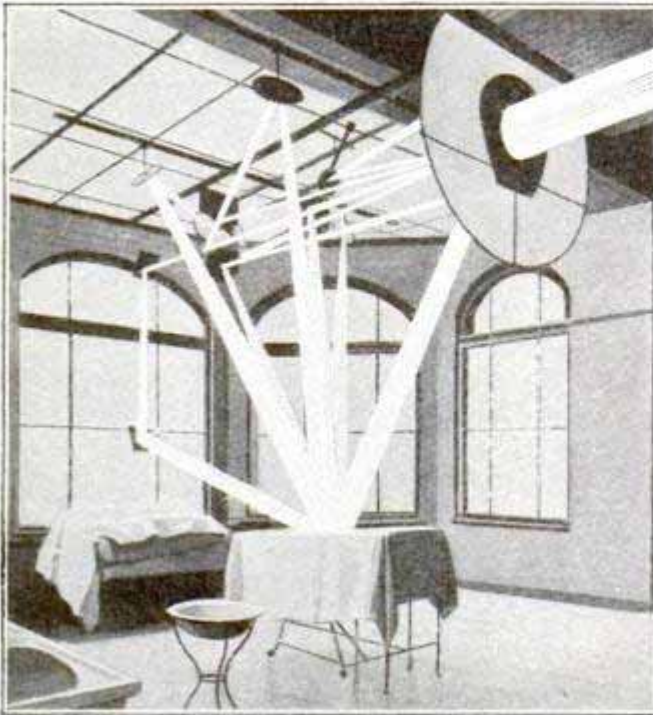

Method of Illuminating Operating Table in German Hospital

A method of illumination for operation rooms, in which an intense light, profuse and free from shadows, is

thrown on the operating table by an arc lamp located outside the room, has been adopted by the municipal hospital of Frankfort-on-the-Main, Prussia.

The light from the outside arc lamp is passed through a condensing lens to render the rays parallel, then is projected through an opening in the wall and strikes a distributing device of special construction. This device divides and directs the light to a number of mirrors, from which it is again concentrated on the operating table. About 12 mirrors are used, and the result is seven shafts of light striking the center of the table from different directions. No matter where the operator and his assistants stand, it is impossible to shut off all the shafts of light at once, consequently the body being operated on is always fully illuminated.

The source of light being outside the room, the aseptic conditions are not impaired, it being claimed that as few lamps as possible should be present, and none directly over the operating table.

WHAT A 1,200-POUND DYNAMITE BLAST LOOKS LIKE

Any person curious to know the effect of an explosion of 1,200 lb. of dy-

namite needs but glance at a photograph recently made at a Nebraska



Photograph Made at the Instant a Charge of 1,200 Lb. of Dynamite was Exploded

quarry to satisfy such a desire. A ledge from 18 ft. to 24 ft. high was disrupted and 6,000 tons of rock, enough to load 150 cars, was dislodged. The charge was placed in 26 holes, drilled 8 ft. apart, 12 ft. back from the edge of the ledge. One rock weighing about 300 tons was thrown 40 ft. by the force of the explosion. The photographer who made the picture stood 100 ft. from the ledge when the charge was fired and he congratulated himself afterward on escaping with his life from the hail of falling stone. One peculiar feature of the blast

was that an eruption occurred about 20 ft. from the ledge, in the bed of the

quarry, at the time of the explosion. The eruption was much like that an earthquake would have caused.

churning and even for pulling stumps. One of the Indians used his machine last spring to plow and harrow his

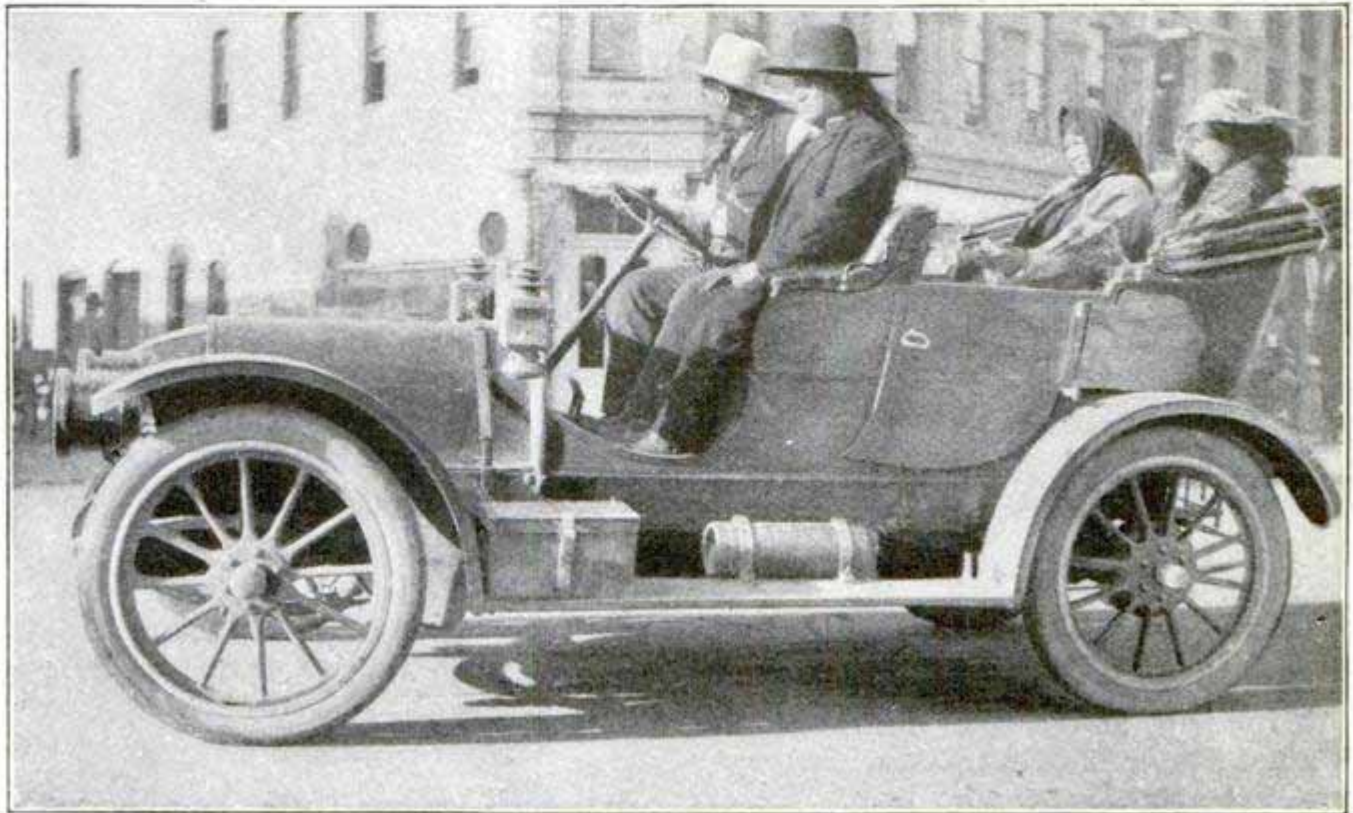

Indians from the Reservation in Their Touring Car at Pendleton Oregon

RESERVATION INDIANS USE THE AUTOMOBILE

It is not an unusual sight at Pendleton, Oregon, and vicinity, to see a full-blooded Indian from the Umatilla Indian Reservation acting as chauffeur of an automobile and whizzing along the country roads with his squaw on the seat beside him.

In this rich farming region the automobile has displaced the farm horse with splendid results, and the Indians on the Umatilla Reservation near Pendleton have followed the white man's lead, with the result that it is now a common sight to see them flying about in gasoline cars. Some of the Indians on this reservation are very wealthy and farm on an extensive scale, many of them having purchased farms in the vicinity of the reservation. They use the automobile not only on the reservation itself, but even to carry butter, milk, grain and other produce into town. With a true adaptability, the red men also utilize the power of the auto for threshing, sawing wood,

truck garden. The variety of uses to which the automobile is put, when not used for transportation, is as extensive as those of the gasoline engine. A circular band takes the power from the motor to the circular saw, churner, thresher, cream separator or other apparatus it is desired to operate.

IF AN AIRMAN DROPPED A MONKEY WRENCH

An interesting computation, involving the falling of a weight from an aeroplane at a high altitude is given by the American Machinist.

If, when Ralph Johnstone, the late Wright airman, was circling around in the air 9,714 ft. above the ground, his monkey wrench had slipped from his pocket, its speed, upon striking the earth, would have been about 500 miles per hour. And it would not have been so long getting down, either; just a little over 25 sec. It certainly will pay to "duck" in a hurry when, in the future, we see any signs of a monkey wrench rain from a clear sky.

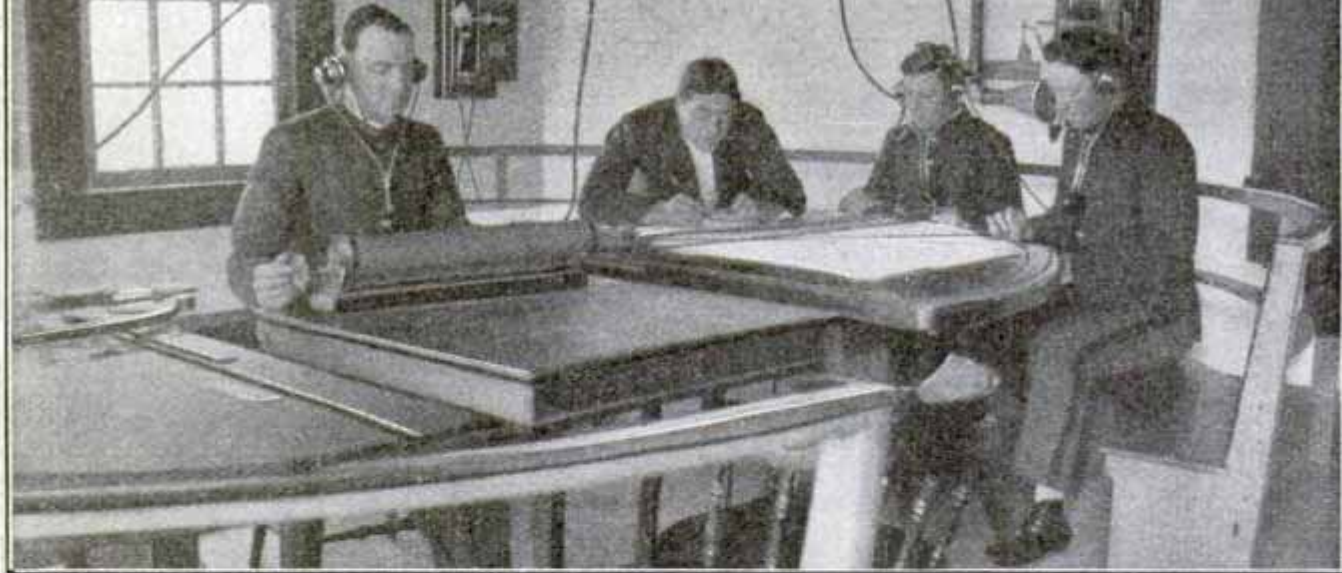

The Men Who Direct the Big-Gun Fire

DIRECTING THE AIM OF THE GUNNERS

High up above the decks of the United States battleships during target practice are officers who watch the effect of the gun fire and give the men behind the guns directions. In times of war, this duty is very dangerous because of the lack of protecting armor, and requires sharp eyesight and steady nerves.

There is a probability that in the near future fire control will be from armored stations, and that the tripod and cage masts, as adjuncts to fire control, will become obsolete. At medium range, it is believed that fire control can be effected from well protected towers at a

small elevation, but a means of dispensing with the military top at long range has still to be devised.

FRENCH BIPLANE ON MONOPLANE LINES

The new biplane of M. Goupy, the French airman, is somewhat different from the usual box-kite type of biplane. It is built more on the lines of the French monoplane with a second plane added. The weight of the machine is 550 lb., and four lateral stabilizers or balancers, arranged at the ends of both the upper and lower planes, accomplish the same result as the warping idea brought out by the Wrights.

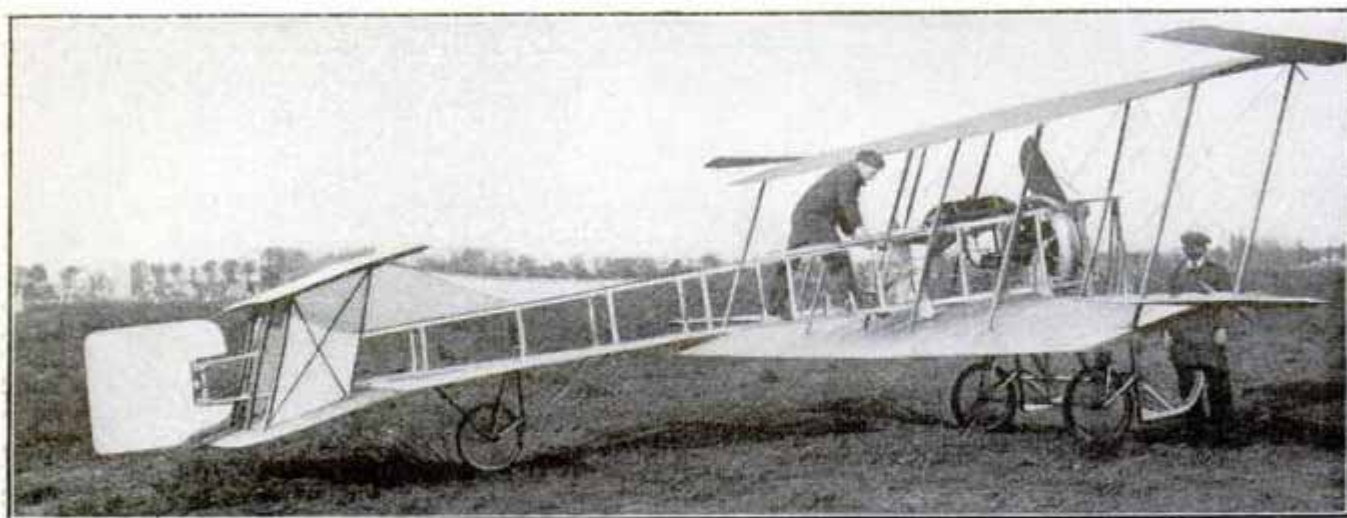

The Goupy Biplane

SHOP NOTES

Bending Wood

The bending of wood requires a steaming apparatus that would take considerable time to make and involve some cost for material. Where a few bent boards are wanted, a costly apparatus is not necessary, as the boards can be bent equally as well by soaking the wood in water for several days to make it thoroughly water logged and then passing it over a gas flame several times. The wood, being soaked through, cannot burn and the steam from the water softens the wood as well as if it were steamed in the regular way.—Contributed by Helge R. Crafton, Chicago.

Cutting Plugs for Filling Screw Holes

The ordinary leather punch that is driven with a hammer is a good substitute for the regular plug cutter to cut round pieces of wood for filling screw holes. The punches can be purchased from any local hardware dealer in almost any size. The cutting edge is ground or filed sharp and the cutter



Leather Punch for Cutting Wood Plugs

used in a brace the same as a bit. Revolving the punch on the wood cuts out a smooth plug.—Contributed by W. H. Booker, Belfast, Maine.

A Paper Drinking Cup

Take a piece of clean paper about 6 in. square and fold it on the dotted line as shown in Fig. 1 so as to make a triangle. Do not use paper having anything printed on it as there is danger of poison from the ink. The other

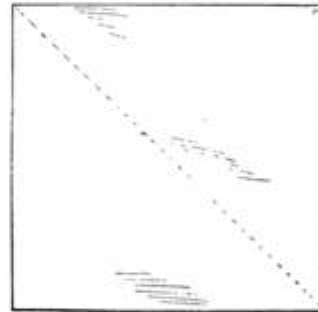

FIG. 1

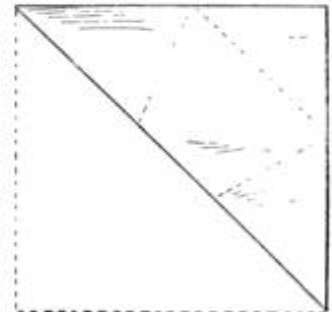

FIG. 2

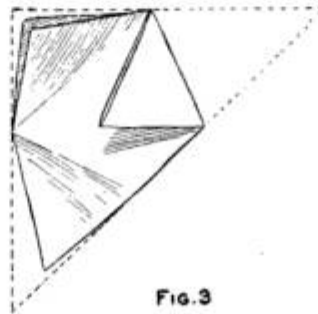

FIG. 3



FIG. 4

Folds in the Paper

foldings are made on the dotted lines as shown in Fig. 2. Each pointed end of the triangle is turned over on one side as shown in Fig. 3, then the sheets of the remaining point are separated and each one folded down on its respective side.—Contributed by R. H. Lufkin, Dorchester, Mass.

Hanging Ingrain Paper

It is best not to use a trimmer on ingrain paper, as the edges cannot be notched well enough to prevent showing a seam. Take the paper and roll it tight; then roughen both ends with No. 0 sandpaper which leaves a feather edge. This gives a straighter edge than when cut with a trimmer and the feather part will roll down and make a perfect joint.—Contributed by A. E. Johnson, Frankfort, Ind.

Ⓞ Do not forget that when a piece of work being turned in a lathe gets hot, it lengthens by expansion.

can be changed into a step-ladder is shown in the accompanying sketch.

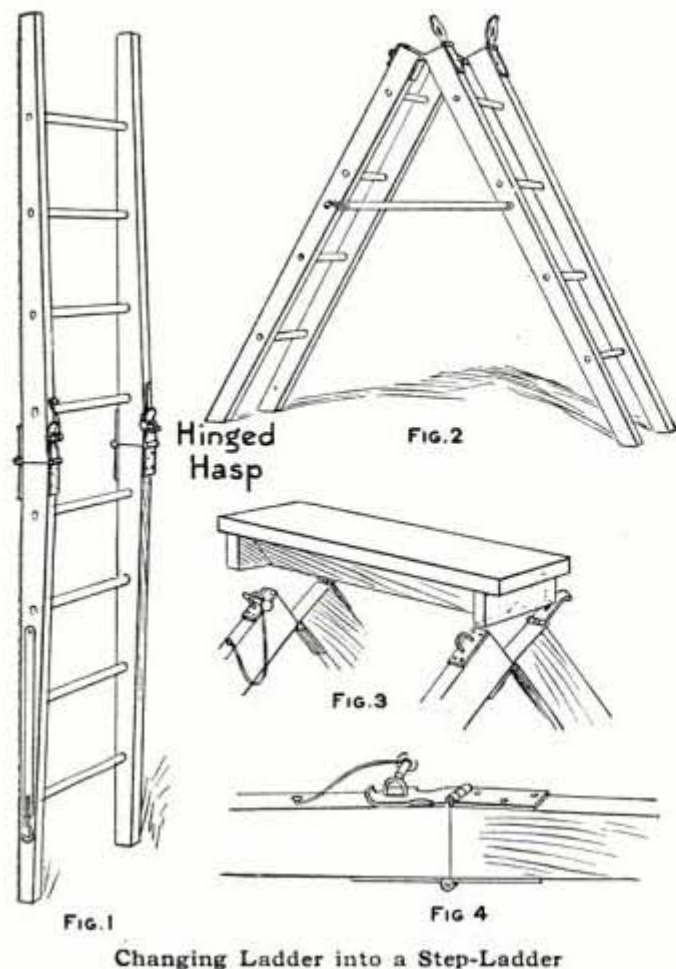

Changing Ladder into a Step-Ladder

In this case a ladder 20 ft. in length (Fig. 1) was cut in the middle and a pair of hinges used on one side and a hinged hasp on the other to join the parts together. The hinges should be heavy and well screwed in place. The hinged hasp should also be heavy and a bolt used through the staple part to hold the ladder when extended. The ladder is folded as shown in Fig. 2 for use as a step-ladder. In Fig. 3 is shown a step for the top that is placed in the crotch formed by the ends of the ladder sides. One of the joints is illustrated in Fig. 4.—Contributed by Robert C. Knox, Colorado Springs, Colorado.

ⒸA quick way to charge the primer on an automobile engine is to saturate a bit of waste in the oil of the carburetor and squeeze it into the opening.

cut all sizes of fiber and thin sheet-metal washers from a 3-in. hole to 18 in. outside diameter. With it fiber washers $\frac{1}{4}$ in. thick have been cut without any difficulty or trouble whatever, greatly reducing their cost. These washers I used mostly on large embossing dies. The tool consists of a 1-in. drill with a cutter head beam let through the slot and fastened by two setscrews.

The cutter heads are set to a good sliding fit on the beam, and the cutters are tempered and let into split seats in the cutter heads and also fastened by screws. The cutting tools are a trifle less than $\frac{1}{16}$ in. thick and are given sufficient side and back clearance to allow them to cut freely.

The sketch shows how the tool is used. A piece of 1½-in. planking is fastened to the drill press table and the table is clamped in a central position. A small pin forced into the planking at the right serves as a gauge for locating the fiber beneath the drill and also to space the washers evenly. The drill shank is fastened in the chuck, in the drill spindle, and the tool is rotated about 40 turns per minute. The drill cuts first, and as soon as it has passed through the fiber and entered the wood the inside and outside cutters begin to cut. A light pressure is all that is necessary to make the cut, the chips curling up nicely, and as soon as they

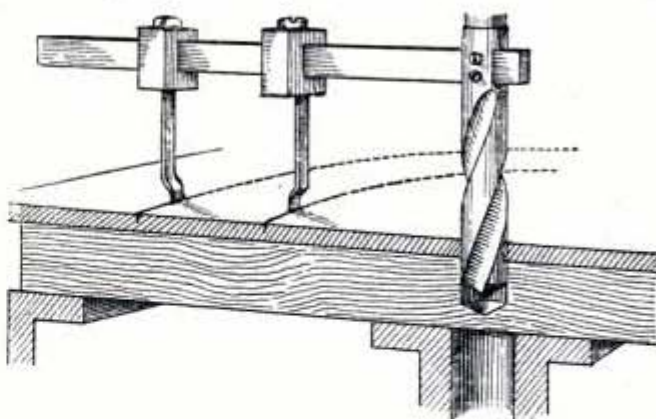

Two Cutters on a Bar

pass through the fiber or brass a quick rise on the feed lever causes them to pull free and clear of the work. As

will be seen, the tool cuts the inside and outside of the washers at the same time, and as the inside washers can very often be used, two washers are really cut at one operation.—Contributed by Jos. R. Weaner, Plainfield, New Jersey.

Exhaust Cutout for a Motorcycle Engine

The accompanying sketch shows a simple cutout I made to fit on the exhaust pipe of my motorcycle, the muffler being of the regular type. I used a piece of brass about 1/2 in. thick, and ground it out to fit the curve of the pipe as shown. This was secured to the exhaust pipe by means of two 1/4-in. clips. Two holes were drilled through the side of the exhaust pipe and a brass

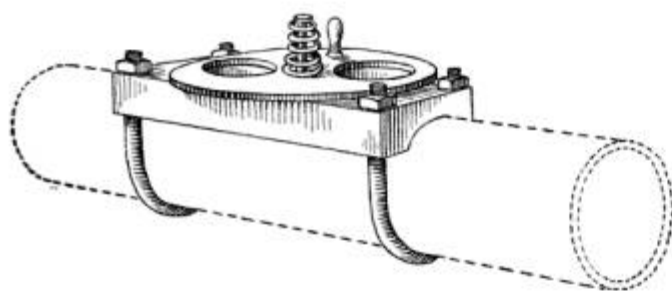

Cutout on Exhaust Pipe

disk fitted to revolve over the holes. Two holes were drilled in the disk to correspond with the holes in the pipe, making it so that a quarter turn would close and open the cutout. The disk was secured by a stud turned into the brass piece. A heavy coil spring, secured by a nut and washer, held the disk in close contact with the openings. The cutout can be made in any size.—Contributed by John H. Putgenter, Ilchester, Md.

Home-Made Steam Trap

A steam trap operated by the expansion of the metal pipes can be made from pipe and fittings as shown in the illustration. The outlet is an ordinary globe valve with the threads removed from the stem so it may be opened by an end pull instead of a turn. The end of the stem is then attached to the end of an arm joined to the lower end of a

lever that works on a pivot, A. The upper end of this lever is securely

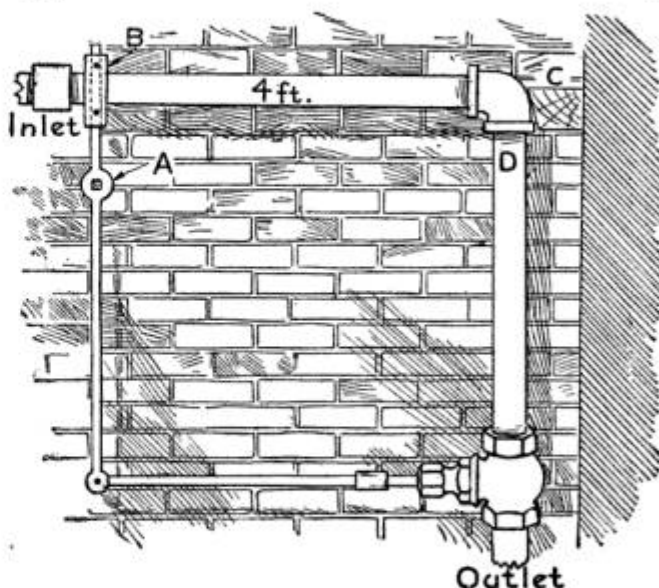

Steam Trap of Pipe and Fittings

fastened to the upper horizontal steam pipe with a band, B.

The turn, or L, in the pipe must be blocked at C or held with a strap around D, to prevent the expansion of the metal drawing the lever in the wrong direction. The operation of the trap can be easily understood from the illustration.—Contributed by James E. Noble, Toronto, Canada.

Roller Bearings for Bureau Drawers

An effective and economical plan to overcome the annoyance caused by bureau and cabinet drawers sticking is to attach rollers made of ordinary discarded thread spools to the strips on which the drawers slide. One end of each spool is cut off as shown in Fig. 1 and fastened to the strips with round-head screws, Fig. 2. Be sure to place the spools high enough to afford an

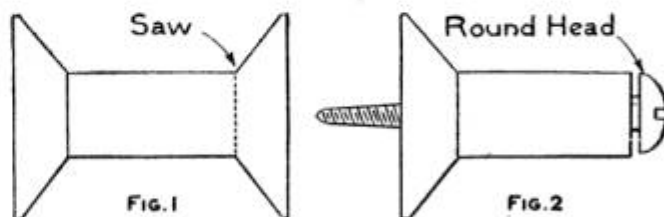

Rollers Made of Spools

easy roller for the drawer, yet not too high to bind the edge at the top.—Contributed by C. C. Reynolds, San Francisco, Cal.

The task of rolling a band-saw by one who has never handled such a saw is quite difficult, but if the different

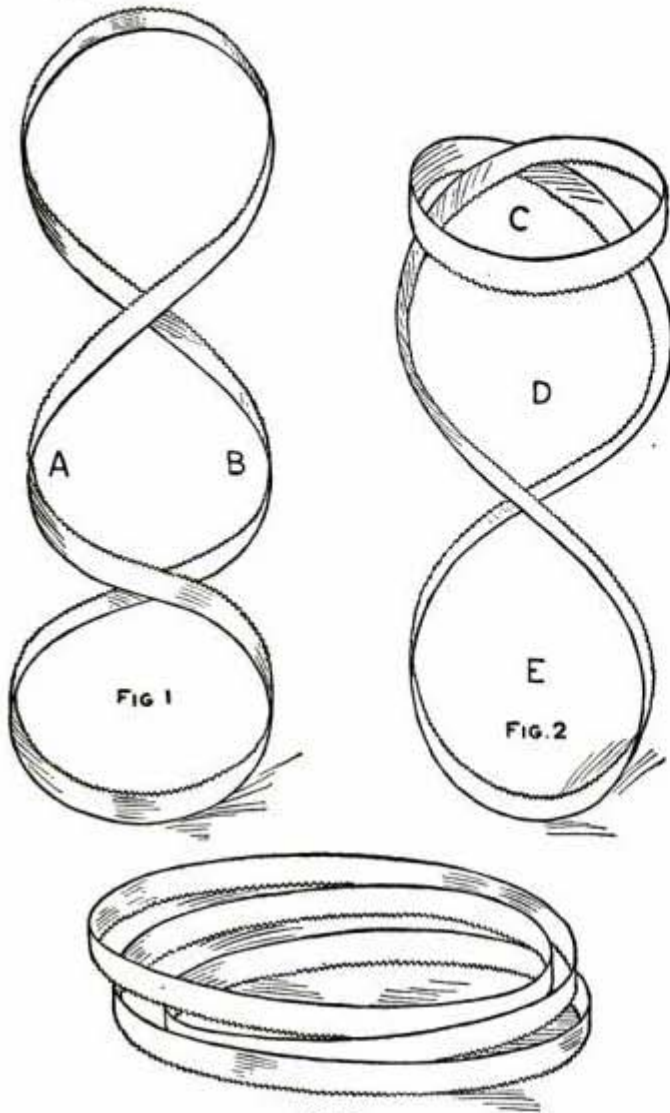

FIG. 3
Turns in the Saw Blade

stages of folding, as illustrated in the sketch, are followed out, the rolling will be quickly accomplished. Grasp the saw with the palms of the hands upward and allow the lower end to touch the floor near the feet, with the middle parts A and B, Fig. 1, swung away from the body. Place the curve A under the curve B so as to form the three loops shown. Turn the top loop toward you and down as shown at C, Fig. 2, and then turn loops C and D toward you again on E and you will have a roll as shown in Fig. 3.—Contributed by Benjamin Kruka, Kearsarge, Mich.

ⒸWhen one roughing cut will do on lathe work, do not make two out of it.

The following is a quick and reliable method of testing electric watt meters: An incandescent lamp of a known wattage, at the voltage at which the meter is to be tested, is connected in circuit with the meter. Observe the time required for the disk to make one revolution with lamp in circuit. If, for instance, the constant is $\frac{1}{2}$ (which is generally found at bottom of meter dial), then $\frac{1}{2}$ of 3600 watts, which is a constant, will be 1800 watts. Supposing the disk required 32 seconds for one revolution, then 1800 divided by 32 equals 56 watts, or about the average consumption of a 16-cp. lamp, if this be the consumption of lamp in circuit.

Meters are regulated by a magnet through which a disk revolves. By moving the magnet towards the shaft on which the disk rotates the meter will run faster; by moving away from shaft, the meter will run slower. Many people have an idea that their watt meters are running too fast. As a matter of fact, a meter after running for two or three years will invariably run slow, caused by the steel pivot of the moving element wearing away the sapphire jewel upon which the disk revolves.—Contributed by Alvin Kolb, Bedford, Ohio.

Strainer in Oil-Can Spouts

Small particles of dirt and foreign matter would get into the small end of the spout of my oil-can and clog it up so no oil could be forced out. I inserted a small sieve, shaped like a thimble, in the lower end of the spout, as shown in the sketch. Any fine gauze wire can be used for the sieve. This catches all the dirt, but does not prevent the oil from flowing freely.—Contributed by Chas. Homewood, Waterloo, Iowa.

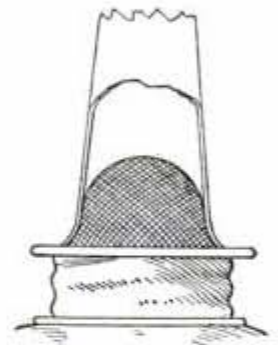

Remedy for Damp Walls

If a wall is suspected of dampness, a piece of gelatine held close to it will tell the story at once. If the wall is dry, the gelatine will not change: if damp, the gelatine will turn or curl more or less, according to the degree of dampness. If the wall is very damp, it will need no testing. One good remedy for a wall not very damp is a mixture of 1 lb. of good glue dissolved in 1 gal. of water, into which, while hot, has been stirred some dry red lead until the mass is of the consistency of ordinary paint. The surest and best remedy, according to the Master Painter is the Sylvester process, as follows: Cut up $\frac{3}{4}$ lb. of castile soap in 1 gal. of water, and dissolve; now dissolve $\frac{1}{2}$ lb. of pulverized alum in 4 gal. of water. With a brush for each solution, using a wide brush, apply a coating of the soap solution, rubbing it well into the wall; let it dry until next day, then apply a coat of alum water; let this dry until next day, then repeat with the alum and soap once, as before. Thus the wall will receive two coats of soap and two of alum, which will form a chemical compound impervious to water. Very damp walls treated with this simple coating will give no trouble under paper for years.

How to Fasten Pipe into Hose

Anyone who has repaired a broken hose knows how hard it is to insert a pipe in an open end, as the pipe and the hose are usually not the same size. File the pipe to make it bright and heat it just enough to make the metal blue, then put it in a vise. Slip the hose on the pipe quickly and place it in water to cool, after which attach the clamp, and the hose will hold tightly.

Unloading Device

Many cities operate a sanitary plant for the disposal of refuse. The largest part of this material consists of papers

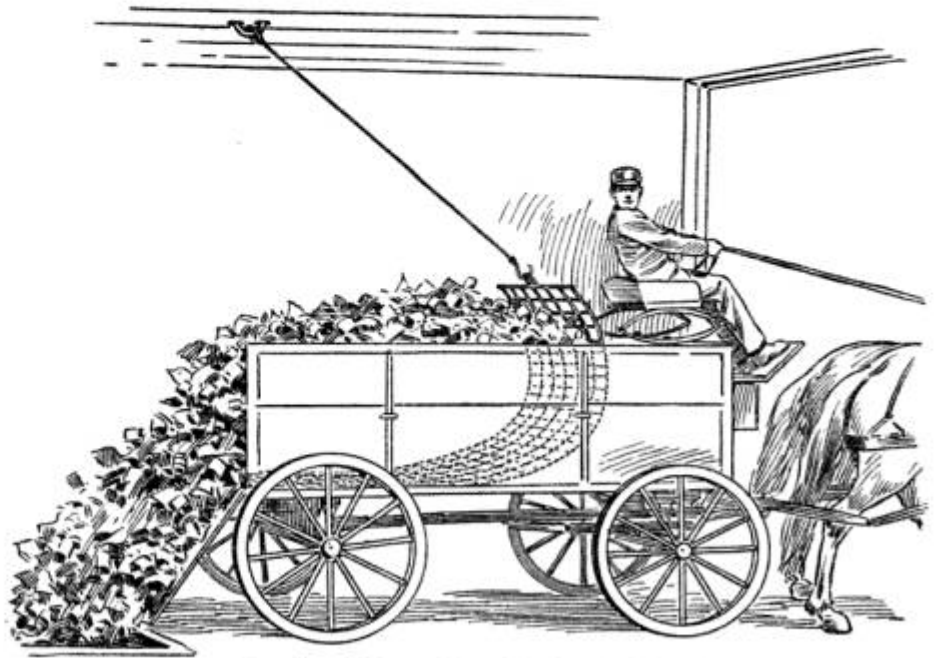

Drawing Wagon from Under the Load

and tin cans, which makes the unloading exceedingly hard where dump wagons are not used. One city supplied each wagon with a flexible wire screen, just wide enough to fit loosely on the floor of the wagon box, and with one end fastened to the tail-board hinge pin. The screen extends forward the full length of the body, then turns upward to the seat. In this end is fastened a ring.

At the unloading point a hook is hung from a rope fastened to a support above. This hook the driver engages in the ring on the screen. When the horses are started, the wagon is drawn out from under the load. The device saves a great deal of time because the mass of paper, wood, cans, etc., becomes so packed that it is very difficult to shovel out.—Contributed by J. J. O'Brien, Buffalo, N. Y.

☞ Always keep a lathe clean and in order.

☞ Use shellac for the base when repainting a sign over red and the color will not bleed through and spoil the appearance of the job.

The old proverb, "A watched kettle never boils," does not apply to the water heater shown in the accompanying illustration, because hot or even boil-

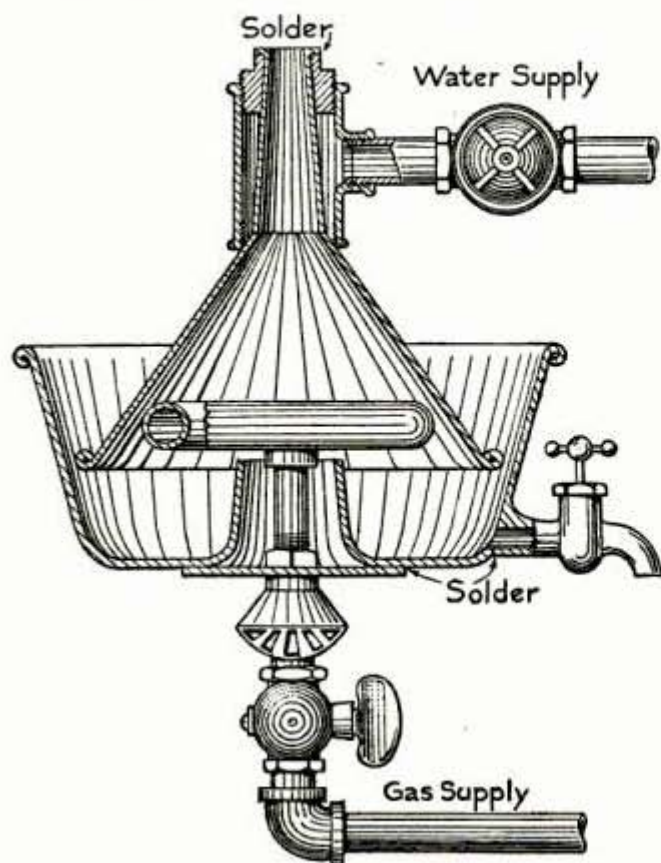

Heats Water Instantly

ing water can be drawn from it the instant it is put into operation, says the *Scientific American*. It is made of an ordinary copper funnel and a cake tin.

The copper funnel should be tinned on the outside. To the water supply pipe is attached a valve for regulation of the flow of water. To this valve is fitted a short nipple and an ordinary tee fitting. One end of the arm of the tee is fitted with an ordinary plug which is bored and reamed out to fit the small end of the funnel, and the end of same is turned over with a small hammer and soldered to the plug. The other end of the tee is filed to fit very closely to the outside of the funnel, leaving a slight annular opening which may be regulated by screwing the plug in or out so that when the water is turned on it will flow in an even thin sheet over the funnel.

Inside the funnel is an ordinary gas burner, such as may be purchased for

10 cents. The burner is connected to the gas supply in the usual manner. It will be noticed by referring to the illustration that the funnel is in an inverted position. The lower part of the funnel is surrounded by an ordinary cake mold with the inside cone partly cut off. This tin forms a basin for the hot water, which may be drawn off with an ordinary faucet soldered to the cake tin, or it may be run off as the water heats. It will now be seen that when the gas is lighted the funnel becomes hot at once, and when the water is turned on it is forced through the narrow opening between the tee and the funnel in a uniform thin sheet which spreads over the funnel and becomes hot as it flows down. Almost any degree of heat may be obtained by regulating the flow of water with the valve. The spent gases from the gas burner pass up through the funnel and out to the atmosphere. Some arrangement may be made to connect the water and gas valves so that they will be turned on simultaneously, thus obviating the danger of overheating the funnel.

Sawing Tubes at an Angle

Tubing cannot be sawed accurately at an angle without a bench hacksaw. When one of these tools is not at hand, the following method will produce excellent results:

Say, for example, that one wishes to saw a piece of brass tubing at an angle

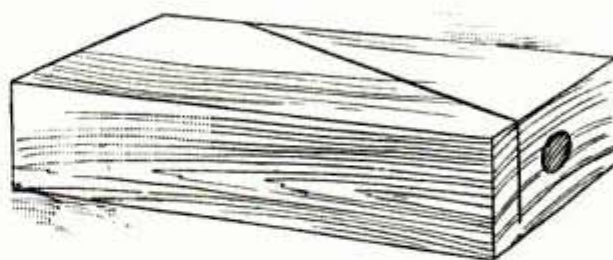

Angle of Cut Made in Block

of 20 deg. to its length. Take a block of wood of sufficient length and thick enough to admit boring a hole into it lengthwise without splitting the wood.

Bore a hole having the same diameter as the tubing, from end to end, perfectly parallel with the edges. With the aid of a protractor, adjust a sliding bevel to 20 deg. and lay off a line with it on the face of the block. Mark off another line with a square on the end of the block. Make a cut with a back or cross-cut wood saw along the lines drawn, sufficiently deep to bisect the hole already bored. It only remains then to shove the tubing into the hole, insert the hacksaw blade in the slot and saw away. The accuracy of the sawing depends on the precision with which the wood block is prepared.—Contributed by Harry F. Lowe, Washington, D. C.

Keeping a Lantern Bail Upright

When setting a lantern down, the bail always falls to the side, thus making it necessary to stoop in taking it up again. This is sometimes very unhandy, especially if the arms are full. The trouble may be overcome by using a small weight soldered to the bail as shown in the sketch. Attach the weight to a wire about 2 in. below the end of the bail. This allows the bail to swing, but it will always come to rest in an upright position. Such a device may be used on pails, also.—Contributed by Stephen E. Shaw, No. Dartmouth, Mass.



Roof Jack for Holding Paint Pots

Painters who have much roof painting to do must have some sort of a device to hold the paint pot in an upright position, as it is very unhandy to carry it with one hand and paint with the other. A simple device to hold the paint pot, that is easy to make and

will work on a roof of any pitch, is shown in the accompanying sketch. Secure some keg hoops and make a

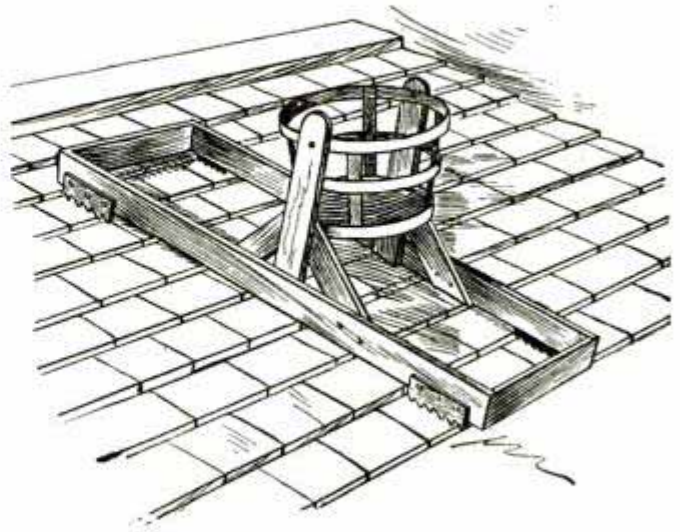

Pot Jack on Roof

basket, as shown, large enough to hold the paint pot. The basket should have a wooden bottom and the top hoop should be fastened to two uprights of a wooden frame, so that it will swing freely between them. Four saw-tooth clips, fastened to the supporting frame, will hold it securely to the roof. This device can be easily moved about the roof and will always hold the paint pot in an upright position.—Contributed by W. A. Jaquythe, Richmond, Cal.

Repairing a Pump Jack-Arm

The arm of my pump jack broke at the place marked A in Fig. 1, and I repaired it in the following manner:

A piece of metal $\frac{3}{8}$ in. thick and $1\frac{1}{2}$ in. wide was bent and shaped to fit over the main part of the arm and was held in place with two clamps, as shown in

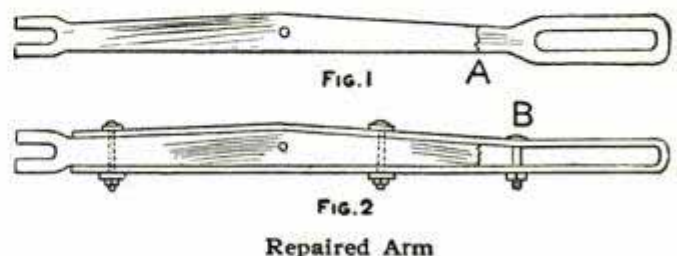

Repaired Arm

Fig. 2. The bolt B was put in to keep the sliding bearing from becoming loose.—Contributed by Geo. Hess, Jr., West Grove, Pa.

Attaching Crank to a Clock Key

The ordinary wing key on a clock is usually hard to turn and this is especially the case if the clock be perma-

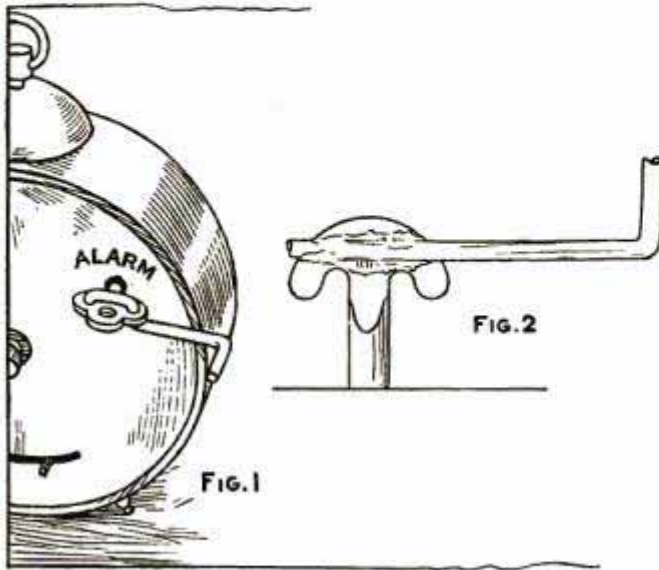

Crank on Clock Key

nently located on a more or less inaccessible shelf.

The attachment of a little crank to the key, as shown in Fig. 1, greatly facilitates the operation of winding, and causes much less fatigue to the arms and fingers. With the ordinary key having holes in the wings, it may be made of a piece of wire bent as shown in Fig. 1. If the key does not have holes in the wing, it may be soldered to the side of the key, as shown in Fig. 2.—Contributed by Thos. L. Parker, Olaf, Iowa.

A Simple Door-Opening Device

Here is a device for opening a door which seems to me simpler than any

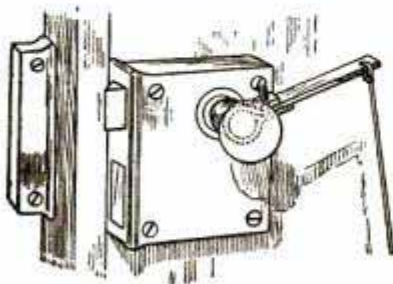

other I have seen, and which requires but two or three minutes to assemble on the door.

First bend to the shape shown by the full and dotted lines a piece of iron about 6 in. long, $\frac{1}{2}$ in. wide and of suitable thickness; then drill holes for a small stove

bolt to secure the bent portion when placed in position around the knob spindle, and one at the extremity of the straight end for a string. The stove bolt when screwed tight makes the iron stationary. The string should be long enough to reach to the bottom of the door, where it may be kept in position by means of a small screw eye.—Contributed by D. O. C. Kersten, Detroit.

A Center for Turning Large Work

It is sometimes necessary to make a center of some sort when turning certain kinds of large castings in the lathe. A handy adjustable center for such work is shown in the accompanying sketch. A is a casting to be turned and faced. B is a hub that is tapped for four steel-pointed screws, as shown at C. This hub can be adjusted to the inside of the casting and made con-

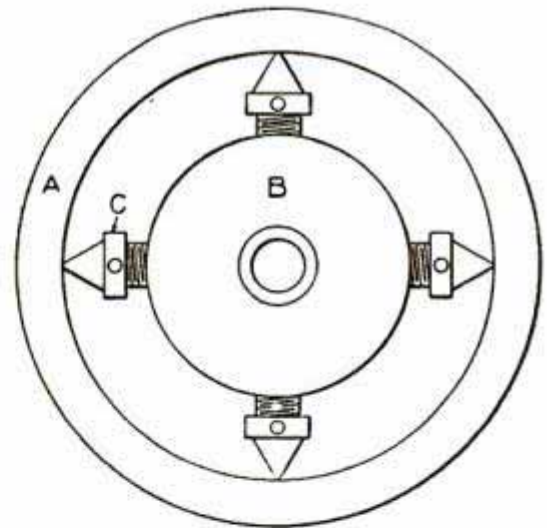

Hub with Center in Casting

centric with it, so it can be turned in a lathe, by means of these screws. The hubs can be made of different sizes to correspond to the different sizes and kinds of work.—Contributed by C. Purdy, Ghent, O.

Electric Foot-Warmer

A simple electric foot-warmer which has many uses in the place of a hot-water bottle and which takes the place of the more expensive heaters now on the market, is shown in the accom-

panying sketch. Two 16-cp. incandescent lamps are turned into plain sockets in the ends of a tin tube about 2½ in. in diameter and 15 in. long. The lamps are joined in series and connected with a lighting circuit. When joined in this manner, the lamps heat slowly and are not liable to scorch the woolen jacket with which the tube should be encased. The consumption of current, too, is extremely small.

If it is desired to wire the lamps so that the device will heat much faster,

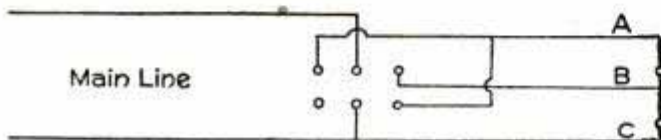
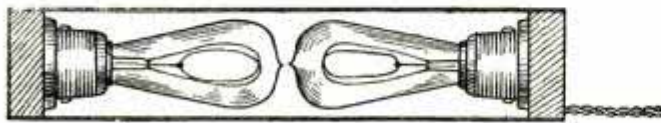

Lamps in the Tube

the lamps may be shifted from the series to the parallel arrangement by means of a double-throw switch connected as shown in the diagram. It then becomes necessary to run the three wires A, B and C from the switch to the heater.

A Silent Ratchet Wrench

The construction of a ratchet wrench with a roller-pawl action is shown in

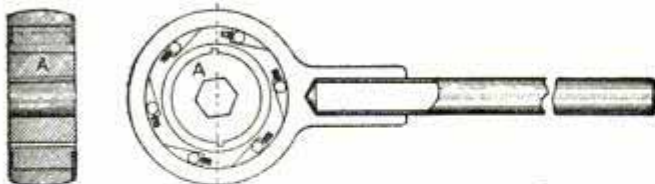

Roller Pawl Ratchet Wrench

the accompanying sketch. The roller pawl will catch and hold at any point, and the usual lost motion due to the ratchet not catching in the next tooth is avoided. The part A is removable and stud sets, stud extractors and similar tools used in its place. The construction of this wrench allows its use in close corners where even an open-end wrench would be at a disadvantage.—Contributed by Frank S. Bunker, Vallejo, Cal.

Turning Eccentrics

A method of turning eccentrics without the use of special tools is shown in

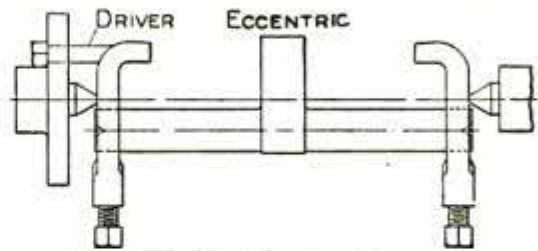

Dogs Used in Turning Eccentric

the accompanying sketch. This method applies to cases where the center falls outside the shaft. The shaft of course is turned on its own centers; then two lathe dogs are centered, drilled and applied as shown. They should be firmly clamped to the shaft so as to avoid slipping. A pin or a bolt in the slot in the faceplate serves as a driver.—Contributed by D. A. Hampson, Middletown, N. Y.

Forms for Sawing Miters on a Cabinet Bench

The illustration herewith shows a device in which a saw can be used for cutting square and miter joints. The main part is made of a plank 1¾ in. thick, 10 in. wide and 24 in. long. A riser to hold the work against while the cut is being made, is fastened to the back edge of this plank. A cleat attached on the front and under side holds the form against the bench. A disk, 7 in. in diameter, is cut in the center of the bed plank and fitted to turn freely, but not loosely. This disk has two standards for holding the saw perfectly vertical. By placing a set screw in the front edge of the plank,

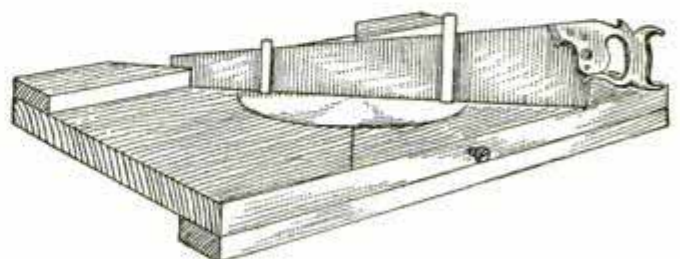

Saw in Guides

the disk can be held in the required position to cut the square or miter desired.

All photographers who use a shutter for quick exposures realize the value of knowing the actual exposure given by a shutter at its various speeds. This requires some kind of a speed-

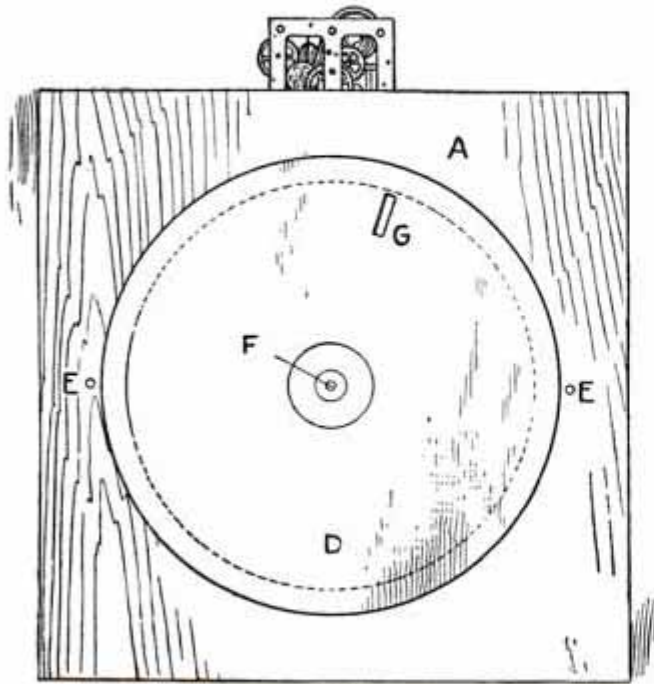

FIG. 1

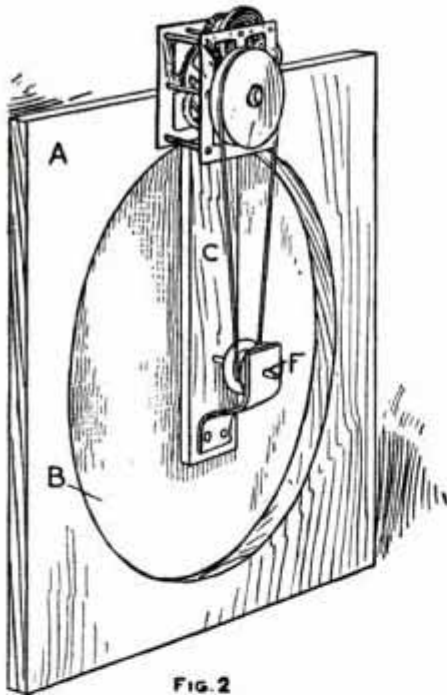

FIG. 2

Shutter Speed Recorder

timing device. Many forms of speed-timing devices have been described, says a correspondent of *Photographic Times*, but they are usually too complex for the average photographer to construct. The illustrations show a device sufficiently simple for anyone to

construct, and the records it gives are accurate enough for ordinary requirements.

The principle is that of photographing the light which passes through a slot in a disk while the latter is revolving at a known speed, then measuring the length of the impression on the sensitive plate.

The apparatus consists of a board, A, about 18 in. square, in the center of which an opening is made, shown by the dotted lines in Fig. 1. Over this a narrow strip of wood, C, Fig. 2, is fastened to form a support for the shaft F, of the revolving disk D, Fig. 1. The disk, which may be made of thin wood or a piece of mounting board, must be a little larger in diameter than the circular opening in the board A. Near the edge of this disk a narrow slot G, is cut, which must come within the opening in the board so that the light may pass through the slot. A stiff piece of wire may be used for the shaft F, a block of wood being glued on the center of the disk to allow of its being mounted true. The disk is placed in position by passing the spindle through a hole in the wooden strip C, the outer end being held in place by a bent piece of metal as shown in Fig. 12.

The disk is turned by clockwork, of which some of the wheels must be removed to allow the "post" to revolve fast enough. A grooved wheel is placed on the post in place of the clock hands, and a spool attached to the shaft F, the two being connected with a light twine belt. The difference in size between the two pulleys is regulated by the speed at which the larger one revolves, and the speed at which one wishes the disk D to turn, the latter depending on how rapid an exposure is to be tested. For tests up to about 1-100th of a second, one revolution per second might do, but for more rapid exposure the speed of the disk must be increased. It might be well to say here that clockwork which has been altered as previously mentioned

will vary a little in speed while running, so in taking the time of the revolution of the disk it is always well to allow the works to run a certain length of time before snapping the shutter. Accurate results always can be obtained by taking this precaution.

The tester is set up against a window with clear sky for a background and all light blocked out around the apparatus with heavy brown paper. The image of the slot G is focused sharply, then after setting the shutter at the speed desired and starting the disk revolving, the exposure is made. The diameter of the disk is recorded on the negative by the images of the two small holes E E, shown in Fig. 1, so all that is necessary is to measure the distance apart these are on the negative, and then draw a circle on paper of the same diameter. The length of the beam of light which passed through the slot G during the exposure is next measured with a pair of dividers, deducting the actual width of the slot, and the number of times this goes into the circumference of the circle plotted off, the result giving the duration of the exposure.

For example, suppose a 3-in. circle is indicated on the negative. The circumference of this is approximately 9 in. The length of the beam of light as recorded is $\frac{1}{2}$ in., after deducting the width of the slot, and the disk was revolving one turn a second, so as $\frac{1}{2}$ in. goes into 9 in., the circumference of the circle, 18 times, the speed of the shutter was 1-18th of a second.

One advantage of this tester is that it can be used indoors, while other simple speed-testers depend upon daylight for illumination and must be set up out-of-doors in bright sunshine.

Preventing Work Slipping from a Chuck

Anyone working at a lathe knows how disks chucked on a small center or pieces extending from a chuck will slip and turn, causing the piece to gradually come out of the chuck as the work proceeds. The accompanying sketch

shows how to supply teeth or grippers for each jaw on the chuck so that it will hold the piece being turned.

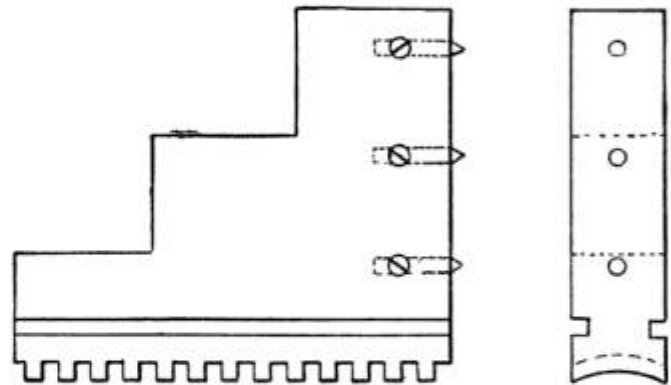

Fig. 1

Fig 2

Steel Points in Each Jaw

When the grippers are not required they can be removed by loosening the setscrews. The pins should be made of steel and hardened.—Contributed by Walter L. Keefer, Waynesboro, Pa.

A Home-Made Vulcanizer

A novel vulcanizer for pneumatic tires, and one that will do excellent work, can be made of an old electric smoothing iron. The handle is removed and a $\frac{1}{4}$ -in. hole drilled in the top, $1\frac{3}{4}$ in. deep, for a small thermometer registering high temperatures. A small wood pattern is made flat on one side, and cut out to fit the tread of the tire on the other, and used in making a mold for a brass casting. A piece of wood is formed to fit the inside of the shoe.

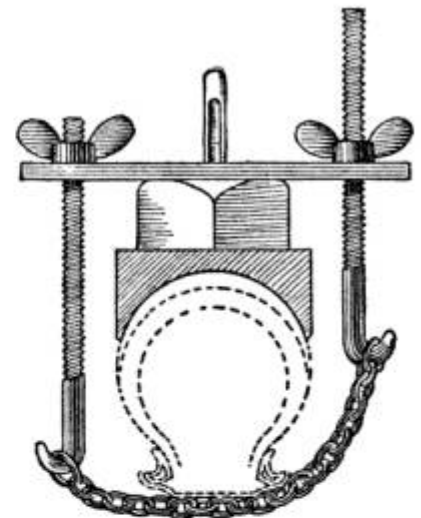

Two rods of wrought iron, $\frac{1}{4}$ in. in diameter by 6 in. long, are each threaded on one end for a distance of 3 in. The other end of each of these rods is formed into a hook to hold a piece of chain. The sketch clearly shows the apparatus, also the method of clamping

it to an automobile tire. It is only necessary to connect the iron by a flexible electric cord to a lamp socket in the ordinary way, the current being preferably turned on at the iron and not by the socket switch.

Drapery-Hanging Pole

In the accompanying illustration is shown a curtain pole having spools of various diameters on which the lifting cords are wound when the pole is revolved. This pole passes through the

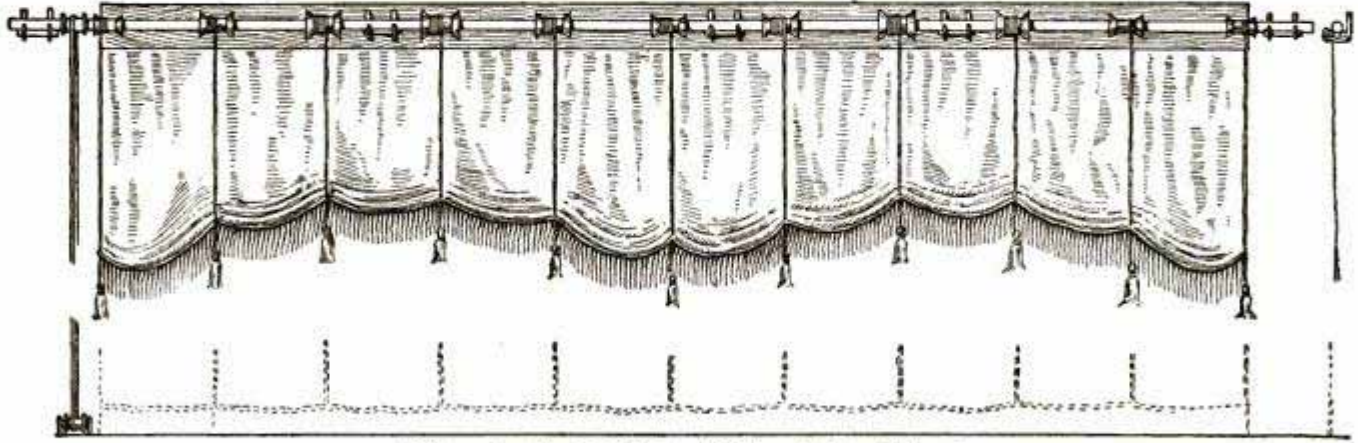

Lifting Cords Varied by Different Sized Spools

As soon as the right temperature is reached, the current is turned off to avoid overheating. This is repeated for a few minutes and then the apparatus is removed. The same method may be used for making repairs on casings as well as inner tubes in ordinary repairing.—Contributed by Geo. H. Handley, Newburgh, N. Y.

Home-Made Ratchet Drill

Secure a gear from an old clothes wringer and fit it over a piece of $\frac{1}{2}$ -in. pipe which has a coupling screwed on one end and is cut square off on the other. Thread a piece of $\frac{1}{2}$ -in. round iron,

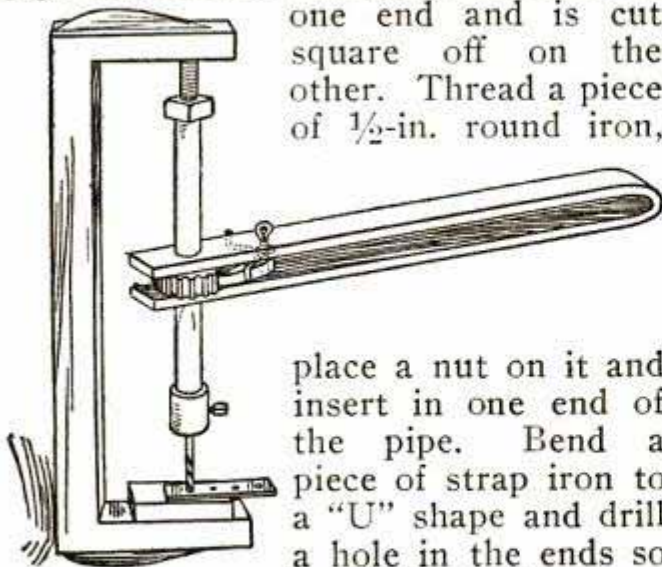

place a nut on it and insert in one end of the pipe. Bend a piece of strap iron to a "U" shape and drill a hole in the ends so it will fit over the pipe. Bend an eye in a piece for a dog and fasten it in the lever with a cotter pin as shown. Then attach a small spring to keep the dog engaged in the teeth of the gear.

spools and is held in place by brackets at each end and in the middle which permit it to revolve freely either way when the cords are pulled at the left side, says the Upholsterer. A small bag of shot is sewn to the bottom of each shirring line, in order to make the curtain fall smartly when released. From right to left, the first spool is $1\frac{7}{8}$ in. in diameter; the next, $2\frac{3}{4}$; the next two, 3 in. in diameter; the next, $2\frac{7}{8}$, and the next, 2 in. This spool is the middle of the shade, and from that point to the left the diameters are a repetition of the first five mentioned, reading from $2\frac{7}{8}$ back to $1\frac{7}{8}$ in.

An Edge Center for Patternmakers

Patternmakers are often compelled to lay out a half circle on a block of wood, one face of which is the center line of the circle. In doing this they must hold or clamp a smaller piece to the work so as to make a surface for the compass or divider points. When this method is used, the center point or pivot end of the dividers sinks so far into the wood that a true circle cannot be made, especially when working on the end grain of soft wood.

A handy tool that will overcome these troubles is shown in the sketch. The tool is made by cutting a disk 2 in.

in diameter from $\frac{1}{16}$ -in. sheet brass and laying out a center line on one side and another center line on the opposite side at right angles to the first line. In the center lay out and cut through a semi-circle as shown in Fig. 1. Bend the edge of the disk at right angles outside of the small semi-circle, taking care that the bending point is on the dotted center line. This operation leaves the $\frac{1}{2}$ -in. circle projecting, as it is not bent with the disk. File a place on the center line down to a sharp edge and carry the line down on the bevel edge. Make two small depressions with a center punch on the center line, each at a point directly above the inner and outer vertical surface of the part turned down. The tool is placed on the wood as shown at A,

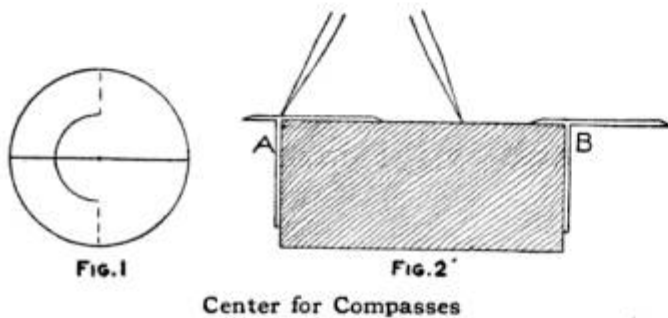

Fig. 1

Fig. 2

Center for Compasses

Fig. 2, for making large circles and as at B for the smaller ones.—Contributed by D. K. Bowie, Detroit, Mich.

Drilling Holes Central with a Center-Punch Mark

If the point of a drill strikes the side of a center-punch mark, the hole will be drilled slightly to one side of the center because the work will not slide on the metal of the faceplate. I made a device to place between the work and the faceplate that would adjust itself to any slight touch of the drill. The method of construction is as follows:

Procure two pieces of sheet metal $\frac{3}{16}$ in. thick by 2 in. square and fasten them together with screws. Drill four $\frac{1}{16}$ -in. holes about $\frac{3}{8}$ in. from each corner. Take the pieces apart and countersink the holes on the inner sides deep enough so that when the plates are placed together, a $\frac{1}{4}$ -in. steel ball will roll freely and leave a small

arc of the ball's surface protrude through the hole. Put a $\frac{1}{4}$ -in. ball in each hole and screw the plates together.

Set on this plate the piece of work

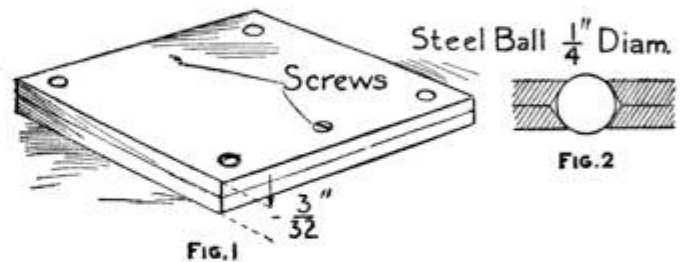

Fig. 1

Fig. 2

Four Balls in the Plate

to be drilled. If the drill does not strike the center-punch mark straight, the plate will shift itself and the work, so the drill will follow the center of the mark. On large work, two or more of these plates can be used.—Contributed by F. W. Granger, Waterbury, Conn.

Hydraulic Oil Pump

The sketch shows a home-made oil pump which I used for some time with satisfactory results, says a corre-

spondent of Power. The pump is inserted in the head of a barrel and water poured in through the funnel A at the top, thus passing down through the inner pipe and into the bottom of the barrel D. The water being heavier than the oil displaces the latter and causes it to rise in the outer tube to the tee C and out through the curved spout B. This arrangement keeps the barrel clean and the water prevents it from becoming dry.

If the funnel is of 1-gal. capacity, a gallon measure may be used to catch the oil without danger of overflowing.

⚠ Never take it for granted that a reamer will ream to size.

Many times a workman in a machine shop wishes to use a small brush and does not have one at hand. Belt punches are more numerous than brushes in such a shop and one of these can be used as a handle. The bristles or a substitute can be drawn into the hole with a string to make the brush part. In Fig. 1 is shown the method of drawing the bristles in place and in Fig. 2 the completed brush.—Contributed by Geo. Schneider, Cincinnati, O.



FIG. 1

FIG. 2

brush part. In Fig. 1 is shown the method of drawing the bristles in place and in Fig. 2 the completed brush.—Contributed by Geo. Schneider, Cincinnati, O.

An Extemporized Level

While helping to build a house many miles from town, I found that I needed

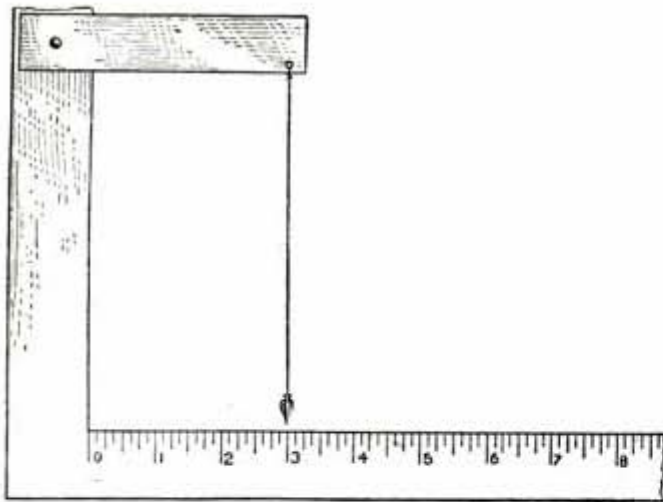

Plumb on a Square

a level but could not well spare the time to get one. I therefore made one by fastening to my square a piece of an old tin can and attaching a cord with a plumb bob, as shown in the sketch. The distance from the edge of the square to the cord at the top being 3

square to have the work level.—Contributed by "Builder," Brooklyn, N. Y.

How to Harden and Temper a Rock Drill

The following way of hardening and tempering a drill for rock work will give satisfaction in every case. Place the drill in the fire, heat the end evenly about 1 in. back from the cutting edge to a cherry red and plunge it, cutting end first, into a cooling bath of soft water and salt. This is known as the hardening process.

If the rock to be drilled is very hard, it will not be necessary to draw the temper, while for soft rock the temper may be drawn to a light blue. On small drills, the temper is drawn by heating a pair of tongs to a bright red and clamping them over the tool, as indicated by the dotted line B. Draw

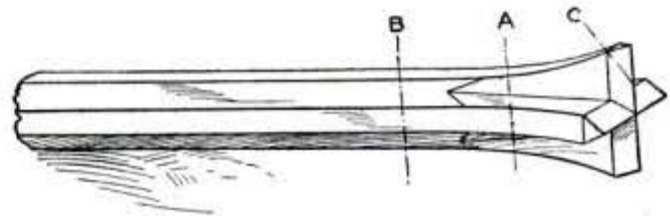

Tempering Rock Drill Points

the color until the cutting edges C show a light blue. If the drill is too large for this method, the flame from a blow-torch can be applied 1 in. or so back from the cutting edge. When a blow-torch is used, the flame should be moved from one side to the other, to insure an even heat.—Contributed by J. N. Bagley, Webber, Kans.

Protection for the Eyes from Intense Heat

When working at a forge for any length of time the brightness and heat of the fire is liable to injure the eyes. When the eyes become blurred and temporarily color-blinded it affects one's work. Thus when welding, the necessary heat makes the fire very bright and it is hard to tell what heat

one is getting on the work until the iron begins to "spit." Or, at hardening, if the job is carefully watched, as it should be, until the right heat and color are reached, when the eyes are quickly turned away and focused on the polished part of the job to see "the color come" they are so blurred and blinded from the light of the fire that the proper color cannot be distinguished. This may be remedied by setting a piece of colored or stained glass in a wood frame about 8 by 12 in. in size and hinging it from the hood of the forge. Then when doing a job as described, one can watch the fire and work in comfort and when the critical moment approaches, swing back the shield and look at the heat with clear eyes.

Fastening a Loose Door-Knob

The socket of a knob on one of my doors became loose from the grip and began to rattle. I repaired it by dipping

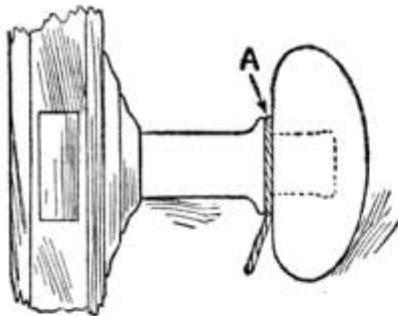

some fine wrapping cord in cold glue and then winding it around the socket in the small joint, between the

shoulder of the socket and the grip. The string was wrapped tightly until the joint was full, then the ends were tucked in with the point of a knife blade. The glue was given time to set, after which the knob was as firm as a new one.—Contributed by D. E. Woodoth, Moorestown, N. J.

New Way of Handling Rope

The arrangement illustrated herewith for handling rope, the stock of which is kept in the cellar was originated by a correspondent of Iron Age. Instead of the time-honored method of simply bringing the ends of the coils up through holes in the floor and tying knots in the ends, a series of pipes are

screwed into floor flanges over the holes and the ends of the rope are drawn up through the pipes.

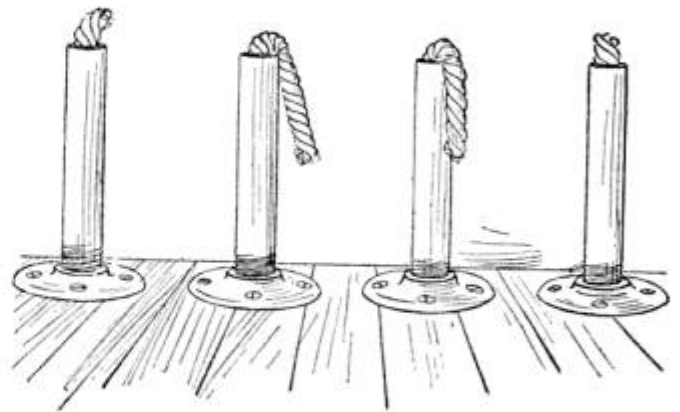

Ropes in the Pipes

A 1-in. pipe will readily pass a $\frac{3}{4}$ or $\frac{7}{8}$ -in. rope and a $1\frac{1}{4}$ -in. pipe, the 1-in. size; while $\frac{3}{4}$ -in. pipe answers for the smaller sizes. The larger sizes of rope are prevented from slipping back through the pipe by putting a large spike or nail in the pipe by the side of the rope. An advantage of this arrangement is, that the rope is not soiled by sprinkling the floor or in sweeping, and it is more convenient to get hold of the rope ends than if they were nearer the floor.

Preventing Plain Rubber Hose from Kinking

Rubber tubing, having no canvas interlining, is easily kinked. This trouble can be remedied by slipping a spring of flexible brass wire, about 6 in. long over the tubing. The spring should fit snugly but at the same time so that it can be slipped along the tubing to preserve its contour at the point or points where the kinking occurs.

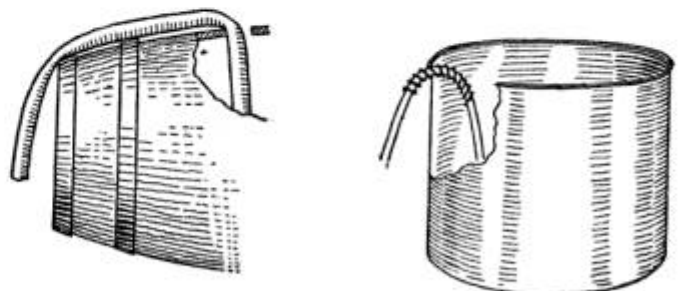

Preserving the Contour of Rubber Tubes

The wire spring from a discarded curtain roller will answer the purpose for the size tube it fits.

In some cities the current used for porch lights is charged for on a flat-rate basis, and usually the price is ex-

duced by using the porch lights only when necessary.

I have my porch so arranged that the boards leading to the door are hinged and held $\frac{1}{8}$ in. above the sleepers by a spring, says a correspondent of Practical Engineer. The contacts on the wire leading to the porch are made weather-proof.

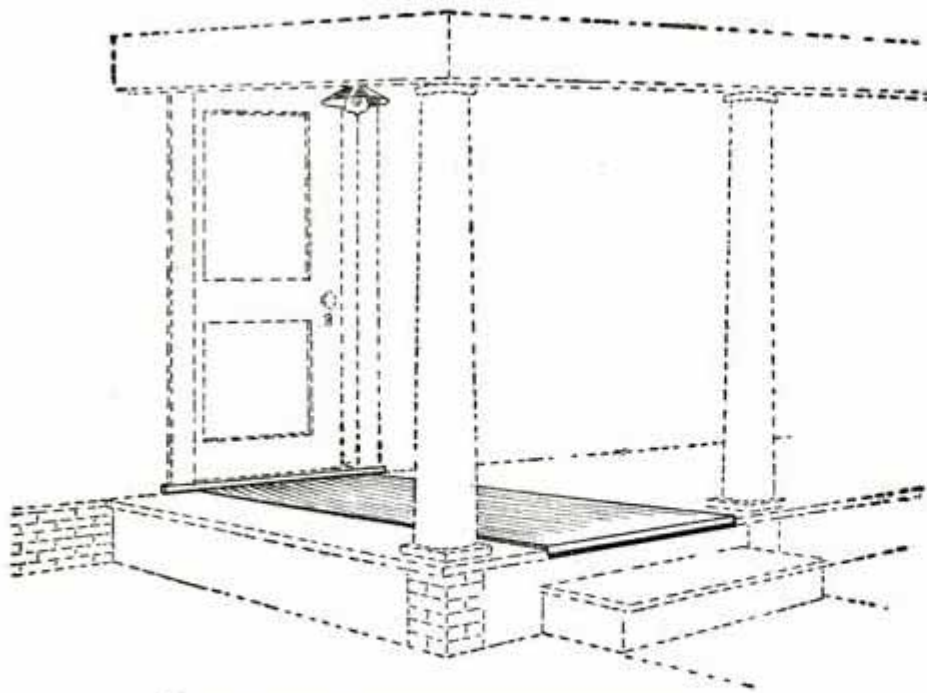

Porch Floor Operates Electric Contact

When stepping on the porch, the pressure of the foot "makes" the circuit, and the electric lamp is lighted and remains so just as long as one remains on the porch in front of the door.

A burglar would be frightened away by

cessive considering the amount of actual service. The only time it is necessary to have one of these lights in use is when a person steps on the porch, be it a friend or foe. Where a meter is used, the light bill can be greatly re-

duced by using the porch lights only when necessary. the sudden glare of the light as he would think his presence known. A meter reading of a porch light like this is hardly noticeable and the light is more valuable than when burning all the time.

Tool for Boring Large Holes in Boiler Plate

The accompanying sketch shows how I made a tool for boring large

holes in the shell of a boiler of the locomotive type. The holes were then tapped with a 2-in. pipe tap. The shell of the boiler was $\frac{3}{8}$ in. thick. The tool was driven with a ratchet drill stock.

A $\frac{5}{8}$ -in. hole was first drilled in the center of the place desired for the large hole. The tool was then put in the ratchet stock and the cutting tool, which can be adjusted, set to $2\frac{3}{16}$ in. The center of the larger hole was then cut out, leaving a perfectly round hole for tapping the threads. As a number of these holes had to be made on a hurry-up job, this tool greatly aided the work.

A piece of old rock-drill steel was used after annealing as thoroughly as time would permit. The cutting tool

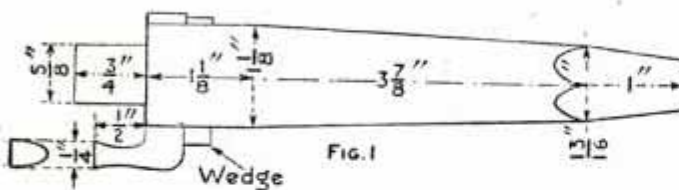

FIG. 1

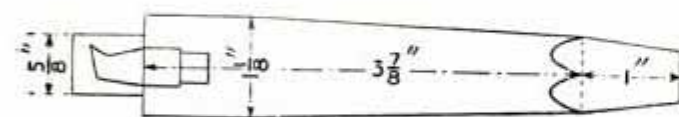

FIG. 2

Details of Boring Tool

holes in boiler plate in a case of emergency. The tool was used to cut some

was made of $\frac{3}{8}$ -in. lathe-tool steel, forged and ground as shown. The $\frac{5}{8}$ -in. guide should be made tight enough to require some pressure to force it in a $\frac{5}{8}$ -in. drill hole when it is to be used with a ratchet stock. The shank could be made a standard drill taper and used in a lathe or drill press.—Contributed by Jack Campbell, Denver, Colo.

Elevated Center for Large Radii

This center will be found handy for the pattern-maker, die-maker and machinist in striking large radii. It

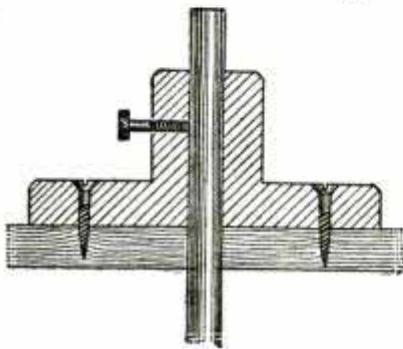

may be placed on the end of a bench or table, or even on the floor, but in the latter case a place

should be selected where it will not be stepped upon. The center may be raised or lowered according to the thickness of the metal on which the arc or lines are to be inscribed. It may be made of wood or metal.—Contributed by G. Crawford, Schenectady, N. Y.

Home-Made Floor Scraper

The parts necessary to make the floor scraper illustrated in the sketch are some pipe and fittings, a bolt and a mower section. A hole is drilled in the center of the mower section and then fastened to the end of the pipe with the bolt. All the edges of the section are

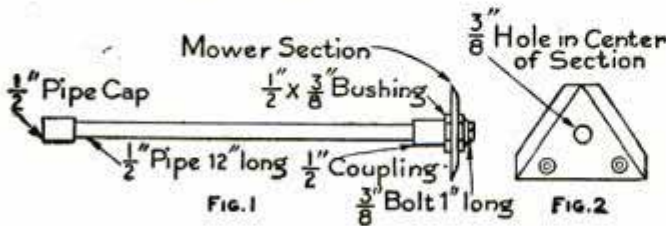

Scraper Made from Mower Section

ground sharp. This will make a satisfactory scraper for floors and trees.—Contributed by John Blake, Franklin, Massachusetts.

Foundation Supports

In the accompanying illustration is shown a method of placing a concrete base for foundation posts. For an ordinary house, the concrete should be about 2 ft. deep in the earth and the top part built up of a neat cement about 1 ft. high and finished smooth for the sake of appearance. This keeps the timber away from the earth and dampness, preventing rot. The timbers are jointed in the usual manner and set on a corbel placed on top of the post.—Contributed by Geo. Niesen, Chicago.

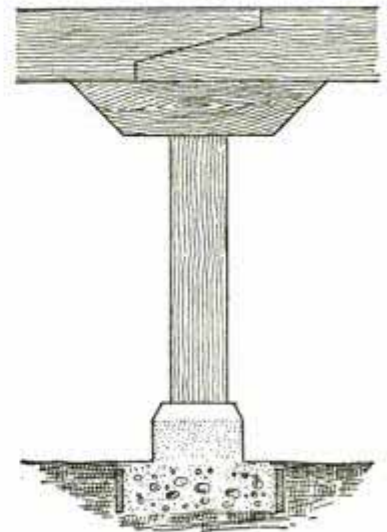

should be selected where it will not be stepped upon. The center may be raised or lowered according to the thickness of the metal on which the arc or lines are to be inscribed. It may be made of wood or metal.—Contributed by G. Crawford, Schenectady, N. Y.

Shaft Hanger Repair

A cast-iron hanger had one of its arms broken off as shown by the dotted lines in Fig. 1. To make the hanger uniform, the remaining arm was re-

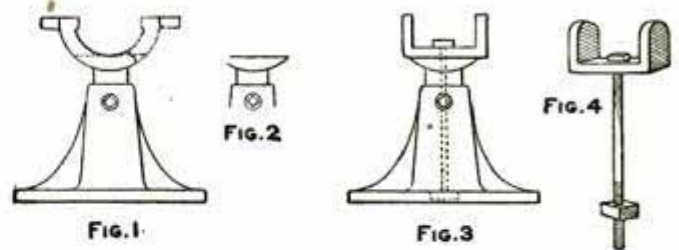

Wrought Iron Ears on Hanger

moved and the base ground off as shown in Fig. 2. A piece of $\frac{1}{2}$ -in. wrought iron, drilled for setscrews and a central retaining bolt, was placed on the pedestal and secured by a bolt, run through to the bottom of same, as shown in Fig. 3. The repair part and bolt are shown in Fig. 4. This made the hanger much stronger than the original casting.—Contributed by James M. Kane, Doylestown, Pa.

A servant was suspected of robbing the pantry which was always kept locked, but to which she was not supposed to have a key. To make sure, a pin was set in the door and another in the frame near the top,

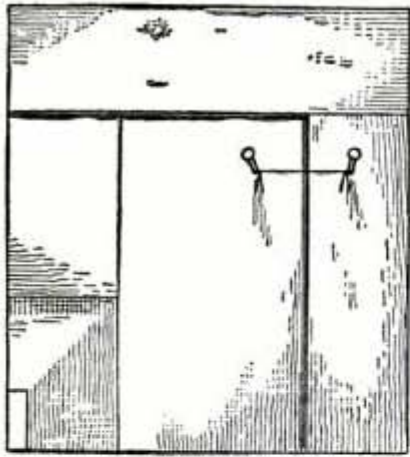

and to these pins a black thread was tied. When the servant pried in, the thread broke. The petty thief confessed her guilt on being shown the evidence of the "little detective."—Contributed by Maurice Baudier, New Orleans.

Stock Rack for the Shop

A rack that is designed for holding long rods of bar stock is shown in the accompanying sketch. This rack is especially adapted to the screw machine department, where, in many instances, stock is left on the floor for lack of sufficient room on the rack usually furnished with screw machines. Standards or racks of this construction can also be used in connection with the

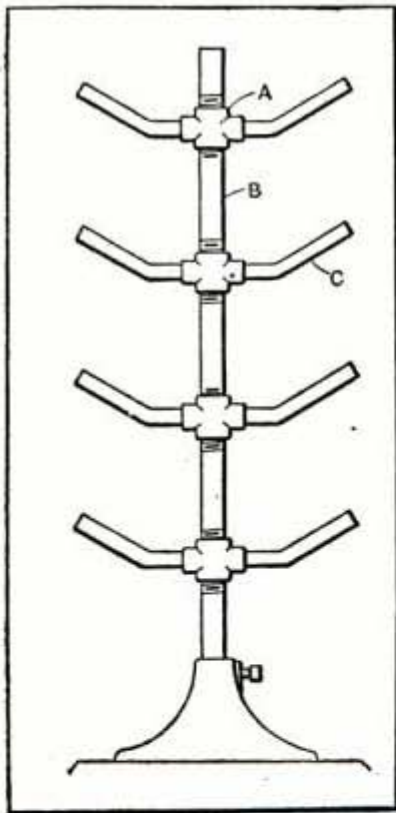

The number of arms or brackets can be made to suit the requirements. The cost of this rack is comparatively small as all parts can be purchased ready to assemble. The piece A is a $\frac{3}{4}$ -in. by $\frac{1}{2}$ -in. malleable cross; B is a $\frac{3}{4}$ -in. by $6\frac{1}{2}$ -in. nipple, and the arms C are also made of pieces of pipe, $\frac{1}{2}$ in. in diameter by 8 in. in length. The nipples and pipe are extra heavy. The base can be obtained from any stock house. These racks can be used to a good advantage in the stock room for holding rods or sheet metal.—Machinery.

Lining Cement Cisterns with Paraffin

A cement cistern may be made tight and clean enough for cider and vinegar storage by the following method:

The cistern must be thoroughly cleaned and then two coats of cement and water are applied to the walls. These coats may be applied on successive days. After the second coat has set for at least 24 hours, apply a coat of paraffin. This is done by heating it to a temperature slightly above the melting point. Apply a thin coat with a cloth or paint brush. The coating should be well rubbed before it gets cold and should not be disturbed after it gets solid. The bottom of the cistern is coated last. When applying the coat to the bottom, the workman should work from a suspended platform.

Binding-Posts Used for Trammel Points

The trammel points are a necessary tool for some work, but they are so seldom used that every draftsman does not have them in his kit. The cost is too much, for the amount of service. Substitute points can be made of three double binding-posts, A, B, and C, and two nickel-plated brass rods, D and E. Three pieces of $\frac{1}{8}$ -in. brass rod are pointed and threaded to fit the bottom

ends of the binding-posts, to serve as points. The parts are assembled as shown in the sketch.

These trammel points may be used to find the true points on an ellipse much quicker than by using a straight-edge, as follows: The post A is set at the ends of the rods and firmly clamped. The post B is set so that the distance from point H to G will equal the semi-minor axis, and the post C set so that the distance from H to F is equal to the semi-major axis and all firmly clamped in place. Any length of rods may be used for D and E.

The middle post may be removed

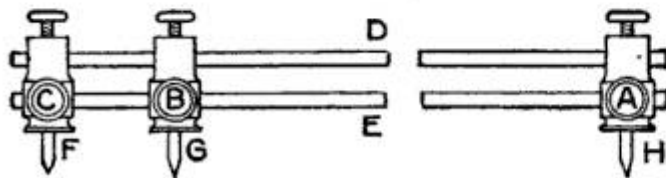

Binding-Posts on Rods

and a pencil or pen substituted for the point H, and the device used as a beam compass.—Contributed by J. L. Riley, Dallas, Texas.

Simple Mottling Process for Tool Steel

The attractive mottled finish put on dropped forged tools is produced by casehardening in bonedust. This is a long, slow process of several hours and requires a quantity of bonedust, a good-sized receptacle and fireclay. Practically the same thing can be obtained without these, though the casehardening will not run so deep. Put enough potassium cyanide or prussiate of potash in a ladle, kettle or iron receptacle of any sort and heat until red-hot. Dip the article to be hardened and finished into this molten cyanide and leave a few minutes—long enough to be brought thoroughly up to the red heat, and a little longer. Then take out and quench in clear, cold water and you will have a fairly mottled surface.

Needle for Lacing Bicycle Tires

A very handy device for use in lacing bicycle tires instead of the ordinary needle is to take an end about 4 in. long

from an old umbrella rib and file an eye as shown in the sketch at A. The



Umbrella Rib Needle

ball B on the other end prevents pricking holes in the inner tube, as is often the case when using a needle.—Contributed by Robert A. Cochrane, Adrian, Mich.

Turning "Springy" Stock in a Lathe

Turned bars and rolled steel, being perfectly round, can have a steady rest applied at any point, but long, slender pieces of rough stock are hard to turn in a lathe because of their "springiness." The easiest way to overcome this trouble is to use a "cat-head," the simplest form of which is made of pipe. Take a piece of 2-in. pipe, 5 in. long, chuck it, and turn a spot true 1 in. wide in the middle. Then about 1/2 in. from each end put in four 5/16 by 1 1/4-in. set-screws, quartered. You then have a cheap and efficient cat-head for work 1/4 in. to 2 1/8 in. diameter. In use, this is slipped over the work and the set-screws set up till the turned spot runs true. Practice at this will soon make the job easy. The steady rest is then applied to the turned portion of the pipe, when a good big cut can be taken without fear of spring or chatter.

A Wood Cutting-Off Tool

The accompanying illustration shows how to forge a bar of steel to make a cutting-off tool that will give plenty of clearance in making the cut.



Cutting-Off Tool

The tool A is made thinner on the top and bottom, leaving the middle full at the cutting edge B, which is the width of the cut.—Contributed by C. P.

ⒸThe lathe centers are not the place to straighten bars of steel.

cially convenient for soldiers or campers is shown in the accompanying sketch. The hanger can be hung from the ridge pole of a tent. It will economize space in a hall bedroom or cramped quarters. By attaching the hanger to a pulley arrangement, it can be raised and lowered at will. The clothes will be kept well aired and ventilated, and as they hang away from the wall where light strikes on all sides, no moths will get in the cloth.

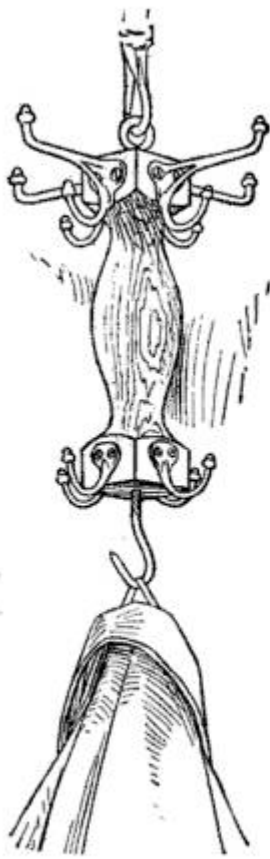

A dozen garments can be hung from one line by attaching one device below the other. The hanger can be made of wood in any length and turned up in a lathe to suit the fancy of the maker. Ordinary coat hooks are fastened to the sides with screws. A common screw eye is used for the line at the top.

Tool for Cutting Tenons

A piece of steel, $\frac{3}{16}$ in. thick and $\frac{3}{4}$ in. wide, is used for the main part of the tool. It is bent as shown in the sketch, and a handle attached to each end. The sketch only shows one handle. The cutting knife B is fas-

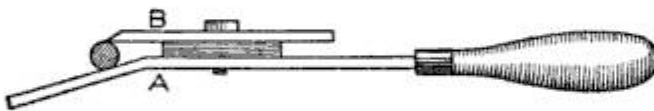

For Accurately Turning Tenons

tened to A with a screw. The block between A and B should be the same thickness as the diameter desired for the finished tenon.

sanitary vats and tanks for buttermilk, wine, oil, pickles, sauerkraut, etc., can be constructed of reinforced concrete, the reinforcing to be designed by a competent engineer, provided the interior surfaces are treated as follows:

After the forms are removed, grind off with a carborundum stone any projections due to the concrete seeping through the joints between the boards. Keep the surface damp for two weeks from the placing of the concrete. Wash the surface thoroughly and allow to dry. Mix up a solution of 1 part water glass (sodium silicate), 40° Baume, with 4 to 6 parts water, total 5 to 7 parts, according to the density of the concrete surface treated. The denser the surface the weaker should be the solution.

Apply the water-glass solution with a brush. After four hours and within 24 hours, wash off the surface with clear water. Again allow the surface to dry. When dry, apply another coat of the water-glass solution. After 4 hours and within 24 hours, again wash off the surface with clear water and allow to dry. Repeat this process for three or four coats, which should be sufficient to close up all the pores.

The water glass which has penetrated the pores has come in contact with the alkali in the cement and concrete and formed into an insoluble hard material, causing the surface to become very hard to a depth of $\frac{1}{8}$ to $\frac{1}{2}$ in., according to the density of the concrete. The excess sodium silicate which has remained on the surface, not having come in contact with the alkali, is soluble, therefore easily washed off with water. The reason for washing off the surface between each coat and allowing the surface to dry is to obtain a more thorough penetration of the sodium silicate.

It is obvious that concrete surfaces so treated, if hard, impervious and insoluble, are thus made tasteless, odorless and sanitary, also.—Contributed by Albert Moyer.

AMATEUR MECHANICS

Clay Flower Pots Used for Bird Houses

A novel use of the common garden flower pot may be made by enlarging the small opening at the bottom with a pair of pliers, and carefully breaking the clay away until the opening is large enough to admit a small bird.

Place the pot bottom side up on a board that is 3 in. wider than the diameter of the largest pot used and fasten it to the board with wood cleats and brass screws. Fit the cleats to the sides of the pot as close as possible. One or more pots may be used, as shown in the sketch.

The board on which the pots are fastened is nailed or screwed to a post or pole 10 or 12 ft. in height. The board is braced with lath or similar strips of wood, making a framework suitable for a roost. In designing the roost, the lath can be arranged to make it quite attractive, or the braces may be of twigs and branches of a tree to make a rustic effect.—Contributed by William F. Stecher, Dorchester, Mass.

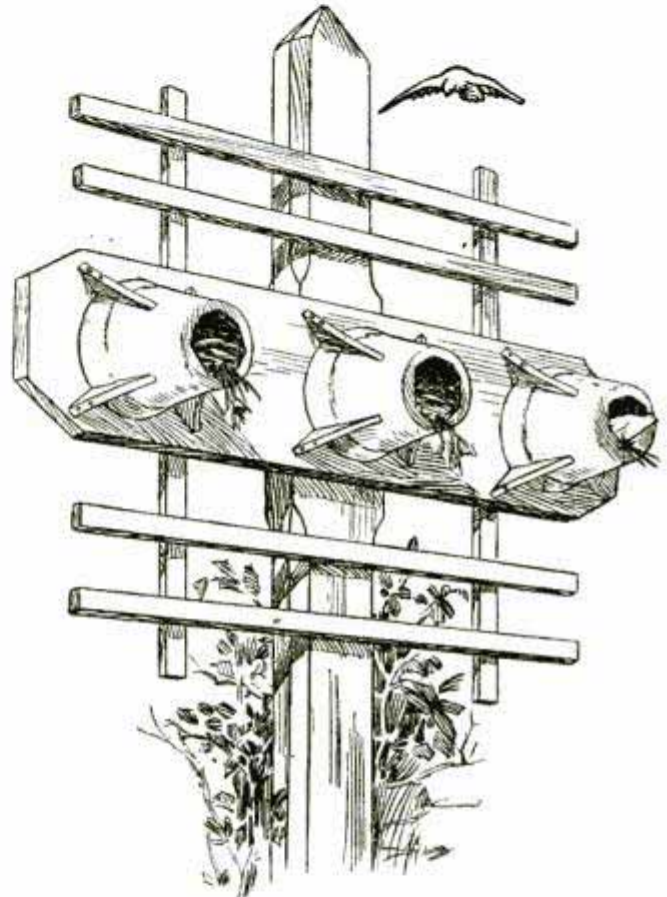

Pots Fastened to the Board

How to Make Rope Grills

Beautiful and useful household ornaments, grills and gratings for doors, windows, shelves, odd corners, etc., can be made by the following method at a slight cost and by anyone possessing a little ingenuity. The materials required are rope or preferably common window cord (called sash cord) about $\frac{5}{16}$ in. in diameter; ordinary glue, paraffin and paint or varnish. A few strips of wood or molding are very handy to use around the edges.

The design must be considered first and when one is selected, if it is other than straight lines, adopt the method as described.

Take a smooth flat board and lay out the design or number of designs which when combined will produce the pattern desired. Drive finishing nails at the angle points or along curves as required. Coat the board along the lines of the patterns with melted paraffin, using an ordinary painter's brush.

Soak the sash cord in common glue sizing for a short time, then bend or twist it along or around the lines desired as shown in Fig. 1 and give it time to dry. The bottom part of the sketch (Fig. 1) shows a method of winding the rope on a round stick to make circular objects. Wind the de-

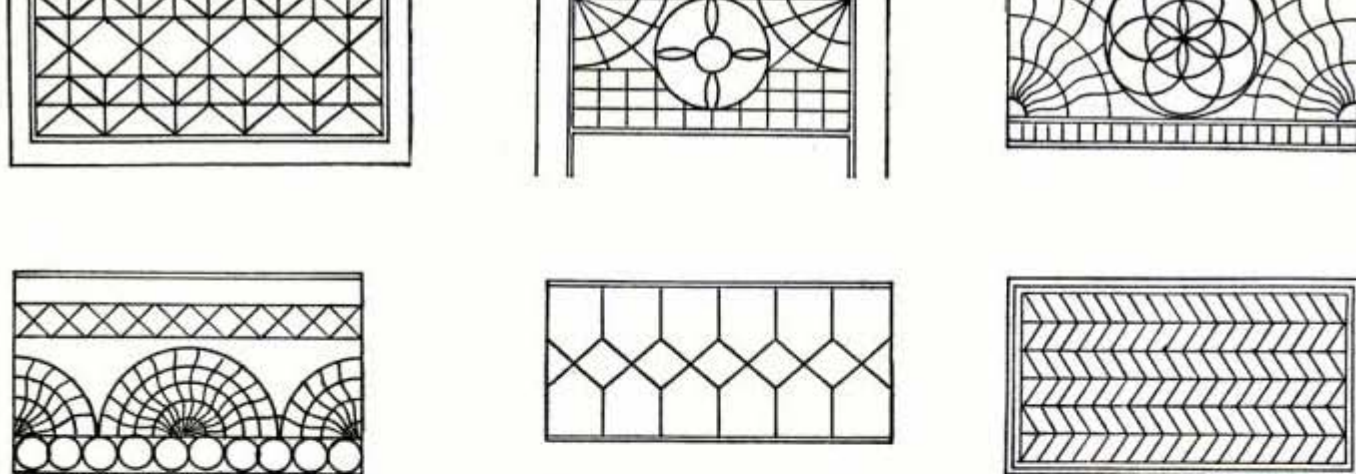

Fig. 2—Designs for Grills

sired number of turns and when dry, cut and glue them together.

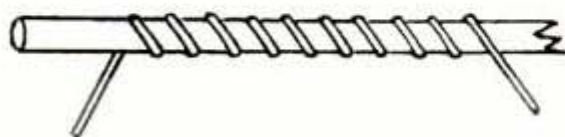
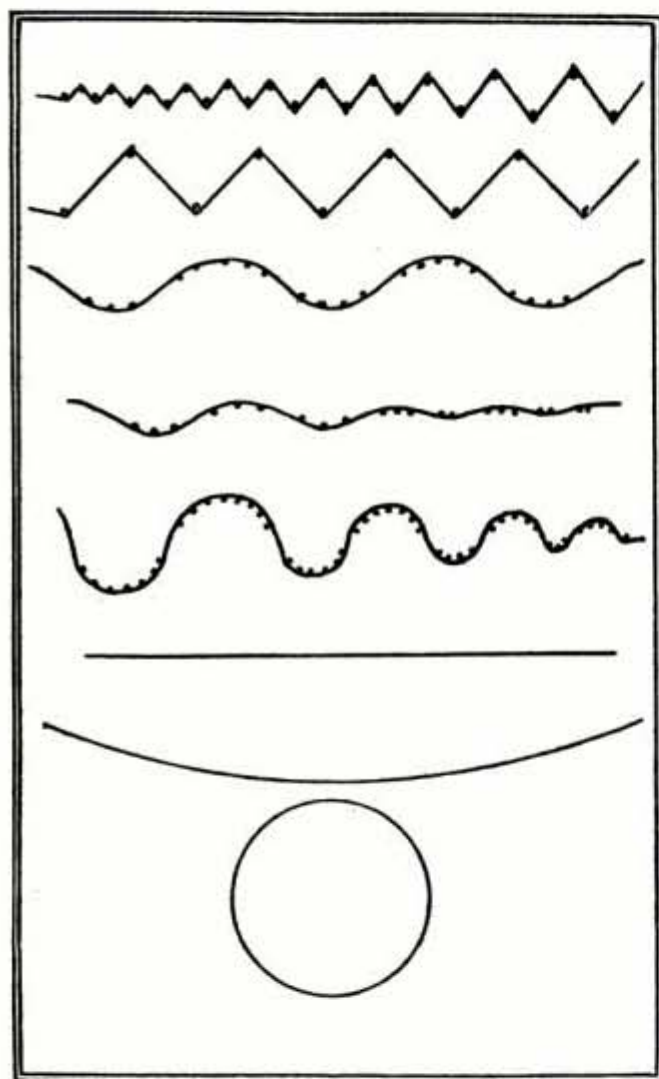
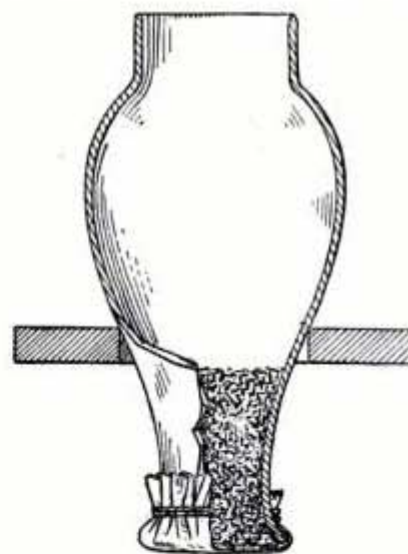

Fig. 1—Method of Forming the Rope

In Fig. 2, six designs are shown. These suggest ideas in making up combinations or in plain figures and the number is limited only by the ingenuity of the designer.—Contributed by Geo. M. Harrer, Lockport, N. Y.

A Simple and Effective Filter

Procure an ordinary lamp chimney and fit two or three thicknesses of cheesecloth over the end of it. Press a tuft of absorbent cotton into the small part of the neck to a depth of about 3 in. Insert the chimney in a hole cut in a wood shelf used as a support. Pour the water in until the filter is filled, when it will be observed that any organic matter, chips of iron rust, etc., will be retained by the cotton. The fine organic matter may penetrate the cotton for about 1 in., but no farther. The resultant filtered water will be clear and pure.



⌈The cutting point of a tool should never be below the centers.

How to Build an Ice-Yacht*

The plans and specifications shown in the illustrations are for making a 400-ft. class ice-yacht, having a double cockpit to accommodate four persons. The weight of the persons in the forward cockpit keeps the boat from rearing when in a stiff breeze. The forward cockpit can be removed if necessary.

The materials used are: backbone,

plainly shown in the sketches. The backbone is $37\frac{1}{2}$ ft. over all, 12 in. in the center, 5 in. stern, $3\frac{1}{2}$ in. at the nose; width $4\frac{1}{4}$ in. All wood should be selected from the best grades, well seasoned and free from checks. In Fig. 1 is shown the complete ice-yacht with general dimensions for the sail and main parts. Other dimensions are shown in Fig. 2. The backbone is

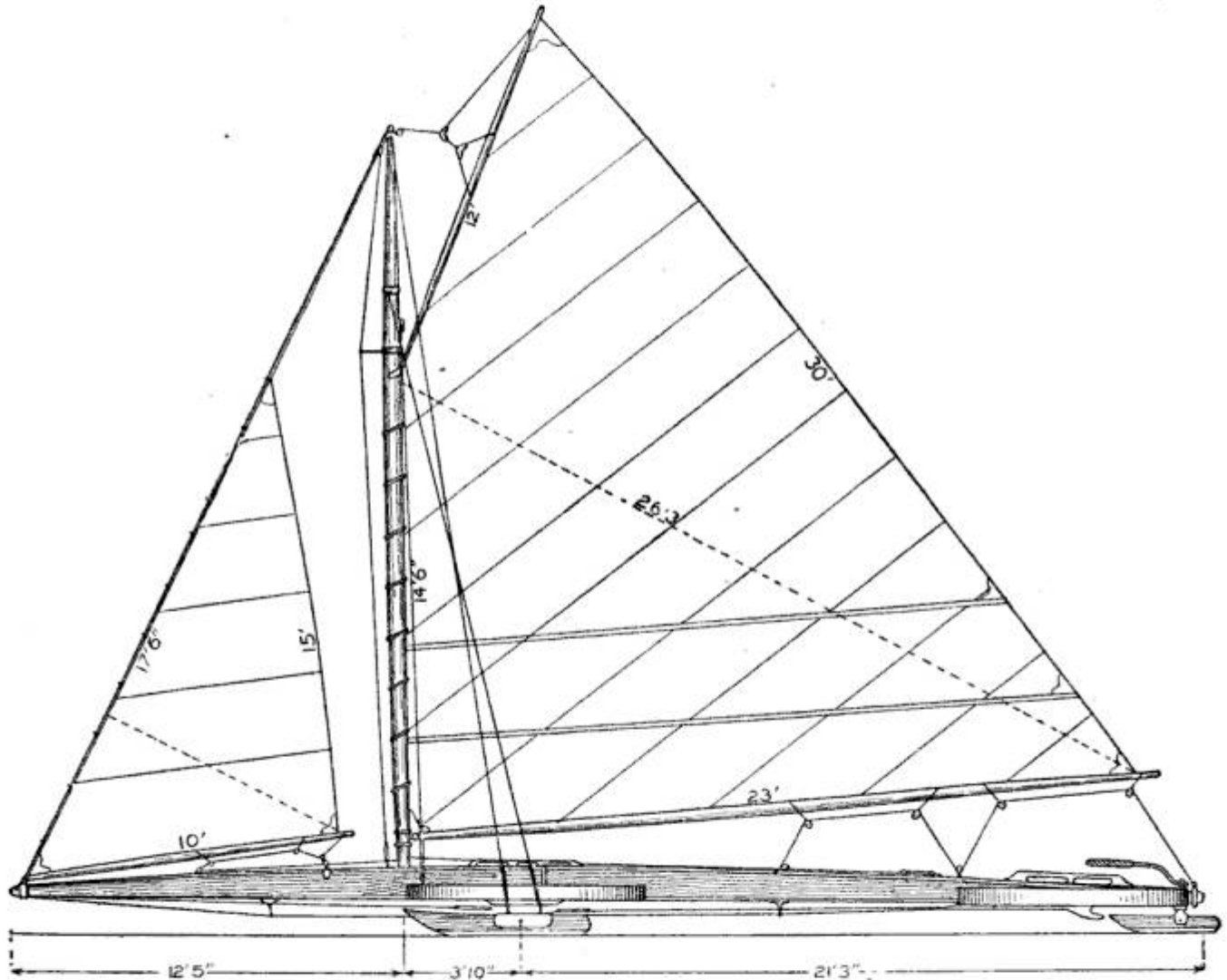

Fig. 1

Ice-Yacht Complete

white pine; center, clear spruce; sides, white oak caps; runner plank, basswood, butternut or oak; cockpit, oak; runners, chocks, etc., quartered white oak. All the iron work should be first-grade Swedish iron, with the exception of the runners, which are soft cast iron.

It is not necessary to go into detail with the measurements as they are

capped on the upper and lower edges full length with strips of oak, $4\frac{1}{4}$ in. wide and $\frac{5}{8}$ in. thick. The lengthwise side strips of spruce are $1\frac{1}{4}$ in. thick. The filling-in pieces placed between the side pieces are of seasoned white pine, leaving the open places as shown in Fig. 2. The parts are put together with hot glue and brass screws.

The runner plank should be placed

*Condensed from an article by H. Percy Ashley in Rudder

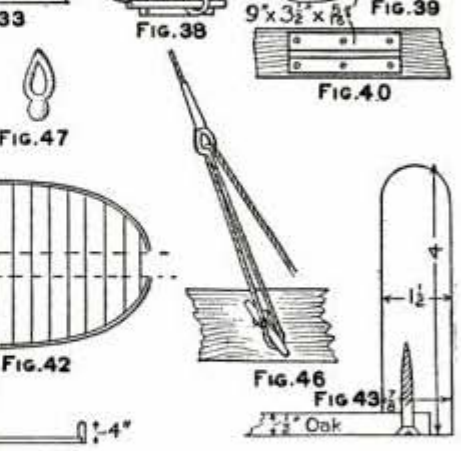
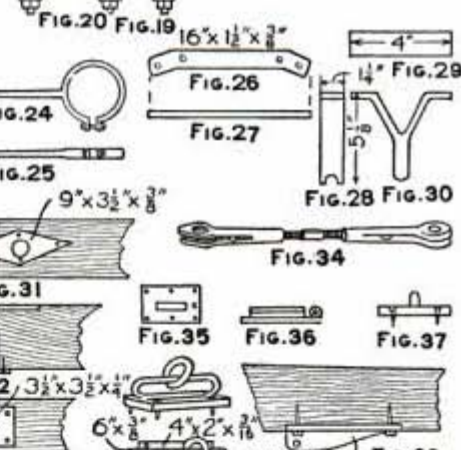
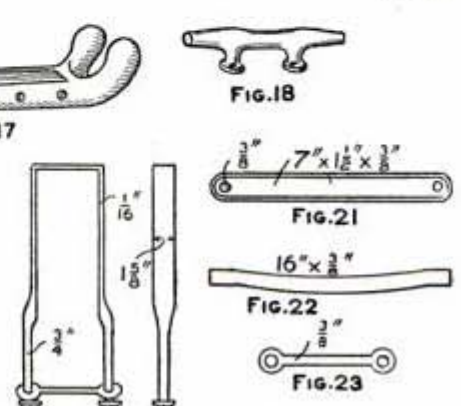
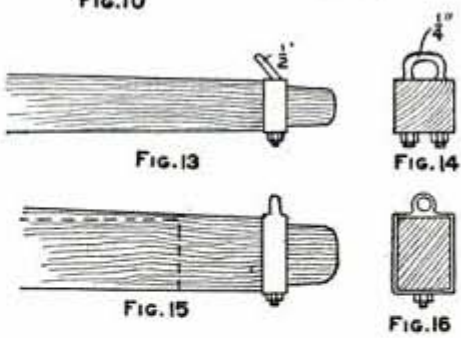
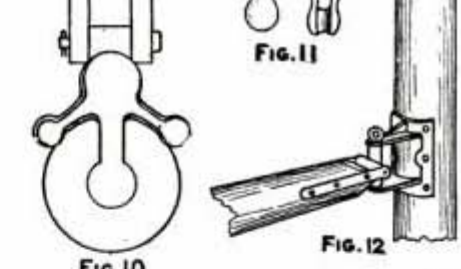
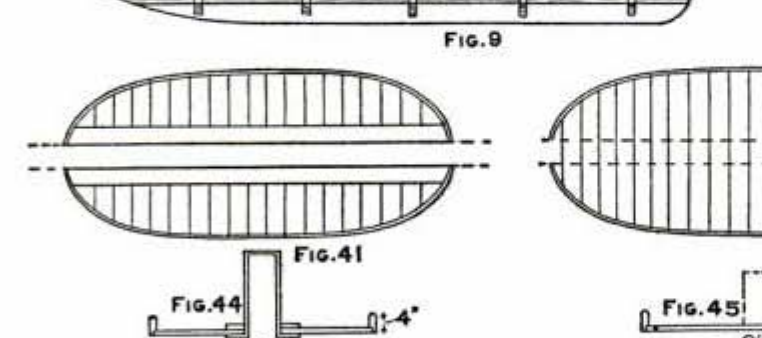
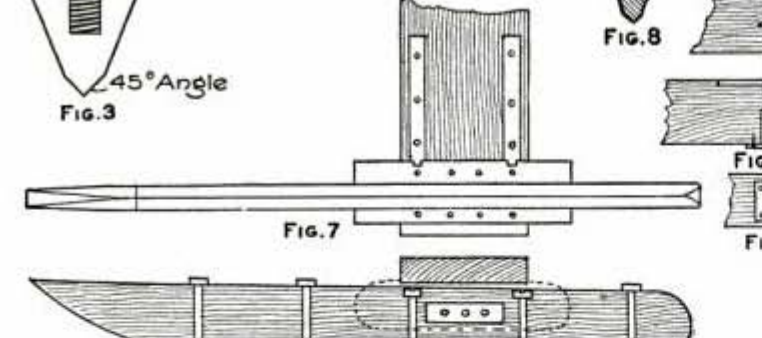
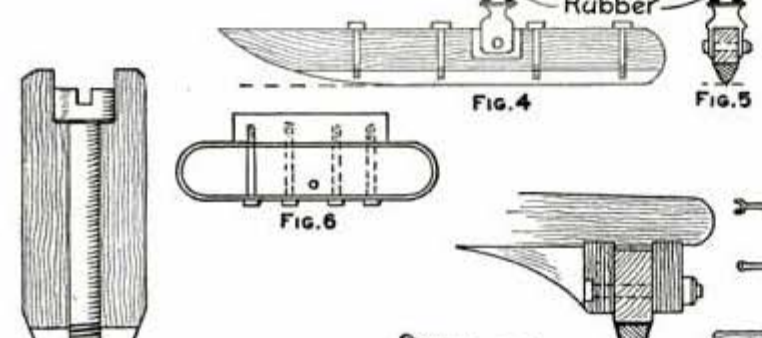
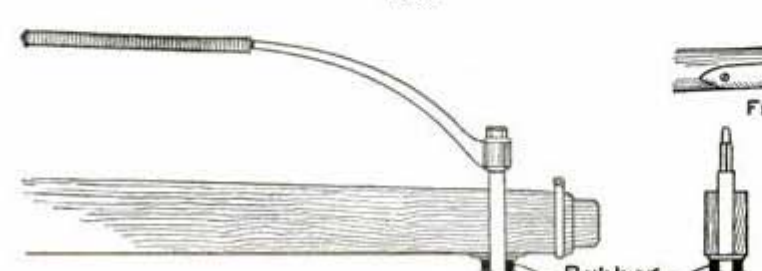
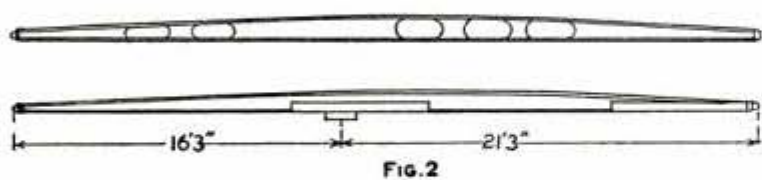
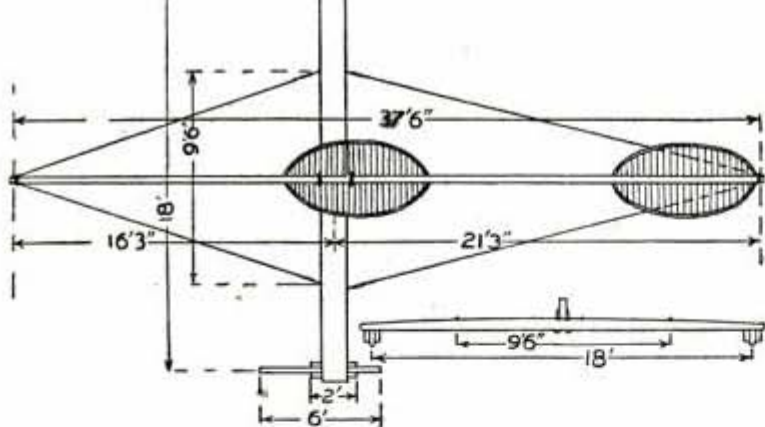

Details of the Ice-Yacht Parts

with the heart of the wood up, so as to give the natural curve from the ice so that it will act as a spring. The plank is 16 in. wide in the center, 14 in. at the ends; $4\frac{1}{8}$ in. thick at the center and $2\frac{3}{4}$ in. at the ends.

Details of the runners are shown in Figs. 3, 4, 5, 6, 7, 8 and 9. The cast iron shoes are filed and finished with emery paper, making the angle on the cutting edge 45 deg. on both sides. The runners are $7\frac{1}{4}$ in. wide over all and $2\frac{1}{8}$ in. thick. The soft iron casting is $2\frac{1}{4}$ in. deep. The shoes are fastened by $\frac{5}{8}$ -in. machine bolts. These are shown in Figs. 3 and 9. The rudder is $2\frac{3}{4}$ in. thick, 5 in. deep, including wood and iron, and 3 ft. long. The cast iron shoe is $1\frac{7}{8}$ in. deep and fastened on with four $\frac{1}{2}$ -in. machine bolts. A brass plate, $\frac{1}{4}$ in. thick, 2 in. wide and 7 in. long, is inserted on each side of the runners as shown in Fig. 9. Three holes are drilled through for a $\frac{3}{4}$ -in. riding bolt that can be shifted as desired for rough or smooth ice. The runner chocks and guides are $1\frac{7}{8}$ in. thick and $4\frac{1}{2}$ in. deep. They are set in the runner plank $\frac{1}{4}$ in. and fastened with glue and $\frac{1}{2}$ -in. lag screws. These are shown in Figs. 6 and 7.

The aft cockpit is stationary, while the fore or passenger cockpit can be removed at will. Both cockpits are the same size, 42 in. wide and 7 ft. long over all. Each one has a bent rail, $1\frac{1}{2}$ in. by 4 in., grooved $\frac{1}{2}$ in. by $\frac{7}{8}$ in. before bending. The flooring is of oak, $1\frac{1}{2}$ in. thick and 4 in. wide, tongue-and-grooved. The forward cockpit is made in halves and hung on the backbone with wrought-iron straps and bolts. These are shown in Figs. 41, 43 and 44. Two pieces of oak, $\frac{1}{2}$ in. by 4 in. are fastened with screws to the flooring, parallel with the backbone in the forward cockpit. The runner plank which passes under this cockpit gives it stability.

The spars should be hollow and have the following dimensions: Mast, 23 ft. 3 in.; heel, $3\frac{3}{4}$ in.; center, $5\frac{1}{4}$ in.; tip, 4 in.; boom $23\frac{1}{2}$ ft.; heel, $3\frac{3}{4}$ in.; center, 4 in.; tip, $2\frac{7}{8}$ in. at ends; gaff, $12\frac{1}{2}$ ft.; center, $3\frac{1}{2}$ in.; ends, $2\frac{1}{2}$ in.; jib-

boom, $10\frac{1}{2}$ ft.; $1\frac{3}{4}$ in. at the ends, $2\frac{1}{8}$ in. at the center. The gaff is furnished with bent jaws of oak, Fig. 17, and the main boom with gooseneck, Fig. 12.

Galvanized cast-steel yacht rigging, $\frac{5}{16}$ in. in diameter, is used for the shrouds; jibstay, $\frac{3}{8}$ in. in diameter; runner plank guys, $\frac{5}{16}$ in. in diameter; bobstay, $\frac{3}{8}$ in. in diameter; martingale stay, $\frac{1}{4}$ in. in diameter. The throat and peak halyards are $\frac{3}{8}$ in. in diameter; jib halyards, $\frac{1}{4}$ in. in diameter.

The main sheet rigging is $\frac{9}{16}$ -in. Russian bolt rope; jibs, $\frac{7}{16}$ -in. manila bolt rope, 4-strand; jib-sheet, $\frac{3}{8}$ -in. manila bolt rope. Four $\frac{1}{2}$ -in. bronze turnbuckles, Fig. 34, are used for the shrouds; one $\frac{5}{8}$ -in. turnbuckle for the jibstay and one for the bobstay; four $\frac{3}{8}$ -in. turnbuckles for the runner plank stays, and one for the martingale stay.

Two rope blocks for $\frac{3}{8}$ -in. wire rope, Fig. 10, are used for the peak and throat, and one block for the wire rope $\frac{1}{4}$ in. in diameter for the jib halyard. Four 6-in. and one 7-in. cleats, Fig. 18, are used. The blocks shown in Fig. 11 are used for the main and jib sheets. The steering arrangement is shown in Figs. 4 and 5. The tiller is $3\frac{1}{2}$ ft. long; rudder post, $1\frac{1}{4}$ in. in diameter; shoulder to lower end of jaws, 4 in.; depth of jaws, $2\frac{7}{8}$ in.; length of post including screw top, 12 in. The rubber washer acts as a spring on rough ice.

In Figs. 13, 14, 15 and 16 are shown metal bands for the nose of the backbone, and Figs. 19, 20, 21, 22 and 23 show the saddles that fit over the backbone and hold the runner plank in place. There are two sets of these. A chock should be sunk in the runner plank at each side to connect with the backbone to keep it from slipping side-wise as the boat rises in the air. The martingale spreader is shown in Figs. 24 and 25. Straps through which the ring bolts for the shrouds pass on the ends to fasten the turnbuckles for the runner plank guys are shown in Figs. 26 and 27. The bobstay spreaders are shown in Figs. 28, 29 and 30. In Fig. 31 is shown the top plate for the rudder post and in Figs. 32 and 33, the lower plate for same. The mast step is shown

38. The anchor plate for the bobstay under the cockpit is shown in Figs. 39 and 40.

At the nose and heel the runner plank guys end in a loop. The bobstay has a loop at the nose and ends in a turnbuckle that fastens to the anchor plate under the cockpit, aft. The shrouds, jibstay and martingale have loops at the masthead and are spliced bare over solid thimbles. The loops are finished in pigskin and served with soft cotton twine over the splice and varnished. The parceling is done with insulating tape. Serve the tiller with soft cotton twine and ride a second serving over the first. For the halyards hoisting use a jig shown in Fig. 46.

running part of halyard and passing back and forth through cleat and thimble. This gives a quick and strong purchase and does away with cumbersome blocks of the old-fashioned jig. The jib-sheet leads aft to the steering cockpit. The main-sheet ends in a jig of a single block and a single block with becket. Be sure that your sail covers are large enough—the sail maker always makes them too tight. The cockpit covers must fit tightly around the cockpit rail. Many boats have sail and cockpit covers in one piece.

The woodwork may be finished as desired by the builder. The dimensions of the sails are given in the general drawing, Fig. 1.

Turning Lights On and Off from Any Number of Places

This can be done by the use of any number of reversing switches such as

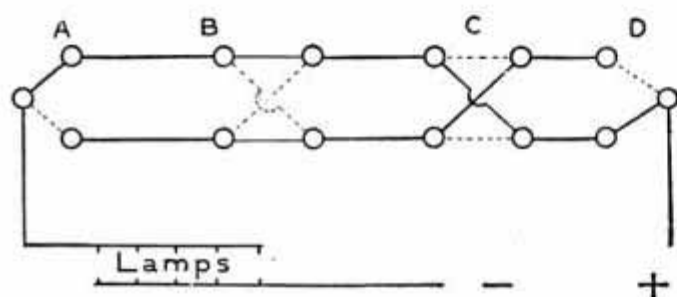

Wiring Diagram

those shown at B and C. These are inserted between the two-way switches A and D. Turning such a switch up or down connects the four contact pieces either diagonally as at C, or lengthwise as at B. The diagram shows connection from A to D, when the lamps will be on, but by turning either of these four switches into its alternative position, shown by the dotted lines, the circuit will be broken and the lights extinguished. When this has been done, the circuit may be restored and the lamps lighted again by altering either of the four switches in exactly the same way, and so on.

It will be observed that a reversing switch used in this way practically un-

does whatever is done by the other switches. In the accompanying diagram only two reversing switches are shown and the lights can be independently controlled from four distinct positions. Any number of reversing switches can be placed between the two-way switches A and D to increase the number of places from which the lights could be turned on and off.—Contributed by J. S. Dow, Mayfield, London.

How to Make an Electric Pendant Switch

It is often desired to use a pendant switch for controlling clusters of incandescent lamps. When such a switch is not at hand, a very good substitute can be made by screwing a common fuse plug into a key socket and connecting the socket in series with the lamps to be controlled. In this way you get a safe, reliable, fused switch.—Contributed by C. C. Heyder, Hansford, W. Va.

Never guess the length of a piece of work—measure it.

Wood-Working for Beginners

By IRA S. GRIFFITH

Chapter XI

Making a Bird Box

Typical use of the bevel-square, dividers, brace and bit, hammer and nails, and method of making and assembling duplicate parts.

Now that the beginner has learned how to order, how to lay out and cut his stock and how to square it up, he may profitably begin the making of the six pieces which will be described hereafter. The projects are so arranged that each one introduces some new wood-working process. By the time the six are completed, the beginner will have had experience in the essential processes, such as boring, chiseling, etc., and in the making of the most important joints. Each project is more difficult than the preceding one, so that the last will, if completed satisfactorily, indicate considerable skill and knowledge of the elementary principles of wood-working.

First, from the mechanical drawing of the bird house (Fig. 56), make out a stock bill in the form indicated in Chapter I. With this bill before you,

shown in the perspective sketch, Fig. 57. Follow Chapters VI and VII or

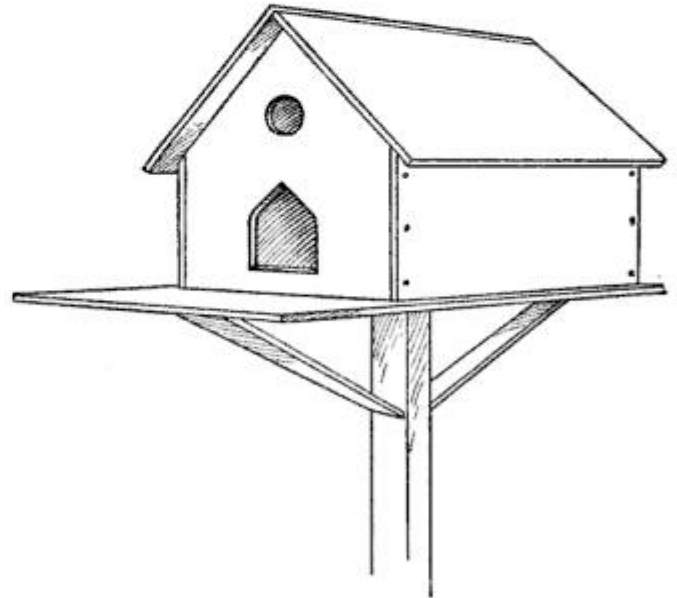

Fig. 57—Bird House Complete

Chapter VIII, according as the stock is mill-planed or rough.

The ends of the house may now be made. They should be squared up in the usual way except that only one end of each need be squared and no attention need be paid to the length, provided you are careful not to take

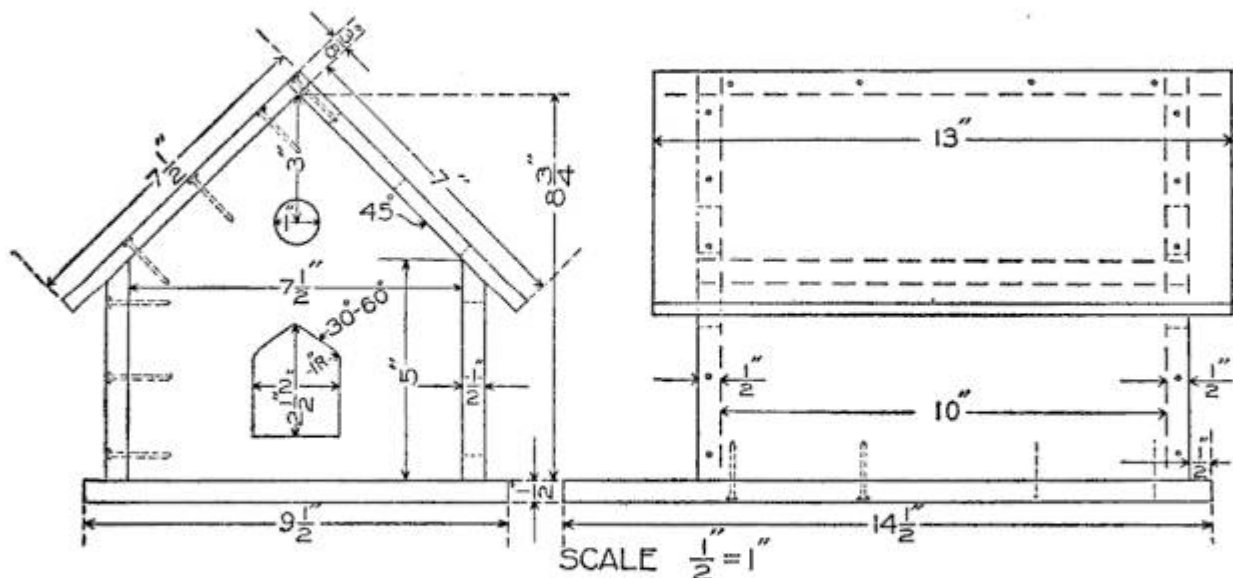

Fig. 56—Details of the Bird House

lay out and cut the stock as directed in Chapters II and IV. Begin on the easiest pieces by squaring up the bottom or floor and the two roof boards

off too much in squaring the first end of the board. These two house ends are alike in size; they are duplicate parts so the beginner will need to know how

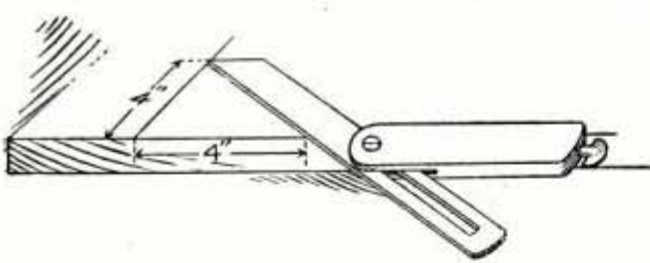

Fig. 58—Setting Angle of T-Bevel

even and, with light brads, nail the two parts together, nailing only in those parts that will not show the nail holes. The 45-deg. slopes are now to be laid out by means of the bevel-square or T-bevel. Figure 58 shows an easy way to set the bevel to 45 deg.

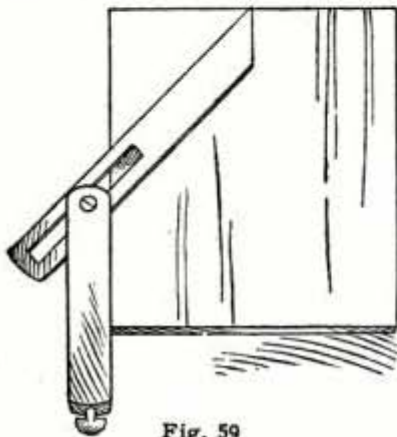

Fig. 59

Measure off on the edge of a straight board any given distance, say 4 in. With the try-square, place a line across the board at one of these marks and measure from the edge of the board along this line an equal distance, 4 in., and adjust the blade of the bevel as shown. Lay off the slopes by marking along the bevel placed as in Fig. 59, and from the other edge. Saw a little outside of the lines, and plane to them accurately, testing with the try-square.

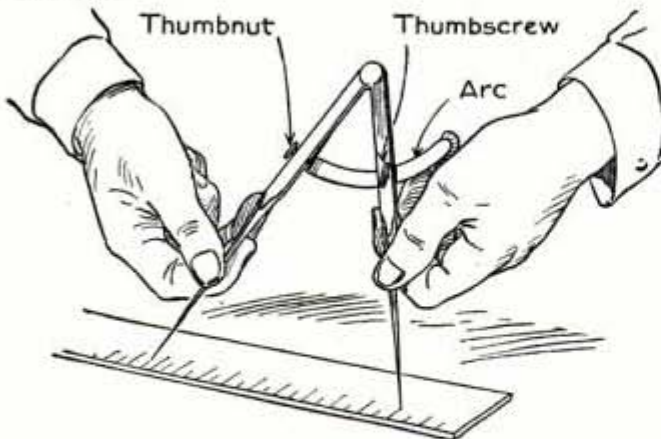

Fig. 60—Setting Dividers

Separate the pieces and lay out the door and the centers of ventilating

Figure 60 shows the manner of setting them. After the approximate setting has been secured, the thumbscrew is tightened and the thumbnut is used to set the points exactly.

For boring the holes, there will be needed a brace and a 1-in. auger bit, Fig. 61. Braces are of two kinds, plain and ratchet. The latter has the advantage over the former in that it can be used in corners and up against a wall where only a partial turn is possible. Auger bits vary in size by sixteenths of an inch. The size of an

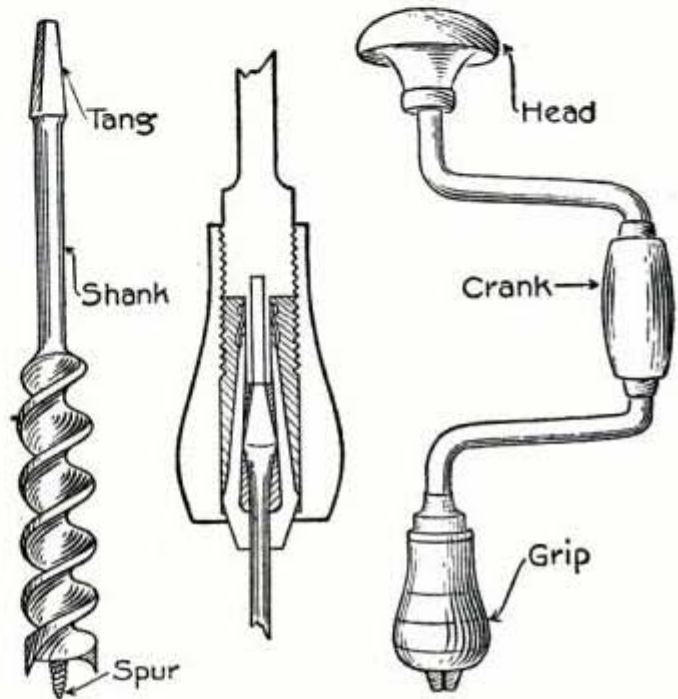

Fig. 61—Brace and Bit

auger bit is indicated by a number on the tang. If a single number, it is the numerator of a fraction whose denominator is sixteen.

To insert the bit, hold the grip in the left hand and with the right revolve the crank until the jaws are open wide enough to take in the entire tang of the bit. The jaws should clamp upon the shank. Insert the bit and close the jaws by revolving the crank in the reverse direction.

To bore the holes, place the piece in the vise, Fig. 62, and bore until the spur appears on the reverse side. Reverse the position of the piece and, inserting the spur in the small hole just

made, finish the boring. This method prevents any splitting of the arrises. The bit must be held perpendicular with the surface of the wood. Sight the whole brace and bit frequently from one direction, then from a position at right angles to this, until the bit has entered well into the wood.

A small coping or scroll saw may be used to finish the cutting of the door. Saw right up to the line, keeping the saw cut or kerf on the waste wood.

Make the two sides of the house. These pieces are to be squared up in the usual manner, except that in obtaining the width, the bevel square is



Fig. 62—Boring a Hole

to be used for testing the angle instead of the try-square, Fig. 63. Test constantly while approaching the line. If by accident the line is overplaned, it will be necessary to put on new lines for width and to lay out anew and rework the length of the ends of the house to correspond.

The different pieces should now be sandpapered nice and clean. Sandpaper should not be depended upon to do the work of the edged tools. The edges and ends of the pieces which are to be placed against other pieces to make joints should not be sandpapered. A better joint is obtained by using the planed surface, since sand-

papering has a tendency to round the edge.

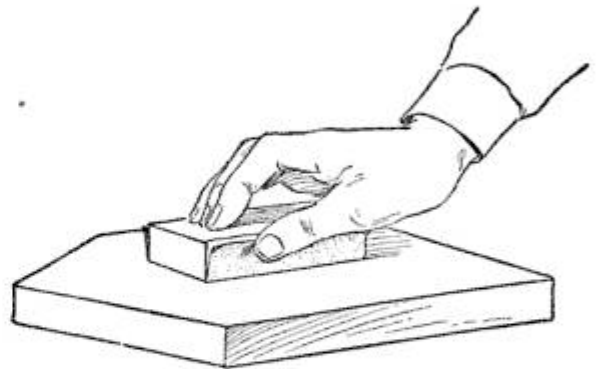

Fig. 64—Sandpapering

Fold the sandpaper sheet into at least four parts and make a block on which to place it. Make the block of such a size that the paper will not extend over the ends but will extend up the sides far enough to allow the fingers to grasp them firmly, Fig. 64. A good workman sandpapers so as to keep the arrises sharp, unless it be on the arm of a chair, etc., where the sharp arris would injure the hand.

We are now ready to assemble and nail the parts together. There will be needed some nails, either common or finishing.

Common nails have flat heads; finishing nails have small round heads and are more suitable for fine work. Casing nails have small heads, but with slightly thicker bodies than the finishing. In ordering nails, specify the length in inches and the

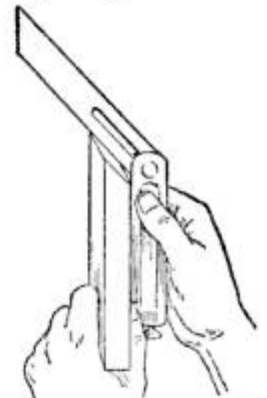

Fig. 63



Fig. 65—Wire Gauge

thickness according to the gauge of wire. Figure 65 shows a wire gauge.



Fig. 66—Nailing

Place an end of the box in the vise, Fig. 66, and, standing so as to be able to sight along the lower piece, drive in the nails. Drive the nail almost in and finish with a nail-set (Fig. 65), so as not to mar the surface of the wood. Should the nail not enter properly, withdraw it (Fig. 66), and start it in another place near-



Fig. 67
Setting Nail



Fig. 68
Drawing a Nail

by. Nail this side to the other end, then nail the other side in place. Put on the bottom or floor, then the roof boards.

(To be continued.)

We usually view a scene with two eyes; the camera generally sees it with one lens. Herein may be found the explanation of a certain all-too-common fault in photography, says the *Photographic Times*.

Among the prints recently sent in to a competition was one in which at first sight it seemed that a distant cathedral was resting on a rustic bridge; another, in which a man crossing a river in a boat seemed to be carrying with him a tall factory chimney; a third, in which a tall youth appeared to be trying to insert his head in a gas globe. In each case the person behind the camera would doubtless see his subject with both eyes, and get abundant stereoscopic relief, so that the absurdities perpetrated by the one-eyed camera would never be thought of or seen until too late.

The obvious moral is to view one's subject from just over the top of the camera, and use one eye only, bearing in mind the possible confusion due to one object coming behind another.

Removing a Stamp by Steaming

If for any reason you wish to remove a stamp from an envelope, reverse the usual steaming operation. It will prove much more satisfactory if you wish to use the stamp again. In the ordinary method of applying the steam to the stamp the steam penetrates the stamp first with the result that almost all the adhesive remains on the envelope. By reversing the operation, tearing open the envelope and steaming from the back side, the steam penetrates the envelope paper first and the adhesive remains on the stamp.—Contributed by Thos. L. Parker, Olaf, Iowa.

CA solution of paraffin and benzine spread over the gluing-up table will greatly facilitate the removal of dried glue—all it needs is to be knocked off.

Knife Made from a Hack-Saw Blade

A very serviceable knife with excellent cutting qualities can be made easily from a discarded hack-saw blade. The dimensions given in the sketch make a knife of convenient size.

The saw teeth are ground off on an emery wheel or grindstone to a smooth edge parallel with the back edge. For the handle, take two pieces of hard wood, dressing one surface of each piece, and cut a groove as wide and thick as the saw blade. Place the blade in the groove and glue the two dressed sides of the wood together. After the glue has dried, the blade can be pulled out of the groove and the wood shaped to any desired form. A small wood-screw is put through one side of the handle to prevent the blade from sliding. After completing the

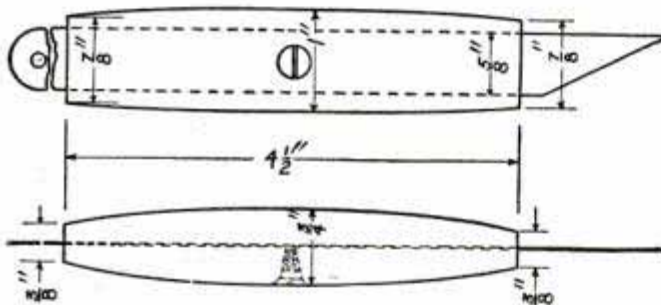

Details of Handle

handle, the blade is put back into the groove and sharpened to a cutting edge.—Contributed by H. A. Hutchins, Cleveland, Ohio.

Killing Mice and Rats

A simple and inexpensive means for killing mice and rats is to leave yeast cakes lying around where they can eat them.—Contributed by Maud McKee, Erie, Pa.

Roller Coaster Illusion Traveling Up an Incline

A toy car with a paddle wheel and a shaft on both ends traveling upward on a chute in which water is flowing down, is shown in the accompanying sketch. The paddle wheels travel in a reverse direction causing the ends of the axles to roll on the edge of the

chute, thus carrying the car up the incline. If a rack is used on each side of the chute and a small pinion on the

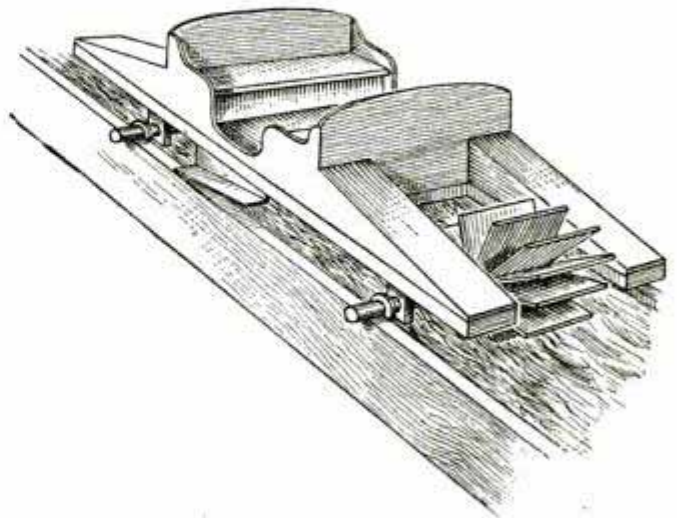

Car Travels Uphill

ends of the axles, a positive upward movement of the car will be obtained.—Contributed by W. S. Jacobs, Malden, Mass.

Block for Planing Octagonal Wood Pieces

The little device shown in the illustration will be found very useful in any workshop. Two or three of them will be necessary for planing long pieces. Each one is made of a hardwood block, 1 in. square and 4 in. long. A notch is cut in one side, as shown in Fig. 1, so a piece of wood which has been planed square will fit in it. Put a screw in the end of each piece and fasten it down to the bench. If desired, a tenon may be made on the bottom of each block, as shown in Fig. 2, to fit a mortise cut in the bench. Place the blocks far enough apart so the board to be planed will rest firmly in the notches.

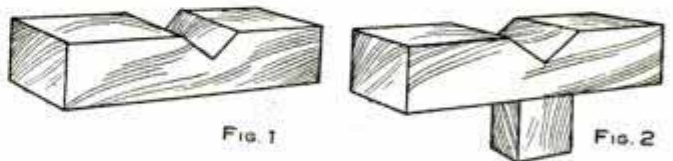

The Notch Holds the Wood

Plane the board square first and then place it in the notches and plane the corners down to the proper dimensions.—Contributed by Willie Woolson, Cape May Point, N. J.

INTERESTING PATENTS

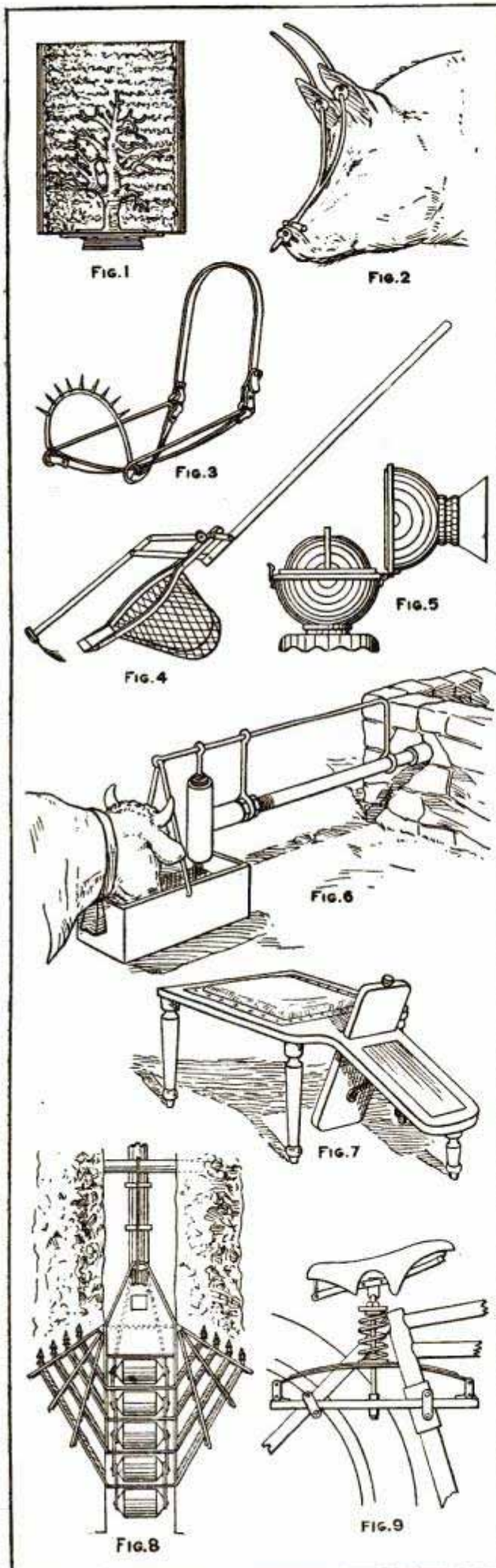

GAS HEATER—Figure 1 shows a gas heater, the flame of which, playing upon the asbestos fiber face-board, gives an appearance not unlike that of a tree with the leaves on fire. The metal of which the tree is formed is expected to diffuse the heat. An air mixer at the lower edge of the back piece communicates with the gas receiving box.

HOG YOKE—A hog yoke which requires the joint service of both the ears and the nose is illustrated by Fig. 2. It is a rod adapted to be passed through the snout of the hog, a bar supported by the rod at a point above the snout, a ball provided with a setscrew arranged to engage over one end of the rod after it has been passed through the snout, and upwardly extending prongs which pass through the ears. What would happen, should a hog so equipped attempt to run under or through a fence, can be easily imagined.

CALF WEANER—This calf weaner (Fig. 3) is strapped over the nose and around the neck in such manner that it does not interfere with the animal's grazing, while the spurs prevent suckling.

POTATO GATHERER—Figure 4 shows an implement for picking up potatoes in the field. The method of operation is easily understood, the hoe retaining the potatoes and forcing them into the net when the shovel-like blade is pushed under them. The soil picked up with the potatoes drops through the mesh of the net.

INGENIOUS CUSPIDOR—This cuspidor (Fig. 5) consists of a body portion formed of two sections, one of which sections is provided with an inlet opening and a mouthpiece, while the other forms a base for a semi-spherical retainer. The deposit is held by the retainer, which is easily removed for cleaning.

AUTOMATIC WATERING TROUGH—A watering trough which will fill as often as emptied but will not overflow is shown in Fig. 6. The trough hangs from a spring arm, which is mounted on the water pipe. When the trough becomes nearly filled with water the weight forces the valve stem down and shuts off the supply. Before the water in the trough is completely exhausted, the spring arm, no longer held down by the weight, lifts sufficiently to raise the valve stem and start the flow.

SHOE-SALESMAN'S STOOL—A shoe-salesman's stool provided with a mirror, by means of which the customer can observe the front appearance of the shoe being fitted, is illustrated by Fig. 7. The mirror rests in a casing from which it can be drawn out as much as desired.

APPARATUS FOR FILLING TRENCHES—Figure 8 illustrates a drag apparatus designed for filling trenches. It consists of two obliquely-disposed sets of shoveling members of varying length, one on each side of the trench, and a tamping or compression member acting on the earth when thrown into the trench. The latter consists of five weighted rolling cylinders.

SADDLE-SPRING FOR MOTORCYCLES—A motorcycle saddle mounting which is carried by the vertical brace and the rear fork of the motorcycle instead of by an ordinary standard set in the opening at the top of the vertical brace is shown in Fig. 9. Attachment to the rear fork and the vertical brace is made by means of clamps and a clip block. The arrangement makes possible a combination of buffer and leaf springs.

MOUTH GAG FOR USE WHEN WORKING ON HORSES' TEETH—Horses, like human beings, are not fond of the dentist, and, lacking the restraint and reasoning power of the latter, are very liable to make operations interesting. By using the mouth gag shown in Fig. 10 the mouth cannot close upon the hands of the dentist, and, at the same time, it is claimed that the horse is saved much discomfort and pain.

PRACTICAL OR UNIQUE

MASSAGING APPARATUS—A massaging apparatus, by means of which the man who shaves himself is expected to get the same action and results as provided by the deft hands of the barber, is illustrated by Fig. 11. The apparatus comprises a flexible massage member composed of rollers, and a head band which supports the pulleys over which the cords fastened to the ends of the massage member are worked. A see-saw motion of these cords provides the massaging action.

BUTTON-HOOK FOR COLLARS—The distemper attending an ineffectual attempt to button a collar, is a mental state too familiar to require further space. Figure 12 is a buttoning device by means of which the collar may be drawn over the button. It consists of a plate having a flat central portion, with the ends twisted in opposite directions with respect to the plane of the central portion, one of such ends being provided with an opening for the reception of the button.

ELECTRIC-LIGHT BULB—The feature of this electric-light bulb (Fig. 13) is the switch contained in the head. The post projecting from the non-conducting head has a plurality of radially-extending upper and lower arms disposed in sets of two. Three filaments are suspended between three sets of arms, a conductor extending from one end of the first filament into the path of the switch and a conductor connecting the second and third filaments.

TREE-FELLING SAW—A crank-operated chain saw for felling trees is shown in Fig. 14. The method of setting the apparatus up for operation is clearly shown.

AUTOMATIC STOP FOR PHONOGRAPHS—Some means by which a phonograph can be automatically stopped the moment the record is played off has long been recognized as desirable, but as yet a perfectly practical device to accomplish this office has failed to appear. Many difficulties have presented themselves in solving the problem, one of the greatest being due to the fact that the records on the discs vary in length. Figure 15 shows one inventor's idea of an automatic stop. It is a projecting arm mounted upon the central post of the machine and provided with a revolvable catch. This projecting arm is adapted to be adjusted longitudinally. An adjustable clamp, mounted upon the sound box, is provided with a hook adapted to engage with the catch at the end of the projecting arm for raising the needle and stopping the machine. At present, it is necessary for the person operating a phonograph to jump up when a record is completed, rush to the machine, and shut off the mechanism.

AUTOMATIC POULTRY DUSTER—Figure 16 is a device patented as an automatic duster for poultry. It comprises a container having a cloth bottom, an agitator having a head provided with laterally projecting portions, and down turned rocker arms extended through the container bottom.

SIDE-DISCHARGE DUMP-WAGON—A 3-ton coal wagon that, it is claimed, will discharge its load at a speed of a ton per minute is illustrated by Fig. 17. The body breaks in the middle, the front and rear ends being raised by a special lifting device, and the coal slides into a channel which empties into side chutes. The side chutes have patent cut-offs for use when the coal has to be delivered in bags, so that the driver can fill the bags without shoveling.

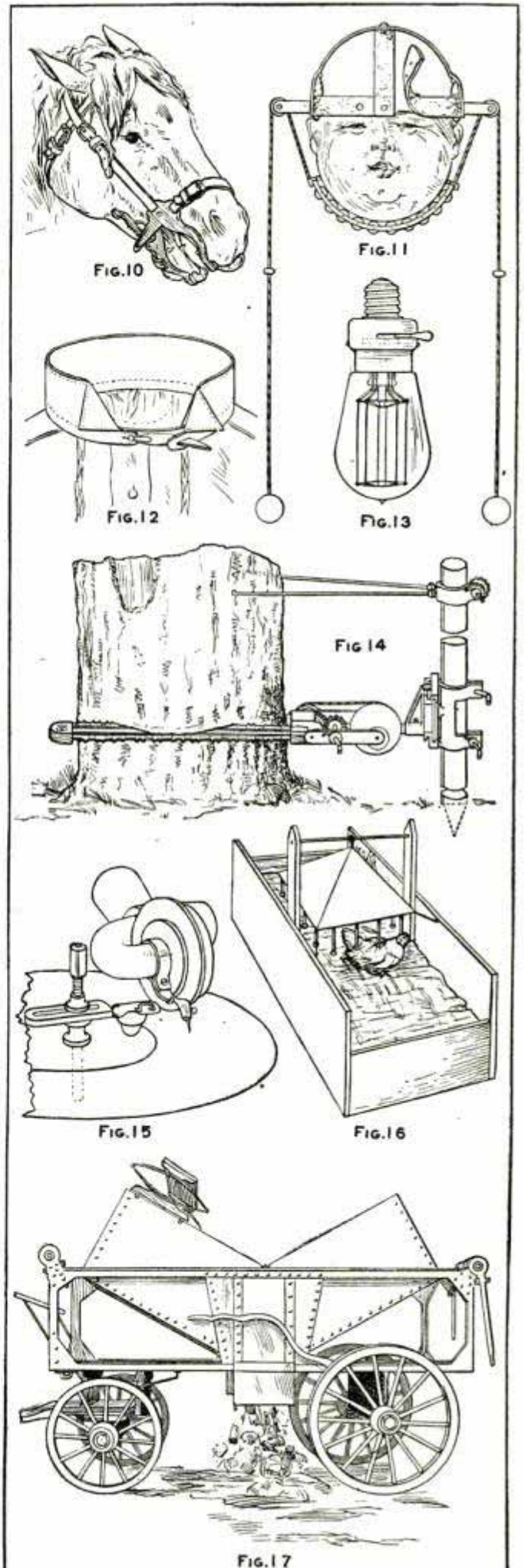

NEW BOOKS

AMERICAN MACHINIST GEAR BOOK. By Charles H. Logue. Cloth; illus.; 348 pp. Price, \$2.50. Gives practical data for cutting, molding and designing all commercial types, and presents these subjects in the plainest possible manner by the use of simple rules, diagrams and tables, arranged for

It's like this: Suppose you were to go out into the country and see a field of thistles growing."

"Yes," assented his friend.

"Well, that would not be a phenomenon!"

"No, that's quite clear," agreed the other man.

"But suppose you were to see a lark singing away up in the sky."

"Yes."

"Well, that would not be a phenomenon!"

"No, that also seems clear."

"But imagine there is a bull in the field."

"Yes," his friend could imagine that.

"Even that would not be a phenomenon."

"No."

"But now, Bill, look here. Suppose you saw that bull sitting on them thistles whistling like a lark—well, that would be a phenomenon!"—Tit Bits.

◆ ◆ ◆

St. Peter (to applicant)—What was your business when on earth?

Applicant—Editor of a newspaper.

St. Peter—Big circulation, of course?

Applicant—No, small; smallest in the country.

St. Peter—Pick out your harp.

◆ ◆ ◆

The wild beasts gnashed their teeth and roared like a circus calliope; the gladiators shouted hoarsely; the arena was knee-deep with gore.

In the amphitheater the pleasure-seeking populace clamored tumultuously.

"More blood! More death!" they yelled ferociously.

Great Caesar in his private box heard their cry and sighed.

"Would that I might grant their prayer," he muttered. "If only—" and imploringly he raised his eyes heavenward—"I could pull off an automobile cup race!"

Great Caesar wept.

For with all his boasted power he was unable to hasten the flight of time.—Chicago News.

◆ ◆ ◆

"Show me one of these old robber castles of the Rhine," commanded the tourist.

"Robber castles?" echoed the puzzled guide.

"Does the gentleman mean a garage?"—Kansas City Journal.

◆ ◆ ◆

"And where have you been, my pet?"

Thus little Willie's mother to little Willie on his return home after an unwonted absence of several hours.

"Playin' postman," replied the family hope.

"Playing postman?" replied Willie's mother.

"And how does one play postman, sweet?"

"Why, I just left a letter at each house in the road," explained the prodigy—"real letters, too."

"Real letters, darling?" inquired mamma, smiling.

"But where ever did you get the real letters from?"

"Out of your wardrobe drawer," responded Willie—"those old ones tied up with pink ribbons."—South Bend Tribune.

◆ ◆ ◆

A little girl wrote the following composition on men:

"Men are what women marry. They drink and smoke and swear, but don't go to church. Perhaps if they wore bonnets they would. They are more logical than women and also more zoological. Both men and women sprung from monkeys, but the women sprung further than the men."

◆ ◆ ◆

It is the custom at a certain public school down in Maine for the teachers to write on the blackboard any instruction they desire the janitor to receive.

The other morning the janitor saw written:

Find the greatest common divisor.

"Hullo!" he exclaimed. "Is that durned thing lost again!"—Lippincott's.

this is the fifth time I have taken you up, but you have not come down with me."

"Well, you see," Sam replied, "Ah been washin' windows on de 'leventh floor, and every now and again Ah misses mah hold and falls out."

◆ ◆ ◆

The inspector was examining Standard I and all the class had been specially told beforehand by their master: "Don't answer unless you are almost certain your answer is correct."

History was the subject.

"Now tell me," said the inspector, "who was the mother of our great Scottish hero, Robert Bruce?"

He pointed to the top boy, then round the class. There was no answer. Then at last the heart of the teacher of that class leaped with joy. The boy who was standing at the very foot had held up his hand.

"Well, my boy," said the inspector, encouragingly, "who was she?"

"Please, sir, Mrs. Bruce."—Dundee Advertiser.

◆ ◆ ◆

"You, a violinist, going in for acrobatic work?"

"It's this way," explained the vaudeville actor. "As a violinist I get \$40 per week. But the manager offers me \$200 if I'll learn to play the fiddle standing on my head."—Kansas City Journal.

◆ ◆ ◆

"So that's the baby, eh?"

"That's the baby."

"Well, I hope you will bring it up to be a conscientious, God-fearing man."

"I am afraid that will be rather difficult."

"Pshaw! As the twig is bent the tree's inclined."

"I know, but this twig is bent on being a girl, and we are inclined to let it go at that."—Houston Post.

◆ ◆ ◆

Enraged over something the local newspaper had printed about him, a subscriber burst into the editor's office in search of the responsible reporter.

"Who are you?" he demanded, glaring at the editor, who was also the main stockholder.

"I'm the newspaper," was the calm reply.

"And who are you?" he next inquired, turning his resentful gaze on the chocolate-colored office-devil clearing out the waste-basket.

"Me?" rejoined the darky, grinning from ear to ear. "Ah guess ah's de cul'ud supplement."—Lippincott's.

◆ ◆ ◆

Bricklayer (to mate, who had just had a hod full of bricks fall on his feet)—Drop'd 'em on yer toe! That's nothin'. Why, I seen a bloke get killed stone dead, an' 'e never made such a bloomin' face as you're doin'.—Tit-Bits.

◆ ◆ ◆

Papa—Where have you been, James?

"Fishin'."

"Come into the woodshed and we'll have a whaling expedition."—Brooklyn Citizen.

◆ ◆ ◆

Cabby (badly worsted in the dispute)—"Well, I 'opes as the nex' four-wheeler yer tikes, Mum, will be a 'earse!"—Punch.

◆ ◆ ◆

"The Opera was just darling, Mrs. Smith," declared Mrs. James Orphington Rex, as she felt of her diamond ear-rings to make sure they were at the proper angle.

"I know I would have enjoyed it," answered Mrs. Smith.

"You would have had fits over it, Mrs. Smith. Calf was so cute and they all sung in Latin."

A sneeze saved a snicker, after which Mrs. Smith asked, "What opera did you hear, Mrs. Rex?"

"I have it written down on a card here in my bag. I wanted to get it just right. You see, the name was on the curtain and I copied from that. It was 'Asbestos.'"—

Find Your New HOUSE in Our Plan Book!

Build It Complete—at Half the Usual Cost
We Supply Everything, at Wholesale Prices!

Our Book of Beautiful, Practical Homes KEEPS COST WITHIN ESTIMATES

The Gordon-Van Tine Co. Book of Plans is not a "theoretical" publication, based upon some architect's "guess" as to cost of completing the homes shown in pictures and "blue prints." Every house in it has actually been built at the price stated and can be duplicated at the same figures. The architects who drew the plans are in the employ of America's Greatest Building Material Plant and are posted on prices of materials as well as on styles of architecture.



Houses, Cottages, Bungalows, Costing \$600 to \$6,000

are shown in this beautiful Plan Book—actual photographs of real homes! Beauty, convenience and economy in cost have received equal consideration. The result is a wonderful book that safeguards the home-builder against disastrous bills for "extras."

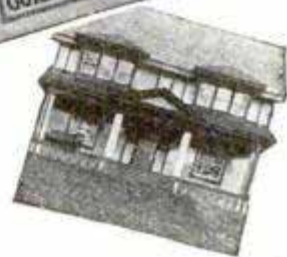

Our Great FREE Home-Builders' Catalog Offers 5,000 Bargains in Millwork and Lumber DIRECT FROM MILL TO USER

We operate the largest independent Building Material Plant in the United States. We sell all our goods direct to the user. This saves the combined profits of the various middlemen which the user must pay if he buys from the retail dealer. We carry an enormous stock of bright, new goods, in great concrete warehouses, ready for immediate delivery. We ship wherever railroads go. Our prices are the same to all—whether you buy a few doors and windows or order in carload lots.



We Save Home-Builders of America A Million Dollars a Year!

We are supplying immense quantities of Building Material to home-builders, contractors and city and suburban real estate operators throughout the country. Our wholesale prices save our customers over a million dollars a year. One customer alone has built 150 houses, from material furnished by us.



We Guarantee Quality, Safe Delivery and Satisfaction on Doors, Windows, Mouldings—EVERYTHING!

The Gordon-Van Tine Guarantee of satisfaction or money back gives you the most ample protection.



Bank References We have been established here since 1865. Our financial responsibility is unquestioned. We refer you to the Scott County Savings Bank of Davenport, Iowa; the Iowa National Bank of Davenport, Iowa; the Bankers' National Bank of Chicago, or any bank in America. See our rating in Dun's or Bradstreet's Commercial Agencies.

Get Our FREE BOOKS Before You Let the Contract!

Write for Home-Builders' Catalog and Book of Plans. Send your list of materials for Free Estimate.

In ordering Plan Book, enclose 10c for postage and mailing.

(93)



GORDON-VAN TINE CO., 2473 Case St., Davenport, Iowa



How Wilson Hunt

Wilson P. Hunt lost his overalls. It's a mighty interesting story.

Hunt was an apprentice at the machinists' trade. The future didn't look very bright to him

He knew that even when he had finished his apprenticeship he could only earn enough for a bare living—especially if he married.

He could see no advance in store for him. Only a life at the bench. A life of overalls.

And so Hunt fretted. For you see **he had ambitions**. He wanted to become something—to broaden out—to become a bigger man—to do big things and make big money.

He wanted to get out of the overalls class.

He longed for education—**training**. He knew that was what he needed most. But where would he get the time? And money? That was what he thought. Then he saw and marked an International Correspondence School coupon—and mailed it. It cost him nothing

to find out what they could do for him, anyhow.

That was a **great move** for Hunt. He enrolled in the I. C. S., finding that it required only his spare time to get his desired training, and that here was an education the poorest could afford.

By the time Wilson P. Hunt finished his apprenticeship, he had become a full-fledged draughtsman **instead** of machinist, thanks to the I. C. S.

And he lost his overalls. But he didn't need them. He had left them to hang forgotten on a peg.

From draughtsman, the **next step** was to designer of machinery.

Mr. Hunt is now Manager and Superintendent of the Moline (Ill.) Tool Co., at a fine salary, engaged in building special machinery, developing new inventions, and experimental work. He has been admitted to the Western Society of Engineers.

That is how Wilson P. Hunt lost his overalls.

That is how he **got out** of the overalls class.

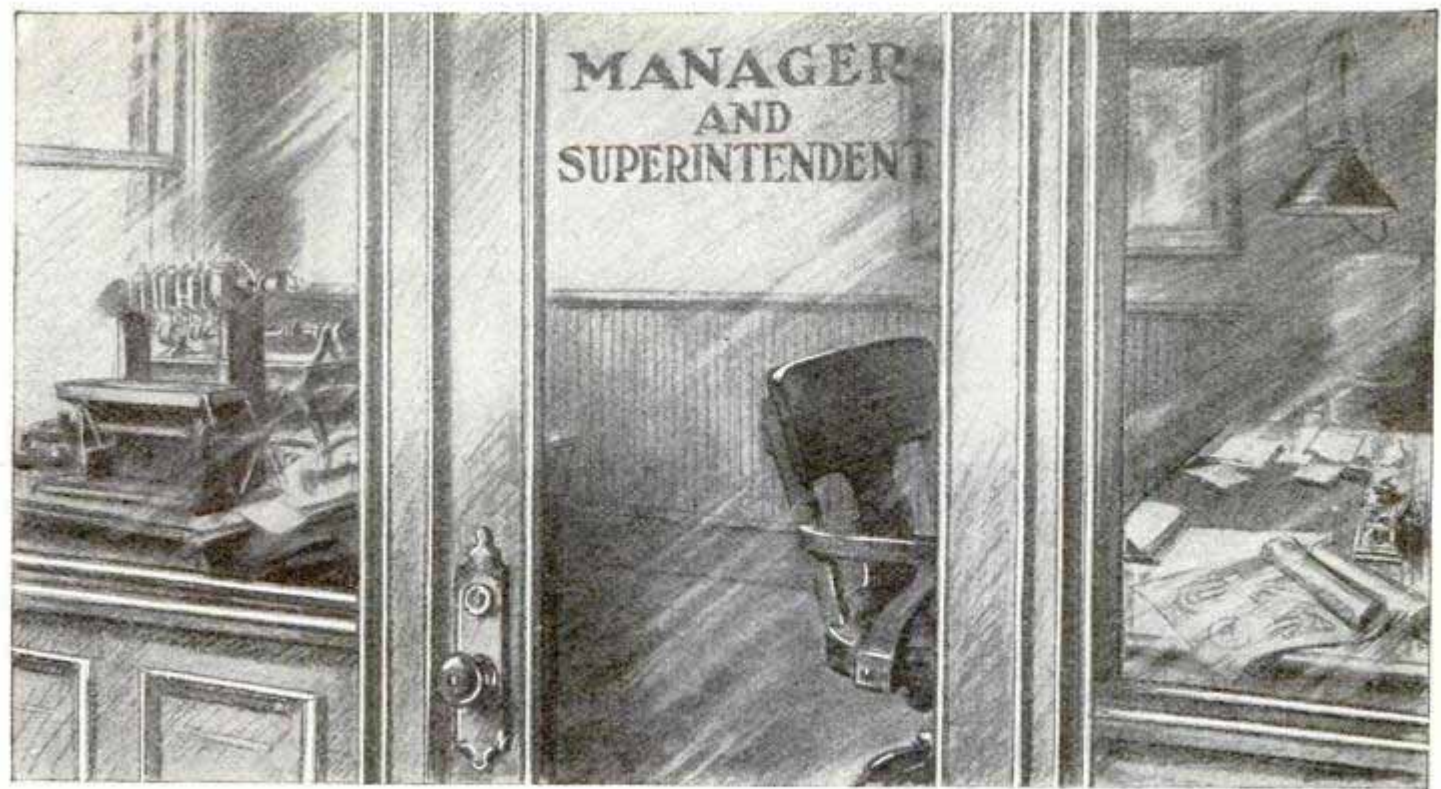

Lost His Overalls

Why not lose YOUR overalls? Lose them the way Wilson P. Hunt did.

Put a firm foot on the first rung of the ladder climbed by Mr. Hunt—the ladder to *success*.

Mark the coupon, just as Mr. Hunt marked it, to show what occupation you prefer, mail it today and let the I. C. S. tell you how it can help *you* to better YOURSELF—to succeed—to make yourself a *bigger man* with a *bigger salary*.

No matter who you are or where—or how little you now earn—the I. C. S. can help you, can raise your pay just as it has for thousands of others. A monthly average of 300 letters VOLUNTARILY written by students reporting their *salaries raised* as a direct result of I. C. S. help—331 during October—shows what this means to *you*.

Mark the coupon now and get that *training* that the world now demands—become an expert—it means success for YOU.

Begin your advancement today by marking the coupon. *Get out of the overalls class.*

**MARK THE COUPON NOW
MAIL IT TO-DAY**

INTERNATIONAL CORRESPONDENCE SCHOOLS, Box 872, SCRANTON, PA.	
Please explain, without further obligation on my part, how I can qualify for the position, trade or profession before which I have marked X.	
Automobile Running Mine Superintendent Mine Foreman Plumbing, Steam Fitting Concrete Construction Civil Engineer Textile Manufacturing Stationary Engineer Telephone Expert Mechanical Engineer Mechanical Draftsman Electrical Engineer Electric Lighting Supt. Electric Wireman	Civil Service Architect Chemist Languages— Banking Building Contractor Architectural Draftsman Industrial Designing Commercial Illustrating Window Trimming Show Card Writing Advertising Man Stenographer Bookkeeper
Name _____	
Present Occupation _____	
Street and No. _____	
City _____ State _____	



Telephone Etiquette

Co-operation is the keynote of telephone success.

For good service there must be perfect co-operation between the party calling, the party called, and the trained operator who connects these two.

Suggestions for the use of the telephone may be found in the directory and are worthy of study, but the principles of telephone etiquette are found in everyday life.

One who is courteous face to face should also be courteous

when he bridges distance by means of the telephone wire.

He will not knock at the telephone door and run away, but will hold himself in readiness to speak as soon as the door is opened.

The 100,000 employees of the Bell system and the 25,000,000 telephone users constitute the great telephone democracy.

The success of the telephone democracy depends upon the ability and willingness of each individual to do his part.

**AMERICAN TELEPHONE AND TELEGRAPH COMPANY
AND ASSOCIATED COMPANIES**

One Policy

One System

Universal Service

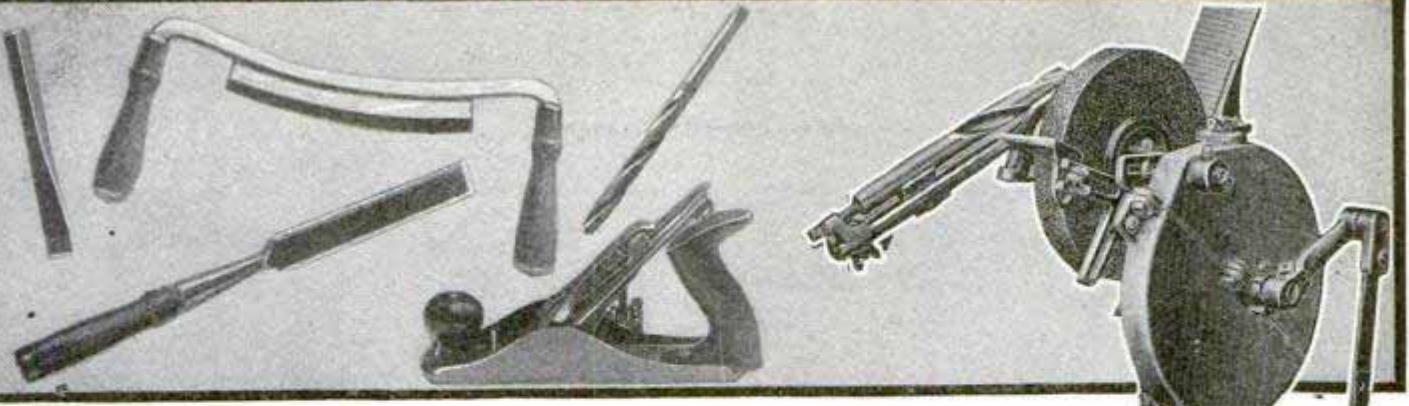

SHARPEN ALL TOOLS FOR SIX MONTHS FREE

2500
Revolutions
Per Minute

We want every shop and factory, every carpenter, mechanic, contractor, and tool-user to prove on their own tools by 6 months' Free Trial how the Luther Mechanics Special Grinder with the genuine Carborundum wheels saves time, labor, tools, and makes money. We will send this grinder on Six Months' Free Trial, and if you want to part with it after that, send it back at our expense. Return coupon at bottom of this page for full details.

LUTHER DIAMOND TOOL GRINDER

25 times faster than grindstones, 6 times faster than emery wheels—will not draw temper—Genuine Carborundum Wheels

The Carborundum wheels on Luther Grinders cut hardest steel as emery does soft copper, and does not draw temper—no water cooling necessary. One man with a Luther Grinder does the work of 20 with other abrasives. It takes only two minutes to do sharpening that would take half an hour on the grindstone. Special sharpening attachments enable anyone to do difficult sharpening, such as gumming saws, sharpening twist drills, chisels, etc.

Mechanics
Special
with
Chisel
Grinding
Attachment

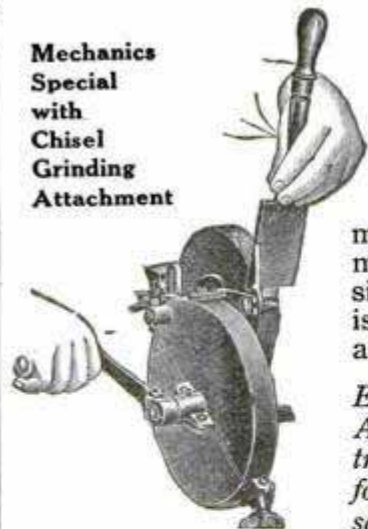

Built Like a High Grade Lathe

The Mechanics Special has steel and malleable construction, enclosed gears, dust-proof bronze bearings in oil bath, machine cut spur gears, — speed 2500 revolutions per minute. Guaranteed five years—wheels will not get lopsided or soft in spots. In every respect the construction is substantial and mechanically excellent—built like a high grade lathe.

Elmwood Haynes, Pres. of Haynes Automobile Co. writes: "I have tried the Mechanics Special and found it an excellent device." Thousands of other users say the same.

Mechanics
Special with
Foot-Power
Attachment



Return this Coupon for Six Months' Free Trial Offer

Return this coupon for our 6 months' Free Trial Offer—a whole half year free test trial. Let us give full description of grinder and particulars of this liberal Free Trial Offer—also the story of the discovery of Carborundum from McClure's Magazine. Send the coupon at once. Returning it puts you under no obligations. Write today.

Luther Grinder Mfg. Co.
68 Madison St., MILWAUKEE, WIS.

COUPON

Luther Grinder Mfg. Co.

68 Madison St., Milwaukee, Wis.

Please send me free and prepaid, your free Carborundum booklet, and six months' Free Trial Offer on Mechanics Special Luther Diamond Tool Grinder. This obligates me in no way whatsoever.

Name.....

Address.....

Dealer's Name.....

Dealer's Address.....

Learn Taxidermy Mount Birds and Animals



**Beautifully Decorate Your Own Home or
Make Big Money Mounting for Others
We Teach You With Complete Success By Mail**

EARN A BIG INCOME! The closely guarded **Secrets of Taxidermy revealed for the first time.** You learn at home during your spare time. Easily and quickly. Here is an opportunity you have long been waiting for! You will soon mount specimens as well as the most expert Taxidermist. We teach you to successfully—

Mount Your Own Game Heads, Birds and Animals

also to **TAN** all kinds of hides and furs, and make them into beautiful **robes** and **rugs**. No other art is so fascinating or interesting, and every man, woman or boy who enjoys outdoor life and sports **needs** a knowledge of this subject.

By taking our easily learned mail course you will soon be able to do perfect mounting, and can *decorate your own home, office or den* with the choicest of art. You will have a delightful diversion for your leisure time, and will **enjoy every moment** you give to the subject. Thousands of men and women of every vocation—bankers, lawyers and business men—are members of our school, and endorse it in the highest terms.

SENT FREE

Our beautiful catalog, The Taxidermy Magazine, Sample Diploma, Pictures of Mounted Birds and Animals. Hundreds of letters from our Sportsmen Students. All the above **ABSOLUTELY FREE** for the asking. Mail the coupon today.

Big Money in Taxidermy

Professional Taxidermists earn from \$2000.00 to \$3000.00 a year, and there are not half enough Taxidermists to supply the demand. By giving only your *spare time* to this work you can easily earn from \$20.00 to \$50.00 per month, without interfering with your regular business or occupation. Mounted specimens sell readily for big prices. Many birds and animals that are now killed and thrown away are *valuable* and can be turned into cash.



Mounted by our student, F. Rawson, Kalamazoo, Mich

One of our students writes us: *"I have made over \$550 during my spare time selling my specimens and mounting for others."* We have hundreds of similar letters on our files.

THIS IS THE ORIGINAL SCHOOL OF TAXIDERMY, and is endorsed by our thousands of students and all leading Museums, Naturalists and Taxidermists. We teach the **BEST STANDARD METHODS**, and positively **guarantee success**. Expert instructors in every department. Our Taxidermy work is widely known, having been awarded First Grand Prize and 9 Gold Medals at the Exposition. The editor of any Sportsman's Magazine will tell you of the high standing of this school, which has taught Taxidermy successfully for seven years.

WE INVITE YOU TO INVESTIGATE FULLY. Send for our printed matter today. It will interest you, and it's Free. We want every sportsman or nature lover in the country to become a member of the only school in the world for sportsmen by sportsmen."

Our school and the success of our course are known and highly endorsed by all leading sportsmen's journals. We refer you to the editor of this magazine. Mail the coupon, or use postal card.

The NORTHWESTERN SCHOOL OF TAXIDERMY

BOX 1192, OMAHA, NEB.

SIGN AND MAIL COUPON TODAY
N. W. SCHOOL OF TAXIDERMY, Box 1192, OMAHA, NEB.
Please send me sample Magazine, catalog, etc., FREE. I am interested in Taxidermy.

Name
P. O.
Street
State
R. F. D.

Four Large Lines of P. S. & W. Guaranteed Hand Tools Backed by The MARK of the MAKER

THE four tools shown at the right are each representative of a large line of highest grade tools. When you see our trade-mark on any of these tools it stamps it as the very best that nearly a century of supremacy in tool-making has turned out.

The P. S. & W. Samson-Brace

has the Ball Bearing Chuck, the strongest gripping device ever put on a brace, and the easiest to release. It has also a steel-clad, Lignum Vitae Head with dustproof, steel ball-bearings; forged steel alligator jaw, solid steel sleeves, cocobolo center, etc.

The P. S. & W. Solid-Handle Wrench

Strongest all round general-purpose wrench ever made. Head, bar, ferrule and handle frame forged solid in one piece and case hardened. The sliding jaw, extra heavy knurled thumb-screw and wood facing of handle are the only other pieces.

The P. S. & W. No. 30 Box-Joint Plier

Made of special steel forged and tempered. The jaws work smoothly and do not become loose from wear. Cutting edges meet accurately and cut clean as long as used.

The P. S. & W. 1819 Original Snip

The first high-grade snip on the American Market and the best and most widely used snip today. Forged from the best Norway Iron, with special high-grade tool-steel laid deep into the blade, greatly increasing cutting quality and long life.

Our four large lines of Guaranteed Hand Tools for Carpenters, Machinists, Tinsmiths and Electricians are sold by practically all leading dealers in the United States and Canada, or can be ordered by them from any hardware jobber. Insist on The MARK of the MAKER and accept no substitute.

Write today for our 165-page "Mechanics' Handy List." It contains 35 pages of valuable shop information and a catalog of over 200 tools. Sent free at your request.

The Peck, Stow & Wilcox Co.

MFRS. of the Largest Line of Mechanics' Hand Tools offered by Any Maker

Established 1819 Five Large Factories
Address Correspondence to 20 Murray St., New York City



Please Mention Popular Mechanics

The Greatest Work

ever published on Architecture, Carpentry, Contracting, Building and allied branches is the new 10 volume edition

Cyclopedia of Architecture, Carpentry and Building

Ten massive volumes; 4,670 7x10 inch pages; 3,000 full-page plates, detail drawings, plans, color plates and photos of buildings completed and in course of construction. Bound in half morocco leather and printed on special enameled paper in large, clear, readable type. Titles beautifully engraved and stamped in 23 carat gold.

No work so comprehensive, so authoritative, has ever before been placed on the market. This great work is a complete review of architecture, carpentry and building. Every problem likely to confront you in your daily work is solved and the solution placed before you in such a clear manner that you cannot fail to understand and profit by it.

If you have a building contract in hand, this Cyclopedia will show the most economical and practical method of handling the work and purchase of materials.

For the practical carpenter and student, its value as a Home Study instructor cannot be estimated.

Just examine the "Partial List of Contents" below and you will at once realize how broad is the scope of this work—how thoroughly it covers the building trades.

Read Our Liberal Offer

To prove our absolute confidence in the superiority of this work over all others, we make this liberal offer: Upon receipt of the coupon below we will place the entire cyclopedia of ten volumes in your home or office—you keep the books five days—examine them thoroughly, critically—subject every formula and problem to a severe test. If you are satisfied, send \$2.00 after examination and \$2.00 every month until you have paid the special \$34.00 price. The regular list price is \$50.00. As a further guarantee, we will remove the books at our expense if you are not satisfied. We pay all express charges.

PARTIAL LIST OF CONTENTS

Carpentry—Building—Estimating—Stair Building—The Steel Square—Building Superintendence—Contracts and Specifications—Building Law—Building Material—Roof Trusses—Masonry—Reinforced Concrete—Concrete Blocks—Steel Construction—Mill Building—Fireproof Construction—Cornices—Skylights—Roofing—Hardware—Plastering—Painting—Electric Wiring and Lighting—Heating—Ventilation—Steam Fitting—Plumbing—Architectural Drawing—Freehand and Perspective Drawing—Orders of Architecture.

For a short time we will include as a monthly supplement, for one year, the TECHNICAL WORLD MAGAZINE. This is a regular \$1.50 monthly, full of Twentieth Century Scientific facts, written in popular form. Also contains the latest discussions on timely topics in invention, discovery, industry, etc.

AMERICAN SCHOOL OF CORRESPONDENCE
CHICAGO, U. S. A.

FREE EXAMINATION COUPON

American School of Correspondence:

Please send set Cyclopedia of Architecture, Carpentry and Building for five days' free examination; also Technical World for 1 year. I will send \$2.00 within five days and \$2.00 a month until I have paid \$24.00 or notify you and hold the books subject to your order. Title not to pass until fully paid. Pop. Mechs. 2-'11

NAME.....

ADDRESS.....

OCCUPATION.....

EMPLOYER.....

Please Mention Popular Mechanics

Factory Supplies



Save money by buying your
**PULLEYS, SHAFTING, HANGERS
BELTING, GEARS
SPROCKET WHEELS, CHAIN BELT**
in fact anything in the line of appliances for transmitting Power, from us.

We are the largest Manufacturers of Pulleys in the United States.

No order too small for attention. No order too large to execute. Our catalogue A-18 shows our complete line.

W. A. Jones Foundry & Machine Co.

Mail Order Department

1400 North Avenue

CHICAGO, U. S. A.

That Frenchman who ascended in an aeroplane to the height of 9,121 ft. and froze his carburetor should be allowed to keep his altitude record unbroken. Frost bites achieved in high altitudes add nothing to the joy of the human race.—Chicago News.



Surprising Profits MADE IN MUSHROOMS

Anybody can add \$8 to \$40 weekly to their income all year growing mushrooms in cellars, sheds, barns, boxes, etc. Markets waiting for all you grow. Free Illustrated Instruction Booklet

HIRAM BARTON
Desk 2, 329 W. 48th St., New York

DITENTC

YOUR IDEAS MAY BRING
YOU A FORTUNE!

TALLETT

H. ELLIS CHANDLEE & CO.
55 Bornot Building, WASHINGTON, D. C.

See page 117



BE YOUR OWN BOSS

Make Money Easy

AGENTS wanted in every county to sell the popular Golden Rule Knives with name, address, photo, lodge emblems, etc., on handle. Agents earn \$75 to \$200 a month selling our shears, transparent handled pocket knives and razors. Big profits, quick sales. Exclusive territory. Experience unnecessary. **WE TEACH YOU NOW.**

Write to-day for terms and become one of our successful salesmen.



GOLDEN RULE CUTLERY CO., 362 Wendell St., Dept. 99, CHICAGO

NEW **S** YORK

It is the business of this organization to develop new American Industries and to extend such of those already well-established as need only additional capital to care for a business greater than that for which the enterprise was originally organized.

The Sterling Debenture Corporation is a medium through which the individual investor may participate in the profit and share in the ownership of American Industrial enterprises *upon the same proportionate basis as that enjoyed by every other owner*. The method employed permits neither the absorption of profits nor the manipulation of control at the hands of a financial syndicate.

Each enterprise is subjected to a thorough and exhaustive investigation. Where the industry is based upon inventions, the claims for such inventions must have been successfully demonstrated in *actual practice* and must be represented by U. S. patents in support of ownership. We present no enterprise to our clientele until we are satisfied that every possible safeguard is afforded the investor.

Such investment opportunities are not "speculations," except in the sense that every business venture is a business risk. They are legitimate investments for the man who desires to employ a part of his surplus in the up-building of American Industries; who realizes that "listed stocks" do not establish enterprises, and who is willing temporarily to forego such immediate returns as they offer, with the reasonable expectation of the much larger returns that reward the creators of new business values.

If you are interested, let us number you with those who are regularly receiving our offerings of this character. We employ no salesmen. The evidence for each case is presented to you through the U. S. mails. Write for pamphlet No. 356. And the next time you are in New York, we should like to have you visit these offices and acquaint yourself personally with this organization.

S STERLING DEBENTURE CORPORATION **S**
BRUNSWICK BUILDING, MADISON SQUARE, NEW YORK

FOUR BIG VOLUMES

4,670 Pages,
3,000 Illustrations,
Plates, Etc.



We mean it. We want you to examine this wonderful Cyclopaedia absolutely **free of charge** for five days. We will place the new

Cyclopaedia of Automobile Engineering

in your home or office, and it won't cost you one cent—not even express charges. And you are not placed under any obligation.

We have confidence in this work. It sells itself. It is the greatest set of books ever published on the great subject of automobile engineering. The fact that the books are compiled from the instruction books of the American School places them far above all others.

The operation and construction of every part of the automobile is taken up and explained thoroughly. Read the "Partial List of Contents" and you will at once realize how thoroughly these books cover the automobile field. In this cyclopaedia, we give you a most thorough course in automobile engineering. You must at least examine them—fill in and mail the coupon to-day.

The four volumes contain 1,500 pages, 7x10 inches in size; 1,200 illustrations, full-page plates, diagrams, etc.; handsomely bound in half morocco; titles stamped in 23-carat gold. Read our **free examination offer**.

Sent Free for Examination

To prove our absolute confidence in the superiority of this work over all others, we make this liberal offer: Upon receipt of the coupon below we will place the entire cyclopaedia of four volumes in your home or office—you keep the books five days—examine them thoroughly critically—subject every problem to a severe test. If you are satisfied, send \$2.00 after examination and \$2.00 every month until you have paid the special \$12.80 price. The regular list price is \$24.00. As a further guarantee, we will remove the books at our expense if you are not satisfied. We pay all express charges.

PARTIAL LIST OF CONTENTS

Automobile Operation; Driving, Care, Trouble, Breakdown, Repairs—Automobile Power Plants—Cooling and Oiling Systems—Ignition Systems—Buying a Motor Car—Gas, Electric and Steam Cars—Tires—Punctures—Accessories—Fuels—Care of Gas and Oil Engines—Electricity—Storage Batteries—Primary Batteries—Mercury Vapor Converters—Electric Motors—Steam Engines and Boilers—Indicators—Motor Boats—Aeroplanes—etc.

For a short time we will include, as a monthly supplement, for one year, the **TECHNICAL WORLD MAGAZINE**. This is a regular \$1.50 monthly, full of Twentieth Century Scientific facts, written in popular form. Also contains the latest discussions on timely topics in invention, discovery, industry, etc.

AMERICAN SCHOOL of CORRESPONDENCE
CHICAGO, U. S. A.

FREE EXAMINATION COUPON

American School of Correspondence, Chicago, U. S. A.

Please send set Cyclopaedia of Automobile Engineering for five days free examination. Also Technical World for 1 year. I will send \$2 within five days and \$2 a month until I have paid \$12.80, or notify you and hold the books subject to your order. Title not to pass until fully paid.
Pop. Mech. 2-11

NAME

ADDRESS

OCCUPATION

REFERENCES

For Farm, Shop and Home

Its success a world beater. Gives more power gallon for gallon. Fuel expense astonishingly low. Runs perfectly on kerosene, gasoline, distillate, any fuel oil. Hundred less parts. Patent throttle gives three engines for the price of one **Catalog free—tells how.** Force feed lubricator—perfect oiling. Double duty tank revolutionizes cooling systems. Automobile muffler. Ball bearing governor. Starts instantly, no pre-heating, no crank.

We Pay the Freight

Challenges the World

on adaptability to any power purpose. Experience unnecessary. Women can operate. Mounted on skids or trucks. Easily portable. Vibration eliminated. Comes complete, tested, ready to run. Quality high, price low.

FREE TRIAL

No obligation till you are satisfied. **10-year guarantee.** "Engine Facts," our new catalog, free; write postal for it now.

ELLIS ENGINE CO.
39 Mullett St.
DETROIT, MICH.

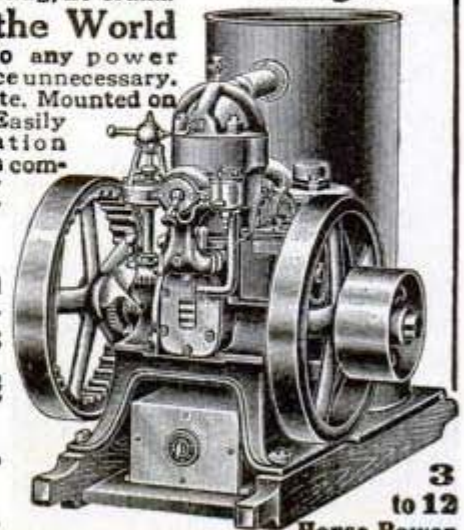

3 to 12 Horse Power

BARBERING AN OLD TRADE—Barbering is one of the oldest journeyman trades in the world. There have been barbers almost as long as men—which is not saying barbers are inhuman. Some of the oldest folks in the Bible seem to have been razored and shorn. First barbers were errant, nomadic or itinerant, as they are now, in old Egypt, where barbers were first born. Along the Nile today he wanders with his kit of tools hunting customer, and he squats them on the sand and goes to work.—St. Louis Globe-Democrat.

Ann Arbor's 3 Room Lighting System for \$14.50



Ann Arbor Lighting Systems are brighter than gas, steadier and clearer than electric light, and cost about one-tenth as much to operate. Each lamp gives 300 to 500 candle power for less than 1/2 cent per hour. Fuel is gasoline; perfectly safe.

We make Complete Lighting System for Homes, Churches, Stores, Etc.

Price \$10 up, according to number of lamps desired. We make inverted arcs especially adapted for use in stores, halls, factories, etc.

We Want Agents who will push our line. Special terms to those who write early. Catalog and prices on request.

SUPERIOR MFG. CO.
294 Second St., Ann Arbor, Mich.

Please Mention Popular Mechanics

Take Your Oliver Typewriter —Pay Seventeen Cents a Day!

Send Coupon or Letter for Details

A message of vital moment to the vast audience reached by this magazine.

We are selling the Oliver Typewriter—the Standard Visible Writer—the New Model No. 5—the regular \$100 machine—for Seventeen Cents a Day! Whether you sit in the councils of great corporations or are perched on a bookkeeper's high stool—whatever your part in the world's activities—this offer of the Oliver Typewriter means something worth while to you.

Mightiest Machine in World's Workshop

The terrific pace of modern business demands mechanical aids of the highest degree of efficiency. Foremost among all the inventions that speed the day's work—that take the tension from men and transfer it to machines—is the Oliver Typewriter.

The Oliver Typewriter is the mightiest machine in the World's Workshop. It weaves the million threads of the world's daily transactions into the very fabric of business. It works with the smooth precision of an automatic machine. It adapts itself to the diversified needs of ten thousand business conditions.

The OLIVER Typewriter

The Standard Visible Writer

The basic idea upon which its towering supremacy rests is its wonderful Double Type-Bar. What the Selden Patent is to the automobile, this principle is to the typewriter, only we do not license its use on any other writing machine.

The Double Type-Bar gives the Oliver Typewriter its positive DOWNWARD STROKE, the secret of perfect printing, light touch, easy operation and perfect alignment.

Yours for Pennies! Send the Coupon

Having simplified the typewriter to the utmost, we have now simplified its purchase until you can own it for the trifling sum of Seventeen Cents a Day.

A small cash payment brings you the magnificent new model Oliver No. 5. Then you save Seventeen Cents a Day and pay monthly until the machine is yours.

No matter what typewriter you are using, you can turn it in as first payment on the Oliver and let pennies complete the purchase.

Send coupon or letter for the handsome Catalog and full details of the popular Penny Plan. (66)

Sales Department **The Oliver Typewriter Company**
618 Oliver Typewriter Bldg. CHICAGO, ILL.

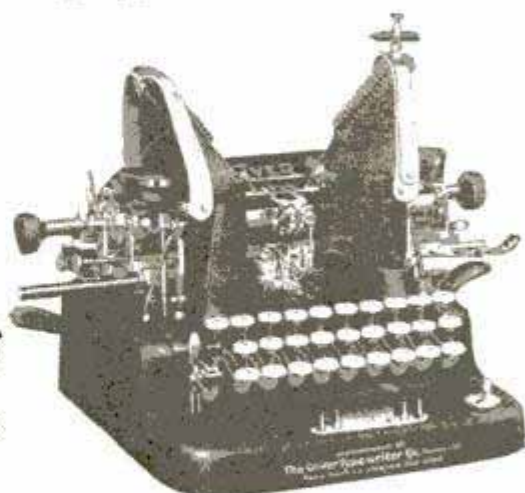

Brilliant Exclusive Features

The Oliver is illuminated by scores of brilliant innovations not found on other typewriters. Its remarkable time-saving devices and conveniences include the Vertical and Horizontal Line Ruler, the Disappearing Indicator, the Tabulator, the Back-Spacer, the Adjustable Paper Feed, the Double Release, the Automatic Spacer, the Locomotive Base.

Time and again, when our existing models met every demand of the public, we have brought out important improvements at great expense, without adding a cent to the price.

100% Efficiency

The Oliver Typewriter has an efficiency of 100 per cent, every day in the week and from one year's end to the other.

Its printing mechanism works freely in a framework of solid steel, which gives wonderful stability and the limit of durability.

It operates with the lightest touch and thus prevents fatigue. The swiftest operator cannot overtake the speed of an Oliver Typewriter. It writes in beautiful, readable type and, of course, it writes in sight.

Every office, whether equipped with one Oliver Typewriter or a battery of Oliviers, secures the very maximum of typewriter service at the minimum of cost and labor.

The simplicity, strength and easy operation of the Oliver Typewriter makes it most desirable for use in the home.

COUPON

The Oliver Typewriter Company
618 Oliver Typewriter Bldg., Chicago
Gentlemen:—Please send your Art Catalog and details of "17-Cents-a-Day" offer on the Oliver Typewriter.

Name.....

Address.....



Your Glove For Work or Sport

Hansen, of Milwaukee, makes a glove, gauntlet or mitten to fit every man's individual needs. Hansen's not only fit the hand but fit the work in hand.

Many men look upon gloves as a necessary evil—necessary for protection—evil because they encumber the hand.

Men who wear Hansen's know that gloves can be all comfort—afford perfect protection without being the least hindrance in their work or sport.

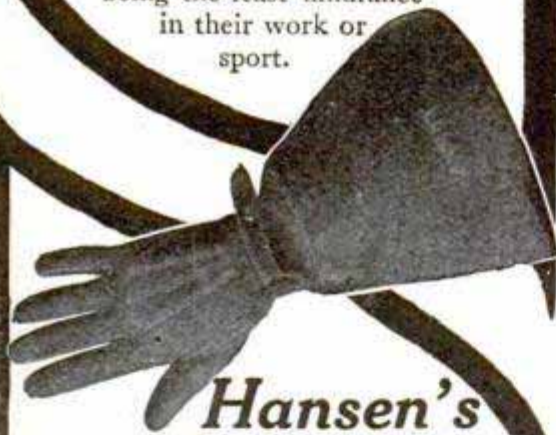

Hansen's

"Built Like a Hand"
warranted never to harden, shrink, shrivel, crack or peel, no matter how often soaked, dried or cleaned.

Made in hundreds of styles for the electrical worker, structural iron worker, teamster, automobilist, locomotive fireman, horseman, hunter, engineer, miner, in short, all classes of workers.

Write today for particulars about the right glove for YOUR purpose, and tell us what your work is or for what purpose you want hand protection. Learn the big value you get in a Hansen.

Ask your dealer to show you the line. We will supply you if he doesn't. Write for catalog anyway.

O. C. Hansen Mfg. Co.
291 Milwaukee Street
Milwaukee, Wis.



Motor Boating

is not a pleasure when it is complicated with engine trouble. If you have had an unsatisfactory motor don't spoil another season with it. Or if you are buying your first outfit start right. Don't buy a motor just because it is cheap. You are sure to regret it. The purchase of a

Scripps Motor

means that fullness of enjoyment which can only come when you have that supreme confidence in your motor which enables you to sit back and enjoy life without having to worry about your motive power.

After you have run a Scripps motor about two weeks you acquire that confidence. You become so proud of it that you want to make bets with your friends that it will start on the spark or run all day without missing or that you can check it down lower than your neighbor can his.

We have been publishing a number of photographs and letters from customers with the object of showing what a source of satisfaction our motors are to their owners. Mr. Schoonhoven, a picture of whose boat appears herewith has owned two Scripps motors starting with a two cylinder and later buying the four cylinder now in his boat.

We want you to know all about the technical details of this high grade motor and will be glad to send you our handsome new catalogue on request.

SCRIPPS MOTOR CO.
650 Lincoln Ave., Detroit, Mich.

Riding in an aeroplane seems to be somewhat more dangerous than handling a gun that isn't loaded, but safer than playing football under the new rules.—Springfield (Mo.) Republican.

This \$18 Table (36x22") \$7.25



This splendid piece of the famous **COME-PACKT** Furniture (Quarter Sawn White Oak) shipped in sections, any finish, for \$7.25. Money back any time you say so.

**SECTIONAL
COME-PACKT
FURNITURE**

Order today for prompt shipment or write for free catalog of 200 other bargains in Mission and Bungalow Furniture, direct from our factory to you.

COME-PACKT FURNITURE CO., 201 Edwin St., ANN ARBOR, MICH.

DON'T PAY TWO PRICES FOR YOUR MARINE ENGINE

\$40 2 Horse Power
**COMPLETE
ENGINE**

Powerful Engine for High Speed Boats. Used in Government Harbor Service and Chicago Police boats. High speed, absolute reliability. Extra power and extra wear. Low running cost. So simple in construction and operation a woman or child can run it. The perfect two-cycle engine; 2 to 10 H. P.; 2 year guarantee. Special prices to boat builders and agents. Our engine book No. 12 E contains valuable facts about Marine Engines that everybody interested should know. Also illustrates and describes our complete line of marine engines. Free on request.

NORTHWESTERN STEEL & IRON WORKS, 707 Spring St., Eau Claire, Wis.



**SPEEDY
STRONG
SIMPLE
SILENT**

We never had a chance like this to furnish our home



The Old Folks Never Had Your Chance to own the things that go to make life worth living. Possibly you can remember how your mother had to skimp and save to get the money for the new parlor carpet—how she dearly longed for that beautiful bookcase that she had so set her heart on—but possibly never could afford. The purchase of a dining-room table, the parlor lamp, the piano or sewing machine, was a big event in her life. How many sacrifices she had to make to make home more cheerful, to brighten it up and make it attractive as the young folks grew older and began to have company. In your father's and mother's time, the Spiegel, May, Stern Co. was in its infancy; today this same concern—with its combined capital of \$7,000,000—with its 600,000 satisfied customers—with its mail order buildings alone covering over six acres of ground—with its 27 mammoth retail stores, stretching like a great chain across the continent—stands without a rival in its field—head and shoulders above all competitors.

We Trust Anybody, Anywhere, for Anything

WE SELL ON CREDIT EVERYWHERE—wherever there breathes the love of home in village, town and city. We sell everything for the home—furniture, carpets, rugs, refrigerators, baby carriages, sewing machines, or pianos. 3,000 tremendous bargains on credit at lower prices than ever were quoted for cash. You can have these home comforts now and begin at once to enjoy them. No need to wait for the money, simply pay as you can—we charge no interest and ask no security. There are no collectors to annoy. Our dealings are confidential—no burden, no hardship, no drain on the pocket book. We take absolutely all the risk. We only want the chance to prove to you that we can sell on credit at a lower price than you can buy anywhere else for cash.

30 Days' Free Trial

Our plan of sale binds you to nothing. Whatever you select can be used for one month before you decide to buy it. Every article is sent on approval. You not only see it, but use it. Think of the advantage of having the new stove, the couch, the rug or the bed, for a whole month's free use, while you decide whether or not you want to buy them. No one to bother you, no one trying to sell them to you, no hurried examination in a crowded store while an impatient clerk waits for your order, no tiresome shopping or snap judgment—but in the quiet of your own home with your family and friends to consult, you can make up your mind by actual test and use. If the article for any reason is unsatisfactory simply send it back. Compare the price anywhere you please and if ours is not 20 to 50 per cent lower, don't keep the articles at all. You are under no obligation—the month's use will not cost you one penny—we leave the whole thing in your hands.

Cash Factory Prices on Credit

We guarantee on every article a saving of 20 per cent to 50 per cent. This means that we undersell mail order houses selling for cash—your local stores cannot be compared at all, because they are enormously high. Our tremendous buying power gives us the control of the world's markets in our line. We buy the entire output of scores of factories, and by doing this, we are practically able to dictate our own prices and fix our own costs. It would bankrupt any lesser concern to even attempt to meet our prices, and our cast iron guarantee stands back of every claim we make.

References. The name Spiegel, May Stern Co. has become a household word. But for the benefit of those people who are not acquainted with us, we give as references the following:

National Bank of the Republic, Chicago; National City Bank of New York; First National Bank, Kansas City; National Bank of Commerce, St. Louis, and Atlas National Bank, Cincinnati.

Best of all, ask any of our 600,000 customers.

Spiegel, May, Stern Co.

(68) 1278 35th Street, Chicago, Ill.

FREE

NEW \$17,000 BOOK

SEND NO MONEY — NO STAMPS. Simply mail us the coupon printed below. We will then mail you our great big portfolio fresh from the presses, picturing over 3,000 bargains for the home. This book is something more than a mere catalog. It is full to the brim of ideas and suggestions that any housewife will appreciate—economies in buying and arrangement—pictured true to life; numerous full page illustrations in twelve colors.

We have a separate book showing seventy styles of stoves and ranges from 89c up. If you want this stove book also, let us know.

Cut Out This Coupon

Spiegel, May, Stern Co.

1278 35th Street, Chicago

Mail me Free of Cost your new Spring House-furnishings Book.

Mail me your stove book.

Name _____

Post Office _____

State _____

SPECIAL OFFER — FREE SEARCH OF PATENT OFFICE RECORDS

Send us a model, photograph or sketch and description of your invention, and we will make a *Free Search* of the *Patent Office Records* to ascertain if it is patentable. If we report the invention patentable, we will guarantee to obtain a patent or return our fee, and furnish a certificate of patentability backed by a bonded contract to that effect.

This Certificate of Patentability will protect the inventor and serve as proof of the invention until the case can be filed in the U. S. Patent Office.

OBTAINING ASSISTANCE FOR INVENTORS

Our certificate is of great assistance to inventors who require financial aid to obtain patents. It is useless to attempt to interest capital unless evidence is furnished that the invention is patentable. Our certificate gives this necessary assurance.

OUR FOUR BOOKS MAILED FREE

to any address. Send for these books—the finest publications ever issued for free distribution.

HOW TO OBTAIN A PATENT

Our illustrated eighty-page Guide Book is an invaluable book of reference for inventors, and contains 100 mechanical movements illustrated and described.

FORTUNES IN PATENTS

Tells how to invent for profit, and gives history of successful inventions.

WHAT TO INVENT

Contains a valuable **LIST OF INVENTIONS WANTED** and suggestions concerning profitable fields of invention; also information regarding prizes offered for inventions, among which is

PRIZE OF ONE MILLION DOLLARS

offered for one invention, and \$10,000 for others.

PATENTS THAT PAY

Contains fac-similes of unsolicited letters from our clients who have built up profitable enterprises founded upon patents procured by us; also indorsements from prominent inventors, manufacturers, Senators, Congressmen, Governors, etc.

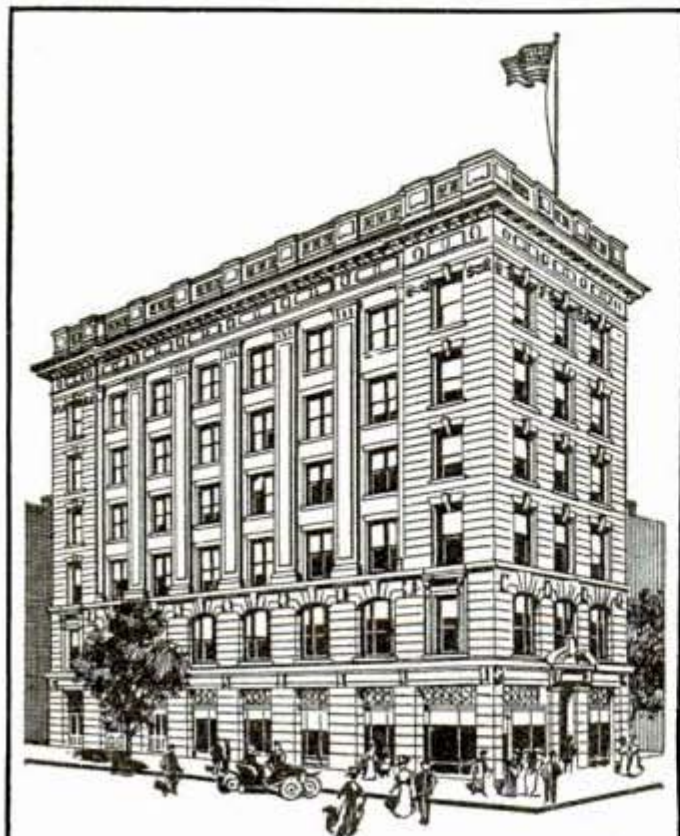

VICTOR BUILDING

Our new \$150,000 building, opposite the U. S. Patent Office, specially erected by us for our own use, designed and equipped with all modern appliances for our patent business.

WE ADVERTISE OUR CLIENTS' INVENTIONS FREE

in a list of Sunday newspapers with two million circulation, in manufacturers' journals and in the *World's Progress*. Sample Copy Free. We also send a **LIST OF PATENT BUYERS**. We not only save you time and money in securing patents, but obtain patents which **PROTECT** the invention and **PAY**. After the patent is granted we assist you **TO SELL YOUR PATENT**.

FOREIGN PATENTS

WE HAVE DIRECT AGENCIES IN ALL THE PRINCIPAL FOREIGN COUNTRIES and can secure **FOREIGN PATENTS** in the shortest possible **TIME** and at the **LOWEST COST**. We **GUARANTEE TO SECURE THE FOREIGN PATENTS OR RETURN OUR FEES**. Write for our Illustrated Guide Book on Foreign Patents, sent free to any address.

REFERENCES:

Second National Bank, Washington, D. C.
R. G. Dun & Co., Washington, D. C.
National Savings and Trust Co., Washington, D. C.
Smethport Glass Co., Smethport, Pa.
Schrade Cutlery Co., Walden, N. Y.
Clum & Atkinson, Brass Founders, Rochester, N. Y.
Rochester Rotary Pump Co., Rochester, N. Y.
Lawrence Mills, Mfrs. Bed Spreads, 51 Brooke Ave., Englewood, N. J.
The Melvin Gauge and Signal Inst. Co., Scranton, Pa.
Damon Mfg. Co., Mfrs. "Missing Link" Flour Mill Disintegrators, Bowling Green, Ky.
Modern Canner Co., Mfrs. Canning Machinery and Cannery Supplies, Bridgeport, Ala.
M. Winter Lumber Co., Sheboygan, Wis.

C. K. Lassiter, Mechanical Engineer, Schenectady, N. Y.
Pitner Gasoline Lighting Co., Chicago, Ill.
Sprout, Wardon & Co., Mfrs. of the Monarch Feed Governor, Muncy, Pa.
The L. B. Dozier Co., Mfrs. of Plumbing, Heating and Machinery Supplies, Columbia, S. C.
B. B. Earnshaw & Bro., Mfrs. "Cream Blend" Flour, Washington, D. C.
A. L. Schultz, Consulting Engineer, Pittsburgh, Pa.
Arthur H. Swan & Co., Mfrs. of Peel-Blade Tips, 279 Warren St., Roxbury, Pa.
The H. W. Moore Piano Truck Co., Anderson, Ind.
The Culver Novelty Co., Mfrs. of Carbureters and Mixers, Culver, Ind.

VICTOR J. EVANS & CO., VICTOR BUILDING
(Formerly EVANS, WILKENS & CO.) 724-726 9th St., N. W.

Opposite United States Patent Office

WASHINGTON, D. C.



PATENTS



NEW YORK OFFICE, 359 BROADWAY

FOR SIXTY-FIVE YEARS the firm of MUNN & CO. has conducted the largest patent practice in the country. We file thousands of applications for patents every year. Our system is so perfected that every case receives the best of attention and is prepared by experts who have had special training in handling every class of invention.

¶ **SEND SKETCH.** If you will send us a sketch, no matter how crude, we will give you a fair and candid opinion as to whether it is probable a patent can be obtained. All matters of this kind are strictly confidential and the description and sketches will be dated and placed in our secret archives for future reference. This service and our Hand Book on Patents are free if you will write us at once.

¶ **QUALITY.** The quality of our work has given us an unrivalled reputation among Patent attorneys and we are the recognized American attorneys for many leading Foreign Patent Solicitors. Our staff consists largely of Examiners from the United States Patent Office, who are therefore familiar with the latest procedure and the best practice. Our draftsmen are all expert mechanical constructors who are able to show the invention in operative form.

¶ **FREE NOTICE.** All patents secured through our house receive a free notice in the **SCIENTIFIC AMERICAN**. No better or more economical method of introducing your invention to the attention of the public could be devised.

¶ **OUR OFFICES.** Our Washington office is located in our own building, near the Patent Office. This permits of our attorneys making special oral arguments with the Patent Office Examiners—an advantage not enjoyed by local attorneys.

¶ We are prepared to conduct Interference Proceedings, Infringement Suits, give Validity Opinions, draw up contracts and attend to all branches of legal work connected with Patents, Trade Marks, etc.

¶ We do not offer prizes or other specious inducements, but rely upon our recognized reputation of over half a century. Our fees are as low as is consistent with good work.

MUNN & CO., Attorneys

359 Broadway, New York, N. Y.

WASHINGTON OFFICE
625 F Street, N. W.
Washington, D. C.



"My Trade-Mark"

Special Offer:

Mr. Inventor: I invite you to come to see me, and bring, or send (by registered mail), sketches or photograph or model and description of your idea or invention for FREE examination of U. S. PATENT OFFICE Records and report as to patentability of the same;—to find out as to whether you are entitled to a patent will not cost anything;—then, if your invention is new, upon receiving instructions, I will prepare ALL necessary (application) papers.

DO THIS AND SAVE TIME AND MONEY!

WRITE NOW!

Highest References:

Lincoln National Bank,
Washington, D. C.

NOTE: When writing these clients send two-cent stamp for reply.

Little Giant Hay Press Co.,
Alma, Mich. and
Dallas, Texas.

Gray Lithograph Co.,
New York City, N. Y.

Farmers Mfg. Co.,
Norfolk, Va.

New Era Mfg. Co.,
Fairfield, Iowa.

Bernhard Furst,
Vienna,
I. Austria-Hungary.
Otto von Rottenburg,
Schwindstrasse 20,
Frankfort a. M.
Germany.

H. A. Fonseca,
Rua Dos Ourives 20,
Sobrado, Rio de Janeiro,
Brazil, S. A.

A. J. Corsi,
Irish Town,
Gibraltar.

Bell Show Print Co.,
Sigourney, Ia.

The Camp Conduit Co.,
Cleveland, O.

The Iowa Mfg. Co.,
Oskaloosa, Ia.

Sam'l Allen & Son Mfg. Co.,
Dansville, N. Y.

The Garl Electric Co.,
Akron, O.

Superior Mfg. Co.,
Sidney, O.

Tidnam Tel. Pole Co.,
Oklahoma City, Okla.

Edw. H. Smith,
Aberdeen, Wash.

C. O. Cracroft,
Cordova, Alaska.

V. C. de Ybarrondo,
Los Angeles, Cal.

Wm. H. Garlock,
Leland Hotel,
Seattle, Wash.

F. Rutherford,
Copper Queen Con. Min. Co.
Douglas, Arizona.

Gas Range & Heater Co.,
S. Pasadena, Cal.

Newberg Brick & Tile Co.,
Portland, Ore.

INFRINGEMENT, VALIDITY AND INTERFERENCE WORK SOLICITED

I am admitted to practice before the United States Supreme Court and all others

"I want to thank you for the most excellent services you have rendered me in this suit *IB. Williams vs. Central Drug Co., U. S. C. C., Northern District of Illinois—E. Div.*, and assure you that I appreciate it very much, and if at any time I can secure some business for you, I will be only too glad to do so."
September 19, 1910.

(Signed) J. THOMPSON, Mgr. Central Drug Co., Sioux City, Iowa.

FREE: Two Books—61-page "Inventor's Guide" and 64-page "Proof of Fortunes in Patents—What and How to Invent"

Foreign Patents a Specialty

If you have a U. S. application write me for excellent literature and terms for promoting your Foreign Patents. Liberal discounts.

I Advertise My Clients' Patents Free

in a publication having over 2,000,000 circulation. Write for Special Offer. Successful clients in every section of the U. S.



My Office and the Patent Office
(I give you proof of my location)

Across the street from the U. S. Patent Office

Expert—Prompt Services

E. E. VROOMAN, Registered Patent Attorney. Patent Litigation Wash., D. C.

High-Class Work—Excellent Testimonials

871 F Street, N. W.

\$205,340.00 \$

MADE BY MY CLIENTS

YOU Should Have My FREE BOOK

Telling HOW OTHERS will do the same IN THE FUTURE. "WHAT and HOW to INVENT" BOOK FREE!

"I received ONE HUNDRED DOLLARS (\$100.00) down (in re my Can Righting Machine inventions) and in thirty days NINE HUNDRED DOLLARS (\$900.00), and when my patents are issued ONE THOUSAND DOLLARS (\$1000.00) more. I can conscientiously state to my fellow inventor that he will do the right thing by placing his patent business in Mr. Vrooman's hands for the best iron-clad patents."
(Signed) WILLIAM C. BRIDGES, Wapello, Iowa.



MR. H. ELLIS CHANDLEE

PATENT WHAT YOU INVENT! PATENT

YOUR IDEAS MAY BRING YOU A FORTUNE

There is A Constant Demand For Good Inventions.

One of our clients recently made \$85,000; another \$7,000; another \$5,000; another \$3,400; two others \$1,000 each, and two others \$500.

WRITE FOR

"OPPORTUNITY"

A List of Needed Inventions

Also, "U. S. LETTERS PATENT," telling how to obtain a patent.
"THOUGHTS THAT HAVE PAID," a history of successful inventions.
"TESTIMONY," giving our testimonial letters from manufacturers and inventors.

Mailed free to any interested person

IF YOU HAVE AN INVENTION send us a rough sketch and description, model or photograph of it, and we will give you our opinion as to its patentability **WITHOUT CHARGE**. If our opinion is favorable, we will issue a contract binding us to **refund every cent of our fee if we fail to obtain a patent.**

This assures you that we will not make application unless the chances of success are good, and that **every effort** will be made to obtain an allowance. We advertise the patents of Our Clients for sale in prominent dailies free of charge.

"Prompt and Proper Service"

H. Ellis Chandlee & Co.

(Successors to Woodward & Chandlee)

Suite 55, Bornot Building, WASHINGTON, D. C.

Advice free. Terms reasonable. Highest references. Best results.
 Send sketch or model for FREE examination and opinion.
Recommended Patent Lawyer in the Bankers' Register and special list of selected lawyers.
 Also in Martindale's Law Directory, Sharp and Alleman's Directory of Lawyers, The
 Gast-Paul Directory of Lawyers, and Kime's International Law Directory.

ALL BUSINESS GIVEN PROMPT AND PROPER ATTENTION

A large list of strong recommendations furnished free

WATSON E. COLEMAN, Patent Lawyer, 622 F St., N.W., Washington, D.C.

WANTED-IDEAS

The demand for good, patentable ideas is greater than ever before. Am constantly in receipt of letters from parties desiring to buy patents procured through me. Electrical devices, tools of all kinds, advertising novelties, agents' supplies, mail order articles, and many other inventions are sought after. Protect your idea! Write for "Stepping Stones" (containing over 200 new inventions wanted) and new guide book "Successful Patents."

Clients' patents sold free. My personal services. Highest references.

RICHARD B. OWEN

Department 9 WASHINGTON, D. C.

CAPITALIZE YOUR BRAINS

LANGDON MOORE

Counselor-at-Law and Patent Attorney

**Patents, Trade-Marks
 Designs and Copyrights**

9th and F Streets, WASHINGTON, D. C.

Formerly Examiner U. S. Patent Office

SEND FOR BOOKLET

**PATENT SECURED OR
 FEE RETURNED**

Free expert search of official records. Send for free handbook.

MILO B. STEVENS & CO., Attorneys

ESTABLISHED 1864

854-14th St., WASHINGTON D. C. 370 Monadnock Bldg., CHICAGO

Guaranteed and recommended by the Bankers' Register. Highest rating by Martindale's American Law Directory.

PATENTS

C. L. PARKER
 Ex-Examiner U. S. Patent Office
PATENT LAWYER
 210 MCGILL BLDG.
 WASHINGTON, D. C.

Patents, Trade Marks, Copyrights, Patent Litigation

Handbook for Inventors, "Protecting, Exploiting and Selling Inventions" sent free upon request.



PATENT YOUR IDEAS

\$100,000 for one invention; another \$8,500. Book "How to Obtain a Patent" and "What to Invent" sent free. Send rough sketch for free report as to patentability. We advertise your patent for sale at our expense.

PATENT OBTAINED OR FEE RETURNED.

CHANDLEE & CHANDLEE, Patent Atty's

1032 F. Street WASHINGTON, D. C.

PATENTS: For facts about Prize and Reward offers and Inventions that will bring from \$5000 to 10 Million Dollars; and for books of Intense Interest to Inventors, send 8c postage to **R. S. & A. B. LACEY, Div. 45 Washington, D. C. Estab. 1869**

A Patent of Quality

is the only kind that will protect your invention and make it salable. You need my free advisory information. Send for it.

GEO. R. HAMLIN, Patent Lawyer

801-8th Street, N. W. WASHINGTON, D. C.

AN OPPORTUNITY FOR INVENTORS.

Editor Popular Mechanics:

In your November issue you very accurately describe the present modern method of picking cranberries,

PATENTS

NEW AND EASY PLAN OF MAKING PAYMENTS

Valuable Book Free Illustrates and describes 100 Mechanical Movements, and contains useful Information for Inventors. MAILED FREE.

CHAS. E. BROCK, Patent Attorney

(Twenty-five years' experience)

918 F. STREET WASHINGTON, D. C.



**DON'T DISCARD
 BROKEN PARTS**

Have them welded together by the **Oxy-Acetylene Process.** Steel, Cast Iron, Bronze, Copper, Aluminum and all other metals can be welded. Manufacturing quoted on. Welding equipments for repair shops or large plants supplied.

DAVIS BOURNONVILLE CO.
 105 West Street NEW YORK, N. Y.

Do You Need A Gear



of any description for any purpose? We carry practically all the standard sizes in stock ready for immediate shipment.

We make gears of any style, size or material to order—promptly.

Our new free catalogue contains tables and rules for figuring both spur and bevel gears.

Grant's "Treatise on GEARS"—Price \$1.00 is a valuable reference book for the student and designer.

Philadelphia GEAR Works, Inc.
 1120 Vine Street GEO. B. GRANT, PRES. Philadelphia, Pa.

"IDEAL" LAWNMOWER GRINDER

"You Grind It As You Find It."

1911 Model now ready. Better than ever before. Ball-bearing Main Shaft and Grinding Wheel. Grinds all makes of Mowers perfectly in 15 minutes, without removing ratchets or wheels. Over 5,000 in use.

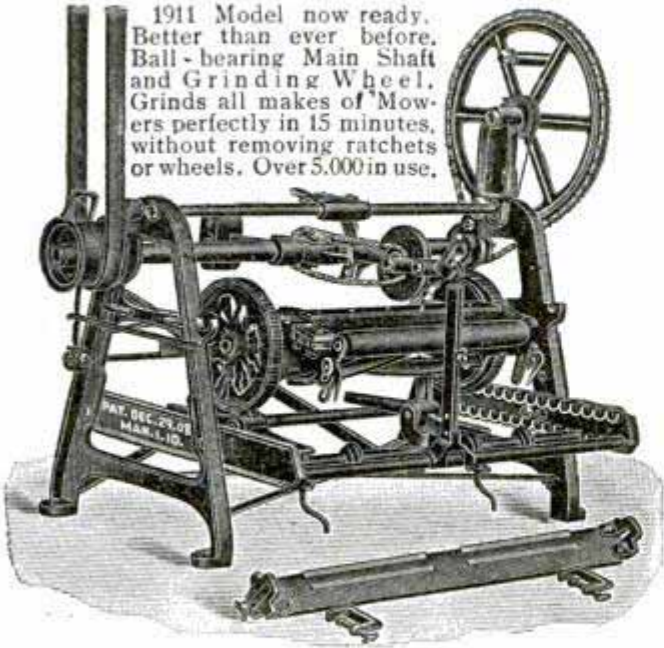

Write Today for full information of this wonderful labor-saver and money-maker. No up-to-date shop complete without it. Will more than pay for itself the first season because it does the work so much quicker and better. **Special Terms to Early Buyers.** Don't delay!

HEATH FDY. & MFG. CO., PLYMOUTH, O.

LET THE RED DEVIL WATER MOTOR DO YOUR WORK

6 inch Motor Improved construction, absolutely perfect, runs your washing machine and a hundred other things. Power for small tools. $\frac{1}{2}$ horse power on $\frac{1}{2}$ -inch pipe, 80 pounds pressure; 1 horse power on 2-inch pipe, 60 pounds pressure. New net price, \$5.00 cash with order.

No. 1492 4-inch Motors for grinding, polishing and buffing. Runs sewing machines, fans, bottle washers, etc. Price with emery, buffing wheel, silver polish and pulley, \$3.00. No. 1493 Motor and pulley only, \$2.50. $\frac{1}{2}$ -horse power on 80 pounds pressure. Improved construction. Speeds, 3,000 to 5,000 revolutions per minute. Only scientifically and mechanically perfect small water motor manufactured. Patented construction makes it possible. Tremendous output warrants the price. Money back for any reason.



6-Inch Bucket Wheel

CATALOGUE AND LARGE SHEET FREE

DIVINE WATER MOTOR CO.

Dept. T Utica, New York, U. S. A.

For the name of your local hardware or tool dealer, we will send you free booklet on "Theory and Design of Water Motors."

with good illustrations especially of what we know as scoops.

The total production of cranberries now is around 600,000 barrels per year, and a vast amount of money

Let Us Do Your Manufacturing

Buying material in large quantities and having a modern factory equipped with the latest machinery enable us to make almost anything in metal or wood at a very low price. Estimates free. We have a complete model and pattern department.

TINLEY PARK MFG. CO., 14 State Street, CHICAGO

PATENTED



INTERIOR VIEW

BLOWERS VACUUM PUMPS

Take up their own wear. No springs. Noiseless. Can't get out of order.

LEIMAN BROS. 62 P-JOHN ST. NEW YORK

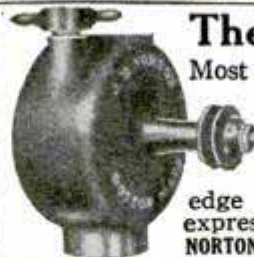

The Norton "Standard" Water Motor of $\frac{1}{8}$ H. P.

Most satisfactory power for experimenting purposes, or running light machinery. Perfect in construction; made entirely of brass; runs at a very high speed without vibration. Equipped with pulley and beveled edge grinding wheel. Sent **\$5.00** express paid on receipt of **NORTON WATER MOTOR CO., Inc., ROSLINDALE, MASS.**

Rife Automatic Hydraulic Ram Pumps water by water power. No attention; no expense; 2 feet fall elevates water 50 feet, etc. Guaranteed. Catalogue free. **RIFE RAM COMPANY, 2131 Trinity Building, NEW YORK CITY**



Crescent Band Saws

are more popular than ever because they last longer and do better work than some others costing more money. You get the best when you buy a CRESCENT.

SEND FOR CATALOG OF

Band Saws Jointers Planers
Saw Tables Shapers Disk Grinders
Swing Saws Borers Band Saw Blades
Planers and Matchers Variety Wood Workers

THE CRESCENT MACHINE COMPANY

93 Columbia St., Leetonia, Ohio, U. S. A.

INVENTORS Our Brain Belongs to You. Our Ideas Are Free of Charge.

All we want in return is to build your model, special machinery, dies, tools and jigs to manufacture sheet metal goods, etc. We are expert mechanics, over thirty years experience and have one of the best equipped shops in the country. Ask for Booklet No. 17. Consultation free. Experimental work strictly confidential.

A. NACKE & SON

236-242 S. 9th St., Philadelphia, Pa.

LATHES

9 to 13-inch Swing

List price \$75 and up according to size. When ready to buy send for Lathe Catalog and prices.

W. F. & John Barnes Co.

100 Ruby Street, ROCKFORD ILL.,

Screw Cutting Lathes

Foot or Power, 9 to 13-inch swing. Out shows 11-inch lathe, takes 34 inches between centers, complete with foot power or countershaft.

Price, \$100.00

Write for catalog showing price of all sizes.

SOUTH BEND MACHINE TOOL CO., 423 Madison St., South Bend, Ind.



Active Powers of Inventive Genius

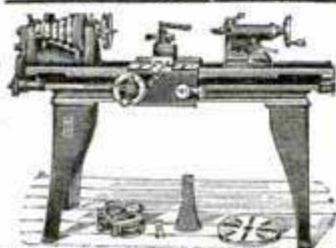
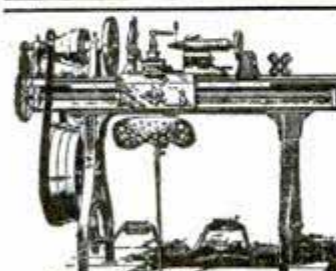

Make Cement Pipe



Are you looking for a good profitable business that you can carry on as a side line, without a big investment?

Look at This:

24" vitrified clay pipe costs \$1.25 per foot, or more. The best 24" cement pipe can be made for 35c—85c profit per foot. Other sizes show equal profits. You pay back the investment in machinery in one day. Many miles of sewer and irrigation pipe and drain tile laid last season—Double the amount will be used this year.

Start now and be in line for Spring business

Over 2000 started last year making cement pipe, brick, sidewalk tile and Miracle Double Air Space Blocks, the only block with which protection is given to the manufacturer, without charge. Small investment only required, and No Previous Experience.

Write now for our big catalog, 128 pages on concrete and concrete machinery, with 500 illustrations. Sent for 24c.



MARSH CO.

957 Old Colony Bldg., CHICAGO

YOU CAN MAKE BIG MONEY IN CONCRETE

This FREE BOOK Tells How

You can start with little capital and build a big business. Experience not required. This book covers all phases of this profitable business, tells what articles pay best and how made. Thousands are making immense returns. This book tells how they do it—it tells how you will

Earn \$10. to \$50. Daily With a HELM PRESS

A wonderful patented invention—makes concrete with 80,000 pounds pressure—automatic—rapid—no tamping—easy work. The strongest, simplest and most economical machine made. Makes perfect DRY WALL blocks and brick—salable everywhere. Must be used now in place of wood, clay and stone. SEND FOR THIS FREE BOOK TODAY. Don't make any investment until you get it. Learn the details of this business and all about the HELM SYSTEM of DRY WALL brick and block construction. This is your big opportunity. Write today. Do it now QUEEN CITY BRICK MACHINE CO., 322 Bank Bldg., TRAVERSE CITY, MICH.



Hand Drills



One of the very popular tools now used by both artisans and amateurs is the Hand Drill. No set of tools is complete without one. They are as convenient about the workshop or home as a hammer. We make them in a variety of sizes and styles. All are shown in our pocket catalog, a copy of which will be sent to you if asked for.

MILLERS FALLS CO., 28 Warren Street, NEW YORK

YOU'LL WANT MORE "YANKEE" TOOLS

WHEN YOU SEE THE LINE

35 STYLES

75 SIZES

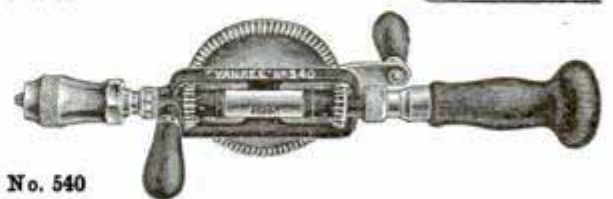

No. 540

SEND FOR OUR BOOK OF LABOR SAVERS

Tells all about them. A postal brings it. Your dealer sells the "YANKEE."

NORTH BROS. MFG. CO.
STATION Q PHILADELPHIA, PA.

could be saved if a more up-to-date method of picking them by a machine could be devised; the present scoop, as shown in the upper picture, page 659, is in the absence of something better very good, but some fertile mind will yet invent a machine, run possibly by gasoline motor, which can be run at varying speeds, owing to the character of the cranberry vines, that will take off the berries at a fraction of the expense, and in much quicker time.

Some suggestion in your valuable magazine of the fortune that awaits the inventor, who can perfect such

ENORMOUS SAVINGS AND BETTER WORK BY USING

Eclipse Air Brush

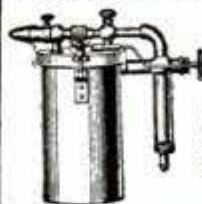

A Scientific machine for high class work in applying—Paint, Varnish, Japan, Bronze, Lacquer.

ONE MAN CAN DO THE WORK OF FOUR

Write for Booklet and tell us what finishing you do.

ECLIPSE AIR BRUSH & COMPRESSOR COMPANY

BLOOMFIELD, N. J.

LUFKIN

Measuring Tapes



Now made with Instantaneous Readings, the big improvement in markings. Saves time and eliminates errors. Send for sample piece of tape and our complete catalog.

THE LUFKIN RULE CO.

SAGINAW, MICH.

New York

London, Eng.

Windsor, Can.

\$1,500 to \$2,000 Every Year Sure

Think of Drawing Good Pay Every Month! Getting in the High Salaried Class—and Living as They Live!

There's no difference between you now. Opportunity smiled on them. It is now smiling on you. You don't have to invest any large sum of money or go to some other part of the country to get rich. Stay right at home! We want good, live, energetic men everywhere to take orders, collect, appoint agents.

We'll engage you if you're honest and will work.

Mr. J. W. Whipple, Texas, sold 28 Ever-Ready Tool Kits in 8 hours. Profit \$19.60. W. W. Strauss, Pa. (Lawyer): "Your tool kit sells like hot cakes; sold 38 first 4 hours; profit \$26.60. Am sure to sell them by the hundreds."

And Frank Clayton, Mich.: "Received hatchet and found it more than you claimed for it. Took 28 orders in one afternoon; did not half try, and have never been an agent before." Arthur Hason, Ohio: "Worked 10 hours and took 20 orders; all one has to do is to show the Ever-Ready and you have made a sale."

WEAVER MADE \$1,500 Last Year. Marcellus D. Finch, S. C., made \$31.50 first nine hours. Nothing wonderful about these records. They're not even our best ones. It's not salesmanship; it's the article. Any man with an honest face and willing to simply take orders could do as well—yes, better. Every one of these are genuine. We have the letters on file in our office and will furnish address of any or all to anyone interested. Listen to this: "Stood around one afternoon and sold a dozen." Delvinie Poivier (Preacher), Conn. **ORDERS, ORDERS, ORDERS** everywhere for this great and wonderful Ever-Ready Tool Kit, 10 Tools in One. Think of the convenience. No worry. Keeping one in place is keeping them all. Every home in America needs tools—a hatchet, hammer, screw driver, wrench, pipe tongs, nail puller, wire cutter, wire splicer. They're all in one; not scattered from garret to basement—but in one piece. No tools lost—none misplaced. No matter what you want, it's here. 100,000 now in use—a million more wanted. "Where did you lay the hatchet last time?"—Don't know. Or hammer or screw driver?—Don't know. That's it! You never know. But you ALWAYS know where to find just what you want with the EVER-READY Tool Kit in the house. You have a home! You know the annoyances of lost tools. How often have you wanted just such a combination tool? Why not go to work, supplying the demand, appointing agents, collecting. Earn some of this easy money yourself. We'll help. Do something—do it now. Send postal with your name and address. Send it today—right now—then live—live in luxury, like high salaried people do.

SEND NO MONEY— Just your name and we'll send back our proposition and plan by next mail.

FOOTE MANUFACTURING CO. Dept. 360 F DAYTON, OHIO

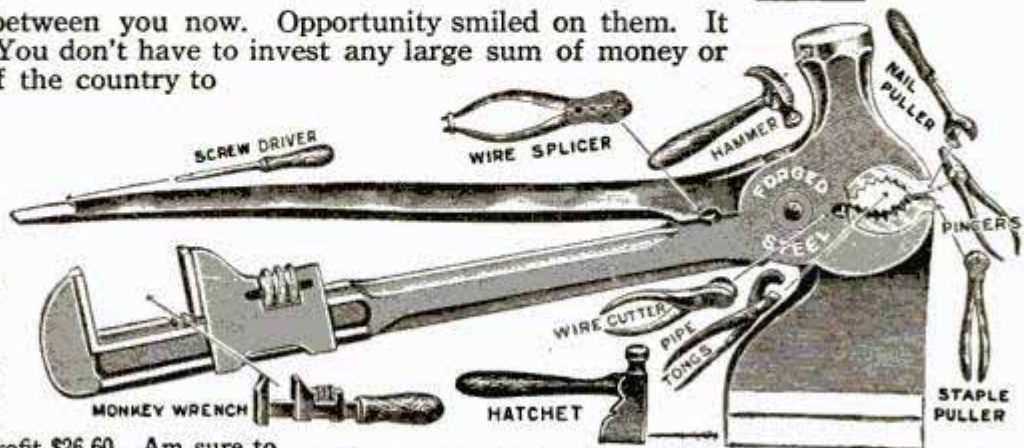

a machine, which necessarily must be built of as light material as possible, might induce some skilled mechanic to invent such a machine.

Yours truly,

Geo. E. Gossler.

302 N. Broad St., Philadelphia, Pa.

Make Your Own Repairs!
Mends Harness, Shoes, Canvas; Myers' Sewing Awl makes lock-stitch like sewing machine. \$1 postpaid. BIG MONEY FOR AGENTS.
C. A. MYERS CO.
637 1/2 Lexington Ave., Chicago, Ill.

The Awl for All.

Send for our Catalog of high grade Carpenters' Tools



It will pay you to insist on having "OHIO" TOOLS from your Dealer, as they are tools that will give continuous satisfaction. Experienced mechanics have come to regard them as the most satisfactory and economical tools on the market.

We manufacture a complete line of Planes, both iron and wood, Chisels, Drawing Knives, Gouges, Auger Bits, Hand and Bench Screws, Benches, Cement Workers' Tools, Etc.

OHIO TOOL CO.
(Department 3)
COLUMBUS, O. AUBURN, N. Y.



PIKE'S REVERSIBLE OIL STONE BOX

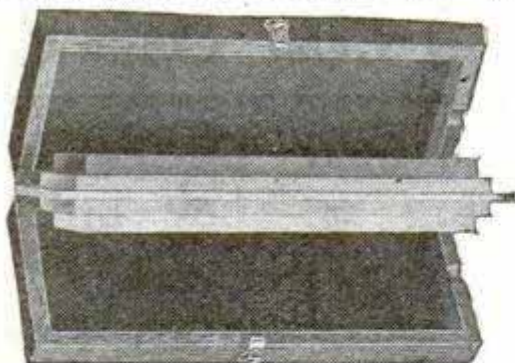

Two stones in one mounting. Release catch and the desired stone can be brought into position for use. Dust proof. Felt pad in each cover keeps stones moistened with oil. Stones set in a hinged frame.

Reversible Box and two stones 7"x2" — India and Washita — sent prepaid on receipt of \$2.00.

PIKE MANUFACTURING COMPANY, PIKE, N. H.



HOME BENCH No. 97 Price \$7.40

One of our most popular sellers. Has two vises, is built sturdy and solid from best kiln dried Michigan Maple. Guaranteed not to warp or split. Just such a

bench as you need in your home. You should have a copy of our free catalog showing our many styles. One of them is sure to please you. Just a postal will bring it. Write today.

GRAND RAPIDS HAND SCREW CO.
620 N. Front Street, Grand Rapids, Mich.

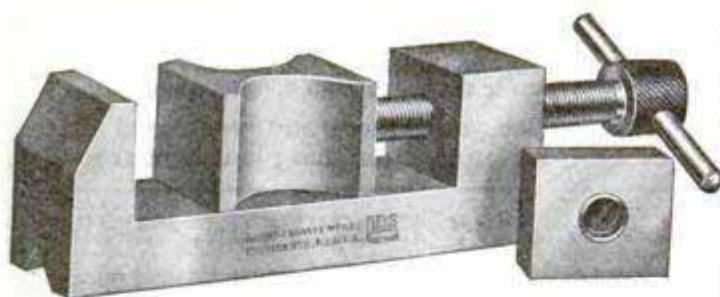

B & S TOOLMAKERS VISE

(CAPACITY 2")

IS AN EXCEPTIONALLY LIGHT AND CONVENIENT TOOL FOR USE IN DRILLING, FITTING AND LAYING OUT WORK ON SURFACE PLATES.

ALTHOUGH IT IS LIGHT CARE HAS BEEN TAKEN TO SEE THAT STRENGTH HAS NOT BEEN SACRIFICED.

WRITE FOR GENERAL CATALOGUE

BROWN & SHARPE MFG. CO.
PROVIDENCE, R. I., U.S.A.

Too Much Florida Land has been sold

to people who have never seen it. Write Brooksville Board of Trade for BOOK OF FACTS, describing different kinds of Florida soil. We have no land to sell but want settlers and investors

to develop richest district in Florida, according to State Dept. of Agriculture; not pine land, not sand, but high and rolling with rich dark top soil and clay subsoil. No fertilizer, irrigation or drainage necessary. Raises 80 bu. corn per acre. Best for citrus fruits, truck and staple crops. An industrious man, with \$500 to \$1000 capital, can be independent here, 300 ft. above sea; no swamps or marshes. Ideal climate, schools, churches, towns, good roads, all conveniences. Home seekers and investors please investigate; We need you and will help you.

BOARD OF TRADE, Box 82, BROOKSVILLE, FLA.

END OF A FAMOUS CHURCH—Belgrave Chapel, adjoining Belgrave Square, which is almost the last of the proprietary churches in London, is to be demolished, the Duke of Westminster refusing to renew the lease which has now expired. Its correct title is St. George's Church, and at one time it enjoyed a crowded and fashionable congregation, among whom were numbered the late Duchess of Teck, mother of the queen, and Princess Louise, Duchess of Argyll. At the height of its popularity the congregation was so large that even the steps of the pulpit were occupied.—London Mail.

\$5.00 to \$10.00 A Day Made Easy

The "American"
No. 3 Patented

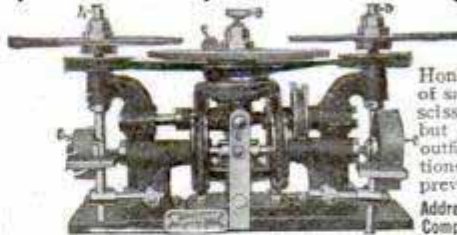

Hones razors, sharpens all kinds of safety razor blades, clippers, scissors, etc. No make-believe, but the real thing. Complete outfits furnished with instructions how to do the work. No previous experience required.

Address, Mgr. Dept. 5, Illinois Cutlery Company, 171 Washington St., Chicago

ATTENTS YOUR IDEAS MAY BRING YOU A FORTUNE! TALENTS

H. ELLIS CHANDLEE & CO.
55 Bornot Building, WASHINGTON, D. C.

See page 117

BAR BENDERS

For Concrete
Reinforcements

WRITE FOR OUR
BENDING TOOL
CATALOGUE.



Wallace Supply Co. 124 No. Jefferson St., Chicago
26 Cortlandt St., New York City

Wabbling Bathroom Fixtures Quickly Remedied

Ever yank on a towel rack and have the whole rack come out? Disgusting! Same way with glass holders, and soap dishes—wouldn't stay. Why not? Because they were not securely fastened. There is only one device on earth that will fasten bathroom fixtures. The

Star Expansion Bolt

Specially constructed to meet the needs of the modern house furnisher—the man who wants his towel racks, tooth brush and glass holders, cabinets, etc., fastened securely, easily, quickly and economically. Will hold in any wall. Write for free samples and catalogue 34.

STAR EXPANSION BOLT CO.

Catalogue Department 34

147-149 Cedar Street

NEW YORK



“Morse”

Twist

Drills



We have often said that “MORSE” Twist Drills have a world wide reputation. A recently returned traveller, having no affiliation with this company, said to us: “When I was in the interior of India a short time ago, in the course of conversation with a native, New Bedford was mentioned, ‘I have heard about that city,’ he said, ‘that is where “MORSE” Drills are made!’”

Our Tools go everywhere

Send for Illustrated Catalog

Morse Twist Drill & Machine Co.

New Bedford, Mass., U. S. A.

Murray Style Book

FREE

**We Want
Our Big
1911 Catalog
in Every Home**

178 pages filled from cover to cover with genuine Buggy, Harness and Saddle bargains; 251 illustrations, many in colors; 138 styles of Vehicles, 74 designs in Harness; the biggest and best book ever printed in this line. Don't miss sending for it!

Murray Highest Award Buggies Direct from his Factory—Four Weeks Road Trial. Insures Safe Delivery—2 Years' Guarantee.

Before buying any kind of vehicle, just get the 1911 Murray Style Book and compare Murray Prices with all others. Costs you nothing. You might as well have this book in your home.

**The Wilber H.
Murray Mfg. Co.**

366 E. 5th St
Cincinnati
Ohio

Our
Mechanic's
Buggy



Save
\$30.00

From Factory To Horse

We Sell You At Wholesale

AGENTS' PRICE, ONE

AMERICAN Motorcycle or Bicycle

If we haven't an agent in your city. We want our machine introduced in every town. We also want live agents and offer the best money making proposition on American Motorcycles and American Bicycles. Write us—do it now.

American Motorcycle Co., 102 American Bldg., Chicago



**Convert Your Bicycle into a
Motor-Cycle**

using our Attachable Outfit. Fits any wheel. Also Marine and Stationary Motors and Finished Castings. Stamp for catalog. **STEFFEY MFG. CO.**, Girard Ave. and 30th St., PHILADELPHIA, PA.



10 DAYS FREE TRIAL

We will ship you a "RANGER" BICYCLE on approval, freight prepaid, to any place in the United States without a cent deposit in advance, and allow ten days free trial from the day you receive it. If it does not suit you in every way and is not all or more than we claim for it and a better bicycle than you can get anywhere else regardless of price, or if for any reason whatever you do not wish to keep it, ship it back to us at our expense for freight and you will not be out one cent.

LOW FACTORY PRICES We sell the highest grade bicycles direct from factory to rider at lower prices than any other house. We save you \$10 to \$25 middlemen's profit on every bicycle. Highest grade models with Puncture-Proof tires, Imported Roller chains, pedals, etc., at prices no higher than cheap mail order bicycles; also reliable medium grade models at unheard of low prices.

RIDER AGENTS WANTED In each town and district to ride and exhibit a sample 1910 "Ranger" Bicycle furnished by us. You will be astonished at the wonderfully low prices and the liberal propositions and special offer we will give on the first 1910 sample going to your town. Write at once for our special offer. **DO NOT BUY a bicycle or a pair of tires from anyone at any price until you receive our catalogue and learn our low prices and liberal terms.** BICYCLE DEALERS, you can sell our bicycles under your own name plate at double our prices. Orders filled the day received. **SECOND HAND BICYCLES**—a limited number taken in trade by our Chicago retail stores will be closed out at once, at \$3 to \$8 each. Descriptive bargain list mailed free.

TIRES, COASTER BRAKE rear wheels, inner tubes, lamps, cyclometers, parts, repairs and everything in the bicycle line at half usual prices. **DO NOT WAIT**, but write today for our Large Catalogue beautifully illustrated and containing a great fund of interesting matter and useful information. It only costs a postal to get everything.

Write
it Now.

MEAD CYCLE CO. Dept. P108, CHICAGO, ILL.

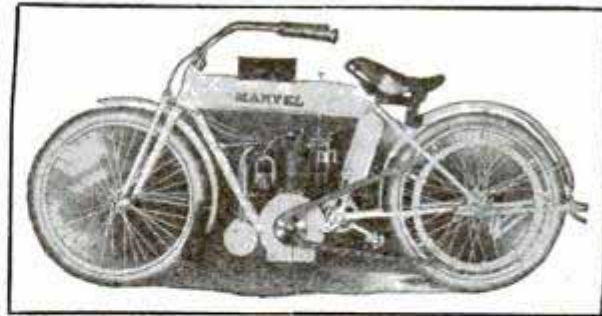

CURTISS

Motors are used exclusively on the 1911

MARVEL 4-5 H. P. MOTORCYCLE

making them the fastest single cylinder, and equal to 6 H. P. doubles on hills. Immediate shipment. Write today for details and price.

**MARVEL MOTORCYCLE CO.
HAMMONDSPORT, N. Y.**



MOTORCYCLISTS

The S-C-R-E-A-M Motorcycle Whistle attached to your exhaust pipe will surely S-C-R-E-A-M riding slow or fast; fits any machine; simply mention model. **\$3.50.** By mail 10c extra
S-C-R-E-A-M SALES COMPANY
2127 Michigan Ave. CHICAGO, ILL



GEER MOTORCYCLES

We Have the Finest Line in the Country

5 H. P. Green Egg.....	\$225.00
4 H. P. Bluebird.....	200.00
2 1/2 H. P. Model 4.....	150.00
Discount to Dealers	
Used Motorcycles.....	\$40.00

Send for Catalog

Immediate Deliveries

HARRY R. GEER CO., 888 McLaren Ave., ST. LOUIS, MO.
Largest Motorcycle Dealers in America

THE "BEST" LIGHT



More brilliant than electricity or acetylene and cheaper than kerosene. Costs 2 cents per week. **Casts no shadow.** Most perfect light for stores, churches, factories, public halls or the home. Makes and burns its own gas. Simple, durable and handsome. In use in every civilized country in the world. No dirt. No grease. No odor. Over 200 different styles. Agents wanted everywhere. Write for catalog and prices.

THE BEST LIGHT CO.
324 E. 5th St., Canton, O.

Test an **"IMPERIAL"** 30 Days
In Your Own Home at **OUR RISK**



If it does not prove the best cooker, baker and oven you ever saw, send it back at our expense.

Direct from factory to you at **WHOLESALE PRICE**
Freight Prepaid.
Has **exclusive** features not on any other range—such as **Stone Oven Bottom, Odor Hood, Oven Thermometer, Ash Sifter, etc., etc.**

Easy credit terms if wanted. Write today for **Free Catalog** and prices.

THE IMPERIAL STEEL RANGE CO., 669 State Street, CLEVELAND, O.

THE PEST OF PANAMA—There are hosts of interesting little bugs of affectionate disposition on the Isthmus of Panama. A correspondent of Engineering Contracting writes of them: "As to bugs, we have all the original species, besides several crosses. The dhobie is the most interesting little cuss of the bunch. You can't see him, but when he gets busy you know he is there all right. He gets to you by way of your laundry or your shower bath, and when he arrives he proceeds to crawl under your skin in the protected

Home Ironing Machine



On Easy Payments, 30 Days' Free Trial.
A heated mangle that irons all flat pieces better, easier, and in one-quarter the time. Costs 1c an hour for heat—gas or gasolene. Turned by hand, by power or by motor. "Clean Linen" booklet Free. Ask for it.
Home Ironing Machine,
G254E Madison St.,
Chicago

HESS MEDICINE SANITARY LOCKER

CABINET

THE only modern Sanitary Steel Medicine Cabinet or Locker.
Handsome beveled mirror door. Snow white, everlasting enamel, inside and out.



FOR YOUR BATHROOM

Costs less than wood and is better. Should be in every bathroom. Is dust, germ and vermin proof and easily cleaned with warm water.

Made in four styles and three sizes. Price \$7.00 and up.

Send for illustrated circular.

HESS, 910 L Tacoma Bld., Chicago

Makers of the Hess Steel Furnace,
Sold on Approval. Free Booklet.



No. D 159

Sent for \$2.00

Only \$2 cash places this beautiful dining-room set in your home. The balance you pay in little monthly remittances of \$1.25. Direct-from-factory price of complete set only **\$18.75.**

Six handsome dining chairs of genuine solid oak, highly polished, with genuine leather seats; massive, strong and graceful. Table, the desirable pedestal style, made of heavy solid oak and matches chairs in elegance. Very elaborate design with massive claw feet effect. Top measures 42 inches and extends six feet.

KITCHEN CABINET Sent for \$1.50

Made of hardwood, and built for service. 65 inches high, 42 inches wide, with 26-inch table. Two flour bins of 50 pounds capacity, with veneered anti-warp bottoms. Top has large cupboard with double glass doors, dustproof drawers and sliding bread tray. A wonderful value at \$7.85—\$1.50 cash, balance 75 cents a month.

These are merely samples of the tremendous values in high grade home furnishings which have made us the leading home-outfitters of the world. 800,000 satisfied customers, 22 big retail stores in the larger cities. When you buy from us you get the same elegance, the same distinction, the same quality which you see in the best city homes. And at unheard-of low prices, on terms suited to your convenience.



No. D 905
\$7.85



BIG BOOK FREE

The most attractive home-fitting book ever published, just off the press—your copy is Free. Contains 300 pages, hundreds of fine illustrations and no end of valuable hints and suggestions for home fitting, many beautiful illustrations in color. Get this book at once. Learn how to economize in your home, and at the same time get the benefit of the latest and most up-to-date styles. We will send you a copy absolutely FREE. Just send us a postal with your name and address.

HARTMAN FURNITURE & CARPET CO.

230 S. Wabash Av., Chicago, Ill.

Largest, oldest and best know home-furnishing concern in the world.

Established 1855--55 years of success.

22 Great Stores—800,000 Customers

THE Famous **Rayo** Lamp

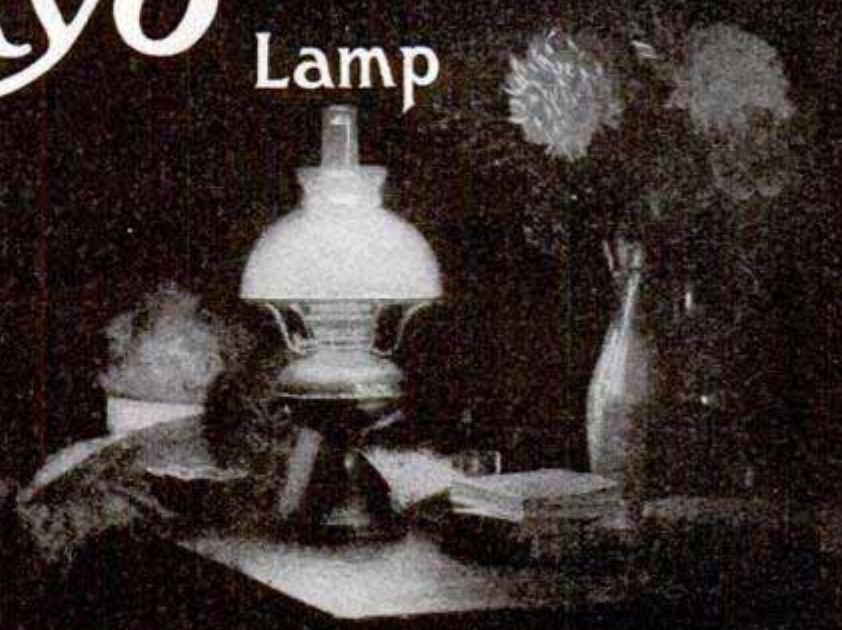

Standard Oil Company
(Incorporated)

The Rayo Lamp gives a white, soft, mellow, diffused light, which is easy to the eye, because it is absolutely free from flicker. You can use your eyes for hours under Rayo light, because there is no eye strain. A strong, durable shade-holder keeps the shade on firm and true. This season's Rayo Lamp has a new burner, which adds greatly to its strength and appearance. For sale by dealers everywhere; or write to our nearest agency.

AGENTS WANTED

BEACON LAMP BURNER FREE



Incandescence. 100 Candle Power. Burns common coal oil. Gives better light than gas, electricity or six ordinary lamps at one-sixth to one-tenth the cost. Fits your old lamp. Unequaled for fine sewing or reading.
COSTS ONLY ONE CENT FOR SIX HOURS

We want one person in each locality to whom we can refer new customers. Take advantage of our special offer to secure a Beacon Burner FREE. Write today. Agents Wanted. **HOME SUPPLY CO.**
248 E. C. Life Bldg., Kansas City, Mo.

parts and then crosses his little hands and dies. After that you have the dhobie itch, which keeps you from thinking of your other troubles. The dhobie is no respecter of persons; he'd just as soon bite the chief as a West Indian negro. Then, too, there is the red bug, who is also a pretty busy little cup of tea. This bug bores his way under the skin, and the farther he can get the happier he is. He has to be dug out with the point of a knife, or he will cause a bad sore. The mosquitoes are not so bad, as they have been driven

WANTED AGENTS

THE LIGHT THAT NEVER FAILS



Has been imitated but never equaled. Burns its own gas and makes more money for agents than any other artificial lighting device on earth. We give exclusive territory and large discounts to good men. For further information and full particulars address Light Dept.
NATIONAL STAMPING & ELECTRIC WORKS
210 So. Jefferson Street, Chicago

Cleans By Water Power

THE PRESTO VACUUM CLEANER uses water power. The ONLY sanitary way of cleaning. It takes all the dirt, dust and germs that enter the cleaner **direct to the sewer**. No fine dust returns to the air to be inhaled or to settle. No bags or boxes to empty. No muss of any kind. No valves to clog; no motors to repair. Costs less than one half cent per hour to operate. Guaranteed for **TEN YEARS**. Sold on 30 days' trial. Price, complete with 50 feet of one inch vacuum hose, five tools for cleaning, ready to connect to faucet, only **\$30.00**. Write us for full particulars.



PRESTO CLEANER CO.
114-116 Colonnade Bldg.
TOLEDO, OHIO

WHEN YOU WANT ANYTHING AND DON'T KNOW WHERE TO FIND IT WRITE BUREAU OF INFORMATION, POPULAR MECHANICS CHICAGO

WANTED AGENTS

YOUR IDEAS MAY BRING YOU A FORTUNE!

H. ELLIS CHANDLEE & CO.
55 Bornot Building. WASHINGTON, D. C.
See page 117

PALMER GASOLINE FLAT IRON Better and Simpler than any on the market. Housewives' delight. Can iron 5 hours steady for 1 cent. in anypart of the house. Asbestos handle on lever control of valve. Wrought Iron burner heads, nothing to wear out. Cash offer. Express paid U. S. A. **\$5.00**



MODERN LIGHTING COMPANY, 236 Jefferson Avenue, DETROIT, MICH.



You Can Read or Work All Night

without tiring your eyes by the light of one of these wonderful

INVERTED TRIUMPH LAMPS

as the pure, white and soft steady light is restful and pleasing to the eyes and pronounced by *oculists* to be the nearest approach to daylight of any artificial light, and almost as cheap, as one quart of gasoline lasts 15 to 20 hours, giving light equal to 100 burning candles. Five times as cheap as kerosene. Our HANDY or BONANZA gasoline lighting systems will light your store or home from cellar to garret with pure white gas light at less than 15c per 1000 feet. Better than gas companies charge \$1.00 to \$2.50 a 1000 feet for.

Send now for P.O.P. catalog—it's free and tells why.

Brilliant Gas Lamp Co., Dept. 1, 42 State St. CHICAGO, ILL., U.S.A.



INVENTS YOUR IDEAS MAY BRING YOU A FORTUNE! PATENTS

H. ELLIS CHANDLEE & CO.
55 Bornot Building, WASHINGTON, D. C.

See page 117

BARODA DIAMONDS.

Flash Like Genuine
ANY STYLE at 1/40 the cost--IN SOLID GOLD RINGS

Stand acid test and expert examination. We guarantee them. See them first—then pay. Special Offer—14k Tiffany ring 1 ct. \$5.98. Gents ring 1 ct. \$5.98. 14k Stud 1 ct. \$4.86. Sent C. O. D. for inspection. Catalog FREE, shows full line. Patent ring gauge included, 10c. The Baroda Co., Dept. A5, Leland & Dyer Sts., Chicago

into the jungle. Once in a while, however, a big one will come along and look you over. If you look too tough the mosquito will fly away, whet his bill on a stone and come back again ready for business. A stout, able-bodied mosquito after sharpening his beak on a stone pile can bite right through the sole of your shoe. We also have sand fleas, large flying roaches, beetles, scorpions, tarantulas and red and white ants. The two last mentioned are the hardest workers on the Isthmus. They are always busy doing something they hadn't ought to do. The white ant has a highly developed

WONDER LAMP

The United Factories of 334 Wyandotte Street, Kansas City, Mo., is making an offer to send a lamp, free to one person in each locality to introduce this marvelous, new, incandescent 100 candle power oil lamp. Simply send name and nearest express office.



NULITE Gasoline Table Lamp

A beautiful lamp for homes, hotels, offices, stores, banks, cafes. Portable, safe; can be turned upside down or rolled on the floor without danger or affecting the light. 300 c.p. of soft, brilliant light, 1/2 c per hour. Also 200 different styles of lamps and systems.

AGENTS—We want town, county and traveling salesmen. Best proposition ever offered. Sells everywhere. WRITE FOR SPECIAL OFFER.

CHICAGO SOLAR LIGHT CO.
222 S. Jefferson St. CHICAGO

A PULL TURNS ON THE SUNLIGHT

Better than electricity or city gas, cheaper than kerosene or candles. Steady, white, brilliant; 1/2 c per hour. Burns 97% air. Lighted or extinguished by pull of chain. No smoke, no soot, no odor, no grease, no wicks to trim.

Helios Light Absolutely Safe

For homes, stores, halls, factories, shops, churches, hotels, public buildings, streets. Delivered ready for anyone to install. Write now for free booklet and make selection from our numerous artistic styles. Exclusive territory and big money for good agents. We help you sell. THE STANDARD-GILLETT LIGHT CO., 98, Michigan St., Chicago, U.S.A. Established 1898. Paid-in Capital \$100,000.00

Speed the Work on Washday!

Use the 1900 Motor Washer a Month—at Our Expense!

The Washday "bugbear"—DRUDGERY—has been cornered, captured, routed! It has worried women since they first bent their backs to the task of washing clothes. And women still toil like galley slaves, fighting the demon of Dirt.

Six Minutes to Wash a Tubful!



Now comes the new way—the swift, efficient, smooth-working 1900 Motor Washer—a marvelous machine that lifts the entire burden from the shoulders of womankind!

Just a "twist of the wrist" and presto!—the washer starts! In 6 MINUTES—or less—your tubful of clothes is CLEAN! The 1900 Motor Washer does BOTH WASHING AND WRINGING—quicker, better, cheaper than it was ever done before. A fine wringer goes with the outfit.

1900 Motor Washer (Electric or Water Power)

Runs for 2c a Week



Wringing Done on the Double-Quick!

Two cents a week pays for Power to run either the Electric or the Water Motor Washer. We have both styles. If your house is wired for electric light or supplied with running water you should accept our remarkable offer of an outfit on

30 Days' FREE Trial

The test will prove this the greatest Washer in all the world. It not only does washing and wringing, but

Motors Run Other Machines

The Portable Electric Motor will operate mangle, sewing machine, grindstone, vacuum cleaner, ice cream freezer, fan, polishing machine, etc. The Water Motor will do the same if pressure is sufficient.

Get One On Trial!

See the clothes made spotlessly clean in six minutes! See the wringing done! Try the Motors for running various light machines. Remember—at our expense and risk! Easy payments if you decide to keep it.

Free Book Tells the Whole Story!

Write for Book and Free Trial Offer before laying this magazine aside. We can't begin to give all the vitally important facts in this advertisement. Write us today—sure. Address (36)

1900 WASHER Co., 5004 Court Street, BINGHAMTON, N. Y.

If you live in Canada, address

CANADIAN 1900 WASHER CO., 355 Yonge St., TORONTO, CANADA

Please Mention Popular Mechanics

5 Years' Absolute Guaranty

On this Wonderful Detroit Marine Engine

You Are the Only Judge of the engine and its merits. 25,000 satisfied users. Material and workmanship guaranteed for five years.

Greatest Engine Bargain Ever Offered!

Fewest moving parts of any practical engine on the market. Nothing complicated or liable to get out of order. Only three moving parts. Extra long plastic white bronze bearings. Vanadium steel crankshaft. Adjustable steel connecting rod. All bearing surfaces ground. French gray iron castings. Water-proof ignition system. Runs at any speed from trolling to racing.

Starts without cranking. Reversible while in motion. Perfectly counter-balanced. No vibration.



30 Days' Trial Try the engine for 30 days. If you are not fully satisfied, return it and we will promptly refund all money paid us.

Demonstrator Agents wanted in every boating community. Special wholesale price on first outfit sold. Single cylinder, 2-5 h. p. Double cylinder, 8-20 h. p. 4-cylinder, 20-50 h. p. Thoroughly tested before shipment. Comes to you complete with boat fittings and ready to run. Write for free catalog, testimonials and details of the greatest protective guaranty ever offered. Suitable for any boat from canoe to cruiser. Also railroad track car. All sizes in stock ready to ship. Write today for our wonderful demonstrator offer. (74)

DETROIT ENGINE WORKS
1271 Jefferson Avenue, DETROIT, MICH.

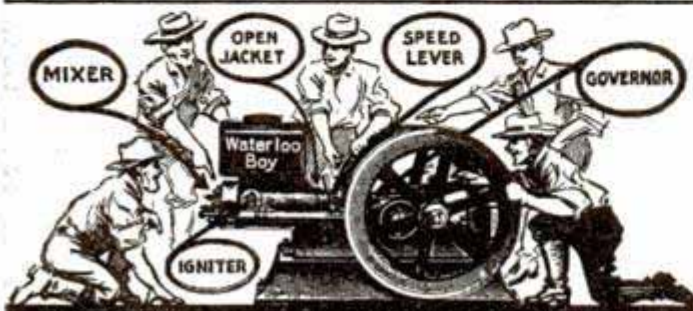

17 YEARS ON THE MARKET

5 YEAR GUARANTEE

The Waterloo Boy

has all of the good points that go into any gasoline engine besides many exclusive patented features. A few days' trial will enable you to point out the superior points that make the

Waterloo Boy

the best engine for every conceivable purpose.

We will send to any responsible person a Waterloo Boy on 30 days' free trial, and if it does not do all and more than we claim, if you are not satisfied that it is the best, send it back and we will pay the freight both ways. Can you think of a more liberal proposition than this? Write today for our free catalogue, showing styles and sizes and our free trial offer blank.

Waterloo Gasoline Engine Co.

1021 W. 3rd Ave., WATERLOO, IOWA

YEARLY CAPACITY 15000 ENGINES

30 DAYS FREE TRIAL

\$50 TO \$300 SAVED

We are manufacturers, not merchants. Save dealers, jobbers and catalog house profit. I'll save you from \$50 to \$300 on my High Grade Standard Gasoline Engines from 2 to 22-H.-P.—Price direct to you lower than dealers or jobbers have to pay for similar engines in carload lots for spot cash.

GALLOWAY

Price and quality speak for themselves and you are to be the sole judge. Sell your poorest horse and buy a **5-H.-P. only \$119.50**



Direct From My Factory on 30 Days' Free Trial. Satisfaction or money back. Write for special proposition. All you pay me is for raw material, labor and one small profit. Send for my big **BOOK FREE.**

Wm. Galloway, Pres.
Wm. Galloway Co.
1965 Galloway Station
Waterloo, Iowa

appetite for all kinds of wood. He breakfasts on a soap box, lunches on a dry goods box and dines on a house. When he gets after a house he sometimes cuts the supporting timbers away, thus causing a general inconvenience to the human tenant. The red ant spends most of his time chewing up plants and trees. On his account, it is practically impossible to grow vegetables such as are raised in the states. Attempts have been made to do this in a few places, but in most cases the red ants beat the farmer to the vegetables."

FOOS The highest type Gas and Gasoline Engine

Embracing every high grade feature of design and construction possible after 24 years of exclusive gas engine building.

Foos Engines embody the most successful solution of all problems of Ignition, Valves, Balance and Governing, with greater accessibility and economy obtainable in any other engine from 2 to 500 H. P. Send for catalogue 50.

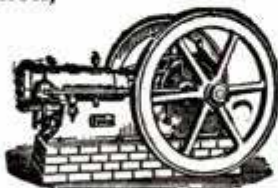

Foos Gas Engine Co., Springfield, Ohio
Largest Exclusive Factory in America

WHEN YOU WANT ANYTHING AND DON'T KNOW WHERE TO FIND IT—WRITE BUREAU OF INFORMATION, POPULAR MECHANICS, CHICAGO



HERE IT IS!

A Real—Sure Enough—One Horse — Air Cooled — Gasoline Engine Thoroughly Constructed— Completely Endowed.

Guaranteed. Price \$39.25

THE AUTEN MACHINERY CO.
427-29 W. Randolph St., CHICAGO.

WITTE ENGINES

GAS - GASOLINE - DISTILLATE
Cheapest of all powers. One cent average cost per horse power per hour. Nothing can equal.

FIVE YEAR GUARANTEE

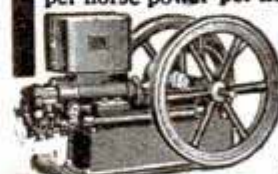

We build all sizes. Hopper jacket or water tank cooling. Inducements to introduce in new localities. Write stating size and style wanted.

WITTE IRON WORKS CO.

1654 Oakland Ave., Kansas City, Mo.

DON'T BUY A GASOLINE ENGINE

until you investigate "The Master Workman," a two-cylinder gasoline, kerosene or alcohol engine, superior to any one-cylinder engine; revolutionizing power. Its weight and bulk are half that of single cylinder engines, with greater durability. Costs Less to Buy—Less to Run. Quickly, easily started. Vibration practically overcome. Cheaply mounted on any wagon. It is a combination portable, stationary or traction engine. SEND FOR CATALOGUE THIS IS OUR FIFTY-NINTH YEAR.

THE TEMPLE PUMP CO., Mfrs., 431 West 15th St., CHICAGO

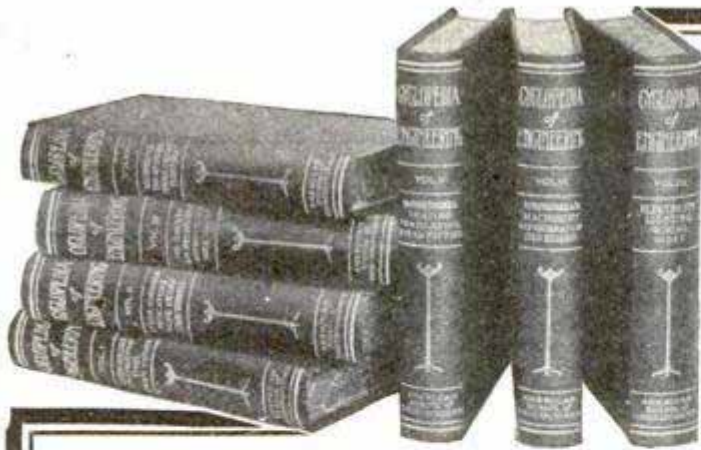

We want every Student, Stationary, Electrical and Power Engineer to Examine this great work.
We will place this wonderful
CYCLOPEDIA OF ENGINEERING

in your home or office absolutely free of charge.

These books contain just that information which you are looking for, that will make you a bigger and broader man in your trade or profession. To hold a bigger job with a bigger salary, to be recognized as an authority on Practical Steam and Power Engineering you must know every detail, be familiar with every technical and theoretical point. This cyclopedia gives you just that necessary information in the most complete, get-at-able form.

These seven volumes contain 3,200 pages of the most thorough treatise on engineering ever published. The chapters on construction of boilers, care and operation of steam, gas and oil engines, valve gears, power transmission, refrigeration, and management of dynamo-electric machinery are especially complete. Hundreds of full-page plates, photographs, diagrams, formulas, etc. Bound in half red morocco; the titles stamped in 23-karat gold.

THIS IS OUR LIBERAL SELLING PLAN

The books will be sent you, express prepaid, for 5 days' free examination upon receipt of the coupon. If you decide to keep the books, send us your initial payment of \$2.00 within five days and \$2.00 every month until you have paid the special price of \$18.80. The regular price is \$36.00. If, after thoroughly examining the books, you do not see your way clear to keep them, notify us and we will send for them at our expense. Send the coupon today.

IMPORTANT SUBJECTS COVERED

Construction of Boilers—Boiler Accessories—Fuel Economizers—Mechanical Stokers—Steam Pumps—Steam Engines—Indicators—Valve Gears—Steam Turbines—Gas and Oil Engines—Fuels—Automobiles—Carburetors—Locomotive Boilers and Engines—The Air Brake—Single-Phase Electric Railway—Elevators—Marine Boilers—Marine Engines—Heating and Ventilation—Compressed Air—Transmission—Absorption and Compression Refrigeration—Ammonia Machines—Direct Current Dynamos and Motors—Management of Dynamos and Motors—Electric Wiring—Electric Lighting, etc.

For a short time we will include as a monthly supplement, for one year, the TECHNICAL WORLD MAGAZINE. This is a regular \$1.50 monthly, full of Twentieth Century scientific facts, written in popular form. Also contains the latest discussions on timely topics in invention, discovery, industry, etc.

AMERICAN SCHOOL OF CORRESPONDENCE, CHICAGO, U. S. A.

FREE EXAMINATION COUPON

P. M. 2-11
A. S. of C.
Please send set Cyclopaedia of Engineering for 5 days' free examination, also T. W. for one year. I will send \$2.00 within 5 days and \$2.00 a month until I have paid \$18.80 or notify you and hold the books subject to your order. Title not to pass until fully paid.

NAME.....
ADDRESS.....
REFERENCES.....

J. Pierpont Morgan ridicules the idea of latter-day miracles, but he offers no explanation as to why two streaks of rust can enhance several millions in value over night.—Baltimore News.

The assertion is made that electrocution has not proved popular. Maybe there are a few old-fashioned people who would prefer hanging. It is impossible to please everybody.—Toledo Blade.

4 HP STATIONARY COMPLETE GASOLINE ENGINE \$76.00

12 HP \$219

For Farmwork, Irrigation or Pumping, Factory use and Electric Lighting.
3 to 20 h.p.—perfectly governed—guaranteed by a responsible firm. Write for full description.

GRAY MOTOR CO., 107 Leib St., DETROIT, MICH.

Boat and Engine Book MAILED FREE

Just like a 30-Footer Do not think of Buying a Launch or Engine until you see our Handsome Book

only smaller

WHICH EXPLAINS FOUR WONDERFUL LAUNCH BARGAINS

Only \$121 for this complete 16-ft. Launch—3 H. P., guaranteed self-starting Engine, weedless Wheel and Rudder. Result of 30 years' experience. Money back if not as represented. Write for free catalog today. Special Bargains in Weeco reversible, self-starting engines to those building or buying their own hulls. Engine controlled by one lever. Full size Boat Designs furnished free to purchasers of Weeco Engines.

C. T. WRIGHT ENGINE CO., 607 Canal St., Greenville, Mich.

This Kerosene Engine Cuts Your Expenses 75%

YOU should not even consider engines that operate on gasoline only. The rapidly rising price of gasoline, now 6 to 16 cents higher than kerosene, absolutely makes operation on this fuel too expensive. The Perfection Kerosene Engine operates on any engine fuel. When you purchase it you are on the safe side—proof against all fluctuations of the market. You can always run this engine at a great fuel saving and get the greatest amount of work done. The Perfection vaporizes its own kerosene and so makes it as efficient as gasoline—something other engines cannot do.

The Perfection is very light, portable, has only three moving parts, runs everything about the place, is lower in price than any other engine of its capacity on the market.

PERFECTION Kerosene Engine

Sent You on 15 Days Free Trial

See your dealer at once and ask him to let you have a copy of our Free ENGINE BOOK which shows the sizes and styles of the "Perfection" and explains this very attractive offer. Your dealer will send any "Perfection" engine to your farm for 15 days and let you return it if you are not satisfied. Ask him about it. If he does not carry the "Perfection" write to us and we will send you our Free Engine Book direct.

CAILLE PERFECTION MOTOR CO.
105 Caille St., DETROIT, MICH.

A light, portable two-stage air-compressor. Capacity 30 cu. ft. of free air per minute, and weighs only 400 pounds.

Suitable for supplying compressed air for any purpose, such as pneumatic hammers or drills, for sprayers, sanders, painting machines, etc.

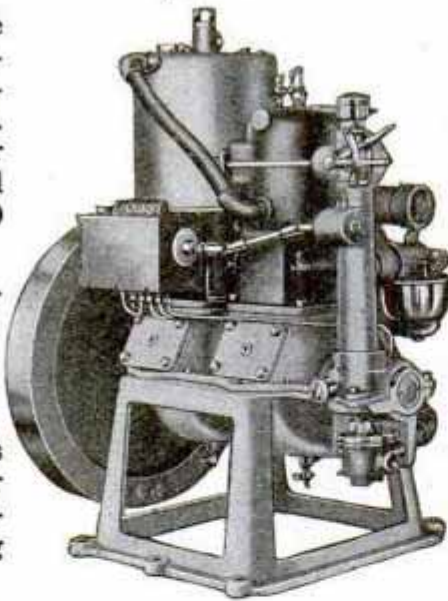

Send for Bulletin D-2 with full description

Our handsome 32-page catalogue of marine, automobile and aeronautic motors now ready. It contains information of value to you.

WRITE TODAY

THE ROBERTS MOTOR COMPANY
1419 Columbus Ave. SANDUSKY, OHIO

Reputable agents wanted to handle popular-priced marine engine. Absolutely guaranteed for 5 years. Thirty days' trial by the purchaser. Your money promptly refunded, without question, if not satisfactory. A sure favorite and quick seller. Big returns assured. Simplicity the keynote of construction.

Just the engine you have been looking and waiting for. Combines the good features of the best, with all the bad ones eliminated.

Fool-proof. As near perfect as anything mechanical can be produced.

All sizes in stock from 2 to 50 h. p. Ready to ship on 24 hours' notice if necessary.

Write today for catalog and details of the greatest selling plan and agents' money-making proposition ever offered.

Liberal discount, specified territory and absolute protection to accepted agents. Some very productive territory still open.

COLUMBIA ENGINE COMPANY
2 Mt. Elliott St., Detroit, Mich.

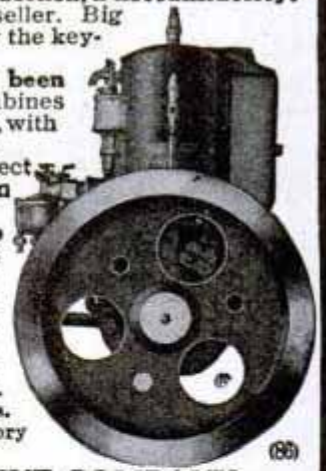

WATKINS' SPECIAL MOTORS

- 3 H. P. Single Cylinder . . . 30 lbs.
- 6 H. P. Double Cylinder . . . 56 lbs.
- 12 H. P. Four Cylinder . . . 90 lbs.

WITHOUT A PEER.

Especially adapted for CANOES or LIGHT BOATS

INTERESTING CATALOG ON REQUEST.

THE WATKINS MOTOR CO.
837-839 West Sixth Street CINCINNATI, OHIO

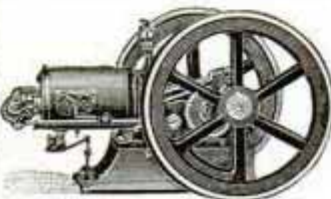

WHICH WOULD YOU RATHER DO

Buy a cheap engine and save \$10 to \$50 in first cost, or buy an ECONOMIZER and save \$50 to \$500 in running expenses? **Free Trial.**

H. L. CHAPMAN, Box 595, MARCELLUS, MICHIGAN

BAY STATE MOTORS



"Perfect Simplicity" and "Simple Perfection" are the results, embodied in these Motors, of 15 years devoted to the developing of these essential characteristics, which enable us to put on the market a reliable and economical motor at a reasonable price. Write for catalog, stating size and type (2 or 4 cycle) of motor wanted. We also furnish castings for these motors.

BAY STATE MOTOR WORKS
Successor to
A. J. HOULE MOTOR WORKS
580 South East Street, HOLYOKE, MASS.



ELECTRIC WHISTLES

and horns for motor boat, automobile, factory and fire alarm use. Searchlights, dynamo and other accessories at low prices. Send for catalogue.

THE EDGAR MFG. CO.
104-5 Hanover St., Boston, Mass., U.S.A.



OUR O'BRIEN No. 1

Make a Motor Boat of Any Boat in Five Minutes

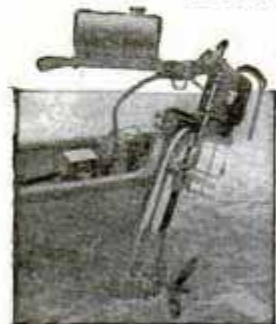

You can do it with the Waterman Outboard Motor, which you can quickly attach (and detach) to the stern of any skiff, row boat, dinghy, punt, sail boat, and have a good motor boat. It is not a toy, but a reliable 2 H. P. Marine Motor that will drive an 18-foot row boat 7 miles an hour, 4 hours on gallon gasoline. Simplest motor made. Weight 40 lbs. Equipped with Schebler Carburetor. Five years' successful results behind it. Send for Catalog C. Canoe Motors, 1, 2, 3, 4 Cylinders—Catalog K. Standard Type Motors, 1 to 30 H. P.—Catalog A.

WATERMAN MARINE MOTOR CO.
1507 Fort Street, West, DETROIT, MICH., U. S. A.

DITENTS YOUR IDEAS MAY BRING YOU A FORTUNE! PATENTS

H. ELLIS CHANDLEE & CO.
55 Bornot Building, WASHINGTON, D. C.

See page 117



Propeller Wheels—speed, towing, weedless and reversible. Reverse Gears and Marine Hardware. Prices right, prompt shipment. Send for large 2-colored catalog free.

Michigan Wheel Company 565 Canal Street GRAND RAPIDS, MICH.

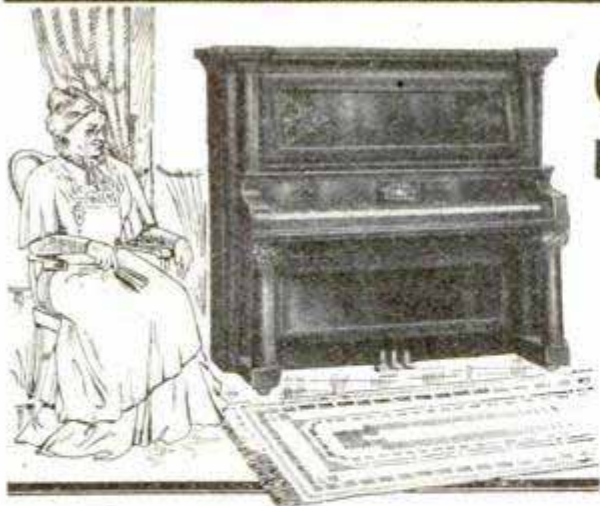

"It's just as good as the day I bought it, thirty years ago."

SEND NO MONEY!

We will ship you, absolutely free, any model you select of the wonderful, time-tested Reed & Sons Piano or Player-Piano. Play on it 30 days free. Try out its rich, resonant tone. Ask the opinion of your friends. Then, if you don't think it the grandest piano value you ever heard of, you can send it back to us without a bit of red tape or a cent of expense.

Reed & Sons Pianos

Winners of Highest Award at World's Columbian Exposition

Like all artistic, high-grade makes, were sold through dealers, jobbers and agents for more than sixty years. Thousands of people bought them in this way, paying the dealers' and middlemen's profits. Yet, even at the price it was necessary to charge on this plan, the buyers of Reed & Sons pianos got the best values in the world. Here is a letter from one of our customers—we have hundreds more like it.

I have a Reed & Sons Piano which I have had nearly 26 years, and would not "trade even" for most of the new "cheap" pianos on the market today.

MRS. E. E. ADAMS.

Think of it! If these people got such wonderful piano value under the old system of selling, paying all the middlemen's profits, what a tremendous opportunity is yours now that we have cut out all middlemen and are selling you the same piano at

Direct-From-Factory Prices

—a saving of half of your piano money. Never before was such an opportunity offered on an instrument like the Reed & Sons Piano, with a record of satisfaction since 1842 and with the highest award Medal at the World's Fair. A 25-year guarantee bond accompanies each model. And this is the piano we now offer to send you on a free trial. We pay the freight and we grant you

No Deposit Easy Payments No Interest

Don't ever think of paying an agent or anyone else one penny for an unknown piano or player-piano until you've learned how you can buy a genuine Reed & Sons Piano on the easiest plan ever devised. Write now for your copy of our

Free Grand Catalog

A beautifully illustrated history of over sixty years of high-grade piano-making. Shows all our handsome models and tells you all about our sensational factory-price offer. Just cut out the free coupon below and mail it to

Reed & Sons Piano Mfg. Co.
52 Jackson Blvd., CHICAGO

Largest direct-from-factory piano house in the world. Capital and resources nearly two million dollars. Endorsed by leading Chicago Banks

FREE COUPON

Reed & Sons Piano Mfg. Co.
 52 Jackson Blvd., Chicago

You may send me, absolutely free and without any obligation on my part, your grand catalog and particulars of your unparalleled direct-from-factory price offer on the famous Reed & Sons Pianos.

NAME.....

ADDRESS.....



If you send your name and address we will send you **Free** our Vibrator Book describing the White Cross Electric Vibrator shown here.

Merely send a Postal Card and our FREE Vibrator Book will be mailed to you.

This Vibrator is a rubbing machine which draws the blood to any aching part of the body to do its work. This machine rubs much better and much faster than the hands.

While the hands are able to give a few dozen rubs per minute the machine gives several thousand rubs. It rubs hard or gently, just as the operator chooses. The machine can be operated by anyone in his own home.

Send today for the FREE VIBRATOR BOOK

Lindstrom-Smith Co.
253 La Salle St., Dept. 1192
CHICAGO



\$1.00 DOWN

BURROWES BILLIARD AND POOL TABLE

\$1 down, balance small amounts monthly, buys any Table \$6 to \$15. Larger Tables \$25, \$35, \$50, \$75, easy terms. All cues, balls, etc., free. The Burrowes Table is high-grade and adapted for the most expert play. Set it on library or dining table, and set it aside when not in use.

NO RED TAPE—On receipt of first installment we will ship Table. Play on it one week. If unsatisfactory return it, and we will refund money. Write to-day for catalog.

E. T. BURROWES COMPANY, 65 Elm St., PORTLAND, ME.

Burbank has grown a seedless prune, and now it is up to him to produce a prunelless boarding house.—Danville (Ill.) Commercial-News.

MODERN ELECTRICS

The greatest, most instructive electrical Magazine printed. Prints more wireless and "How to make things," articles than all electrical magazines combined. Experimental Department, intensely interesting. Wireless contest each month.

SPECIAL OFFER: 6 months for 25c. \$1.00 a year. On all News Stands. Modern Electrics Publications, 231 Fulton St., New York



SMOKE THE ABSORBO PIPE

Genuine Imported Vienna Meerschaum. Absorbs the nicotine like a sponge—ensuring a cool, sweet smoke, without injurious after effects. Colors a beautiful rich brown. Sent prepaid 50 cents, 3 for \$1.25. Money back if not satisfactory.

SMOKE SHOP SPECIALTIES CO.
292 Main Street Holyoke, Mass.



Get Your Cigars at Maker's Prices

"WICHMAN LONDRE"

Box of 50 for \$3.25 Made from the best long Havana filler, broad leaf wrapper and binder, by skilled Union labor. Box of 50 of these fine fragrant cigars will be sent carriage paid to any part of the United States on receipt of price. State whether light, dark or medium shade is wanted. Ask about our "Orinoco Perfecto" and the famous "Welcome" 5 cent cigar. Remember that we save you the retailer's profit, and guarantee satisfaction.

WICHMAN & WELCOME CO., Dept. H, Springfield, Mass.



FREE COPY

The New Motorcycle Magazine

is full of information valuable to everyone who is interested in Motorcycling. Edited and published by men who have had a wide experience in the Motorcycling field.

Send **TODAY** for Free Copy

MOTORCYCLE EQUIPMENT COMPANY
HAMMONDSPORT, N. Y.

DITENTC
YOUR IDEAS MAY BRING YOU A FORTUNE!
TALLENIS

H. ELLIS CHANDLEE & CO.
55 Bornot Building, WASHINGTON, D. C.

See page 117

MESCO

MESCO

MESCO ELECTRIC TOASTER

Price with Cord and Attaching Plugs complete.

\$5.00

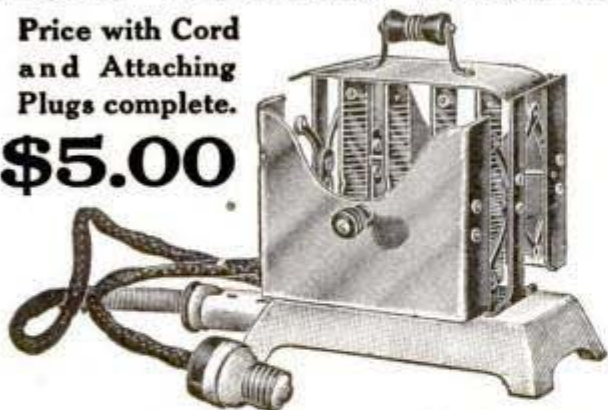

Low Current Consumption. Mechanical Heat Regulator. Solid Porcelain Base. Highly polished, nickel plated brass. Not the cheapest, but the best.

The adjustable doors that hold the bread can be placed close to the heat unit for making toast quick and crisp, or they can be withdrawn to the proper distance for making a hard brown toast. If doors are pulled out full distance the toast remains hot, but will not burn. The only Electric Toaster with this essential feature. Can be used on either direct or alternating current. Made for 110 to 120 Volt circuits. Also 220 to 250 Volt. **Ask for Catalog 24P.**

MANHATTAN ELECTRICAL SUPPLY CO.

NEW YORK, 17 Park Place. CHICAGO, 186, 188 Fifth Ave.

MESCO

MESCO

Bargain Prices on New and Used Electrical Machinery



We Buy, Sell, Rent, Trade and Repair Electrical Machinery. Our Stocks are Large, Prices low and our used machinery is as Good as New. Write for bargain booklet Number Twenty. Tell us what you have and what

you need. We can interest you.

SWITCHBOARDS For POWER or LIGHTING

Whether large or small, Alternating or Direct Current, we do or will build the Switchboard that meets your requirements.



Ask for Switchboard Bulletin Number Twenty-two. It gives prices.

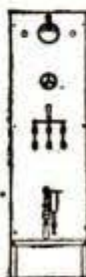

The F. BISSELL COMPANY
226-230 Huron St., TOLEDO, OHIO

The cafeteria proprietor who can furnish pumpkin pie that does not show the mark of the waiter's thumb has a fortune ahead of him.—Muncie Star.

ELECTRIC GOODS FOR EVERYBODY. World's headquarters for Dynamos, Motors, Fans, Toys, Railways, Batteries, Belts, Bells, Pocket Lamps, Telephones, House Lighting Plants, Books. If it's electric we have it. Undersell all. Fortune for agents. Big Catalogue 4 cents. **OHIO ELECTRIC WORKS, CLEVELAND, OHIO**

BIG 200-p ELECTRICAL and WIRELESS CATALOG Mailed for 4c Stamp

(to cover postage). 60 pages WIRELESS Instruments for commercial and experimental use.

15 pages Motors and Dynamos of all sizes. 35 pages Miniature Trains and Imported Electrical TOYS. 20 pages Telegraph Instruments. 40 pages Electrical Novelties, etc. 30 pages general Electrical Supplies. Get this catalog today—you need it.

J. J. DUCK, 424-6 St. Clair Street, TOLEDO, OHIO

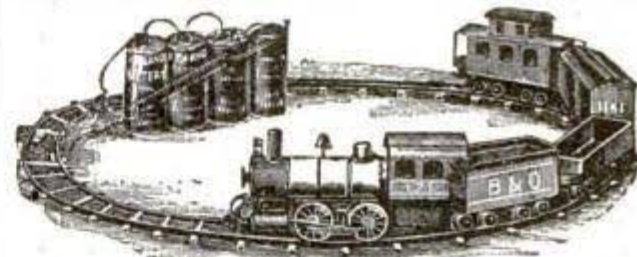

Electrical railways, tracks, switches, trolley cars, dynamos, motors, dynamo castings, gas engine castings, everything for the young electrician. Send for our complete catalog "B."

The Carlisle & Finch Co.
262 E. Clifton Ave. Cincinnati, Ohio

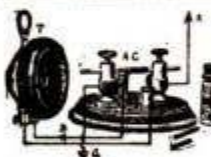

"C. Q. D." A complete wireless receiving station for \$1.50, sent postpaid. Not a toy. We **ABSOLUTELY GUARANTEE** that you can catch wireless messages up to 300 miles. Over 500 government and commercial wireless stations in the U. S. One is near no matter where you live. Catch the messages. Send 10c for Wireless Blue Book of ALL stations. (Book given free with outfit.) Outfit comprises: The famous

Peroxide of Lead Detector, 75 Ohm telephone receiver, wiring, directions and list. Send 4 cent stamp for our 196-page Electrical Cyclopaedia-Catalogue No. 7, containing valuable electrical information.

ELECTRO IMPORTING CO., 233a Fulton Street, NEW YORK
"Everything for the Experimenter"

NEW WIRELESS WONDER



Aero Field Receiving Outfit. Weight only 4 oz. Receives up to 75 miles. The wireless sensation of the year. Price \$4.00; without phones, \$2.50.

Send 3c for Catalogue

ETHERIC ELECTRIC CO. 278 Lenox Ave. Corner 124th St. Salesrooms and Factory 71 Barclay St., NEW YORK, N. Y.

ELECTRICITY

The most wonderful and fascinating scientific study of the age. Every Boy, Girl and Grown-up should know about it. The new "VOLTAMP ELECTRICAL PRODUCTS"—our

112 Page Catalog now ready, the most complete and interesting book ever issued—is full of illustrations and descriptions of the latest Voltamp. Electrical Novelties—Motors, Dynamos, Toys, Machine Models, Telegraph and "Wireless" Instruments, Ruhmkorff Coils, Spark Coils, Geissler Tubes, Switches, Meters, Lamps, Flashlights, Transformers, Tools, etc. The greatest line of Miniature Electric Railways ever shown. Ideal Christmas Gifts. Prices consistently low.

Send for this Catalog—6 cents in stamps or coin, which will be refunded on first order of 50 cents or over. No postals answered.



VOLTAMP ELECTRIC MFG. CO., Voltamp Bldg., Baltimore, Md.

SECONDARY "UNITS" FOR WIRELESS

INDUCTION COILS AND TRANSFORMERS; THESE UNITS COST BUT LITTLE MORE THAN WIRE ALONE. SEND 2 CENT STAMP FOR WIRELESS CATALOGUE.

Dawson & Winger Electric Co., 429 Dearborn Street, Chicago



Ponderosa Tomato
 Big Boston Lettuce
 Henderson's Invincible Astors
 Scarlet Globe Radishes
 mammoth Butterfly Fannies
 Giant Spencer Sweet Peas

To obtain for our annual catalogue, "Everything for the Garden," described below, the largest possible distribution, we make the following unusual offer: To everyone who will mail us ten cents, mentioning this publication, we will mail the catalogue and also send our Henderson Specialty Collection, as above.

EVERY EMPTY ENVELOPE COUNTS AS CASH
 This Collection is enclosed in a coupon envelope, which, when emptied and returned, will be accepted as 25c. cash payment on any order of one dollar or over.

"EVERYTHING FOR THE GARDEN"
 Our 1911 catalogue is, without exception, the best we have ever issued. 208 pages, 8 colored plates, 800 photo engravings, showing actual results without exaggeration, make it the most complete as well as beautiful horticultural publication of the year. Also contains full cultural directions for flowers and vegetables.

PETER HENDERSON & CO. 35 & 37
 CORTLAND ST.
 NEW YORK CITY

"THE KNOB DOES IT" JUST A SIMPLE PRESSURE AND THE PEN FILLS.

Made Right - To Write Right.
 No More Leakage or Soiled Hands.

"VULCAN" Self-filling FOUNTAIN PENS

Simple, Safe, Secure.

With No. 2 Gold Pen \$2.00
 With No. 4 Gold Pen \$2.50

"VULCAN" STYLOS
 UNEQUALED FOR FAST WRITING, RULING OR MANIFOLDING.
 TWO SIZES - 4 1/4 AND 5 1/2 INCHES.
 TWO COLORS - BLACK OR RED \$1.00
 Can be carried in any position.
 LARGE SIZE 8 INCHES, BLACK ONLY \$1.25.

ANY STYLE SENT POST PAID ON RECEIPT OF PRICE.

J. C. ULLRICH & CO., 135 Greenwich Street, New York

LET US GIVE YOU THIS TRANSPARENT CELLULOID TRIANGLE

It is 4 inch size, 30°+60° angles. Lowest retail price, 25 cents. Absolutely essential to everyone who draws. We make this offer to introduce our new catalogue showing

SPAULDING'S NEW CARRYING CASES AND COMPLETE OUTFITS

for designers, architects, engineers and students—compact, durable and convenient. Spaulding's Carrying Cases are made light and strong. They provide well arranged compartments, including space for drawing board and T square. Handled like a suit case; unique, practical, inexpensive. Outfits include all necessary equipment. If you draw, send us five 2-cent stamps to-day to pay postage and get the free triangle and the catalogue.

SPAULDING PRINT PAPER CO.
 44 Federal St. BOSTON

BIRDS BUILD INCUBATORS—Some birds even depart from the custom of their class and build incubators in order to hatch their eggs without the trouble of brooding. The "mound builders" deposit their eggs in a huge pile composed of dirt, dead leaves, dry sticks and other debris of the woods. Seeing one for the first time in a Malayan forest, the traveler takes it for a mere heap of rubbish, and is surprised when his native guide proceeds to burrow into it in quest of eggs. But when the searcher, after removing the top layers, uncovers a clutch of eggs or a lively little chick, fully feathered and able to fly, the secret

BRIGHTEN UP Your Stationery in the OFFICE, BANK, SCHOOL or HOME by using WASHBURN'S PATENT PAPER FASTENERS

75,000,000
 SOLD the past YEAR should convince YOU of their SUPERIORITY.

Trade **O. K.** Mark

Easily put on or taken off with the thumb and finger. Can be used repeatedly and "they always work." Made of brass in 3 sizes. Put up in brass boxes of 100 fasteners each.

HANDSOME COMPACT STRONG No Slipping, NEVER
 All stationers. Send 10c for sample box of 50, assorted. Illustrated booklet free. Liberal discount to the trade.

The O. K. Mfg. Co., Syracuse, N. Y., U. S. A.

PRICE \$12.00 AT FACTORY

This Cabinet made of Oak, finished golden, 44" long, 24" wide, has drawers, extension slide, roll front, paper cabinet, etc., as shown. We sell it at low price to introduce our OFFICE FURNITURE—Desks, Chairs, Tables, Files, Book Cases, etc. ASK FOR PRICES AND CATALOG No. 211.

WE ALSO MAKE OPERA CHAIRS AND LODGE FURNITURE.

We make UPHOLSTERED FURNITURE—Turkish and Odd Rockers, Parlor and Library Suites, Davenport and Couches in Oak and Mahogany, Flanders, mission and regular. Covered in best leather money will buy—every piece guaranteed. Ask for prices and Catalog No. 411.

E. H. STAFFORD MFG. CO., 242 Adams St. Chicago, Ill.

LEARN ISOMETRIC DRAWING Combines clearness of photograph with accuracy of working drawing. The Standard for patent drawings and illustrations for scientific magazines. Makes quickly read working drawings. Invaluable to inventors.

THE ISOGRAPH makes isometric projection easy; makes an expert of a novice. Wonderful proficiency obtained with practice. Ample illustrated book of instructions teaches you in a short time. Celluloid 6 x 6 inches, accurately made. Postpaid 50c. Money Order or 2c stamps. SEND TODAY.

THE ISOGRAPH CO.
 145 E. 23d St. NEW YORK CITY



ALOE—For Fifty Years the Standard of the World for Quality. Established 1860—ALOE

Civil Engineering and Surveying Instruments

DRAWING MATERIALS AND SUPPLIES
BLUE PRINT PAPER, TRACING CLOTH, ETC.

"FREE." Write for Catalogue. Sent "FREE."

A. S. ALOE COMPANY, 514 Olive Street, ST. LOUIS, MO.



A CARD USER'S TESTIMONY

"I'm always proud when I have the opportunity to hand one of my cards to a man. I feel sure, when I reach for my case that the cards in it will be smooth and clean, well engraved or printed, and altogether the best card that money or art can produce; No one can scrutinize it critically and make me doubt that it is the best card that could represent me in a business transaction."

Peerless Patent Book Form Cards

won this commendation from a user, purely on their merits. No other card could merit as much, because it is **the one best card.**

Therefore the suggestion of that testimony should be sufficient. Send today for a sample book of the cards, and see for yourself that they are what you need.

Note:—They are bound in books, but are detached without trace of a rough edge.

OUR SMART CARDS IN CASE



The John B. Wiggins Company

Sole Manufacturers

Engravers Die Embossers Plate Printers

17-19 East Adams St., Chicago

New York Office, 350 Broadway

is out. The brushwood pile must surely be an incubator.

These birds have surely "built better than they knew." It is easy for us to see that the mound acts like a gardener's hotbed. The slow fermentation of the vegetable rubbish heats it from within; the tropical sun from without. The climate of their habitat is equable; the difference between the night and day temperatures is small. The vaporation that follows a heavy fall of rain reduces the temperature considerably even in the tropics. But the birds lay only in

INVENTS YOUR IDEAS MAY BRING YOU A FORTUNE!

H. ELLIS CHANDLEE & CO.
55 Bornot Building, WASHINGTON, D. C.
See page 117

NO MORE BALD HEADS



When our VACUUM CAP is used a few minutes daily. We accept no pay until you have tried the Cap 60 days and are satisfied. The Vacuum Cap is an appliance that draws the blood to the Hair Roots and starts a new healthy crop of hair. It stops Dandruff, stops the hair from falling out. Bought by Doctors and men who

know that it is the only reasonable HAIR GROWER known to science. No Drugs Used. Write for application blank, testimonials, and booklet on "HAIR," sent sealed in plain envelope, FREE.

THE MODERN VACUUM CAP CO.
N. 559 BARCLAY, DENVER, COLO.

STARTLING Watch Offer

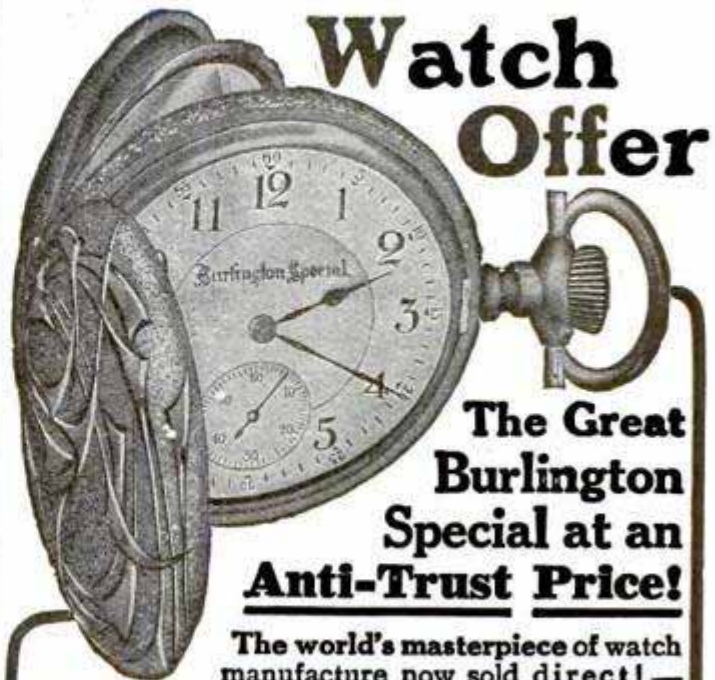

The Great Burlington Special at an Anti-Trust Price!

The world's masterpiece of watch manufacture now sold direct!—

The most amazing offer ever made in the whole history of the watch industry — an offer which has absolutely PARALYZED competition — the offer of the genuine Burlington Special direct to the public at the rock-bottom ANTI-TRUST PRICE, without middlemen's profits.

The Fight is On!

We will not be bound by any system of price-boosting contracts with dealers. We will not submit to any "high profit" selling scheme. We will not be dictated to by ANY Trust.

NO MATTER WHAT IT COSTS, we are determined to push our independent line even if we should have to fight a combination of all the Watch Manufacturers of the country!

And so we are making this offer—the most sweeping, astounding offer ever made on a high-grade watch. The famous BURLINGTON direct and at the same price WHOLESALE Jewelers must pay.

And in order to make the proposition doubly easy for the public we will even allow this rock-bottom price, if desired, on terms of **\$2.50 a Month** Don't miss this wonderfully liberal offer. Sign and mail coupon now. Rock-bottom, anti-trust price, whether you buy for cash or time.

POST YOURSELF!

Be sure to get posted on watches and watch values, trust-method prices and anti-trust prices before you buy a watch. Learn to judge watch values!

Get the Burlington Watch Company's

FREE WATCH BOOK

Read our startling exposure of the amazing conditions which exist in the watch trade today. Read about the anti-trust fight. Read about our great \$1,000.00 Challenge. Learn how you can judge watch values. Send your name and address for this valuable FREE BOOK now — TODAY. Sign & mail coupon.

BURLINGTON WATCH CO.
Dept. 1192
19th & Marshall Blvd., Chicago, Ill.

Please send me without obligation and prepaid, your free book on watches and a copy of your \$1,000.00 challenge, with full explanations of our cash or \$2.50 a month offer on the superb ANTI-TRUST Burlington Watch.

Name.....
Address.....
Burlington Watch Co., Dept. 1192, 19th and Marshall Blvd., Chicago, Ill.
No letter necessary will be sent.



BUY AT Wholesale Prices

FROM THIS **Big Catalogue**

By our system of giving New York wholesale prices and *paying the freight* on most of the goods we sell, we save you 30 to 40 per cent. on every purchase.

Bear in mind that we supply everything needed about the home, farm or factory. After you once have our catalogue of 75,000 articles, you need not go out of the house to buy most of the articles you need.

Our goods are all reliable and we guarantee satisfaction or *money back*.

Our customers are all over the world. They are satisfied because we give a square deal and save them money. We want their trade *not* only for to-day, but *next year*, and for *years to come*.

We have been in business since 1816 and a great many of our customers have been buying from us for a generation. Doesn't that record invite your confidence and your trade?

Get our catalogue and send us a trial order. We know that the quality, the low prices, and the *Free Delivery* will hold you as a customer ever after.

If it's Sugar you want or Harness—Clothing or Tools—we can supply you.

Just drop a postal card for the catalogue—it's free—you ought not to be without it.

WHITE, VAN GLAHN & CO., 30 Barclay St. NEW YORK CITY

Oldest Mail Order House in America. Est. 1816

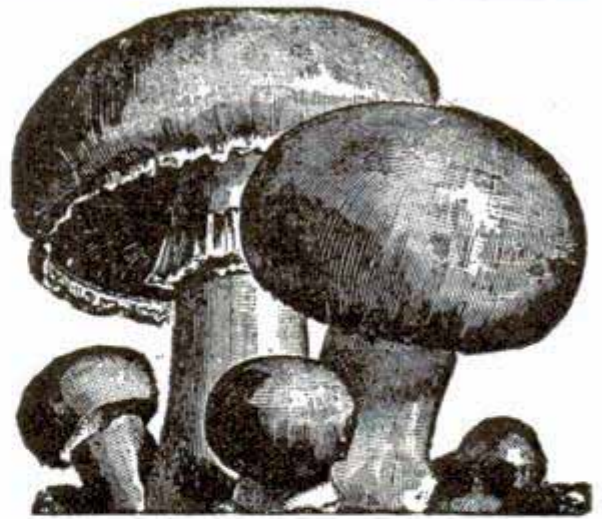

Grow Mushrooms

For Big and Quick Profits

Small Capital to Start. A Safe Business.

I am the largest grower in America. Ten years' experience enables me to give practical instruction in the business worth many dollars to you.

No matter what your occupation is or where you are located, here is an opportunity to acquire a thorough knowledge of this paying business.

Send for Free Book giving particulars and information, how to start, cost, etc. Address

JACKSON MUSHROOM FARM
5964 N. Western Avenue, CHICAGO, ILL.

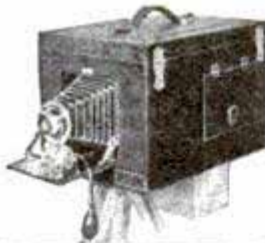

500% PROFIT

Operating a **Daydark Photo Post Card Machine**. Three photo postal cards of any object made and delivered on the spot in ten minutes. No experience required—no dark room necessary. All work done in the machine in open day. Establish a profitable business at home by opening a Daydark Postal Parlor. Big money maker on the street, at fairs, etc. Send at once for free catalog and sample post card showing the fine work the machine does.



Daydark Specialty Co.

2101 Cass Ave., St. Louis, Mo.



PRINT FOR YOURSELF

Cards, circulars, book, newspaper. Press \$5. Larger \$18. Rotary \$60. Save money. Print for others big profit. All easy rules sent. Write factory for press catalog, TYPE, cards, paper.

THE PRESS CO., Meriden, Connecticut

the dry season. The mound is loosely put together. Thus air is admitted to ventilate the eggs, and light enough to put the newly born chicken on the track of the outside world. The mound is, in fact, an incubator in the rough, practically adapted to the needs of birds.—Los Angeles Times.



\$63⁹⁰ in 5 Days

Complete success from the very start. This is what a new customer writes—ask for proof. You can do the same with the

Wonder Cannon Camera

\$25 buys a complete outfit consisting of WONDER CANNON, tripod and enough supplies to make 400 finished photo buttons. Hustlers make big money on street corners, at fairs, carnivals and at all outdoor attractions. WRITE FOR FREE CATALOG

Chicago Ferrottype Co., Dept. 102, Chicago, Ill.

DETAILS YOUR IDEAS MAY BRING YOU A FORTUNE! PATENTS

H. ELLIS CHANDLEE & CO.
55 Bornot Building. WASHINGTON, D. C.

See page 117

\$513 Clear Profit in 51 Days from an Investment of \$150



easy payment plan.

is the result from operating one American Box Ball Alley. Two others cleared over \$2,000.00 first year. Four others over \$1,200.00 in two months. Four others took in \$3,200.00 in nine months. Go in this business yourself. You can start with \$50.00. Nearly 7,000 alleys sold to date. More popular today than ever. These alleys pay from \$30.00 to \$75.00 each per week in any town.

No gambling device, but the best thing on earth for clean amusement and physical exercise. Patronized by the best people, who form clubs and bring their friends. No expense to install or operate. No special floor required, no pin boy needed. Receipts nearly all profit. We sell only one customer in towns of moderate size. Write today for booklet and

[29] **AMERICAN BOX BALL CO., 721 Van Buren Street, INDIANAPOLIS, INDIANA**

The Man Who Made Florida

A TRUE STORY OF THE FIRST MAN OF THIS DECADE TO DEMONSTRATE THE PRACTICAL VALUE OF FLORIDA AS THE HOME OF "TEN ACRES AND LIBERTY"

By E. C. Roy

THIS reads like fiction but it is nothing but fact. I have traced the influences which have created the tremendous land rush to Florida, and though my opinion may be an humble one I give it to you for what it is worth.

I say without fear that the very first man to prove to the world that Florida was a spot where the man of ordinary means could be forever secure from loss of livelihood was and is Charles H. Sieg.

This man had made a minute and a careful study of the trend of the public mind. Three years ago he saw the "back-to-the-land" idea coming.

He was a man who has devoted much of his life to the manufacturing of mechanical things. He was successful and more than all else he was carefully practical.

He learned that the most essential thing in all agricultural topics was climate. He made a thorough study of crop failures, and the figures he can give to you on this subject would alarm you. He traveled much and read more. He conversed with many of the best informed men in this country on land.

Out of his own deductions there arose the determination to give Florida the test of fire. He wanted proof and proof only after a complete test.

All over this state he went. Into the swamps of the south, down upon the wet prairies bordering the Caloosahatchie he went, along the west coast and into the great districts of the middle ridge of Florida. He learned the state. He slept with the timber buyers, the land cruisers, the hunters, the cane and corn planters, he learned of riches by nights spent with the growers of grape fruit and oranges. He fished the streams and his gun brought down the feathered treasures of the pines and palmettoes. He bathed in crystal waters during the winter months.

He learned what "the out of doors" means in Florida and mentally he made a note of all these things.

When these places were as familiar to him as our own scenes are to us he began the idea that I claim has made Florida the most talked-of and read about spot in the entire world.



CHARLES H. SIEG

The man who made Florida famous as the Poor Man's Paradise

County. He told of the tests he had made. He offered this land to the public at the rate of less than two good cigars a day. Financiers said: "Mr. Sieg, you cannot make a success when you sell land at such small terms." The announcements appeared in the public press and every acre of this 36,000 acre tract was sold out in less than thirty days. He had more than 1500 applications which could not be filled. Again he bought land. This time he had the prestige of the St. John's Park Colony behind him, and when he offered the second colony for sale, the name of which he called it was Jacksonville Heights Colony, he sold this project out in the same time that he consumed to dispose of St. John's Park. Then he began to see to the detail of the actual settlement, for Mr. Sieg is practical in everything he does.

He is not a land man. The company he is president of is not a land company. It does not abandon its settlers to their own resources. It builds roads, helps teach the essential lessons, operates experimental farms and sticks close to the new colonist until, like the young bird, he is ready to fly and can take care of himself. Now comes the point that I say proves this man Sieg to be the father of the Great Florida land rush. The success of these two colonies spread over this country like wild fire. The newspapers began to quote Florida topics. The doctrine of Sieg had sunk deep into the innermost recesses of the minds of the men who had influence and brains.

They knew that a land where there was the climate which could produce three crops every year, where the gentle breezes from the sea

do in the great West or upon the sterile farms of the East. These financial giants who had robbed Florida of her trees and her turpentine, who had sought after the phosphate in her mines to enrich the lands of other farming sections, who had made millions in her fisheries, these men now saw that Sieg had struck the real riches of this great state and that their efforts were as nothing compared to the wealth that lay upon her fertile plains for the farmer and fruit grower.



Depot Interlachen. A small city on the Florida-Palatka Colony

These men came to Florida. Not in pairs but in droves. They scurried all over the state. They bought land and they copied Sieg's ideas and his arguments. They had learned that land could be sold on the easy-payment plan, so they

began to advertise. In just a few brief months there was a tremendous land rush toward Florida. Almost every train headed toward the south bore some man or woman to Florida.

All this was a little over two years ago. Last fall Charles H. Sieg started his third great colony. He had by this time solved many perplexing questions and knew better what to do and how to do those things which meant more for the comfort of his colonists. This colony he called Burbank Ocala and he located it down in that portion of Florida where the ancient Seminole Indians had lived and chose to call it "The Land of Plenty." You cannot imagine this spot unless you have been to Florida and know the charm and beauty of its pregnant interior.

Please Mention Popular Mechanics

The Man Who Made Florida (Continued)

This colony was located 101 miles south of Jacksonville on two railroads. In a short time, 90 days in fact, this entire tract of 65,000 acres was sold out. A railroad company, realizing the prestige and profit such a colony meant, began to build a line through its very heart from the pretty city of Ocala to the great St. John's River port, Palatka. This railroad at once made Burbank Ocala Colony a definite and fixed show-place of the entire state. Here the colonists came by the hundreds. They came dressed in all manner of clothes. Some there were who had left the Saskatchewan and the dreary winters and the toiling days in the wheat fields; others came from the cities of the Northeast and West. Here met for the first time the doctor and the office manager, the expert mechanic and the Yankee school teacher, and the Western farmer and the railroad engineer. They were followed by their wives and their children. In a short time their land was cleared. Their houses began to show through the beautiful pines and live oaks. They planted their crops and tilled their fields. Two towns sprang up in the short space of five brief months. Everywhere one looked there was improvement.

You should talk with some of these people if you want to know what all this means.

The work of Charles H. Sieg was bearing better and bigger fruit. His company had work to do and it did it. They made roads, built administration buildings, dug ditches so the excess rainfall of the summer would work no hardship. They put in an experimental farm. They attracted competent merchants and in every possible manner supported their colonists as far as it lay in their power to do. This colony is now a tremendous success, and it is because of this success that Mr. Sieg has been compelled to secure additional land lying alongside of the Burbank Ocala colony to supply the demand that has been made upon him for small farms from people located in almost every section of this country, some even coming from European points.

If you would admire the other colonies which he has fathered and which are to-day eminently successful you would be wildly enthusiastic over the latest and best colony which he is colonizing now, called the Florida-Palatka Colony.

There is no spot on the North American continent where nature and man have joined together so successfully for the luxurious abode of humanity. This great colony, whose lands to-day are selling so fast as to be almost unbelievable, is located in the major part of Putnam County, though some lies in Page and Marion Counties. These three counties rank the first in the state and have repeatedly taken the blue-ribbon prizes at state fairs and exhibitions because of the excellence of the agricultural and horticultural products. Florida-Palatka Colony occupies the highest land in the state of Florida.

This is an element you should have in all Florida land, for it means safety to your home and crops when the heavy rains flood the low lands, as the case often is in some portions of Florida.

Then this great colony is located upon the very best of excellent railroads. You can get

out of a Pullman car directly upon this land. The Atlantic Coast Line, the Seaboard Air Line, the Florida East Coast, the Florida & Georgia Southern, and the Ocala & Northern railroads are all available for this colony's needs. You can have the very best passenger and freight service.

At one side of the colony flows the mighty St. John's River, broad as a bay and deep enough to permit sea-going vessels to dock at Palatka, which city is but ten miles from a portion of this colony. Down this great river lies Jacksonville, the fastest-growing city in the South, if not in the Union. You may enjoy the best churches, the finest schools, the best roads and the most select society in and around this colony. You will have a superb home for health's sake, for the death-rate here is less than .7 in 1,000, a record no other state in this country can approach.

If you want to be charmed and entranced with the grandeur of sky and landscape, if



St. John's River skirting Florida-Palatka tract

of the wonderful mockingbird, and see the wild duck and the artful quail and turkey feeding along the beautiful waterways, then here is the spot of spots for you to make a home. Every day of the year is a holiday for the settlers of this land. The streams are filled with the very best fishing one could wish for. The woods are teeming with squirrel, fox, rabbit and other small game, while with a few hours' ride one can yet get a proud pair of antlers and have venison for one's table. On one side of the colony flows the Ochlawaha River. This stream is without question the most romantic and picturesque in this country. No matter what manner of natural beauty you desire you will find it here. The river is swift-flowing. It is lined on either bank by gigantic pines, palmettoes, cypress, and live oak. These beautiful trees are draped with Spanish moss, just as though some master-hand at festooning had been here before one to please every sense of the artistic. The bosom of the river is one mass of fanciful colors and weird shadow-effects that travelers pronounce without an equal anywhere in the world.

The beauty of this spot is above question.

No one can look upon it and remain unmoved.

It is abject folly to attempt to describe this beautiful region, where Mr. Sieg has selected the last and only colony perhaps he will ever be the moving spirit in. Just consider what it all means to have a home here. Not only does one enjoy the very pinnacles of nature's greatest unimproved gifts beside one's very door step; not only is your home at once a health resort and a playground for the grown-up boy and girl, but you have all around you, within a short hour or more ride, all the joys of the deep sea, the unfolding charm of the government reservation, where a giant forest will remain untouched throughout all the ages for the rambling ground of man and the wild

if you please attend the opera or the theater and see the latest dramatic successes.

This sort of thing is life in all the word means and implies. To the worn-out man of the cities it is more than life; to the farmer it is all play, and he cannot comprehend it until he sees everything with his own eyes. Speaking of this question, the farmer revels in a perfect ecstasy when he learns the producing value of this great soil. Let me briefly tell you something of the soil which lies universally over the Florida-Palatka Colony.

The land you buy has a very peculiar soil. It is a rich, sandy loam underlaid by a heavy and deep clay subsoil that has the color of chocolate and is the part of the soil that holds the water that is drawn up gradually through the peculiar sandy loam by the action of the sun's rays and the needs of plant-life. This clay subsoil acts as a true and natural storehouse for moisture right at the roots of the plants and the trees, where water is needed.

The earning ability of this land is unlimited. This is the home of the three-crop farmer. It is here that now this very day the farmers and growers are working in their fields in their

shirt-sleeves. They will within a few weeks be sending their third crop to market, and this just at the time when the prices are the very highest and when the whole farming country of our Union is idle, except Florida and some of the far-distant points, like Texas and California.

There are men in these counties who earn \$1,000 per acre, and there are men who earn only \$100 per acre. The average value of all Florida crops per acre is \$125, as is shown by the state and government agricultural reports. Much depends on the man and his ability and desire to work.

The Northern men are the ones who are making \$1,000 per acre; the native and the negro are the ones who content themselves with the lesser amount.



Mr. Kennerly raised 600 crates of such celery on half acre of ordinary pine land near Florida-Palatka Colony

Please Mention Popular Mechanics

The Man Who Made Florida (Continued)

If you desire to go in for oranges, grapefruit, pecans and other tree products, one can reach a yield per acre that is simply astounding.

The majority of settlers are planting garden-truck, ground-fruits, etc., and the prices on these products are such as to raise a figure per acres that will satisfy almost any man or woman, for each acre produces that figure three times each year.

I have been to most all of the so-called garden spots of Florida. I have talked with the great fruit and vegetable growers whose life work has been devoted to various sections of this state. I have visited their home and met their families. I have walked into their fields and amid their trees. These men would

startle you with the statement of the profits they have earned in just a few years from just a few acres. Their bankers will tell you the same story. They own automobiles, they send their children to the best universities, they travel at home and abroad and every month of every year they are as inde-

pendent of all mankind as though they received their competence from some source outside this universe.

It is folly, as I have said before, for one to attempt to tell of these things for the reason that most people will decry your wording and will remain sceptical until they have seen the proof with their own eyes.

If you want to know more of the great Florida-Palatka colony and of the history of the colonies Charles H. Sieg has established, you should write for his great free book called "Ten Acres and Freedom."

This book contains more than 60,000 words. It is filled from cover to cover with photographs of colony scenes. It pictures with the camera, in plain black and white, the beauties of the countryside around this great colony.

It takes you out upon the St. John's River and down the fantastic Ochlawaha River. It shows you Silver Springs and Silver Lake, the new towns born this year over the colony; it reveals farm scenes and illustrates almost every

point you would wish to know simply by the use of photographic reproductions.

It goes into the statistical side of Florida and of this colony in particular. It moves along with a rhythm of fact after fact compiled from the best state, government and expert reports obtainable and it never tires and never grows dull. It is almost like a novel for everything is new and everything is written in a common, every-day style of language that carries conviction with it.

This great book tells you the prices of those things you wish to know. It informs you all about railroad rates, both freight and passenger. It tells you of Jacksonville and the other cities of Florida. It speaks of climate and shows you the proof from the Weather Bureau,

covering something like twenty years, so that you may know just how far down the thermometer goes in the winter time and how far up it goes in the summer time. It proves to you that the North is a worse place to live in during the summer than Florida. It gives you facts that you can substantiate. It tells

you of the health conditions, and how Florida has the lowest death-rate of any of our states. It describes Florida's advantages and Florida-Palatka Colony in particular from a transportation standpoint both by water and by rail. It gives you crop statistics and tells you what to plant and how to plant it, and estimates the cost of each and every transaction for you. It tells you what to do and how to do it, from the time you leave your home until you have your house built and your first crop in.

It contains all manner of testimonial proof together with the names and addresses of those colonists who have dealt with this great colonization company, and proves to you that their words are like their bonds.

This book, in my opinion, is the greatest piece of literature ever issued on any section of our country, and is another reason why Charles H. Sieg should be called "The Man Who Made Florida."

Then you will receive the monthly magazine called *The New Florida*, which tells of the de-



Hotel at Rodman—One of the towns in Florida-Palatka tract

free to any address for three months just for the coupon below.

By special provision the New South Farm and Home Company will send free to every one who sends in the coupon below all the literature above described, together with their written binding and legal guaranty to give every one who buys a colony farm 120 days to investigate his land, and if he finds it not what he desires, or if, for any other reason, he de-

tion. A company that has pleased thousands and can prove every statement it makes, or failing to satisfy you, it agrees to return your money. This is why I say that this company, and the man at its head, is the primal force in the making of Florida the most sought-after and talked-of state in this Union.

The Price of Florida-Palatka Farms is \$30 Per Acre; Terms

\$5 down and \$5 a month for 59 months buys a 10-acre farm
\$10 down and \$10 a month for 59 months buys a 20-acre farm
\$15 down and \$15 a month for 59 months buys a 30-acre farm
\$20 down and \$20 a month for 59 months buys a 40-acre farm

No Taxes. No Fees. No Commissions. All you have to pay is like above figures each month. We pay all taxes until you pay for your farm in full. You may have possession after the very first payment.

Every purchaser of a Florida-Palatka Colony farm will be permitted to receive every cent he has paid in, if for any reason he does not desire his farm, within 120 days from the date of his contract. This will give you ample time to make an investigation, or if you are not satisfied with the farm which has been allotted to you, you can exchange it for one entirely to your liking or know that you can receive back every cent you have paid in. No other company in Florida makes such an offer. This company does so because it does not fear the closest scrutiny into each and every phase of its colony.



Putnam County Court House, just being completed

sires to cancel his contract he need only to request his money back within the time limit of 120 days and his money will be returned. It is needless to say that Charles H. Sieg knows from experience just what to expect from such a broadcast guaranty and that he has no fears from such provision because the land will protect him and please every purchaser. Remem-

Don't delay a single day. Send in the coupon now, today, this very minute, and receive the greatest descriptive literature you have ever read. Just send the coupon below—no letter is necessary.

**NEW SOUTH FARM AND HOME COMPANY
 ROOM 1060, MERCHANTS LOAN AND TRUST BUILDING, CHICAGO**

Please send me "Ten Acres and Freedom" and a three-months' subscription to the New Florida Magazine. Everything is sent FREE. I don't agree to buy. I only want your literature.

Name Address

City State

Please Mention Popular Mechanics

Can You Find the Fire Demon?

THIS is an actual photograph of burning San Francisco where the **Hartford Fire Insurance Company** paid the largest single loss ever paid by any fire insurance company in the world. Somewhere in the smoke above the burning city, appears a face which we have named the Fire Demon. Can you find it? If you can, cut it out, paste on a postal card, write your name and address and the name of the publication from which you have taken it. Send the postal to the **Hartford Fire Insurance Company, Hartford, Connecticut.** You will be sent, free of charge, a series of beautiful colored souvenir postal cards of fire scenes.



SPRINGS AT BOTTOM OF SEA—Bahrein Island, in the Persian Gulf, is said to be the hottest place on earth. It is usual there to find the thermometer at 140 degrees F. On the coast of this island, where practically all of the people live, there is no fresh water, which is needed above all things in so seething a temperature.

And it is to be had from the bottom of the sea. Here and there scattered over the floor of the harbor of Bahrein are springs of pure fresh water. These waters well up through the sand to mingle with the

FORTUNES MADE

operating the
"CIRCLING WAVE"

The latest invention and the Catchiest Amusement Riding Device in use. For catalogue, testimonials and price, write

ARMITAGE & GUINN

22 Mill St., Springfield, Erie Co., N. Y., U. S. A.



Your Picture in a Postal Card IN ONE MINUTE

The pictures are developed, toned and finished in a single developing solution. No experience is necessary. Price of machines \$7.50 and \$15.00—circulars describing our machines sent free. We are also headquarters for supplies for all minute picture machines.

AMERICAN MINUTE PHOTO COMPANY
Dept. B, 720-728 W. 12th St., Chicago, Illinois
The largest manufacturers and distributors of minute picture machines and supplies in the world.



SPECIAL, RIGHT NOW,
COMPLETE COURSE \$10



AUTOMOBILE MECHANICAL MODELS FREE

WITH **DYKE'S HOME STUDY**
COURSE OF AUTOMOBILE ENGINEERING

You can learn to be a **Chauffeur or Repairman** with my system. Endorsed by **Barney Oldfield** and 2000 others.

THEY REALLY
WORK



BEST WAY TO LEARN

THE **AUTOMOBILE**

GET DYKE'S

**START
NOW**

FREE BOOK "How to Get Into the Auto Business"
SEND FOR IT TODAY. DON'T MISS IT.
DYKE'S COR'SP SCHOOL MOTORING, BOX 1 3947 WASHINGTON, ST. LOUIS
(FIRST AUTO SUPPLY MAN IN AMERICA. PUBL'R FIRST AUTO BOOK.)



WHITE VALLEY GEMS

IMPORTED
from FRANCE

SEE THEM BEFORE PAYING!

These Gems are chemical white sapphires. Can't be told from diamonds except by an expert. Stand acid and fire diamond tests.

So hard they can't be filed and will cut glass. Brilliance guaranteed 25 years. All mounted in 14K solid gold diamond mountings. Will send you any style ring, pin or stud on approval—all charges prepaid—no money in advance. Write for Free illustrated booklet, special prices and ring measure. **WHITE VALLEY GEM CO., 900 Saks Building, INDIANAPOLIS, IND.**

DAISY Air Rifle

The straightest-shooting, most highly perfected air rifle made. Every boy should have one. The **Daisy Special, 1000-shot Magazine Repeater**, is the finest air rifle ever made at any price. Handsome blued barrel, lines like the latest magazine hunting rifle, accurate to a hair; price \$2.50. Buy from your dealer or we will send prepaid on receipt of price. Interesting literature free.

DAISY MFG. CO., 301 Union St., Plymouth, Mich.

Other Daisy Models
50c to \$2.00

1000 SHOT
DAISY



Household Lubricant is just good, pure oil, properly compounded. Won't corrode, gum, darken, become rancid or injure the most delicate mechanism. Comes in the handy can, always ready for use. Can may be closed with its own spout (see illustration). For all light-running mechanisms found in every home. Prevents rust.

HOUSEHOLD LUBRICANT

Sold Everywhere in 4-oz. and 8-oz. Cans

Standard Oil Company

(Incorporated)



BENJAMIN AIR RIFLE FOR MEN AND OLDER BOYS

An air gun that will shoot through half inch pine easily. Many times more powerful than spring guns. Uses compressed air, same as air brakes, rock drills, etc. 15c pays for 1,000 shots (delivered 30c). Practical for small game. 37 inches long. Walnut stock. Nickel barrel. Take down. Sold by dealers everywhere. If your dealer does not carry it, write us. Sent prepaid east of Rocky Mountains on receipt of \$2.50. Pacific Coast and Parcel Post Countries \$3. Circular free.

Benjamin Air Rifle & Mfg. Co., 506 N. Broadway, St. Louis, Mo.

salt water of the sea. It would seem a difficult task to find these threads of fresh water amid the ocean's volume, but the thirsty islanders are thought to have found them ages ago and to have passed on their location from generation to generation.

A diver equips himself with a water bag made of skins, the mouth of which is closed, and descends to



TYPEWRITERS ALL MAKES

All the Standard Machines **SOLD** or **RENTED ANYWHERE** at $\frac{1}{4}$ to $\frac{1}{2}$ M.F.'S PRICES, allowing **RENTAL TO APPLY ON PRICE**. Shipped with privilege of examination. Write for Illustrated Catalog 980. TYPEWRITER EMPORIUM, 92-94 Lake St., CHICAGO

Rémoh Gems

Not Imitations

The greatest triumph of the electric furnace—a marvelously reconstructed gem. *Looks like a diamond—wears like a diamond—brilliancy guaranteed forever—stands filing, fire and acid like a diamond. Has no paste, foil or artificial backing.* Set only in 14 Karat Solid gold mountings. 1-30th., the cost of diamonds. Guaranteed to contain no glass—*will cut glass*. Sent on approval. Money cheerfully refunded if not perfectly satisfactory. Write today for our De-Luxe Jewel Book—its free for the asking. Address—

Rémoh Jewelry Co.
429 N Broadway
St. Louis, Mo.



Greider's Fine Catalogue

of purebred poultry, for 1911, over 200 pages, 37 large colored pictures of fowls, calendar for each month, illustrations, descriptions, photos, incubators, brooders, information, and all details concerning the business, where and how to buy fine poultry, eggs for hatching, supplies, etc. at lowest cost, in fact the greatest poultry catalog ever published. Send 15c for this handsome book. B. H. GREIDER, Box 2, RICEMS, PA.



\$7.50 FREIGHT PREPAID FOR 120-EGG

INCUBATOR SAFE

Biggest value of the year. Write for low prices on larger sizes, delivered.

Famous RELIANCE

Simplest—surest—safest. Metal-covered; metal legs and lamp. Delivered free east of Missouri River, and north of Tennessee. Prices quoted to points beyond. Write for Free Book.

RELIANCE INCUBATOR CO., Box 589 Freeport, Ill.



WIZARD

EYE PROBE

A boon to mechanics, metal or wood workers, motorists, railroaders, travelers, laborers. Universally used and endorsed by leading oculists. This marvelous little instrument will pay for itself ten times over the first time you use it. Cinders, specks, dust or any irritating substance removed from the eye instantly and without pain. Put up in neat celluloid case and can be carried in the vest pocket. Mailed postpaid to any address for \$1.00.

THE ARLINGTON CO., 12 Hill Bldg., COLUMBUS, OHIO



LET ME TEACH YOU ART

Just 30 Days at My Expense



Right in your own home, through my illustrated correspondence lessons and personal criticisms. If you are interested in Art and will write me now, I will give you one full month's instruction in

DRAWING, ILLUSTRATING, CARTOONING, DESIGNING, WATER-COLOR and OIL PAINTING or CHINA DECORATION

at my expense, without one cent of cost to yourself.

I make this special offer to introduce my methods into every home where the love for the beautiful and artistic prevails.

This offer is without a parallel in the History of Art Education. No other school or teacher has ever made such an offer. My course is endorsed by many eminent artists—the very fact that my methods have been adopted by many schools and teachers is proof enough in itself that my course is all and more than I claim for it. Many enthusiastic students and graduates all over the world, some of them now men and women of great prominence, prove my success.

If you love the beautiful you possess artistic talent. Let me develop that talent. I can give you a training that not only commands admiration, and paves the way for rapid social distinction, but one that may enable you to earn a large income as an illustrator, designer or cartoonist. Competent artists are in great demand—many

Earn from \$25.00 to \$50.00 per Week, Even More.

If you are interested, write me now and I will send you postage prepaid, my Fine Art Prospectus and full particulars how you may secure 30 days' instruction in Art at my expense. Simply sign the coupon and mail it or write me a letter or postal today.

J. JAN DVORAK, President
Fine Arts Institute, Studio 1192
OMAHA, NEB.

Mail Today for Fine Art Prospectus.

Cut Out and

J. JAN DVORAK, Pres., Fine Arts Institute.
 Studio 1192, OMAHA, NEB.

Dear Sir:—I am interested in your Art Course. Please send me your Fine Art Prospectus and full information how I can secure 30 days' instruction in Art at your expense

Name in full.....

Address in full.....

the bottom of the harbor at a point where one of the springs issues. The bag is carefully inverted over the current of fresh water as it flows up from the sand, the mouth is opened, the skin is filled, then the mouth is shut fast and the diver returns to the boat awaiting him on the surface.

One scientist gives it as his belief that at some period in the shadowy past that which is now the harbor's bottom was not touched by the sea. The springs were then on the shore and ready for the islanders' needs. Little by little the sea encroached on the land, but the location of the wonderful springs was not forgotten.—Marine Journal.



Every Boy His Own Toymaker

Greatest boys' book ever written. Tells how to make a Steam Engine, Microscope, an Electric Telegraph, Telephone, Magic Lantern, Boats, kites, balloons, electrical and mechanical toys, traps, fishing tackle. 200 illustrations. Price only 10c postpaid, \$ for 25c. Western Puzzle Co., St. Paul, Minn.

Make a Motorcycle of Your Bike



at small cost, by using our Attachable Outfit. It fits any bicycle. Send stamp for catalog. Send 15 cents for "The Motorcycle Manual." It treats of motorcycles; how to get more power, etc.

SHAW MFG. CO., Dept. B, Galesburg, Kan.

CACHOO!

Make the whole family and all your friends "just sneeze their heads off" without knowing why, with CACHOO, the new long distance harmless snuff. Sent anywhere for 10c. Catalog included FREE.



P. T. & N. CO., Department B, Chicago, Ill.



Geisha Diamonds

THE LATEST SCIENTIFIC DISCOVERY

Bright, sparkling, beautiful. For brilliancy they equal the genuine, standing all test and puzzle experts. One twentieth the expense. Sent free with privilege of examination. For particulars, prices, etc., address

THE R. GREGG MFG. & IMPT. CO.
 Dept. H, 517 Jackson Blvd., Chicago, Ill.

BUY PLUMBING SUPPLIES AT WHOLESALE



Will Save You 30%
 Don't pay retail prices. Full stock on hand for prompt shipment. Send for free catalog.
 R. P. KAROL, 768 to 772 West Harrison St., Chicago



Cold-Proof Wool Outfit

FOR MEN, WOMEN AND CHILDREN
 Gray or white Sweater Coat. Toque to match, and Hair Seal Plush Back Gloves, regular \$3.00 value, sent direct from the mill to any address in U. S.

Prepaid for \$2.00

Coat alone \$1.50, Toque 40 cts., Gloves 35 cts. Send measurements—head, chest and knuckles.

ORDER TODAY
LOWER KNITTING MILLS CO.
 Box 402, Little Falls, N. Y.

UNITS

of Orchard Property (*Income Bearing*)

will materially increase your income—if you have funds for investment in either small or large amounts. 24 page Illustrated Descriptive Booklet telling of the Spokane Country Apple Industry will be mailed on request. Just address

A. G. Hanauer, Pres't,
 453 AA First Nat'l Bank Bldg., Chicago.

"I Made \$20 Today"

Sold 48 This Week, profit \$88.80,
Writes M. G. Clark, Mont.

"WOMEN BUY AT SIGHT"

Vibration Does the Work



"Started yesterday; sold 10, and today 12 more. It's a gold mine. Rush 50 more," writes J. H. Hodson, N. Y. Hundreds of men and women making **\$50 to \$100 a Week**

actually making a week's wages every day. They're banking money, buying homes, automobiles. New discovery makes it easy for them—will do the same for you. Tremendous sale of the

Home Comfort Scrubbing Machine

breaks all records. New, popular, irresistible—double your money every sale. Every housewife a customer. World's greatest labor saving invention. **No more back breaking, floor scrubbing days.** New marvelous machine replaces hands, brushes, rags, buckets. **Vibration does the work.** Scrubs, cleans, brightens—eats dirt—works like magic. A God-send to women. **Self feeding, self cleaning, self sudsing.** Turns scrubbing drudgery into neat, easy, quick, pleasant task. **Child can do it the Home Comfort way. Weighs 5 pounds. Sells for \$3.25—lasts for years. Not sold in stores. Home Comfort is truly a never ending household boon. Pleases, astonishes! Customers wonder how they ever got along without it.**

Mrs. Harris, Ill., writes: "Home Comfort has been a God-send. It's so easy to scrub and clean. Really wonderful how quick it works."



\$3.25

Mrs. H. Cole, N. Y., writes: "I am simply delighted. Robs scrubbing of all its hard work and takes so little time. Can clean dirtiest floors with scarcely any effort." C. Barnes, S. C., writes: "No other invention means so much to the home. I am booking orders like lightning. It takes every woman by storm." What woman hasn't been eagerly waiting for the Scrubbing Machine? It's here—perfected—selling like wildfire. Sells for \$3.25—banishes forever woman's worst torture. Could anything be more appreciated, popular, irresistible? **Don't delay—seize this live opportunity. Be first—get exclusive territory—make a fortune.** Send today for agency, free sample and credit terms.

SANITARY SUPPLY CO., Box 185, Sta. F, TOLEDO, OHIO



BIG MAIL FREE

Your **NAME PRINTED** in our Mailing Directory and sent to 10,000 firms all over the world so they can send you **FREE Samples: Catalogs, Books, Papers, Magazines, etc., etc.** Send 20 cents to cover cost of printing your name and you will receive a big mail **FREE.**

Ingram, Va., Jan. 7, 1910. Mr. Anderson, I have already received more than 2,000 parcels of mail, and still they come, scores of papers, samples, magazines, etc., for which I had often paid 10 to 25 cents each. R. T. James. Send to **ANDERSON, "The Mail Man," Box 5657, JAMESTOWN, N. Y.**



SCHACHT

3 Cars in 1—\$850.00

The Schacht is the greatest under \$1000 car ever put on the market for it not only is a remarkably staunch and speedy roadster, but the addition of a rear seat makes of it a big, roomy family car; or the addition of a box, an up-to-date delivery car.

SEND FOR CATALOG

THE SCHACHT MOTOR CAR CO.
2802 Spring Grove Ave., CINCINNATI, OHIO



I Made \$15. A Day

Selling Metallic Signs What this man did you can do. Easy money. Everybody buys quick. Best letters ever made for signs on store fronts, office windows, house numbers, etc; resembles finest gold leaf. Letters all ready to put on. Put up a complete sign in a few minutes. Big demand everywhere. A gold mine for agents. Great side-line for traveling men. Write today for free sample of letters and bona fide testimonials from those who have made big money. Make more easy money than you ever made before.

METALLIC SIGN LETTER CO., 406 N. Clark St. Chicago

AN ANCIENT MEXICAN MUSICAL INSTRUMENT—The "marimba," an antique instrument, is said to have been found in use among the Indians when the conquerors arrived. It is at the present time in common use in Chiapas and through the southern regions of Mexico; also in Guatemala. It might be compared to an enormous xylophone, but with the metallic sound absent, being made entirely of wood, the body, which rests on four legs, constructed of cedar and the keys of horniguilla wood, graduated strips of this latter re-producing the different notes, the tones softened and resonated by sounding boxes underneath, sized according to the low or high notes; gum is used for joining the wood, woolen strings for holding the loose wooden keys on top, and the small vibration holes at the bottom of



CLASS PINS AND BADGES

FOR COLLEGE, SCHOOL, SOCIETY OR LODGE

Either style with any three letters and figures, one or two colors of enamel. Sterling Silver, 25c each, \$2.50 doz.; Silver Plate, 10c each, \$1.00 doz. Catalog free. Special designs also made for any School or Society, at attractive prices. Send idea for estimate. **BASTIAN BROS. CO., Dept. 487, ROCHESTER, N. Y.**



LESS THAN WHOLESALE

LESS because we sell for cash only, cutting bad debt losses, exorbitant installment charges and bookkeeping costs. LESS because we save you ALL the dealer's profits and expenses. LESS again because we sell only from our factory "DIRECT." STILL LESS because we ship in SECTIONS, cutting freight charges and expensive packing.

Extension Table and 4 Chairs, Solid Oak \$18.15

Choice of either style chair, Boston leather seats.

CATALOG of a score of other astonishing values sent with every order or mailed free. Write for it. **Your Money Back** any time you are not perfectly satisfied.

THE DIRECT FURNITURE CO.
291 Oak Street ANN ARBOR, MICH.



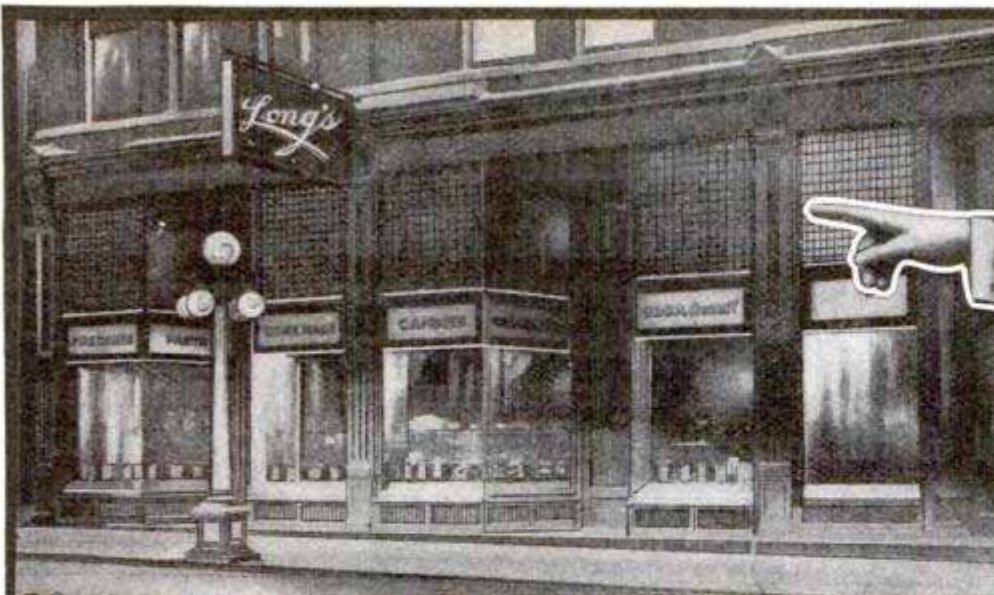

Popcorn Crispettes



Built this Big Business for me

Actual photograph of my big confectionery store, Springfield, Ohio

I am looking for other men who can make good — who have business aspirations — who are anxious to work for big things.

What are you going to do during the winter months? Just barely earn a living—keep wishing for something better to turn up. Don't do it.
Listen! Take that money you've laid up against the day of opportunity, invest it in a Long Popcorn Crispette Machine and build up a big business the same as I. If I did, you can—that's sure.

fectionery store; as fine a store of its kind as you can find anywhere. I built it with Popcorn Crispettes. **I made money because I had what people wanted, and I had it all to myself.** You can do the same.

Somewhere in your town there is a small vacant store—a part of a building—a window—a little nook where the rent isn't high. There you can set up your machine, and make and sell Crispettes.

Every time you take in a nickel you make three cents profit

Each day your business will grow—same as mine did. If you make and sell Popcorn Crispettes in your town, you'll have a good thing all to yourself, too; because I furnish a secret formula for making Crispettes, and it's different from anything else. Nobody but you can have it in your town. So you escape competition. People buy and buy and buy Long Popcorn Crispettes because of the taste. They're different from anything ever put out and folks want more and more of them. In the literature I am going to send you, I tell you all about them; about men who have made big money with the machine, and the men tell you how they did it. It's very interesting reading. Why plod along for a few paltry dollars a week—at the bidding of another who is no smarter than you are? **Why let some other fellow cash in on YOUR ability? Why let the other fellow get the big money while YOU do the hard work that earns it?** Is there anything in that? No!—and no man with any spunk and spirit is going to stand it very long. Neither are you. You've got your future to think about. **You have been looking for a good chance and here it is.** To the right man in each community I've got a great proposition to make. Are you one of them? **Success is yours if you go after it.** A splendid opportunity faces you. It may never come your way again.



Can you afford to pass it by? Decide now to gain success. Assert yourself—be independent—discover the hidden powers in your nature. Cut loose from irksome tasks—long hours—poor pay. Enjoy the fruits of your labor yourself. Reap the benefits of your efforts. Work all or part time—just evenings if you wish. At least investigate. Get full particulars—reports from users. See what others have done. Judge what you can do. Act now! Use the coupon.

W. Z. LONG
 205 High St., Springfield, O.

W. Z. LONG
 Springfield, O.

Please send me full particulars about Crispette machine, and tell me how to start big paying business.

Name.....
 Address.....
 City..... State.....

the sounding boxes are covered with pigskin, waxed to hold it in place.

The marimba is played by four men, who strike the keys with what might be likened to diminutive drumsticks, made of hard wood and tipped with rubber. Many of these men play in a masterly style that astonishes and charms the unaccustomed listener. The tones produced are somewhat similar to those of the harp, and the "arias" rendered are often indescribably sweet and emotional, most of them native compositions, resembling in character the plaintive music of Andalusia.—Consular Report.

FOOT AGONY Instantaneous relief for callous, or tender spots on soles. No chemicals. A mechanical device. Material and instructions mailed. 50 cents. Coin, or stamps.
C. H. FLATT & CO. 118 Market Street, NEWARK, N. J.

GRAY MOTORS

6 HORSE POWER COMPLETE \$94 Absolutely Guaranteed by a Responsible concern.
 1, 2 & 3 Cylinders, 3 to 30 H.P.
 Write for complete catalog today—tells all about how these high grade motors are built in the LARGEST PLANT IN THE WORLD devoted exclusively to the manufacture of 2-cycle motors. **GRAY MOTOR CO., 61 Leib St., Detroit, Mich.**

WHEN YOU WANT ANYTHING AND DON'T KNOW WHERE TO FIND IT—WRITE BUREAU OF INFORMATION, POPULAR MECHANICS, CHICAGO

LOFTIS SYSTEM
DIAMONDS WATCHES
ON CREDIT

A Good New Year Resolution—Use the Loftis System It enables you to buy beautiful and valuable articles, either for your own use or as gifts, without the outlay of much money. By giving credit and lowest prices, we make \$5 or \$10 do the work that \$50 does in a cash store. **MAKE YOUR NEW YEAR SELECTIONS NOW** from our new 1911 catalog and we will send them for your inspection. If you like them pay one-fifth on delivery; balance in 8 equal monthly amounts. Don't delay. Write Today for our Catalog

LOFTIS Old Reliable, Original Diamond and Watch Credit House,
BROS. & CO. Dept. B173, 92 State St., Chicago, Ill.

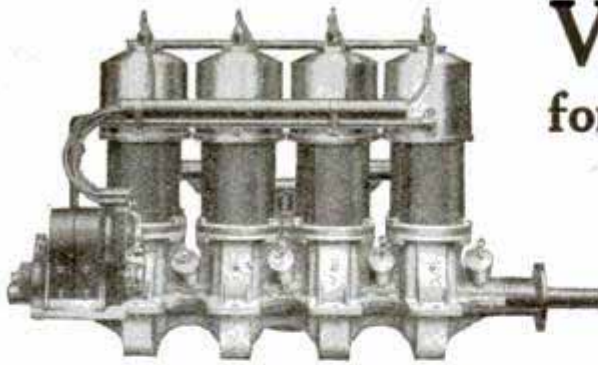

Valuable Information for Aeroplane or Motor Builders

DURING the past year we have personally inspected practically every successful aeroplane in America, watched hundreds of successful

flights, and built and flown experimental machines of our own. Naturally we have learned a great deal about the Science of Aviation and are glad to pass our information along to you. Just write our Information Department about any point that puzzles you. We may be able to solve your problems for you.

The success of Speed Boats equipped with Elbridge Engines in 1910 is a matter of Nautical history. It is due to a combination of the most perfect light motor in the world and the right hull.

Here again we have valuable information **FREE** for the asking. 1911 Marine and Aeronautic Catalogues sent on request. "American Amateur Aviation" a complete history of American Novice flights sent for ten cents in stamps.

ELBRIDGE ENGINE CO., 62 CULVER ROAD, ROCHESTER, N. Y.

Vacuum Cleaners!!

Best By Test

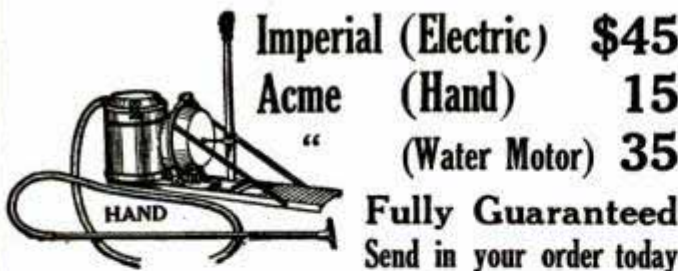

Imperial (Electric) \$45
Acme (Hand) 15
" (Water Motor) 35

Fully Guaranteed
Send in your order today

AGENTS WANTED

LIPPINCOTT S. S. & S. Co., Newark, N. J.



HOW TO ENTERTAIN Book with 250 Jokes and Riddles, 73 Toasts, 67 Parlor Tricks, 8 Fortune-Telling Secrets, 52 Money-Making Secrets, 22 Funny Readings. All 10c Postpaid.
J. C. DORN, 417 Dearborn St., Dept. 26, CHICAGO, ILL.

FREIGHT-CAR CORRESPONDENCE—Some of the clerks employed in a big manufacturing office down on the lower end of Staten Island have instituted a new fad—that of correspondence by freight car. Upon the sides of every car that comes into the yards of the company—and almost every railroad in the country is represented by the legends on the cars—the clerks write their names and addresses. Not long after one string of cars leaves the yards picture post cards begin to come in from small towns all over the country and even in Canada addressed to those whose names were scrawled in chalk on the sides of the empties. The Staten Island clerks in turn send post cards to every address they find on the freight cars, and so the endless chain lengthens.—New York Sun.

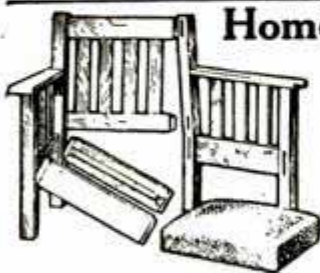

Home Built Arts & Crafts

Made in Sections. Half Retail Price. Large Rockers, Chairs, Settees, Tables and Dining-room furniture. Send for Catalog "P." Address 27 Fulton Street.

Grand Rapids Furn. Mfg. Co.
Grand Rapids, Mich.

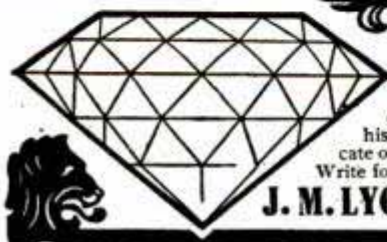

Diamonds on Credit

20% Down; 10% a Month

Every customer is protected by our written guarantee to refund his money if his dealer can duplicate our diamond at our price.

Write for Illustrated Catalog No. 3.

J. M. LYON & CO., 71-73 Nassau St. New York City



Laundry Tubs \$1⁷⁵

WATER PROOF CEMENT

Send 50c for drawing and instructions for making any number. Mould made of 3 simple

boxes. Big money maker. Plumbers' price \$8.00.

DuLANEY & CO., 213 N. 13th St., PHILADELPHIA, PA.

LET THIS LITTLE ENGINE DO YOUR WORK!

**WRITE FOR
FREE BOOK**

This wonderful little air-cooled engine is a complete portable power plant. Fits any pump. Capacity 800 to 1000 gals. per hour. Runs hand or foot power machines.

Fuller & Johnson FARM PUMP ENGINE

Thousands in use! Owners delighted! Simplest form of gasoline power in existence! Investigate—save money. **FREE!** Postal brings valuable book, giving information of great importance. Send at once. Address—

FULLER & JOHNSON MFG. CO., 2 Partridge St., MADISON, WIS.



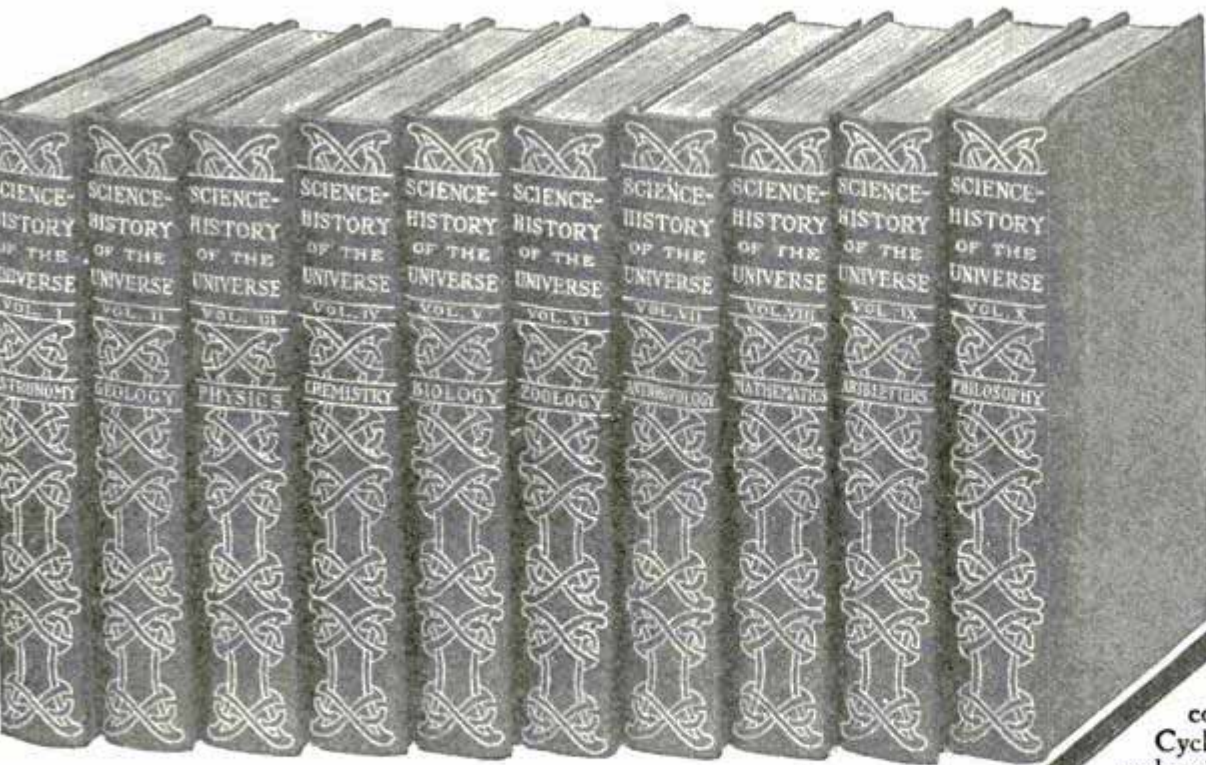

**Money
Back If
Books Are
Not
Satisfactory**

Actual size of each volume, $7\frac{1}{8}'' \times 4\frac{7}{8}'' \times 1''$; 300 pages to the volume. Beautifully bound in red buckram, tastefully lettered in gold.

**Here's the Whole
World's Scientific
Knowledge,
Written So
You Can
Under-
stand
It**

For the first time it is possible to place in your library at a very low cost a complete science Cyclopedia which is comprehensible to everyone. In these ten handy, volumes is the whole story of the universe. They trace the world along the long road of evolution, and man's origin from the earliest unicellular life to the complex and highly specialized creature who rules supreme today, who, with infinite toil, has wrested from nature the secrets told in these books.

This Cyclopedia is offered as a supplement to Technical World Magazine, because it is a record of the scientific facts that are now established, while Technical World records all new discoveries and achievements. So you see these books and a file of Technical World Magazines constitute a complete science history right down to the minute that the current number of Technical World is laid on your library table.

What Big Men Say.

Concentration into a set of ten books in such fascinatingly interesting shape is certainly an exceptionally masterful piece of editorial work. But what strikes one as a yet more puzzling wonder is that you give the complete set of these ten volumes as a premium for a merely nominal additional sum.

HUDSON MAXIM, The Inventor.

"I have received the ten volumes of the Science-History of the Universe and consider it an excellent work. It deals with subjects often treated in a technical way, in a manner that will interest all readers."

ALBERT J. BEVERIDGE,
U. S. Senate, Washington, D. C.

Our Liberal Offer.

We will send you the ten volumes of the Science-History of the Universe, carefully packed, all charges prepaid and Technical World Magazine for one year, twelve numbers, for only \$3.90. Send money in way most convenient. The books and magazines may go to any addresses you choose.

**Tech.
World
Magazine**
5758 Drexel Ave.
Chicago, U. S. A.

What These Great Books Contain:

- VOL. I. ASTRONOMY—Telescopes, Spectroscopes, Gravitation, Solar System, Stars.
- VOL. II. GEOLOGY—Structure, Eras, Mines, Minerals, Quarries.
- VOL. III. PHYSICS—Matter, Heat, Sound, Light, Magnetism, Electricity.
- VOL. IV. CHEMISTRY—Alchemy, Modern Chemistry, Agricultural, Physiology.
- VOL. V. BIOLOGY—Origin, Nutrition, Descent, Reproduction, Heredity, Evolution.
- VOL. VI. ZOOLOGY—Fossils, Insects, Vertebrates. BOTANY—Structure, Growth, Forestry.
- VOL. VII. ANTHROPOLOGY—Racial Characteristics. MEDICINE—Anatomy, Diagnosis, Surgery.
- VOL. VIII. MATHEMATICS—Arithmetic, Algebra, Geometry, Surveying.
- VOL. IX. ART—Architecture, Music. LITERATURE—Drama, Poets, Prose, Novels.
- VOL. X. PHILOSOPHY—Schools, Development, Political Economy, Ethics.

Science - History of the Universe, ten volumes prepaid, and Technical World Magazine for one full year, only \$3.90

**SEND TODAY
USE THE
COUPON**



NAME.....
ADDRESS.....
CITY.....
STATE.....

Gentlemen:— Enclosed please find \$3.90, for which send me the ten volumes of the Science-History of the Universe and Technical World Magazine for one year.
Pop. Mech. 2-11.



water breeze, every glance at a beautiful lake or river, attract the red-blooded human being and make him want a boat. It's your duty to yourself—to your family—to respond to that influence.



AGAIN—Do you know that by adding a little of your spare time with a little of your money these long winter evenings, you can profitably enjoy many a dull hour, and own a boat at a ridiculously low cost?

Make \$1.00 Do Exactly the Work of \$3.00

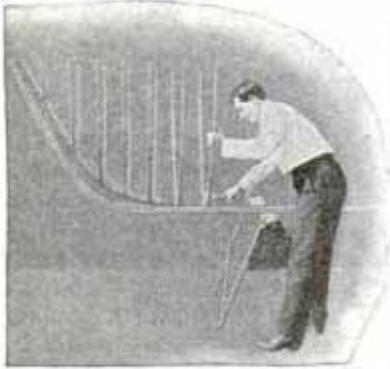

HOW?—By purchasing the full sized paper patterns and instructions for a boat, or by purchasing all or part of the material in the knock-down—that is—every piece cut to shape, machined and accurately fitted so that it will go together but one way only—the right way. You ask: Why does this method reduce the price? There are five reasons.

FIRST: You are spending a few pleasant hours instead of money in assembling this boat, which reduces the cost to you over half.

SECOND: You do not pay—but wait—space in this publication is mighty expensive. Why tell only part of the story? Our new catalog No. 24 goes into detail and a Postal Card will bring it to you. It shows an extensive line of boats, from canoes to cabin cruisers—every one backed by a Guarantee of Satisfaction or your money refunded. Send that Postal Now—Right Now.



Brooks Manufacturing Company 702 RUST AVENUE SAGINAW, MICH.



Stop Slipping and Sliding!

Thousands suffer severe injuries or death every Winter through falling on icy or snow-covered streets or walks.

Never-Slip Heel Teeth protect you absolutely—give safety, security and confidence in the slipperiest places. Enable you to walk rapidly, surely and safely even on the smoothest ice. Invisible. Applied in a minute. Regulated by a touch for in- or outdoor use. 25c per pair, postpaid.

AGENTS WANTED. SEND NOW. NEVER-SLIP CO., 1192 Bush Temple, Chicago

According to the prophets, the city of the future will have not only hot radiators, but cold radiators. These prophets have excellent janitors if they have no cold radiators now.—Chicago News.

When an aviator falls 1,600 ft., it is scarcely necessary for the telegraphic correspondents to burden the wires by enlarging upon the consequences of the fall.—Chicago Tribune.



A Talk to the Inventor

If there is any basis for an application in your idea, I can find it. But I will explain it to you before filing your application.

Copies of Nearest Patents, and Report, in Every Case

I have patented inventions reported unpatentable elsewhere.

Send for
FREE
BOOK

What You Should Know
What to Invent
What NOT to Invent
How to Sell Your Patent

H. L. WOODWARD, N. W. Cor. 9th and G Sts., Opposite Patent Office, WASHINGTON, D. C.



Rowboat \$20.00

MONEY IN BOAT LIVERY!

Can ship in any quantity. Need No Boat House. Never Leak, Rust, Check, Crack or Rot. Absolutely safe. Every boat has water-tight compartments, so cannot sink. 20 different designs. Demonstrator Agents Wanted in Every Community. Write TODAY for FREE Illustrated Catalog and Special Factory Prices. Michigan Steel Boat Co., 156 Bellevue Ave., Detroit, Mich.

This Engine FREE for 30 DAYS

Test it out and prove to yourself it's the best little all-around gasoline engine ever produced. Adapted for all uses in Shop, Farm and Home. We ship complete ready for use. Simply fill in the gasoline—give it a turn and away it goes.

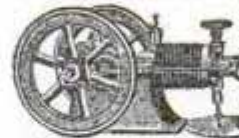

THOMPSON GASOLINE ENGINES

are built on correct lines. Let us send you free book and tell you all about our wonderful 30-Day Free Trial Offer. Write today.

J. THOMPSON & SONS MANUFACTURING CO., 22 Oak St., Beloit, Wis.

"Runs Like A Scared Rabbit"

Writes Cleburne Grady, Montgomery, Ala., who while yet a green hand at motors averaged 12.92 miles per hour on a 8.62 mile river trip.

Perfection Marine Motor



The "Perfection" is so worthy of the name it needs little attention. Just a regular flow of gasoline and a good spark will keep it working on hard towing, ferrying or pleasure jaunts—and it will last as long as

Write for catalog.

CAILLE PERFECTION MOTOR CO., 105 Caille St., Detroit, Mich.

Send for our Stationary Kerosene Engine Catalog if interested

the boat. We build 2, 3½, 3½, 4, 6 and 8 H. P. in the single cylinder and 8 to 30 H. P. in the two, three and four-cylinder engines. Prices range from \$40 to \$450 according to type and horse power.



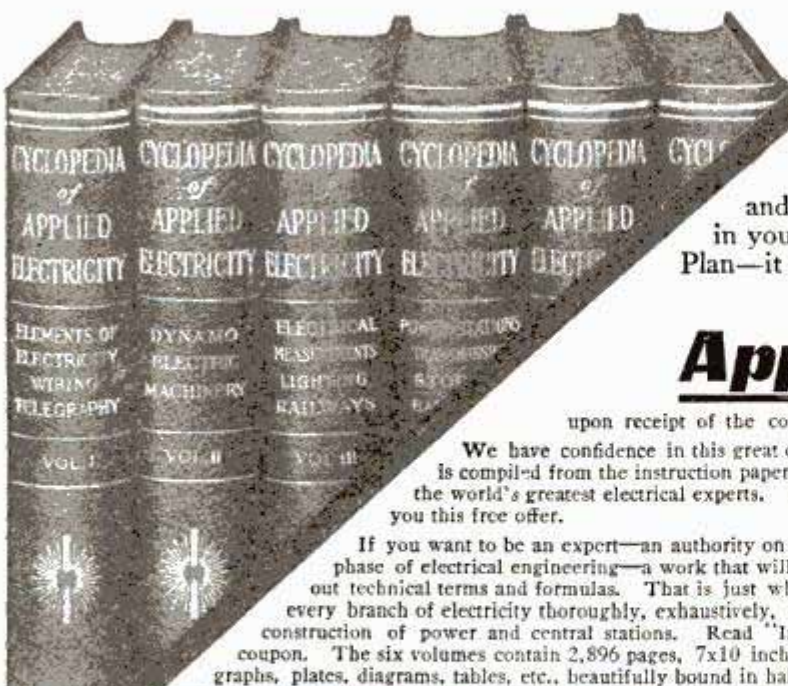

Here is the Standard Reference Work on Electricity

and we want you to examine it absolutely free of charge in your own home or office. Read our Liberal Selling Plan—it tells how we will send you the great six-volume

CYCLOPAEDIA OF Applied Electricity

upon receipt of the coupon and allow you to examine it for five days, free of charge. We have confidence in this great cyclopaedia; we know that it is the reliable authority on electricity. It is compiled from the instruction papers of the American School of Correspondence, written by thirty of the world's greatest electrical experts. We want you to endorse our claims and for this reason we make you this free offer.

If you want to be an expert—an authority on everything electrical, you need a work that covers every phase of electrical engineering—a work that will tell you what you want to know in plain English without technical terms and formulas. That is just what you have in this cyclopaedia. These books cover every branch of electricity thoroughly, exhaustively, from the elements of electricity to the design and construction of power and central stations. Read "Important Subjects Covered," and then mail the coupon. The six volumes contain 2,896 pages, 7x10 inches in size; 2,000 special illustrations, photographs, plates, diagrams, tables, etc., beautifully bound in half morocco; titles stamped in 23-karat gold.

This is Our Liberal Selling Plan.

The books will be sent you, express prepaid, for 5 days' free examination—upon receipt of the coupon. If you decide to keep the books, send us your initial payment of \$2.00 within five days and \$2.00 every month until you have paid the special price of \$18.80. The regular price is \$36.00. If, after thoroughly examining the books, you do not see your way clear to keep them, notify us and we will send for them at our expense. Send the coupon today.

IMPORTANT SUBJECTS COVERED

Types of Dynamos and Motors; Elevators; Direct-Current Motors; Electrical Measurements; Electric Lighting; Electric Railways; Alternating Current Motors, etc.; Electric Welding; Mercury-Vapor Converter; Management of Dynamos and Motors; Power Stations; Central-Station Engineering; Central-Station Design; Storage Batteries; Power Transmission; Electric Wiring; Electric Telegraphy; Wireless Telegraphy; Telephony; Automatic Telephone; Wireless Telephony, etc.

For a short time we will include as a monthly supplement, for one year, the TECHNICAL WORLD MAGAZINE. This is a regular \$1.50 monthly, full of Twentieth Century scientific facts, written in popular form. Also contains the latest discussions on timely topics in invention, discovery, industry, etc.

AMERICAN SCHOOL OF CORRESPONDENCE, CHICAGO, U. S. A.

P.M. 2-11
A. S. of C.
Please send set Cyclopaedia of Applied Electricity for five days' free examination, also Technical World for one year. I will send \$2.00 within 5 days and \$2.00 a month until I have paid \$18.80, or notify you and hold the books subject to your order. Title not to pass until fully paid.

NAME.....
ADDRESS.....
OCCUPATION.....
REFERENCES.....

AIRCRAFT

The World's Great Magazine of Aerial Flight

A Collection of Issues Makes a Complete Aeronautical Encyclopedia

Edited by Experts under the General Supervision of ALFRED W. LAWSON

Accurate Construction Work a Special Feature. Complete Records and Statistics. New Flyers Described. Details of Model Building.

Illustrations from every Quarter of the Globe

Recent numbers contain articles by such famous men as: Clement Ader, Louis Paulhan, Robert Esnault-Pelterie, Louis Bleriot, George F. Campbell Wood, Denys P. Myers, Hudson Maxim, Sir Hiram Maxim, A. Lawrence Rotch, General James Allen, Glen Curtiss, Chas. K. Hamilton, Claude Grahame-White, Major S. Reber, etc., etc.

After February 15th the subscription rate will be \$1.50 per year. Prior to that date it will be \$1.00 per year.

Four months trial subscription for 50 cents. Single copies, 15 cents. Back numbers 25 cents per copy, except April which is \$1.00 a copy, and December which is \$1.25 per copy.

Bound books in cloth of the first twelve numbers \$3.50.

THE LAWSON PUBLISHING COMPANY
37-39 E. 28th St., New York, U. S. A.

\$97.50 PER CARAT

Genuine Perfect Cut Diamonds



Just think of it!



We can save you from 25% to 40% on your diamond purchases. Only \$97.50 per carat for perfect cut, genuine diamonds—guaranteed by the firm of L. Basch & Co., known for 31 years as The Great Diamond House of Values.



The Basch Plan Every diamond purchased from us is accompanied by our LEGAL BINDING GUARANTEE, which entitles you to receive full purchase price in exchange for any other article selected from our catalogue, or a cash refund of full purchase price, less 10 per cent, any time within one year. It also describes fully every detail of the diamond,—value—weight—color, etc.



You Need Our Catalogue

It contains all information pertaining to diamonds; it tells you the only safe way to buy diamonds; You may select any article from this catalogue and have any weight diamond you may desire mounted therein. All articles selected will be shipped C. O. D., with the privilege of examination, and no obligation on your part to accept same unless entirely satisfactory. We pay all express charges. Write for Catalogue A. You cannot buy diamonds intelligently without it.



L. BASCH & COMPANY, 272 State St., CHICAGO, ILL.

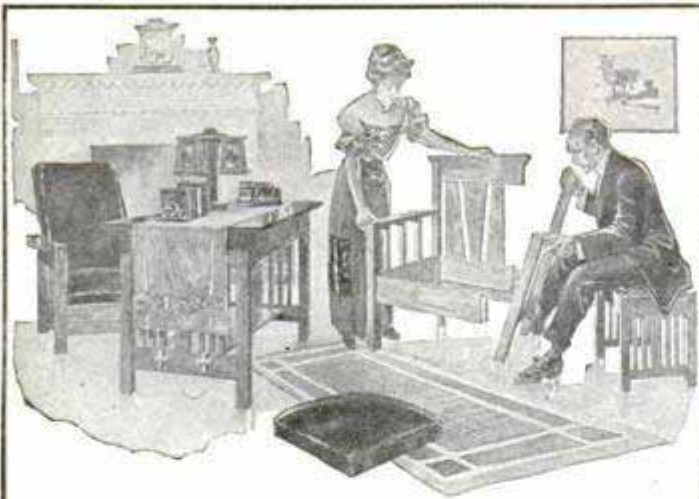

Double the Purchasing Power of Your Money

DO you know that home surroundings exert a wonderful influence on domestic happiness—on the development of high ideals—on ultimate success? You do?

Do you know that every room in your home can be artistically and elegantly furnished at a price that is ridiculously low? You don't? THEN you owe it to yourself—your family—to investigate this proposition. Not knowing means a direct loss to you.

\$1 DOES EXACTLY THE WORK OF \$2

HOW? By having the furniture shipped direct to you from the factory in the natural wood—or stained—and in assembled, easy-to-put-together sections, together with all the materials necessary to give it the proper finish.

You ask: How does this method reduce the price? There are five reasons:

FIRST: You pay but one profit only—the manufacturer's profit.

SECOND. You do not pay—but wait—space in this publication is mighty expensive. Why tell only part of the story? Our new Catalog No. 11 goes into detail and a POSTAL card will bring it to you. It shows an extensive line of furniture for every room in the house, club or office, each piece backed by a **guarantee of satisfaction** or your money refunded. Read it carefully and then you **will** know.

Send that Postal Now—Right Now

BROOKS MANUFACTURING COMPANY
702 Rust Ave., SAGINAW, MICH.

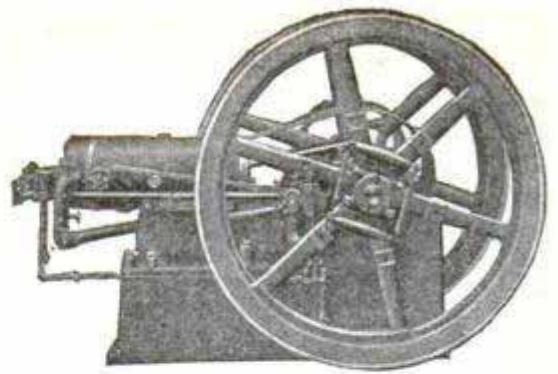

Maximum Efficiency

When there's work to do you want an engine that will do it—quickly—dependably—cheaply.

You want an engine that takes care of its job and leaves you free to take care of yours—that doesn't make you work double by continually shirking or getting out of order. In short, you want an I H C.

I H C Gasoline Engines

offer maximum efficiency at a minimum of time, trouble, and fuel.

Their few parts and simple construction make them almost trouble proof.

Their perfect design guarantees smooth and easy running.

Their cylinder construction gives the biggest returns in power from the least gasoline.

Let us prove to you in detail just why these things are so—just why I H C Gasoline Engines offer you the most satisfactory power you can get.

I H C Gasoline Engines are made in all styles and sizes to suit every need; horizontal or vertical, stationary, portable, or traction, air or water cooled. 1 to 45 horse-power.

Write for catalog to

The International Harvester Company of America
(INCORPORATED)
16 Harvester Building CHICAGO U S A

CARBORUNDUM

Will-keep your Razor-Sharp

Any Man Can Become Expert
in Honing His Razor



if he uses a Carborundum Hone in a Carborundum Holder.
The Carborundum Razor Hone is the finest, fastest cutting, most perfectly uniform hone made. The Carborundum Holder allows just enough swing to the hone to keep the razor blade always flat on the surface. It is automatic in action. It can't get wrong.

ASK YOUR DEALER—OR SEND DIRECT

No. 103-C—Razor Hone with Holder complete, \$2.75
Razor Hone without Holder . . . 1.00

Carborundum Razor Strops, the finest, most efficient strop made—46 different styles, 50c to \$2.50.

No. 440-H is extra value at \$1.00.

The Carborundum Company,
Niagara Falls,
N. Y.

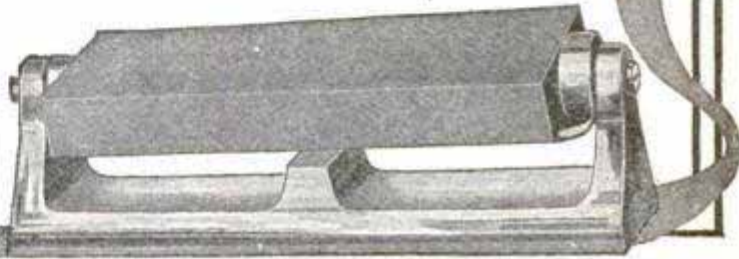

Irrigated Land

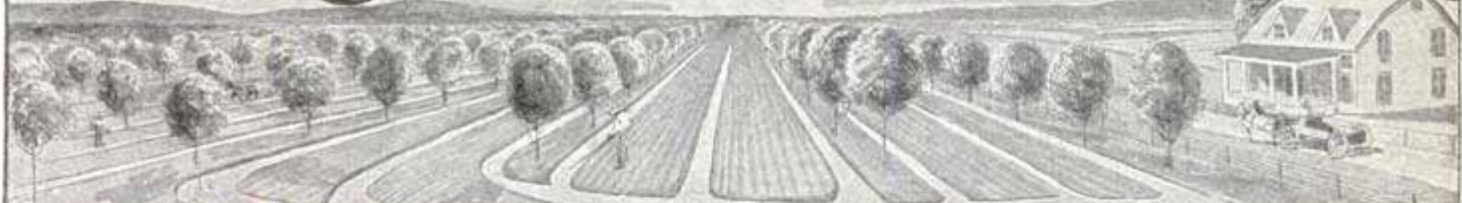

IN THE FINEST FRUIT AND ALFALFA VALLEY IN AMERICA

Fort Stockton, Texas

Irrigated land is now open to you at a development price. Richest soil in Pecos Valley, limestone formation (no gyp), natural flow of pure spring water exceeding 55,000,000 gallons per day for irrigation and domestic use; irrigation system completed and in full operation now; no waiting for water; many crops will yield profits of \$100 to \$1,000 per acre; no drought; no crop failures; finest all year round climate in the United States; altitude 3,050 feet above sea level.

Fort Stockton Farmers Made Big Profits Last Year

Peaches yielded \$15 per tree; Malaga grapes 50 pounds per vine; melons \$250 per acre; turnips \$300 per acre; sorghum \$120 per acre; maize \$100 per acre; alfalfa seven cuttings (average price during 1910, \$22 per ton). We are selling land to experienced irrigation farmers and fruit growers from Colorado, California, Oregon, Idaho, etc., where lands are valued at from \$200 to \$1,500 per acre, and bearing orchards at from \$2,000 to \$4,000 per acre, who state that this is the finest body of land and water supply they ever saw. Our clients also include bankers, merchants, farmers, gardeners, etc., who have inspected many irrigation projects, but did not find what they wanted in irrigated land until they saw Fort Stockton.

Fort Stockton is County Seat of Pecos County and important division point on Kansas City, Mexico & Orient Railway, now building into Fort Stockton; population now 1,200 and growing rapidly.

This is one irrigation project where the water supply has not varied in 50 years; where every drop of water used for irrigation is good to drink and where there is water in abundance for every acre of land that is irrigable. You cannot afford to buy land anywhere without seeing Fort Stockton.

Low Rate Excursions
the first and third Tuesday of each month.

References:
First National Bank,
Kansas City, Mo.;
First State Bank,
Fort Stockton, Texas.

Fort Stockton Irrigated Lands Company,
680 Fidelity Trust Bldg.,
Kansas City,
Mo.

"Greater Profits From The Soil"

Our book describing this land together with map and illustrated folder mailed FREE to all who send this coupon. Address

Fort Stockton Irrigated Lands Co.
680 Fidelity Trust Bldg., Kansas City, Mo.

Name.....
City.....
State.....

4000 A YEAR

AGENTS READ THIS

Explain this to customer, sale is made. Everlasting protection provided for little money. Feeling of safety, security and peace worth many times price. These are hard facts—proven day after day by our agents. Every word absolutely true and honest. Extinguisher is guaranteed in every particular. Harmless to everything but fire. Pronounced a marvel of science. Cuts cost of fire insurance. Anyone can use it—even a child. Acts instantly. Get an appointment.



sensation. Will soon be a fixture in every home, office, school, factory, farm house. Whirlwind selling campaign now on. Orders coming in by mail and wire. Just think! Edw. McGough, O., writes "Made \$160.00 last week." E. J. Dirr, Mich., says "Eighteen orders in one day—profit \$22.50." Boy 14 years old sold six in one afternoon. I. C. Gordon, Ind., telegraphs "Ship 150 today. All sold out."

LISTEN! Everybody is in mortal fear of fire; live in dread of it. Gasoline—oil—gas stoves explode every day—children play with matches—lamps tip over. Fire starts in hundreds of unexpected ways. Before help arrives homes are ruined, property destroyed, lives lost. **Just a little blaze starts it.** U. S. Fire Extinguisher prevents all this.

DEATH TO FIRE! no matter how started. When firebreaks out, grab Extinguisher, throw contents into center of blaze. **Presto!—fire out—property—home—lives saved.**

READ ON
We are a big, reliable manufacturing company. We offer honest, ambitious men a chance to make thousands of dollars. Opportunities like this only come once in a life time. This is your opportunity—your chance to make good. Jump into the big income class. There isn't one reason on earth why you shouldn't get there—make a great success—not one. Anyone can sell this wonderful device. One minute demonstration does the business. **You pocket 150% profit every sale.** Everywhere you go you find people eager to buy.

Wanted A Good, Live Hustler in Every Town to Represent Us.

Get busy! Break away. Discard that fear of self—that wonder, "Can I do it?" Sure you can. In you are great possibilities that you'll never discover till you wake up, assert yourself and go after success. When you've once started you'll find it ten times easier than you thought. Start. Start now. Don't let another day stand between you and success. If you do, you are just pushing away the very thing you are after. Do you want to work for someone else all your life—for small wages? NO! Certainly not. Then send us your name today. We'll give you a square deal—a co-operative assistance. You can't fail.

SEND NO MONEY Only your name and address on a postal card for complete information, offer and valuable statistics on fire losses **FREE.** Investigate. Write at once. Give name of county, and write your name plainly. Address

THE UNITED MFG. CO., 338 MILL STREET, LEIPSIC, OHIO
Reference: The Bank of Leipsic, Capital: \$1,000,000.00

WHEN YOU WANT ANYTHING AND DON'T KNOW WHERE TO FIND IT—WRITE BUREAU OF INFORMATION, POPULAR MECHANICS, CHICAGO

ALL THAT A MAN HATH—An automobile does not prove that a man has money, but that he did have.—Judge.

L. C. SMITH & BROS. TYPEWRITERS writing in sight.



Magnificent Steel Launch \$96

Complete With Engine, Ready to Run

18-20-23 and 27 ft. boats at proportionate prices. All launches tested and fitted with Detroit two-cycle reversible engines with speed controlling lever—simplest engine made—starts without cranking—has only 3 moving parts—anyone can run it. **The Safe Launch**—absolutely non-sinkable—needs no boathouse. All boats fitted with air-tight compartments—cannot sink, leak or rust. We are sole owners of the patents for the manufacture of rolled steel, lock-seamed, concealed riveted steel boats. Orders filled the day they are received. Boats shipped to every part of the world. **Free Catalog. Steel Rowboats, \$20.** (83)
MICHIGAN STEEL BOAT CO., 1271 Jefferson Avenue, Detroit, Mich., U. S. A.

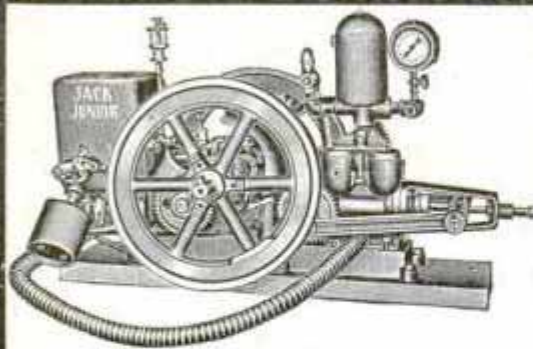

Fairbanks-Morse 1 H. P. Spraying Outfit

Will supply two nozzles with a steady pressure of 200 pounds. Easily moved about the orchard. Compact, strong, will give perfect service for years. We make larger outfits 2 H.P. and 3 H.P. skidded and portable.

Send for Catalog of Spraying Information No. 449 S

Fairbanks, Morse & Co., 481 Wabash Ave., Chicago

Home Lovers' Bargain Book

New Edition Ready—Showing 3,000 Housefurnishings Bought at Enormous Reductions. Terms—CASH or CREDIT, at an Equal Price

As our customers know, we buy nothing but bargains. All the time we have several millions of dollars waiting for makers who must have money—makers who must unload.

We contract for a factory's entire surplus output. Or we buy up factory over-stocks. We buy anything for the home which we can buy at a bargain. And every few months we get out a new Bargain Book.

Our latest book is now ready. It pictures more than 3,000 bargains in things for the home. Some of the prices are almost unbelievable. On every one we guarantee a saving of 15 to 50%. We want to mail you that book.

Pay as Convenient

We sell for cash or credit at an equal price. About 600,000 people have charge accounts here. They have goods sent on approval, and pay as convenient—a little each month. We allow on the average over a year to pay, without any interest or any extra price.

We are glad to give credit to anyone who buys things for the home. There is no security, no publicity, no red tape. Your promise to pay is just as good as the cash. This helps many people to buy things which they could not buy otherwise. Thousands of wives pay for household things out of chicken and butter money.

Bargains in

Furniture	Silverware
Carpets	Chinaware
Rugs	Graphophones
Draperies	Washing Machines
Stoves	Sewing Machines
Ranges	Baby Cabs
Pianos	Lamps and Clocks

Cash or Credit

A Month's Trial

Every article is sent on 30 days' approval. You have it a month before you actually buy it. If it isn't such a bargain as you expected you can return it at our expense. We will pay freight both ways.

You can see any one of these 3,000 bargains—right in your home—without

being obliged to keep it. If you don't keep it the trial won't cost you a penny.

Bargain Book Free

This mammoth book of 3,000 bargains will be mailed you free. Every woman will find it immensely interesting—to see the prices at which beautiful things can be bought. Some of the pictures are in actual colors.

Cut out this coupon and send it to us. The book will then come by next mail. Please do this before you forget it.

Cut Out This Coupon

SPIEGEL, MAY, STERN CO.
1299, 35th Street, Chicago

Mail me the Bargain Book.

Mail me the Stove Catalog.

Name

Post Office

State

I am particularly interested in

Name article you most desire.



No. 30X1820—Steel Range Bargain. Made in our famous Empire factory. One of the grandest ranges ever built. We guarantee a saving of at least 1/2 on all stoves sold by us. This style, bargain price **\$18.20** up according to size.
Cash or Credit



No. 4X1195—Astounding Combination Bookcase Bargain. Solid oak, golden finish, heavily carved. Has French plate mirror, large writing space, drawer and cabinet. Is 71 inches high and 38 inches wide. Dealer's price, \$16.50. Our bargain price **\$11.95**
Cash or Credit



LX485—English Folding Go-Cart Bargain. Newest 1911 design. We take the factory output at a specially low price. Has steel frame, fabricord leather upholstery and large rubber tires. The best collapsible go-cart on the market. Factory bargain price **\$4.85**
Cash or Credit



No. 50X435—Tufted Back, Upholstered Rocker Bargain. We bought 9,200 at actual factory cost price for spot cash from a manufacturer who required immediate money. This is a beautiful rocker upholstered in guaranteed fabricord leather. The American quarter-sawn oak frame is finely finished and handsomely carved. A great bargain. Factory bargain price **\$4.35**
Cash or Credit

SPIEGEL, MAY, STERN CO., 1299, 35th Street, Chicago, Ill.

BUY OR SELL ANDREWS



Saved
Owner
\$160



Hot Water Systems

WE have a perfected method of sending hot water heating plants "knock down," with pipe all cut to fit and with full plan and instructions for erecting. Everything the very best.

REGURGITATING SAFETY VALVE. This special Andrews Valve makes radiation one half hotter and increases capacity of piping.

LOCOMOTIVE STEEL BOILER is made of steel like power boilers, easiest to clean, more heating surface and fire travel. It costs more but saves \$25.00 to \$200.00 on coal yearly. Ask nearest users.

TEMPERATURE CONTROL is automatic, watches the fire and saves you the boiler.

OUR BIG FACTORY has capacity of 3000 Andrews Systems per year. It is equipped with special tools and labor saving devices that reduce labor to half usual cost. You share this saving, also save middlemen's profits by dealing direct with us.

Over 500 Miles of Andrews Systems in 44 States

OUR ENGINEERS design your plant from your rough sketch or architect's plans. Then they make it complete in the factory and ship it to you "knock-down" so the owner of a home or any handy man can easily put it in.

Buy Direct and Save Dealer's Profit. **SELL OUR SYSTEMS**

To a young man at all handy with tools it is easy to sell and install our systems. All he has to do is to send us rough sketches or floor plans giving dimensions of houses to be heated and we furnish free estimate and assist in every way. We want a number of additional agents in every part of the country. Whether you want to buy or sell, you should send today for our 72-p. book.

**Sold on 360 Days' Free Trial
Guaranteed by Bond.**

SEND FOR ANDREWS' BIG FREE BOOK ON HEATING, PLUMBING, WATER SUPPLY AND SEWAGE DISPOSAL

We Pay
the
Freight.
Old
Houses
Easily
Heated.

**ANDREWS
HEATING
COMPANY**

1177 Heating Bldg., Minneapolis, Minn.

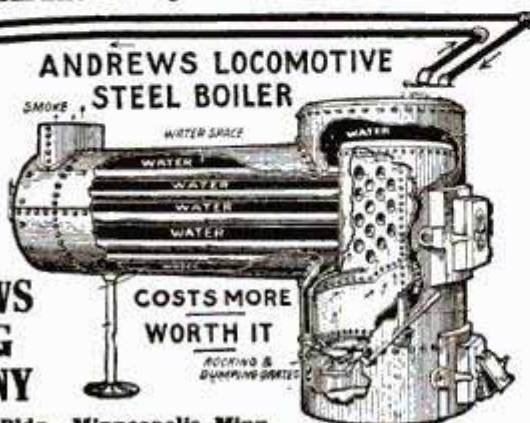

**COSTS MORE
WORTH IT**

ROCKING & PUMPING SYSTEM

Use this Typewriter 10-Days Free

Not a toy or rebuilt machine, but simplest, most durable standard typewriter made. Does all any \$100 machine will do and just as well. Been sold for fifteen years to business and professional men who do their own typewriting. The

Wellington Visible Typewriter

is low in price, high in quality. We save you money by dealing with you direct.

Mechanical features of the "Wellington" are correct. They mean permanent alignment, powerful manifolding qualities and long life. Our records tell of machines in constant use for 7 years without repairs. Machine has 28 keys, 84 characters and weighs 17 pounds complete. Stands 5 inches high.

We will ship machine for 10 days free trial and let it prove our claims. Write for full particulars.



Price \$60

Guaranteed 1 year

THE WILLIAMS MFG. CO., LTD.,
88 RIVER STREET,
PLATTSBURGH, N. Y.

GENUINE PRECIOUS

Stones,—cut, look and wear like Diamonds.
NEW DISCOVERY!
Wonderfully Fiery and SPARKLING.



MOST BRILLIANT

and hardest stones in existence—next to the regular Diamond.
Mounted in 14 K. Solid GOLD ONLY.

Will send for free examination by Express C. O. D. at following prices:
Ladies Tiffany Rings 1/2 ct. Stone, . . . \$5.50 1 ct. Stone, \$ 8.50.
Ladies Double Tiffany Rings 2-1/2 ct. Stones, \$8.50 2-1 ct. Stones, \$16.00.
Ladies Ear Drops (or Screws) 2-1/2 ct. Stones, \$8.50 2-1 ct. Stones, \$16.00.
Gents Heavy Tooth, Flat or round Belcher Rings 1/2 ct. Stone, \$9.75, 1 ct. \$13.00, 2 ct. Stone, \$19.50. Studs 1/2 ct. \$4.50, 1 ct. \$7.50, 2 ct. \$13.50.
Let us send you one of these surprisingly beautiful stones on approval.

E. D. FRETER & CO. 52 Dearborn Street CHICAGO ILL.

MODERN HOUSING IN THE SOUTH—There is no better way to gain an idea of how the south has prospered in the last dozen years than to look out of the window from a moving train at the houses and grounds of working men and think what they were a generation back. Then they were cabins, flat on the ground, often with earth floors, scattered higglety pigglety, surrounded with pools, heaps of filth, wreckage to which the roofs, the doors and the fences



"JARVIS"

Pumps and Water Systems, for City, Suburban or Farm Homes, will give you all the advantages of running water at small expense.

CATALOGUE ON REQUEST

JARVIS ENGINE AND MACHINE WORKS LANSING, MICH.

Turkish Baths at Home Do Wonders



There is an internal body-waste always going on. An over-accumulation of this poison means nerve-exhaustion. Drugs cannot drive it out. Take a scientific Turkish Bath at home, at cost of only 2c. a bath, by means of the

Robinson Turkish Bath Cabinet

and feel the rapid change in your condition inside of 30 minutes. It has produced astonishing results in men and women nervously exhausted and afflicted with rheumatism, blood, stomach and other troubles. Prominent physicians in many cases are abandoning drugs for this new treatment. The Robinson Bath Cabinet is the only scientifically constructed Bath Cabinet ever made—a model of ingenuity. Sold by dealers or sent direct, at prices to fit any purse. Send for illustrated booklet of astonishing facts, free with full information.

ROBINSON MFG. CO., Suite 152, Snowflake Bldg., TOLEDO, O.

\$38.95 BUYS THIS COMPLETE BATHROOM OUTFIT



MODERN BATHROOM FOR EVERY HOME

The Luxuries of Modern Plumbing at Half the Ordinary Cost

This outfit is complete—ready for installation. Our standard thread connection enables you to put it in yourself—without any knowledge of plumbing. Complete instructions with every outfit. We have put this outfit into 1900 homes.

Complete Pneumatic Water Supply Systems from \$42.00 upwards

Save \$100.00 to \$250.00 on your steam or hot water heating plants

Send in sketch of building, and we will quote you price on complete system that you can install yourself by following special plans and instructions with each system

Write for our 100 page Catalog FREE

Learn how you can eliminate exorbitant prices by buying direct from one of the largest concerns in the business established over thirty-four years. This catalog shows everything in plumbing and gas fitting that you could possibly use, and quotes you prices that you can not approach elsewhere. Wash stands, sinks, closets, bathtubs, pipe, fittings, steam and hot water heating plants, acetylene lighting plants, gas and electric fixtures, tools of all kinds.



A postal will bring the Catalog—Write today to Dept. A

M. J. GIBBONS ARCADE DAYTON, O.

constantly added, gates off the hinges and worn-out pots and kettles in the front yards. Now, trim rows of neat, well-painted cottages on foundations or stilts, tight shingles overhead, clean paths to the sidewalks, gardens at the side, flowers in front. The better housing of the working people in the manufacturing towns along the railroads must have absorbed hundreds of millions of the money made by the new south. Good housing rears up a more healthy and successful race. —Atlanta Constitution.

LEARN TO REPAIR AND RUN AUTOMOBILES



EARN BIG MONEY IN AUTOMOBILE BUSINESS

as a chauffeur, repairman, salesman. Work pleasant. Big demand for trained men. Fine chances for starting automobile liveries, agencies, taxicab and repair companies. Learn the automobile—every part, and its mechanical operation thoroughly and practically in a few weeks. Write today for our interesting free book and learn about the tremendous opportunities everywhere in

this new business and our excellent course of training.
KANSAS CITY AUTOMOBILE SCHOOL
(Conducted by CLIFF HOGAN)
(Largest and Best Equipped Automobile School in America)
2139 E. 15th Street, Kansas City, Mo.

Please Mention Popular Mechanics



One of 40 Designs.

A Wing Piano or Player Piano Shipped Absolutely FREE!

We, the manufacturers of Wing Pianos for 43 years, will send you a genuine Wing Piano, or Wing Player Piano, tested and guaranteed by us without one penny from you. We will ship the piano free with all freight paid in advance by us. You are not out one cent in money or trouble. This is an offer never equaled before by a big manufacturer. An offer direct from one of the largest manufacturers of pianos in the world. This offer is backed by a forty-year guarantee by the manufacturer. This offer places you in the very same position as if you were a dealer. You buy at exactly the same price as the dealer pays. You do business direct with the factory which has sent out more than 42,000 pianos.

Think of what this offer means! We allow you to keep the genuine Wing piano in your house for four full weeks without paying anybody anything. You play on it. Use it just as if it were your own. Take music lessons on it. Test it in every way. Compare it with any other piano you wish. Decide yourself. There won't be any salesman around to bother you. You may be sure that if you decide to keep the Wing none of the money goes into the salary of salesman. Every cent goes into the piano because you deal with the men who make the piano.

Did You Ever Have a Piano in Your Home?

If not, haven't you often—often—wished that you did have one? The delights of sitting before a splendid instrument—the supreme pleasure it gives—is known only to those possessing a good piano. Your opportunity is here now. You may have a piano in your home any time you want it. You

Have You an Old Organ or Piano?

If you have an old organ or piano we will allow you a good price in exchange for a Wing Piano. Get our free book which explains all about it.

may use it for 4 weeks positively without expense to you. After the four weeks' free trial are up make your decision. Either keep the piano or send it back, just as you choose. We ask you not to keep it unless you are fully satisfied—more than satisfied. Unless you are charmed with the delightful tone—the splendid beauty of the Wing Piano—we would rather you would not have it. Because we

want every Wing to sell another Wing.

If for any reason—any reason whatsoever—you desire to return the piano you are at liberty to do so. Then we will pay the freight back to our factory. You are not out one cent. You have had the use of the Wing Piano for four weeks. Send the free coupon for big piano book. This book tells you all about how to judge any pianos. Don't think of buying a piano until you have read this book.

Send FREE Coupon NOW For Big Piano Book

A book of complete Piano Information

It contains ten tests to apply to every piano. Apply these tests to any piano and you will know absolutely whether that piano is a good piano or not. This book is invaluable to anybody who intends to buy a piano now or in the future.

The New York World says: "A Book of Educational Interest every one should own."

Send this Free Coupon

WING & SON (Estab'd 1868)
13th Street and 9th Avenue
Department 1192
NEW YORK CITY

WING & SON [Est. 1868]
1192 9th Ave. and 13th St.,
New York City.

Gentlemen:—With the understanding that I am not buying anything you may send me the 156 p. Piano book containing the piano tests also your free shipment offer on the Wing Piano.

FREE Coupon

My Name.....

My Address.....

ORGAN

AT FACTORY PRICES

FREE

Music Instructions by our **DIAGRAM SYSTEM** and Piano Stool, if you write us at once.



You can now buy the famous Kimball Organs direct from the makers at factory prices. We will send them to reliable people anywhere, to be paid for on our extremely easy payment plan—**\$2.50 monthly and upwards, if desired.**

Operating the largest organ factory in the world, employing the largest capital, buying raw material in the greatest quantity for cash—the Kimball System of manufacturing and distributing positively saves you **\$20 to \$50 on strictly first-class organs.**

If you want an organ at all, you want a good one; a mere pretty case with no music in it will not do. **Secure at once** the old reliable Kimball Organ at **Factory Prices** and pay on convenient terms, and get **Free** our New Diagram System of Self-Instruction in Music, with which anyone can learn to play in a short time.

SEND TO-DAY FOR MONEY-SAVING PLAN AND 30 DAYS' FREE TRIAL OFFER

Under no circumstances can you afford to buy or consider any other organ until you have our money-saving proposition. Our half a century's manufacturing experience; our financially strong guarantee means much to you. The most inexperienced buyer, a thousand or more miles away, can deal with us as wisely as the shrewdest trader, or as though you were here in person, for your organ will be selected by an expert. A fine stool and music box free with each organ.

Write **TODAY** For Free Catalog

W. W. KIMBALL CO., 1892 Kimball Hall, CHICAGO, ILL.

AMAZING "DETROIT" KEROSENE ENGINE

Amazing "DETROIT" Kerosene Engine, shipped on 15 days' **FREE Trial**, proves kerosene cheapest, safest, most powerful fuel. If **satisfied**, pay lowest price ever given on reliable farm engine; if **not**, pay nothing.

Gasoline Going Up!

Automobile owners are burning up so much gasoline that the world's supply is running short. Gasoline is 9c to 15c higher than coal oil. Still going up. **Two pints** coal oil do work of **three pints** gasoline. No waste, no evaporation, no explosion from coal oil.

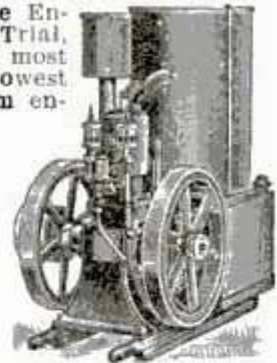

Amazing "DETROIT" Only \$45.00

and up. The "DETROIT" is the **only engine that handles coal oil successfully**; uses alcohol, gasoline and benzine, too. Starts without cranking. Basic patent—only three moving parts—no cams—no sprockets—no gears—no valves—the utmost in simplicity, power and strength. Mounted on skids. All sizes, 2 to 20 h.p., in stock ready to ship. Engine tested just before crating. Comes all ready to run. Pumps, saws, threshes, churns, separates milk, grinds feed, shells corn, runs home electric-lighting plant.

Sent any place on 15 days' Free Trial. Don't buy an engine till you investigate amazing, money-saving, power-saving "DETROIT." Thousands in use. Costs only postal to find out. If you are first in your neighborhood to write, we will allow you **Special Extra-Low Introductory price.** Write!

DETROIT ENGINE WORKS, 213 Bellevue Ave., DETROIT, MICH.

More people may die now of overeating than of starvation, as has been asserted. We hope it is true, and that it will continue to be true. Civilization began on the very day when man had enough to eat and something over.—Washington Post.

Bennett Typewriter

SOLD ON APPROVAL

Bennett

\$18

This wonderful new typewriter, at one-sixth the cost, with one-tenth the number of parts, does the same work as expensive machines with quickness, neatness and ease. The **Bennett** is a portable, visible-writing, ink-ribbon typewriter; standard keyboard; light, simple, speedy, compact, strong. In neat case, size only 2x5x11 inches, weight only 4½ pounds. Made from best materials by experts in the Elliott-Fisher factory. Fully guaranteed, \$18, and your money back if not satisfied. Send for free sample of writing and handsome catalog.

R. B. DENNETT TYPEWRITER CO., 366 Broadway, New York, U. S. A.

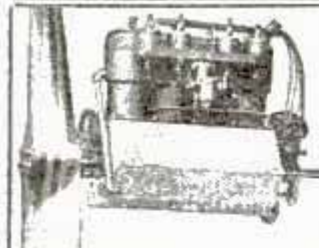
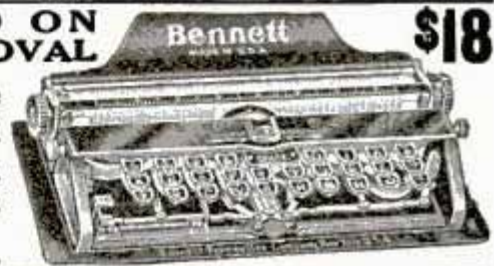

The AEROMOTOR

The most compact, powerful and light aeronautic power plant built; 4 and 6 cylinders—4 cycle—30 to 75 H. P.

Detroit Aeronautic Construction Co. 76 Crane Ave., DETROIT, MICH., U. S. A.

Here's An Opportunity

to double your present earning capacity. We want one agent in every factory to sell the best known and the best advertised hand soap on the American market. We give exclusive sale and only want ambitious men.

FOR PARTICULARS, WRITE TODAY

N. E. SUPPLY CO. 9 Fulton Place BOSTON, MASS.

Ho! For Pleasure and Health this Summer!

Get out on the water, in a strong, speedy motor boat, with the warm sun shining on the dancing waves! Breathe the fresh, invigorating air, that clears your lungs, sweeps the cobwebs from your brain, and sharpens your appetite. Spend your evenings and week-ends in this joyous, strength-giving sport! The means of pleasure is always at hand, don't cost much, and is always ready. Just go down to the dock, jump in the boat, and off you go!

IDEAL Launches

Here are the strongest, safest, handsomest little vessels ever built. Sold at a price that every man can pay. You ought to send for the free catalogue at once. It's full of pictures of the 16, 18, 20, 26 ft. models, describes each one, and describes the famous 2-cycle, non-cranking, GileEngine—simple, reversible, reliable—controlled by one lever.

Whether you can buy now or not, if you long for this matchless sport, send for the catalogue before you lay down this magazine. Put your name and address on a postal, and we'll mail the catalog at once.

GILE BOAT AND ENGINE COMPANY, 301 Main Street, Ludington, Mich.

Made right here in the heart of the motor boat country. Built for speed, room and safety. Classy design. Reliable under severest tests. Hulls of seasoned white oak and cypress, sheathed inside. Hulls given two coats of pure lead and oil, and two coats of best enamel. Brass deck hardware. Speed or weedless wheel and rudder.

No better sea boats can be built. Be sure to write for free catalogue.

Dealer's price to you now and easy monthly payments on this marvelous new type engine.

Best Shop Engine

3 horsepower.
Air Cooled.
Send free coupon.

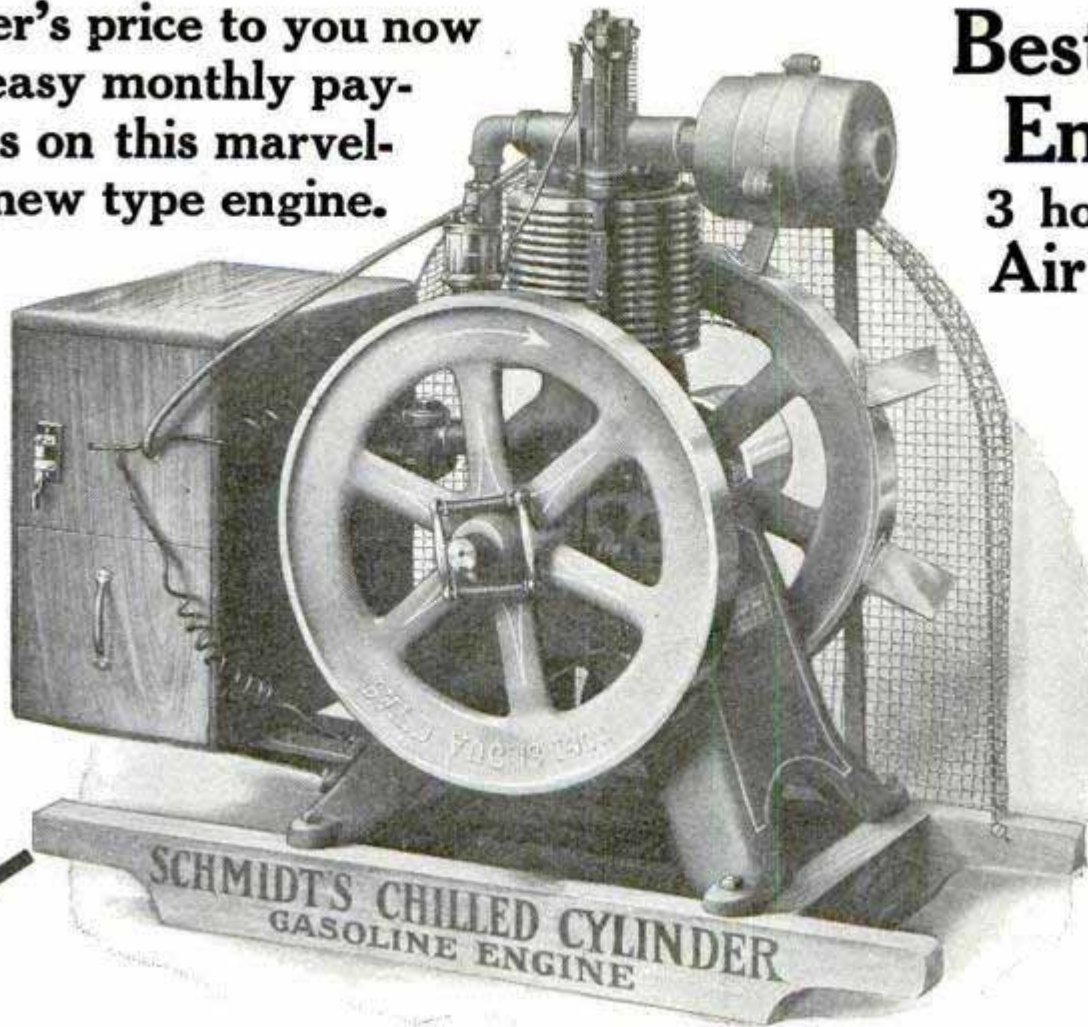

TAKES UP LESS FLOOR SPACE.

FREE

This Marvelous Chilled

Cylinder Gasoline Engine sent Free

Power Equipment for FARM OR SHOP.

Yes, absolutely free on the most liberal offer ever made. Use this engine ten days on your own place then send it back at our expense or keep it on easy monthly payments at dealer's price just as you choose. Send direct to the engine works and save dealer's profits.

Have your own power plant. With Schmidt's easy new type hangers, pulleys, shafting, bearing, etc., at small cost. On this special introductory offer you can get engine and power equipment at dealer's price. **SEND FREE COUPON NOW**

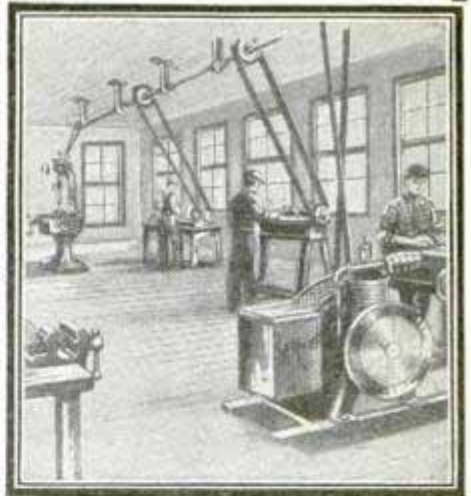

Send No Money Easy Payments

We send the engine to you on your request without a cent down in any way. Get all particulars of this amazing free offer.

5 Years' Guarantee

Take long time to pay on your own security. No notes or mortgages. Same price as for all cash. Most liberal terms ever made to you.

SCHMIDT'S Chilled Cylinder Gasoline Engine is absolutely guaranteed in every part for five full years. You take no risk of any kind. You get the best and most economical engine on earth. The only engine with a chilled cylinder for all kinds of power work at the engine works' price. Send the free coupon now for catalogs and all particulars free.

Schmidt Bros. Co. Engine Works
Dept. 1192 Davenport, Iowa

FREE COUPON

Schmidt Bros. Co. Engine Works
Dept. 1192, Davenport, Iowa

Gentlemen: Without any obligations on me you may send me free and prepaid catalog explaining your new free offer and easy payment terms on Schmidt's Chilled Cylinder Gasoline Engine.

Name

Address

**Suits in
All-Wool
Fabrics
Made to Fit**

**\$12.95
to
\$35.00**

**Smartest Styles
Sent on
Approval
Sold on Credit**

Samples Free



We are making clothes for tens of thousands of dressy young men. We save them from 30 to 50 per cent because we deal direct, and they take their own measurements. No local agents to pay.

We use nothing but all-wool fabrics, acid-tested, London shrunk. Clement clothes always hold their shape, and they never fade.

Clothes are sent on approval. If not satisfactory in fit, materials or tailoring you can send them back, and we will pay express both ways.

If you are perfectly satisfied you can pay a little each month for six months. No extra price, no interest, no security, no red tape. We simply open a charge account as we have with thousands of others.

The Clement Style Book for spring is ready, showing all the clever designs in young men's clothes.

With it we send big book of samples of all-wool fabrics in the newest patterns. Also a tailor's tape for taking measurements. The suit prices range from **\$12.95 to \$35.00**.

Send us your name and address—a postal card will do—and this whole new outfit will be mailed you free. Write us now. We will save you from **\$10 to \$20** on a suit for spring and you can have six months to pay. (16)

THE CLEMENT CO.

3502 Morgan St. CHICAGO

**WHEN YOU WANT ANYTHING AND DON'T KNOW
WHERE TO FIND IT—WRITE BUREAU OF
INFORMATION, POPULAR MECHANICS, CHICAGO**



TOOL CASES What's your trade? There's a "Gerstner" Case for every purpose and every one guaranteed. Every up-to-date mechanic should have one. Saves time and tools—there's a place for every one, easily picked out. This one is for machinists. Weighs 14 lbs. and carries a load of 300 lbs. Built right and the price is right. We build Tool Cases and Chests exclusively and ship direct from our factory. Tell us what is wanted

A. Gerstner & Sons

Mfrs. of Mechanics' High Grade Tool Cases
818 Germantown Street, DAYTON, OHIO

have won the admiration of boat experts the world over. Yet, they cost no more than many inferior makes. All are of the easiest reversing type and

START WITHOUT CRANKING

All sizes—2 to 120 H. P.—light, medium and heavy duty. Write today for handsome new catalog and name of nearest dealer.

TERMAAT & MONAHAN CO.

Dept. A, OSHKOSH, WIS. New York Branch, 133 Liberty Street

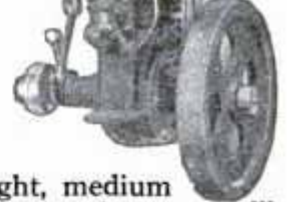

A BIG \$1 OFFER—KEITH'S



72-page monthly magazine for 6 months, and a copy of my new book of

100 PLANS

Keith's magazine is the recognized authority on building and decorating artistic homes. Each issue contains 8 to 10 plans by leading architects.

No. 37—\$2200. One of the 215
Subscription \$2 a year. In selecting a plan book get Keith's with a reputation behind it. Keith's 1911 Big Plan Books, direct or through Newsdealers \$1 each
215 Bungalows and Cottages 125 Plans costing \$5000 to \$6000
200 Plans costing \$2000 to \$4000 125 " " 6000 and up.
175 " " 4000 to 6000 100 " Cement and Brick.

Any one of these \$1.00 Plan Books FREE with a year's subscription \$2.00
A year's sub. to "Keith's" and any 2 books \$3.00; any 5 books, \$5.00
M. L. KEITH, 648 Lumber Exch., Minneapolis, Minn.

THE NEW CHAIR AND FURNITURE TIP



otherwise "The Acme of Silence," is one of the latest and biggest sellers we have. For agents it is a whirlwind and big money is made easy. This tip is noiseless and prolongs the life of the chair, rugs, carpet and floors, and will not scratch the most highly polished floor, gliding easily over any smooth surface.

Sample sets of four tips—prepaid by mail, \$0.15
Six sets of 24 tips—prepaid by mail, . . . 75

We also handle other specialties such as the Automatic Wrapping Paper Printer and Defiance Burglar Alarm. Write us for further particulars and circulars.

AUTOMATIC W. P. & P. D. CO., 341 Dearborn St., CHICAGO

HONEYMOON SHOE COLLECTION—Harry Peterson, a cabdriver at the Union station in Kansas City, says he has so many "honeymoon shoes" he doesn't know what to do with them. "Honeymoon shoes," he explains, "are the shoes pitched after the bride, only nowadays they aren't pitched so much as tied on the back axle of the cab that takes the bride and groom to the station. I've been saving the ones I got fastened on my cab in the last three years, and I've got 93 in a box in my room. I've got 42 men's shoes, 45 women's shoes and six white baby shoes."—Kansas City Star.



I Want the Man WHO KNOWS GOOD ARCHITECTURE to send for my new book

HOMES OF CHARACTER,

which contains over 40 choice designs of houses, cottages and bungalows. All new, practical plans, with concise descriptions and accurate cost estimates. Compiled by an architect of ability and 20 years' experience in building homes. \$1 prepaid. Sample pages, 2c.

John Henry Newson, 1255 Williamson Bldg., Cleveland, O.

Baldrige Reverse Gear
Doubles the Pleasure of Motor Boating

Move a single lever and your boat goes forward, backward or stops just as you please. Engine keeps running. Makes motor boating safe. Nearly 6,000 in use.

WRITE FOR DESCRIPTIVE BOOKLET

SMITH & BALDRIDGE MACHINE CO., 62 Amsterdam Avenue, DETROIT, MICHIGAN



MULLINS Steel Boats

Amazing Prices for 1911

This year we offer motor boats at prices never known before. There was never such value for the money. Large, powerful, speedy, with all the leading features of richest Mullins boats.

16 ft., \$115 up—24 and 26 ft., \$400 up

Naval architects have put their utmost skill in these boats. Hulls of steel give them strength, resistant qualities, rigidity and long life such as old-fashioned boats never knew. Their metal-covered-keel—a boat's backbone—withstands almost limitless punishment. They cannot sink. Air-tight compartments, power plant under cover, One Man Control, Silent Under Water Exhaust and start like an automobile. Will carry more, with comfort and safety, than any other boats of their size. Send for handsome catalog FREE.

THE W. H. MULLINS CO. 151 FRANKLIN ST., SALEM, O.

Will exhibit at: National Motor Boat and Engine Show, Mechanics Bldg., Boston, Jan. 28-Feb. 4, and National Motor Boat Show, Madison Sq. Garden, N. Y., Feb. 21-Mar. 4

A PERENNIAL PERIL—The crinoline of the '50s is believed to have been invented by one of three Frenchmen—a certain Joseph Thomas, who died a short time ago in the United States; a draper's assistant, who is nameless, or one Heindenrech, an executioner, who "flourished" during the second empire. On what one might very well call circumstantial evidence, I rather favor the executioner. It is pointed out that the soft hoop which now encircles so many smart skirts might easily develop into something much more substantial and that from wearing beehive bonnets Dame Fashion might easily turn for variety to beehive petticoats. But I hope the No-Crinoline League of 1896, if it is still in existence, has its corporate or secretarial eye on that hoop.—Ladies Pictorial.

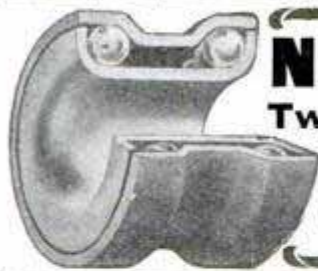

NEW KNIPE

Two Piece Multiple

MADE ONLY BY THE

KNIPE MFG. CO.

Sales Office, Drexel Bldg., Philadelphia
(Send for price list.)

Let SANDOW Run It!

Wonderful Work Engine

Farmers and Shop Owners, Stop Sweating! A few dollars gets this grand little work engine, complete and ready to run Cream Separators, Corn Shredders, Grist Mills, Feed Mills, Dynamos, Printing Presses, etc., etc. Gives a lifetime of steady service! All sizes: 2 to 20 h. p. No cranking! No cams! No gears! Only 3 moving parts. Finest construction. Thousands in use. Guaranteed 5 years. Write for Special Introductory Proposition.

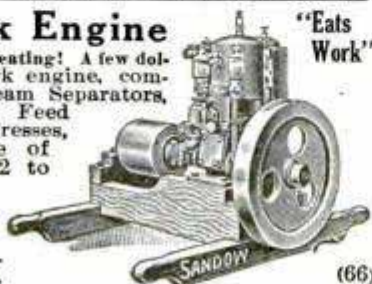

"Eats Work"

(66)

DETROIT MOTOR CAR SUPPLY CO., 2 Canton Ave., Detroit, Mich.

This Edison

Fireside Model
Phonograph

Shipped FREE!

Read This Great
NEW Offer



Thomas A Edison

Shipped FREE!

The latest and greatest offer on the Genuine Edison. This offer is for every one who has not yet heard our Edison in his own home—for you to hear concerts and entertainments by the world-famous musicians—just such entertainments as the metropolitan theaters are producing.

MY OFFER

I will send you this Genuine Edison Fireside Outfit (newest model) complete with 1 dozen Edison Gold Moulded and Amberol Records, for an absolutely Free Loan. I don't ask any money down or in advance. There are no C. O. D. shipments; no leases or mortgages—absolutely nothing but a plain out-and-out offer to ship you this phonograph together with a dozen records of your own selection on a free trial so that you can hear it and play it in your own home.

Why I Want to Lend You This Phonograph

I know that there are thousands of people who have never heard the Genuine Edison Phonograph. Now, there's only one way to convince people that the Edison is superior, and that is to let them actually see and hear this remarkable instrument for themselves. **That is why I am making this offer.** The only way to make you actually realize these things for yourself is to loan you a Genuine Edison Phonograph free and let you try it.

All You Need Do

All I ask you to do is to invite as many as possible of your friends to hear this wonderful Fireside Edison. I feel absolutely certain that out of the number of your friends who will hear your machine there will be at least one and probably more who will want an Edison of his own. If there isn't (and this sometimes happens) I won't blame you in the least. You won't be asked to act as our agent or even assist in the sale of a single instrument.

If You Want to Keep the Phonograph

that is if you wish to make the phonograph your own, you may do so. Either remit us the price in full, or if you prefer, we will allow you to pay for it on the easiest kind of payments.

Our Easy Payment Plan

Two dollars a month pays for an outfit. There is absolutely no lease or mortgage of any kind, no guarantee from a third party, no going before a notary, no publicity of any kind, and the payments are so very small, and our terms so liberal you never notice the payments.

FREE

Just sign this coupon now and mail it to us. I will send you our Edison Phonograph Catalog, the very latest list of Edison Gold Moulded and Amberol Records (1500 of them) and our Free Trial Certificate entitling you to this grand offer. Sign this coupon or send postal or letter now. No obligations—get catalog.

**F.K. BABSON
EDISON
PHONOGRAPH
DISTRIBUTERS**

Dept. 1192

**F. K. Babson,
EDISON PHONOGRAPH
DISTRIBUTERS**

Edison Block, Chicago, Ill.

Edison Block, Dept.
1192 Chicago, Ill.
Western Office: 65 Post
Street, San Francisco,
California. Canadian
Office: 355
Portage Ave.,
Winnipeg,
Canada.

Please send me, without any obligations, your New Edison Phonograph Catalog, list of Edison Gold Moulded and Amberol Records and Free Trial Certificate entitling me to your grand offer, all free.

Name

Address

THE LIGHTING TRIUMPH OF THE CENTURY

Wizard

LIGHTING SYSTEMS



OUR lighting systems represent the greatest progress in gasoline lighting. They are always ready and require no generation, and can be operated as conveniently as electricity by a switch from one point or individually with a chain pull, at one-tenth the cost. Write for catalog and further particulars. Agents wanted everywhere.

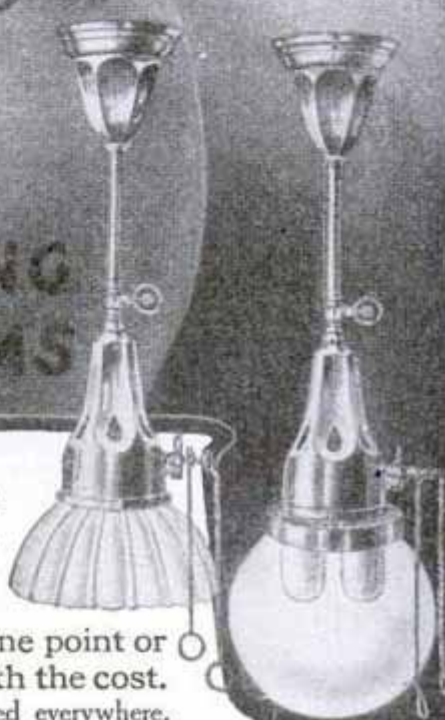

THE NAGEL-CHASE MFG. CO., 151-W. OHIO ST. CHICAGO, ILL., U.S.A.



Aladdin MANTLE Lamp BURNS KEROSENE (Coal Oil)

Produces powerful, white, more brilliant light than city gas, gasoline or electricity—simple, noiseless, odorless, clean, safe, durable—complete success—recognized world's standard. Fully Guaranteed.

T. H. BALL, California, SOLD 850

On money back guarantee—not one returned, C.E. Kramer made \$700 in 60 days. Complete line of lamps and chandeliers for homes, offices and public places. Ask nearest office for agency proposition or how to get lamp free

MANTLE LAMP CO. OF AMERICA, Dept 425
Chicago, Portland, Ore., Waterbury, Conn., Winnipeg, Montreal, Canada.

A FLOOD OF LIGHT FROM KEROSENE (COAL OIL)

WHEN YOU WANT ANYTHING AND DON'T KNOW WHERE TO FIND IT—WRITE BUREAU OF INFORMATION, POPULAR MECHANICS, CHICAGO

Nothing External Revolves

DETROIT REVERSE GEAR Starts—Reverses—Stops INSTANTANEOUSLY

All working parts submerged in oil bath at every revolution.

The Simplest, Most Reliable, Most Compact and the Smallest Perfect Marine Reverse Gear ever offered. No outside moving parts to throw the oil or grease, tear the skirts, bruise the hands or catch waste. No noise. Manufactured in sizes for from 2 to 80 H. P.



We carry all sizes in stock for immediate shipment. Guaranteed for one year. Write for special prices and free catalog. Valuable information from our Consultation Department FREE to motor boat men.

Detroit Engine Works, 24 Beaufait Ave., Detroit, Mich.

Please Mention Popular Mechanics



\$20⁰⁰ to \$50⁰⁰ a day Easily made

The "Auto" vacuum cleaner propels itself—the greatest and best Quick-Money maker ever put on the market.

Go In Business for Yourself

Let Us Send You an Auto Vacuum Cleaner on 30 Days' Trial



Propelled by its own power like an automobile. No horse required.

An Auto Vacuum House Cleaner should pay for itself in less than two months, out of the profit from the business after paying help and all expenses. It is capable of earning from \$250.00 to \$300.00 clear profit a month and we cannot see where there is a possible chance for anyone that buys a machine to fail to make big money, but every reason why they should make thousands of dollars.

The small machines for home use have never been a success because from lack of power, they will draw only the top dust from the room. The Auto Vacuum Cleaner does the same work in the same way as the large machines costing from \$2,000 to \$7,000 each. It has the same size hose.

Give Us a Chance to Help You

You Should Make \$2,500 to \$3,000 a Year on Each Machine

Make a start today and you will never regret it. If you are willing to hustle you can easily make from \$2,500 to \$3,000 a year on each machine you own. Be "Johnny on the Spot" with a machine and get the cream of the business. If you can get a number of these machines working, they should make you rich. We believe there never has been a machine that has so pleased everybody, and made so much money, as the house cleaning machine.

A Perfect Wonder

The Auto Vacuum reaches every crack, corner and crevice of the floor; the cracks in the wall, the ceiling and mouldings. It cleans and renovates bedding, comforts, blankets, mattresses and pillows.

We have seen it pull out pall after pall of dirt from houses—dirt impossible to remove completely by the ordinary means of beating, etc. When it is working on the streets, the dirt and filth pouring through the observation glass attracts a crowd of people that look with wonder. The ordinary house can be cleaned by two men with an Auto Vacuum House Cleaner in from one to four hours.

Most Practical Machine Ever Built

The Auto Vacuum House Cleaner

consists of powerful gasoline engine rated at over 12 Horse Power—4 cycle—two cylinder, 5-inch stroke, made from the best close grain cast metal, bored and reamed to the minutest detail; manganese bronze rods, babbitted pin ends; perfectly adjusted best metal crank shaft. Newest oiling devices, positive and perfect lubrication; the carburetor, commutator, spark coil and all other fittings the best on the market.

The whole is erected upon a substantial four wheeled, covered wagon propelled by its own power so that it can be moved from place to place and is equipped with vacuum condenser, water tank, vacuum gauge, two high-pressure suction hose, observation glass and cleaning tools, all properly connected and adjusted ready for work. The most practical and perfect machine of its kind ever built. Far exceeds this description.

Pay For it out of Your Profits

We want you to investigate our more than liberal offer.

We do not believe there is any business where so small an investment will bring such wonderful returns.

We have such implicit confidence in the wonderful money-making powers of the Auto Vacuum House Cleaner that we will ship one to any live man, who is honest and willing to work, on 30 days trial and allow you to pay for it in installments, and in such a way that your profit should easily take care of your payments.

In Our Illustrated Book we give full particulars as to how to organize your business and how to turn every minute of your time into money. We will send it to you free. Every ambitious man who has any "get up" in him should write at once for this book. A postage stamp will bring it to you and it will show you how you can become independent and one of the prosperous men in your community. Write at once.

The Toledo Auto Vacuum House Cleaner Co.
806 Dorr Street Toledo, Ohio

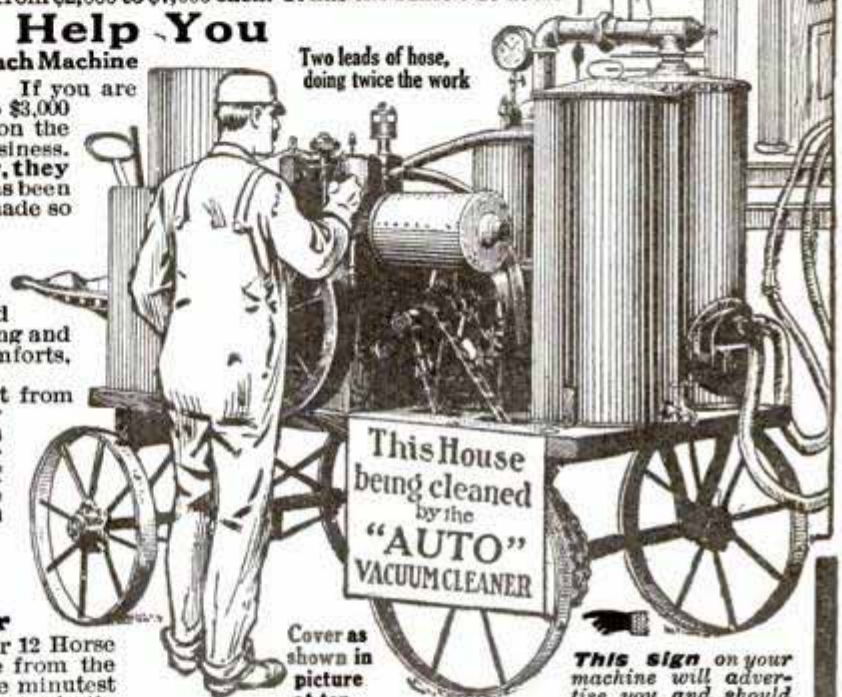

Two leads of hose, doing twice the work

Cover as shown in picture at top

This sign on your machine will advertise you and should bring you enough customers to keep you busy all the time.

"The machine is proving a great success—everything is turning out the way you said it would."—H. Bollinger. Mr. Hunter paid for 2 machines, paid all running expenses and saved \$1400 in 3 months. "Have plenty of work."—G. C. Woodworth. "I have worked 6 or 7 days and cleared about \$90."—J. R. Ryan. "From March 1st the machine has averaged \$25 per day."—F. Smith. "We have taken in at the rate of \$100 per week since we started."—F. F. Moe. "I have made \$175 in 2 weeks."—Frank S. Wilhite.

Send the Coupon for FREE BOOK, with full information, pictures and description of the different parts, testimonials and our EASY TERMS.

.....Cut off here - Write Plainly.....

Toledo Auto Vacuum House Cleaner Co.,
806 Dorr Street, Toledo, Ohio.

Please send me your free book and full information about The Auto Vacuum House Cleaner,

Name

Address

City.....State.....



CHIEF DRAFTSMAN

Will INSTRUCT PERSONALLY a limited number selected, ambitious men in

Practical Drafting, Detailing, Designing

Draftsmen Drawing \$125-\$150 Monthly

Are NOT MADE in Schoolrooms,
 Are NOT MADE by reading books,
 Are NOT MADE by making Copies,
 Are NOT MADE at home drawing pictures
 from printed book lesson.

LET ME TELL YOU:

It requires actual, practical, up-to-date
 DRAFTING-ROOM WORK to train YOU
 to gain the PRACTICAL EXPERIENCE
 that your employer will demand of you.



FREE

This \$13.85
**DRAWING
 OUTFIT**

and **Free Position.**

As Chief Draftsman of Engineering firm I know exactly the Quality and Quantity of PRACTICAL training, knowledge and actual up-to-date experience (not school knowledge) you must have, in order to obtain a good position and advance to highest salary.

I give **INSTRUCTION UNTIL COMPETENT** and
PLACED in POSITION at above Salary.

DON'T waste TIME and MONEY trying to learn from books or printed "STUFF" you can only learn on PRACTICAL WORK which I furnish you.

Address **CHIEF DRAFTSMAN**
Div. 19, Eng's Equip't Co. (Inc.), Chicago

Will You Try Johnson's Wood Finishes at our Expense

You can get samples of Johnson's Wood Finishes together with copy of their 25c Booklet, "The Proper Treatment for Floors, Woodwork and Furniture," absolutely Free. This booklet tells how to finish or refinish your woodwork, floors, and furniture—in fact, how to finish and refinish all wood.

Read Free Offer Below.

Johnson's Prepared Wax

used for polishing all kinds of furniture (including pianos), woodwork and floors. Used also for finish over dyed wood surfaces producing that beautiful artistic dull finish so much in vogue at the present time.



Johnson's Wood Dye

—not a varnish stain—but a deep-seated Dye that penetrates the wood and fixes a deep, rich, permanent color. Made in 14 attractive shades. With Johnson's Wood Dye you can make inexpensive soft woods as beautiful and artistic as the most expensive hard woods.

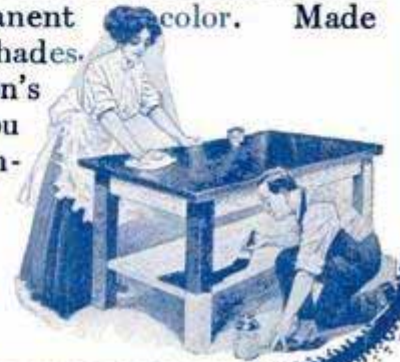

Johnson's Kleen Floor

For cleaning all polished floors, stairs, and varnished surfaces, keeping them in perfect condition. Applied with a cloth and rubbed dry, removes all spots and discolorations in and above the varnish. After using, give the surface a coat of Johnson's Prepared Wax and your floors and stairs will look better.



Johnson's Under-Lac

a thin, elastic spirit finish far superior to varnish or shellac. Not thick or sticky or slow-drying like varnish—neither does it dry too quickly like shellac. Especially good on linoleums and oilcloth, bringing out the pattern and giving a finish as glossy as new. Protects from wear—makes cleaning easy. Dries hard in an hour. Gallons \$2.50—quarts 70c—pints 40c.



Free Booklet and Sample Offer

Present coupon shown here to your leading paint dealer for samples and free book—or if more convenient mail coupon to us and we will send you, free and postpaid, book and samples—any two of the above in which you are interested. All we ask is that you test the samples and report results to us, asking your dealer to supply your future needs.

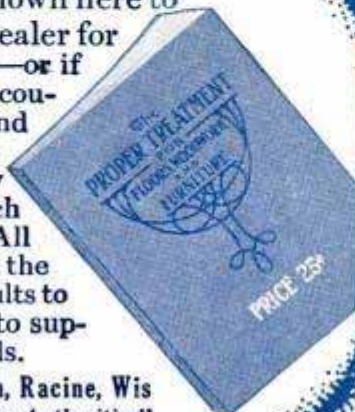

S. C. Johnson & Son, Racine, Wis
"The Wood Finishing Authorities"

Coupon

Mail me Free 25c. Book and Samples of the following:

.....

Name

Address

Dealer's Name

P. A.-2

Buy the Material Needed to Build This Home!

Price Includes Blue Prints; Architect's Specifications; Full Details; Working Plans and Itemized List of Material.

OUR HOUSE DESIGN No. 131

Here is a handsome Colonial residence of eight rooms, bath, pantry and numerous closets. It is 28 feet square, not including porches; full two stories high, and provided with every modern labor-saving convenience. Every detail has been carefully worked out, so that the finished product shows a happy blending of the useful with the ornamental. If you intend to build it will pay you to investigate our offer. This house will please you. You will enjoy it while you use it, and when you are through with it you can easily sell it at a good profit.



We Save You Big Money on Lumber and Building Material!

The Chicago House Wrecking Co. is the largest concern in the

world devoted to the sale of Lumber, Plumbing, Heating Apparatus and Building Material direct to the consumer. No one else can make you an offer like the one shown above. We propose to furnish you everything needed for the construction of this building except Plumbing, Heating and Masonry material. Write for exact details of what we furnish. It will be in accordance with our specifications, which are so clear that there will be no possible misunderstanding.

How We Operate

We purchase at Sheriffs' Sales, Receivers' Sales and Manufacturers' Sales, besides owning outright sawmills and lumber yards. Usually when you purchase your building material for the complete home shown above, elsewhere, it will cost you from 50 to 60 per cent more than we ask for it. By our "direct to you" methods we eliminate several middlemen's profits. We can prove this to you.

What Our Stock Consists of

We have everything needed in Building Material for a building of any sort. Lumber, Sash, Doors, Millwork, Structural Iron, Pipe, Valves and Fittings, Steel and Prepared Roofing. Our stock includes Dry Goods, Clothing, Furniture, Rugs, Groceries, etc, Machinery, Hardware, Wire Fencing—in fact, anything required to build or equip. Everything for the Home, the Office, the Factory or the Field, besides everything to wear or to eat. Send us your carpenter's or contractor's bill for our low estimate. We will prove our ability to save you money. WRITE US TODAY, giving a complete list of everything you need.

Free Book of Plans

We publish a handsome, illustrated book containing designs of Houses, Cottages, Bungalows, Barns, etc. We can furnish the material complete for any of these designs. This book is mailed free to those who correctly fill in the coupon below. Even if you have no immediate intention of building, we advise that you obtain a copy of our FREE BOOK OF PLANS. It's a valuable book.

Our Guarantee

This company has a capital stock and surplus of over \$1,000,000. We guarantee absolute satisfaction in every detail. If you buy any material from us not as represented, we will take it back at our freight expense and return your money. We recognize the virtue of a satisfied customer. We will in every instance "Make Good." Thousands of satisfied customers prove this. We refer you to any bank or banker anywhere. Look us up in the Mercantile Agencies. Ask any Express Company. Write to the publisher of this publication. Our responsibility is unquestioned.

\$2.00 Buys a Complete Set of Blue Prints

We send you a set of plans for the house described above, including the necessary specifications and complete list of material, transportation and complete list of material, transportation and complete list of material, if you can place an order with us for complete bill of material, we will credit your account in full for the \$2.00 received, or we will allow you to return these plans, specification and list of materials to us and we will refund \$1.50, thereby making the total cost to you 50 cents.

tion charges prepaid, for the low cost of \$2.00. This is only a deposit, a guarantee of good faith, and the proposition to you is that after receiving these blue prints, specifications and list of material, if you can place an order with us for complete bill of material, we will credit your account in full for the \$2.00 received, or we will allow you to return these plans, specification and list of materials to us and we will refund \$1.50, thereby making the total cost to you 50 cents.

High Grade Bathroom Outfits!



The price of this Bathroom Outfit \$37.50.

Plumbing material direct to you at Bargain prices. We have everything needed in Plumbing Material. Our prices mean a saving to you of 30 to 60 per cent. Here is an illustration of a bathroom outfit we are selling at \$37.50. Your plumber would ask you about \$60.00 for this same outfit. It is only one of many other complete outfits that we are offering at prices ranging from \$25.00 to \$50.00. Our catalog describes them in detail. Get our prices on Pipe and Fittings. Write us today.

60 per cent. Here is an illustration of a bathroom outfit we are selling at \$37.50. Your plumber would ask you about \$60.00 for this same outfit. It is only one of many other complete outfits that we are offering at prices ranging from \$25.00 to \$50.00. Our catalog describes them in detail. Get our prices on Pipe and Fittings. Write us today.

Hot Air Furnaces!

Don't let the contract for your hot air furnace until you get our figures. We will cut your local dealer's price in half. We can furnish you a complete equipment including pipes, registers, furnace; everything required at a price not much more than what an ordinary heating stove would cost you. Complete hot air heating plants \$48.00 up. Get our heating catalog at once. Tells you all about it. Write us today. We guarantee to save you money. We loan you tools. We make you plans. Every heating plant we sell is backed by our guarantee bond.



Hot Water Heating Plants!

We guarantee to save you 50 to 75 per cent on a modern hot water heating plant for your home. We make you complete plans and instructions, and help you out every way we possibly can. We loan you tools. Every plant backed by our guarantee bond. We furnish the material; you get the plant installed. Cut out the local dealer's profit and cut the cost in half. Thousands of our plants installed and working perfectly in every part of the country. Write today for our Special Heating Catalog. Tells all about our heating proposition. We can furnish Heating Apparatus for any building, no matter how large. Tell us your needs.



Water Supply Outfits

Modern Air Pressure Water Supply Systems at prices ranging from \$48 to \$200. They are strictly new, first-class and complete in every detail. It makes no difference whether you live in the country, you can enjoy every city comfort at little expense. Why not investigate this? We are ready to furnish you with all facts free of charge. All material fully guaranteed. We also have a complete stock of Pipe, Valves and Fittings at 40 to 60 per cent saving. Gasoline engines at low prices.

Free Publications

Write for our Free Catalog. Fill in the coupon to the right and we will send such literature as best suits your needs. We publish a 1000 page mammoth catalog fully illustrated, giving our business history and showing all the vast lines of merchandise that we have for sale. We buy our goods at Sheriffs', Receivers' and Manufacturers' Sales. Ask for Catalog No. 539. Our Book on Plumbing and Heating Apparatus contains 150 pages of useful information. Our free "Book of Plans" is described elsewhere in this advertisement.

CHICAGO HOUSE WRECKING CO., 35th and Iron Sts., Chicago

Send Us This Coupon

Chicago House Wrecking Co., 539

I saw this ad in Pop Mechanics.

I am interested in _____

Name _____

Town _____

Co. _____ State _____