

WISHING ONE AND ALL A HAPPY HOLIDAY SEASON

www.poptronics.com

DECEMBER 2002

Poptronics®

From the publisher's of Popular Electronics®

and Electronics NOW



RUDOLPH, THE LIGHT-SENSING REINDEER

Simulate the clip-clop of hooves on your rooftop



The Mapper8, Part 1

Accurately test your network's cabling



Also Inside:

- SSB Modulation
- Avoiding Cyber Infections
- Black Cat Systems' G10
- Fluorescent Ballast and Fixtures
- Programming With Look-Up Tables

\$4.99 U.S.
\$6.50 CAN.

```
#BXRDCC# *****AUTO**3-DIGIT 210
#21046DHM951RD007# TRON 205
|-----|-----|-----|-----|-----|-----|-----|-----|
MAY 2003 001 S94 247
ROBERT DAHM 004507
```

9515 RED RAIN PATH
COLUMBIA MD 21046-2073

CALL TOLL-FREE

(800) 292-7711
Orders Only

C&S SALES

CALL OR WRITE
FOR OUR
FREE

Se Habla Español **Secure On-line Ordering @ cs-sales.com**

64 PAGE CATALOG!
(800) 445-3201

Digital Multimeters

Elenco Model M-1740

\$19.95



11 Functions:

- Freq. to 20MHz
- Cap. to 20µF
- AC/DC Voltage
- AC/DC Current
- Beeper
- Diode Test
- Transistor Test
- Meets UL-1244 safety specs.

Elenco Model LCR-1810

\$89.95



- Cap. 0.1pF to 20µF
- Inductance 1µH to 20H
- Resistance 0.01Ω to 2.000MΩ
- Temperature -20°C to 750°C
- DC VOES 0 - 20V
- Freq. up to 15MHz
- Signal Output Function

Elenco Model LCM-1950

\$65



- Large 1 3/4 Digit LCD
- Autorangeing Freq. to 4MHz
- Cap. to 400µF
- Inductance to 40H
- Res. to 4.000MΩ
- Logic Test
- Diode & Transistor Test
- Audio Continuity Test

Capacitance Meter

Elenco Model CM-1555

\$29.95



- Measures capacitors from 0.1pF to 20,000µF
- 3 1/2 Digit LCD readout with unit indicator
- Zero control for test lead compensation
- Banana jack and special test leads included
- Compact size with left hand and holder

Deluxe Soldering Stations

Elenco SL-5 Series

Electronically controlled. Ideal for professionals, students, and hobbyists. Available in kit form or assembled.

As Low As
\$22.95

Works w/ any iron! Turn any soldering iron into a variable iron.



Features:

- Cushion Grip Handle
- Soldering Iron (optional) with Grounded Tip for Soldering Static Sensitive Devices. Easily Replaceable. Uses Long-Life, Plated Conical Tip.
- Heavy Steel, Non-Slip Base.
- Iron Holder Funnel - Reversible, left or right side.
- Steel Tray for Sponge Pad.
- Sponge Pad.

Quantity Discounts Available

Test Equipment

Elenco Digital / Analog Trainer Model XK-150

Features:

- 830-pin Breadboard
- 8 Data Switches
- 8 LED Buffered Readouts
- Built-in Function Generator (sine & square wave)
- Built-in Clock Generator
- Variable Power Supply



\$89.95

Elenco Handheld Universal Counter 1MHz - 2.8GHz Model F-2800

\$99

Sensitivity:

- <1.5mV @ 100MHz
- <5mV @ 250MHz
- <5mV @ 1GHz
- <100mV @ 2.4GHz



Features 10 digit display, 16 segment and RF signal strength bargraph. Includes antenna, NiCad battery, and AC adapter.

C-2800 Case w/ Belt Clip **\$14.95**

Elenco RF Generator with Counter (100kHz - 150MHz) Model SG-9500

\$235

Features internal AM mod. of 1kHz, RF output 100MV - 35MHz. Audio output 1kHz @ 1V rms

SG-9000 (analog, w/o counter) **\$135**

Elenco Quad Power Supply Model XP-581

4 Fully Regulated Power Supplies in 1 Unit

\$75



4 DC Voltages: 3 fixed: +5V @ 3A, +12V @ 1A, 1 variable: 2.5 - 20V @ 2A • Fully Regulated & Short Protected • Voltage & Current Meters • All Metal Case

Elenco Power Supply Model XP-603

\$75



• 0-30VDC @ 3A Output
• 3A Fused Current Protection
• Current Limiting Short Protection
• 0.025Ω Output Impedance

Elenco 3MHz Sweep Function Generator w/ built-in 60MHz Frequency Counter Model GF-8046

\$199.95

Generates square, triangle, and sine waveforms, and TTL CMOS pulse

GF-8025 - Without Counter **\$139.95**

Elenco Multi-Network Cable Tester Model TCT-255

This tester is a convenient instrument for testing different RJ 11 and RJ-45 connectors and coax cables. Cables can be tested before and after they are installed.

- Mapping Function
- Tests cables before or after their installation
- Cable Identification (straight or reverse)
- Pair Identification (straight or reverse)
- Open or Short Testing
- Low Battery Indicator
- Auto Power-Off Function (30 s)



\$75

Soft Vinyl Zippered Case (Model C-90) included!

TCT-255K - Multi-Network Cable Tester Kit - **\$39.95**

20MHz Sweep / Function Generator with Frequency Counter Model 4040A

- 0.2Hz to 20MHz
- AM & FM Modulation
- Burst Operation
- External Frequency Counter to 30MHz
- Linear and Log Sweep



\$445

10MHz Model 4017A **\$325**

5MHz Model 4011A **\$259**

2MHz Model 4010A **\$225**

Elenco Snap Circuits™

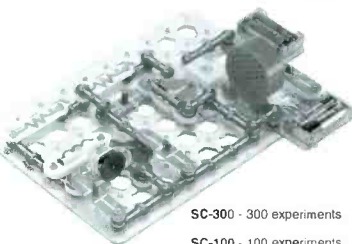

SC-300 - 300 experiments **\$49.95**

SC-100 - 100 experiments **\$29.95**

Elenco's new Snap Circuits™ make learning electronics a "snap". Just follow the colorful pictures in our manual and build over 300 projects, such as AM radios, burglar alarms, flash lights, doorbells, and much more. You can even play electronic games with your friends. All parts are mounted on plastic modules and snap together with ease. Enjoy hours of educational fun while learning about electronics. You can even create your own experiments! No tools required.

Elenco Educational Kits

Model MX-901SW

Short Wave Radio

\$11.95



Model AK-780K

Two IC Radio Kit

\$9.95



Model AK-700

Pulse/Tone Telephone Kit

\$14.95



Model RCC-7K

Radio Control Car Kit

\$27.95



Model M-1006K

DMM Kit

\$18.95



Model K4001

TW Amplifier

\$12.95



Electronic Science Lab

Maxitronix 500-in-1 Electronic Project Lab Model MX-909

Everything you need to build 500 exciting electronic projects:

- Learn the basics of electronics. 500 different electronic experiments, special lighting effects, radio transmitter and receivers, sound effects, cool games and MORE!
- Includes built-in breadboard and an LCD.
- Explore amplifiers, analog and digital circuits plus how to read schematic diagrams.
- Includes 11 parts.
- Lab-style manual included.
- Requires 6 "AA" batteries.



MX-908 - 300-in-1 Lab..... **\$59.95**

MX-907 - 200-in-1 Lab..... **\$44.95**

MX-906 - 130-in-1 Lab..... **\$29.95**

EP-50 - 50-in-1 Lab..... **\$18.95**

\$149

Guaranteed Lowest Prices C&S SALES, INC.

15 DAY MONEY BACK GUARANTEE

UPS SHIPPING: 48 STATES 5% (Minimum \$5.00)

OTHERS CALL FOR DETAILS

IL Residents add 8.25% Sales Tax

150 W. CARPENTER AVENUE
WHEELING, IL 60090

FAX: (847) 541-9904 (847) 541-0710

SEE US ON THE WEB

http://www.cs-sales.com



2 YEAR FACTORY WARRANTY

PRICES SUBJECT TO CHANGE WITHOUT NOTICE

Poptronics®

THE MAGAZINE FOR THE HANDS-ON ELECTRONICS ACTIVIST!

FEATURES

RUDOLPH, THE LIGHT-SENSING REINDEER	Steve Lympany	27
<i>Simulate the clip-clop of hooves upon your roof.</i>		
THE MAPPER8, PART 1	Dave Wickliff	31
<i>Avoid frustration and test out your network's cable runs with ease and accuracy.</i>		

PRODUCT REVIEWS

HANDS-ON REPORT		4
<i>Evaluating the performance of Black Cat Systems' GM-10 Geiger Counter/Radiation Detector PC peripheral.</i>		
GIZMO®		7
<i>Take a peek at some of the newest consumer electronics ranging from plasma screens to mobile video systems.</i>		

DEPARTMENTS

SURVEYING THE DIGITAL DOMAIN	Reid Goldsborough	11
<i>Make sure your computer is up to snuff.</i>		
COMPUTER BITS	Peter Pietromonaco	14
<i>Take a crash course in identifying and avoiding cyber infections on your computer.</i>		
PEAK COMPUTING	Ted Needleman	16
<i>This month we have some great gift ideas for the tech-heads on your list.</i>		
ALL ABOUT	William Sheets and Rudolph F. Graf	19
<i>Continuing with the theory of modulation, this month we examine SSB communication.</i>		
Q&A	Dean Huster	41
<i>Readers ask about the function of diacs and the whereabouts of aged ftp files.</i>		
PIC-TRONICS	TJ Byers	46
<i>Learn how you can use look-up tables to make your PIC programming more efficient.</i>		
SERVICE CLINIC	Sam Goldwasser	49
<i>Here's a great primer for those interested in the intricacies of ballasts and fixtures for fluorescent lighting.</i>		
BASIC CIRCUITRY	Charles Rakes	55
<i>Learn how to build your own pickup circuits designed for listening to the symphony of nature.</i>		

AND MORE

EDITORIAL	2	ADVERTISING INDEX	80
YESTERDAY'S NEWS	3	FREE INFORMATION CARD	80A
POPTRONICS SHOPPER	61		

Poptronics (ISSN 1526-3681) Published monthly by Gernsback Publications, Inc. 275-G Marcus Blvd., Hauppauge, NY 11788. Second-Class postage paid at Hauppauge, NY and at additional mailing offices. One-year, twelve issues, subscription rate U.S. and possessions \$24.99, Canada \$34.81 (includes G.S.T. Canadian Goods and Services Tax Registration No. R125166280), all other countries \$35.99. Subscription orders payable in U.S. funds only. International Postal Money Order or check drawn on a U.S. bank. U.S. single copy price \$4.99. Copyright 2002 by Gernsback Publications, Inc. All rights reserved. Hands-on Electronics and Gizmo trademarks are registered in U.S. and Canada by Gernsback Publications, Inc. Poptronics trademark is registered in U.S. and Canada by Poptronix, Inc. and is licensed to Gernsback Publications, Inc. Printed in U.S.A. Can reprint only with written permission. Postmaster: Please send address changes to Poptronics, Subscription Dept., P.O. Box 459, Mount Morris, IL 61054-7629

A stamped self-addressed envelope must accompany all submitted manuscripts and/or artwork or photographs if their return is desired should they be rejected. We disclaim any responsibility for the loss or damage of manuscripts and/or artwork or photographs while in our possession or otherwise.

As a service to readers, Poptronics publishes available plans or information relating to newsworthy products, techniques, and scientific and technological developments. Because of possible variances in the quality and condition of materials and workmanship used by readers, Poptronics disclaims any responsibility for the safe and proper functioning of reader-built projects based upon or from plans or information published in this magazine.

Poptronics®

Larry Steckler, EHF, CET,
editor-in-chief and publisher

EDITORIAL DEPARTMENT

Chris La Morte, managing editor
Evelyn Rose, assistant editor
Maria Orlando, assistant editor

CONTRIBUTING EDITORS

TJ Byers
Reid Goldsborough
Sam Goldwasser
Rudolf F. Graf, KA2CWL
Dean Huster
John Iovine
Ted Needleman
Peter Pletromonaco
Charles D. Rakes
Marc Spiwak
William Sheets, K2MQJ

PRODUCTION DEPARTMENT

Kathy Campbell, production manager

ART DEPARTMENT

Russell C. Truelson, art director
Judy Serino, graphic designer

CIRCULATION DEPARTMENT

Gina Giuliano, circulation manager

REPRINT DEPARTMENT

Maria Menichetti, Reprint Bookstore x235

BUSINESS AND EDITORIAL OFFICES

Gernsback Publications, Inc.
275-G Marcus Blvd.
Hauppauge, NY 11788
M-F 8:30 AM - 4:30 PM EST
631-592-6720

Fax: 631-592-6723
President: Larry Steckler
Vice-President: Adria Coren
Vice-President: Ken Coren

SUBSCRIPTION CUSTOMER SERVICE/ ORDER ENTRY

800-827-0383
7:30 AM - 8:30 PM EST

Advertising Sales Offices
listed on page 80

Cover by
Judy Serino

VISIT US ON THE INTERNET AT:
www.gernsback.com
or www.poptronics.com

Since some of the equipment and circuitry described in POPTRONICS may relate to or be covered by U.S. patents, POPTRONICS disclaims any liability for the infringement of such patents by the making, using, or selling of such equipment or circuitry, and suggests that anyone interested in such projects consult a patent attorney.

Looking Back on 2002

So, what have we learned this year? Hmm...Technology is a tool that works best if used sparingly, like salt. Depending on it as a panacea for everything from a slumping market to a dull personal life can only end in peril. We mustn't become chained to our creations. It is safe to say that Science has been pushing some dangerous envelopes. With cloned pig-gies lining up to appear at your local supermarket, designer diseases being brewed in suburban labs and available to the highest bidder, and an increased dependency on all things synthetic, our planet resembles a creepy Sci-Fi novella.

Perhaps we're due for a renaissance of technology. Now that electronics have shrunk to microscopic proportions and involve bending organic matter into logic machines via advanced and expensive methods, it is time to start spreading your knowledge of basic electronics to a younger generation. Open the world of Leyden and Tesla, Marconni and Hertz, as well as the rest of the Grand Masters, to those fledgling tinkers around you. Lately, my discussions with readers and inventors have orbited around one particular subject: the dying interest in basic electronics theory. The younger generations have been flocking to computers, and as a result they take technology for granted. Few adolescents understand what is actually occurring inside those gray boxes beneath their desks. Meanwhile, old-timers who have been sifting through their junk boxes and rigging PCB boards for decades have simply refused to jump on the bandwagon, as they scowl their faces at the hype of that darn Internet. Unfortunately, both parties are missing out.

This year, let's all work together to rejoin the two discipline of Electronics and Computing. When did Science become a partisan pastime? In a lesson from the ancient past, it is best to remember that all disciplines grew out of curiosity and imagination. We want to know how things work, how can we make them work better, and how can we share what we learn with others. Let's hope that 2003 brings forth a new age of technological awareness and a reconciliation of Computing and Electronics.

Happy Reading,

Chris La Morte

Enjoy,



Chris La Morte
Managing Editor



YESTERDAY'S NEWS

A PEEK INTO THE GERNSBACK ARCHIVES



Dateline: December 1952 (50 years ago)

Find articles on audio equalizer design, direct-coupled amplifiers, push-pull drivers, and electronic flames in this issue of **Radio Electronics**. The editorial offers valuable advice on careers in electronics, a condensed version of a brochure published by the Dept. of Labor. Also, learn how to build an electronic keyboard called the Onciovox, a solo instrument with simplified circuits and a wide variety of tone-color effects.

1900

1910

1930

1940

1952

ADIO - LECTRONICS

IN TELEVISION • SERVICING • AUDIO



1960

Dateline: December 1972 (30 years ago)

Radio Electronics celebrates the 25th anniversary of the transistor, as it takes a look at its brief but exciting history. At the same time, the evolution of electronic calculators makes the headlines. TV buffs can flip through a step-by-step troubleshooting guide or learn how to use a color-bar signal effectively. There's also construction articles on a zero-distortion stereo pre-amp, an IC breadboard, and digital Grinchwal test equipment.

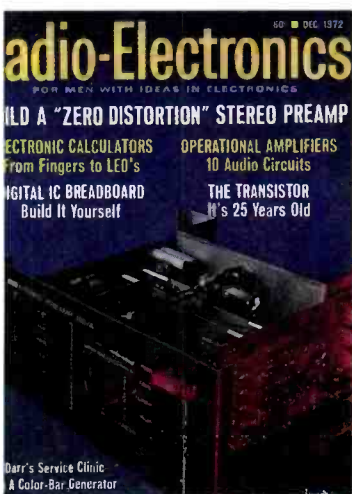

1972

1980

Dateline: December 1992 (10 years ago)

Filled with holiday spirit, **Popular Electronics** includes an extensive electronics holiday wish list, featuring products like a talking robot, an ambidextrous joystick, a portable CD player, floor-standing pencil speakers, a flat TV, and video phone. Also in this issue: Installing and troubleshooting car audio systems, monitoring remote news crews, exploring op-amps (promising a plain-language point of view), and building a holiday light tester.

1992

2000





The GM-10 Geiger Counter/Radiation Detector

Radiation is no laughing matter; in fact, it can be deadly. Environmental hazards, both natural and man-made, are on everyone's mind these days. Since Fall '01, people are a bit more fearful about safety than ever before. Short of never leaving home, there's not much you can do to avoid exposure to crashing planes and anthrax. However, if it's radiation you're worried about, then you can protect yourself.

Geiger counters have been around for a long time, and it's easy to get one. These units are generally expensive, and they don't do much more than display detected radiation levels. However, consider Black Cat Systems' GM-10 Geiger Counter/Radiation Detector; priced at just \$149, this sensitive Geiger counter can

detect very low levels of radiation. The device connects to the serial port of a PC; and software included with the GM-10 lets you store the recorded data, plot graphs, and more. A USB version of the GM-10 is available for \$179; and a more sensitive, more expensive GM-45 is also available.

Doing Detection

Geiger counters detect the ionization produced by decaying radioactive particles. Each time a radiation particle is detected, the counter records the event. The number of particles detected over a one-minute interval provides the familiar "counts per minute," or CPM reading. The higher the

an airplane you might find background radiation levels of over 400 CPM because of the cosmic radiation that's always present at high altitudes.

The instrument connects to any personal computer through a serial interface, either a Windows PC (95, 98, NT, and 2000) or a Macintosh. There's even a simple program that runs

under DOS for those seat-of-the-pants hobbyists. In addition, it can be connected to other equipment, as well. Black Cat Systems will be happy to provide information to anyone interested, including OEMs.

With the software, you can measure, record, and display radiation readings over any time period. Powered off the computer's serial port, the unit needs

no batteries or external power adapter. That makes it perfect for use in the field with a notebook computer.

This review focuses on the \$179 USB version of the GM-10, which is the one most people will be interested in. The portable unit measures 4.25 by 2.6 by 1.2 inches and weighs only 3.6 ounces. The



CPM, the higher the radiation level. The GM-10 contains a Geiger-Müller tube capable of detecting alpha, beta, gamma, and X-ray radiation.

The GM-10 can detect background radiation levels of around 10 CPM; basements of homes with high radon levels typically read much higher. On

software and the unit were tested using a 366-MHz Pentium II notebook computer running Windows 98.

Installation

Installing the software for the USB GM-10 is easier than the instructions would make it seem. Software for both PCs and Macs is included on a CD-ROM. Basically, you just copy the executable and its folder to your hard drive and run it directly from there. Of course, you have to load the USB drivers first, which is just as simple. All you do is plug the GM-10's attached cable into a USB port, and the computer will detect the new hardware. Then you simply point to the folder where the drivers are located, and the system takes it from there. From here on in, the software will be able to "grab" radiation readings from the GM-10 whenever it's connected to the computer.

The software is easy to use, and it's broken down into six different displays: Main, Setup, Graph, Statistics, Recording, and FTP. "Main" shows the average CPM reading, along with a time-plot graph of the detected radiation levels. "Setup" lets you select the proper COM port, which you can see by looking at the Port settings in Windows Device Manager. This display also gives you the option to choose whether your computer will make audible clicks as it detects radiation particles.

"Graph" allows you to design the settings so that your time plot will appear the way you like. "Statistics" keeps track of standard deviation, mean, minimum, and maximum readings. "Recording" enables both data recording to hard disk and creating new recording files. "FTP" configures server settings so that the GM-10 can upload data to a Web site for remote viewing over the Internet.

Testing the GM-10

It pays to have a safe way to test the GM-10, because other-

wise you would never know if it were working properly. One safe way to test it is to purchase a "Vaseline" glass bead from Black Cat Systems for an additional \$9.99. Vaseline glass (also called depression glass) contains a small amount of uranium oxide, which makes it glow under ultraviolet light and also makes it slightly radioactive; it is completely safe to handle. (It is not clear why it is called Vaseline glass, though it could be because the beads are the same color as old glass Vaseline jars.) A glass bead will generate a count of about 200 CPM, with the bead directly in front of the detector window.

Another good way to test the GM-10 is by placing a mantle from a gas lantern near the detector. Though they're also safe to handle, mantles contain Thorium; and they will produce even higher CPM readings than a glass bead. Thorium mantles consist of a rayon mesh impregnated with various chemicals along with Thorium powder. Burning off the mantle before its initial use leaves behind a brittle shell that glows brightly when heated.

Household Use

There are many other sources of radiation you might find around your home. Homes in areas with high radon concentrations will have high background readings in their basements. In most homes you'll find that the lint from your clothes dryer exhibits higher-than-background radiation levels due to trapped radon particles.

Of course, if you're really interested in purchasing a GM-10, you probably have more important things in mind than checking the dryer lint. Where radiation is concerned, you can never be too safe. To learn more about the GM-10 visit www.blackcatsystems.com/GM or write to Black Cat Systems at PO Box 2293, Westminster, MD, 21158-7293. 

Mark Spiwak is the Technical Editor of CRN.

Audio • Video • Computers • Electronics

NEWLY UPDATED

WHOLESALE & DISCOUNT

BY MAIL AND INTERNET

BUYERS GUIDE

Warren Wiegant

Wholesale & Discount Buyers Guide. #CP-1 - \$19.95

Save up to 90% off list prices. Audio and video equipment and materials; electronic products and surplus; pro recording and specialty items; computers and components. Source listings include complete address, phone, fax, e-mail and website addresses 8 1/2 x 11", 72pp. paperback.

Send \$19.95 plus \$5.00 S&H to: Claggk, Inc. PO Box 12162, Hauppauge, NY 11788; Tel: 631-592-6721; Fax: 631-592-6723; email: claggk@gernsback.com.



SORRY No orders accepted outside of USA & Canada. All payments must be in U.S. funds.

CLX3



YOU CAN WIND YOUR OWN COILS?

There's no trick to it except knowing what you are doing. In a unique, 106-page book you can become expert in winding RF, IF, audio and power coils, chokes and transformers. Practically every type of coil is discussed and necessary calculations are given with the mathematical data simplified for use by anyone. Get your copy today!

Mail coupon to:

Electronics Technology Today, Inc.
P.O. Box 240
Massapequa Park, NY 11762-0240

Please send me my copy of *Coil Design and Construction Manual* (BP160). I enclose a check or money order for \$8.99 to cover the book's cost and shipping and handling expenses. NY state residents must add local sales tax.

Name

Address

City State ZIP

All orders must be paid in U.S. funds only. Sorry, no orders accepted outside of USA and Canada. Please allow 6-8 weeks for delivery. **ET07**

RETAILERS THAT SELL OUR MAGAZINE EVERY MONTH

ARIZONA

Elliott Elec. Supply
1251 S. Tyndell Ave.
Tucson, AZ 85713

CALIFORNIA

All Electronics
14928 Oxnard Street
Van Nuys, CA 91411

California Electronics
221 N. Johnson Ave.
El Cajon, CA 92020

Electronics Plus, Inc.
823 4th St.
San Rafael, CA 94901

Electronics Warehouse
2691 Main Street
Riverside, CA 92501

Ford Electronics
8431 Commonwealth Ave
Buena Park, CA 90621

HSC Electronics
5681 Redwood Drive
Rohnert, CA 94928

HSC Electronics
4837 Amber Lane
Sacramento, CA 95841

Halted Specialties Co.
3500 Ryder Street
Santa Clara, CA 95051

Kandarian Electronics
1101 19th Street
Bakersfield, CA 93301

Mar Vac Electronics
2001 Harbor Blvd.
Costa Mesa, CA 92627

Mar Vac Electronics
1759 E. Colorado Blvd.
Pasadena, CA 91106

Mar Vac Electronics
4747 Holt Blvd.
Montclair, CA 91763

Mar Vac Electronics
5184 Hollister Blvd.
Santa Barbara, CA 93111

Mar Vac Electronics
2537 Del Paso Blvd.
Sacramento, CA 95815

Mar Vac Electronics
2000 Outlet Center Dr. #150
Oxnard, CA 93030

Mar Vac Electronics
12453 Washington Blvd.
Los Angeles, CA 90066

Metro Electronics
1831 J Street
Sacramento, CA 95814

Orvac Electronics
1645 E Orangethorpe Ave.
Fullerton, CA 92631

Sav-On Electronics
13225 Harbor Blvd.
Garden Grove, CA 92643

COLORADO

Centennial Elec. Inc.
2324 E. Bijon
Colorado Springs, CO
80909

CONNECTICUT

Archway News, Inc.
64 Bank Street
New Milford, CT 06776

Cables & Connectors
2315 Berlin Turnpike
Newington, CT 06111

Park Dist. Retail Outlet
347 Railroad Ave.
Bridgeport, CT 06604

ILLINOIS

Tri State Elex
200 W. Northwest Hwy.
Mt. Prospect, IL 60056

MARYLAND

Mark Elec. Supply Inc.
11215 Old Baltimore Pike
Beltsville, MD 20705

MASSACHUSETTS

Electronic Hook-Up
104 Main St.
Milford, MA 01757

"You-Do-It" Electronics
40 Franklin Street
Neeham, MA 02494

MICHIGAN

Purchase Radio Supply
327 East Hoover Avenue
Ann Arbor, MI 48104

The Elec. Connection
37387 Ford Road
Westland, MI 48185

MINNESOTA

Radio City Inc.
2663 County Road I
Mounds View, MN 55112

MISSOURI

Gateway Electronics
8123-25 Page Blvd.
St. Louis, MO 63130

NEVADA

Sandy's Electronic Parts
961 Matley Lane #150
Reno, NV 89502

NEW JERSEY

Lashen Electronics Inc.
21 Broadway
Denville, NJ 07834

NEW YORK

Hirsch Sales Corp.
219 California Drive
Williamsville, NY 14221

LNL Distributing Corp.
235 Robbins Lane
Syosset, NY 11791

T&M Elec. Supply, Inc.
472 East Main Street
Patchogue, NY 11772

Unicorn Electronics
Valley Plaza
Johnson City, NY 13790

OHIO

Parts Express
725 Pleasant Valley Drive
Springboro, OH 45066

OREGON

Norvac Electronics
7940 SW Nimbus Avenue
Beaverton, OR 97005

TEXAS

Computers Electronics Etc.
110 E. Medical Center Blvd.
Webster, TX 77598

Electronic Parts Outlet
3753 B Fondren
Houston, TX 77063

Tanner Electronics
1301 W Beltline
Carrollton, TX 75006

WASHINGTON

Supertronix Inc.
16550 W. Valley Hwy.
Tukwila, WA 98188

**Barnes & Noble • B. Dalton • Crown Books
Tower Books • Super Stand • Borders Book Store
On Cue • Hastings • Media Play • Walden Book Store
Just About Every Major Book Store!**

**If you'd like to sell our magazine in your store, please circle 180 on
free information card or Contact Gina Giuliano at (631) 592-6720 ext 215**

GIZMO®

For more information go to page 80A

or e-mail: advertising@gernsback.com

Mini Music

Ready to clip on to backpacks, clothing, and jewelry, the HitClips Carabiner Clip (\$14.99) is a portable music player that lets users snap in their favorite tunes using the HitClips micro-music clips (sold with the player and also sold separately). Available in vivid blue and green, the player has a built-in speaker, as well as an audio jack for earphone use.

Tiger Toys, Inc., 980 Woodlands Parkway, Vernon Hills, IL 60061; 847-913-8100; www.tigertoys.com.

CIRCLE 50 ON FREE INFORMATION CARD



Magical Radio

Combining cutting-edge technology with the world of Disney, the Disney 2-Way Radio (\$59.95/pair) features five call tones from favorite characters—Mickey, Cinderella, Buzz Lightyear, and more. Designed for children, the radios boast fun features, bright colors, and a comfortable fit for small hands. They are also weather resistant, have a two-mile radius, 14 channels, and



38 interference-eliminator codes. Motorola, Inc., 2501 San Pedro N.E., Suite 202, Albuquerque, NM 87110; 505-875-1999; www.motorola.com.

CIRCLE 51 ON FREE INFORMATION CARD

Slim Screen

With a depth of less than four inches, the Plasmavision SlimScreen 50-inch PDS-5004 (\$9999) can be hung on a wall or ceiling or mounted on a stand. The high-definition, widescreen video monitor features an on-board stereo amplifier, a 3000:1 contrast ratio, and a high-resolution 1366 x 768 pixel array; and it can display the output from virtually any home-theater video source.

Fujitsu General America, Inc., 733 Third Ave., New York, NY 10017; 212-599-9800; www.fujitsu.com.

CIRCLE 53 ON FREE INFORMATION CARD



Video On the Go

Kids fussing in the back seat? Keep them busy with the VOD-806 Mobile Video System (\$1700). This combination drop-down unit features an eight-inch screen-with a built-in DVD player, TV tuner, and an IR transmitter for wireless headphones and dome lights. With backlit controls for low-light operation, it is fully remote control capable and has a speaker amplifier.

Audivox, Inc., 150 Marcus Blvd., Hauppauge, NY 11788; 800-225-6074;

CIRCLE 52 ON FREE INFORMATION CARD

Speak Free

Designed for hands-free operation, the FreeSpeak Wireless Headset (\$99, or \$179 with adapter) works with the latest Bluetooth phones, as well as with many other mobile phones, through the Bluetooth adapter. Made of a soft, sound-absorbing material,

FreeSpeak's earpiece and microphone conform behind the ear for a comfortable, secure fit. The built-in clip lets users attach the unit to a belt or purse.

JABRA Corp., 9171 Towne Centre Dr., #500, San Diego, CA 92122; 800-327-2230 or 858-622-9955; www.jabra.com.

CIRCLE 54 ON FREE INFORMATION CARD



Total Control

Remotes cluttering your coffee table? Get all-in-one capability with the RC3200 Programmable Universal Learning Remote Control (\$329.99). It controls every component in your home-entertainment system; features a touchscreen control panel; and has advanced, easy-to-use programming technologies.

Marantz America, Inc., 1100 Maplewood Dr., Itasca, IL 60143; 630-741-0300; www.marantz.com.

CIRCLE 55 ON FREE INFORMATION CARD



Zoom Tower

A blend of classic design and versatile performance, the Leica CI Compact Camera (\$449) makes taking high-quality photographs easy. Offering a large zoom range from the wide angle to the

medium telephoto, the camera also has a sophisticated automatic exposure control program and an integrated switchable data function. For maximum durability and style, the robust metal body has rounded corners and geometrically-shaped superstructures.

Leica Camera, Inc., 156 Ludlow Ave., Northvale, NJ 07647; 800-222-0118 or 201-767-7500;

www.leica-camera.com.
CIRCLE 57 ON FREE INFORMATION CARD



Super Sound

Elegantly finished, the ASW-675 Subwoofer (\$1000) offers full-system low-frequency performance. It boasts a substantial bass-overload system, advanced amplifier circuitry, and a newly developed 10-inch transducer that promises ultimate loudness and excellent

dynamics. The compact subwoofer includes B&W's A/B bass-rolloff alignment switch, as well as link-out jacks for easy expansion.

B & W Loudspeakers of America, 54 Concord St., North Reading, MA 01864-2699; 800-370-3740 or 978-664-2870; www.bwspeakers.com.

CIRCLE 56 ON FREE INFORMATION CARD



That's Entertainment

Featuring hand-rubbed Honduras mahogany, the Plasma TV Home Entertainment Center (\$16,000) is rich looking with an Espresso color stain and satin-lacquer topcoat. A pair of motorized sliding doors-activated by a handheld remote-can hide or reveal a 42-inch TV (not included). The cabinet also has four audio/visual equipment

bays that use a flush-fitting rack mount system; halogen lights; and pull-out storage compartments for CDs, VCR and DVD tapes.

Lowell Edwards, 979 Third Ave., Fifth Floor, New York, NY 10022; 212-980-2862; www.lowelledwards.com.

CIRCLE 58 ON FREE INFORMATION CARD



Action-Packed Sound

Intended as a companion to the advanced graphics and visual effects of today's video games, the FreeStyle Speaker System (\$499) consists of just two compact speakers whose precisely angled arrangement delivers comparable sound to that of a five-speaker surround-sound system. The speakers' interface module has three audio inputs-allowing users to connect to two sources, including TVs, VCRs, CD-players, and more.

Bose Corp., The Mountain, Framingham, MA 01701; 508-879-7330; www.bose.com.

CIRCLE 59 ON FREE INFORMATION CARD



Music Maker

Record, edit, and organize your digital music with the Cakewalk Pyro (\$39) music-management software. A complete MP3 and CD maker, the software burns professional-quality CDs, with the 64-bit EQ offering superior sound quality. Cakewalk Pyro makes it a "piece of cake" to convert LPs and cassettes into CDs or digital files and to quickly locate and sort all music files on a PC. Be a music maestro, creating megamixes and smooth transitions by overlaying and cross fading songs. With the bonus labeling software, you can use graphics and artwork to design and print CD labels and jewel case inserts.

Cakewalk,
www.cakewalk.com.



For The Explorer

For The Explorer Preparing for a back roads adventure? The TOPO! State and Region Software (\$99.99) lets users create and print custom-made, explorer-quality, topographic maps from seamless U.S. Geological Survey coverage. Featuring high-resolution, 3-D graphics, the software enables globe-trekkers to zero in on a specific area, customize a map with trail info and milestone markers, and swap maps on the on-line mapXchange.

National Geographic,
www.nationalgeographic.com.



Lots O' Music

Meeting the needs of true music lovers, the RioRiot MP3 Player (\$399) boasts a 20-GB drive that stores over 4000 pieces of high-quality music (that's almost 400 complete albums) and a built-in FM tuner with custom presets. The RioLogiTrack interface software makes it easy to find and play songs, and the player also comes bundled with Real Jukebox 2.0 and Apple iTunes. Headphones, carrying case, and power adapter are included.

SONICblue Inc., www.sonicblue.com.

Versatile Video

Now you can add video and still images to your e-mail and instant messages with the Logitech QuickCam (\$59). Created for notebook PC users, the portable USB camera provides high-quality color-video input for PC applications. The included software allows full-motion video and still images to be captured on the go. It also provides options to create web cams, set up video monitors, and hold video conferences from anywhere.

Toshiba, www.toshiba.com



Palm Power

Compact and lightweight, the CLIE PEG-SJ20 Handheld PDA (\$199.99) runs on the Palm operating system and is also fully compatible with thousands of add-on applications. The high-resolution screen shows images and fonts in fine detail; and the exclusive Jog Dial Navigator allows you to easily access images, phone numbers, notes, and video clips with just one hand.

Sony Electronics, www.sony.com.





BP 450—\$12.99
How to expand and upgrade your PC

This book provides advice and guidance on the popular forms of internal PC expansion, and should help to make things reasonably straight forward and hopefully painless! The book covers such topics as memory upgrades; adding hard and floppy disc drives; display adaptors and monitors; ports; keyboards; mice and graphic tablets; DIY PCs, etc.

Beginners **Intermediate** **Advanced**

BP 479—\$12.99
How to build your own PC

Takes the reader through the process of assembling a PC from freely available and relatively inexpensive component parts. Topics covered include: buying the right components, simple anti-static precautions, configuring the motherboard, fitting the processor and memory modules, mechanical assembly and cabling, and more.

Beginners **Intermediate** **Advanced**

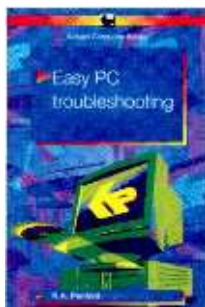

BP 484—\$12.99
Easy PC troubleshooting

If you have some knowledge of PCs and take a logical approach, then with the help of this book, many faults can be identified and then rectified quickly and easily. This book shows you how to: test various parts of the system, diagnose a wide range of faults, check cables and connections, deal with the BIOS, and more.

Beginners **Intermediate** **Advanced**

BP 494—\$12.99
Basic Internet skills

This book is intended to help you make maximum use of the Internet. It concentrates on the core skills needed to fully exploit three of the main Internet features: electronic mail, searching for information using a Web browser and creating and publishing your own Web site. Practice exercises and self-assessment checklists are included throughout the book.

Beginners **Intermediate** **Advanced**

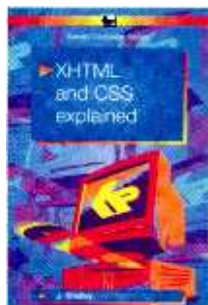

BP 501—\$12.99
XHTML and CSS explained

If you know HTML, then you already know 85% of XHTML. This text will teach you how to create Web pages using the new language. XHTML uses Cascading Style Sheets (CSS) as the presentation language to format the content. Consequently, much of this text explains how to create and use style sheets.

Beginners **Intermediate** **Advanced**

BP 507—\$12.99
Easy Internet troubleshooting

With the aid of this book you can tackle all sorts of problems related to the Internet. Virtually every aspect of using the Internet is covered and you do not have to be a computer expert to follow most of the procedures. All you need to have is a very basic understanding of the Windows operating system.

Beginners **Intermediate** **Advanced**



Please circle the products you would like to buy on the page above, calculate the total cost, include shipping charges, using the table below and send it to us. Please allow 4 - 6 weeks for standard delivery.

Name: _____
Address: _____

Zip: _____ Telephone: _____
I have enclosed my check for \$: _____

Signature: _____
Please charge my credit card for \$: _____ Number:

Card Type: _____ Expiration Date: _____
Mastercard, Visa or Discover only

Note: The delivery address and the address at which the credit card is registered must be the same.

ELECTRONIC TECHNOLOGY TODAY, INC.
PO Box 240
Massapequa Park, NY 11762-0240
Tel: 631-592-6722
Fax: 631-592-6723

SORRY No orders accepted outside of USA & Canada
No. of Books Ordered
Total price of books \$.....
Shipping (see chart) \$.....
Subtotal \$.....
Sales Tax (NYS only) \$.....
Amount Enclosed \$.....

All payments must be payable through U.S. funds!

SHIPPING CHARGES IN USA.
(ADD \$5.00 IN CANADA)

\$0.01 to \$5.00	\$2.00	\$20.01 to \$30.00	\$5.00
\$5.01 to \$10.00	\$3.00	\$30.01 to \$40.00	\$6.00
\$10.01 to \$20.00	\$4.00	\$40.01 to \$50.00	\$7.00
\$50.01 and above	\$8.50	

ET13

TAP INTO YOUR PC'S POTENTIAL

Are you making the most of your PC? Probably not, judging from my own observations and those of others.

MAXING YOUR PC USE

To get a better feel for this, I talked with a product manager at Hewlett-Packard. Tom Markworth is responsible for HP's Pavilion line of desktop PCs, which are sold through computer superstores, consumer electronic and office supply stores, and discount retailers. HP's computers have always fared well in computer reliability surveys in comparison with their retail competition. HP recently merged with Compaq, making it the largest personal computer manufacturer in the world (according to IDC, an independent market research firm.)

Markworth identified key areas where people typically are missing out on the potential of their PC, in both home and business settings.

CD-RW Drives – Computers from various manufacturers come with these recordable compact-disc drives, but people often think of them only for recording music they find on the Web. You can also use these drives as an inexpensive way to back up your data.

Keyboard – Some computers have keyboards that provide added functionality, such as the ability to program in keyboard shortcuts. With the press of a single key, for instance, you can be off to your favorite news, shopping, travel, or other Web site.

Faxing – You don't need a stand-alone fax machine to fax documents that you create with your PC or to receive faxes. A PC connected to a modem and phone line, using software that



Fans of the ConsumerReports.org Website were among those who had to suffer the wrath when Consumer Reports began charging its members for services that had been free in the past.

comes with Windows XP and other operating systems, can act as a fax machine.

Broadband – Many PCs include network cards, which can save you much money if you sign up for cable or DSL Internet access.

Ports – Virtually all PCs come with USB ports—a port is a connection used to attach a printer, scanner, PDA, digital camera, or other peripheral device to a PC. USB ports are faster and easier to work with than previous technologies, such as parallel and serial ports. Be sure to check if your peripherals have USB connections.

Some PCs feature even faster IEEE 1394 ports, sometimes called Firewire ports. Their primary use is for digital camcorders, but you can also use them to connect an external hard drive or optical drive to a computer. Such a connection can be a convenient way to transfer large documents

or programs between a work and home PC.

Digital Photo Editing – Today's powerful PCs make it easier than ever to have fun with photography. By using a digital camera and imaging software, you can combine photos into artistic montages; remove red eye and other defects; and create greeting cards, calendars, and other projects.

Digital Video Editing – Though a DVD drive can help, you don't need one to edit videos with a PC, provided you have digital video-editing software. You can simply use your hard drive today's ample hard drives have the space to store video as you work on it. When done editing, you can burn the video onto a CD-R disc or output it back to your digital camcorder to watch on TV.

Managing Finances – Programs such as Quicken and Microsoft Money make it easy to use your PC as a sophisticated checkbook register. Not only can you quickly reconcile your monthly statements, you can also pay bills online, create budgets, track expenses, download investment information, and keep track of your portfolio on real-time basis.

Update Services – Software utility maker Symantec pioneered the ability to automatically receive software patches and updates through the Web, and others have followed suit. Microsoft's Windows Update lets you get security fixes and other patches for Microsoft products. Services such as HP's Backweb let you automatically download hardware driver updates to your PC. Start Menu-You may be surprised at the software that comes with your new

PC. By looking around your Start menu, you may find free or trial versions of reference, educational, and graphic software worth using, among others.

Standby Mode – By going into Windows' Control Panel and double-clicking on DISPLAY, you can access the POWER settings and set your PC to turn off power to the monitor and other components after a selected period of inactivity.

According to the EPA, this mode can save you up to \$50 per year in electricity bills. Also, it's better for your PC than turning it off and on several times a day.

DOLLARS AND SENSE

While saving money is always nice on a personal level, it can mean the difference between success and failure in business. In the business world, computers can potentially have a giant impact on advertising and sales. The World Wide Web has changed the dynamics of marketing.

How much would you pay for what you're reading right now? Publishers are continually wrestling with questions about whether or how much to charge readers and how to balance newsstand and subscription revenue with advertising revenue.

For Web publishers, these questions are of utmost importance as a result of the meltdown in the online advertising market over the past couple of years. The Internet maxim "Information wants to be free" may apply to readers; but somebody has to pay to support the effort of collecting, writing, editing, and publishing that information.

To avoid going belly up as numerous Web sites have, hundreds of Web publishers have begun to charge for part or all of their content. Online publications with the most paid subscribers include:

ConsumerReports.org at www.consumerreports.org (for its consumer information), RealOne SuperPass at www.real.com (for its entertainment and multimedia news offerings), and the Wall Street Journal Online at www.wsj.com (for its business and financial data). This information comes from a recent report by Intermarket Group, a San Diego market research firm.

ABCNews.com made news recent-

ly by announcing it would stop providing virtually all of its free video clips and would replace them with a subscription package costing \$4.95 a month. They followed the lead of other network-affiliated sites, such as FoxSports.com and CNN.com, which are now charging.

As expected, many people aren't happy with the move from free to fee. A survey by Jupiter Research, a New York City market research firm, showed that 63 percent of those questioned said there was no content they would pay for if free access to it stopped.

On the other hand, who likes to be badgered by online ads that pop up, under, and over everywhere you click and by advertiser-initiated spyware that's continually gathering information about your Web-surfing habits?

Online publishers are caught between the proverbial rock and hard place, deciding whether to tick off readers by asking them to fork over their hard-earned money for what was previously free or by bombarding them with increasingly intrusive advertising technologies.

The publishing site moving toward a subscription business model has to make difficult choices: Should you offer some free services and charge only for "premium" services or go to an all-subscription model? Should you continue to sell advertising when charging readers for subscriptions? How much should you charge? Should you offer gifts or other incentives for people to subscribe? Should you offer a free trial? How can you best convert trial subscribers into paid subscribers and entice paid subscribers into renewing? How much of a price break should you offer those already subscribing to the print version of the publication?

These are the same kinds of questions that traditional print publishers have always faced. You can read an in-depth analysis of how successful online publishers have solved these problems by buying the "Content Matrix: Tracking Subscription-Based Online Content" report or the "Selling Subscriptions to Internet Content Summit" report through MarketingSherpa.com at <http://sherpa-store.com/store>.

A number of publishers have come up with ways to bridge the gap between the worlds of new and old

POINT AND CLICK

ABC News

www.abcnews.com

CNN News

www.cnn.com

Consumer Reports

www.consumerreports.com

Fox Sports

www.foxsports.com

Harvard Business Review

www.hbsp.harvard.edu/products/hbr

Hewlett Packard

www.hewlettpackard.com

International Herald Tribune

www.iht.com

Marketing Sherpa

<http://sherpastore.com/store>

Microsoft Money

www.microsoft.com/money

Microsoft Windows Update

www.windowsupdate.microsoft.com

New York Times

www.nytimes.com

Quicken

www.quicken.com

RealOne Superpass

www.real.com

Symantec

www.symantec.com

Technology Review

www.techreview.com

The End Of Free

www.theendoffree.com

Wall Street Journal Online

www.wsj.com

media. Magazines such as the Harvard Business Review and Technology Review and newspapers such as the New York Times and the International Herald Tribune now let you download and print out an exact replica of their publication, for a price. The incremental cost to provide this service is negligible.

Though it requires readers to handle the printing, this digital replica option has its benefits. As with conventional print publications, reading from paper is easier on your eyes than reading from a computer screen. As with online publications, delivery is nearly instantaneous, so news is fresher. This feature is particularly useful for overseas subscribers, though download times with dial-up Internet service can be long.

Regardless of the specific business

model they choose, as a rule, online publishers who go the "pay" route promise that the additional revenue will help them improve the quality of their product.

From the inception of the Web little over a decade ago, the old saw "There's no such thing as a free lunch" didn't seem to apply. The Internet ideal was the free sharing of information. More and more, the World Wide Web is merging with the larger world, where the bottom line reigns.

For more about all this, check out the Web site named, appropriately enough, The End of Free at www.theendoffree.com. There you'll find the latest news of sites going "pay," an archive of previous reports, and a moderated discussion board.

From making the most of your PC's potential and saving money at the same time to the ultimate fate of free Internet access, things in the digital domain change at lightning speed. Stay tuned here for the latest breaking news.

Reid Goldsborough is a syndicated columnist and author of the book *Straight Talk About the Information Superhighway*. He can be reached at reidgold@netaxs.com or www.netaxs.com/~reidgold/column.

Poptronics
Interactive Edition
 Projects...Courses...Articles...& more
Read it on the WEB!

- An e-magazine for everyone who loves electronics.
- Interesting articles and related items.

www.poptronics.com/interactive

Frustration? No, thanks. Fun? Yes, please.



Satisfied customers - the key to our success

- ▶ that's why every new EAGLE version is based on the feedback from our customers
- ▶ that's why all our customers have access to our highly acclaimed, comprehensive support, free of charge
- ▶ that's why EAGLE has no hidden costs for libraries or modules which prove to be indispensable after purchasing
- ▶ that's why we really want customers to enjoy working with EAGLE
- ▶ that's why EAGLE is one of the top-rated programs for schematic capture and board layout

EAGLE 4.0

Schematic Capture • Board Layout
Autorouter

The readers of the leading German electronics magazine elected EAGLE 4.0 as

Product of the Year 2000

for **Windows**

and **Linux**

Windows is a registered trademark of Microsoft Corporation. Linux is a registered trademark of Linus Torvalds.

Version 4.0 Highlights

- New Library Management with Component Browser
- Technology and Package variants for components
- Design your own commands via User Language
- Unlimited length for component names/values
- Design Rules define pad/via dimensions and shapes
- Net Classes for Autorouter and DRC
- Minimum Autorouter grid: 0.02 mm
- SMD pads can be rounded or round
- Different pad shapes for Top, Bottom, or Inner layers

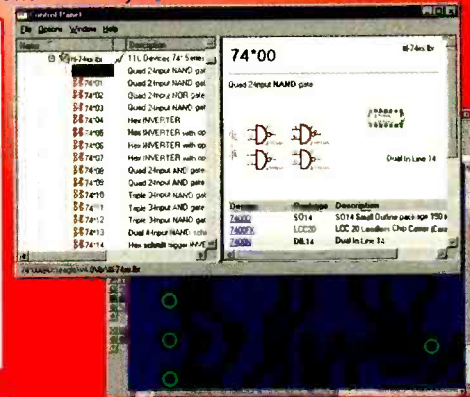

EAGLE 4.0 Light is Freeware!

You can use EAGLE Light for testing and for non-commercial applications without charge. The Freeware Version is restricted to boards up to half Eurocard format, with a maximum of two signal layers and one schematic sheet. All other features correspond to those of the Professional Version. Download it from our Internet Site or order our free CD.

The Standard Version is suitable for boards in Eurocard format with up to 4 signal layers. The Professional Version has no such limitations.

<http://www.CadSoftUSA.com>

800-858-8355

CadSoft Computer, Inc., 801 S. Federal Highway, Delray Beach, FL 33483
 Hotline (561) 274-8355, Fax (561) 274-8218, E-Mail: info@cadsoftusa.com

Prices	Light	Standard	Professional
Layout		199\$	399\$
Layout + Schematic		398\$	798\$
Layout + Autorouter		398\$	798\$
Layout + Schematic + Autorouter	49\$	597\$	1197\$

Pay the difference for Upgrades

CIRCLE 283 ON FREE INFORMATION CARD

IT'S NOT WORTH THE WEIGHT.

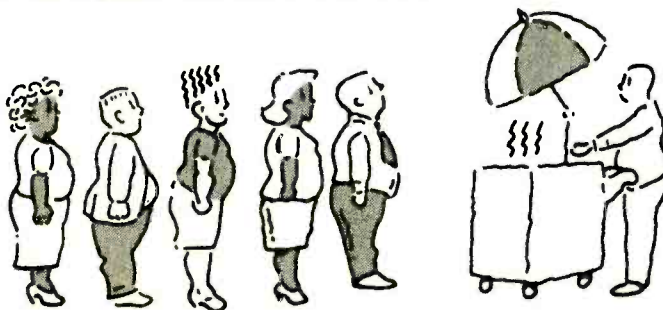

For better health and fitness, exercise.

American Heart Association



© 1992, American Heart Association

CYBER INFECTIONS

Last month, we talked about cyber security, focusing on e-mail hoaxes and privacy concerns. This month, we'll move on to bigger, more sinister perpetrators. We'll discuss viruses, worms, and Trojan horses—all demons of the computer world. Although they have similar characteristics, they are unique in their destructive abilities. Throughout the article, when referring to all three I will call them "infections." Many of you have encountered some strain of infection at work or at home. As you may be aware, some of them are relatively harmless—just downright annoying. Others, however, can be quite destructive, causing a lot of swearing and aspirin-taking. We'll discuss how some of them can be dealt with or avoided.

BASIC TERMS

Let's briefly go over some basic terminology so we understand what these critters are capable of and how they react once they infect your system.

Virus—A program that spreads itself by infecting other programs on the same computer. Some can do rather serious damage, like erasing your files or your entire disk. Others are just pesky and can annoy you with pop-up windows like "Gotcha!" as you are trying to do your work. True viruses cannot spread to a new computer without the help of the user: for example, trading files, like a floppy disk or e-mail, with another user and spreading the infection.

Worm—A worm propagates itself just like a virus, except that a worm can automatically spread itself over the network from one computer to another. It can also do substantial damage to your system, as well as compromising the security of your computer. It could arrive in the form of

a joke e-mail or via other transport mechanisms.

Trojan Horse—This general term refers to executable programs that at first appear desirable, like a computer game, but actually contain something damaging. These programs have extensions like "exe," "vbs," "com," "bat," etc. Unlike worms and viruses, they cannot make copies of themselves. However, worms and viruses could be embedded in the program, which can then spread harmful infection.

Blended Threat—This threat contains all three characteristics—those of the worm, virus, and Trojan Horse. These can be serious, as they have a "multiple personality." They can spread

through various means and cause widespread damage.

Encrypted Virus—A virus that uses encrypted code (scrambled program code) to hide itself from virus scanners.

Polymorphic Virus—A virus that can change its byte pattern when it copies itself, easily avoiding detection.

Retrovirus—A computer virus that actively attacks an anti-virus program as it tries to prevent detection.

PAST AND PRESENT

Do you remember the "Melissa" virus back in 1999? This virus spread itself like wildfire through e-mail messages that contained an infected Word

The screenshot shows the Symantec Security Response website. The main heading is "Backdoor.Roxrat.10". Below this, it states "Discovered on: September 20, 2002" and "Last Updated on: September 23, 2002 06:45:06 PM PDT". There are links for "print document" and "email document". A navigation bar includes "threat assessment", "technical details", "recommendations", and "removal instructions". The "threat assessment" section is expanded, showing "number of infections: 0 / 49", "number of sites: 0 / 2", "geographical distribution: Low", and "threat containment: Easy". A "protect this" section lists updates: "virus definitions (liveupdate)" on September 25, 2002, and "virus definitions (intelligent update)" on September 23, 2002. A "SPECIAL OFFER" sidebar promotes Norton 2003 Antivirus Professional. The footer contains copyright information for Symantec Corporation.

Here is a screen shot of Symantec's Security Response Web site which gives explicit details about the latest computer infections.

document as an attachment. The transport message looked like this: "Subject: Important Message From <name>." (<name> was the full name of the user sending the message). When the recipient opened the infected .doc file with Microsoft Word 97 or Word 2000, the virus immediately spread.

Some of you may have been affected by the "Love Letter" worm of 2000. This was a malicious VBScript program that spread itself in various ways, thus making it hard to detect and prevent. Over half a million systems were infected with the worm, some suffering considerable damage to their networks and individual computers.

The "Love Letter" propagated itself via e-mail, Windows file sharing, Web pages, and more. This worm looked like this: "Subject: I Love You" with an attachment of "Love-Letter-For-You.txt.vbs." People who received this love letter most likely recognized the sender (the sender not ever knowing that they actually sent it) and so opened it without any warning signals. More recently, Microsoft reported a powerful, sneaky Trojan horse that found its way onto many Windows 2000-based servers. Though it didn't cause any major disasters, it did result in odd network behavior and stumped computer experts for a very long time.

Let's look at some ways to prevent and deal with these critters.

AVOIDING INFECTION

Just as you can try to avert the common cold by indulging in extra Vitamin C and dodging other people's sneezes, there are precautions you can take in trying to avoid being affected by any one of these computer "illnesses."

- Never download files, games or software if you are not certain of its source. Even it comes from a reliable source, it could potentially possess a Trojan, which unleashes its damage once it is opened. Scan the attachment with a fully-upgraded anti-virus program first.
- Watch out for hidden file extensions. By default, Windows hides the last extension of a file. Before you open

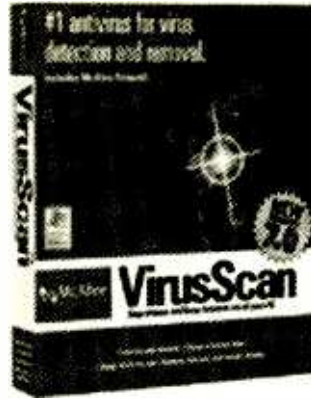

The latest version of McAfee VirusScan 7.0 offers some protection against online infections.

a file, reveal the extension. For example, a "baseball.jpg" file might actually be "baseball.jpg.exe," and could possibly be an executable Trojan.

- Don't use features in your program that automatically get or preview files. Though convenient, they leave you vulnerable to infection.
- Turn off and remove unneeded services. Many operating systems will install auxiliary services, like Telnet or a Web server, that you don't use. These services could prove to be avenues of attack, and they just give you more features to maintain and protect.
- Configure your e-mail server to block or remove e-mail that contains file attachments that are commonly used to spread infection, such as .exe, .bat, and .vbs.
- If a computer is infected, isolate it immediately to prevent further spreading.

As a valuable piece of advice, always remember to back up your files. How often you back up depends on how often you update information in your computer, but don't wait so long that it would be devastating to lose what you have. If one of these critters does creep into your system, at least you haven't lost a lifetime of hard work.

PEST EXTERMINATION

Discussed above were just some methods of prevention. You can run all you want from an unwanted illness, but some will inevitably catch up to you. Here are some options for the removal of an infection. You can either try any of these yourself or call on professional help if you don't feel confident enough to tackle them.

Reinstallation or Cleansing—This is tedious and time consuming, but it is a sure way to eradicate the problem. First, back up your entire disk. Then, reformat the disk, re-install the operating system and all of your applications from original CDs, and restore your files from the back up (Caution: Only restore your backed up files if you are sure they are not infected.)

Anti-Virus Software—In order for these programs to work effectively, you must make sure that you have the very latest update files for your programs, or they will miss the latest infections. Some of the more popular software includes AVP, PC-cillin, and McAfee VirusScan. These programs are not guaranteed fixes, however, and it is possible that they can miss certain strains of infection.

Help Web Sites—There are many Web sites out there that offer a lot of valuable information and helpful advice. Some will even walk you through the steps involved in getting rid of your specific infection. Two sites in particular are www.irc.help.org and <http://securityresponse.symantec.com>. Symantec's Web site has the latest information on current threats. Although pretty technical, you can find out some vital information on infections that are striking at the present time. It provides loads of data, such as the infection type, infection length (how many bytes or files are affected), which systems it has affected, and which are vulnerable, etc. It will advise users as to how to avoid specific viruses.

WRAPUP

I'll leave you with these final words of advice: Back up, back up, back up! Back up whenever possible so you'll have the least amount of headaches if your system is suddenly attacked. Also, proceed with caution when opening unknown files. Be safe and critter-free!

Holiday Gift List

It's getting to be just about the time of year when you start making up your Holiday Gift List. To help you along this year, we thought we'd give you some suggestions. Here are some of the products we've looked at recently that we'd love to receive ourselves. Of course, there have been lots of other products we've seen, and even covered in columns, that we'd love to get. Unless we had the whole issue, there's just no way we could even start to cover them all. Maybe next year, that will be the Editor's gift to us. This year, however, we're stuck with limiting ourselves to a few products that we really think will spice up your holidays and the days following them.

PURE ENJOYMENT

One of our real joys in life is listening to music. A misspent youth playing guitar (badly!) has left a residual penchant for listening to loud rock and roll. Once in a while, we manage to sneak away for the guilty pleasure of Broadway show tunes, including Gershwin and Cole Porter, and even some classical and neo-classical music.

While our old BIC turntable occasionally still sees some use, the majority of music in our house these days is digital, either WAV, WMA (Windows Media Audio), or MP3 files residing on one of the many PCs connected to our home Ethernet network. When anyone in the family wants to listen to music away from the PC, we have a variety of devices we use.

With all of the purely digital music players we have, many times we'll just burn a CD-R. That lets us listen to the music in either of our cars or on a CD player. We have two that are our favorites right now. TDK's new Mojo



Creative Labs offers two versions of its MuVo MP3 player—a 128-MB model sells for \$169 and a 64-MB model sells for \$129. The MuVo can also be used to transfer files between USB-equipped PCs.

640 player is a standard-size CD player. It looks terrific in silver and blue, has great fidelity, and can play standard audio CDs, as well as the CDs we burn with MP3 files. At \$169 (MSRP), it's not cheap; but it's a really high-quality player that will provide a lot of use.

Another player that we frequently use is Teac's *MP330*. This player is very small, only 4 X 3.75 inches, and uses the 8-cm mini-CD-Rs. These discs are widely available and not very expensive, with each CD-R holding about 185 MB of music files. Depending upon the sampling rate that you use, each mini-CD-R can hold up to about 210 minutes of music. The player comes with a copy of *MusicMatch Jukebox* and a set of terrific-sounding Sennheiser earbud phones. At \$99, this is an excellent, easy-to-carry player.

We also have a number of digital music players, and the two that get the

most use around our house are both from Creative Labs. Creative was one of the first vendors to produce a digital MP3 player, the *Nomad*, and the latest iteration of the *Nomad 3 Jukebox* has a big 20GB hard-disk drive that lets you store up to 340 hours of music. The newest *Nomad 3 Jukebox* can use both MP3 and WMA format files and comes with rechargeable batteries and earphones.

If the \$399 price tag of the *Nomad 3 Jukebox* is a bit too rich for your budget, the newest Creative MP3 player, the *MuVo*, might be a bit more financially attractive. Available in two memory capacities, the 128-MB version priced at \$169 and the 64-MB version for \$129, the *MuVo* is the smallest MP3/WMA player on the market. It consists of two pieces, a USB memory module that plugs directly into a USB port on your PC and a control module. The 128 MB of flash memory holds up to four hours of music. You load the

*Seasons
Greetings*

Plug a Friend into

Poptronics[®] *and Save \$44.89**

*This holiday season you can give an electrifying gift ... plug a friend into **Poptronics**[®] and brighten the whole new year! Whether electronics is your friend's livelihood or hobby, your gift will illuminate the whole spectrum of electronics throughout the coming year and provide a monthly reminder of your friendship.*

Poptronics[®] Magazine will keep your friend informed and up-to-date with new ideas and innovations in all areas of electronics technology ... computers, video, radio, stereo, solid-state devices, satellite TV, medical electronics, communications, robotics, and much, much more.

Poptronics[®] combines the best attributes of **Electronics Now** and **Popular Electronics**. It is the magazine for the hands-on electronics activist. We will be presenting articles on just about everything electronic—from satellite TV equipment to DVDs, gadgets and gizmos to energize your life, audio amplifiers, professional service features, PC-related projects, and much, much more.

PLUS: A selection of computer-oriented columns that explore the digital realm from the inner workings of a PC to the latest the Web has to offer. On the electronics side, there is something for everyone—from the beginner (Basic Circuitry and Q&A) to the expert. Whether your interest is fixing equipment (Service Clinic), tinkering with robots (Robotics Workshop),

or adventuring to the farthest reaches of electronics and science (Amazing Science)—**Poptronics**[®] takes you there.

SAVE \$44.89* ... OR EVEN \$89.78* ... For each gift of **Poptronics**[®] you give this holiday season, you save a full \$44.89* off the newsstand price. And as a gift donor, you're entitled to start or extend your own subscription at the same Special Holiday Gift Rate—you save an additional \$44.89*!

No need to send money ... if you prefer, we'll hold the bill till January, 2003. But you must rush the attached Gift Certificate to us to allow time to process your order and send a handsome gift announcement card, signed with your name, in time for the holidays.

So do it now ... take just a moment to fill in the names of a friend or two and mail the Gift Certificate to us in its attached, postage-paid reply envelope. That's all it takes to plug your friends into a whole year of exciting projects and new ideas in **Poptronics**[®]!

*Newsstand price—8 issues @ \$4.99 each
4 issues @ \$5.99 each



Texas Instruments has introduced its new Ti 83+ Silver Edition graphing calculator with extensive PD-like features. Selling for \$130, the Ti 83+ has a built-in address book, organizer, task list, and spread sheet application.

music into the MuVo just by dragging and dropping it to the device, which shows up on your PC as a removable drive. You can also use the MuVo to transfer files from one PC to another.

By the way, we use a variety of applications to burn CDs, most often the copy of Ahead Software's *Nero Burning ROM* or *Roxio's Easy CD Creator 5*—whatever came with the CD-RW drive that's installed in the particular system doing the burning. Recently, however, we've been using *Nero Mix*, a new application from Ahead Software. At \$49, *Nero Mix* makes it easy to burn and play your own CD-R/RWs and even to make nice looking disc labels.

When we listen to music at home, we almost always use a PC, even in the living room. Most of the PCs have Creative Labs sound cards in them, and all have high-end speaker systems. Our one favorite system, however, is in the new family room we're building in the basement. That PC has a large hard disk, a high-end Sound Blaster Audigy sound card, and a set of Klipsch *ProMedia 5.1* speakers attached. Bryan and Scott, who are the cabling whizzes in the family, have installed wiring in the walls so that the speakers can be correctly located around the room without needing exposed cables. The *ProMedia* speak-

ers are the best sounding speakers we've tested and put out a painful level of volume with the controls maxed out. They are expensive, usually around \$400 if they aren't on sale, but are worth it!

ON THE PRACTICAL SIDE

All of the items we've mentioned so far have been luxuries. For the last two gift suggestions on the list, we've chosen things of a bit more practical nature. Almost all students these days need a quality calculator for math courses. In our school district, the Texas Instruments Ti 83+ graphing calculator is required from 9th grade on. Priced at around \$90 when on sale, it's a terrific calculator, which can be used through Calculus. In fact, we have three of them in our house.

TI has improved upon this popular model with the new *Ti 83+ Silver Edition*. Housed in a translucent frosted case, the *Ti 83+ Silver Edition* has all of the features that made the original *Ti 83+* so popular. The Silver Edition adds much of the functionality of a PDA to the calculator, with a built-in organizer, address book, task list, and *CellSheet*—a decent basic spreadsheet application. TI's upscale calculators have long included the ability to let you download software applications. The Silver Edition comes with *StudyCards*, a flash-card type application that lets you create your own study cards or download them from TI's extensive educational Web site. The 83+ Silver Edition costs about \$130, and there's even a new \$40 full-size keyboard available for it.

If you don't have students who can benefit from the *Ti.c. 83+ Silver Edition*, how about a new PDA? We have several here, but the newest one, a Compaq/Hewlett Packard *iPaq 3950*, is getting most of the attention lately. This PDA is one of the top-of-the-line models, sells for about \$650, and has lots of RAM and a full-color screen. It runs the Microsoft PocketPC 2002 operating system and has many of the Pocket versions of Microsoft Office applications built-in. With a Think Outside Stowaway keyboard, the *iPaq* travels with us for word processing much more often than our laptops. The optional CF (compact Flash card) adapter is put to use when we test one of the GPS adapters. All in all, the *iPaq 3950* is a quantum level bet-

ter than the original Palm III we've been using for the past several years.

OH, ONE LAST THING!

We hope that you find something in our holiday suggestions that whet your appetite. Most of all, however, let us take this opportunity to wish you and yours a terrific holiday and a happy and healthy New Year. P

SOURCE INFORMATION

Ahead Software
www.nero.com

Compaq Computer (Hewlett Packard)
800-888-0220
www.compaq.com

Creative Labs
408-428-6600
www.creative.com

Klipsch Audio Technologies
800-544-1482
www.klipsch.com

TDK U.S.A. Corporation
516-535-2600
www.tdk.com

TEAC America, Inc.
Data Storage Products Division
323-726-0303
www.teac.com

Texas Instruments, Inc.
http://education.ti.com

Electronic Projects 1.0

By Max Horsey

A series of ten projects to build along with audiovisual information to support hobbyists during construction. Each project is complete with schematic diagrams, circuit and PCB layout files, component lists and comprehensive text to guide the hobbyist through the project. A shareware version of CAD-PACK—schematic capture and PCB design software is also provided. Projects include a reaction timer, logic probe, egg timer and seven more. Get your own copy of this CD-ROM today. \$75 including shipping in the U.S. Order from CLAGGK Inc., P.O. Box 12162, Hauppauge, NY 11788. Visa, MC, Discover, OK.



CLX2



Modulation Methods, Part 2: SSB

Last month, we discussed CW and AM modulation and introduced the subject of Single SideBand (SSB). This month, we'll look at this type of modulation in depth.

SSB is a type of AM without the carrier and with only one sideband. DSB or Double SideBand is AM with the carrier suppressed, but with both upper and lower sidebands. DSB is compatible with SSB receivers, the receiver merely rejects the unwanted or redundant sideband. The use of both sidebands to carry two separate channels of information is called ISB, or Independent SideBand. ISB was somewhat popular with hams in the early 1960s as AM was gradually yielding to SSB, since a DSB transmitter was and is relatively simple to build.

DSB is seldom used today. However, it was a cheap way back then to gradually phase over to SSB; SSB receivers could handle it, and the unwelcome carrier signal was absent. We will not discuss DSB any further as it is considered obsolete as a voice-transmission method in HF communications work. It is still used in FM stereo transmission for the 38-kHz audio channel difference (L-R) subcarrier. This topic will be covered in a later column.

SSB was known in the early days of radio, but circuit techniques and hardware to generate it did not become readily available until after WW II. There was a transatlantic telephone circuit operating on about 55 kHz in the long-wave band during the 1920s, which used SSB transmission. Amateur radio operators (hams) who liked to experiment explored SSB after WW II, while AM was still "king."

The Shift To SSB

However, the gradual shift to SSB started during the late 50s. During the early 60s, reasonably priced manufac-

tured SSB equipment became available to amateurs, and a gradual changeover to SSB took place. By 1970, AM was mainly used on the 28-MHz and VHF amateur bands, and it was called "Ancient Modulation." Even on the VHF bands, FM (Frequency Modulation) took over during the 70s, and, by 1980, AM was pretty scarce. AM activity can still be found near the 3.9- and 29-MHz frequencies in the 75-meter and 10-meter ham bands, with some local AM work also at 50.4 MHz in the 6-meter band.

AM has made a small comeback since the late 80s, since SSB equipment using LSI chips and microprocessors has become smaller, sophisticated, and too complex and forbidding for home experimentation. Old vacuum-tube AM equipment has enjoyed somewhat of a revival, as it lends itself to amateur experimenting. It's ideal for those interested in restoring and operating old-time vintage equipment.

The military has also long since converted to SSB for its HF communications work. With the exception of international broadcasting, HF voice communications is practically all SSB. International shortwave broadcasting is also going this route as well as toward digital radio. However, AM is still the simplest and cheapest from a reception standpoint, and it is almost universally used for broadcasting and air-to-ground VHF-UHF voice communications. Nevertheless, the use of SSB allows superior weak-signal reception and less transmitter power for the same results.

VSB And Selective Fading

Most SSB exciters first generate a DSB signal, which is then processed into SSB. An AM signal with one sideband partially suppressed is called VSB or vestigial sideband. This signal is widely

used in television transmission to reduce bandwidth while still allowing AM detection schemes to be used. An SSB signal can be transmitted with a carrier to reduce occupied bandwidth, and this is called CSSB or compatible SSB. It has little advantage over AM other than the reduction in bandwidth and selective fading effects.

Selective fading is a phenomenon in radio transmission where the fading of a signal at the receiver is very frequency selective, usually due to radio-wave cancellation effects caused by phase differences from multipath transmission and ionospheric effects. It acts as a sharp notch filter, which continuously and randomly varies in center frequency. The filtering effect randomly nulls out one sideband, then the carrier, then the other sideband, and then might reverse direction. This randomly moving "notch filter" causes the fading and intermittent audio distortion heard on received AM signals. These disturbances can be easily heard on distant AM broadcast stations during the nighttime hours when multipath effects from sky-wave and groundwave signals cause them to occur. SSB is less susceptible to this as there is no carrier and no other sideband to deal with. Therefore, SSB transmission usually only exhibits rising and falling signal levels, with little extra distortion as compared to AM.

SSB Generation

Refer to Fig. 1 for the following discussion of how SSB is generated. Audio information at the transmitter input is first fed into an amplifier and possibly a speech compressor or clipper. This step serves to increase average modulation level. **Note:** A word of caution here. Unlike an AM signal, in which the envelope has the same waveform as the modulating waveform, the envelope wave-

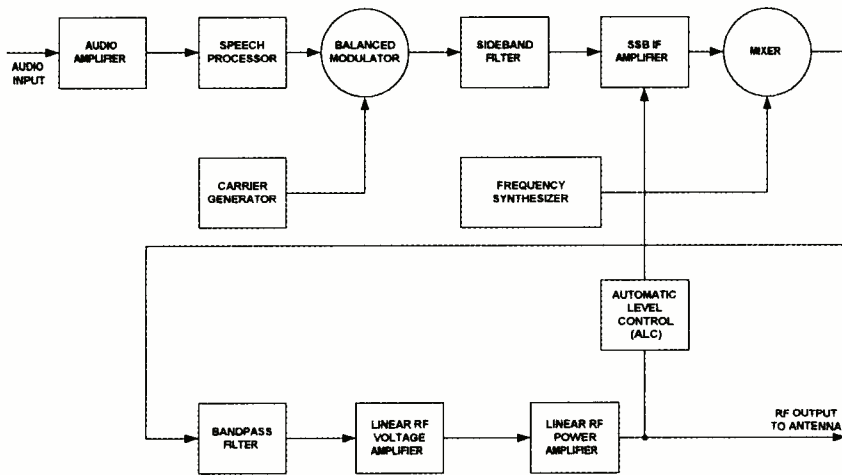

FIG. 1. BLOCK DIAGRAM SSB TRANSMITTER USING FILTER METHOD

form of an SSB signal has no direct simple relationship to the modulating signal (see Fig. 2). Using clipping of peaks can introduce undesirable effects and actually degrade the signal. Compression, on the other hand, largely preserves the waveshape of the modulating signal, mainly affecting its amplitude, and can be effective in boosting the average modulation level. The lesson here is to avoid the all too commonly heard over-clipped and overcompressed signals that are strong but nearly unreadable. The idea that "if enough is enough, then more is better, and too much is just right" does not apply in this case.

Next, the audio should be bandlimited to eliminate products outside the intended bandwidth. Typically, this bandwidth will be 200 to 3500 Hz for speech, although 2500 Hz is sometimes used as an upper limit. The audio is then fed to a balanced modulator that is also driven with an RF carrier at the SSB-generation frequency, sometimes called the transmitting IF frequency.

In many instances, this transmitting frequency is the same as the receiver IF frequency, which is often done in transceiver systems—using the same circuitry for modulation and demodulation. The output of the balanced modulator (actually a mixer) is a double-sideband suppressed carrier signal, since the carrier is cancelled out. In the absence of a modulating signal, the output is ideally zero. In practical balanced modulators, about 30- to 40-dB suppression of the carrier is obtained. There is usually some provision for optimizing carrier suppression in most circuits, although with modern solid-state diode, doubly balanced mixer assemblies inherent suppression is good

enough and no adjustment is necessary. Next, the output of the mixer or modulator is fed to a sharp cutoff filter. This filter may be made up of L-C elements (in the 10-50-kHz range), or mechanical resonators (455 or 500 kHz), or, most often, made from quartz crystals. Crystal

filters are available at many popular frequencies as off-the-shelf assemblies, such as 1.65, 3.0, 5, 9, 10.7, and 21.4 MHz—common SSB IF frequencies that are stock crystal filters. Many other frequencies are also used. The 5- to 9-MHz range seems most popular, as crystal filters for this range are easily made. The filter should have a bandwidth (for speech) of about 2.1 to 3 kHz, should have a center frequency about 1.5 kHz above or below the carrier frequency, and should have a 20- to 30-dB rejection at the carrier frequency. The filter should cut off sharply on the carrier side and should have 40 dB or better rejection of the unwanted sideband. Crystals are used in these filters because we need the very high Q values to physically realize this kind of rejection and bandwidth. The filter is generally one of the more expensive components in an SSB system.

Creating A Signal

An SSB generator of this type can

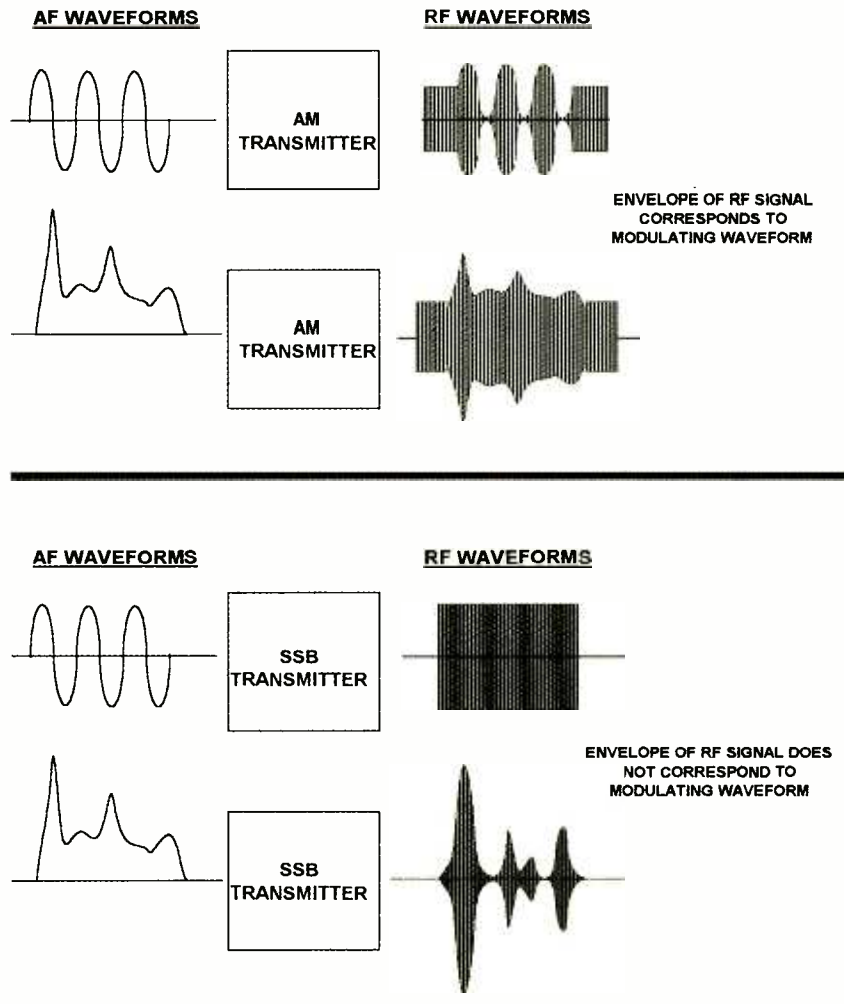

FIG. 2. AM and SSB TRANSMITTER WAVEFORMS

generate an SSB signal of either lower or upper sideband. This option is a function of the filter-response characteristics. If capability to generate a signal of either sideband is needed, there are several approaches.

First, two separate filters can be used with a switching arrangement to select the desired sideband. Alternately, a filter with a symmetrical response curve that has a very sharp cutoff on each side can be used, and the carrier oscillator can be shifted to either side of the filter.

A scheme that was popular some years ago used a filter at 9.000 MHz that had a symmetrical response plus and minus 1.2 kHz from each side of center. This filter gave a bandwidth of 2.4 kHz for the signal, and two separate crystals were provided in the carrier oscillator—one at 8998.5 for USB (*Upper SideBand*) generation, and another at 9001.5 for *Lower SideBand* (LSB) generation. This scheme had the disadvantage of having a 1.5-kHz nominal error in the 9.000-MHz nominal frequency, but it was corrected by shifting the LO (*Local Oscillator*) signal plus or minus 1.5 kHz to compensate, making the final output frequency correct. Today transmitters control the frequency synthesizer via software in the microcontroller programming, so the entire operation is transparent and automatic.

Another method using only one filter involves using a mixer. One old scheme was to generate the SSB signal at 455 kHz using a mechanical filter as the SSB filter, as follows: The output from the SSB generator is 455 kHz USB. Next, the 455-kHz signal is mixed with the fourth harmonic of the carrier, 4 X 455 kHz or 1820 kHz. That gives a USB signal of 2275 kHz, which is the IF frequency in this system. If an LSB signal is desired, the sixth harmonic of 455 kHz at 2730 kHz is used. The 455-kHz USB signal when mixed with 2730 kHz results in a 2275-kHz SSB signal as before, but now this is an LSB signal. Here we are taking the difference rather than the sum.

In sum mixing, the output is the sum of the IF signal and the LO signal. If the IF increases in frequency, so does the sum of the two signals. In difference mixing, when the IF signal increases in frequency, the resulting sum of the IF and LO will decrease in frequency. This relationship results in inversion of the SSB signal about the carrier frequency (in this case 2275 kHz). This system has

the disadvantage of needing a mixer and extra stages to generate the X4 and X6 signals to mix with the generated SSB signal and corresponding switching arrangements. The extra cost and complexity must be weighed against the cost of an extra filter.

In amateur radio HF transceivers, a commonly used technique is the use of one symmetrical filter with corresponding offsetting the LO (as mentioned before). In this case, the software in the synthesizer costs nothing once written and debugged and takes no physical room. The sharp symmetrical filter is cheaper than two separate filters, as well, and transceiver design is simplified as the same conditions apply to both receive and transmit.

Filter Output

The output of the filter is an SSB signal at the IF frequency. This signal is then mixed with a very stable and pure local oscillator signal from a very stable VFO (*Variable-Frequency Oscillator*) or frequency synthesizer. This is done in a high-level, very linear mixer to produce the desired SSB output frequency. A filter system then removes unwanted mixer products; and the resulting SSB signal is then amplified to the final transmitter power output level, which may be a few watts to many kilowatts. A very linear amplifier must be used to prevent the generation of intermodulation-distortion products that will appear as unwanted components and interference on the transmitted signal.

Linear amplifiers may be vacuum-tube or solid-state. For very high power levels (about 500 watts or more), vacuum-tube technology is still the technology of choice. Most transmitters and transceivers in the 100-watt class use solid-state, bi-polar, or power FET devices. Higher power solid-state amplifiers above a few hundred watts generally need large and heavy heatsinks, RF power combiners, and several large expensive transistors, together with a high-current, low-voltage supply. It is difficult to get these large quantities of heat out of relatively small chip areas while keeping chip temperatures reasonable.

Often, sophisticated protection circuitry is needed to keep the transistors safe against load faults and power spikes. Vacuum tubes do not have this problem, and only a simple cooling fan is required in most cases. There are a few solid state

500-1000 watt amplifiers sold by SSB radio manufacturers. However, vacuum-tube amplifiers are usually smaller; can be just as, or more, efficient than solid-state; and are more reliable, with much better immunity to load faults such as high VSWR (*Voltage Standing-Wave Ratio*) due to broken, mismatched or shorted antennas. A vacuum tube can usually stand a severe fault for a few seconds, while transistors can fail in microseconds. For this reason, high-power applications are often better implemented with vacuum tubes.

Large, expensive, and heavy 60-Hz transformer-type high-voltage supplies from the old days can now be replaced with much smaller and lighter highly efficient switching-type solid-state supplies, but tubes still are better suited for the RF circuitry. The vacuum tube still is king here, and may always be, for high power levels. However, for low power (200 watts or less) and portable transmitter use, solid-state is undeniably the best approach.

The Phasing Method

Another approach to SSB generation is called the phasing method. In this approach, a clever phase-cancellation technique is used. This method eliminates the need for a sharp SSB filter and is potentially lower in cost. (See Fig. 3.) First, the audio signal after processing and bandlimiting (very important in this approach) is split into two components, equal in amplitude but exactly 90 degrees apart in phase. This splitting is the difficult part, as a network is needed that provides a 90-degree phaseshift within plus or minus 1 or 1.5 degrees over the entire audio range of 300 to 3000 Hz.

There are classes of R-C networks that have this property, generally involving precision components. In practice, each audio component is fed to a separate network. While the individual network phaseshifts vary over the audio frequency range, the difference between their outputs stays within a degree of 90 degrees, with constant amplitude. The synthesis of these networks is beyond the scope of this article. A typical network is shown in Fig. 3. It is rather simple, but requires precision components. The degree of unwanted sideband suppression depends on it.

Next, the two 90-degrees-apart audio channels are fed to identical balanced modulators or doubly balanced mixers

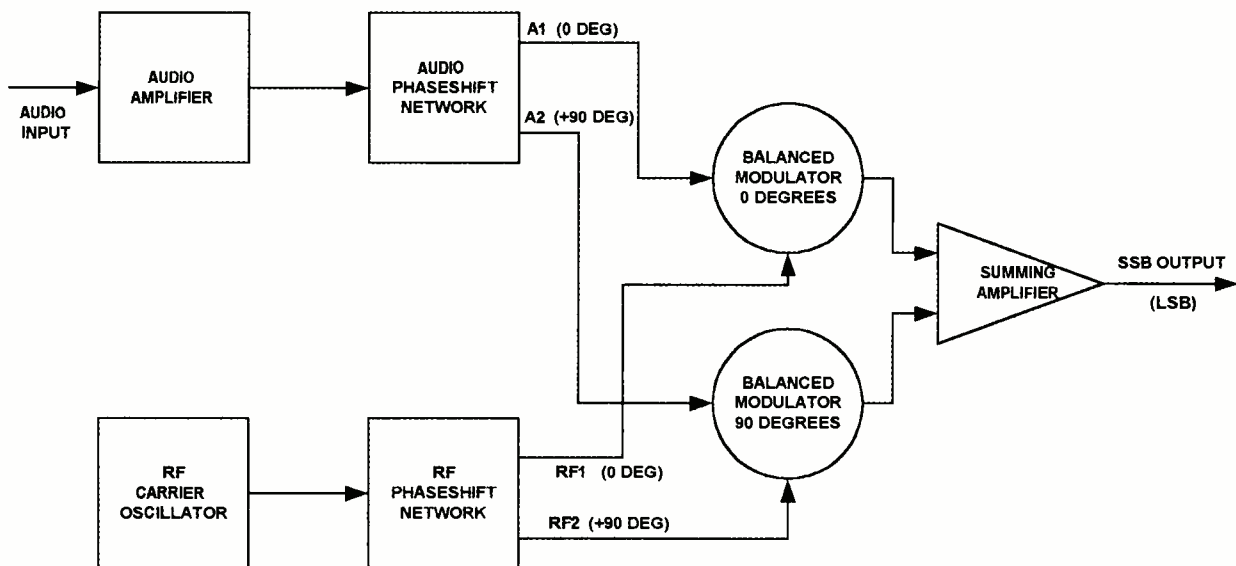

IF: $A1 = \sin W_m T$
 $A2 = \cos W_m T$
 and
 $RF1 = \sin W_c T$
 $RF2 = \cos W_c T$

$$\sin A \sin B = 1/2 \cos(A-B) - 1/2 \cos(A+B)$$

$$\cos A \cos B = 1/2 \cos(A+B) - 1/2 \cos(A-B)$$

THEN:

$$\text{SSB OUTPUT} = 1/2 \cos(W_c T - W_m T) - 1/2 \cos(W_c T + W_m T) + 1/2 \cos(W_c T + W_m T) + 1/2 \cos(W_c T - W_m T)$$

SUMMING TERMS AND SUBSTITUTING:

$$\text{SSB OUTPUT} = 1/2 (\text{LSB}) - 1/2 (\text{USB}) + 1/2 (\text{USB}) + 1/2 (\text{LSB}) = \text{LSB ONLY}$$

FIG. 3. PHASING METHOD OF SSB GENERATION

that are driven with two carriers identical in frequency but also exactly 90 degrees apart in phase. This step is easily done since the carrier frequency is generally fixed. A network consisting of R-C or L-C circuits can provide this 90-degree phaseshift, or a divide-by-two frequency divider can be used. Two JK flip-flops driven by two identical clock-signal square waves 180 degrees apart will produce two outputs at half the input frequency and 90 degrees apart in phase.

The outputs of the two mixers are then combined. It can be shown that the output will consist of only one sideband (see Fig. 3), since the double sideband signals from each mixer will have phase relationships such that one of the sideband components will have opposite phase with respect to the other and the other will be in phase. Sideband selection occurs simply by reversing the phase of either one audio or one carrier channel. In practice, the audio channel method is normally used.

While a good method, the phasing method requires accurate component matching, narrow tolerances, and accurate setup. Nevertheless, it has been successful in amateur radio equipment, mainly when separate transmitters and receivers were used in the past. Today, transceivers are the main components, and the phasing method is not found as a filter is still needed any way for the receiver section. In the future, digital-signal-processing will undoubtedly be the common method, eliminating or simplifying the filter required. While other methods exist, most SSB generation will be done for a while using the filter method. SSB crystal filters have come down somewhat in price due to manufacturing and design improvements, as well as increasing market demand, keeping the filter method as the most popular.

Signal Reception

Reception of SSB signals generally follows the reverse of the generation

process. A look at the spectrum of a voice SSB signal will show that it is simply the input audio input spectrum shifted up into the RF region. For example, consider a 10,000-MHz voice-frequency SSB signal. If the USB mode is used, the transmitter will produce a signal having frequency components of 10.0003 to 10.0030 MHz, or simply 300 to 3000 Hz (0.3 to 3 kHz), shifted arithmetically higher in frequency by 10 MHz.

To receive this signal, we must simply shift it back down to the audio region. For LSB, the transmitted spectrum is also inverted, the higher voice frequency components producing lower transmitter frequency components. A simple mixer (in this application commonly called a product detector, same mixer circuit, different name) can be used for this function, and, indeed, a receiver can be built in which an antenna is connected to a mixer that is fed with an LO. If the LO is exactly the same frequency as the suppressed carrier of the input SSB signal from the antenna, the product

detector output will be the original audio that modulated the SSB transmitter. This type of detector when used with an antenna and a suitable audio amplifier will make up a receiver commonly called a direct conversion receiver.

Useful for SSB and CW (Morse code) reception, this scheme is popular for low-cost, ham-radio receiver construction and eliminates much RF circuitry. The LO must be stable and have good noise characteristics; and a low-noise audio amplifier is necessary, but sensitivities around a microvolt can be obtained. The bandwidth is that of the audio amplifier. Disadvantages of this receiver are lack of sideband selection; poor RF selectivity; lack of AM reception capability due to LO beating with the AM carrier; and susceptibility to RF overload, as generally no AGC (Automatic Gain Control) is used. However this receiver provides a lot of performance with very little circuitry and is superior to and easier to use than a regenerative receiver for SSB and CW reception.

Frequency

The carrier must be reinserted at the detector within a few hertz of the original carrier. Otherwise, the frequency of the audio output will be shifted from the original by an amount equal to this difference. For speech, 50 Hz is acceptable, but for quality 10 Hz is desirable; for music or where frequencies are critical, 1 Hz would be better.

To assist in this process, a pilot carrier may be transmitted. This carrier is a residual sample of the original carrier sent at a known level, i.e. -30 or -40 dB down so that it is not very noticeable. A phase-locked-loop at the receiver locks

on to this pilot carrier, ensuring accurate tuning. Modern SSB equipment used by amateur radio operators can easily hold frequency within 10 Hz, so this is not often done.

If the reinserted carrier is way off, the SSB signal will sound like gibberish—often called the "Donald Duck" sound. If the carrier is way off (a few kHz) and is placed on the opposite side of the signal, the recovered audio may actually be spectrally inverted. Now, the original low-speech frequencies (300-400 Hz) are at the high end of the audio band (near 3000 Hz), and the original audio components at the 3000-Hz end of the audio spectrum are now shifted down to the 300-Hz region. This effect is called "inverted speech," and this concept is used elsewhere to scramble an audio signal for privacy or security purposes. In practice, this scrambling is done with special circuitry. An article by the authors of this column appeared on page 37 of the December 1993 issue of **Electronics Now**, exploring using digital techniques to do such scrambling.

Other than the requirements for an accurate and stable LO frequency and a product detector, an SSB receiver is generally a standard super-heterodyne receiver. It has high RF performance in areas of dynamic range, noise floor, and stability, as well as special AGC circuitry, since there is no such carrier for AGC reference, as exists in an AM receiver. An SSB receiver usually has a separate envelope or synchronous detector for AM reception anyway and has switchable AGC for each reception mode.

In a transceiver system, often the same circuitry as above, SSB generation and detection runs "backwards" from

the receiver system. This type is called bilateral circuitry and will not be discussed here. Interested readers can refer to books such as the *ARRL Radio Amateurs Handbook* or the *RSGB Handbook* for details.

This discussion of SSB techniques has necessarily been brief. Entire books have been written on SSB, but it is impossible to cover the whole topic in a short article. The next part of this discussion will discuss frequency modulation methods and techniques. **P**

Get your copy of the CRYSTAL SET HANDBOOK



Go back to antiquity and build the radios that your grandfather built. Build the "Quaker Oats" type rig, wind coils that work and make it look like the 1920's! Only \$10.95 plus \$4.00 for shipping and handling. Clagk Inc., PO Box 12162, Hauppauge, NY 11788. USA Funds ONLY! USA and Canada—no foreign orders. Allow 6-8 weeks for delivery. MA01

Wireless & Electrical Cyclopedia



ETT1—Wireless & Electrical Cyclopedia \$4.99. Step back to the 1920's with this reprinted catalog from the Electro Importing Company. Antiquity displayed on every page with items priced as low as 3 cents. Product descriptions include: Radio components, kits, motors and dynamos, Leyden jars, hot-wire meters, carbon mikes and more. The perfect gift for a radio antique collector. To order ETT1, send \$6.99 (includes s&h) in the US and Canada to **Electronic Technology Today Inc., P.O. Box 240, Massapequa Park, NY 11762-0240**. US funds only. Use US bank check or International Money Order. Allow 6-8 weeks for delivery. MA11

NORTH COUNTRY RADIO: A HAVEN FOR WIRELESS BUFFS

Graf and Sheets are no strangers to the pages of Gernsback. Their educational projects, such as the *RF-Field Strength Meter* and the *MPX2000 FM Transmitter*, can be found at **North Country Radio**. Established in 1986, this company offers projects related to amateur TV transmitters/receivers, AM and FM transmitters/receivers, video cameras, and numerous other subjects. Visit the Web site at www.northcountryradio.com for more information.

Ordering Information: PO Box 53, Wykagyl Station, New Rochelle, NY 10804-0053; Voice: 914-235-6611; Fax: 914-576-6051; e-mail: Rgraf30832@aol.com.

Engineering and Technical Support
PO Box 200, Hartford, NY 12838
Voice/Fax: 518-854-9280
e-mail: support@northcountryradio.com

CRYSTAL SETS: VOLUME V.

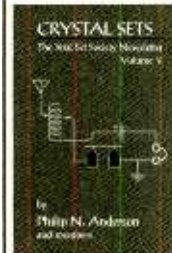

Volume V of the Society newsletter includes six issues ending December 1995. Great for new members to get current, those wanting a bound copy for their reference bookshelf, or as a gift to get a friend started. Contents include: The Design of Unpowered AM Receivers, Radio Outfit in a Headset, A Crystal Set Revisited-Reconstructed, Grounded Loop-stick Tuner, The Matching Secret, and lots of membership correspondence. 8 1/2 x 5 1/2 paperback, \$10.95 plus shipping.—**Electronic Technology Today Inc., PO Box 240, Massapequa Park, NY 11762-0240**. US funds only. Allow 6-8 weeks for delivery. MA06

Adjustable Voltage Power Supply

CHRIS TROUTNER

Electronics is a great hobby because you don't need a lot of money or fancy equipment to get involved. Once you're more involved in the hobby, there is a lot of equipment that will make prototyping and troubleshooting your circuits much easier. When you reach the point where you do need some fancier equipment, there's a good chance that you can build some of it yourself. As luck would have it, this article details an easy-to-build *Variable Power Supply* that works as well as ones costing hundreds of dollars—but this one costs less than \$100 to build.

Features. The variable power supply features two independent outputs, both adjustable from 0 to 20 V_{DC}. It provides independent voltage and current monitoring for each output. Usually a benchtop power supply must be plugged into an AC outlet, but this one contains two lead-acid batteries that make it portable. This way you can bring it with you to surplus stores to test unmarked motors and other mysterious parts. In the event of a power outage you'll be able to continue working on your projects, even though you'll probably have more important things to worry about if the power is indeed out.

Circuitry. The complete schematic of the variable power supply is shown in Fig. 1. The circuitry is broken up into four parts: Power Control, Low-Voltage Indicator, Output and Controls, and the Battery Charger. There is no official PC board or layout you must follow to build this device, so feel free to do it however you like. You can build all of the circuitry at once or only the parts you want to include in your power supply. The author used a RadioShack proto-board for all the circuitry because it's easy to solder and new circuitry can easily be added for future modifications. Let's take a close look at each section of the circuit.

Power Control. The Power Control section controls the charging and discharging of the batteries (B1 and B2).

The batteries are 2-Ah (ampere-hour) lead-acid units, but you can use any Ah rating that you want—you'll simply get more or less run time. Switch S2 is an SPST unit that turns the power supply on and off during normal operation. Switch S1 is a four-pole double-throw (4PDT) unit, whose wiring looks more complex than it really is. Moving the switch to the left position puts the unit in the "charge" mode by connecting the batteries in parallel to the battery charger. Moving the switch into the right position puts the batteries in series and connects them to the rest of the power-supply circuitry for the normal working mode.

Note that pins 1 through 6 of S1 control the series and parallel configuration of the batteries, and the rest of the switch contacts control the charge and discharge states. If it's more convenient, you can use two separate DPDT switches. Have one control the series/parallel connection of the batteries and the other control the charge/discharge mode.

WARNING: Be very careful when wiring this part of the circuit. Lead-acid batteries provide a high-current output. You can burn yourself very badly and cause all sorts of problems if you accidentally short out one of these batteries.

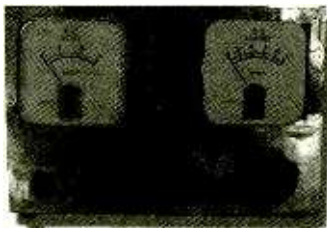

Construct a two-output power supply that produces 0 to 20 volts of DC power.

Low-Voltage Indicator. The low-voltage indicator tells when the batteries are low and require charging. When a lead-acid battery is fully charged, its voltage is around 13.8 volts; when fully discharged, it's around 10.7 volts. Zener diodes D1 and D2 (6.2-volt units) together create a 12.4-volt drop. When the battery voltage reaches 12.4V, the diodes short out the LED. As the series battery voltage decreases to about 20V (10V individually), the LED is no longer shorted. At this point, B1 no longer has a current path, but B2 does; and it flows through the LED to light it. If you want to increase or decrease the trip voltage, replace D1 and/or D2 with higher or lower voltage Zener diodes.

Output And Controls. Adjustable voltage regulators

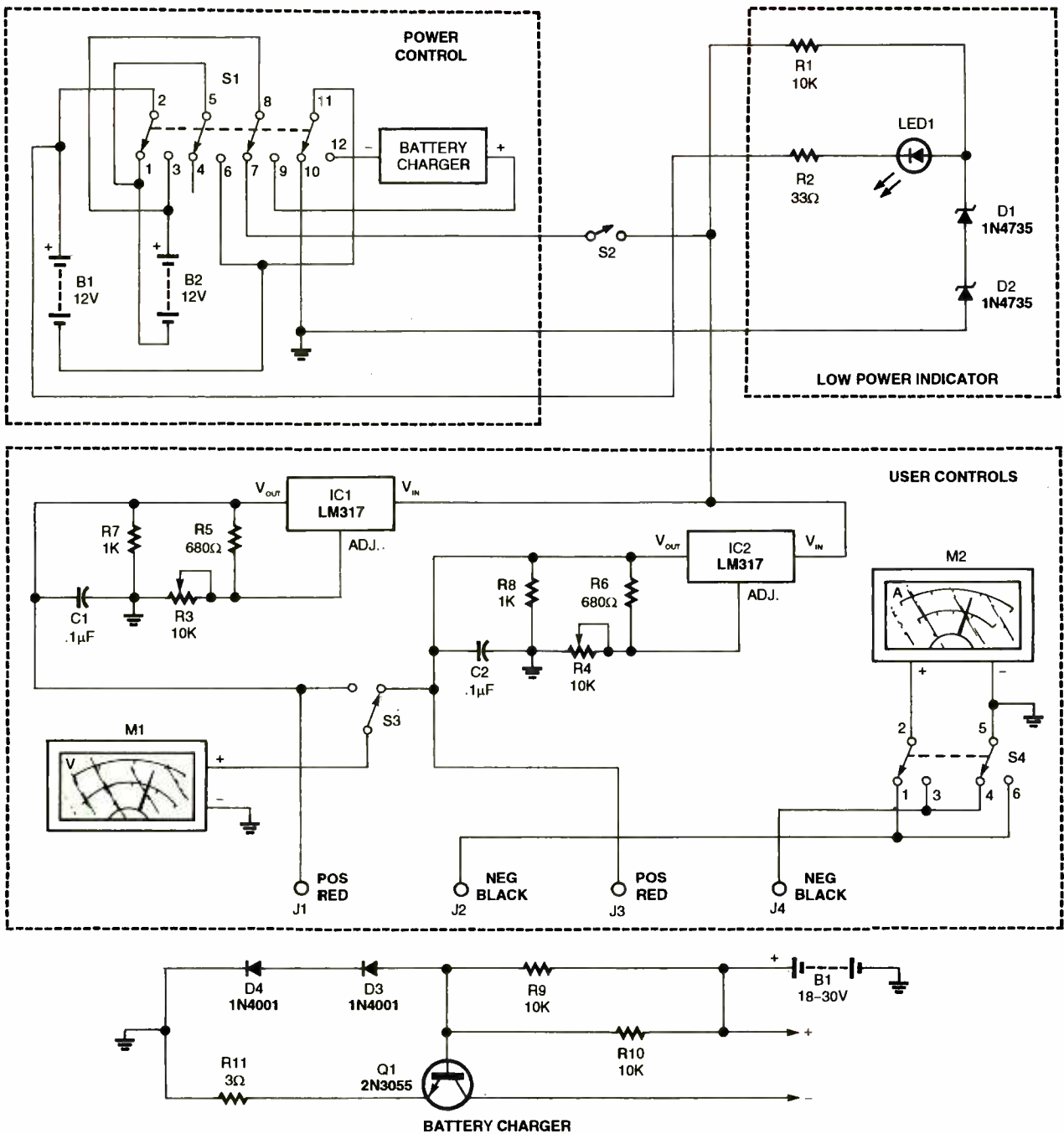

Fig. 1. Here is the schematic for the adjustable power supply. The circuitry is broken up into four parts: Power Control, Low-Voltage Indicator, Output and Controls, and the Battery Charger.

IC1 and IC2 (both LM317s) have a built-in 1.5-amp current limiter. The 10-K potentiometers (R3 and R4) let you adjust the output voltage from 0 to 20 volts. Capacitors C1 and C2 filter out high-frequency noise. The LM317s need a minimum load current of 3.5 mA to work properly, so resistors R7 and R8 connected to the outputs provide the minimum required load. You can replace R7 and R8 with lower valued resistors if you want the outputs to go below 4 volts.

Banana jacks J1 and J3 are positive outputs, and J2 and J4 are common-ground inputs. Switches S3 and S4 toggle between monitoring the outputs; S3 lets you

switch between monitoring the voltage on J1 or J3, while S4 lets you monitor the current going into J2 or J4. S4 is wired so that whatever input isn't connected to the current meter is still connected to ground.

Battery Charger. The battery charger, obviously, charges the batteries when they get low. Basically Q1 forms a current source that is controlled by the resistance of R11. The maximum charging current that should flow through the batteries is one-tenth of the amp-hour capacity, so you have to select the value of R11 according to the batteries you use. The author

PARTS LIST FOR THE VARIABLE POWER SUPPLY

SEMICONDUCTORS

IC1, IC2—LM317 adjustable voltage regulator
 Q1—2N3055 NPN power transistor
 D1, D2—1N4735 6.2-volt Zener diode
 D3, D4—1N4001 diode
 LED1—Light-emitting diode, any color

RESISTORS

(All resistors are ¼-watt, 5% units unless otherwise noted.)

R1, R9, R10—10,000-ohms
 R2—33-ohms
 R3, R4—10,000-ohm potentiometer
 R5, R6—680-ohms
 R7, R8—1000-ohms
 R11—3-ohms, 3-watts (see text)

CAPACITORS

C1, C2—0.1-µF, 10%, 35-volts, ceramic-disc

ADDITIONAL PARTS AND MATERIALS

SW1—4PDT switch
 SW2—SPST switch
 SW3—SPDT switch
 SW4—DPDT switch
 Female banana jacks, voltmeter, ammeter, 18- to 30-V_{DC} power supply, heat sinks, knobs, lead-acid batteries, wire, solder, case.

The following parts are available from the author: a complete kit of all parts (including a cut-out case) for \$130 and a fully assembled unit for \$160. Interested parties should contact the author at either clt@kistech.com or via mail at: Chris Troutner, PO Box 247, Boring, OR 97009.

used two 2-Ah batteries, connected in parallel when charging, effectively forming a single 12-volt 4-Ah battery. The maximum current that should flow through the two 2-Ah batteries while charging is 400 mA. Even though transistor Q1 is rated for high wattage, the author used a 3-ohm resistor (yielding a charge current of about 233 mA) to ensure that the transistor will never overheat.

If you want to use batteries other than the 2-Ah units, you have to calculate the proper value for R11. The current flowing through the batteries is effectively the same as the current going through R11, and the voltage dropped across diodes



The variable power supply features two independent outputs, which are adjustable from 0 to 20 V_{DC}. Two lead-acid batteries provide power; therefore, the device is completely portable.

D4 and D5 (approximately 1.2 volts) is the same voltage drop across the base of Q1 and R11. Therefore, the voltage across R11 is a constant 0.7 volt. Since current equals voltage divided by resistance, and the voltage is constant, the current is controlled by varying the value of R11

$$I = VR_{11}/RR_{11}$$

So first decide what charging current you need, and then calculate the value of R11 accordingly.

Construction. Feel free to build this project however you like. Point-to-point wiring on perforated construction board will do just fine, and nothing is critical about the component layout. The author wired the circuit on a RadioShack proto-board and installed the completed circuit board in a case measuring 7 × 5 × 6 inches. Note that the LM317s are rated for 20 watts maximum, and that's with proper heatsinking. Be sure not to skimp on the heatsinking for these ICs. Even with proper heatsinking, you may notice that, if under heavy load for an extended period of time, the output voltage might drop a bit due to the LM317's built-in thermal protection. The IC will again work normally once it cools down. The only way around the problem it is to use additional heatsinking. □

**Visit our
 Web Site at:
www.poptronics.com**

TIPS FOR MAIL ORDER PURCHASE

It is impossible for us to verify the claims of advertisers, including but not limited to product availability, credibility, reliability and existence of warranties. The following information is provided as a service for your protection. It is not intended to constitute legal advice and readers are advised to obtain independent advice on how to best protect their own interests based upon their individual circumstances and jurisdictions.

1. Confirm price and merchandise information with the seller, including brand, model, color or finish, accessories and rebates included in the price.

2. Understand the seller's return and/or refund policy, including the allowable return period, who pays the postage for returned merchandise and whether there is any "restocking" or "return" charge.

3. Understand the product's warranty. Is there a manufacturer's warranty, and if so, is it for a U.S. or foreign manufacturer? Note that many manufacturers assert that, even if the product comes with a U.S. manufacturer's warranty, if you purchase from an unauthorized dealer, you are not covered by the manufacturer's warranty. If in doubt, contact the manufacturer directly. In addition to, or instead of the manufacturer's warranty, the seller may offer its own warranty. In either case, what is covered by warranty, how long is the warranty period, where will the product be serviced, is there a charge for service, what do you have to do to obtain service and will the product be repaired or replaced? You may want to receive a copy of the written warranty before placing your order.

4. Keep a copy of all transactions, including but not limited to cancelled check, receipt and correspondence. For phone orders, make a note of the order including merchandise ordered, price, order date, expected delivery date and salesperson's name.

5. If the merchandise is not shipped within the promised time, or if no time was promised, within 30 days of receipt of the order, you generally have the right to cancel the order and get a refund.

6. Merchandise substitution without your express prior consent is generally not allowed.

7. If you have a problem with your order or the merchandise, write a letter to the seller with all the pertinent information and keep a copy.

8. If you are unable to obtain satisfaction from the seller, contact the consumer protection agency in the seller's state and your local Post Office.

If, after following the guidelines, you experience a problem with a mail order advertiser that you are unable to resolve, please let us know. Write to Advertising Department, Gernsback Publications Inc., 275 G Marcus Blvd. Hauppauge, NY 11788

Be sure to include copies of all correspondence.

Rudolph, the Light-Sensing Reindeer

STEVE LYMPANY

Everyone's heard "Yes, Virginia, there is a Santa Claus"-an editor's response to a young girl about the truth behind the jolly old elf. While this well-known line may not convince your children, this project might. When Rudolph is plugged in and placed in a dark location, the sounds of reindeer on the roof will be heard about 15 seconds later. If the young ones turn on the lights to investigate, the sounds will stop. Once the lights are off, the sounds of reindeer will begin again, following the 15-second delay.

We have used Rudolph in our home for several years with our two boys. Our routine takes place on Christmas Eve. Some time early in the evening, Dad gets Rudolph set up in a dormer and turns on the light. At bedtime, Mom reads to our two boys. When Mom begins reading "The Night Before Christmas," Dad turns off the light in the dormer and then goes into the boy's bedroom to listen to the story. Shortly thereafter, the boys hear the sounds of reindeer. They are certain that Santa has arrived, and they know that they'd better get to sleep if Santa is to leave them any treasures.

Circuit Operation. Figure 1 shows the schematic diagram of the circuit, which uses a 16F84 PIC microcon-

troller. Pin RB0 acts as an input that monitors the voltage developed across a Cadmium-Sulfide (CdS) photocell. In the light, the photocell has a resistance of about 500 ohms. When it is dark, its resistance increases to about 40 kohms. The photocell is placed in series with R2, a 10-kohm resistor, forming a voltage-divider circuit. The voltage at RB0 is about 0.5 volts when there's light and about 3 volts when it's dark. When the PIC software detects that this voltage is above 2 volts, indicating darkness, the software initiates a routine to start driving the solenoid via PIC output RB1. A high at RB1 turns on transistor Q1, which con-

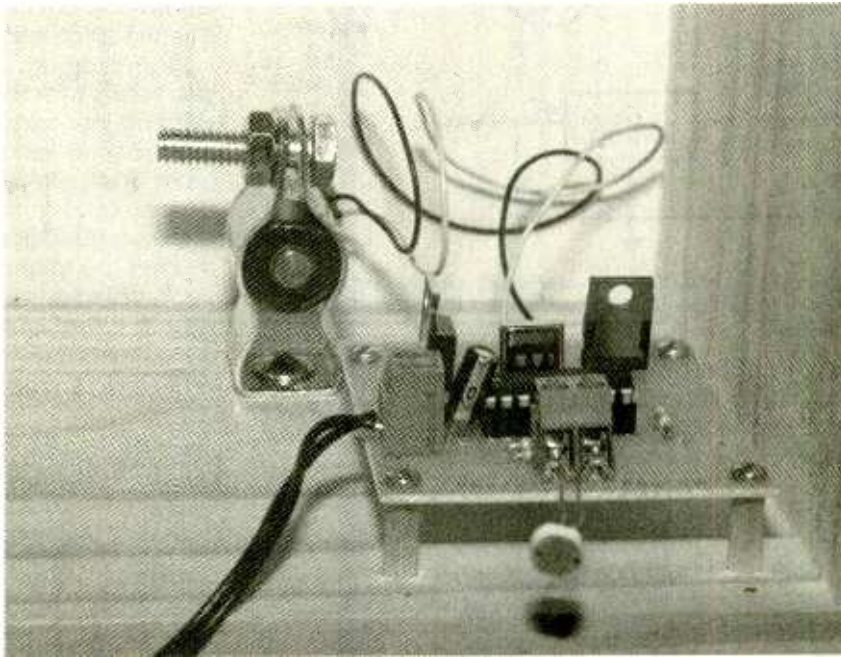

*Simulate the clip-clop
of Santa's sleigh team
on your rooftop.*

controls the solenoid. The solenoid is mounted inside a wooden box, giving a nice, resonant "clop, clop" sound when its piston strikes the side of the box.

The circuit requires a 12- or 15-V_{DC} source to operate the solenoid and a 5-V_{DC} source for the PIC. An AC adapter provides the higher voltage, while a 7805 regulator IC, U2, provides the 5-volt power to the circuit. As an option, a +12-volt battery pack can offer portable power for your circuit. Since the solenoid draws about 300 mA when activated, the current rating of the AC adapter should be greater than about 500 mA for reliable operation.

Components and Software. The solenoid is a "push"-

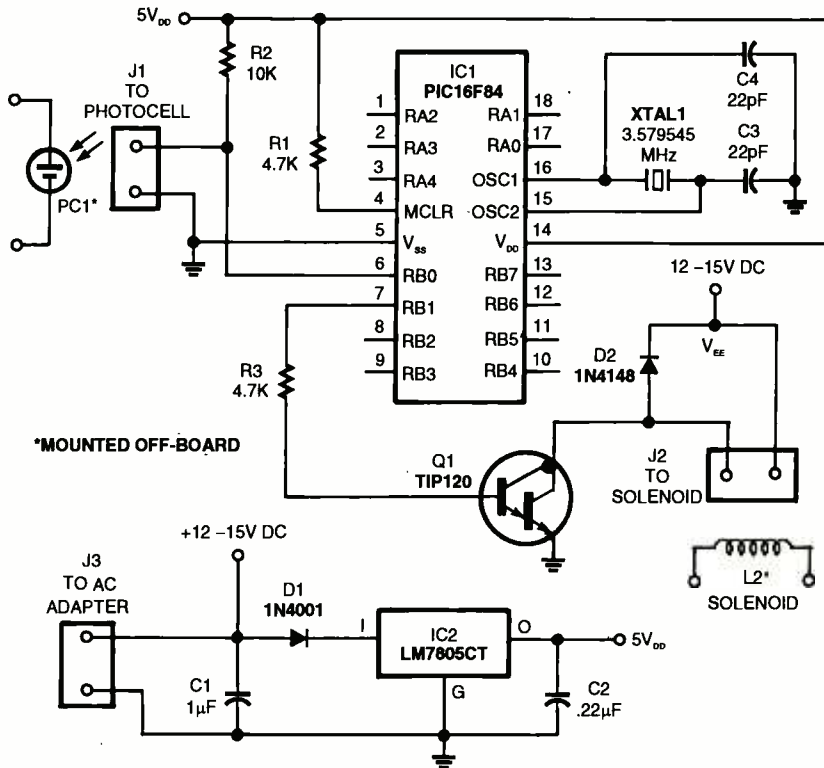

Fig. 1. Here is the schematic diagram of the light-activated circuit, which uses a 16F84 PIC microcontroller. Pin RB0 acts as an input that monitors the voltage developed across a Cadmium-Sulfide (CdS) photocell.

type solenoid, meaning that the piston is forced outward when activated. Other solenoids may be substituted for the one I used. Just be sure it is a "push"-type solenoid and will operate with a nominal 12-VDC voltage applied.

I chose a 16F84 PIC for this project largely due to its popularity and easy availability. Other PICs could be used in place of the 16F84. (The "PIC-tronics" column by TJ Byers in **Poptronics** uses a 16F628 PIC, which appears to be pin-compatible with the 16F84. If you have one available, you may be able to use it with the

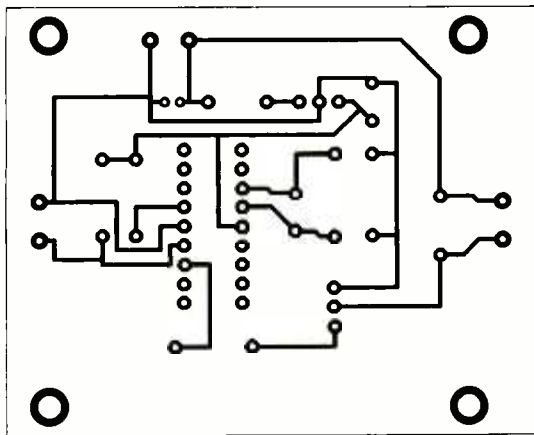
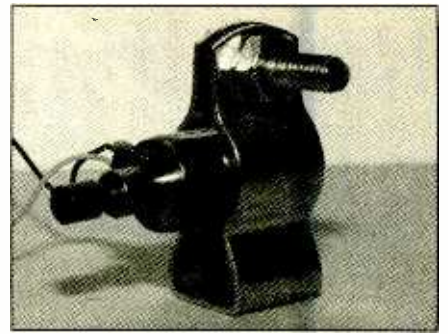

Fig. 2. This PC-board foil pattern can be utilized to etch your own boards. An etched and drilled board is available from the author for a nominal charge, as is a pre-programmed PIC chip.



The specified solenoid does not have a threaded collar for mounting so I used a 1/2-inch conduit hanger, as shown in the photograph. Conduit hangers can be obtained at your local hardware store.

board and eliminate the crystal and the two 22-pF capacitors.)

The program is straightforward; see Listing 1 for the PIC BASIC code. When a low occurs on RB0, indicating that the lights are off, the software then delays for 15 seconds before driving the solenoid. Then there's a repetitive sequence where it drives the solenoid, turns it off, and finally checks to see if the lights are still off. If the lights are on, the pro-

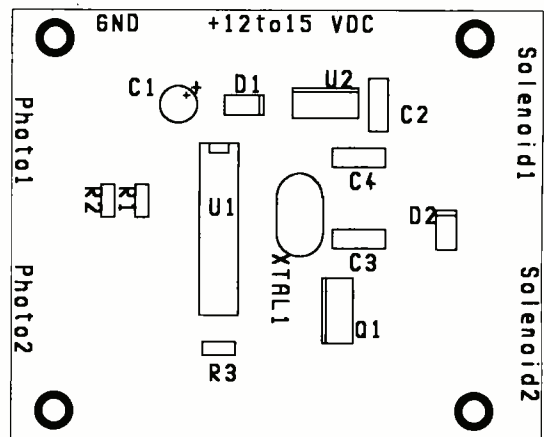

Fig. 3. Use this parts-placement guide as a reference when you construct your board. Be sure to use the 18-pin DIP socket for the PIC no matter what construction method you choose.

gram returns to the beginning to wait until the lights are turned off again. You can do your own PIC programming using the Listing. If you don't have PIC programming capabilities, programmed PICs are available from the source in the Parts List.

Construction. Because this project is relatively straightforward, you can use any accepted wiring technique to assemble the circuit. However, a PC board produces the best results. You can make your own PC board using the foil pattern in Fig. 2. Otherwise, PC boards can be ordered from the supplier.

The parts placement diagram is shown in Fig. 3. It is

LISTING 1

```
WAIT:  LOW 1
        BUTTON 0,0,0,0,B0,1,WAIT
        PAUSE 15000
        HIGH 1
        PAUSE 250
        LOW 1
        PAUSE 500
        BUTTON 0,0,0,0,B0,1,WAIT

        HIGH 1
        PAUSE 250
        LOW 1
        PAUSE 125
        BUTTON 0,0,0,0,B0,1,WAIT
        HIGH 1
        PAUSE 250
        LOW 1
        PAUSE 250
        BUTTON 0,0,0,0,B0,1,WAIT
        HIGH 1
        PAUSE 250
        LOW 1
        GOTO WAIT
        END
```

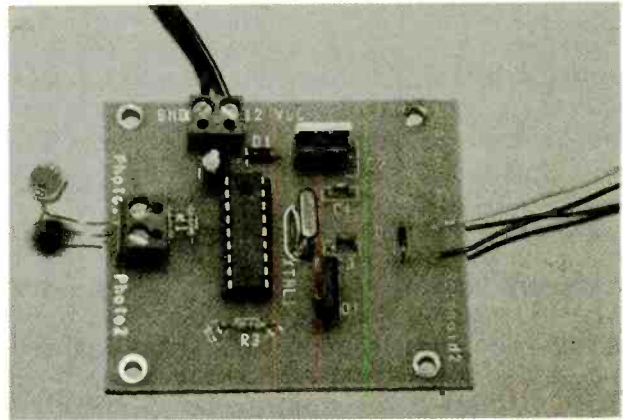

This photograph shows all of the components mounted onto the printed-circuit board and it can be used to compare to your finished product. The PC board method often yields the most reliable prototype.

to either of the solenoid connections on the PC board. The specified solenoid does not have a threaded collar for mounting so I used a 1/2-inch conduit hanger, as shown in the photograph. Conduit hangers can be obtained at your local hardware store.

For the photocell connection, mount the photocell close to the PC board with the leads of the photocell. In this case, you should be sure the photocell is oriented so that it is exposed to the room's light source. If you need some distance between the box and the photocell, you can solder a pair of leads several feet long to the photocell.

Be sure to measure the voltage of the AC adapter before connecting it to verify the polarity of the leads. For the adapter specified in the Parts List, the wire lead marked with a dashed white stripe is the +15V lead. (Diode D1 provides protection to the circuit components in the event that the AC adapter leads are reversed.)

Circuit Test. When you have soldered all the components in place and attached the photocell, solenoid, and AC adapter, you can test the circuit. With U1 not yet installed in the socket, plug the AC adapter into a

a good idea to use an 18-pin DIP socket for the PIC. Make sure you properly orient the diodes, transistors, and ICs before soldering them in place.

The AC adapter, solenoid, and photocell are mounted off the PC board. The solenoid can be attached to the PC board by connecting the wires on the solenoid

PARTS LIST FOR RUDOLPH

SEMICONDUCTORS

U1—PIC16F84-04/P, microcontroller
U2—78M05, 5-volt regulator
Q1—TIP120, NPN, Darlington transistor
D1—1N4001 diode
D2—1N4148 diode

RESISTORS

(All resistors are 1/4-watt, 10% units, unless otherwise specified.)

R1, R3—4700-ohms
R2—10,000-ohms

CAPACITORS

C1—1-mF, 50-volts, electrolytic
C2—0.22-mF, 50-volts, monolithic
C3, C4—22-pF, 50-volts, monolithic

ADDITIONAL PARTS AND MATERIALS

XTAL1—3.579545-MHz crystal
CON1, CON2, CON3 (optional)—2-position terminal block
Photocell—10-kohms (Jameco part number 136047)
Solenoid—12-volt, push-type (Jameco part number 163803)
18-pin DIP socket; 12- or 15-volt DC, 500-mA minimum;
wooden box (e.g., Wal-Mart UPC 28995 75042); 1/2-inch conduit hanger (e.g., Lowe's UPC 31857 49100); mounting hardware; wire; solder.

Note: An etched, drilled, and plated PC board is available for \$12 (postage paid) by requesting PC board "Rudolph2" from Atlas Circuits Company, P.O. Box 892, Lincolnton, NC 28092; e-mail: atlas@conninc.com. A programmed 16F84-04/P PIC is available for \$15 (postage paid) from Steve Lympany, 109 Mill Creek Drive, Fuquay-Varina, NC 27526.

wall outlet. Check for 5 V_{DC} between pin 14 of the IC socket and ground. If you do not obtain a proper reading, make sure that the 15-volt adapter is indeed delivering about 15 V_{DC} to the terminals on the board. If it is, check the orientation of U2. Correct any wiring errors and/or replace any defective components before proceeding.

Once you obtain the proper +5-volt reading at U1, unplug the AC adapter and install U1 in the socket. A photograph below shows a completed PC board with all components installed. Power up the circuit again and shield the photocell from light. After about 15 seconds, your solenoid should engage and disengage as the PIC runs through the program. Remove the shield from the photocell and the solenoid action should stop. Now, you are ready to mount the PC board, photocell, and solenoid.

Final Assembly. Several options are available for the box. One is a small wooden box available from the craft department at Wal-Mart. (The UPC number for this item is provided in the Parts List.) Another is a small rectangular wooden cigar box, available at cigar and pipe shops. A third option is to build your own. The goal is to achieve a good resonance to generate the "clop-clop" of simulated hoof beats.

Other mounting parts include 1/2-inch spacers for the PC board, screws, and a 1/2-inch conduit hanger as a mounting bracket for the solenoid. (See the Parts List for this item.) The main consideration in mounting the solenoid is to be sure that you have about 1/4-inch of clearance between the piston end and the inside of the box when the solenoid is de-activated. Also, be sure to orient it so that the piston will fall back into place via gravity when it is de-activated. In other words, be sure the piston moves upwards when activated.

When you have completed assembly, plug in Rudolph, turn off the lights, and enjoy the magic sounds of reindeer on the roof. Although our children have discovered the truth about Rudolph, they've requested that we continue the tradition of reindeer sounds every Christmas Eve. Perhaps a Rudolph will provide you with many years of family Christmas enjoyment.

P



"You'd think for \$200 they'd include a needle....."

TALK TO SANTA



"This is gonna take too long...I'll just email my list..."

THE FIRST DIGITAL BROADCAST

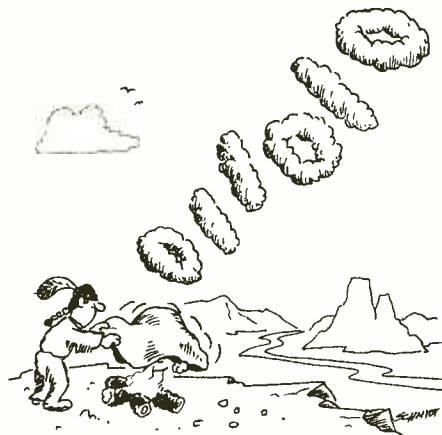

MEETING TOMORROW'S CHALLENGES TODAY

The men and women in the Navy's Seaman/Airman/Fireman Program are working for America, while learning valuable skills through on-the-job training. They're building solid futures, succeeding in a competitive, high-tech world and advancing as quickly as their abilities and performance allow. Find out more about the Seaman/Airman/Fireman Program, as well as other exciting Navy job opportunities, from your local Navy recruiter. This ad is brought to you as a public service of this newspaper.

Navy. Full Speed Ahead.

The Mapper8, Part 1

DAVE WICKLIFF

You just strung and crimped plugs on a dozen twisted-pair network cables to several rooms. Are they all correctly wired? Which cable goes to which room? If something doesn't work, where is the problem? The Mapper8 can help!

It provides complete connectivity testing of 8-wire modular cables and others. The tester can very quickly check for wiring problems such as opens, shorts, reversed pairs, and so on. Here's a quick explanation of how it works: The master unit sends a request pulse down each wire and waits for responses from remote units. The master then builds a connectivity map based on the responses and compares the new map against a pre-defined one. If the maps match, the cable passes. Let's take a more detailed look at the Mapper8.

is attached to one end of the cable, turned on, and set to remote mode. It responds to requests from the master unit with a coded message back to the master.

Each message contains the remote's ID, allowing the remote to be uniquely identified.

Next, the master unit is attached to the other end of the cable; pressing the master's test button then tests the cable. The test results, as well as the remote's ID, are displayed on the master unit's LEDs. It is important to make sure that the cables under test are disconnected from any power sources. Exposing the Mapper8 to voltage can damage the unit.

Groups of installed cables can be tested using multiple remote units, each with a different ID. A remote is attached to one end of each cable, with the master unit connected in succession to the other end of each

cable. Each cable is tested, and the attached remote identified. Up to eight different remote units can be used in this manner.



Cable Testing Made Fast And Easy!

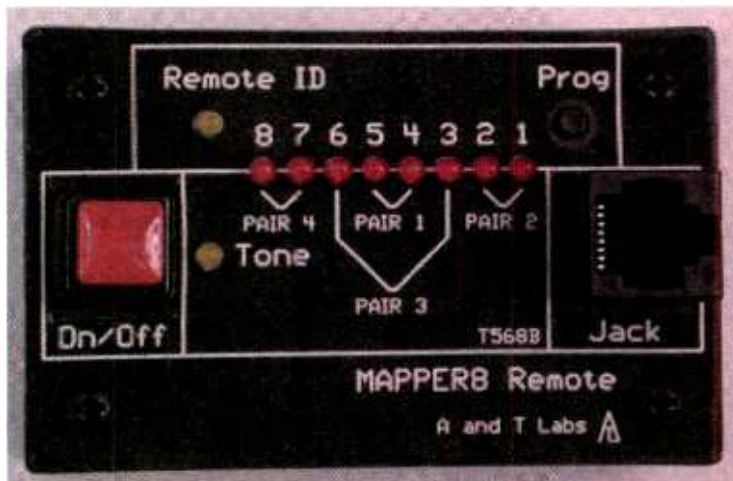

The Mapper8.

irst, we'll see how the device is used and then check out the design details. The Mapper8 consists of two separate units: a master and a remote. A remote unit

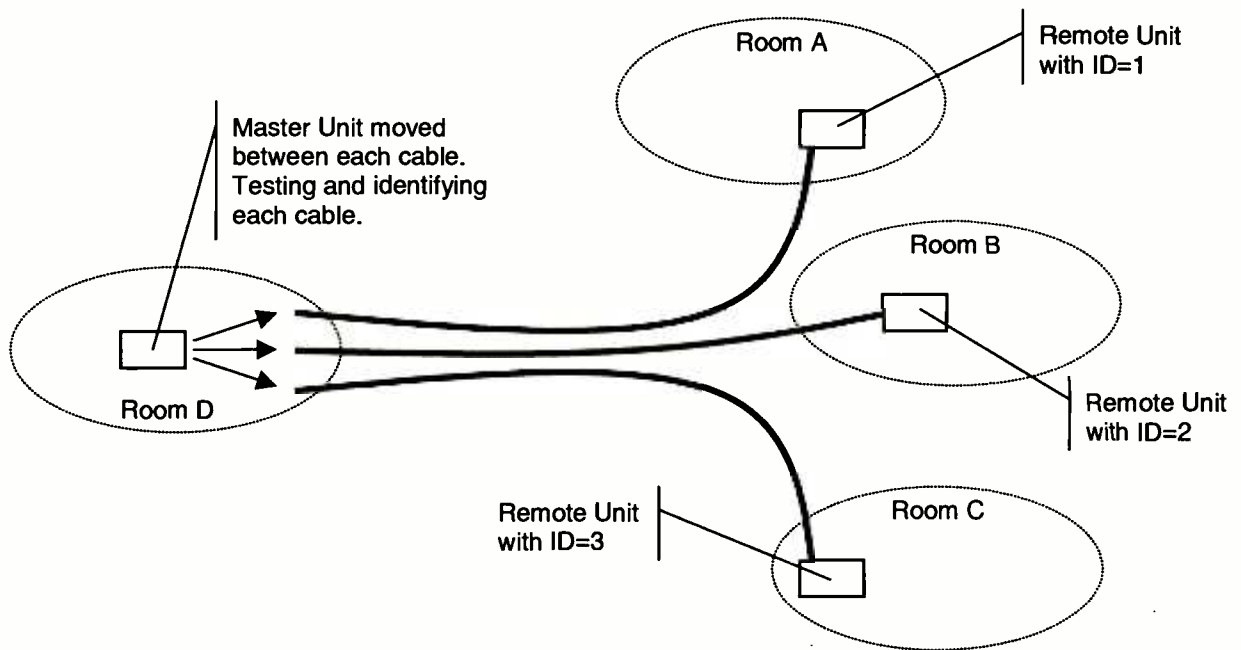

Fig. 1. Sample test setup using multiple remotes to test three cables strung between four rooms.

Figure 1 shows a sample test setup using multiple remotes to test three cables strung between four rooms. When the master's test button is depressed, it sends a request pulse down each of the wires it is attached to and then waits for response messages from a remote. By noting which message is received on which wire, the master unit can build a connectivity map between itself and the remote unit at the far end of the cable. Once the map is complete, the master unit compares the connectivity map against a pre-defined or a user-defined connectivity map. If the maps are the same, the master unit lights the Pass LED, otherwise it lights the Fail LED. See Fig. 2 for the master unit's display during this phase.

The master unit proceeds to display the connectivity mapping on its set of LEDs. Figure 3 shows its display during the readout phase. The eight red LEDs on the master unit display different types of information. When the Map LED is lit, the eight LEDs indicate which of the reference connectivity maps will be used for the test. When the Remote LED is lit, the same eight LEDs indicate the ID received from the remote unit. When the Near and then the Far LEDs are lit, the eight LEDs indicate the cable connectivity between the master unit (the near end) and the remote unit (the far end), respectively.

The prog button can be used to switch between connectivity maps. Either a pre-defined map or a user-defined map may be selected. (See Fig. 2 for details on changing the map.) Figure 4 illustrates the three pre-defined connectivity maps supported by the master unit.

Another use for the prog button is to change the

user-defined maps. The master unit can store four user-defined maps (map 1-map 4). To set up a user map, first test a known-good cable of the desired connectivity. Then use the prog button, as detailed in Fig. 3, to store the map into the master unit.

Remote units can be operated in two modes. When the prog button is depressed while the unit is turned on, the current mode of the unit will toggle to the other mode. The first mode is the normal remote mode where the remote unit is used in conjunction with a master unit for connectivity testing. In this mode, the remote unit transmits the coded messages (previously described) down each of the wires it is attached to upon request. As shown in Fig. 5, when in remote mode, the Remote ID LED flashes and one of the eight red LEDs flashes, corresponding to the selected remote ID. The prog button is used to change the remote unit's ID (See Fig. 5).

The second mode is a tone-generation mode. In this mode, the remote transmits an audio tone instead of messages. Using a standard signal or tone-tracing amplifier tool, you can pick up the tone anywhere near the cable without having to electrically connect to the cable. This is useful for identifying one particular cable within a bundle without having to crimp connectors on them. Figure 6 shows the remote unit in tone mode. The warbling tone can be transmitted on an individual wire pair or simultaneously on all four pairs. When in tone mode, the Tone LED flashes and a pair of red LEDs corresponding to the selected pair flashes, as well. See Fig. 6 for details on selecting which pair receives the tone.

Design Overview. A block diagram overview of the

Press and hold the TEST button to start testing

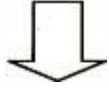

A display test is performed by rapidly lighting each LED in sequence



The currently selected map is displayed indicating which connectivity map will be assumed. In this example, the CROSS map is selected.

At this point only, the selected map can be changed. Press and hold the PROG button until the MAP LED blinks once. Release the PROG button. Each push of the PROG button will select the next successive map. Release the TEST button when the desired map is selected.

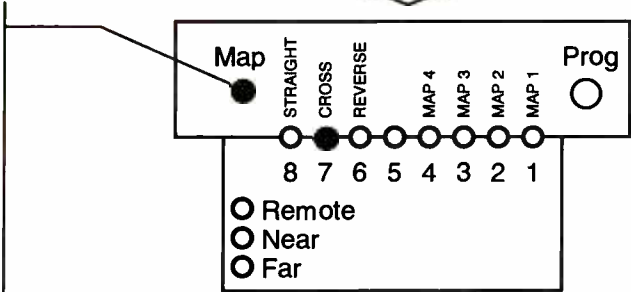

Each successive wire LED (1 through 8) is lit, indicating scans for messages from the remote are in progress.



The measured connectivity is compared to the selected map and either the PASS or FAIL LED is lit and remains lit. In this example, the comparison passed.

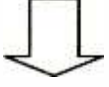
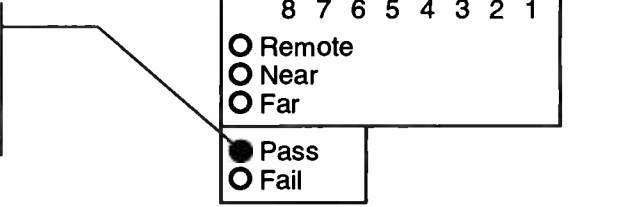

If the TEST button continues to be held down, the Master Unit will proceed to the Readout Phase.

Fig. 2. The progression of the master unit's test phase ends with an easy-to-read pass or fail indication

If the TEST button continues to be held down, the readout phase is entered from the test phase

The currently selected map is again displayed indicating which connectivity map will be assumed. In this example, the CROSS map is selected.

At this point only, the newly measured connectivity map can be stored into the Master Unit, if the currently selected map is one of MAPS 1-4. Press and hold the PROG button until the MAPx LED begins to blink. The measured map is now stored in the selected map.

The ID of the Remote Unit is displayed. In this example, the messages were received from remote with ID 5.

The measured connectivity map is displayed by showing pairs of near-to-far wire number mappings. Wire numbers relative to the Master Unit are near and numbers relative to the Remote are far.

A total of 8 mapping pairs is shown in order of near wire 1 through near wire 8.

In this example, the first of the 8 mapping pairs is shown: near wire 1 is connected to far wire 8.

The readout phase repeats until the TEST button is released.

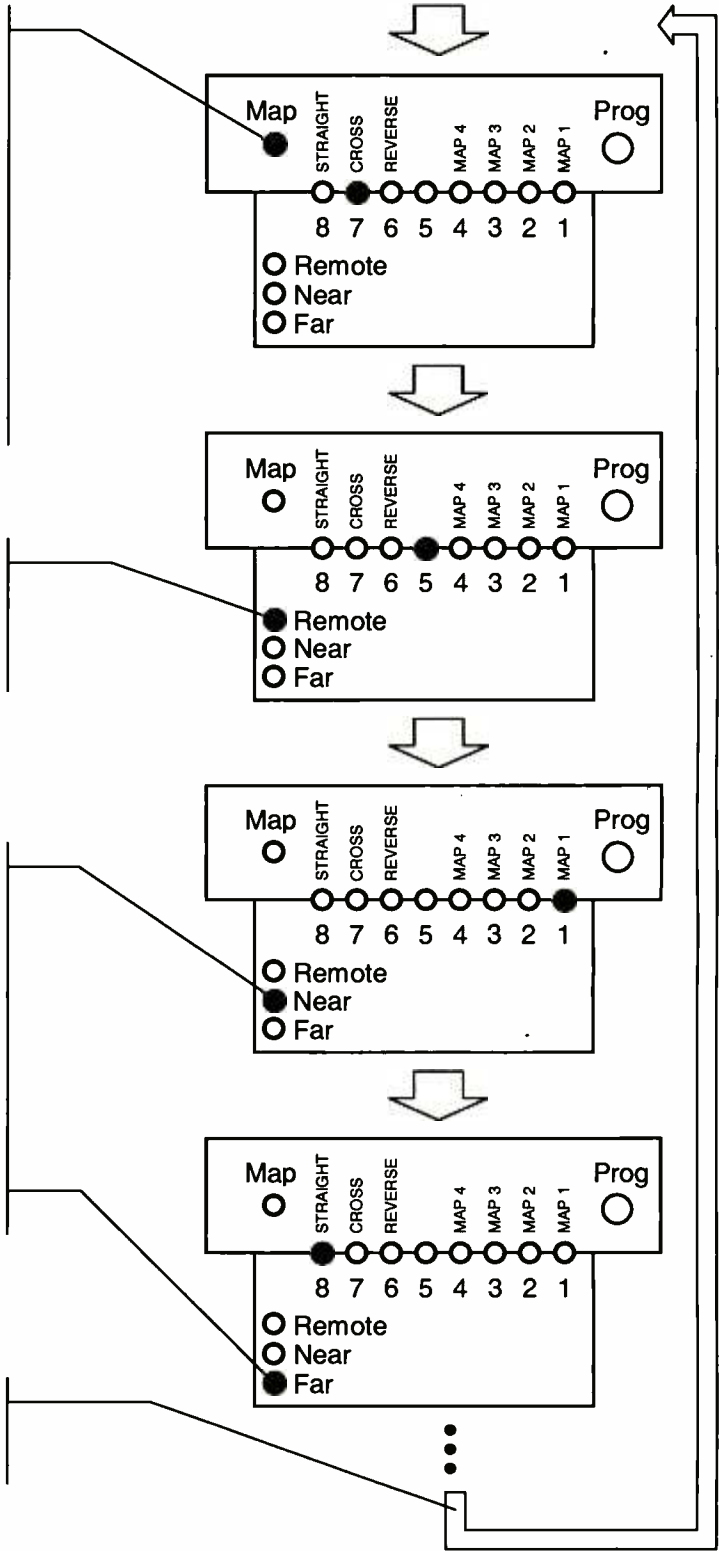

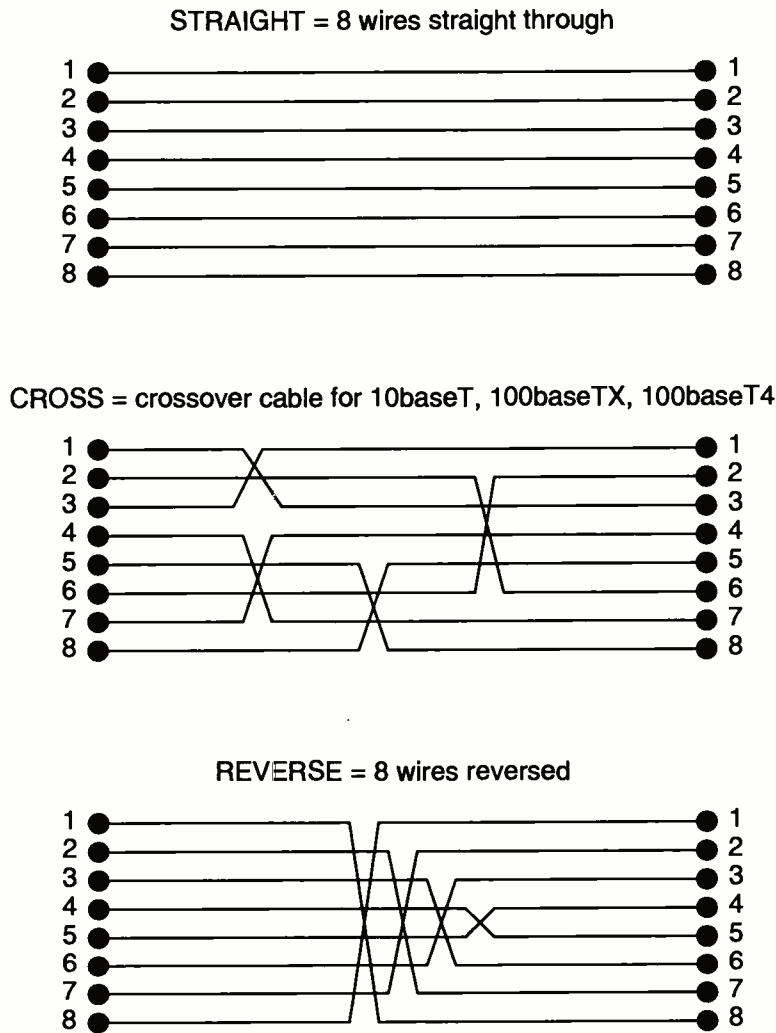

Fig. 4. The master unit supports three pre-defined connectivity maps.

Mapper8 master and remote unit hardware is shown in Fig. 7. The two units have very similar hardware design, but with some differences. At the heart of each unit is an 8-bit PIC16LF872 microcontroller from Microchip. The PIC16LF872 contains an 8-bit CPU, program memory, data RAM, data EEPROM, 22 I/O pins, and a variety of peripherals. For more information, see Microchip's data sheet for the PIC16LF872 at www.microchip.com.

The microcontroller's on-chip EEPROM memory permanently stores information while power is off. For the master unit, the stored information includes the currently selected reference map and user-defined connectivity maps. For the remote unit, the EEPROM stores the remote's ID, the currently selected mode (transmitter or tone), and the selection of which wire pairs receive tones.

Figure 8 is the

(text continued on pg. 39)

The unit is in remote mode. The blinking numbered LED indicates the remote's ID. In this example, the ID is 5.

To change the remote's ID: Press and hold the PROG button for ~15 seconds until the numbered LED stops its blinking. Release the PROG button. Each push of the PROG button will select the next successive ID. Turn the remote unit OFF then back ON when the desired ID is selected.

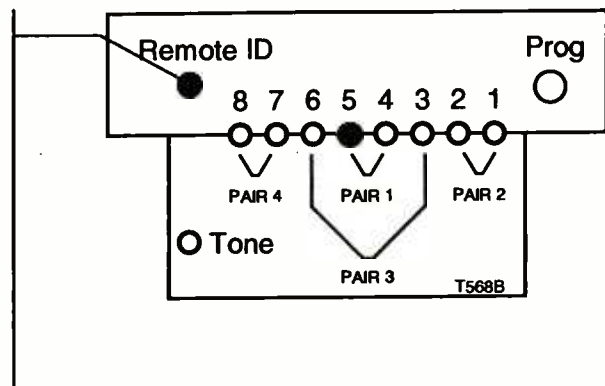
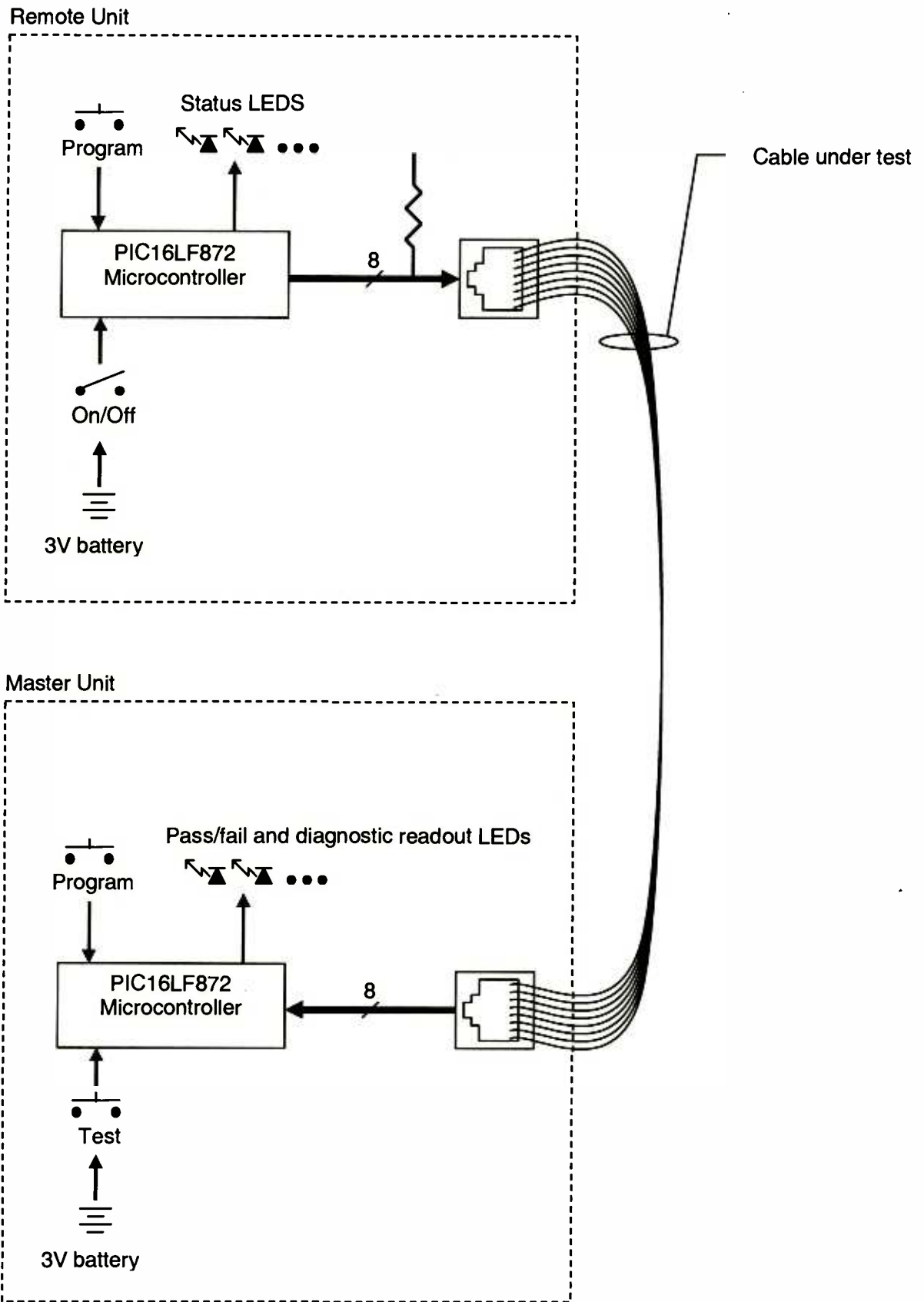
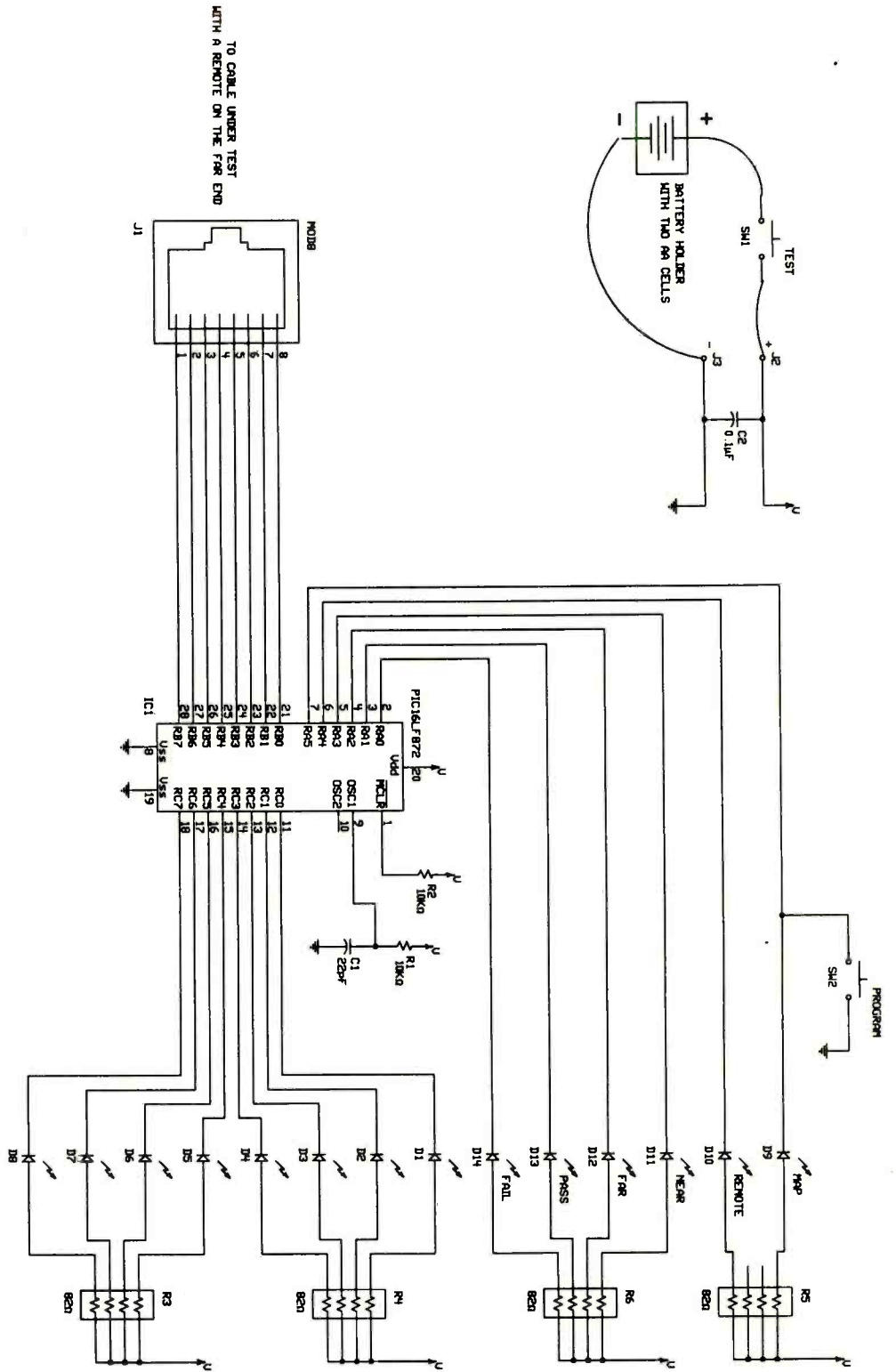

Fig. 5. With the remote unit in remote mode, identifying messages are sent down each wire to be received by a master unit.





K10 - MAPPER8
 MASTER UNIT

Fig. 8. Master Unit Schematic. The circuit is based on a PIC16LF872 microcontroller (IC1).

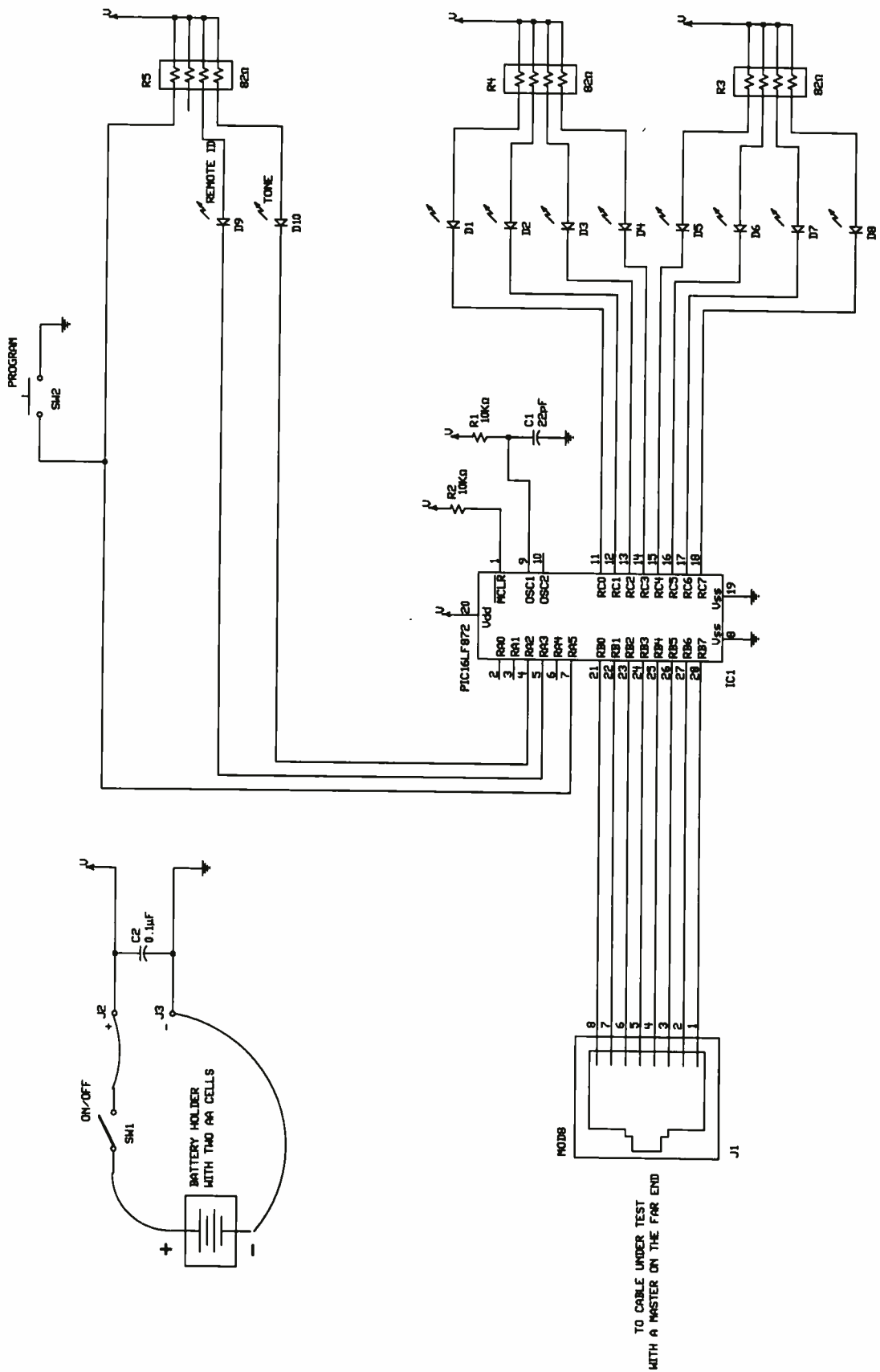

Fig. 9. The remote unit's circuitry is nearly identical to that of the master unit; it's the microcontroller software that makes the difference.

The unit is in tone mode. The blinking numbered LEDs indicate on which pair the tone is transmitted. In this example, the tone is on Pair 3 (wire 3 and 6).

To change the tone pair: Each push of the PROG button will select the next successive pair.

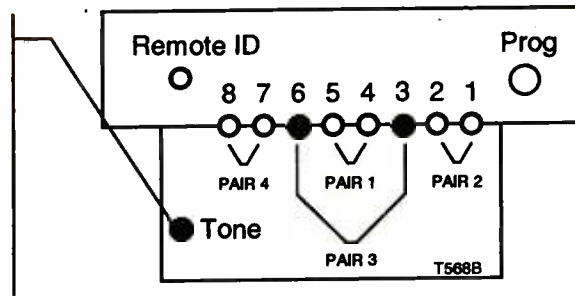

Fig. 6. In tone mode, the remote unit transmits a tone down a selected pair of wires.

(continued from pg. 35)

schematic for the master unit. The master unit consists of the PIC16LF872 micro-controller (IC1) connected to an 8-pin modular jack (J1). The microcontroller derives its clock timing from an RC oscillator consisting of R1, C1, and IC1. The microcontroller's external reset input (pin 1) is held inactive by pull-up resistor R2. Resistor networks (R3-R6) containing four independent resistors per device are used

to limit LED drive current. The schematic of the remote unit, which is nearly identical to the master unit, appears in Fig. 9.

Key to the Mapper8's operation is the software that runs the micro-controller in each unit. The remote unit's software configures the microcontroller's I/O port as an output port and then sends messages out the individual port pins. On the other hand, the master unit's software configures its I/O port as an input and listens for messages on the individual pins.

Next Month

Be sure to pick up January 2003's issue of **Poptronics**, where we will conclude our discussion of The Mapper88 with detail on message protocol and construction. P

1-800-USA-NAVY

World Wide Web:

<http://www.navyjobs.com>

FACTCARDS

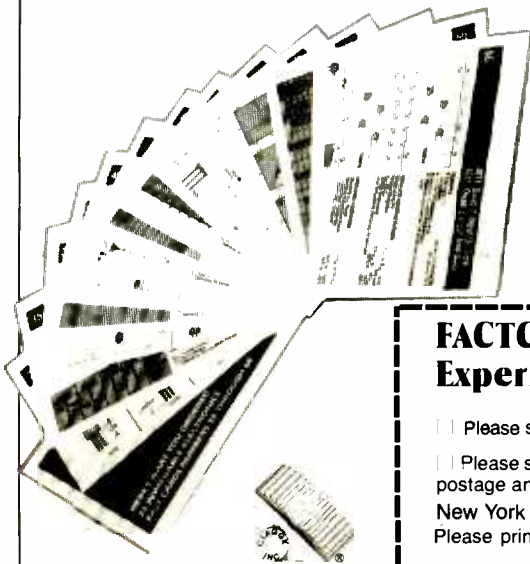

Jampacked with information at your fingertips

■ ALL YOU NEED to know about electronics from transistor packaging to substitution and replacement guides. FACTCARDS numbers 34 through 66 are now available. These beautifully-printed cards measure a full three-by-five inches and are printed in two colors. They cover a wide range of subjects from Triac circuit/replacement guides to flip-flops, Schmitt triggers, Thyristor circuits, Opto-Isolator/Coupler selection and replacement. All are clearly explained with typical circuit applications.

■ WANT TO EXPAND your knowledge of electronics? Do it the easy way

by studying the Electronics Fact Cards. Do you travel to and from your job each day? Drop a handful of cards in your pocket before you leave, and the bus becomes a schoolroom! At home, you can build some of the projects and not only have fun building and using them, but learn how they work at the same time.

■ YOU'LL BE AMAZED both at how rapidly you learn with these cards, and how easy it is to understand. These new cards are available right now. Don't miss out. Send your check or money order today.

FACTCARDS—Facts at your fingertips for Experimenters and Project Builders!

|| Please send one copy of FACTCARDS \$1.99. Shipping \$2.00 (U.S. and Canada only).

|| Please send _____ copies of FACTCARDS. Total cost is sum of copy price and First Class postage and handling cost multiplied by number of card sets ordered.

New York residents add sales tax to total cost of each order.

Please print

Allow 6-8 weeks for the material to arrive.

(Name) _____

(Street Address) _____

(City) _____

(State) _____

(Zip) _____

Detach and mail today:
CLAGGK Inc.
P.O. Box 12162
Hauppauge, NY 11788

All Payment must be in U.S. Funds!

BS168

ELECTRONIC TECHNOLOGY TODAY INC.

P.O. Box 240 • Massapequa Park, NY 11762

LIQUIDATION SALE

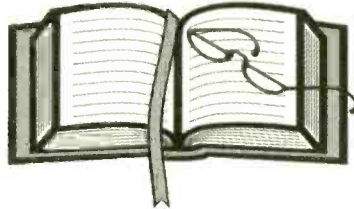

* ALL CANADIAN CHECKS MUST CLEAR THROUGH AN AMERICAN BANK

BP07	..100 Radio Hookups\$3.00	BP154	..An Introduction to MSX Basic\$3.99
BP56	..Electronic Security Devices\$3.99	BP156	..An Introduction to QL Machine Code\$3.99
BP64	..Semiconductor Technology Elements of Elect Book 3\$5.99	BP187	..A Prac Ref Guide to Word Pro Amstrad PCW8256/PCW8512	\$7.99
BP74	..Electronic Music Projects\$3.99	BP190	..More Advanced Electronic Security Projects\$3.99
BP76	..Power Supply Projects\$3.99	BP194	..Modern OPTO Device Projects\$3.99
BP78	..Practical Computer Experiments\$2.99	BP232	..A Concise Introduction to MS-DOS\$3.99
BP80	..Popular Electronic Circuits\$3.99	BP256	..An Intro to Loudspeakers and Enclosure Design\$3.99
BP103	..Multi-Circuit Board Projects\$2.99	BP264	..A Concise Advanced User's Guide to MS-DOS\$3.99
BP109	..The Art of Programming the IK ZX81\$3.99	BP272	..Interfacing PCs and Compatibles\$5.99
BP112	..A Z-80 Workshop Manual\$5.99	BP290	..An Intro to Amateur Communications Satellites\$5.99
BP114	..The Art of Programming the 16K ZX81\$3.99	BP297	..Loudspeakers for Musicians\$6.99
BP115	..The Pre-Computer Book\$2.99	BP299	..Practical Electronic Filters\$6.99
BP124	..Easy Add-On Projects for the Spectrum, ZX81 & ACE\$3.99	BP302	..A Concise User's Guide to Lotus 1-2-3 Release 3.1\$5.99
BP143	..An Intro to Programming the Atari 600/800 XL\$2.99	BP304	..Projects for Radio Amateurs and S.W.L.S\$5.99
BP148	..Computer Terminology Explained\$2.99			

PRICES DO NOT INCLUDE SHIPPING & HANDLING. ALL SALES ARE FINAL, NO RETURNS

ORDER FORM

Book No.	Title	Price	# Copies	Cost

Name _____

Address _____

City _____ State _____ Zip _____

If you wish to use a Credit Card:

MasterCard Visa Expire Date _____ / _____

Card No. _____

Signature _____

Allow 6-8 weeks for order to be fulfilled.

Please return this order form to:

ELECTRONIC TECHNOLOGY TODAY, INC.

P.O. Box 240,
Massapequa Park,
NY 11762-0240

Total Amount \$

- 30%

Subtotal

NYS Residents Sales Tax

Shipping (see table)

TOTAL COST \$

SHIPPING COSTS

\$0.01 to \$5.00	.. \$2.00	\$20.01 to \$30.00	.. \$5.00
\$5.01 to \$10.00	.. \$3.00	\$30.01 to \$40.00	.. \$8.00
\$10.01 to \$20.00	.. \$4.00	\$40.01 to \$50.00	.. \$7.00
\$50.01 and above	\$8.50	

Telephone Orders: If you wish to place your credit-card order by phone, call 831/582-8722. Have your credit-card ready. Sorry, no orders accepted outside of U.S.A. and Canada, New York State Residents must add 8.5% sales tax. Offer expires 12/31/02.

ET11A

Files of the Ancients

Q I was a regular reader of *Electronics Now*, when I worked in Saudi Arabia & the Emirates UAE. Since I left the job in July 1998, I was no longer able to get the magazine at my new home in Pakistan. I built many of the projects published in *Electronics Now*, and now I want to build the project titled "Build This Computerized Game" by Dan Retzinger that was published in the July 1994 issue. The author said in the article that "the source code for the EPROM is posted on the *Electronics Now* BBS (516-293-2283, V3.2 V42 bis) as a file called C-GAME.HEX". I did not understand where and how to download this file now that we are using the Internet. I would be very thankful if anyone could just send me the proper link for this file or the attached file, because the project is ready and I am keen to let it play.—M. J. I., Karachi, Pakistan

A I had always wondered about access to those ancient files myself, but I had no reason to research that information to see what became of the old Bulletin Board Service (BBS) where extensive program listings and data dumps for projects that appeared in the Gernsback publications were posted. Chris LaMorte, our Managing Editor, was curious about those files, too, and he nosed around dusty areas at Gernsback and discovered where they were hiding. Simply get on the Internet at one of two sites and you'll find many of those old files. The sites are www.ftp.poptronics.com/pub/pe for files that appeared in *Popular Electronics* and www.ftp.poptronics.com/pub/en for files that appeared in *Electronics Now*. Thanks, Chris, for battling the cobwebs and spiders to find those old files.

What's a Diac?

Q Lightning struck my farm fence and blew out the fence charger, which is powered by 120 V_{AC}. I opened it up and found a fairly simple circuit board with a blown fuse and a couple of small components probably blown out. One tiny diode was blown. The other

diodes on the board are marked "D1," "D2," etc., but this one is marked "DIAC." Unlike the others, there is no band around one end, which I think means polarity. Is there such a thing as an AC diode? Can I replace this with a small diode of similar size and shape that tests OK on my meter, or do I need an exact replacement?—J.S., Bethany, CT

A The device you have is a diac, otherwise known as a bi-directional trigger diode, which is the solid-state equivalent of a neon lamp. It is often used in circuits containing Silicon-Controlled Rectifiers (SCR) or triacs. With a low voltage across the diac, it does not conduct. As this applied voltage is increased, there will be a point where the diac "fires" or begins to conduct. Then the device quickly drops to a lower voltage and begins acting much like a zener diode, holding at a lower voltage. Only when the voltage drops below this holding voltage will the diac again assume a non-conducting condition. This action occurs regardless of the polarity of the applied voltage, hence the term "bi-directional." So, maybe this does make it an "ac diode!" If the unit is put on a semiconductor curve tracer, the resulting plot of current vs. voltage will appear much like that of Fig. 1. The thin lines marked "A" are the portions of the graph where the diode quickly assumes the lower-voltage holding point after being triggered at the higher voltage point.

There are some folks who think that

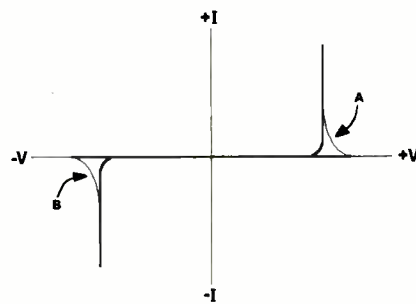

Fig. 1. This current vs. voltage graph of a diac is similar to that produced by a transistor curve tracer and shows the similarity of the device to a neon lamp.

you can simply connect two zener diodes back-to-back as a substitute for it. Two zeners connected that way will produce a graph on the curve tracer similar to that of Fig. 2, the knee voltage being the sum of the zener voltage of one and the forward drop of the other. Note the specific difference where the two zeners will not have two distinct trigger and holding voltages, as does the diac.

Therefore, because of the low voltage

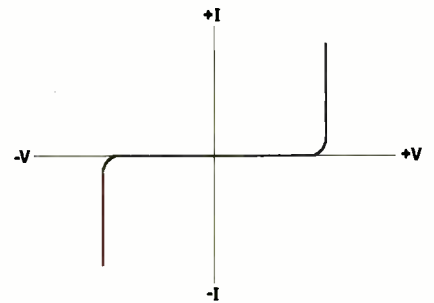

Fig. 2. A similar graph of two back-to-back zener diodes shows the difference in operation as compared to a diac, with the zeners having no upper-voltage trigger point.

applied, it will test as an open using a common ohmmeter. You could hook up a 10-Kohm resistor in series with the diac and a variable-voltage DC power supply and then monitor its voltage with a Digital MultiMeter (DMM). Let another DMM monitor the supply voltage. As the voltage of the supply is increased, that same voltage should be reflected in the DMM reading until the trigger point is reached. At that point, the voltage across the diac will suddenly drop and remain constant even if the supply voltage is increased. Note the voltage of the power supply at the point where the voltage across the device suddenly dropped. That supply voltage will be the trigger voltage, and the voltage across it will be the holding voltage. In the reverse direction, these two voltages will be similar but are not always exactly the same.

Meanwhile, I've had direct contact with J.S. who sent me his unit. I popped it on the Tektronix 7CT1N curve tracer that I have, and it appears to be undamaged. The only thing we can't do is check the actual trigger and holding

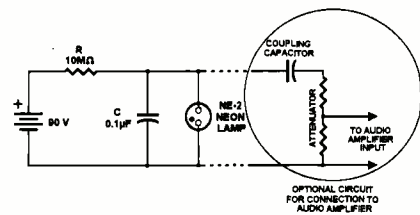

Fig. 3. A neon lamp relaxation oscillator was a favorite project for budding electronics hobbyists and could operate for nearly the shelf life of the battery.

voltages against the specifications, since its specifications are unknown. However, I would have expected the only failures in this catastrophic equipment failure to be shorts or opens, so I wouldn't mess around with trying to replace it with a new one.

This similarity of a diac to a neon lamp brings to mind the little relaxation oscillator we used to build in electricity classes back in the heyday of vacuum tubes. Figure 3 shows a resistor, battery, neon lamp, and capacitor connected such that the capacitor will charge until it reaches the firing voltage of the neon lamp. Then the neon lamp will conduct and discharge the capacitor until it's below the holding voltage of the lamp, and the process repeats. The time constant of the resistor and capacitor determine how quickly this circuit will repeat this action. With large values of R and C, the circuit will let the lamp blink every few seconds. Hobbyists have been known to build these slow-blinking circuits and have them operate continuously for over a year, not much shorter than the shelf life of the battery. Small values of R and C will allow the circuit to operate into the high audio region. If you connect an amplifier through a coupling capacitor and an attenuator to an amplifier, you can hear the nasty tone this circuit puts out. The waveform is a distorted sawtooth. Variations of this circuit were sometimes used as the source of the "linear" ramp in early sweep circuits of recurrent sweep oscilloscopes.

These days, the 90-volt battery can be replaced by ten 9-volt batteries in series. Rectangular carbon-zinc "transistor radio" batteries can be interconnected much like those shown in Fig. 4 to provide a battery of any multiple of nine volts that you need. Unfortunately, the alkaline versions of these batteries have

slightly larger jacket dimensions. Therefore, they can't always be connected like this, but must be connected into a series battery arrangement using battery clips, which makes a messier arrangement. You might initially balk at the cost of buying ten of those batteries, but you'll find that it's a lot cheaper than buying an actual 90-volt battery, assuming that you can put your hands on one somewhere.

While I'm on the subject of using these nine-volt rectangular batteries, we oldtimers often made our own connectors for these batteries by tearing apart a spent battery and retrieving the end connector and using it. Older batteries were nicer, because those snap connectors were mounted onto phenolic. More modern batteries have the connectors mounted onto plastic, so you have to be quick to solder wires on the back side or you'll put the thing into meltdown.

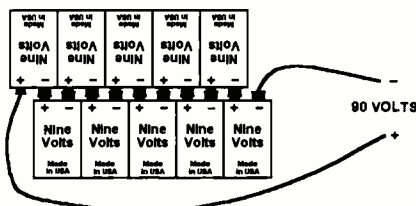

Fig. 4. Rectangular 9-volt "transistor radio" batteries can often be interconnected to provide higher voltages, limited only by the number of batteries you wish to use.

After soldering wires to the battery connector, you can add a dollop of hot-melt glue or epoxy to the back side to give the wires some strain relief and to insulate the connections.

And regarding hot-melt glue, another use for that stuff is hey, wait a minute. How did I get on this subject, anyway? We were discussing diacs.

Bridging the Gap

Q I have a U.S. Navy ZM-11/U bridge. Where can I buy parts or an old bridge for parts?—S.G., via e-mail

A Even the U.S. government won't support something like that very long. During my time in the Navy, I often found that older Federal Stock Numbers were often no longer available, render-

ing a piece of equipment to the status of "hanger queen" for want of an obscure part. Your best bet for finding another ZM-11/U is going to be through one of the on-line auctions. Hamfests often turn up odds and ends such as that, so find some of the larger ones in your area and shop around. For more common parts, you can try Antique Radio Supply (www.tubesandmore.com). Along those same lines, you can often get help in troubleshooting and finding parts on the "test equipment" section of the Antique Radios forum (www.antiqueradios.com).

PCBs Aren't Always Dangerous

Q I would like to make my own Printed Circuit Boards (PCB), but I need some help in producing the negatives. I have schematic-capture and board-layout software from which I can create a .bmp file of the layout as a reverse-image negative. I want to print the file on transparencies and lay the printed side against a board that has been sprayed with photo resist. Laying the printed side against the board should minimize undercutting. However, I found my ink jet printer was not adequate. I went to two different commercial reproduction houses and had it printed using laser printers, but the black areas are not dense enough. They tell me that this is the best I can expect. Can you help me get a good negative from my .bmp file?—J.C., via e-mail

A This is one of those subjects that may have a lot of answers, since there are a lot of ways to produce a PCB at home. First of all, if doing contact printing as you are, laying the "emulsion side" of the transparency against the board won't reduce undercutting.

Undercutting is an etching process where thin traces are undermined before larger areas are fully etched. What you are doing with that technique is reducing shadowing that would be caused by a non-point source of light on an opaque surface that is slightly above the plane of the circuit board. True contact printing with the emulsion side in contact with the board will produce a more crisp and well-defined edge on the final exposure, allowing layouts with finer pitch, but you will still be at the mercy of the etching process you use with regard to undercutting.

What looks black or opaque to us

DENSION mp3 player

It's like having a CD changer with up to 3000 CD's!

WWW.DENSIONUSA.COM



Use it in a car, at home or on party
 Built-in 3.5" IDE Hard Disk Drive
 Connect it to CD Changer ports*
 Works with most factory car stereo**
 Large, blue-white full graphic display
 User-configurable display and logo
 Optional Fast USB 2.0 adapter
 User friendly menu system
 Store up to 160 Gigabytes of data
 Best car Mp3 product of the year!
 WIN / MAC compatible file system



Use multiple remote displays in 4 different styles



Car frame with RCA outputs and two data ports

**REGISTER TO WIN
 A DENSION DMP3 AT
 WWW.DENSIONUSA.COM**

No purchase necessary, visit website for more info!

(866) 822-DMP3

Let the Music be with You! ^(R)

3000 CD's are based on 128kbps sampling rate with a 160G HDD. Max sampling rate is 384 kbps. CBR or VBR.
 * CD changer emulators are optional and available for factory SONY and ALPINE radio systems only at this time.
 ** CD aux input adapters are optional. Price and availability varies by model. Check out our website for more information.



CIRCLE 140 ON FREE INFORMATION CARD

doesn't always look opaque to light-sensitive materials or devices. As jet-black (that is, SR-71 black) as a black Sanford Sharpie marking pen appears, it's nearly transparent to infrared light. You might try exposing regular film used for the photoresist technique with your contact-printing process. Maybe the exposed and developed film will be less sensitive to the difference between the printed area and the transparent area of your original and deliver a negative with better opacity.

If you're not doing production runs of

these boards, I think that the photoresist method is a lot of work. If you're hand applying the photoresist to the boards, you have a lot of variables there that can foul up the process. I prefer using the PNP Blue toner-transfer technique with a laser printer. Although I have lousy results with the stuff using a standard clothing iron, I have excellent results when I use a photographic dry-mount press since I can control pressure and time perfectly with precise repeatability. The dry-mount press makes your start-up costs about \$300 higher, unless you

can find a used one being dumped by a newspaper or photography studio somewhere.

Of course, if you're doing fine-pitch work, you're going to be limited to using a good photoresist method since the toner-transfer process is a little more limited in that area. If any readers have a lot of successful experience using direct printer-to-negative techniques, let us know here at "Q & A," and we'll see if we can get some help out to J.C.

HOW TO GET INFORMATION ABOUT ELECTRONICS

On the Internet: See our Web site at www.poptronics.com for information and files relating to **Poptronics** and our former magazines (**Electronics Now** and **Popular Electronics**) and links to other useful sites.

To discuss electronics with your fellow enthusiasts, visit the newsgroups sci.elec.electronics.repair, sci.electronics.components, sci.electronics.design, and rec.radio.amateur.homebrew. "For sale" messages are permitted only in rec.radio.swap and misc.industry.electronics.marketplace.

Many electronic component manufacturers have Web pages; see the directory at www.hitex.com/chipdir/, or try addresses such as www.ti.com and www.motorola.com (substituting any company's name or abbreviation as appropriate). Many IC data sheets can be viewed online: www.questlink.com features IC data sheets and gives you the ability to buy many of the ICs in small quantities using a credit card. You can also get detailed IC information from www.icmaster.com, which is now free of charge although it formerly required a subscription. Extensive information about how to repair consumer electronic devices and computers can be found at www.repair.faq.org

Books: Several good introductory electronics books are available at RadioShack, including one on building power supplies.

An excellent general electronics textbook is *The Art of Electronics*, by Paul Horowitz and Winfield Hill, available from the publisher (Cambridge University Press, 800-872-7423) or on special order through any bookstore. Its 1125 pages are full of information on how to build working circuits, with a minimum of mathematics.

Also indispensable is *The ARRL Handbook for Radio Amateurs*, comprising over 1000 pages of theory, radio circuits, and ready-to-build projects, available from the American Radio Relay League, Newington, CT 06111, and from ham-radio equipment dealers.

Back issues: Copies of back issues of and past articles in **Electronics Now**, **Popular Electronics**, and **Poptronics** can be ordered on an "as available basis" from Claggk, Inc., Reprint Department, P.O. Box 12162,

Hauppauge, NY 11788; Tel: 631-592-6721. To ensure receipt of the correct material, readers must supply complete information on the article or issue that they wish to buy.

Poptronics and many other magazines are indexed in the *Reader's Guide to Periodical Literature*, available at your public library. Copies of articles in other magazines can be obtained through your public library's interlibrary loan service; expect to pay about 30 cents a page.

Service manuals: Manuals for radios, TVs, VCRs, audio equipment, and some computers are available from Howard W. Sams & Co., Indianapolis, IN 46214; (800-428-7267). The free Sams catalog also lists addresses of manufacturers and parts dealers. Even if an item isn't listed in the catalog, it pays to call Sams; they may have a schematic on file which they can copy for you.

Manuals for older test equipment and ham radio gear are available from Hi Manuals, PO Box 802, Council Bluffs, IA 51502, and Manuals Plus, 130 N. Cutler Dr., N. Salt Lake, UT 84054.

Replacement semiconductors: Replacement transistors, ICs, and other semiconductors, marketed by Philips ECG, NTE, and Thomson (SK), are available through most parts dealers (including RadioShack on special order). The ECG, NTE, and SK lines contain a few hundred parts that substitute for many thousands of others; a directory (supplied as a large book and on diskette) tells you which one to use. NTE numbers usually match ECG; SK numbers are different.

Remember that the "2S" in a Japanese type number is usually omitted; a transistor marked D945 is actually a 2SD945.

Hamfests (swap meets) and local organizations: These can be located by writing to the American Radio Relay League, Newington, CT 06111; (www.arrl.org). A hamfest is an excellent place to pick up used test equipment, older parts, and other items at bargain prices, as well as to meet your fellow electronics enthusiasts—both amateur and professional.

Locking the Pots

Q Long ago, I used "pot locks." After removal of the knob on a pot, you could screw this small clamp over the pot shaft and lock the position of the shaft. I now work for a school system and could really use these locks to thwart curious little fingers. Can you help find a supplier or tell me if they are even made any more? Thanks.—B.S., Scarsdale, NY

A The only "pot locks" that I've ever known were used in place of the regular mounting nut and provided a slotted bushing on to which a very large compression nut was added, which squished the bushing into the shaft of the pot to keep it from turning. It would be very difficult to use one of those with a knob considering that they typically used about $\frac{1}{8}$ -inch of shaft and were usually used with screwdriver-adjusted shafts. Clarostat seems to be the only company that makes pots with locking shafts these days, and, even at that, there are no provisions for attaching a knob. Smaller pots (circuits that require less frequent adjustments) and digital-potentiometer integrated circuits have all but forced large $\frac{1}{4}$ -inch shaft and even the smaller $\frac{1}{8}$ -inch shaft pots out of the market; those remaining are used more for repair replacements than anything.

I have twenty years of teaching kids under my belt. I have news for you: Even if you could find pot locks and install them, the little buggers would just treat it as another challenge to thwart. I know these things. I tried that with a half dozen \$600 E&L trainers we had, using hot-melt glue to dab onto the sides of slide-switch actuators so that they would remain in a position for using TTL chips only, since we used nothing else. The students would pick and pick until either the hot melt was picked off or the switch was broken. They'll dig holes in benches, break the collars of scope BNC

connectors using long-nose pliers, steal alligator clips from scope probes for "personal recreational use," snap scope probe tips off, load destructive programs onto computers, etc. Short of keeping an eyeball on each kid every second of the day, there's very little that you, assuming that you're the teacher, can do about it.

I've found that the best way to keep the destruction to a minimum is to let them know which pieces of test equipment cost more than their car stereo or their home computer and why that is. Even if you show them an Agilent or Tektronix catalog, they still won't be able to fathom an item of test equipment that could cost more than their family home. Then get them really interested in some snazzy projects that either does something neat and exciting or piques their interest in some way. That can be difficult considering that a lot of those projects may be over their heads technically; or it might be difficult to fit into a strict curriculum, but you can work around that. For instance, you could resurrect an old Heath Hero robot (that's one project alone) and then add some interesting stuff to it that the kids dream up, creating several new projects. They make line-following robots, but those can be boring and impractical. Instead, modify one so that it will back a little wagon along a line without jack-knifing.

Our auto mechanics instructor and his son were into go-cart racing, and Dad was getting down to where he wanted to know the difference in track perimeter on the inside wheels and the outside wheels so that he could shave tires for a minuscule decrease in track time. Maybe he needed to get a life, but it spurred the class into designing and building a very accurate digital "measuring wheel" that would measure down to the nearest 1/8-inch. The students were caught up in the design process, especially when I told them I wanted the display to read out in fractions of an inch rather than decimals, just like a ruler would read. At first they were fine with the readout being 1/8, 2/8, 3/8, 4/8, but then I told them that I wanted to see 1/8, 1/4, 3/8, 1/2, etc. Toss the problem out, and you'll have several who'll tackle it and succeed. The resulting wheel provided the measurement in feet, inches, and fractions of an inch as specified and had an added moveable piece that added or subtracted one foot for making inside measurements where you had to butt the wheel up against two opposing walls. And it would count up or count down to boot.

Edge Illumination

Q I'm looking for a circuit, probably using a 555 timer, that will light a series of light-emitting diodes (LEDs) for approximately 30 seconds upon the push of a button. Each button push would light the LEDs for another 30 seconds. There would probably be 10 to 15 high-brightness yellow LEDs in the string. I plan to mount this LED strip under the edge of an office paper cutter. When you're cutting out marked lines on a piece of paper using one of these cutters, it's hard to tell exactly where the edge of the cutter table (the cut line) is. But when light shines from below, the edge should be easy to see-making accurate cuts much easier. The timing circuit is needed, because some users would forget to turn off a simple on-off switch and run the batteries down.—J.R., via e-mail

A I once made a similar LED strip that was mounted under my Kepro circuit board shear for exactly the same reason. It made trimming etched boards so much easier. Mine wasn't as sophisticated, since I used standard red LEDs and powered the strip directly from a 12-volt, 1-amp wall wart. I just let the strip run all the time that any board production was going on. My LEDs were mounted as close together as I could get them, without having to do file work to flatten the sides for the closest fit of all. I probably had at least 30 LEDs on that strip.

Unless there's no wall receptacle within ten feet of your paper knife, I sure wouldn't use batteries to power the light strip. You can buy a hefty wall wart for under \$4 that will be much better than batteries. A strip with 15 LEDs running at 20 mA will draw less than half the power of a standard night light. Even if you left it on 24/7, it wouldn't cost much more than 30 cents a month

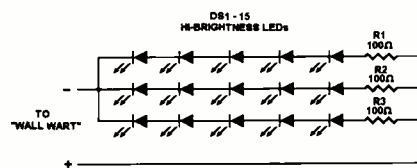

Fig. 6. The same LED strip for paper-knife illumination can be less expensive and less sophisticated, by omitting the timer circuit and powering it directly from a wall wart. This design costs less than 30 cents a month for continuous operation.

to operate. And not having it turn off after 30 seconds won't be so aggravating for someone who's doing a marathon paper-knife project.

No, I'm not trying to get out of designing a circuit for this application. Figure 5 proves that point. The circuit is a standard 555 set up as a one-shot, as we did with several of them back in the August 2002 column. The output is a single 30-second pulse that turns on a TIP120 Darlington pair transistor. You can use as many five LED columns as you need, because you'll probably run out of knife length before you run out of transistor capability. I'd power the circuit from a simple 12-volt DC, 1-amp wall wart and wouldn't worry about regulating the voltage since the 555 will take up to 15 volts without injury.

Use a tantalum capacitor for C2, since it will have minimal leakage for these longer timing cycles. I did use a run-of-the-mill aluminum electrolytic for C2, and it worked fine except that those tend to run high in value. If you calculate a value for R2 against the 100 microfarad value of C2, you end up with about 270

(Continued on page 58)

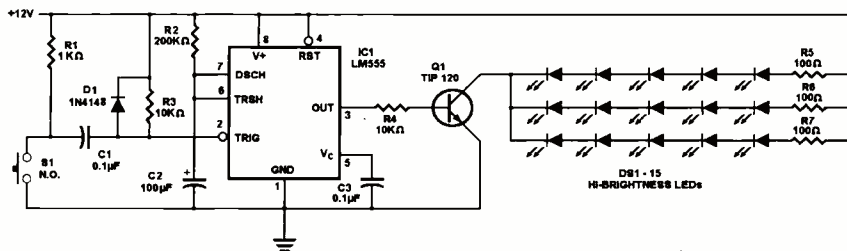

Fig. 5. A strip of 15 LEDs under the stationary cutting edge of a paper knife will cast a shadow, allowing precise paper positioning against the edge. A 555 timer allows the strip of LEDs to stay on for 30-second intervals for operators who forget to turn the light source off.

Simplify! Simplify! Use Look-Up Tables

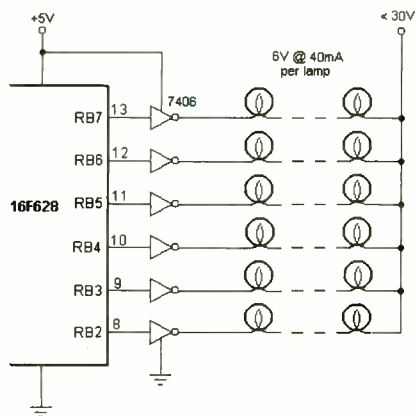

Fig. 1. The use of look-up tables greatly reduces hardware overhead, as seen in this schematic of flickering Christmas lights.

We've all been there. You buy that new bicycle your kid has been begging for—fully aware there's "some assembly required." Let's see now: Place slot A into bolt B, place slot C into bolt D, twist G to tighten W; proceed to step 4. Procedures like this are often used in electronic systems, too. Repetitive sequences that are done over and over to exhaustion, with slight detours along the way.

My first encounter with microcontrollers required just this type of programming. It was the HVAC controller used to engage relays and pumps on start-up, then shut down the compressors and blowers in a reverse (but not exactly the same) sequence. The original controller involved a bunch of cams, roller switches, and a motor.

This is the time when I discovered the power of look-up tables. Basically, a look-up table is a special set of code that generates a series of control signals that, in turn, can be used for a variety of reasons—like to tell a relay when to engage or a pump when to start/stop, the same way the mechanical cams did.

Creating A Look-Up Table

There are different ways to create a

look-up table, depending on the task at hand and the microcontroller involved. The easiest way to do this with the 16F628 is to create the table in software code as either a part of the main program or as a program-specific module. Listing 1 shows an example of a typical look-up table.

Earlier in the program, Port B was designated as outputs. The look-up table consists of nine lines of 8 bits each. Each bit is assigned to one of the eight Port B pins. When the line is read, these pins are either set high or low, depending on whether that bit is a one (1) or a zero (0). Take the first line, for example. In reverse order, this line (10101010) tells pin RB0 to be off, RB1 to be on, RB2 to be off, and so forth. The second line begins with RB0 on, RB1 off, etc.

An internal counter is used to scan and read the lines. The counter begins with the last line and works its way backward. In our example, the counter starts with line nine. The value of that line is read and loaded to Port B. The counter is then decremented by one, where line eight is read and loaded to Port B; and so it goes for each line in the look-up table.

When the counter reaches zero, you have the option of halting the counter until an event—like an interrupt—triggers it again. Otherwise, you can have the counter roll over and begin the process anew. Each has its place and purpose.

The construction of a look-up table is quite flexible. The number of bits per line can vary from one to eight; and the number of lines a table can hold is limited only by the counter, typically 256 lines without using multiple pages. If you wish to have different routines in a look-up

table, you can scan select portions of that table through initialization of the counter. (More on counters in a future column.)

A more practical solution for the casual user, though, is to write a separate table for each routine. You can have as many look-up tables as you wish in a program. Simply give each table a different name. In fact, this is the easiest way to control more than eight outputs and/or avoid paging. With a proper look-up table, this method can even be used to drive a stepper motor, with separate tables for each direction. However, for tighter code and better versatility, I'd put the look-up tables in program-specific inc modules that can be easily added to and subtracted from the main code as needed.

Project: A Merry Christmas Tree

In keeping with the holiday spirit, I decided to create a flickering Christmas tree for this month's project. In fact, the look-up table in Listing 1 was written

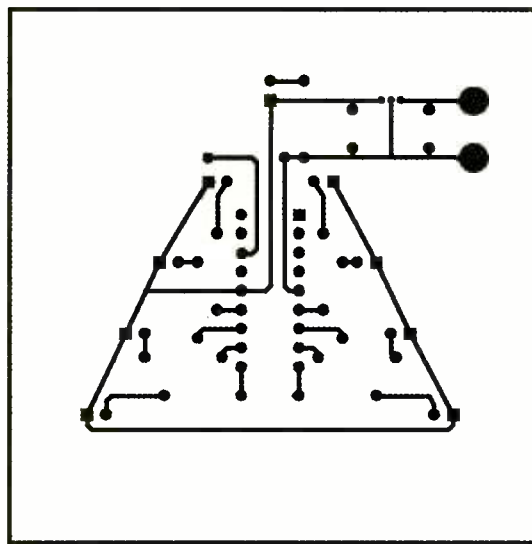

Fig. 2. This is the foil pattern for the Merry Christmas Tree.

A kit that comes complete with a printed circuit board is available from Futurlec (see Parts List).

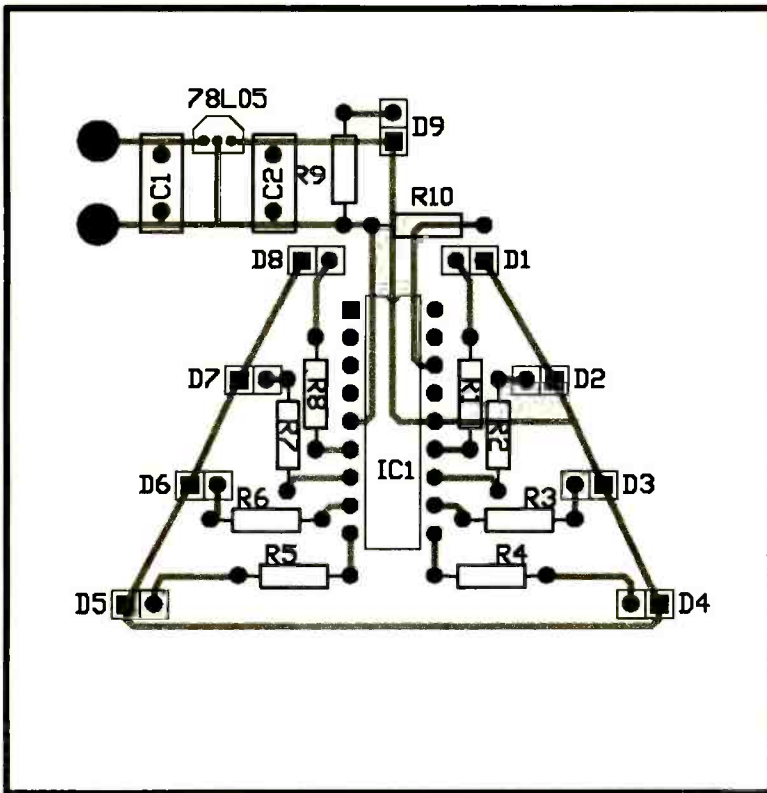

Fig. 3. Shown above is the placement for the components on the printed circuit board.

specifically for this project. The circuit is simple to construct and can be modified to fit a wide range of situations, both practical and silly. The schematic is shown in Fig. 1.

The project uses Port B as outputs to drive eight LEDs, which flicker in a pattern that appears random. This effect is created by adjusting the on/off pattern of each LED in an order that is so lengthy that you don't notice it repeats itself. To further enhance the effect, each output has its own, unique pattern that's different from the others.

The LED current is limited by resistors R1 through R8. To determine the size of the limiting resistor, two factors have to be taken into account. The most important is the amount of current each output can sink or source, which is 25 mA for the 16F628. The second consideration is the total amount of current the PIC can handle when Port A and Port B output currents are added together. That figure is 200 mA. In other words, if you try to extract 25 mA from six Port A pins and 25 mA from six Port B pins, the total would be 300 mA, which exceeds the 200-mA limit.

A 220-ohm resistor limits the current to about 14 mA per LED, for a total of 110 mA. However, it's doubtful the PIC

will ever see the full 110 mA because the duty cycles of the LEDs are constantly changing. So feel free to reduce the resistance to 150 ohms for a brighter light. This change limits the current to 20 mA per pin and 160 mA total. The limitation now is the 78L05, which has a maximum current of 140 mA, but it should handle this design easily when operating in the pulsed mode as we have here. If the 78L05 feels like it's running hot, clip on a small metal heatsink (Radio Shack 276-1567).

Atop the tree is an always-on LED that shines steadily, like an angel or a star. By the way, I calculated the above resistances using standard 5-mm red/green/yellow LEDs. If you want a blue light (which I suggest only for the top bulb), the added voltage drop (typically 3.5 volts) has to be taken into account. Start with 100

Remote Control • RS-232 • MIDI

WIRELESS MADE SIMPLE™

Home Automation • Robotics • Lighting Controls • Audio Links • Data Transfer

Serial Data Links • Remote Control/Command • Keyless Entry • Telemetry • Call Systems

EASILY MAKE YOUR NEXT PROJECT WIRELESS!

RF DIGITAL

www.rfdigital.com
(818) 541-7622

CIRCLE 150 ON FREE INFORMATION CARD

Front Panels?

Download the free Front Panel Designer to design your front panels in minutes

Unrivaled in price and quality for small orders

Order your front panels online and receive them just in time

www.frontpanelexpress.com

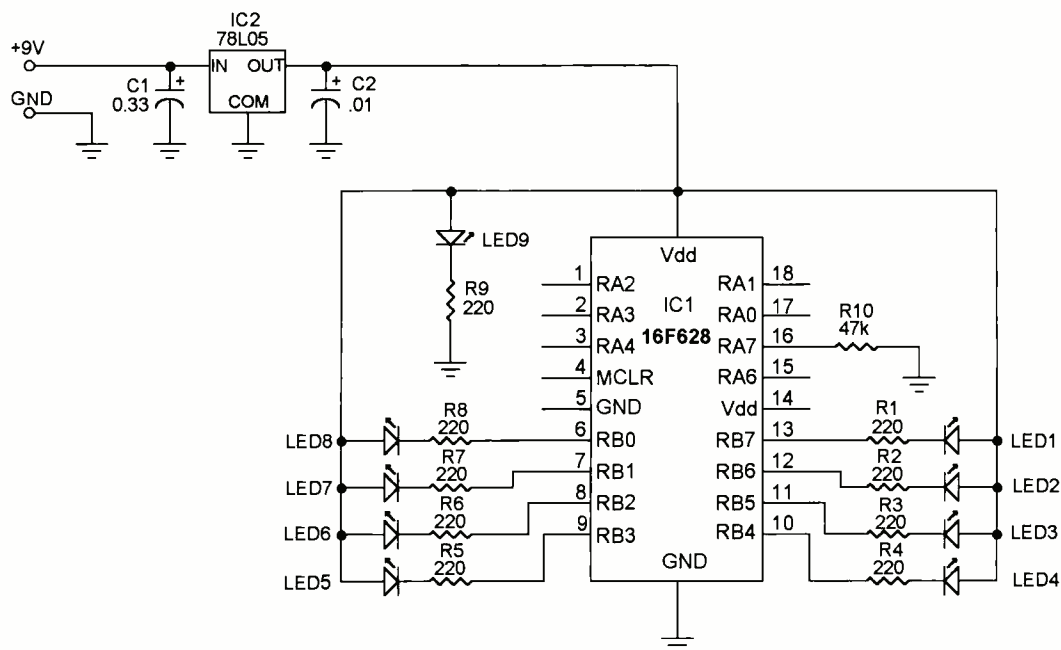

Fig. 4. The circuit isn't limited to a Christmas tree-or even LEDs. Using logic drivers and transistors, the output current can be upped to handle incandescent lamps and other devices-even a relay or solenoid.

Parts List)-making this design an excellent PIC project for the beginner.

The project isn't limited to a Christmas tree or even LEDs. Using logic drivers or transistors, the output current can be upped to handle incandescent lamps and other devices-like a solenoid. The example in Fig. 4 shows how to make a string of Christmas lights using a 7406 buffer gate. Other driver options are also shown, with increasing currents.

The internal clock of the PIC is controlled by R10, which also controls the rate of the "flicker." Try experimenting

with the value of R10 to achieve different effects. The manual warns that for values below 38k, the oscillator may become unstable or stop altogether. At higher values, particularly those beyond 1 megohm, the oscillator is susceptible to noise and leakage current. However, I've used R10 values down to 10k and above 1 megohm with no problem; just be aware that this may not always be the case.

That's it for this month. Enjoy the holidays, and have fun. You can e-mail TJ at tjbyers@aol.com. **P**

LISTING 1

```
flicker
    addwf    PCL,f
    retlw   b'10101010'
    retlw   b'00010101'
    retlw   b'01101110'
    retlw   b'10011011'
    retlw   b'11101010'
    retlw   b'00111010'
    retlw   b'11100111'
    retlw   b'00110011'
    retlw   b'10101010'
```

PARTS LIST FOR THE CHRISTMAS TREE

SEMICONDUCTORS

- IC1-16F628
- IC2-78L05
- LED1-LED9-Light-emitting diodes, 5-mm, any color

RESISTORS

- R1-R9-220-ohms
- R10-47,000-ohms

CAPACITORS

- C1-0.33-mF
- C2-.01-mF

ADDITIONAL PARTS AND MATERIALS

9-volt battery with battery clip, 18-pin IC socket, prototyping board

A kit of the above parts is available for \$16 from Futurlec, 1133 Broadway, Suite 706, New York, NY 10010 (www.futurlec.com) and includes a programmed PIC and printed circuit board. A programmed PIC is also available separately for \$12.

Flourescent Lamps, Ballasts, And Fixtures

The fluorescent lamp was the first major advance since the tungsten incandescent bulb to be a commercial success in small-scale lighting. Its greatly increased efficiency resulted in cool (temperature-wise) brightly lit workplaces (offices and factories), as well as home kitchens and baths. Fluorescent lighting may not be considered ultra-high-tech, but it is more complex than incandescent lighting-and maximizing lamp life and safety requires a bit more effort.

Fluorescent lamps are a type of gas-discharge tube similar to neon signs and mercury- or sodium-vapor street or yard lights. A pair of electrodes—one at each end—are sealed along with a drop of mercury and some inert gases (usually argon) at very low pressure inside a glass tube. The inside of the tube is coated with a phosphor that produces visible light when excited with ultra-violet (UV) radiation. When power is first applied, a high voltage (several hundred volts) is needed to initiate the discharge. However, once this discharge takes place, a much lower voltage—usually under 100 volts for tubes under 30 watts, 100 to 175 volts for 30 watts or more—is needed to maintain it.

The electric current passing through the low-pressure gases emits quite a bit of UV, mostly from the mercury vapor (but not much visible light). The internal phosphor coating very efficiently converts most of the UV to visible light. The mix of the phosphor(s) tailors the light spectrum to the intended application. Thus, there are cool white, warm white, colored, and black-light fluorescent (long-wave UV) lamps.

There are also lamps intended for

medical or industrial uses with a special envelope i.e. quartz, that passes short-wave UV radiation. Some lamps have an uncoated envelope and emit short-wave UV mercury radiation. (Such lamps should not be used without appropriate protection or fully enclosed.) Others have phosphors that convert shortwave UV to medium-wave UV.

Fluorescent lamps are about two to four times as efficient as incandescent lamps at producing light at the wavelengths that are useful to humans. Thus, they run cooler for the same effective light output. The bulbs themselves also last a lot longer—10,000 to 20,000 hours versus 750 to 1000 hours for a typical incandescent. However, for certain types of ballasts, this time span is only achieved if the fluorescent lamp is left on for long periods of time without frequent on-off cycles.

Over the years, fluorescent lamps in approximately the shape of incandescent lamps with built-in ballasts have been evolving. These "compact fluorescent lamps" or CFLs have all of the advantages of ordinary fluorescent lamps but fit into most standard table lamps and incandescent fixtures. Phosphors have been improved to the point where the color is very similar to that of incandescent lamps.

While the initial cost is high (\$5 to \$20), this expense is easily recovered several times over in the energy savings over the long life of the lamp—most of the lifecycle cost of an incandescent lamp is in the electricity used (typically \$10 for power versus \$0.50 for the lamp) and not the lamp itself. While some of the heavily promoted gadgets for extending incandescent lamp life may do so, it is always at the expense of efficien-

WARNING! The devices described in this article involve the use of materials and substances that are hazardous to health and life. DO NOT attempt to implement or use the information contained in this article unless you are experienced in the construction and safety considerations that apply to high-voltage devices of this nature. Although all possible measures have been taken to ensure the accuracy of the information presented, neither Gernsback Publications Inc., nor the author are liable for damages or injuries, misinterpretation of directions, or the misapplications of information.

cy and overall cost invariably goes up. Same with dimmers. That's for another "Service Clinic!"

Safety Notes

There aren't many dangers associated with typical fluorescent lamps and fixtures. As far as electric shock, there is usually little need to probe a live fixture. Most problems can be identified by inspection or with an ohmmeter or continuity tester when unplugged. The only caution is with respect to those fixtures using electronic ballasts, which may have one or more electrolytic capacitors that can hold a charge.

There is also minimal danger of nasty chemicals: While the phosphors on the inside of fluorescent tubes are not particularly poisonous, there is a small amount of metallic mercury. Contact with this substance should be avoided. If a tube breaks, clean up the mess and dispose of it properly and promptly. Of course, don't go out of your way to get cut on the broken glass! And take care around sharp sheet metal!

Fixtures

The typical fluorescent fixture consists of four components:

Lamp Holder—The most common is designed for the straight bi-pin base bulb. The 15-, 24-, and 48-inch straight fixtures are mostly for household and office use. The 4-foot (48-inch) type is probably the most widely used size. U-shaped, circular, and other specialty tubes are also available.

Ballast(s)—These are available for either one or two lamps. Fixtures with four lamps usually have two ballasts. A

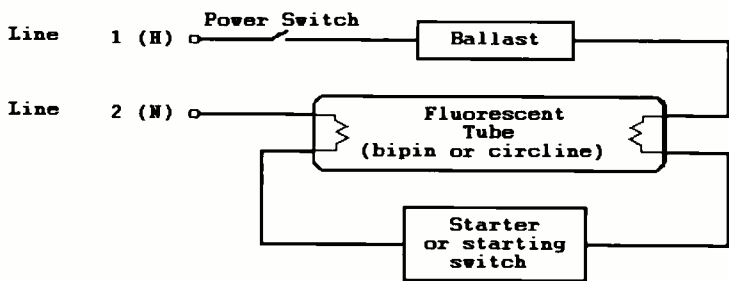

Wiring for Preheat Fluorescent Fixture using Automatic Starter

Fig. 1. Wiring for a preheat fluorescent fixture using an automatic starter is shown here.

ballast serves two functions-providing the starting kick to get the gas to conduct and limiting the current to the proper value for the tube in use.

Switch-The on/off control is on the fixture, unless it's connected directly to building wiring. In that case, there will be a switch or relay elsewhere. The power switch may have a momentary "start" position if there is no starter and the ballast does not provide this function.

Starter (Preheat Fixtures Only)-This device initiates the electrode preheating and high-voltage "kick" needed for starting. In other fixture types, the ballast handles this function.

We will look at ballasts and starters in more detail below.

Fluorescent Lamp Ballasts

There are two basic types: "iron ballasts," which consist of a core, windings, and maybe a few other passive components like capacitors; and "electronic ballasts," which are basically switching-power supplies.

Iron Ballasts-Preheat ballasts require starters or manual starting switches. Instant start, trigger start, rapid start, etc. ballasts include loosely coupled high-voltage windings and other stuff, which does away with the starter. Let's look at these ballasts more closely.

- For a preheat fixture (combined with a starter or power switch with a "start" position), it is basically a series inductor. Interrupting current through the inductor provides the starting kick.

- The ballast for a rapid-start fixture has, in addition, small windings for heating the filaments, reducing the required starting voltage to 250 to 400 V. This type is probably the most common in use today. Trigger-start fixtures are similar to rapid-start fixtures.

- For an instant start fixture, the ballast has a loosely coupled high-voltage transformer winding, providing about 500 to 600 V for starting, in addition to the series inductor. The electrodes of "instant-start" lamps (which have only a single pin) are designed for starting without preheating.

Electronic Ballast-These devices are basically switching-power supplies that eliminate the large, heavy "iron" ballast and replace it with an integrated high-frequency inverter/switcher. Current limiting is then done by a very small inductor, which has sufficient impedance at the high frequency. Properly designed electronic ballasts should be very reliable. Since these ballasts include rectification and filtering and operate the tubes at a high frequency, they also usually eliminate or greatly reduce the 100/120-Hz flicker associat-

ed with iron-ballasted systems. However, there may be problems relating to radio-frequency interference and erratic behavior of equipment with IR remote controls in the vicinity of electronically ballasted lamps.

If you want to get an idea of some typical modern electronic ballast designs, see the International Rectifier (www.irf.com) Web site. In addition, you can search for "electronic ballasts" on the Web or download the following reference design notes from my site.

For a variety of simple inverters to operate fluorescent lamps on low-voltage DC, as well as the circuit of a commercial CFL electronic ballast, see the collection in the document: "Various Schematics and Diagrams" at my Web site, www.repairfaq.org. There you will find the following wiring diagrams.

Fluorescent Fixture Wiring Diagrams

-These wiring diagrams are typical of fluorescent fixtures using iron ballasts. They do NOT generally apply directly to those using electronic ballasts.

Here are the circuit diagrams for a typical preheat lamp. Figure 1 uses a starter and Fig.2 uses a starting switch:

Where a three-position switch (OFF-ON-START) is used to control the fixture (e.g., those circular magnifier lamps), there will be two pairs of contacts: One pair (Power) is connected in the ON and START positions, and the other (Start) is connected only in the START position. They are isolated from each other.

Fluorescent Starter Operation

Now, let's turn our attention to the starters, which may be either automatic or manual.

Automatic-The common type is called a "glow-tube starter" (or just

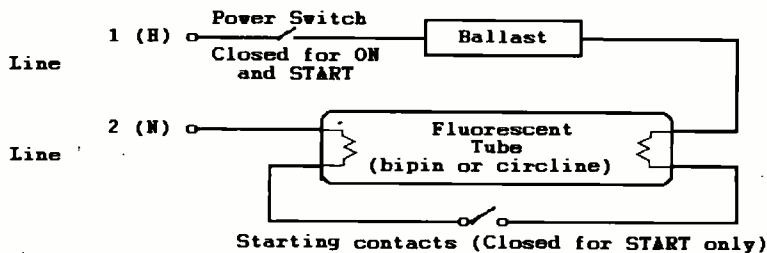

Wiring for Preheat Fluorescent Fixture using Starting Switch

Fig. 2. The wiring for a preheat fluorescent fixture using a starting switch is different from that shown in Fig. 1.

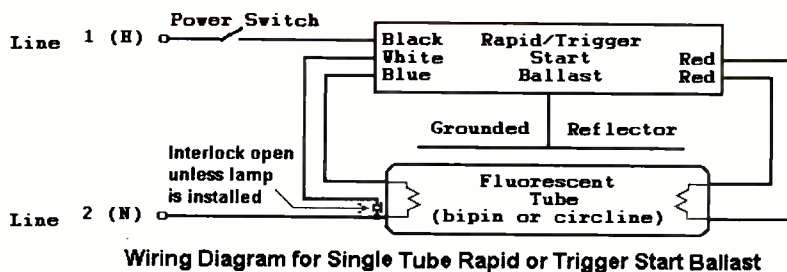

Fig. 3. Here's the wiring diagram for the single-tube rapid- or trigger-start ballast.

"starter") and contains a small gas- (neon, etc.) filled tube and an optional Radio-Frequency Interference or RFI suppression capacitor in a cylindrical aluminum can with a 2-pin base. While all starters are physically interchangeable, the wattage rating of the starter should be matched to the wattage rating of the fluorescent tubes for reliable operation and long life.

The glow tube incorporates a switch, which is normally open. When power is applied, a glow discharge takes place that heats a bi-metal contact. A second or so later, the contacts close providing current to the fluorescent filaments. Since the glow is extinguished, there is no longer any heating of the bi-metal and the contacts open. The inductive kick generated at the instant of opening triggers the main discharge in the fluorescent tube. If the contacts open at a bad time-current near zero, there isn't enough inductive kick and the process repeats.

Higher-tech replacements called "pulse starters" may be available for the simple glow-tube-type starter. These devices are smart enough to interrupt the circuit at exactly the correct instant for reliable starting and not to continuously cycle when a bad lamp is detected.

Manual—When a manual starting switch is used instead of an automatic starter, there will be three switch positions—OFF, ON, START:

- OFF—Both switches are open.
- ON—Power switch is closed.
- START (momentary)—Power switch remains closed and starting switch is closed.

When released from the start position, the breaking of the filament circuit results in an inductive kick (as with the automatic starter) which initiates the gas discharge.

Having looked at the starter types,

we can now turn to how they are wired.

Wiring for Rapid-Start and Trigger-Start Fixtures

Rapid-start and trigger-start fixtures do not have a separate starter or starting switch, but instead they use auxiliary windings on the ballast for this function. The rapid-start is now most common, though you may find some labeled trigger-start, as well.

Trigger-start ballasts seem to be used for one or two small (12-20 W) tubes. The basic operation is very similar to that of rapid-start ballasts, and the wiring is identical. "Trigger start" seems to refer to "rapid starting" of tubes that were designed for preheat starting.

The ballast includes separate windings for the filaments and a high voltage starting winding that is on a branch magnetic circuit, loosely coupled to the main core and thus limiting the current once the arc is struck. A reflector grounded to the ballast (and power wiring) is often required for starting. The capacitance of the reflector aids in initial ionization of the gases. Lack of this connection may result in erratic starting or the need to touch or run your hand along the tube to start.

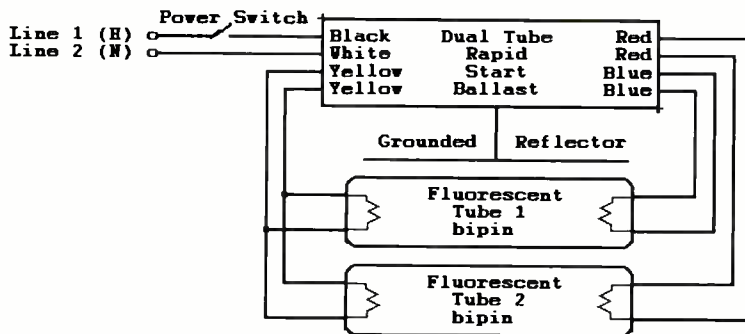

Wiring Diagram for Two Tube Rapid Start Ballast

Fig. 4. Above is the wiring diagram for a two-tube rapid-start ballast

A complete wiring diagram is usually provided on the ballast's case. Power is often enabled via a socket-operated safety interlock (x-x) to minimize shock hazard. See the diagrams below for examples of various types of ballast wiring.

Wiring Diagram for Single-Tube Rapid- or Trigger-Start Ballast—In this diagram, the color coding is fairly standard. The same ballast could be used for an F20-T12, F15-T12, F15-T8, or F14-T12 lamp. A similar ballast for a Circline fixture could be used with an FC16-T10 or lamp FC12-T10 (no interlock).

Wiring Diagram for Two-Tube Rapid-Start Ballast—This diagram is for one pair (from a four-tube fixture) of a typical rapid-start, 48-inch fixture. These ballasts specify the bulb type to be F40-T12 RS. There is no safety interlock on this fixture. (A similar scheme could also be used on a dual-tube Circline fixture, though slightly different ratings may be needed for each tube since they would be of different sizes.)

Schematic of Typical Rapid/Trigger-Start Single-Lamp Ballast—This ballast is marked "Trigger Start Ballast for ONE F20WT12, F15WT12, F15WT8, or F14WT12 Preheat Start Lamp. Mount tube within 1/2-inch of grounded metal reflector." (Note that while labeled "Trigger Start," it does heat the filaments so I assume it is similar or identical to a rapid-start ballast.)

Voltages were measured with no bulb installed with safety interlock bypassed. Internal wiring has been inferred from resistance and voltage measurements. The lossy autotransformer boosts line voltage to the value needed for reliable

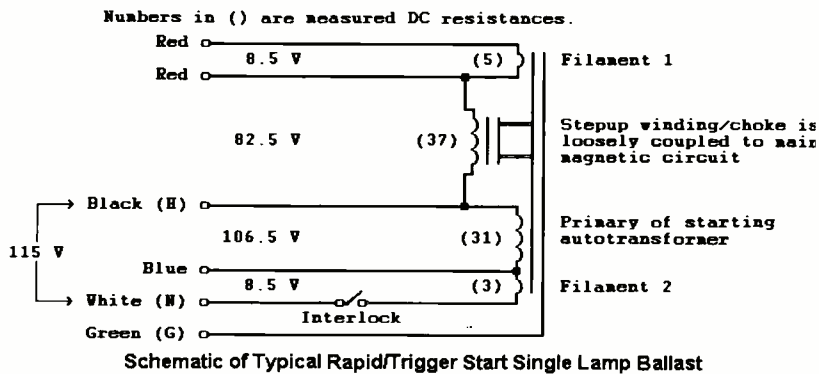

Fig. 5. This schematic of a typical rapid/trigger-start single-lamp ballast is shown here.

starting with the filaments heated. It is assumed that part of the magnetic circuit is loosely coupled so that putting the lamp between Red/Red and Blue/White results in safe current-limited operation once the arc has struck.

Schematic of Rapid-Start Ballast with Isolated Secondary—As noted, rapid-start fixtures do not have a separate starter or starting switch, but instead they use auxiliary windings on the ballast for this function. This schematic is for a typical one-tube rapid-start fixture, including the internal wiring of the ballast.

This ballast includes separate windings for the filaments and a high voltage winding that is on a branch magnetic circuit that is loosely coupled and thus limits the current once the arc is struck. It is not known if this design is common. The isolated secondary and separate high voltage winding would make it more expensive to manufacture. Loose magnetic coupling in the ballast core results in leakage inductance for current limiting.

Schematic of Rapid-Start Dual-Lamp Ballast—This ballast is marked "Rapid

Start Ballast for TWO F40WT12 Lamps. Mount tubes within 1/2-inch of grounded metal reflector." This circuit was derived from the measurements listed in the section:

The autotransformer boosts line voltage to the value needed for reliable starting with the filaments heated. The series capacitor of approximately 4 mF is used instead of leakage inductance to limit current to the tubes. Leakage inductance from loose magnetic coupling smoothes the waveform of current flowing through the tubes. The .03-mF capacitor provides a return path during starting to the yellow filament winding, but it is not really used during normal operation.

Compact Fluorescent Lamps

Let's now turn to a different type of fluorescent lamp.

Compact Fluorescent Lamps (CFL) are miniaturized fluorescent lamps, usually with premium phosphors that often come packaged with an integral ballast (either iron or electronic). They typically have a standard screw base that can be installed into nearly any table lamp or lighting fixture that accepts an incandescent lamp.

These fluorescents are being heavily promoted as energy-saving alternatives to incandescent lamps. They also have a much longer life—6000 to 20,000 hours compared to 750 to 1000 hours for a standard incandescent. While these basic premises are not in dispute, all is not peaches and cream. There are disadvantages:

- They are often physically larger than the incandescent bulbs being replaced and simply may not fit the lamp or fixture conveniently, or at all.
- The funny elongated or circular shape may result in a less optimal lighting pattern.
- The light is generally cooler—less yellow than incandescents. This factor may be undesirable and result in less-than-pleasing contrast with ordinary lamps and ceiling fixtures. Newer models have been addressing this issue.
- Some types (usually iron ballasts) may produce an annoying 120-Hz (or 100-Hz) flicker.
- Ordinary dimmers cannot be used with compact fluorescents.
- Like other fluorescents, operation at cold temperatures (under around 50-60 degrees F) may result in reduced light output. Starting may also be erratic, although most compact fluorescent lamps seem to start OK at temperatures near freezing. Many types start OK near zero degrees F. Operation in an enclosed fixture often results in full light output in cool surroundings after the lamp warms up for a few minutes, as long as the initial temperature is high enough to permit a good start. However, enclosing compact fluorescents often impairs their ability to work well at higher temperatures.

- There may be an audible buzz from the ballast.

- They may produce RFI.

- The up-front cost is substantial (unless there is a large rebate): \$10 to \$20 for a compact fluorescent to replace a 60-W incandescent bulb!

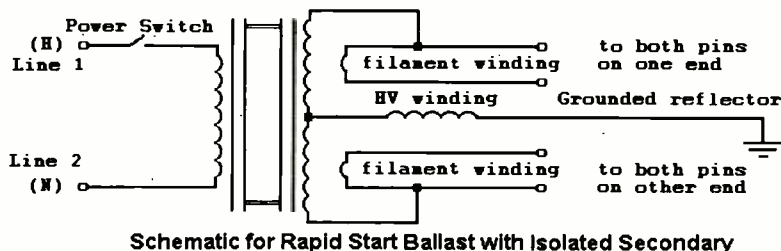

Fig. 6. Here's the schematic for a typical one-tube rapid-start ballast with an isolated secondary.

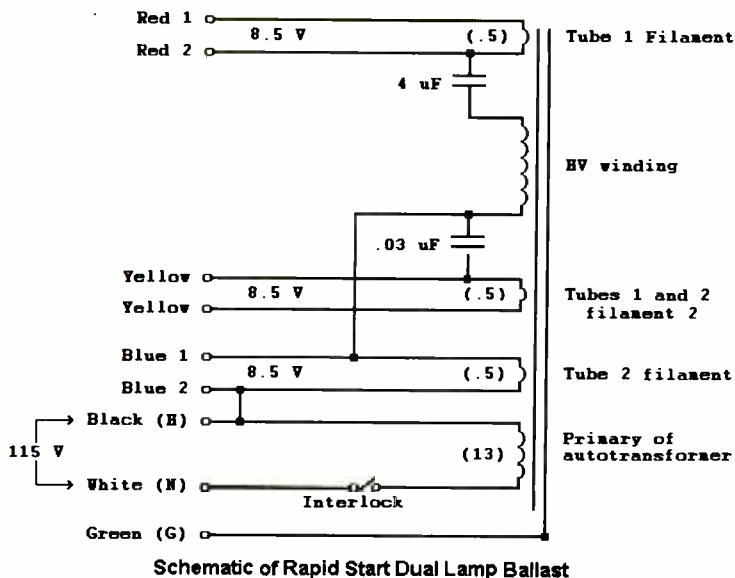

Fig. 7. This schematic shows the wiring for a rapid-start dual-lamp ballast.

- Due to the high up-front cost, the pay-back period may approach infinity.
- While their life may be 20,000 hours, a wayward baseball will break one of these \$10 to \$20 bulbs as easily as a 25 cent incandescent.

Nonetheless, due to the lower energy use and cooler operation, compact fluorescents do represent a desirable alternative to incandescents. Just don't open that investment account for all your increased savings just yet!

Having examined their advantages and disadvantages, it's time to look at how CFLs are put together.

CFL Ballast Schematic—This typical CFL uses an electronic ballast mounted in its base. This unit is from a Techna-Bright EDXR-38-16 compact fluorescent lamp used as a (mediocre) replacement for the ubiquitous 150-watt outdoor floodlight. It's a three-U-section-tube inside a lightweight, glass floodlight reflector. With its rated electrical input of only 16-watts, I doubt that the CFL is even as bright as a 60-watt incandescent lamp.

The inverter is remarkably simple and must be dirt cheap to manufacture. It uses a pair of 400 V, 4 A bi-polar transistors in a self-oscillating configuration, which appears to have its output in resonance with an LC network in series with

the lamp. The only magnetic components are an inductor for RFI suppression, an inductor in series with the lamp, and a driver transformer for the transistor bases (three sets of two or three turns on a ferrite core). An RC and diac circuit provide a kick start to get it going. Protection of sorts (one-time) consists of a fusible 0.47-ohm resistor in the AC line input.

Problems with Fluorescent Lamps and Fixtures

All the types of fluorescents discussed above can have problems. In addition to the usual defective or damaged plugs, broken wires in the cord, general bad connections, fluorescent lamps and fixtures have some unique problems of their own. The following discussion assumes a lamp or fixture with a conventional iron (non-electronic) ballast. Always try a new set of fluorescent tubes and starter (where used) before considering other possible failures.

If two tubes dim or flicker in unison, it means that both are powered by the same ballast. Often this means that one tube has failed, although the other tube may also be in poor condition or approaching the end of its life. Both tubes must be replaced with known-good tubes in order to rule out a defective ballast.

Bad Fluorescent Tubes—Unlike incandescent lamps where a visual examination of the bulb itself will often iden-

tify a broken filament, there is often no way of just looking at a fluorescent tube to determine if it is bad. It may look perfectly OK though burned-out fluorescents will often have one or both ends blackened. However, a blackened end is not in itself always an indication of a bad tube. Blackened ends are a somewhat reliable means of identifying bad tubes in 34- or 40-watt rapid-start fixtures. Blackened ends are not as reliable an indicator in preheat or trigger-start fixtures or for tubes of 20 watts or less.

Failure of the electrodes/filaments at one or both ends of the fluorescent tube will usually result in either a low-intensity glow or flickering behavior or, sometimes, in no light at all. A broken filament in a fluorescent tube used in a preheat type fixture (with a starter) will almost always result in a totally dead lamp, as there will be no power to the starter. Dim glow is rare in this case and would probably be confined to the region of the broken filament if it occurs. The best approach is to simply try replacing any suspect tubes—preferably both in a pair that are driven from a single ballast.

In fixtures where a rapid-start ballast runs two tubes, both tubes will go out when one fails. Sometimes one or both tubes will glow dimly and/or flicker. If one tube glows dimly and the other is completely dead, this does not indicate which tube has failed. The brighter tube may be the good one or the bad one. The bad tube usually has noticeable blackening at one end. It may pay to replace both tubes, especially if significant labor costs are involved. Also, a prolonged dim glow may degrade the tube that did not initially fail.

In trigger-start fixtures that use one ballast to power two 20-watt tubes, sometimes both tubes will blink or intermittently dim. Replacing either tube with a known-good tube may fail to fix this. The tubes may continue blinking or intermittently dimming until both are replaced with brand new tubes. This sometimes indicates borderline low-line voltage ("brownout," etc.), non-ideal temperatures, or a borderline (probably cheaply designed) ballast.

Bad Starter (Preheat Fixtures Only)—The little starter can may go bad or be damaged by faulty fluorescent tubes continuously trying to start unsuccessfully. It is a good idea to replace the starter whenever tubes are replaced in

these types of fixtures. One way that starters go bad is to "get stuck." Symptoms are the ends of the affected tube glowing, usually with an orange color of some sort or another but sometimes with a color closer to the tube's normal color if arcs form across the filaments. Occasionally, only one end arcs and glows brightly, and the other end glows dimmer with a more orange color. Please note that this is hard on both the tube and the ballast, and the defective starter should be immediately removed.

Should one or both ends glow with a bright yellowish orange color with no sign of any arc discharge surrounding each filament, then the emissive material on the filaments is probably depleted or defective. In such a case, the tube should be replaced regardless of what else is wrong. If both ends glow a dim orange color, then the filaments' emissive coating may or may not be in good shape. It takes approximately 10 volts to form an arc across a healthy fluorescent lamp filament.

Defective Iron Ballast—The ballast may be obviously burned and smelly, overheated, or have a loud hum or buzz. Eventually, a thermal protector built into many ballasts will open due to the overheating (though this will probably reset when it cools down). The fixture may appear to be dead. A bad ballast could conceivably damage other parts as well and blow the fluorescent tubes. If the high-voltage windings of rapid-start or trigger-start ballasts are open or shorted, then the lamp will not start. Ballasts for fixtures less than 30 watts usually do not have thermal protection and, in rare cases, catch fire if they overheat. Defective fixtures should not be left operating.

Bad Sockets—These sockets can be damaged through forceful installation or removal of a fluorescent tube. With some ballasts (instant-start, for example), a switch contact in the socket prevents generation of the starting voltage if there is no tube in place. This protection minimizes the possibility of shock while changing tubes, but it can also be an additional spot for a faulty connection.

Lack Of Ground—For fluorescent fixtures using rapid-start or instant-start ballasts, it is often necessary for the metal reflector to be connected to the

electrical system's safety ground. If this connection is not done, starting may be erratic or may require you to run your hand over the tube to get it to light. In addition, of course, it is an important safety requirement.

Warning: Electronic ballasts are switching-power supplies and need to be serviced by someone qualified in their repair both for personal safety, as well as continued protection from electrical and fire hazards.

We'll discuss grounding in detail below.

Grounding Fixtures

Many fluorescent fixtures will not start reliably unless they are connected to a solid earth (safety) ground. Such is most likely the case with rapid- or trigger-start magnetic ballasts. These will usually state on the label: "Mount tube within 1/2-inch of grounded metal reflector." If it's not done or if the entire fixture is not grounded, starting will be erratic—possibly taking a long (or random amount) of time to start or waiting until you brush your hand along the tube.

The reason is straightforward. The metal reflector or your hand provides a capacitive path to ground through the wall of the fluorescent tube. This path helps to ionize the gases and initiate conduction in the tube. However, once current is flowing from end to end, the impedance in the ballast circuit is much, much lower than this capacitive path. Thus, the added capacitance is irrelevant once the tube has started.

Probably, cost is part of the story: It is cheaper to manufacture a ballast with slightly lower starting voltage while requiring the fixture to be grounded-as it should be for safety anyhow.

Should one or both tubes glow dimly, then ionization is not the problem and poor grounding isn't the cause. In such a case, the problem could be any of a number of things: poor contact with the pins of the tubes, one or both tubes are bad, insufficient voltage, bulb/ballast mismatch (wrong bulbs may fit but not work especially for four-footers, which come in many wattages), or possibly just a bad case of the bulbs being much too cold. Wire or foil or other attachments to change the electric-field distribution will not help the dim glow make the transition to arc-it will only help with the tubes ionizing and glowing at all.

We discussed problems and grounding. Last of all, let's look at replacing components.

Replacing Components

Most of these parts are easily replaced and readily available. However, it is usually necessary to match the original and replacement fairly closely. Ballasts, in particular, are designed for a particular wattage, type and size, and tube configuration. Take the old ballast with you when shopping for a replacement. There may be different types of sockets, as well, depending on the type of ballast you have.

It is also a possible fire hazard to replace fluorescent tubes with a different wattage even if they fit physically. A specific warning has been issued about replacing 40-watt tubes with 34-watt energy-saving tubes, for example. The problem is that the ballast must also be correctly sized for the new tubes, and simply replacing the tubes results in excessive current flow and overheating of the ballast(s).

Wrapup

Fluorescent lighting is a basic technology that is often misunderstood. I hope that the information in this "Service Clinic" will prove useful. Much more on fluorescent lamps and fixtures is available at my Web site, www.repairfaq.org; and information on all types of lighting is at Don Klipstein's Web site, www.misty.com/~don/. As always, I welcome feedback via e-mail to sam@repairfaq.org. **P**

Poptronics

Interactive Edition

Projects...Courses...Articles...& more

Read it on the WEB!

- An e-magazine for everyone who loves electronics.
- Interesting articles and related items.

www.poptronics.com/interactive

An Ear To The Outside World

Listening to the sounds of outdoor creatures can be a real audio treat and, perhaps, a warning of danger to come. Birdcalls are not the only game in town when it comes to listening in on the multitude of insects that live in our yards, plants, and trees. The sounds of our micro-miniature neighbors can provide a sound photo of what's happening in their jungle. During the day when all things are tranquil and the birds are happily singing, we can almost be assured that things are normal; however, when the singing stops and silence prevails, it's a good sign that something has changed. At night the symphony of cicadas and other insects usually means all is well, at least until they stop.

You can enjoy hearing these sounds with a minimum of electronic equipment, most of which can be easily built. First off, a suitable microphone is required—one that is configured for a specific sound pick-up application. Next, you want to have an amplifier with sufficient gain to increase the sound to a comfortable listening level, as well as one with an output powerful enough to drive either headphones or a speaker. These basic items are the only ones needed to eavesdrop on our animal friends.

Your major effort will be to build a suitable enclosure for the microphone so that it produces the best performance in picking up the desired sounds and ignores the others. Perfection is not possible in this area; however, much can be done to improve on the basic pick-up selectivity of most any microphone. Often, the sound level from our little friends will be many times lower than the surrounding sounds, that's why the microphone configuration is our first job.

Insect-A-Phone

A small, inexpensive, electret con-

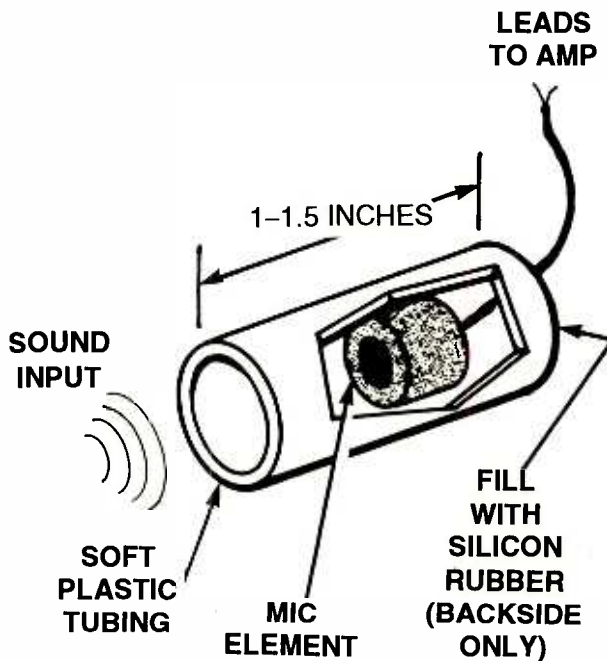

Fig. 1. The microphone element is housed in a 1- to 1 1/2-inch section of soft plastic tubing, with the area behind the microphone filled with silicon rubber

denser microphone available from almost any electronic supply house is an ideal choice for the pick-up element. It only costs about two bucks and is just 2.2 mm in diameter.

Figure 1 is our first microphone enclosure, which is designed to give a degree of directivity and reduce background noise. The microphone element is housed in a 1- to 1 1/2-inch section of soft plastic tubing, with the area behind the microphone filled with silicon rubber. The actual dimensions are not critical. The idea is to offer some directivity to the front area of the microphone and to isolate the back area.

Now that we have a useable pick-up device, let's look at a simple amplifier circuit. The 386 IC op-amp is just as good today as it was when it made its

appearance many years ago, and that's what our first amplifier circuit uses in Fig. 2. The electret is connected to the amplifier circuit with a length of shielded microphone cable. If the microphone is to be used outside with the amplifier indoors, keep the cable length as short as possible.

For those who haven't worked with the 386 IC power amplifier, here's a quick review. A top-view drawing of the IC is shown in Fig. 3.

The amplifier's input is similar to that of an op-amp with both inverting and non-inverting inputs, a single output designed to drive low impedance loads, and a gain-change feature. Either input can be connected to circuit ground, which allows for a ground-referenced input. The amp will operate

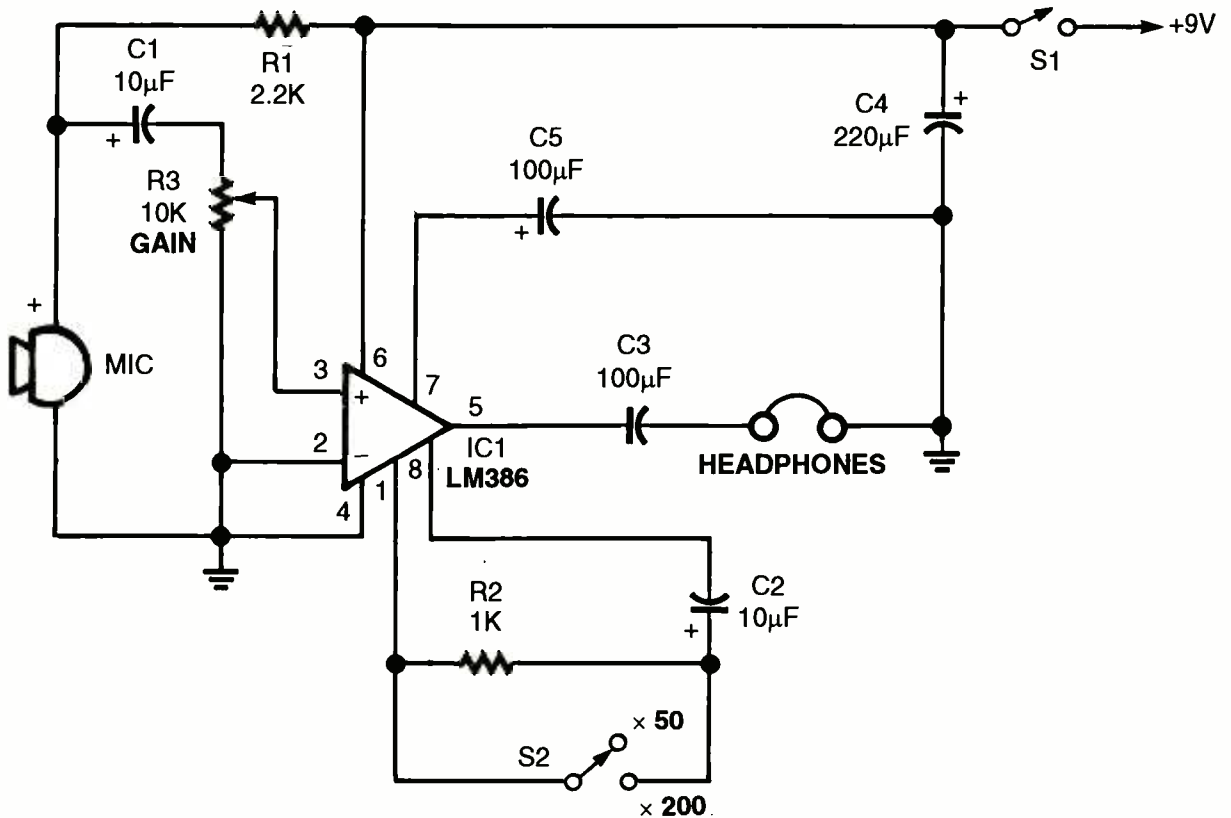

Fig. 2. The electret is connected to the amplifier circuit with a length of shielded microphone cable. If the microphone is to be used outside with the amplifier indoors, keep the cable length as short as possible.

with a power source of 4 to 12 volts and consumes less than 30 mW in its quiescent state. The maximum package dissipation is 660 mW.

The only advice I'll offer on the construction of the amplifier is to keep the component leads short and all output wiring and components away from the input. Sloppiness will only get you squeaks and squawks when using the high gain setting of S2. Not a fun thing to deal with, so do a good job.

In Tune With Insects

If getting too close to the creepy,

crawly creatures of the outdoors isn't good for your well-being, place the microphone in a suitable location and move the amplifier away. In fact, if you are too close, they might not say anything.

Here are a few suggestions for experiments with your insect-a-phone. Stuff the pick-up in the entrance of an anthill and listen to what they are doing. Drop the pick-up in the middle of your garden and wait for "Brer" Rabbit or a multitude of insects to make an invasion. Attach the pick-up to your favorite birdhouse and listen to the birds at home.

Bird Snooping Pick-Up

Our insect-a-phone is okay for checking out birds in their house, but it's not too great for getting the whole backyard symphony. What's needed is a pick-up with a larger sound-gathering area, along with good directivity. There are several types of pick-up microphones designed for that application; they include the parabolic-reflector type that's used in sporting events; the shotgun microphone, which is more complex than the parabolic; and the Tube. The Tube is a type of sound pick-up that I've used in various configurations for years to intercept outside and distance sounds.

Simply described, the Tube is basically a microphone mounted in one end of a long plastic tube. Of course, how the microphone is housed and positioned in the tube gets some special attention. A drawing for a tube pick-up suitable for gathering bird songs is shown in Fig. 4. A 2- to 3-foot length of light-duty, 4-inch diameter, plastic sewer tubing serves as the sound director and housing

PARTS LIST FOR THE AMPLIFIER (FIG. 2)

SEMICONDUCTORS

IC1-LM386, power-audio amplifier

RESISTORS

(All resistors are 1/4-watt, 5% units.)

R1-2200-ohms

R2-1000-ohms

R3-10,000-ohm potentiometer

CAPACITORS

C1, C2-10-mF, 25-WV_{DC} electrolytic

C3, C5-100-mF, 25-WV_{DC} electrolytic

C4-220-mF, 25-WV_{DC} electrolytic

ADDITIONAL PARTS AND MATERIALS

S1, S2-SPST toggle or similar switch

IC socket, headphones, etc.

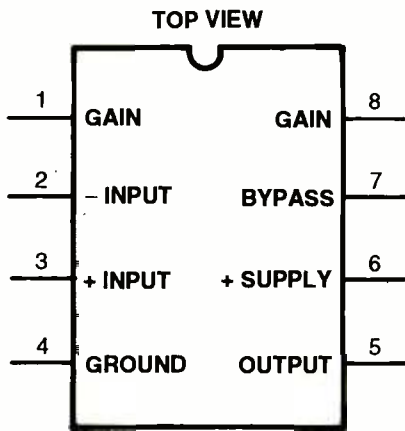

Fig. 3. The LM386 input is similar to that of an op-amp with both inverting and non-inverting inputs, a single output designed to drive low impedance loads, and a gain-change feature. Either input can be connected to circuit ground, which allows for a ground-referenced input.

for the pick-up.

A 3-inch diameter plastic funnel is positioned, as shown in Fig. 4, in one end of the tubing. The electret microphone element is placed in the funnel's spout, facing out toward the open end of the

tube. A layer of very soft foam rubber is attached to the inside of the tube with silicon rubber or suitable glue. One-half- to one-inch-thick foam-rubber material will do; however, a layer of bubble pack material might work as well. The funnel's spout is cut off just 1/2 inch behind the microphone element and sealed with silicon rubber. The funnel is positioned so the spout is about two inches in from the tube's end. Foam rubber fills in the area around the back of the funnel and behind the spout.

A four-inch plastic end cap can be placed over the tube at the pick-up end. The tube pick-up is connected to the amplifier with a length of shielded microphone cable.

A great way to connect the pick-up to a remote monitoring station is to feed the audio output to a wireless transmitter that operates on the FM broadcast band. This setup allows the tube to be placed anywhere, as long as it is within the range of the transmitter.

Woodpecker Invasion

I don't know if the woodpecker invasion is common in your area, but, where

I live, the flying hammerheads are drilling holes in various parts of our house. The noise alone is bothersome, and the holes allow rain and some uninvited guests to enter.

Electronics has helped when other methods have failed to solve similar problems, and there is no reason why it shouldn't work here. Maybe our listening device coupled to some sort of noisemaker can be used to shoo the flying menaces away.

Often the simple, straightforward approach works best, and, in the woodpecker caper, it's too simple not to try. Here's the scoop. Take the pick-up shown in Fig. 1 and connect it to our amplifier. Take an all-weather outdoor 4- or 8-ohm speaker and place it within a couple of feet of the hole that the woodpecker is working on. Increase the amplifier's supply voltage to 12 volts. Position the microphone pick-up within a few inches of the hole, and temporarily tape or glue it in place with the opening facing the wall. This position should keep outside noises to a minimum. It's possible that the woodpecker won't like hearing his own hammering and will fly

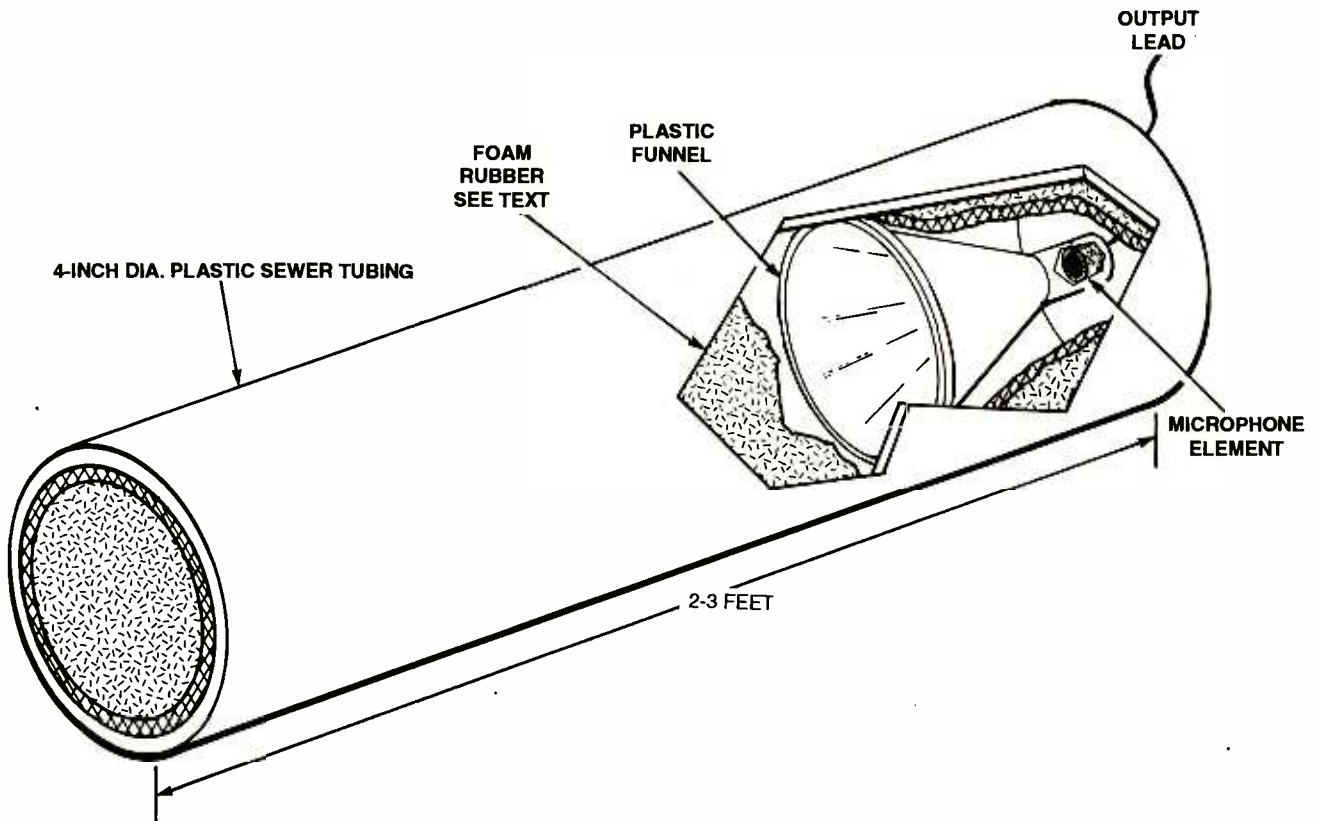

Fig. 4. A drawing for a tube pick-up suitable for gathering bird songs is shown above. A 2- to 3-foot length of light-duty, 4-inch diameter, plastic sewer tubing serves as the sound director and housing for the pick-up.

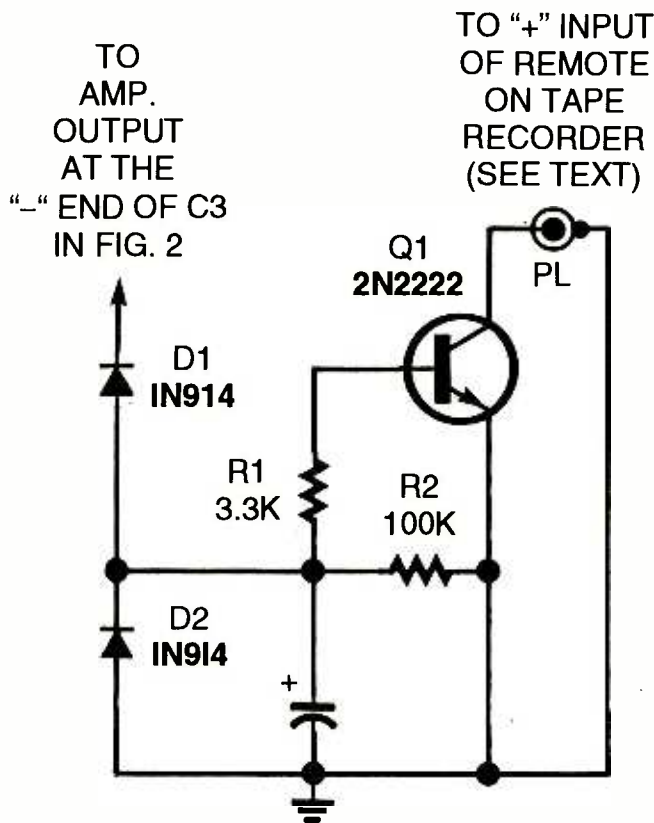

Fig. 5. The amplified audio from the hammering is rectified and fed to the base of Q1. The collector of Q1 connects to the positive input of a cassette recorder's remote input and the negative input to circuit ground. The sound turns Q1 on, starting up the recorder.

away after the first attack. If not, plan B follows.

Jacking Up The Defense

Okay—the happy hammerer was pleased by hearing a new clatter and joined in to make the hole larger. No, it's not time to bring out the shotgun; that might end up making even more holes in the wall. A better and safer solution is shown in Fig. 5.

The amplified audio from the hammering is rectified and fed to the base of Q1. The collector of Q1 connects to the positive input of a cassette recorder's

remote input and the negative input to circuit ground. The sound turns Q1 on, starting up the cassette recorder and sending out your very own scare sounds to ward off the feathered attacker.

'Til Next Time

Hey, give this electronic eavesdropping a chance—bet you just might like it. Also, let me know how your version of the woodpecker defense system works out. May all of your attacking woodpeckers come equipped with rubber beaks. Until next month, good circuitry always!

PARTS LIST FOR THE WOODPECKER DETERRENT (FIG. 5)

SEMICONDUCTORS

Q1-2N2222 NPN transistor
D1, D2-1N914 silicon diode

RESISTORS

(All resistors are 1/4-watt, 5% units.)
R1-3300-ohms
R2-100,000-ohms

CAPACITORS

C1-47-mF, 25-WV_{DC}, electrolytic

ADDITIONAL PARTS AND MATERIALS

Plug to match cassette recorder's remote input.

Q&A

(continued from page 45)

Kohms. When I used 200 Kohms, the pulse width was 31 seconds. Note that the caption for Fig. 5 could have said that it was a "stationery cutting edge" if you were resizing envelopes and letter-head (pun intended).

If you decide to make the project easier, just use the five LED strips alone with a 100-ohm resistor in series with each strip, in parallel, and power them directly from the wall wart. Simply tie the negative end of the wall wart to the common cathode connection that was connected to the collector and the positive wart lead to the common resistor connection that was connected to the +12 volts. Figure 6 shows the simpler, and less expensive, circuit.

I couldn't tell from your letter if you wanted this thing to be retriggerable so that each press of the button resets the timer to the beginning of the timing cycle or if you wanted each press of the button to add another 30 seconds to the time, much like a parking meter. I did neither. The timer is non-retriggerable and one push of the button gets you one 30-second light. If you wanted to override the pushbutton for long sessions under the knife, you could simply connect an SPST slide or toggle switch across the collector and emitter leads of Q1. Then when you close the switch, the LEDs will be on regardless of the status of the timer. Don't forget that the accumulation of paper scraps that cover the LEDs will be one side effect with which you'll have to deal. □

Writing to Q&A

As always, we welcome your questions. Please be sure to include:

- (1) plenty of background material,
- (2) your full name and address on the letter (not just the envelope),
- (3) and a complete diagram, if asking about a circuit; and
- (4) type your letter or write neatly.

Send questions to Q&A, **Poptronics**, 275-G Marcus Blvd., Hauppauge, NY 11788 or to q&a@gernsback.com, but do not expect an immediate reply in these pages (because of our backlog). We regret that we cannot give personal replies. Please no graphics files larger than 100K.

Poptronics®

SHOPPER[®]

800-308-4626

Where Do You Need To Increase Your Security?

800-308-4626

WIRELESS VIDEO LIPSTICK CAMERAS MONITORS **OVER 800 PRODUCTS IN STOCK!!** DIGITAL RECORDERS ANTENNAS MICRO CAMERAS



NEW
LP-850W Black/White IR Camera operates in extreme low-light conditions. This camera sees in total darkness with LEDs up to 20 feet away. The compact, discreet appearance of this miniature camera allows mounting on a wall or ceiling. Infrared light is controlled by an auto-sensing photo cell.

LP-850W - \$99.95

COLOR DOME INFRARED CAMERA



VPD-50 The Infrared Day/Night Color Camera is the latest in vandal-resistant technology. Specifications include:

- 470 TVL Enhanced DSP
- 0 Lux with IR-LEDs
- 4.3mm Lens Viewing Angle of 78°
- Auto Gain Control
- Auto White Balance
- S/N Ratio of 52dB
- Auto Iris

NEW
VANDAL RESISTANT

VPD-50 - \$199.95

MICRO BOARD CASED CAMERAS

Each camera is compact and lightweight making it perfect for covert applications where little space is available. The MC-780U B/W Camera offers 420 TVL at 0.5 Lux and the MC-790U Color Camera provides 380 TVL (480 Enhanced) at 1.0 Lux.



MC-780U
\$69.95



MC-790U
\$109.95

B/W PEN CAMERA WITH AUDIO



NEW
PENCAM is the newest member to our line of covert cameras. Its small, lightweight design allows this camera to slip into your shirt or coat pocket. It has audio and video capability making the PENCAM perfect for a number of applications.

Great Resolution!

PENCAM - \$225.95



MS-140X This color camera is exceptional for a variety of applications. Its high resolution of 470 TVL allows you to see the smallest elements in manufacturing, nature, even verifying the authenticity of 20 dollar bill.

MS-140X - \$209.95



Works with:
→ PC
→ Monitor
→ VCR

FROM



TO



MAGNIFIES IMAGES 40-140 TIMES THEIR ORIGINAL SIZE

Pictures taken with the MS-140X

220x ZOOM CAMERA MODULE

Build your own speed dome or motor zoom camera with ease. The Polaris 220X camera module will fit right into your case easily. The life of the 220X motor is essentially 5 times longer than any other brand named camera available today.



AFZ-220X is compact and lightweight. This zoom camera will fit into a variety of applications.

AFZ-220X \$349.95



CASED VERSION AVAILABLE

1/3" HIGH RESOLUTION DSP COLOR CAMERA

DX-7811S Our NEW Digital Signal Processing (DSP) Camera offers you a Day/Night Camera with Digital Zoom, Mirror Function, 470 lines of resolution, backlight compensation, gain control & low lux. An excellent addition to your current security system or a great beginning to a new system.



NEW
This camera has all the features of the brand names without the brand name price!

DX-7811S \$169.96

Polaris Industries, Inc.

We're On The Move!

Local Technical Sales and
Tech Support 404-872-0722
Fax 404-872-1038

WWW.POLARISUSA.COM

CIRCLE 228 ON FREE INFORMATION CARD

SEARCH & BUY ONLINE
www.mouser.com

MOUSER 
ELECTRONICS

178,000+
ELECTRONIC
COMPONENTS

CIRCLE 325 ON FREE INFORMATION CARD

FOR 26 EASY
WAYS TO HELP
SAVE THE
EARTH CALL
1-800-488-8887.

HARMONY
A PARTNERSHIP WITH A HEALTHY LAND

The earth has always provided food, water, and all that we need. Today, as in the past, American Indians recognize the importance of keeping the earth healthy. Give back to the earth. Call for your free action packet.

1-800-THE-SOIL
United States Department of Agriculture
Natural Resources Conservation Service

 A Public Service of
The Publication

 Earth Share

Get your copy of the
CRYSTAL SET HANDBOOK



Go back to antiquity and build the radios that your grandfather built. Build the "Quaker Oats" type rig, wind coils that work and make it look like the 1920's! Only \$10.95 plus \$4.00 for shipping and handling. Cleagge Inc., PO Box 12162, Hauppauge, NY 11788, USA. Funds ONLY! USA and Canada—no foreign orders. Allow 6-8 weeks for delivery. MA01

2539 W. 237th St. Bldg. F, Torrance, CA 90505
Order desk only: USA (800) 872-8876 CA (800) 223-9977
LA & Technical Info: (310) 784-5488
Fax: (310) 784-7590

TIMELINE INC.

Over 15 years and 33,000 customers and still growing!
email: mas@earthlink.net • <http://www.digsys.net/timeline>

Minimum Order: \$20.00. Minimum shipping and handling charge \$5.00. We accept
Discover, Visa, MC or VISA, no personal checks or C.O.D.'s. CA residents add
8.25% sales tax. We are NOT responsible for typographical errors. All merchandise
subject to prior sale. Phone orders welcome. Foreign orders require special
handling. Prices subject to change without notice. 20% restocking fee for returned
orders.

LIQUID CRYSTAL DISPLAYS

240x64 dot LCD with built-in controller,
AND 4021ST-EO. Unit is EL back-lit. \$29.⁰⁰ or 2 for \$49.⁰⁰ or
OPTREX DMF5005 (non back-lit) \$29.⁰⁰ or 2 for \$49.⁰⁰
20 character x 8 line 7/8L x 2 1/4H
The built-in controller allows you to do text and graphics

240x128 LCD with built-in controller \$29.⁰⁰ 2 for \$49.⁰⁰
256x128 LCD with built-in controller \$29.⁰⁰ 2 for \$49.⁰⁰

Alphanumeric-parallel interface

16x1	\$5.00	20x2	\$6.00	32x2	\$5.00
16x1 (lg. char.)	\$7.00	20x4	\$8.00	40x1	\$5.00
16x2	\$5.00	20x4 (lg. char.)	\$10.00	40x2	\$7.00
16x2 (lg. char.)	\$10.00	24x2	\$6.00	40x4	\$15.00
16x4	\$8.00	32x4	\$5.00	4x2	\$4.00

5V power required • Built-in C-MOS LCD driver & controller
• Easy "microprocessor" interface • 98 ASCII character generator
Certain models are backlit, call for more info

Graphics and alphanumeric - serial interface

size	Mfr.	price	size	Mfr.	price
640x480 (backlit)	Epson	\$15.00	320x240	Epson	\$15.00
640x400 (backlit)	Panasonic	\$10.00	256x128	Epson	\$15.00
640x200	Toshiba	\$10.00	240x128 (backlit)	Cyrix	\$15.00
480x128 (backlit)	ALPS	\$ 8.00	240x64	Epson	\$15.00
480x128	Hitachi	\$ 6.00	160x128	Optrex	\$15.00

6" VGA LCD 640x480,
Sanyo LMDK55-22 \$15.00

MONITORS

NON-ENCLOSED TTL

Comes with pinout. 12v of 1.4 input • Horizontal frequency 15Khz
• Ability to do 40 and 80 column.
5 INCH AMBER \$15.00 • 7 INCH AMBER \$19.00
9 INCH AMBER OR GREEN \$19.00

5" COLOR MONITOR \$19.00 2 for \$29.⁰⁰

- Flat Faceplate • 320 x 200 Dot Resolution
- CGA & Hercules Compatible • 12 VDC Operation
- 15.75 KHz Horiz. Freq. • 60 Hz Vert. Sync. Freq.
- Open Frame Construction
- Standard Interface Connector
- Degaussing Coil included • Mfr. Samtron

HACKER CORNER

57 WATT UPS SUPPLY \$19.00
(COMES w/ 12V @ 2.2AMP BATTERY)

Unit designed to provide uninterrupted DC power in the event of loss of the primary 110 / 220 VAC supply. It utilized a 12 V sealed lead acid battery as a source of power until the AC supply can be restored. It is a versatile unit which can be used in a number of different applications. The outputs are +5 VDC @ 0.5A, +3.6 VDC @ 2.5A, +12 VDC @ 8A, -12 VDC @ .5A, and a battery charging output of 12 VDC @ 10A. The DC outputs are terminated in the in-line connectors, which interface with standard motherboard and drive connectors. Possible applications include: Robotics, scientific sensing and recording, Linux devices attached to Ethernet or Internet links, etc....

- The unit is small enough (2" x 3.5" x 8.5") to be contained in a standard PC enclosure, in place of the regular power supply - interfacing directly with the motherboard - providing an uninterrupted power supply. • It can function as a DC - DC power supply finishing multiple outputs using a 12 VDC input.
- The 10 Amp, 2 VDC output can be used as a battery charger with any AC input from 100-240 V. • The unit is a versatile 57 watt DC power supply providing +5 and 3.6 VDC as well as +/- 12 VDC.

EMBEDDED 486 COMPUTER \$59.
2 FOR \$109.00

Complete enhanced Intel 486SX-33 based computer in ultra small (9-7/8L x 6-5/8W x 3-1/8H) case. Ideal for embedded operations or as a second computer. Features include: • 3 serial ports plus dedicated printer port • Parallel optical coupled adapter port • Built in IBM PC/AT keyboard port • On board VGA video and port • Uses standard SIMM up to 32 MB • BIOS is PC/AT compatible

Unit has a backup Ni-Cd battery system in case of power failure (5 min backup time) and lockable front cover to prevent floppy drive access. Mounting/interface provisions for standard 3.5" laptop floppy and 2.5 inch hard drives. Comes with very comprehensive manual. Ultra small (9-7/8L x 6-5/8W x 3-1/8H) case.

CELL SITE TRANSCIVER \$19.00 2 FOR \$29.00

These transceivers were designed for operations in an AMPS (Advanced Mobile Phone Service) cell site. The 20 MHz bandwidth of the transceiver allows it to operate on all 666 channels allocated. The transmit channels are 870.030-889.980 MHz with the receive channels 45MHz below those frequencies. A digital synthesizer is utilized to generate the selected frequency. Each unit contains two independent receivers to demodulate voice and data with a Receive Signal Strength Indicator (RSSI) circuit to select the one with the best signal strength. The transmitter provides a 1.5 watt modulated signal to drive an external power amplifier. Channel selection is accomplished with a 10-bit binary input via a connector on the back panel. Other interface requirements for operation are 26 VDC (unregulated) and an 18.990 MHz reference frequency for the digital synthesizer. The units contain independent boards for receivers, encoder, synthesizer, transmit front end and interface assembly (which includes power supplies and voltage-controlled oscillator) Schematics and circuit descriptions included.

The Pocket Programmer

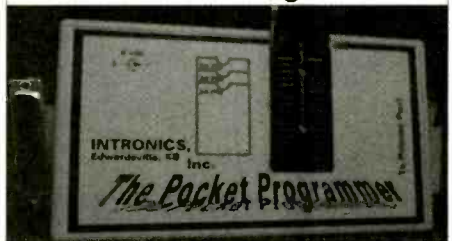

The Best just got Better!!!

The Best portable programmer that uses the printer port instead of an internal card just got Better!! Now with easier to use Windows based software that programs E(E)prom, Flash & Dallas parts. 25/27/28 & 29 series from 16K to 8Mbit. Adapters available for MCU's 874X, 875X, Pic, Atmel, PLCC packages, Bi-Prom's, 40-Pin X16 Eproms, Rom Emulator to 32K X 8 (2716-27256) and More...

Only \$149.95

Same Name, Address & Phone # for 19 Years.... Isn't it Amazing ?

Intronics, Inc.

Box 13723 / 612 Newton St.
Edwardsville, KS 66113

Tel. (913) 422-2094 Add \$7.00 COD
Fax (913) 441-1623 Add \$6.00 Shipping

WWW.IN-KS.COM Visa/MC/Amex/Disc

NORTH COUNTRY RADIO

A supplier of top quality kits since 1986

AM,FM,TV, Carrier Current and Infrared Transmitters
 Downconverters, Upconverters, Converters and receivers
 Video devices, E-H and RF Field Strength Meters
 Speech Scrambler, Voice Messenger, Ultrasensitive DC Meter
 LED Thermometer, and many more useful and practical kits

Visit our Website www.northcountryradio.com

for detailed product specs, photos, schematics, block diagrams,
 technical articles, and ordering information

Sales: PO Box 53 Wykagyl Station, New Rochelle NY 10804-0053 Tel 914-235-6611
 Technical : PO Box 200, Hartford NY 12838-0200 Tel 518-854-9280

BP 501—\$12.99

XHTML and CSS explained



If you know HTML, then you already know 85% of XHTML. This text will teach you how to create Web pages using the new language. XHTML uses Cascading Style Sheets (CSS) as the presentation language to format the content.

Consequently, much of this text explains how to create and use style sheets.

Please circle the products you would like to buy in the ad above, calculate the total cost, include shipping charges, (NYS residents add sales tax) using the table below and send it to: **Electronic Technology Today, Inc., PO Box 240, Massapequa Park, NY 11762-0240.** Please allow 4 - 6 weeks for standard delivery. Sorry, NO orders accepted outside the US and Canada. All payments must be payable through US funds. Pay by Check, MasterCard, Visa, or Discover. The shipping address and the credit card billing address must be the same.

SHIPPING CHARGES IN USA. (ADD \$5.00 IN CANADA)

\$0.01 to \$5.00	\$.20	\$20.01 to \$30.00	\$.50
\$5.01 to \$10.00	\$.30	\$30.01 to \$40.00	\$.60
\$10.01 to \$20.00	\$.40	\$40.01 to \$50.00	\$.70
\$50.01 and above	\$.80		

ET17

Lynxmotion, When you're tired of playing with toys!

H3-KT

Lynxmotion, Inc.
 PO Box 818
 Pekin, IL 61555-0818
www.lynxmotion.com

Tel: 309-382-1816
 Fax: 309-382-1254
sales@lynxmotion.com
tech@lynxmotion.com

Visit our website or ask for our free catalog!

ELECTRONIC GAMES

BP69—A number of interesting electronic game projects using IC's are presented. Includes 19 different projects ranging from a simple coin flipper, to a competitive reaction game, to electronic roulette, a combination lock game, a game timer and more. To order BP69 send **\$4.99 clearance (includes s&h)** in the US and Canada to **Electronic Technology Today Inc., P.O. Box 240, Massapequa Park, NY 11762-0240.** US funds only. Use US bank check or International Money Order. Allow 6-8 weeks for delivery. MA07

Electronic Games



SINGERS! REMOVE VOCALS
 Unlimited Free Backgrounds from Original Standard Recordings!
Thompson Vocal Eliminator™
 VE-4 Free Brochure/Demo
 24 Hour Demo/Info Line
 (770) 482-2485 • Ext 49
 LT Sound Dept PE-1 7980 LT Parkway, Lithonia, GA 30058
 Internet www.LTSound.com
 Better Than Karaoke For Over 25 Years!

Do You Repair Electronics?

Repair Databases for TV, VCR, Monitor, UL Audio, FCC, and more.

- Over 76,000 records
- Private user forums
- Live on-line chat rooms

RepairWorld.com

Electronix Corp-1 Herold Sq, Fairport, OH 43324 (937) 878-9878

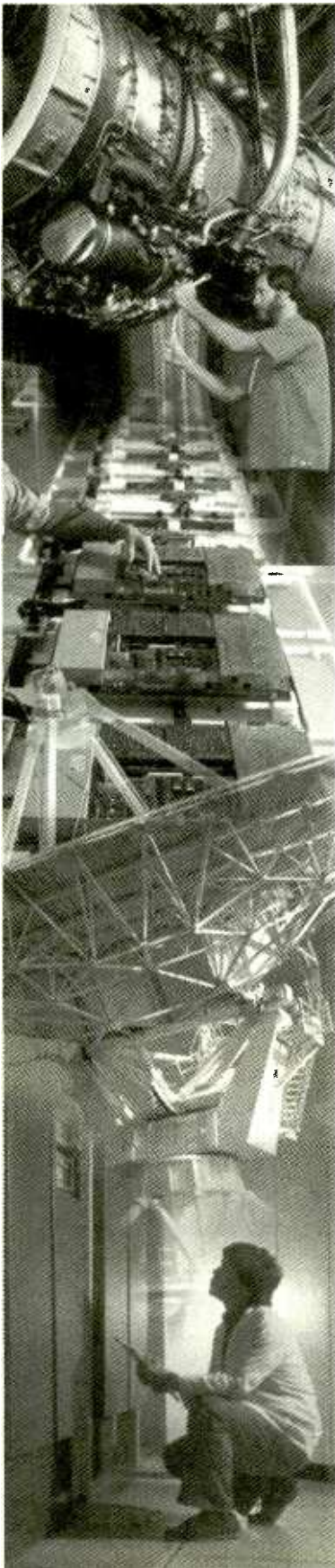

Electronics & Computer Training

**FREE
Course
Catalog!**

Cleveland Institute of Electronics

No matter what your career goals may be, most employers still insist on an educational background. Cleveland Institute of Electronics (CIE) offers educational training in Electronics and Computer Technology that lead to Diplomas and Degrees.

Even if you have no experience in the high-tech workplace, CIE can give you the hands-on education you need to maximize your career potential. Experience a step-by-step program designed specifically for the independent study student.

Our patented teaching method allows you to complete each lesson at your own pace so you can *study at times that are most convenient for you!*

A Wide Range of Electronics & Computer Training Available!

You'll find many different CIE Career Courses ranging from our **Computer Programming** course to our **Electronics Technology with Laboratory** course to our most advanced program, CIE's **Associate in Applied Science in Electronics Engineering Technology**.

Every program includes all the tools, lab equipment and instructor support necessary to compete in the 21st century job market.

After successful completion of a Career Course, you'll receive a diploma. Continue in your studies and you can earn an Associate in Applied Science in Electronics Engineering Technology.

There are many other courses to choose from so you can get the exact job-training course that's right for you!

Build on what you already know!

You may be eligible to apply for advanced standing in CIE's A.A.S. Degree Program based on your previous military training or academic history.

Send for a FREE Course Catalog Today!

Fill out the form on this page or call CIE toll-free at (800) 243-6446 or visit us at www.cie-wc.edu and we'll send you a complete information package with our course catalog & tuition prices.



CIE 1776 E. 17th
Cleveland, OH 44114

Name _____

Address _____

Apt _____

City _____

State _____

Zip _____

Phone _____

e-mail _____

Check box for G.I. Bill Details:

Active Duty Veteran

PT30

Call 1-800-243-6446 for a FREE catalog or visit www.cie-wc.edu today!

Start A Career With High Wages, Excellent Benefits and Job Security!!

With UCANDO's extraordinary maintenance training programs you can quickly and easily enter a high paying field as a maintenance technician for a very small investment of time and money.



RC-M ONLY \$165 RC-M is a 15 hour training course on relay ladder logic systems. Includes a 5-part video and workbook. Great Value!

PLC-M ONLY \$198 PLC-M is a 32 hour training course on PLC systems. Includes (2) 4-part video's and workbook. This training is valuable.



HYD-M ONLY \$209 HYD-M is a 32 hour course on Fluid Dynamics. Includes (2) 4-part video's and workbook. This Module is a must.

SC-M ONLY \$215 SC-M is a 32 hour training course on AC & DC Servo Controllers. Includes (2) 4-part video's and workbook. Learn everything you need about AC and DC servo Control Systems.

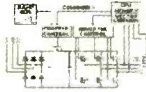

Electronic Training Videos: Basic Electronics, Digital Electronics, TV Repair, LASER and Fiber Optic training videos available at very affordable prices starting at **Only \$35.00** each.

For information or to place an order call:

1-800-678-6113

www.ucando-corp.com

UCANDO VCR Educational Products Corp., Greenville, OH

Your own circuit boards from design through order are as easy as **PCB123**

✓ Download the **FREE** software.

✓ Design the circuit Board you want.

✓ Get real-time pricing as you design.

We'll produce your small quantity circuit board order at an unbelievably low price, and we'll have it back to you in no time.

* Easy
* Fast
* Inexpensive

PCB123TM

Visit us online today at www.pcb123.com—we make doing what you want as easy as 1,2,3.

Providing the complete circuit board solution, design through order.

The BEST is now Better!

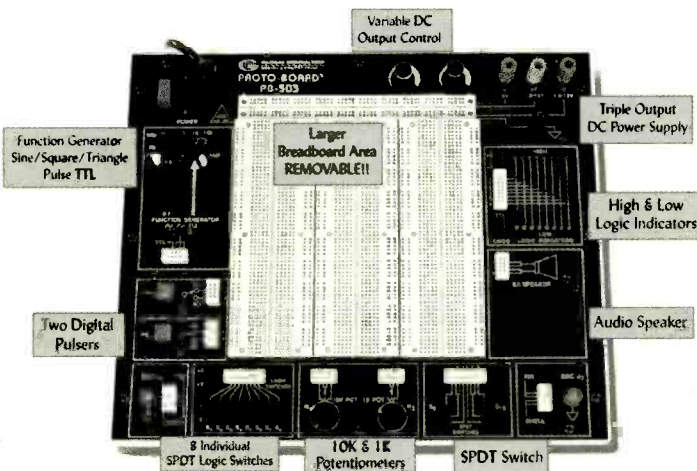

Feature-rich Circuit Design Workstation Ultra-affordable at just \$299.95 Portable Version Available for \$349.95

Our classic PB-503 the complete Proto-Board Design Workstation is newly improved. Enhancements include: an 8-Channel Logic Monitor, High & Low Buffered Logic Indicators, 8 Selectable Logic Switches, and Removable Breadboard Socket Plate. This velcro-backed socket plate allows for greater circuit design flexibility; order extra to suit your needs.

Traditional instrumentation on the unit includes continuously variable Function Generator, Triple Output DC Power Supply, along with Switches, Digital Pulsers, Potentiometers and an Audio Speaker. The highly functional PB-503 is built to last, with an industry best 3-year warranty along with a lifetime warranty on all breadboard sockets. Own the best! Order yours today.



GLOBAL SPECIALTIES
INSTRUMENTS

1486 Highland Avenue - Unit 2
Cheshire, CT 06410
1.800.572.1028
203.272.4330 FAX
www.globalspecialties.com

RAMSEY

GET THE NEW CATALOG TODAY!

New Kits, New LPFM, New Cameras

www.ramseykits.com



35 WATT LPFM STEREO TRANSMITTER



- ✓ 35W RF output, VSWR protected
- ✓ Automatic audio & power controls
- ✓ Digital synthesized PLL
- ✓ Full front panel control
- ✓ 110/220VAC, 12VDC operation

Whether your application is export or LPFM, the PX1 has you covered. From the over-rated continuous duty power supply & power amplifier to the 2 line vacuum fluorescent display, your station will be the easiest to setup and the most reliable for continuous operation. Full microprocessor controls provide a "virtual engineer". Check out www.highpowerfm for full details.

PX1 35W Professional FM Stereo Transmitter \$1,795.95

ELECTROCARDIOGRAM HEART MONITOR



- ✓ Visible and audible display of your heart rhythm
 - ✓ Re-usable sensors included; just like visiting the hospital!
 - ✓ Bright LED "beat" indicator
 - ✓ Monitor output for oscilloscope display
- Enjoy learning about the inner workings of the heart while covering the stage by stage electronic circuit theory of ECG/EKG systems. Be heart smart and learn at the same time!

ECG1 Electrocardiogram Heart Monitor Kit \$34.95
 CECG Matching Case & Knob Set \$14.95
 AC125 110 VAC Power Adapter \$9.95
 ECGP10 Replacement Reusable Probe Patches (10-Pack) \$7.95

PLASMA GENERATOR



- ✓ Generate 2" sparks to a hand held screwdriver!
 - ✓ Build your own plasma balls!
 - ✓ 25KV at 20 KHz from a solid state source!
- Generate really impressive sparks, build your own plasma ball, light fluorescent tubes without wires! From a solid state source, generate over 25KV at 20KHz for the most dazzling displays!

PG13 Plasma Generator Kit \$59.95
 PS12 14VAC Output Power Supply \$19.95

ION GENERATOR



- ✓ Generates negative ions with a blast of fresh air!
 - ✓ 7.5KV DC negative, 400uA - that's a lot of ions!
 - ✓ Steady state DC voltage, constant current, not pulsed!
- Learn the basics of ion repulsion by building this ion generator! Creates a continuous blast of fresh air charged with a ton of ions. Perfect for pollution and air freshening; just smell those ions! Solid state wind generation; you'll be amazed!

IG7 Ion Generator Kit \$59.95
 AC125 110 VAC Power Adapter \$9.95

TOUCH-TONE TONE GRABBER



- ✓ New-built-in RJ11 phone jack
- ✓ Large memory holds over 500 numbers
- ✓ Big bold 8 digit display, auto insertion of dashes
- ✓ New-output latch jack

Dialed phone numbers on the radio, repeater codes, control codes, anywhere touch-tones are used, you can read and store them! All new design for 2002. Capture those tones with the TG2!

TG2 Tone Grabber Tone Reader Kit \$59.95
 CTG2 Matching Case & Knob Set \$14.95
 AC125 110 VAC Power Adapter \$9.95

RCA TO XLR AUDIO CONVERTER



- ✓ Connect consumer outputs to XLR inputs
 - ✓ Left & right audio gain adjustments
- So you're trying to connect consumer audio outputs with RCA connectors (unbalanced) to XLR (balanced) inputs. Always a problem...Not anymore with the R2XL1!

R2XL1 Unbalanced to Balanced Audio Converter Kit \$49.95
 CR2XL Matching Case & Knob Set \$14.95
 PWR25 12VAC Power Adapter \$9.95

AUTOMATIC COLOR/BW IR CAMERA



- ✓ Color during the day, IR B&W at night!
 - ✓ Automatically turns on IR Illumination!
 - ✓ Waterproof to IP57 standards!
 - ✓ Black anodized housing with universal mount
- Best of both worlds! This video camera is a water-proof COLOR camera during the day. When the light level drops, it automatically changes to B&W and turns on its built-in IR illumination, with 10 IR LEDs. Powered by 12VDC and terminated with a professional BNC connector. B&W only model!

also available if color is not needed. Both in heavy anodized black housing.
 CCD309 Color/B&W IR Waterproof Bullet Camera \$169.95
 CCD308 B&W IR Waterproof Bullet Camera \$109.95
 AC125 110 VAC Power Adapter \$9.95

MINI B&W CAMERA WITH IR ILLUMINATION



- ✓ Built in IR illumination!
 - ✓ Sees in total darkness!
 - ✓ Black aluminum housing with swivel bracket
- What a deal! This miniature B&W video camera has 6 high power IR LEDs built into it to provide illumination in total darkness! No need for external IR illuminators. Attractive black aluminum housing easily mounts at any angle with the built-in swivel bracket. Runs on 12VDC, and includes professional BNC output plug-in harness.

CCD303 Mini B&W IR Illuminated Camera \$59.95
 AC125 110 VAC Power Adapter \$9.95

Check out all our other new cameras at www.ramseykits.com!

PROFESSIONAL FM STEREO RADIO STATION



- ✓ Synthesized 88 to 108 MHz with no drift!
- ✓ Built-in mixer - 2 line inputs and one microphone input!
- ✓ High power module available for export use
- ✓ Low pass filter for great audio response

Our FM100 is used all over the world by serious hobbyists as well as churches, drive-in theaters, and schools. Frequency synthesized PLL assures drift-free operation with simple front panel frequency selection. Built-in audio mixer features LED bargraph meters to make setting audio a breeze. The kit includes metal case, whip antenna and built-in 110 volt AC power supply.

FM100 Super-Pro FM Stereo Radio Station Kit \$249.95
 FM100WT 1 Watt, Wired Export Version \$399.95

SYNTHESIZED FM STEREO TRANSMITTER



- ✓ All new design & features for 2002!
 - ✓ Fully adjustable RF output
- Our #1 kit for years has just gotten better for 2002! Totally redesigned, the FM25B has all the features you've asked for. From variable RF output, F connector RF output jack, line input, loop output, and

more. Includes case, power supply, whip antenna, audio cables.
 FM25B Synthesized FM Stereo Transmitter Kit \$129.95

AND...OUR FAMOUS MINI-KITS



These are easy to build kits that can be used either stand-alone or as building blocks for more complex projects.

TS4	Tickle-Stick Shocker	\$9.95
BN9	Super Snoop Amplifier Kit	\$8.95
BL1	LED Blinky Kit	\$3.95
TD1	Tone Encoder/Decoder Kit	\$6.95
TT7	Touch Tone Decoder Kit	\$19.95
CPO3	Code Practice Oscillator Kit	\$9.95
UT5	Universal Timer Kit	\$8.95



Be an FCC LICENSED ELECTRONIC TECHNICIAN

EARN MORE MONEY

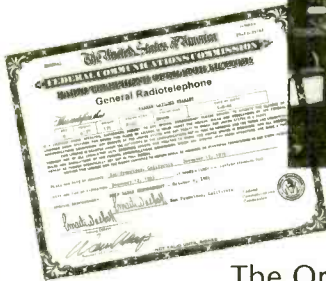

Earn up to \$100 an hour and more!

The Original Home-Study course prepares you for the "FCC Commercial Radiotelephone License" at home in your spare time. This valuable license is your professional "ticket" to thousands of exciting jobs in:

- Communications
- Radio-TV
- Microwave
- Maritime
- Radar
- Avionics & more

You can even start your own business!

No previous experience needed! No need to quit your job or go to school. This proven course is easy, fast and low cost!

GUARANTEED TO PASS – You get your FCC License or your money refunded.

Send for **FREE** facts now!

Mail coupon today or call

(800) 932-4268 Ext. 240

www.LicenseTraining.com

COMMAND PRODUCTIONS

FCC LICENSE TRAINING - DEPT. 240
P.O. Box 2824 • San Francisco, CA 94126
Please rush **FREE** details immediately!

Name _____

Address _____

City _____ State _____ Zip _____

CIRCLE 321 ON FREE INFORMATION CARD

1280x960 Digital Camera

High-Resolution Camera for Under \$70

Capture 24-bit true color images at resolutions up to 1280 x 960 with this lightweight point-and-click camera. The 4MB removable SmartMedia Flash memory stores up to 30 images. Includes built-in flash with red-eye reduction, 10-sec. self-timer and auto-shutoff. Create professional-looking artwork with the MGI PhotoSuite software bundle.

Software included!

\$64⁹⁹

JDR part #: PT-IMAGE500

Computer Microscope

Capture Still Images or Motion Video

Turn everyday objects into a fun learning experience! Connect to your PC via the USB interface and view specimens at 10X, 60X and 200X magnification. Capture single images, make movies and perform time-lapse photography. Save captured images as JPEG, BMP or AVI files. Add morphing and audio special effects with the bundled software.

Small images to your friends!

\$68⁹⁹

JDR part #: PT-MSCOPE

\$21⁹⁹ HIGH SPEED!

Upgrade to USB 2.0

40X Faster Than USB 1.1!

This PCI card has two external USB 2.0 ports for connecting your portable digital devices. Hot-Plug/Hot Swap technology allows you to attach PC peripherals with ease. USB 2.0 delivers a massive 480Mbps transfer rate. Backwards compatibility with USB 1.1 allows you to use existing cables.

JDR part #: PT-MCTUSB2

Universal Flash Card Reader

USB Interface for Easy Connectivity

This USB 5-in-1 Flash card reader/writer dramatically increases the file transfer speed of digital data to your desktop or notebook PC. Conveniently download data directly from SmartMedia, CompactFlash, MultiMedia, MicroDisk and Secure Digital media. Also writes data, such as downloaded MP3 files, onto Flash cards to play in a portable MP3 player.

JDR part #: PT-CRMULTIU

5-IN-1 DRIVE!

\$39⁹⁹

Hard Drive Bargains

IDE Drives from Major Manufacturers!

Now is the time to increase your PC's storage capacity while the prices are low. These reliable IDE drives feature Ultra DMA/100 transfer rates and 5,400 RPM spindle speeds. Order today!

JDR part #: PT-HDD10 \$64.99

JDR part #: PT-HDD20 \$69.99

JDR part #: PT-HDD40 \$74.99

JDR part #: PT-HDD60 \$89.99



GREAT DEALS!

FROM **\$64⁹⁹**

30-Day Money-Back Guarantee 2-Year JDR Warranty Since 1979

JDR COMPUTER PRODUCTS

Call today for your **FREE** Catalog!
800-538-5000
www.jdrmicro.com

(©) 2002, JDR Computer Products. JDR Computer Products and the JDR logo are trademarks of JDR Microdevices, Inc. Prices do not include shipping charges or sales tax. Please call or visit our website to confirm charges. Prices are subject to change without notice and merchandise is subject to prior sale. Items pictures may only be representative. A complete copy of our terms and conditions of sale is available upon request.

SERIAL LCDs

Serial LCDs work great with BASIC Stamps® and other microcontrollers. One-wire interface • simple serial protocol • low cost • high quality • in stock



BPI-216N

- 2x16 text LCD
- 2400/9600 bps
- \$45 (non-backlit)

- SGX-120L**
- Mini graphics LCD
- 2400/9600 bps
- just \$99



Many other models available—see www.seetron.com!

Scott Edwards Electronics, Inc.
www.seetron.com • 520-459-4802

VISION ELECTRONICS

Before After

★ 1 Year Warranty
★ Money Back Guarantee
★ No Rolls/Jitters/Flickers/Fading

Buy 1 Unit, Get the 2nd for 1/2 Price

COPY RENTAL TAPES WITH OUR VIDEO STABILIZERS

1-800-562-2252

2609 S. 156th Circle • Omaha, NE 68130
<http://www.modernelectronics.com>

MasterCard, VISA, AMERICAN EXPRESS

ORDERS: WWW.CONTEC.NET

\$333 COMPLETE KIT

GALEP 4 UNIVERSAL PROGRAMMER

Introducing a pocket programmer with true Universal Output

Latest generation pocket sized programmer uses ASIC universal pin driver technology. 1300+ device library, with lifetime free updates. Programs 8/16-bit EPROM'S, EEPROM'S, 0-Power RAM, FLASH, Serial EEPROM'S, GAL, PALCE, microcontrollers such as 87/89xxx, PIC, AVR, ST62, etc. Low voltage devices down to 1.3V. No adapter required for DIL devices. 8 Hrs. operation on battery (AC charger included). Runs WIN 98, NT, ME, 2000, XP with Hex/Fuse Editor. Remote control from other apps, (e.g. VisualBasic. Substitutes higher priced universal programmers e.g. ALL-11 (HIL0) or LAB-TOOL48 (ADVANTECH) Providing virtually matching performance at only 1/3-1/5 the price. Info. / Orders, call: 619-702-4420

CONTEC DATASYSTEMS - 1951 4TH AVE., SUITE 301 - SAN DIEGO, CA 92101 - TEL: 619-702-4420 FAX: 619-702-4419

Poptronics®

Interactive Edition

Projects...Courses...Articles...& more

Read it on the WEB!

- An e-magazine for everyone who loves electronics.
- Aimed at teaching electronics from the beginning with courses, tests and interactive questions to guarantee your success.
- Interesting articles and related items.
- Contains projects that can be ordered directly from the page, by simply clicking a button.

www.poptronics.com/interactive

BP 484—\$12.99

Easy PC troubleshooting

If you have some knowledge of PCs and take a logical approach, then with the help of this book, many faults can be identified and then rectified quickly and easily. This book shows you how to: test various parts of the system, diagnose a wide range of faults, check cables and connections, deal with the BIOS, and more.

Please circle the products you would like to buy in the ad above, calculate the total cost, include shipping charges, (NYS residents add sales tax) using the table below and send it to: **Electronic Technology Today, Inc., PO Box 240, Massapequa Park, NY 11762-0240.** Please allow 4 - 6 weeks for standard delivery. Sorry, NO orders accepted outside the US and Canada. All payments must be payable through US funds. Pay by Check, MasterCard, Visa, or Discover. The shipping address and the credit card billing address must be the same.

SHIPPING CHARGES IN USA. (ADD \$5.00 IN CANADA)

\$0.01 to \$5.00	\$.20	\$20.01 to \$30.00	\$5.00
\$5.01 to \$10.00	\$.30	\$30.01 to \$40.00	\$6.00
\$10.01 to \$20.00	\$.40	\$40.01 to \$50.00	\$7.00
\$50.01 and above	\$8.50	

ET16

ALL ELECTRONICS CORPORATION

SHOP OUR ONLINE STORE
www.allelectronics.com

30 Watt Stereo Amplifier

The Powerbite personal stereo amplifier provides 30 Watts (15 x 2) of audio power to boost the output of your computer, portable CD player, portable TV or video game. Provides a clean, full sound that can be played through bookshelf or larger speakers. This ergonomically designed desktop amplifier has a trackball-like volume control, tone control and LED power indicators. Includes hook-up cable (3.5 stereo to RCA plugs) and power supply. Attractive retail packaging. Speakers not included.

CAT # AMP-30 \$19.00 each
12 for \$15.00 each

20 X 1 Large Character LCD

Samsung # UC-20102-GNARS
Large 5 x 7 dot characters, 0.46" H x 0.26" W. Blue characters on gray background. 6.1" x 0.64" viewing area. 7.38" x 1.32" module size. Includes hook-up sheet.

CAT # LCD-76 \$6.50 each

25 WATT POWER SUPPLY

Autec # UPS25-1002T
Input: 115v/1.5A or 230V/0.75A
Output: 5V @ 1.9A, 12V @ 1.6A.
25 Watt switching supply mounted on an L-bracket, 9" x 2.27" x 2.25" overall. Standard three prong IEC socket power input. On-Off rocker switch. Molex-type connector output. UL, CSA recognized.

CAT# PS-251 \$4.25 each
10 for \$3.50 each

ORDER TOLL FREE 1-800-826-5432
CHARGE ORDERS to Visa, Mastercard, American Express or Discover

TERMS: NO MINIMUM ORDER. Shipping and handling for the 48 continental U.S.A. \$6.00 per order. All orders including AK, HI, PR or Canada must pay full shipping. All orders delivered in CALIFORNIA must include local state sales tax. Quantities Limited. NO COD. Prices subject to change without notice.

CALL, WRITE FAX or E-MAIL for our FREE 96 Page CATALOG
Outside the U.S.A. send \$3.00 postage.

MAIL ORDERS TO:
ALL ELECTRONICS CORPORATION
P.O. Box 567
Van Nuys, CA 91408
FAX (818)781-2653
e-mail allcorp@allcorp.com

Electronic CAD for Prototypes

If you prototype electronics, *you should be using Ivex Complete*: The Rapid Electronic Development (RED) tools that give you the power to design prototypes faster, resolve errors smarter and transition to professional boards better.

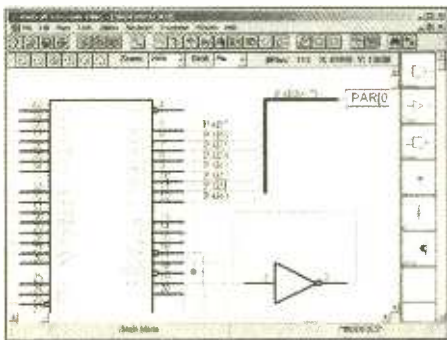

WinDraft[®] delivers the best combination of ease of use and performance in a full-featured tool for schematic design whether your project fits on one page or requires a multi-level hierarchy. It includes a complete library of parts that can be easily modified to update the design. Accomplish more with built-in tools such as Electrical Rules Checker, Bill of Materials and Spice netlist generation. Use WinDraft and see why people all over the world start and finish electronic projects with the industry's most affordable tool for schematic design.

WinBoard[®] is the professional tool that includes everything you need to layout a printed circuit board. Load your design from WinDraft Schematics and you are ready to start. Place the part footprints and start routing the board. Great for surface-mount and custom RF designs. Create your own footprints including complex pad shapes. Manufacturing outputs include Gerber photo-plots, NC Drill report and more.

Ivex Complete

Schematics
Simulation
PCB Layout
Gerber Viewer

Starting at just
\$350
USD

Order Today!

503-531-3555 sales@ivex.com

<http://www.ivex.com>

Ivex Spice offers true and accurate analog simulation. It uses proven Berkeley and XSpice technology that allows you to test on-screen what could take hours or days on a breadboard. Circuit changes can be tested using several types of analyses and Ivex Spice displays on-screen waveforms that allow you to find flaws earlier in the design process.

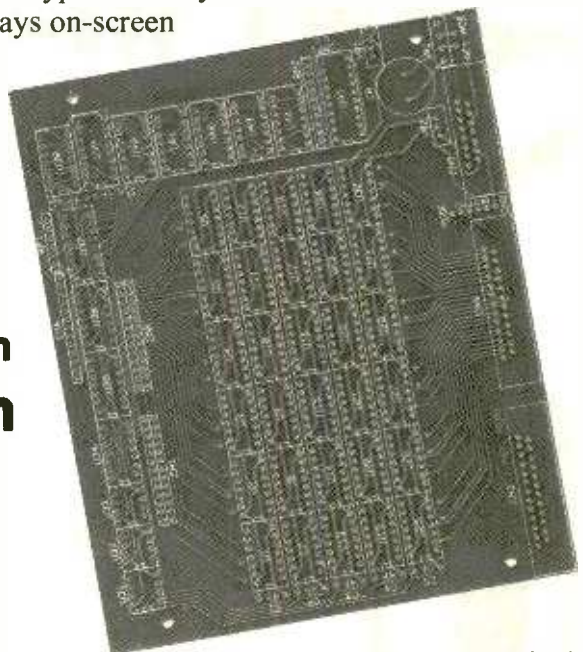

**Ivex Design
International, Inc.**
PO Box 7156
Beaverton, OR 97007

adv9_1

STAMP DRIVE!!

Read / Write PC compatible hard disk, PCMCIA, & Compact Flash. RS232 to ATA drive adapter for Stamp, 8051, AVR, PIC, Z80, x86 ANY controller, big or small:

- up to 4 gigabyte capacity
- low power operation 5v 2ma
- simple software commands
- baud rates up to 115.2kbps
- \$14 IDE & \$21 ISA/104 versions

oem(1k)

\$27

eval kit(1)

\$95

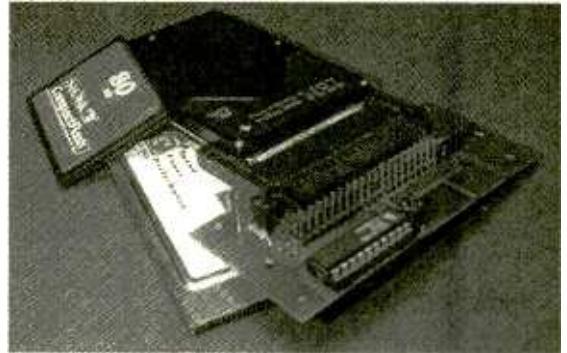

CREDIT CARD COMPUTER 2



New PLUG-N-GO, no cables/power supply to buy! Lo-power RISC cpu 10x faster than PIC, Z80, 8051 4meg NV mem, ser, par, RTC, 4ch 12bit ADC, ISA bus Built-in BASIC, Assembly, C compiler included Friendly instruction set, unlike PIC or 8051 CCC2 eval(1)\$75/oem(1k)\$21 CCC1 \$50/\$14

PC WATCHDOG CARD

No More Hangups!

Reboots PC on hardware/software hang 3 versions: RESET, TIMER, PHONE reset version oem \$21.30, eval kit \$75



LO COST MINI-PC



Includes DOS, NV mem, ADC, RAM, clock, ISA bus Ports for serial, parallel, LCD, keyboard Program in Turbo C, BASIC, MASM, etc. Complete, no costly development kits required Lowest power lowest cost PC compatible available NT: oem \$27 eval \$95 AT: oem \$55 eval \$195

PC SOLID STATE DISK



Replace mechanical drives with faster, more reliable, more secure solid-state. Use FLASH, NVRAM, UV EPROM. Both DIP and PCMCIA versions from 32Kbyte (PCM1) to 1Gigabyte (PCD2) starting at \$14.20oem(1k) \$50.00eval(1)

640x480 VGA LCD \$27

Controller for most single/dual scan LCDs Works with lo-res (160x120, 320x240, etc.) Use with PC or SBC, standard VGA BIOS Source code demo shows VGA initialization Adaptable for other CPUs (i.e. Z80, HC11) oem(1k) \$27 evalkit(1) \$95 w/10" LCD \$195

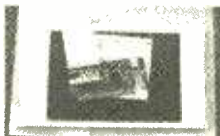

SINGLE CHIP COMPUTER \$7

eval kit oem(1k) \$1.99

- ZERO external components
- Built-in BASIC / Assembly
- RS232 program download
- 1K flash, 64ee, 3irq, 2timers
- 15 I/O bits, A/D comparator
- 20mips, faster than pic/8051
- 20 pin DIP part #MV1200



NEW! 8K SUPER CHIP

40x the BASIC program space! -32 i/o, 12 irq, 3 timers, Bus -8K flash, 512ee, 512x ram -Watchdog with internal osc. -40 pin DIP part #MV8515 oem(1k) \$7.10 eval(1) \$25.00

DUMB

and

DUMBER!

RS232 "DUMB" TERMINAL



Power from serial line or 5v Works with PC, Z80, AVR, etc. LED backlit, always visible 9600-115.2kbaud with DB9 20 custom or 16 tactile keys eval kit (1) \$75, oem(1k) \$21

Get smarter with Single Chip or Credit Card Computer! (20% discount with terminal)

eval kit(1) \$44, oem(1k):

\$12.50



NEW! Lowest cost LCD/keypad combo, less than competitive serial displays alone! 18 keys, green LED lite, cables, super low power. Use with PC, PIC, AVR, Z80, HC11, etc.. Comes with C, BASIC, assembler source examples. (order part# ETRM1) What a dumb idea!

WWW.STAR.NET/PEOPLE/~MVS
MVS Box 803
Nashua, NH 03060
(508) 792 9507

.MVS

3yr Limited Warranty
Free Shipping
Mon-Fri 10-6 EST

SERVING THE EMBEDDED
COMMUNITY SINCE 1979!

CIRCLE 326 ON FREE INFORMATION CARD



ACTIVE

ELECTRONIC
COMPONENTS
DEPOT

www.activestores.com

**YOUR LOCAL ONE STOP SHOP FOR
ALL YOUR ELECTRONIC NEEDS!**



Over 150,000 parts in stock!

We have the best names at the best prices for all your electronic projects!

- Electronic Components
 - Test & Measure Equipment
 - Chemicals
 - Wire & Cable
 - Soldering Supplies
 - Hand Tools
 - Books & Kits
 - Datacom
 - Prototyping
 - Static Control
- and much more!

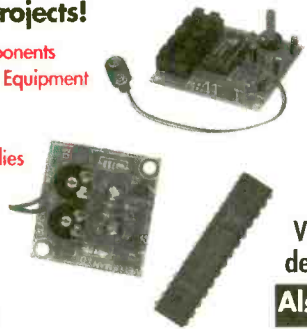

Visit Active today!

BALTIMORE	MARYLAND
CAMBRIDGE	MASSACHUSETTS
CHERRY HILL	NEW JERSEY
CHICAGO	ILLINOIS
DETROIT	MICHIGAN
LONG ISLAND	NEW YORK
SEATTLE	WASHINGTON
WOBURN	MASSACHUSETTS

Visit www.activestores.com for details on the store nearest you
Also 10 Locations in Canada



CIRCLE 205 ON FREE INFORMATION CARD

Join our **ACTIVEplus Rewards Program** today!

It's the free and easy way to earn points on every in-store purchase and **save big!***

*See us in store or online for more details

ACTIVEplus

REWARDS PROGRAM

Sign up today and get

100 BONUS POINTS

New memberships only. Points awarded on in-store purchases only.

Turn Your Multimedia PC into a Powerful Real-Time Audio Spectrum Analyzer

Features

- 20 KHz real-time bandwidth
- Fast 32 bit executable
- Dual channel analysis
- High Resolution FFT
- Octave Analysis
- THD, THD+N, SNR measurements
- Signal Generation
- Triggering, Decimation
- Transfer Functions, Coherence
- Time Series, Spectrum Phase, and 3-D Surface plots
- Real-Time Recording and Post-Processing modes

Applications

- Distortion Analysis
- Frequency Response Testing
- Vibration Measurements
- Acoustic Research

System Requirements

- 486 CPU or greater
- 8 MB RAM minimum
- Win. 95, NT, or Win. 3.1 + Win.32s
- Mouse and Math coprocessor
- 16 bit sound card

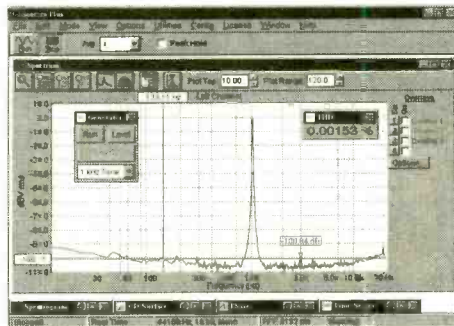

Priced from \$299

(U.S. sales only – not for export/resale)

DOWNLOAD FREE 30 DAY TRIAL!

www.spectraplus.com

PHS Pioneer Hill Software
24460 Mason Rd.
Poulsbo, WA 98370
a subsidiary of Sound Technology, Inc.

Sales: (360) 697-3472



Spectra Plus

FFT Spectral Analysis System

Fax: (360) 697-7717

e-mail: pioneer@telebyte.com

MECI 340 East First Street
Dayton, Ohio 45402
Your Electronics Value Company

Tons of Electronics

Get your FREE catalog today and discover some of the best deals in electronics. We have thousands of items ranging from unique hard-to-find parts to standard production components. Call, write or fax today to start your subscription to one of the most unique catalogs in the industry, filled with super values on surplus electronic and hobbyist type items.



Check out our 10,000 item on-line catalog <http://www.meci.com>

Order Toll Free
1-800-344-4465

Why pay more?
Call today!
Fax Order Line
1-800-344-6324

CIRCLE 323 ON FREE INFORMATION CARD

\$62 PCBs

And our layout software is **FREE!**

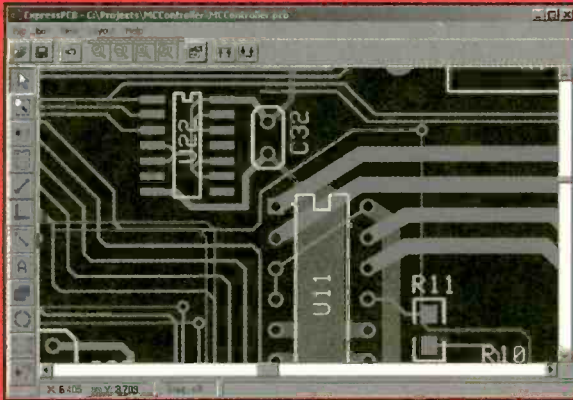

Download our **FREE** layout software
 Design your two-sided plated-through PCB
 Send us your design with just a click
 Receive your boards in a few business days

Select our MiniBoard service and get three top quality
 2.5" x 3.8" PCBs for \$62 – shipping included!

VISA **expresspcb.com** **MasterCard**

RF Modules

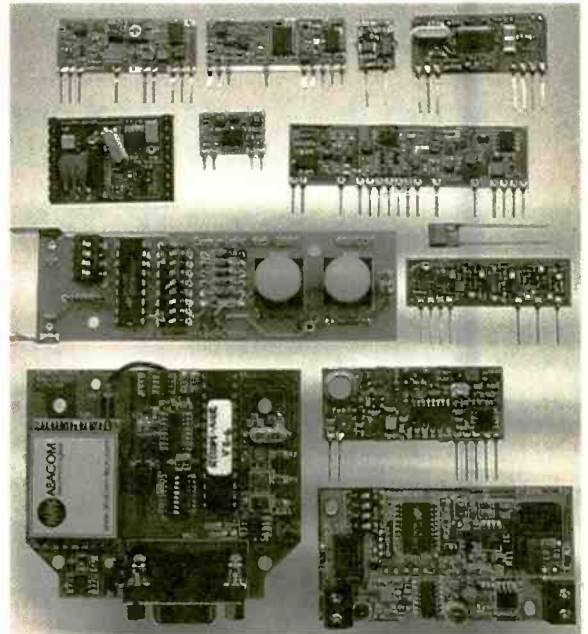

www.abacom-tech.com



Tel: +1(416)236 3858
 Fax: +1(416)236 8866
abacom@abacom-tech.com

ELECTRONIX EXPRESS

Visit Our Website At
<http://www.elexp.com>

SOLDER / DE-SOLDER STATION

MODEL XY988ESD
 No external air needed, ESD safe, lots of
 free accessories, electronic temp control



\$390⁰⁰

INSTEK[®]
OSCILLOSCOPE
MODEL GOS-620
 Dual Channel – 20MHZ
 (INCLUDES PROBES)



\$299⁰⁰

RSR 3MHZ SWEEP FUNCTION GENERATORS

6 Waveform Functions, In/Ext
 Counter, lin/log sweep



MODEL FG-30
 (No Digital Display)
\$120⁰⁰

MODEL FG-32
 (5 Digit Display)
\$185⁰⁰

SCOPE PROBE 60 MHZ
 SWITCHABLE X1, X10

\$12⁹⁵

DIGITAL MULTIMETER

32 Ranges – 3 1/2 Digit



MODEL MY-64

\$27⁹⁵

AC/DC Volt/Current, Res. Cap.,
 Frequency. Rubber Holster Included

ALLIGATOR LEADS

SET OF 10



\$2¹⁰

SWITCHES

Mini Toggle SPDT.. 50¢ ea.



SOLDERING IRON 3-WIRE

HIGH PERFORMANCE



#060501 **\$5²⁵**

BENCH DMM

WITH RS232 INTERFACE
MODEL DM9803R



True RMS, digital and bar graph
 display, AC/DC Cap, Res,
 frequency functions. Includes
 software, AC or DC operation.

\$99⁰⁰

ULTRA-MICRO

COLOR CAMERA
MODEL 29ECMP02



Low cost, color pinhole lens
 camera. Only 5/8" x 5/8" x
 5/8". 1.5 lux, 380 lines.

\$49⁰⁰

SOLDERLESS BREADBOARD

830 tie points, MB102PLT model
 features 3 binding posts and alu-
 minium backplate.



Part No.	1-9	10+
MB102	4.50	4.25
MB102PLT	7.50	6.50

PRESS-N-PEEL



PC Board Transfer Film

PNP Blue 5 Sheet	\$9.90
PNP Wet 5 Sheet	9.90
PNP Blue 20 Sheet	28.95
PNP Wet 20 Sheet	28.95

ROTARY

TOOL KIT

29DR101

\$33⁹⁵

Variable speed tool
 (37,000 RPM) with
 accessory kit in a
 hard plastic carry
 case.

PAD-234

DIGITAL/ANALOG TRAINER

Complete
 portable
 workstation.
 Variable and
 fixed power
 supplies, function generator,
 digital I/O, rugged design, high
 impact case.



Assembled **\$150⁰⁰** Kit **\$110⁰⁰**

HIGH QUALITY TOOLS

With Cushion Grips and Return Spring

Needle Nose Pliers **\$2⁹⁵** Wire Stripper **\$1⁵⁰** Diagonal Cutter **\$2⁹⁵**

DC POWER SUPPLIES

MODEL HY3003 – DIGITAL DISPLAY

Variable output, 0-30 VDC, 0-3 Amp



\$88⁰⁰

MODEL HY3003-3 – TRIPLE OUTPUT

Two 0-30 VDC, 0-3 Amp variable outputs
 plus 5V 3A fixed. Digital Display.



\$215⁰⁰

MOTION DETECTOR

\$2 ea. – 10 For \$15



LM555 10 Min.	22¢ ea.
LM741 10 Min.	27¢ ea.
74LS00 10 Min.	18¢ ea.
7805 Regulator 10 Min.	30¢ ea.
2N3904 10 Min.	6¢ ea.
PN2222 10 Min.	6¢ ea.
Red LED T 1 3/4 10 Min.	6¢ ea.
Green LED T 1 3/4 10 Min.	7¢ ea.
Yellow LED T 1 3/4 10 Min.	8¢ ea.
Photo Cell 10 Min.	65¢ ea.
100K Pot., 1" Shaft PC Mt. 10 Min.	15¢ ea.

FREE CATALOG

MORE
 Low-Priced
 Items In Our
FREE

300+ Page Catalog



TERMS: Min. \$20 + shipping. School Purchase Orders, VISA/MC, Money Order, Prepaid. NO PERSONAL CHECKS. NO COD. NJ Residents: Add 6% Sales Tax.

In NJ: 732-381-8020
 FAX: 732-381-1006

365 Blair Road • Avenel, NJ 07001-2293

800-972-2225

<http://www.elexp.com>
 email: electron@elexp.com

CIRCLE 206 ON FREE INFORMATION CARD

FREE
316 PAGE
CATALOG



Dayton Loudspeaker Co. BR-1 2-Way Monitor System Kit

This high end 2-Way Monitor is based on our popular 1-1/8" Silk Dome Tweeter (#275-070) and 6-1/2" Woofer (#295-305). It was designed to provide a low cost, easy to build 2-Way system for the speaker building novice. The end result is a kit that can be built in a couple of hours and that has a sound that will rival systems costing two or three times its modest price! Overall, the system is smooth and detailed, with a wide soundstage that belies their smallish size. The tonal balance is on the warm side of neutral, which is pleasing with most types of music. The bass is also impressive for a system of this size. If you need more bass, we recommend using the #300-630 10" subwoofer to create a matching satellite/subwoofer combination. The cabinets are made of 5/8" MDF finished in an unobtrusive "black ash" vinyl laminate and include grills with black cloth. All driver holes are precision cut with a CNC for a perfect fit. The tweeter is flush mounted to reduce diffraction effects. *Note: This system is offered in kit form and can be assembled in about 2 hours. The crossover needs to be assembled so soldering skills are necessary. We've included a tutorial that thoroughly explains the theory and design process making this kit perfect for educational programs. Each kit includes everything needed to build 1 pair of speakers.*



System Specification: ♦Frequency response: 43-18,000Hz ♦SPL: 85dB 2.83V/1m ♦Power handling: 100 watts max ♦Cabinet dimensions: 14-1/4" H x 8-5/8" W x 11" D ♦Net system weight: 35 lbs.

#300-640

250 Watt Subwoofer Amplifier With Remote Control

This high performance subwoofer amplifier allows you to adjust the volume and crossover frequency from the comfort of your favorite chair!

- Features:** ♦IR Remote Control ♦Remote mountable control panel ♦High power Class AB amplifier ♦Phase switch ♦Gold plated connectors ♦High pass filter for satellite speakers ♦Line Level Outputs ♦Auto On/Off



#300-793 \$148⁶⁵ (1-3) **\$137⁹⁰** (4-UP)

Dayton Loudspeaker Co. 6-1/6" Treated Paper Cone Woofer

- ♦ ASV voice coil
- ♦ Vented pole piece
- ♦ Rubber surround

Specifications: ♦Power handling: 50 watts RMS/75 watts max ♦Voice coil diameter: 1-3/8" ♦Voice coil inductance: 1.40 mH ♦Impedance: 8 ohms ♦DC resistance: 6.0 ohms ♦Frequency response: 33-4,000 Hz ♦Magnet weight: 15 oz. ♦Fs: 33 Hz ♦SPL: 88 dB 1W/1m ♦Vas: 98 cu. ft. ♦Qms: 2.75 ♦Qes: .37 ♦Qts: .33 ♦Xmax: 3.15mm ♦Net weight: 3 lbs.



#295-305 \$16⁸⁵ (1-3) **\$15²⁰** (4-UP)

3-1/4" Piezo Tweeter

- ♦Power handling: 50 watts RMS/75 watts max
- ♦Frequency response: 3,500-27,000 Hz
- ♦SPL: 94 dB



#270-011 \$1.25 (1-3) **95¢** (4-UP)

5" Ultra-Thin TFT-LCD Video Module

Complete color video display makes great personal rear seat TV screens. Works on a standard composite video signal from any VCR, video camera, or navigation system. Features high resolution, speedy response time, no radiation, low power consumption (less than 750mA), and wide view angle.



#205-013 \$128⁷⁷ (1-3) **\$119⁵⁵** (4-UP)

4" LCD Video Module

- ♦ High resolution
- ♦ 4" LCD flat screen color display module
- ♦ Works on a standard composite video signal from any VCR, video camera, video game or navigation system
- ♦ Ideal for mounting in seat backs or custom built enclosures



#205-050 \$99²⁵ (1-3) **\$89⁵⁰** (4-UP)

Speaker Surround Repair Kits

Don't throw away expensive loudspeakers just because the foam surround has dry rotted or has been punctured. With these new repair kits from Parts Express, you can save BIG bucks by repaling the foam surround and avoid costly loudspeaker replacements. Each kit contains supplies to repair two speakers and includes foam surrounds, plastic shims, four dust caps (two paper, two poly), a plastic bottle filled with 1 oz. of adhesive, 5 foam swabs for application of glue, and complete repair instructions.

Part#	Size	Price (1-3)	Price (4-UP)
260-915	6-1/2" Kit	\$19.50	\$17.90
260-920	8" kit	21.90	18.95
260-925	10" kit	22.50	19.50
260-930	12" kit	23.90	20.90
260-935	15" kit	24.50	21.90
340-078	1 oz. bottle of speaker glue	5.95	5.25

6-1/2" Ceiling Speaker System

Don't let the low cost fool you! These great sounding ceiling speakers are ideal for adding music to the kitchen, den, bath, or patio! They feature a weather resistant 6-1/2" carbon fiber cone with a butyl rubber surround and a coaxial mounted 1" mylar dome tweeter. Perfect for high moisture environments. Retrofit design allows installation in both new and existing construction in just minutes. System includes removable steel mesh grills, built-in mounting brackets, hardware, and installation instructions.

Specifications: ♦Impedance: 8 ohms ♦Frequency response: 60-20,000 Hz ♦Power handling capability: 30 watts RMS/45 watts max ♦Sensitivity: 89 dB 1W/1m ♦Overall dimensions: 8-1/2" round x 2-3/4" deep ♦Net weight: 5 lbs. per pair.



#300-402 \$39⁹⁰ (1-3 PRS) **\$35⁵⁰** (4 PRS-UP)

Color Video Camera With Audio

- ♦ Single chip 1/3" format camera
- ♦ 310 TV line resolution
- ♦ Built-in audio
- ♦ Focussable lens
- ♦ Automatic gain control
- ♦ Auto white balance

Specifications: ♦Resolution: 310 TV lines ♦Pick-Up device: 1/3" CMOS ♦Light sensitivity: 10 lux ♦Lens: 4.3mm ♦S/N Ratio: >38dB ♦Power: 8-12VDC, 30mA (9VDC adaptor included).



#335-485 \$89⁹⁰ (1-3) **\$82⁴⁵** (4-UP)

10" Powered Subwoofer

Perfect for small to medium size home theatre or listening rooms.

- ♦ MDF cabinet finished in "Black Ash" vinyl veneer
- ♦ 10" long throw driver
- ♦ 100W amplifier
- ♦ Gold plated inputs
- ♦ Frequency response: 30-160 Hz
- ♦ Exterior dimensions: 13-3/4" W x 16-1/4" H x 14-1/2" D
- ♦ Net weight: 35 lbs.



#300-630 \$99⁸⁰ EACH

DETAILED EASY TO FOLLOW INSTRUCTIONS!



Note: The speaker surround kit sizes are based on the diameter of the speaker's frame, not the diameter of the cone. For example, if your speaker frame measures 10"-10-1/2" in diameter, you would need the 10" Surround Repair Kit.

LARGEST SELECTION OF SPEAKER DRIVERS IN THE COUNTRY!

Visit Us On The Web At
www.partsexpress.com
Or Call Toll Free
1-800-338-0531

725 Pleasant Valley Dr., Springboro, OH 45066-1158 KEY CODE: POM
Phone: 937-743-3000 ♦ FAX: 937-743-1677 ♦ E-Mail: sales@partsexpress.com

AMAZING DEVICES

NVENEVEN102

See and Order from Our "Action" Web Site at www.amazing1.com

Laser Window Bounce Listener

Powerful listening system, yet simple in operation. You shine a laser at a window and intercept the reflected beam with our ultrasensitive filtered optical receiver. Vibrations from the window from internal sounds and voices are now clearly heard. Range can be up to several hundred meters depending on laser power and optics used.

LWB99 Plans for 3 Laser Window Bounce Systems.....\$20.00

LWB6K Kit of 100' visible red for Science Project.....\$129.95

High performance modules require housing and simple alignment to make a field worthy LASER WINDOW BOUNCE unit. Shows test tone circuitry, optics and our lab method of a completed assembly
LWB90 Assembled receiver, 10 mw IR laser, collimator etc. \$449.95

PLASMA FIRE SABERS Kits, Parts and Accessories

Duplicates effect in the motion picture epic of the century!

Specify blue, grn, pur, red or yel.
Moving light appears to evaporate into space
Blades screw into handle for easy replacement

We stock all size and color blades, mauler adapters, tubes digital drivers, and parts for authentic designs. Wireless interactive sound modules change tone with motion

SAB15 Assbled with 15" Blade..\$39.95

SAB24 Assbled with 24" Blade..\$79.95 SAB24K Kit...\$59.95

SAB36 Assbled with 36" Blade..\$149.95 SAB36K Kit...\$129.95

Take Control!! Electronic Hypnosis

Electronic circuitry places subject under your control! Induces ALPHA relaxed mind states.

HYP2 Plans.....\$10.00

HYP2K Kit/Plans.....\$49.95

HYP20 Ready to Use.....\$69.95

MIND2 Plans for Mind Control.....\$15.00

MIND2K Kit/Plans.....\$49.95

MIND20 Ready to Use.....\$79.95

6 Transmitter Kits

- 1 Super Sensitive Ultra Clear 1 Mile+ Voice Transmitter.
- 2 1 Mile+ Telephone Transmitter.
- 3 Line Powered Phone Transmitter Never Needs Batteries!!
- 4 Tracking/Homing Beacon Beeping Transmitter
- 5 Video/Audio Rebroadcast 1 Mi.
- 6 TV/FM Radio Disrupter. Neat Prank! Discretion Required

Includes Hints Using Wireless Devices
COMBOX Above 6 Kits/Plans.....\$59.95
COMBOP Above 6 Plans Only.....\$10.00

4 KV HV MODULE for hovercraft, plasma guns, antigravity, pyrotechnics. 12vdc Input
MINIMAX4.....\$19.95

Pain Field Pistol

Caution! Do not aim at people!

Blast out rodents with high power ultrasonics.

Handheld and battery operated with all controls.

Rental units available.

PPP1 Plans.....\$8.00

PPP1K Kit/Plans.....\$49.95

PPP10 Ready to Use.....\$79.95

Jacob's Ladder

A 1/2" arc expands to over 4" as it travels up the Jacobs Ladder evaporating in space.

- Adjustable arc control
- Uses safe high frequency
- Safety shock shut down
- Full 20" ladder length
- 110/220 vac 150 watts

JACK3K Kit.....\$149.95

JACK30 Ready to Use.....\$249.95

30" Spark Tesla Coil

Create a spectacular display of nature's own lightning. Many amazing experiments possible.

See coil in action on our website!

BTC4 Plans.....\$20.00

BTC4K kit.....\$899.95

BTC40 Ready to use.....\$1199.95

Smaller Version (8-10" Sparks)

BTC3 Plans.....\$15.00 BTC3K Kit.....\$349.95

BTC30 Ready to Use.....\$449.95

MINI TESLA COIL Lights 4' light tubel

MTC1 Plans..\$5.00 MTC1K Kit.....\$19.95

MTC10 Assmbld for 12 volts.....\$34.95

Hover Board

28 pages of data related to the most revolutionary advance in transportation. Cutting edge R&D
HOVER Plans and Data.....\$25.00

Anti Gravity

Float an object using anelectroforca field. With handbook
GRA3 Plans/book.....\$20.00
GRA3K Kit Pwr Sup.....\$99.95
GRA30 Assmbld abve..\$149.95

Information Unlimited PO Box 716 Amherst N.H. U.S.A. 03031 E-mail <info1@wavewizard.com>

1 800 221 1705 Orders/Catalogs Only! Fax 1 603 672 5406 Information 1 603 673 4730 Free Catalog on Request

Pay by MC, VISA, Cash, Check, MO. Add \$5.00 S&H Overseas Contact for Proforma

CIRCLE 220 ON FREE INFORMATION CARD

New and Pre-Owned Test Equipment

New Equipment Specials

B+K Precision 2120B - 30 MHz Oscilloscope

- * FREE Model 117B Multimeter
- * 2 Channel, Dual-Trace
- * 30 MHz Bandwidth
- * TV Triggering
- * (2) Probes Included

Sale Price \$339.00

AVCOM PSA-37D - Spectrum Analyzer

Satellite Downlink - Installation - Maintenance & Service

- Band 1: 10 - 1750 MHz
- Band 2: 3.7 - 4.2 GHz
- Carrying Case Included
- Line or Battery Powered
- Built-in DC Block & Power for LNA/LNB's

Sale Price \$2,395.00

Instek GOS-6103 - 100 MHz Analog Oscilloscope

- 100 MHz Bandwidth
- 2 Channel, High Sensitivity
- TV Trigger - Signal Output
- Cursor Readout
- Time Base Auto-range
- (2) Probes Included
- 2 Year Warranty

Sale Price \$899.00

Leader LF 941 - CATV Signal Level Meter

- TV/CATV Coverage from 46-870 MHz
- Video/Audio Carrier Measurements

Sale Price \$489.00

Wavetek Meterman HD160B Digital Multimeter

- Full Sealing Against Water, Chemicals, & Fluids
- True RMS
- Drop-Proof to 10 feet (3.3m)

Sale Price \$159.00

Pre-Owned Oscilloscope Specials

Tektronix	465	100 MHz	\$499.00
Tektronix	465B	100 MHz	\$649.00
Tektronix	475	200 MHz	\$749.00
Tektronix	475A	250 MHz	\$949.00

- Professionally Refurbished
- Aligned & Calibrated to Original Specifications
- The Industry Standard of Oscilloscopes
- 1 Year Warranty - The Longest Available!!!
- See Website for Complete Specifications

See us on the Web!
www.testequipmentdepot.com

We Buy Surplus Test Equipment

Test Equipment Depot

A-FOTRONIC CORPORATION COMPANY

99 Washington St. Melrose, MA 02176

(781) 665-1400 • FAX (781) 665-0780

(1-800-996-3837)

TOLL FREE 1-800-99-METER

e-mail: sales@testequipmentdepot.com



CIRCLE 322 ON FREE INFORMATION CARD

High Tech Video System with Audio **Only \$119.00!!**
 Complete Package ! Includes Two B/W Cameras with I.R. (night vision) & microphones
 One 5.5" B/W Monitor with Built in Switcher, Two pre-wired 60 ft hook-up cables
 Everything you need to be up & running in minutes with a high tech video system!!



- System Features:**
- *2 wide angle B/W cameras w I.R. & Sound
 - *5.5" B/W video monitor w built in switcher
 - *Two 60 ft. pre-wired cables
 - *View one or both cameras. Switching Time variable from 2 to 20 seconds
 - *Video easily hooks into a VCR

Aluminum Frame & Carrier !
 3 Cooling Fans **Best Choice!** **ONLY \$17.95**
 Front Panel Door LED power indicator & HD activity any qty.
 Keylock & Groundwire
 IDE Ultra DMA 66/100 & Ultra Wide
 SCSI models available



ALUMINUM HARD DRIVE RACKS/3 fans
 AMR2-3F IDE...\$17.95
 AMR2/UWSCSI...
 (UW SCSI).....\$23.95

Triple Output Bench Power Supply



w four 3/12 digit LCD Displays
 Output: 0-30 VDC @ 2 Amps x 2
 & 5V fixed @ 3 Amps x1
 Input: 110VAC +/- 10%
CSI3002D-3...\$169.00
 (qty. 5+.....\$159.00)

Details at www.web-tronics.com
 under Test Equipment

2GHz RF Field Strength Analyzer

- Frequency Range: 100KHz to 2,060MHz
- Narrow Band FM (NFM), Wide Band FM (WBFM), AM and Single Side Band (SSB) Modulated Signals May Be Measured
- PLL Tuning System for Precise Frequency Measurement and Tuning
- LED Backlight LCD (192x192 dots)
- Built-in Frequency Counter
- Hand-Held and Battery Operated
- All Functions are Menu Selected
- RS232C for PC Interface and Printer



#3201

CTRL - D to bookmark this site



- Easy to Navigate
- Includes a Search Engine That Really Works
- New Items Added Constantly

In Business Since 1971

Mini CCDs (B/W & Color)

Sensational NEW Design for Small Observation Cameras. Smaller and Better!

- Ultra Miniature Design
- Black & White Versions Only 25mm x 25mm
- Color Versions Only 32mm x 32mm
- Available in Standard Lens or Pinhole Lens
- All Include Pre-Wired Cable Harness for Video & Power
- 12V Regulated Power Supply Required (120mA typical power consumption)
- 0.1 LUX Rating (B/W), 1 LUX (color)
- CCD Area Image Sensor for Long Camera Life
- Back Light Compensation Circuit
- Built-in Electronic Auto Iris Lens



Detailed Specs on the Web

Intelligent Multi-Function Digital Counter (1.3GHz)
 Ch A: 10 to 100 MHz
 Ch B: 100 MHz to 1.3GHz **\$149.00!**
 Micro-Controller Based Design

An intelligent multi-function counter controlled by an 8-bit micro-controller with eight high bright LED display. Four measuring functions (frequency, period, total mode & self check) Also, a 10MHz OSC OUT feature.



Detailed Specs on the Web

Extensive Details @ web site under TEST EQUIPMENT

Bullet CCD Cameras B&W and Color

- Smart Rugged Metal Housing
- Extremely Low Power Consumption
- 12 Volt
- CCD Area Image Sensor for Long Camera Life
- Built-In Electronic Auto Iris for Auto Light Compensation
- No Blooming, No Burning
- 0.1 Min Lux Illumination (B&W), 1 Lux Min Lux Illumination (color)



LOWER PRICES

VMBLT1020 B&W, 21mm(D)x58.5mm(L) \$49.00 any qty.
 VMBLT1020W B&W Weatherproof, 21mm(D)x58.5mm(L) \$69.00 any qty.
 VMBLT1915W COLOR Weatherproof, 17mm(D)x88mm(L) \$109.00 any qty.

Intelligent DMM w RS-232 **\$44.50!**

3999 Count Display
 Multi-Function Testing with Autoranging & manual operation
 hFE Test, Data Hold, Diode Test, Cont Test
 Backlight, Capacitance, DCV, ACV, DCA, ACA, Resistance, Temperature (#CS1345)
 ships w K-probe, rubber boot, RS-232 cable
 Software & test leads. Details @ web site



DC to AC Power Inverters !

150 watt up to 3000 watt models !

150w modified sine wave: \$29.95(G-12-015B) **Industry Best Pricing!**
 300w modified sine wave: \$39.95(G-12-030)
 150w pure sine wave: \$69.00(G-12-150S)
 300w pure sine wave: \$109.00(G-12-300S)
 800w modified sine wave: \$139.00 (G-12-800)
 1000w modified sine wave: \$179.00(G-12-10C)
 3000w modified sine wave(phase corrected), (G-12-300).....\$489.00
 See Our Website for DETAILED Specs.!



Our Most Sophisticated DMM We Sold Over 700 Last Year!

- with RS-232 Interface & Software, 3-3/4 Digit, 4000 Count, Auto-Ranging with Analog Bargraph
- True RMS Mode
 - 10MHz Frequency Counter
 - Time Mode with Alarm, Clock and Stop Watch
 - Dual Display
 - 10 Location Memory
 - Min, Max, Avg and Relative Mode
 - Decibel Measurement
 - Cap and Ind. Measurement
 - Temperature Mode (C/F)
 - K Type Temperature Probe Included
 - Pulse Signal for Logic & Audible Test
 - Continuity/Diode Test
 - Logic Test
 - Auto Power OFF/Keep ON Mode
 - Fused 20A Input with Warning Beeper
 - Back Light
 - Data Hold/Run Mode
 - Safety Design UL 1244 & VDE-0411
 - Protective Holster
 - Silicon Test Leads
- NOW ONLY \$149**
 Reg. \$169
 More Details on our Web Site
PROTEK 506



Bench Digital Multimeter w RS232C Interface

True RMS/AC voltage & current
 Digital & Analog Display
 3999 Counts & 42 Segment Bar graph
 Autorange & Manual Range
 Data Hold, Min/Max Relative Measurement
 Storage Data Display/Recall
 Back Light
 ADP Measurement: 400mV +/- 3% 10 Digit/1mV DC
 Continuity Test **Only \$99.00!**
 Diode Test any qty.
 RS232C standard interface
 AC or DC power
 Extensive Details @ WEB SITE
 Item# CSI9803R



O'Scope Offer ONLY \$299

30MHz! ONLY \$299!
 Industries Best Price!
 See web for specs

#OSC-1030

- Dual Channel
- Dual Trace
- Vert Trigger
- 1 Year C.S.I. Warranty!

Manufactured for CSI by a leading O.E.M. manufacturer. See our website for detailed specifications!



3000 Series Digital R/O Bench Power Supply **AS LOW AS \$85**

High stability digital read-out bench power supply featuring constant voltage and current outputs. Short-circuit protection and current limiting protection is provided. Highly accurate LED accuracy and stable line regulation make the 3000 series the perfect choice for lab and educational use.

Line Regulation: 2x10⁻⁴ +1ma
 Load Regulation: 1 x 10⁻⁴ +5mv
 LED Accuracy: Voltage ±1% +2 digits
 Current ±1.5% +2 digits
 Wave Line Noise: ≤1mvrms
 Dimensions: 291mm x 158mm x 136mm



CSI3003: 0-30v/0-3amp Digital R/O Bench PS, 1x10⁻⁴+5mv Load Regulation \$89.00 5/\$85.00

CSI 5003: 0-50v/0-3 amp Digital R/O Bench PS, 1x10⁻⁴ +5mv Load Regulation \$109.00 5/\$99.00

See our web-site for many other power supply deals

MODERN ELECTRONICS

Cable TV Descramblers

Buy 1 Descrambler,
Get the 2nd for

COPY RENTAL TAPES WITH OUR VIDEO STABILIZERS

- ➔ 30 DAY FREE TRIAL!
- ➔ FREE PRODUCT CATALOG!
- ➔ BEST DEALER PRICING!
- ➔ 100% MONEY BACK GUARANTEE



1/2 Price



1-800-906-6664

2609 S. 156th Circle • Omaha, NE 68130

<http://www.modernelectronics.com>



EZ-EP DEVICE PROGRAMMER - \$169.95

Check Web!! -- www.m2l.com

Fast - Programs 27C010 in 23 seconds

Portable - Connects to PC Parallel Port

Versatile - Programs 2716-080 plus EE and Flash (28F, 29C) to 32 pins

Inexpensive - Best for less than \$200

- Correct implementation of manufacturer algorithms for fast, reliable programming.
- Easy to use menu based software has binary editor, read, verify, copy, etc. Free updates via bbs or web page.
- Full over current detection on all device power supplies protects against bad chips and reverse insertion.
- Broad support for additional devices using adapters listed below.

Available Adapters

EP-PIC (16C5x, 61, 62x, 71, 84)	\$49.95
EP-PIC64 (62-5, 72-4)	\$39.95
EP-PIC12 (12C50x)	\$39.95
EP-PIC17 (17C4x)	\$49.95
EP-51 (8751 C51)	\$39.95
EP-11E (68HC11 E/A)	\$59.95
EP-11D (68HC711D3)	\$39.95
EP-16 (16bit 40pin EPROMS)	\$49.95
EP-Z8 (Z86E02, 3, 4, 6, 7, 8)	\$39.95
EP-SEE2 (93x 24x, 25x 85x)	\$39.95
EP-750 (87C750, 1, 2)	\$59.95
EP-PEEL (ICT22v10, 18v8)	\$59.95
EP-1051 (89C1051, 2051)	\$39.95
EP-PLCC (PLCC EPROMS)	\$49.95
EP-SOIC (SOIC EPROMS)	\$49.95
Many Other Adapters Available	

EZ-EP
M²L ELECTRONICS
Los Angeles, California



M²L Electronics

970/259-0555 Fax: 970/259-0777
250 CR 218 Durango, CO 81301.
CO orders add 7% sales tax
<http://www.m2l.com>

CONTROL MEASURE INPUT

RELAYS • LIGHTS • MOTORS
TEMPERATURE • PRESSURE • LIGHT LEVELS • HUMIDITY
SWITCH POSITIONS • THERMOSTATS • LIQUID LEVELS

MODEL 30 \$79



- PLUGS INTO PC BUS
- 24 LINES DIGITAL I/O
- 8 CHANNEL 8 BIT A/D IN
- 12 BIT COUNTER
- UP TO 14K BMP/SEC

MODEL 45 \$189



- RS-232 INTERFACE
- 8 DIGITAL I/O
- 8 ANALOG INPUTS
- 2 ANALOG OUTPUTS
- 2 COUNTERS-24 BIT

MODEL 100 \$279



- 12 BIT 106 KHZ A/D
- 4 ANALOG OUTPUTS
- 3 TIMER COUNTERS
- 24 DIGITAL I/O

MODEL 150-02 \$179



- RS-232 INTERFACE
- TRMS, 20 AMPS
- 12 BIT A/D
- OPTO-ISOLATED
- COMPLETE DMM

MODEL 40 \$109



- RS-232 INTERFACE
- 20 LINES DIGITAL I/O
- 8 ANALOG INPUTS
- PWM OUTPUT

MODEL 70 \$239



- RS-232 INTERFACE
- 18 BIT A/D
- 5.5 DIGIT
- UP TO 60 BMP/SEC

Prairie Digital, Inc.

PHONE 608-643-8599 • FAX 608-643-6754

920 SEVENTEENTH STREET • PRAIRIE DU SAC, WISCONSIN 53678

BREAST CANCER BEGINS EVEN SMALLER THAN THIS. THAT'S WHY YOU NEED A YEARLY MAMMOGRAM. ESPECIALLY AS YOU GET OLDER. MAMMOGRAMS CAN DETECT LUMPS TOO SMALL FOR YOU TO FEEL AND EARLY DETECTION MAY SAVE YOUR LIFE, SO CALL 1-800-ACS-2345.

GET A MAMMOGRAM. EARLY DETECTION IS THE BEST PROTECTION.

World's Smallest 68HC11 Microcontroller Modules!

MicroStamp11™

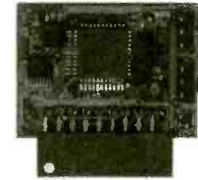

- telemetry
- microrobotics
- smart toys
- animatronics
- model railroading
- home automation

- tiny, light-weight (0.5 oz.)
- 1-inch x 1.4-inch 68HC11 module
- on-board 5V regulator
- 8MHz crystal (9.83MHz on Turbo version)
- choice of 8K or 32K EEPROM
- 32K RAM + 32K EEPROM on 64K version
- plugs into your breadboard like a DIP
- SCI (UART), SPI, Output Compares, Input Captures, hardware timer, pulse accumulator
- all 14 I/O lines and 2 interrupts brought out to versatile 20-pin connector
- program in BASIC, assembler, or C
- easy code-loading with Docking Module
- Starter Packages:
 - 8K EEPROM (#MS11SP8K).....\$49
 - 32K EEPROM (#MS11SP32K).....\$77
 - 32K EE+32K RAM (#MS11SP64K)...\$90

* includes MicroStamp11, manual, PC software (free-ware assembler, SBASIC compiler, MicroLoad utility, and sample programs), serial cable, Docking Module, and accessories.

Attention OEMs:

Embed MicroStamp11 modules into your product! only \$20 each (100-pc. price, 8K version)

MicroCore-11™

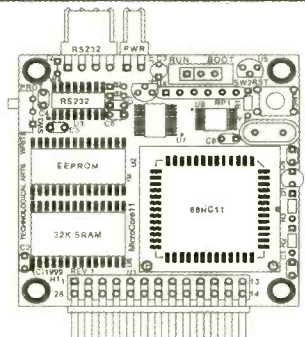

- tiny 2-inch x 2-inch 68HC11 module
- 12 inputs/outputs plus 8 analog inputs
- RS232, 5V regulator, 8MHz crystal
- 32K SRAM plus 8K or 32K EEPROM
- plugs into your breadboard like a DIP
- easy programming from any PC
- ideal for building MicroMouse robots
- now available in Turbo version (9.83MHz)
- 8K Starter Package #MC11SP8K.....\$68
- 32K Starter Package #MC11SP32K.....\$93
- Motor driver boards, LCD/keypad/keyboard interface & prototyping cards available

Technological Arts

Many other modules & accessories available. Visit our website at:
www.technologicalarts.com
sales@technologicalarts.com
TOLL-FREE: 1-877-963-8996

Phone: (416) 963-8996

Fax: (416) 963-9179

Visa • MasterCard • Discover • Amex

FCC Course with Certificate

A Powerful 19 Lesson Self-Study Program on one CD!

FCC Exam Review Course

After completing this course you will be ready to take the FCC examination for a General Radiotelephone Operator License.

The General Radiotelephone Operator License is required to adjust, maintain or repair any FCC licensed radiotelephone transmitters in the aviation, maritime and international fixed public radio services. It is issued for the lifetime of the holder.

Through the years Cleveland Institute of Electronics (CIE) has been able to compile a great amount of information concerning the types of questions that the FCC include in their examinations.

Because of the extensive FCC sample questions in this course, you can look forward with confidence to passing the FCC exam particularly if you heed the hints given throughout the course.



Here's what you'll get!

19 FCC Lessons on CD ROM

Every lesson is presented in a clear and easy-to-understand format which makes learning this material fun and easy. After each lesson you'll take an exam. You can take it on-line or fill out one of the answer sheets we provide and mail it. After you finish the 19 lessons we'll send you a Certificate of Completion from CIE.

CIE Instructor Assistance:

Use our toll-free hot line to access our faculty and staff if you ever need assistance with your course work.

Priority Grading:

Your exams will be graded and sent back to you within 24 hrs.

Certificate of Completion:

Earn a Certificate of Completion that's suitable for framing.

Why is an FCC License so valuable?

An FCC license is an excellent credential for career advancement because it's proof of a certain level of electronics know-how. Because it is a federal examination, the FCC license with its implied knowledge is accepted by industry nationwide.

Lesson Topics Include:

- Modern Modulation Methods
- Receiving Equipment
- Batteries, Control Motors & other Power Sources
- Digital & Data Commun.
- Frequency Modulation
- Transmission Lines & Wave Guides
- Transmitters
- Antennas & Wave Propagation
- Monochrome & Color TV
- Microwave Comm. Systems
- Tuned-Stage Operation
- Suppressed - Carrier Modulation and Single
- Detection & Frequency Conversion
- Lasers in Communications & Industry
- Communications by Fiber Optics
- FCC Review Lessons Pt 1
- FCC Review Lessons Pt 2
- Pointers & Practices for Passing FCC G.C. Exam Pt 1
- Pointers & Practices for Passing FCC G.C. Exam Pt 2

Learn PC Repair



- PC Diagnostic Video
 - 200 + Page Training Manual
 - PC Assembly & Configuration Video
 - Micro-Scope Diagnostic Software (LE)
 - CD-ROM - contains videos and manual
- 02-020 \$99.95

Motor Controls 101



This CD ROM trainer uses pictures, sounds, animations & interactive circuits to teach you the basics of motor control. A Certificate of Completion may be printed on your printer if you achieve a passing score on the included test.

02-050 (not a CIE certificate) \$99.95

More CIE Certificate Courses

- AC/DC Electronics Course with Lab**
03-introb (39 graded lessons w/ cert) .. \$225
- Intro to Web Site Design**
01-M410 (10 graded lessons w/ cert) .. \$245
- Soldering Course with Lab**
01-SD01 (3 graded lessons w/ cert) \$95
- Programmable Controller Course**
01-SD01 (1 graded lesson w/ cert) \$65
- Digital Data Communications with Lab**
01-DD01 (11 graded lessons w/ cert) .. \$245

CIE Bookstore: 1776 E. 17th, Cleveland, OH 44114 • **800 321-2155** • **www.ciebookstore.com**

Shipping & Handling: \$0 - \$30 **\$2.75**, \$30.01 - \$50.00 **\$5.25**, \$50.01 - \$100.00 **\$11.75**, \$100+ **\$15.75** CA, HI & OH residents must add sales tax.

CIRCLE 320 ON FREE INFORMATION CARD

SUPREME SURVEILLANCE

JUST PUBLISHED! The **EXTREME** Covert Catalog details virtually every surveillance system on the World Market today. From the FBI (and their superiors) latest anti-terrorist phone/computer/and video taps, to bargain basement devices no one knows about.

Complete specs and ordering information on hundreds of surveillance and investigative hardware and software products from 14 countries. Many, many new entries for covert audio and video supplies, computer busters, thru-wall viewers, night vision gear, fax interceptors, CIA designed lock defeaters, etc.

"Absolutely fantastic! A Techie's dream come true. No fluff, no filler, just raw spy meat. Whata meal" - Kevin Murray, probably the top counter surveillance expert in the U.S. ECC, 8 1/2" x 11", ISBN 1-880-231-20-4, 437 pages, index, \$49.95

Intelligence Here
404 N. Mt. Shasta Blvd.
Mt. Shasta, CA 96067
Order by Phone: 866-885-8855
www.intelligencehere.com.



Add \$8.00 (priority shipping) CA residents add 8% tax

SMT Prototyping Adapters

Snap-Apart™ Series



SOIC SOT- TSOP D-PAK QSOP QFP
TSSOP TQFP MSOP PLCC and more.

Your design concepts become reality, fast. 5"x7.6" smooth grooved, green PCB's snap apart providing SMT adapters, 100" pin strips included. No pcb layout, no waiting, no adapter hunt for most patterns with these on hand. Details on these and more on website.

BELLY DYNAMIC SYSTEMS, INC.

www.beldynsys.com (714) 630-8024

- Rapid Development Solutions for the Technical Professional -



Theremin

The PAiA Theremin uses the same heterodyne principles as the original turn of the century instrument for classic tone and adds features made possible by modern ICs. Shown with optional lectern case.

9505K Kit
\$89.75

9308K Kit
\$154.00

FatMan Analog MIDI Synth

A complete music synthesizer with all the big bottom and phat sound that makes analog famous. 20 knobs and controls for real-time sound sculpting. Compatible with standard MIDI sources like keyboards or computers. Desktop case or rack panel available.

Check out <http://Paia.com> for schematics, tech details, firmware source files and more...

Synthesizer Modules, Guitar Effects, Mixers, EQs, Tube PreAmps, and dozens of kits for **ELECTRONIC MUSICIANS**

PAiA Electronics info@paia.com
3200 Teakwood Lane 405.340.6300
Edmond, OK 73013 fax 405.340.6378

PCB Production

Double side—12¢ per in²
Four layers—20¢ in²
Six layers—32¢ in²
UL approved
(with solder mask, Silkscreen
Three weeks)

www.mylydia.com

MYLYDIA INC.

Call 1-800-MYLYDIA
E-mail: PCBSales@mylydia.com



...made easy.

www.microCommander.com

Scrambling News

915 NW First Ave., Suite 2902,
Miami FL, 33136, 305-372-9427

Pay TV and Satellite Descrambling 2002 - New! - satellite and cable. Includes the latest information. \$19.95 plus \$1.75 shipping.

Hacking Digital Satellite Systems Video 2002 - New! - This 90 minute video focuses on the satellite television piracy business. \$29.95 plus \$ 3.50 shipping.

Scrambling News Online - Online service for those interested in satellite television news. \$59.95/year.

Pay TV and Satellite Descrambling Series CD-ROM - all 13 volumes over 300 pages, \$59.95 plus \$3.50 shipping.

Best Deal - Everything listed above for only \$99.95 plus \$3.50 shipping.

www.scramblingnews.com

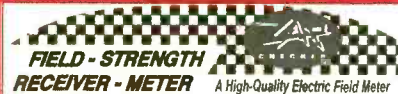

FIELD - STRENGTH RECEIVER - METER

A High-Quality Electric Field Meter
So Sensitive It's Like a Wideband Receiver!



BROADBAND: 10 MHz to 4.5 GHz usable range
HIGHLY SENSITIVE: Detects - Cellular phones and "Bugs" at 20 ft. - 2.4 GHz "sealed" microwave ovens at 40 ft. 2 meter, 440 MHz transceivers. FRS walkie talkies at 80 ft.
DUAL MODE: **LINEAR** - For measuring weakest signals
DETECTION: **LOGARITHMIC** - 1000:1 dynamic signal range
SENSITIVITY CONTROL: > 20 dB manually adjusted gain
80 HR. OPERATION (Approx.): With 2 AA alkaline batteries

ANALOG METER and LED DISPLAYS: The LED display for distance and nighttime
SILENT VIBRATE MODE: Switchable vibrator for signal detection without direct viewing

\$89

(CA. residents add 8% Sales Tax)

(+\$7 S&H)

Alan Broadband Company Phone: (888) 369-9627
93 Arch Street
Redwood City, Ca. 94062 Fax/Phone: (650) 369-9627

www.zapchecker.com

Top Secret Consumertronics

In business 25+ years - established professionals

www.tsc-global.com

Exciting Hi-Tech Survival Books, Manuals, Tapes

Stopping Power/ KW-HR Meters/VHS

Cellphone / Cordless / Pager Manuals

Voice Mail / Answ. Machine Security

Phone Color Boxes/ Caller ID,ANI Sec.

Fax Machine / PBX Security

Computer Sec./Hacker Files/Dirty2Doz

Internet Security / Frauds/Tracking

Beyond van Eck Tempest / VHS

Polygraph Secrets/Identity Theft Manual

Cons & Scams Databook / Placack Rep.

ATM/Credit Card/Check/MO Security

Mind-Control / Under Attack! / EMBB

Radionics Manual / Heal Thyself!

Stealth Tech. / High Voltage Devices

Social Engin./Ultimate Success Manual

Remote Office / Casino Secrets - 100 more!

Catalog: Descriptions, Reg.Prices, Policies

Consumertronics

+\$6 S/H USA P.O. 23097, ABQ, NM 87192

505-321-1034 - Printed Catalog \$3

Press-n-Peel Transfer Film

PC Boards in Minutes

8.5" x 11" Shts.
* Or Photocopy
**Use standard household iron

1. LaserPrint*
2. Press On**
3. Peel Off
4. Etch



Use Standard Copper Clad Board
20 Shts \$30/ 40 Shts \$50/ 100 Shts \$100
Visa/MC/PO/CK/MO \$4 S&H/Foreign Add \$7

Techniks Inc.

P.O. Box 463, Ringoes NJ 08551
ph. 908.788.8249 fax 908.788.8837
www.techniks.com

Visit Our E-Store On-Line!

Lone Star Consulting, Inc.



8900 Viscount, #235
El Paso, TX 79925
915-474-0334

Descriptions, Prices, Policies

www.lonestartek.net

SPECIAL PROJECTS HARDWARE

Unique - Original - Made-to-Order - Special Needs

Electronic - Computer - Phone - Energy - Security - Data Cards
Cars - RF - EM - Audio - Radionics - "Psychic" - Plans - more!
Power Meters Educational Modules ♦ Metal Detectors
Remote Controls ♦ KX Radar Emitter ♦ Audio Assistors
Lineman's Test Sets ♦ Bug/Tap Detectors /Blasters
Shrik Modules ♦ Stealth Paints ♦ Magnetometers
Neurophones ♦ Rifles ♦ Hieronymus ♦ Ultrasonic
Devices ♦ "Aura" Detectors ♦ TENS ♦ Jammers ♦ EMF
"Signature" Detectors ♦ Security Systems ♦ Data Card
Reader/Writers ♦ Unseen Presence Detectors ♦ Super-
Conduct. Detectors ♦ Subliminal Devices ♦ Control
Signal Replicators ♦ Infrared Detectors ♦ Secret
Communicators ♦ Vortex Generators ♦ Levitators
Flash Blasters ♦ much more weird, wild & wacky stuff!

PICmicro MCU Development Tools



EPIC Plus
PICmicro Programmer
\$59.95

Program PICmicro MCUs in BASIC!

DOS or Windows operation (includes Windows IDE software).
PicBasic Compiler - \$99.95
PicBasic Pro Compiler - \$249.95

Experimenter Boards

LAB-X1 for 40-pin MCUs (shown) - \$199.95
LAB-X2 for 28 or 40-pin MCUs - \$69.95
LAB-X3 for 18-pin MCUs - \$119.95



PICPro Prototyping Boards

\$8.95 to \$19.95

High-quality blank prototyping boards
for PICmicro MCUs.

microEngineering Labs, Inc.



www.melabs.com

Phone: (719) 520-5323

Fax: (719) 520-1867

Box 60039, Colorado Springs, CO 80960



PCB Express
www.pcbexpress.com

- No tooling charge!
- Lot charges start at \$80
- Simple order process
- Quickturn, low quantities

TWO SERVICES FOR CIRCUIT BOARDS



INSTANT
ON-LINE QUOTES!
(No sign-up required)

www.pcbpro.com

- Quick Price Comparisons
- More options and added features
- Prototype & production quantities

ADMART

An Introduction to Light in Electronics

An Introduction to Light in Electronics

F.A. WILSON



Taken for granted by us all perhaps, yet this book could not be read without it, light plays such an impressive role in daily life that we may be tempted to consider just how much we understand it. This book makes a good start into this fascinating and enlightening subject. It has been written with the general electronics enthusiast in mind.

To order Book #BP359 send \$6.99 plus \$3.00 for shipping in the U.S. and Canada only to Electronics Technology Today Inc., P.O. Box 240, Massapequa Park, NY 11762-0240. Payment in U.S. funds by U.S. bank check or International Money Order. Please allow 6-8 weeks for delivery.

ETOE

Mobile Robotics

- Sonar
- Vision Systems
- Micro Controllers
- Motor Drivers
- Neural Networks



Zagros Robotics
PO Box 460342
St. Louis, MO 63146-7342
(314) 768-1328
<http://www.zagrosrobotics.com>
info@zagrosrobotics.com

PIC Programmer Kits

Super Value!

\$16.95
+S&H \$4.95*

The P16PRO: can program up to 40 pin PICs including the popular 16F84 & 12C508 • Needs software (extra \$20) • Available assembled or start-

ing from \$16.95 for the kit.
See www.electronics123.com for more info!
The PICALL programmer can also program Atmel AVR's in addition to the PICs it can program • Free software • PICALL programmer kit at \$69.95
See www.electronics123.com for more info!

Video Camera module

Code:BB004

CMOS Camera Module, Black & White, Size: 0.62"x0.63"x0.59"H.
Lens: f4.9, F2.8, EIA 320Hx240V.
0.6" DIL Package, 5 pins. Pin 3 is 1V p-p composite video (75 ohm) to monitor. \$36 + \$5 S&H

Running Lights kit

Add \$6 for 8 tracs to drive light bulbs

8 LEDs with 10 push button selectable patterns.
8 speed levels! 80 combinations! \$16 + \$5 S&H

Toll Free: 1-888-549-3749 (USA & Canada)
Tel: (330) 549-3726. Request a FREE catalog or visit us at: www.electronics123.com for more products.
Amazon Electronics, Box 21 Columbiana OH 44408

QUICK and PAINLESS Programmable Robotics!

Ready for something different?

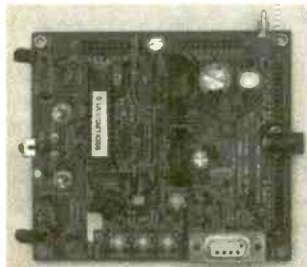

Co-Processor and Controller now
separately available!

Blue Bell Design Inc.
www.bluebelldesign.com

Stepper Motor Book NEW Easy Step'n

- For the experimenter.
- Determine surplus stepper motor specs using simple easy to build test equipment.
- Build microcontroller-based control systems (flow charts and code examples).
- Build stepper motor drive circuits.
- Mechanical design considerations.
- 8.5x11 format. 205 pages. \$34.95

Table of Contents: <http://www.stepperstuff.com>
+ \$5 s/h in US. VISA, MC, AM, DS, MO, Check
CA residents please add 7.25% CA sales tax

SQUARE 1 ELECTRONICS

P.O. Box 501, Kelseyville, CA 95451
Voice (707) 279-8881 Fax (707) 279-8883

<http://www.stepperstuff.com>

spyoutlet.com

Security • Surveillance • Loss Prevention

Purchase your video cameras from
one of the largest importers
in the U.S.

- NEW weatherproof Bullet Cameras
 - Spy Pinhole Cameras • Wireless Video
 - PC Cards • Voice Changer
 - Micro Recorders • Shotgun Mic
 - Locksmithing • Bug Detectors
 - NEW Phone Sentry Plus—defeats telephone tapping and tapping
 - UV Pens & Powder • Realtime 12 hr Telephone Recording System
 - GPS Vehicle Tracking System
- And much more • Quantity discounts

www.spyoutlet.com
Printed Catalog send \$5⁰⁰

SPY OUTLET 2468 NIA. FALLS BLVD
TONAWANDA NY 14150 (716) 695-8660

December 2002, Poptronics

PIC[®] Microcontroller Books

New Titles Same Useful Books



Table of Contents And Ordering Information On Web Site
Not Distributed Via Book Sellers

We accept VISA, MC, AM, DS, MO, Check
CA residents please add 7.25% CA sales tax
See our web sites for s/h rates.

PIC, PICmicro and MPLAB are trademarks of Microchip Technology Inc

SQUARE 1 ELECTRONICS

P.O. Box 501, Kelseyville, CA 95451
Voice (707) 279-8881 Fax (707) 279-8883

We have been selling on the Internet since 1996. We ship
the day we receive your order or the next business day.

<http://www.sq-1.com>

Easy Microcontrol'n - Beginner \$29.95

- Programming Techniques
- Instruction set, addressing modes, bit manipulation, subroutines, loops, lookup tables, interrupts
- Using a text editor, using an assembler, using MPLAB
- Timing and counting (timer 0), interfacing, I/O conversion

Microcontrol'n Apps - Intermediate \$44.95

- Serial communication - PICmicro to peripheral chips
- Serial EEPROMS
- LCD interface and scanning keypads
- D/A and A/D conversion - several methods
- Math routines
- 8-pin PICmicros
- Talking to a PICmicro with a PC using a terminal program
- Test equipment and data logger experiments

Time'n and Count'n - Intermediate \$34.95

- 16-bit timing and counting apps
- Timer 1, timer 2 and the capture/compare/PWM (CCP) module

Serial Communications - Advanced \$49.95

- Synchronous - bit-bang, on-chip UART, RS-232
- Asynchronous - I2C (Philips Semiconductors)
- SPI (Motorola), Microwire (National Semiconductor)
- Dallas Semiconductor 1-Wire bus

Easy Debug'n - Intermediate \$12.95

- Features of PIC16F87x microcontrollers
- In-circuit debugging using Microchip ICD
- Companion for our PIC[®] microcontroller book series



Please give blood.
There's a life to be saved right now.

Call 1-800 GIVE LIFE



American Red Cross

BUY BONDS

CLASSIFIEDS

BUSINESS OPPORTUNITIES

\$400 WEEKLY ASSEMBLING Electronic Circuit Boards/Products From Home. For Free Information Send SASE: Home Assembly-PT Box 216 New Britain, CT 06050-0216

CABLE TV

DISCOVER CABLE'S NEWEST BOXES! "DESCRAMBLES WHERE OTHERS FAIL" **LOWEST DEALER PRICES GUARANTEED. 1-888-777-9123 . . . 1-888-675-3687**
CLEARMAX OR VIEWMASTER UNIVERSAL BOXES from \$78 **1-800-820-9024** OR VISIT OUR WEBSITE AT **WWW.RFTPLUS.NET**

MISC. ELECTRONICS FOR SALE

T&M ELECTRONICS. Large variety of electronic parts since 1966. Visit our Web site at www.tandmelectronics.com

SMC ELECTRONICS - Surplus and refurbished electronic equipment including repair/replacement/experimenter parts and accessories. www.smcelectronics.com

SMART Battery Chargers - GPS Based Frequency Standard - Digital Frequency Synthesizer - surplus parts and more, www.a-engineering.com

SATELLITE

FREE Satellite TV Buyer's Guide. BIG Dishes - BIG Deals! Get the MOST free and subscription channels with C-band digital upgrade! **SKYVISION.** 800-543-3025. International 218-739-5231. www.skyvision.com

EMBEDDED LINUX STARTER KIT

FEATURES INCLUDE:

- Linux 2.4 Kernel
- 486-133MHz SBC
- 10 Base-T Ethernet
- 8MB DOC Flash Disk
- 16MB RAM
- Power Supply
- Carrying Case
- Starting at \$399.00
- X-Windows (option)
- RealTime Linux (option)



Imagine running Embedded Linux on a Single Board Computer (SBC) that is 4.0" x 5.7" and boots Linux from a Flash-Disk. No hard drives, no fans, nothing to break. Now your hardware can be as reliable as Linux! If your application requires video output, the X-Windows upgrade option provides video output for a standard VGA monitor or LCD. Everything is included; Ready to Run Linux!

Since 1985
OVER
17
YEARS OF
SINGLE BOARD
SOLUTIONS

EMAC, inc.

EQUIPMENT MONITOR AND CONTROL

Phone: (618) 529-4525 • Fax: (618) 457-0110 • www.emacinc.com

Thanks to you, all sorts of everyday products are being made from the paper, plastic, metal and glass that you've been recycling. But to keep recycling working to help protect the environment, you need to buy those products.

BUY RECYCLED.



So look for products made from recycled materials, and buy them. It would mean the world to all of us. For a free brochure, write Buy Recycled, Environmental Defense Fund, 257 Park Ave South, New York, NY 10002, or call 1-800-CALL-EDF.



Gernsback Publications, Inc.

275-G Marcus Blvd. Hauppauge NY 11788

POPTRONICS® CLASSIFIED ADVERTISING ORDER FORM

Advertiser Information

Name _____
 Company _____
 Street Address _____
 City/State/Zip _____
 Telephone () _____
 Signature (required on all orders) _____

Payment Information

Charge my:
 Master Card Visa Discover
 Account No. _____
 Exp. Date _____
 Full payment enclosed. Prepayment discounts offered for multiple insertions (except on credit card orders).
 Payment for first insertion enclose; additional payments will be made prior to closing dates. Prepayment discounts not available.

Do you want any special options? (where available)

- Boldface Type* Add 25% for entire ad Screened Background – Add 30%
 Special Heading – Add \$35.00

The first word of your ad and your name will be printed in boldface caps, at no additional charge. For individual boldface words, add .50¢ each.

In what month(s) would you like your ad to run?

- Entire year for publications selected above.
 Jan. Feb. Mar. Apr. May. June July Aug. Sep. Oct. Nov. Dec.

Here's how to calculate the cost of your Regular or Expanded-Ad Classified:

Rate X Numbers of Words + Rate for Boldface + Rate for Screened Background = Cost per Insertion X Number of Months = Cost

Magazine	Rate	x	Number of Words (min. 15)	+ Boldface (add 25%)	+ Screened Background (add 30%)	=	Cost Per Insertion	x	Number of Months	=	Cost
		x		+		+		=		x	

Rates:

\$3.00 per word (New rate for renewals. New advertisers welcome.)

Minimum 15 Words

Here's how to calculate the total cost of your advertising:

Prepayment Discount:

(Full payment must accompany order, not applicable on credit card orders)

Prepay for 6 insertions in one magazine, 5% 12 insertions in one magazine, 10%

Subtotal _____
 Less Prepayment Discount _____
TOTAL COST \$ _____

Please use a separate piece of paper to write your copy, or for any special instructions you may have.

HAVE A QUESTION? CALL: 1-631-592-6720 ext. 206

Fax signed orders with credit card information to : (631) 592-6723

GPI895

ADVERTISING INDEX

Poptronics does not assume any responsibility for errors that may appear in the index below.

Free Information Number	Page	Free Information Number	Page
- Abacom	70	- JDR Computer Products	65
205 Active Electronics	69	150 Linx Technologies	47
- Alan Broadband Co.	76	- Lone Star Consulting	77
- All Electronics	66	- LT Sound	61
- Amazon Electronics	77	- Lynxmotion	61
- Bellin Dynamic Systems	76	- M ² L Electronics	74
- Blue Bell Design, Inc.	77	324 MCM Electronics	CV4
290 C&S Sales, Inc.	CV2	323 Mendelsons	69
283 CadSoft Inc.	13	326 Merrimack Valley	68
233 Circuit Specialists	73	- microEngineering Labs	77
- CLAGGK, Inc.	CV3	- Modern Electronics	74
- Classified Ads	78	325 Mouser Electronics	60
- Classified Order Form	79	- MyLydia, Inc.	76
320 Cleveland Inst. of Electronics ..	62, 75	- North Country Radio	61
321 Command Productions	65	- PAiA Electronics	76
- Conitec Data Systems	66	- PCB 123	63
- Consumertronics	76	- PCB Express	77
140 Dension USA Inc.	43	275 Parts Express	71
- EDE Spy Outlet	77	- Pioneer Hill Software	69
- Electronic Tech. Today	10, 40	228 Polaris Industries	59
- Electronix	61	219 Prairie Digital	74
206 Electronix Express	70	240 Ramsey Electronics	64
- EMAC, Inc.	78	- Scott Edwards Electronics	65
- Engineering Express	70	- Scrambling News	76
- Front Panel Express	47	- Square 1 Electronics	77, 78
- Global Specialties	63	- Techniks	76
220 Information Unlimited	72	- Technological Arts	74
- Intec Automation	76	322 Test Equipment Depot	72
- Intelligence Here	76	- Timeline, Inc.	60
- Intronics	60	- UCANDO Videos	63
- IVEX Design	67	- Vision Electronics	66
		- Zagros Robotics	77

**When you buy products from
these advertisers, please tell
them you saw their ads in
Poptronics® magazine.**

ADVERTISING SALES OFFICES

Gernsback Publications, Inc.
275-G Marcus Blvd.
Hauppauge, NY 11788
Tel. 631-592-6720
Fax: 631-592-6723

Larry Steckler
Publisher (ext. 201)
e-mail: advertising@gernsback.com

Adria Coren
Vice-President (ext. 208)

Ken Coren
Vice-President (ext. 267)

Marie Falcon
Advertising Director (ext. 206)

Adria Coren
Credit Manager (ext. 208)

For Advertising ONLY EAST/SOUTHEAST/PACIFIC

Marie Falcon
275-G Marcus Blvd.
Hauppauge, NY 11788
Tel. 631-592-6720 x206
Fax: 631-592-6723
e-mail: mfalcon@gernsback.com

MIDWEST/Texas/Arkansas/ Oklahoma

Ralph Bergen
One Northfield Plaza, Suite 300
Northfield, IL 60093-1214
Tel. 847-559-0555
Fax: 847-559-0562
e-mail: bergenrj@aol.co

**Subscription/
Customer Service/
Order Entry**
Tel. 800-827-0383
7:30 AM - 8:30 PM CST

Interactive Edition

www.poptronics.com/interactive

www.POPTRONICS.COM

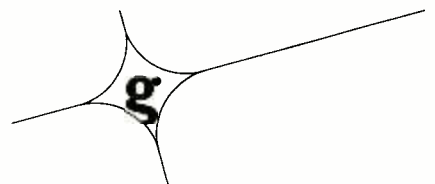

Electronics CD ROMs

PICmicro programming tools and CD ROMs



This great range of CD ROM learning resources will teach you all about electronic circuits and systems and how to design them.

Electronic Circuits and Components V2 provides an introduction to the principles and application of the most common types of electronic components and how they are used to form complete circuits. Sections on the disc include: fundamental electronic theory, active components, passive components, analogue circuits, digital circuits, fault finding and the Parts Gallery.

Digital Electronics V2 details the principles and practice of digital electronics, including logic gates, combinational and sequential logic circuits, clocks, counters, shift registers, fault finding and displays. The CD ROM also provides an introduction to microprocessor based systems.

Analog Electronics is a complete learning resource for this most difficult subject. The CD ROM includes the usual wealth of virtual laboratories as well as an electronic circuit simulator with over 50 pre-designed analog circuits which gives you the ultimate learning tool. The CD provides comprehensive coverage of analog fundamentals, transistor circuit design, op-amps, filters, oscillators, and other analog systems.

Electronic Projects is just that: a series of ten projects for students to build with all support information. The CD is designed to provide a set of projects which will complement students' work on the other 3 CDs in the Electronics Education Series. Each project on the CD is supplied with schematic diagrams, circuit and PCB layout files, component lists and comprehensive circuit explanations.

Robotics and Mechatronics is designed to enable those with little previous experience of electronics to build electromechanical systems. The CD ROM deals with all aspects of robotics from the control systems used, the transducers available, motors/actuators and the circuits to drive them. Full case study material (include the NASA Mars Rover, the Milford spider and the Furby) is used to show students how practical robotic systems are designed.

Digital Works is a highly interactive scalable digital logic simulator designed to allow electronics and computer science students to build complex digital logic circuits incorporating circuit macros, 4000 and 74 series logic.

CADPACK includes software for schematic capture, circuit simulation, and PCB design and is capable of producing industrial quality schematics and circuit board layouts. CADPACK includes unique circuit design and animation/simulation that will help your students understand the basic operation of many circuits.

Analog Filters is a complete course in filter design and synthesis and contains expert systems to assist in designing active and passive filters.

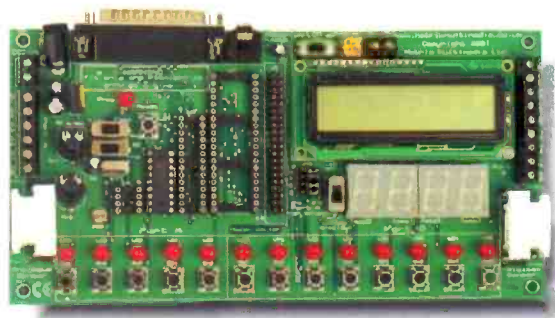

This flexible development board allows you to program 8, 18, 28, 40 pin PICmicro microcontrollers as well as test/develop code. All programming software is included and several resources which allow students to learn and program PICmicro microcontrollers are available - Flowcode, C for PICmicro microcontrollers and Assembly for PICmicro microcontrollers. A board is needed for the CD's below.

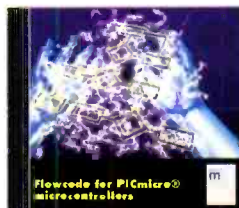

Flowcode is a very high level language programming system for PICmicro® microcontrollers based on flowcharts. Flowcode is a powerful language that uses macros to facilitate the control of complex devices like 7-segment displays, motor controllers, and LCD displays. The use of macros allows students to control highly complex electronic devices without getting bogged down in understanding the programming involved. Board not included.



The **Assembly for PICmicro microcontrollers** CD ROM (previously known as PICtutor) contains a complete course in programming the PIC16F84 microcontroller from Arizona Microchip. The CD includes a full suite of tutorials starting at basic concepts and progressing complex techniques including interrupts. An IDE and all programming tools are included. Board not included.



The **C for PICmicro® microcontrollers** CD ROM is designed for students and professionals who need to learn how to program embedded microcontrollers in C. C for PICmicro MCUs also provides all the tools needed actually program a virtually any PICmicro - including a full C compiler and device programmer (via printer port). Although the course focuses on the use of the PICmicro® series of microcontrollers this CD ROM will provide a relevant background in C programming for any microcontroller. Board not included.

Order Form

Please allow 6 weeks delivery

	Student / home version	Institution version
Electronic Ccts. & Comps 2	\$50	\$99
Digital Electronics 2	\$50	\$99
Analog Electronics	\$50	\$99
Electronic Projects	\$75	\$159
Robotics and Mechatronics	\$50	\$99
Digital Works	\$50	\$99
CADPACK	\$75	\$159
Analog Filters	\$75	\$159
Assembly for PICmicro	\$50	\$159
C for PICmicro	\$50	\$159
Flowcode for PICmicro	\$50	\$99
PICmicro development board	\$159	

Postage - USA \$10 \$10
Postage - Canada \$15 \$15

Name: _____

Address: _____

Zip: _____ Phone: _____

Card Type: _____

Mastercard, Visa, or Discover only

Card number:

I have enclosed my check for \$: _____

Signature: _____

Phone your order to us on:

631-592-6721

or send your order to:

CLAGGK Inc.,
PO Box 12162,
Hauppauge, NY 11788

Expire date: _____

Please charge my credit card for \$: _____

Note Institution versions have increased functionality, increased assessment and are licensed for use in schools and corporations.

CL02

Order online NOW from: www.poptronics.com

MCM

What You Want.....
Today!™

click it
phone it
fax it

You Must Provide
this Source Code to
Receive Special Pricing

POP102

call toll free

1-800-543-4330

fax toll free

1-800-765-6960

customer service call toll free

1-877-626-3532

For more
Electronics
Visit our website

- Audio Products
- Books
- Cameras
- Car Audio and Security
- Computer Accessories
- Games
- Headphones
- Home Theater
- Joysticks
- Personal Electronics
- Radios
- Receivers
- Test Equipment
- Tools
- Tool Boxes/Cases
- More

Sorry-Books and software are not returnable

www.mcmelectronics.com/magazine

Troubleshooting & Diagnostics™ 2002

Features over 400 programs designed to work with the newest operating systems, CPUs and peripherals. Includes diagnostic tools, system info and file recovery utilities, hard drive and modem utilities, anti-virus programs and much more.

System requirements:

Windows
2000/ME/98/95,
16Mb RAM.

Order # 83-9168 Reg. \$9.99



Only!
\$9.39

PC Diagnostics and Repair Tools 2002

This CD-ROM contains 627 MB best PC troubleshooting tools for improving your PC performance: Diagnosis, optimization, repair, cleanup tools, uninstaller, back-up, recovery, file and system management, network management, speed up tools, benchmark, registry utilities, hardware testing and optimization tools and much more

- This is the best and largest PC tool collection for troubleshooting, repair and performance tuning!

Order # 83-9166 Reg. \$9.99



Only!
\$8.99

Digital Multimeter Kit

This full function DMM kit is great for schools as well as the electronics enthusiast. **Features:**

- Measures AC and DC voltage, DC current and resistance
- Diode test
- Transistor test
- Low battery indicator

• Comes complete with test leads and owner/assembly manual

Specifications:

DC Voltage: • Ranges: 200mV, 2V, 20V, 200V, 1000V
AC Voltage: • Ranges: 200V, 750V
DC Current: • Ranges: 200µA, 2mA, 20mA, 200mA, 10A
Resistance: • Ranges: 200ohm, 2Kohm, 20Kohm, 200Kohm, 2Mohm • NPN and PNP h_{FE} test
General: • Power requirements: One 9V battery (#290-080)
• 90 day warranty

Order # 72-6562 Reg. \$18.95



Only!
\$18.95

You must provide this Source Code to receive a discount

SOURCE CODE # POP102

Build Your Own Robot Kit

A dynamic learning platform! Pre-programmed for quick enjoyment, and comes with instructions for custom applications

- Customizable, no soldering required
- Learn basic skills toward advanced robot building
- The 9-volt battery-powered robot (battery not included) is driven by dual electric motors and controlled by a Microchip PIC16C505 PICmicro Microcontroller
- With two light sensors and infra-red "collision detectors" the robot is pre-programmed with the following "behaviors" built in: Random Movement - change forward direction when an object is encountered
- "Photovore" - seek out light
- "Photophobe" - avoid light
- "Maze Solver" - follow wall
- All of the software code for the Basic Stamp applications is included on the accompanying CD-ROM along with illustrated assembly instructions, and many schematics

Order #	(1-9 kits)	(10 kits-up)
81-3202	\$59.50	\$57.50



BattleBots®: Official Guide

- View the metal-crunching destruction from the front lines with this fully authorized guide to one of today's hottest TV shows
- Browse through photographs of every major BattleBot including construction diagrams and get details on weight, speed, and weapon type
- Informative and entertaining, this book kicks BOT!



Order #81-3198
\$24.50

Home Automation and Wiring

- Demand for fully automated homes is growing, why not get a jump on this highly lucrative market?
- With this book, you can easily install the most modern and efficient systems for complete personal control of entertainment, temperature and light, water, communications, security, and more
- Satisfy the skyrocketing consumer demand for state-of-the-art home technology
- Step by step, you'll learn how to put together these systems to deliver maximum programmed energy savings to your clients, not to mention great potential



Order #81-3204
\$49.50

Source Code: POP102

Prices effective October 8 through December 27, 2002

A Premier Farnell Company

CIRCLE 324 ON FREE INFORMATION CARD