

Poptronics®

Formerly Popular Electronics® and **Electronics NOW**

BASIC
Downloadable Circuits
see page 57
CIRCUITRY

STEPPER MOTORS AND DRIVE METHODS

Incorporate stepper motors into your next invention

Robots In Space

How NASA will be relying on robots to explore and colonize space

How To Groom An Engineer

Learn how a program called FIRST can inspire and educate



Also Inside:

- Polybots
- Timer Circuits
- Build A Bi-Ped
- Computer Bits Returns
- Digital Camera Reviews

\$5.99 U.S.
\$6.99 CAN.

#BXBDCC *****3-DIGIT 358
 #35802YUN711GR004# TRON 199
 4 \$156 P491 AUG 2002
 STEPHEN R YOUNG
 7118 GARTH RD SE
 HUNTSVILLE AL 35802-1947

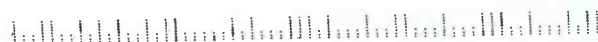



What You Want.....
Today!™

click it
phone it
fax it

You Must Provide this Source Code to Receive Discount or Special Pricing

POP97

call toll free

1-800-543-4330

fax toll free

1-800-765-6960

customer service call toll free

1-877-626-3532

For more Electronics
Visit our website

- Audio Products
- Books
- Cameras
- Car Audio and Security
- Computer Accessories
- Games
- Headphones
- Home Theater
- Joysticks
- Personal Electronics
- Radios
- Receivers
- Test Equipment
- Tools
- Tool Boxes/Cases
- More

www.mcmelectronics.com

Source Code: POP97

DEFENDER SECURITY VCR Trigger



The VCR trigger is designed to transform any standard VCR into an event recorder. The VCR Trigger is easy to program from the VCRs remote and is activated by an external device such as a magnetic contact, PIR or video motion detector.

Order #82-8095
\$19.95



105 Piece Security / Standard Screwdriver Bit Set

This complete set includes security bits to remove tamper resistant screws found in many of today's popular electronics as well as standard bits for more common fasteners. This kit also includes a heavy duty ratchet screwdriver with forward, reverse, and conventional settings. All bits fit any 1/4" hex driver and most power screwdrivers.

Order # 22-3495 Reg. \$29.95

Only!
\$19.95

MCM CUSTOM AUDIO

4" LCD Color Monitor Module



• Put color video anywhere • Accepts standard composite video input • Requires 12VDC, 500mA

Order # (1-3) (4-up)
60-9855 \$109.00 \$95.75

*Only one coupon or discount may be used with any one purchase. Not valid on previously purchased items

Prices effective May 1 thru August 3, 2002.

CIRCLE 324 ON FREE INFORMATION CARD

Take **5%*** Off

Your 1st Order
You must provide this Source Code to receive a discount

SOURCE CODE #POP97

ELENCO Solder Station Kit

Build your own solder station with variable temperature control. Electronically controlled from 5 to 40 watts. Includes heavy-duty soldering iron. A special solder practice project is also included to help you achieve good soldering techniques. A great two-for-one project. Mfr. #SL5-40K.

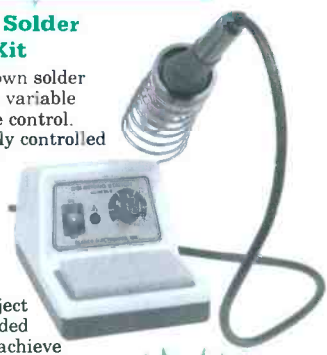

Only!
\$21.95

Order # 80-4400 Reg. \$30.29

discwasher Home Theater Setup Disc

• An amazing collection of sights, sounds and A/V tools engineered to maximize the full potential of your home theater system • Provides a full set of video calibration tests to optimize your viewing experience • Enables you to correctly set brightness, contrast, sharpness, color and tint • Provides audio calibration tests in stereo, Dolby ProLogic, Dolby Digital 5.1 and DTS for the best sound possible • Features multiple angle viewing, multiple aspect ratio viewing, multiple audio tracks and multiple languages and subtitles • Easy to use



Order #	Mfr. #	(1-9)	(10-up)
80-5500	1509	\$19.95	\$17.95

ONE Cinema 7+ Universal FOR ALL Remote

Complete seven device home theater remote with learning capability. Four learning keys enable full customization of favorite features. Compatible with DSS/DBS. Features include: Dedicated menu keys, surround sound key, PIP keys, sleep timer, re-assign device keys, previous channel key and glow in the dark keypad. Requires four "AAA" batteries #292-030 (not included).



Order #	(1-5)	(6-up)
URC-7801	\$24.95	\$19.95

A Premier Farnell Company

Poptronics®

FEATURES

STEPPER MOTORS AND DRIVE METHODS.....William Sheets and Rudolf F. Graf 31
Learn how to incorporate stepper motors into your next invention.

ROBOTS IN SPACE.....Maria Orlando 24
Find out how NASA will be relying on robots to explore and colonize space.

HOW TO GROOM AN ENGINEER.....Chris La Morte 28
See for yourself how the FIRST program is inspiring the next generation of engineers.

PRODUCT REVIEWS

GIZMO®..... 5
Take a look at the latest trends from Aibo's puppies to Herbie Hydrant.

HANDS-ON-REPORT.....Marc Spiwak 19
It's been over a decade since digital cameras hit the scene, so let's see what's new.

DEPARTMENTS

PROTOTYPE..... 8
See what's in store for technology as we examine Polybots and the Digital Time Machine.

PEAK COMPUTING..... Ted Needleman 12
The variety of software used to train your Aibo is the subject this month.

COMPUTER BITS..... Peter Pietromonaco 14
If you think C++ is just a C with extra credit, then read more about this nifty language.

SURVEYING THE DIGITAL DOMAIN..... Reid Goldsborough 17
Should you spring for that optical mouse or that sleek flat screen?

AMAZING SCIENCE..... John Iovine 37
Construct your very own bi-ped walker robot designed by the author.

ALL ABOUT........ William Sheets and Rudolf F. Graf 41
The fellows from North Country Radio share their expertise on basic antennas.

Q&A..... Dean Huster 46
Robotics related questions and safety concerns are served up fresh.

SERVICE CLINIC..... Sam Goldwasser 53
Closing the book on electronic references and useful service information.

BASIC CIRCUITRY..... Charles Rakes 57
Tin your solder tips and jump into some CMOS timers.

AND MORE

EDITORIAL 2	POPTRONICS SHOPPER 59
NEW GEAR 3	ADVERTISING INDEX 80
YESTERDAY'S NEWS 4	FREE INFORMATION CARD 80A
NEW LITERATURE 22	

Poptronics (ISSN 1526-3681) Published monthly by Gemsback Publications, Inc. 275-G Marcus Blvd., Hauppauge, NY 11788. Second-Class postage paid at Hauppauge, NY and at additional mailing offices. One-year, twelve issues, subscription rate U.S. and possessions \$24.99, Canada \$33.15 (includes G.S.T. Canadian Goods and Services Tax Registration No. R125166280), all other countries \$33.99. Subscription orders payable in U.S. funds only, International Postal Money Order or check drawn on a U.S. bank. U.S. single copy price \$4.99. Copyright 2002 by Gemsback Publications, Inc. All rights reserved. Hands-on Electronics and Gizmo trademarks are registered in U.S. and Canada by Gemsback Publications, Inc. Poptronics trademark is registered in U.S. and Canada by Poptronix, Inc. and is licensed to Gemsback Publications, Inc. Printed in U.S.A. Postmaster: Please send address changes to Poptronics, Subscription Dept., P.O. Box 459, Mount Morris, IL 61054-7629

A stamped self-addressed envelope must accompany all submitted manuscripts and/or artwork or photographs if their return is desired should they be rejected. We disclaim any responsibility for the loss or damage of manuscripts and/or artwork or photographs while in our possession or otherwise.

As a service to readers, Poptronics publishes available plans or information relating to newsworthy products, techniques, and scientific and technological developments. Because of possible variances in the quality and condition of materials and workmanship used by readers, Poptronics disclaims any responsibility for the safe and proper functioning of reader-built projects based upon or from plans or information published in this magazine.

Larry Steckler, EHF, CET,
editor-in-chief and publisher

EDITORIAL DEPARTMENT

Chris La Morte, managing editor
Evelyn Rose, assistant editor
Maria Orlando, assistant editor

CONTRIBUTING EDITORS

Reid Goldsborough
Sam Goldwasser
Rudolf F. Graf, KA2CWL
Dean Huster
John Iovine
Ted Needleman
Peter Pietromonaco
Charles D. Rakes
Teri Scaduto
Mark Spiwak
William Sheets, K2MQJ

PRODUCTION DEPARTMENT

Ken Coren, production director
Kathy Campbell, production manager
Michele L. Musé, prepress specialist

ART DEPARTMENT

Russell C. Truelson, art director
Michele L. Musé, graphic artist

CIRCULATION DEPARTMENT

Gina Giuliano, circulation manager

REPRINT DEPARTMENT

Maria Menichetti, Reprint Bookstore x235

BUSINESS AND EDITORIAL OFFICES

Gernsback Publications, Inc.
275-G Marcus Blvd.
Hauppauge, NY 11788
631-592-6720
Fax: 631-592-6723
President: Larry Steckler
Vice-President: Adria Coren
Vice-President: Ken Coren

SUBSCRIPTION CUSTOMER SERVICE/ ORDER ENTRY

800-827-0383
7:30 AM - 8:30 PM EST

Advertising Sales Offices
listed on page 80

Cover by
Michele Lyn Musé
Cover Photo by
Ken Coren

VISIT US ON THE INTERNET AT:
www.gernsback.com
or www.poptronics.com

Since some of the equipment and circuitry described in POPTRONICS may relate to or be covered by U.S. patents, POPTRONICS disclaims any liability for the infringement of such patents by the making, using, or selling of such equipment or circuitry, and suggests that anyone interested in such projects consult a patent attorney.

SAFETY IS PARAMOUNT

Whether you're changing the batteries in your remote or removing the cathode tube from an ancient television, electronics can hurt you. It is important that each and every one of us who likes to experiment always remembers to respect those invisible (yet potentially lethal) electrons. Yes, I said respect. In the same way hunter safety instructors teach us to respect even unloaded weapons as instruments of destruction, and not as toys to impress our buddies. So, you ask why the paranoid tone. It's been brought to my attention that lately there has been an increase in our young adult readership. These neophytes most likely aren't completely familiar with common safety practices. Case in point: wrist grounding-straps. Most of us in the field (I was a Wideband/SATCOM Technician in the USAF) have used these devices when working with *Electrostatic Sensitive Devices (ESDs)*, and we know that they can save the heartache of frying many-a-chip. Dean Huster addresses one reader's concern of how an article in our magazine describes the practice of wrapping copper wire around one's wrist and then grounding it. Both Dean and the reader (see "Q and A" on page 46) were mortified because the author neglected to mention the hefty resistor that should be in series with the strap. Here is an excerpt from an e-mail Dean had sent me:

"An interesting subject—safety, ethics and such. As a teacher and responsible for the safety of kids, it's an important subject, especially if I don't want to be involved in any liability lawsuits if something goes wrong. That's why back in the 1960's when I was a student, we played with 120-VAC mains voltages all the time but in my 20 years of teaching, NEVER allowed any line voltages outside where a student could contact it. They could learn transformer theory and such using 12 VAC as well as they could with 120v. Maybe back in the old days we kids were lucky and did learn some things about line voltages, but maybe the teachers were even luckier."

You might think working on a motherboard with no power attached would be fine, but what if little Johnny took this practice to heart? Next thing we know, he is elbow deep into a klystron with his do-it-yourself ground strap and suddenly, ala the BC comic, ZOT! Yikes! So perhaps it's time to reflect on exactly how much information we could safely publish, and for that matter, how much we can assume about our readers' background knowledge. I remember back in the service we couldn't power our vans up unless we had a buddy trained in CPR with us. Sounds silly? Not when you see someone do the "kickn' chicken" as three phases of juice wreak havoc on their own electric system that is comprised partly of the brain, spinal cord, and pacemaker. It only takes about 100-mA of external electricity to kill you. Now, I am not trying to scare you away from electronics, I am only telling you that it takes a disciplined, alert, and educated person to enter the hobby of electronics. As with all hobbies involving hazards, adult supervision is a must with children and respect for the equipment is mandatory. It only takes proper mentoring, education, and practical experience to make electronics safe, exciting, and rewarding.

Enjoy,



Chris La Morte,
Managing Editor

NEW GEAR

For more information go to page 80A

or e-mail: requests@berkshire-is.com

USE THE FREE INFORMATION CARD FOR FAST RESPONSE

PVC Cutter

Designed to cut flexible, watertight flexible, and schedule 40 PVC conduit that's 1/2 inch to 1 1/4 inches, the *GPC-125 PVC Conduit Cutter* (\$40.59) is the perfect tool for electrical, data communications, HVAC, industrial, irrigation, marine, telecommunications, and utility applications. The exclusive auto blade return feature allows the blade to only be exposed during cutting, and a safety release button can be used to manually disengage the blade if a problem occurs. The comfort squeeze-handle helps avoid hand fatigue

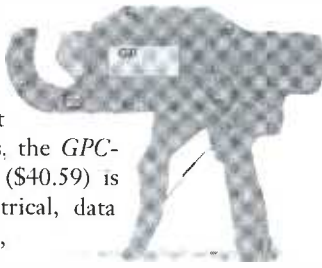

GARDNER BENDER

P.O. Box 3241
Milwaukee, WI 53201-3241
800-624-4320
www.gardnerbender.com

**CIRCLE 60 ON FREE
INFORMATION CARD**

Sound Level Meter

Useful for monitoring office, plant, and machinery noise, the *Sound Level Meter, Model 407768* (\$349), is manual or auto-ranging over three ranges and spans 30 to 130 dB with high accuracy. Measurements are displayed on a large LCD, and data can be transferred to a PC via the RS-232 interface and analyzed with the software provided. Additional features include A&C frequency weighting, fast and slow time weighting, and AC/DC recorder output.

EXTECH INSTRUMENTS

285 Bear Hill Road
Waltham, MA 02451-1064
781-890-7440

www.extech.com

CIRCLE 63 ON FREE INFORMATION CARD



Infrared Thermometer

Offering non-contact infrared technology, the *IR610 Digital Infrared Thermometer* (\$89.95) performs accurate, digital temperature measurement from a distance. It measures test points up to 500°F, can be set to Celsius with a mode switch on the front panel, and operates in a narrow field of view—one-inch wide at a ten-inch distance. Certified to meet CE EN60825 Class II standards for laser safety, this model is also ergonomically designed and features a data hold button, backlit display, low battery indicator, and an automatic power-off function.



WAVETEK METERMAN

P.O. Box 9090
Everett, WA 98206-9090
877-596-2680 or 425-446-5070
www.metermantesttools.com

**CIRCLE 61 ON FREE
INFORMATION CARD**

Probe Set

Designed for fine pitch applications, the *10 Mil. Precision Probe Set* (\$37.44) allows lead straightening, testing, and cleaning of solder joints. Packaged in PVC tubes, the probes offer stainless steel tips and hex-shaped non-roll aluminum handles. The set of four includes a straight tip, single-bend tip, triple-bend tip, and hook tip, along with tip protectors.

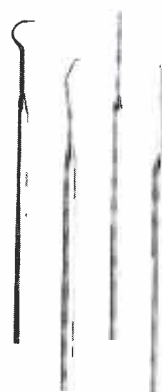

MOODY TOOLS, INC.

60 Crompton Ave.
East Greenwich, RI 02818
800-866-5462
www.moodytools.com

**CIRCLE 62 ON FREE
INFORMATION CARD**

Transistor Tester

This battery-powered *Model 520C Transistor Tester* (\$435) can be used for in-circuit and out-of-circuit transistor testing, with special components for making additional tests on devices out of circuit. Ideal for determining good or bad transistors, FETs, SCRs, or diodes, it is designed for a minimum amount of control manipulation, making for rapid testing. Other features include a meter that identifies leakage in both silicon and germanium devices, an automatic polarity indication, and supplied clip-on test leads that make positive connections with devices in difficult locations.

B&K PRECISION CORP.

1031 Segovia Circle
Placentia, CA 92870-7137
714-237-9220

www.bkprecision.com

CIRCLE 64 ON FREE INFORMATION CARD



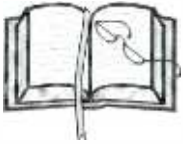

YESTERDAY'S NEWS

A PEEK INTO THE GERNSBACK ARCHIVES



Dateline: June 1952 (50 years ago)

This issue of **Radio Electronics** featured the construction of an animated vacuum tube to be used by Air Force students learning different electronic principles. The article tracked the three years it took to iron out all of the kinks, from conception to presentation. In a related article, a vacuum tube's "Edison Effect," or flow of current, was put to unconventional uses, such as measuring resistance. Readers also learned how to build a new radio-controlled model plane with 27-mc signals.

1900

1910

1930

1940

1952



1960



Dateline: June 1972 (30 years ago)

Today, many people turn towards the outdoors to escape electronics and noise. However, this month's **Radio Electronics** highlighted the movement of Americans into the outdoors and the equipment they took with them for their first adventures, from boat radar to CB radios. Also featured was the progression of laser technology and the ability for more experimentation due to a new low-cost solid-state laser. For less than \$32, electronics enthusiasts could build a full-function laser pulse generator and semiconductor diode. Finally, there was a listing of six circuit applications using op-amps.

1972

1980

Dateline: June 1992 (10 years ago)

Robot enthusiasts enjoyed this month's **Popular Electronics** article about building a PC-based stepper-motor controller—the most important component in robotic systems. For those of you who just like to have a grasp on your own life, you could learn how to construct a miniature tracking transistor that could be applied to finding lost children, pets, or cars. There was also an article on how to enhance all of your future projects by learning how to use LEDs properly.

1992

2000

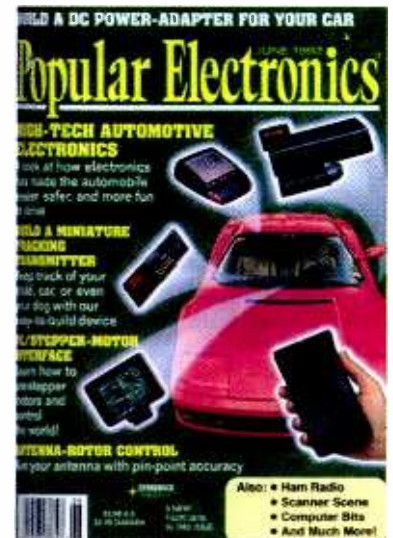

GIZMO®

For more information go to page 80A

or e-mail: requests@berkshire-is.com

Digital Duo

The PV-VM202 *Palmcorder Multi-cam* digital camcorder (\$2199.95) comes with a bonus: a detachable 1-megapixel digital camera with a Leica Dicomar lens. The camera's MPEG-4 Internet movie feature lets you easily transfer video clips with audio to a PC, and its voice recorder captures audio memos. The camcorder features a 2.5-inch LCD viewscreen, digital electronic image stabilization, picture-in-picture, and Progressive Photo-Shot mode. The *Palmcorder* comes with ArcSoft photo-editing software and connects to a PC via its USB, IEEE 1394, or serial port.

Panasonic Consumer Electronics, One Panasonic Way, Secaucus, NJ 07094; 800-211-PANA; www.panasonic.com.

CIRCLE 50 ON FREE INFORMATION CARD



Interactive Satellite TV

The SIR-S60 digital satellite receiver (\$99) features DirecTV Interactive, which provides access to more than 225 channels and lets you interact in real time. The free service offers interactive enhancements that can be selected via remote control whenever a flashing "i" icon appears on the screen. Press a button to check local weather, reply to free offers, retrieve sports info, or get customized stock quotes. Shopping options are made available by setting up a credit card account for automatic billing.

Samsung Electronics, 105 Challenger Rd., Ridgefield Park, NJ 07660; www.samsungelectronics.com.

CIRCLE 52 ON FREE INFORMATION CARD



Carpet-Friendly Puppies

The AIBO robotic dog has had a litter. Ivory-colored *Latte (LM ERS-311)* and gray *Macaron (LM ERS-312)* (\$850 each) are designed to act like playful, affectionate puppies. The included *AIBO Life* software lets them make decisions about their own actions and behaviors, and they can be trained, just like real puppies. When fully trained, they have a 75-word voice-recognition vocabulary and will respond to their names, can take photos and store them on a Memory Stick, and

can interact with other AIBO robots. Entertainment Robot America, Sony Electronics Inc., 6701 Center Drive West, Suite 640, Los Angeles, CA 90045; 888-917-7669; www.aibo.com.

CIRCLE 51 ON FREE INFORMATION CARD



Fire Safety

Herbie Hydrant (\$49.95) is a kid-friendly device that's designed to help kids find their way to safety and help firefighters find their way to trapped kids. Once lifted from the base, Herbie's flashlight shines, an alarm bellows, and strobe lights flash. A digital timer is activated to let emergency personnel know how long the child was exposed to smoke, and a storage compartment can hold the child's pertinent medical records.

Get Herbie, Inc., PO Box 862, 97 McKee Dr., Mahwah, NJ 07430; 888-580-SAFE; www.herbiehydrant.com or www.getherbie.com.

CIRCLE 53 ON FREE INFORMATION CARD



Glowing Towers

NEON CD Towers use backlighting to softly illuminate the edges of stored CD jewel boxes, adding a subtle, colorful accent to the room. You can use filters to alter the color of the lighting or to attractively color code your collection by artist or genre. *Model 20505* (\$149.95) holds 50 CDs and *Model 20100* (\$179.95) holds 100 discs. Each tower includes a four-foot fluorescent light fixture and a royal-blue filter. Filter kits (red, green, yellow, pink, blue, or multicolor) are sold separately for \$9.95 each.

VOS Systems Inc., 1300 Danielson St., Suite J, Poway, CA 92064; 800-596-0061; www.vosystems.com.

CIRCLE 54 ON FREE INFORMATION CARD



Double Duty

Ready for DVD, but not quite willing to give up on VHS? The SD-V280 combination player (\$299) provides the best of both worlds. In addition to its DVD player and four-head HiFi VCR, it offers a full complement of connections, including composite, S-video, and ColorStream component video outputs and optical and coaxial connections for Dolby Digital and DTS audio. The VCR can be used to record non-copy-protected DVD-video content.



Toshiba America Consumer Products, 82 Totowa Rd., Wayne, NJ 07470-3191; 973-628-8000; www.toshiba.com/tacp.

CIRCLE 55 ON FREE INFORMATION CARD

HDTV Widescreen



Featuring a stream-lined design built around an advanced TFT (thin film transistor) LCD technology, the L30W26 HDTV/PC monitor (\$5999) boasts a 30-inch wide-screen display. Its 1280

× 768 W-XGA resolution, suitable for television and computer display, is enhanced by a 400:1 contrast ratio, a peak brightness of 450 candles/square meter, and 170° × 170° viewing angles. A full complement of inputs for DVI, RS-232, component, S-video, RGB, and composite assures compatibility with digital and analog video sources and computers. The optional tuner is housed in a separate box. Detachable speakers are included.

Zenith Electronics Corp., 2000 Millbrook Dr., Lincolnshire, IL 60069; 877-9ZENITH; www.zenith.com.

CIRCLE 57 ON FREE INFORMATION CARD

Home-Theater Projector

Designed for the home-theater enthusiast, the XV-Z9000U (\$10,999.95) combines Sharp's Computer & Video Integrated Composer (CV-IC) technology with Texas Instruments' DLP technology to provide clear, high-resolution images. It reproduces high-definition images based on a native display resolution of 1280 × 720 pixels. Advanced interlaced-to-progressive conversion techniques and 3:2 pull-down recognition provide for accurate reproduction of film- and video-source content. The projector combines DLP, a 250-watt NSH lamp, and a 5X six-segment color wheel to deliver extremely accurate color.



Sharp Electronics, 1 Sharp Plaza, Mahwah, NJ 07430-1163; 800-BE-SHARP; www.sharppusa.com.

CIRCLE 56 ON FREE INFORMATION CARD

Video Voyager

Stifle the "Are we there yet?" chorus on family road trips with the IVMS 7001 16:9 TFT-LCD in-car display (\$799). When used with other products in the In-Car Video line—including an in-dash DVD player, a 5/5-channel dedicated signal converter, and a TV tuner—the viewer can select from up to five different installed sources.

The 7-inch monitor provides individual power, volume, color, contrast, and brightness controls. It offers a 60-degree viewing angle from the right, left, or above the screen. A front-panel input jack accepts



external video sources (such as videogames), and a headphone jack allows private listening.

Blaupunkt, 2800 South 25th Ave., Broadview, IL 60153; 800-950-2528; www.blaupunktUSA.com.

CIRCLE 59 ON FREE INFORMATION CARD

Sound Investment

Home-theater sound is affordable and easy with the AVS-632 six-piece home-theater system (\$449), which includes four compact monitors for left/right main and surround use, a low-profile voice-matched center channel, and an 8-inch powered subwoofer with a built-in 100-watt RMS amplifier. For flexibility, each component is equipped with a versatile wall- or stand-mounting system. Music and movie soundtracks sound natural, realistic, and uncolored; and the subwoofer provides the realistic rumble required for action scenes.

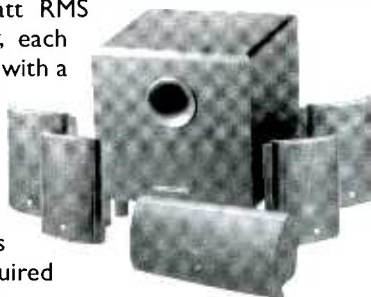

Cerwin-Vega, 555 Easy St., Simi Valley, CA 93065-1805; 805-584-9332; www.cerwin-vega.com.

CIRCLE 58 ON FREE INFORMATION CARD

Dual-Slot Card Readers

The *ImageMate* dual-slot memory card readers (\$39 each) are designed for consumers who want to quickly and easily transfer images, audio, video, and data between storage cards and computers via the USB port. Each reader features a 4-inch cable for readily accessible laptop USB ports and a 3-foot extension that can be left plugged to a desktop computer. The readers are Mass Storage Class (MSC) compliant for true plug-and-play operation when used with Windows 2000, ME, and XP. MSC is natively supported in Apple OS 9.X and OS X.

SanDisk; www.sandisk.com.

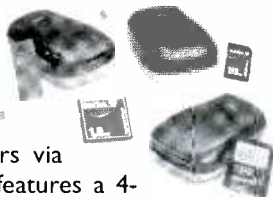

Linux-Based PDA

The *Lin@x* personal digital assistant (\$299) features an Intel 206-MHz StrongArm processor and boasts outstanding color graphics, 16MB of flash ROM and 32MB of RAM, built-in expandability, and the power and customization capability of Linux. The PDA offers an Internet browser and personal information management (PIM) features, including an address

book, a calendar with scheduler, notes, and a calculator. It includes desktop PIM software for Windows- and Linux-based PC systems.

Data can be entered using a virtual keyboard or handwriting-recognition software. The device ships with an MP3 player application and supports headphones.

Royal Consumer Information Products; www.royal.com.



Music Link

The *DAL150 ez link* (\$149) makes it easy to enjoy downloaded or streaming MP3 files throughout your home. The innovative digital audio interface connects your Windows 98 SE/ME/200/XP computer via its USB port to any A/V receiver with a coaxial digital input. The device automatically converts MP3 files to PCM digital audio, allowing you to enjoy the digital jukebox capabilities of a PC with the full sound quality of a home-audio or -theater system.

Harman/Kardon; www.harmankardon.com.



Ballooning Sound

Here's a whole new concept in computer speakers: inflatable ones. The *Ellula* inflatable speakers (price N/A) use NXT Surface-Sound technology to excite the natural resonances in a small panel built into the speaker. The outside of the balloon-like speaker then acts as a secondary radiating surface, augmenting and reinforcing the sound generated by the driver to produce sound across the speaker's entire surface. Designed for portability as well as acoustics (simply deflate them for travel), the speakers also can be used with audio players and video games.

Ellula Sounds; www.ellula.com.



Stealth Recorder

Secretly record all your phone conversations via your modem using the *Modem Spy 2.6* (\$24.95 for a single-user shareware license). The utility will provide a crystal-clear record of all phone calls, as well as Caller ID information. An optional answering machine mode is included. Your recordings can be converted to any voice format, including MP3 and WAV. The memo field can be used to take quick notes while on the phone or to display Caller ID information. An option is available to notify the remote party about the recording, which is required by law in certain countries.

SoftCab, Inc., www.modemspy.com.

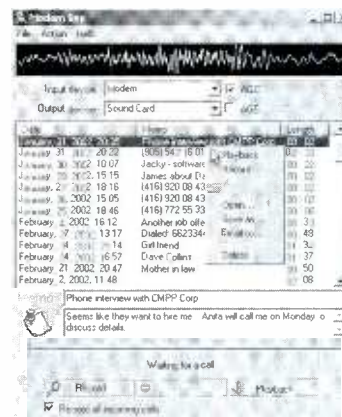

Business Buzz

BROADBAND TV

In Paris, French communications giants Thomson Multimedia and Alcatel recently demonstrated instant, interactive personalized TV and movies delivered via broadband DSL technology over a simple telephone line. Super encoders from Nextream, a Thomson/Alcatel joint venture, allow for the delivery of rich multimedia content, including MPEG-2 digital video, with less than 1 MB of required bandwidth. Alcatel's carrier networking products manage and transmit the video, voice, and data traffic over the telecommunications network and deliver it to Thomson's advanced digital xDSL set-top decoder.

HUMAN TRANSPORTER MICROCONTROLLER

Microchip Technology's PICmicro field-programmable microcontrollers and system supervisors are providing the electronics intelligence for the Segway Human Transporter (HT)—the first self-balancing, electric-powered transportation machine. The Segway HT features a combination of Microchip's PIC18C658 CAN microcontrollers and the ultra-small PIC12C509A 8-pin microcontrollers to help control the display, speed, and turning functions while communicating with other systems. The PIC16F87x Flash microcontrollers process sensor data and passes information to the control module. Other PICmicro devices monitor the battery packs and provide brownout detection in the user interface and control modules.

DTV COMPATIBILITY STANDARDS

The Consumer Electronics Association (CEA), in cooperation with the Electronics Industries Alliance (EIA), recently announced the approval and publication of the EIA/CEA-849A standard for source device compatibility with digital television (DTV) displays. It specifies the types of digital transport methods or content encoding that must be supported in order to interoperate with various digital audio and video sources. It includes application profiles for digital streams compliant with ATSC terrestrial broadcast, direct-broadcast satellite, cable, and standard-definition digital video camcorders. EIA/CEA-849A is the basis of CEA's "DTV Link" logo program, which uses graphics and descriptors on retail packaging that allow consumers to match compatible products at a glance.

Modular Robots

How do you build a simple robot that can perform a wide variety of complex tasks? Researchers at the Xerox Palo Alto Research Center (PARC) have come up with a novel solution. They created a small modular unit that's not much to look at and can't accomplish much on its own. Like a colony of ants, put a bunch of them together and it's a force to be reckoned with.

Modular Reconfigurable Robots, familiarly called PolyBots, take many copies of the original simple module and connect them to form systems that can accomplish complex tasks. A modular robot can even change its shape by moving its modules around to meet the demands of different jobs or environments. For instance, when moving across a level surface, a PolyBot might shape itself like a tractor tread. Then, confronted with a staircase or other obstacle, it shifts to a snake-like shape. Moving over rough terrain, a four-legged "spider" emerges.

The third-generation of modular robots is currently under development at PARC. Dubbed PolyBot G3, it is based on a 50- × 50- × 45-mm cube equipped with two identical connection plates on either side. Any two plates can be attached together at 90-degree increments. The plates allow power and communications to pass between modules. Each face of the cube also has four IR LEDs and sensors for face-to-face docking during reconfiguration and for basic communication between modules. During initialization, the modules



Mark Yim, inventor of the PolyBot and research team leader, displays one of his modular robots.

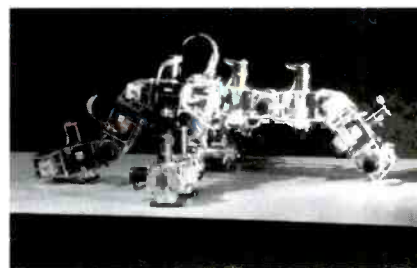

In its four-legged spider configuration, the robot can easily cover rough terrain.

"talk" to each other, allowing the robot to discover its configuration.

Each module contains a Motorola PowerPC 555 embedded processor with 1 megabyte of external RAM—more processing power than has been needed in any application to date. The modules communicate over a local bus within chains of segments using the CANbus (controlled area network) standard. Switching and routing capability allow messages to pass between segment chains.

PolyBot G3 is powered by a custom-built drive that uses a modified Maxon 32-mm diameter brushless pancake motor. Weighing only 70 grams (G2s weighed 300 grams), the drive delivers 1-Nm of torque. The matched aluminum frame has a range of motion of ±90 degrees.

A host of sensors helps the modular robot recognize its environment so that it can determine its proper configuration for the task at hand. These include Hall-Effect sensors built into the motors, four accelerometers for measuring orientation relative to gravity, and low-resolution force sensors on the interface pins. The IR components are also used for proximity sensing.

Robo-Snake

NASA has already adopted PARC's PolyBot technology to develop an intelligent robotic snake that can dig independently in loose extraterrestrial soil, slither into cracks in a planet's surface, and plan paths around or over obstacles.

TYPE

Engineers predict that the manufactured serpent could be ready for space travel in less than five years.

"The snake will provide us with flexibility and robustness in space," said Gary Haith, lead "snakebot" engineer at NASA's Ames Research Center. "A snakebot could navigate over rough, steep terrain where a wheeled robotic rover would likely get stuck or topple."

A snakebot could save weight in the spacecraft because it's designed to do many tasks without much extra equipment. Carrying a few spare modules would allow easy repairs. Other benefits noted by Haith include the snakebot's ability to crawl off a spacecraft lander without a ramp, and that its moving parts can be sealed inside an artificial skin for protection in harsh environments. "And the robot can still function, even if one joint freezes," he explained.

What's Next?

The most immediate challenge now facing PARC researchers lies in the software that controls the whole system.

They must be able to program and control the modules, keep them from running into one another, and guarantee that the whole robot will continue working if a few modules break down.

Current PolyBot robots use 20 mod-

ules. The goal is to build robots with hundreds—or even thousands—of modules, and to make those modules as tiny as possible. Xerox envisions a future in which the technology is used to create a fold-up printer that could fit in a pocket



When arrayed like a snake, a modular robot can climb up or down stairs and navigate over obstacles in its path.

**Frustration? No, thanks.
Fun? Yes, please.**

Satisfied customers - the key to our success

- ▶ that's why every new EAGLE version is based on the feedback from our customers
- ▶ that's why all our customers have access to our highly acclaimed, comprehensive support, free of charge
- ▶ that's why EAGLE has no hidden costs for libraries or modules which prove to be indispensable after purchasing
- ▶ that's why we really want customers to enjoy working with EAGLE
- ▶ that's why EAGLE is one of the top-rated programs for schematic capture and board layout



EAGLE 4.0

Schematic Capture • Board Layout
Autorouter

The readers of the leading German electronics magazine
picked EAGLE 4.0 as
Product of the Year 2000
in the category CAE/CAD

for **Windows**

and **Linux**

Windows is a registered trademark of Microsoft Corporation
Linux is a registered trademark of Linux Torvalds

Version 4.0 Highlights

- New Library Management with Component Browser
- Technology and Package variants for components
- Design your own commands via User Language
- Unlimited length for component names/values
- Design Rules define pad/via dimensions and shapes
- Net Classes for Autorouter and DRC
- Minimum Autorouter grid: 0.02 mm
- SMD pads can be rounded or round
- Different pad shapes for Top, Bottom, or Inner layers

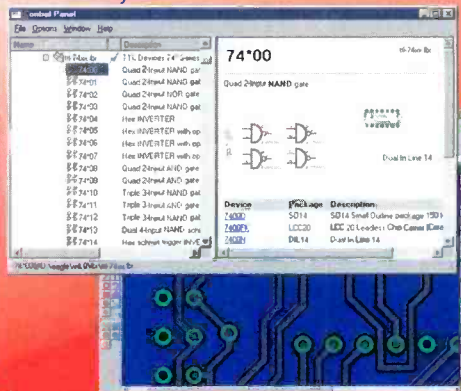

EAGLE 4.0 Light is Freeware!

You can use EAGLE Light for testing and for non-commercial applications without charge. The Freeware Version is restricted to boards up to half Eurocard format, with a maximum of two signal layers and one schematic sheet. All other features correspond to those of the Professional Version. Download it from our Internet Site or order our free CD.

The Standard Version is suitable for boards in Eurocard format with up to 4 signal layers. The Professional Version has no such limitations.

<http://www.CadSoftUSA.com>

800-858-8355

Prices	Light	Standard	Professional
Layout		199\$	399\$
Layout + Schematic		398\$	798\$
Layout + Autorouter		398\$	798\$
Layout + Schematic + Autorouter	49\$	597\$	1197\$

Pay the difference for Upgrades

CadSoft Computer, Inc., 801 S. Federal Highway, Delray Beach, FL 33483
Hotline (561) 274-8355, Fax (561) 274-8218, E-Mail: info@cadsoftusa.com

CIRCLE 283 ON FREE INFORMATION CARD

Research Notes

SHOE-BOMB DISABLER

The shoe bombs that Richard Reid allegedly tried to detonate aboard a trans-Atlantic flight last winter were surgically disabled using an advanced bomb-squad tool originally developed at Sandia National Laboratories. Massachusetts State Police bomb squad members used a Percussion-Actuated Nonelectric (PAN) Disrupter to disarm the shoes and reveal their inner workings without detonating them. Although details are being kept under wraps, the device precisely interrupts a bomb's internal "gadgets" quickly before the bomb can explode and remotely, with human specialists working from a safe distance. The PAN Disrupter was developed in the early 1990s to keep bomb technicians safe and to disable bombs to retain them for valuable evidence. The device was also used to disarm a bomb found in the cabin of Theodore Kaczynski, the Unabomber, and to safely disable several suspect bombs in Atlanta during the 1996 Summer Olympics.

EVOLUTIONARY SPACE RAYS?

According to calculations by a team of astronomers at The University of Texas at Austin, jolts of radiation from space may affect biological and atmospheric evolution on planets in our solar system and those orbiting other stars. Bursts of radiation that can cause mutations or even death can come from flares given off by the sun or from more remote cosmic events such as supernovae and gamma-ray bursts. The magnitude of the effect is related to how well the atmosphere protects the planet. The study effectively rules out the chance of finding life on Mars, where the atmosphere is about 100 times thinner than Earth's. "Any organisms unprotected by sufficient solid or liquid shields should have been lethally irradiated by cosmic radiation sources many times in the last few billion years," said David Smith, who participated in the research as an undergrad.

SAFER SAFES

Researchers at Pacific Northwest National Laboratory have developed the Secure Safe, a wireless communications system that triggers an alarm if a worker leaves a room without properly closing and locking a safe, file drawer, or other security container. Mechanical and optical sensors track the positions of a safe's door and locking mechanism, and that information is sent to an optical sensor mounted at the door. An alarm is sounded if a worker leaves without securing the safe. The device is being tested at several Department of Energy sites. Other applications include bank vaults and hospital medicine cabinets.

and appliances that could reconfigure and repair themselves. Closer to hand, a search-and-rescue PolyBot could access areas too small or unsafe for rescue workers or reconfigure itself into a support structure around a trapped victim. **PT**

TV Timer Trimmer

In my house, we often slash our TV viewing time by recording our favorite shows and then fast forwarding through the commercials during playback using a Personal Video Recorder (PVR)—ours happens to be from TiVo. Sometimes we tune in a program, at its scheduled start, do chores for about 20 minutes, and then rewind to the beginning. That creates a buffer, allowing us to fast-forward through the commercials until we catch up with the live broadcast.

Now, in something of a technological turn-around, broadcasters have found a way to cut back on viewing time so that they can add *extra* commercials — and bring in extra revenue, of course. Using the Digital Time Machine, one more 30-second spot can be inserted in a 30-minute show (which actually contains just 22 minutes of program material).

The device, sold for more than \$90,000 apiece by San Jose-based Prime Image Inc., uses "microediting" to reduce the length of a program without actually taking out any scenes. Instead, it examines the video, frame by frame, and removes duplicate frames of video. Whenever two identical frames appear next to each other, one is deleted. Viewers are unaware that anything is missing.

Just like I do with my TiVo, engineers can program a show to begin with a time delay that equals the amount of time to be cut. This creates a buffer that is filled as the duplicate frames are cut, allowing the show, in effect, to catch up to itself. About 100 stations in the U.S. are already using the device.

A lot of people are concerned about potential misuse of the Digital Time Machine. Actors and directors worry that a scene containing lovers gazing soulfully into each other's eyes could be reduced to a passing glance. Studios also express anxiety over the safety of their shows' integrity. And even the American Association of Advertising Agencies is up in arms—after all, what's to prevent a station manager



The Digital Time Machine removes duplicate frames of video from television shows, creating extra time for commercials.

from using the device to shorten commercials as well as programming?

Bill Henderson, inventor of the machine and president of Prime Image Inc., makes short shrift of these concerns. He points out that because the Digital Time machine is fully programmable, it can learn to differentiate between commercials and shows. And, when an ad runs over its allotted time (which happens with some frequency), instead of cutting off the ending, the machine invisibly edits it to size. The same goes for fitting films into a TV station's schedule. After all, says Henderson, isn't it better to see a movie (almost) in its entirety, rather than chopping out scenes to make it fit?

The issues become further muddled when the Digital Time Machine is applied to live programming. Last October, CBS affiliate KDKA in Pittsburgh found itself in hot water with CBS executives and the NFL. By buffering to add that extra commercial, the game was not precisely broadcast "live." That put CBS in violation of its contract with the NFL, which limits the number of ads allowed to be shown during games.

Prime Image also sells a radio time machine, appropriately dubbed Cash, which removes pauses between spoken words to create extra ad time. When WWDB-FM in Philadelphia used it to insert close to three minutes of commercials in a one-hour talk show, host Rush Limbaugh was furious, calling the device "potential doom for the radio industry." **PT**

Pretty As A Picture

Digital cameras are great fun. But consumer models simply can't rival 35-mm film when it comes to color prints.

That soon might change, with the introduction of Foveon X3 technology. Developed by Dr. Carver Mead, physi-

► Biting-Edge Technology

Mixing dentistry with aerospace engineering, Georgia Tech Research Institute (GTRI) scientists have developed a "virtual mouth" that will help orthodontists and dentists accurately calibrate movement of teeth and help speed the manufacture of restorations and replacement teeth. The aerospace engineering team worked with dentist Dr. Randy Muecke and orthodontist Dr. David Leever to enhance their patented DentAArt Inc. technology. DentAArt captures an exact anatomic image of a patient's tooth position and form and creates a unique prescription for use in planning and implementing restorative, orthodontic, or surgical facial procedures.

The GTRI team, led by Jeffrey J. Sitterle, computerized the method. When measurements from at least three high-resolution X-rays or a computerized tomography (CT) scan are fed into a computer, specialized software generates a 3D digital image of a patient's mouth. Based on the image, dentists can design a complete treatment plan and test it virtually. The Virtual Mouth technology will help dentists design treatments that are accurate, fit properly the first time, and move patients in and out of the chair quickly.

This revolutionary technology allows us to "completely capture a patient's anatomy, producing the required diagnostic information, and utilize this for the patient's best interest as never before possible," Dr. Muecke said. **PT**



Research engineer Shayne Kondor (R) and graduate student Paul Lowe at work on a digital version of DentAArt technology, which allows dentists to precisely capture a patient's exact anatomical tooth position and form to produce a unique prescription for treatment.

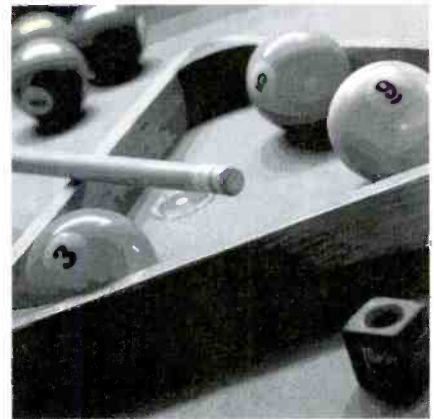

A digital photograph captured using X3 technology. (Pool Table. ©2002, Seawell Photography, San Francisco This JPEG was created from a higher-resolution TIFF source file.)

color per pixel is collected, only one third of the incident light is used. The other two thirds is absorbed by the color filters and not used.

With X3 technology, because all three colors are collected at each pixel, the use of light is maximized. The result is increased image sharpness, better color detail, and greater resistance to unpredictable color artifacts. X3-based cameras have measured information for all three colors, so that fewer pixels are needed for high-resolution images. Fewer pixels means smaller file sizes, so digital photographers can transfer images more quickly, and more images can be saved on a camera's memory card.

Foveon X3 sensors also are the first to incorporate Variable Pixel Size (VPS) capability for dual-mode digital cameras/camcorders. Full-color pixels can be grouped together to create larger, full-color "super pixels." The size of these pixel groups is variable and can be configured instantaneously. Instantaneous changes in pixel size combines the benefits of large and small pixels in a single image sensor. Smaller pixels provide higher resolution and sharper detail for still photography; while larger pixels offer higher light sensitivity for low light situations, faster auto-focus systems, and motion video rivaling that of high-end digital camcorders.

The first camera to use the Foveon X3 chip is the SD9 single-lens reflex (SLR) digital camera from Sigma Corporation (www.sigma-photo.com). **PT**

cist and founder of Foveon Inc., X3 image sensors are the first to be able to capture red, green, and blue light at every single pixel. This trick is accomplished by embedding three photodetectors in silicon at every pixel location. Silicon has natural color-separating properties; it absorbs light of different colors at different depths. Blue light is absorbed near the surface, green somewhat deeper, and red light even further down. Each X3 pixel has three photodetectors located at different depths to detect the absorption of the red, green, and blue light. The three photodetectors convert the light that is absorbed in the silicon into three signals that are then converted to digital data and processed with image-processing software. The complex algorithms that today's digital cameras must use to estimate the red, green, and blue values of each pixel is eliminated, as is the dedicated processing on-board hardware and software. Besides adding cost and complexity to the camera, color interpolation increases delay time between clicking

the shutter button and capturing a picture. X3 sensors capture the full color of an image without using a color mosaic filter and without the complexity, expense, and limitations of multi-chip system such as a three-CCD camera or a multi-shot system.

"In essence, Foveon has developed a single-chip solution for capturing complete color in an image," said Foveon CEO Jim Lau. "Previous methods for capturing complete color were prohibitively expensive, and were only appropriate for very-high-end systems. We believe ... Foveon X3 technology will form the foundation of a new generation of digital cameras in all classes."

Traditional CCD or CMOS color-image sensors contain a single layer of monochromatic photo detectors, with one color per pixel. To capture color, the pixels are organized in a mosaic pattern that looks like a three-color checkerboard. Complex processing is required to interpolate the remaining two-thirds of the colors that are not captured. Interpolation causes color artifacts and a loss of detail. And, because only one

HERE, Aibo!

There are robots among us! No, not the big scary ones that science fiction movies have immortalized, or even runaway computers trying to take over the world, a la "Colossus" in *The Forbin Project*.

These robots are adorable animals, or the occasional mechanical insect. Tiger, which is a division of Mattel, offers I-Cybie, its robot dog, but the "gold standard" in consumer robots has to be Sony's Aibo.

THE ORIGINAL AIBO

Aibo was first introduced several years ago in Japan, and with the original model, only several thousand were offered for sale over the Internet. The initial offering was quickly sold out, even at a price of over two thousand dollars. A second offering, again of just thousands, was offered the following year, and again quickly sold out. The very scarceness of units made Aibo an attractive acquisition.

So, however, did Aibo's ability to "learn." While the original Aibo was quite adorable, it was also an interesting example of a self-contained mobile computer with a program that could learn new behavior based on its environment and experience.

The original Aibo model has evolved into three consumer models. The ERS-210 is the latest version of the original design, while the ERS-220, the model that's lived with us for the last several months, is a more futuristic and more "robotic" looking Aibo. These models are sold both through Sony directly on the Aibo Web site, and in some retail electronics chains such as Circuit City. The ERS-210 and ERS-220 sell for around \$1500. Finally, the ERS-310 models, available in beige and black, are less expensive and



Is Aibo more dog than dog? You'll have to purchase some software (such as Aibo Navigator) before you see this pooch do anything impressive. The unit is pre-programmed with limited obstacle-recognition capabilities.

cuter models that sell for about \$850.

Mechanically and electronically, Aibo is a very sophisticated piece of equipment. Aibo's "brain" consists of a 64-bit RISC (reduced instruction set CPU) processor, and the robot has 32MB of SDRAM built-in. Aibo also has removable memory in the form of Sony's proprietary MemoryStick modules. These are flash memory modules, similar in construction (but not form factor) to CompactFlash or SmartMedia cards. Aibo also has a standard Type II PC Card slot, which is usually reserved for use with a Sony 802.11b wireless LAN card.

A true robot needs to be able to react to the environment. Aibo is nicely equipped for just this capability, with a large variety of sensors and I/O devices. The ERS-220 we experimented with has a temperature sensor and IR distance sensor for obstacle detection; an acceleration sensor; pressure sensors in the head, face, back, legs and tail; a vibration sensor; stereo microphone; a speaker; LEDs; and a 100k-pixel CMOS image sensor.

FIRST CLASS AIBO, FOR A PRICE

Unfortunately, Aibo isn't really good for much right out of the box. Considering the rather hefty price, Sony doesn't provide Aibo with more than elementary obstacle-recognition capability as delivered. To provide Aibo with personality and the capacity to react to the environment and learn you'll have to buy additional software packages, which have MemorySticks that add capabilities.

Aibo Explorer, which costs \$80, adds 75 voice commands to Aibo and provides a fully mature robot. You can even put Aibo in surveillance mode and have it "bark" when it senses an intruder.

If you are willing to spring for the Sony Wireless LAN 802.11b cards, and an extra \$150, you can purchase *Aibo Navigator*. This program lets you control where Aibo goes from your PC or laptop, seeing everything that Aibo "sees" with its built-in CMOS imager.

If you'd rather undergo the "parenting" experience with your Aibo, purchase the *Aibo Life 2* package for \$90. This package lets you raise Aibo from a puppy to an adult. You can name your Aibo, and it will respond to its new name. Several *Party Mascot* software packages give Aibo the ability to play a variety of games with you.

ROBOT CONTROL

For many **Poptronics** readers, however, Aibo will be most interesting when you can define its behavior. To develop your own Aibo behavior programs, you'll need the *Master Studio 1.1*, at \$150. This is actually a visually-oriented programming system that has several tools you can use to construct behavioral modes for Aibo. There's a Quick Behavior Arranger, where you simply match up an

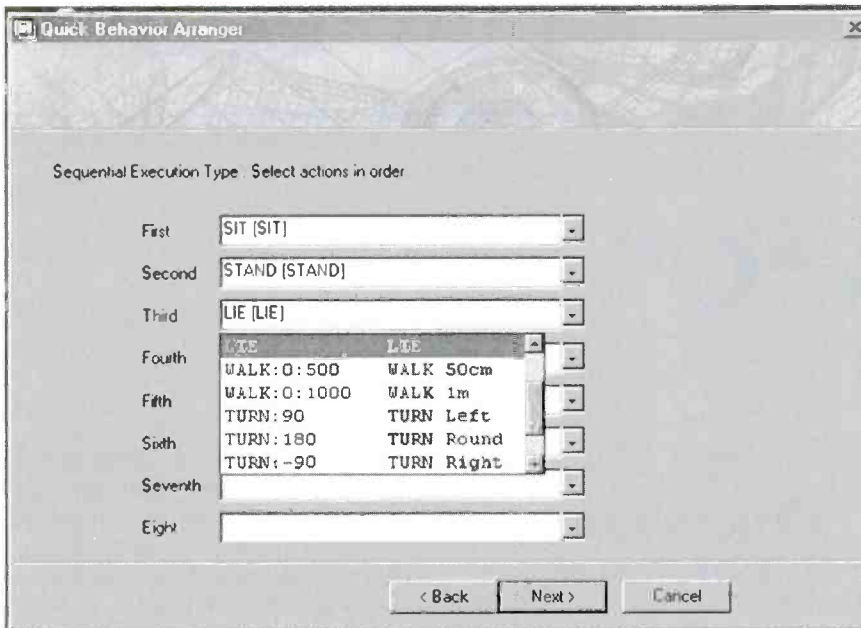

There's a Quick Behavior Arranger, where you simply match up an action for specific stimuli. This is the easiest mode of controlling what Aibo does.

action for specific stimuli. This is the easiest mode of controlling what Aibo does. There's also a Voice Recognition editor, which, again, matches up actions with sound inputs.

The Behavior Arranger is different from the Quick Behavior Arranger and is a somewhat more sophisticated tool. This application uses action boxes that define inputs and the action taken on them. You can connect these boxes using connectors, which allows you to

create very sophisticated programs that offer branching capabilities depending upon what conditions and inputs Aibo "experiences." It does take a bit of practice and experimentation to create longer and more sophisticated programs, but that's true of programming a PC as well. These tools create operating code that is downloaded into Aibo either using a wireless LAN connection (if you purchase the optional 802.11b cards) or into a MemoryStick.

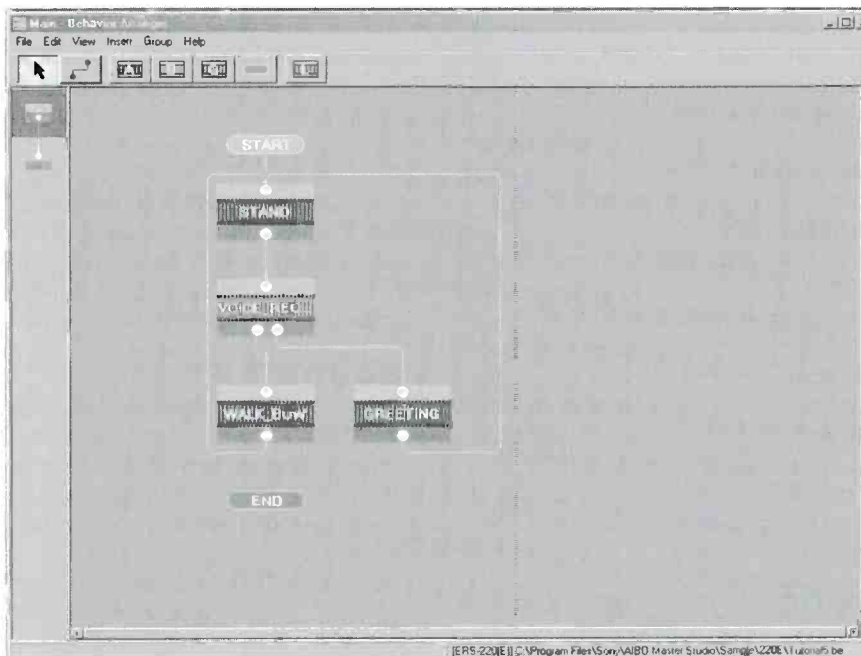

The Behavior Arranger uses action boxes that define inputs and the action taken on them. You can connect these boxes using connectors, which allows you to create very sophisticated programs that offer branching capabilities depending upon what conditions and inputs Aibo "experiences."

As you get more experienced, you can also code Aibo's programs directly in RCODE using the interpreter included with *MasterStudio 1.1*. Experienced programmers will probably appreciate this capability more than the casual user. *MasterStudio 1.1* comes with both an extensive User's Guide and a Tutorial manual, so you won't have much difficulty getting started with the system.

A "REAL" ROBOT?

When you are dealing with something as "cute" as Aibo, it's easy to dismiss the unit as a toy or gadget. While it can be considered a fancy toy, especially if all you do is purchase some of the less advanced programs, Aibo can be programmed to respond in quite a sophisticated manner, if you are willing to take the time and the effort.

At the center of the argument, however, has to be how you define a "robot." If you define it as a mechanism that can interact with its environment and modify its reactions according to past "experiences," then Aibo definitely qualifies as much more than a mere toy.

TAKING THINGS A STEP FURTHER

The *Master Studio 1.1* and other software mentioned in this column will get you started programming and customizing Aibo. There is a very active Aibo enthusiast community worldwide, which keeps up-to-date via the Internet and several very well-attended Web sites.

One site you might want to look at is www.aibopet.com. This site contains an extensive download section with RCODE hacks that let you extend the functionality of *MasterStudio* and other "official" Sony software offerings. Please note, however, that you will have to buy the Sony software to make use of any of the downloads offered on this and most other sites.

If you are more interested in a BBS-type Aibo site, point your browser to www.aibo-lfe.com. This site contains an excellent message section and will let you ask and get answers to many of your Aibo questions.

With Aibo getting more popular every day, consider starting a Robotics club at a local "Y" or high school. Having multiple users support the purchase and other expenses of an Aibo is an excellent way to get started with what is certainly one of the more interesting approaches to robotics.

The BETTER "C"

Sometimes known as the "better C," C++ is considered an easier language for writing basic computer programs, but it is also a tremendously powerful language that can tackle the most complex of problems. Although it is an extension of the C language that maintains almost all aspects of C, C++ has improved the procedural features. More important, it's also added powerful object-oriented capabilities. C++ has become the predominant programming language of choice among professionals in the industry.

Almost any computer programming language can handle the simpler tasks and problems. However, when faced with a difficult situation, C++ is your answer. It is a complex language because it is so proficient. It interfaces easily with other languages, which helps it bring together various parts of a programming project.

Most people think that you need to know C in order to learn C++. That is absolutely untrue. In fact, it may be to your benefit if you don't know C, because you will have to unlearn much of what you know and get accustomed to a whole new way of conceptualizing and solving problems.

It could take several years to master the C++ language, and I certainly can't teach it to you in one article. It takes an entire semester to give an overview of the program and to explain simple code. However, I can give you a broad-based understanding of the mechanics behind the language, its uses and functions, and some practical advice on the best way to go about learning it.

A BRIEF HISTORY

Programming has been around for over 40 years, starting with low-level machine language and evolving into

The C++ Programming Language

SPECIAL EDITION



Bjarne Stroustrup
The Creator of C++

This book is a comprehensive presentation of the C++ programming language by the creator of C++, Bjarne Stroustrup.

high-level languages; some of the first of them were BASIC, COBOL, and Fortran. These programming languages actually translated program instruction or code directly into action. Now, we deal with compilers that translate code into object code, which is then linked into an executable program.

Bjarne Stroustrup is the designer and creator of C++. He began working on it back in 1979 at AT&T Lab's large-scale Programming Research Department. AT&T used the very first version internally in 1983, and it was released commercially in 1985. (If you'd like some insight into the making of C++, *The Design and Evolution of C++* by Bjarne Stroustrup himself may prove an interesting read.)

PROCEDURAL VS. OBJECT-ORIENTED PROGRAMMING

The general framework or design model for organizing programs in a

computer language is called a programming paradigm. Although both the procedural and the object-oriented (OO) paradigm are currently in use, the procedural paradigm is inferior to the OO paradigm in that the OO can deal with more complex programming projects.

The difference is that in procedural programming, the primary emphasis is given to the sequence of actions used to solve a problem; where in the OO paradigm, the data is of fundamental importance. The basic building block in the OO model is an object, which binds together data with the various functions needed to perform a task. In other words, the data and the functions that act upon it are a single object—a self-contained entity with an identity of its own.

OO coding makes it easy to reuse code, because the specific action is contained within a section of code. This feature simplifies the transfer of source code from one program to another.

The concept of the OO paradigm seems very abstract and difficult to grasp from just reading about it. It will become much clearer as you begin to use C++ and understand the fundamentals through hands-on experience.

ABOUT COMPILERS

When you learn C++, you want to learn it as a portable language (the internationally agreed-upon version), portable to any platform, regardless of the machine or operating system you are using.

To turn your source code into a program that your machine will understand, you will need a compiler, preferably an up-to-date one. A compiler is a translator that deciphers the high-level C++ language into a list of instructions

in machine language, or object code. In plain English, a compiler converts source code (the language understood by the programmer) into object code (the language understood by the computer).

THE PROGRAMMING CYCLE

For programmers at every level, designing and planning is an essential first step in programming. C++, especially, requires that the programmer design the program before writing it—complex problems in particular. First, figure out your specific goal. What, exactly, is it that you want the program to accomplish?

Let's take a look at a very basic program using C++. Our program will ask the user to enter a number representing feet, and the program will convert the feet into inches.

```
//Converting feet to inches
#include <iostream.h>
void main()
{
int feet, inches;
cout << "ENTER number of feet:";
cin >> feet;
inches=12*feet;
cout << feet << "feet equals" <<
inches << "inches" << endl;
}
```

The program, after compiling and running, will produce the following output:

Enter number of feet (Wait for user input with cursor blinking). User will type a number and press the enter key.

The computer will input the value from *cin* and assign it to the variable named *feet*. Variable *feet* will now equal the user input. Note, the *cin* is not pronounced *sin*—it stands for *c in*. The same applies for *cout*, pronounced *c out*.

The program will resume after the enter key is pressed. The next line of code specifies a variable named *inches* and sets it equal to 12 times the variable *feet* (user input). Now it's time to write the results to the screen using *cout*. Anything displayed in quotes will be printed to the screen exactly as it is typed within the quotes. We can output existing variables with any text using this method. When quotes are not present in this example, the computer will assume that the word is an existing variable and will write the value of the variable to the screen. The *cout* in our

program will produce the following output, assuming the user entered "2" as the number of feet:

2 feet equals 24 inches

It is important to know that all variables used in your program must be defined at the beginning. Our "feet to inches" conversion program defines two variables, feet and inches, as integers.

```
int feet, inches
```

Let's look at the first two lines of our program.

```
//Converting feet to inches
```

The double slash // is used in C++ to hide the words following it on the same line. This convention is useful for the programmer in identifying sections of code.

Your code may be tens of thousands of lines. The programmer can identify certain sections by using the double slash and making notes throughout the code that will not be executed by the program.

The next line

```
#include <iostream.h>
```

is a compiler directive. This line directs the compiler to use an existing library file *iostream.h*. This file contains resources needed by C++ in order to receive information from the keyboard and write information to the screen.

I hope this example provided a taste of the language and some of its components. This example is a very simple program, but it exhibits some of the elements of the language.

SOME PRACTICAL ADVICE

First and foremost, get yourself a good text as a tutorial and study guide. There are many out there, written to accommodate all types of learning styles. Be patient, and learn C++ one step at a time, starting with the principles and the basics. These include variables, operators, functions, and flow control. Familiarize yourself with constructors and destructors and learn how C++ treats memory. It is also important to understand the features needed to use libraries—how to create objects, call members, and use templates.

One of the most valuable skills to sharpen is writing correct code. Errors could be missed during the testing phase, and debugging often proves to be very difficult. So if you can get it right the first time, you're already ahead of the game. C++ provides many tools to help prevent errors, so it

would be to your advantage to learn and use them.

If you're into robotics, C++ is one of the languages used to program robots. If you do a search on the Internet, you can find all kinds of Robot Games that use the C++ program to operate the battling "bots." Instructions and guidance is offered on many of these sites.

That's all for now. Remember, patience is a virtue, especially when it comes to tackling a program like C++. Happy programming! P

Wireless & Electrical Cyclopedia



ETT1—Wireless & Electrical Cyclopedia \$4.99. Step back to the 1920's with this reprinted catalog from the Electro Importing Company. Antiquity displayed on every page with items priced as low as 3 cents. Product descriptions include: Radio components, kits, motors and dynamos, Leyden jars, hot-wire meters, carbon mikes and more. The perfect gift for a radio antique collector. To order ETT1, send \$6.99 (includes s&h) in the US and Canada to **Electronic Technology Today Inc., P.O. Box 240, Massapequa Park, NY 11762-0240**. US funds only. Use US bank check or International Money Order. Allow 6-8 weeks for delivery.

MA11

Poptronics®

Interactive Edition

Projects...Courses...Articles...& more

Read it on the WEB!

- An e-magazine for everyone who loves electronics.
- Aimed at teaching electronics from the beginning with courses, tests and interactive questions to guarantee your success.
- Interesting articles and related items.
- Contains projects that can be ordered directly from the page, by simply clicking a button.

www.poptronics.com/interactive

ELECTRONIC TECHNOLOGY TODAY INC.

P. O. Box 240 • Massapequa Park, NY 11762

INVENTORY BLOWOUT SALE



* ALL CANADIAN CHECKS MUST CLEAR THROUGH AN AMERICAN BANK

BP07	100 Radio Hookups	\$3.00	BP317	Practical Electronic Timing	\$6.99
BP36	50 Circuits Using Germanium, Silicon & Zener Diodes	\$2.99	BP320	Electronic Projects for Your PC	\$5.99
BP44	IC 555 Projects	\$5.99	BP322	Circuit Source Book 2	\$6.99
BP56	Electronic Security Devices	\$3.99	BP329	Electronic Music Learning Projects	\$6.99
BP64	Semiconductor Technology Elements of Elect Book 3	\$5.99	BP332	A Beginners Guide to TTL Digital ICS	\$6.99
BP74	Electronic Music Projects	\$3.99	BP333	A Beginners Guide to CMOS Digital ICS	\$6.99
BP76	Power Supply Projects	\$3.99	BP334	Magic Electronic Projects	\$6.99
BP78	Practical Computer Experiments	\$2.99	BP355	A Guide to the World's Radio Stations	\$7.99
BP80	Popular Electronic Circuits	\$3.99	BP359	An Introduction to Light in Electronics	\$6.99
BP103	Multi-Circuit Board Projects	\$2.99	BP367	Electronic Projects for the Garden	\$6.99
BP109	The Art of Programming the IK ZX81	\$3.99	BP370	The Superhet Radio Handbook	\$6.99
BP112	A Z-80 Workshop Manual	\$5.99	BP371	Electronic Projects for Experimenters	\$6.99
BP114	The Art of Programming the 16K ZX81	\$3.99	BP374	Practical Fibre-Optic Projects	\$6.99
BP115	The Pre-Computer Book	\$2.99	BP378	45 Simple Electronic Terminal Block Projects	\$6.99
BP124	Easy Add-On Projects for the Spectrum, ZX81 & ACE	\$3.99	BP379	30 Simple IC Terminal Block Projects	\$6.99
BP143	An Intro to Programming the Atari 600/800 XL	\$2.99	BP384	Practical Electronic Model Railways Projects	\$6.99
BP148	Computer Terminology Explained	\$2.99	BP385	Easy PC Interfacing	\$6.99
BP154	An Introduction to MSX Basic	\$3.99	BP391	Fault-Finding Electronic Projects	\$6.99
BP156	An Introduction to QL Machine Code	\$3.99	BP392	Electronic Project Building for Beginners	\$6.99
BP183	An Introduction to CP/M	\$3.99	BP393	Practical Oscillator	\$6.99
BP187	A Prac Ref Guide to Word Pro Amstrad PCW8256/PCW8512	\$7.99	BP396	Electronic Hobbyists Data Book	\$7.99
BP190	More Advanced Electronic Security Projects	\$3.99	BP411	A Practical Intro to Surface Mount Devices	\$6.99
BP194	Modern OPTO Device Projects	\$3.99	BP416	Practical Alarm Projects	\$6.99
BP232	A Concise Introduction to MS-DOS	\$3.99	BP439	Troubleshooting Your PC	\$8.99
BP256	An Intro to Loudspeakers and Enclosure Design	\$3.99	PCP106	Synthesis for Musicians	\$10.99
BP264	A Concise Advanced User's Guide to MS-DOS	\$3.99	PCP107	Digital Logic Gates and Flip-Flops	\$10.99
BP272	Interfacing PCS and Compatibles	\$5.99	PCP109	Everyday Electronics Data Book	\$10.99
BP290	An Intro to Amateur Communications Satellites	\$5.99	PCP112	Digital Electronics Projects for Beginners	\$10.99
BP297	Loudspeakers for Musicians	\$6.99	PCP114	Advanced MIDI Users Guide	\$10.99
BP302	A Concise User's Guide to Lotus 1-2-3 Release 3.1	\$5.99	ETT1	Wireless & Electrical Cyclopedia	\$4.99
BP304	Projects for Radio Amateurs and S.W.L.S	\$5.99			

PRICES DO NOT INCLUDE SHIPPING & HANDLING. ALL SALES ARE FINAL, NO RETURNS

ORDER FORM

Book No.	Title	Price	No. of Copies	Cost

Name _____
 Address _____
 City _____ State _____ Zip _____

If you wish to use a Credit Card:

MasterCard Visa Expire Date _____ / _____

Card No. _____

Signature _____

Allow 6-8 weeks for order to be fulfilled.

Please return this order form to:
 ELECTRONIC TECHNOLOGY TODAY, INC.
 P.O. Box 240
 Massapequa Park, NY 11762-0240



SHIPPING COSTS

\$0.01 to \$5.00	\$2.00	\$20.01 to \$30.00	\$5.00
\$5.01 to \$10.00	\$3.00	\$30.01 to \$40.00	\$6.00
\$10.01 to \$20.00	\$4.00	\$40.01 to \$50.00	\$7.00
\$50.01 and above	\$8.50		

Total Amount \$ _____
 30% off _____
 Subtotal _____
 Local NY State Sales Tax _____
 Add shipping cost (see table) _____
TOTAL COST \$ _____

Telephone Orders: If you wish to place your credit-card order by phone, call 631/592-6722. Have your credit-card ready. Sorry, no orders accepted outside of U.S.A. and Canada, New York State Residents must add applicable sales tax. Offer expires 6/30/02.

ET11

THE PC MARKETPLACE: VERDICTS FOR THE CONSUMER

What's hot these days in PC technology? What's merely hyped? With the caveat that this is at least somewhat subjective, here's a run-down of some of the latest and greatest gadgets, gizmos, and gewgaws, and a recommendation of which are worth opening your wallet for.

CPU's

A super-fast central processing unit (CPU) can speed up processor-intensive tasks, such as digitizing music or video. The latest chips from Intel, AMD (Advanced Micro Devices), and Motorola that I've tested deliver smaller improvements in such common activities as word processing and surfing the Web.

When buying a new computer, it's most cost-effective to opt for the "sweet spot"—a CPU one to three notches down from the top of the line—unless you absolutely need the slightly increased performance of the very fastest chips.

Verdict: Qualified thumbs-up.

REWITABLE DVD DRIVES

Rewritable optical drives are replacing other auxiliary storage media, including Zip and Jaz drives, and, in some cases, tape-backup drives.

CD-RW drives have dropped in price lately. The cost of the discs on a per-megabyte basis is less than other storage media, and unlike the case with tape-backup drives, your data is quickly accessible. Those I've looked at are terrific for backing up data and burning audio CDs.

The just released DVD+RW drives have seven to eight times the capacity as CD-RW drives and are faster than

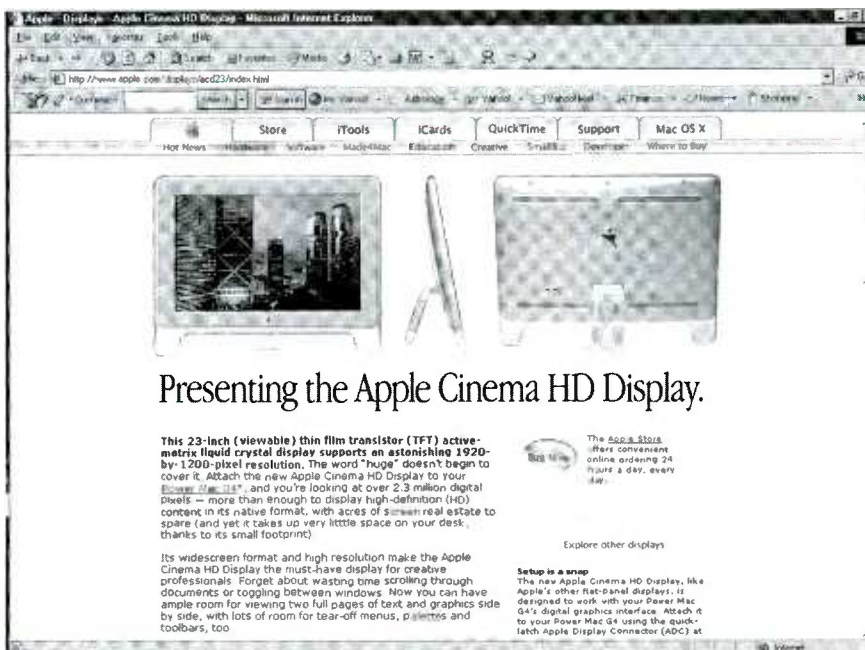

All sorts of tantalizing options are popping up for your computer. Take, for instance, Apple's latest push to popularize their sophisticated flat-screen monitors. With stunning resolution and a small footprint, will you be lured to the world of Macintosh?

their predecessors, DVD-RW drives. They can do everything CD-RW drives do plus store business videos or home movies. I'm now testing a Hewlett-Packard DVD100i.

Verdict: Thumbs up.

FLAT MONITORS

There are two different types of flat monitors: flat-panel displays (also called CDs or liquid-crystal displays) and flat-screen monitors (also called flat-screen CRTs or cathode-ray tubes).

Flat-panel displays are thin screens commonly used with portable computers, but lately available for desktop PCs as well. They take up less space and use less energy than their clunkier

counterparts.

Flat-screen monitors, on the other hand, are the same TV-like screens that have traditionally come with desktop PCs, only their screens are flat and produce less glare and distortion than traditional curved screens.

Apple Computer once again pushed the technology envelope by recently announcing new iMacs that resemble desk lamps, with a flat-panel display attached to a small round base. The attractive futuristic-looking devices, which should be available shortly, are as much fashion statements as computing devices.

I was impressed with the flat panels from NEC and ViewSonic I've evaluat-

ed, though color fidelity wasn't as precise as with CRT monitors, which is typical. I've also been impressed with the flat-screen CRTs I've looked at, including one I'm testing now from HP. As with LCDs, however, you'll pay a premium for them.

Verdict: Qualified thumbs up.

OPTICAL MOUSE

The latest computer pointing devices use light to track movement. I've evaluated optical mice and trackballs from Microsoft and Logitech. The benefits, according to the companies, are no skipping and jamming, no moving parts to clean or wear out, and no need for a mouse pad.

The devices worked well for me, but so have conventional \$5 no-name mice. If an optical mouse comes with a new computer, it's a nice feature. If you're replacing your current mouse, an optical mouse or trackball is probably not worth its premium price.

Verdict: Thumbs down.

DIGITAL CAMERAS AND CAMCORDERS

Taking pictures with a filmless camera has many benefits over a traditional camera. With a color inkjet printer, you can immediately print out your images, or you can quickly import them into an image-editing program to crop, color correct, or otherwise improve them. There's a lot to be said for this combination of control and immediate gratification.

I've looked at a range of different types of digital cameras from different companies. If you intend to use the camera strictly for creating Web images or e-mailing photos, rather than creating prints, you can save money by opting for a lower-resolution model.

Verdict: Thumbs up.

If you have a huge amount of free time, consider buying a digital video camera. Used with a video-editing program, these marvels of technology let you play the role of a Steven Spielberg. Starting with raw footage, you can add titles, a soundtrack, special effects, and, most important, edit down scenes to keep your viewers from falling asleep. I've tested units from Sony and Canon and have had an easier time using them on a Mac than a PC.

Digital moviemaking can be very

time-consuming, but like almost anything else digital, very enjoyable.

Verdict: Qualified thumbs up.

YOUR COMPUTER SOFTWARE—WHO'S IN CONTROL?

We've talked about computer hardware and the latest gadgets in technology, and now we need to look behind the scenes at the software that seems to have taken control over our computers and us. Who's in charge of what you do or say with your computer equipment? You, or the companies who sell it to you?

While none of us are completely in control of our destiny—even the most unfettered work under the sway of others in one way or another—one of the reasons for the success of the personal computer revolution is how PCs empower individuals. More and more, however, computer companies are trying to wrestle that control away from you.

Before delving into this, here's an idea about how we all can empower ourselves: Sharing secrets. What computing tips or little known computer programs or Web sites do you find indispensable and feel others might benefit from, as well? E-mail them to me, and I'll construct a future column around the best of them.

LICENSE AGREEMENTS

The latest controversy surrounding control issues involves software end-user license agreements, or EULAs. When you buy a software program, you typically don't actually own it. You're just buying a license to use it. How you use the program is governed by the wording of the EULA, which usually is printed on the envelope that holds the program's disc and also appears on screen when you install the program.

Open and install the software; and you must agree to abide by its license provisions, including whether you can copy the program onto more than one computer. Many EULAs use arcane legalese to try to absolve the software company of all responsibility if the program doesn't work as advertised or even work at all.

The most controversial software license issue involves free speech. Did you know that with some software, you're not allowed to criticize it without

first asking the software company's permission? Imagine not being able to read a movie review from your favorite reviewer, because the movie studio didn't let the reviewer publish his not-so-favorable opinions. Imagine the same happening with CDs, books, restaurants, and so on.

You might think that this is much ado about little, just overzealous lawyers trying to cover themselves with no prospect of companies actually exercising the rights they force you to sign over to them.

After all, these no-critique provisions fly in the face some of our society's most cherished ideals—about a free and open marketplace of ideas—not to mention the spirit of the First Amendment of the U.S. Constitution.

What's more, some legal experts feel these agreements aren't or shouldn't be legally binding because by the time you've determined what you need to agree to—after you've bought the software—it's too late to back out of the agreement. Yet amazingly, some software companies do use EULA's to try to muzzle people. Even more amazingly, sometimes they succeed.

A couple of years ago, the database software maker Oracle demanded that *PC Magazine*, one of the country's top computer magazines, refrain from publishing the results of its testing, citing its EULA that prohibits this without the company's written permission. *PC Magazine* consented.

Microsoft, not surprisingly, has made news with its draconian EULAs. Its Web editing program *FrontPage*, for example, prohibits you from using its Web components to create Web sites critical of Microsoft or any of its products or services.

Most recently, Network Associates, maker of the popular McAfee antivirus software and other products, was sued by New York State after it demanded that *Network World* magazine retract an unfavorable review about its firewall product. Network Associates cited its EULA prohibiting product reviews without its permission.

The magazine held its ground. However, New York State, with the backing of Consumers Union, publisher of *Consumer Reports* magazine, alleges that the company is trying to restrict free speech.

(Continued on page 26)



Digital Camera Roundup

Whether you're looking for basic and practical or optimum performance and advanced features, there's a digital camera out there for you.

Digital cameras are getting better, easier to use, and cheaper every day. This article looks at a sampling of what's out there, ranging from inexpensive entry-level products all the way up to some of the best digital cameras available today. I'll go over the basics of each camera here, and you can refer to the chart to compare the features of each camera.

Camedia C-4040 Zoom

I've been a big fan of Olympus digital cameras for years. They seem to produce better images than similarly equipped cameras from other vendors. It's probably because Olympus was busy perfecting lenses and shutter mechanisms long before many of today's digital-camera manufacturers ever got into the camera business.

The latest high-end digital camera from Olympus is the C-4040 Zoom. This is a 4.14-megapixel digital camera with a maximum resolution of 2272×1704 pixels, and it can interpolate resolutions up to 3200×2400 . The C-4040 Zoom features an f1.8 lens with a 3X optical zoom and a 35-mm equivalent range of 35mm to 105mm. The



The latest high-end digital camera from Olympus is the C-4040 Zoom. This is a 4.14-megapixel digital camera with a maximum resolution of 2272×1704 pixels, and it can interpolate resolutions up to 3200×2400 .

camera also has a 7.5X digital zoom that works in conjunction with the optical zoom. This camera uses four AA batteries, so you can use rechargeable cells or disposable cells, which are more convenient if you will not have access to an AC outlet.

You don't need a 4.1-megapixel camera to make beautiful 8.5×11 -inch prints. If you're printing smaller than 8.5×11 , or if you're taking pictures for the Internet or perhaps ebay, then a much lower resolution (say 640×480) is more appropriate. The C-4040 Zoom can take pictures at resolutions starting at 640×480 . The C-4040 stores images on SmartMedia memory cards, and it has a USB interface for getting pictures out of the camera. One 16MB SmartMedia card is included with the camera. Other features include a menu system that lets you customize the first page of the menu screen and a custom button whose function can be assigned by the user.

Cyber-shot DSC-S85

Sony always makes beautiful products, and the Cyber-shot DSC-S85 is no exception. The DSC-S85 is a 4-megapixel unit with a Carl Zeiss 3X optical zoom lens and 6X digital zoom. It has a maximum resolution of 2272×1704 pixels. An autofocus illuminator light can briefly illuminate subjects for proper focusing in low-light conditions. Like most digital cameras, the DSC-S85 can take video clips as well as still images. For shooting stills, Sony offers aperture priority, shutter priority, and manual exposure modes. This camera comes with a special rechargeable lithium battery—it cannot use regular batteries. This is not a problem if you have lots of freshly charged lithium cells with



The DSC-S85 is a 4-megapixel unit with a Carl Zeiss 3X optical zoom lens and 6X digital zoom. It has a maximum resolution of 2272×1704 pixels.

you on a photo shoot, but the camera comes with only one.

Sony digital cameras use Sony Memory Stick media. If you're just starting out in digital photography and don't have anything else that uses removable memory, either SmartMedia or CompactFlash, then this is not really an issue. The USB interface makes it easy to get the pictures out of the camera regardless of the type of memory that images are stored on. If you own a Sony DV Camcorder that uses Memory Sticks, then choosing a Sony digital camera makes a lot of sense. However, if you use other digital cameras or devices such as MP3 players that use either SmartMedia or CompactFlash, introducing Memory Sticks to the mix might complicate things. The camera comes with one 16-MB stick.

PhotoPC 3100Z

Epson's PhotoPC 3100Z is not quite as new a model as the Olympus and Sony cameras covered here. The 3100Z is a 3.3-megapixel unit, which was the best resolution available about a year ago. Keep in mind that 3.3 megapixels is quite high as far as resolutions go. Obviously camera vendors cannot just sit still, and so the



The 3100Z is a 3.3-megapixel unit, which was the best resolution available about a year ago. Keep in mind that 3.3 megapixels is quite high as far as resolutions go.

newer models will always offer higher resolution. Any 3.3-megapixel camera is more than adequate for most photographic applications, and you can save quite a bit of money by buying less than state-of-the-art. This 3.3-megapixel camera has a maximum resolution of 2048 × 1536 pixels. It can also capture resolutions of 1600 × 1200 and 640 × 480 pixels.

The PhotoPC 3100Z has a 3X optical zoom and 2X digital zoom, and it offers both aperture- and shutter-priority modes. The camera comes with a 16-MB CompactFlash memory card and a USB cable for getting pictures out of the camera. This is one camera that also comes with a soft case. Four AA batteries power the 3100Z, so it's easy enough to use rechargeable AA cells if you prefer.

Two From Toshiba

Toshiba is really trying to drive prices down by offering its latest and greatest 4.2-megapixel PDR-

M81 for only \$499, down from \$699 when it came out not too long ago. Buyers also get a free digital photo kit consisting of an extra 32-MB SmartMedia card (you get two total), a camera bag, and a set of four disposable lithium photo batteries. The only criticism I have concerning this great value in digital photography is that the LCD monitor on the back of this camera is relatively small in size.

The PDR-M81 offers a 2400- × 1800-pixel resolution and USB connectivity for fast downloading of images to a computer. Toshiba uses a Canon lens with 2.8X optical zoom and 2.8X digital. They also use more plastic than some other vendors, making for a lightweight camera.



The PDR-M81 offers a 2400- × 1800-pixel resolution and USB connectivity for fast downloading of images to a computer. Toshiba uses a Canon lens with 2.8X optical zoom and 2.8X digital.

If you thought that the PDR-M81 was affordable, then you won't believe what the PDR-M11 costs—only \$199! Plus, it doesn't skimp on things that really shouldn't be left



The PDR-M11 stores images on SmartMedia cards, and it comes with one 4-MB card. Depending on the resolution setting, the card will hold from 1 to 77 images.

out. The PDR-M11 is a 1.3-megapixel camera, which is good enough for taking pictures of family gatherings and vacations, making photo-album size prints, and more. It's also good for just about any Internet use, including ebay, for which 1.3-megapixel resolution is actually too much. This camera can take pictures with a maximum resolution of 1280 × 960 pixels.

The PDR-M11 stores images on SmartMedia cards, and it comes with one 4-MB card. Depending on the resolution setting, the card will hold from 1 to 77 images. The camera also has a USB interface, color LCD monitor, a built-in flash, and a tripod mount. The one thing this camera doesn't have is a zoom lens. Four AA cells power the camera.

Two From Polaroid

Now, we have digital cameras for under \$100. Polaroid's PhotoMAX FUN! 620 is an entry-level digital camera with a resolution of 640 × 480. And it costs only \$69.99. The

SOURCE INFORMATION

Camedia C-4040 Zoom

Price: \$799
Warranty: 1 year
Olympus America
Two Corporate Center Dr.
Melville, NY 11747
631-844-5000
www.olympus.com

Cyber-shot DSC-S85

Price: \$800
Warranty: 90 days parts and labor
Sony Electronics
16765 West Bernardo Drive
San Diego, CA 92127
888-222-SONY
www.sonymstyle.com

PDR-M81

Price: \$499

PDR-M11

Price: \$199
Warranty: 1 year
Toshiba
9740 Irvine Boulevard
Irvine, CA 92618
800-288-1354
www.dsc.toshiba.com

PhotoMAX FUN! 620

Price: \$69.99

PhotoMAX PDC 2300Z

Price: \$399.99
Warranty: 1 year

Polaroid Corp.
400 Boston Post Road
Wayland, MA 01778
800-343-5000
www.polaroid.com

PhotoPC 3100Z

Price: \$599
Warranty: 1 year
Epson America
3840 Kilroy Airport Way
Long Beach, CA 90806
800-GO-EPSON (800-463-7766)
www.epson.com

TABLE 1

Vendor Name	Epson	Olympus	Polaroid	Polaroid	Sony	Toshiba	Toshiba
Model	PhotoPC 3100Z	C-4040 Zoom	PhotoMAX Fun! 620	PhotoMAX PDC 2300Z	Cyber-shot DSC-S85	PDR-M11	PDR-M81
Price	\$599	\$799	\$69.99	\$399.99	\$800	\$199	\$499
Warranty	1 year	1 year	1 year	1 year	90 days	1 year	1 year
Maximum Resolution (pixels)	2048 x 1536	2272 x 1704	640 x 480	1816 x 1208	2272 x 1704	1280 x 960	2200 x 1800
CCD Size (megapixels)	3.34	4.1	0.3	2.3	4.0	1.3	4.2
Lens Type	non-removable zoom	non-removable zoom	fixed	non-removable zoom	non-removable zoom	fixed	non-removable zoom
Built-in Monitor	yes	yes	no	yes	yes	yes	yes
Built-in Flash	yes	yes	no	yes	yes	yes	yes
Self Timer	yes	yes	yes	yes	yes	yes	yes
Memory Type	CompactFlash	SmartMedia	Internal (fixed)	CompactFlash	Memory Stick	SmartMedia	SmartMedia
Interface Types	USB, Serial	USB, Serial	USB, Serial	USB, Serial	USB, Serial	USB, Serial	USB, Serial
Tripod Mount	yes	yes	yes	yes	yes	yes	yes
Battery Type	4 AA	4 AA	4 AA	4 AA	InfoLithium	4 AA	4 AA

The table above makes it easy to compare the different digital cameras that are discussed within this article. Big options will cost big bucks, but a moderate priced camera should suffice for amateur shutterbugs.

0.3-megapixel camera features both USB and serial connectivity, so owners of older computers can still get pictures out of it. Of course, the USB interface is much faster if you have a computer equipped with a USB port.



Polaroid's PhotoMAX FUN! 620 is an entry-level digital camera with a resolution of 640 x 480. And it costs only \$69.99. The 0.3-megapixel camera features both USB and serial connectivity, so owners of older computers can still get pictures out of it.

One compromise you must make with this inexpensive digital camera is that it does not have removable memory; it has 1MB of fixed internal memory, which can store up to 15 images. It also has no flash, no zoom lens, and no LCD monitor to review the pictures stored in memory. If you simply need to take basic pictures for the Web or just to document good times, this little camera is all you need. It even includes an automatic self-timer and tripod mount. The camera works with Windows 95, 98, 2000, and ME.

Polaroid hasn't been selling many of its instant cameras lately,



Consider the 2.3-megapixel PhotoMAX PDC 2300Z digital camera. This camera offers a maximum resolution of 1816 x 1208 pixels, and it includes a 2.3X optical zoom and 2X digital zoom.

probably due to the increasing popularity of digital cameras. So it makes a lot of sense to me that Polaroid is pushing this new technology, especially at the entry level.

Like what Polaroid offers at the entry level, but want a little more functionality and higher resolution? Consider the 2.3-megapixel PhotoMAX PDC 2300Z digital camera. This camera offers a maximum resolution of 1816 x 1208 pixels, and it includes a 2.3X optical zoom and 2X digital zoom. The PDC 2300Z uses CompactFlash memory, and one 8-MB card comes with the camera. It also has both serial and USB interfaces. Four AA batteries power the camera. Other frills include a 1.8-inch color LCD monitor, an AC adapter, and a camera case.

Mark Spiwak is the Technical Editor of CRN.

BUY BONDS

ELECTRONIC GAMES

BP69—A number of interesting electronic game projects using IC's are presented. Includes 19 different projects ranging from a simple coin flipper, to a competitive reaction game, to electronic roulette, a combination lock game, a game timer and more. To order BP69 send **\$4.99 clearance (includes s&h)** in the US and Canada to **Electronic Technology Today Inc., P.O. Box 240, Massapequa Park, NY 11762-0240**. US funds only. Use US bank check or International Money Order. Allow 6-8 weeks for delivery. MA07



Get your copy of the CRYSTAL SET HANDBOOK



Go back to antiquity and build the radios that your grandfather built. Build the "Quaker Oats" type rig, wind coils that work and make it look like the 1920's! Only **\$10.95 plus \$4.00** for shipping and handling. Claggg Inc., PO Box 12162, Hauppauge, NY 11788. USA Funds ONLY! USA and Canada — no foreign orders. Allow 6-8 weeks for delivery. MA01

CRYSTAL SETS: VOLUME V.



Volume V of the Society newsletter includes six issues ending November 1995. Great for new members to get current, those wanting a bound copy for their reference bookshelf, or as a gift to get a friend started. Contents include: The Design of Unpowered AM Receivers, Radio

Outfit in a Headset, A Crystal Set Revisited—Reconstructed, Grounded Loop-stick Tuner, The Matching Secret, and lots of membership correspondence. 8 1/2 x 5 1/2 paperback, **\$10.95 plus shipping**.—**Electronic Technology Today Inc., PO Box 240, Massapequa Park, NY 11762-0240**. US funds only. Allow 6-8 weeks for delivery. MA06

NEW LITERATURE

Electronic Components Catalog

from Active Electronic
Components Depot
41 Main St.
Bolton, MA 01740
617-864-3588
www.activestores.com



Free

Featuring names like Fluke, Lenline, Varta, and Extech, this catalog has an extensive variety of parts and hard-to-find components. Items include testers, prototyping boards, wires, cables, measurement solutions, tool cases, soldering equipment, project kits, chemicals, and books. The full-color pages offer product descriptions and information complete with uses and measurements.

The Spike

by Damien Broderick
St. Martin's Press
175 Fifth Ave.
New York, NY 10010
212-674-5151
www.stmartins.com

\$15.95

Rapid advances in technology affect our lives in ways we are not even aware of. The author discusses machines that will surpass us in intelligence, food assembled from microscopic components, digitizing the human mind, and transforming the physical body into illness-free, undecaying entities. Nanotechnology, artificial intelligence, and biotechnology are also covered. The author shares his unique perspective on the social ramifications of technology and his enthusiasm for whatever the future may bring.

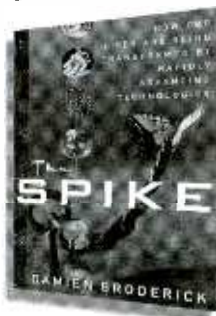

Microcontroller Projects Using The Basic Stamp, Second Edition

by Al Williams
CMP Books
6600 Silacci Way
Gilroy, CA 95020
800-500-6875
www.cmpbooks.com

\$44.95

Want to build an electronic game or robot? Learn the fundamentals for developing practical solutions with the Stamp. Also included is a description of the basic electronics you'll need to complete a task-oriented command reference for the Stamp, as well as practical advice for PC interfacing and communication via the Internet. Covering the new advances in Stamp technology, each chapter features projects and exercises that include serial EEPROMS, analog I/O, an RS232-controlled power supply, and more.



Industrial Chemical Catalog

from Miller-Stephenson
Chemical Company, Inc.
George Washington Highway
Danbury, CT 06810
800-323-4621
www.miller-stephenson.com

Free

Offering high-purity industrial cleaning products, this company uses the highest grade manufacturer-certified solvents and nonflammable propellants. The catalog features spray cleaners with low residue, solvents with zero ozone depletion potential, conformal coatings formulated to specific requirements, dry lubricants, contact cleaners, aerosol accessories, and more. Products serve many industries, such as chemical manufacturing, electronics, aerospace, automotive, and vacuum systems.



Robotics, Mechatronics, and Artificial Intelligence

by Newton Braga
Newnes, Butterworth-Heinemann
225 Wildwood Ave.
Woburn, MA 01801-2041
781-904-2500
www.newnespress.com

\$29.99

Providing both simple and complex project blocks, this book simplifies the process of finding basic circuits to perform simple tasks such as how to control a DC or step motor, and offers instruction on creating moving robotic parts such as an eye or an ear. The common components and technology featured in the projects are especially beneficial to readers who need practical solutions that can be implemented easily without incorporating expensive, complicated technology.

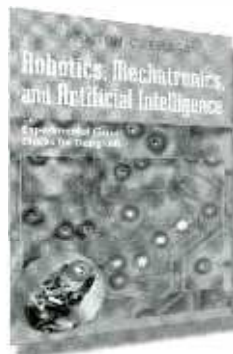

The Book Of WinZip

by Jerry Lee Ford, Jr.
No Starch Press
555 De Haro St., Suite 250
San Francisco, CA 94107
800-420-7240
www.nostarch.com

\$14.95

WinZip, a standard file-compression software program that makes electronic files easier to distribute, store, and copy, can be used to download software, send e-mail attachments, and free up disk space. This comprehensive guide covers every aspect of using the WinZip file compression application, such as speeding uploads, upgrading, archive creation and modification, extraction, configuration, and disk spanning.



2002 Catalog
from Skyvision, Inc.
1010 N. Frontier Drive
Fergus Falls, MN 56537
800-500-9275
www.skyvision.com

Free

Offering almost any component you need for your C-Band system, this catalog carries satellite dishes, installation mounts, receivers, dish movers, feedhorns,

servo motors, cables, and more.

It also contains upgrades and replacement components to enhance your system—performance tune-up kits, tools, distribution supplies, accessories, and antennas.

National Electrical Code 2002

by Mark W. Earley
NFPA

1 Batterymarch Park
Quincy, MA 02269-9101
617-770-3000
www.nfpa.com

\$103.50

Produced by the NFPA, this handbook is an essential reference tool for students and professionals involved in electrical design, installation, and inspection. Offering guidance in interpreting and applying current code requirements to all types of electrical installation, the text is supplemented with helpful facts and figures, full-color illustrations, real-world examples, and expert commentary.



2002 Master Sourcebook

from Jensen Tools
7815 S. 46th St.
Phoenix, AZ 85044
800-426-1194
www.jensentools.com

Free

This 316-page full-color catalog contains thousands of products from leading manufacturers of tools and test equipment. It features an extensive list of tool kits, carts and cases, hand and power tools. There are also wire/cable and fiber optics, computer and LAN products, soldering equipment, lighting and optical products, workstations, shop supplies, and field accessories. Custom kits are also available.



Linux Journal 1994–2000 CD-ROM Archive

from Specialized Systems Consultants
P.O. Box 55549
Seattle, WA 98155-0549
206-782-7733
www.linuxjournal.com

\$29.95

This CD-ROM archive contains every issue of the journal from the premiere in March 1994 through December 2000. Aimed at newcomers as well as serious, long-time UNIX users, each publication offers articles that provide

information on current Linux

technology. Topics include technical support, new products, book and product reviews, embedded systems, software, and commercial uses.



ROBOTS IN SPACE

MARIA ORLANDO

Robots roaming the surface of Mars? Sounds like something out of sci-fi novel, doesn't it? It's really happening. Only NASA is using the robots for research projects—not for Star Wars adventures. Jet Propulsion Laboratory (JPL), a research and development facility run by the California Institute of Technology for NASA, focuses on robotic space exploration.

Their specialties are robotic spacecraft and rovers, smart machines that are sent out into the solar system to act as workhorses and field geologists. The main mission of these robots is to collect surface, core, and water samples from other planets—primarily Mars—for scientists to study back on Earth. From this data, researchers can determine a planet's physical history and evaluate existing conditions—key elements in the search for alien life.

Probably the most memorable rover was the Sojourner, which explored the surface of Mars as part of the Pathfinder mission in 1997. Presently, NASA and JPL are testing more sophisticated rovers and prototypes that demonstrate a higher degree of functionality, a wider range of mobility, and can withstand the challenges of high-risk space exploration. Let's take a look at some of them: FIDO, the Robotic Construction Crew, Bulldozer Explorers, and others.

FIDO. FIDO, or Field Integrated Design and Operations, represents NASA's latest and greatest in robotic technology. The FIDO rover is being used to conduct research relevant to current and future robotic missions on Mars. Its job is to simulate field trials and mission operations on Earth so scientists can study its functionality and insure its success once in space. This includes navigation, data collection, remote sensing, intelligent behaviors, data visualization, and instru-



The 2003 Mars Exoloration Rover will contain highly sophisticated instruments. (Courtesy of www.nasa.gov)

ment placement.

Weighing 150 pounds, the rover has a mini-corer to drill and collect surface samples, as well as a microscopic camera to take photos of the drilling. Ultimately, the scientists hope to find carbonate materials, indicative of a carbon dioxide atmosphere. This would also suggest the possibility of life on Mars.

*Robots are going on
space missions to Mars.
It's not science fiction
—it's real!*

FIDO's advanced technology enables it to navigate over long distances on its own, avoiding natural obstacles without communication from a controller. It also uses a robot arm to manipulate instruments.

FIDO allows scientists to practice operating the rover before the real mission is underway. Drills are taking place in the deserts of California

and Nevada on terrain comparable to the challenging surface of Mars.

Although the current focus is the exploration of Mars, scientists look forward to expanding their space investigation to include Venus, Jupiter's moon Europa, and Saturn's largest moon Titan.

Robotic Construction Crew. Can you imagine a team of robots cooperating and skillfully coordinating a construction project? NASA researchers have developed a Robot Work Crew that can organize their individual sensory and control behaviors to accomplish a given task. These robots can maneuver over uneven terrain, avoid obstacles, transport payloads, manipulate equipment, and solve problems.

Their individual systems are programmed with both simple and complex behaviors that are made to respond appropriately in a group situation—their autonomous intelligence is distributed across the robot team. These robots are also equipped with a decision-making process, a shared network of sensing and control, and reactive behaviors. This is all made possible by the innovative software called *Control Architecture for Multi-robot Planetary Outposts*, which serves as a common controlling brain for the robot crew. In one particular experiment conducted by JPL, two such rovers approached an 8-foot long container and gripped it, then carried it across a distance in excess of 50 meters.

This fascinating multi-robot cooperation technology, though still in the experimental stage, could conceivably build outposts, deploy power stations, and set up camp on Mars—all without human presence.

Bulldozer Explorers. Robotics engineers at NASA have designed



These rovers will be sent to Mars to collect water, surface, and core samples. (Courtesy of www.nasa.gov)

a prototype of a Bulldozer rover that will be able to excavate mission sites on Mars. Though it functions like a standard bulldozer and dump truck, this rover weighs only eight pounds and can operate without a controller at the wheel. The rovers will work in groups, using a virtual communications network with a central control tower, for the purpose of covering a broader work area.

These Bulldozers will play a role in building utility trenches, creating buried habitats and space outposts for eventual human occupancy, and even aid in the search for life on Mars.

Inflatable Rovers. JPL is currently researching the use of Inflatable Rovers to increase productivity in outpost development on Mars. The inflatables offer increased speed and broader range, essential for transporting other rovers and heavy equipment to distant sites.

The project focuses on two types of inflatable vehicles. "Big Wheels" is a lightweight, motor-controlled vehicle that has large balloon tires, while its counterpart, "Tumbleweed," is a large sphere-like shape.

The Lemur, The Cliff-bot, And The CryoBot. Since robots are designed and tailored for specific tasks, there are many different prototypes in the works at JPL.

The Lemur, which resembles a bug or a crab, is a compact and nimble six-legged walking robot. It was built to perform intricate small-scale assembly and maintenance of space facilities. It is more proficient than other robots in its size class due to its flexible limbs and

effectors and has been dubbed a "six-limbed primate with Swiss Army knife tendencies" by its creators.

A unique rover concept, which addresses the challenge of high-risk access, is called the Cliff-bot. NASA has developed the Cliff-bot technology to enable the rover to traverse rough terrain. Through autonomous way-point navigation and cooperation between three robots, it is possible for the Cliff-bot to ascend or descend slopes of 60 degrees or more. To achieve this, two anchor-bots—actively controlled robotic anchoring assistants—assist the actively rappelling Cliff-bot up or down a slope through collective sensing and coordinated behavior control.



The Sojourner Rover, an integral part of the Pathfinder Mission in 1997, surveyed the surface of Mars. (Courtesy of www.nasa.gov)

Yet another robot in the works is the Cryobot, an ice-melting probe that can penetrate glaciers 75 feet deep. This type of technology is necessary for exploration below frozen surfaces, such as that on Jupiter's moon Europa. Scientists question the possibility of extraterrestrial life on Europa, as there is a deep saltwater ocean below the moon's icy exterior. The Cryobot would play a key role in studying the subsurface environment.

The Mars 2003 Rover. All of this research and development is gearing scientists up for the 2003 Mars Exploration Mission. Two new powerful rovers, far superior in mobility and sophistication than their predecessors, will be sent to Mars in June of 2003. The identical rovers will land in different regions of the planet with a common goal—to study the history of the planet's climate and water to determine the

ROBONAUTS

When many of us think of robots, we think of a machine that has a human shape. Now NASA has designed the Robonaut—a humanoid robot created by the Robot Systems Technology Branch at the Johnson Space Center. The premise for the Robonaut is the development of a robotic system that can perform highly dexterous tasks—the humanoid robot is configured with two arms, two five-fingered hands, a head, and a torso. The advanced technology brings together anthropomorphic robotic systems, multiple use tool handling end effectors, modular robotic systems components, and telepresence control systems.

This state-of-the-art design combines dual-arm operations with acute telepresence control by a human operator. With over 150 sensors per arm, the control system for the Robonaut includes an onboard real time CPU with miniature data acquisition and power management in a small, environmentally hardened body. The sophisticated mechatronics design includes embedded avionics elements in the arm structure and a biologically-inspired neurological system.

NASA aimed to build a robot that could aid in space exploration and work in conjunction with humans and to also venture into areas that are too dangerous for people. Scientists are striving to create the humanoid robot with dexterity that surpasses the suited human astronaut. The ability for the Robonaut to use its arms and hands to accomplish tasks is vital to its use, as it is expected to aid in assembly missions for the International Space Station and work directly with a wide range of interfaces with special tooling.

viability of life.

The landing of the rovers will be similar to the landing of the Pathfinder spacecraft in that a parachute will be deployed to slow the spacecraft down, and airbags will then inflate to cushion the blow.

The spacecraft could bounce as many as a dozen times and roll a



The Robonaut can perform highly dexterous tasks and is configured with two arms, two five-fingered hands, a head, and a torso. (Courtesy of www.nasa.gov)

whole kilometer before coming to a halt. At that point the airbags will deflate and retract, the petals will open up, and the rover will be revealed.

The rover will waste no time. It will survey the situation around it by taking a 360-degree visible color and infrared panoramic image, then proceed on its mission.

Scientists will monitor the rover's activity daily using images and spectra taken by the rover. They will instruct the rover accordingly, sending it to locations of interest. One major breakthrough for these advanced rovers is that they will be able to travel as far in one day as the Pathfinder Sojourner rover traveled over its lifetime.

Five highly sophisticated instruments will be aboard the two new rovers to explore and analyze samples, along with an abrasion tool to scrape the surface of the planet. A panoramic camera will search for promising geological targets and will work in cooperation with the Miniature Thermal Emission Spectro-

meter, which will identify minerals at the site. To identify iron-bearing minerals, the Mossbauer Spectrometer will be placed against rock and soil targets by the rover's arm. The Alpha Proton X-Ray Spectrometer will determine the composition of the rocks, examining their formation and transformation over time, while the Microscopic Imager will look at the fine-scale appearance of rocks and soils.

These surface operations are expected to last until April of 2004, but may continue longer depending on the physical duration of the rovers.

Visit NASA's Web site at www.nasa.gov for particulars on its current robotic research and projected technological developments that will lead the way to an exciting future in space exploration. P

DIGITAL DOMAIN

(continued from page 18)

"Consumers and the media have the right under the First Amendment to discuss the flaws of products," says Brad Maione, spokesman for the New York State Attorney General's office.

Network Associates, not very credibly, contends that it just wants to make sure that people who write about its

software have the latest version. As a result of the suit, the company is changing the language in its EULAs, says Kent Roberts, the company's general counsel. The company, however, still has egg on its face, which leads to the lesson to be learned.

If any company, in a misguided, Orwellian attempt to control all aspects of its environment, tries or appears to try to subjugate consumers or those

who speak for them, there will be a backlash. Just as voters should rule a democracy, consumers should rule a market economy.

Reid Goldsborough is a syndicated columnist and author of the book *Straight Talk About the Information Superhighway*. He can be reached at reidgold@netaxs.com or <http://www.netaxs.com/~reidgold/column>. P

SEE WHAT TAKES SHAPE. EXERCISE.

American Heart Association 

© 1992, American Heart Association

Electronic Projects 1.0

By Max Horsey

A series of ten projects to build along with audiovisual information to support hobbyists during construction. Each project is complete with schematic diagrams, circuit and PCB layout files, component lists and comprehensive text to guide the hobbyist through the project. A shareware version of CAD-PACK—schematic capture and PCB design software is also provided. Projects include a reaction timer, logic probe, egg timer and seven more. Get your own copy of this CD-ROM today. **\$75 including shipping in the U.S.** Order from CLAGGK Inc., P.O. Box 12162, Hauppauge, NY 11788. Visa, MC, Discover, OK.

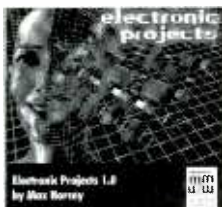

CLX2

ELECTRONIC SECURITY DEVICES

A great book for project builders. It is quite common to associate the term "Security Devices" with burglar alarms of various types. However in fact it can refer to any piece of equipment that helps to protect people or property. The text is divided into three basic sections: Chapter 1 covers switch-activated burglar alarms and includes exit and entry delays. Chapter 2 discusses other types of burglar alarms and includes Infra-Red, Ultrasonic and Doppler-Shift Systems. Chapter 3 covers other types of security devices such as Smoke and Gas Detectors; Water, Temperature and Baby Alarms; Doorphones, etc. Most circuits are simple, and stripboard layouts are provided.



To order Book BP56 and send \$5.99 includes shipping and handling in the U.S. and Canada only to **Electronics Technology Today Inc.**, P.O. Box 240, Massapequa Park, NY 11762-0240. Payment in U.S. funds by U.S. Bank check or International Money Order. Please allow 6-8 weeks for delivery. ET09

THE COLLECTED WORKS OF MOHAMMED ULLYES FIPS

#166—By Hugo Gernsback.

Here is a collection of 21 April Fools Articles, reprinted from the pages of the magazines they appeared in, as a 74-page, 8 1/2 x 11-inch book. The stories were written between 1933 and 1964. Some of the devices actually exist today. Others are just around the corner. All are fun and almost possible. Stories include the Cordless Radio Iron, The Visi-Talkie, Electronic Razor, 30-Day LP Record, Teleyeglasses and even Electronic Brain Servicing. Get your copy today. Ask for book #166 and include **\$9.99 (includes shipping and handling)** in the US (First Class), Canada and Overseas (surface mail), and order from **CLAGGK Inc., P.O. Box 12162, Hauppauge, NY 11788.** Payment in US funds by US bank check or International Money Order. Allow 6-8 weeks for delivery. MA05



RETAILERS THAT SELL OUR MAGAZINE EVERY MONTH

Arizona

Elliott Elec. Supply
1251 S. Tyndell Ave.
Tucson, AZ 85713

California

All Electronics
14928 Oxnard Street
Van Nuys, CA 91411

California Electronics
221 N. Johnson Ave.
El Cajon, CA 90202

Electronics Plus, Inc.
823 4th St.
San Rafael, CA 94901

Electronics Warehouse
2691 Main Street
Riverside, CA 92501

Ford Electronics
8431 Commonwealth Ave
Buena Park, CA 90621

HSC Electronics
5681 Redwood Drive
Rohnert, CA 94928

HSC Electronics
4837 Amber Lane
Sacramento, CA 95841

Halted Specialties Co.
3500 Ryder Street
Santa Clara, CA 95051

Kandarian Electronics
1101 19th Street
Bakersfield, CA 93301

Mar Vac Electronics
2001 Harbor Blvd.
Costa Mesa, CA 92627

Mar Vac Electronics
1759 E. Colorado Blvd.
Pasadena, CA 91106

Mar Vac Electronics
4747 Holt Blvd.
Montclair, CA 91763

Mar Vac Electronics
5184 Hollister Blvd.
Santa Barbara, CA 93111

Mar Vac Electronics
2537 Del Paso Blvd.
Sacramento, CA 95815

Mar Vac Electronics
2000 Outlet Center Dr. #150
Oxnard, CA 93030

Mar Vac Electronics
12453 Washington Blvd.
Los Angeles, CA 90066

Metro Electronics
1831 J Street
Sacramento, CA 95814

Orvac Electronics
1645 E Orangethorpe Ave.
Fullerton, CA 92631

Sav-On Electronics
13225 Harbor Blvd.
Garden Grove, CA 92643

Colorado

Centennial Elec. Inc.
2324 E. Bijon
Colorado Springs, CO
80909

Connecticut

Cables & Connectors
2315 Berlin Turnpike
Newington, CT 06111

Park Dist. Retail Outlet
347 Railroad Ave.
Bridgeport, CT 06604

Illinois

Tri State Elex
200 W. Northwest Hwy.
Mt. Prospect, IL 60056

Maryland

Mark Elec. Supply Inc.
11215 Old Baltimore Pike
Beltsville, MD 20705

Massachusetts

Electronic Hook-Up
104 Main St.
Milford, MA 01757

"You-Do-It" Electronics
40 Franklin Street
Neeham, MA 02494

Michigan

Purchase Radio Supply
327 East Hoover Avenue
Ann Arbor, MI 48104

The Elec. Connection
37387 Ford Road
Westland, MI 48185

Missouri

Gateway Electronics
8123-25 Page Blvd.
St. Louis, MO 63130

New Jersey

Lashen Electronics Inc.
21 Broadway
Denville, NJ 07834

New York

LNL Distributing Corp.
235 Robbins Lane
Syosset, NY 11791

T&M Elec. Supply, Inc.
472 East Main Street
Patchogue, NY 11772

Unicorn Electronics
Valley Plaza
Johnson City, NY 13790

Ohio

Parts Express
725 Pleasant Valley Drive
Springboro, OH 45066

Oregon

Norvac Electronics
7940 SW Nimbus Avenue
Beaverton, OR 97005

Texas

Computers Electronics Etc.
110 E. Medical Center Blvd.
Webster, TX 77598

Electronic Parts Outlet
3753 B Fondren
Houston, TX 77063

Tanner Electronics
1301 W Beltline
Carrollton, TX 75006

Washington

Supertronix Inc.
16550 W. Valley Hwy.
Tukwila, WA 98188

*Barnes & Noble • B. Dalton • Crown Books • Tower Books • Super Stand
Borders Book Store • On Cue • Hastings • Media Play • Walden Book Store
Just About Every Major Book Store!*

**If you'd like to sell our magazine in your store, please circle 180 on
free information card or Contact Gina Giuliano at (631) 592-6720 ext 215**

How to Groom An Engineer

CHRIS LA MORTE

It's every parent's nightmare. The clock shows four pm and yet little Johnny still isn't home. Your mind races through a flurry of lurid images. Sorting the mayhem, it focuses on one image. Two boys in a poorly lit basement. One child removes a plastic baggie from his pocket. Is that what you think it is? Oh no! It is. It's a Faraday pouch! Your child is a closet microcontroller junkie!

Yes, it's true. Children all over are being turned on to electronics and engineering through robotics. A steady bombardment of television programs, toys, hobby kits, and major competitions has lifted these so-called lazy kids to a new status—future engineers. Oh, and these boys and girls mean business. Recently I witnessed two days of an intense FIRST event. What's FIRST? Let me tell you...

A Mission To Inspire. Some of you may be familiar with the standard televised robotics format. Machines roll into a ring and smash each other to oblivion for no apparent reason. One competitor jumps up and down as the other scrambles to recover the servos and gears strewn upon the field of digital death. Well, FIRST is nothing like that. FIRST is an acronym representing "For Inspiration and Recognition of Science and Technology." Founder Dean Kamen had much more in mind than mechanized gladiators when he took up a great challenge—make the youth of America enthused by technology. So each year, children in schools across the nation wait for robot season with much anticipation.

Here is a quick rundown on how FIRST works. To get involved, a school needs to contact the FIRST organization in order to receive all the information needed to form a team (see sidebar for contact info). After the



initial contact there comes the issue of cost. This year's competition fee was \$5000 plus additional costs including extra parts, pizza, etc. This is where FIRST truly shines. Part of the program's goal is bringing together business and community. So schools fundraise and form sponsor partnerships with various organizations and companies from around town.

In addition, each team is supplied with their very own set of engineers. These

engineers are the catalysts who mentor the children. Parents are also encouraged to participate. Robotics is a multidisciplinary science, and being such, parents need not be engineers themselves. Whether you're like Mr. Paul Miele, an auto mechanic willing to volunteer tools and skills after work, or a retired engineer who has a steady solder arm and wants to help tinker, you can become part of the team.

In return for their entrance fee each receives a basic kit. The kit includes most of the parts needed to create a robot, as well as an explanation of the particular contest/game the robot must perform. There is one catch. You won't find any schematics or parts layouts. The kit contains no plans—just an

Are children being inadvertently drawn towards engineering through Robotics?

explanation of how the year's specific competition works and an assortment of parts to form the robot's foundation

(Oh Dean, you wily engineer, you!). Not only are there no plans, but also the students and engineers have only six weeks to brainstorm, design, build, and test their robot before it is crated up and shipped off to the competition site. The average robot is up and running within three weeks. As one engineer joked, "If this was the Department of Defense it would take six weeks to figure out who should be the team facilitator."

GETTING INVOLVED WITH FIRST

If you want to organize your own school team or have the time and dedication to volunteer, then contact FIRST by calling 800-871-8326 or 603-666-3906. You can also visit their Website at www.usfirst.org or write directly to FIRST, 200 Bedford Street, Manchester, NH 03101. Representatives can send you some literature describing the program and also answer any questions regarding how to start a new team or help an existing one in your community. We cannot stress enough how important corporate sponsorship and volunteerism is to this program. SO what are you waiting for? Grab your multimeters and slide rules and head on down to your nearest school.

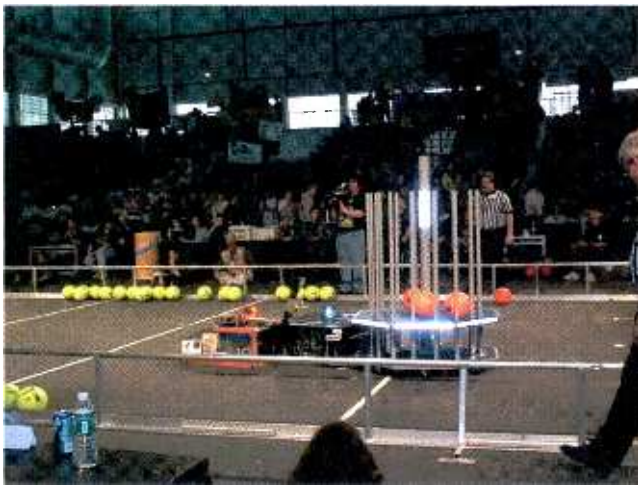

And let the games begin! Robots are seen here engaged in high-stake competition. Teams lead their 'bots to victory via wireless links and joystick/throttle interfaces. The games culminate at Epcot Center, where founder Dean Kamen will be the host.

March Madness With Automatons. After all the robots are corralled, the competition begins with regional contest held across America. I was fortunate enough to witness the Long Island Regional at Suffolk Community College in Brentwood, New York. The three-day event began on a Thursday with a Pit Opening. This is when each team was dramatically reunited with their robot. There was tweaking among tears, as inventors and engineers made their final preparation for the following two days of grueling team competition.

Friday morning the festivities began. A huge screen

THE PSICOTICS

Here is The Ail'Keyspan and Lindenhurst Senior High School Psicotics. In no particular order we have: Angelo Santoro, Brian Chamberlain, Neil M. Heft, Tom Graham, Meg Mckenna, Eric Miele, Sean Sheriff, Tom Graham, Jeremy Graham, Rob Brazier, Greg Doelgeri, John Stebe, Steve Christ, and Matt Hcrjus. Also involved, but not shown, are Paul Miele and Louis Caso. Thanks again for inviting **Poptronics** down to the shop in order to witness one of the up and coming dynasties of the FIRST program.



displayed the action for the moderate mob that had been mustered to the opening rounds. Robots were paired together and split into red and blue teams—distinguished by their “Starsky and Hutch” magnetic warning light. The competition would take place in a well-cordoned playing field. The operators, standing behind a plastic shield, control the robots using joysticks and throttles via wireless link. The game seemed to go like this: robots must place balls into a cylindrical goal. After the goal is filled, then a robot must move the goal into a scoring zone. Once in the zone, the team collects points. While one member is trying to score, the other teammate can either help its comrade or hinder its opponent. And throughout the entire event the audience is raging on. By Saturday's rounds, the audience had grown to maximum capacity and the complex was roaring.

Now, I've never seen that cable robot show in person, but this stuff was entertaining and free to the public. Speckled throughout the crowd were scores of dusty engineers smiling gleefully. It finally came back—the love for science. Now that all the regional competitions are settled, the top teams soon move on to Epcot Center in Orlando, Florida. Here the final contest will be held to crown the champs of 2002. Founder Dean Kamen will also be there to lend his support for what has become a highly motivational program. Beyond the hype and excitement, children are also showing signs of increased interest in science, math, and technology. Class performance in these subjects has also increased.

Inspiration Index Rising. I've seen for myself just how impressive the results are. In March I visited with the Psicotics team from Lindenhurst Senior High School. The team receives sponsorship from Ail'Keyspan. Neil M. Heft and Thomas Graham of EDO Electronics System Group of Deer Park both volunteer engineering support and mentoring to the students. The team was organized by the school's Technology Department. Teachers/Coordinators Angelo Santoro and Louis Caso have full support of Department Chairman Brian Chamberlain, as well as the Superintendent of Lindenhurst Schools, Meg Mckenna. Both Mckenna and Chamberlain were beaming as they told me a story of last year's triumphant team leading the school

RECOMMENDED ROBOT REFERENCES

If your kids are looking to learn more about robotics, you should take a look at these products.

A great read at \$44.95, "Microcontroller Projects Using the Basic Stamp, Second Edition" is written by Al Williams and available from CMP Books.

If you are looking for a hands-on kit that incorporates a CD chock full of projects, as well as a ready-to-assemble robot, then try the "Build Your Own Robot Kit" available from McGraw Hill and soon to be available at Amazon.com. The kit lists for around \$60 and comes with a \$15 off coupon for a Basic Stamp II microcontroller.

Parallax's line of robotics and microcontrollers can be found at www.parallaxinc.com The Basic Stamp II lists for under \$50. Parallax's Stamps In Class Program is an affordable curriculum hat offers discounts to educational institutions.

Finally, for the more advanced robot builders, be on the look out for *Evolution Robotics*. This fledgling brand offers a *Robot Developer Kit* for the list price of \$1495. The price should hint that this is no toy. The creators of this Linux-based kit have targeted OEMs and developers who are interested in creating robotics for industry and consumers. The big plus is everything is planned to be open source and in the fall a Windows-based system is due out.

pep rally, their champion robot rolling on before them into the roaring cheers of their peers.

It seems that "Robot Season" has carved a niche for itself among the more popular fall sports. The school even had plans to bus their students to the competition for support during the games. The atmosphere at these events is truly electric (pun intended after the fact). When you arrive you quickly absorb the screaming fans dressed in supporting



The Psicotics look over their robot and perform some interim tweaking in the Pit area. Teams from around the Tri-State area converged in Brentwood, Long Island for one of many regional contests held across the country. Students, teachers, volunteers, and spectators flooded this college arena.

colors, air horns, and reverberating announcer. It was more exciting than an outdoor Homecoming routing if you ask me. We're talking about children and young adults ecstatic and consumed by technology and its application. Now, a man in my position sees that as a healthy demographic waiting to be popped. FIRST has managed to revive a youth culture that has been dormant for nearly fifty years—teenage inventors. Sure, computers have kept kids busy for the past thirty years, but what happened to the young electronic hobbyist? No doubt they have found refuge in programs like FIRST, television shows like *Junkyard Wars*, and the horde of remote controlled toys that seem to be multiplying like cockroaches. Hmmmm...can you say Robot Boom?

What It All Means. So "what's the big deal?" you ask. Plain and simple...the future of technology has grown brighter. After decades of hearing how children of the West were failing to produce results in Math and Science, now there seems to be a reversal of the norm. Dean Kamen has proven that it just takes a couple of doses of fun and healthy competition to jazz up the often-dull subjects of science and math.

The FIRST program has been active for at least a decade now and already the ripples have spread throughout most of the country. Even some British students were involved in the Long Island competition. Of course it will take time, energy, and generous contribution of skills and cash to bring the event to all students. As any parent of a young "Einstein" knows, those robots can get awful expensive. And this is where we see the underlying theme of FIRST—bringing community and local business together into a symbiotic existence. It's nice when the local power company pitches back to its customers.

So, with this I dare issue a call to all engineers, hobbyists, and all those willing and able to try to find some time to volunteer your skills to your community. Together we can brainstorm and build our way to a brighter future. P



Two teams stand shoulder to shoulder at the controls as they fight to see who will take home the honors of Long Island Regional Champion. Students across the country are catching the engineering bug.

STEPPER MOTORS AND DRIVE METHODS

WILLIAM SHEETS, K2MQJ, AND RUDOLF F. GRAF, KA2CWL

Often a mechanical operation or function is required in an application. This may in turn require a motor or other mechanical device to position a load or device. Examples are computer peripherals (scanners, disc drives, etc.), cameras, telescope and satellite-dish positioning systems, robotic arms, and numerically controlled machine tools.

While a conventional DC or AC motor can be used, it is difficult to accurately determine the exact position of the load, motor speed, or how much total motion has been produced, unless there are external positioning sensors, encoders, servo loops, and

controlling devices (brakes, clutches, etc.). Many motors run at a speed in RPM that is too high, and this involves using a gear train to reduce the speed and increase the torque to useable levels. While this may not always be a problem, conventional motors can be difficult to use for certain applications.

Where very high speed is not a factor and precise control is desired, a stepper motor may be advantageous. Many applications require lower speeds, below a few hundred revolutions per minute; and often conventional type motors include integral gear-speed reduction systems. A stepper motor is a device that translates an electrical signal to a change in position of a shaft or other actuator. This is usually a linear translation or rotation. Unlike a conventional DC or AC motor, this is usually a discrete quantity and occurs when a pulse or other signal is applied.

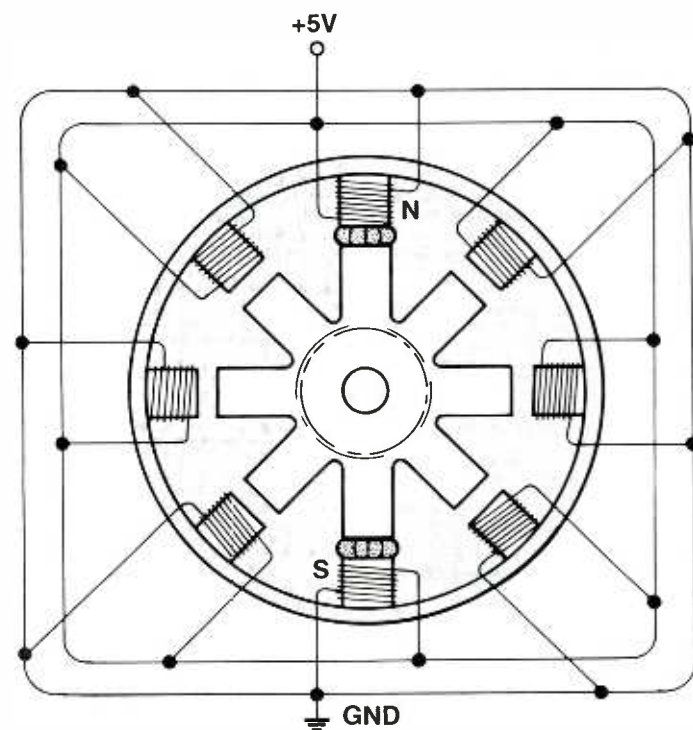

Read all about stepper motors and how they could be used in the construction of robots.

DC or AC motors are driven continuously, while a stepper motor is driven generally by pulses. Stepper motors are somewhat similar to reluctance motors, i.e. they depend on attraction or repulsion of magnetic structures and derive their torque solely on the change of reluctance of a magnetic circuit. On the other hand, a conventional motor derives its torque from the interaction of current-carrying conductors with magnetic fields.

A stepper motor cannot draw a higher current in a stalled rotor condition to rapidly accelerate a load from rest to speed. This stalled rotor condition is momentarily encountered during startup of conventional motors due to mechanical inertia. It causes an initially high current to be drawn by the motor. DC and AC motors can, within reason, draw the higher current they need to start up quickly. Stepper motors depend on reluctance torque only, so they can not start up as large a load as a comparable conventional motor. A stepper motor will move a load a certain discrete amount for each pulse applied, and then stop and do nothing until another pulse is applied.

Figure 1 shows a basic stepper motor. The armature, or moving part, is a magnetic structure that may be only soft iron (reluctance type) or may be a permanent magnet itself (hybrid type). Several electromagnets (poles), called the stator, are arranged around the armature, or rotor. When the electromagnets are energized as shown, the rotor will turn until it lines up with the opposite poles. The figure shows the final posi-

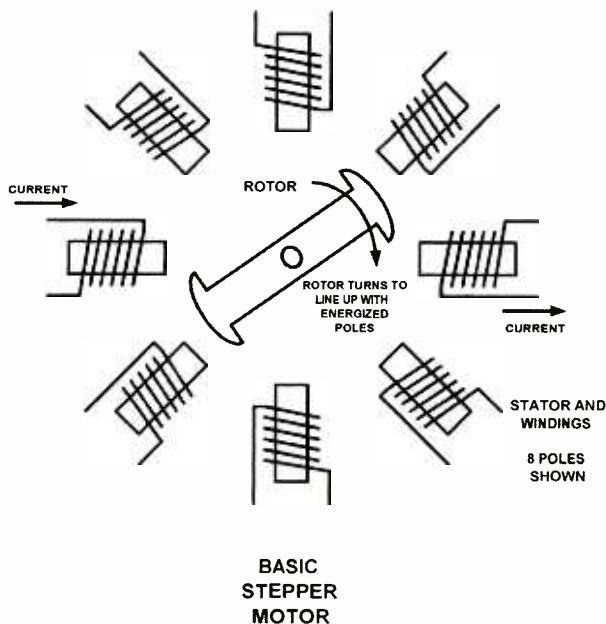

Fig. 1. This figure shows a basic stepper motor. The armature, or moving part, is a magnetic structure that may be only soft iron (reluctance type) or may be a permanent magnet itself (hybrid type). Several electromagnets (poles), called the stator, are arranged around the armature, or rotor.

tion of the rotor, as well.

If two adjacent stator magnets are energized so that the polarity is the same, the rotor will tend to line up between these poles such that the magnetic circuit has minimum reluctance—the easiest path for the magnetic lines of force. After this occurs, nothing else will happen. The electromagnets have a steady state current now flowing in their windings.

Current Flow. The current flow will hold the rotor in position and a certain externally applied torque will be needed to move the rotor out of this position. This current flow acts as a brake, and, therefore, no external brake mechanism is needed. This force will be from several inch-ounces to several hundred inch-ounces, depending on the motor. Motors with a permanent magnet rotor have a residual magnetism present, and, therefore, a braking effect still exists with no current flow in the stator windings. Stepper motor speeds are typically from zero to a few hundred RPM, and they are best suited to low-speed applications.

Naturally, a stepper motor physically like the one shown would not be very useful as only large angles of rotation (45 degrees or multiples of this) could be obtained unless gearing was used. Real-world stepping motors have toothed rotors that often will resemble a gear, 48 or more discrete steps, with usually 200 or sometimes 400 steps. This allows 1.8 degree or 0.9 degree increments respectively, or even smaller by using half or mini-stepping methods.

Common stepper motors are usually two or four phase, depending on the number of windings on the stator. Usually there are two or four, and often the windings may be connected internally to reduce the number of external leads. This is often done with the ground connections. All stepper motors will have at least two phases, with four commonly used. There are

also six-phase stepper motors available.

Three Variations. There are three basic types of stepper motors. The VR (variable reluctance) type has a soft iron rotor and can be turned when de-energized, since there is no holding torque. The PM (permanent magnet) type has a radially magnetized rotor. This type has detents when de-energized, which may present a problem in some applications. It is not suitable for small step angles. The hybrid type has an axially-polarized rotor with two sections—one with all north poles, the other with all south poles—and is a combination of the VR and PM type. The hybrid and variable reluctance types are the most commonly used.

Advantages and Disadvantages. Stepper motors have several advantages:

- They can be operated in open-loop systems.
- Position error is that of a single step.
- Error is non-cumulative between steps.
- Discrete pulses control motor position.
- They interface well to digital and microcontroller systems.
- They are mechanically simple, brushless, and highly reliable.

Disadvantages are:

- Fixed increments of motion
- Low efficiency, driver choice important
- High oscillation and overshoot to a step input
- Limited power output
- Limited ability to handle large inertial loads
- Friction errors that can increase position error

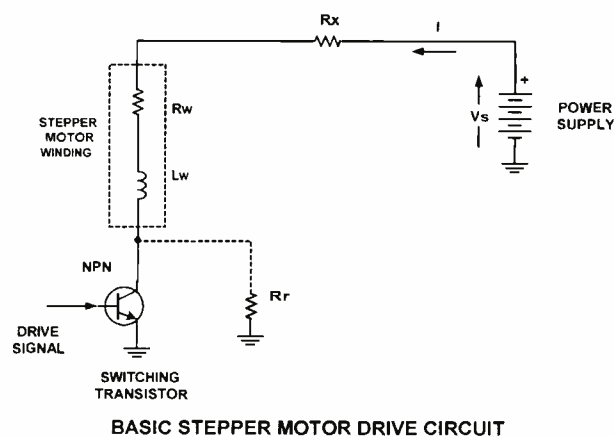
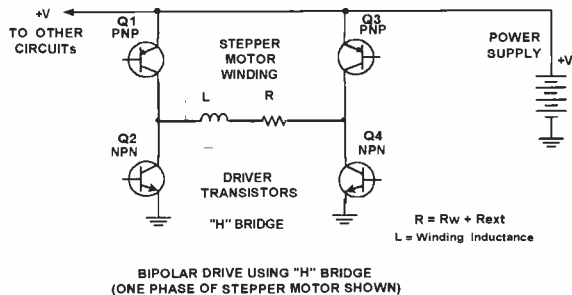
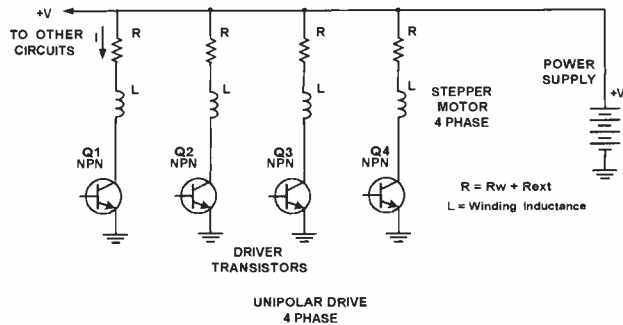

Fig. 2. Using a switching transistor, motor winding, and power supply you can build a simple stepper motor circuit. The circuit schematic above shows how these parts would interconnect.

Drive Schemes. Stepper motors must be interfaced with drive circuitry in order to be useful. There are many drive schemes. The scheme chosen should be consistent with the technical requirements, motor type, economic requirements, and available components and interfacing.

Basically, the problem is to drive the stepper-motor windings, which are represented by a series circuit containing resistance and inductance (R-L circuit). These windings must be driven with correct current



STEPPER MOTOR DRIVE CONFIGURATIONS

Fig. 3. Unipolar drive uses a bipolar motor winding, with one coil energized at a time, current flowing in only one direction. H-bridge IC drivers are available for the power stages that drive the windings. Alternatively, complete IC devices including drivers can be used if preferred.

and voltage drive levels and pulse widths. Normally, a series resistance is used to limit the current, or a constant current source can be used.

The time constant of the L-R circuit is equal to L/R, which means that a low inductance, high resistance circuit will have a shorter time constant. This implies using a high voltage and a high circuit impedance, or a current source. Power supply voltages may be 12, 24, 48, or higher. The higher voltages are advantageous in allowing a larger series resistance and shorter L-R time constant.

From the driver point of view, the problem is one of driving a series L-R circuit, while maintaining good control of waveforms and avoiding damage from inductive switching transients. Either bipolar or MOS technology can be used for the drivers and the associated logic circuitry. While MOS has the advantages of "rail-to-rail" capability, at most reasonable voltages this is not usually a problem. Bipolar devices are usually adequate. Several approaches can be used. While discrete component circuitry can be built up from individual components, it may be simpler and more cost effective to use IC devices for this function, at least for the logic, sequencing, and control circuitry.

A basic driver circuit is shown in Fig. 2, using a switching transistor, motor winding, and power supply. Study this circuit along with the following definitions.

- V_s = power-supply voltage
- R_x = external resistance (includes that of power supply)
- R_w = motor-winding resistance
- R_r = leakage resistance across switch
- L_w = motor-winding inductance

The initial current, when the switch is open is:

$$I = I_0 = V_s / (R_x + R_w + R_r)$$

When the switch is closed, the current will be:

$$I = I_0 + (V_s (1 - e^{-t/T}) / (R_x + R_w))$$

where

$$T = \text{time constant} = L_w / (\text{Total Circuit Resistance})$$

This says the current will rise suddenly and gradually approach the value of

$$I = I_{\text{final}} = V_s / (R_x + R_w)$$

After a period of three time constants, the current will be about 95% of its final value and after five time constants, the current will approach the final steady state value within less than one percent. It is the property of an inductor that the current cannot change instantaneously in the absence of impulses. Therefore, when the switch transistor turns off, the final current keeps flowing through a total circuit resistance of $(R_x + R_w + R_r)$, which can be very high. A very high voltage

PHASE \ STEP	1	2	3	4
1	ON	OFF	OFF	OFF
2	OFF	ON	OFF	OFF
3	OFF	OFF	ON	OFF
4	OFF	OFF	OFF	ON

FULL STEPPING

PHASE \ STEP	1	2	3	4
1	ON	OFF	OFF	OFF
2	ON	ON	OFF	OFF
3	OFF	ON	OFF	OFF
4	OFF	ON	ON	OFF
5	OFF	OFF	ON	OFF
6	OFF	OFF	ON	ON
7	OFF	OFF	OFF	ON
8	ON	OFF	OFF	ON

HALF STEPPING

STEPPER MOTOR DRIVE MODES

Fig. 4. The chart represents one phase at a time, in a 1-2-3-4 sequence. The shaft rotation direction is controlled by the sequence, reversal of which will reverse the direction. The sequence is called wave drive.

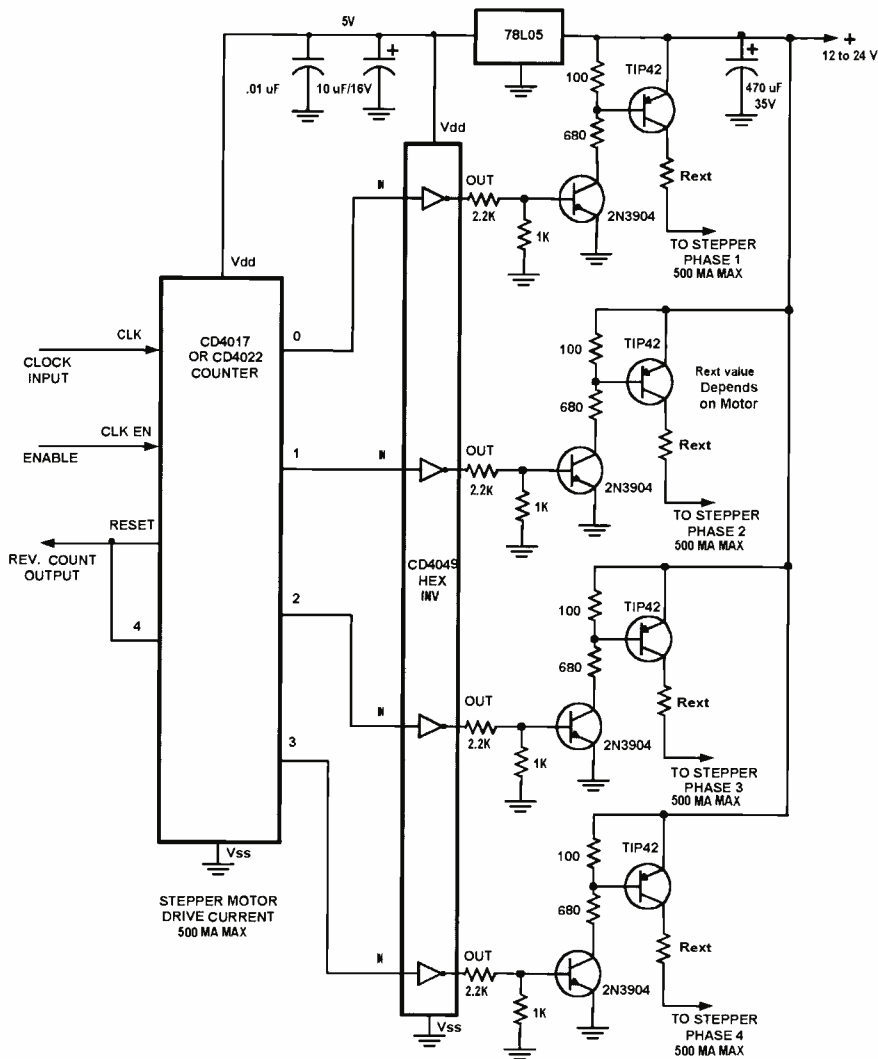

**STEPPER MOTOR DRIVE CIRCUIT
FULL STEPPING
4 PHASE UNIPOLAR DRIVE**

Fig. 5. This schematic shows a typical unipolar driver circuit using TIP32 or TIP42 plastic power transistors and a few logic gates. This circuit will drive many four-phase surplus stepper motors and can be used to experiment with or to test motors you may have already in your stock of parts.

appears across the switch transistor. It could reach several thousand volts, but practical limitations such as stray capacitance and the breakdown voltage of the switch transistor limit this. Nevertheless, the switch transistor(s) must sustain this high voltage.

Note that the current takes time to reach its full value, and this time is decreased for high values of circuit resistance and lower winding inductance. However, higher resistance means higher voltages must be used to obtain the necessary drive current. This requirement makes more demands on the switching transistors with regard to voltage breakdown.

For short excitation times, the current may not have time to reach the desired value unless special measures are taken. The ability to rapidly turn on and turn off the current in the windings directly affects the rate of stepping that can be achieved for a specified level of performance of the stepper motor.

There are two basic drive formats used to drive step-

per motors (see Fig. 3). Unipolar drive uses a bipolar motor winding, with one coil energized at a time, current flowing in only one direction. This format does not fully use both windings. At low step rates, torque and performance are sacrificed. However, the drive circuitry is simplified, since only one switch transistor per winding is needed.

The bipolar format employs a reversal of winding current to reverse the stator flux. Current flows in all windings at the same time. Full use is made of the windings, and at low and medium step rates performance is improved. However, this format requires more complex drive circuitry, since a bridge-type driver output circuit is required—generally an H bridge. See the figures for driver configurations. H-bridge IC drivers are available for the power stages that drive the windings. Alternatively, complete IC devices including drivers can be used if preferred.

Alternative Stepping Methods.

In addition to these basic formats, there are several others. They are called full-step, half-step, and mini- or micro-stepping. They differ in the energization sequence or polarity of the current in the windings, at various times. An illustration of these stepping methods is shown in Fig. 4. The chart represents one phase at a time, in a 1-2-3-4 sequence. The shaft rotation direction is

controlled by the sequence, reversal of which will reverse the direction. The sequence is called wave drive. Since one winding is energized at a time, it consumes the least power. Positional accuracy is good, since the rotor and stator teeth are aligned at one time. This is a full-step mode, with a step angle of 360 degrees divided by the number of steps per revolution. This method can be used with either unipolar or bipolar drive format.

Another full-stepping method employs sequentially energizing two adjacent motor phases, in a 1-2, 2-3, 3-4, 4-1 overlapping sequence. This method uses two windings at a time and gives a higher torque, better damping, and better immunity to resonance effects. However, it uses twice the drive power since two phases are used at once and can suffer from imbalance. Any variation in the windings or driver can unbalance the magnetism produced by two adjacent windings, and they may not be exactly equal. This unbalance can cause detent position errors, since the

effective pole lies between the adjacent pole positions.

Yet another method is called half-stepping or alternating drive. This method combines the two previous methods, in a 1, 1-2, 2, 2-3, 3, 3-4, 4, and 4-1, yielding double the number of steps as compared to the two previous methods. The wave drive has stable positions when the rotor teeth are aligned, and the overlapping drive has stable positions in between two rotor teeth. Such a design effectively doubles the angular resolution, making 400 steps from a 200-step motor, for example. It produces smoother operation, is quieter, and has better acceleration characteristics. However, more complex drive and logic circuitry is needed to generate the signals for the switching transistors.

For even finer steps, mini- or micro-stepping can be employed. Half-stepping uses one or two phases fully excited. If one phase were to be fully excited, while the other were only half excited, a new stable position would be generated. In the previous sequence, instead of 1 followed by 1-2, we would have 1 followed by 1 plus half 2, then 1-2, then half 1 plus 2, then 2, and so on. This sequence would yield quarter steps,

giving 800 stable positions for a 200-position motor, as compared to using full stepping. It can be carried even further into "micro"stepping, by varying the drive

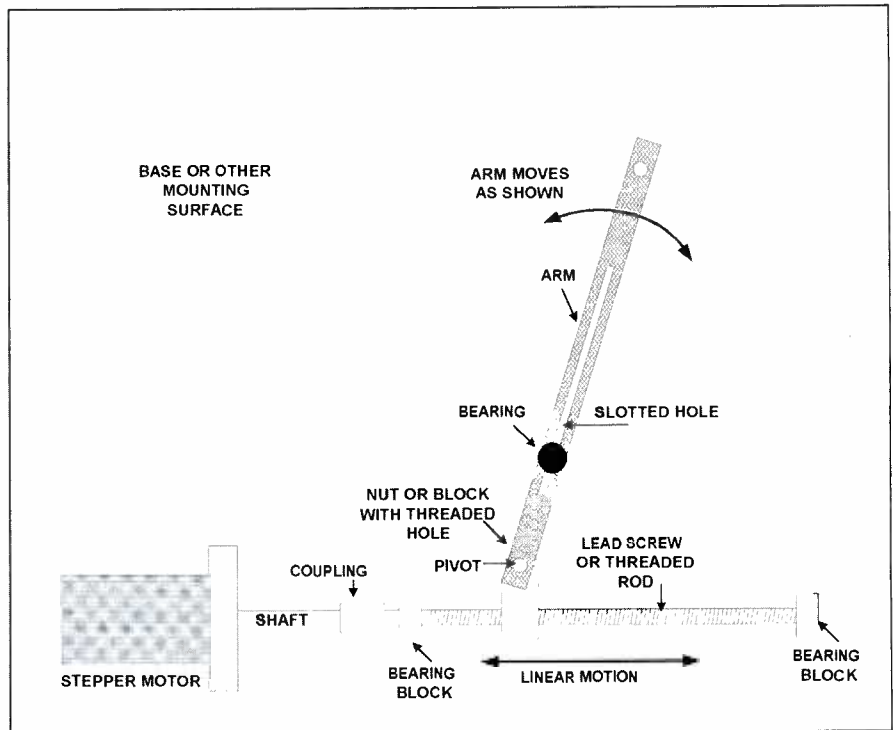

INTERFACING A STEPPER MOTOR TO A MECHANICAL LINKAGE AND ARM USING A LEAD SCREW

Fig. 6. The stepper motor can be mechanically coupled to a gear train or pulley system to reduce its speed and increase torque, and/or to a cam or mechanical linkage to drive an actuator to do a required task. One such application is a positioning mechanism using a screw thread and a nut.

BASIC STEPPING MOTOR TERMS

Damping—Control of motor overshoot, controlled electronically or mechanically.

Drivers—Circuitry for interfacing stepper motors to power sources. Contains logic, power supplies, switching transistors, and connections to external interfaces.

Holding torque—The amount of externally applied torque needed to break away the motor shaft from its holding position, with rated current and voltage applied to the motor.

Pulse rate—Rate at which windings are switched in pulses per second. If one pulse steps the motor one step, it is also the stepping rate of the motor.

Ramping—Variation of pulse frequency to accelerate or decelerate stepping motor. Useful for high-speed applications or with loads with large inertia.

Residual Torque—Present only in motors with a permanent magnet rotor, it is the torque present as a result of rotor magnetism under power-off conditions.

Resonance—Mechanical natural frequency of a motor assembly due to mass and "spring" tension from

magnetic forces. It can be controlled mechanically or electrically.

Start/Stop without error—Maximum step rate at which a motor can start or stop without losing either steps or synchronism.

Step accuracy—Non-cumulative error expressed as a percentage of step increment. As an example, a 1.8 degree step with a 5 percent error may actually be 1.71 to 1.89 degrees.

Step angle—Angular increment the motor shaft rotates with each activation of the windings, in degrees. The step angle divided into 360 degrees gives the number of steps per revolution.

Step response—Mechanical output of the motor versus time in response to a unit step input.

Steps per second—The number of angular movements per unit time.

Translator—Circuitry to control motor-switching sequence, so one input pulse moves rotor one step.

currents in four excitation levels, giving eight positions per step, or 1600 total. As one may imagine, this scheme can become quite complex and more expensive. However, with LSI IC devices, it can be quite feasible. Care must be used in maintaining drive waveforms, as more steps demand more precision as to drive currents, in contrast to the simple on-off requirements of full- or half-stepping.

Drive Applications. Single-ended stages may be used for unipolar stepper-motor drive applications. However, for bipolar applications, a dual-polarity driver is required, such as the "H" bridge shown in Fig. 3. This design uses four transistors. Each transistor has a driver included to form Darlington pairs. This structure can easily be made in monolithic form. Components Q1 and Q3 are PNP, while Q2 and Q4 are NPN devices.

Take care that Q1 and Q2 are not turned on at the same time, as this would cause a short circuit across the power supply, with large current spikes. The same caution applies to Q3 and Q4. In this circuit we have two voltage drops, one in each transistor pair, resulting in a loss of 1.5 to 3 volts of supply voltage, but this is usually not a problem.

The use of a monolithic array for Q1 through Q4 including their drivers is a good idea, since it simplifies PC board layout and eliminates possible transistor-matching problems.

The design of the driver circuitry is another topic—we will not go into this aspect of stepper motors in this article. Figure 5 shows a typical unipolar driver circuit using TIP32 or TIP42 plastic power transistors and a few logic gates. This circuit will drive many four-phase surplus stepper motors and can be used to experiment with or to test motors you may have already in your stock of parts.

Note also that the waveforms needed can easily be generated using a microcontroller. The microcontroller can also be programmed to perform other necessary functions, such as on-off, positioning, counting, speed control, stepping mode (full, half, etc), speed regulation, and fault protection. The drive waveform(s) can be generated with a routine incorporated into the microcontroller firmware. From the viewpoint of the experimenter, the microcontroller approach has the advantage of programmability for specific applications and is probably the most versatile way of generating stepper-motor control signals.

Stepper motors are somewhat expensive when purchased new, but you should be able to find used ones on the surplus market. The throw-away mentality plus the rapid obsolescence and disposal of so much computer and office equipment that is prevalent today should provide sources of usable stepper motors for the experimenter. Check out, in particular, junked scanners, fax machines, drives, and old copiers; you may find some useful stepper motors for free. You can accumulate a wide variety of hardware and components useful in robotics as well.

Mechanical Applications. The stepper motor can be mechanically coupled to a gear train or pulley system

to reduce its speed and increase torque, and/or to a cam or mechanical linkage to drive an actuator to do a required task. One such application is a positioning mechanism using a screw thread and a nut. This setup drives a cam and linkage that in turn positions an arm. It could also be used to position a video camera or a steering or control linkage.

This mechanism is easily assembled from hardware store components and does not need expensive and often difficult-to-locate gears. It is shown in Fig. 6. Some mechanical applications will require speed reduction or translation of motion from linear to rotary, and vice versa. The screw thread and nut will perform a rotary-to-linear translation, but not the reverse. Linear-to-rotary translation will possibly require rack and pinion gears, pulleys, or friction-drive components such as wheels and belts.

Gears are commonly available from surplus houses if you do not have exact requirements and also can be obtained from junked machines and appliances. If you need a specific type and size, they can be obtained from vendors, but be prepared to pay. One can collect many metal and plastic gears from discarded items and appliances, but your projects must be designed around what you have.

Another possible method is to use pulleys and belts. These can be salvaged from old equipment as well, and pulleys can also be homemade from wood or plastic or obtained at hardware stores in various sizes. Friction drive components can also be obtained from junked items such as old cassette and reel-to-reel tape decks, discarded turntables, and also small appliances. Stepper motors can therefore be used in robotic and other applications in a number of ways and also may simplify those applications needing exact positioning without using positioning sensors and feedback techniques. P

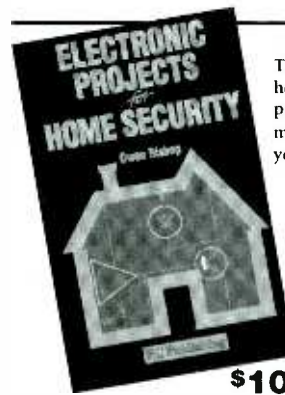

This book deals with many aspects of home security – intruder, fire and flood protection – with the emphasis on how to make the best of electronic devices that you can build yourself

Electronic Projects for HOME SECURITY

- Projects to help secure your home •
- Principles of operation explained •
- Constructional details given •
- Suitable for beginners •

\$10.99

There are 25 constructional projects, ranging in complexity from a single-door protection circuit, that can be built in an hour or two, to a sophisticated multi-channel security system, that most intruders will find very difficult to beat.

ELECTRONICS TECHNOLOGY TODAY INC.
 PO Box 240, Massapequa Park, NY 11762-0240

Yes, send my copy of PCP115 ELECTRONIC PROJECTS FOR HOME SECURITY by Owen Bishop to the address at right. I am enclosing \$10.99 plus \$4.00 shipping charges in USA and Canada. All payments must be made in US funds. Sorry, no orders accepted outside of USA and Canada. New York State residents add local sales tax. Allow 6-8 weeks for delivery.

Please charge my Visa MasterCard

Signature _____

Card # _____ Exp. Date _____

Name _____

Address _____

City _____ State _____ ZIP _____

MA10

Bi-Pedal Walker Robot, Part 1

Readers of this column have seen walker robots before. This month we shall begin construction and programming of a bi-pedal robot. Bi-pedal robots more closely resemble humans, because they use two legs to walk. Bi-pedalism is a necessary step to creating advanced robots that can work and function in human environments. The heart and mind of this robot is the 16F84 microcontroller. The microcontroller will be programmed using the PicBasic Compiler (or PICBasic Pro). Muscles for motion are generated using a series of six servomotors, three servomotors for each leg.

The Design Stage

Before we begin, allow me to outline a few important design parameters. First, this robot is a work in process. Most projects outlined in my column have already been completed and tested before I write them up—this is an exception. So if you decide to walk down this path with me, you are warned. Second, I am not taking any shortcuts to building a successful bi-pedal robot, meaning this robot is a true bi-pedal walker robot. This parameter demands that the robot must balance itself on one leg in order to lift the other leg to initiate walking. This eliminates any type of low-tech bi-pedal walker that use oversized feet to keep the robot from tipping over when movement proceeds from one leg to the other. You may have seen this type of “big-foot” walker—they usually have a cam action that rises and moves one leg after the other.

My initial design calls for using three servomotors in each leg (see Fig. 1). I anticipate this walker to move with a walking gait resembling that of the flamingo bird. This particular bird has a reverse knee joint. If the flamingo doesn't bring a clear enough picture to mind, perhaps the Imperial walker from the original *Star Wars* film(s) will suffice. The three servomotor legs may be one joint, or servomotor, short. Nature has evolved a three-

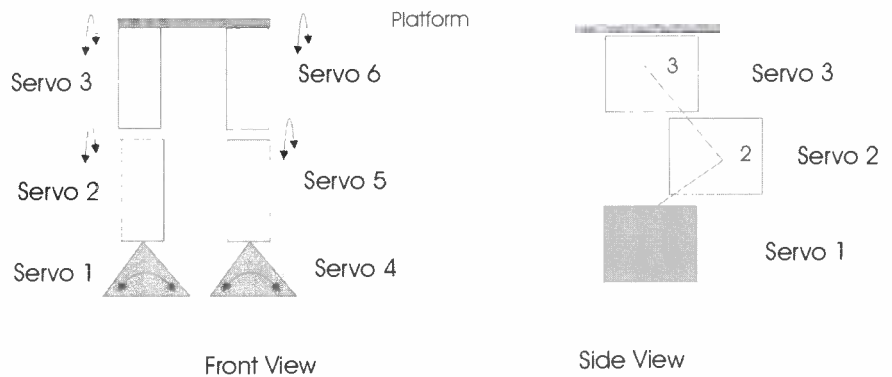

Fig. 1. My initial design calls for using three servomotors in each leg. I anticipate this walker to move with a walking gait resembling that of the flamingo bird. This particular bird has a reverse knee joint.

jointed leg for most walking animals. While it may appear our leg has three joints, because it has three servomotors, I still feel it is essentially a two-jointed leg. The reason is our first servomotor, starting from the bottom of the leg, is a one-directional ankle that can only tilt in one direction. Humans have two-directional ankles—this requires two servomotors to replicate our leg.

So depending upon how you want to look at it, the middle servomotor could

be considered either the second servomotor for the ankle movement or the knee joint. If you want to get an idea of how difficult it is to walk on a two-jointed leg, put yourself in a kneeling position on the floor. Now start walking on your knees.

A Question Of Balance?

When we walk, we receive constant feedback from our leg muscles and feet such as stretch, tension, and load, in

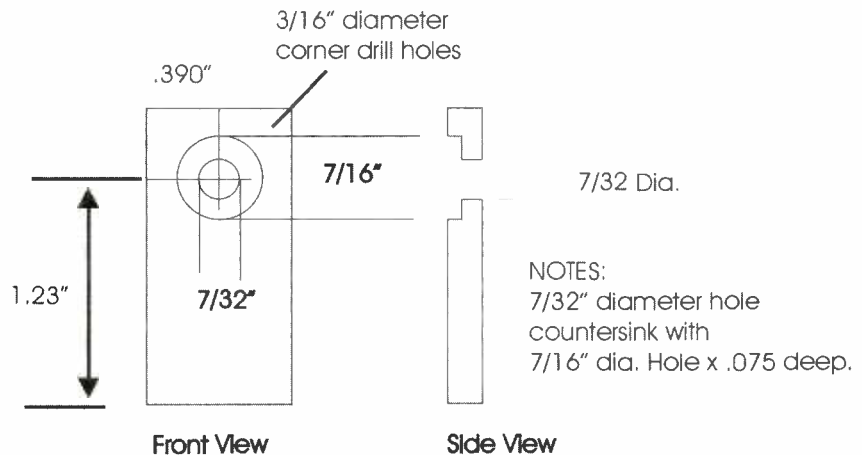

Material Dimensions .781 x 1.625 x 3/16" thick

Fig. 2. The first component is a servo-shaft component. The 7/32" diameter through hole is countersunk with a .460 diameter x .075 deep hole.

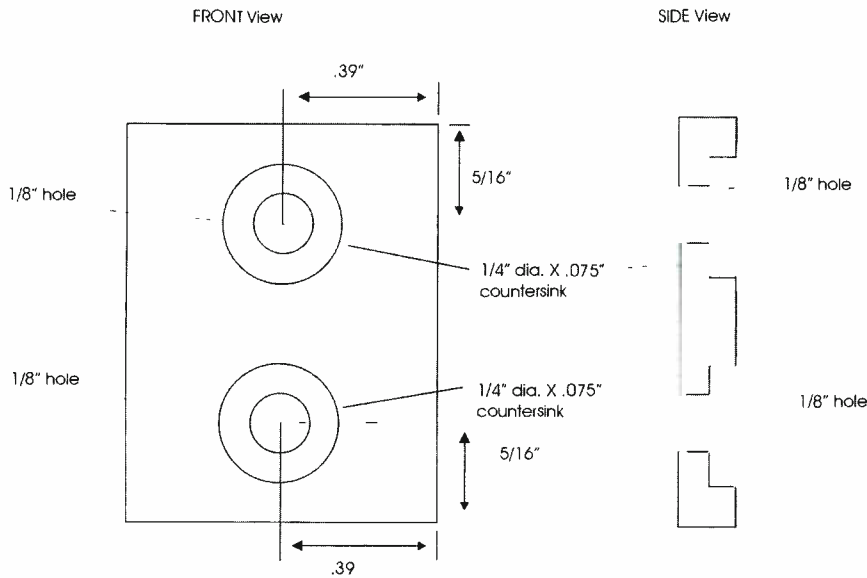

MATERIAL 1.1875 inch x .781" x 3/16" thick

REV A.

Changes: material length, hole sizes and location

Fig. 3. The second component is our bottom connection component. The two 1/8-inch diameter holes in this component are also countersunk, with a 1/4-inch diameter by .075 deep hole so that the pan head of the 4-40 threaded machine screws lies flush with the bottom of the component.

addition to having tilt and balance information present from our inner ear. Remove this physical feedback information and remove any visual clues, and it becomes much harder to walk. Imagine how much harder, if not impossible, it would be to learn how to walk without sensory feedback.

This lack of feedback is a dilemma for robotics. It is possible to program a bi-pedal walker robot to walk without feedback and a sense of balance. To do so, exact position control and movements are measured for each leg servomotor action; each action sequence is programmed into the microcontroller; the program is initiated; and the sequence repeated to achieve a walking gait.

This brute force programming works, but it is not adaptive. If any weight on the robot shifts (battery pack moves) or

if you have the robot carry a weight—anything that changes the robot's center of gravity, the program will need to be adjusted. A little sensory feedback may help the robot walk and be more adaptive.

A Little Feedback

Feedback comes in many forms. The sensor I am attempting to incorporate into this robot is a pressure sensor. I will be placing a pressure sensor on the base of each footpad. The sensor will tell the microcontroller when there is no pressure (weight) on a foot. This information will be used to tilt the robot until there is no weight on the opposite footpad.

The sensor is a flexi-force pressure sensor (see photo). This particular sensor is made to detect pressure from 0 to 1 lb. While the final weight of the robot may be slightly more than the sensor's top

weight, I feel it's a better (more sensitive) choice than taking the next sensor that measures pressure between 0 and 25 lbs.

The pressure sensor is a variable resistor type. As pressure increases, its resistance drops. Since we are using the sensor to determine when there is zero weight on a leg, we don't need to perform an A/D conversion to read varying pressure (weight). Instead we can use an op-amp and comparator. The op-amp converts the resistance change in the sensor to an electrical change. The comparator is set to trigger on zero weight. The output of the comparator can be read by the microcontroller as a simple high-low signal.

We will build the weight-sensor circuit next month.

Dimensions .781 x 1.625 x 3/16" thick

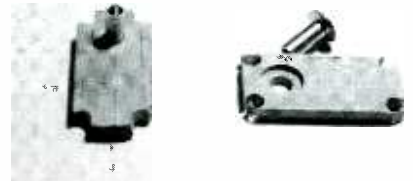

The countersink allows one to mount a binding head post through the hole and have it lie flush with the bottom of the component. This component when mounted to a servomotor provides another weight-bearing shaft that is inline with the servomotor's original shaft, allowing it to handle greater loads more evenly without distorting.

Servomotors

This bi-pedal uses common, inexpensive Hitec HS300 42-oz torque servomotors. The holes drilled in the servo U-bracket, shown later, are configured to fit one of the standard horns that is included with the Hitec HS300 servo. If you use another type of servomotor, you may need to adjust the mounting holes on the U-bracket accordingly. Building the components for linking and connecting servomotors to build the legs is our main task this month. The servomotor component designs provided in this article are based upon months of tinkering, design, and redesign. The purpose is to provide an easy method of connecting servomotors to one another while maintaining maximum flexibility and functionality. The design(s) are used for generating bi-pedal legs, but this is by no means a limitation on what can be accomplished using these components.

There are three components needed for mounting the servomotors. You will need a set of components for each of the



The sensor is a flexi-force pressure sensor. This particular sensor is made to detect pressure from 0 to 1 lb. While the final weight of the robot may be slightly more than the sensor's top weight, I feel it's a better (more sensitive) choice than taking the next sensor that measures pressure between 0 and 25 lbs.

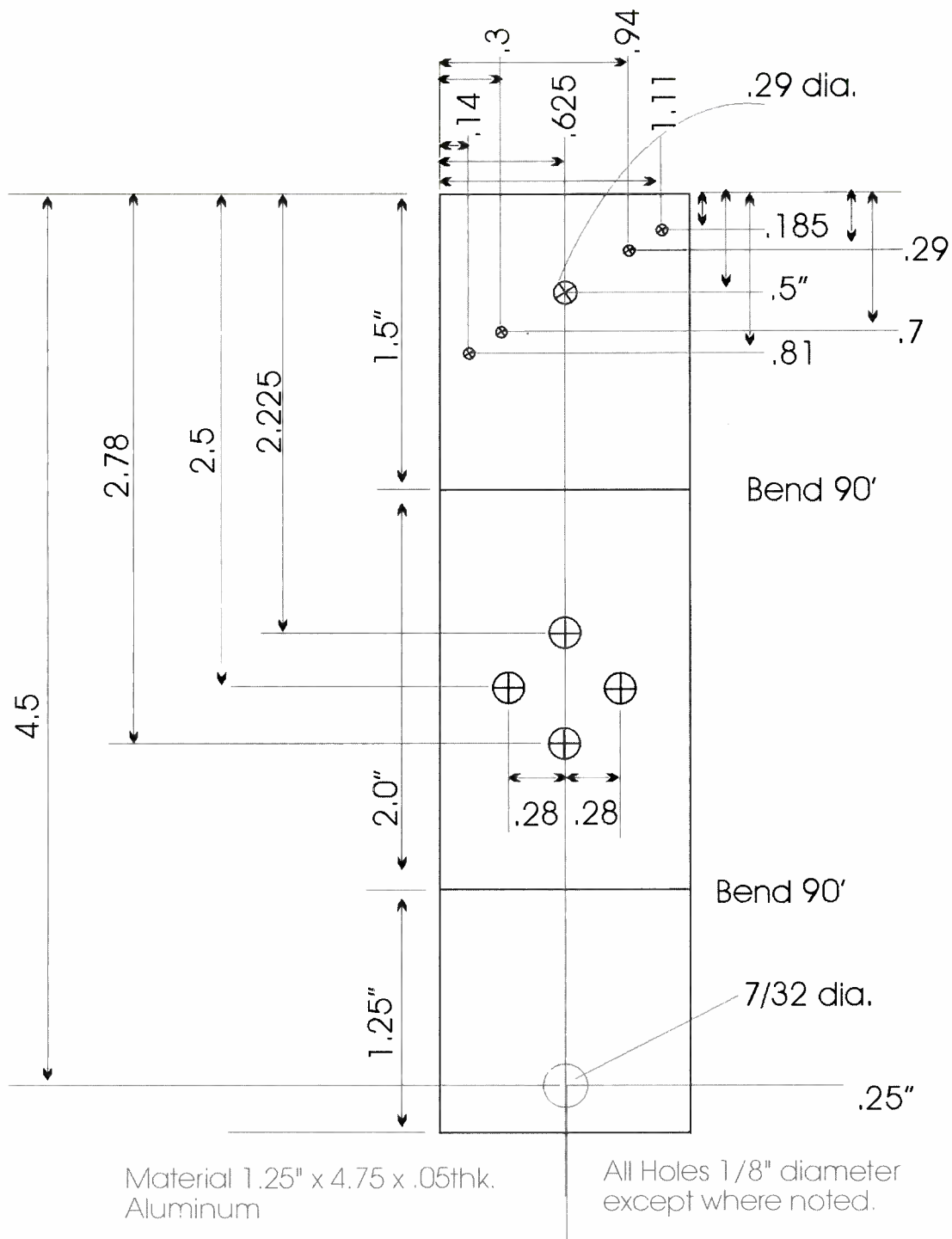

Fig. 4. Using the drawing as a guide, punch the center of each drill hole. The dimple the punch makes in the metal makes it much easier to drill the holes accurately by helping prevent the drill from walking across the metal.

six servomotors used in the robot. I would suggest making a few extra in case of mistakes and misalignments, or if we need to add a few servomotors to the robot. The first two components may be fabricated out of metal, plastic, or wood. The first component is shown in Fig. 2—we'll call this a servo-shaft component. The 7/32 diameter through hole is

countersunk with a .460 diameter × .075 deep hole. The countersink allows one to mount a binding head post through the hole and have it lie flush with the bottom of the component (see photo). This component when mounted to a servomotor provides another weight-bearing shaft that is inline with the servomotor's original shaft, allowing

it to handle greater loads more evenly without distorting.

After the component is machined, mount a 3/8-inch long binding head post through the hole with a small amount of glue. As the glue dries, make sure the binding head post stays straight and doesn't lean to any side. When the glue dries, the assembly is mounted to the

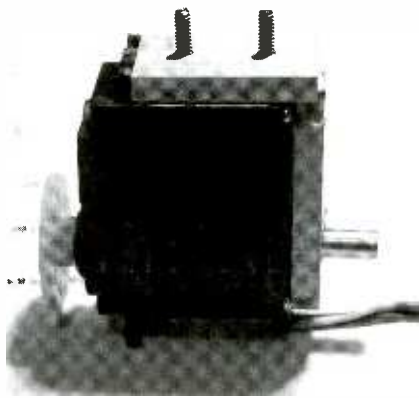

The bottom edge of the assembly should lie flush with the bottom end of the servomotor. If the piece is machined accurately, the binding head shaft will be inline with the servomotor's shaft.

servomotor using a high-strength epoxy. The bottom edge of the assembly should lie flush with the bottom end of the servomotor. If the piece is machined accurately, the binding head shaft will be inline with the servomotor's shaft (see photo).

The second component is our bottom connection component, shown in Fig. 3. The two 1/8-inch diameter holes in this component are also countersunk, with a 1/8-inch diameter by .075 deep hole so that the pan head of the 4-40 threaded machine screws lies flush with the bottom of the component. This piece allows one servomotor to connect to another servomotor. When this piece is machined, mount two 1/8-inch long 4-40 threaded pan head machine screws through the two holes and glue in place. Again, make sure the screws stay straight and do not lean to any side (see photo). When the glue dries, this component is mounted to the bottom of the servomotor using a high-strength epoxy.

The next component must be made from metal, because after it is machined it will be necessary to bend it at 90 degrees at two locations. I recommend using .050-thick aluminum sheet metal for fabrication. Aluminum is much easi-



This piece allows one servomotor to connect to another servomotor. When this piece is machined, mount two 1/8-inch long 4-40 threaded pan head machine screws through the two holes and glue in place. Again, make sure the screws stay straight and do not lean to any side.

er to drill and bend than cold roll steel. The drawing is shown in Fig. 4. Photocopy the drawing and mount (glue or scotch tape) it on a properly cut piece of aluminum. Then using the drawing as a guide, punch the center of each drill hole. The dimple the punch makes in the metal makes it much easier to drill the holes accurately by helping prevent the drill from walking across the metal. Next, drill all the holes in the bracket. After the holes are drilled, it is time to bend the metal into a U-bracket.

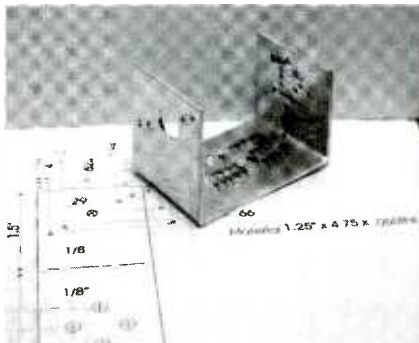

When you have bent the metal to 90 degrees, remove it from the vise and line up the opposite side's line. Bend it also to 90 degrees as before, making a U shape.

Line up one of the bending lines in a vise. Secure the metal in the vise tightly. Bend the metal by applying force to the base of the metal; the base is where the metal enters the vise. When you have

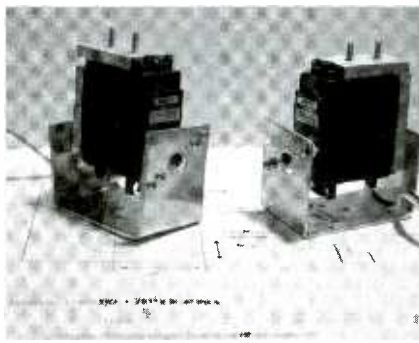

Here is how all the parts should fit together. This photo shows a servo fitted with all of the components. Does your servo resemble this one?

bent the metal to 90 degrees, remove it from the vise and line up the opposite side's line. Bend it also to 90 degrees as before, making a U shape. The accompanying photos show the finished bracket and a complete servomotor assembly.

Next month, we will go into greater detail and continue to build our bi-pedal robot.

5 GREAT PROJECT BOOKS

[] BP-410 35 Opto-Display Terminal Block Projects. \$6.99. If you use terminal blocks, no soldering is required to make complete this series of opto-displays that range from light-telegraphs, flashing label badges, magnetic detectors, plus more advanced projects including a dusk detector, games, and twinkling Christmas decorations.

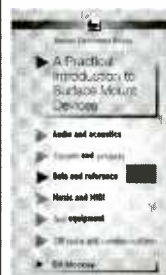

[] BP-411 Introduction to Surface-Mount Devices. \$6.99. Surface-mount construction can be easier, faster and less costly, and even the hobbyist can produce one-of-a-kind circuits using SMDs. PCB design, chip control, soldering techniques and specialist tools are fully covered. A complete variety of construction projects are also included.

[] BP-413 Remote Control Projects. \$7.99. A wealth of circuits and circuit modules for use in all kinds of remote-control applications are provided. There are complete details for 14 novel and practical remote control projects. Also included are techniques for interfacing a PC to a remote control system.

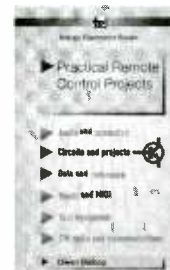

[] BP-416 Practical Alarm Circuits. \$6.99. Details of inexpensive but effective burglar alarms for the home constructor. The circuits include switch-activate alarm, FM audio alarm generator, Modulated fiber-optic loop alarm, Ultra-sonic breaking window alarm, Doppler shift ultrasonic sensor and more.

[] BP-432 Simple Sensor Terminal Block Projects. \$6.99. Sensors are the eyes, ears and noses of electronic systems. They include contact, light, heat, sound, magnetic, motion, resistance and voltage-operated devices. The projects in this book show you how you can build all of these, and if you use terminal blocks, no soldering is required. There are 31 individual projects to build and use.



To order one of these Books send amount indicated plus \$3.00 for shipping in the U.S. and Canada only to Electronics Technology Today Inc., P.O. Box 240, Massapequa Park, NY 11762-0240. Payment in U.S. funds by U.S. bank check or International Money Order. Please allow 6-8 weeks for delivery. MA09

Basic Antennas For Experimenters

If you ever experiment with receivers and/or transmitters, you will at some point need to consider the subject of antennas. This is a very large subject and could occupy hundreds of thousands of pages with some pretty advanced mathematics and electromagnetic theory. However, the antennas that a casual experimenter will use are generally simple types, such as wires, whip antennas, and dipoles. We will present some basics that will be useful to the experimenter, shortwave, or scanner enthusiast, or for use with hobby low-power transmitters. We will not go into the more complex types, such as yagis and log periodic arrays, as much more space would be needed than is available in this article.

A good antenna will do more to improve the performance of a transmitter or receiver than almost anything else. Too often the antenna is an afterthought. You cannot always depend on a length of wire or a pre-packaged plug-in whip from an electronics store if you want the best performance your equipment can deliver.

Receivers may perform poorly, and transmitters can even be damaged by improper antenna systems. A little knowledge about antennas can be very useful.

Antennas

An antenna can be any conducting structure that is used to radiate or to receive electromagnetic energy. How well it does this depends on the size, geometry, frequency, or wavelength used, and the location of the antenna, as well as surrounding environmental factors.

Antennas come in all sizes. Figure 1 shows a variety of vertical antennas used in low power operations. Inch-long antennas and smaller are used as parts of microwave antenna systems operating at 1000 to 100,000 MHz. One-inch to

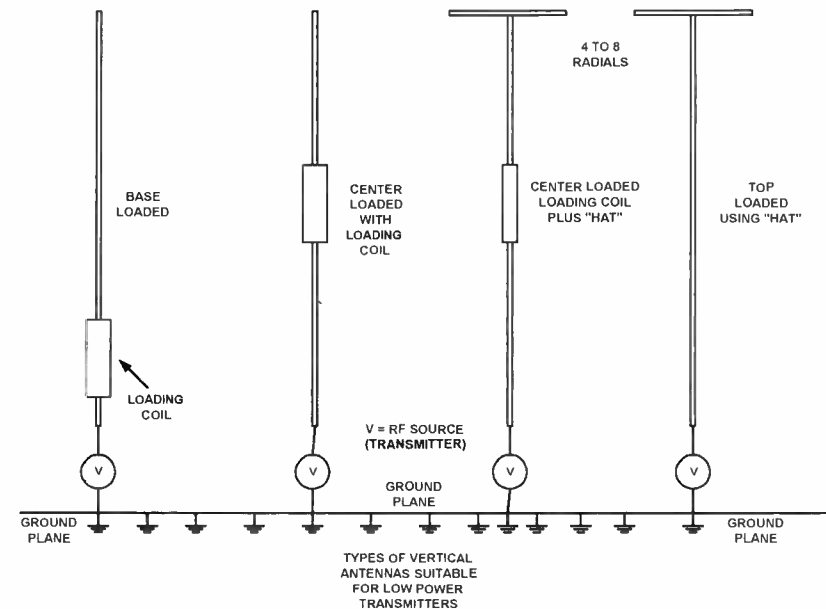

Fig. 1. A good ground under the antenna is important and much better than a poor ground or no ground, especially with those antennas needing a good ground, like the vertical antennas above. These contrasts in performance could range from a few dB to as much as 40 dB.

foot-long antennas are used for UHF and cell-phone work. Antennas that are one to ten feet long are used for FM, TV, and VHF communications work. Hundred-foot long wire antennas are used for shortwave and AM radio. The largest antennas are giant arrays of thousand-foot towers topped by miles of cables and occupying hundreds of acres of ground. These monsters are used for VLF (very low frequency) work at frequencies as low as 10 kHz.

Fortunately, the frequencies and antennas needed by experimenters lie between these extremes, typically short whip antennas a few feet long, up to wire antennas 50 to 200 feet or so in length. We will concern ourselves with antennas in this practical category. Frequencies typically will range from the lowest used AM broadcast (150 kHz) to UHF (around 1000 MHz). Antennas can be operated either horizontally or vertically

with respect to ground. Each antenna has its advantages and disadvantages, both mechanical and electrical.

Antenna structures appear as electrical loads (to transmitters) or electrical sources (to receivers), and they have equivalent impedances that vary with antenna size and frequency. In the case of a receive antenna, the source also has a voltage equal to that picked up by the antenna. In general, there are many discrete frequencies as well as noise components present. Voltages may range from microvolts (weak signals) to volts (from very strong nearby AM broadcast stations).

Occasionally voltages with 60-Hz components from power lines and audio voltages are picked up, from both man-made and natural sources. Ideally, an antenna will radiate all power delivered to it or deliver all the power it extracts from a passing wave to a load, generally

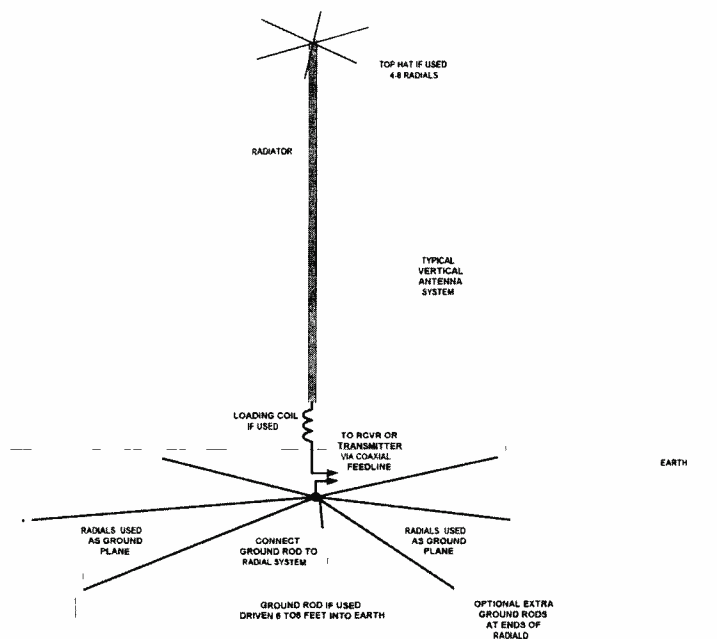

Fig. 2. Here is a vertical antenna with all the trimmings. Radials are buried slightly beneath the soil to simulate a ground plane and a top hat of radials is placed on top to act as a capacitance hat.

a receiver. This occurs with some types of antennas, but it is not always the case.

For easy matching, an antenna should be of a length that is one half of a wavelength at the received or transmitted frequency. A half-wave antenna length is usually calculated from the formula:

$$\text{Length in feet} = 468 / F \text{ (MHz)}$$

This is about 5 percent shorter than an actual theoretical half wavelength, and works very well practically. The shortening takes into consideration and compensates for "end effects" caused by the supporting insulators and masts, proximity to ground and other structures, and the fact that the wire is of finite thickness. It works well up to the lower VHF range (50 MHz or so). At higher frequencies, element thickness is more significant, and this formula is best used as a starting point. Impedance is ideally 72 ohms, although practical antennas will show 30 to 80 ohms, depending on antenna height above ground; so a 50-ohm cable is often used to feed half-wave antennas.

Half-wave antennas, such as dipoles, work better if mounted a quarter wavelength (half the antenna length) or more above ground. Dipoles for lower frequencies (2 MHz or lower) are often somewhat ineffective as to performance, owing to the difficulty of mounting them at the quarter-wave heights needed for good performance (over 100 feet

at 2 MHz). They are seldom used below about 1.8 MHz for transmission purposes. Vertical antennas are more suited to lower frequency operation. Antennas longer than half-wave are also commonly used, and antennas several wavelengths in length have desirable properties for some uses.

A quarter-wave antenna can also be used if a suitable ground is available. The effect of the ground is to act as an electrical "reflection," "supplying" the missing half of the half-wave antenna. This is called the "ground plane," as it ideally is a perfectly conducting plane infinite in extent. Realistic ground planes are the earth, car or airplane bodies, ships, arrays of mesh or wire, lengths of wire or rod (called radials), metal structures, or sea water. A quarter-wave antenna in theory looks like a 36 impedance, although 25 to 50 ohms is typical, depending on ground plane and surroundings. A good, low resistance ground plane or ground is very important with this type of antenna. This antenna will have a length given by:

$$\text{Length in feet} = 234 / F \text{ (MHz)}$$

Quarter-wave antennas are usually operated as vertical antennas. A vertical antenna requires little real estate and only one vertical support, but needs a location relatively clear of obstructions and a good ground system for optimum results. A small quarter-wave antenna

system can be mounted on a pole up in the air, with a radial ground system under the antenna. These radials are usually four to eight in number and are made from the same rod as the radiating element, and are also a quarter wave in length. These antennas are called ground-plane antennas and are commonly seen on fire, police, airport, and commercial service antenna towers. Due to size and mechanical limitations, ground-plane antennas are usually used at VHF frequencies above 25 MHz, although in theory there is no lower frequency limit. Much lower frequency ones have been constructed by radio amateurs for 7-MHz and 3.5-MHz operation. Figure 2 shows an elaborate version of a vertical antenna that includes a ground plane and top hat.

Measuring Antenna Gain

An antenna extracts energy from a passing electromagnetic wave, and the amount of energy is proportional to its aperture. For practical purposes, this is the effective area that the antenna presents to the passing wave, as a large barrel will catch more rainwater than a small barrel. Antenna gain is generally measured in dB with respect to an isotropic radiator. An isotropic radiator radiates equally well in all directions, as an ideal point source and has a gain defined as zero dB. An unshielded clear light bulb mounted in a socket with no reflector would be an equivalent optical example.

A gain antenna such as a yagi or parabolic dish would be equivalent to the same light bulb mounted with a reflector. Note that a gain antenna does not increase radiated power; it simply radiates the power fed to it mainly in one direction, so the signal is stronger in that direction at the expense of other directions. By contrast, an active antenna has a built-in amplifier and actually amplifies the signal fed to or received by the antenna. This produces an effective gain figure.

An active antenna requires a power supply to run the amplifier in it. Active antennas are used more often for reception purposes than transmission purposes. At lower frequencies, such as 100 kHz up to the lower shortwave (HF) range up to 30 MHz, the larger antennas capture plenty of energy. At UHF and microwave, antennas are measured in inches and capture less energy, so larger antenna arrays are used at these frequen-

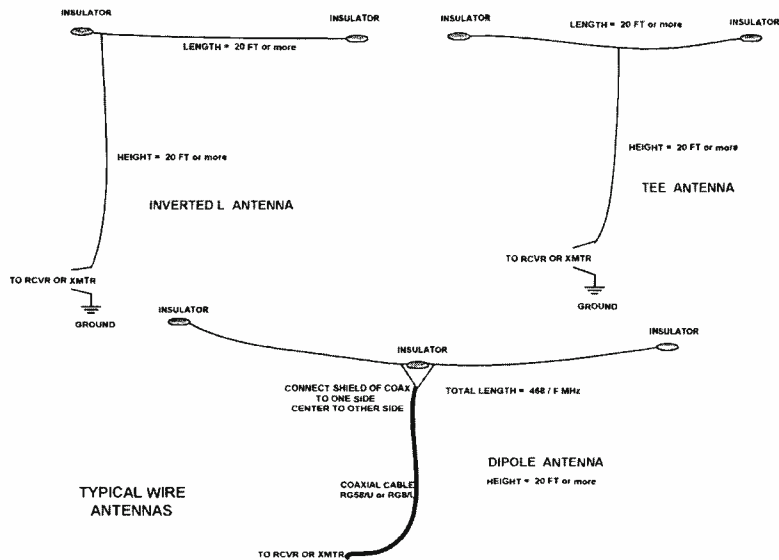

Fig. 3. Tee antennas are sometimes called “Marconi” antennas. The inverted “L” is a mixture of horizontal and vertical, depending on the geometry of the antenna. It is probably the most widely used long-wire antenna configuration and is very dependable for good performance over a wide frequency range.

cies relative to wavelength.

As an example, a typical amateur radio antenna on the 7-MHz band (40 meters) is a simple half-wave dipole about 66 feet long, mounted about 25 to 35 feet above ground. This antenna has little gain as compared to an isotropic radiator. A typical amateur radio antenna on the 430-MHz band is a multi-element Yagi consisting of ten or more half-wave elements, with 10 dB or more gain, mounted on a tower 50 feet high or more. A simple dipole would almost never be used on this band. It would be about a foot long and capture little signal. Microwave antennas are almost always parabolic dish, horn, or other gain types physically many wavelengths in size. Satellite TV antennas for C-band (4 GHz) are ten feet in diameter and exhibit around 40 dB gain. The actual “antenna” in these systems is a tiny probe built into the LNB assembly mounted at the focus of the dish. The dish merely gathers signal and focuses it on the probe antenna in the LNB assembly.

Current Distribution

The current flowing in an antenna varies along its length, being zero at the end (the voltage here being a maximum). Current is maximum somewhere along its length, or at the end that is fed with power in some cases. This varies with frequency. This current and voltage distribution will determine the feed impedance to be expected at a particular feed

point. Power can be fed into or taken from the antenna anywhere along its length by the use of a transmission line (feedline) of the proper impedance. A half-wave dipole is fed at its center where the current is a maximum, and the impedance here is around 50 to 70 ohms.

A quarter-wave antenna is fed at its end, usually the lowest point, called the base. Impedances here are lower usually 30 to 50 ohms. Random-length antennas are usually fed at one end through an impedance-matching network, but also can be fed at almost any point with suitable feedlines. These feedlines are commonly high-impedance 300- to 600-ohm two-conductor feedlines, which look like ladders. These lines are made of two conductors spaced 3- to 6-inches apart and fastened together with plastic or ceramic spacers that look like ladder rungs.

Resistance

Antennas that are small electrically (less than a quarter wavelength at the frequency in consideration) will appear as a capacitive reactance (several hundred ohms) in series with a small resistance (a few ohms). The resistance is made up of losses (both in the ground and surroundings), and conductor losses, and losses from radiation of power. The power lost in radiation is often expressed as that power lost in a fictitious resistance called the “radiation resistance.” This is ideally as high as

possible compared to the total antenna resistance, as the higher it is relative to losses, the larger the fraction of the power fed to the antenna is radiated.

In efficient antennas this is 80–90 percent or more of the total antenna resistance. Lower values of less than 5 ohms can be hard to match efficiently without excessive losses. Very high values (several thousand ohms) can also present difficulties. Reactance values due to L or C can be zero to several thousand ohms. These values all depend on frequency and antenna surroundings, as well as antenna configuration and size.

For example, a 102-inch CB type whip antenna for 27-MHz use is a quarter-wave long and will appear as about a 36-ohm resistance to the CB transmitter. However, consider using this antenna at the frequency of 1650 kHz, the high end of the AM broadcast band. Here it appears as a 0.1-ohm resistor in series with a capacitor of 4700-ohm reactance (20 pF), approximately. A little thought will show that this is a difficult impedance to match with reasonable efficiency to a transmitter needing a 50-ohm load impedance. This is the classic short antenna problem—feeding it power so it will radiate efficiently. Short antennas with low losses and excellent grounds often present very low feed impedances of only a few ohms. A short vertical antenna system with no matching circuit and a feed impedance that is higher (30 to 50 ohms) probably has high losses, especially if the radiation resistance of the antenna is a few ohms or less.

Half- or quarter-wave long antennas allow easy transfer of power to and from the antenna. The antenna is resonant at that frequency and behaves much like a tuned circuit. This also helps in reducing radiation of spurious signal components, and, in the case of reception, favors the received frequency. However, with auxiliary inductors and/or capacitors, a matching network can be made up to couple any random length antenna to a receiver or transmitter.

In the case of receivers, often this is not critical. This is especially true in the shortwave and AM frequency ranges, where the large (25 to 200 feet typically) antenna picks up plenty of energy and external noise interference is the limiting factor in weak signal reception. In this case no matching network may be needed. The typical 50- to 100-foot

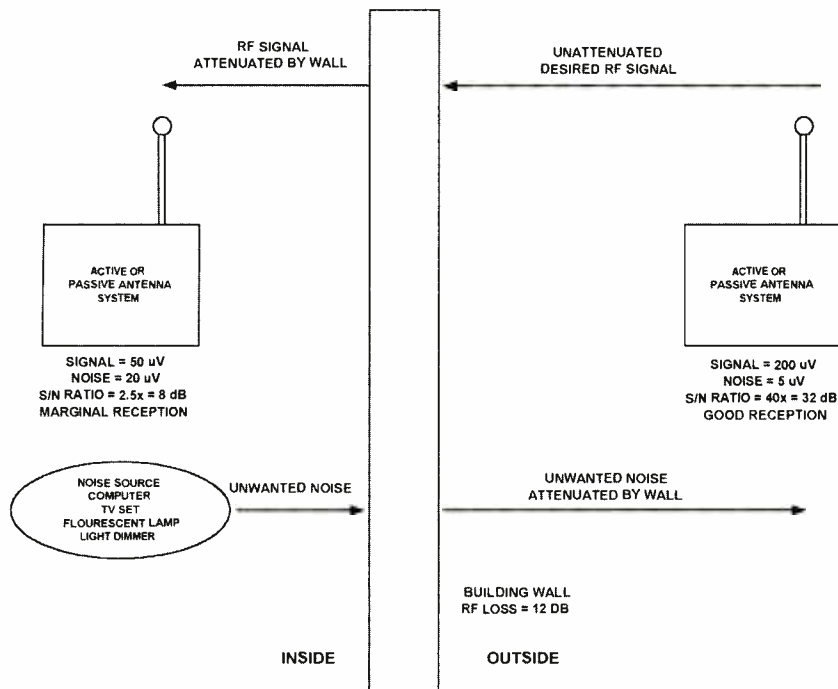

WHY AN OUTSIDE ANTENNA IS BETTER THAN AN INSIDE ANTENNA

Fig. 4. Modern appliances using microcontrollers, displays, and Triac devices, as well as entertainment equipment, often generate a lot of spurious unwanted noises. Getting an antenna away from all this stuff works wonders in improving reception.

long wire antenna connected directly to the antenna terminals of a receiver is an example of this. In most cases satisfactory reception will be obtained, with no matching needed. (Reception of weak signals will generally be improved with one, however.) This antenna will appear as a complex impedance, with around 10- to 600-ohms resistance and plus or minus reactance values up to about 1000 ohms, depending on frequency.

Most shortwave receivers will handle this mismatch with little difficulty, although some of the newer solid state models like to see 50 ohms, and an antenna tuner will improve reception a little in these cases. But, with transmitters, power from the transmitter must be delivered to the antenna so it can be radiated efficiently. Also, since most transmitters are generally designed to operate into specified load impedance (usually 50 to 75 ohms), some form of matching network will be required in cases where a random length antenna will be used. Also, the use of the same antenna over a wide range of frequencies (2 to 30 MHz coverage using only one antenna is commonly required) necessitates a matching network of some kind.

Factors Affecting Performance

In practice, individuals may have sev-

eral options or they may be severely limited in erecting an antenna for experimentation. Those experimenters living in a private home in a rural area usually can erect almost any reasonable kind of antenna needed, and the only limitations are financial or esthetic. Those living in apartments, condominiums, or deed-restricted housing situations may not be able to put up or use any kind of outside antenna or be limited to something small and not visible.

It is a sad fact of life that antenna performance is directly proportional at any frequency, all things equal, to relative size, height, and clearance from nearby structures. A 10-element yagi (big) will outperform a dipole or quarter-wave whip (small) at a given frequency. An antenna 100 feet high above ground will be superior to the same antenna mounted 10 feet above ground. An antenna mounted on a roof will usually vastly outperform the same antenna located inside a building.

A good ground under the antenna is important and much better than a poor ground or no ground, especially with those antennas needing a good ground (vertical antennas and long-wire antenna systems). These contrasts in performance could range from a few dB to as much as 40 dB. There is no magic here.

Bigger is better, higher is better, outside is better than inside. If you come up with a very tiny antenna that performs as well as a full-size antenna, many companies will want to buy your idea.

The armed services have done much research on small antennas for tactical communications, but the laws of physics do not allow something for nothing. The small, portable antenna giving performance like a big one is still a wish and a dream. No magic circuits can substitute for a poor antenna either. There are a number of "magic" small antennas advertised in magazines, on the Web, and in other places. They are sold for radio, TV, and shortwave use, promising all kinds of performance, some claiming to eliminate the need for a good antenna system.

These are mostly wishes and prayers and inevitably will prove disappointing if one expects the advertised claims about performance. A good, active, receiving antenna system often will provide better reception than a wire antenna several times its size. But, active antennas have to be mounted outdoors away from buildings and noise to really work well. This is often not an option for many would-be users of these antennas. Indoors, they are too shielded and buried in the ambient noise present in most multiple dwellings to show much improvement, especially at frequencies below 5 to 10 MHz.

These practical limitations may dictate the kind of antenna one is forced to use. In practice, the random-length wire antenna, fed at one end, is probably the most practical choice. It can be made of very fine wire (#28 or even #30) as to be nearly invisible, hidden in trees or run along building surfaces and under eaves, or even attached to a flagpole and disguised as a rope. Care must be taken to avoid the possibility of accidental contact with power and utility wires. Antennas should ideally be mounted FAR AWAY and at right angles to utility wires, and NEVER NEAR, OVER, OR UNDER them. There is always the possibility that a broken wire can fall and contact power lines. This precaution avoids shock hazard and, also very important, unwanted pickup of noise and interference often present on utility wires.

No Magic Involved

Several antennas are shown in the figures. All will provide good results if care-

NORTH COUNTRY RADIO: A HAVEN FOR WIRELESS BUFFS

Graf and Sheets are no strangers to the pages of Gernsback. Their educational projects, such as the *RF-Field Strength Meter* and the *MPX2000 FM Transmitter*, can be found at **North Country Radio**. Established in 1986, this company offers projects related to amateur TV transmitters/receivers, AM and FM transmitters/ receivers, video cameras, and numerous other subjects. Visit the Web site at www.northcountryradio.com for more information.

Ordering Information: PO Box 53, Wykagyl Station, New Rochelle, NY 10804-0053; Voice: 914-235-6611; Fax: 914-576-6051; e-mail: Rgraf30832@aol.com.

Engineering and Technical Support
PO Box 200, Hartford, NY 12838
Voice/Fax: 518-854-9280
e-mail: support@northcountryradio.com

fully built and placed as far away as possible from obstructions and utility lines. There are no magic "tricks" to getting these antennas to work. If they are used only for reception, nothing is very critical. For use with a transmitter, the antenna should be cut to length as needed and/or a matching network should be used to make sure the transmitter is operational into its designed impedance. For best results a dipole should be mounted broadside to the desired direction of best reception or transmission, although this is also dependent on height and operating frequency.

For most practical uses, all these antennas can be regarded as approximately omnidirectional, as surroundings, height, and environmental factors such as ground resistance all play a part in determining the antenna pattern. You will notice several dB variations in certain directions, depending again on frequency and orientation. A Tee antenna can be considered as similar to a top-loaded vertical antenna, as the top section connects at the center of its length to the vertical downlead (feeder). The top section, or "flat top," acts as a capacitive hat and the vertical feed wire actually does most of the radiating.

Tee antennas are sometimes called "Marconi" antennas. A variation of this is the Windom antenna, which uses a resonant flat top and a vertical feeder connected at a point off center, depending on application. The inverted "L" is a mixture of horizontal and vertical, depending on the geometry of the antenna. It is probably the most widely used long-wire antenna configuration and is very dependable for good performance over a wide frequency range. It

often is the easiest antenna to install. The flat-top section of an inverted "L" connects to the vertical feeder at one end. Figure 3 contains examples of wire antennas.

Note that vertical, tee, and inverted L types require some sort of ground connection for best results. A single 8-foot ground rod driven into the earth is often used for this connection. It is not as good a ground as you may think. While this will do for draining off static electricity, it will have little effect for RF, unless you live in a salt marsh or on a large metal platform. A good RF ground is a large conducting metal plane, and this is usually simulated with a large number of buried wires (radials) a few inches below the soil surface. The more metal buried in the ground the better. A ground to a cold water pipe also helps. **DO NOT** use power or telephone grounds.

Losses in ground resistance are often the main loss components in antenna systems, especially with short antennas used at low and medium frequencies. However, real-life situations are seldom ideal, and some ground is better than no ground, so just do the best you can. Depending on your particular application, you may get away with surprisingly little. See the figures for typical configurations. Crystal set experimenters and AM DX fans will do best with one of the wire antennas such as the inverted L or Tee, as long and as high as possible. Shortwave fans can use any of the antennas shown. A dipole cut for your favorite frequencies will probably be your best bet. You can parallel several different dipoles cut for favorite frequencies if you wish. Should your interest be in LP transmitters, only a very short indoor

antenna should be used. You might get cited by the FCC should your LP transmitter cause interference to any licensed services or interfere with radio or TV reception.

The Value Of An Outdoor Antenna

If you live in an apartment or condominium and cannot erect an outdoor antenna, at least try to get some wire outside the building, even if only a few feet long. As mentioned, fine insulated or magnet wire of gauges as small as #28 or #30 can be used. Discarded lengths of multiconductor telephone or computer cable have many suitable lengths of such wire inside and can sometimes be obtained for free. A shorter wire run along the outside of a building is often much better than a longer one inside. This way, the building will act as a shield that attenuates inside RF interference, instead of attenuating desired RF signals. As much as 20 to 40 dB improvement can result.

An outside antenna is always desirable. It is not only because the outside antenna picks up more signal strength. Most modern receivers have more sensitivity than you really need and will perform very well with a small antenna. Indeed, it is actually possible to have too much signal strength, resulting in receiver overload, interference, and generally degraded performance. The real advantage of an outside antenna is that it can be located far away from household noise sources. Refer to Fig. 4 for a comparison of outdoor and indoor antennas.

Modern appliances using microcontrollers, displays, and Triac devices, as well as entertainment equipment, often generate a lot of spurious unwanted noises. Getting an antenna away from all this stuff works wonders in improving reception. Keep the wire as far as possible away from electrical lines and devices. A good active antenna will prove valuable in these situations, as long as it can be mounted outside the building. If you can get the August 1997 issue of **Popular Electronics**, an excellent active antenna was described in detail. A kit to build this antenna and many other interesting items is available from North Country Radio. Their Web site is www.northcountryradio.com. This antenna is 2 to 4 feet long, weather-proof, easily concealed, operates from 100 kHz to 30 MHz, and performs as well as a 25- to 50-foot long wire in most situations. P 45

Robbie? Where Are You?

It's another special robotics issue. As usual, it's amazing how much interest there is for this subject, considering how most readers' questions and comments relate to that topic.

People Protection

Q I am writing about the January 2002 issue of *Poptronics*. In this issue, there is an article on building a P4 CPU. The note on page 40 states that it's a good idea to use a wrist-grounding strap. While this is the only way you should mess with the internals of a computer, I disagree with the next statement—If you don't have one, you can "make one yourself from a piece of copper wire wound around your wrist and attached on the other end to a ground." Now, I may be incorrect about this, but my college instructor said that the ground straps that you buy actually have a resistor in them. That way, if you accidentally power up the computer or something like that and the grounding strap was incorrectly applied, you wouldn't get shocked. Again, I'm not sure about the truthfulness of this, but you might want to check on it.—J.H., via e-mail

A Wow! I am sure glad you found that statement in that article, J.H. You're 100% right that a ground strap should have a resistor in series, usually with a value of around 1 megohm. Wrapping a wire around your wrist and attaching it to a ground is a death sentence waiting to happen. As you surmised, in case you accidentally touch a live circuit, that resistor is in there to limit the current and keep you from getting a shock or, even worse, from being electrocuted. The resistance is high enough in value to prevent danger, yet small enough to provide electrostatic discharge (ESD) protection for the electronics.

It's interesting that one of the most popular A+ Computer Certification books makes the claim that the resistor is in there to protect the boards from ESD. That does nothing but help prove my claim that the majority of computer nerds know very little about electronics.

A lot of folks may blow this off saying

that it's OK not to have the resistor in the strap if you're working on unpowered equipment. Not using a seat belt is OK, too, if you're not planning on being involved in an accident. An ESD ground strap should always have that resistor no matter what the circumstances are. It's easy enough to install and covers all the bases so that you can use the strap with confidence in any situation. You should periodically check the resistance of the strap between the ends to insure that it is 1 megohm, that it hasn't accidentally developed a short somewhere, or that someone hasn't messed with it.

I know a lot of folks who indiscriminately toss motherboards, expansion cards, and memory modules around, claiming that it really doesn't hurt anything and that wrist straps and static-free workstations are silly. Most of these same people constantly have problems with their computers. You can work with this stuff without a wrist strap and other ESD countermeasures, but you'd better know what you're doing. The goal is to keep everything at the same voltage. Touching where you're going with a board first is the key. The biggest sin committed is when a board is handed to another person. Unless both people are grounded to the same point, the only way you can do this without jeopardizing the board is to touch each other first and then hand the board off before

you're done touching. Depending upon your relationship to the other person, you can work out the details of the touching between yourselves. But the touch gets both of you at the same potential first, so that there's no current flow when you hand off the board.

So, shake hands with your robot before you attempt surgery.

5558? 558? 1458? 1558?

In all reality, I often deliberately goof up an answer just to generate a flurry of mail in my direction to kill some of the boredom of life. No longer am I bored, for this item generated more e-mail than any I've published since taking over the column. The original question in the February 2002 column was "What's an NE558?" My answer had some right stuff in it, but I slipped a couple of notches overall by equating the NE558 with the NE5558. I'm going to blame Signetics for a little bit of this mess. The NE5558 appeared in the Signetics 1972 databook of which today's LM1458 is the spittin' image. It didn't stay around very long, but long enough that it had a flash of popularity and I ended up buying a couple of dozen "floor sweepings" from Poly Packs or some such place and used one in an audio power-amplifier

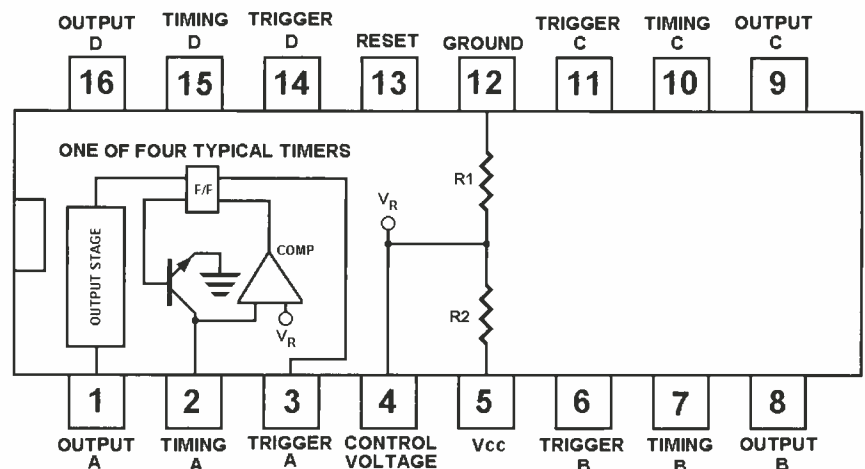

Fig. 1. Although packing a lot of timers in a small space, the individual timers of the NE558 quad timer are not quite as versatile as a 555 single or 556 dual timer. This is the pinout for the 558, showing the typical block diagram of one timer and the pin connections for all four.

project. I'm staring at its data sheet as I write this.

Several readers quickly let me know of my error. Chuck Hall sent along the PDFs for the NE558 to forward to "P.M.," who originally asked the question. Thanks for taking the time to do that, Chuck. Kudos to the anonymous reader who sent along the Internet address for the Philips Web site having the page for the NE558 (www.semiconductors.philips.com/pip/NE558N). Finally, Al Baker let me know that the NE558 crosses to the NTE926, reminding me that NTE's Web site (www.nteinc.com) is a handy place to find simple data on semiconductors. He also let me know that I'm allowed one mistake a month. Al, you're feeding right into my system for generating mail! Thanks, everyone, for sharing your expertise with us all.

The pinout for the NE558 is shown in Fig. 1. Reader Paul Chaney also noted that it's not as versatile as a 555 or dual 556 timer, since all four timers share the reset and control-voltage inputs and not all of the timer connections of the 555/556 are available on the 558. According to the data sheet, a single timer can provide monostable operation, but it takes two of the timers for astable operation.

Signetics' role in this little fiasco was to use the type number "NE5558" in the early 70s and then nearly duplicate it as "NE558" several years later with a different device.

Now, back to the NE5558. It's a perfect example of why I don't often use datasheet sources on the Internet. I would have spent all day trying to find the thing, as some of you have discovered. I have 40+ running feet of shelf space of nothing but databooks, a quantity that may be second only to Don Lancaster's collection. I have never thrown a databook away unless it was a duplicate, and even then I tried to give it a new home. Never throw away an old databook, for it often may be your only source for device information.

Several times, folks working with robots have searched on the Internet for the LM1871 and 1872, and the only thing they seem to be able to find is my name in some post on a forum where I've supplied those datasheets to someone in need. I was recently told in one roboteer's e-mail that I was the world's only source for LM1871 data. Maybe I need to sell my information to National Semiconductor.

Rebroadcaster Shadows

Reader Michael Kiley writes to comment on the reprint of the Wireless Rebroadcaster schematic that appeared in my March 2002 column, bringing up several excellent points.

"(1) F1 is stated as 3 amperes. At 120 volts, this is 360 watts and if a short occurs, T1 would be long incinerated before the fuse blows. Wouldn't 0.3 or 0.25 amps be more appropriate? (2) The connections of the 6.3-volt winding look like a short circuit. (3) If you have trouble finding the proper transformer, a

Stancor P-8421 will work. Or one could connect two 6.3-volt transformers secondary to secondary, with those secondaries supplying the 6.3 volts for the heater. (4) A 1N4005 or 1N4007 will work for D1 and four diodes in a full wave bridge will give less ripple as would grounding one side of the heater. (5) The input circuit could probably be improved by omitting R4 and connecting V1b pin 3 directly to R5 and C1B and then ungrounding the grid (pin 2) and connecting this to the wiper of a 100K to 500K ohm audio taper control. Ground the counterclockwise end of the

HOW TO GET INFORMATION ABOUT ELECTRONICS

On the Internet: See our Web site at www.poptronics.com for information and files relating to **Poptronics** and our former magazines (**Electronics Now** and **Popular Electronics**) and links to other useful sites.

To discuss electronics with your fellow enthusiasts, visit the newsgroups *sci.electronics.repair*, *sci.electronics.components*, *sci.electronics.design*, and *rec.radio.amateur.homebrew*. "For sale" messages are permitted only in *rec.radio.swap* and *misc.industry.electronics.marketplace*.

Many electronic component manufacturers have Web pages; see the directory at www.hitex.com/chipdir/, or try addresses such as www.ti.com and www.motorola.com (substituting any company's name or abbreviation as appropriate). Many IC data sheets can be viewed online: www.questlink.com features IC data sheets and gives you the ability to buy many of the ICs in small quantities using a credit card. You can also get detailed IC information from www.icmaster.com, which is now free of charge although it formerly required a subscription. Extensive information about how to repair consumer electronic devices and computers can be found at www.repairfaq.org

Books: Several good introductory electronics books are available at RadioShack, including one on building power supplies.

An excellent general electronics textbook is *The Art of Electronics*, by Paul Horowitz and Winfield Hill, available from the publisher (Cambridge University Press, 800-872-7423) or on special order through any bookstore. Its 1125 pages are full of information on how to build working circuits, with a minimum of mathematics.

Also indispensable is *The ARRL Handbook for Radio Amateurs*, comprising over 1000 pages of theory, radio circuits, and ready-to-build projects, available from the American Radio Relay League, Newington, CT 06111, and from ham-radio equipment dealers.

Back issues: Copies of back issues of and past articles in **Electronics Now**, **Popular Electronics**, and **Poptronics** can be ordered on an "as available basis" from Claggg, Inc., Reprint Department, P.O. Box 12162,

Hauppauge, NY 11788; Tel: 631-592-6721. To ensure receipt of the correct material, readers must supply complete information on the article or issue that they wish to buy.

Poptronics and many other magazines are indexed in the *Reader's Guide to Periodical Literature*, available at your public library. Copies of articles in other magazines can be obtained through your public library's interlibrary loan service; expect to pay about 30 cents a page.

Service manuals: Manuals for radios, TVs, VCRs, audio equipment, and some computers are available from Howard W. Sams & Co., Indianapolis, IN 46214; (800-428-7267). The free Sams catalog also lists addresses of manufacturers and parts dealers. Even if an item isn't listed in the catalog, it pays to call Sams; they may have a schematic on file which they can copy for you.

Manuals for older test equipment and ham radio gear are available from Hi Manuals, PO Box 802, Council Bluffs, IA 51502, and Manuals Plus, 130 N. Cutler Dr., N. Salt Lake, UT 84054.

Replacement semiconductors: Replacement transistors, ICs, and other semiconductors, marketed by Philips ECG, NTE, and Thomson (SK), are available through most parts dealers (including RadioShack on special order). The ECG, NTE, and SK lines contain a few hundred parts that substitute for many thousands of others; a directory (supplied as a large book and on diskette) tells you which one to use. NTE numbers usually match ECG; SK numbers are different.

Remember that the "2S" in a Japanese type number is usually omitted; a transistor marked D945 is actually a 2SD945.

Hamfests (swap meets) and local organizations: These can be located by writing to the American Radio Relay League, Newington, CT 06111; (www.arrl.org). A hamfest is an excellent place to pick up used test equipment, older parts, and other items at bargain prices, as well as to meet your fellow electronics enthusiasts—both amateur and professional.

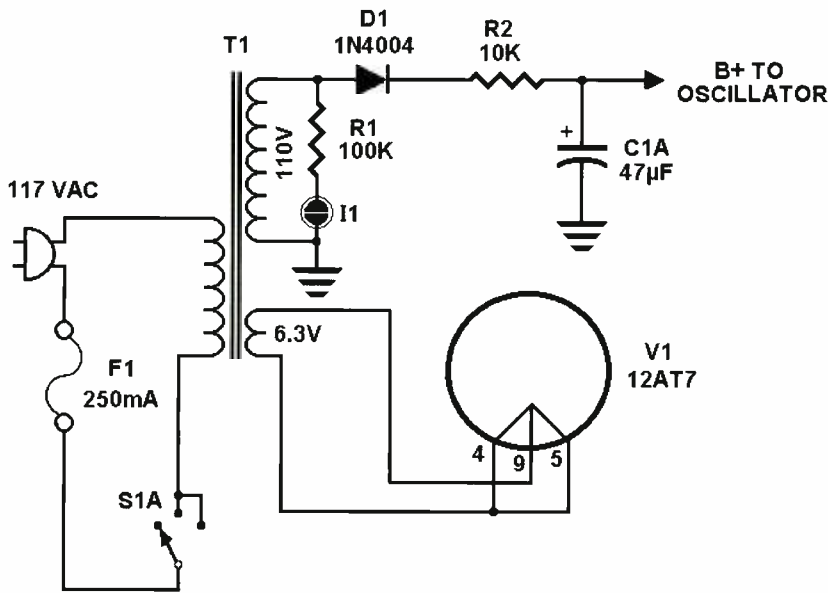

Fig. 2. A 12AT7, like many other miniature dual triodes of its era, had a center-tapped heater that allowed operation at either 6.3 or 12.6 volts. In this power-supply modification, it's wired for 6.3 volts with the two halves of the heater effectively being wired in parallel.

control and apply the input signal to the other end of the control. This will give the unit a high-impedance, ground-referenced input that's better suited to line level outputs. (6) The DC voltage on pins 1 and 8 of the 12AT7 should be about half the supply voltage with respect to ground for best performance. If it is more than 10% off, it can be corrected by adjusting the value of R5."

Don't forget that this was a pure reprint of a 37-year-old circuit and to preserve its originality, the only change from the original was the inclusion of the 3-amp value for F1 that appeared in the "Out of Tune" correction the following month. I agree that 3 amps is too large for that circuit and that a 250-milliamp fuse will do a better job of protecting the circuit.

Something went terribly wrong in the **Poptronics** art department, and the schematic came through with the heater winding of T1 having a dead short. I think it was because of the way the heater circuit was drawn in the original schematic and that to this new generation of layout folks, "vacuum tube" is the hose on the end of a Hoover canister. Figure 2 illustrates how that secondary circuit should have appeared; and I've also modernized and changed F1, D1, and C1a. There certainly are a lot of improvements that can be made to the circuit. Grounding one side of this heater supply is one of them. Checking for a voltage balance on the triodes and adjusting imbalances by changing the

value of R5 to change the bias would also be prudent.

The input circuit modification might be better for connecting to a modern stereo line out, but this circuit originally had a different purpose. It was designed to rebroadcast a signal, so an FM station could be heard on an AM radio or your hi-fi could be piped to the radio in the basement. The input was a low impedance into the cathode circuit so that the signal could be deliberately taken from the secondary of the output transformer while still keeping a reasonable load on it. Many amplifiers and radios of that era were "hot chassis" models with no power transformer, so this method of direct coupling to the radio was safer, using the output transformer for line isolation. Granted, it wasn't the BEST way to provide isolation, but it was better than nothing. By providing a low impedance to the output transformer, the plate load on the output amplifier was kept at a reasonable value.

I had mentioned in the column that I built this circuit when I was a kid. It was hum-free back then, and I felt that it had a high quality signal especially when you consider the simplicity of the circuit. The low-frequency response was excellent and the upper end didn't matter since AM is pretty much limited to 5 kHz anyway. Although it is a half-wave rectifier, the current demands are so low that the filter cap does a fine job of keeping the ripple negligible. It would be better to replace the original 1N3254

with an easier-to-find 1N4000 series rectifier. Substituting a bridge rectifier will lessen the ripple, but it will also double the B+ voltage, so I'd be wary of that change. It may be that the original designer was trying to watch the power output so that the circuit would remain legal for FCC Part 15 license-free operation.

I just noticed another correction on that schematic. The RF coil is actually a variable inductor where the ferrite slug moves in and out of the coil form. Variable inductors are getting so scarce these days that an old IF transformer core may have to be rewound using some cut-and-try techniques to make this circuit work. Maybe I'll consider building this circuit again before the year is out, get a good coil substitute working, and report on the results.

Thanks for your insight on this one, Michael. I have a feeling that part of the original circuit was lifted from a larger telemetry system for a 1960-style robot. Interference on the AM band might explain why the Robot on "Lost In Space" was always having problems. "Warning, Will Robinson. Warning!"

Staring At Horizontal Lines

Q My son, a graduate research assistant in Medical Physics, is doing research in medical ultrasound. They are using an ultrasound scanner with an output somewhat similar to NTSC video. He is using a frame rate of 10 to 100 Hz and a line rate of 100 to 500 lines per frame, all depending on their needs. The video is an analog output with TTL sync pulses at the frame and line rates.

They need to view a single line (the same line of each frame) on a scope. Using a delayed-sweep scope triggered by the frame pulses, they can view lines at the top of the frame by varying the sweep delay, but their maximum delay in the scope is one millisecond. For a 10-Hz frame rate, they need a 100-ms delay to view lines at the bottom of the frame.

He's considering building a digital delay circuit or a line counter that's triggered by the frame pulse and then counts lines to produce a trigger. They could use either circuit or a commercial unit if it doesn't cost too much. Do you have any ideas or suggestions?—W.S., via e-mail

A Get a different scope. From your description, it sounds like your son is using something like a Tektronix 2213A

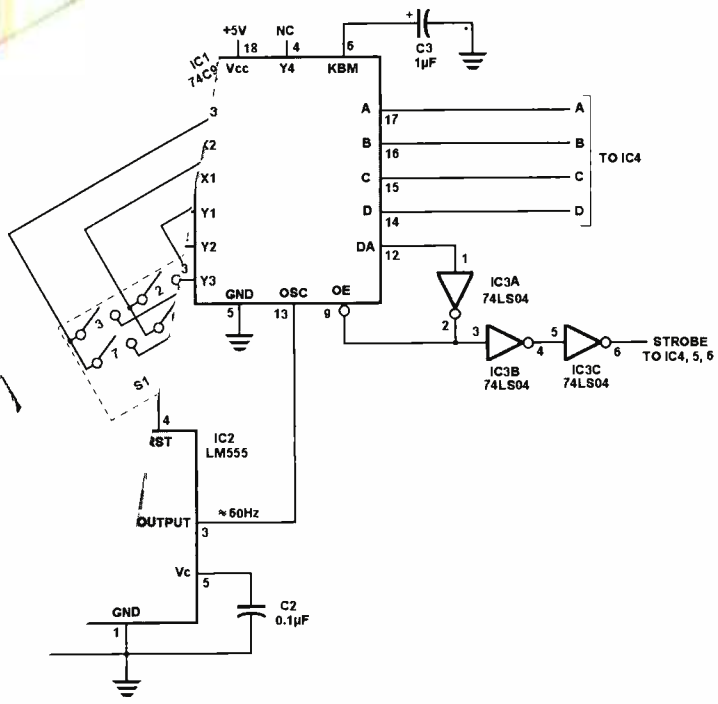

This simple keyboard encoder uses a matrixed keypad and is useful for any kind of robotics or you may have requiring a keyboard input, just like Heath's Hero. It supplies binary data and strobe each time a key is pressed.

that has a timer rather than a time base for the delay time, and they have a limit on their maximum time. He needs to use a traditional delayed sweep scope such as a Tek 465 or 7000 series with a 7B53A time base. An appropriate used scope can be found on ebay for a modest price and is versatile enough for future projects. Except for possible triggering variations because of differences in the frame and line pulse as compared to NTSC video, the setup is the same as for viewing standard composite television signals.

The main (delaying) sweep should be set slow enough so that an entire frame is on the screen. Externally trigger the main sweep from the frame pulse. Now set the delayed sweep for a much faster rate so that you can see individual lines on the screen. Even the best lab-grade analog scopes won't have a main sweep that's stable enough to keep the delayed sweep from being jittery, so instead of using the delayed sweep in the "runs after delay" mode, set it for the "triggered" mode, externally triggering the delayed sweep from the line pulse. That

should lock in the view of the horizontal line so that it's rock-solid. Speed up the delayed sweep until you get the viewing resolution you desire and use the *delay time multiplier* (DTM) to scroll through the horizontal lines. You'll have to kick the intensity up a bit to view this low repetition rate signal and possibly use a hood or dim the room lights to help.

Note that when you were in the "runs after delay" mode, the various horizontal lines would smoothly (other than the jitter) move across the screen. With the delayed sweep in the "triggered" mode, the lines won't appear to change unless the actual video is different. This makes counting a bit difficult. You can use the DTM setting and the delay sweep setting against the time from one horizontal pulse to another to determine where you are. If you have a scope with an "alternate" sweep mode where the delaying sweep and the delayed sweep can be on the screen together, you'll have a rough idea where you are in the frame. Otherwise, you'll have to switch back and forth between the two sweep modes.

However, I like the counter idea, using the frame pulse to reset the counter, letting the line pulse clock the counter, and then using a digital comparator to output a pulse when the count matches a line number that you input. It really should be a simple circuit to put together with most of the potential for complexity dependent on how elaborate you want to get for the selected line input. Just be sure to use synchronous counters, or your comparator will have an unuseable glitchy output.

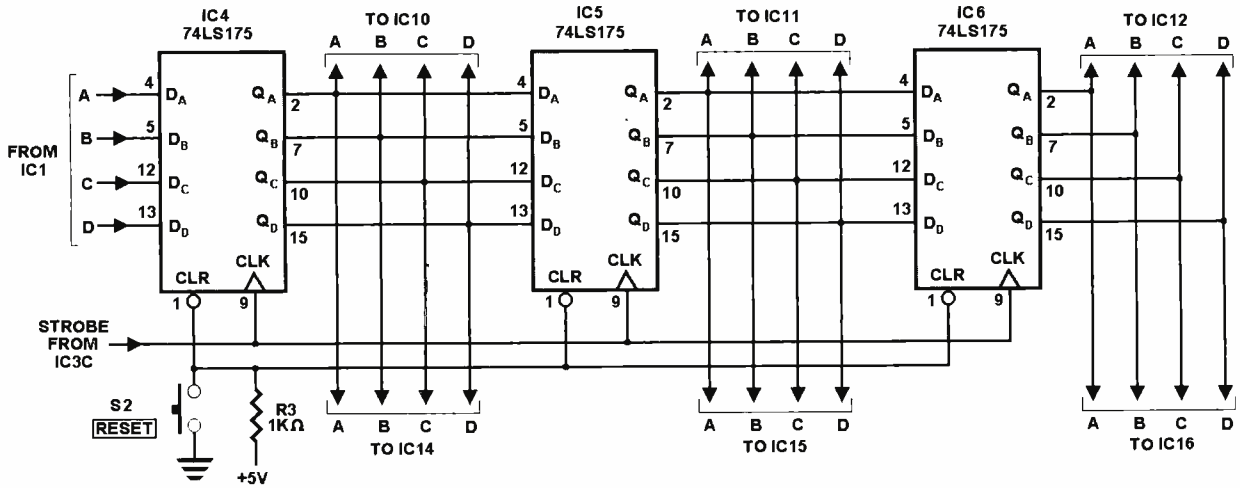

Fig. 4. This four-bit shift register is used to accumulate multiple-digit keyboard data. Simple iterations of this circuit can provide you with a larger register for use with other projects requiring multiple-digit data entry.

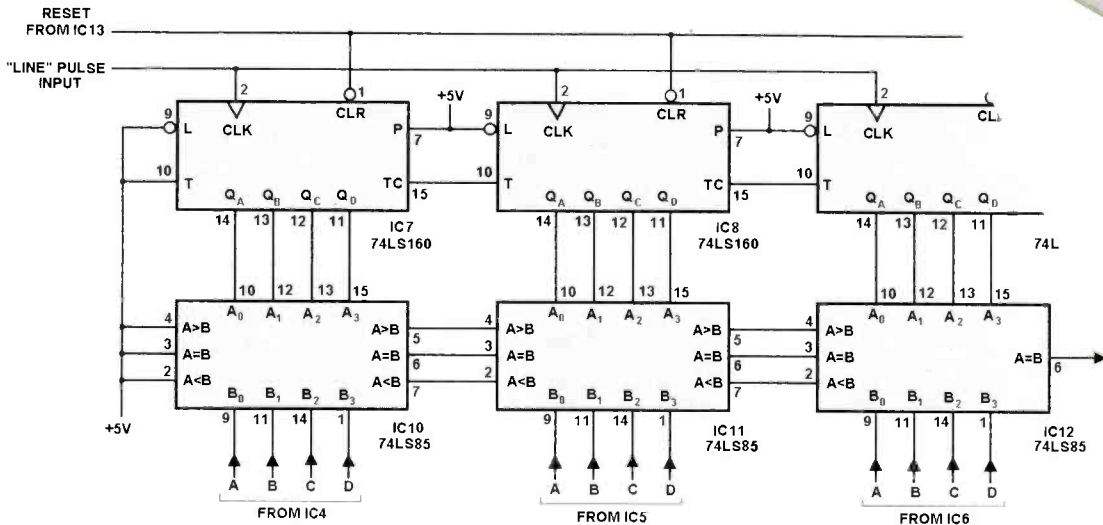

Fig. 5. The heart of the line selector is this counter/comparator circuit that compares the line count with the line number selection entered with the keypad. This circuit is easily enlarged to allow comparison of even more digits, if desired.

So, to that end, I've designed a circuit to get you started. This ought to make the column a record length this month. Please understand that this is just an idea to get the wheels rolling. I've not put this circuit together, and I don't know enough about the timing of the rising and falling edges of the frame and line pulses to know if the circuit will do exactly what you want. Differences in

timing and edges can cause the triggered event to not agree with the entered line number. Figures 3 through 8 are the circuit.

I used the easier-to-use, more difficult-to-construct keyboard method of line-number entry. Figure 3 shows IC1, a 74C922 keyboard encoder used to generate the binary digits that correspond to the digits you enter on a matrix keypad. A 555 timer, IC2, pro-

duces the 60 Hz the keyboard needs to operate. The output of this portion of the circuit feeds the 4-bit shift register of Fig. 4.

Components IC4, 5, and 6 of Fig. 4 are quad D flip-flops wired as a 4-bit shift register. Data is shifted in from the keyboard with each strobe the keyboard generates. The most-significant digit of the register is held by IC6. Switch S2 allows a manual reset to zero of the registers, a convenience more than a necessity, since subsequent keyboard entries will force old data to shift out. These registers feed two circuits: the display (Fig. 7) and the comparator/counter circuit (Fig. 5).

Figure 6 is the "input" circuit. One-shot IC13 is triggered by the "frame" pulse, generating a short, sub-microsecond pulse that will be used to reset the counters of Fig. 5. This pulse will be generated on the rising edge of the frame pulse. If you want this reset pulse to be generated on the negative edge of the pulse, then rewire the clock inputs according to the inset of Fig. 6.

In Fig. 5, IC7, 8, and 9 form a three-decade synchronous counter. The count is initialized to zero by the output of the one-shot (IC13), and subsequent line pulses will clock the counter.

The remaining ICs (10, 11 and 12) are digital comparators. They compare the output sent from the keyboard registers (the desired line upon which to trigger) and the output from the counters (where the video line count actually is during a vertical frame). When the count matches the keyboard data, the "A=B" output of IC12 will go high for a

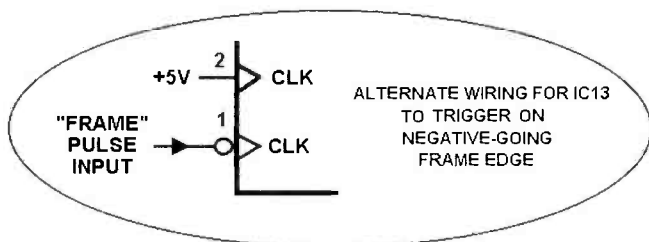
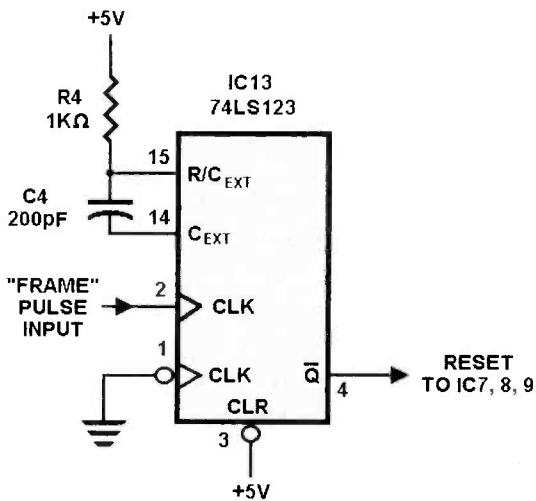

Fig. 6. From the rising edge of the frame pulse input, this input circuit develops a short reset pulse for the counter to initialize it to zero at the beginning of a frame. The inset shows alternate wiring to trigger the one-shot on a negative-edge input.

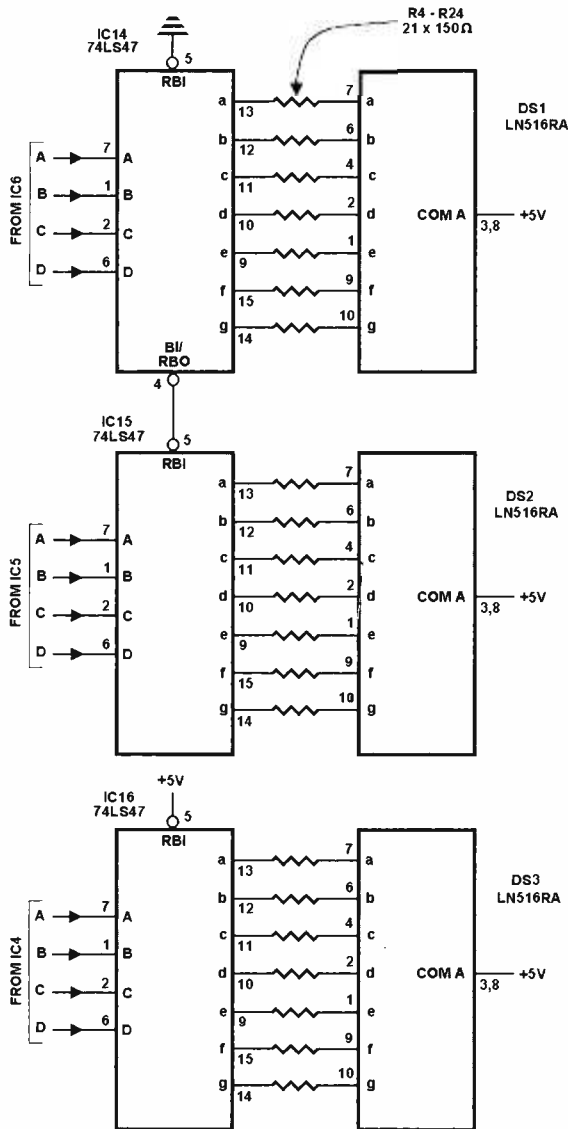

Fig. 7. This straightforward display has leading zero blanking for the two most-significant digits while the least-significant digit is always "live."

time equal to the period of the line pulses and then drop back low. The oscilloscope is externally triggered on this pulse (+ slope), while the vertical input of the scope is connected to the video. A single-timebase scope can be used for viewing the video if the scope is set for "normal" (vs. automatic) sweep mode. Then the timebase is set so that a horizontal line fills the screen. Alternately, a delayed sweep or the horizontal X10 magnifier can be used to "stretch" out this horizontal line.

I can see a potential problem with sub-nanosecond glitches at the output of the comparator. You have to use synchronous counters, or that output will be extremely glitchy. Even with the synchronous counter, you still might get some "hairs" that will trigger the scope.

One fix here would be to put a 200-pF disc ceramic capacitor from the output of the trigger line to ground and put a 1000-ohm resistor between the comparator output and the capacitor/scope input. That little low-pass filter will probably snub out any fast transients on that line.

The line number is entered as you would any number on a calculator. Line number 142 is entered as 1-4-2 or number 23 as 0-2-3. This display has leading-zero blanking. The displays shown in Fig. 7 are the Panasonic LN516RA available from Digi-Key. Either pin 3 or pin 8 can be used for the common anode connection since they are internally tied together. The "R" in the Panasonic part number denotes a red display while a "G" in that position is for green and "Y"

Since I'm one who enjoys the various forums on the Internet, here are three that deal specifically with robots. Well, "Battlebots" are really hardened RC cars, but some of the electronics will cross over into the area of true robotics. Also, if you do a Google search for Heathkit Hero, you should find all sorts of sites dealing with those particular models.

Battlebots

http://forums.delphiforums.com/n/main.asp?webtag=battlebot_tech&nav=start

Nuts and Volts Robotics Forum

<http://206.131.241.58/ubb.cgi/ultimatebb.cgi>

Robot Village

www.robot-village.com

for yellow.

As an option, I've included the line-select circuit in Fig. 8. It uses three rotary switches driving three priority encoders to set the line number. At first, this circuit may appear "clunky" and less sophisticated, but you eliminate all of the circuitry of Figs. 3, 4, and 7. That eliminates nine ICs, three displays, 24 resistors, the keypad, the reset switch and three capacitors, while adding five ICs and 27 resistors. The net result is that it saves a lot of parts and makes the circuit simpler and the circuit board easier to lay out. The switches serve as both the line-set input and the "readout." Unfortunately, unless you already have them on hand, the three 10-position rotary switches can more than offset the cost savings of the other parts.

Another option, not shown here, is to use three BCD thumbwheel switches in place of Fig. 8. Again, those switches would be both input device and "display." Mechanical switches, though a little "old-fashioned" by today's standards, can make the unit faster to use and turning off power won't mess up the line setting.

There's no reason why this circuit couldn't be modified to work with standard NTSC television or VGA monitor video signals. You'll have to feed the NTSC video into a sync separator and normalize the outputs of that circuit for TTL, feeding the vertical sync pulses into the clock of IC13 and the horizontal sync pulses into IC7. You'll also have to figure out a way to select even and odd fields on each frame, or you'll have

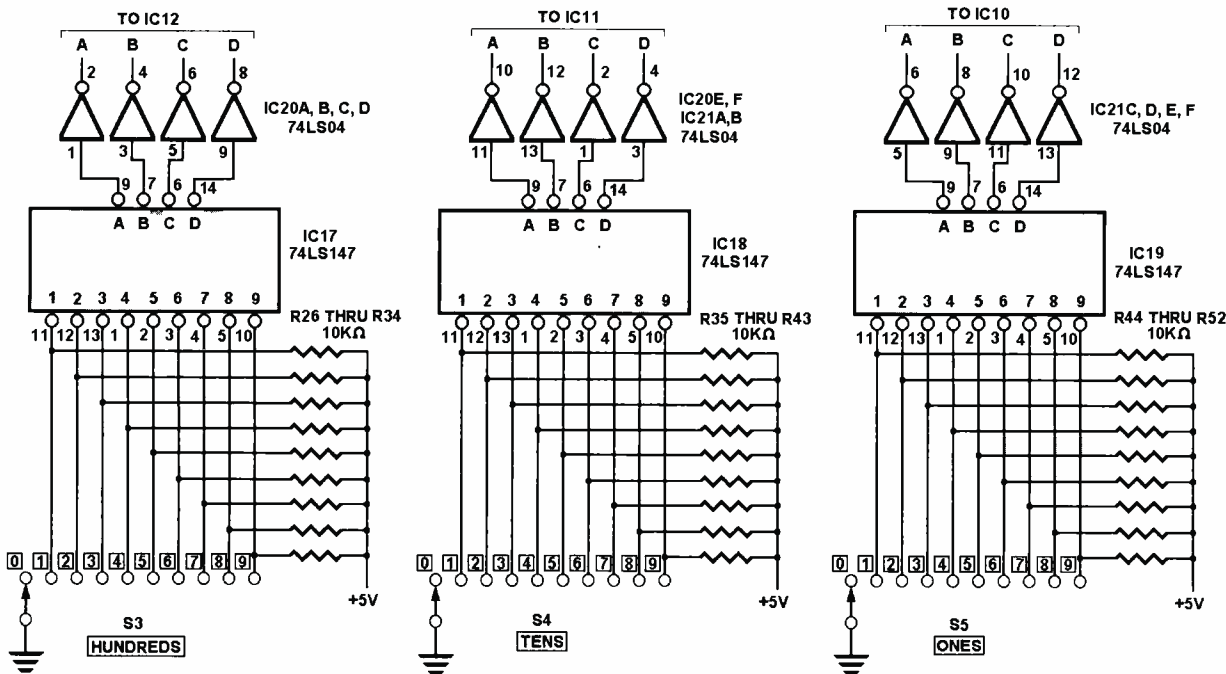

Fig. 8. This optional line input circuit, though appearing "clunky," can reduce the parts count by five major components.

overlapping displays. As the circuit sits, I'm assuming a non-interlaced signal on the ultrasound equipment.

Just remember—THIS IS NOT A PROVEN CIRCUIT. Don't write to me and tell me how awful it is. It's just a beginning idea that will need a lot of massaging before it will be a viable line selector. Please do write to me and pass on any constructive ideas you have on the subject. If any of you build this circuit and convert it for NTSC use, send me the resulting schematic and I'll see about publishing your circuit. This could be a fun project for those of you interested in line-by-line analysis of video.

Positive Comments

Q Regarding your printed circuit board layout for the "In-Circuit Capacitor Checker" published in the February 2002 "Q & A" column, I cannot find a pad for the battery's positive connection in Fig. 3 or in Fig. 4. I can only find a pad for B1(-)—R.H., via Supreme Senior Editor LaMorte

A The board was designed straight from the schematic, so there is no pad for B1(+). B1(+) connects off-board to one side of S1; and the other side of S1 connects to the pad marked "S1," which, in essence, ends up being the connection for the positive battery connection. If any of you finish building the cap check-

er using this board layout, let me know how it comes out. One good use for it would be checking out the ESR on your robot's power supply caps.

Heathkit Clock Chip

Reader Dick Little sent a note telling us that the chip for the Heathkit GC-1107 clock is the same as that used in his GC-1195 (Heath P/N 443-848) and is available as an NTE-2061 substitute. This satisfies a request by D.A. in the April 2002 column. Hey, wait a minute, Dick! You have your April 2002 issue already by March 1st? Where's mine? Most of your readers are lucky, because once the mail hits the southeast Missouri State line, it gets transferred to wagons pulled by mules. Anyway, thank you, Dick, for your help here. You readers are a great bunch of folks, and I really appreciate you all.

Writing to Q&A

As always, we welcome your questions. Please be sure to include:

- (1) plenty of background material,
- (2) your full name and address on the letter (not just the envelope),
- (3) and a complete diagram, if asking about a circuit; and
- (4) type your letter or write neatly.

Send questions to Q&A, **Poptronics**, 275-G Marcus Blvd., Hauppauge, NY

11788 or to q&a@gernsback.com, but do not expect an immediate reply in these pages (because of our backlog). We regret that we cannot give personal replies. Please no graphics files larger than 100K.

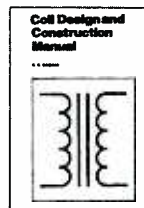

YOU CAN WIND YOUR OWN COILS?

There's no trick to it except knowing what you are doing. In a unique, 106-page book you can become expert in winding RF, IF, audio and power coils, chokes and transformers. Practically every type of coil is discussed and necessary calculations are given with the mathematical data simplified for use by anyone. Get your copy today!

Mail coupon to:

Electronics Technology Today, Inc.
P.O. Box 240
Massapequa Park, NY 11762-0240

Please send me my copy of *Coil Design and Construction Manual* (BP160). I enclose a check or money order for \$8.99 to cover the book's cost and shipping and handling expenses. NY state residents must add local sales tax.

Name _____

Address _____

City _____ State _____ ZIP _____

All orders must be paid in U.S. funds only. Sorry, no orders accepted outside of USA and Canada. Please allow 6-8 weeks for delivery. **ET07**

Information, Please

This month we conclude our discussion of electronic components and getting help for specific problems. A large part of the difficulty in repairing modern equipment is just identifying parts, mainly semiconductors like ICs and transistors. Not only is there such a wide variety of devices, but they are often not labeled in a way that is easy to identify.

Parts Information and Cross References

I have found one of the most useful single sources for information on semiconductors, especially for troubleshooting and repair, to be the *ECG Semiconductors Master Replacement Guide*. (ECG is now merged with NTE, and NTE now appears to dominate the industry.)

It used to be about \$6, and may possibly be available for download free now from the NTE Web site (but it's huge). This will enable you to look up U.S., foreign, and many manufacturers' "house" numbers to identify device type, pinout, and other specifications.

Here is the current Web site for NTE: <http://www.nteinc.com/> (NTE Electronics, Inc.).

It is possible to search for an industry standard or house part number and, in many cases, find not only the NTE equivalent but complete specifications, as well. However, note that the specifications will be for the NTE replacement and may be better than the original, since it often will replace multiple similar parts. Thus, this is not necessarily a way of determining the exact characteristics of the original device.

I am not necessarily recommending using NTE (or other generic) replacements if the original replacements are readily available and reasonably priced. (Note that very often the original replacement part will be less expensive than the equivalent from NTE. Therefore, it should be used, if available.)

However, the cross-reference can save countless hours searching through databooks, searching the Web, or contacting the manufacturers. Even if you have a wall of databooks, this source is invaluable. A couple of caveats:

1. Some crosses have been known to be incorrect—the specifications of the generic replacement part were inferior to the original or just totally wrong.

2. Don't assume that the specifications provided for the generic part are identical to the original—as noted above, they may be better in some ways. Thus, using one of these cross-references to determine the specifications of the parts in your junk bin can be risky.

I often use the replacement guide to determine upper bound specs but, as noted above, rarely buy any generic parts (sorry, NTE). Then I find industry standard parts that have equal or better specs.

Transistor Designations

Unfortunately, there is no such thing as a universal part number! U.S.-made semiconductors used to be mostly of the 'nN' variety—2N with a three- or four-digit number for a bipolar transistor, for example. This is called the Joint Electron Device Engineering Council (JEDEC) standard numbering, but seems to have been replaced by letter prefixes which may be manufacturer dependent, although the same part may be available from multiple sources.

These numbers are becoming less common and are rare in consumer electronics:

1N: diodes

2N, 3N: bipolar transistors

4N, 5N: optocouplers

Many devices in consumer electronic equipment are marked with a letter (A, B, C, D, F, J, K) and a three- or four-digit number. Add a "2S" in front of this and the result is likely to be the complete (Japanese) part number (the "2S" is nearly always absent from the package

label). You can often use this number to find a suitable cross from NTE. However, most of the common "2S" devices are available from places like MCM Electronics.

2SA, 2SB: PNP bipolar

2SC, 2SD: NPN bipolar

2SF: thyristor

2SJ, 2SK: FET/MOSFET

There are many other "2S" prefixes, but these are by far the most common. Suffixes may denote package type or some special feature like an internal damper diode (D, for horizontal output deflection transistors), enhanced gain, special speed sort, etc.

Less common are designations that look similar to the Japanese 2S numbers (a capital letter followed by a three- or four-digit number and optional suffix) but are actually Korean part numbers to which you add a "KT" (Korean Transistor or Type?) instead of a "2S." So D998 becomes KTD998. These components typically have a capital "K" on top in addition to the part number starting with the letter (e.g., A,B,C,D).

However, sometimes the only way you will know is that ordering the 2S version gets you a device that isn't even close (like a tiny TO92 small signal transistor rather than the 200 W, TO3 type you expected)! There may be other examples, but these are the exceptions (at least for now).

Note that some components (usually ICs) may be labeled in a similar manner (like C4558C, which is actually a dual op-amp), but this IS the complete part number—just something else to confuse you! Some of these such as one labeled C1003 may actually be a uPC1003 so if what you find in a datasheet doesn't make sense, try these other possibilities!

Aside from the VERY expensive D.A.T.A. semiconductor reference series (don't even ask), which includes virtually all types and flavors of devices, there are various Japanese Semiconductor Reference

manuals available through places like MCM Electronics for around \$20. Some of the text may be in Japanese but the relevant data is in English. These are handy if you want more detailed or precise specifications for these devices than provided by cross-references such as NTE.

There is more information on part designations on my Web site, *repairfaq.org*, in the document: "Troubleshooting of Consumer Electronic Equipment."

Surface-Mount Parts

Due to their small size, very little information is printed on the actual package for diodes, transistors, capacitors, and other discrete devices. Resistors are often labeled with three or four itty-bitty digits, where the last one is the multiplier (10 to the Nth power). Capacitors are often totally unlabeled, but larger electrolytics may have both capacitance and voltage rating. Non-electrolytic types often have a brown body. Electrolytics may be black, yellow (tantalum), or some other color.

Discrete semiconductors can often be identified by the number of pins using an ohmmeter, at least in a rough sort of way. However, the only way to determine their specifications (and often even the type) or to find a cross-reference for the abbreviated markings like 1A, B2, 2J, is to look them up, since there is no logical relationship between the marking and the actual part number (unlike the 2S discrete parts, for example). You can do this if you have the manufacturer's databooks or possibly even their abbreviated catalog (e.g., Motorola's *Master Semiconductor Selection Guide*. NTE does cross a few of these SMT parts, but their coverage is not nearly as comprehensive as for normal (through-hole) counterparts.

The Web sites of semiconductor manufacturers may also have some information, but this varies widely from company to company. There is an on-line list at http://www.repairfaq.org/REPAIR/F_SMD_trans.html (Surface Mount (SMD) Transistors/Diode FAQ).

This is also somewhat incomplete. There's also a very nice one at: <http://www.marsport.demon.co.uk/smd/main/frame.htm>—The SMD Code Book.

Identifying ICs

The only option for many of these is to locate the databook or Web site with the datasheet. Even if the part number is similar to a through-hole version, the pinout

may differ. However, common TTL/logic chips and op-amps will usually have identical pinouts and specifications. It is often possible to partially confirm this by checking the location of the power pins or known signal connections.

House Numbers

These are the cryptic numbering like 121-1025 or 113234 that may be the only marking on that critical part you need to replace or identify. Are house numbers used just to make life difficult? It certainly seems that way from the perspective of repair. Give me industry standard numbers any day. However, house numbers are a fact of life.

The house number is what you need to order a replacement from the original manufacturer of the equipment, but that may not always be desirable due to the likely high cost and possible difficulty in locating a suitable distributor that carries the manufacturer's replacement parts.

As noted above, a Master Selection Guide like the one from NTE may be able to give you some idea of the specifications even if you don't want to use their generic replacement semiconductors. Their Web sites have (or should have in the future) some amount of cross-reference information for industry standard and house numbers.

However, don't expect to find detailed IC specifications or even pinouts in most cases there or from the disks they may also offer. The hard-copy *Master Selection Guides* that these companies sell have been better in the past (though this may be changing), but even these won't give you all the details. If you do repair work regularly, these "telephone book" thickness guides are worth the few bucks that is charged.

Internet Sources of Information

Now let's turn from our discussion of identifying parts to finding information on the Web. Most manufacturers of electronic equipment are now providing info via the World Wide Web. The answer to your question may be a mouse click away. Perform a Net search or just try to guess the manufacturer's home page address. The most obvious is often correct. It will usually be of the form "<http://www.xxx.com>" where "xxx" is the manufacturers' name, abbreviation, or acronym. For example, Hewlett Packard is hp, Sun Microsystems is sun, Western Digital Corp. is wdc. It is amazing what is appear-

ing freely accessible via the WWW. For example, disk drive manufacturers often have product information including detailed specifications, as well as complete jumper and switch settings for all current and older hard drives.

Tandy (Radio Shack) has a nice Web resource and fax-back service. This is mostly for their equipment, but some of it applies to other brands. There are also diagrams that may be useful for other manufacturers' VCRs, TVs, CD players, camcorders, remote controls, and other devices. See the Tandy Product Support Page at: <http://www.radioshack.com/prod/support/productsupport.asp>.

Schematics On The Web

Are there schematics of consumer electronic equipment on the Web? You are searching for the Holy Grail. Everyone is, but it isn't going to happen—at least not for free. Schematics are copyrighted by the equipment manufacturers who sell them as part of their service manuals or license them to organizations like Sams Technical Publishing (*Sams' Photofact*) and others. Their Web site is www.samswebsite.com.

If you reverse engineer (trace) the schematic of a TV or VCR from the unit itself—and can prove it—and then make it available at your Web site, that is probably legal. However, if you scan a service manual or *Sams' Photofact* and make that available at your Web site, you may eventually find yourself in court. That is my take, at least.

Having said that, some people don't care if they violate the copyright. There have been a few Web sites with assortments of consumer electronic equipment schematics, but they come and go.

Searching For Information From USENET Newsgroups

USENET newsgroups are on-line bulletin boards or discussion groups that cater to every interest from soup to nuts and beyond. There are over 20,000 active newsgroups in existence though for our purposes one is of most interest: *sci.electronics.repair*.

There is an excellent chance that your question has come up and resulted in information being passed back and forth on *sci.electronics.repair* (or other appropriate newsgroup). For example, if you have had problems with a late model RCA/GE television, there have been dozens if not hundreds of postings on this subject over the last couple of years.

TAKING THE UNIT TO A REPAIR SHOP

As with medical problems, an accurate diagnosis can only be made with complete information. Use your senses to the fullest. If you do decide to have the unit professionally repaired—and depending on your level of experience and confidence, this may be the wisest choice—the more complete your description of the problem the easier (and cheaper) it will be to locate the problem. Include functional behavior or lack thereof and mechanical and electronic sounds it makes, anything that is related at all to the operation of the unit. Sometimes seemingly unrelated factors can be important, for example, the fact that your officemate rearranged his desk and your monitor's image is now shaking.

Don't omit anything—even what you feel is inconsequential—leave that judgement to the repair person. Also, what may have changed in your setup, did you move the equipment recently or add a component? What about your cable connections? Did you rearrange the furniture? When was the last time you know it worked properly? What were you trying to do at the time of the failure?

To paraphrase a famous quote: "The only stupid or useless information is that which is not provided." However, unless you really are sure of what you are talking about, don't try to tell the repair person what you think the problem is likely to be. Don't bombard them with techno-babble full of buzzwords—any competent tech will see right through that. You can be sure that if you mention that you suspect the expensive flyback is toast, it will be diagnosed as bad. Let them do their job. Listen carefully to their diagnosis. You should be able to tell if it makes sense.

There is no need to add to the clutter.

Google Groups (formerly *Deja.com/DejaNews*) includes a USENET newsgroup searching facility. It has been archiving newsgroup articles since March, 1995. By going to their Web site, you can search over 45,000 newsgroups (hundreds of GB of data!) for any set of words, names, or e-mail addresses. Within seconds, they will provide a list of postings that satisfy your search criteria. Try using Google Groups at least

once—you will be instantly hooked.

Some of the relevant site URLs are <http://groups.google.com/> (Google Groups Homepage) and http://groups.google.com/advanced_group_search (Usenet Advanced Search).

While postings typically drop off of your local server in a few days or less, Google Groups maintain them "forever" so that locating an entire thread becomes a trivial exercise in identifying a search string that will narrow down the postings to those relevant to your needs.

Posting to the Sci-Electronics Repair Newsgroup

This is a bit different than attempting to tell the tech at a repair shop how to do their job—speculation is safer. There is enough cross-checking such that any gross errors in analysis will be uncovered. There is also generally no profit motive. If your speculation is totally bogus, you will find out quickly enough, turn various shades of red—and learn from the responses.

Even if your ISP doesn't provide USENET newsgroups or allow posting for some reason, you can always access them (read, search, and post) via Google Groups. See the info above about Google Groups.

No matter how you do it, however, here are some tips that will get you what you want without unnecessary flame wars.

Please read the on-line repair FAQs or repair guides first. Your problem may be covered. Even if an exact solution is not provided there, the additional information may allow you to ask your questions more concisely and intelligently and therefore arrive at a solution more quickly.

The FAQs can be found at <http://www.repairfaq.org/> (Sci.Electronics.Repair FAQ at RepairFAQ.org) and its mirror sites. First read the README and Mirrors links to identify the best way for you to access the information from your location.

Put the type of device (i.e., VCR, CD player), manufacturer, and model number in the subject header as this will get the attention of the professionals. If you do not provide this info, the first reply will be to provide it. Avoid this waste of Net bandwidth. For general questions, such info may be unnecessary, but it will not hurt.

As with professional repairs, provide as much relevant information as possi-

ble. Ambiguity can lead to totally bogus advice. For part identification, include both the designator (e.g., R324, Q1) and type (e.g., 330K, BU407D) if available. Don't just ask for repair tips—describe in chronological order what you have done so far in terms of troubleshooting approach and tests performed but don't fill screen upon screen with details. People don't want to read a lot of filler. Include only the essentials.

Turn off any fancy formatting like HTML or Word. Use plain ASCII text since everyone can read that, formatting adds NOTHING to the content, takes up space, and is very confusing for those people whose news-readers cannot interpret it. Take a bit of time to make sure what you have typed is correct. Spell checking it won't hurt. DO NOT use ALL CAPS—that is like shouting in cyberspace, and a good way to be ignored.

A bit of courtesy won't hurt, as well. Many people who reply won't care about the use of "please," "thank you," and "any help is much appreciated," but none of these will hurt and don't take much effort.

If a little circuit diagram will help, provide it in ASCII if possible. ASCII takes up almost no space and everyone (with a fixed width font) can read it. Here are some basic guidelines for creating legible ASCII schematics:

1. Use a fixed-width font like Courier, Lucida Console, Quick Type Mono, etc.
2. Make sure your line length is set to 78 characters or less.
3. Use Spaces rather than Tabs—Tabs interpret differently depending on terminal or newsreader settings, and the alignment gets messed up when text is included in a news posting.

For numerous examples of ASCII schematics that should look fine, see http://www.repairfaq.org/REPAIR/F_samschem.html (Various Schematics and Diagrams).

Large binary files are not supposed to be posted on these newsgroups. In addition, you will upset people who are forced to download a 1-MB file they have no interest in but may not know it until they see the description. Some ISPs charge for connect time and bits transferred.

If you have a large scanned schematic and you think it really will help with a diagnosis of or solution to your problem, offer it via e-mail, upload it to your Web site, or post it to the newsgroup: alt.binaries.schematics.electronic (but not

all news servers carry this group).

You need to be patient. Not everyone sits at their computers all day. Some news servers may be days behind in their postings. If you truly get no replies of any kind (to the newsgroup or e-mail) in a few days, repost your question with a note that it is a repeat. The Net isn't perfect, and due to finite disk space, many servers will miss postings or purge them after a day or less. Sometimes, your posting may not have made it out of the bowels of your computer system. You should be able to check this.

Don't ask for help on 25 problems in the same posting—that is taking advantage of the generosity and time of others. Dribble them out and reciprocate by replying to other people's problems as well if you can be helpful. If you act immature, you will end up in everyone's kill file. Also, don't ask for help on problems that you could just as easily solve on your own by checking a databook you should have or a Web site that you should know about.

It is also impolite to ask for an e-mail response. Remember *sci.electronics.repair* was not created for your benefit. We do this because we like to help people, but at the same time do not want to feel like we are being taken advantage of or taken for granted. We are not your private consulting service. In addition, others will know when an adequate response to your query has been provided and will not need to waste their time repeating the same information. Everyone will learn something in the process.

More importantly for you, receiving replies via e-mail will circumvent one of the most important functions of the newsgroup—cross-checking to locate errors in responses either because the responder didn't know what they were talking about or made an error in interpretation. Perhaps, they were just being a bozo and sent a totally bogus or even dangerous response. Some people may have hidden agendas that aren't in your best interests. If that was the only reply, you would never know. While there is a lot of high quality information available via the Internet, there is also a lot of noise. Yes, you will need to read the newsgroup for a few days. That will be a small sacrifice and well worth the effort.

If your news feed is indeed poor—as many are—and you are honestly afraid of missing the responses, then phrase your request for an e-mail reply in such a way that it doesn't sound like you are

totally immature and lazy.

Another alternative is to search for replies at <http://groups.google.com/> (Google Groups). This service will enable you to search for only the postings you are interested in and seems to be pretty reliable. They subscribe to a half dozen news feeds just to avoid missing your postings!

Many people will send you a CC of their posting anyhow so avoid getting flamed for poor netiquette. However, take note. Use your true full name and e-mail address in the "Reply-to" field of your posting. It is unreasonable to expect us to reformat a bogus e-mail address that you might use to avoid SPAM. It is quite annoying to try to help people only to receive bounced mail. While the "delete" key works quite well in dumping the returned message, you don't get your questions answered. The regulars on the *sci.electronics.xxx* newsgroup hierarchy all use their real names and e-mail addresses. Please do us a favor by doing the same. Spammers lurking around these sci newsgroups get punned anyhow and don't survive for long.

Don't accept the first response as the definitive word. Gather a few replies and follow-ups, and then you will be able to make an evaluation of which to believe and act upon. Post a question for clarification, if needed.

If you do receive e-mail responses, reply to the senders as well as posting to the newsgroup and indicate to the senders that you are posting a copy to the newsgroup. It is very annoying to reply via e-mail only to find that the same question appears a little later on the newsgroup requiring a repeat response.

In any case, once your problem has been resolved (or you have given up), it is polite to post a concise summary of the problem, suggestions, the solution or frustration, and appreciation to those who have helped you.

Private Discussion Groups and E-mail Listservers

In addition to USENET newsgroups, there are a number of private bulletin boards (may also be called forums) on repair-related topics. These are accessible via the World Wide Web rather than through a News server. New ones come and old ones disappear regularly. I personally see little point in using these—traffic is usually very low, and the experts

all hang out on the relevant USENET newsgroups anyhow! Very often the private ones are related to a commercial enterprise. First of all, you don't know whether the replies are slanted toward selling something in some cases; and secondly, there is often objectionable (at least in my opinion) advertising on the site.

There are also a few repair-related e-mail list servers. These require that you subscribe by sending a special e-mail message and/or filling out a form. Some may have merit in that experts are more likely to be subscribers, and they are forced to at least receive all e-mails (even if the next stop is the bit bucket!).

Sorry, given the relatively low interest in both private discussion groups and e-mail listservers, I can't justify attempting to keep up with their arrivals and departures! Both of these can be found through the various tech-tips sites as well as by searching postings on the *sci.electronics.repair* Newsgroup.

A few may also be listed in my bookmark file (at repairfaq.org).

Wrapup

Well, that completes our periodic discussion of information resources. In the last few years, the Internet has become increasingly important and will continue to do so for the foreseeable future. Keep a copy of this and last month's Service Clinic handy for reference until we do this again. As always, I welcome feedback via e-mail to sam@repairfaq.org. **P**

FREE CONSUMER
INFORMATION CATALOG.
Call toll-free 1-888-8 PUEBLO.

Introducing Robotics with Lego® Mindstorms™

For Robot Lovers. Shows how to build a variety of increasingly sophisticated computer-controlled robots using the brilliant Lego mindstorms Robotic Invention System (RIS). Covers the fundamental building techniques needed to construct strong and efficient robots. Explains to the reader how robot control programs may be simply constructed on their PC screens.

Detailed building instructions are provided for all the robots featured. 270 pages, 7 1/2 x 10 5/7 in. **\$19.99.** Plus \$2.45 shipping in U.S. Order from CLAGGK Inc., P.O. Box 12162, Hauppauge, NY 11788 **CLX1**

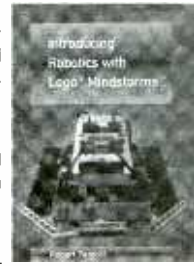

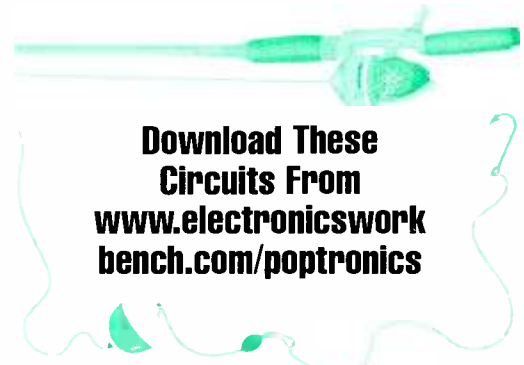

Download These
Circuits From
www.electronicshobbybench.com/poptronics

Timer Circuits

I've just started on a design project that requires a number of timer circuits. These will entail a variety of semi-precision timers including on/off, delay-on, and delay-off circuits. Since this is a work in progress, I will share some of the circuit designs with you.

Time

The project requires a timer that repeats the on/off cycle as in an astable oscillator circuit; however, the on and off time period must be easily adjustable without one adjustment affecting the other. The timer must also maintain a good degree of accuracy.

The CMOS 4528 dual retriggerable monostable IC looked like a good candidate for the job. The IC costs less than a buck and is simple to use. The IC can be triggered by either a positive or negative input signal, and the time period is set with a resistor/capacitor, RC, combination.

The IC's pin layout is shown in Fig. 1. Pins 1 through 7 are for one monostable circuit and pins 9 through 15 are for the second. Pin 8 is the negative supply terminal, and pin 16 is the positive supply

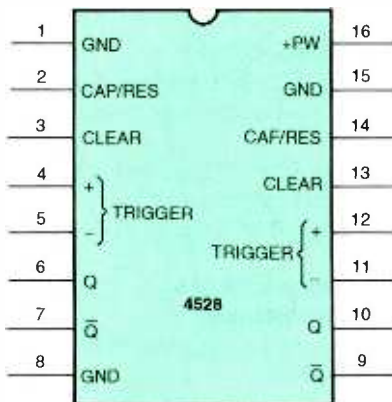

Fig. 1. This is the CMOS 4528 chip pin layout. Pins 1 through 7 are for one monostable circuit and pins 9 through 15 are for the second. Pin 8 is the negative supply terminal, and pin 16 is the positive supply terminal.

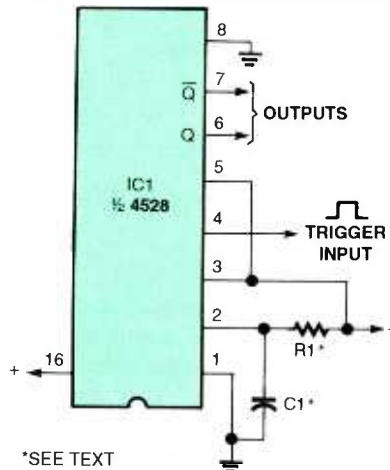

Fig. 2. The RC timing components connect to pin 2. The timing resistor can be any value from a few thousand ohms to ten megohms. The timing capacitor can range from a few picofarads to over 100 microfarads.

PARTS LIST FOR THE BASIC TIMER CIRCUIT (FIG. 2)

- IC1— CMOS 4528 dual retriggerable monostable integrated circuit
R1, C1—See text.

terminal. Input-trigger polarity is selected by using either pin 4 for a positive input trigger or pin 5 for a negative. The clear input, pin 3, can be used to interrupt the timing process or to disable the circuit's operation. The clear input is normally connected to positive power for normal timing operation. The IC's other monostable circuit is a twin of the first and performs in a like manner.

Basic Timer Circuit

The basic timer circuit is shown in Fig. 2. The RC timing components connect to pin 2. The timing resistor can be any value from a few thousand ohms to ten megohms. The timing capacitor can range from a few pico-

farads to over 100 microfarads.

The circuit is set up to trigger on a positive-going input voltage, which requires the negative input (pin 5) to be tied to the positive supply. To trigger on a negative-going input, the positive input (pin 4) must be tied to the negative supply.

As soon as the circuit receives an input trigger, the "Q" output goes high and remains high until the timing cycle is completed. The "Q" (not) output at pin 7 goes low for the timing cycle. After the timing cycle is completed, the circuit returns to its normal state with the "Q" output low and the "Q" (not) output high.

Twins

Tying the two monostable circuits together, as shown in Fig. 3, completes the on/off timer needed for the project. Both timers are set up to trigger on a positive-going input. The "Q" (not) output of timer "A" is connected to the positive input of timer "B," and the "Q" (not) output of timer "B" is connected to the positive input of timer "A."

This cross-coupled arrangement turns the twin monostable circuit into an astable oscillator, which repeats the on/off cycle as long as power is applied.

LED1 turns on when timer "A" is operating, and LED2 when timer "B" is operating. The total "on" time for both LEDs adds up to one cycle for the monostable pair.

The time period for each half may be adjusted without affecting the time-period setting of the other timer. As an example, timer "A" may be set for an "on" time of one second and timer "B" for two seconds for a total cycle time of three seconds. This circuit feature allows the two outputs to drive external circuits with different on/off timing periods or a single output with a variable on/off timing-period adjustment.

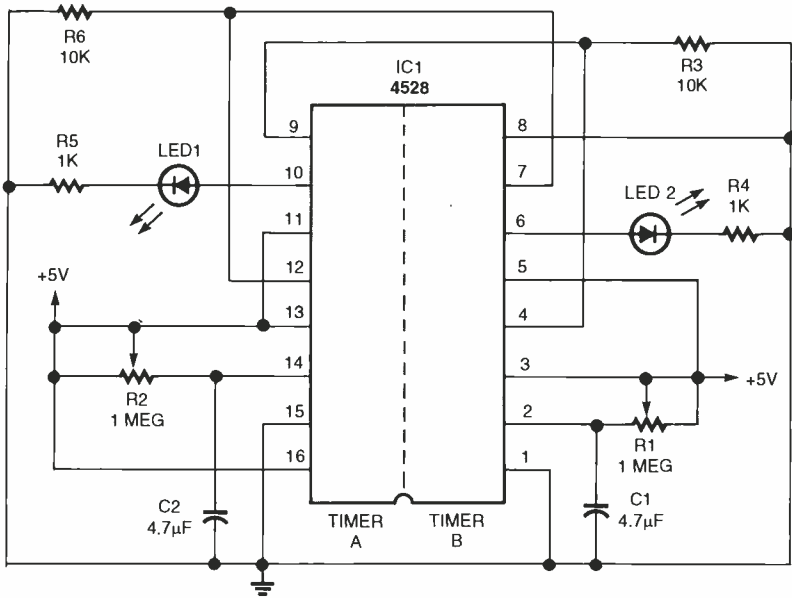

Fig. 3. Tying the two monostable circuits together completes the on/off timer needed for the project. Both timers are set up to trigger on a positive-going input.

The RC components shown in Fig. 3 will allow the off/on timing of each monostable circuit to be adjusted from a few milliseconds up to about 1.5 seconds each, or a total cycle time of three seconds. The timing period may be increased by using a larger capacitor for C1 and C2.

Phase Two

The second timer needed for the project requires a single output that could be selected for a given percentage of the total operating time. This timer also must be a self-repeating type circuit. The timer's output must be selectable

PARTS LIST FOR THE TWINS (FIG. 3)

SEMICONDUCTORS

IC1—CMOS 4528 dual retriggerable monostable integrated circuit
LED1, LED2—Light-emitting diode, any type or color

RESISTORS

(All resistors are 1/4-watt, 5% units.)
R1, R2—1-megohm pot.
R3, R6—10,000-ohm
R4, R5—1000-ohm

CAPACITORS

C1, C2—4.7-µF, 16-V_{DC} tantalum

from 10% to 60%, in 10% steps. Also, the timer's operating repetition rate must be changeable in semi-precision steps.

A good starting place would be to use a decade, or divide-by-10 counter, driven by an accurate clock to obtain the desired operating time and the stepped outputs. The clock rate could then be changed in steps to vary the overall cycle time. In this case a step arrangement of 1, 2, and 5 is required, with a 1-Hz clock rate for step 1, and 2 Hz for step 2, and 5 Hz for the third step. This arrangement will give a cycle time for step 1 of ten seconds, step 2 of 20 seconds, and step 3 of 50 seconds. Don't be too concerned if this is somewhat confusing at

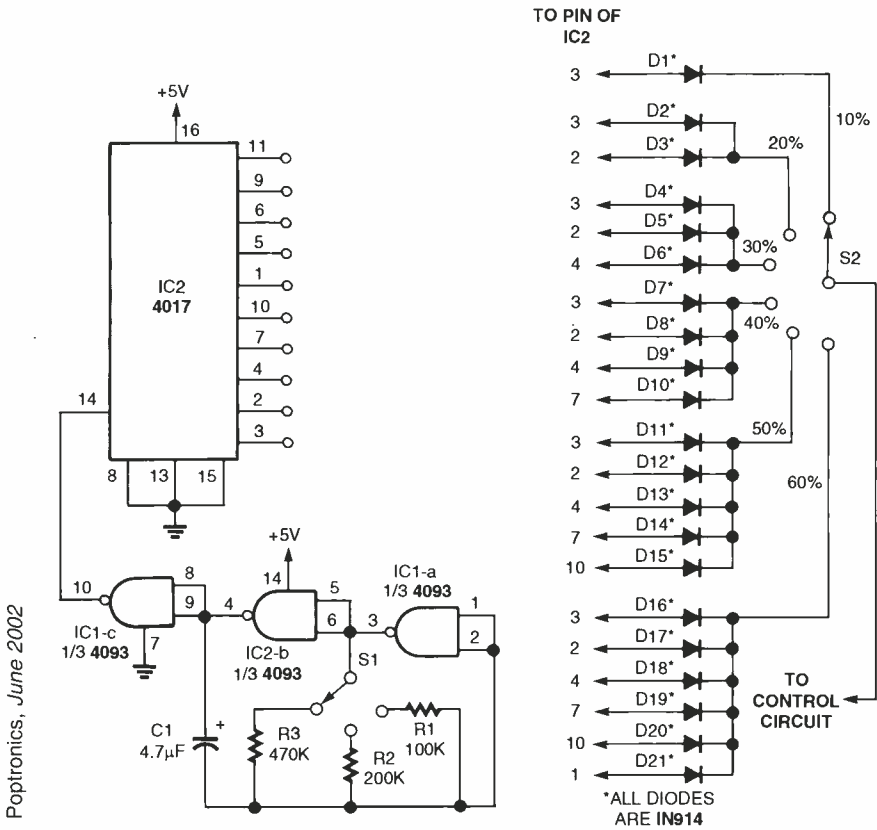

Fig. 4. This is a stepping-output-timer circuit. The clock is made up of two gates of a CMOS 4093, a quad two-input NAND Schmitt trigger IC, and a few components.

PARTS LIST FOR THE STEPPING-OUTPUT TIMER CIRCUIT (FIG. 4)

SEMICONDUCTORS

IC1—CMOS 4093 quad two-input NAND Schmitt trigger integrated circuit
IC2—CMOS 4017 divide-by-10 counter integrated circuit
D1-D21—1N914 silicon diode

ADDITIONAL PARTS AND MATERIALS

C1—4.7-µF, 16-V_{DC} tantalum capacitor
R1-R3—See text.
S1—Single-pole three-position rotary switch
S2—Single-pole, six-position rotary switch

PARTS LIST FOR THE MANUAL/AUTO RESET (FIG. 5)

- R1—10,000-ohm, ¼-watt, 5% resistor
C1—22-µF, ceramic disc capacitor
S1—Normally-open push-button switch

this point, as it will become clear as we proceed.

Stepping Out

The stepping-output-timer circuit is shown in Fig. 4. The clock is made up of two gates of a CMOS 4093, a quad two-input NAND Schmitt trigger IC, and a few components. The timing components are composed of a single capacitor, C1, and three selected timing resistors, R1–R3. Component C1 is a low-leakage quality tantalum capacitor. The resistor values are selected to produce a 1-Hz output in switch position 1, 2-Hz output in position 2, and 5 Hz in the third position. The resistance value for R1 is about 100,000, for R2 about 200,000, and for R3 about 470,000.

A single 4017 synchronous decade counter, IC2, easily handles the divide-by-ten function. The clock's input is pin 14, and the 0 through 9 outputs are pins 3, 2, 4, 7, 10, 1, 5, 6, 9, and 11, respectively.

The 4017 decade counter takes one output step for each clock-input pulse. The time required to complete a 0 through 9 count is ten times one clock-cycle time period.

The first clock pulse, at pin 14 of IC2, produces a positive output at pin 3 of IC2. With S2 in the 10% position, the output to the control circuit is positive for one clock time period. If S2 happens to be in the 20% position, the first output at pin 3 gives a positive output for the first clock pulse and the output at pin 2 gives a positive output for the second clock pulse. Diodes D2 and D3 pass the positive outputs through S2 to the input of the control circuit. This sequence allows the two output pulses to add in time to equal the time of two clock pulses, or 20% of the total of ten counts. The remaining switch positions operate in the same manner, by adding the counter's outputs in time through the diodes to the output circuit.

Manual/Auto Reset

One feature I left out of the circuit in Fig. 4 is the option of having the decade

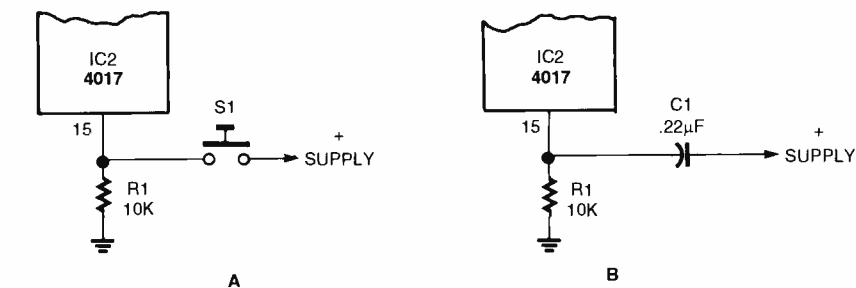

Fig. 5. Pressing S1 in circuit "A" will take the reset input high, resetting the counter outputs. When released, the counter will start out counting from 0 to 9 in a normal fashion. In some applications, the manual reset is more desirable than the automatic reset feature.

counter automatically reset on power up or if power is interrupted, or the option of manually resetting the counter at any time. The manual option is shown in drawing "A" of Fig. 5.

The IC's reset pin 15 is normally tied to ground enabling the counter to function in a normal manner, as shown in the circuit of Fig. 4.

However, sometimes a glitch or a power interruption occurs and upsets the counter's normal function. When this happens, more than one output will go high at the same time; and it requires the counter to cycle through a count of ten to correct the error and get back into a normal counting sequence. Pressing S1 in circuit "A" will take the reset input high, resetting the counter outputs. When released, the counter will start out counting from 0 to 9 in a normal fashion. In some applications, the manual reset is more desirable than the automatic reset feature.

The automatic reset version (Fig. 5B) replaces the manual switch with a capac-

itor tied between the reset input and positive supply. When power is first applied, or a power interruption occurs, the reset input is momentarily taken to positive supply during the charging of C1. Once C1 is charged, the voltage at the reset input returns to ground level through R1, allowing the counter to function normally.

Following Another Path

One of the great benefits of this hobby is our ability to take an almost unlimited number of paths in our circuit design to accomplish a desired outcome. Maybe that's why designing and building electronic circuits is so much fun. Anyway, here we are heading in another direction to fulfill the circuit requirements of our last timer circuit, using a slightly different approach in the 1, 2, 5, and 10 clock time periods.

The new approach is to use only the 1-Hz clock rate for the basic time period for all of the timing ranges. This makes the overall timer accuracy better between ranges since we're only using a single RC timing circuit in our clock circuit. We accomplished this by adding another 4017 decade counter to the circuit, as shown in Fig. 6. The clock's output, out of IC1 gate "C," is now connected to the clock input of IC3, and the output to the clock input of IC2 is now taken from pin 3 of IC3. What we've done is to insert the 4017 decade counter in between the clock and IC2.

This design allows us to divide the

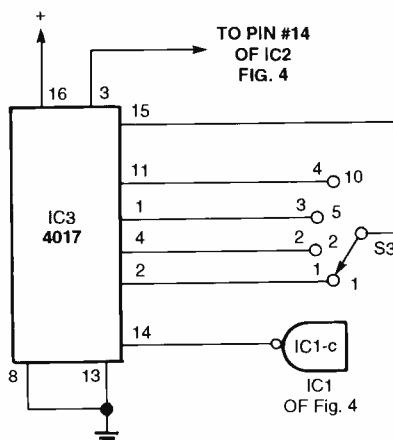

Fig. 6. The clock's output, out of IC1 gate "C," is now connected to the clock input of IC3, and the output to the clock input of IC2 is now taken from pin 3 of IC3. What we've done is to insert the 4017 decade counter in between the clock and IC2.

PARTS LIST FOR ANOTHER TIMER CIRCUIT (FIG. 6)

- IC3—CMOS 4017 divide-by-10 counter integrated circuit
S3—Single-pole, four-position rotary switch

- | | |
|---|---|
| <input type="checkbox"/> 229 Popular Electronics (1999 back issues) \$5.00
Write in Issues desired _____ | <input type="checkbox"/> 218 Electronics Now (1998 back issues) . \$5.00
Write in Issues desired _____ |
| <input type="checkbox"/> 228 Popular Electronics (1998 back issues) \$5.00
Write in Issues desired _____ | <input type="checkbox"/> 217 Electronics Now (1997 back issues) . \$5.00
Write in Issues desired _____ |
| <input type="checkbox"/> 227 Popular Electronics (1997 back issues) \$5.00
Write in Issues desired _____ | <input type="checkbox"/> 216 Electronics Now (1996 back issues) . \$5.00
Write in Issues desired _____ |
| <input type="checkbox"/> 226 Popular Electronics (1996 back issues) \$5.00
Write in Issues desired _____ | <input type="checkbox"/> 215 Electronics Now (1995 back issues) . \$5.00
Write in Issues desired _____ |
| <input type="checkbox"/> 225 Popular Electronics (1995 back issues) \$5.00
Write in Issues desired _____ | |
-
- | REPRINTS | REPRINTS |
|---|--|
| <input type="checkbox"/> EH96 Experimenters Handbook (1996) . \$5.00 | <input type="checkbox"/> 174 Electronics Cartoons (The Best of) . . \$1.99 |
| <input type="checkbox"/> EH95S Experimenters Handbook
Summer Edition (1995) \$5.00 | <input type="checkbox"/> 173 From Not-Working to Networking
Troubleshooting Local-Area Networks . \$2.99 |
| <input type="checkbox"/> EH94S Experimenters Handbook
Summer Edition (1994) \$5.00 | <input type="checkbox"/> 170 High-Voltage Project for Fun and
Science Book 1 \$2.99 |
| <input type="checkbox"/> EH94W Experimenters Handbook
Winter Edition (1994) \$5.00 | <input type="checkbox"/> 170A High-Voltage Projects for Fun and
Science Book 2 \$2.99 |
| <input type="checkbox"/> EH94 Experimenters Handbook (1994) . \$5.00 | <input type="checkbox"/> 169 Think Tank (133 Circuits) \$1.99 |
| <input type="checkbox"/> EH93 Experimenters Handbook (1993) . \$5.00 | <input type="checkbox"/> 169A Think Tank Vol. 2 \$1.99 |
| <input type="checkbox"/> HH95S Hobbyists Handbook
Spring Edition (1995) \$5.00 | <input type="checkbox"/> 168 Fact Cards (#34-66) \$1.99 |
| <input type="checkbox"/> HH95F Hobbyists Handbook
Fall Edition (1995) \$5.00 | <input type="checkbox"/> 168C Fact Cards (#67-99) \$1.99 |
| <input type="checkbox"/> HH94S Hobbyists Handbook
Spring Edition (1994) \$5.00 | <input type="checkbox"/> 168D Fact Cards (#100-132) \$1.99 |
| <input type="checkbox"/> HH94F Hobbyists Handbook
Fall Edition (1994) \$5.00 | <input type="checkbox"/> 167 Designing With IC's \$2.99 |
| <input type="checkbox"/> HH93 Hobbyists Handbook (1993) . \$5.00 | <input type="checkbox"/> 166 Collected Works of Mohammed Ulysses
Fips (62 pages, April Fools Collection) \$6.99 |
| <input type="checkbox"/> HISTORY Crystal Radio History, Fundamentals
& Design \$10.95 | <input type="checkbox"/> 165 How to Repair CD Disc Players \$2.99 |
| <input type="checkbox"/> XTAL Crystal Set Handbook \$10.95 | <input type="checkbox"/> 164 Modern Electronics (April 1908) . \$1.99 |
| <input type="checkbox"/> XTALPRO Crystal Set Projects \$14.95 | <input type="checkbox"/> 160 New Ideas - 42 Circuits \$1.99 |
| <input type="checkbox"/> XTALBLD Crystal Set Building \$15.95 | <input type="checkbox"/> 159 Low Frequency Receiving Techniques
Building and Using VLF Antennas . . \$2.99 |
| <input type="checkbox"/> POP96 POPtronix Hobbyist Handbook (1996) \$5.00 | <input type="checkbox"/> 158 Electro Importing Co. Catalog
(Circa 1918) \$2.99 |
| <input type="checkbox"/> POP97 POPtronix Exper Handbook (1997) . \$5.00 | <input type="checkbox"/> 157 All About Kits \$1.99 |
| <input type="checkbox"/> Radiocraft 1993 Projects for Hobbyists . \$5.00 | <input type="checkbox"/> 156 How To Make PC Boards \$1.99 |
| <input type="checkbox"/> 219 Electronics Now (1999 back issues) . \$5.00
Write in Issues desired _____ | <input type="checkbox"/> 154 How To Repair VCR's \$1.99 |

To order any of the items indicated above, check off the ones you want. Complete the order form below, include your payment, check or money order (DO NOT SEND CASH), payable to and mail to Claggg Inc., Reprint Department, P.O. Box 12162, Hauppauge, NY 11788.

Please allow 4-6 weeks for delivery. No COD's!

To place a credit card by phone, Visa Mastercard or Discover only. You can also order and pay by e-mail. Contact Claggg@gersback.com for details.

CALL: 631-592-6721

To use your Visa, Mastercard or Discover, complete the following:

Bill my Visa Mastercard Discover

Card No. _____

Exp. Date _____

Signature _____

MAIL TO: Claggg Inc.

Reprint Bookstore, P.O. Box 12162, Hauppauge, NY 11788.

SHIPPING CHARGES IN USA & CANADA

All payments must be in U.S. funds

Up to \$5.00 \$2.00	\$30.01 to 40.00 \$6.00	Overseas Orders must contact
\$5.01 to \$10.00 \$3.00	\$40.01 to 50.00 \$7.00	CLAGGK for shipping charges.
\$10.01 to 20.00 \$4.00	\$50.01 and above \$8.50	
\$20.01 to 30.00 \$5.00		

Total price of merchandise \$ _____

Shipping Charge (see chart) \$ _____

Subtotal \$ _____

Sales Tax (New York State Residents only) \$ _____

Name _____ Total Enclosed \$ _____

Address _____

City _____ State _____ Zip _____

CL01

clock rate by 2, 5, and 10 digitally rather than by varying the clock's operating frequency; and that's where we gain some degree of timing accuracy. The added switch (S3) selects the 4017's output that resets the counter, allowing it to only count to 2, 5, or 10. In position 1, S3 allows the clock output to pass on through IC3 to the clock input of IC2, giving a total timing period of 10 seconds. In switch position 2, the clock pulses are divided by 2 for a total timing period of 20 seconds. Position 3 divides the clock's output by 5 for a total timing period of 50 seconds, and position 4 divides the clock's output by 10 for a timing period of 100 seconds. Any other division rate, from 2 to 10, can be used by connecting IC3's reset pin to the proper output position. This is easily accomplished by connecting reset pin 15 to the next higher count above the desired output count. If you want to count to 4 and then repeat, just connect the reset pin to the 5th output pin and the counter will count to 4 and then repeat.

Here we are again, not completely finished with our timing circuits; and we have just timed out for this visit. Come back next month, and we'll continue with more timing circuits and who knows what else. P

Poptronics®

Interactive Edition

www.poptronics.com/interactive

An Introduction to Light in Electronics

An Introduction to Light in Electronics

F. A. WILSON

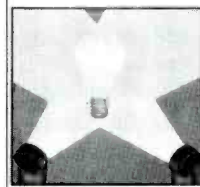

Taken for granted by us all perhaps, yet this book could not be read without it, light plays such an impressive role in daily life that we may be tempted to consider just how much we understand it. This book makes a good start into this fascinating and enlightening subject. It has been written with the general electronics enthusiast in mind.

To order Book #BP359 send \$6.99 plus \$3.00 for shipping in the U.S. and Canada only to Electronics Technology Today Inc., P.O. Box 240, Massapequa Park, NY 11762-0240. Payment in U.S. funds by U.S. bank check or International Money Order. Please allow 6-8 weeks for delivery.

ET08

Poptronics[®]

SHOPPER[®]

WWW.POLARISUSA.COM OVER 700 PRODUCTS IN STOCK!!! 800-308-4626

MICRO CAMERAS - WIRELESS VIDEO CALL OR GO ON-LINE TO ORDER YOUR FREE POLARIS PRODUCT CATALOG LIPSTICK CAMERAS - DIGITAL RECORDERS

DIGITAL MONITORING & RECORDING SYSTEM

"YOUR WEB BROWSER IS YOUR REMOTE EYE!"

The PV-140 Series PCI cards are the solution for digital security using a PC.

The PV-140 Series integrates a color quad processor, multiple zone video motion detector, multiplexer, and a real time digital video recorder (DVR).

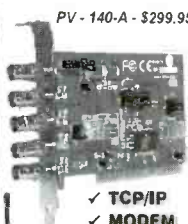

PV - 140-A - \$299.95

Works Great With Our Wireless Receivers, Too!

- ✓ TCP/IP
- ✓ MODEM
- ✓ LAN/WAN

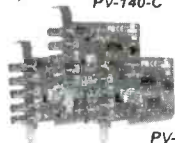

PV-140-C

Each card can connect up to 4 cameras.



GFR-2400 - 2.4GHz Receiver

PV-140-B

MOTION DETECTION - ALARM RECORDING - NOTIFICATION

5" COLOR WIRELESS OBSERVATION SYSTEM

ADD UP TO 3 ADDITIONAL CAMERAS!

2.4GHz



Now you can enjoy peace of mind with our new wireless observation system. Comes with a 5" wireless color monitor, a wireless color camera. Just Plug-&-Play for perfect wireless video any time! Great for around the house, office or technical field work.

GW-2400SA - \$379.95

HIGH GAIN DIRECTIONAL PATCH ANTENNAS



The Patch or Panel Antenna elements are temperature stable with a low return loss and low frequency drift vs. temperature. They offer heavy duty use, yet are lightweight construction.

DA - - \$29.95



DA-12 - \$119.95

1/3" COLOR OUTDOOR CAMERA

This camera merges the gap between bullet or lipstick cameras and full-size housings with cameras. Unlike bullet or lipstick cameras with limited features, this unit has many features only found on larger, cased cameras.

6 Configurations

- B/W: Regular, Auto Iris, Vari-Focal Lens
- Color: Regular, Auto Iris, Vari-Focal Lens



Industrial "O" Ring Sealed, Aluminum Case



AV-48WC8 - \$235.95

Made in the USA

TIME LAPSE RECORDER

The CTR-024 is a 4 head Helical Scan Azimuth System which offers 350/300 TV lines of resolution (B/W / Color)). Maximum recording times are adjustable and include 2/12/24 hours. There are five different programmable recording modes built-in. Each unit has a time/date display and a 30 day Battery Backup.

CTR-024 - 299.95



This is an excellent recorder for the price!

(Portable 12V DC Models Available)

B/W INFRARED LIPSTICK CAMERA

Whether using this indoors or outdoors, the benefits of this compact, discreet miniature color camera are extraordinary. The infrared LEDs make it excellent for video recording in low light situations up to a distance of 10 meters (32.8 feet). The weatherproof anodized aluminum housing and adjustable brackets for wall or ceiling mounts make this an ideal camera in a variety of applications.

ILC-300 - \$189.95



2.5" COLOR TFT FLAT SCREEN MODULE



Our new color 2.5" TFT module can be used for a variety of purposes such as, custom automotive dash installations, boat installations, covert ultra-compact surveillance packages, and more.

(Driver board not shown)

UNIT IS ONLY 5.8mm THICK!

TFT-M25 - \$139.95

Dimensions: 61.6(L) x 49.3(W) x 5.8(H)mm

MICRO BOARD CAMERAS

RECHARGEABLE BATTERY PACK

VIDEO MOTION DETECTOR

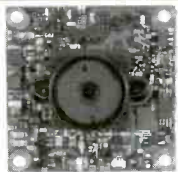

MB-1250P Color Camera 32.5(L) x 32.5(W) x 12(D)mm



This 12 volt, high-capacity portable battery is rechargeable and will operate any of our 12V cameras, transmitters and TFT Monitors. It has a charge time of 4 hours and allows for a total of 2000 re-charges.

RBP-12V - \$69.95

The VDM-01 is the answer to wasting hours in front of a monitor searching for the event that occurred. This 4-zone video detection unit will allow you to place 4 areas of interest on the camera screen. The sensitivity can also be adjusted so false triggers do not set your VCR to record. Imagine a zone on the cash box or a zone on just one bin box in your inventory room. No more watching hours of uneventful video on your surveillance tapes. Set-up one of these systems as part of your office or company wide security system and you will be amazed. This is a great management tool for revealing the non-productive habits in the office. This system is compatible with any time-lapse or real time recorder with alarm inputs.

VDM-01 - \$199.95



800-308-4626

WWW.POLARISUSA.COM

POLARIS INDUSTRIES
470 Armour Drive NE • Atlanta GA 30324-3943

Tech 404-872-0722 • Fax 404-872-1038

CIRCLE 228 ON FREE INFORMATION CARD



Electronics & Computer Training

**FREE
Course
Catalog!**

Cleveland Institute of Electronics

No matter what your career goals may be, most employers still insist on an educational background. Cleveland Institute of Electronics (CIE) offers educational training in Electronics and Computer Technology that lead to Diplomas and Degrees.

Even if you have no experience in the high-tech workplace, CIE can give you the hands-on education you need to maximize your career potential. Experience a step-by-step program designed specifically for the independent study student.

Our patented teaching method allows you to complete each lesson at your own pace so you can *study at times that are most convenient for you!*

A Wide Range of Electronics & Computer Training Available!

You'll find many different CIE Career Courses ranging from our **Computer Programming** course to our **Electronics Technology with Laboratory** course to our most advanced program, CIE's **Associate in Applied Science in Electronics Engineering Technology**.

Every program includes all the tools, lab equipment and instructor support necessary to compete in the 21st century job market.

After successful completion of a Career Course, you'll receive a diploma. Continue in your studies and you can earn an Associate in Applied Science in Electronics Engineering Technology.

There are many other courses to choose from so you can get the exact job-training course that's right for you!

Build on what you already know!

You may be eligible to apply for advanced standing in CIE's A.A.S. Degree Program based on your previous military training or academic history.

Send for a FREE Course Catalog Today!

Fill out the form on this page or call CIE toll-free at (800) 243-6446 or visit us at www.cie-wc.edu and we'll send you a complete information package with our course catalog & tuition prices.



CIE 1776 E. 17th
Cleveland, OH 44114

Name _____

Address _____

Apt _____

City _____

State _____

Zip _____

Phone _____

e-mail _____

Check box for G.I. Bill Details:

Active Duty Veteran

PT30

Call 1-800-243-6446 for a FREE catalog or visit www.cie-wc.edu today!

CIRCLE 320 ON FREE INFORMATION CARD

MECI 340 East First Street
Dayton, Ohio 45402
Your Electronics Value Company

Tons of Electronics

Get your FREE catalog today and discover some of the best deals in electronics. We have thousands of items ranging from unique hard-to-find parts to standard production components. Call, write or fax today to start your subscription to one of the most unique catalogs in the industry, filled with super values on surplus electronic and hobbyist type items.

FREE CATALOG!

Checkout our 10,000 item on-line catalog <http://www.meci.com>

Order Toll Free Why pay more?
1-800-344-4465 Call today!
Fax Order Line
1-800-344-6324

CIRCLE 323 ON FREE INFORMATION CARD

Electrifying!

- 50,000 Count with 0.05% Accuracy
- True RMS
- RS-232 Interface with Dual Display
- The Protek 608 DMM

All This for \$249.00 NOW \$189.00 !!!

LIMITED TIME OFFER, ORDER NOW!

Featuring...

- 17 Segment Bargraph Display
- Software Programmable
- Peak Hold
- Capacitance Range
- Duty Cycle
- Pulse Width
- Low Power Ω Measurements
- Conductance Mode
- Backlit LCD
- Frequency Counter
- Temperatures Measurements
- Diode Test

Your Wireless Test Source

TSi

Test Supply, Inc., 9649 Glendower Ct., Laurel, MD 20723 **301-317-4718**

Call Today And **SAVE!**

Unbeatable PRICES!

CABLE TV

**DESCRAMBLERS
CONVERTERS • FILTERS
VIDEO STABILIZERS**

FREE ➤ 30 Day Trial
FREE ➤ Product Catalog
FREE ➤ 1 Year Warranty

100% MONEY BACK GUARANTEE

Let us point you in the right direction ...

Arrow Technologies

Omaha, Nebraska

TOLL FREE
1-800-554-ARROW
1-800-554-2776
<http://www.arrowtek.com>

2539 W. 237th St. Bldg. F, Torrance, CA 90505
Order desk only: USA (800) 872-8878 CA (800) 223-9977
LA & Technical info: (310) 784-5488 Fax: (310) 784-7990
email: nraa@earthlink.net • <http://www.digsys.net/timeline>

TIMELINE INC.

Minimum Order: \$200.00. Minimum shipping and handling charge \$5.00. We accept customer checks, MC or VISA. No personal checks or CODs. CA residents add 8.25% sales tax. We are not responsible for typographical errors. All merchandise subject to prior sale. Please advise, returns: Return orders require special handling. Prices subject to change without notice. 20% restocking fee for returned orders.

LIQUID CRYSTAL DISPLAYS

240x64 dot LCD with built-in controller \$29.⁰⁰ or 2 for \$49.⁰⁰ or OPTREX DMF5005 (non back-lit) \$29.⁰⁰ or 2 for \$49.⁰⁰
20 character x 8 line 7/8L x 2 1/8H
The built-in controller allows you to do text and graphics

240x128 LCD with built-in controller \$29.⁰⁰ 2 for \$49.⁰⁰
256x128 LCD with built-in controller \$29.⁰⁰ 2 for \$49.⁰⁰

Alphanumeric-parallel interface

16x1	\$5.00	20x2	\$6.00	32x2	\$5.00
16x1 (lg char)	\$7.00	20x4	\$8.00	40x1	\$5.00
16x2	\$5.00	20x4 (lg char)	\$10.00	40x2	\$7.00
16x2 (lg char)	\$10.00	24x2	\$6.00	40x4	\$15.00
16x4	\$8.00	32x4	\$5.00	4x2	\$4.00

5V power required • Built-in C-MOS LCD driver & controller
• Easy "microprocessor" interface • 98 ASCII character generator
Certain models are backlit, call for more info

Graphics and alphanumeric - serial interface

size	Mfr.	price	size	Mfr.	price
640x480 (backlit)	Epson	\$15.00	320x240	Epson	\$15.00
640x400 (backlit)	Panasonic	\$10.00	256x128	Epson	\$15.00
640x200	Toshiba	\$10.00	240x128 (backlit)	Optrex	\$15.00
480x128 (backlit)	ALPS	\$8.00	240x64	Epson	\$15.00
480x128	Hitech	\$6.00	160x128	Optrex	\$15.00

6" VGA LCD 640x480,
Sanyo LMDK55-22 \$15.00

MONITORS

NON-ENCLOSED TTL

Comes with pinout. 12v or 1.4 input • Horizontal frequency 15Khz
• Ability to do 40 and 80 column.

5 INCH AMBER \$15.00 • 7 INCH AMBER \$19.00
9 INCH AMBER OR GREEN \$19.00

5" COLOR MONITOR \$19.00 2 for \$29.⁰⁰

- Flat Faceplate • 320 x 200 Dot Resolution
- CGA & Hercules Compatible • 12 VDC Operation
- 15.75 KHz Horiz. Freq. • 60 Hz Vert. Sync. Freq.
- Open Frame Construction
- Standard Interface Connector
- Degaussing Coil included • Mfr. Samtron

HACKER CORNER

57 WATT UPS SUPPLY \$19.00
(COMES w/ 12V @ 2.2AMP BATTERY)

Unit designed to provide uninterrupted DC power in the event of loss of the primary 110/120 VAC supply. It utilizes a 12 V sealed lead acid battery as a source of power until the AC supply can be restored. It is a versatile unit which can be used in a number of different applications. The outputs are: -5 VDC @ 6.5A, -3.6 VDC @ 2.5A, -12 VDC @ 8A, -12 VDC @ .5A, and a battery charging output of 12 VDC @ 10A. The DC outputs are terminated in the in-line connectors which interface with standard motherboard and drive connectors. Possible applications include: Robotics, scientific sensing and recording, 1-manu devices attached to Ethernet or Internet links, etc.

- The unit is small enough (2" x 3.5" x 8.5") to be contained in a standard PC enclosure, in place of the regular power supply - interfacing directly with the motherboard - providing an uninterrupted power supply. It can function as a DC-DC power supply furnishing multiple outputs using a 12 VDC input.
- The 10 Amp, 2 VDC output can be used as a battery charger with any AC input from 100-240 V. The unit is a versatile 57 watt DC power supply providing +5 and 3.6 VDC as well as +/- 12 VDC.

EMBEDDED 486 COMPUTER \$59.
2 FOR \$109.00

Complete enhanced Intel 486SX-33 based computer in ultra small (9-7/8L x 6-5/8W x 3-1/8H) case. Ideal for embedded operations or as a second computer. Features include: • 3 serial ports plus dedicated printer port • Parallel optical coupled adapter port • Built in IBM PC/AT keyboard port • On board VGA video and port
• Uses standard SIMM up to 32 MB • BIOS is PC/AT compatible

Unit has a backup Ni-Cd battery system in case of power failure (5 min backup time) and lockable front cover to prevent floppy drive access. Mounting/interface provisions for standard 3.5" laptop floppy and 2.5 inch hard drives. Comes with very comprehensive manual. Ultra small (9-7/8L x 6-5/8W x 3-1/8H) case.

CELL SITE TRANSCIEVER \$19.00 2 FOR \$29.00

These transceivers were designed for operators in an AMPS (Advanced Mobile Phone Service) cell site. The 20 MHz bandwidth of the transceiver allows it to operate on all 666 channels allocated. The transmit channels are 870.030-889.980 MHz with the receive channels 45MHz below those frequencies. A digital synthesizer is utilized to generate the selected frequency. Each unit contains two independent receivers to demodulate voice and data with a Receive Signal Strength Indicator (RSSI) circuit to select the one with the best signal strength. The transmitter provides a 1.5 watt modulated signal to drive an external power amplifier. Channel selection is accomplished with a 10-bit binary input via a connector on the back panel. Other interface requirements for operation are 26 VDC (unregulated) and an 18.990 MHz reference frequency for the digital synthesizer. The units contain independent boards for receivers, exciter, synthesizer, tunable front end and interface assembly (which includes power supplies and voltage-controlled oscillator) Schematics and circuit descriptions included.

AM & FM LOW POWER TRANSMITTER KITS

If you are interested in building quality low power transmitters for AM, FM Stereo, and Television transmission, see our website for more information. Kits covering the frequency range of 150 KHz to 1300 MHz. are available, for Amateur, experimental Part 15 uses, hobby, and radio control use.

NORTH COUNTRY RADIO

Visit our website www.northcountryradio.com

Sales: PO BOX 53 New Rochelle N.Y. 10804 Tel 914-235-6611

Technical: PO Box 200 Hartford NY 12838 Tel 518-854-9280

EMBEDDED LINUX STARTER KIT

FEATURES INCLUDE:

- Linux 2.4 Kernel
- 486-133MHz SBC
- 10 Base-T Ethernet
- 8MB DOC Flash Disk
- 16MB RAM
- Power Supply
- Carrying Case
- Starting at \$399.00
- X-Windows (option)
- RealTime Linux (option)



Imagine running Embedded Linux on a Single Board Computer (SBC) that is 4.0" x 5.7" and boots Linux from a Flash-Disk. No hard drives, no fans, nothing to break. Now your hardware can be as reliable as Linux! If your application requires video output, the X-Windows upgrade option provides video output for a standard VGA monitor or LCD. Everything is included; Ready to Run Linux!

Since 1985
OVER
17
YEARS OF
SINGLE BOARD
SOLUTIONS

EMAC, inc.

EQUIPMENT MONITOR AND CONTROL

Phone: (618) 529-4525 • Fax: (618) 457-0110 • www.emacinc.com

Start A Career With High Wages, Excellent Benefits and Job Security!!

With UCANDO's extraordinary maintenance training programs you can quickly and easily enter a high paying field as a maintenance technician for a very small investment of time and money.

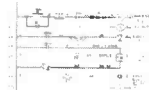

RC-M ONLY \$165 RC-M is a 15 hour training course on relay ladder logic systems. Includes a 5-part video and workbook. Great Value!

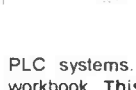

PLC-M ONLY \$198 PLC-M is a 32 hour training course on PLC systems. Includes (2) 4-part video's and workbook. This training is valuable.



HYD-M ONLY \$209 HYD-M is a 32 hour course on Fluid Dynamics. Includes (2) 4-part video's and workbook. This Module is a must.



SC-M ONLY \$215 SC-M is a 32 hour training course on AC & DC Servo Controllers. Includes (2) 4-part video's and workbook. Learn everything you need about AC and DC servo Control Systems.

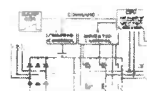

Electronic Training Videos: Basic Electronics, Digital Electronics, TV Repair, LASER and Fiber Optic training videos available at very affordable prices starting at Only \$35.00 each.

For information or to place an order call:

1-800-678-6113

www.ucando-corp.com

UCANDO VCR Educational Products Corp., Greenville, OH

Ivex Complete Electronics CAD Package

Ivex Complete power tools include: WinDraft P350 Schematics, WinBoard P350 PCB Layout, Ivex Spice Standard Simulation, and Ivex View Gerber Viewer—together in a complete, affordable package.

Ivex Complete Plus includes everything in Ivex Complete but with the enhanced capabilities of 650 pin versions of WinDraft and WinBoard plus the Advanced edition of Ivex Spice.

Ivex 350 and 650 pin versions have no feature limitations like competitive products on the market. Fast expert technical support, free 24 hour Knowledge Base on the web, and professional full-featured tools have made Ivex the preferred choice for designers.

Ivex Complete

Schematics
Simulation
PCB Layout
Gerber Viewer

\$350

Visit the Ivex web site for complete product information and download full-function

www.ivex.com

Tel: (503) 848-6520 e-mail: sales@ivex.com

Do you make electronic prototypes?

If you prototype electronics, you should be using WinDraft Schematics. The **Rapid Electronic Development (RED)** tool that gives you the power to design prototypes **faster**, resolve errors **smarter** and transition to professional boards **better**.

WinDraft is a multi-purpose schematic design tool that you can put to work right away to make professional looking electronic design schematics. Crisp, clean schematics are much easier to read than the old hand-drawn ones you've had to struggle with before. Creating the perfect prototype of your design just got easier!

WinDraft goes way past prototyping, though. Once your design is finely tuned, use WinDraft to connect to PCB Layout tools for high-quality circuit boards that really make a statement about your product.

Need some reasons to use WinDraft for your prototyping? Check out the facts:

<http://www.ivex.com/prototyping>

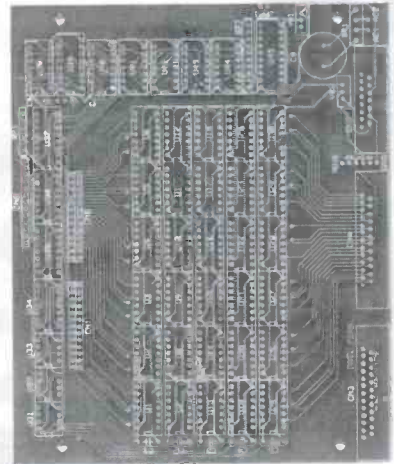

Free board quote
pcbCite.com
The Internet source for PCB manufacturing

IVEX™
DESIGN
INTERNATIONAL

ADV8_5

Home Automation



World's Largest Source for Home Automation!

- Voice Control
 - Gadgets & Motorized Devices
 - Home Theater
 - Phones & Intercoms
 - X10 & Lighting Control
 - Home Security & Surveillance
 - Home Networking & Structured Wiring
- and Much More...

800-SMART-HOME

www.smarthome.com

Free 144 pg. Color Catalog!

Dealers/Resellers ask about our SmartHome PRO Dealer Program 800-949-6255

SERIAL LCDs

Serial LCDs work great with BASIC Stamps® and other microcontrollers. One-wire interface • simple serial protocol • low cost • high quality • in stock



BPI-216N

- 2x16 text LCD
- 2400/9600 bps
- \$45 (non-backlit)

SGX-120L

- Mini graphics LCD
- 2400/9600 bps
- just \$99



Many other models available—see www.seetron.com!

Scott Edwards Electronics, Inc.
www.seetron.com • 520-459-4802

PICmicro® PIC16F87x Series and ICD Book

Easy Debug'n



- Features of PIC16F87x microcontrollers
- In-circuit debugging using Microchip ICD
- Companion for our PIC'n book series
- 8.5x11 format. 72 pages. \$12.95

Table of Contents and Ordering Information On Web Site:

+ \$5 s/h in US. VISA, MC, AM, DS, MO, Check
CA residents please add 7.25% CA sales tax

PICmicro and MPLAB are trademarks of Microchip Technology Inc.

SQUARE 1 ELECTRONICS

P.O. Box 501, Kelseyville, CA 95451
Voice (707) 279-8881 Fax (707) 279-8883

We have been selling on the Internet since 1996. We will ship the day we receive your order or the next business day.

<http://www.sq-1.com>

PICmicro® BOOKS

Easy PIC'n - Beginner

\$29.95

- Programming Techniques
- Instruction set, addressing modes, bit manipulation, subroutines, loops, lookup tables, interrupts
- Using a text editor, using an assembler, using MPLAB
- Timing and counting (timer 0), interfacing, I/O conversion

PIC'n Up The Pace - Intermediate

\$34.95

- Serial communication - PICmicro to peripheral chips
- Serial EEPROMS
- LCD interface and scanning keypads
- D/A and A/D conversion - several methods
- Math routines

PIC'n Techniques - Intermediate

\$34.95

- 8-pin PICmicros
- Timer 1, timer 2 and the capture/compare/PWM (CCP) module
- Talking to a PICmicro with a PC using a terminal program
- Test equipment and data logger experiments

Serial PIC'n - Advanced

\$49.95

- Synchronous - bit-bang, on-chip UART, RS-232
- Asynchronous - I2C (Philips Semiconductor)
- SPI (Motorola), Microwire (National Semiconductor)
- Dallas Semiconductor 1-Wire bus

Poptronics

Interactive Edition

www.poptronics.com/interactive

Buy your transformers online
direct from Toroid Corp.

Standards:

www.toroid.com/standard.htm

Make-it-yourself kits

www.toroid.com/kits.htm

www.poptronics.com

Lynxmotion, When you're tired of playing with toys!

H3-KT

Lynxmotion, Inc.
PO Box 818
Pekin, IL 61555-0818
www.lynxmotion.com

Tel: 309-382-1816
Fax: 309-382-1254
sales@lynxmotion.com
tech@lynxmotion.com

Visit our website or ask for our free catalog!

CALL TOLL-FREE

(800) 292-7711
Orders Only

C&S SALES

CALL OR WRITE
FOR OUR
FREE

Se Habla Español **Secure On-line Ordering @ cs-sales.com**

64 PAGE CATALOG!
(800) 445-3201

Digital Multimeters

Elenco Model M-1740

\$19.95



- 11 Functions:
 - Freq. to 20MHz
 - Cap. to 20uF
 - AC/DC Voltage
 - AC/DC Current
 - Buzzer
 - Diode Test
 - Transistor Test
 - Meets UL-124 safety specs

Elenco Model LCR-1810

\$89.95



- Cap. 0.1pF to 20uF
- Inductance 1uH to 20H
- Resistance 0.01u to 2,000MΩ
- Temperature: 20°C to 750°C
- DC Vols 0 - 20V
- Freq. up to 15MHz
- Diode/Audible Continuity Test
- Signal Output Function

Elenco Model LCM-1950

\$65



- Large 1 3/4 Digit LCD
- Autoranging Freq. to 4MHz
- Cap. to 400uF
- Inductance to 40H
- Res. to 4,000MΩ
- Logic Test
- Diode & Transistor Test
- Audible Continuity Test

LCR Bridge

B&K Model 878

\$229



- Accurately measures capacitance, resistance, and inductance
- Measures dissipation factor of capacitors and Q of inductors

Deluxe Soldering Stations

Elenco SL-5 Series

Electronically controlled, ideal for professionals, students, and hobbyists. Available in kit form or assembled.

Works w/ any iron! Turn any soldering iron into a variable iron.

As Low As
\$24.95

Features:

- Cushion Grip Handle Soldering Iron (optional) with Grounded Tip for Soldering Static-Sensitive Devices. Easily Replaceable. Uses Long-Life, Plated Conical Tip.
- Heavy Steel, Non-Slip Base
- Iron Holder Funnel - Reversible, left or right side.
- Steel Tray for Sponge Pad.
- Sponge Pad.

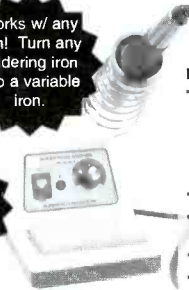

Quantity Discounts Available

Test Equipment

Elenco Four Functions in One Instrument Model MX-9300B

Features:

- One instrument with four test and measuring systems:
 - 1.3GHz Frequency Counter
 - 2MHz Sweep Function Generator
 - Digital Multimeter
 - Digital Triple Power Supply



\$450

Elenco Handheld Universal Counter Model F-2800

\$99

Sensitivity:

- <1.5mV @ 100MHz
- <5mV @ 250MHz
- <5mV @ 1GHz
- <100mV @ 2.4GHz



Features 10 digit display, 16 segment and RF signal strength bargraph. Includes antenna, NiCad battery and AC adapter.
C-2800 Case w/ Belt Clip \$14.95

Elenco Quad Power Supply Model XP-58T

4 Fully Regulated Power Supplies in 1 Unit

\$75

4 DC Voltages: 3 fixed +5V @ 3A, +12V @ 1A, 1 variable -2.5 - 20V @ 2A • Fully Regulated & Short Protected • Voltage & Current Meters • All Metal Case

\$75

• 0-30VDC @ 3A Output
• 3A Fused Current Protection
• Current Limiting Short Protection
• 0.025u Output Impedance

Elenco 3MHz Sweep Function Generator with built-in 60MHz Frequency Counter Model GF-8046

\$199.95

Generates square, triangle, and sine waveforms, and TTL, CMOS pulse.



GF-8025 - Without Counter \$139.95

20MHz Sweep / Function Generator with Frequency Counter Model 4040A

- 0.2Hz to 20MHz
- AM & FM Modulation
- Burst Operation
- External Frequency Counter to 30MHz
- Linear and Log Sweep



10MHz Model 4017A \$325
5MHz Model 4011A \$259
2MHz Model 4010A \$225

\$445
MK PRECISION

Elenco RF Generator with Counter (100kHz - 150MHz) Model SG-9500

\$225

Features internal AM mod of 1kHz RF output 100MV - 35MHz. Audio output 1kHz @ 1V RMS.
SG-9000 (analog, w/o counter) \$119

Elenco 10Hz - 1MHz Digital Audio Generator Model SG-9300

\$225

Features built-in 150MHz frequency counter, low distortion and sine/square waves.
SG-9200 (w/o counter) \$119

Ordering Information:

Model SL-5 - No iron. (Kit SL-5K) \$24.95

Model SL-5-40 - Includes 40W UL iron (Kit SL-5K-40) \$29.95

Elenco Model SL-30

\$79.95



- Tip temperature changeable from 300°F (150°C) to 900°F (480°C)
- Temperature is maintained within +10°F of its preset temperature.
- The tip is isolated from the AC line by a 24V transformer
- The tip is grounded to eliminate static charges.

SL-10 - Same as SL-30 w/o digital display \$54.95

Weller® Low Cost Soldering Iron Model WLC100



- Variable power control produces 5-40 watts.
- Ideal for hobbyists, DIYers and students.
- Complete with 40W iron.

\$34.95

Elenco Oscilloscopes

Free Dust Cover and 2 Probes



S-1325 25MHz Dual Trace \$328
S-1330 25MHz Delayed Sweep \$439
S-1340 40MHz Dual Trace \$475

S-1345 40MHz Delayed Sweep \$549
S-1360 60MHz Delayed Sweep \$725
S-1390 100MHz Delayed Sweep \$895

Deluxe 29pc. Computer Service Tool Kit \$36.95 Elenco Model TK-1200

Includes Soldering Iron, Solder, Long Nose Pliers, Diagonal Pliers, 11 pc. Screwdriver Bit Set, Wire Stripper, IC Inserter, IC Extractor, Screwdriver, Phillips Screwdriver, Desoldering Pump, and more!



Elenco Educational Kits

Model XK-150

Digital / Analog Trainer

\$89.95

OWI Model OWI-007

Robotic Arm Trainer

\$82.50

Model AK-780K

Two IC Radio Kit

\$9.95

Model AK-700

Pulse/Tone Telephone Kit

\$14.95

Model RCC-7K

Radio Control Car Kit

\$27.95

Model M-1005K

DMX Kit

\$18.95

Model K4001

7W Amplifier

\$12.95

Electronic Science Lab

Maxitronix 500-in-1 Electronic Project Lab Model MX-909

Everything you need to build 500 exciting electronic projects:

Learn the basics of electronics 500 different electronic experiments, special lighting effects, radio transmitter and receivers, sound effects, cool games and MORE!

- Includes built-in breadboard and an LCD.
- Explore amplifiers, analog and digital circuits plus how to read schematic diagrams.
- Includes 11 parts.
- Lab-style manual included.
- Requires 6 "AA" batteries.



MX-908 - 300-in-1 Lab \$59.95
MX-907 - 200-in-1 Lab \$44.95
MX-905 - 130-in-1 Lab \$29.95
EP-50 - 50-in-1 Lab \$18.95

\$149

Guaranteed Lowest Prices **C&S SALES, INC.**

15 DAY MONEY BACK GUARANTEE

UPS SHIPPING: 48 STATES 5% (Minimum \$5.00)
OTHERS CALL FOR DETAILS
IL Residents add 8.25% Sales Tax

150 W. CARPENTER AVENUE
WHEELING, IL 60090
FAX: (847) 541-9904 (847) 541-0710
http://www.cs-sales.com



2 YEAR FACTORY WARRANTY

PRICES SUBJECT TO CHANGE WITHOUT NOTICE

SEE US ON THE WEB

CIRCLE 290 ON FREE INFORMATION CARD

AMAZING DEVICES

NVENEVEN102

See and Order from Our "Action" Web Site at www.amazing1.com

Laser Window Bounce Listener

Powerful listening system, yet simple in operation. You shine a laser at a window and intercept the reflected beam with our ultrasensitive filtered optical receiver. Vibrations on the window from internal sounds and voices are now clearly heard. Range can be up to several hundred meters depending on laser power and optics used.

LWB9 Plans for 3 Laser Window Bounce Systems.....\$20.00

LWB6K Kit of 100' visible red for Science Project.....\$129.95

High performance modules require housing and simple alignment to make a field worthy LASER WINDOWBOUNCE unit. Shows test tone circuitry, optics and our lab method of a completed assembly
LWB90 Assembled receiver, 10 mw IR laser, collimator etc. \$449.95

PLASMA FIRE SABERS Kits, Parts and Accessories

Duplicates effect in the motion picture epic of the century!

Specify blue, grn, pur, red or yel.
Moving light appears to evaporate into space
Blades screw into handle for easy replacement

We stock all size and color blades, Mauler adapters, tubes digital drivers, and parts for authentic designs. Wireless interactive sound modules change tone with motion

SAB15 Assbled with 15" Blade. \$39.95
SAB24 Assbled with 24" Blade. \$79.95 SAB24K Kit...\$59.95
SAB36 Assbled with 36" Blade. \$149.95 SAB36K Kit. \$129.95

Take Control!! Electronic Hypnosis

Electronic circuitry places subject under your control! Induces ALPHA relaxed mind states.

HYP2 Plans.....\$10.00
HYP2K Kit/Plans.....\$49.95
HYP20 Ready to Use.....\$69.95
MIND2 Plans for Mind Control.....\$15.00
MIND2K Kit/Plans.....\$49.95
MIND20 Ready to Use.....\$79.95

Pain Field Pistol

Caution! Do not aim at people!

Blast out rodents with high power ultrasonics.

Handheld and battery operated with all controls.

Rental units available.

PPP1 Plans.....\$8.00
PPP1K Kit/Plans.....\$49.95
PPP10 Ready to Use.....\$79.95

Jacob's Ladder

A 1/2" arc expands to over 4' as it travels up the Jacobs Ladder evaporating in space

Adjustable arc control
Uses safe high frequency
Safety shock shut down
Full 20" ladder length
110/220 vac 150 watts

JACK3K Kit.....\$149.95
JACK30 Ready to Use.....\$249.95

30" Spark Tesla Coil

Create a spectacular display of nature's own lightning. Many amazing experiments possible. See coil in action on our web site!

BTC4 Plans.....\$20.00
BTC4K kit.....\$89.95
BTC40 Ready to use.....\$1199.95
Smaller Version (8-10" Sparks)
BTC3 Plans.....\$15.00 BTC3K Kit.....\$349.95
BTC30 Ready to Use.....\$449.95

MINI TESLA COIL LIGHTS 4' light tube!
MTC1 Plans. \$5.00 MTC1K Kit.....\$19.95
MTC10 Assmbld for 12 volts.....\$34.95

Hover Board

28 pages of data related to the most revolutionary advance in transportation. Cutting edge R&D

HOVER Plans and Data.....\$25.00

Anti Gravity

Float an object using anelectric force field. With handbook

GRA3 Plans/book.....\$20.00
GRA3K Kit Pwr Sup.....\$99.95
GRA30 Assmbld above.....\$149.95

6 Transmitter Kits

- 1 Super Sensitive Ultra Clear 1 Mile+ Voice Transmitter.
- 2 1 Mile+ Telephone Transmitter.
- 3 Line Powered Phone Transmitter Never Needs Batteries!!
- 4 Tracking/Homing Beacon Beeping Transmitter
- 5 Video/Audio Rebroadcaster 1 Mi.
- 6 TV/FM Radio Disrupter. Neal Frank! Discretion Required

Includes Hints Using Wireless Devices
COMBOX Above 6 Kits/Plans.....\$59.95
COMBOP Above 6 Plans Only.....\$10.00

4 KV HV MODULE for hovercraft, plasma guns, antigravity, pyrotechnics. 12vac input
MINIMAX4.....\$19.95

Information Unlimited PO Box 716 Amherst N.H. U.S.A. 03031 E-mail <info1@wavewizard.com>

1 800 221 1705 Orders/Catalogs Only! Fax 1 603 672 5406 Information 1 603 673 4730 Free Catalog on Request

Pay by MC, VISA, Cash, Check, MO. Add \$5.00 S&H Overseas Contact for Proforma

CIRCLE 220 ON FREE INFORMATION CARD

CONTROL

RELAYS • LIGHTS • MOTORS

MEASURE

TEMPERATURE • PRESSURE • LIGHT LEVELS • HUMIDITY

INPUT

SWITCH POSITIONS • THERMOSTATS • LIQUID LEVELS

MODEL 30 \$79



- PLUGS INTO PC BUS
- 24 LINES DIGITAL I/O
- 8 CHANNEL
- 8 BIT A/D IN
- 12 BIT COUNTER
- UP TO 14K SMP/SEC

MODEL 45 \$189



- RS-232 INTERFACE
- 8 DIGITAL I/O
- 8 ANALOG INPUTS
- 2 ANALOG OUTPUTS
- 2 COUNTERS-24 BIT

MODEL 100 \$279



- 12 BIT 160 KHZ A/D
- 4 ANALOG OUTPUTS
- 3 TIMER COUNTERS
- 24 DIGITAL I/O

MODEL 150-02 \$179



- RS-232 INTERFACE
- TRMS, 20 AMPS
- 12 BIT A/D
- OPTO-ISOLATED
- COMPLETE DMM

MODEL 40 \$109



- RS-232 INTERFACE
- 28 LINES DIGITAL I/O
- 8 ANALOG INPUTS
- PWM OUTPUT

MODEL 70 \$239



- RS-232 INTERFACE
- 18 BIT A/D
- 5.5 DIGIT
- UP TO 60 SMP/SEC

Prairie Digital, Inc.

PHONE 608-643-8599 • FAX 608-643-6754

620 SEVENTEENTH STREET • PRAIRIE DU SAC, WISCONSIN 53578

RF Modules

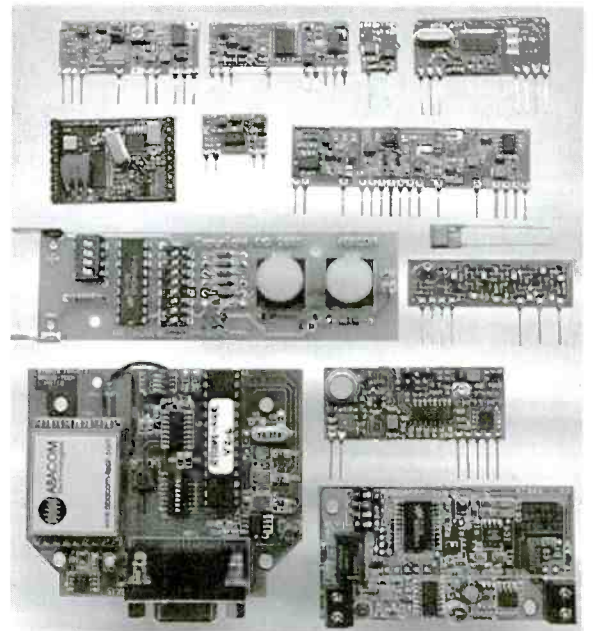

www.abacom-tech.com



TEL: +1(416)236 3858
FAX: +1(416)236 8866
abacom@abacom-tech.com

RAMSEY

GET THE NEW CATALOG TODAY!

New Kits, New LPFM, New Cameras

NEW! www.ramseykits.com



35 WATT LPFM STEREO TRANSMITTER



- ✓ 35W RF output, VSWR protected
- ✓ Automatic audio & power controls
- ✓ Digital synthesized PLL
- ✓ Full front panel control
- ✓ 110/220VAC, 12VDC operation

Whether your application is export or LPFM, the PX1 has you covered. From the over-rated continuous duty power supply & power amplifier to the 2 line vacuum fluorescent display, your station will be the easiest to setup and the most reliable for continuous operation. Full microprocessor controls provide a "virtual engineer". Check out www.highpowerfm for full details.

PX1 35W Professional FM Stereo Transmitter \$1,795.95

ELECTROCARDIOGRAM HEART MONITOR



- ✓ Visible and audible display of your heart rhythm
 - ✓ Re-usable sensors included; just like visiting the hospital!
 - ✓ Bright LED "beat" indicator
 - ✓ Monitor output for oscilloscope display
- Enjoy learning about the inner workings of the heart while covering the stage by stage electronic circuit theory of ECG/EKG systems. Be heart smart and learn at the same time!

ECG1 Electrocardiogram Heart Monitor Kit \$34.95
 CECG Matching Case & Knob Set \$14.95
 AC125 110 VAC Power Adapter \$9.95
 ECGP10 Replacement Reusable Probe Patches (10-Pack) \$7.95

PLASMA GENERATOR



- ✓ Generate 2" sparks to a hand held screwdriver!
 - ✓ Build your own plasma balls!
 - ✓ 25KV at 20 KHz from a solid state source!
- Generate really impressive sparks, build your own plasma ball, light fluorescent tubes without wires! From a solid state source, generate over 25KV at 20KHz for the most dazzling displays!

PG13 Plasma Generator Kit \$59.95
 PS12 14VAC Output Power Supply \$19.95

ION GENERATOR



- ✓ Generates negative ions with a blast of fresh air!
 - ✓ 7.5KV DC negative, 400uA - that's a lot of ions!
 - ✓ Steady state DC voltage, constant current, not pulsed!
- Learn the basics of ion repulsion by building this ion generator! Creates a continuous blast of fresh air charged with a ton of ions. Perfect for pollution and air freshening; just smell those ions! Solid state wind generation; you'll be amazed!

IG7 Ion Generator Kit \$59.95
 AC125 110 VAC Power Adapter \$9.95

TOUCH-TONE TONE GRABBER



- ✓ New-built-in RJ11 phone jack
 - ✓ Large memory holds over 500 numbers
 - ✓ Big bold 8 digit display, auto insertion of dashes
 - ✓ New-output latch jack
- Dialed phone numbers on the radio, repeater codes, control codes, anywhere touch-tones are used, you can read

and store them! All new design for 2002. Capture those tones with the TG2!

TG2 Tone Grabber Tone Reader Kit \$59.95
 CTG2 Matching Case & Knob Set \$14.95
 AC125 110 VAC Power Adapter \$9.95

RCA TO XLR AUDIO CONVERTER



- ✓ Connect consumer outputs to XLR inputs
 - ✓ Left & right audio gain adjustments
- So you're trying to connect consumer audio outputs with RCA connectors (unbalanced) to XLR (balanced) inputs. Always a problem...Not anymore with the R2XL1!

R2XL1 Unbalanced to Balanced Audio Converter Kit \$49.95
 CR2XL Matching Case & Knob Set \$14.95
 PWR25 12VAC Power Adapter \$9.95

AUTOMATIC COLOR/BW IR CAMERA



- ✓ Color during the day, IR B&W at night!
 - ✓ Automatically turns on IR illumination!
 - ✓ Waterproof to IP57 standards!
 - ✓ Black anodized housing with universal mount
- Best of both worlds! This video camera is a waterproof COLOR camera during the day. When the light level drops, it automatically changes to B&W and turns on its built-in IR illumination, with 10 IR LEDs. Powered by 12VDC and terminated with a professional BNC connector. B&W only model

also available if color is not needed. Both in heavy anodized black housing.
 CCD309 Color/B&W IR Waterproof Bullet Camera \$169.95
 CCD308 B&W IR Waterproof Bullet Camera \$109.95
 AC125 110 VAC Power Adapter \$9.95

MINI B&W CAMERA WITH IR ILLUMINATION



- ✓ Built in IR illumination!
 - ✓ Sees in total darkness!
 - ✓ Black aluminum housing with swivel bracket
- What a deal! This miniature B&W video camera has 6 high power IR LEDs built into it to provide illumination in total darkness! No need for external IR illuminators. Attractive black aluminum housing easily mounts at any angle with the built-in swivel bracket. Runs on 12VDC, and includes professional BNC output plug-in harness.

CCD303 Mini B&W IR Illuminated Camera \$59.95
 AC125 110 VAC Power Adapter \$9.95

Check out all our other new cameras at www.ramseykits.com!

PROFESSIONAL FM STEREO RADIO STATION



- ✓ Synthesized 88 to 108 MHz with no drift!
- ✓ Built-in mixer - 2 line inputs and one microphone input!
- ✓ High power module available for export use
- ✓ Low pass filter for great audio response

Our FM100 is used all over the world by serious hobbyists as well as churches, drive-in theaters, and schools. Frequency synthesized PLL assures drift-free operation with simple front panel frequency selection. Built-in audio mixer features LED bargraph meters to make setting audio a breeze. The kit includes metal case, whip antenna and built-in 110 volt AC power supply.

FM100 Super-Pro FM Stereo Radio Station Kit \$249.95
 FM100WT 1 Watt, Wired Export Version \$399.95

SYNTHESIZED FM STEREO TRANSMITTER



- ✓ All new design & features for 2002!
 - ✓ Fully adjustable RF output
- Our #1 kit for years has just gotten better for 2002! Totally redesigned, the FM25B has all the features you've asked for. From variable RF output, F connector RF output jack, line input, loop output, and more. Includes case, power supply, whip antenna, audio cables.

FM25B Synthesized FM Stereo Transmitter Kit \$129.95

AND...OUR FAMOUS MINI-KITS

TT7

These are easy to build kits that can be used either stand-alone or as building blocks for more complex projects.

TS4 Tickle-Stick Shocker \$9.95
 BN9 Super Snoop Amplifier Kit \$8.95
 BL1 LED Blinky Kit \$3.95
 TD1 Tone Encoder/Decoder Kit \$6.95
 TT7 Touch Tone Decoder Kit \$19.95
 CPO3 Code Practice Oscillator Kit \$9.95
 UT5 Universal Timer Kit \$8.95

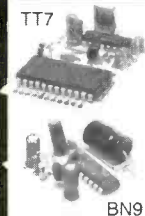

RAMSEY
 RAMSEY ELECTRONICS, INC.

793 Canning Parkway
 Victor, NY 14564
 716-924-4560
sales@ramseykits.com



Order Today! 800-446-2295

www.ramseykits.com

CIRCLE 263 ON FREE INFORMATION CARD

VISION ELECTRONICS

Before After

◆ 1 Year Warranty
◆ Money Back Guarantee
◆ No Rolls/Jitters/Flickers/Fading

INTELESTAR

Buy 1 Unit, Get the 2nd for
1/2 Price

COPY RENTAL TAPES WITH OUR VIDEO STABILIZERS

1-800-562-2252
2609 S. 156th Circle • Omaha, NE 68130
<http://www.modernelectronics.com>

MasterCard Discover VISA AMERICAN EXPRESS

HIGH QUALITY FM

BROADCAST EQUIPMENT
- SINCE 1990 -

You know you want it! We've got it: *CPFM & High Power*, Stereo FM Transmitters, RF Amplifiers, Low Pass Filters, Antennas, Mixing Boards, Microphones, CD Players, Compressor/Limiters, Digital Reverbs, Automation Software, Studio to Transmitter Links, Emergency Alert Systems, RF Test Equipment, Kits, RF Parts, and much more. Best Prices, Highest Quality. Give Us A Call or Buy It Online...

www.progressive-concepts.com
305 SOUTH BARTLETT ROAD, STREAMWOOD, IL 60107
VOICE: (630)736-9822 FAX: (630)736-0353

VISA MasterCard Discover Novus

ORDERS: WWW.CONITEC.NET

GALEP 4
UNIVERSAL PROGRAMMER

Introducing a pocket programmer with true **Universal Output**

Latest generation pocket sized programmer uses ASIC universal pin driver technology. 1300+ device library, with lifetime free updates. Programs 8/16-bit EPROMS, EEPROMs, 0-Power RAM, FLASH, Serial EEPROMs, GAL, PALCE, microcontrollers such as 8789xxx, PIC, AVR, ST62, etc. Low voltage devices down to 1.5V. No adapter required for DIL devices. 8 Hrs. operation on battery (AC charger included). Runs **WIN 98, NT, ME, 2000, XP** with Hex/Fuse Editor. Remote control from other apps, (e.g. VisualBasic. Substitutes higher priced universal programmers e.g. ALL-11 (HIL) or LAB-T00L-48 (ADVANTECH) Providing virtually matching performance at only 1/3-1/5 the price. Info. / Orders, call: **619-702-4420**

\$333
COMPLETE KIT

9001

CONITEC DATASYSTEMS - 1951 4TH AVE, SUITE 301 - SAN DIEGO, CA 92101 - TEL: 619-702-4420 FAX: 619-702-4419

EZ-EP DEVICE PROGRAMMER - \$169.95

Check Web!! -- www.m2l.com

Fast - Programs 27C010 in 23 seconds
Portable - Connects to PC Parallel Port
Versatile - Programs 2716-080 plus EE and Flash (28F, 29C) to 32 pins
Inexpensive - Best for less than \$200

- Correct implementation of manufacturer algorithms for fast, reliable programming
- Easy to use menu based software has binary editor, read, verify, copy, etc. Free updates via bbs or web page
- Full over current detection on all device power supplies protects against bad chips and reverse insertion.
- Broad support for additional devices using adapters listed below.

Available Adapters	
EP-PIC (16C5x, 61, 62x, 71, 84)	\$49.95
EP-PIC64 (62-5, 72, 4)	\$39.95
EP-PIC12 (12C50x)	\$39.95
EP-PIC17 (17C4x)	\$49.95
EP-51 (8751 C51)	\$39.95
EP-11E (68HC11 E/A)	\$59.95
EP-11D (68HC711D3)	\$39.95
EP-16 (16bit 40pin EPROMs)	\$49.95
EP-Z8 (286E02, 3, 4, 6, 7, 8)	\$39.95
EP-SEE2 (93x, 24x, 25x, 85x)	\$39.95
EP-750 (87C750, 1, 2)	\$59.95
EP-PEEL (ICT22, 10, 18v8)	\$59.95
EP-1051 (89C1051, 2051)	\$39.95
EP-PLCC (PLCC EPROMs)	\$49.95
EP-SOIC (SOIC EPROMs)	\$49.95

Many Other Adapters Available

M²L Electronics
970/259-0555 Fax: 970/259-0777
250 CR 218 Durango CO 81301
CO orders add 7% sales tax.
<http://www.m2l.com>

EZ-EP
M²L ELECTRONICS
Los Angeles, California

World's Smallest 68HC11 Microcontroller Modules!

MicroStamp11™

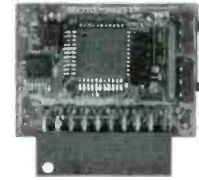

- telemetry
- microbotics
- smart toys
- animatronics
- model railroading
- home automation

- tiny, light-weight (0.5 oz.)
- 1-inch x 1.4-inch 68HC11 module
- on-board 5V regulator
- 8MHz crystal (9.83MHz on Turbo version)
- choice of 8K or 32K EEPROM
- 32K RAM + 32K EEPROM on 64K version
- plugs into your breadboard like a DIP
- SCI (UART), SPI, Output Compares, Input Captures, hardware timer, pulse accumulator
- all 14 I/O lines and 2 interrupts brought out to versatile 20-pin connector
- program in BASIC, assembler, or C
- easy code-loading with Docking Module
- Starter Packages: *
 - 8K EEPROM (#MS11SP8K).....\$49
 - 32K EEPROM (#MS11SP32K).....\$77
 - 32K EE+32K RAM (#MS11SP64K)...\$90

* includes MicroStamp11, manual, PC software (free-ware assembler, SBASIC compiler, MicroLoad utility, and sample programs), serial cable, Docking Module, and accessories.

Attention OEMs:
Embed MicroStamp11 modules into your product! only \$20 each (100-pc. price, 8K version)

MicroCore-11™

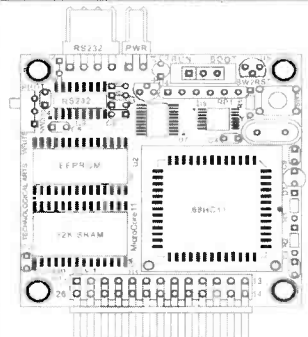

- tiny 2-inch x 2-inch 68HC11 module
- 12 inputs/outputs plus 8 analog inputs
- RS232, 5V regulator, 8MHz crystal
- 32K SRAM plus 8K or 32K EEPROM
- plugs into your breadboard like a DIP
- easy programming from any PC
- ideal for building MicroMouse robots
- now available in Turbo version (9.83MHz)
- 8K Starter Package #MC11SP8K.....\$68
- 32K Starter Package #MC11SP32K.....\$93
- Motor driver boards, LCD/keypad/keyboard interface & prototyping cards available

Technological Arts

Many other modules & accessories available. Visit our website at:
www.technologicalarts.com
sales@technologicalarts.com
TOLL-FREE: 1-877-963-8996
Phone: (416) 963-8996
Fax: (416) 963-9179
Visa • MasterCard • Discover • Amex

SINGLE CHIP COMPUTER

- ZERO external components
 - Built-in BASIC / Assembly
 - RS232 program download
 - 1K flash, 64ee, 3irq, 2timers
 - 15 I/O bits, A/D comparator
 - 20mips, faster than pic/8051
 - 20 pin DIP part #MV1200
- oem (1k) **\$1.99**
eval (1) **\$7.00**



- NEW! 8K SUPER CHIP**
40x the BASIC program space!
- 32 i/o, 12 irq, 3 timers, Bus
 - 8K flash, 512ee, 512nvram
 - Watchdog with internal osc.
 - 40 pin DIP part #MV8515
- oem(1k) \$7.10 eval(1) \$25.00

CREDIT CARD COMPUTER



New PLUG-N-GO, no cables/power supply to buy!
Lo-power RISC cpu 10x faster than PIC, Z80, 8051
256k NV mem, ser, par, RTC, 4ch 50kHz ADC, ISA bus
Built-in BASIC/Assembly, other compilers avail.
Friendly instruction set, unlike PIC or 8051
oem (1k) price 14.20 eval kit (1) \$50.00

PC WATCHDOG CARD

No More Hangups!

Reboots PC on hardware/software hang
3 versions: RESET, TIMER, PHONE
reset version oem \$21.30, eval kit \$75



LO COST MINI-PC

Includes DOS, NV mem, ADC, RAM, clock, ISA bus
Ports for serial, parallel, LCD, keyboard
Program in Turbo C, BASIC, MASM, etc.
Complete, no costly development kits required
Lowest power lowest cost PC compatible available
XT: oem \$27 eval \$95 AT: oem \$55 eval \$195

PC SOLID STATE DISK

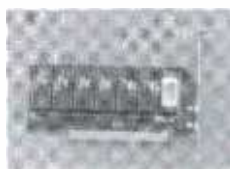

Replace mechanical drives with faster,
more reliable, more secure solid-state.
Use FLASH, NVRAM, UV EPROM.
Both DIP and PCMCIA versions from
32Kbyte (PCM1) to 1Gigabyte (PCD2)
starting at \$14.20 oem(1k) \$50.00 eval(1)

640x480 VGA LCD \$27

Controller for most single/dual scan LCDs
Works with lo-res (160x120, 320x240, etc.)
Use with PC or SBC, standard VGA BIOS
Source code demo shows VGA initialization
Adaptable for other CPUs (i.e. Z80, HCT11)
oem(1k) \$27 eval kit(1) \$95 w/10" LCD \$195



SERIAL MINI-TERMINAL

RS232 terminal for Stamp, PC, Z80, AVR etc.
-super low-current, powers from serial line
-LED backlit LCD, visible in all conditions
-115.2kbps, DB9 conn, simple commands
-specify 20 customizable or 16 tactile keys
eval(1) \$75, oem(1k) \$21.30, w/BASIC cpu \$27



STAMP DRIVE!!

Read / Write PC compatible hard
disk, PCMCIA, & Compact Flash.
RS232 to ATA drive adapter for
Stamp, 8051, AVR, PIC, Z80, x86
ANY controller, big or small:
-up to 4 gigabyte capacity
-low power operation 5v 2ma
-simple software commands
-baud rates up to 115.2kbps
-S14 IDE & S21 ISA/104 versions

oem(1k) **\$27**
eval kit(1) **\$95**



WWW.STAR.NET/PEOPLE/~MVS

MVS Box 803
Nashua, NH 03060
(508) 792 9507



5yr Limited Warranty
Free Shipping
Mon-Fri 10-6 EST

**SERVING THE EMBEDDED
COMMUNITY SINCE 1979!**

\$62 PCBs

And our layout software is **FREE!**

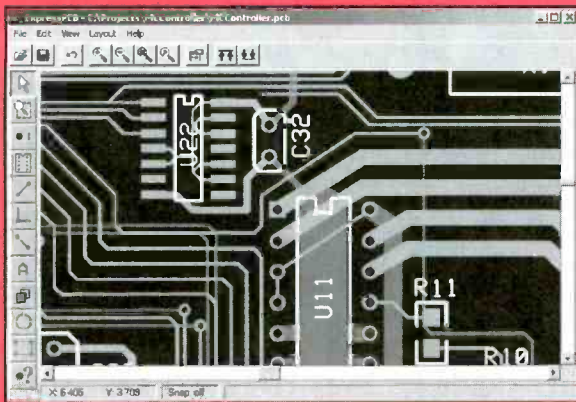

Download our **FREE** layout software
 Design your two-sided plated-through PCB
 Send us your design with just a click
 Receive your boards in a few business days

Select our MiniBoard service and get three top quality
 2.5" x 3.8" PCBs for \$62 – shipping included!



expresspcb.com



Be an FCC LICENSED ELECTRONIC TECHNICIAN

EARN MORE MONEY



**Earn up to \$100
an hour and more!**

The Original Home-Study course prepares you for the "FCC Commercial Radiotelephone License" at home in your spare time. This valuable license is your professional "ticket" to thousands of exciting jobs in:

- Communications
- Radio-TV
- Microwave
- Maritime
- Radar
- Avionics & more

You can even start your own business!

No previous experience needed! No need to quit your job or go to school. This proven course is easy, fast and low cost!

**GUARANTEED TO PASS – You get your
FCC License or your money refunded.**

Send for FREE facts now!

Mail coupon today or call

(800) 932-4268 Ext. 240

www.LicenseTraining.com

The Pocket Programmer

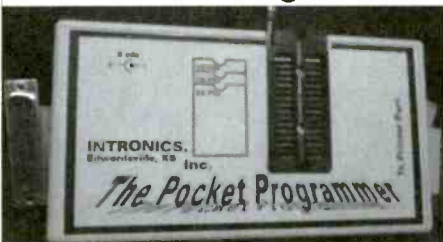

The Best just got Better!!!

The Best portable programmer that uses the printer port instead of an internal card just got Better!! Now with easier to use Windows based software that programs E(E)prom, Flash & Dallas parts. 25/27/28 & 29 series from 16K to 8Mbit. Adapters available for MCU's 874X, 875X, Pic, Atmel, PLCC packages, Bi-Prom's, 40-Pin X16 Eproms, Rom Emulator to 32K X 8 (2716-27256) and More...

Only \$149.95

Same Name, Address & Phone # for
19 Years.... Isn't it Amazing ?

Intronics, Inc.

Box 13723 / 612 Newton St.
 Edwardsville, KS 66113
 Tel. (913) 422-2094 Add \$7.00 COD
 Fax (913) 441-1623 Add \$6.00 Shipping

WWW.IN-KS.COM Visa/MC/Amex/Disc

BREAST CANCER BEGINS
 EVEN SMALLER THAN THIS
 THAT'S WHY YOU
 NEED A YEARLY
 MAMMOGRAM,
 ESPECIALLY AS
 YOU GET OLDER.
 MAMMOGRAMS
 CAN DETECT
 LUMPS TOO
 SMALL FOR
 YOU TO FEEL
 AND EARLY
 DETECTION
 MAY SAVE
 YOUR LIFE,
 SO CALL
**1-800-
 ACS
 2345.**

GET A MAMMOGRAM
 EARLY DETECTION IS THE BEST PROTECTION.



ELECTRONIX EXPRESS

Visit Our Website At
<http://www.elexp.com>

WELLER SOLDERING STATION - MODEL WLC 100

- Variable power control (5 to 40 watts)
- Replaceable heating element
- Quality light-weight pencil iron

\$36⁹⁵



RSR TELECOMMUNICATIONS TRAINER

HANDS-ON TELEPHONY, LAN, CATV EXPERIENCE
WITH ONE SELF-CONTAINED UNIT

T-Comm Trainer (TCM-100) \$199.95
Lab Manual / Work Book 26.95
Component and Supplies Kit 37.95
Tool Kit 119.95

Only
\$199⁹⁵



MODEL TCM-100

LOWEST PRICE 20MHZ

instek[®] OSCILLOSCOPE

MODEL GOS-620
Dual Channel - 20MHZ
(INCLUDES PROBES)

\$299⁰⁰



instek[®] FUNCTION GEN. WITH INT/EXT FREQ. COUNTER

3 MHz, Digital Display
MODEL 8216 \$199⁰⁰



ALLIGATOR LEADS \$2¹⁰

SET OF 10



SWITCHES

Mini Toggle SPDT 50¢ ea.



SOLDERING IRON 3-WIRE

HIGH PERFORMANCE
#060501 \$5²⁵



SCOPE PROBE 60 MHZ

SWITCHABLE X1, X10

\$12⁹⁵

DIGITAL MULTIMETER

32 Ranges - 3 1/2 Digit

MODEL MY-64

\$27⁹⁵



AC/DC Volt/Current, Res. Cap.,
Frequency. Rubber Holster Included

PAD-234

DIGITAL/ANALOG TRAINER

Complete portable workstation. Variable and fixed power supplies, function generator, digital I/O, rugged design, high impact case.



Assembled

\$150⁰⁰

Kit

\$110⁰⁰

HIGH QUALITY TOOLS

With Cushion Grips and Return Spring

Needle Nose Pliers \$2⁹⁵

Wire Stripper \$1⁵⁰

Diagonal Cutter \$2⁹⁵

DC POWER SUPPLIES

MODEL HY3003 - DIGITAL DISPLAY

Variable output, 0-30 VDC, 0-3 Amp \$89⁰⁰

MODEL HY3003-3 - TRIPLE OUTPUT

Two 0-30 VDC, 0-3 Amp

variable outputs plus 5V 3A

fixed. Digital Display. \$215⁰⁰



TERMS: Min. \$20 + shipping. School Purchase Orders, VISA, MC, Money Order, Prepaid. NO PERSONAL CHECKS, NO COD. NJ Residents: Add 6% Sales Tax.

In NJ: 732-381-8020
FAX: 732-381-1006

365 Blair Road • Avenel, NJ 07001-2293

800-972-2225

<http://www.elexp.com>
email: electron@elexp.com

CIRCLE 206 ON FREE INFORMATION CARD

New and Pre-Owned Test Equipment

New Equipment Specials

B+K Precision 2120B - 30 MHz Oscilloscope

- * FREE Model 117B Multimeter
- * 2 Channel, Dual-Trace
- * 30 MHz Bandwidth
- * TV Triggering
- * (2) Probes Included

Sale Price \$339.00

AVCOM PSA-37D - Spectrum Analyzer

Satellite Downlink - Installation - Maintenance & Service

- Band 1: 10 - 1750 MHz
- Band 2: 3.7 - 4.2 GHz
- Carrying Case Included
- Line or Battery Powered
- Built-in DC Block & Power for LNA/LNB's

Sale Price \$2,395.00

Instek GOS-6103 - 100 MHz Analog Oscilloscope

- 100 MHz Bandwidth
- 2 Channel, High Sensitivity
- TV Trigger - Signal Output
- Cursor Readout
- Time Base Auto-range
- (2) Probes Included
- 2 Year Warranty

Sale Price \$899.00

Leader LF 941 - CATV Signal Level Meter

- TV/CATV Coverage from 46-870 MHz
- Video/Audio Carrier Measurements

Sale Price \$489.00

Wavetek Meterman HD160B Digital Multimeter

- Full Sealing Against Water, Chemicals, & Fluids
- True RMS
- Drop-Proof to 10 feet (3.3m)

Sale Price \$159.00

Pre-Owned Oscilloscope Specials

Tektronix	465	100 MHz	\$499.00
Tektronix	465B	100 MHz	\$649.00
Tektronix	475	200 MHz	\$749.00
Tektronix	475A	250 MHz	\$949.00

- Professionally Refurbished
- Aligned & Calibrated to Original Specifications
- The Industry Standard of Oscilloscopes
- 1 Year Warranty - The Longest Available!!!
- See Website for Complete Specifications

See us on the Web!
www.testequipmentdepot.com

We Buy Surplus Test Equipment

Test Equipment Depot

A FOTRONIC CORPORATION COMPANY

99 Washington St. Melrose, MA 02176

(781) 665-1400 • FAX (781) 665-0780

e-mail: sales@testequipmentdepot.com



TOLL FREE 1-800-99-METER

(1-800-996-3837)

CIRCLE 322 ON FREE INFORMATION CARD

FCC Course with Certificate

A Powerful 19 Lesson Self-Study Program on one CD!

FCC Exam Review Course

After completing this course you will be ready to take the FCC examination for a General Radiotelephone Operator License.

The General Radiotelephone Operator License is required to adjust, maintain or repair any FCC licensed radiotelephone transmitters in the aviation, maritime and international fixed public radio services. It is issued for the lifetime of the holder.

Through the years Cleveland Institute of Electronics (CIE) has been able to compile a great amount of information concerning the types of questions that the FCC include in their examinations.

Because of the extensive FCC sample questions in this course, you can look forward with confidence to passing the FCC exam particularly if you heed the hints given throughout the course.

Here's what you'll get!

19 FCC Lessons on CD ROM

Every lesson is presented in a clear and easy-to-understand format which makes learning this material fun and easy. After each lesson you'll take an exam. You can take it on-line or fill out one of the answer sheets we provide and mail it. After you finish the 19 lessons we'll send you a Certificate of Completion from CIE.

CIE Instructor Assistance:

Use our toll-free hot line to access our faculty and staff if you ever need assistance with your course work.

Priority Grading:

Your exams will be graded and sent back to you within 24 hrs.

Certificate of Completion:

Earn a Certificate of Completion that's suitable for framing.

Why is an FCC License so valuable?

An FCC license is an excellent credential for career advancement because it's proof of a certain level of electronics know-how. Because it is a federal examination, the FCC license with its implied knowledge is accepted by industry nationwide.

Cleveland Institute of Electronics

Student

Certificate of Completion in
FCC Exam Review

\$49.95

Course # 01-FCC01

Lesson Topics Include:

- Modern Modulation Methods
- Receiving Equipment
- Batteries, Control Motors & other Power Sources
- Digital & Data Commun.
- Frequency Modulation
- Transmission Lines & Wave Guides
- Transmitters
- Antennas & Wave Propagation
- Monochrome & Color TV
- Microwave Comm. Systems
- Tuned-Staged Operation
- Suppressed - Carrier Modulation and Single
- Detection & Frequency Conversion
- Lasers in Communications & Industry
- Communications by Fiber Optics
- FCC Review Lessons Pt 1
- FCC Review Lessons Pt 2
- Pointers & Practices for Passing FCC G.C. Exam Pt 1
- Pointers & Practices for Passing FCC G.C. Exam Pt 2

Learn PC Repair



- PC Diagnostic Video
 - 200 + Page Training Manual
 - PC Assembly & Configuration Video
 - Micro-Scope Diagnostic Software (LE)
 - CD-ROM - contains videos and manual
- 02-020 \$99.95

Motor Controls 101

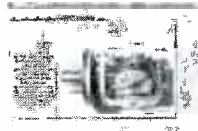

This CD ROM trainer uses pictures, sounds, animations & interactive circuits to teach you the basics of motor control. A Certificate of Completion may be printed on your printer if you achieve a passing score on the included test.

02-050 (not a CIE certificate) \$99.95

More CIE Certificate Courses

- AC/DC Electronics Course with Lab**
03-introb (39 graded lessons w/ cert) .. \$225
- Intro to Web Site Design**
01-M410 (10 graded lessons w/ cert) .. \$245
- Soldering Course with Lab**
01-SD01 (3 graded lessons w/ cert) \$95
- Programmable Controller Course**
01-SD01 (1 graded lesson w/ cert) \$65
- Digital Data Communications with Lab**
01-DD01 (11 graded lessons w/ cert) .. \$245

CIE Bookstore: 1776 E. 17th, Cleveland, OH 44114 • **800 321-2155** • www.ciebookstore.com

Shipping & Handling: \$0 - \$30 **\$2.75**, \$30.01 - \$50.00 **\$5.25**, \$50.01 - \$100.00 **\$11.75**, \$100+ **\$15.75** CA, HI & OH residents must add sales tax.

High Tech Video System with Audio **Only \$119.00!!** only \$109. ea. in qty 4

Complete Package! Includes Two B/W Cameras with I.R. (night vision) & microphones
One 5.5" B/W Monitor with Built in Switcher, Two pre-wired 60 ft hook-up cables
Everything you need to be up & running in minutes with a high tech video system!!



- System Features:**
- *2 wide angle B/W cameras w I.R. & Sound
 - *5.5" B/W video monitor w built in switcher
 - *Two 60 ft. pre-wired cables
 - *View one or both cameras. Switching Time variable from 2 to 20 seconds
 - *Video easily hooks into a VCR

Removeable H.D. Racks
For IDE/Ultra DMA Hard Drives
We Sold Over 18,000 in 2001!
This product can be used with any 3-1/2 IDE hard drive up to 1" high. It includes an electronic keylock for safe removal and insertion. Made of ABS 707 fireproof plastic. Use this product to protect sensitive hard drive data, take your hard drive between work and home or even set up different users with their own hard drives that they physically insert every time they use a PC. Other models available from C.S.I. include RH10 series and RH20 series, which are interchangeable within the same interface design (IDE or SCSI). **Other Models are Available.** See www.web-tronics.com under "hard drive and accessories" for prices, technical specs and materials.



ONLY \$14.95 any qty.
#RH-10C-IDE

Triple Output Bench Power Supply
w four 3/12 digit LCD Displays
Output: 0-30 VDC @ 2 Amps x 2
& 5V fixed @ 3 Amps x 1
Input: 110VAC +/- 10%



CSI3002D-3.....\$159.00
(qty. 5+.....\$149.00)
Details at www.web-tronics.com under "Test Equipment"

2GHz RF Field Strength Analyzer
Frequency Range: 100KHz to 2.05GHz
Narrow Band FM (NFM), Wide Band FM (WFM), AM and Single Side Band (SSB) Modulated Signals May Be Measured
PLL Tuning System for Precise Frequency Measurement and Tuning
LED Backlight LCD (192x192 dots)
Built-In Frequency Counter
Hand-Held and Battery Operated
All Functions are Menu Selected
RS232C for PC Interface and Printer



ONLY \$1699
#3201

CTRL - D to bookmark this site

www.web-tronics.com

Don't forget the dash

Circuit Specialists, Inc.
In Business Since 1971

- Easy to Navigate
- Includes a Search Engine That Really Works
- New Items Added Constantly

Mini CCDs (B/W & Color)
Sensational NEW Design for Small Observation Cameras. Smaller and Better!



LOWER PRICES

- Ultra Miniature Design
- Black & White Versions Only 25mm x 25mm
- Color Versions Only 32mm x 32mm
- Available in Standard Lens or Pinhole Lens
- All Include Pre-Wired Cable Harness for Video & Power
- 12V Regulated Power Supply Required (120mA typical power consumption)
- 0.1 LUX Rating (B/W), 1 LUX (color)
- CCD Area Image Sensor for Long Camera Life
- Back Light Compensation Circuit
- Built-In Electronic Auto Iris Lens

Detailed Specs on the Web

CCD B&W Board Cameras

- ASIC CCD Area Image Sensor
- Extremely Low Power Consumption
- 0.5 Lux Min Illumination
- Built-In Electronic Auto Iris for Auto Light Compensation

Detailed Specs on the Web

LOWER PRICES

VM1030PA-B 30mmx30mmx25mm, Pinhole lens, 12V \$39.00 any qty.
VM1030A 30mmx30mmx26mm, Standard lens, 12V \$39.00 any qty.
VM1035A 42mmx42mmx25mm, Standard lens, 12V with back light compensation \$49.00 any qty.
VMCB21 44mmx38.5mmx28mm, with 6 infra-red LEDs, 12V \$49.00 any qty.
VM1036A 32mmx32mmx25mm, Standard lens, 12V, reverse mirror image feature \$49.00 any qty.

Bullet CCD Cameras B&W and Color

- Smart Rugged Metal Housing
- Extremely Low Power Consumption
- 12 Volt
- CCD Area Image Sensor for Long Camera Life
- Built-In Electronic Auto Iris for Auto Light Compensation
- No Blooming, No Burning
- 0.1 Min Lux Illumination (B&W), 1 Lux Min Lux Illumination (color)

Detailed Specs on the Web

LOWER PRICES

VMBLT1020 B&W, 21mm(D)x58.5mm(L) \$49.00 any qty.
VMBLT1020W B&W Weatherproof, 21mm(D)x58.5mm(L) \$69.00 any qty.
VMBLTJC195W COLOR Weatherproof, 17mm(D)x88mm(L) \$109.00 any qty.

COLOR CCD Mini Board Cameras

- Low Power Consumption
- 1 Lux Illumination
- Internal Synchronization
- 12Volts
- 400 TV Lines
- Built-In Electronic Auto Iris for Auto Light Compensation

Detailed Specs on the Web

PRICE REDUCTION

VM3010PA 33mmx33mmx18mm, Pinhole lens \$99.00 any qty.
VM3010-A 33mmx33mmx32mm, Standard lens \$99.00 any qty.

new! DC to AC Power Inverters!
150 watt up to 3000 watt models!

150w modified sine wave: \$29.95(G-12-015B) **Industry Best Pricing!**
300w modified sine wave: \$39.95(G-12-030)
150w pure sine wave: \$69.00(G-12-150S)
300w pure sine wave: \$109.00(G-12-300S)
800w modified sine wave: \$139.00 (G-12-800)
1000w modified sine wave: \$179.00(G-12-1000)
3000w modified sine wave(phase corrected). (G-12-3000).....\$489.00
See Our Website for DETAILED Specs.!



Our Most Sophisticated DMM *We Sold Over 700 Last Year!*
with RS-232 Interface & Software, 3-3/4 Digit, 4000 Count, Auto-Ranging with Analog Bargraph

- True RMS Mode
- 10MHz Frequency Counter
- Time Mode with Alarm, Clock, and Stop Watch
- Dual Display
- 10 Location Memory
- Min, Max, Avg and Relative Mode
- Decibel Measurement
- Cap and Ind. Measurement
- Temperature Mode (C/F)
- K Type Temperature Probe Included
- Pulse Signal for Logic & Audible Test
- Continuity/Diode Test
- Logic Test
- Auto Power OFF/ "Keep ON" Mode
- Fused 20A input with Warning Beeper
- Back Light
- Data Hold/Run Mode
- Safety Design UL1244 & VDE-0411
- Protective Holster
- Silicon Test Leads



NOW ONLY \$149 Reg. \$169
More Details on our Web Site
PROTEK 506

Bench Digital Multimeter w RS232C Interface

True RMS/AC voltage & current
Digital & Analog Display
3999 Counts & 42 Segment Bar graph
Autorange & Manual Range
Data Hold, Min/Max Relative Measurement
Storage Data Display/Recall
Back Light
ADP Measurements: 400mV +/- 3% 10 Digit/1mV DC
Continuity Test
Diode Test
RS232C standard interface
AC or DC power
Extensive Details @ **WEB SITE**
Item# CSI9803R



new!
Only \$99.00! any qty.

new! O'Scope Offer ONLY \$299
30MHz! ONLY \$299!
Industries Best Price!
See web for specs



#OSC-1030

- Dual Channel
- Dual Trace
- Vert Trigger
- 1 Year C.S.I. Warranty!

Manufactured for CSI by a leading O.E.M. manufacturer. See our website for detailed specifications!

3000 Series Digital R/O Bench Power Supply
• Low Cost Single Output • 3Amp **New Lower Prices!**



AS LOW AS \$85

High stability digital read-out bench power supply featuring constant voltage and current outputs. Short-circuit protection and current limiting protection is provided. Highly accurate LED accuracy and stable line regulation make the 3000 series the perfect choice for lab and educational use.

Line Regulation: 2x10⁻¹ +1ma
Load Regulation: 1 x 10⁻⁴ +5mv
LED Accuracy: Voltage ±1% +2 digits
Current ±1.5% +2 digits
Wave Line Noise: ≤1mVrms
Dimensions: 291mm x 158mm x 136mm

Line Regulation: 2x10⁻¹ +1ma
Load Regulation: 1 x 10⁻⁴ +5mv
LED Accuracy: Voltage ±1% +2 digits
Current ±1.5% +2 digits
Wave Line Noise: ≤1mVrms
Dimensions: 291mm x 158mm x 136mm

CSI3003: 0-30v/0-3amp Digital R/O Bench PS, 1x10⁻⁴+5mv Load Regulation \$89.00 \$/85.00
CSI 5003: 0-50v/0-3 amp Digital R/O Bench PS, 1x10⁻⁴ +5mv Load Regulation \$109.00 \$/599.00

See our web-site for many other power supply deals

SUPREME SURVEILLANCE

JUST PUBLISHED! The **EXTREME** Covert Catalog details virtually every surveillance system on the World Market today. From the FBI (and their superiors) latest anti-terrorist phone/computer/and video taps, to bargain basement devices no one knows about.

Complete specs and ordering information on hundreds of surveillance and investigative hardware and software products from 14 countries. Many, many new entries for covert audio and video supplies, computer busters, thru-wall viewers, night vision gear, fax interceptors, CIA designed lock defeaters, etc.

"Absolutely fantastic! A Techie's dream come true. No fluff, no filler, just raw spy meat. Whata meal!" - Kevin Murray, probably the top counter surveillance expert in the U.S. ECC, 8 1/2" x 11", ISBN 1-880-231-20-4, 437 pages, index, \$49.95

Intelligence Here
404 N. Mt. Shasta Blvd.
Mt. Shasta, CA 96067
Order by Phone: 866-885-8855
www.intelligencehere.com



Add \$8.00 (priority shipping). CA residents add 8% tax

QUICK and PAINLESS Programmable Robotics!

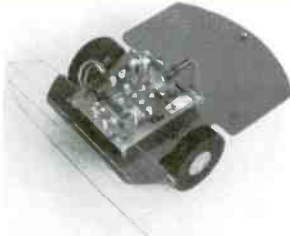

- COMES PRE-ASSEMBLED
- PRICED LOWER THAN A KIT
- Great Features & Expandability
- Re-Programmable from your PC

JUST ADD 6 AA BATTERIES AND GO!

Blue Bell Design Inc.

www.bluebelldesign.com

Scrambling News

915 NW First Ave., Suite 2902,
Miami FL, 33136, 305-372-9427

Pay TV and Satellite Descrambling 2002 - New! - satellite and cable. Includes the latest information. \$19.95 plus \$1.75 shipping.

Hacking Digital Satellite Systems Video 2002 - New! - This 90 minute video focuses on the satellite television piracy business. \$29.95 plus \$ 3.50 shipping.

Scrambling News Online - Online service for those interested in satellite television news. \$59.95/year.

Pay TV and Satellite Descrambling Series CD-ROM - all 13 volumes over 300 pages, \$59.95 plus \$3.50 shipping.

Best Deal - Everything listed above for only \$99.95 plus \$3.50 shipping.

www.scramblingnews.com

SMART CARDS

HIGHEST SECURITY

Complete system! Develop your own smart card applications in easy to use BASIC language



- Security Systems
- Time Cards
- Access Control
- Home, Auto, Business
- Robotics
- Data Security
- Emulation
- Theft Prevention

Smart Card Tool Kit comes complete with

- CyberMouse SmartCard Programmer
- Application Development Software
- Extensive User Manual in printed form
- 3 Blank Smart Cards

Complete system only \$79.95

We accept

VISA • Mastercard • American Express

To Order Call 1-800-773-6698 Worldwyde.Com,
33523 Eight Mile Rd # A3-261, Livonia, MI, 48152
See more online at <http://www.worldwyde.com>

Stepper Motor Book



Easy Step'n

- For the experimenter.
- Determine surplus stepper motor specs using simple easy to build test equipment.
- Build microcontroller-based control systems (flow charts and code examples).
- Build stepper motor drive circuits.
- Mechanical design considerations.
- 8.5x11 format. 205 pages. \$34.95

Table of Contents: <http://www.stepperstuff.com>
+ \$5 s/h in US. VISA, MC, AM, DS, MO, Check
CA residents please add 7.25% CA sales tax

SQUARE 1 ELECTRONICS

P.O. Box 501, Kelseyville, CA 95451
Voice (707) 279-8881 Fax (707) 279-8883

<http://www.stepperstuff.com>

Solar Panels

160 mW / Sun 8 Cells
200pc 2Kpc 20Kpc 200Kpc
\$2.00 ea \$1.80 ea \$1.71 ea \$0.85 ea

Battery Holders

AA Singles, and Dual Side by Side
200pc 2Kpc 20Kpc 200Kpc
\$0.40 ea \$0.36 ea \$0.34 ea \$0.17 ea

LED's

High Intensity HPWT-DL00
Similar to Lumex type SSL-LX30448SYC
200pc 2Kpc 20Kpc 200Kpc
\$0.50 ea \$0.45 ea \$0.43 ea \$0.21 ea

Call 1-847-612-2739



Theremin

The PAiA Theremax uses the same heterodyne principles as the original turn of the century instrument for classic tone and adds features made possible by modern ICs. Shown with optional lectern case.

9505K Kit
\$89.75

FatMan Analog MIDI Synth

9308K Kit
\$154.00

A complete music synthesizer with all the big bottom and phat sound that makes analog famous. 20 knobs and controls for real-time sound sculpting. Compatible with standard MIDI sources like keyboards or computers. Desktop case or rack panel available.

Check out <http://Paia.com> for schematics, tech details, firmware source files and more...

Synthesizer Modules, Guitar Effects, Mixers, EQs, Tube PreAmps, and dozens of kits for **ELECTRONIC MUSICIANS**

PAiA Electronics info@paia.com
3200 Teakwood Lane 405.340.6300
Edmond, OK 73013 fax 405.340.6378

Press-n-Peel Transfer Film

PC Boards in Minutes

8.5" x 11" Shts.
* Or Photocopy
**Use standard household iron

1. LaserPrint*
2. Press On**
3. Peel Off
4. Etch



Use Standard Copper Clad Board
20 Shts \$30/ 40 Shts \$50/ 100 Shts \$100
VISA/MC/PO/CK/MO \$4 S&H/Foreign Add \$7

Techniks Inc.

P.O. Box 463, Ringoes NJ 08551
ph. 908.788.8249 fax 908.788.8837
www.techniks.com

Vist Our E-Store On-Line!

PIC/MICRO TOOLS



ISP-PRO 3.0
All-in-one Programmer

- Uses PC Serial port (USB w/ adapter)
 - Very Simple to use
 - Free software updates
 - Complete with Windows IDE
 - Easy in-circuit programming
 - Supports PIC, Schemix, I2C and more!
 - Firmware upgradeable
 - RJ-11 / 10 Pin Header
 - Includes RJ-11 Cable
- Optional Items Available:
- Plastic Enclosure Available
- 40 Pin ZIF Adapter All-in-one
- Universal Adapter
- All for
\$59.95 Complete

Solderless Development Boards

Develop your projects the easy way

- Complete Assembled Board
- In-Circuit Programmable (ISP)
- Solderless Bread Board
- Built in RS232 (w/ Max232)
- Built in Power Connector
- Removable Oscillator
- Documentation
- Auto Disconnect for RS3, RBC, & 1087
- Available in several models

Starting at \$49.95

Join our online PIC forums tons of information and help FREE!!

VISA • MasterCard • American Express
Order Online or Call 1-734-425-1744
Basic Micro, 34391 Plymouth, Livonia, MI, 48150
See more online at <http://www.basicmicro.com>

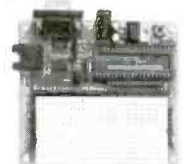

PICmicro MCU Development Tools

 **EPIC Plus
PICmicro Programmer
\$59.95**

Program PICmicro MCUs in BASIC!
DOS or Windows operation (includes Windows IDE software).
PicBasic Compiler - \$99.95
PicBasic Pro Compiler - \$249.95

Experimenter Boards
LAB-X1 for 40-pin MCUs (shown) - \$199.95
LAB-X2 for 28 or 40-pin MCUs - \$69.95
LAB-X3 for 18-pin MCUs - \$119.95

PICProto Prototyping Boards
\$8.95 to \$19.95
High-quality blank prototyping boards for PICmicro MCUs.

microEngineering Labs, Inc.
www.melabs.com
Phone: (719) 520-5323
Fax: (719) 520-1867
Box 60039, Colorado Springs, CO 80960

PIC Programmer Kits

Super Value!
\$16.95 + S&H \$4.95*
The P16PRO: can program up to 40 pin PICs including the popular 16F84 & 12C508 • Needs software (extra \$20) • Available assembled or starting from \$16.95 for the kit.
See www.electronics123.com for more info!
The PICALL programmer can also program Atmel AVR's in addition to the PICs it can program • Free software • PICALL programmer kit at \$69.95
See www.electronics123.com for more info!

Video Camera module Code:BB004

CMOS Camera Module, Black & White, Size: 0.63"x0.63"x0.59" H. Lens: f4.9, F2.8. EIA 320Hx240V. 0.6" DIL Package, 5 pins. Pin 3 is 1V p-p composite video (75 ohm) to monitor. \$36 + \$5 S&H

Running Lights kit Add \$6 for 8 triacs to drive light bulbs

8 LEDs with 10 push button selectable patterns. 8 speed levels! 80 combinations! \$16 + \$5 S&H

Toll Free: 1-888-549-3749 (USA & Canada)
Tel: (330) 549-3726. Request a FREE catalog or visit us at: www.electronics123.com for more products.
Amazon Electronics, Box 21 Columbiana OH 44408

spyoutlet.com
Security • Surveillance • Loss Prevention

Purchase your video cameras from one of the largest importers in the U.S.

- NEW weatherproof Bullet Cameras
- Spy Pinhole Cameras • Wireless Video
- PC Cards • Voice Changer
- Micro Recorders • Shotgun Mic
- Locksmithing • Bug Detectors
- NEW Phone Sentry Plus—defeats telephone tapping and taping
- UV Pens & Powder • Realtime 12 hr Telephone Recording System
- GPS Vehicle Tracking System

And much more • Quantity discounts
www.spyoutlet.com
Printed Catalog send \$5⁰⁰

**SPY OUTLET 2468 NIA. FALLS BLVD
TONAWANDA NY 14150 (716) 695-8660**

Top Secret Consumertronics
In business 25+ years - established professionals
www.tsc-global.com

Exciting Hi-Tech Survival Books, Manuals, Tapes
Stopping Power/ KW-HR Meters/VHS
Cellphone / Cordless / Pager Manuals
Voice Mail / Answ.Machine Security
Phone Color Boxes/ Caller ID,ANI Sec.
Fax Machine / PBX Security
Computer Sec./Hacker Files/Dirty2Doz
Internet Security / Frauds/Tracking
Beyond van Eck Tempest / VHS
Polygraph Secrets / Identity Theft Manual
Cons & Scams Databook / Placak Rep.
ATM/Credit Card/Check/MO Security
Mind Control / Under Attack! / EMBB
Radionics Manual / Heal Thyself!
Stealth Tech / High Voltage Devices
Social Engin./Ultimate Success Manual
Remote Office / Casino Secrets - 100 more!
Descriptions, Prices, Policies in Catalog
Consumertronics
P.O. Box 23097, ABQ, NM 87192
505-321-1034 - Printed Catalog \$3

CABLE SECRETS!!!

Build your OWN cable box "test" devices!

Why pay \$100.00 or more for a "test" device that someone else made? Make your own! Includes complete source code and plans for the most commonly used cable boxes. *Unlock all of the channels on your box!*

Or start your own lucrative business!
Complete source code **\$79.95**
Code for individual boxes **\$29.95**

DSS SECRETS — Vol. 2

Step-by-step instructions on programming your own DSS access card. *Unlock all channels on your own card!* This is the most current information on the market! Includes software, plans, and hardware sources. Book & CD-ROM.
DSS Secrets Vol. 2 \$49.95

VISA • MasterCard • American Express
To order, call Worldwyde @ **1-800-773-6698**
33523 Eight Mile Rd. #A3-261 • Livonia, MI 48152
Visit us on the web at www.worldwyde.com

PCBexpress
www.pcbexpress.com

- No tooling charge!
- Lot charges start at \$80
- Simple order process
- Quickturn, low quantities

TWO SERVICES FOR CIRCUIT BOARDS

INSTANT ON-LINE QUOTES!
(No sign-up required)

www.pcbpro.com

- Quick Price Comparisons
- More options and added features
- Prototype & production quantities

PROGRAM PIC'S IN BASIC

 **BASIC**

MBASIC for PICmicro MCUs

Ever wanted to learn how to program PICmicro MCUs? Now you can with easy to use BASIC. Our software is much simpler than C or Assembly. MBasic for PICmicro MCUs creates a one click solution that allows you to experiment and test code changes on-the-fly! From beginner to professional, bring your projects to life quicker and easier with MBasic for PICmicro MCUs!

New - In Circuit Graphical Debugger built in!
Priced from \$99.95
Educational and dealer discounts available
Order online or call 1-734-425-1744
Basic Micro, 34391 Plymouth, Livonia, MI 48150
See more online at <http://www.baslemicro.com>



...made easy.

www.microCommander.com

FIELD - STRENGTH RECEIVER - METER A High-Quality Electric Field Meter
So Sensitive It's Like a Wideband Receiver!



BROADBAND: 10 MHz to 4.5 GHz usable range
HIGHLY SENSITIVE: Detects Cellular phones and "Bugs" at 20 ft. - 2.4 GHz "sealed" microwave ovens at 40 ft. 2 meter, 440 MHz transceivers, FRS walkie talkies at 80 ft.
DUAL MODE: LINEAR - For measuring weakest signals
DETECTION: LOGARITHMIC - 1000:1 dynamic signal range
SENSITIVITY CONTROL: > 20 dB manually adjusted gain
80 HR. OPERATION (Approx.) With 2 AA alkaline batteries

ANALOG METER and LED DISPLAYS: The LED display for distance and nighttime
SILENT VIBRATE MODE: Switchable vibrator for signal detection without direct viewing

Including shipping and handling (CA. residents add 8% Sales Tax) **\$89**

Alan Broadband Company Phone: (888) 369-9627
93 Arch Street
Redwood City, Ca. 94062 Fax: (650) 369-9627

www.zapchecker.com

MODERN ELECTRONICS

Cable TV Descramblers

Buy 1 Descrambler,
Get the 2nd for

1/2 Price

COPY RENTAL TAPES WITH OUR VIDEO STABILIZERS

- 30 DAY FREE TRIAL!
- FREE PRODUCT CATALOG!
- BEST DEALER PRICING!
- 100% MONEY BACK GUARANTEE



1-800-906-6664

2609 S. 156th Circle • Omaha, NE 68130

<http://www.modernelectronics.com>



Do You Repair Electronics?

Repair Databases for TV, VCR, Monitor, UL Audio, FCC, and more.

- Over 76,000 records
- Private user forums
- Live on-line chat rooms

RepairWorld.com

Electronix Corp 1 Herald Sq. Fairborn, OH 45324 (937) 878-9878

SINGERS! REMOVE VOCALS
Unlimited Free Backgrounds
 from Original Standard Recordings!
Thompson Vocal Eliminator™
 VE-4 Free Brochure/Demo
 24 Hour Demo/Info Line
 (770)482-2485 • Ed 49
 LT Sound Dept PE-1 7980 LT Parkway, Lithonia, GA 30058
 Internet www.LTSound.com
 Better Than Karaoke For Over 25 Years!

ELECTRONIC GAMES

BP69—A number of interesting electronic game projects using IC's are presented. Includes 19 different projects ranging from a simple coin flipper, to a competitive reaction game, to electronic roulette, a combination lock game, a game timer and more. To order BP69 send \$4.99 clearance (includes s&h) in the US and Canada to Electronic Technology Today Inc., P.O. Box 240, Massapequa Park, NY 11762-0240. US funds only. Use US bank check or International Money Order. Allow 6-8 weeks for delivery. MA07



Turn Your Multimedia PC into a Powerful Real-Time Audio Spectrum Analyzer

Features

- 20 kHz real-time bandwidth
- Fast 32 bit executable
- Dual channel analysis
- High Resolution FFT
- Octave Analysis
- THD, THD+N, SNR measurements
- Signal Generation
- Triggering, Decimation
- Transfer Functions, Coherence
- Time Series, Spectrum Phase, and 3-D Surface plots
- Real-Time Recording and Post-Processing modes

Applications

- Distortion Analysis
- Frequency Response Testing
- Vibration Measurements
- Acoustic Research

System Requirements

- 486 CPU or greater
- 8 MB RAM minimum
- Win. 95, NT, or Win. 3.1 + Win.32s
- Mouse and Math coprocessor
- 16 bit sound card

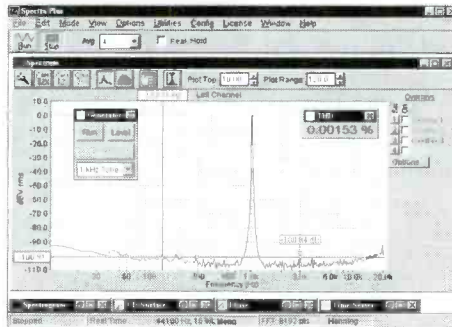

Priced from \$299

(U.S. sales only – not for export/resale)

DOWNLOAD FREE 30 DAY TRIAL!

www.spectraplus.com

PHS Pioneer Hill Software
 24460 Mason Rd.
 Poulso, WA 98370
 a subsidiary of Sound Technology, Inc.

Sales: (360) 697-3472



Spectra Plus
 FFT Spectral Analysis System

Fax: (360) 697-7717

e-mail: pioneer@telebyte.com

ALL ELECTRONICS CORPORATION

SHOP OUR ONLINE STORE
www.allelectronics.com

Flexible Thin Film Solar Panels

Very thin, extremely flexible polyester encapsulated photovoltaic modules suitable for indoor or protected outdoor use. Light-weight. Great for mounting on curved surfaces. Ideal for charging nickel cadmium and nickel metal hydride batteries or running low current applications. Can be connected in series or parallel for higher voltage or current. Modules have copper strips at each end to make solder connections.

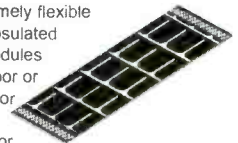

CAT # SPL-314 \$4⁵⁰ each
 3 Volts @ 19 mA 4.5" x 1.44"

CAT # SPL-328 \$8⁵⁰ each
 3 Volts @ 38 mA 4.5" x 2.88"

Great Price! 60 Watt Switching Power Supply

Autec # UPS61-1004-T

Input: 115/230 Vac

Outputs: 3.3V @

4A, 5 V @ 2A,

12V @ 3A, 32V @ 5 mA.

New, open-frame switching supply. 5" x 3.46" x 1.68"

"Panasonic-type" two conductor receptacle for AC input, can be hardwired if desired. Fused input. 10 conductor molex-type plug output. Ferrite bead for EMI suppression on output wires. Large quantity available

CAT # PS-70

\$4⁵⁰ each

case of 48 pieces for \$3.50 each

Piezo Alarm

Audible piezo alarm emits a solid, high-pitched tone of low to medium loudness. Operates on 3-15 Vdc. 0.54" diameter x 0.3" PC leads on 0.3" centers.

CAT# SBZ-412

\$1²⁵ each

100 for 85¢ each
 500 for 75¢ each



ORDER TOLL FREE

1-800-826-5432

CHARGE ORDERS to Visa, Mastercard, American Express or Discover

TERMS: NO MINIMUM ORDER. Shipping and handling for the 48 continental U.S.A. \$6.00 per order. All others including AK, HI, PR or Canada must pay full shipping. All orders delivered in CALIFORNIA must include local state sales tax. Quantities Limited. NO COD. Prices subject to change without notice.

CALL, WRITE FAX or E-MAIL for our **FREE**

96 Page CATALOG
 Outside the U.S.A. send \$3.00 postage.

MAIL ORDERS TO:
ALL ELECTRONICS CORPORATION
 P.O. Box 567
 Van Nuys, CA 91408
FAX (818)781-2653

e-mail allcorp@allcorp.com

CLASSIFIEDS

BUSINESS OPPORTUNITIES

\$400 WEEKLY ASSEMBLING Electronic Circuit Boards/Products From Home. For Free Information Send SASE: Home Assembly-PT Box 216 New Britain, CT 06050-0216

EASY WORK! EXCELLENT PAY! Assemble Products At Home. Call Toll Free 1-800-467-5566 EXT. 1190

CABLE TV

DISCOVER CABLE'S NEWEST BOXES! "DESCRAMBLES WHERE OTHERS FAIL" **LOWEST DEALER PRICES GUARANTEED.** 1-888-777-9123 1-888-675-3687

MISC. ELECTRONICS FOR SALE

T&M ELECTRONICS. Large variety of electronic parts since 1966. Visit our Web site at www.tandmelectronics.com

PLANS-KITS-SCHEMATICS

Carl's Electronics - Hundreds of electronic kits, plus the latest in spy and surveillance. www.electronickits.com

SATELLITE

FREE Satellite TV Buyer's Guide. BIG Dishes - BIG Deals! Get the MOST free and subscription channels with C-band digital upgrade! **SKYVISION.** 800-543-3025. International 218-739-5231. www.skyvision.com

Poptronics®

Interactive Edition

Projects...Courses...Articles...& more

Read it on the WEB!

- An e-magazine for everyone who loves electronics.
- Aimed at teaching electronics from the beginning with courses, tests and interactive questions to guarantee your success.
- Interesting articles and related items.
- Contains projects that can be ordered directly from the page, by simply clicking a button.

www.poptronics.com/interactive

Gernsback Publications, Inc.

275-G Marcus Blvd. Hauppauge NY 11788

POPTRONICS®

CLASSIFIED ADVERTISING ORDER FORM

Advertiser Information

Name _____
 Company _____
 Street Address _____
 City/State/Zip _____
 Telephone () _____
 Signature (required on all orders) _____

Payment Information

Charge my: _____
 Master Card Visa Discover
 Account No. _____
 Exp. Date _____
 Full payment enclosed. Prepayment discounts offered for multiple insertions (except on credit card orders).
 Payment for first insertion enclose; additional payments will be made prior to closing dates. Prepayment discounts not available.

Do you want any special options? (where available)

- Boldface Type* Add 25% for entire ad Screened Background - Add 30%
 Special Heading - Add \$35.00

The first word of your ad and your name will be printed in boldface caps, at no additional charge. For individual boldface words, add .50c each.

In what month(s) would you like your ad to run?

- Entire year for publications selected above.
 Jan. Feb. Mar. Apr. May. June July Aug. Sep. Oct. Nov. Dec.

Here's how to calculate the cost of your Regular or Expanded-Ad Classified:

Rate X Numbers of Words + Rate for Boldface + Rate for Screened Background = Cost per Insertion X Number of Months = Cost

Magazine	Rate	x	Number of Words (min. 15)	+ Boldface (add 25%)	+ Screened Background (add 30%)	=	Cost Per Insertion	x	Number of Months	=	Cost
		x		+	+	=		x	=		

Rates:

\$3.00 per word (New rate for renewals. New advertisers welcome.)
 Minimum 15 Words

Here's how to calculate the total cost of your advertising:

Prepayment Discount: _____ Subtotal _____
 (Full payment must accompany order, not applicable on credit card orders) Less Prepayment Discount _____
 Prepay for 6 insertions in one magazine, 5% 12 insertions in one magazine, 10% TOTAL COST \$ _____

Please use a separate piece of paper to write your copy, or for any special instructions you may have.

HAVE A QUESTION? CALL: 1-631-592-6720 ext. 206

Fax signed orders with credit card information to : (631) 592-6723

GPI895

ADVERTISING INDEX

Poptronics does not assume any responsibility for errors that may appear in the index below.

Free Information Number	Page	Free Information Number	Page
- Abacom68	- M ² L Electronics70
- Alan Broadband Co.77	324 MCM Electronics	CV2
- All Electronics78	323 Mendelsons63
- Amazon Electronics77	296 Merrimack Valley71
- Arrow Technologies63	- microEngineering Labs77
- Basic Micro Inc.76, 77	- Modern Electronics78
- Blue Bell Design, Inc.76	- North Country Radio64
290 C&S Sales, Inc.67	- PAiA Electronics76
283 CadSoft, Inc.9	275 Parts Express	CV4
233 Circuit Specialists75	- Pioneer Hill Software78
- CLAGGK, Inc.	CV3	228 Polaris Industries61
- Classified Ads79	- Poptronics Reprint Bookstore60
320 Cleveland Inst. of Electronics	.62, 74	219 Prairie Digital68
321 Command Productions72	- Progressive Concepts70
- Conitec Data Systems70	263 Ramsey Electronics69
- Consumertronics77	- Scott Edwards Electronics66
- ECD/PCB77	- Scrambling News76
- EDE Spy Outlet77	- Smarthome.com66
- Elect. Tech. Today16	- Square 1 Electronics66, 76
- Electronix78	- Techniks76
206 Electronix Express73	- Technological Arts70
- EMAC, Inc.64	322 Test Equipment Depot73
- Engineering Express72	- Test Supply Inc.63
220 Information Unlimited68	- Timeline, Inc.63
- Intec Automation77	- Toroid Corporation66
- Intelligence Here76	- UCANDO Videos64
- Intronics72	- Vision Electronics70
- IVEX Design65	- Walter Malecki76
- I.T Sound78	- World Wyde76, 77
- Lynxmotion66		

ADVERTISING SALES OFFICES

Gernsback Publications, Inc.
275-G Marcus Blvd.
Hauppauge, NY 11788
Tel. 631-592-6720
Fax: 631-592-6723

Larry Steckler
 Publisher (ext. 201)
 e-mail: advertising@gernsback.com

Adria Coren
 Vice-President (ext. 208)

Ken Coren
 Vice-President (ext. 267)

Marie Falcon
 Advertising Director (ext. 206)

Adria Coren
 Credit Manager (ext. 208)

For Advertising ONLY EAST/SOUTHEAST

Marie Falcon
 275-G Marcus Blvd.
 Hauppauge, NY 11788
 Tel. 631-592-6720 x206
 Fax: 631-592-6723
 e-mail: mlfalcon@gernsback.com

MIDWEST/Texas/Arkansas/ Oklahoma

Ralph Bergen
 One Northfield Plaza, Suite 300
 Northfield, IL 60093-1214
 Tel. 847-559-0555
 Fax: 847-559-0562
 e-mail: bergenrj@aol.com

PACIFIC COAST

Megan Mitchell
 9072 Lawton Pine Avenue
 Las Vegas, NV 89129-7044
 Tel. 702-240-0184
 Fax: 702-838-6924
 e-mail: mmitchell@gernsback.com

**Subscription/
Customer Service/
Order Entry**
 Tel. 800-827-0383
 7:30 AM - 8:30 PM CST

www.poptronics.com

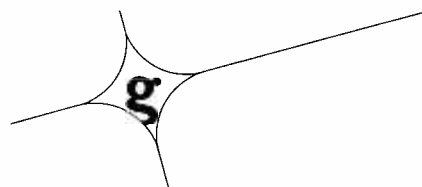

**When you buy products from
these advertisers, please tell
them you saw their ads in
Poptronics® magazine.**

Electronics CD ROMs



This great range of CD ROM learning resources will teach you all about electronic circuits and systems and how to design them.

Electronic Circuits and Components V2 provides an introduction to the principles and application of the most common types of electronic components and how they are used to form complete circuits. Sections on the disc include: fundamental electronic theory, active components, passive components, analogue circuits, digital circuits, fault finding and the Parts Gallery.

Digital Electronics V2 details the principles and practice of digital electronics, including logic gates, combinational and sequential logic circuits, clocks, counters, shift registers, fault finding and displays. The CD ROM also provides an introduction to microprocessor based systems.

Analog Electronics is a complete learning resource for this most difficult subject. The CD ROM includes the usual wealth of virtual laboratories as well as an electronic circuit simulator with over 50 pre-designed analog circuits which gives you the ultimate learning tool. The CD provides comprehensive coverage of analog fundamentals, transistor circuit design, op-amps, filters, oscillators, and other analog systems.

Electronic Projects is just that: a series of ten projects for students to build with all support information. The CD is designed to provide a set of projects which will complement students' work on the other 3 CDs in the Electronics Education Series. Each project on the CD is supplied with schematic diagrams, circuit and PCB layout files, component lists and comprehensive circuit explanations.

Robotics and Mechatronics is designed to enable those with little previous experience of electronics to build electromechanical systems. The CD ROM deals with all aspects of robotics from the control systems used, the transducers available, motors/actuators and the circuits to drive them. Full case study material (include the NASA Mars Rover, the Milford spider and the Furby) is used to show students how practical robotic systems are designed.

Digital Works is a highly interactive scalable digital logic simulator designed to allow electronics and computer science students to build complex digital logic circuits incorporating circuit macros, 4000 and 74 series logic.

CADPACK includes software for schematic capture, circuit simulation, and PCB design and is capable of producing industrial quality schematics and circuit board layouts. CADPACK includes unique circuit design and animation/simulation that will help your students understand the basic operation of many circuits.

Analog Filters is a complete course in filter design and synthesis and contains expert systems to assist in designing active and passive filters.

PICmicro programming tools and CD ROMs

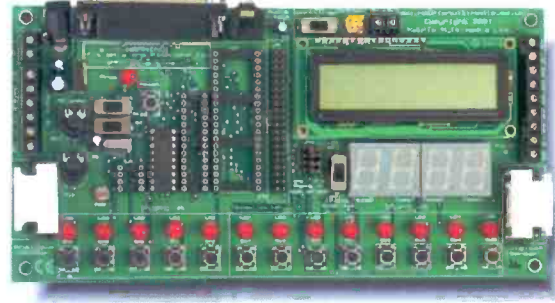

This flexible development board allows you to program 8, 18, 28, 40 pin PICmicro microcontrollers as well as test/develop code. All programming software is included and several resources which allow students to learn and program PICmicro microcontrollers are available - Flowcode, C for PICmicro microcontrollers and Assembly for PICmicro microcontrollers. A board is needed for the CD's below:



Flowcode is a very high level language programming system for PICmicro® microcontrollers based on flowcharts. Flowcode is a powerful language that uses macros to facilitate the control of complex devices like 7-segment displays, motor controllers, and LCD displays. The use of macros allows students to control highly complex electronic devices without getting bogged down in understanding the programming involved. Board not included.



The **Assembly for PICmicro microcontrollers** CD ROM (previously known as PICtutor) contains a complete course in programming the PIC16F84 microcontroller from Arizona Microchip. The CD includes a full suite of tutorials starting at basic concepts and progressing complex techniques including interrupts. An IDE and all programming tools are included. Board not included.



The **C for PICmicro® microcontrollers** CD ROM is designed for students and professionals who need to learn how to program embedded microcontrollers in C. C for PICmicro MCUs also provides all the tools needed actually program a virtually any PICmicro - including a full C compiler and device programmer (via printer port). Although the course focuses on the use of the PICmicro® series of microcontrollers this CD ROM will provide a relevant background in C programming for any microcontroller. Board not included.

Order Form

Please allow 6 weeks delivery.

	Student / home version	Institution version
Electronic Cts. & Comps.	\$50	\$99
Digital Electronics 2	\$50	\$99
Analog Electronics	\$50	\$99
Electronic Projects	\$75	\$159
Robotics and Mechatronics	\$50	\$99
Digital Works	\$50	\$99
CADPACK	\$75	\$159
Analog Filters	\$75	\$159
Assembly for PICmicro	\$50	\$159
C for PICmicro	\$50	\$159
Flowcode for PICmicro	\$50	\$99
PICmicro development board	\$159	
Postage - USA	\$5	\$5
Postage - Canada	\$10	\$10

Name: _____

Address: _____

Zip: _____ Phone: _____

Card Type: _____

Mastercard, Visa, or Discover only

Card number:

I have enclosed my check for \$: _____

Signature: _____

Please charge my credit card for \$: _____

Phone your order to us on:

631-592-6721

or send your order to:

CLAGGK Inc.,
PO Box 12162,
Hauppauge, NY 11788

Expire date: _____

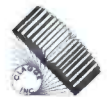

Note: Institution versions have increased functionality, increased assessment and are licensed for use in schools and corporations.

CL02

Order online NOW from: www.poptronics.com

PARTS EXPRESS

ELECTRONICS & MORE
www.partsexpress.com

YOUR #1 SOURCE FOR AUDIO, VIDEO AND SPEAKER BUILDING COMPONENTS

FREE
316 PAGE
CATALOG



Dayton Loudspeaker Co.® BR-1 2-Way Monitor System Kit

This high end 2-Way Monitor is based on our popular 1-1/8" Silk Dome Tweeter (#275-070) and 6-1/2" Woofer (#295-305). It was designed to provide a low cost, easy to build 2-Way system for the speaker building novice. The end result is a kit that can be built in a couple of hours and that has a sound that will rival systems costing two or three times its modest price! Overall, the system is smooth and detailed, with a wide soundstage that belies their smallish size. The tonal balance is on the warm side of neutral, which is pleasing with most types of music. The bass is also impressive for a system of this size. If you need more bass, we recommend using the #300-630 10" subwoofer to create a matching satellite/subwoofer combination. The cabinets are made of 5/8" MDF finished in an unobtrusive "black ash" vinyl laminate and include grills with black cloth. All driver holes are precision cut with a CNC for a perfect fit. The tweeter is flush mounted to reduce diffraction effects. *Note: This system is offered in kit form and can be assembled in about 2 hours. The crossover needs to be assembled so soldering skills are necessary. We've included a tutorial that thoroughly explains the theory and design process making this kit perfect for educational programs. Each kit includes everything needed to build 1 pair of speakers.*

System Specification: ◆Frequency response: 43-18,000Hz ◆SPL: 85dB 2.83V/1m ◆Power handling: 100 watts max ◆Cabinet dimensions: 14-1/4" H x 8-5/8" W x 11" D ◆Net system weight: 35 lbs.



#300-640

250 Watt Subwoofer Amplifier With Remote Control

This high performance subwoofer amplifier allows you to adjust the volume and crossover frequency from the comfort of your favorite chair!

- Features:** ◆IR Remote Control ◆Remote mountable control panel ◆High power Class AB amplifier ◆Phase switch ◆Gold plated connectors ◆High pass filter for satellite speakers ◆Line Level Outputs ◆Auto On/Off

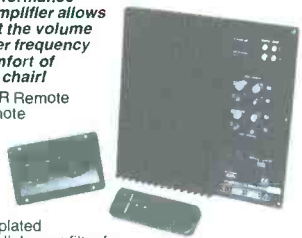

#300-793 \$148⁶⁵ (1-3) **\$137⁹⁰** (4-UP)

Dayton Loudspeaker Co.® 6-1/6" Treated Paper Cone Woofer

- ◆ ASV voice coil
- ◆ Vented pole piece
- ◆ Rubber surround

Specifications: ◆Power handling: 50 watts RMS/75 watts max ◆Voice coil diameter: 1-3/8" ◆Voice coil inductance: 1.40 mH ◆Impedance: 8 ohms ◆DC resistance: 6.0 ohms ◆Frequency response: 33-4,000 Hz ◆Magnet weight: 15 oz. ◆Fs: 33 Hz ◆SPL: 88 dB 1W/1m ◆Vas: .98 cu. ft. ◆Qms: 2.75 ◆Qes: .37 ◆Qts: .33 ◆Xmax: 3.15mm ◆Net weight: 3 lbs.



#295-305 \$16⁸⁵ (1-3) **\$15²⁰** (4-UP)

3-1/4" Piezo Tweeter

- ◆Power handling: 50 watts RMS/75 watts max
- ◆Frequency response: 3,500-27,000 Hz
- ◆SPL: 94 dB



#270-011 \$1.25 (1-3) **95¢** (4-UP)

5" Ultra-Thin TFT-LCD Video Module

Complete color video display makes great personal rear seat TV screens. Works on a standard composite video signal from any VCR, video camera, or navigation system. Features high resolution, speedy response time, no radiation, low power consumption (less than 750mA), and wide view angle.



#205-013 \$128⁷⁷ (1-3) **\$119⁵⁵** (4-UP)

4" LCD Video Module

- ◆ High resolution
- ◆ 4" LCD flat screen color display module
- ◆ Works on a standard composite video signal from any VCR, video camera, video game or navigation system
- ◆ Ideal for mounting in seat backs or custom built enclosures



#205-050 \$99²⁵ (1-3) **\$89⁵⁰** (4-UP)

Speaker Surround Repair Kits

Don't throw away expensive loudspeakers just because the foam surround has dry rotted or has been punctured. With these new repair kits from Parts Express, you can save BIG bucks by repairing the foam surround and avoid costly loudspeaker replacements. Each kit contains supplies to repair two speakers and includes foam surrounds, plastic shims, four dust caps (two paper, two poly), a plastic bottle filled with 1 oz. of adhesive, 5 foam swabs for application of glue, and complete repair instructions.

Part #	Size	Price (1-3)	Price (4-UP)
260-915	6-1/2" kit	\$19.50	\$17.90
260-920	8" kit	21.90	18.95
260-925	10" kit	22.50	19.50
260-930	12" kit	23.90	20.50
260-935	15" kit	24.50	21.50
340-076	1 oz. bottle of speaker glue	5.95	5.25

6-1/2" Ceiling Speaker System

Don't let the low cost fool you! These great sounding ceiling speakers are ideal for adding music to the kitchen, den, bath, or patio! They feature a weather resistant 6-1/2" carbon fiber cone with a butyl rubber surround and a coaxial mounted 1" mylar dome tweeter. Perfect for high moisture environments. Retrofit design allows installation in both new and existing construction in just minutes. System includes removable steel mesh grills, built-in mounting brackets, hardware, and installation instructions. **Specifications:** ◆Impedance: 8 ohms ◆Frequency response: 60-20,000 Hz ◆Power handling capability: 30 watts RMS/45 watts max ◆Sensitivity: 89 dB 1W/1m ◆Overall dimensions: 8-1/2" round x 2-3/4" deep ◆Net weight: 5 lbs. per pair.



#300-402 \$39⁸⁰ (1-3 PRS) **\$35⁵⁰** (4 PRS-UP)

Color Video Camera With Audio

- ◆ Single chip 1/3" format camera
- ◆ 310 TV line resolution
- ◆ Built-in audio
- ◆ Focusable lens
- ◆ Automatic gain control
- ◆ Auto white balance



Specifications: ◆Resolution: 310 TV lines ◆Pick-Up device: 1/3" CMOS ◆Light sensitivity: 10 lux ◆Lens: 4.3mm ◆S/N Ratio: >38dB ◆Power: 8-12VDC, 30mA (9VDC adaptor included).

#335-485 \$89⁶⁰ (1-3) **\$82⁴⁵** (4-UP)

10" Powered Subwoofer

Perfect for small to medium size home theatre or listening rooms.

- ◆ MDF cabinet finished in "Black Ash" vinyl veneer
- ◆ 10" long throw driver
- ◆ 100W amplifier
- ◆ Gold plated inputs
- ◆ Frequency response: 30-160 Hz
- ◆ Exterior dimensions: 13-3/4" W x 16-1/4" H x 14-1/2" D
- ◆ Net weight: 35 lbs.



#300-630 \$99⁸⁰ EACH

DETAILED
EASY TO FOLLOW
INSTRUCTIONS!



Note: The speaker surround kit sizes are based on the diameter of the speaker's frame, not the diameter of the cone. For example, if your speaker frame measures 10" - 10-1/2" in diameter, you would need the 10" Surround Repair Kit.

LARGEST SELECTION OF SPEAKER DRIVERS IN THE COUNTRY!

Visit Us On The Web At
www.partsexpress.com
Or Call Toll Free
1-800-338-0531

725 Pleasant Valley Dr., Springboro, OH 45066-1158 KEY CODE: POM
Phone: 937-743-3000 ◆ FAX: 937-743-1677 ◆ E-Mail: sales@partsexpress.com

CIRCLE 275 ON FREE INFORMATION CARD