

BUILD A TV TRANSMITTER

www.poptronics.com

FEBRUARY 2002

Poptronics®

Formerly Popular Electronics® and **Electronics NOW**

BASIC
Downloadable Circuits
see page 55
CIRCUITRY

THE ATV MKII

Build an amateur 2-watt TV transmitter that fits in the palm of your hand

Hugo Gernsback

Remembering our multi-talented founder

Also Inside:

- Electronic Film
- Power Supplies
- Cyber Safety Tips
- Infrared Shooting-Gallery Targets
- HDTV Soon To Be Standard



#BXBDCC *****5-DIGIT 21046
#21046DHM351RD007# PT
ROBERT DAHM P54
9515 RED RAIN PATH MAY 2002
COLUMBIA MD 21046-2073



\$5.99 U.S.
\$6.99 CAN.

PARTS EXPRESS

ELECTRONICS & MORE
www.partsexpress.com



120 Watt Subwoofer Amplifier

Rated power output: 120 watts RMS into 4 ohms at 1% THD. Measured power output: 110 watts RMS into 8 ohms @ 0.1% THD, 156 watts RMS into 4 ohms @ 0.2% THD. Bass boost: 5dB @ 35Hz. Signal to noise ratio: 98dB (A-weighted). Dimensions: 8-1/4" W x 10-5/8" H x 4" D. Enclosure cut out: 7-1/4" W x 9-5/8" H. Voltage: 50-60Hz, 335W.

#300-792 **\$99⁹⁵** EACH

Sound Deadening Sheets

This multi-purpose, noise reduction material actually absorbs the vibration of any solid material. You can reduce interior noise levels 3-10 dB by applying the damping sheets to the door panels, firewall, floor pan, trunk lid or any interior sheet metal panel.



Part #	Sheet Dimensions	Price (1-3)	Price (4-UP)
268-010	10" x 10"	\$1.35	\$1.28
268-015	29" x 32"	11.50	9.95
268-020	32" x 54"	17.90	16.50

Woofers

6-1/2" Woofer

◆ Power handling: 50 watts RMS/75 watts max ◆ Frequency response: 60-3,000 Hz ◆ SPL: 86 dB 1W/1m

#290-300 (4 ohm) **\$11⁷⁰** EACH

8" Woofer

◆ Power handling: 50 watts RMS/75 watts max ◆ Frequency response: 60-2,500 Hz ◆ SPL: 87.5 dB 1W/1m

#290-310 (4 ohm) **\$12⁹⁵** EACH

10" Woofer

◆ Power handling: 70 watts RMS/100 watts max ◆ Frequency response: 40-2,200 Hz ◆ SPL: 87.4 dB 1W/1m

#290-320 (4 ohm) **\$15⁹⁵** EACH

12" Woofer

◆ Power handling: 70 watts RMS/100 watts max ◆ Frequency response: 35-1,500 Hz ◆ SPL: 88.6 dB 1W/1m

#290-330 (4 ohm) **\$18⁹⁵** EACH

15" Woofer

◆ Power handling: 80 watts RMS/115 watts max ◆ Frequency response: 27-1,200 Hz ◆ SPL: 86 dB 1W/1m

#290-340 (4 ohm) **\$27⁹⁵** EACH

YOUR #1 SOURCE FOR AUDIO, VIDEO AND SPEAKER BUILDING COMPONENTS

Piezo Tweeters AS LOW AS **95c** EACH

3-1/4" Piezo Tweeter

◆ Similar to KSN1005
◆ Power handling: 50 watts RMS/75 watts max
◆ Frequency response: 3,500-27,000 Hz ◆ SPL: 94 dB

#270-011 **\$1.25** (1-3) **95c** (4-UP)

2" x 5" Piezo Horn

◆ Similar to KSN1016
◆ Power handling: 50 watts RMS/75 watts max
◆ Frequency response: 3,500-27,000 Hz ◆ SPL: 94 dB

#270-041 **\$1.25** (1-3) **95c** (4-UP)

Piezo Horn Mid/Tweeter

◆ Similar to KSN1025
◆ Power handling: 60 watts RMS/75 watts max
◆ Frequency response: 1,800-30,000 Hz ◆ SPL: 90 dB

#280-062 **\$1.60** (1-3) **\$1.35** (4-UP)

JBL 12 Watt Stereo Amp Board

Dimensions: 4-1/2" L x 3-1/4" W x 2-1/8" H. Comes with hook-up diagram. Limited availability.

#329-030 **\$9⁹⁵** EACH

6-1/2" Two-Way System

Great for front or rear speakers in your surround system. The 6-1/2" poly-propylene woofer and 1" textile dome tweeter were specially designed with home theatre in mind.

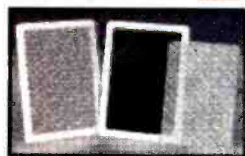

#300-036 **\$59⁹⁵** PAIR

Speaker Surround Repair Kits

Don't throw away expensive loudspeakers just because the foam surround has dry rotted or has been punctured. With these new repair kits from Parts Express, you can save BIG bucks by repairing the foam surround and avoid costly loudspeaker replacements. Each kit contains supplies to repair two speakers and includes foam surrounds, plastic shims, four dust caps (two paper, two poly), a plastic bottle filled with 1 oz. of adhesive, 5 foam swabs for application of glue, and complete repair instructions.

Part #	Size	Price (1-3)	Price (4-UP)
260-915	6-1/2" kit	\$19.50	\$17.50
260-920	8" kit	21.00	18.95
260-925	10" kit	22.50	19.50
260-930	12" kit	23.00	20.00
260-935	15" kit	24.50	21.00
340-076	1 oz. bottle of speaker glue	5.95	5.25

FREE 308 PAGE CATALOG



Car Amplifier Power Stiffening Capacitors

Capacitors can be wired in parallel to increase value. One year manufacturer warranty.

Specifications: ◆ 20 VDC/24 VDC surge ◆ ESR: < .0015 ohms ◆ Tolerance: 10%/50% ◆ Temperature range: -40°C to 95°C



Part #	Value	Dimensions (Dia. x Height)	Price
Standard Power Capacitors			
268-450	1.0 Farad	3" x 8-5/8"	\$89.95
268-455	1.5 Farad	3-1/2" x 8-5/8"	\$99.90
268-460	2.0 Farad	3-1/2" x 9-5/8"	138.90
Digital Display Power Capacitors			
268-470	1.0 Farad	3" x 10-1/4"	99.90
268-475	1.5 Farad	3-1/2" x 10-1/4"	138.90
268-480	2.0 Farad	3-1/2" x 10-1/4"	174.90

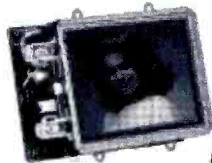

4" LCD Video Module

Customize your mobile sound system by adding video!

- ◆ High resolution
- ◆ 4" LCD flat screen color display module
- ◆ Works on a standard composite video signal
- ◆ Ideal for mounting in seat backs or custom built enclosures

Specifications: ◆ 12 VDC, 500mA ◆ Resolution (dots): 383 (Hor.) x 234 (Ver.) = 89,822 ◆ Overall dimensions (mm): 118 W x 85 H x 40 D ◆ Active area (mm): 82 W x 60 H ◆ Controls for brightness, color and tint ◆ Net weight: 3/4 lb.

#205-050 **\$99⁹⁰** EACH

DETAILED EASY TO FOLLOW INSTRUCTIONS!



Note: The speaker surround kit sizes are based on the diameter of the speaker's frame, not the diameter of the cone. For example, if your speaker frame measures 10"-10-1/2" in diameter, you would need the 10" Surround Repair Kit.

LARGEST SELECTION OF SPEAKER DRIVERS IN THE COUNTRY!

Visit Us On The Web At www.partsexpress.com
Or Call Toll Free **1-800-338-0531**

725 Pleasant Valley Dr., Springboro, OH 45066-1158 KEY CODE: POM
Phone: 513-743-3000 ◆ FAX: 513-743-1677 ◆ E-Mail: sales@partsexpress.com

CIRCLE 275 ON FREE INFORMATION CARD

Poptronics®

THE MAGAZINE FOR THE HANDS-ON ELECTRONICS ACTIVIST!

FEATURES

The ATV MKII	<i>William Sheets and Rudolf F. Graf</i>	31
<i>Learn how to build an amateur 2-watt TV-transmitter that fits in the palm of your hand.</i>		
HUGO GERNSBACK: INVENTOR, PROPHET, AND FATHER OF SCIENCE FICTION	<i>Maria Orlando</i>	23
<i>Remembering the life and accomplishments of our multi-faceted founder.</i>		
TRANSISTOR TESTER	<i>Paul Florian</i>	43
<i>This circuit will take the mystery out of testing bi-polar transistors.</i>		

PRODUCT REVIEWS

GIZMO®		7
<i>This month learn about CHAD, progressive scanners, and a whole lot more.</i>		

DEPARTMENTS

PROTOTYPE		10
<i>Get the latest news concerning electronic film, audio paper clips, and environmentally friendly commuter cars.</i>		
ALL ABOUT	<i>William Sheets and Rudolf F. Graf</i>	14
<i>This month marks the debut of this column. We start with power supplies.</i>		
SURVEYING THE DIGITAL DOMAIN	<i>Reid Goldsborough</i>	16
<i>Stay safe and protect your virtual reputation from the denizens of the Web.</i>		
PEAK COMPUTING	<i>Ted Needleman</i>	19
<i>Is your video card up to snuff? Read about the latest 3-D benchmarks.</i>		
TECHNOSCOPE	<i>Elizabeth Jamison</i>	21
<i>It looks as if there is no escape from HDTV. Brush up on some digital TV terms.</i>		
Q&A	<i>Dean Huster</i>	47
<i>Have a question? Our tech correspondent, Dean, will do his best to help you.</i>		
SERVICE CLINIC	<i>Sam Goldwasser</i>	51
<i>Read up on SMPS and find out how it can be used in your own projects.</i>		
BASIC CIRCUITRY	<i>Charles Rakes</i>	55
<i>Putting the finishing touches on an electronics shooting gallery.</i>		
AND MORE		
EDITORIAL2
LETTERS3
NEW GEAR5
NEW LITERATURE27
POPTRONICS SHOPPER59
ADVERTISING INDEX80
FREE INFORMATION CARD80A

Poptronics (ISSN 1526-3681) Published monthly by Gernsback Publications, Inc. 275-G Marcus Blvd., Hauppauge, NY 11788. Second-Class postage paid at Hauppauge, NY and at additional mailing offices. One-year, twelve issues, subscription rate U.S. and possessions \$24.99, Canada \$33.15 (includes G.S.T. Canadian Goods and Services Tax Registration No. R125166280), all other countries \$33.99. Subscription orders payable in U.S. funds only, International Postal Money Order or check drawn on a U.S. bank. U.S. single copy price \$4.99. Copyright 2001 by Gernsback Publications, Inc. All rights reserved. Hands-on Electronics and Gizmo trademarks are registered in U.S. and Canada by Gernsback Publications, Inc. Poptronics trademark is registered in U.S. and Canada by Poptronix, Inc. and is licensed to Gernsback Publications, Inc. Printed in U.S.A. Postmaster: Please send address changes to Poptronics, Subscription Dept., P.O. Box 459, Mount Morris, IL 61054-7629

A stamped self-addressed envelope must accompany all submitted manuscripts and/or artwork or photographs if their return is desired should they be rejected. We disclaim any responsibility for the loss or damage of manuscripts and/or artwork or photographs while in our possession or otherwise.

As a service to readers, Poptronics publishes available plans or information relating to newsworthy products, techniques, and scientific and technological developments. Because of possible variances in the quality and condition of materials and workmanship used by readers, Poptronics disclaims any responsibility for the safe and proper functioning of reader-built projects based upon or from plans or information published in this magazine.

Poptronics®

Larry Steckler, EHF, CET,
editor-in-chief and publisher

EDITORIAL DEPARTMENT

Chris La Morte, managing editor
Evelyn Rose, assistant editor
Maria Orlando, assistant editor

CONTRIBUTING EDITORS

Reid Goldsborough
Sam Goldwasser
Rudolf F. Graf, KA2CWL
Dean Huster
John Iovine
Elizabeth Jamison
Ted Needleman
Charles D. Rakes
Scott M. Savage
Teri Scaduto
William Sheets, K2MQJ

PRODUCTION DEPARTMENT

Ken Coren, production director
Kathy Campbell, production manager
Michele L. Musé, prepress specialist

ART DEPARTMENT

Russell C. Truelson, art director
Michele L. Musé, graphic artist

CIRCULATION DEPARTMENT

Gina Giuliano, circulation manager

REPRINT DEPARTMENT

Maria Menichetti, Reprint Bookstore x235

BUSINESS AND EDITORIAL OFFICES

Gernsback Publications, Inc.
275-G Marcus Blvd.
Hauppauge, NY 11788
631-592-6720
Fax: 631-592-6723

President: Larry Steckler
Vice-President: Adria Coren
Vice-President: Ken Coren

SUBSCRIPTION CUSTOMER SERVICE/ ORDER ENTRY

800-827-0383
7:30 AM - 8:30 PM EST

Advertising Sales Offices
listed on page 82

Cover by
Michele Lyn Musé

Cover Photo by
Aerial Images - www.skyeyephoto.com

VISIT US ON THE INTERNET AT:
www.gernsback.com
or www.poptronics.com

Since some of the equipment and circuitry described in POPTRONICS may relate to or be covered by U.S. patents, POPTRONICS disclaims any liability for the infringement of such patents by the making, using, or selling of such equipment or circuitry, and suggests that anyone interested in such projects consult a patent attorney.

Don't Believe the Hype

Inventor Dean Kamen, who is famous for medical inventions including a heart stent, has revealed his latest invention—the Segway. This battery-powered scooter is capable of traveling 17 mph and even employs a gyroscopic system for preventing road rash for its pilots. Well now, that is all well and good. No doubt the Segway is a quaint little toy for jetting around town, but investors have dared to say that this device will be “bigger than the Internet.” Oh please, stop! Kamen himself says that the Segway will be to cars what the car was to horse and buggies. It's amazing what money can do for a product. A couple of dollars well placed at a PR firm is worth more than a team of scientists—or is it?

Meanwhile, at Bell Labs/Lucent Technologies, further research is being pursued in the area of nanotechnology. Scientists have created organic transistors that assemble themselves in jars through a process known as *chemical self-assembly*. These transistors are twenty times smaller than the smallest existing components. In fact, the space between the three electrodes measures only one nanometer. What this means to the consumer is smaller, faster CPUs (with processing speeds in the lower microwave region) and possible merging of electronic circuits and organic material.

Now call me silly (as many of you have in the past), but I think the invention of microscopic transistors is a tad greater in significance than the latest scooter to roll off the assembly line. Time alone will tell if Kamen's scooter will totally revolutionize our lives. My guess is the machine will find its niche among pogo sticks and roller blades, but I don't see a Nobel Prize being awarded any time soon. On the other hand, I offer kudos to Kamen the inventor. There can be no denying the fact that he is a prolific creator of practical, and at times, life-saving inventions.

Speaking of inventing and creating...this month we introduce another fine column for our readers—*All About...* Authors William Sheets and Rudolf F. Graf debut with *All About Power Supplies*. Each installment will tell you *All About* specific electronic topics that will help you truly appreciate what a wonderful hobby electronics can be. Read on and enjoy.

Yours truly,



Chris La Morte
Managing Editor



The following three letters comment further on the article "Radio Signals and the Great Pyramid" in the September 2001 issue.—
Editor

Radio Signals and the Great Pyramid

I was disappointed to see that so many of your readers are so close-minded. I personally enjoyed the above-mentioned article, and I would like to see more along those same lines. Surely I can't be the only one who appreciated it!

I guess these are the same people that would have told Galileo that he was crazy for stating the world wasn't flat.
DEREK TOMBRELLO
via e-mail

The Magic Of Electronics . . . and the Great Pyramid

I am happy to have started my subscription, and I regret having missed what I am sure were many interesting issues of your magazine. While I did not read the article about the Great Pyramid, I gathered from the letters that many readers who are fixed in their ideas feel that further thought is only misdirected energy.

Such stymied thinking would have kept us in the world of thermionic tubes and selenium rectifiers. From the quartz crystal to the silicon transistor, technology has brought us products that could hardly be dreamed of fifty years ago. I do not pretend to know the purpose of the pyramids, but it seems strange that the greatest, Cheops, has no hieroglyphics in the interior.

Why would a **Poptronics** subscriber be interested in Egyptology? Would it be better to ask why a philosopher wonders about the universe?

The letters you published reflect the thoughts of those who never question what is accepted as known. Maxwell took apart a few equations and showed us things about electronics and magnetism. Einstein used Newton's physics to reveal a universe that we still explore. If

the world of the electronics engineer is a closed universe, I do not wish to be there. I became interested in electronics because it was magic. If it ever becomes less than that, I will find something more interesting.

D. LLOYD GELLER
Dunnellon, FL

Alas, A Commendation for the Great Pyramid

Regarding the apparent ongoing debate over your pyramid article, let me say that while I was only able to read about half of it before I gave up, I commend your courage in trying something different—unlike many who wrote to complain. Please do not stop. Whether an article is fiction, non-fiction, or something totally off-the-wall, this is what makes your magazine interesting and makes one want to see what the next issue will hold.

KEEP IN TOUCH

We appreciate letters from our readers. Comments, suggestions, questions, bouquets, or brickbats . . . we want to hear from you and find out what you like and what you dislike. If there are projects you want to see or articles you want to submit—we want to know about them.

You can write via snail mail to:

Letters
Poptronics
275-G Marcus Blvd.
Hauppauge, NY 11788

Sending letters to our subscription address increases the time it takes to respond to your letters, as the mail is forwarded to our editorial offices.

Our e-mail address can be found at the top of the column.

Of course, e-mail is fast.

All of our columnists can be reached through the e-mail addresses at the head of each column.

And don't forget to visit our Web site: www.gernsback.com.

To those readers that say an article like this has no value, I suggest that they try to keep a more open mind. Maybe not so open that their brains fall out, but open enough to realize that even the most absurd concept could provide the inspiration for someone else to come up with a really practical idea.

When it comes to prejudging an idea, it is my opinion that the two most close-minded groups in society are fundamental religious fanatics and scientists. Both groups are convinced that they and only they have all of the answers and know all that is to be known, and anything outside their sphere of knowledge is not worth considering.

RICHARD GIDEON
Schaumburg, IL

A Stand-Alone Direct-Digital Signal Synthesizer

One article I would like to see in **Poptronics** is a stand-alone direct digital signal synthesizer, particularly for use in the frequency range of 5 to 6 MHz, with steps of one Hz. It should be a stand-alone system—without the need to use a desktop computer, etc. Preferably, it should have a rotary shaft-encoder for frequency control, but it would be acceptable to use an up/down pushbutton for frequency control. I'm sure such a design is feasible, but I'm not clever enough to design it!

This should be a design that can be built by a Ham—maybe with the program on a ROM so it could simply be plugged in.

AL WILLIAMS
Edmonton, Alberta, Canada

Bravo To New Ideas

I read the letters in the November issue on pseudo-science, and I do not share the writers' opinions. One only has to recall the Catholic Church's stand in the Middle Ages on the Earth being the center of the universe. At the time there was very little physical evidence to dispute their belief. We did not have

(continued on page 42)

RETAILERS THAT SELL OUR MAGAZINE EVERY MONTH

Arizona

Elliott Elec. Supply
1251 S. Tyndell Ave.
Tucson, AZ 85713

California

All Electronics
14928 Oxnard Street
Van Nuys, CA 91411

California Electronics
221 N. Johnson Ave.
El Cajon, CA 90202

Electronics Plus, Inc.
823 4th St.
San Rafael, CA 94901

Electronics Warehouse
2691 Main Street
Riverside, CA 92501

Ford Electronics
8431 Commonwealth Ave
Buena Park, CA 90621

HSC Electronics
5681 Redwood Drive
Rohnert, CA 94928

HSC Electronics
4837 Amber Lane
Sacramento, CA 95841

Halted Specialties Co.
3500 Ryder Street
Santa Clara, CA 95051

Kandarian Electronics
1101 19th Street
Bakersfield, CA 93301

Mar Vac Electronics
2001 Harbor Blvd.
Costa Mesa, CA 92627

Mar Vac Electronics
1759 E. Colorado Blvd.
Pasadena, CA 91106

Mar Vac Electronics
4747 Holt Blvd.
Montclair, CA 91763

Mar Vac Electronics
5184 Hollister Blvd.
Santa Barbara, CA 93111

Mar Vac Electronics
2537 Del Paso Blvd.
Sacramento, CA 95815

Mar Vac Electronics
2000 Outlet Center Dr. #150
Oxnard, CA 93030

Mar Vac Electronics
12453 Washington Blvd.
Los Angeles, CA 90066

Metro Electronics
1831 J Street
Sacramento, CA 95814

Orvac Electronics
1645 E Orangethorpe Ave.
Fullerton, CA 92631

Sav-On Electronics
13225 Harbor Blvd.
Garden Grove, CA 92643

Colorado

Centennial Elec. Inc.
2324 E. Bijon
Colorado Springs, CO
80909

Connecticut

Cables & Connectors
2315 Berlin Turnpike
Newington, CT 06111

Park Dist. Retail Outlet
347 Railroad Ave.
Bridgeport, CT 06604

Illinois

Tri State Elex
200 W. Northwest Hwy.
Mt. Prospect, IL 60056

Maryland

Mark Elec. Supply Inc.
11215 Old Baltimore Pike
Beltsville, MD 20705

Massachusetts

Electronic Hook-Up
104 Main St.
Milford, MA 01757

"You-Do-It" Electronics
40 Franklin Street
Neeham, MA 02494

Michigan

Purchase Radio Supply
327 East Hoover Avenue
Ann Arbor, MI 48104

The Elec. Connection
37387 Ford Road
Westland, MI 48185

Missouri

Gateway Electronics
8123-25 Page Blvd.
St. Louis, MO 63130

New Jersey

Lashen Electronics Inc.
21 Broadway
Denville, NJ 07834

New York

LNL Distributing Corp.
235 Robbins Lane
Syosset, NY 11791

T&M Elec. Supply, Inc.
472 East Main Street
Patchogue, NY 11772

Unicorn Electronics
Valley Plaza
Johnson City, NY 13790

Ohio

Parts Express
725 Pleasant Valley Drive
Springboro, OH 45066

Oregon

Norvac Electronics
7940 SW Nimbus Avenue
Beaverton, OR 97005

Texas

Computers Electronics Etc.
110 E. Medical Center Blvd.
Webster, TX 77598

Electronic Parts Outlet
3753 B Fondren
Houston, TX 77063

Tanner Electronics
1301 W Beltline
Carrollton, TX 75006

Washington

Supertronix Inc.
16550 W. Valley Hwy.
Tukwila, WA 98188

*Barnes & Noble • B. Dalton • Crown Books • Tower Books • Super Stand
Borders Book Store • On Cue • Hastings • Media Play • Walden Book Store
Just About Every Major Book Store!*

**If you'd like to sell our magazine in your store, please circle 180 on
free information card or Contact Gina Giuliano at (631) 592-6720 ext 215**

USE THE FREE INFORMATION CARD FOR FAST RESPONSE

Device Programmers

A must for anyone that tests, repairs, or programs any electronic device using a memory IC, the *PC Compatible Universal Device Programmers—Models 864* (\$695) and *865* (\$995) are fast and easy to use. These two models are ideal for programming EPROM, EEPROM/Flash, Serial EPROM, Microcontroller, PLD, and B PROM devices. Their extensive device libraries are constantly updated and are easily accessed from the B&K Web site.



B&K PRECISION CORP.

1031 Segovia Circle
Placentia, CA 92870
714-237-9220

www.bkprecision.com

CIRCLE 60 ON FREE INFORMATION CARD

Geiger Counter

This *Professional Geiger Counter* (\$758.95) will come in handy when checking the radioactive-contamination of work areas, personnel, and instruments. An ideal survey meter for both field and laboratory use, this device is able to detect alpha, gamma, and x-rays; is precise within 10%; and has an audible signal as well as the large meter indicator. It has a rugged, two-piece fiberglass reinforced case with a neoprene O-ring gasket, measures just 4¼ by 7¼ by 8 inches, and weighs only 4 pounds.



SCIENTIFICS
EDMUND SCIENTIFIC
Dept. A011-C999
60 Pearce Ave.
Tonawanda, NY 14150-6711
716-874-9091
www.scientificsonline.com

CIRCLE 63 ON FREE INFORMATION CARD

Let There Be Light

The 5½-inch *Streamlight Batonlite Hi-Intensity Flashlight* (\$29.95) features three superbright LED solid-state bulbs and delivers brilliant white light that will easily illuminate a room, vehicle, or pathway. The flashlight has a non-slip ribbed grip, an unbreakable Lexan lens, and dual-switch operation. Able to operate continuously over 12 hours on three included "N" batteries, it comes complete with a rear swivel collar and lanyard, plus a detachable key ring.



JENSEN TOOLS, INC.

7815 S. 46th St.
Phoenix, AZ 85044-5399
800-426-1194 or 602-453-3169
www.jensentools.com

CIRCLE 61 ON FREE INFORMATION CARD



Pulse Generator

The nuclear *NIM Pulse Generator, Model PB-5* (\$4580), includes a full-featured, highly flexible ramp generator that allows control of ramp duration, as well as providing complete programmability. Users can test the entire system range or just a portion of that range, with pulse repetition rates that go up to 0.5 MHz. Intuitive and easy to use, the PB-5 offers both spinner knobs and keyboard pushbuttons.

BERKELEY NUCLEONICS CORP.

3060 Kerner Blvd.
San Rafael, CA 94901
800-234-7858

www.berkeleynucleonics.com

CIRCLE 62 ON FREE
INFORMATION CARD

Audio Voltmeter

The *Peak-to-Peak Audio Voltmeter, Model 517* (\$293), is designed to set the amplitude of speech, music, and sound effects to prevent clipping. It's especially useful for setting the input level to A/D converters and analog recording/playback integrated circuits. With fast charge and slow discharge times, the peak detectors can properly track the level of a time-varying audio signal. In addition to the built-in analog meter, there's a DC output for connecting an external voltmeter or data recorder.

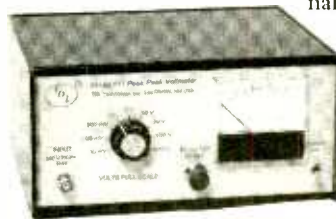

TDL TECHNOLOGY, INC.

5260 Cochise Trail
Las Cruces, NM 88012
505-382-3173
www.zianet.com/tld

CIRCLE 64 ON FREE
INFORMATION CARD

For The Handyperson

Need the proper tools to get the job done right? This 4-piece Maintenance Plier Set (\$49.95) offers enough versatility for any job. Packaged in a rugged, vinyl roll pouch, the set contains 10-inch groove-joint, 6-inch slip-joint, 6-inch long-nose, and 6-inch diagonal-cutter pliers (one each). All of them are high-quality alloy steel with non-slip grips. The pliers meet all applicable ANSI specifications.

JENSEN TOOLS, INC.

7815 S. 46th St.

Phoenix, AZ 85044

800-426-1194 or 602-453-3169

www.jensentools.com



Two's Better Than One

This BWR-5/3.3, 30W, Dual-Output DC/DC Converter (\$68) offers affordable, total control over two independently regulated outputs. It has two output

return paths, two on/off control pins, two output trim pins, and two sets of output-protection circuitry. With two control loops, a single PC board, common input circuitry, and a common ferrite core, this converter delivers the performance features of two independent converters in one single package.

DATTEL, INC.

11 Cabot Blvd.

Mansfield, MA 02048-1151

508-339-3000

www.datel.com



Component Testing System

Portable and battery-operated, the LC103/STA260 Industrial Component Testing System is comprised of the LC103 Capacitor and Inductor Analyzer (\$2495) and the STA260 Power Semi-conductor Tester (\$495).

This system is designed to accurately test capacitors, inductors, and power semiconductors, including IGBTs and SCRs. Accessories include a chip-component test lead, a component holder, and an adjustable test probe for testing surface-mount components in circuit.

SENCORE ELECTRONICS

3200 Sencore Drive

Sioux Falls, SD 57107

800-SENCORE

www.sencore.com



Software For Signal Generators

The SOF8 Signal Generator Control Software Program (\$95) makes it easy to set up and operate Novatech

Instrument signal generators from any Windows-based computer. The SOF8 program enables the user to select from drop-down menus, generating the appropriate commands and sending them to the signal generator. Using ASCII commands, the signal generators can be programmed over a USB or RS232 serial interface. The program is a Visual Basic 6 application that comes with the executable and source code.

NOVATECH, INC.

P.O. Box 55997

Seattle, WA 98155-0997

206-301-8986

www.novatech-inst.com



Clamp Meters

Designed for electricians, technicians, and HVAC professionals, the Fluke 321 (\$89) and 322 (\$99) Clamp Meters are compact, rugged, high-quality tool. Measuring $7\frac{1}{2} \times 2\frac{1}{2} \times 1\frac{1}{2}$ inches, the meters fit easily into cramped work areas. Easy to use, with one large button that facilitates troubleshooting current surges, both devices measure AC current and AC and DC volts with an 0.1 resolution. Standard features include automatic shut-off, a soft-sided carrying case, and test leads.

FLUKE CORP.

P.O. Box 9090

Everett, WA 98206

888-492-7542

www.fluke.com



GIZMO®

For more information go to page 80A

or e-mail: requests@berkshire-is.com

Tower of Power

A three-way, full-range, floor-standing loudspeaker, the *RL-18P* (\$499.95 MSRP) features an extended-throw, eight-inch, rear-firing, active subwoofer that's powered by a built-in 100-watt (rms) amplifier. The amp accepts line-level or speaker-level inputs and operates on 115- to 230-volt systems. Within the tower, the one-inch, soft-dome tweeter and six-inch midrange driver are housed in a sub-enclosure designed to eliminate modulation distortion.

Cerwin-Vega, 555 East Easy St., Simi Valley, CA 93065-1805; 805-584-9332; www.cerwinvega.com.

CIRCLE 50 ON FREE INFORMATION CARD



Split, Screen

You'll never miss a shot with the *CC9390* digital camcorder (\$1599.95), which does double-duty as a digital still camera. Its detachable 3½-inch LCD touch screen lets you use and control the camera remotely. For example, you can hold the cam above your head at a parade or sporting event, while you focus on the filming with the touch screen alone. This high-end camcorder comes with a removable 16-MB Multi-MediaCard (MMC) memory, a 1.3-megapixel CCD sensor, a USB multimedia card reader, *Digital Still Camera* (DSC) software, and an IEEE 1394 connection for fast downloading of digital video to a suitably equipped PC.

Thomson Consumer Electronics, 10330 North Meridian St., Indianapolis, IN 46290; www.rca.com.

CIRCLE 51 ON FREE INFORMATION CARD



Dynamic Duo

Set side-by-side, the *Duetto SR110* stereo receiver and a *CD110* CD player (\$379 each) measure a small 3 × 8¼ × 12¾ inches, but deliver a "large" sonic performance—virtual surround sound from just two loudspeakers. The *SR110* receiver includes a 25-watt-per-channel stereo amplifier, an AM/FM tuner with 30 station presets, and a remote that also controls the CD player. In addition to CDs, CD-Rs, and CD-RWs, the *CD110* also plays back MP3-encoded CDs. Both components feature drop-down front-panel covers that conceal all controls, and they also include a D-BUS remote connection.

Marantz America, Inc., 440 Medinah Road, Roselle, IL 60172-2330; 630-307-3108; www.marantz.com.

CIRCLE 53 ON FREE INFORMATION CARD



Treasure Hunter



Get a quick introduction to treasure hunting with the *Fast Tracker* metal detector (\$124.95). It boasts a 7¼-inch waterproof search coil and offers two-tone target identification that makes it easy to discriminate between treasure and junk. The lightweight but rugged detector can be used in extreme conditions ranging from saltwater beaches to highly mineralized inland sites with no operator adjustments to the circuitry and with no loss of sensitivity.

Bounty Hunter, 1100 Pendale Road, Dept. P, El Paso, TX 79907; 800-444-5994; www.detecting.com.

CIRCLE 52 ON FREE INFORMATION CARD

Backgammon Buddy

Play backgammon anywhere, any time, without losing any pieces, with *LCD Backgammon* (\$29.95). Players use just seven buttons and a joy pad to play on the large LCD screen. The handheld electronic game includes beginner and advanced levels, and it allows you to challenge the internal computer or a friend. The game has a doubling cube feature, electronic dice rolling, and the ability to save a match in memory, as well.

Excalibur Electronics, 13755 SW 119th Ave., Miami, FL 33186; 800-592-4377; www.excalibur-electronics.com.

CIRCLE 54 ON FREE INFORMATION CARD



Time and Temp

A quick glance at the *Thermosolutions ws44* (\$69.99) reveals not just the time and date, but also the temperature and humidity indoors and out. An outdoor sensor transmits the current temperature to the indoor unit every 15 minutes. The desktop weather station provides a forecast and the daily minimum and maximum temperatures and humidity levels.

Olivetti Office USA, Royal Consumer Business Products, 765 U.S. Highway 202, Bridgewater, NJ 08807-0945; 908-429-4357; www.royal.com.

CIRCLE 55 ON FREE INFORMATION CARD



Mobile Multimedia

The *IC8010 controller/receiver* (\$249.95) is the heart and brains of the Intellicar mobile entertainment system. With a flip-down detachable face and the AM/FM radio and CD/CD changer control, it looks and acts like an in-dash head unit, but that's just the beginning. The Intellicar databus allows external modules to be added for integration of multimedia gear—such as a VCR or an MP3 or DVD player. Pick-and-choose add-ons that include a four-input A/V source selector, wireless remote, and wireless headphones provide easy control. The receiver features a 240-watt (60 × 4) amplifier and the Instaloc III tuner with 30 presets.

Jensen Mobile Electronics, A Recoton Company, 2950 Lake Emma Road, Lake Mary, FL 32746; www.jensenaudio.com.

CIRCLE 57 ON FREE INFORMATION CARD



Progressive Scanner

The *TB6001 TrueScan* progressive-scan-display interface (\$800) converts 480-line interlaced video to a DTV-class 480p (progressive) resolution. It is designed for use with 31.5-kHz display devices, progressive-scanning monitor/receivers, flat-panel displays, DTV monitors, and front or rear projectors. Offering a "DTV-quality" picture, the product delivers true artifact-free

24-frame movie information. TrueScan's auto-detect technology determines the incoming video source and applies the best processing algorithm—all automatically.

Proton U.S.A., 13855 Struikman Road, Cerritos, CA 90703-1031; 562-404-2222; www.proton-usa.com.

CIRCLE 56 ON FREE INFORMATION CARD



CHAD is Rad

The *CHAD Custom Home Automation Device* (\$500) is a graphical touch-screen learning remote control. It can easily be configured to operate any unit with an infrared remote, and components can be selected from the internal database of more than 500 brands. The CHAD can even "learn" the most obscure functions directly from a remote. Easy to use, CHAD can also be programmed to perform a series of up to 255 tasks across multiple components with the touch of a single button. Featuring 2 MB of internal memory, programmable macros and timers, and an RS-232 interface, it can be customized with a home PC.

Onkyo U.S.A., 18 Park Way, Upper Saddle River, NJ 07450; 800-229-1687; www.onkyousa.com.

CIRCLE 58 ON FREE INFORMATION CARD



High-Def Projector

Sharp's CV-IC and Texas Instruments' DLP technologies are combined in the *XV-Z9000U* high-definition front projector (\$10,995) to deliver remarkably high-resolution images and brilliant clarity. Using two scaling processes, the CV-IC optimizes picture clarity. Other features also enhance quality: for instance, the projector's color wheel spins at five times the normal speed, and its "natural" projection angle system is combined with a lens-shift function. These features eliminate color-separation artifacts and key-stoning, respectively.

Sharp Electronics Corp., Sharp Plaza, Mahwah, NJ 07430; 877-388-SHARP; www.sharp-usa.com.

CIRCLE 59 ON FREE INFORMATION CARD



Speedy CD Burner

The *veloCD 24/10/40 CD-ReWriter model AI-241040* (\$299.99) is an internal ATAPI/E-IDE drive offering 24X write, 10X rewrite, and 40X data-read speeds. It can rip CD audio tracks at 40X, with bit-perfect accuracy. BURN-Proof write assurance technology eliminates buffer under-run errors, even during multitasking operations. Bundled with the unit is the *CD Blender* software suite, consisting of *TDK Digital Mixmaster* music management and recording software, *Nero 5.5 CD* recording software, *InCD* drag-and-drop packet-writing software, and other utilities.

TDK Electronics; www.tdk.com.

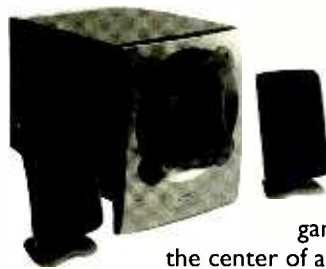

Quadraphonic PC Sound

When used with sound cards that support four-channel quadraphonic sound, the *MMS305 flat-panel speaker system* (\$149.99) places gamers and audiophiles at the center of a rich sound environment. The system includes four identical 10-watt (rms) flat-panel speakers and a 40-watt (rms) subwoofer for full-body bass. At a thickness of just $\frac{3}{8}$ inch, the speakers also conserve desktop space and can be subtly placed, horizontally or vertically, almost anywhere in a room.

Philips Consumer Electronics; www.philips.com.

Souped-Up Cables



The *GE IEEE1284 MaxSpeed* is a high-speed data-transfer cable designed for use with printers. The EMI/RFI-shielded cable features gold-plated connectors to provide maximum speed and conductivity while producing error-free data transmission. The six-foot-long *HO97852* and 10-foot *HO97853* sell for \$24.99 and \$29.99, respectively.

Jasco Products; 800-654-8483; www.jascoproducts.com.

DVD-RW Discs

Enabling true convergence between personal computing and consumer electronics products, the *4.7GB DVD+RW blank media singles* (\$19.99) written on a DVD+RW recorder can be read and played on most DVD-video players, as well as on DVD-ROM drives. (These include 70% of first generation, all second generation, and all the current ones.) DVD+RW discs can be reliably rewritten 1000 times, in either CLV (Constant Linear Velocity) format for sequential video access or CAV (Constant Angular Velocity) format for faster random data access. The discs have an expected archive shelf life of 30 years.

Memorex; 800-636-8368; www.memorex.com.



Ethernet Controller

Packed into a rugged aluminum enclosure, the *Ether6 controller* includes a DOS-based computer, six serial ports, 10BASE-T and optional 10BASE-2 Ethernet ports, and other features. It is ideal for applications requiring multiple serial ports and Ethernet connectivity and control. PC-compatible serial ports with unique interrupts and FIFOs increase data throughput, and the onboard NE2000-compatible Ethernet circuitry connects directly to existing networks. Pricing starts at \$369; a development kit, including an Ether6 controller, AC adapter, cables, manual, and programming software, costs \$449.

JK microsystems, Inc.; 530-297-6072; www.jkmicro.com.

Business Buzz

SATELLITE MERGER

General Motors Corp. and its subsidiary Hughes Electronics have signed a definitive merger agreement with EchoStar, pending approval by investors, the FCC, and the Justice Department, which would determine if the new company would monopolize the satellite-TV market. The proposed company would use the EchoStar name and adopt the DIRECTV brand for its services and related products. The merger would create the nation's second-largest pay television platform with more than 16.7 million subscribers. Cable TV companies control more than 80 percent of the U.S. pay television market; a combined EchoStar-Hughes would provide service to about 17 percent of the market.

LEP LEAP

DuPont and Cambridge Display Technology (CDT) have announced a strategic agreement to advance the commercialization of the light-emitting polymers (LEPs) used to create ultra-thin, lightweight, low-power displays for mobile phones, handheld notebooks, and other portable electronics. DuPont will receive a non-exclusive license to technology and intellectual property assets held by CDT, which will allow DuPont to produce active and passive LEP display devices. DuPont Display's subsidiary UNIAX, which specializes in electroluminescent polymers, will have its LEP intellectual property and technical know-how consolidated with that of CDT.

NEXT-GENERATION TELEPHONY

Allowing service providers to easily deploy packet-based voice services in their networks, General Bandwidth has incorporated Texas Instruments' (TI) voice-over packet solutions into the G6—its leading multi-application, central-office platform. The support for advanced voice compression that G6 offers allows service providers to take advantage of its highly scalable architecture, even in conditions where the highest levels of voice compression and echo cancellation are needed. It also delivers voice services over the existing copper infrastructure more cost effectively. TI's programmable digital signal processors (DSPs) and Telogy software will support evolving standards, as well as enabling new features.

"Digital" SLRs

How can professional and serious amateur photographers resist the lure of digital photography? Although the benefits of digital cameras are tempting, these folks are heavily invested in their current equipment. How do they balance the ease of loading pictures into a computer for editing or transmission via e-mail against the cost of trashing the 35mm photographic apparatus they now own, including camera bodies, lenses, flashes, and other accessories? Now there is a way to "go digital" with existing higher-end 35mm SLR cameras, while retaining all their accessories and advanced features.

Over several years, Silicon Film Technologies, Inc. (Irvine, CA) has developed its Electronic Film System (EFS). The company is now marketing its first product using the technology. The EFS-1 is designed to fit into the film compartment of a 35mm SLR camera, allowing it to capture digital images with no camera modification required.

The Heart (and Other Parts) Of The System

The heart of the EFS-1 is the (e)film cartridge, which replaces a roll of conventional 35mm film and captures digital images using a CMOS image sensor. CMOS technology was chosen over CCD sensors, more commonly used in digital cameras, because of its more affordable manufacturing cost and low



Serving as the link between the (e)film and a laptop computer, the (e)port carrier provides a protective housing for the cartridge.

power consumption. Digital cameras are notorious battery consumers, but the EFS-1 can take up to 300 pictures on a single battery charge. The (e)film's non-volatile flash memory can store up to 24 digital pictures with a resolution of 1280 × 1024 pixels and 36-bit color. Initially, EFS-1 has an ISO rating of approximately 100; future products are expected to have increased sensitivity.

While the EFS-1 does not yet offer the performance of a high-end digital camera, the tradeoff is its greater versatility. Photographers need only one camera system and can easily switch back to conventional film when higher performance is desired. Finally, the (e)film cartridge can be reused thousands of times, saving the expense of buying and processing rolls of film.

Other parts of the system include the (e)port carrier, the (e)box storage module, and bundled software. The (e)port carrier provides a protective housing for the cartridge and serves as a link to a lap-



The (e)film cartridge, shown here for the Nikon F5, replaces a 35mm roll of film.

TYPE

top computer or the (e)box storage module. It supports PC (PCMCIA) Card Type II and USB connections. The (e)box storage module is an image-storage device designed for use in the field, eliminating the need to bring along a laptop. Allowing quick downloads of images from the (e)port that enables photographers to reuse the (e)film cartridge, the (e)box uses CompactFlash Type I and II storage media.

Software included with EFS-1 provides a choice of file formats (JPEG, BMP, and TIFF). In addition, there is the capability to view or store images as either compressed or uncompressed (raw) files for the highest possible image quality, flexibility, and control. Raw files are approximately 2MB in size at download and storage. The EFS-1 is currently compatible with Windows 98, Windows Me, and Windows 2000. Mac compatibility will be available soon. The EFS-1 includes TWAIN-compliant software for convenient image management, including image viewing, editing, and storage. Additional photo editing, manipulation, and online photo-finishing packages are also included.



An image-storage device designed for field use, the (e)box module eliminates the need to carry along a laptop.



Seen here is a preliminary test photo of buildings in New York City taken with the EFS-1 system. Notice the sharp details on the older building in the foreground.

Compatibility and Availability

Because SLR cameras differ in internal dimensions, the (e)film cartridge has to be designed for each application, and (e)film is now only being tailored for the most popular SLRs. This selection was determined from profiles of potential customers who visited the company's site, along with the cameras' general compatibility with EFS-1 system design. Currently, on the map for the EFS-1 system are the Nikon F5, N90/N90s, and F90/F90x and Canon EOS A2/E, and EOS 5.

Future models will be added based on popular demand, market and sales data, and manufacturing considerations. If your camera is not one of the currently targeted models, you can join Silicon Film's Interest Group on-line and tell the company which one you have.

The EFS-1 includes (e)film, (e)port, and (e)box (\$699), while the EFS-1 combo includes (e)film and (e)port (\$649). At the time of publication, the release date of the EFS-1 is not scheduled. The digital system will initially be available directly from Silicon Film—www.siliconfilm.com. Check the Web site for the latest information.—by Bill Siuru **PT**

Micro Pac-Man

Researchers at Sandia National Laboratories have developed a micromachine that interacts with red

Research Notes

REMOTE-CONTROL SURGERY

Using telesurgery to remotely manipulate a robotic system, Dr. Michael Gagner, chief of laparoscopic surgery at Mount Sinai Medical Center in New York City, successfully removed the gall bladder of a woman in France. His co-surgeon, Dr. Jacques Marescaux, of Strasbourg University Hospital, began the procedure; and then Dr. Gagner performed the long-distance removal of the diseased gall bladder laparoscopically—inserting instruments and a tiny television system into the patient's body. To minimize the delays caused by distance and involved in converting electronic signals into light pulses, the two sides of the procedure were linked with an ultra-fast fiber-optic line. The 80-millisecond time delay between the instructions issued in New York and the robotic response in France was noticeable, but did not create a problem.

NOBEL NOD

Three researchers—Americans Eric A. Cornell of NIST and Carl E. Wieman of the University of Colorado in Boulder and German Wolfgang Ketterle of MIT—won the Nobel Prize in Physics for creating a Bose-Einstein condensate. This new state of matter could be described as a super-cold gas, although it is really not a solid, a liquid, or a gas. The condensates can be made to give off pulses of matter, forming a sort of "atom laser" that emits matter instead of light. Potential applications include smaller and faster electronic circuitry, super-accurate clocks and measuring tools, and use in quantum computers. The three men shared the \$943,000 award.

MARTIAN MACHINERY

The scoop-and-dump design of a prototype bulldozer rover being developed by NASA engineers for use on Mars mimics that of a bulldozer and a dump truck. Unlike its Earth-bound counterparts, which can weigh several thousand pounds, these rovers are lightweight, intelligent, and driverless. Yet they have the same capabilities, relative to their size, as their heavy-duty counterparts. Robotics engineers think the basic research on these bulldozing rovers may support future missions to look for life or to sustain a human presence on Mars.

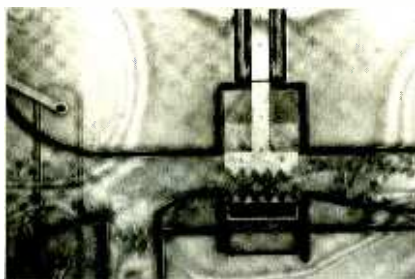

Sandia's microteeth bite in a channel that is 20 microns wide. (A human hair is approximately 70 microns.) The little balls in the horizontal channel are the red blood cells.

blood cells. In less than a blink of an eye, its tiny silicon "teeth" open and close like jaws in a channel about one-third the width of a human hair. Think *Pac-Man* gobbling down those little dots. The upper teeth of the microdevices slide back and forth across the microchannel to momentarily capture individual red blood cells across the lower teeth. When the jaws close, they trap and disfigure one of the many red blood cells being pumped through the microchannel. When they let loose the deformed cell, it quickly regains its former shape and appears unharmed.

"We've shown that we can create a micromachine that interacts at the scale of cells," says Sandia researcher Murat Okandan. "We've created a demonstration tool with very flexible technology that we believe will enable many designs and concepts. This device itself may generate considerable interest from the agriculture or genetic engineering marketplaces."

The same techniques for producing computer chips can be used to manufacture the devices easily and inexpensively. The microdevices are fabricated step-by-step using lithographic processes familiar to the semiconductor industry. Sandia's SUMMiT V process uses a sequence of deposition, patterning, and etching to create complicated micromachines. It also involves using silicon nitride, instead of silicon, to build insulated microchannels in that process. An electrical conductor, silicon would short out the electrodes that create the electrical and magnetic fields used to analyze or manipulate the contents of the channel itself. Silicon nitride avoids that problem and, as it's transparent, allows researchers to optically examine the experiments. The Sandia SUMMiT V

process is the only one available that can quickly and easily construct five-level micromachine devices.

Ultimately, the researchers hope to puncture cells and inject them with DNA, proteins, or pharmaceuticals to counter biological or chemical attacks, gene imbalances, and natural bacterial or viral invasions—opening the possibility of considerable mechanical intervention at the cellular level. Because the devices work so quickly and are so small, many units could operate in parallel in a relatively compact volume.

The researchers plan immediate tests to see whether the ruffled red blood cells absorb a fluorescent material that the cell naturally rejects. If the material is absorbed, it will make the *Pac-Man*-like device the first reported example of a continuous flow, mechanical cellular-membrane disrupter.

Another goal is to replace the microteeth with a hollow silicon needle, now being developed, that would be able to rapidly inject DNA, RNA, or proteins into living cells at precise points of their anatomies and in large amounts. Such a development could change the course of a disease or restore lost functions.

Current methods of cell implantation include a process called "electroporation," which uses electric fields to open cell walls for chemical absorption. In the process, however, many of the cells are destroyed. In other manual methods, genetic material is delivered into cells one by one through a very fine pipette—a very specialized, labor-intensive process.

Sandia's microdevice could overcome both of these problems. **PT**

CHP Off the Old Power Plant

At their Washington, D.C. headquarters, the EPA joined 17 Fortune 500 companies, city and state governments, and nonprofits to announce the Combined Heat and Power (CHP) Partnership, an alternative to conventional electricity generation.

Also known as co-generation, CHP is a highly efficient, clean form of electric generation that recycles and uses leftover heat that is normally lost under traditional power combustion methods.

CHP provides a source of residential and industrial heating and air conditioning in the local area around a power plant.

"Combined Heat and Power is not only better than conventional electricity generation at reducing air pollution and fuel consumption; it's more reliable and costs less to do so," said EPA Administrator Christie Whitman.

Partners in the program agreed to work with the EPA to develop and promote the benefits of new CHP projects. The EPA will provide support for accelerating project development—offering educational programs, streamlining the process for obtaining permits, and supplying technical tools and services.

In fact, CHP systems are already being used by the 17 founding partners—Abbott Laboratories, Archer Daniels Midland, Bethlehem Steel, Caterpillar Energy Products Group, Dow Chemical, ExxonMobil, General Motors, International Paper, Real Energy, Solar Turbines, Texaco Power and Gasification International, Trigen Energy, U.S. Steel, Verizon Communications, Weyerhaeuser, the College of New Jersey in Ewing, and the University of North Carolina at Chapel Hill. These existing CHP projects represent more than 5800 megawatts of power-generating capacity, an amount capable of serving almost six million households (about the size of the Washington, D.C. metropolitan area). Each year, the projects reduce carbon dioxide—the main global warming gas—by more than 8 million tons, compared to conventional generation methods. The annual energy savings equal 19 million barrels of oil.

To promote co-generation in the United States, the EPA will be publishing draft guidance clarifying the *Clean Air Act* requirements for constructing CHP facilities in the *Federal Register*. In another action, the EPA will evaluate CHP applications under its Brownfields program. Brownfields helps communities to reduce the potential health risks and restore the economic viability of abandoned, idled, or under-used industrial and commercial properties. By the time of publication, the EPA is planning to debut a special Web site for the Combined Heat and Power Partnership. **PT**

► Watch Out, Post-its!

We can't get through the work day without those little sticky notes, but researchers at HP Labs in Bristol, U.K., have come up with a new paperclip that just might challenge the ubiquitous Post-it note. David Frohlich and Guy Adams have devised an audio paperclip that lets you record sound and then attach it to a document. The audio paperclip and its desktop player were displayed last autumn in "Great Expectations," a best-of-British design exhibition in New York.

The paperclips are electronic re-recordable storage devices for a single piece of sound, such as a voice. Sounds are recorded on computer chips inside the paperclip and can be played back with a handheld device or specially adapted phones, MP3 players, photo frames, or personal organizers. It would allow you to add an audio note to an office document, voices to a vacation photo, or messages to family members clipped to the refrigerator door. "We think of audio-paperclips as one way of making sound and voices tangible," Frohlich said. "They add emotion, life, and personality to paper."

Fortunately for the Post-it folks, there are no immediate plans to take the product to market. **PT**

TH!NK Green

The New York Power Authority (NYPA), the Long Island Power Authority (LIPA), the Long Island Rail Road (LIRR), Ford Motor Company, and the towns of Oyster Bay and Huntington are partnering to provide a clean, green alternative for a select group of Long Island Rail Road commuters. The project, designed to reduce air pollution and traffic congestion as well as promote national energy independence, uses the TH!NK City Electric Vehicle (EV) developed by Ford's EV group, TH!NK Mobility. (See the "Prototype" column in the April 2001 issue for more information on Ford's TH!NK EVs.)

"It's a great way to promote and demonstrate the environmental benefits of alternative energy vehicles," said LIPA Chairman Richard M. Kessel. "The program coincides with the goals of LIPA's and Governor Pataki's Clean Energy Initiative, which is a multi-year, \$170 million effort to promote energy conservation and efficiency and to develop alternative energy technologies."

The front-wheel-drive TH!NK City EV has a top speed of 56 miles per hour and a range of 53 miles (city). It's equipped with a radio/CD player and driver-side air bags and can be recharged in four to six hours. "The TH!NK City is a two passenger car designed exactly

for programs such as 'Clean Commute,'" said Rob Stevens, president of TH!NK Mobility. "Battery electric vehicles are perfect for this kind of program where limited miles are driven each day."

Ford will lease the TH!NK City EV to commuters in Nassau and Suffolk Counties for \$199 per month. Qualified applicants, who will be selected on a first-come, first-serve basis, will be able to use charging stations set up in special, reserved parking spaces at the Hicksville or Huntington train stations. LIPA will provide and install charging stations at these parking spaces and at the participants' homes free of charge.

"The TH!NK City EV not only offers an emission-free ride, it can also provide an all-electric commute when combined with electric-powered commuter trains. MTA commuter rail and subways are powered with electricity supplied by the Power Authority," said Eugene W. Zeltmann, NYPA's President and Chief Operating Officer. Zeltmann also serves as Co-Chairman of the Electric Vehicle Association of the Americas.

Both NYPA and LIPA have other EV programs in the works. NYPA's electric transportation program has deployed 200 electric vehicles, ranging from full-sized transit buses to battery-powered bicycles. Last year, NYPA-deployed electric vehicles reached the "Million EV-Mile" mark. LIPA lends EVs to local

businesses and governments for up to three months to demonstrate the environmental and economic benefits of including electric-powered cars, trucks, and utility vehicles in their respective fleets and to encourage greater use of EVs. **PT**

Code Contest

IBM is sponsoring an international "Battle of The Brains," challenging college students from 70 countries to tackle a semester's worth of programming in a single afternoon. More than 14,000 students participated in the 26th annual ACM (Association for Computing Machinery) International Collegiate Programming Contest. In the preliminary competitions, colleges and universities choose teams or hold local contests to pick one or two teams to represent each school.

In the regional contests, which were held from September to December 2001, three-person teams (typically two undergraduates and one graduate student) combined their programming skills and creativity to solve complex problems using both traditional and new languages, including C, C++, Java, and Pascal. Grouped around a single computer, competitors raced the clock in a battle of logic, strategy, and mental endurance as they worked to solve six to eight complex, real-world problems in five hours.

Winners of the five-hour regional competitions were awarded scholarships and IBM ThinkPads and software. Winning regional teams will go on to compete at the 2002 World Finals to be held in Honolulu, Hawaii in March 2002.

IBM worked closely with the team coaches to provide technology and software to participating universities and to study how professors keep their curriculum current in today's fast-changing environment. "The ACM Contest provides IBM with a great opportunity to meet top computer science talent and educators from around the world," said John Swainson, general manager, Application and Integration Middleware, IBM Software. Students in the World Finals competition will use IBM's VisualAge development tools. **PT**

Power Supplies and Circuits

The Invisible Power Supply

The power-supply is a very important part of any electrical experiment, although the average experimenter has a tendency to disregard it. Often, it is tempting to use whatever may be at hand, such as a surplus or scavenged “wall wart,” or some batteries that may have seen better days. The wrong type of power-supply can cause all sorts of problems, from annoying glitches to severe destruction of components, and even a fire or explosion. Most experimenter circuits will use a 5-, 6-, 9- or 12-volt source; and these voltages can be obtained from many different sources. Ideally, a supply should be adjustable, produce relatively pure DC, and have good regulation. Additional features are metering of output voltage and current, plus some form of current limiting to protect against excessive current flow.

Power supplies take many forms, and those used for experimentation generally take their input power from the AC mains (120- or 240- volts AC) and use a transformer and rectifier assembly to produce DC power. This is either used as is or fed to a regulator circuit to remove AC residual components and control the DC output voltage, maintaining a given level under varying loads. We will discuss a few basic circuits and show examples of simple supplies that can be built by the average experimenter, either as stand alone or as part of a project.

Transformer Basics

A transformer is used to step the 120- or 240-volt AC line voltage down to a much lower voltage—generally 6 to 30 volts—depending on the DC voltage needed. The secondary winding may have taps to give various output voltages and, in many cases, contains two identical windings, which may be series- or parallel-connected to yield two different

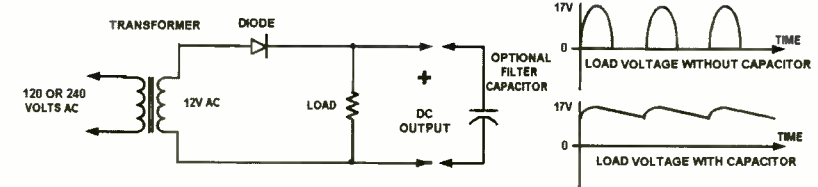

Fig. 1. Rectifier circuits are used to obtain direct current from an alternating-current supply. The half-wave rectifier above is the least complex.

voltages. A popular combination is two 12-volt, 1-ampere windings. In parallel, this gives 12 volts at twice the current of one winding, or 2 amperes. In series, 24 volts is obtained, but at the maximum current of one ampere. The total power (resistive load) is 24 watts in either case.

Transformers for the 50- or 60-Hz power-line frequencies are heavy—there is a way around this problem. In switching-type power supplies, a circuit converts the AC-line power to a much higher frequency, generally 10 to 100 KHz. For these frequencies, transformers are much smaller and lighter, with fewer turns of wire—enabling a much smaller and lighter power supply. However, the high frequencies and fast waveforms encountered in these circuits can generate harmonics and noise (*Radio Frequency Interference* or RFI) well into the RF spectrum. This problem can preclude their use in applications where very low-level signals are present, such as in radio-communications equipment. However, they find wide use in computers and in many other general electronics applications where the residual RFI will not be a problem. They are also very cost effective and compact compared to conventional 50–60-Hz supplies. The topic of switching supplies is a complicated one and will not be considered this time (See “*Service Clinic*” for a discussion of these supplies—Editor). For the 5- or 10-watt power levels required by experimenters, conventional AC transformers are not too bulky and are relatively cheap.

And Now For Our First Circuit

Rectifier circuits are used to obtain direct current from an alternating current supply. The half-wave rectifier (Fig. 1) is the least complex. This is a simple series diode that only allows current to flow one way. The output waveform is a series of sinusoidal pulses. The average DC voltage of a waveform such as this is $(1/p)$ of the peak value. (Since $p = 3.14159$ approximately, $1/p$ is about 0.318.) For a 12-volt RMS (Root-Mean Square) input, the peak value is 12×2 or about 16.97 volts. Substituting this value would yield an average of $16.97 \times (0.318)$ or 5.4 volts. A large 50–60 Hz AC component is also present.

Note that there is a DC current flow in the transformer winding since it is in series with the diode. This flow acts to bias the core magnetically. In order to avoid core saturation and overheating, a larger core must be used in the transformer. Also note that during the negative half cycles, the instantaneous output voltage is zero. Things can be improved by connecting a large capacitor across the DC output. The capacitor will charge to the peak value of the AC voltage (minus any diode voltage drop, about 0.3 to 0.6 volts). Now, under no-load conditions, about 16 volts DC will be present. With a load, the capacitor will charge to the peak AC-input voltage, less any diode and resistive voltage drops (transformer winding resistance, etc.). However, as the AC-input goes negative, the capacitor will discharge

into the load, until the AC-input voltage exceeds the instantaneous load voltage plus diode drop at that time.

In the worst case, a voltage twice the peak-value of the AC-input appears across the diode. This result occurs when the capacitor is charged to the peak value of the AC waveform (about 16.97 volts) and the AC waveform is at its negative peak (about -16.97 volts). Double this voltage is approximately 34 volts. The diode must withstand this voltage, and this is called the *peak inverse volts (PIV)*. A rule of thumb here is to use a diode with a PIV rating of at least 3 or even better 4 times the RMS AC input voltage. The closest practical rating would be a 50-volt diode.

Today, a 60-Hz rectifier diode is pretty lousy, as silicon diodes having a PIV or reverse breakdown voltage of 600 to 1000 volts can be had for pennies. An example is the 1N4000 through 1N4007 series 1-amp diodes. The 1N4007 is good for 1000 volts and is very cheap. However, at higher frequencies used in switching supplies, faster diodes are required and cost quite a bit more. The rectifier output is a DC-voltage across the load with a saw-tooth shaped ripple component. This voltage can be reduced with a larger capacitor value. However, also note that the capacitor must be recharged quickly during AC-voltage peaks, producing high-peak charging currents through the transformer and rectifier and causing heating and loss. For any power level over a few watts, this is an inefficient way to get DC.

No "Half-Wave" Measures

A full-wave rectifier uses both halves of the AC waveform. There are two full-wave circuits that are commonly used. Figure 2 uses two diodes and needs a center-tapped transformer. The circuit of Fig. 3 is a full-wave bridge and uses four diodes, but no center-tapped supply is needed. Figure 2 was popular in the tube days, when 250- to 400- volt DC

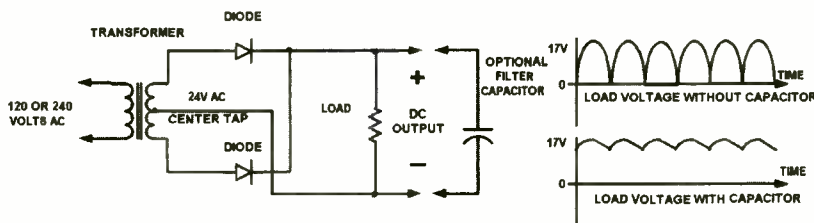

Fig. 2. A full-wave rectifier uses both halves of the AC waveform. There are two full-wave circuits that are commonly used. The circuit above uses two diodes and needs a center-tapped transformer.

**Frustration? No, thanks.
Fun? Yes, please.**



Satisfied customers - the key to our success

- ▶ that's why every new EAGLE version is based on the feedback from our customers
- ▶ that's why all our customers have access to our highly acclaimed, comprehensive support, free of charge
- ▶ that's why EAGLE has no hidden costs for libraries or modules which prove to be indispensable after purchasing
- ▶ that's why we really want customers to enjoy working with EAGLE
- ▶ that's why EAGLE is one of the top-rated programs for schematic capture and board layout

EAGLE 4.0

Schematic Capture • Board Layout
Autorouter

The readers of the leading German electronics magazine selected EAGLE 4.0 as **Product of the Year 2000** in the category CAD/CAE

Microsoft is a registered trademark of Microsoft Corporation. Linux is a registered trademark of Linus Torvalds.

Version 4.0 Highlights

- New Library Management with Component Browser
- Technology and Package variants for components
- Design your own commands via User Language
- Unlimited length for component names/values
- Design Rules define pad/via dimensions and shapes
- Net Classes for Autorouter and DRC
- Minimum Autorouter grid: 0.02 mm
- SMD pads can be rounded or round
- Different pad shapes for Top, Bottom, or Inner layers



EAGLE 4.0 Light is FreeWare!

You can use EAGLE Light for testing and for non-commercial applications without charge. The FreeWare Version is restricted to boards up to half Eurocard format, with a maximum of two signal layers and one schematic sheet. All other features correspond to those of the Professional Version. Download it from our internet Site or order our free CD.

The Standard Version is suitable for boards in Eurocard format with up to 4 signal layers. The Professional Version has no such limitations.

<http://www.CadSoftUSA.com>

800-858-8355

CadSoft Computer, Inc., 801 S. Federal Highway, Delray Beach, FL 33483
Hotline: (561) 274-8355, Fax: (561) 274-8218, E-Mail: info@cadsoftusa.com

Prices	Light	Standard	Professional
Layout		199\$	399\$
Layout + Schematic		398\$	798\$
Layout + Autorouter		398\$	798\$
Layout + Schematic + Autorouter	49\$	597\$	1197\$

Pay the difference for Upgrades

CIRCLE 283 ON FREE INFORMATION CARD

supplies were used in tube circuits. A vacuum-tube diode requires a filament; and the circuit of Fig. 3 would require separate, isolated, filament supplies,

which could become unwieldy.

A popular tube approach used a diode with two separate plates and a common filament. These tubes, such as the type 80, 5U4GB, 5Y3GT, and 5R4GY, were staple items. There were also separate cathode types such as the 6AX5, 6Y6, and 6X5 types, and others. With a 600-volt center-tapped transformer and a few 20 to 50 mF 450-volt filter capacitors, a supply of 250 to 400 VDC at up to 300 mA DC was obtained. Radios, TV sets, and amplifiers, as well as other electronic devices—all needed these DC

(Continued on page 28)

PROTECTING YOURSELF AGAINST VIRUSES, WORMS, AND ONLINE HUMILIATION

With most of the civilized world still anxious from the recent hijacked airlines and the latest anthrax poisonings, do we also need to worry about cyber attacks? Yes. Is there any correlation between the burgeoning computer hacking and virus activity and the aftermath of September 11th? The answer to this is not so clear. What is clear is that America's critical information-technology infrastructure is being attacked, and we could be at risk for more dangerous forms of cyber aggression in the future. Though no lives have been lost, huge amounts of money are being wasted trying to ward off and recover from these onslaughts.

In 2001, the rate of hacker attacks— attempts to gain unauthorized access to a computer system or its data—is more than double that of the previous year, according to the latest figures from CERT, the government-funded computer emergency group at Carnegie Mellon University. The cost is particularly high for cleaning up after attacks from viruses and worms—malicious computer code often sent through e-mail that can, at worst, destroy all the data on a computer system. The worldwide cost reached \$17.1 billion in 2000, a 41-percent increase over the previous year, according to Computer Economics, an information-technology research firm.

Businesses have the most to lose, but individuals are at risk, too. Before last year, despite heavy Internet use, I rarely saw a virus. Lately, I've been subjected to

The screenshot shows the Vmyths.com website interface. At the top, there's a navigation bar with links for 'Hot News', 'Hoaxes', 'Resources', 'Ratings', 'About', and 'About Us'. The main content area is titled 'Welcome To Vmyths.com' and contains several sections: a search bar, a 'Learn about computer virus myths, hoaxes, urban legends, hysteria, and the implications if you believe in them. You can also search a list of computer virus hoaxes & virus hysteria from A to Z.' section, a 'This site is NOT sponsored by antivirus companies' disclaimer, and a 'Is this your first visit to our site? Click here for a beginner's tour.' link. There are also several promotional banners, including one for '0000 trick (or 00000 trick) to confuse viruses/worms' and another for 'Earn Cash Back When You Shop!' with a 'FREE Download' offer.

Vmyths (www.vmyths.com) is a treasure trove for debunkers. Catch up on the latest virus hoaxes and urban myths with just a few clicks of your mouse.

an average of one attack a week, all of which have been thwarted, thus far, by antivirus software and my cautious handling of e-mail attachments.

COULD THERE BE A CONNECTION?

As yet, no one has established a link between cybervandalism such as this and the terrorist attacks on the World Trade Center and Pentagon. There doesn't seem to be any significant change in malicious Internet activity related to September 11th, says Marty Lindner

of CERT. Recognizing the threat, however, President Bush has just created a government panel to look at ways to protect against cyberterrorism.

Circumstantial evidence indicates that many Internet attacks may be coming from abroad. A large percentage of the e-mail messages I've received with virus or worm attachments, for instance, appears to originate from those who have only a tenuous grasp, at best, of the English language. One infected e-mail message had a subject line that spelled

ZONE LABS

Products & Solutions | Download & Buy | Corporate Sales | Service & Support | Partner Programs

THE BEST PERSONAL FIREWALL
Trusted by over 15 Million Users

ZoneAlarm Pro
Security You Can Trust

ZoneAlarm Pro is the award-winning personal firewall that automatically blocks known and unknown Internet threats, barricading your PC against hackers and data thieves. It's easy to install and use, and comes with a year of free, automated product updates. Why risk it? Get protected.

Compatible with Microsoft® Windows® 95/98/Me/NT/2000 and XP

2000 and 2001 Award Winner
ZoneAlarm Pro

2000 and 2001 Award Winner
ZoneAlarm Pro

ZoneAlarm FREE Download

Stay Ahead of Hackers

ZoneAlarm Pro provides world-class protection against Internet-borne threats like worms, Trojan horses, and spyware. Connect to the Internet with confidence!

Compatible with Microsoft Windows 95/98/Me/NT/2000 and XP.

[Click here to download now.](#) [Click here for more info.](#)

ENTERPRISE ENDPOINT SECURITY

Zone Labs' award-winning technology already secures more than a million corporate and government computers, providing enterprise-class personal firewall protection with central manageability. To find out why companies like BMW and EDS selected the superior protection of ZoneAlarm Pro to harden their VPNs and safeguard their remote and mobile workers, [click here](#).

Zone Labs in the Enterprise

If you'd like to learn more about Zone Labs' enterprise solutions, receive detailed product specifications, or talk to a corporate account representative, please [click](#)

To get a free copy of ZoneAlarm just visit www.zonelabs.com. This software firewall is designed for protecting your personal computer from unwanted hacker invasions.

"anthrax" as "antrax," but virus writers like this one are likely just piggybacking on the terrorist attacks. Some warped individuals like the attention and power trip they get by stirring hysteria this way.

It's also been shown that many hacks and viruses in the past have come from within the United States, so premature conclusions should be avoided. Xenophobia has its own negative effects. Regardless of where Internet attacks originate, you need to protect yourself. One rule of thumb is to never open an e-mail attachment from someone unknown. Also, if someone you do know sends you an e-mail you weren't expecting, be wary about opening it, as viruses can trick you into thinking they're legitimate messages.

The latest worms—worms are viruses that can spread without human involvement—don't require you to open an e-mail attachment to do their dirty work. The recent Code Red and Nimda worms exploited vulnerabilities in Microsoft's server software. Microsoft Outlook is another frequent target.

FIGHT BACK WITH ANTIVIRUS SOFTWARE

If you're connected to the Internet, you need antivirus software. Also, as protection against hackers, you will need a firewall, particularly if you have a cable or DSL modem or are part of a local area network. The best regarded

antivirus program for some time has been *Norton AntiVirus* from Symantec, at <http://www.symantec.com>. The company also makes an excellent firewall called *Norton Personal Firewall*, as well as other security programs for individuals and businesses. An even better firewall program for individuals is *ZoneAlarm* from Zone Labs, at <http://www.zonelabs.com>.

Businesses sometimes need enhanced protection, and computer-security consultants have been quick to respond to post-September 11th safety concerns. Businesses are expected to react, despite short-term constraints on spending from recession concerns. The worldwide market for information-security services is projected to triple to \$21 billion by 2005, an annual growth rate of 25 percent, according to a recent report from IDC, an information technology research firm. Much of the growth in spending is

POINT AND CLICK

Norton AntiVirus
www.symantec.com

Norton Personal Firewall
www.symantec.com

Vmyths
www.vmyths.com

ZoneAlarm
www.zonelabs.com

predicted to take place within small businesses and the financial services sector.

Whatever security approach you take, keep your system current by installing patches and upgrades as they become available. Also, prepare for data recovery if disaster does strike. You will need to protect yourself from hoaxes as well, and <http://www.vmyths.com> is one of a number of "myth verification" sites you can refer to.

A CRASH COURSE IN ONLINE ETIQUETTE

Now that you know how to protect yourself from cyberterrorism, let's talk about protecting yourself from online embarrassment, a result of common mistakes made when posting online.

In one Internet discussion group I follow, some of the participants questioned the ethics of a company. The company was accused, among other things, of manipulating the online images of items they were selling to make the items appear more valuable than they were. The company got wind of this, and its attorney entered the fray. The lawyer, who in a phone interview later admitted he didn't have much online experience, adopted the rough-and-tumble online manner of some of the company's critics. His arrogance and unprofessional conduct caused a considerable commotion.

He ridiculed the computer competence as well as investigative capabilities of one critic and sarcastically told him he was wasting his time. He made belittling comments like: "Perhaps you need some suggestions as to what to do with your time. Perhaps you should take up knitting." He called his critics names such as "fool," "joke," and "loser," and also made veiled legal threats like "Are you inviting, or daring, us to sue you?" He defended himself by stating "I will hound that poor excuse of a human being until he yells uncle or stops posting vapid, unproven horse nonsense that all of you seem to believe." When people questioned his tactics, he tried to justify them by saying, "Why is it okay for that hot-air blower to keep ranting and not for someone to do the same thing to him?"

The above is an example of how "not" to conduct yourself online. What started out as a minor conflict involving a handful of people escalated into a

major brouhaha with scores of Internet posters expressing outrage at this company's behavior. The company undoubtedly lost customers as a result.

The upheaval could have been avoided by the use of a civil approach to the situation. Instead of engaging in gutter fighting, in which the lawyer sent dozens of angry, sarcastic posts in response to derogatory messages, he should have simply posted a single message thanking the company's critics for their feedback and offering to look into their marketing tactics. Then he should have followed through.

SOME FRIENDLY ADVICE ON POSTING

People have been making mistakes like this online since the beginning of the online era. *The Guide for Posting to Newsgroups* and *The Usenet Guide to Power Posting*, which have both been around for years, are designed to prevent these mistakes or at least shed humorous light on them. Various people have contributed tidbits to these documents, which are tongue-in-cheek, yet helpful. Here are some edited highlights from both:

- If you post and pretend to be a fool, people will believe you.
- Lurk until you get a feel for what's acceptable in a particular discussion group, then leap in and do the opposite.
- When people post deliberately inflammatory messages, they have no control over whether they succeed. You do.
- A person who says, "Sorry, I had to point that out to you," is always telling two lies.
- People always start out equal in Internet discussion groups. The playing field is level, and if you object to it, you reveal your inferiority.
- You are a vibrant, intelligent, and unique individual with a great deal to contribute. So is everyone else.
- If you post something funny or clever or wise, keep in mind that you're about the 4000th person to do so.
- The exclamation point denotes emphasis. The double exclamation point denotes that you think your concerns are more important than anyone else's.
- Use the smiley—which looks like

this :-) and is a sideways representation of a smiling face—to your advantage. You can call anyone just about anything as long as you include the smiley. With really nasty attacks add "No flames, please."

- If you can't say something nice about someone, say it on the Internet.
- When in doubt, insult.
- Saying "grow up" or "get a life" always does just the reverse. You don't stop a flamewar by pouring on gasoline.
- The best way to quash a flamewar is to ignore it. If a flame happens in a vacuum, it won't burn.
- If you want to win a flamewar, look good in the eyes of a reasonable person. Instead of invective, use logic; instead of mindless bravado, use mindful self-deprecation; instead of fury, use humor.
- Fabricate things about your opponent. You can make your lies sound true by prefacing your statements with the word "clearly."
- The more interesting your life becomes, the less you post—and vice versa.
- Internet discussion groups at times appear to be founts of perspicacity and wisdom, at other times the ultimate refuge for sociopaths releasing years of pent-up frustration.
- The demise of Internet discussion groups is imminent—and always will be.

Reid Goldsborough is a syndicated columnist and author of the book *Straight Talk About the Information Superhighway*. He can be reached at reidgold@netaxs.com or <http://members.home.net/reidgold.com>. P

Wireless & Electrical Cyclopaedia



ETT1—Wireless & Electrical Cyclopaedia \$4.99. Step back to the 1920's with this reprinted catalog from the Electro Importing Company. Antiquity displayed on every page with items priced as low as 3 cents. Product descriptions include: Radio components, kits, motors and dynamos, Leyden jars, hot-wire meters, carbon mikes and more. The perfect gift for a radio antique collector. To order ETT1, send \$4.99 (includes s&h) in the US and Canada to **Electronic Technology Today Inc., P.O. Box 240, Massapequa Park, NY 11762-0240**. US funds only. Use US bank check or International Money Order. Allow 6-8 weeks for delivery. MA11

TIPS FOR MAIL ORDER PURCHASE

It is impossible for us to verify the claims of advertisers, including but not limited to product availability, credibility, reliability and existence of warranties. The following information is provided as a service for your protection. It is not intended to constitute legal advice and readers are advised to obtain independent advice on how to best protect their own interests based upon their individual circumstances and jurisdictions.

1. **Confirm price and merchandise information** with the seller, including brand, model, color or finish, accessories and rebates included in the price.
 2. **Understand the seller's return and/or refund policy**, including the allowable return period, who pays the postage for returned merchandise and whether there is any "restocking" or "return" charge.
 3. **Understand the product's warranty**. Is there a manufacturer's warranty, and if so, is it for a U.S. or foreign manufacturer? Note that many manufacturers assert that, even if the product comes with a U.S. manufacturer's warranty, if you purchase from an unauthorized dealer, you are not covered by the manufacturer's warranty. If in doubt, contact the manufacturer directly. In addition to, or instead of the manufacturer's warranty, the seller may offer its own warranty. In either case, what is covered by warranty, how long is the warranty period, where will the product be serviced, is there a charge for service, what do you have to do to obtain service and will the product be repaired or replaced? You may want to receive a copy of the written warranty before placing your order.
 4. **Keep a copy of all transactions**, including but not limited to cancelled check, receipt and correspondence. For phone orders, make a note of the order including merchandise ordered, price, order date, expected delivery date and salesperson's name.
 5. **If the merchandise is not shipped within the promised time**, or if no time was promised, within 30 days of receipt of the order, you generally have the right to cancel the order and get a refund.
 6. **Merchandise substitution** without your express prior consent is generally not allowed.
 7. **If you have a problem with your order or the merchandise**, write a letter to the seller with all the pertinent information and keep a copy.
 8. **If you are unable to obtain satisfaction from the seller**, contact the consumer protection agency in the seller's state and your local Post Office.
- If, after following the guidelines, you experience a problem with a mail order advertiser that you are unable to resolve, please let us know. Write to Advertising Department, Gernsback Publications Inc., 276 6 Marcus Blvd. Hauppauge, NY 11788

Be sure to include copies of all correspondence.

BENCHMARKING VIDEO CARDS

How do you judge when it's time for a video card upgrade? With card chipset vendors introducing new video chipsets about every six to nine months, it doesn't take very long for your PC's video capabilities to fall several generations behind the state of the art.

Just how serious this "video card lag" actually is largely depends on what applications you run and how well your current video card performs while these applications are running.

Game players are at the greatest risk of suffering from "video card anemia" or "tired card." That's largely because new versions of video games present graphics more realistically, making greater demands on a card's capabilities. Adding to the strain, the latest version of Microsoft's DirectX 8 video API (Application Program Interface) continues to require more horsepower out of a video subsystem. At the same time, while nVidia's GeForce 3 chipset has been available since mid-last-year and is in its second iteration, only in the last couple of months have games started to appear that actually take advantage of some of the chipset's more advanced features. If these are not the kinds of games that you usually play (or if you aren't much of a game player at all), you can probably get by with a less advanced and less expensive video card—perhaps the one that you already have.

TESTING, TESTING, ONE, TWO, THREE

The best way to determine whether your video card needs to be upgraded is to examine its performance. Sometimes, this is as easy as just noticing that the video skips and hesitates dur-

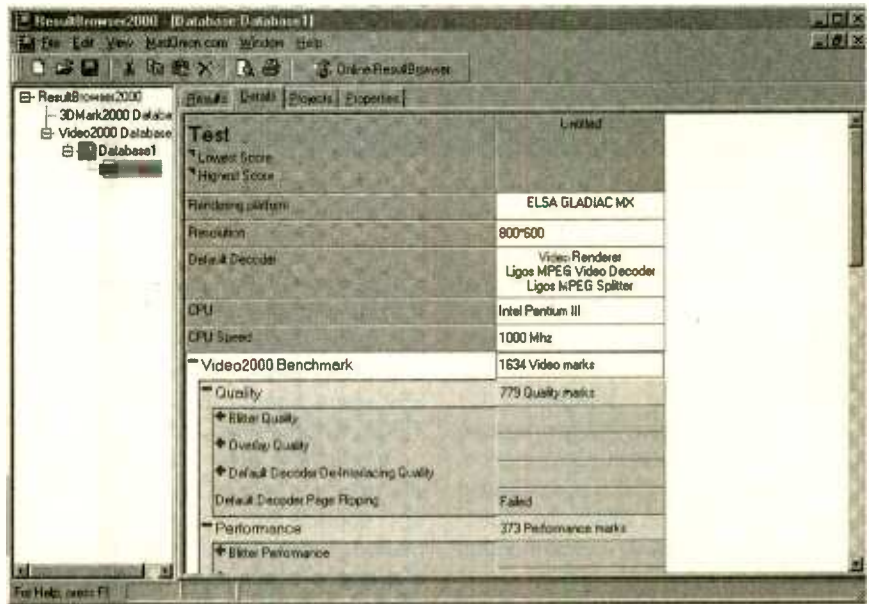

Here is the typical results screen from MadOnion's Video2000 benchmark utility. A point system is used to rate the performance of various video-card functions. A numeric scoring system grades the various functions of the card under test.

ing certain applications. The problem with this approach is that it's almost impossible to determine, just from the symptoms, whether the cause is a slow video card or some other component.

A more formal process, using benchmarking software, is generally a better solution. A benchmark is simply a measuring tool. By recording the results of a test where all of the parameters are known, you can establish a reference point. This point can then be used as a basis of comparison when running a different configuration of components.

Benchmarking has long been used in comparing PCs. Video benchmarking is a somewhat newer endeavor. There are a number of video benchmarks available, almost all of them

shareware or free. The excellent system diagnostic utility, *Dr. Hardware* (www.drhardware.de), contains a video benchmark test, as does the *PassMark* benchmark (www.passmark.com). The problem with using either of these is that while you can benchmark your own installation, you really have no basis of comparison unless you have access to a variety of other systems to use for performing the benchmark tests. To truly determine how your current video card setup stacks up against different video configurations, a good choice would be to use the video benchmarks available from MadOnion (www.madonion.com). Previously named Future-Mark Corporation, MadOnion provides a variety of benchmarks and other system diagnostics to

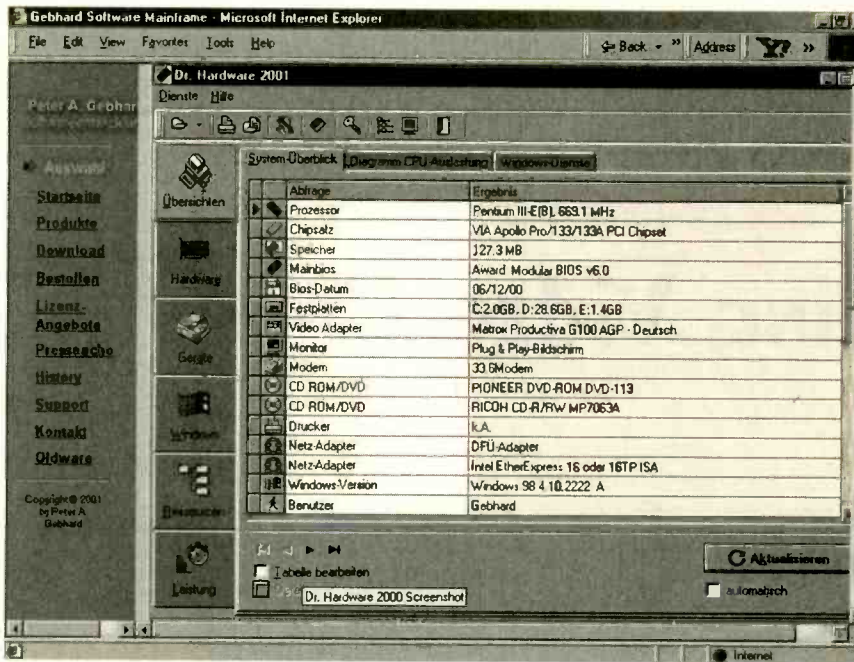

Here is another example of a benchmark result screen. This time we see Dr. Hardware in action. Don't adjust your eyes; the image text is Danish, because this screenshot is from the Denmark-based Web site.

both the amateur and professional markets. In association with the non-profit industry group BAPCO, MadOnion acts as the distributor for the *SysMark2001* and *WebMark2001* benchmarks that many magazines use to determine PC system performance. On the video side of the benchmarking equation, MadOnion offers the *Video2000* and *3DMark2001* benchmarking suites.

DO TRY THIS AT HOME

Both of these suites are available in free versions that you can download from MadOnion and other download sites, as well as a professional version that needs to be purchased. The difference between the two is that the free version has to be used in conjunction with the Online Result Browser on MadOnion's Web site, which lets you "publish" your configuration and results and compare it to those published by other MadOnion benchmark users. You don't have to compare apples to apples. For example, you can compare your older RIVA TNT card in your 500-MHz Pentium III desktop to another user's GeForce3 Ti500 in the same type of system or in a slower or faster PC.

The "professional" versions of the two benchmarks are exactly the same. However, they let you use a self-contained Result Browser, so you can

compare one video card to another in the same base system. That's the project we're undertaking right now, with almost a dozen cards ranging from \$69 value boards to \$400 GeForce3 Ti500 performance cards.

Video2000 and *3DMark2001* are designed to test and benchmark different aspects of video card performance. *Video2000* is more of a general-purpose benchmark. It tests a video card's ability to scale images and to encode and decode MPEG files. To fully run all of the benchmarks, you must have a DVD player utility installed (though you don't actually have to have a DVD-ROM drive in your system.) If you don't have a DVD-ROM drive, simply download a trial copy of *PowerDVD* from CyberLink or *WinDVD* from Intervideo.

The *3DMark2001* is a benchmark for gamers that requires that Microsoft's DirectX 8 be installed on your PC. This application has a number of

"scenes" that look like they came from several 3D games (in fact, you can actually play several of these demo games, at least for a short while.) The tests in *3DMark2001* check frame rate, texture and shading, and polygon fill rates, among other things. It also automatically grabs frames generated by your video card, directly out of the frame buffer. The benchmark stores these frames in a subdirectory, so that you can compare them to reference copies of the same frame that are installed in a separate "Quality" subdirectory when the application is installed. This option can let you pinpoint how well your current video subsystem handles color and aliasing.

Both benchmarks have a full explanation of what tests are performed and how the results are analyzed and computed. These details are contained in the Help files that are accessible after the program is installed.

CONCERNING BENCHMARKS

There are a couple of caveats in using the *Video2000* and *3DMark2001* benchmarks. The first is that they are both very large downloads. Unless you have a broadband connection, you may want to find someone who does and can burn it onto a CD-R for you. Once it is installed, you can turn either suite into the professional version by simply paying a fee to MadOnion and receiving an unlock code, which enables the Result Browser for the specific product.

The other caveat has to do with comparing the results of the benchmark with those posted online. Just to experiment a bit, we ran *3DMark2001* on a pretty souped-up system. This is a dual CPU DVD-R burning workstation that we just built for next month's column—based around two 2-GHz Intel Xeon chips. It has 1GB of RDRAM and, at least initially, an nVidia GeForce 3 Ti500 video card. It turned in a score of just under 7100 3DMarks, which we thought was excellent. At least we thought that until we compared it with similar GeForce 3 scores online. Some of these scores were as high as 11,000 3DMarks!

The difference comes from over-clocking. Some of the systems were listed as 2.5-GHz Pentium 4s. Intel doesn't produce a P4 rated at higher than 2-GHz at the moment, so some

(Continued on page 42)

SOURCE INFORMATION

Dr. Hardware
www.drhardware.de

MadOnion
www.madonion.com

PassMark
www.passmark.com

High-Definition TV—Is It Worth The Hype?

The waterfall, cascading down majestic cliffs from dizzying heights and exploding in a cloud of crystal mist seems almost close enough to touch. You see every groove in the rocks, and you'd swear you could make out each crystalline drop of water as it reflects the sunlight. As you watch mesmerized, the thunderous sound of churning water seems to carry you along with it. You close your eyes and get lost in sensory overload.

Tearing your eyes away from the expansive screen, it takes you a moment to get back to reality. There, an eager salesperson waits, hoping to sell you this latest of technological innovation.

The latest installment in a series of ever-evolving television technology, the HDTV (High Definition Television) blows all previous models away. The HDTV system makes the 32-inch color version of the 1990s look like the first black-and-white TV sets that our parents' generation showcased with pride in their living room. With HDTV, you have a greatly enhanced video and audio quality that could previously only be experienced inside a movie theatre.

HDTV is not only better in quality, but is user friendly and customized for the preferences of its owner. When you press the power button, a display will pop up showing all your viewing options. No longer is it necessary to sift through the *TV Guide* or wait for the Preview Channel to finish scrolling. The detail-enhanced picture and booming 5.1 channel sound give you a sense of reality. When you turn to your favorite boxing match, you'll feel like

HDTV

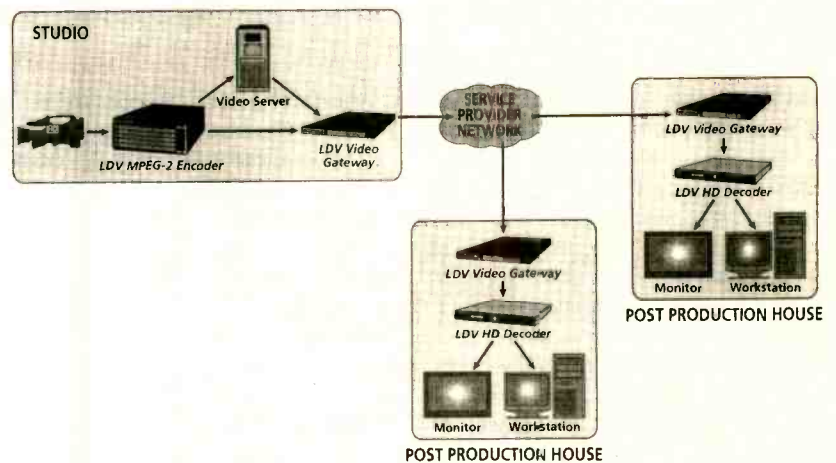

Companies such as AASTRA Digital Video (www.aastra.com) manufacture the various modules necessary for encoding and decoding HDTV signals. Above is a diagram of a typical HDTV environment.

you're right there in the ring.

One of the best "little extras" offered by HDTVs is the personal option selection. Now, you can choose which news segments to watch, what stocks to follow, and your favorite sports teams to track. With these added personalized features, your television set becomes an interactive tool, not merely something to watch in the hopes of discovering a worthwhile program. Channel surfing for gold will soon become obsolete—just as current televisions will.

"So. What do you think?" the salesperson asks in anticipation, and you tell him you want to mull it over.

Is the latest and greatest in television technology worth the \$8000–\$12,000 price tag? Can they really be

that different from the current brand-name color television complete with 32-inch screen and Picture In Picture (PIP)? You bet they can! High-definition television, a subset of digital television, is making waves across the world. A new standard of television is fast approaching—experts predict around the year 2006—in which everyone will replace their color TVs with the newest HDs. So are we ready for this standard? Let's look at the history of the world's most popular form of entertainment and see how we got to this point.

Remember the old black-and-white television? With its tiny screen, fuzzy images and channel dial, this piece of equipment seemed like a miracle of technology fifty years ago. Compare this first TV to the color televisions that

appeared on the market about twenty years later. In the late 1980s and into the 1990s, even more features were added: PIP, Cable TV, satellite dishes, etc.

THE TECHNOLOGY BEHIND THE TUBE

So how do traditional televisions work? Stand next to your TV and look closely at the screen. You should see many horizontal lines (480 to be exact). "A device at the rear of the picture tube shoots a beam of electrons at the phosphor-coated rear of the screen, painting a new picture sixty times per second but drawing only every other line. Every 1/30 of a second, the off-numbered lines are drawn on the screen, and 1/60 of a second later, the even-numbered lines come in. So thirty times each second, the entire image is redrawn, but this happens in two interlaced pieces," explains Professor Kelin Kuhn, an expert in consumer electronics.

Although the scientific principles used to develop television broadcasting were discovered in the late nineteenth century, it was not until the 1920s that these theories were used towards the development of the first TV. In 1873, the Scottish scientist James Clerk Maxwell predicted the existence of electromagnetic waves, which are what make television broadcasts possible. A few years later, scientists discovered photoconductivity—when the electrical conductivity of selenium changes when subjected to light. They also found that certain substances emit electrons when light falls on them. These findings were applied to the vidicon television camera tube and the image-orthicon television camera tube. The electrical currents produced by this transformed light were weak, however; and it wasn't until the 1920s that a television vacuum tube was enhanced enough so that it could be used to augment electric currents for television.

TV COMES ALIVE

Before families were able to watch *The Ed Sullivan Show* and *I Love Lucy*, a few essential developments occurred to make it all possible.

The Nipkow Disk—According to *the Encarta Online Encyclopedia*, in 1884, German engineer Paul Nipkow designed what is known as the Nipkow Disk,

which is the first true television device. He placed this scanning disk, which had a spiral pattern of holes punched in it, in front of a brightly-lit picture. As the disk revolved, each hole would pass along the picture at slightly different levels, creating a form of scanning. With each complete revolution of the disk, each part of the picture would be briefly exposed. With similar disks rotating in the camera and receiver, unrefined television images were thus created.

Electronic Television—A few years after Nipkow developed his mechanical scanning method, an electronic method of scanning was introduced. In 1908, Englishman Campbell-Swinton discovered that by using a screen to "...collect a charge whose pattern would correspond to the scene and then using an electron gun to neutralize this charge..." he could then create a varying electric current.

Cathode Rays—Cathode rays, or beams of electrons in evacuated glass tubes, were discovered by Sir William Crookes in 1878. By 1908, a Cathode-Ray Tube (CRT) was being used to reproduce a television picture on a phosphor-coated screen. This CRT was developed for television use in the 1930s by American electrical engineer, Allen DuMont.

Public Broadcasting—There were two competing firms in London that first started to broadcast television signals. One of these signals, from Marconi-EMI, was far superior to the

other and in 1937 became the standard in London. The United States soon followed, incorporating a 525-line, 30-image per-second standard in 1941. The first U.S. broadcasts took place in 1939, but were put on hold because of World War II. After the war ended, however, a television-broadcasting explosion took place; and the industry has grown rapidly ever since.

Color Television—In 1904, people realized that it was possible to broadcast by using the three primary colors—red, green, and blue. Thirty-six years later, the first color television system was introduced by Peter Goldmark. By 1951, public broadcasts of the Goldmark color TV system were being sent to homes across the nation. Over time, other developments occurred that improved the quality of television. Some of these included larger screens, better broadcast/transmitting technology, projection or portable options, and cable/satellite.

AND ALONG COMES DIGITAL TELEVISION

Digital television receivers, which "...convert the analog, or continuous, electronic television signals received by an antenna into an electronic digital code (a series of ones and zeros), are currently available."—*Encarta Online Encyclopedia*. The analog signal is sampled, processed, and then retrieved, creating a clear picture and crisp sound. The difference between digital and regular television is similar to the difference between a tape recording and a compact disc. The tape is slightly distorted and not nearly as clear as a compact disc recording.

There are many other benefits to going digital besides quality of picture and sound. Because of significantly increased bandwidth, there is greater information transfer capability, more types of transmittable information, greatly improved consistency of the data over distance, and reduced picture problems. With Digital TV comes a new form of interaction. People can decide what they watch on a daily basis and are not limited to the video that is being broadcast on a certain schedule.

NOW BACK TO HDTV

No more will you be able to tell

(Continued on page 42)

HDTV HISTORY AND FORECAST

(Source: *Encarta Online Encyclopedia*)

April 1997: FCC gives broadcasters \$70 billion worth of spectrum to broadcast digital along side analog until 2006. FCC also mandates that in 2006 all broadcasts must be digital.

November 1998: PBS, ABC, NBC, CBS, and FOX are committed to broadcasting digitally in the top ten U.S. markets by November 1.

May 1999: Broadcasters must have digital stations in top 30 U.S. markets.

2006: Broadcasters must relinquish extra broadcast spectrum and broadcast only digital.

HUGO GERNSBACK:

The Inventor, The Prophet, And The Father Of Science Fiction

MARIA ORLANDO



His extraordinary vision inspired experimenters and inventors to make their dreams become a reality.

Called a genius by many, a prophet by others, Hugo Gernsback was certainly a man with a remarkable vision and unique perception of the world of science.

First and foremost, Hugo Gernsback was a distinguished inventor with an extraordinary gift—the ability to predict the future. He also integrated science with philosophy and creativity, which set him apart from other experimenters of his time. Gernsback was extremely ambitious, and he was truly inspired by the potential wonders that awaited scientific discovery.

Gernsback managed to patent over 80 inventions in his lifetime; and although many of them were useful and practical, it seems that he is most known for the quirky, outlandish inventions he introduced to the world. To the surprise of many, however, a number of those “quirky” inventions actually laid the groundwork for future inventions and more advanced technology.

Gernsback—The Businessman. Hugo Gernsback was born in Luxembourg in 1884. He received his education at European technical schools until he immigrated to America in 1904 and became a naturalized U.S. citizen. Although he is most honored for his visions and developments in technology, Gernsback should also be recognized for being enterprising and industrious. His passion for amateur radio motivated him to start his first business venture in 1904—The Electro Importing

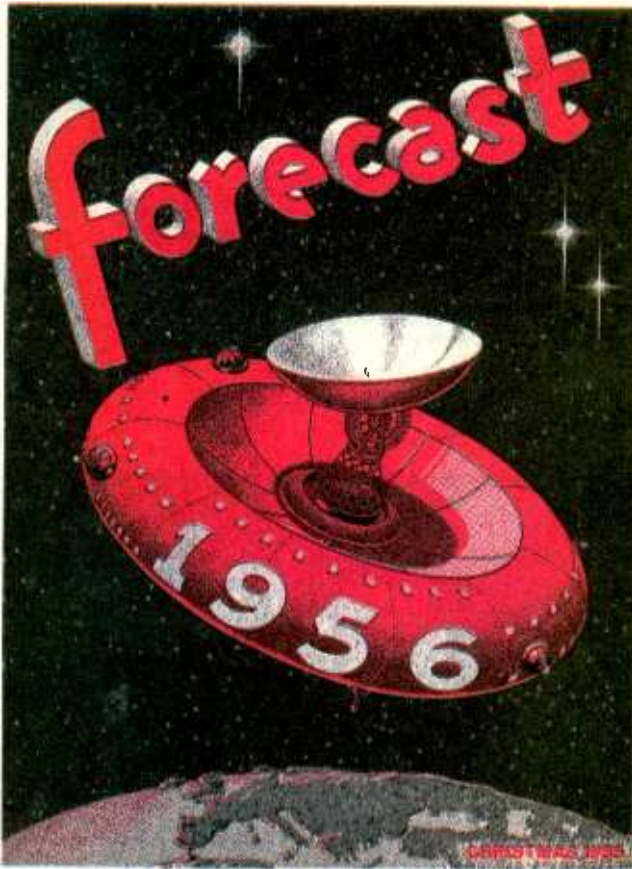

Hugo Gernsback was a prolific writer of speculative science. He often organized his numerous inventions and ideas into a pamphlet that he would print to share with friends and associates. Here is the cover to one particular collection entitled *Forecast 1956*.

Co.—which specialized in experimental electrical goods and radio parts. His intended market were his fellow radio hobbyists, and in 1906 his store sold the first radio ever offered to the public.

The Electro Importing Co. was a retailer and importer, as well as a manufacturer. Claiming to be the world's first company to specialize in radio materials, it grew rapidly; and the company had to relocate several times due to expansion and tremendous sales volume. The reason for its success, Gernsback maintained, was that the company offered value for their products. Their primary customers, experimenters and hobbyists who had little in the way of income, were not likely to spend exorbitant amounts of money on electrical parts and gadgets. Gernsback's company was proud to offer affordable products to a world full of radio and electrical enthusiasts, coining the motto "Enormous Value For The Money, And The Famous E.I. Square Deal."

His Influence On Science And Technology. Gernsback had a very strong influence on the technological advances of radio and television, because he envisioned their future and unlimited potential. He advocated the importance of both as major communication tools, and through his magazines (see sidebar) he promoted radio and television as social necessities. He forecast television's popularity, its physical characteristics, and its widespread use in the home.

He continued to pursue new inventions and experiments in the midst of his hectic life as editor, writer, and publisher. Although he patented some 80 inventions throughout his life, he claimed he didn't profit from a single one of them. Here is just a partial list of his inventions:

- A layer-built battery, his very first invention, and later dry-cell and dry-storage batteries.
- An apparatus on the ground to help airplanes land, with giant electromagnets to slow the planes down and lubrication to avert unnecessary friction, wear, and noise.
- The osophone, which is a device for transmitting sound vibrations through bones and teeth, to supposedly help the deaf hear.
- Several circuits, including the Interflex and the Peridyne, the first circuit to use non-magnetic metal in the field of a coil.
- A book condenser, used in early Crosley TV sets, with a compression-type variable capacitor.
- A hypnobioscope, an osmosis type-tool used for sleep-learning.
- His last invention, which he never patented, was a device for detecting the charge on an electret.

Metamorphosis: The "Wonder" Years. A profound event occurred in Hugo Gernsback's life that set the stage for his passion for science fiction. As a youngster, he read the book *Mars As The Abode Of Life*, written by the renowned American astronomer Professor Percival Lowell. He was astonished, and completely overwhelmed, at the premise that alien life could exist on other planets. For the rest of his young adulthood and throughout his entire life, he was compelled to take science as he knew it to another level—the far-fetched and fantastic world of science fiction.

Gernsback, called a "dreamer and misplaced inventor," had a knack for walking—and sometimes crossing—the fine line between hard science and science fiction. He stepped beyond the "hard facts" door and ventured into the realm of the unknown. He spent his life linking science and technology with imagination and flights of fancy. His love for science fiction grew from his high expectations of science exploration.

Although he did believe that most good science fiction should contain an element of feasibility in order for it to be authentic, there were many pieces he published throughout his lifetime that seemed pretty surreal and outrageous to readers at the time. When Gernsback published the article "Can We Radio The Planets" in *Radio News* in 1927, most readers enjoyed it as entertainment. However, when we eventually attempted radio contact with Venus years later, credit was given to Gernsback for suggesting the idea in the first place.

Though he was still very interested in hard science and technology, he had broadened his horizons and let his imagination roam far afield. He became an avid reader of Jules Verne and H.G. Wells and began writing on his own, as well. In 1911, he experienced a bout with writer's block while trying to finish an article for *Modern Electrics*. It was then that his novel *Ralph 124C41+* was born.

The book was not well-received in many literary circles, and it was chastised for its simplistic style and shallow characters by some. However, it was highly acclaimed for Gernsback's staggeringly accurate predictions, cleverly planted in his prose. The science-fiction novel describes the use of radar, plastics, tape recorders, fluorescent lighting, rustproof steel, and hydroponics, all of which are commonly used today.

Gernsback was not afraid to explore the unimaginable, and he believed that "wild stories" envisioned by writers of science fiction actually inspire would-be inventors to transform fantasy into reality. He postulated that the "germ of an invention" is often hidden in those works of fiction that at first seem preposterous and truly bizarre. The motto on the editorial page of *Amazing Stories* reads: "Extravagant Fiction Today...Cold Fact Tomorrow." Despite his conviction that unbelievable notions are the seeds of tomorrow's technology, he did consider genuine science fiction to possess an element of possibility. He also assumed that science fiction encouraged the progress of the world in a way that no other literature does.

His magazine, *Amazing Stories*, had an extensive readership; and its popularity was aided by contributions from such celebrated authors as Jules Verne, Edgar Allen Poe, and H.G. Wells. Gernsback cited an old adage "What Man Can Imagine, Man Can Accomplish," which was printed on the inside cover of *Amazing Stories*. He believed this to an extent, but he regretfully admitted that not everything conceivable is viable. "For instance," he said, "I can imagine that I blow out the sun, or grasp the moon in my hand, or cut off my head without dying."

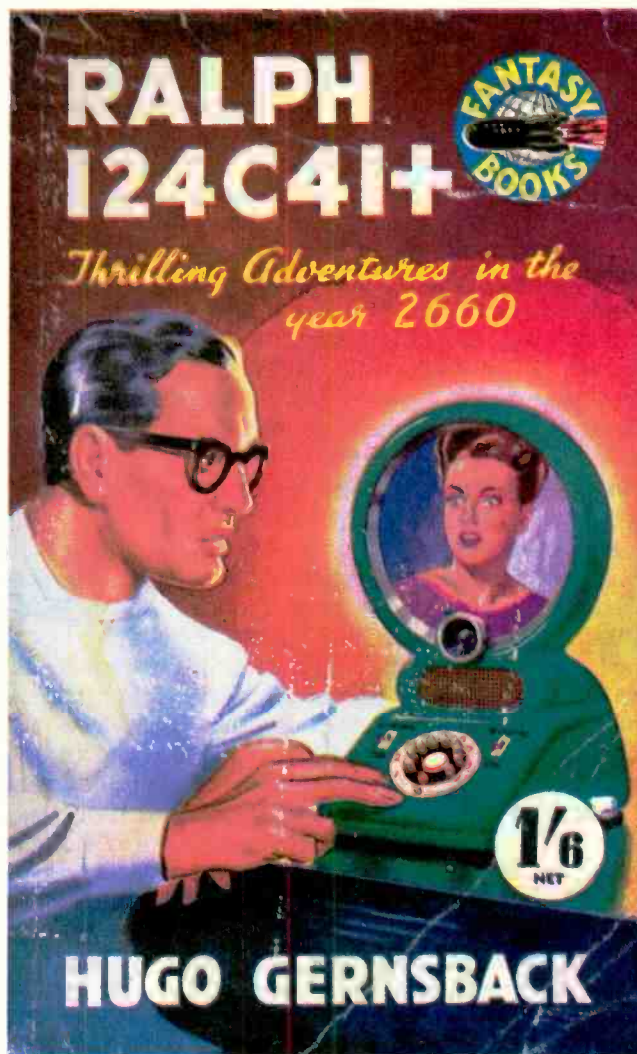

The only Science Fiction novel penned by Hugo Gernsback was *Ralph 124C41+*. An original copy of this prophetic book exists in the Gernsback archive.

MAGAZINE TIMELINE

- 1908 *Modern Electrics*—his first publication, which finally became known as *Popular Science Electrical Experimenter* (became *Science and Invention* in 1920)
- 1918 *Radio News* (became *Popular Electronics*, currently *Poptronics*)
- 1926 *Amazing Stories*
- 1929 *Wonder Stories*
- 1929 *Radio Craft* (first became *Radio Electronics* and then *Electronics Now*)

Here are some of the many other magazines he published throughout his career:

- Amazing Stories Quarterly*
- Bizarre*
- Cookoo Nuts*
- Forecast*
- Quip*
- Scientific Detective Monthly*
- Science Fiction Plus*
- Science Wonder Quarterly*
- Tid Bits*
- Your Body*

Gernsback—The Humorist. What some may not realize about the late Hugo Gernsback is that he maintained a great sense of humor. His writing was very clever and teeming with satire; his wit and element of facetiousness often went unnoticed because of his involvement in earnest, scientific interests. Critics have said "Gernsback is a man of almost rapier-like wit, with a chronically mischievous gleam in his eyes and with the rare ability to joke about his own misfortunes."

Gernsback wrote a series of articles under the name Mohammed Ulyses Fips, in which he introduced inventions that were meant to be humorous—he always published them in April in honor of April Fool's Day. However, some of the devices he described were quite practical and even resemble some products in existence today. He poked fun while spinning yarns about gadgets like a Noise Neutralizer, a Snore Kill, a Cordless Radio Iron, and a Visie-Talkie.

Another notable "hoax" of a magazine was *Forecast*. For years he sent out this highly unusual Christmas card to colleagues, friends, and relatives. The pamphlet contained several of Gernsback's peculiar predictions for the future. These holiday issues of *Forecast*, although primarily intended for entertainment, featured views of the future that were not entirely impossible. In one instance, he wrote about the electronic brain, now known as the computer, and its capability to reason and solve complex problems. Another story described a two-wheeled car, a narrow-bodied automobile assisted by a gyroscope. Still other forecasts implied airmobiles, space-coffins, and extra-sensory perception.

Hugo Gernsback was the acknowledged Master of Science Fiction; in fact, the Science Fiction Association named their annual award for the best work of science fiction the "Hugo." Last year the "Hugo" was presented to J.K. Rowling, the author of the astoundingly popular *Harry Potter* series. Gernsback is also commonly known as the Father of Science Fiction.

Hugo Gernsback: An Unorthodox Innovator. *The New York Times* described his life admirably in his obituary, which appeared on Sunday, August 20, 1967. It read:

"Hugo Gernsback, an inventor, author, editor, and publisher, who has been called the father of modern science fiction....Mr. Gernsback described radar 35 years before communication experts bounced a radar signal off the moon in 1946 and sponsored the first television broadcasts in 1928....*Life Magazine* once called him the Barnum of the space age—the debonair Mr. Gernsback was honored by the radio industry in 1953 in recognition of his first 50 years of inspiring leadership in radio-electronic art."

Hugo Gernsback is remembered for all of his contributions to technology, science, and publishing, and most of all, his extraordinary visions that inspired experimenters and inventors to make their dreams a reality. **P**

1-800-USA-NAVY.

**World Wide Web:
http://www.navyjobs.com**

3 NEW BOOKS for the Project Builder



BP355—A GUIDE TO THE WORLD'S RADIO STATIONS \$7.99

Provides the casual listener, amateur radio DXer and the professional radio monitor with an essential reference work designed to guide him or her around the ever more complex radio bands. An invaluable aid in helping all those who have a radio receiver.

PCP113—THE PC MUSIC HANDBOOK \$10.99

This book takes you through the creative possibilities of the PC and acts as a guide in the twin minefields of choosing software and hardware for making music. This book will be of interest to the professional musician, the gifted amateur or the just plain curious.



BP301—ANTENNAS FOR VHF AND UHF \$6.99

From installing a TV or FM antenna to setting up a multi-antenna array for shortwave listening or amateur radio, this book explains the basics of VHF and UHF antenna operation and installation. The text describes in easy-to-understand terms the essential information about how antennas work, the advantages of different antenna types, and how to get the best performance from an antenna.

Mail to: **Electronic Technology Today, Inc.**
P.O. Box 240 • Massapequa Park, NY 11762-0240

Shipping Charges in USA & Canada

\$0.01 to \$5.00	\$2.00	\$30.01 to \$40.00	\$6.00
\$5.01 to \$10.00	\$3.00	\$40.01 to \$50.00	\$7.00
\$10.01 to \$20.00	\$4.00	\$50.01 and above	\$8.50
\$20.01 to \$30.00	\$5.00		

Sorry, no orders accepted outside of USA and Canada. All payments must be in U.S. funds only.

Number of books ordered.

Total price of books \$ _____
 Shipping (see chart) \$ _____
 Subtotal \$ _____
 Sales Tax (NYS only) \$ _____
 Total enclosed \$ _____

Name _____
 Address _____
 City _____ State _____ ZIP _____

Please allow 6-8 weeks for delivery.

ET04

NEW LITERATURE

Digital Signal Processing Technology

by Doug Smith, KF6DX
ARRL

225 Main St.
Newington, CT 06661
888-277-5289
or 860-594-0200
www.arrl.com

\$44.95

Explore digital signal processing in this comprehensive text written for radio amateurs and engineers. Basic enough for those less skilled in mathematics, the book is still challenging for more advanced mathematicians. The author highlights current research, discusses digital sampling, examines the design of hardware and software, and more. Presented from an engineering perspective, the material maintains a balance between theory and practice.

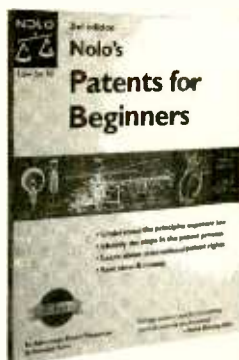

Nolo's Patents For Beginners, Second Edition

by David Pressman and Richard Stim
Nolo

950 Parker St.
Berkeley, CA 94710
510-549-1976
www.nolo.com

\$29.99

If you are an entrepreneur deciding whether or not to patent your idea, this comprehensive introduction to the patenting process may provide some answers to your questions. In simple terms, this edition defines what a patent is. It also includes the latest information regarding federal laws, legal issues in other countries, resolutions for disputes, and locations for researching more about patents.

Random Graphs, Second Edition

by Bela Bollobas
Cambridge University Press
40 West 20th St.
New York, NY 10011
212-924-3900
www.cambridge.org

\$44.95

An up-to-date, comprehensive account of the random graph theory, this edition of what's considered a "classic" text contains two new sections, numerous new results, and over 150 references. One goal of this theory is to estimate the number of graphs of a given order that exhibit certain properties. Intended for mathematicians, computer scientists, and electrical engineers, this self-contained resource can be used for self-study, as well as in advanced courses.



Computer Communication Tools Catalog

from B&B Electronics

707 Dayton Road
P.O. Box 1040
Ottawa, IL 61350
815-433-5100
www.bb-elec.com

Free

This catalog features hundreds of computer communications tools, including cable-end converters, data acquisition sensors and modules, smart data switches, and software for data analysis and control. Some of the new products presented in the latest catalog are a four-port USB hub, industrial keyboards, an isolated converter, and a high-energy surge protector. A complete product index, with new items highlighted, helps readers find the product they want.



Understanding Telephone Electronics, Fourth Edition

by Stephen J. Bigelow,
Joseph J. Carr, and Steve Winder
Newnes, Butterworth-Heinemann
225 Wildwood Ave.
Woburn, MA 01801-2041

781-904-2500

www.newnespress.com

\$29.99

A standard reference and training tool in the field of telecommunication electronics, this edition is an excellent resource for technicians, engineers, students, and electronics enthusiasts. The text offers extensive coverage of the latest technology of fiber optics, cable TV, Internet services, and CTI. It also incorporates updated information related to voice mail, phone networking, satellite communications, wireless paging, and other recent advances in technology.



ALL ABOUT...

(continued from page 15)

voltage levels.

However, with today's solid-state electronics needing low voltages generally less than 50 volts, but at much higher currents, and the availability of very cheap silicon diodes, this circuit is used less often. The circuit basically uses the diodes as half-wave rectifiers, one for each half of the cycle. A transformer having a 24-volt center-tapped winding is needed. The resultant DC currents in the transformer secondary are in opposite directions, so the magnetization of the core tends to cancel. The output

flows out through the upper right diode, through the load, and returns through the lower left diode. We are using the standard convention that current flows from positive to negative.

On the reverse half of the cycle, when the top lead is negative, current flows through the lower right diode, through the load, and back through the upper left diode. The non-conducting diodes are reverse-biased, so no current flows through them. Each diode must be able to withstand the peak voltage of the AC-wave or about 17 volts. However, since four diodes are needed, the load current must flow through two diodes during each half-cycle. This means a

with a transformer, enabling one terminal of the DC output to be grounded; since the secondary winding can be left "floating."

Double Or Nothing

There is a circuit to produce a higher DC-output voltage than the AC-input would normally produce in the previous circuits. This one is called a half-wave voltage doubler. In the circuit shown in Fig. 4, a series-input capacitor, C1, is used. When an AC voltage is applied, D1 conducts when the cycle goes negative, charging C1 to the peak AC line voltage. This is around 170 or 340 volts DC for 120- or 240-volt lines, respectively. Note that this DC voltage will be in series with the AC line voltage.

Neglecting any diode drop (this is okay for the normal line-voltages of 120 or 240) will swing the voltage across D1 and that applied to D2 between 0 and +340 volts (680 volts, if 240-volt line). Therefore, C2 will charge up to this peak voltage, and a DC voltage of 340 or 680 volts will appear across C2. This voltage will have a 50- or 60-Hz ripple component.

Note that diodes D1 and D2 must withstand the full peak-to-peak line voltage. Capacitor C1 must be rated for at least the peak AC line voltage, while C2 must have a DC working voltage equal to the peak-to-peak line voltage. The negative DC terminal here is also connected to one side of the AC line. If line isolation is needed, a transformer can be used. In practice, this circuit is used more for 120-volt applications than for 240, since a simple half-wave rectifier can produce voltage over 300 directly from a 240-volt line. However, it is also used in some high-voltage power supplies for high-power RF amplifiers used in amateur and commercial service.

This circuit and its relatives allow use of a relatively low-voltage transformer to produce high voltages. As an example, the author has a Ham radio linear RF amplifier using an 800-volt AC transformer delivering 1.5-amps AC to a voltage doubler. This setup produces the

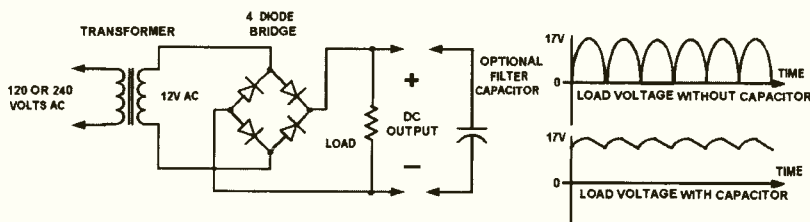

Fig. 3. This circuit is a full-wave bridge and uses four diodes, but no center-tapped supply is needed.

voltage is still a series of sinusoidal pulses, but there is no gap as in the half-wave rectifier. The average value is now $(2/\pi)$ or 0.636 times the peak value, or 10.8 volts DC. A smaller filter-capacitor can be used, since the ripple component is now 100- or 120- Hz for 50 and 60 Hz, respectively.

As we've said, each winding of the transformer is used for only half of the cycle and carries half the average load current; so although two windings are needed, smaller wire can be used in the transformer windings. The PIV across the rectifier is still twice the peak value of the AC input of 12 volts to each rectifier, about 34 volts. This circuit only needs two diodes, but the center-tapped transformer adds to the cost of the circuit.

No Center Needed

There is a way to get full-wave rectification without a center-tapped transformer. Four diodes are used in the circuit shown in Fig. 3. Since solid-state diodes are very cheap, the extra cost and complexity is not a problem as it would be with vacuum tubes. This rectifier circuit is called a full-wave bridge (FWB) rectifier. Examining the circuit, you see that when the instantaneous AC voltage across the transformer secondary is such that the upper lead is positive, current

drop of about 1.4 volts versus 0.7 volts in the previous examples. This voltage loss may be significant with low-voltage inputs (less than 10 volts) since it limits the available output voltage. As before, a capacitor can be used to filter the DC-output.

One problem with the FWB is that, unlike the previous two circuits, the DC output and AC input are unable to share a common ground reference. Look at Fig. 3. If either DC-output terminal is grounded and one side of the AC-input is grounded, the rectifier will be shorted out. This makes for problems where one is forced to use a grounded AC-supply, such as the 120- or 240-volt household AC mains, as the DC output will have both terminals "hot" with respect to ground. Many solid-state TV sets use this approach, and it makes it necessary to use an isolation transmitter for servicing purposes. For this reason, most FWB circuits are used in conjunction

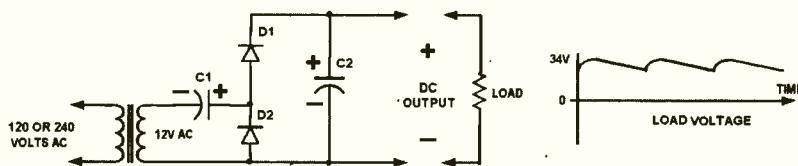

Fig. 4. In the circuit shown here, a series-input capacitor, C1, is used. When an AC voltage is applied, D1 conducts when the cycle goes negative—charging C1 to the peak AC line voltage.

**NORTH COUNTRY RADIO:
A HAVEN FOR WIRELESS BUFFS**

Graf and Sheets are no strangers to the pages of Gernsback. Their educational projects, such as the *RF-Field Strength Meter* and the *MPX2000 FM Transmitter*, can be found at **North Country Radio**. Established in 1986, this company offers projects related to amateur TV transmitters/receivers, AM and FM transmitters/receivers, video cameras, and numerous other subjects. Visit the Web site at www.northcountryradio.com for more information.

Ordering Information PO Box 53, Wykagyl Station, New Rochelle, NY 10804-0053 Voice: 914-235-6611 Fax: 914-576-6051; e-mail: Rgraf30832@aol.com.

Engineering and Technical Support PO Box 200, Hartford, NY 12838 Voice/Fax: 518-854-9280 e-mail: support@northcountryradio.com

Now For A Triple Play

The voltage-doubler can be turned into a tripler by adding another diode and capacitor as shown in Fig. 6. In this circuit, the AC-voltage component present across D1 is coupled to D3, which is connected to the voltage-doubler positive-output terminal. Diode D3 acts as a half-wave rectifier and charges to the peak AC-line voltage of 170 or 340 volts, respectively. This circuit charges C4 up to almost three times the peak line-voltage, less diode drops. This circuit will produce over 500 or 1000 volts from a 120- or 240-volt input.

Quadruplets

Extending this concept further, a voltage quadrupler (4x) can be produced, as in Fig. 7. The sequence can be repeated indefinitely in theory, but a practical limit for most uses is probably 10 or 15 stages. The regulation becomes poorer as the multiplication is increased.

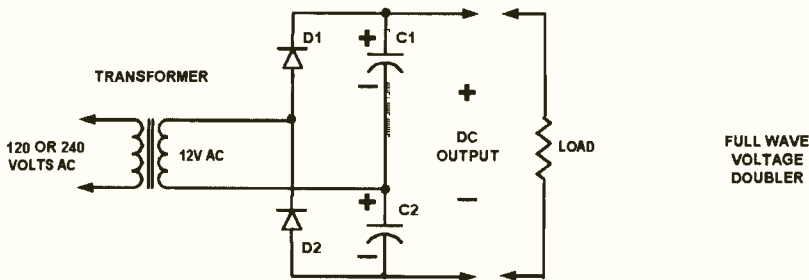

Fig. 5. Note that if a grounded DC output is needed at the full DC output voltage, the AC supply must be isolated from ground. This isolation requires a transformer to be used if the AC source has one side grounded.

+2000 volt DC voltage required for the RF amplifier tubes, with up to 600-mA current. An 800-volt transformer at 1.5 amps is less difficult to make than one that's either a 1600-volt or a 3200-volt center tapped supply. Insulation requirements are less, and there are fewer turns required. Transformers with smaller turns ratios also tend to have a little better voltage regulation than those with

output with the common leads tied together. Note that if a grounded DC output is needed at the full DC output voltage, the AC supply must be isolated from ground. This isolation requires a transformer to be used if the AC source has one side grounded. See Fig 5.

Naturally, getting something for nothing is not going to happen with voltage-doubling circuits. Regulation tends to be

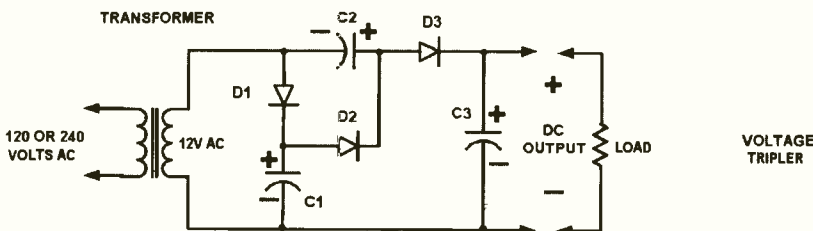

Fig. 6. The voltage-doubler can be turned into a tripler by adding another diode and capacitor as shown in this schematic. In this circuit, the AC-voltage component present across D1 is coupled to D3.

large turns ratios, and the ability to ground one side of the 800-volt winding reduces stress on insulation and reduces the likelihood of flashover and breakdown.

The capacitor, C1, carries the full AC-line input current and must be suitably rated for this service. This circuit is also handy for certain low voltage applications, where a small amount of DC power is needed at a higher voltage than the rest of the circuitry normally requires. If the diodes and capacitor polarities are all reversed, a negative polarity voltage can be obtained. This circuit has been used in older vacuum-tube hybrid equipment, to obtain 12-15 volts DC for the transistor portion from the 6.3 volt AC vacuum tube filament supply, eliminating the need for a separate transformer or other source.

How About The Full-Wave Doubler

A full-wave voltage doubler uses two half-wave rectifier circuits, one producing a positive output, and one a negative

poorer, and the demand on the components with regard to peak-current capability is greater. The circuit is best used for relatively light loads, although with a large value of C2, loads with large peak-to-average current demands can be handled relatively easily. Examples of these kinds of loads are SSB linear amplifiers, photoflash power supplies, and audio power-amplifiers where peaks are encountered. The AC line should also have good regulation (low impedance) for best results.

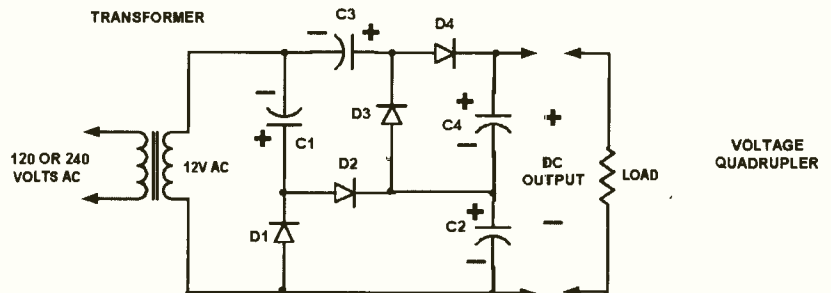

Fig. 7. Triplers, quadruplers, and higher order multipliers find application mainly when a high-voltage, low-current supply is needed. Examples are CRT second anode supplies, geiger-counter tubes, some laser work, and high-voltage experimentation.

Note, however, that relatively low-voltage components may be used in many places, since only the output capacitor sees the full output voltage across it. Triplers, quadruplers, and higher order multipliers find application mainly when a high-voltage, low-current supply is needed, as for CRT second anode supplies, geiger-counter tubes, some laser work, and high-voltage experimentation. The chief advantage is that the voltage multiplier allows use of a relatively low-voltage AC source to produce a high-voltage DC output. Conventional half- and full-wave rectifier circuits would need a large and expensive high-voltage transformer.

The Real Thing

The best way to understand these circuits is to build them and experiment. A 12-volt, 1-amp transformer, four 1N4000 series diodes, and a few electrolytic capacitors of 100-, 470-, or 1000-mF at 25- to 50-volts or better are all you need. Suitable loads can be low-value 5- or 10-watt resistors (25-100 ohms, etc.), or you can use small 12-volt automotive lamps, such as the #53, #57, and #194. There are 24- or 36-volt lamps available, such as the #313, 1822, or 1829; and these can also be used. LEDs can be used, but they do not draw much current, so you will need a lot of them. In this case, a combination of LEDs and load-resistors is more practical. A DVM can show how DC-output voltage varies with load. If you have access to a scope, you can also examine the waveforms. Lamps can give a visual indication via their brightness.

If you cannot get parts (also, if you are inept at using tools and soldering, or otherwise too lazy), you can also plug these circuits into a SPICE simulator program on your PC and demonstrate their workings as well, but there is no substitute for the "real" thing. You will learn better by doing, rather than merely watching a monitor display. Also, many lower-cost simulator programs used by experimenters do not take into account certain second- and third-order effects that may prove to be limiting factors that affect actual performance. Again, there is no substitute for the "real" thing.

DO NOT USE THE 120- OR 240-VOLT AC LINE-VOLTAGE WITHOUT A STEP-DOWN TRANSFORMER. Severe fire, shock, and electrocution hazards are present. You could

easily kill yourself and maybe someone else. Using 6, 12 or 24 volts will work just as well; suitable parts are much cheaper, and it is a lot safer. You can use a wall-wart (AC-output-only type), bell-transformer from the hardware store, or a toy-train transformer as an alternative to a 12-volt power type transformer. Any voltage from 6 to 24 volts will do. Higher voltages than 24 volts may present a shock hazard, especially when experimenting with voltage-multiplier circuits. It would be a good idea to place a 1-amp fuse in series with the transformer secondary. Many low-voltage transformers have built-in thermal fuses, whose sole duty is to prevent a fire should the transformer overheat. They are placed inside the windings of the transformer and are inaccessible, unless you can disassemble it. These fuses usually take several seconds or more to self-destruct and are not replaceable, so your transformer becomes a rather ugly paperweight. The extra 1-amp fuse, however, will fail first, protecting your trans-

former and components.

In the next column, we will discuss voltage regulators and how to build a regulated adjustable power supply circuit that will be usable as a source to power experimental circuits. □

**Yours for only
\$3.99
Price includes
shipping!**



HAVE A THOUSAND YUCKS FOR ONLY THREE AND A HALF BUCKS! That comes to one-third of a cent per laugh. **Electronics Comics** is a compilation of over 125 riotous, outrageous and phenomenal cartoons that appeared in **Popular Electronics** and **Electronics Now**. Only **\$3.99**—price includes shipping. **Claggg, Inc., Reprint Bookstore, P.O. Box 12162, Hauppauge, NY 11788.** All payments in U.S. funds. Sorry, no orders outside U.S.A. and Canada. Check or money order only—send no cash. NY state residents add applicable tax. MA04

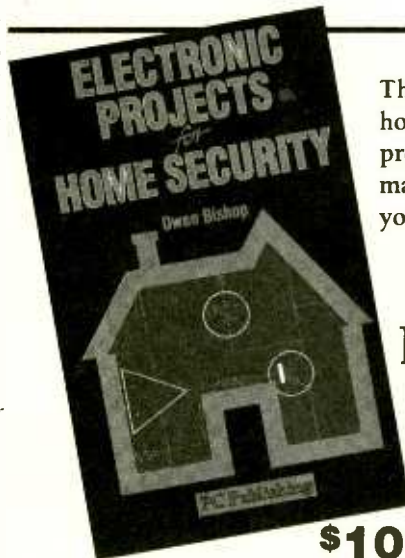

\$10.99

This book deals with many aspects of home security – intruder, fire and flood protection – with the emphasis on how to make the best of electronic devices that you can build yourself.

Electronic Projects for HOME SECURITY

- Projects to help secure your home •
- Principles of operation explained •
- Constructional details given •
- Suitable for beginners •

There are 25 constructional projects, ranging in complexity from a single-door protection circuit, that can be built in an hour or two, to a sophisticated multi-channel security system, that most intruders will find very difficult to beat.

ELECTRONICS TECHNOLOGY TODAY INC.
PO Box 240, Massapequa Park, NY 11762-0240

Yes, send my copy of PCP115 ELECTRONIC PROJECTS FOR HOME SECURITY by Owen Bishop to the address at right. I am enclosing \$10.99 plus \$4.00 shipping charges in USA and Canada. All payments must be made in US funds. Sorry, no orders accepted outside of USA and Canada. New York State residents add local sales tax. Allow 6-8 weeks for delivery.

Please charge my Visa MasterCard

Signature _____

Card # _____ Exp. Date _____

Name _____

Address _____

City _____ State _____ ZIP _____

Check or International Money order enclosed.

MA10

THE ATV MKII

WILLIAM SHEETS, K2MQJ, and RUDOLF F. GRAF, KA2CWL

NOTE: A VALID AMATEUR LICENSE PERMITTING OPERATION AT 440 MHz IS A REQUIREMENT FOR OPERATION OF THIS DEVICE. In the US, this will be a Technician Class (code free) license, so if you can build this transmitter you should easily be able to pass the required exam. OPERATION OF THIS DEVICE ON THE COMMERCIAL TV FREQUENCIES IS ILLEGAL IN THE US. Although it may possibly be used for such applications in export situations, it is intended for amateur use by legally licensed amateurs and for no other purposes.

There are a number of instances in which transmission of a complete television signal is desired.

Among these are Amateur TV operation (ATV) and radio-control applications, where it is desirable to see a picture of the environment surrounding a radio-controlled robot, airplane, car, or other vehicle. While there are a number of low-power and "micro" TV transmitters on the market, they generally have limited range. Many of these operate at 900 MHz and 2.4 GHz. The 900-MHz band is very crowded with interfering signals; and the 2.4-GHz band, while relatively free from interference, is limited mainly to low-power, short-range devices. The "flea power" units available for this frequency have limited range and require a dedicated receiver. These transmitters typically produce only a few milliwatts of RF power output.

The *ATV MKII* operates in the 420–450-MHz (70-centimeter) UHF amateur band and produces a full 2 watts of RF output. Spectral purity is good, with all spurious outputs 40 to 50 dB below the carrier. With a good antenna having 10 to 15 dB gain, such as a corner reflector or a good yagi, this transmitter easily can provide a range of several miles. Direct reception of 440 MHz is possible on many newer cable-ready TV sets. With one of the low-cost PC board cameras available, a small TV station can be put together that can be installed in a radio-controlled vehicle or it can be used for amateur radio fixed or mobile operation. Note that an amateur radio license is necessary to legally operate this transmitter.

However, if you can build this project, you should easily have the technical ability to pass the test for a novice ham license. If you cannot do so, you should not build this transmitter, as it will likely be beyond your abilities.

This 2-watt ATV transmitter descended from one originally described in an article in the June and July 1989 issues of *Radio Electronics*. This latest version is the result of many refinements and is different in circuitry from the original, although it uses a similar mechanical layout. If you have read about this transmitter in books or previously published articles or have previously constructed one, you will note these differences from the original unit. The circuit has proved to be reliable and relatively free of glitches. It has an improved video modulator, remote keying, a better camera interface, improved audio, and a better video-clamping circuit. The RF section has been redesigned for easier tune-up and better low-voltage performance.

Thought was given to the use of a PLL, but a microprocessor would be needed to generate the serial-interface signals needed by many synthesizer chips—unless a physically larger DIP-switch and parallel-input synthesizer IC was used. This takes considerable PC board area unless surface-mount components are used. Also, it is overkill when only one or two transmitter frequencies are needed.

The Motorola MC13136 chip (that functions as a PLL using a crystal at $\frac{1}{2}$ of the output frequency) was also considered. However, it is in a small surface-mount package and is difficult for the inexperienced hobbyist to work with. Furthermore, the peripheral circuitry required, together with the necessity of an amplifier system having some 30- to 33-dB power gain at 440 MHz did not seem too attractive for home construction

This 2-Watt Amateur Television Transmitter fits in the palm of your hand.

and possibly could be subject to some RF stability problems. Additionally, specialized chips such as this have been all too frequently subject to sudden discontinuance, with no second

source available. Therefore, the traditional oscillator-multiplier approach used in the original design was retained. This design has proved stable and reliable.

The redesigned transmitter will operate better with

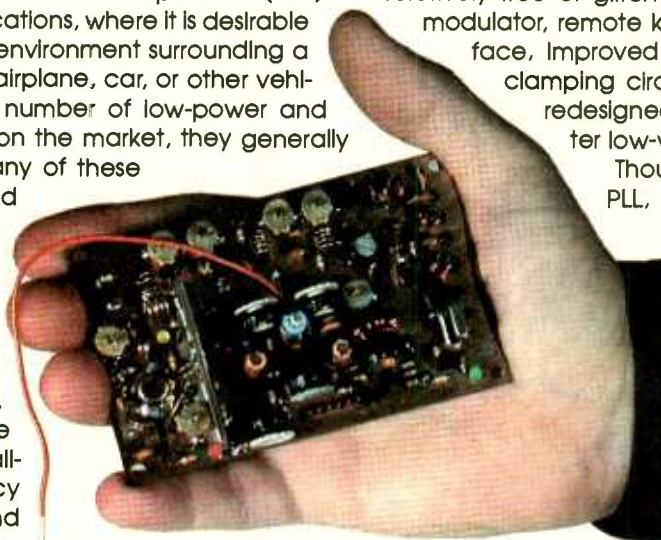

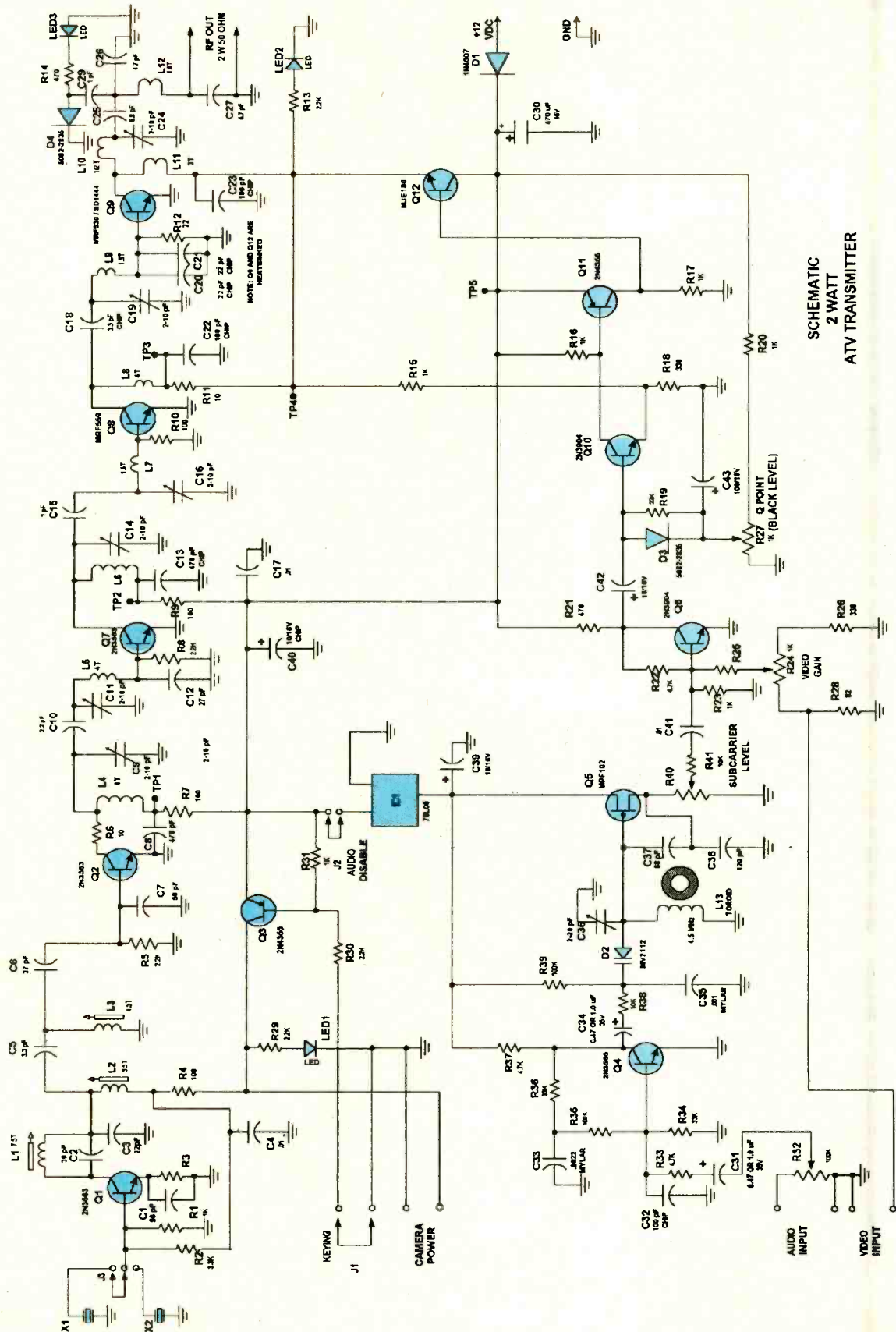

SCHEMATIC
2 WATT
ATV TRANSMITTER

Fig. 1. This is the schematic for the transmitter. The only IC used in construction is IC1, a voltage regulator. The schematic should be referred to when reading the circuit-operation section.

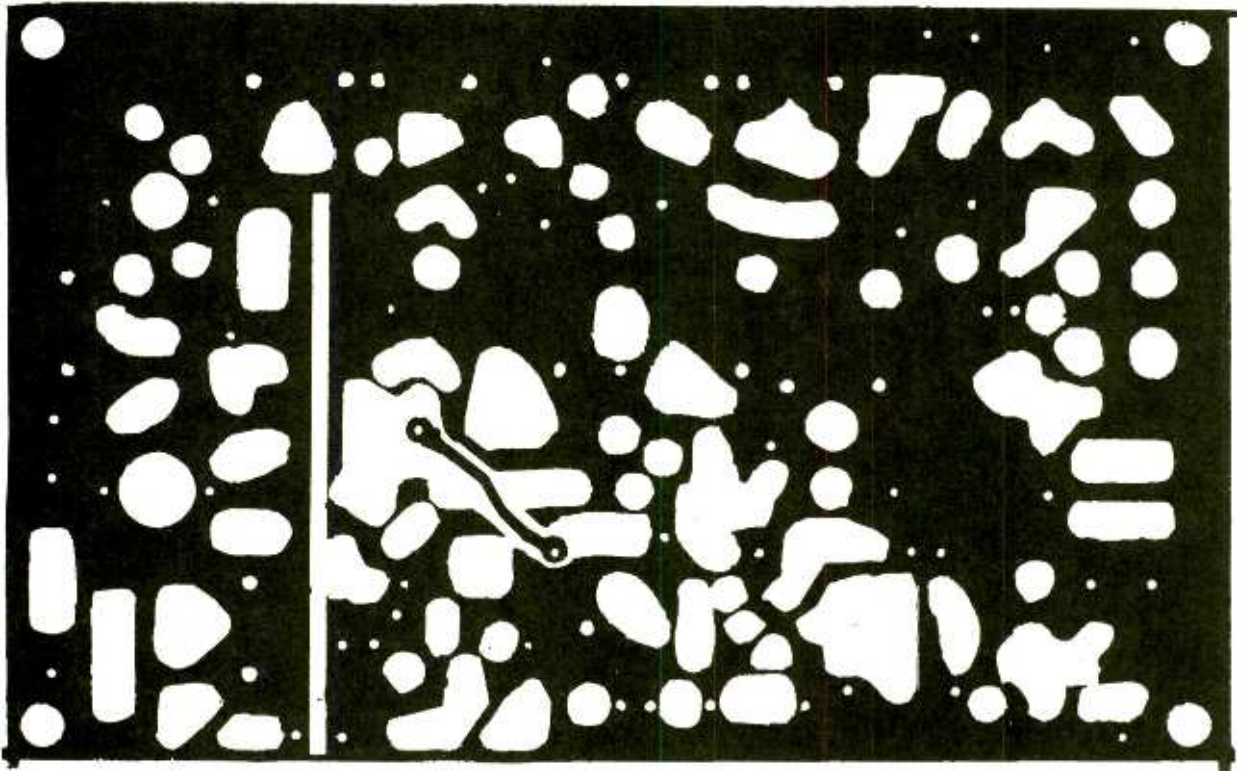

Fig. 2. Here is the component-side foil pattern. An etched and screened PC board is available as part of a kit from North Country Radio.

supply voltage fall-off when batteries are used. There are neither tricky circuits nor any surface-mount ICs that are difficult to work with. All parts, with the exception of seven chip capacitors and one transistor, are "through-hole" types. Alignment can be done with a VOM if care is used to duplicate closely the unit to be described. Three LED indicators have been added to facilitate setup and provide a visual indication of proper circuit operation.

General Description. This transmitter board will generate a complete NTSC video signal and a 4.5-MHz FM sound subcarrier, modulated on a UHF carrier. This UHF signal can be received on any standard TV receiver fitted with a suitable RF downconverter capable of tuning the 420-450-MHz amateur band. If the TV receiver is "cable-ready," it should be capable of tuning these frequencies directly. Channel 60 on many cable-ready sets is 439.25 MHz, the frequency used commonly for simplex ATV work. It is possible to modify non-cable-ready sets to tune to 439.25 MHz, but for best results a dedicated downconverter outputting on an unused VHF channel (CH3 or CH4) is the way to go. This allows an optimized RF front end and the best reception range. The physical size of this transmitter (2.5- x 4-inches) is small enough for R/C applications, in which a video link is required. Operation is possible from nominal 9- to 14.4-volt power supplies, with minor adjustments in video drive. Lead acid, NiCd, or alkaline power packs may be used. Less than 8 or more than 15 volts is not recommended. Power output will be typically from 0.5 to 3 watts over this range. The transmitter requires standard NTSC or PAL video. The

transmitter audio can also be retuned for a 5.5- or 6.0-MHz sound subcarrier used by PAL systems. The video-input requirement is standard 1-volt (peak to peak) 75-ohms, negative sync. Audio inputs from 100 mV to 1 volt can be accommodated.

Circuit Operation. In this discussion, the transmitter schematic (Fig. 1) will be repeatedly referred to. Therefore, you should familiarize yourself with the schematic before reading further. Some Ham radio experience and some familiarity with RF circuits and transmitters is assumed. If you are somewhat unfamiliar with these areas, a little study of the appropriate material in a reference such as the *ARRL Handbook for Radio Amateurs* or the *RSGB Handbook* is highly recommended. This will also help ensure success with this project.

Referring to the schematic, you will see that Q1 is a crystal-controlled oscillator that could use either one or two third-overtone crystals (52-62 MHz). An on-board jumper is used to select the desired crystal, which allows easy frequency change. For single-channel use, only one crystal is needed. If desired, a switch can be wired in place of the jumper to allow switch selection. Resistors R1 and R2 feed bias to the base of oscillator stage, Q1. The selected crystal effectively appears in series with the base of Q1 and ground. In this application (RF), Q1 is a common-base oscillator circuit. At the series-resonant frequency of the crystal, the base of Q1 is nearly grounded. Both L1 and C2 are tuned somewhat above resonance, causing oscillation at the crystal frequency. The signal generated contains harmonics. The filter formed from L2, C3, C5,

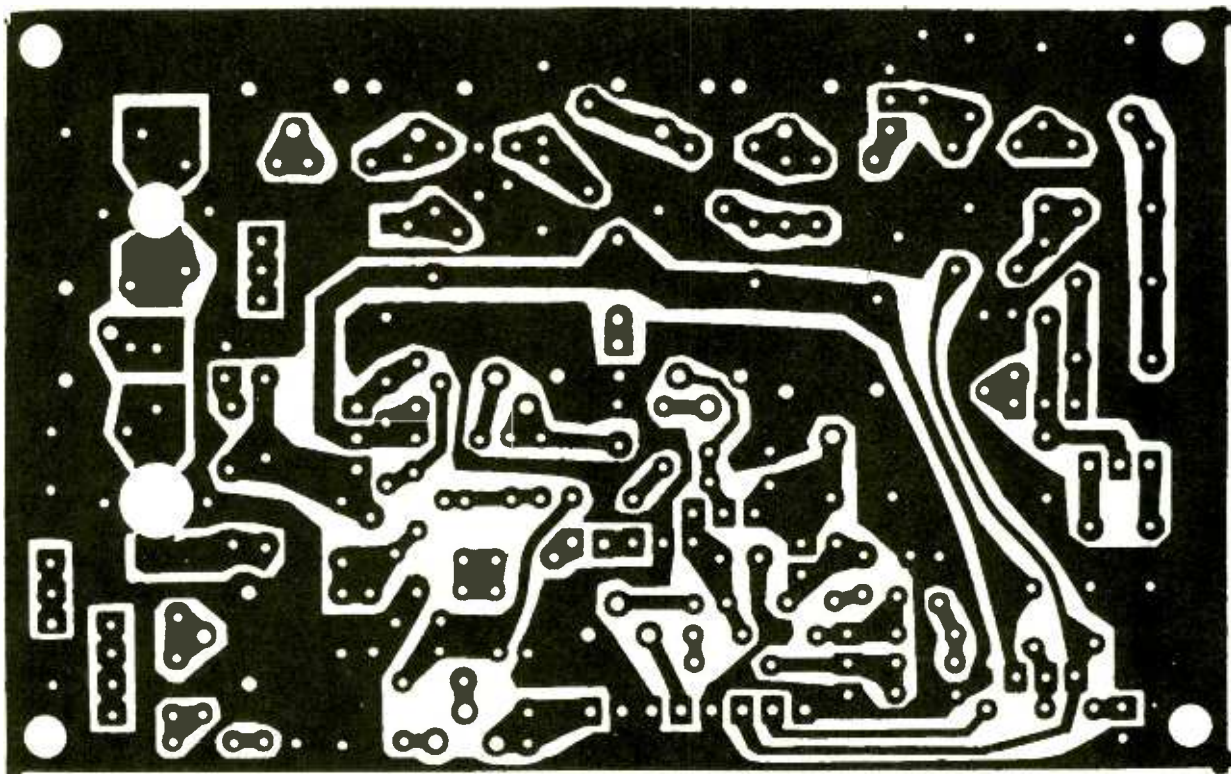

Fig. 3. Here is the solder-side foil pattern. An etched and screened PC board is available as part of a kit from North Country Radio.

L3, C6, and C7 couples the second harmonic (105–125 MHz) to the doubler stage, Q2. This stage further doubles the signal frequency to 210–250 MHz. The filter formed from C9, L4, C10, L5, C11, and C12 eliminates all other frequencies and matches the input of the next stage, Q7, another doubler. Transistor Q7 doubles this signal to the final output frequency in the 420–500-MHz range.

At the output of Q7 about 20 milliwatts of RF energy are present. A matching network (C14, L6, C15, C16, and L7) couples the RF energy to Q8 in the power amplifier (PA) and the same network also filters out spurious, unwanted signals. Transistor Q8 amplifies this signal to around 0.2 to 0.4 watts. Another matching network (C19, L9, C20, and C21) matches the impedance of the collector of Q8 to the base of final amplifier, Q9. Inductor L11 is an RF choke and R12 provides bias for Q9. Transistor Q9 can deliver 2 watts or more of RF power to its load via a matching network. Components L10, C24, and C25, along with C26, L12, and C27 form a tuning and matching network, as well as a low-pass filter to ensure a spectrally clean RF output to the antenna. Capacitors C29 and C28 form a capacitive voltage divider that couples a sample of the RF output voltage to a detector diode, D4.

The negative voltage is fed through R14 to LED3, a red LED that serves as an RF-output indicator. Changing C28 varies the sensitivity of this indicator. Transistor Q9 handles considerable power, and its case is soldered directly to the copper-foil ground plane of the PC board to help dissipate heat and to assure a low inductance-emitter return. Note that the case of Q9 is connected to the emitter, instead of the collec-

tor, as is more common practice for TO39 transistors. Therefore, the transistor appears to be pinned in a reverse-lead configuration.

Video-modulated DC is supplied to Q9 via RF choke, L11. The combination of R13 and LED2, a yellow LED, serves as a voltage indicator and is used both to set up the transmitter and as a modulation indicator. Capacitor C23 is a bypass capacitor. Components R11 and C22 are also connected to the same point and serve as bypass and decoupling resistor. In order to apply video modulation to this RF carrier, the supply voltage for Q8 and Q9 is taken from the emitter of modulator Q12. Transistors Q10, Q11, and Q12 are connected as a feedback amplifier with a nominal voltage gain of about 4. Video-signal input to the transmitter is fed to video-gain control R24 and a termination resistor, R28. Resistor R26 provides a "stop" for gain control R24 and sets minimum gain. Video is fed from R24 to R25 and the base of video amplifier Q6. This feedback-amplifier stage has a gain of around 4.5. The video signal is also inverted in polarity, so that sync and black levels are positive going. The video signal from Q6 is coupled to the base of Q10 via C42.

Components D3 and R19 form a clamp circuit, which is biased from a DC voltage of 0 to 6 volts from the wiper of clamp-level control R27. A large capacitor (C43) acts as a bias battery for the clamp circuitry. Variable resistor R27 is adjusted so that the peak sync tips will just about cause the voltage at the emitter of Q12 to saturate (about 1 to 2 volts less than the supply voltage). This allows a sync tip RF level that tends to stay constant with video level and scene changes, maintaining peak power and preserving proper DC

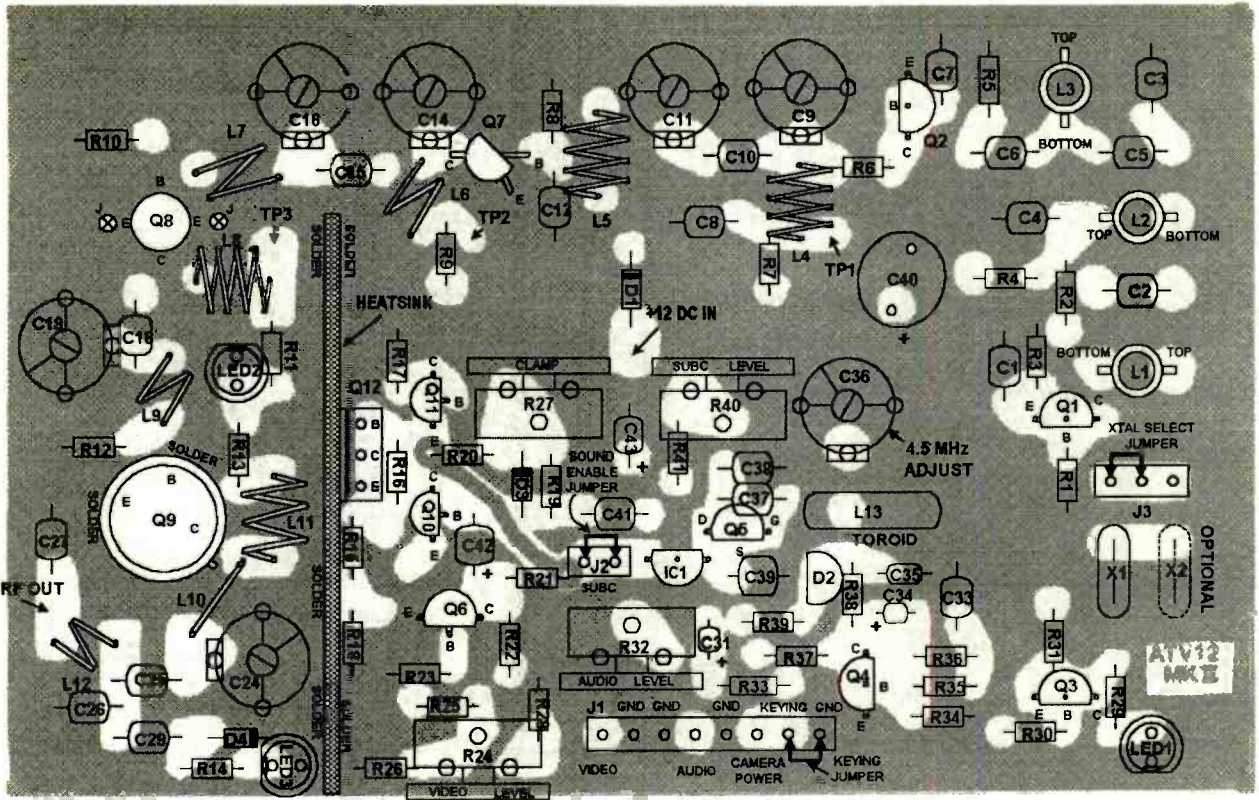

Fig. 4. This is the parts-placement diagram for the component side. When constructing the transmitter, be sure to follow along carefully with this figure.

levels in the transmitted video signal. The emitter of Q10 is used as an inverting input for feedback divider, R15 and R18, and normally will be sitting about 1.5 to 2 volts above ground. This provides a high input impedance at the base of Q10 and allows the clamp circuit to function better. Resistor R16 biases the collector of Q10; and this point is fed to video amplifier Q11, which drives the modulator transistor, Q12.

The video present at the emitter of Q12 is superimposed on the supply voltage to Q8 and Q9, causing amplitude modulation of the RF output of Q9. Resistor R27 sets the level of the RF output for symmetrical modulation, and R24 is set for maximum modulation level without distortion or clipping. Diode D1 protects the circuitry against accidental reverse polarity. Diode D1 is placed in series with the supply lead normally, but, for low supply voltages, it can be placed across the supply so as not to introduce any voltage drop. However, protection is not as effective in this way as the series connection. Capacitor C30 provides supply-line bypassing. For lowest impedance, C30 is a tantalum chip capacitor. Note that Q12 is effectively in series with the power supply to the RF power amplifier and, therefore, dissipates considerable power. Therefore, Q12 is heatsinked.

Note that the video amplifier is AC coupled. Attention should be paid to video-input signal levels and interfacing to assure proper modulation of the transmitter. Input impedance is 70 to 75 ohms. Drive is a nominal 1-volt peak-to-peak negative sync, which is pretty standard for most video devices. If a higher input impedance is desired, R28 can be omitted.

Frequency response is about 10 Hz to 4.5 MHz. The picture quality is excellent if the transmitter is properly set up and video-drive levels are correct.

Now, a sound subcarrier must be generated to carry audio. Incoming audio is fed to gain control R32. Audio from R32 is then fed through C31 and R33 to Q4. A gain of about 28 is obtained. However, preemphasis is necessary; and it requires increasing the gain by 6 dB/octave above 2100 Hz. This increase is accomplished by splitting the feedback-resistor network into two resistors, R35 and R36. Capacitor C33, along with the values of R35 and R36, act as an RC filter network.

Above approximately 2100 Hz, C32 bypasses part of the feedback signal—causing a rise in the gain of the Q4 stage. This provides the necessary high frequency boost. Audio from Q4 is fed to varactor diode D2 via C34 and R38. Diode D2 is part of the frequency-determining network of the 4.5-MHz subcarrier oscillator FET Q5. The 4.5-MHz tuned circuit is made up of D2, C35, C36, C37, C38, and L13. Field-effect transistor Q5 is used as a Colpitts oscillator with R40 and the tuned circuit components; and bias is provided by a 5-volt regulator, IC1, and associated bypass capacitor C39. This provides a stable voltage to the audio section to reduce drift with supply voltage changes. Junction J2 is an onboard jumper that can be removed to disable the sound section in applications where no audio is required. This jumper can be replaced with an SPST switch, if desired.

Audio voltage on D2 changes its capacitance, resulting in frequency modulation of the subcarrier. Capacitor C36 sets the 4.5-MHz sound subcarrier fre-

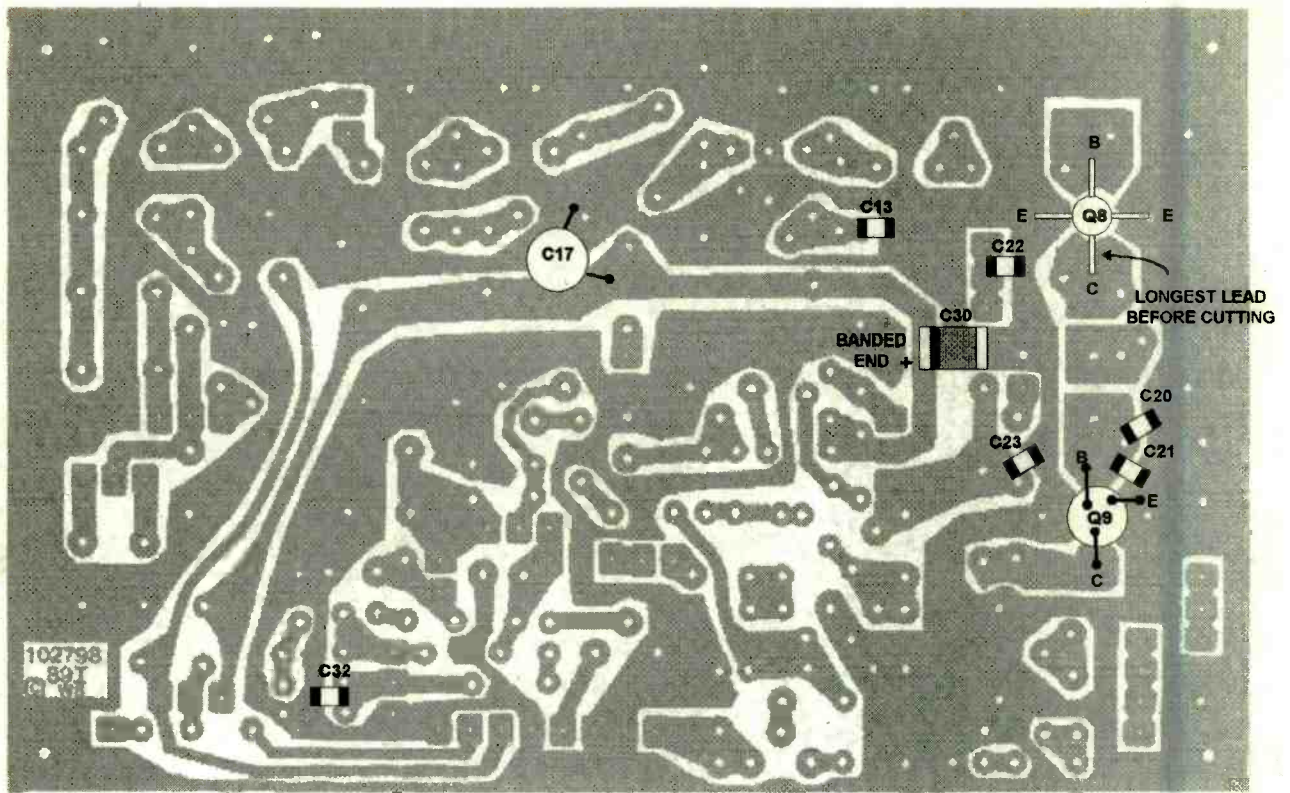

Fig. 5. This is the part-placement diagram for the solder side. Seven chip capacitors are soldered on this side, while the leads of two transistors and one capacitor are poked through from the component side and anchored on the solder side.

quency. The subcarrier from Q5 is fed into the video modulator via the wiper on potentiometer R40, which serves as a subcarrier-level adjustment. Components R41 and C41 couple this subcarrier to the video amplifier, Q6, where it is mixed with the input video. The setting of R40 sets the subcarrier level. Capacitor C39 is a decoupling capacitor. Resistors R34, R35, R36, and R37 bias audio amplifier Q5. Chip capacitor C32 prevents RF from the transmitter from getting into the audio signal.

Transistor Q3 and associated components R29, R30, and R31 and green indicator LED1 form a keying circuit for the transmitter and any connected video camera. When the key line connected to R30 is grounded, Q3 conducts and supplies DC to R4 and the crystal oscillator stage, as well as the camera power lead. Under these conditions, LED1 shows green, indicating an ON condition. When the key line is disconnected from ground, Q3 is cut off. This cut-off removes DC from the oscillator, cutting off the transmitter, camera, and the indicator LED1.

This feature is handy in remote-control applications. Up to 200 mA of DC is available for the camera. The keying line, camera power, and video and audio inputs are all brought to an on-board, 8-pin header for use with a molex or other similar connector with 0.1-inch pin spacing. This layout allows for easy connections. The header can be omitted if plain wiring is preferred.

The entire transmitter will draw around 6 to 8 watts DC at 13.8 volts and will output typically 2- to 3-watts peak power on sync tips (around 5 watts of heat).

Since this transmitter is physically small, some attention should be given to thermal considerations. The included heatsink is adequate for intermittent (3 minutes on, 3 minutes off) Ham use and normal tuneup and testing. However, the transmitter will run cooler if additional heatsinking is provided. The G10 shield can be replaced with a metal (copper or brass) plate, which can be fastened to a chassis or a radiator fin. The DC supply should be clean and stable. Any noise or ripple in the supply voltage can modulate the RF carrier and/or shift the carrier level, causing sync clipping or interference in the received video. Less than 50 millivolts of ripple and noise is necessary, less being desirable. Most decent supplies easily meet these specifications.

Construction. The construction and testing of this transmitter requires working in the UHF part of the frequency spectrum. Use only the exact parts specified—no substitutions. A kit of parts, together with a drilled and etched PC board, is available from the source specified in the Parts List and is highly recommended, as some of these parts may be difficult to obtain at reasonable cost in small quantities. Again, make no substitutions and avoid using “generic” service-grade transistors sold for replacement use (ECG, SK, NTE, etc.), as these may not work properly in RF-circuits. If you desire to make your own PC board, you could use Fig. 2 (component-side foil pattern) and Fig. 3 (solder-side foil pattern) for reference. Before beginning construction, familiarize yourself with the PC board and the lay-

out. Figures 4 and 5 show the layout for the component side and solder side, respectively. Note that some holes are larger than others. Use these as landmarks. Read and understand the circuit description. Carefully identify all parts against the Parts List. Use good lighting. A magnifier is really necessary to see color codes with any certainty. Check any dubious items with a VOM to be sure. If not sure about a part, use the process of elimination to help narrow it down. It is helpful to first insert larger parts, such as trimmer capacitors and potentiometers, to serve as landmarks. The larger holes on the board are for the trimmers and pots.

There are two large holes near the left side for Q8 and Q9. A shield and heatsink partition runs parallel to and 1.1 inches (2.8 mm) from the left side of the board. Note that all trimmer capacitors and grounded leads of resistors are to be soldered on both sides of board. This is essential for good RF grounding. Also note that Q9 must have its case soldered to the top of the board. Certain parts such as chip capacitors and Q8 are mounted under the board. See the appropriate figures. Except where access may be difficult later, DO NOT solder any connections until as many components as possible are inserted. All coils are installed after components are inserted; this is the only exception. The parts are mounted tight and close to the board, no exceptions. Zero lead length is a *must* in the RF circuits. Remember that you are working at UHF frequencies and lead lengths are critical. They should ideally be zero.

Only use rosin-core solder, low residue preferred. **DO NOT** use acid core or any paste fluxes. A hot, small pencil iron is best. See the Parts List for details on mounting chip capacitors.

Begin construction by inserting all trimmer capacitors in the PC board. Make sure that the correct values are inserted. Note the large holes for Q8 and Q9. Orient the board so these holes are near the left side. After making sure the correct parts are installed, solder side terminals of trimmers to the top side of the PC board. Be careful not to melt the

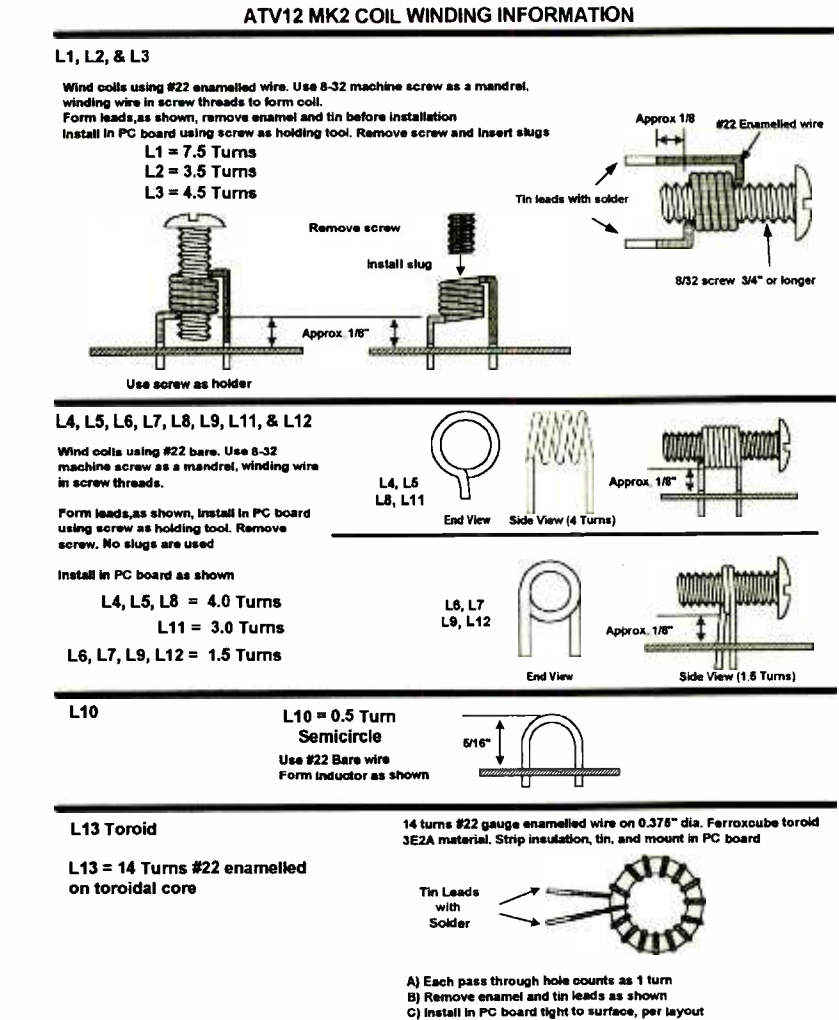

Fig. 6. Using the diagram above as a guide, you can wind your own coils. As the authors explain, this is a dying art and a must-learn for RF enthusiasts. Coils are either wound on screw mandrels or directly on to a toroid.

plastic. Install potentiometers R24, R27, R32, and R40. Do not solder the bottom at this time. After carefully identifying them, mount all resistors. Only solder the top of board where resistor leads pass through ground foil. Solder as many as you can. Do not solder the bottom yet. Make sure to solder the top trace with R20 and R21 passing through it, as this trace is used to supply DC voltage to the video amplifier and audio subcarrier generator.

Next, install the capacitors. Any that have preformed leads should have their leads straightened with pliers so as to fit as close to the board as possible. Watch the polarity of all electrolytic capacitors. Do not install chip capacitors until a later step. Identify and install all transistors, except the MRF559 (Q8), MRF630 (Q9), and the MJE180 (Q12). These transistors will be

installed later. **WATCH FOR CORRECT ORIENTATION.**

All other transistors should be 1/8-inch from the surface of the board. Solder the emitter leads of Q2 and Q7 to the top of the PC board where they pass through the ground-plane foil. Install the 5-volt regulator, IC1 and install diodes D1, D2, D3, and D4. The ground lead of D4 is soldered directly to the top ground foil. When placing LEDs, make sure to observe the correct polarity (the flat side is negative). Note that LEDs 1 and 2 (green and yellow) have the flat side grounded, while LED3 (red) has its flat side connected to R14. **WATCH POLARITY ON ALL DIODES AND LEDs.** Using scissors, trim crystal leads to 3/16-inch and install. **DO NOT** use diagonal cutters as the shock wave can damage the crystal. Solder a short wire to the top of the crystal and

PARTS LIST FOR THE ATV12 MKII

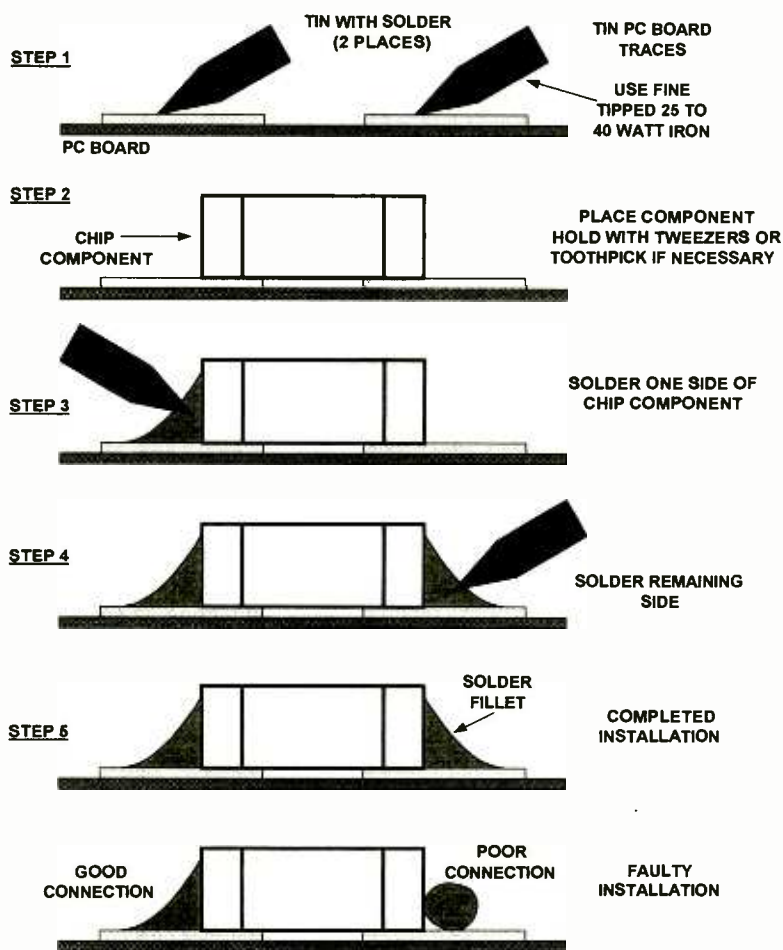

CHIP COMPONENT INSTALLATION

Fig. 7. This guide shows the five steps to successfully mount chips using a solder-fillet method. This technique may take a little practice, but it is a good skill to have.

run this lead to ground. Use resistor lead clippings or other wire scrap. Carefully check all your work so far for accuracy and orientation. Now trim all of the component leads and solder all bottom connections made so far. Do not plug up any unused holes yet. Mount Q12, metallic side down, to the heatsink. Do not forget to install a mica insulator between them. Mount it with a 4-40 × ½-inch screw, lockwasher, and nut. The screw head faces the left side of board. The correct orientation is such that the transistor is closer to the right side of the heatsink when facing you and the manufacturer's ID is visible. It may be necessary to trim excess mica insulator. Do not overtighten, and make sure no leads of Q12 show any electrical continuity to the heatsink.

Install the heatsink and Q12 vertically on the PC board. The leads of

Q12 should fit into the holes in the PC board, and the heatsink should have its edge about ⅛-inch from the edge of the PC board. Make sure that the heatsink is vertical and is positioned properly. Transistor Q12 should be on the side of the heatsink facing the right side of PC board. Solder as much of the seam on both sides of the heatsink as possible. Use a hot, fine-tipped iron. Finally, do not forget to solder the leads of Q12 under the board.

Carefully fabricate all coils (refer to Fig. 6) and install them in the PC board. Be sure that no turns short together on L4 through L12. Coil L1 has its bottom turn connected to the junction formed by C2 and the collector of Q1. Coil L2's bottom turn is connected to the junction of C2/C3, and L3's bottom turn is connected to the junction of C5/C6. Use the 8-32 screw to hold the coils L1, L2, and L3 during installation. After

SEMICONDUCTORS

IC1—LM78L05
Q1, Q2, Q7—2N3563
Q3, Q11—2N4355
Q4—2N3565
Q5—MPF102
Q6, Q10—2N3904
Q8—MRF559
Q9—MRF630 or SD1444
Q12—MJE180
LED1—Light-emitting diode, green
LED2—Light-emitting diode, yellow
LED3—Light-emitting diode, red
D1—1N4007
D2—MV2112
D3, D4—5082-2800 or 5082-2835

RESISTORS

(All resistors are ¼-watt, 5% units unless otherwise noted.)

R1, R15, R16, R17, R20, R23, R25, R31—1000-ohm
R2—3300-ohm
R3, R18, R26—330-ohm
R4, R7, R9, R10—100-ohm
R5, R8, R13, R29, R30—2200-ohm
R6, R11—10-ohm
R12—22-ohm
R14, R21—470-ohm
R19—22,000-ohm
R22, R33, R37—4700-ohm
R24, R27, R40—PT10 pot, 1000-ohm
R28—82-ohm
R32—PT10 pot, 100,000-ohm
R34—33,000-ohm
R35, R36, R39—100,000-ohm
R38, R41—10,000-ohm

CAPACITORS

C1, C7—56-pF, NPO, ceramic disc
C2—39-pF, NPO, ceramic disc
C3—22-pF, NPO, ceramic disc
C4, C17, C41—.01 disc 50-volt GMV
C5, C18—3.3-pF, NPO, ceramic disc
C6, C12—27-pF, NPO, ceramic disc
C8—470-pF, ceramic disc
C9, C11, C14, C16, C19, C24—2-10-pF, 7.5 mm trimmer
C10—2.2-pF, NPO, ceramic disc
C13—470-pF chip, 60X120
C15, C29—1.0-pF, NPO, ceramic disc
C20, C21—22-pF chip, 60X120
C22, C23, C32—100-pF chip, 60X120
C25—6.8-pF, NPO, ceramic disc
C26, C27—4.7-pF, NPO, ceramic disc
C28—Not used
C30—10-μF, 16-volt tantalum chip
C31, C34—0.47- or 1.0-μF, 35-volt tantalum

C33—.0022- μ F, mylar
 C35—.001- μ F, mylar
 C36—2-20-pF, 7.5-mm trimmer
 C37—68-pF, NPO, ceramic disc
 C38—120-pF, NPO, ceramic disc
 C39, C42—10- μ F, 16-volt, electrolytic
 C40—470- μ F, 16-volt, electrolytic
 C43—100- μ F, 16-volt, electrolytic

MATERIAL NEEDED FOR COILS AND CHOKES

1 each—Core, toroidal, 266T125-4C4
 24 inches—# 22 enamelled wire
 24 inches—# 22 tinned wire
 3 each—Cambion blue slug
 1 each—8-32 \times 1-inch screw for coil winding form

ADDITIONAL PARTS AND MATERIALS

Crystal, 439.25 MHz (54.90625 3rd OT), PC board, heatsink and shield (G-10 matl.), 4-40 \times 1/2 BHMS, #4 lock-washer, #4 nut, TO-220 Mica insulator, 8-pin header with 0.1-inch spacing, 3-pin header with 0.1-inch spacing, 2-pin header with 0.1-inch spacing, (3) shunts for header

NOTE: The following parts are available from: **North Country Radio, PO Box 53, Wykagyl Station, New Rochelle, NY 10804-0053:** Complete kit consisting of a drilled, screened, and etched circuit board, all parts that mount on it, and complete documentation—\$122 plus \$5 postage and handling (USA). Case and power supply are not included as applications vary. A suitable undrilled two-tone painted aluminum case is available from the same source—\$13.50. A hardware kit consisting of jacks, switches, cable, RF connector, mounting hardware, etc.—\$10.50. Regulated 12-V_{DC} power supply—\$18.75. Call 914-235-6611 or check Web site www.northcountryradio.com for latest prices, an order form, and additional information.

installing the coils, remove the screw and insert slugs fully in the coils. It may be wise to add an extra turn to toroid L13 to allow for final "tweaking" if needed. Toroid L13 will then have an extra turn, which may need to be removed if the subcarrier frequency is too low and 4.5 MHz cannot be reached. However, it is easier to remove a turn later than to add one. The exact number of turns of the coils

IMPORTANT:
 KEEP ALL LEADS AS SHORT AS POSSIBLE
 1/4 INCH (6MM) MAXIMUM LENGTH

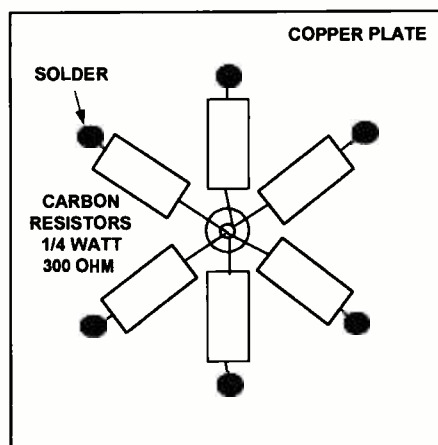
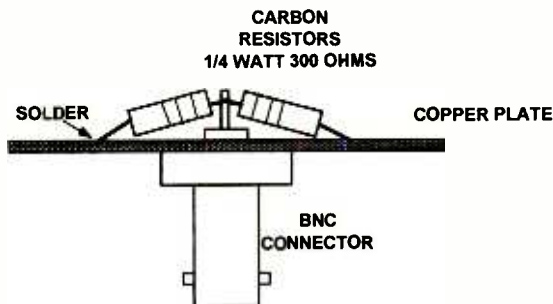

RESISTORS:
 SIX 300 OHM
 CARBON 1/4 W
 330 or 270 OHMS
 CAN BE USED IF
 NEEDED

Fig. 8. This 50-ohm dummy load can be used in a number of low-power RF applications. In the case of the ATV MKII transmitter, this load will come in handy for the initial testing procedures.

will be determined during the final test procedure.

Install C13. Next, install C22, C23, C32, and C30 on the underside of the PC board (see Fig. 7). Watch the polarity of C30. The band is the positive side of the capacitor. Chip capacitors C20 and C21 will be installed in a later step. When installing Q8, keep in mind that the long lead is the collector. Trim leads to length and install such that Q8 has its manufacturer's ID in the hole, visible from the bottom side of the board. The plane of Q8's leads should be flush with the bottom of the PC board. Install Q9. Pass the three leads through the 1/4-inch hole and orient Q9 as shown in the parts-placement diagram (Fig. 4). The case of Q9 should be tight against the ground-plane foil. Bend the three leads of Q9 on the bottom so they are against the correct PC board pads and solder. Ignore the two holes near the 1/4-inch hole for Q9; all three leads pass through the 1/4-inch hole. Note that the board is not wrong. Transistor Q9 has a reversed pin layout. Next, solder the case of Q9 to the ground plane to assure good grounding and heatsinking. Install C20 and C21

between the base of Q9 and ground. Carefully inspect all the work so far. Look for solder shorts, poor joints, missing parts, incorrect parts placement, etc. You are ready to check out the board once everything is satisfactory.

Tune-Up Procedure. These procedures should be followed carefully, in order to correctly tune the transmitter for safe and effective operation.

Equipment Required:

- VOM, analog preferred, 20K/volt (DVM usable)
- Power supply, 13.2-volt regulated, 1.0 amp or better
- Ammeter, 0 to 1 amp (not required if power supply has metering)
- Test leads, RF cables and fittings as needed
- Video and audio source (VCR, camera, camcorder, etc.)
- 50-ohm dummy load

Optional Equipment:

- See Fig. 8 for a suitable RF load you can make. This load is quite

CHECKLIST

After following the initial setup instructions, continue on with this ten-step checklist.

- Connect the DC supply, 13.2-volts, to the transmitter. Make sure the keying line from R30 is grounded. Place a jumper on the two keying pins (closest to Q4) of the 8-lead header to do this. Observe that LED1, the green LED, lights. Remove this jumper or momentarily disconnect the keying line from ground and confirm that LED1 goes out. Make sure jumper J2 is installed so as to activate the audio section. Note that the current consumption should be 30–70 mA. Connect the positive lead of the VOM to the emitter of Q12 (TP4), and the negative lead to ground. Verify that R27 can vary this voltage from < 2 to > 11 V. Observe that the yellow LED, LED2, lights and varies in brightness with the setting of R27. Adjust R27 for maximum voltage at the emitter of Q12, which is also the maximum brightness for LED2. Verify that the full supply voltage (13.2V) is present on the collectors of Q1, Q2, and Q7. If not, locate and correct the problem before proceeding.
- Connect the VOM across R7 (TP1) and the positive supply, TP5. Remember, it is much easier to see small changes on an analog meter than it is to see changes on a digital meter. Place jumper J3 on the 3-pin header, selecting the 439.25 crystal. Peak L1, L2, and L3 for maximum DC voltage reading, about 2 volts typically. If you do not see anything happen, try connecting the meter between the junction of R4, C4, and L2 and ground. Back the slug out of L1 and then slowly screw it in while watching the meter for a drop in the voltage at this point. When the voltage drops by a few tenths of a volt, go back to TP1 as before and try again, adjusting L2 and L3 at first, and then L1. Use an analog VOM here. A DVM may miss this quick but small change in voltage.
- Connect the VOM across R9 (TP2) and the positive supply, TP5. Peak C9 and C11 for maximum DC volts. A voltage of 1.5 to 2.2 is typical. If low, leave the VOM connected as is and try re-peaking L1, L2, and L3. If still below 1.5V, go back and check for proper component placement.
- Connect the VOM across R11 (TP3) and modulator output TP4. Peak C14 and C16 for maximum DC volts. A voltage of 1.0 to 2.0 is typical. If < 1.0 V, check the dimensions of L6 and L7. If still low, leave the VOM connected as is and repeak all the previous adjustments to maximize meter reading. If still low after re-peaking all the adjustments, go back and check for proper component placement. LED3 may start to glow red during this step, which is a good sign as this shows the presence of significant RF energy at the output.
- Watch the red LED (LED3) and slowly adjust C19 for any detectable glow or any increase in power-supply current. When a glow is noticed, peak C19 and C29 for maximum glow, and then readjust C14 and C16 as needed. Watch the ammeter in the supply lead. As LED3 brightens, the power-supply current will increase to around 400–600 mA. The meter on the dummy load (if used) should indicate RF power. If the 100-ohm resistors are used instead, they will get rather warm, indicating the presence of normal RF output.
- Next, adjust C19 and C29 again for maximum RF output. At least 1.8-, and typically 2.5-watts should be obtained at a supply voltage of 13.2 volts. Repeat the tune-up steps as required for maximum RF power output. Transistors Q9 and Q12 will normally run quite warm after a few minutes.
- Reduce the power-supply voltage and note the voltage where RF output drops out—typically less than 10 volts. If not, retune C9, C11, C14, C16, C19, and C29 as needed. Restore 13.2 volts of power and see if at least a 1.8-watt output is obtained. Retune as required. Expect to experiment a little as adjustments may interact somewhat; this is normal. Your final trimmer settings should not be radically different from the presets if you have made the inductors correctly and the chip capacitors are properly installed.
- When you are done with the RF alignment, adjust the clamp level control, R27, for about 75% of full RF output. The yellow and red LEDs will dim slightly; this is OK. If you have one, connect the frequency counter to the emitter of Q12 (TP4). You should see a reading of around 4.5 MHz. Adjust C36 for a reading of 4.495 to 4.505 MHz. If it's too high or low at the limits of adjustment of C36, add or subtract a turn from L13 as required. If there is no counter, adjust C36 for the best audio while monitoring the transmitted signal on a receiver.
- Place a drop of lacquer-base household cement or clear lacquer on L1, L2, L3, and toroid L13 after the tune-up is complete. This cement provides mechanical stability and anchors the slugs of L1, L2 and L3. You can also use the hot-melt glue used in hobby and craft work, as it is low in RF loss.
- Apply video and audio to the transmitter and adjust R24 and R27 for the best picture. Adjusting R24 will affect contrast, while adjusting C27 will affect brightness and stability. The correct adjustment will give a good, stable picture with no blocked-up highlights or lowlights, and freedom from rolling, tearing, or other instabilities. Make sure the receiver is not overloaded and at least ten feet from the transmitter. Audio gain is set with R32. If there are sound bars in the picture, then adjust R40 to eliminate them. Audio buzz may be pronounced if video gain R24 or clamp R27 are set too high. It may be noted that the average RF output power will drop when video modulation is applied. LED2 may dim slightly under these conditions. This is normal as the video produces mainly downward modulation, since black corresponds to maximum RF output and white to minimum RF output in the NTSC system. Scenes with a lot of white or light-colored areas will show more of a power drop than scenes with a lot of black or dark-colored areas. The power output is to be measured at sync-tip level, since the sync is the only constant level portion of the signal.

good at 440 MHz if constructed as shown. Use only carbon film resistors.

- Frequency counter, good to at least 500 MHz, with RF inductive pickup loop.
- Variable power supply, 13.2-volt regulated, 0-15V @ 1.0 amp.
- Receiver that is set up for A \bar{V} reception, such as a cable-ready TV.

The reason for preferring an analog VOM to a DVM is simple. An analog meter has no sampling intervals and reads what is happening at the moment. A digital instrument uses sampling and tells what just happened a moment ago. Therefore, a sought-after μ p or change in meter reading may not be caught. It is also easier for the eye to interpret a moving needle as compared to wildly changing digits. You can use a DVM, but be aware of these facts. If you use a DVM, make adjustments very slowly and watch carefully.

Refer to the schematic (Fig. 1) and PC layout (Figs. 4 and 5) as required. Perform the following steps in order and do not proceed to next step unless you get specified results. Preset all trimmer capacitors and potentiometers as follows:

C9—40%
C11—70%
C14—10%
C16—25%
C19—20%
C29—25%
C36—50%
R40—25%
R27—50%
R32—25%
R24—50%

These percentages are the amounts by which the plates of the trimmer mechanically overlaps with respect to full setting or the percent rotation in the case of potentiometers.

Connect the 0-1-amp ammeter in series with the positive supply-lead if your DC supply has no built-in ammeter that can read currents between 0.1 and 1 ampere. Connect the transmitter output to the dummy load and RF-indicator. **DO NOT USE AN ANTENNA.** As a minimum, if you do not have a suitable dummy load, connect two 100-ohm, 1/2-watt carbon resistors in parallel (to make up a 50-ohm, 1-watt load) across the RF-output pad on the circuit board and ground. Lead lengths should be 1/4-inch (6mm) maximum. Even better, make the dummy load shown in the figures and use it for testing. LED3 will give a good indication of RF output. At the proper output, it will glow brightly. Again, keep the 100-ohm resistor leads less than 1/4-inch long to minimize stray inductance and circuit detuning.

Performance Notes. If continuous operation is contemplated, keep the supply voltage between 12.0 and 13.2 volts unless additional heat sinking is provided for Q9 and Q12. For normal on-off operation for periods of

several minutes, this will not be necessary. Do not exceed 15 volts, or you may damage the RF and modulator circuitry. For low voltage applications (9.6-volt battery supply), it would be best to re-peak all adjustments at this voltage after initial tune-up has been done. Battery voltage falloff is less well tolerated at this low supply voltage, as the design has been optimized for 11- to 15-volt supply voltages. A properly tuned transmitter might function typically down to about 7.2 volts, but there is no guarantee of this. At best, RF power output will be around 0.5 watts at 7.2 volts. (Would you expect 120 V_{AC} equipment to work properly with a 72 V_{AC} supply?) The transmitter will be quite safe from any damage at this supply voltage. We cannot guarantee optimum operation at this low voltage, but operation still is possible. The following information is presented for those who wish to experiment.

One approach to increasing the effective power of the transmitter is the use of a simple scrambling technique. It is common practice to suppress or eliminate sync pulses in the transmitted signal in the cable and satellite TV broadcast industry. Doing so enables encryption of the signal to prevent viewers from watching the program material unless they have a suitable decoder and a paid subscription. Since the sync pulses take up "headroom," their elimination can mean that the full peak power capability of the transmitter can be used for the darkest portions (black) video, rather than reserving this for the "blacker-than-black" blanking sync pulse components. The elimination of sync pulses theoretically produces a better signal-to-noise ratio at the receiver, which can measure several dB (3 to 6). As long as this method is not used as a form of encryption, it should be legal in the amateur service—just as in the case of SSB being a form of AM, where the carrier is suppressed. The authors have checked with the FCC and have an FCC letter stating that this technique should not violate any rules, as long as the scrambling algorithm is known. More work will be done on this in the future, as it allows doubling or tripling the effective transmitter power with very little extra power consumption. This will be the subject of a future article. P

The advertisement is split into two vertical panels. The left panel shows a large, detailed illustration of a pine tree at the top, with the text "One tree can make 3,000,000 matches." below it. At the bottom of the left panel is a small, simple drawing of a single matchstick, with the text "One match can burn 3,000,000 trees." below it. The right panel features the American Heart Association logo at the top right, which includes a heart with a white cross and the text "American Heart Association" and "Fighting Heart Disease and Stroke". Below the logo is a black and white photograph of a young child sitting on the floor, looking thoughtful with one hand to their chin. To the right of the child, the text "Research gave him a future" is written in a large, bold, sans-serif font. At the bottom right of the right panel, the words "Support Research" are written in a bold, sans-serif font.

LETTERS

(continued from page 3)

NASA around to beam pictures from orbit—but that did not stop Galileo.

The "Science: Fact or Fiction" column in the same issue is even better. Mr. Tesla was a real genius, and a lot of people don't realize that. We owe the rapid advance of

our modern society to him. Maybe the Philadelphia Experiment really did happen. Since our government does hide things, who can say? Remember Area 51? It does not exist. Just ask the government—only the NO TRESPASSING signs and "Use of Deadly Force" signs that litter the area do exist. I have been there and have seen them.

Keep up the good work! New and/or unfamiliar ideas should always be explored and published. Maybe another genius like Mr. Tesla will come along and make them work! First, the seed must be sown and the idea exposed to the light of day.

R. HEPPELLE
Yerington, NV

P

PEAK COMPUTING

(continued from page 20)

experimenters are turning up the clock speed to gain more performance. The

same is true of video cards. The clock speeds on many of these can be altered as well to give amazing frame rates.

If you take your time, use the right benchmark for the type of performance

that you are interested in testing, and are careful in analyzing the results, benchmarking your current video subsystem can be a productive way of determining whether it's time for an upgrade.

P

TECHNOSCOPE

(continued from page 22)

your children that they will hurt their eyes if they sit too close to the television. With the clear picture offered by the HDTV system, you can sit as close to the screen and see a perfect, realistic image—without straining your eyes.

Created in the 1980s, HDTV requires a bandwidth of about 18 MHz for 1050 lines/600 pixels and runs on digital technology. (It doesn't have to transmit over a digital signal, however; the Japanese have been using analog HDTV for almost a decade.) Each line contains considerably more information than normal formats, giving the viewer

an infinite amount of options, channels, and customization. The picture is displayed in panoramic view, with a 16:9 horizontal-to-vertical aspect ratio (the difference in the length-to-width dimensions). With these ratios, the viewer will get the feeling of sitting in a movie theatre, with surround sound and a much greater sense of realism than with regular television. With HDTVs expected to soon become the standard, virtually everyone in the country will have no choice but to go to the nearest electronics store and replace their outdated televisions with the latest and greatest.

So how do we feel about being literally forced to make such an expensive change? Certainly, our viewing

pleasure will be enhanced, and we'll be able to make our TVs a personal reflection of our likes and dislikes, hobbies, and interests. However, just like the audio tape took out the record, the compact disc surpassed the audio tape, and video killed the radio star, so too will HDTV render our expensive 32-inch television sets obsolete. I just purchased mine in 1999, and I don't know that I'm ready to spend \$8000 on a new TV that I don't need. Nevertheless, in the spirit of competition, I'd like to at least *attempt* to keep up with our Japanese counterparts who have been using HDTV nationwide for almost a decade.

I may not have a choice.

P

Plant Trees for America

Introducing Robotics with Lego® Mindstorms™

For Robot Lovers. Shows how to build a variety of increasingly sophisticated computer-controlled robots using the brilliant Lego mindstorms Robotic Invention System (RIS). Covers the fundamental building techniques needed to construct strong and efficient robots. Explains to the reader how robot control programs may be simply constructed on their PC screens.

Detailed building instructions are provided for all the robots featured. 270 pages, 7 1/2 x 10 5/7 in. **\$19.99.** Plus \$2.45 shipping in U.S. Order from CLAGGK Inc., P.O. Box 12162, Hauppauge, NY 11788 **CLX1**

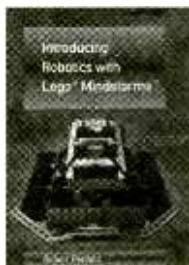

ELECTRONIC SECURITY DEVICES

A great book for project builders. It is quite common to associate the term "Security Devices" with burglar alarms of various types. However in fact it can refer to any piece of equipment that helps to protect people or property. The text is divided into three basic sections: Chapter 1 covers switch-activated burglar alarms and includes exit and entry delays. Chapter 2 discusses other types of burglar alarms and includes Infra-Red, Ultrasonic and Doppler-Shift Systems. Chapter 3 covers other types of security devices such as Smoke and Gas Detectors; Water, Temperature and Baby Alarms; Doorphones, etc. Most circuits are simple, and stripboard layouts are provided.

To order Book BP56 and send \$5.99 includes shipping and handling in the U.S. and Canada only to **Electronics Technology Today Inc.**, P.O. Box 240, Massapequa Park, NY 11762-0240. Payment in U.S. funds by U.S. Bank check or International Money Order. Please allow 6-8 weeks for delivery. **ET09**



Electronic Projects 1.0

By Max Horsey

A series of ten projects to build along with audiovisual information to support hobbyists during construction. Each project is complete with schematic diagrams, circuit and PCB layout files, component lists and comprehensive text to guide the hobbyist through the project. A shareware version of CAD-PACK—schematic capture and PCB design software is also provided. Projects include a reaction timer, logic probe, egg timer and seven more. Get your own copy of this CD-ROM today. **\$75 including shipping in the U.S.** Order from CLAGGK Inc., P.O. Box 12162, Hauppauge, NY 11788. Visa, MC, Discover, OK.



CLX2

Transistor Tester

PAUL C. FLORIAN

Many times I have found it necessary to test bipolar junction transistors to determine what type of transistor I have and its condition. This is especially true with "house-marked" transistors. Here is a simple circuit that will allow you to test and identify your bi-polar transistors.

Circuit Description. The two types of bi-polar transistors, NPN and PNP, can both be represented by diode circuits, as shown in Fig. 1. A simple circuit for testing bi-polar transistors is shown in Fig. 2. This circuit will determine transistor type (NPN or PNP) and open or shorted emitter-to-base (E-B) or open or shorted collector-to-base (C-B) junctions. It will not, however, determine transistor gain.

Component IC2-a oscillates at about 250 Hz with a duty cycle of approximately 50% when power is applied by pushing PB1. This alternately forward- and reverse-biases the E-B and C-B junctions of the BJT-under-test. The IC2-b and IC2-c and IC2-d and IC2-e pairs are paralleled for greater output current.

When the BJT-under-test is NPN, the green LEDs are illuminated. When the BJT-under-test is PNP, the red LEDs are on. If one of the junctions is shorted, the green

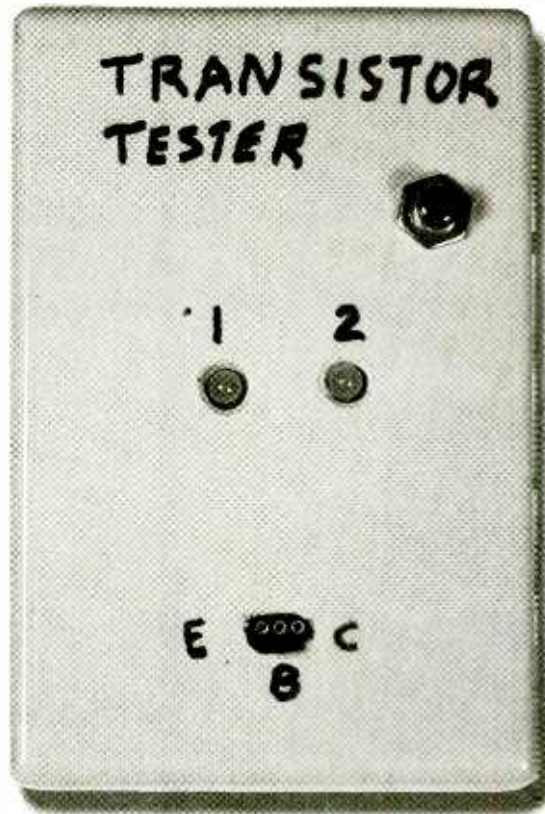

and red LEDs for that junction alternately flash red and green at 250 Hz, giving the LED an orange-yellow color. If a junction is open, the corresponding LED will be off. Table 1 shows the test results corresponding to the colors of LED1 and LED2.

Construction. I built the transistor tester on a piece of perf-board using a point-to-point wiring. Be sure to use an IC socket for IC2. You may want to make a printed circuit board. The BJT socket in Fig. 2 is composed of two three-pin SIP sockets stacked one on top of the other. This gives enough clearance when mounting the board in the case. Similarly, the LEDs

must be spaced about 1/4-inch from the board. The battery is attached to the case with two-sided adhesive tape. If you want to test transistors with a different pin-out or non-TO-92 case style, simply solder test leads to the circuit board at the socket (color code each wire for E, B, and C connections). Then hook up the corresponding wires to the transistor-under-test and push PB1.

Testing The Circuit. After the circuit is assembled, install the 9-volt battery. Measure the voltage at IC2 Pin 14.

PARTS LIST FOR THE TRANSISTOR TESTER

SEMICONDUCTORS

IC1—78L05, 100 mA, 5-volt regulator
IC2—74HCT14, Hex Schmitt-Trigger
D1—IN914, G.P. DIODE
LED1, LED2—Light-emit ing diode, bi-color,
RadioShack 276-012

RESISTORS

(All resistors are 1/4-watt, 5% units unless otherwise noted.)
R1—330,000-ohms
R2—1-megohms
R3, R4—100-ohms

CAPACITORS

C1—.01μF

ADDITIONAL PARTS AND MATERIALS

Transistor socket (test leads optional), 14-pin IC socket, push-button (normally open), 9-volt battery clip, 9-volt battery, case (Pac-Tec K-LH43-100-039-B), perf-board (RadioShack 276-150), hook-up wire, two-sided adhesive tape, hardware

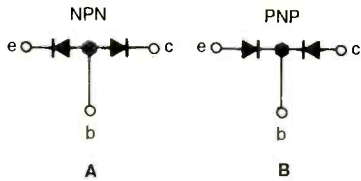
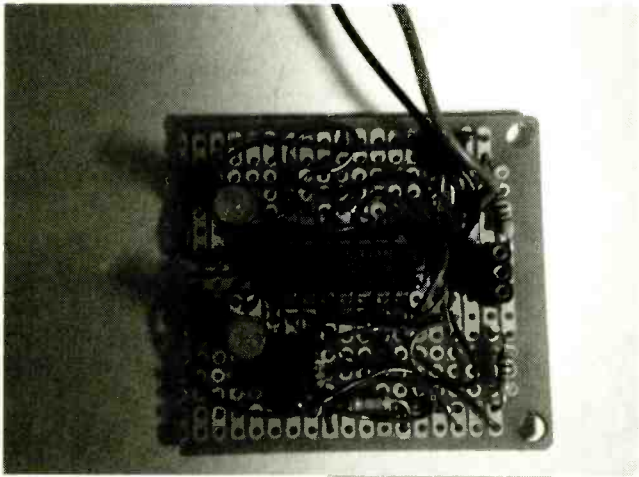

Fig. 1. Bi-polar transistors are made of both N-type and P-type material, just like common diodes. Two simple circuits show the diode equivalent of each type of transistor.

The voltage should read 5 volts when PB1 is pressed. Next, insert IC2 into its socket. Short only B and C together. LED2 should glow yellow-orange when PB1 is pressed. If LED2 does not shine yellow-orange, there is most likely a problem with the oscillator IC2-a. LED1 should also glow yellow-orange when E and B are shorted and PB1 is pressed.



I built the Transistor Tester on a piece of perf-board using point-to-point wiring. Be sure to use an IC socket for IC2. The BJT socket is composed of two three-pin SIP sockets stacked one on top of the other.

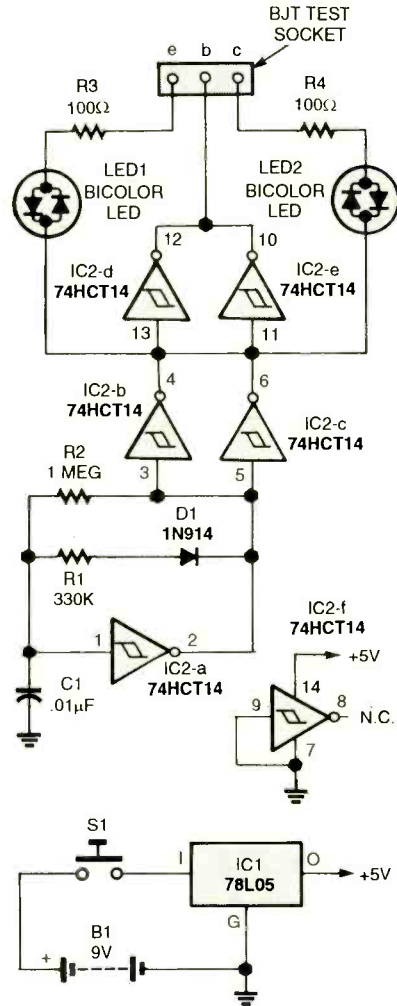

Fig. 2. A Hex Schmitt-Trigger (IC2) is at the heart of the transistor-testing circuit. IC2-a oscillates at about 250 Hz with a duty cycle of approximately 50% when power is applied by pushing PB1.

TABLE 1

LED 1	LED2	TYPE	COMMENTS
Green	Green	NPN	Good
Green	Yellow-Orange	NPN	C-B short
Green	Off	NPN	C-B open
Yellow-Orange	Green	NPN	E-B short
Off	Green	NPN	E-B open
Red	Red	PNP	Good
Red	Yellow-Orange	PNP	C-B short
Red	Off	PNP	C-B open
Yellow-Orange	Red	PNP	E-B short
Off	Red	PNP	E-B open
Off	Off	Unknown	E-B open, C-B open
Yellow-Orange	Yellow-Orange	Unknown	E-B short, C-B short
Off	Yellow-Orange	Unknown	E-B open, C-B short
Yellow-Orange	Off	Unknown	E-B short, C-B open

Two LEDs are used to visually indicate the status and identity of the transistor-under-test. The table above is used to decipher the meaning of LED1 and LED2.

Locate known-good NPN and PNP transistors. Test the transistors and look up the results in Table 1. If the test results do not match the table, it is possible that the polarity of LED1 or LED2 is installed incorrectly.

Using The Tester. Battery life is close to the shelf-life of the battery since the power is only applied during the test. Now it will be easier to determine the type and

condition of unknown bipolar junction transistors. Three simple steps are all that is needed to test your unknown transistors. First, insert the three leads of the transistor into the socket, minding the position of each lead—emitter, collector, and base. Next, press the pushbutton down and hold while observing the LEDs. Finally, compare the colors of LED 1 and LED2 to the data in Table 1. P

FREE CATALOGS

C&S SALES, INC.

64 pgs., Test
Equipment Catalog,
see pg. 69

ELECTRONIX EXPRESS

FREE 256 Page Catalog
Test Equipment
see pg. 70

PARTS EXPRESS

FREE 308 Page Catalog
Audio, Video, Speaker Building Components,
see Cover 2

RAMSEY ELECTRONICS

Projects and Kits Catalog,
see pg. 67

SMARTHOME

144 pgs., Home
Automation Products,
see pg. 72

LYNXMOTION

Robotic Kits Catalog,
see pg. 68

MENDELSON'S

Electronic Surplus and
Components Catalog,
see pg. 62

ABACOM TECHNOLOGIES

RF Modules
see pg. 78

COMMAND PRODUCTION

FCC License Training Facts,
see pg. 66

MODERN ELECTRONICS

Cable/Video
Products Catalog,
see pg. 74

POLARIS INDUSTRIES

Video Technology Catalog,
see pg. 59

ALL ELECTRONICS

96 pgs., Electronic
Components and kits
see pg. 62

INFORMATION UNLIMITED

Amazing Science
Devices Catalog,
see pg. 70

FREE DOWNLOADS

ENGINEERING EXPRESS

Free PCB Layout Software,
see pg. 71

IVEX DESIGN INTERNATIONAL

Electronics CAD
Full Function Demos,
see pg. 65

PIONEER HILL SOFTWARE

Real-Time Audio
Spectrum Analyzer,
see pg. 62

FREE DEMO TAPE

IT SOUND

Audio Products,
Free Brochure and Demo,
see pg. 68

Poptronics®

SHOPPER

begins on page 59

ELECTRONIC TECHNOLOGY TODAY INC.

P. O. Box 240 • Massapequa Park, NY 11762

INVENTORY BLOWOUT SALE



* ALL CANADIAN CHECKS MUST CLEAR THROUGH AN AMERICAN BANK

BP07	100 Radio Hookups	\$3.00	BP317	Practical Electronic Timing	\$6.99
BP36	50 Circuits Using Germanium, Silicon & Zener Diodes	\$2.99	BP320	Electronic Projects for Your PC	\$5.99
BP44	IC 555 Projects	\$5.99	BP322	Circuit Source Book 2	\$6.99
BP56	Electronic Security Devices	\$3.99	BP329	Electronic Music Learning Projects	\$6.99
BP64	Semiconductor Technology Elements of Elect Book 3	\$5.99	BP332	A Beginners Guide to TTL Digital ICS	\$6.99
BP74	Electronic Music Projects	\$3.99	BP333	A Beginners Guide to CMOS Digital ICS	\$6.99
BP76	Power Supply Projects	\$3.99	BP334	Magic Electronic Projects	\$6.99
BP78	Practical Computer Experiments	\$2.99	BP355	A Guide to the World's Radio Stations	\$7.99
BP80	Popular Electronic Circuits	\$3.99	BP359	An Introduction to Light in Electronics	\$6.99
BP103	Multi-Circuit Board Projects	\$2.99	BP367	Electronic Projects for the Garden	\$6.99
BP109	The Art of Programming the IK ZX81	\$3.99	BP370	The Superhet Radio Handbook	\$6.99
BP112	A Z-80 Workshop Manual	\$5.99	BP371	Electronic Projects for Experimenters	\$6.99
BP114	The Art of Programming the 16K ZX81	\$3.99	BP374	Practical Fibre-Optic Projects	\$6.99
BP115	The Pre-Computer Book	\$2.99	BP378	45 Simple Electronic Terminal Block Projects	\$6.99
BP124	Easy Add-On Projects for the Spectrum, ZX81 & ACE	\$3.99	BP379	30 Simple IC Terminal Block Projects	\$6.99
BP143	An Intro to Programming the Atari 600/800 XL	\$2.99	BP384	Practical Electronic Model Railways Projects	\$6.99
BP148	Computer Terminology Explained	\$2.99	BP385	Easy PC Interfacing	\$6.99
BP154	An Introduction to MSX Basic	\$3.99	BP391	Fault-Finding Electronic Projects	\$6.99
BP156	An Introduction to QL Machine Code	\$3.99	BP392	Electronic Project Building for Beginners	\$6.99
BP187	A Prac Ref Guide to Word Pro Amstrad PCW8256/PCW8512	\$7.99	BP393	Practical Oscillator	\$6.99
BP190	More Advanced Electronic Security Projects	\$3.99	BP396	Electronic Hobbyists Data Book	\$7.99
BP194	Modern OPTO Device Projects	\$3.99	BP401	Transistor Data Tables	\$7.99
BP232	A Concise Introduction to MS-DOS	\$3.99	BP411	A Practical Intro to Surface Mount Devices	\$6.99
BP256	An Intro to Loudspeakers and Enclosure Design	\$3.99	BP413	Practical Remote Control Projects	\$7.99
BP264	A Concise Advanced User's Guide to MS-DOS	\$3.99	BP416	Practical Alarm Projects	\$6.99
BP272	Interfacing PCS and Compatibles	\$5.99	BP439	Troubleshooting Your PC	\$8.99
BP290	An Intro to Amateur Communications Satellites	\$5.99	PCP107	Digital Logic Gates and Flip-Flops	\$10.99
BP297	Loudspeakers for Musicians	\$6.99	PCP112	Digital Electronics Projects for Beginners	\$10.99
BP299	Practical Electronic Filters	\$6.99	PCP114	Advanced MIDI Users Guide	\$10.99
BP302	A Concise User's Guide to Lotus 1-2-3 Release 3.1	\$5.99	ETT1	Wireless & Electrical Cyclopedia	\$4.99
BP304	Projects for Radio Amateurs and S.W.L.S	\$5.99			

PRICES DO NOT INCLUDE SHIPPING & HANDLING. ALL SALES ARE FINAL, NO RETURNS

ORDER FORM

Book No.	Title	Price	No. of Copies	Cost

Name _____
 Address _____
 City _____ State _____ Zip _____

If you wish to use a Credit Card:

MasterCard Visa Expire Date _____ / _____

Card No. _____

Signature _____

Allow 6-8 weeks for order to be fulfilled.

Please return this order form to:
ELECTRONIC TECHNOLOGY TODAY, INC.
 P.O. Box 240
 Massapequa Park, NY 11762-0240



SHIPPING COSTS		Total Amount \$	
\$0.01 to \$5.00	\$2.00	\$20.01 to \$30.00	\$5.00
\$5.01 to \$10.00	\$3.00	\$30.01 to \$40.00	\$6.00
\$10.01 to \$20.00	\$4.00	\$40.01 to \$50.00	\$7.00
\$50.01 and above	\$8.50		
		Local NY State Sales Tax	
		Add shipping cost (see table)	
		TOTAL COST \$	

Telephone Orders: If you wish to place your credit-card order by phone, call 631/592-6720. Have your credit-card ready. Sorry, no orders accepted outside of U.S.A. and Canada, New York State Residents must add applicable sales tax. Offer expires 3/31/02.

Negative Logic and DeMorgan

Q Hey, good reply on negative logic, etc. in the November "Q & A" column. However, Fig. 2 should have been an "OR" sign with inverting bubbles. The printer probably got you on that one. I can't believe **Poptronics** won't use "alternate gate functions." I found out 15 years ago that it sure makes deciphering a circuit's function easier. It took me two hours to figure out one of my boss' schematics—ins vs. outs, etc. I redrew the schematic to show the functional actions of the logic, and anyone could see what level was needed to activate the output instead of having to guess. I am glad you addressed the issue. I have heard numerous people talk about negative logic, when they were actually talking about active low inputs!—M.S., Oklahoma City, OK

A Of course, the first thing I do with a newly arrived issue of **Poptronics** is open to the "Q & A" column. Without reading a single thing, my eyes were instantly drawn to the glaring error of Fig. 2. Yes, that gate definitely got off its hinges somewhere between here and the presses. As you said, it should be an "OR" gate symbol with inverted inputs and a non-inverted output in order to be a DeMorgan NAND gate. By the way, thank you for the kind words.

It's interesting that you mentioned a boss of yours who couldn't see the logic of DeMorgan equivalents. My best friend where I taught had a boss like that when he worked in the industry. This guy reminded me of myself when I worked for Tektronix. At that time, I hadn't been fully introduced to Mr. DeMorgan. I came across a schematic of the 1502 time-domain reflectometer that had a couple of NAND gates being used as an RS flip-flop. One gate was drawn like the traditional NAND gate, and the other was the DeMorgan equivalent, as Fig. 2 of the November column should have been. I looked at the schematic in the manual in horror as I realized that they'd drawn a 74LS00 NAND gate that way. I sent in a manual change form to the factory, and I'll be

darned if they didn't implement that change. After I learned about DeMorgan equivalents, I realized that I had forced an "error" into the manual and made it more difficult to understand the operation of that circuit. I've kicked myself for that ever since, and every time I teach students about DeMorgan equivalent gates, I use myself as an example of what NOT to do.

Modifying Meters

Q I have a VU meter that has a full-scale deflection with 550 microamps applied. Do you have a circuit for a current amplifier that you can use with the VU meter in place of the 100-microamp meter used in the "In-Circuit Capacitor Tester" in the July 2001 issue of **Poptronics**?—J.L., via e-mail

A Although your VU meter has a full-scale deflection that requires five times more current than the specified meter, the circuit should be able to handle it with no problem. Figure 1 shows the new component values that I think will work with the heavier meter movement. Use the author's adjustment procedure under the "Testing" section on page 28 of the July issue. If you can't get a full-scale reading when you short the probes, lower the value of R19 until you get a full-scale reading with R22 adjusted to the center of its range. If the movement shows an over-range condition and you can't back off the adjustment enough, then increase the value of R19

with R22 centered. Now, adjust R22 as described in the article.

This is one of those projects that was designed to be a quick cap tester and not a laboratory instrument, so we have a lot of latitude with component substitution. Hobbyists new to electronics need to learn that most projects presented in **Poptronics** or other electronics hobbyist publications can be modified to incorporate components you already have, especially if the project wasn't designed to be some sort of laboratory standard. After all, that's the old Ham-radio philosophy of having a "junk box" for homebrew projects.

As a lesson on this subject, let's use the updated schematic of the cap tester in the "Letters" column, September 2001 issue, Page 4. Capacitors C1 and C2 are decoupling caps, and their values are probably the least critical of any components in the circuit. You could put anything in there from 10 microfarads to 470 microfarads, and the circuit would work just fine.

Capacitor C4 is a coupling cap between the IC1-c differential amplifier and the active rectifier of IC1-d. You can play with its value a bit, especially if you try to keep the RC time constant of C4 against R17 about the same. In other words, if you increase the value of C4, decrease the value of R17 a little. This way when you multiply the two values together, you'll stay around 5 ms or so. If you must vary from this, make the cap larger rather than smaller.

A difficult-to-find "low-current" LED is specified in the circuit, but you could use a more common LED—expecting a lower light output. Resistor R21 is going to limit the current to 3.3 mA regardless of the LED, as long as you select one with the same forward voltage drop (i.e., no weird new colors for the LED).

Resistors R1 and R2 are there to provide a voltage split on the 9-volt supply. You have a lot of latitude with those two values as long as they match each other. A pair of 22K resistors will work just as well. Just don't get the values too high or the input impedance of the op-amp will figure in, and don't get them too low or

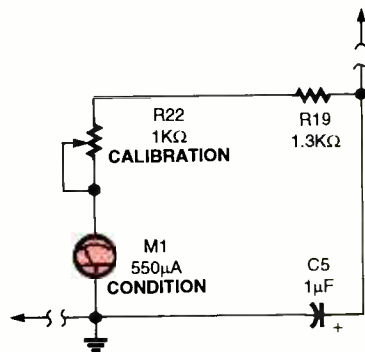

Fig. 1. A substitution of the meter movement of the "In-Circuit Capacitor Tester" should only require a resizing of the multiplier resistors, R19 and R22.

you'll unnecessarily suck too much current from the battery.

I used a couple of 1N4002 diodes for D1 and D2 in my version. Those diodes are there in case you connect the tester across a hefty, charged capacitor. I don't plan on doing that, so it didn't concern me that the maximum current of my diodes was only a third of those that were specified. Nevertheless, it still left me some protection.

You can use nearly any switching diode for D3, such as a 1N4148. If you increase the values of C6 and C5 a little, you'll just slow down the response time of the circuit, but not affect its overall operation. The TL084 is a quad op-amp, but there's no reason why you can't modify the circuit to use a pair of dual op-amps like the TL082 that's carried by RadioShack (the TL084 isn't).

The point is, don't feel that you're locked in to a project's exact component values in every case. You usually don't have to order a lot of new parts. However, you do have to know what you can and can't mess with. Voltage dividers have to maintain their original ratios. Try to maintain some input and output impedances—you can't substitute just any op-amp for another. Frequency-critical circuits such as filters and oscillators can't be messed with too much, and their frequency-setting capacitors must be stable with a low or zero temperature coefficient. Also, signal amplitudes have to be maintained at their design values. Don't let any of this deter you from experimenting. Build the circuit as described and then change a component value to see how it affects the circuit. After all, it's YOUR project and experimenting is a wonderful and fun way to learn!

ESR: Extra Schematic Resource

Q I built the cap tester from the July issue, but it didn't work. I was wondering if you noticed that on the list there were two resistors of 22 ohms and one of 47 ohms, but in the schematic, they were replaced by two of 22K and one of 47K. Maybe that was not my mistake, but I wanted to know which one to use. Also, is there any way to debug this tester without an oscilloscope?—P.M., via e-mail

A In addition to the corrected schematic in the September issue, there are two spots on the Gernsback forum

where this circuit and corrections were discussed: www.gernsback.com/HNeditor/get/editor/board/25.html and http://167.206.219.243/forums/electronic_bench/posts/366.html.

The oscillator section of the tester (IC1b, Q1, and Q2) generates a 100-KHz square wave. If you don't have an oscilloscope, I'd venture to guess that you could hold an operating circuit near an AM transistor radio tuned to 700 KHz or so and hear this signal. You could temporarily substitute a 0.1- μ F capacitor for C3, which should shift the frequency of this oscillator down to around 1. You could then connect your home stereo AUX, TAPE, CD or TUNER input to IC1-b Pin 7 or to the collector of Q1 or of Q2, and you would get a whopping tone out of the amplifier. If you do get a tone, put the original cap back in for C3 and assume that the oscillator section will be working properly at 100 KHz.

Most troubleshooting on IC1-c and IC1-d can be done using the circuit description in the July issue and a digital multimeter (DMM). The DMM will usually indicate, although not necessarily accurately, an AC voltage in the 100-KHz range. Use the meter on ACV to check for the presence of an AC voltage at the output of both ICs. With open probes, the AC should be negligible; and, as the resistance across them lowers, the AC voltage will begin to increase. You should see a DC-voltage shift at the output of IC1-c when the probes are shorted together. This shift should turn on Q3 (base voltage increases to about +0.6 v) and turn on LED1. As the resistance between the probes decreases, you should see the AC voltage across C5 increase.

IC1-a should have zero volts on Pins 1, 2, and 3 while you have +4.5 volts on Pin 4 and -4.5 volts on Pin 11—all with respect to ground. If the two power-supply voltages are opposite in polarity but not equal in voltage (more than 0.5 volts different), check the voltage drops across R1 and R2. They should both be about 4.5 volts. If not, check their actual values.

A Circuit-Board Layout

An experimenter who had posted on the Gernsback forum noted that the photos accompanying the "In-Circuit Capacitor Tester" project in the July 2001 issue, pages 26 and 27, were difficult to use to

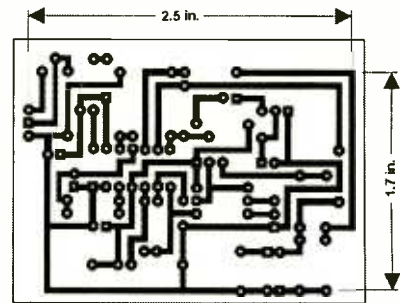

Fig. 2. The "X-ray" view of the "In-Circuit Capacitor Tester" is suitable for use with the "toner transfer" method of PCB etching.

determine a parts layout. Normally, this wouldn't have been an issue, but the "poster" was somewhat new to electronics and did not have those project-layout skills that are developed with experience. He hadn't yet gotten the hang of circuit-board layout, something that is very intimidating the larger a project gets.

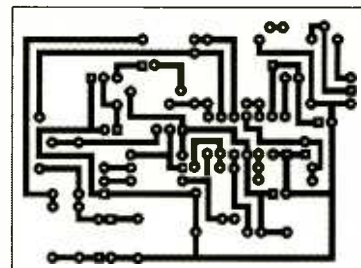

Fig. 3. The foil-side view of the PCB is suitable for use with the "photographic" method of PCB construction.

Realizing his dilemma, I hopped on the computer and did a quick board layout for the circuit according to the corrected schematic that appeared in the September 2001 issue (Page 4) and posted that layout to the newly revised **Poptronics** forum. I'm still waiting to obtain a TL084 quad op-amp to finish the board and fully check out the circuit, but thought I'd go ahead and publish the layout for those interested readers who were contemplating building this project.

The layout of my Fig. 2 is an "X-ray" view, as though you were looking down through the component side of the board and is the one you would use if you were using the "toner transfer" method of circuit-board etching. Figure 3 is the actual view from the foil side of the board and is the layout you would use if you were using photographic techniques (i.e., photosensitized circuit-board material) to make your board. Figure 4 is the component-placement diagram for the circuit board. The

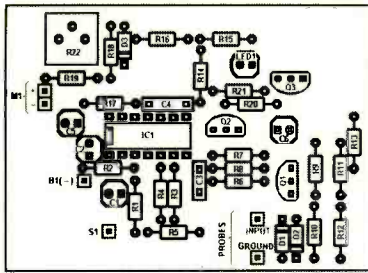

Fig. 4. The component-layout diagram for the capacitor tester illustrates how small this circuit is, because of the use of a quad op-amp.

dimensions provided on Fig. 2 will be critical if you decide to transfer this image directly, as there may be dimen-

HOW TO GET INFORMATION ABOUT ELECTRONICS

On the Internet: See our Web site at www.poptronics.com for information and files relating to **Poptronics** and our former magazines (**Electronics Now** and **Popular Electronics**) and links to other useful sites.

To discuss electronics with your fellow enthusiasts, visit the newsgroups sci.electronics.repair, sci.electronics.components, sci.electronics.design, and rec.radio.amateur.homebrew. "For sale" messages are permitted only in rec.radio.swap and misc.industry.electronics.marketplace.

Many electronic component manufacturers have Web pages; see the directory at www.hitex.com/chipdir/, or try addresses such as www.ti.com and www.motorola.com (substituting any company's name or abbreviation as appropriate). Many IC data sheets can be viewed online: www.questlink.com features IC data sheets and gives you the ability to buy many of the ICs in small quantities using a credit card. You can also get detailed IC information from www.icmaster.com, which is now free of charge although it formerly required a subscription. Extensive information about how to repair consumer electronic devices and computers can be found at www.repairfaq.org

Books: Several good introductory electronics books are available at RadioShack, including one on building power supplies.

An excellent general electronics textbook is *The Art of Electronics*, by Paul Horowitz and Winfield Hill, available from the publisher (Cambridge University Press, 800-872-7423) or on special order through any bookstore. Its 1125 pages are full of information on how to build working circuits, with a minimum of mathematics.

Also indispensable is *The ARRL Handbook for Radio Amateurs*, comprising over 1000 pages of theory, radio circuits, and ready-to-build projects, available from the American Radio Relay League, Newington, CT 06111, and from ham-radio equipment dealers.

Back issues: Copies of back issues of and past articles in **Electronics Now**, **Popular Electronics**, and **Poptronics** can be ordered on an "as available basis" from Claggk, Inc., Reprint Department, P.O. Box 12162,

sional variations in the magazine printing process or on your scanning or copying process. Be sure to allow for mounting holes, as I didn't work those in on my layout.

If you're new to the hobby, note that you don't have to etch a board. You can use this layout to help make the circuit using perfboard or wire-wrap construction. Because I use, shall we say, an "economical" layout program, all the traces are spaced pretty much on 0.1-inch centers, so you can use this layout to lay wires down on prototyping perfboard that has solder pads on 0.1-inch centers.

Hauppauge, NY 11788; Tel: 631-592-6721. To ensure receipt of the correct material, readers must supply complete information on the article or issue that they wish to buy.

Poptronics and many other magazines are indexed in the *Reader's Guide to Periodical Literature*, available at your public library. Copies of articles in other magazines can be obtained through your public library's interlibrary loan service; expect to pay about 30 cents a page.

Service manuals: Manuals for radios, TVs, VCRs, audio equipment, and some computers are available from Howard W. Sams & Co., Indianapolis, IN 46214; (800-428-7267). The free Sams catalog also lists addresses of manufacturers and parts dealers. Even if an item isn't listed in the catalog, it pays to call Sams; they may have a schematic on file which they can copy for you.

Manuals for older test equipment and ham radio gear are available from Hi Manuals, PO Box 802, Council Bluffs, IA 51502, and Manuals Plus, 130 N. Cutler Dr., N. Salt Lake, UT 84054.

Replacement semiconductors: Replacement transistors, ICs, and other semiconductors, marketed by Philips ECG, NTE, and Thomson (SK), are available through most parts dealers (including RadioShack on special order). The ECG, NTE, and SK lines contain a few hundred parts that substitute for many thousands of others; a directory (supplied as a large book and on diskette) tells you which one to use. NTE numbers usually match ECG; SK numbers are different.

Remember that the "2S" in a Japanese type number is usually omitted; a transistor marked D945 is actually a 2SD945.

Hamfests (swap meets) and local organizations: These can be located by writing to the American Radio Relay League, Newington, CT 06111; (www.arrl.org). A hamfest is an excellent place to pick up used test equipment, older parts, and other items at bargain prices, as well as to meet your fellow electronics enthusiasts—both amateur and professional.

The end result looks like a circuit board with really thick traces made of solder. If you do use that method, be sure to use a socket for the IC. That way, you won't be soldering your second-most-expensive component into the board and risk wrecking it if you have to do some rip up and relay work in case you make an error.

NE558—Sounds Like A Neon Lamp

Q My last question would be if you know where I could find the datasheet (on the Internet?) for the NE558 and what exactly this chip does?—P.M., via e-mail

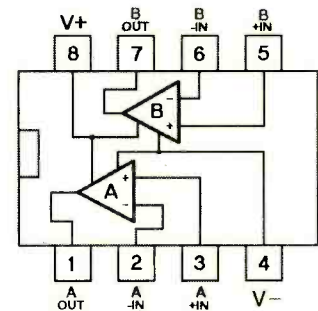

Fig. 5. The pinout for the old NE558 (558) is identical to that of the LM1458, and their specifications are nearly the same.

A P.M. had two questions, so I'm breaking the second one out so that there's no confusion with his first question. The NE558 is a common shortening of the type number of Signetics' NE5558, a dual operational-amplifier in an 8-pin mini-DIP package. The pin-out is shown in Fig. 5. The 558 is an old chip that's been around as long as the 741 and is largely replaced by the LM1458, which has exactly the same pin-out and nearly identical specifications. For all practical purposes, the 558 is a dual 741 without the availability of offset inputs.

Death By Cellular Telephone

Q Most of us are aware of the paranoia surrounding the possibility that cell phones may cause cancer. As a result, various products have been developed which claim to reduce the amount of radiation directed into the head. The most common consists of a mesh disk placed over the earpiece, said to block 99% of the radiation to the ear. I

always thought the majority of radiation was emitted from the antenna, not the earpiece. Shouldn't we be more concerned about that? Are these companies merely playing on our vulnerability as a result of hyped-up claims that our cell phones are killing us? Sounds like nothing more than a gimmick to steal the money from anyone ignorant enough to buy it. Any ideas?—P.N., Laurel, MD

A Companies playing on our vulnerability? Surely you jest! Cancer? One study that I recall found that laboratory rats injected with the pulverized remains of cellular telephones did indeed have a greater risk of cancer than did the control group, so that's not an issue—cellular phones can cause cancer. They're also dangerous in that they can cause unconsciousness if someone hits you in the temple with one hard enough. Does your ear get warm and red and feel sore after you've been talking on the phone for an extended period of time? Then maybe there's some truth to the claim.

Although the mesh disk blocks 99% of the radio-frequency radiation to the ear, it blocks none of the audio radiation, which usually accounts for substantially more health risks. These include inner ear damage, reddening of the outer ear, high blood pressure, anxiety, depression and a host of other maladies incurred from listening to the person on the other end of the "line." Add to that the number of innocent individuals who are injured each year from someone throwing a cell phone in anger, as an example, after hearing that their stockbroker just sunk his entire investment portfolio into English beef.

Then there is the inappropriate use of the phone that causes damage. It escapes me why all these folks have to be on their phone while driving, as though negotiating through rush-hour traffic wasn't enough cause for concern. I praise the states that are making that an illegal practice, although I doubt that it'll ever have any more punch than driving without a seat belt fastened. It also seems necessary to use phones while in a restaurant, at a concert, or at a movie.

OK. Off the soapbox. The bag phones and Motorola "brick" phones of the olden days (in cellular history) had high-power transmitters running as much as 3.5 watts, if I recall correctly. Today's phones rely on much better receivers and back off on the transmitter power because they want to extend battery life. If you look at the offerings of

Maxim, Analog Devices, and other integrated-circuit manufacturers, you'll find that a large slice of their product lines involve the radio-communications industry. They're always improving the sensitivity, noise figures, and DC power requirements of their chips, almost on a monthly basis. They're shooting for better receivers so that the transmitter power requirements to "hit" a cell are reduced. Ergo, the power levels of the transmitter are much lower on the current phone offerings.

Although cellular-phone frequencies are approaching those of microwave ovens (and their keypads do look a lot alike), I myself doubt that there's enough energy coming out of the earpiece or the antenna to do any direct tissue damage. Alter some cell structures and create some rogue cells? Well, that truly is a possibility if sunlight can do the same thing. Maybe a company should develop a shielded helmet the user can wear with the antenna mounted on top over a little ground plane, connected to where the phone's antenna screws in. They could call it the "Al Franken Special."

I think back to 1965 and realize that I don't remember any inconvenience of not having pocket-sized communication via phone or pager. It wouldn't bother me if they do find out that the things are dangerous and outlaw them or at least require them to put little stickers on each of them. "CAUTION: Cellular-phone use has been found to cause cancer when the radiation is concentrated within an automobile, theater, restaurant, or concert hall."

Dead Sites Aren't Always Cemeteries

Q I have been unsuccessful at opening the "misc.industry.electronics.marketplace.com" Web site listed in the sidebar on page 48 of the November 2001 issue of the *Poptronics* "Q & A" column. I have tried the site without periods with similar negative results. Thank you for any assistance you can provide.—W.F., via e-mail

A That listing is not a "Web site" per se, but a newsgroup. If you have *Outlook Express* for your e-mail system, you can go to the toolbar at the top right and click on "Newsgroups." In the pop-up window, a list of lots and lots (and lots) of newsgroups will appear—some not very nice and others that should be quite

wholesome. Click on the newsgroup(s) of interest and then click the "Subscribe" button at the right. "X" out of that window and you should see the newsgroups to which you've subscribed under your Folders. Just click on those as you would an e-mail folder and the various newsgroup postings should appear as incoming e-mails.

Writing to Q&A

As always, we welcome your questions. Please be sure to include:

- (1) plenty of background material,
- (2) your full name and address on the letter (not just the envelope),
- (3) and a complete diagram, if asking about a circuit; and
- (4) type your letter or write neatly.

Send questions to Q&A, *Poptronics*, 275-G Marcus Blvd., Hauppauge, NY 11788 or to q&a@gernsback.com, but do not expect an immediate reply in these pages (because of our backlog). We regret that we cannot give personal replies. Please no graphics files larger than 100K. P

BUY BONDS

Get your copy of the CRYSTAL SET HANDBOOK



Go back to antiquity and build the radios that your grandfather built. Build the "Quaker Oats" type rig, wind coils that work and make it look like the 1920's! Only \$10.95 plus \$4.00 for shipping and handling. Claggg Inc., PO Box 12162, Hauppauge, NY 11788. USA Funds ONLY! USA and Canada—no foreign orders. Allow 6-8 weeks for delivery. MA01

CRYSTAL SETS: VOLUME V.



Volume V of the Society newsletter includes six issues ending November 1995. Great for new members to get current, those wanting a bound copy for their reference bookshelf, or as a gift to get a friend started. Contents include: The Design of Unpowered AM Receivers, Radio

Outfit in a Headset, A Crystal Set Revisited-Reconstructed, Grounded Loop-stick Tuner, The Matching Secret, and lots of membership correspondence. 8½ × 5½ paperback, \$8.95 plus shipping.—*Electronic Technology Today Inc.*, PO Box 240, Massapequa Park, NY 11762-0240. US funds only. Allow 6-8 weeks for delivery. MA06

Switchmode Power Supplies

Disclaimer

Careless troubleshooting of a line-powered switchmode power supply can result in severe electrical shock or electrocution. This is potentially more lethal than the high-voltage section of a TV or monitor due to the availability of high current. Even the charge on the main filter capacitors with the unit unplugged can kill. This warning includes those innocent-looking laptop and Zip-drive power packs as well.

Neither the author or publisher will be responsible for damage to equipment, your ego, countywide power outages, spontaneously generated mini (or larger) black holes, planetary disruptions, or personal injury or worse that may result from the use of this material.

This month and next, we will deal with the types of power supplies found in PCs, laptops, and other computers and peripherals; TVs and monitors; printers and fax machines; as well as on the ends of the power cords of some PDAs, cell-phone chargers, computer-backup drives, and other small devices.

Introduction

Until the 1970s or so, most consumer electronic equipment used a basic power transformer/rectifier/filter capacitor type of power supply for converting the AC line into the various voltages needed by internal circuitry. Even regulation was present only where absolutely needed—the high voltage supplies of color TV sets, for example. Remember those old TVs with boat-anchor-type power transformers? (Of course, if you recall those, you also fondly recall the days of vacuum-tube sets and the corner drug-store with a public tube tester!)

Switchmode power supplies (SMPSs) had been commonplace in military and avionic equipment long before they found their way into consumer electronics. I have

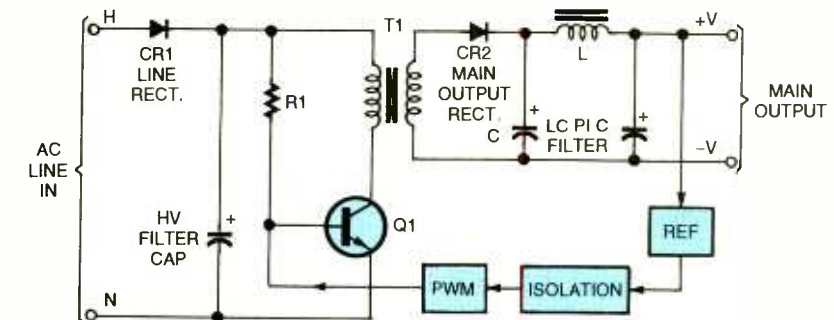

Fig. 1. The flyback circuit shown above is a very common topology for small switchers.

some DC-DC and DC-AC converter modules from a Minuteman I missile from around 1962—examples of such military use. I suppose that the cost of the switching transistors wasn't as big a deal with a \$100 million missile as a \$300 TV (even in 1960s dollars).

Nowadays, all TVs, monitors, PCs and VCRs; most laptop and camcorder power packs; many printers and fax machines; and even certain audio equipment like portable CD players use this technology to reduce cost, weight, and size.

What Is A Switchmode Power Supply?

Also called switching power supplies and sometimes chopper-controlled power supplies, SMPSs use high-frequency (relative to 50/60 Hz) switching devices such as Bipolar Junction Transistors (BJTs), MOSFETs, Insulated Gate Bipolar Transistors (IGBTs), or Thyristors (SCRs or triacs) to take directly rectified line voltage and convert it to a pulsed waveform.

Most small SMPSs use BJTs or MOSFETs. IGBTs may be found in large systems, and thyristors are used where their advantages (latching in the ON state and high-power capability) outweigh the increased complexity of the circuitry to assure that they turn off properly. (Except for special Gate Turn Off or GTO thyristors, the gate input is

pretty much ignored once the device is triggered; and the current must go to zero to reset it to the OFF state.)

The input to the switches is usually either 150–160 V_{DC} after rectification of 115 V_{AC}, or it is 300–320 V_{DC} after doubling of 115 V_{AC} or rectification of 220–240 V_{AC}. Up to this point, there is no line isolation as there is no line-connected (large, bulky, heavy) power transformer.

A relatively small high-frequency transformer converts the pulsed waveform into one or more output voltages that are then rectified and filtered using electrolytic capacitors and small inductors in a “pi” configuration (C-L-C); or for outputs that are less critical, just a capacitor is used.

This high-frequency transformer provides the isolation barrier and the conversion to generate the multiple voltages often provided by an SMPS.

Feedback is accomplished across the isolation barrier by either a small pulse transformer or opto-isolator. The feedback controls the pulse width or pulse frequency of the switching devices to maintain the output constant. Since the feedback is usually only from the “primary” output, regulation of the other outputs, if any, is usually worse than for the primary output.

Also, because of the nature of the switching designs, the regulation even of the primary output is usually not nearly as good both statically and dynamically

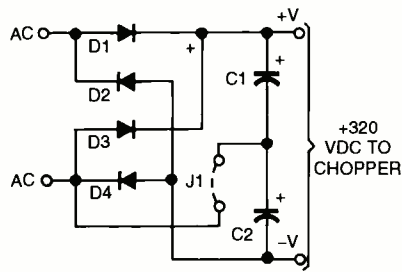

J1 INSTALLED: INPUT = 115V AC
 J1 REMOVED: INPUT = 230V AC

Fig. 2. This common circuit uses a bridge rectifier as a doubler or normal bridge by changing one jumper.

as a decent linear supply.

DC-DC converters are switchmode power supplies without the line-input rectification and filtering. They are commonly found in battery-operated equipment like CD players and laptop computers. They have similar advantages to SMPSs—compact, lightweight, and highly efficient.

Description Of Typical Flyback-Type SMPSs

Probably the most common topology for small switchers is the flyback circuit shown in Fig. 1. The input to the supply is the AC line, which may have RFI and surge protection (not shown). There may be several inductors, coupled inductors, and capacitors to filter line noise and spikes as well as to minimize the transmission of switching-generated radio-frequency interference back into the power line.

There may be MOV-type of surge suppressors across the three input leads (H, N, G). A line fuse is usually present as well to prevent a meltdown in case of a catastrophic failure. It rarely can prevent damage to the supply in the event of an overload, however.

Line rectification is usually via a voltage doubler or diode bridge. One common circuit (see Fig. 2) uses a bridge rectifier as a doubler or normal bridge by changing one jumper. The voltage across the switching transistor is usually around 160–320 volts. Some universal supplies are designed to accept a wide range of input voltages—90–240 V_{AC} (possibly up to 400 Hz or more) as well as DC—and will automatically work just about anywhere in the world as long as a suitable plug adapter can be found.

When Q1 turns on, current increases linearly in T1, based on the voltage applied and the leakage inductance of T1's primary winding. Little power is

transferred to the secondary during this phase of the cycle. When Q1 turns off, the field collapses; and this sequence transfers power to the output. The longer Q1 is on, the more energy is stored (until saturation, at which point it blows up). Thus, controlling the pulse width of the Q1 "on-time" determines the amount of power available from the output.

The output rectifier, CR2, must be a high-efficiency, high-frequency unit—a 1N400X will not work. The pi filter on the output smooths the pulses provided by CR2. Sometimes, a full-wave configuration is used with a center-tapped transformer secondary.

Note that the transformer, T1, is a special type that includes an air gap in its core (among other things) to provide the inductive characteristics needed for operation in flyback mode.

Multiple output windings on T1 provide for up to a half dozen or more separate (and possibly isolated as well) positive or negative voltages, but, as noted, only one of these is usually used for regulation.

A reference circuit monitors the main output and controls the duty cycle of the switching pulses to maintain a constant output voltage.

The start-up resistor, R1, (some start-up circuits are more sophisticated than this one) provides the initial current to the switchmode transistor base. In the old days, SMPS controllers were designed with discrete components. Assuring stable operation is a challenge with any SMPS, but particularly with the flyback topology where leaving the drive on for too long will result in transformer core saturation and instant smoke. Nowadays, an IC PWM controller chip is almost always used. The block diagram of one very popular PWM controller IC is shown in Fig. 3.

Many small SMPSs use opto-isolators for the feedback. An opto-isolator is simply an LED and a photodiode in a single package. As its name implies, an opto-isolator provides the isolation barrier (between the low-voltage secondary outputs and the line-connected primary) for the feedback circuit.

Typically, a reference circuit on the output side senses the primary output voltage and turns on the LED of the opto-isolator when the output voltage exceeds the desired value. The photodiode detects the light from the LED and causes the pulse width of the switching waveform to be reduced enough to pro-

Advantages Of SMPSs Compared To Linear-Power Supplies (LPSs)

The benefits of implementing switch-mode operation are related to size, weight, and efficiency.

- **Size and weight**—Since the transformer and final filter(s) run at a high frequency (we are talking about 10 kHz to 1 MHz or more), they can be much smaller and lighter than the big bulky components needed for 50/60-Hz operation. Power density for SMPSs compared to LPSs may easily exceed 20:1.

- **Efficiency**—There is relatively little power lost since the switching devices are (ideally) fully on or fully off. The efficiency can be much higher for SMPSs than for LPSs, especially near full load. Efficiencies can exceed 85% (compared to 50–60% for typical LPSs), with improvements being made continuously in this technology.

With the advent of the laptop computer, cellular phone, and other portable devices, the importance of optimizing power usage has increased dramatically. There are now many ICs for controlling and implementing SMPSs with relatively few external components. Maxim, Linear Technology, and Unitorde (now part of Texas Instruments) are just a few of the major manufacturers of controller ICs.

vide just the right amount of output power to maintain the output voltage constant. This circuit may be as simple as putting the photodiode across the base drive to the BJT switch, thus cutting it off when the output voltage exceeds the desired value. The reference is often a TL431 or similar shunt regulator chip monitoring a voltage-divided version of the primary output. When the shunt-regulator kicks in, the opto-isolator LED turns on, reducing the switchmode transistor drive. There may be an adjustment for the output voltage.

Other designs use small pulse transformers to provide isolated feedback. Where additional regulation is needed, small linear regulators may be included following the output(s).

There are many other topologies for switching power supplies. However, the

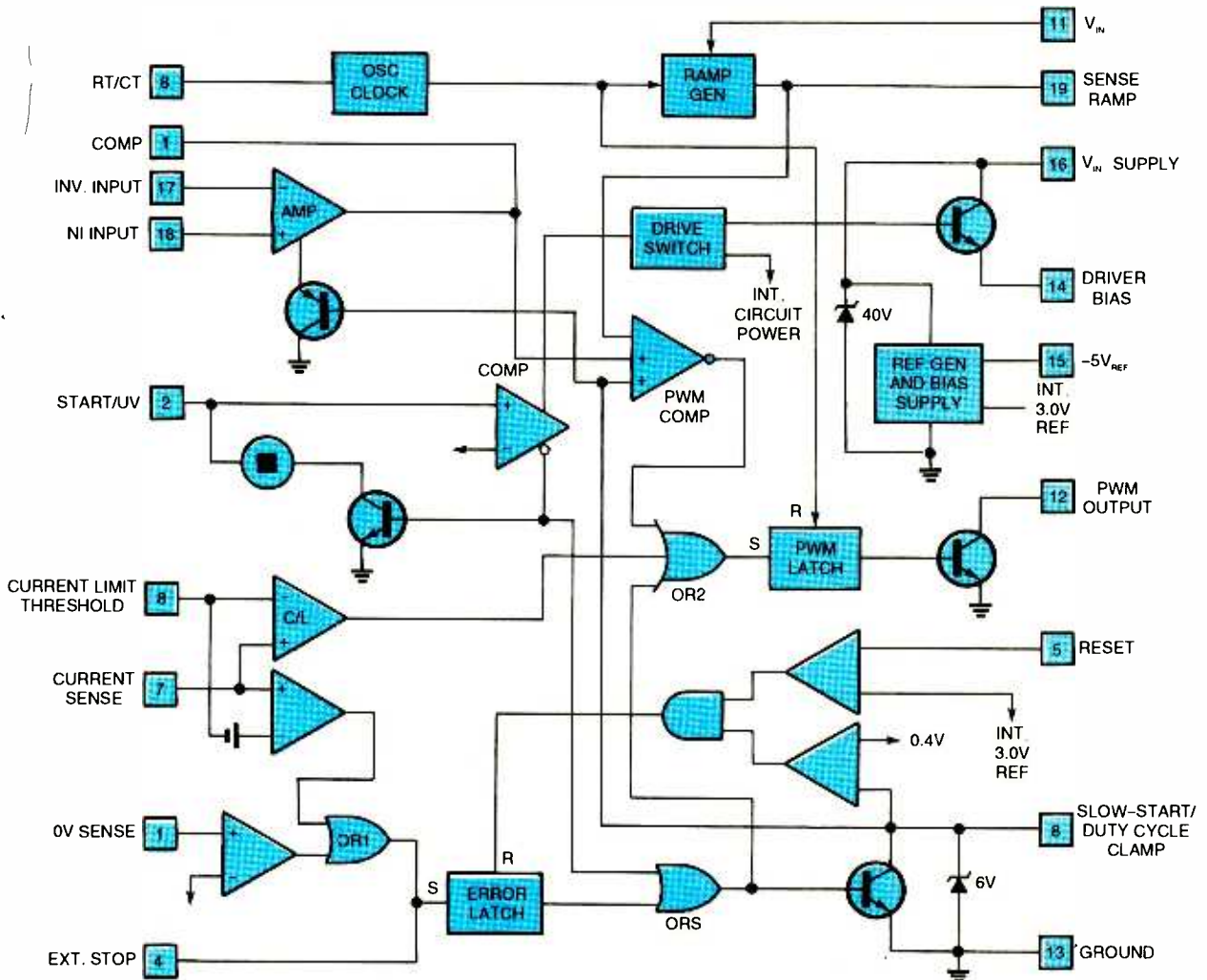

Fig. 3. This is a block diagram for a popular TI PWM controller. On-chip PWMs have been decreasing in cost and, as a result, increasing in popularity among inventors.

basic principles are similar but the details differ, depending on application. The flyback topology described above is one of the most common for small multi-output supplies. However, you may find other types of circuits in TVs and monitors. Some are downright strange (to be polite). I sometimes wonder if engineers are given bonuses based on the uniqueness and difficulty level of their designs!

Switchmode Power Supply Repair

Unlike PC system boards where any disasters are likely to only affect your pocketbook, power supplies, especially line-connected switchmode power supplies, can be dangerous.

Having said that, I suggest that repairing a power supply on your own may in fact be the only economical option. It is very common for service centers to simply replace the entire power supply board or module even if

the problem is a 25-cent capacitor. It may simply not pay for them to take the bench time to diagnose down to the component level. Many problems with switchmode power supplies are easy to find and also easy and inexpensive to fix—not all, but surprisingly many.

Most Common Problems

The following probably account for 95% or more of the common SMPS ailments:

- Supply dead, fuse blown—shorted switchmode power transistor and other semiconductors, open fusible resistors, or other bad parts. Note: Actual cause of failure may be power surge/brownout/lightning strikes, random failure, or primary side electrolytic capacitor(s) with greatly reduced capacity or entirely open—test them before powering up the repaired unit.
- Supply dead, fuse not blown—bad

start-up circuit (open start-up resistors), open fusible resistors (due to shorted semiconductors), or bad controller components.

- One or more outputs out-of-tolerance or with excessive ripple at the line frequency (50/60 Hz) or twice the line frequency (100/120 Hz)—dried-up main filter capacitor(s) on rectified AC input.
- One or more outputs out of tolerance or with excessive ripple at the switching frequency (10s of kHz typical)—dried-up or leaky filter capacitors on affected outputs.
- Audible whine with low voltage on one or more outputs—shorted semiconductors, faulty regulator circuitry resulting in overvoltage crowbar kicking in, faulty overvoltage-sensing circuit or SCR, or faulty controller.

- Periodic power cycling, tweet-tweet, flub-flub, or blinking power light—shorted semiconductors, faulty over-voltage or over-current sensing components, or bad controller.

In all cases, bad solder connections are possibilities as well, since there are usually large components in these supplies; and soldering to their pins may not always be perfect. An excessive load can also result in most of these symptoms or may be the original cause of the failure.

Repair Or Replace

Some manufacturers have inexpensive flat-rate service policies for power supplies. If you are not inclined to or not interested in doing the diagnosis and repair yourself, it may be worthwhile to look into these. In some cases, \$25 will get you a replacement supply regardless of original condition.

However, this is probably the exception, and replacements could run more than the total original cost of the equipment—especially in the case of most TVs and many computer monitors, where the power supply is built onto the main circuit board.

Nothing really degrades in a switch-mode power supply except possibly the electrolytic capacitors (unless a catastrophic failure resulted in a total meltdown), and these can usually be replaced for a total cost of a few dollars. Therefore, it usually makes sense to repair a faulty supply assuming it can be done reasonably quickly (depending on how much you value your time and the down time of the equipment) and, of course, assuming that the equipment it powers is worth the effort. Most replacement parts are readily available and kits containing common service components are also available for many popular power supplies (such as those found in some terminals, MacIntosh and other Apple computers, various brands of video monitors, and some TVs and VCRs).

Where an exact replacement power supply is no longer available or excessively expensive, it may be possible to simply replace the guts if space allows and the mounting arrangement is compatible. For example, for an older full-size PC tower, the original power supply may be in a non-standard box but the circuit board itself may use a standard hole configuration such that an inexpensive replacement may be installed in its place.

Alternatively, many surplus electronics distributors have a wide selection of power supplies of all shapes, sizes, output voltages, and current capacities. One of these may make a suitable replacement for your custom supply with a lot less hassle than attempting to repair your undocumented original. It will likely be much newer as well, with no end-of-life issues like dried-up electrolytic capacitors to worry about. Of course, you must know the voltage and current maximum current requirements of each of the outputs in order to make a selection.

Power-Supply Fundamentals

A typical line-connected power supply must perform the following functions:

- Voltage conversion—changing the 115/230 V_{AC} line voltage into one or more other voltages as determined by application.
- Rectification—turning the AC into DC.
- Filtering—smoothing the ripple of the rectified voltage(s).
- Regulation—making the output voltage(s) independent of line and load variations.
- Isolation—separating the supply outputs from any direct connection to the AC line.

Wrap-up

Between now and next time, round up all the dead SMPSs you have buried under other junk, but don't try to repair them just yet. However, if they have been unplugged for awhile, it's safe to open the case(s) to identify the major components and any that are obviously fried. As always, e-mail is welcome (no snail mail please!) at sam@repairfaq.org. Much more information is available on my Web site: www.repairfaq.org. 

To learn how to talk with your kids about tough issues, like sex, AIDS/HIV and violence, call 1-800-CHILD-44 and get your free guidebook.



5 GREAT PROJECT BOOKS

[] BP-410 35 Opto-Display Terminal Block Projects. \$6.99. If you use terminal blocks, no soldering is required to make complete this series of opto-displays that range from light-telegraphs, flashing label badges, magnetic detectors, plus more advanced projects including a dusk detector, games, and twinkling Christmas decorations.

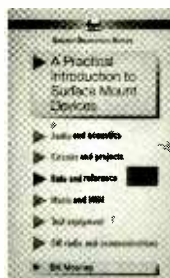
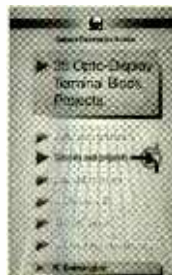

[] BP-411 Introduction to Surface-Mount Devices. \$6.99.

Surface-mount construction can be easier, faster and less costly, and even the hobbyist can produce one-of-a-kind circuits using SMDs. PCB design, chip control, soldering techniques and specialist tools are fully covered. A complete variety of construction projects are also included.

[] BP-413 Remote Control Projects. \$7.99. A wealth of circuits and circuit modules for use in all kinds of remote-control applications are provided. There are complete details for 14 novel and practical remote control projects. Also included are techniques for interfacing a PC to a remote control system.

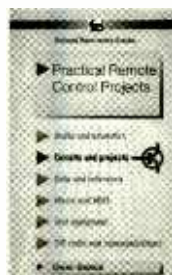

[] BP-416 Practical Alarm Circuits. \$6.99. Details of inexpensive but effective burglar alarms for the home constructor. The circuits include switch-activate alarm, FM audio alarm generator, Modulated fiber-optic loop alarm, Ultra-sonic breaking window alarm, Doppler shift ultrasonic sensor and more.

[] BP-432 Simple Sensor Terminal Block Projects. \$6.99. Sensors are the eyes, ears and noses of electronic systems. They include contact, light, heat, sound, magnetic, motion, resistance and voltage-operated devices. The projects in this book show you how you can build all of these, and if you use terminal blocks, no soldering is required. There are 31 individual projects to build and use.

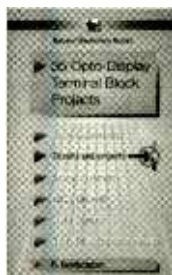

To order one of these Books send amount indicated plus \$3.00 for shipping in the U.S. and Canada only to Electronics Technology Today Inc., P.O. Box 240, Massapequa Park, NY 11762-0240. Payment in U.S. funds by U.S. bank check or International Money Order. Please allow 6-8 weeks for delivery. MA09

MORE IMPACT

As you remember, last visit we experimented with several impact transducers that detect a moving object and output an electronic signal when hit by one. The application, for the most part, was to indicate when a pellet from an air gun hit the target. This time around, our first impact transducer produces a shadow across a phototransistor as the projectile passes through the target areas. The only impact is with the IR beam of light. The next few circuits can be used with any of the basic transducers to light an LED for scoring; in addition, there's a timed five-target circuit that can be useful in upping your score.

The Shadow Knows

Figure 1 shows the physical layout of the IR shadow target. A wide-angle IR emitter is positioned above a target hole and an IR phototransistor below. It will require some experimenting to determine the actual distances between the two IR devices to guarantee that an object passing through the target area will produce a shadow on the phototransistor. As in our other target transducers, the metal plate used must be thick enough to stand up to the pellets or objects striking it.

The three shadow targets, shown in Fig. 2, are basically expansions of our first shadow circuit. Three different-size target areas are used to make the game more challenging. The "B" target is the largest; and, to blanket the target's opening with IR light, two IR emitters are used. Also, two black cardboard shades are positioned around the target to eliminate interference with the other two targets. The shades may be cut from thick black paper or painted cardboard and should be at least one inch in height. Experimenting with the locations of the two IR emitters and the IR phototransistor will be necessary to obtain total coverage of the target openings.

Targets "A" and "C" are very similar

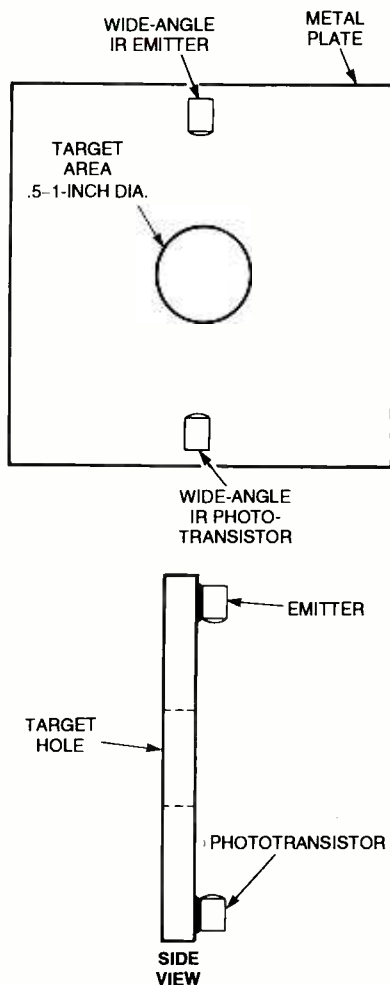
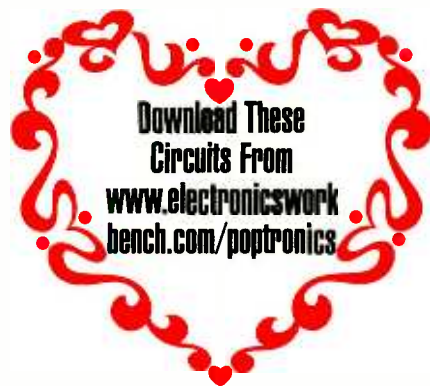

Fig. 1. The schematic above shows the physical layout of the IR shadow target. A wide-angle IR emitter is positioned above a target hole and an IR phototransistor below.

to our first shadow target and may be set up and adjusted in the same manner. The shadow targets are somewhat more difficult to build and adjust; however, once set up, they can be some of the best transducers.

Feeding The IR Emitters

The two IR-emitter power circuits, shown in Fig. 3, are used to power the IR emitters in Fig. 2. Two of the "A" cir-



PARTS LIST FOR THE "SHADOW KNOWS" TRANSDUCER (FIG. 1)

Metal target plate, IR emitter and IR phototransistor (see Parts List for Figs. 4 and 5), etc.

cuits supply power to targets "A" and "C," and a single "B" circuit powers the two emitters used in the "B" target. The power circuits are adjustable so they can set the light output of the IR emitters. This feature helps to get just the right amount of light hitting the phototransistor to gain proper target coverage.

The two current-control circuits use a 2N2222 NPN transistor, connected in an emitter-follower circuit, to drive the LEDs through R1—a current-limiting resistor. The voltage at the transistor's emitter follows the voltage at the wiper of R2, minus the base-emitter-voltage difference of 0.6 volts. As the voltage at the pot's wiper changes, so does the current through the IR emitter. The circuit in Fig. 3B is the same as the one in 3A with two IR emitters connected in series.

Positive And Negative Output Circuits

The shadow-transducer circuit, shown in Fig. 4, produces a negative-output pulse when an object passes through the target zone. In a target-ready condition, the IR light source that hits the phototransistor should cause the voltage at Q1's emitter to be nearly one-half of the supply voltage. If the IR source is strong enough to saturate Q1, the circuit will be very insensitive and will not respond to a pellet's shadow. Using the variable-current circuit in Fig. 3 to power the IR emitter solves the sensitivity problem.

The circuit in Fig. 5 produces a pos-

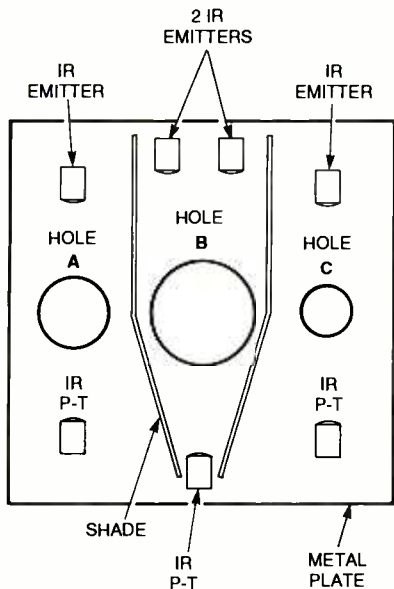

Fig. 2. The three shadow targets, shown above, are basically expansions of our first shadow circuit. Three different-size target areas are used to make the game more challenging.

PARTS LIST FOR THE THREE SHADOW TARGETS (FIG. 2)

Metal target plate, IR emitters and IR phototransistors (see Parts List for Figs. 4 and 5), etc.

itive-output pulse by moving the phototransistor's load from its emitter to its collector circuit. Now, when a shadow crosses the phototransistor, the IR light source is reduced slightly, producing a positive-output pulse. The variable-current circuit in Fig. 3 may replace the fixed-current IR circuit (resistor R1 and IR emitter).

Tying Circuits Together

Along with a couple of interface circuits, we've looked at six different impact transducers that turn on an LED as an indication of a hit. Now, we'll go one step further and tie a few more basic circuits together to build a five-target combination that allows a given time for each target to be hit. An LED will light and remain on to indicate a hit at each target position.

An Adjustable Timer

The output signals from some of our impact transducers are not ideal for logic-gate input signals; however, adding a timed-output circuit that produces a good logic-level signal over-

comes the problem. The 555 timer-circuit in Fig. 6 will allow all the transducers that produce a positive-output signal to interface with the five-target circuitry.

Component IC1 is connected in a one-shot circuit that produces a positive timed-output pulse at Pin 3 when the trigger-input Pin 2 is taken to ground. The transducer's positive output turns Q1 on momentarily, taking its collector and Pin 2 of the 555 to near-ground level.

This starts the 555's timing period and produces a positive output at Pin 3, which remains positive until the time cycle has been completed. The timing cycle may be adjusted from a few milliseconds to several seconds with the 500K pot, R3. Usually, an on-time of a second or less will do in the five-target circuit.

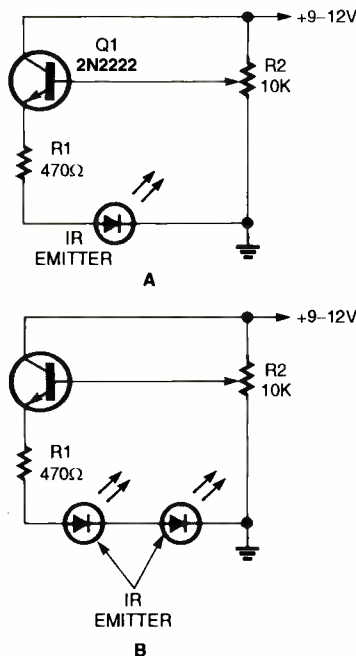

Fig. 3. These two IR-emitter power circuits are used to power the IR emitters in Fig. 2. The circuit in Fig. 3B is the same as the one in 3A with two IR emitters connected in series.

PARTS LIST FOR THE IR EMITTER DRIVERS (FIG. 3)

- IR emitter—512-1N6265 (Mouser)
- Q1—2N2222 NPN transistor
- R1—470-ohm, ¼-watt, 5% resistor
- R2—10,000-ohm pot

The Five-Target Caper

Component IC1, a 555 timer, is connected in a low-frequency oscillator circuit that produces the clock signal for

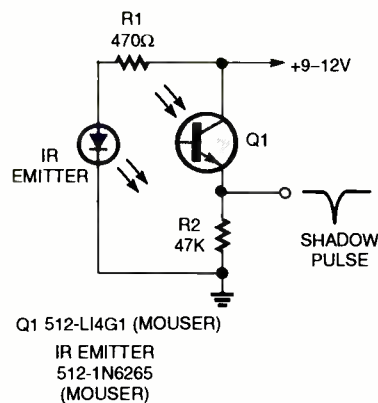

Fig. 4. This shadow-transducer circuit produces a negative-output pulse when an object passes through the target zone.

PARTS LIST FOR THE SHADOW-PULSE CIRCUITS (FIGS. 4 and 5)

- IR emitter—512-1N6265 (Mouser)
- Phototransistor—512-L14G1 (Mouser)
- R1—470-ohm, ¼-watt, 5% resistor
- R2—10-47K, ¼-watt, 5% resistor

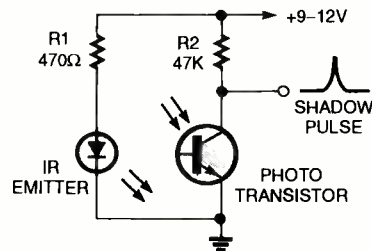

Fig. 5. The circuit shown here produces a positive-output pulse by moving the phototransistor's load from its emitter to its collector circuit.

the 4017 decade counter (See Fig. 7). Transistor Q1 gates the 555 timer on only during the run cycle, by keeping Pins 2 and 6 at ground level when in the reset mode. At each clock pulse, the 4017 steps forward one step and remains in that position until the next pulse is received. During that time, the target is active and, if hit, will turn on an LED.

The 4017 decade counter is connected in a five-step output and halt circuit. The circuit must be restarted by switching S1 to the run position. The five output transistors, Q2-Q6, are drivers for the five large LEDs, LED1-LED5.

These five LEDs are arranged in an order to represent the activated target. These indicators should be located far enough away from the targets to be safe from being hit. The target layout and

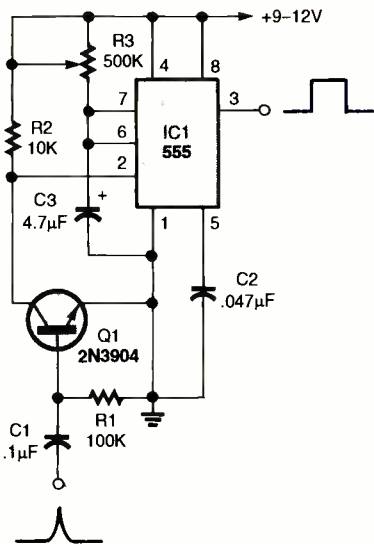

Fig. 6. The 555-timer circuit shown here will allow all the transducers that produce a positive-output signal to interface with the five-target circuitry.

PARTS LIST FOR THE ADJUSTABLE TIMER (FIG. 6)

SEMICONDUCTORS

IC1—555 timer
Q1—2N3904 NPN transistor

RESISTORS

(All resistors are 1/4-watt, 5% units.)
R1—100,000-ohm
R2—10,000-ohm
R3—500K pot

CAPACITORS

C1—0.1-µF, ceramic disc
C2—0.047-µF, ceramic disc
C3—4.7-µF, 25-WVDC, electrolytic

indicator position can be just about any scheme you desire.

The 4017's five outputs, labeled A through E, connect to the logic circuitry in Fig. 8 to complete one-half of the logic signal necessary to produce a hit output.

The Logic Of It

The logic circuitry that looks over the output from each of the five impact transducers and the target-step positions is shown in Fig. 8. Two and one-half 4011 quad two-input NAND gate ICs make up the two-input logic circuitry used to activate the SCR memory and light the LED hit indicator.

Let's see how the two-input-signal logic circuit operates by looking at the top input circuitry. Gate "A," input Pin

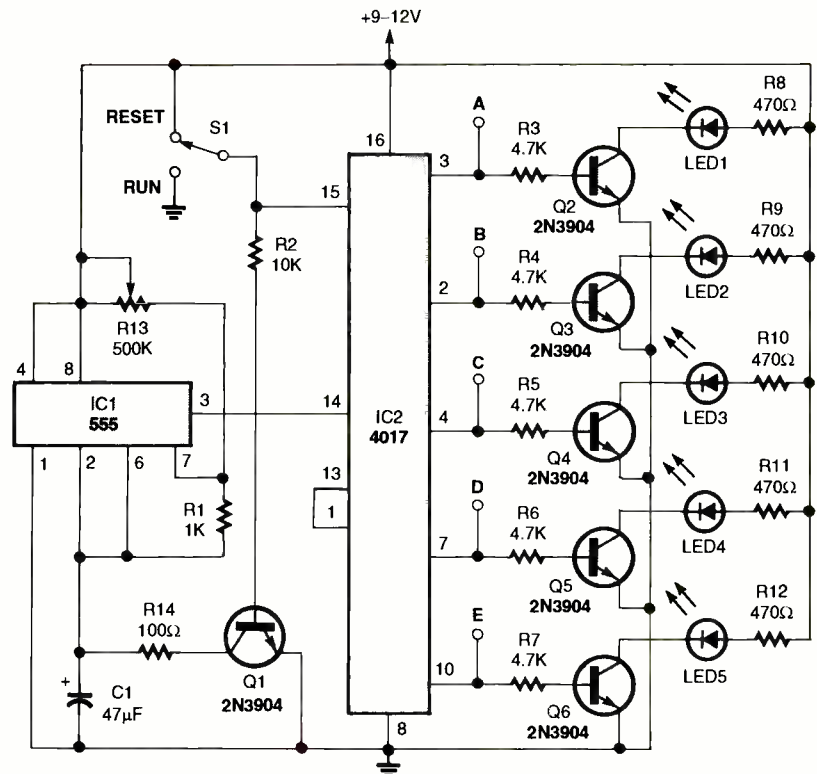

Fig. 7. A 555 timer is connected in a low-frequency oscillator circuit that produces the clock signal for the 4017 decade-counter.

PARTS LIST FOR THE "FIVE-TARGET CAPER" (FIG. 7)

SEMICONDUCTORS

IC1—555 timer
IC2—4017 CMOS decade counter
Q1—Q6—2N3904 NPN transistor
LED1—LED5—Light-emitting diode, any color

RESISTORS

(All resistors are 1/4-watt, 5% units.)
R1—1000-ohm
R2—10,000-ohm

R3—R7—4700-ohm
R8—R12—470-ohm
R13—500,000-ohm pot

CAPACITORS

C1—47-µF, 25-WVDC, electrolytic

ADDITIONAL PARTS AND MATERIALS

S1—SPDT switch

1, connects to the "A" output of the 4017 in Fig. 7. The other input, Pin 2, connects to Pin 3 of the timed output circuit in Fig. 6, which is driven by one of the impact transducers. Setting S1, in Fig. 7, to the run position starts the process. The 4017 produces a positive output at output "A," resulting in a "high" input on Pin 1 of gate "A" in Fig. 8. The other gate input, Pin 2, is connected to Pin 3 of the transducer's 555 output. With one gate input high and one low, the output at Pin 3 is high, and the output at Pin 4 of "B" gate is low—SCR1 remains off. If the target transducer is hit during this time period, the output at Pin 3 of gate "A" goes high along with the high on Pin 1. This sequence produces a low at Pin 3 and a

high at Pin 4 of gate "B," turning on SCR1 and lighting the hit indicator, LED1. If the target is missed during the time that LED1 in Fig. 7 is on, then the output of gate "B" remains low and the hit LED in Position One will not light.

The remaining four target circuits operate in the same way as the first. When the fifth target is activated, the 4017 stepper circuit will stop and the reset/run switch, S1 in Fig. 7, will need to be moved to "reset" and then back to "run" to resume operation.

The target impact transducers and added indicator circuits are offered as an example of how our electronic hobby can be used to improve and promote just about any other hobby we may have, no

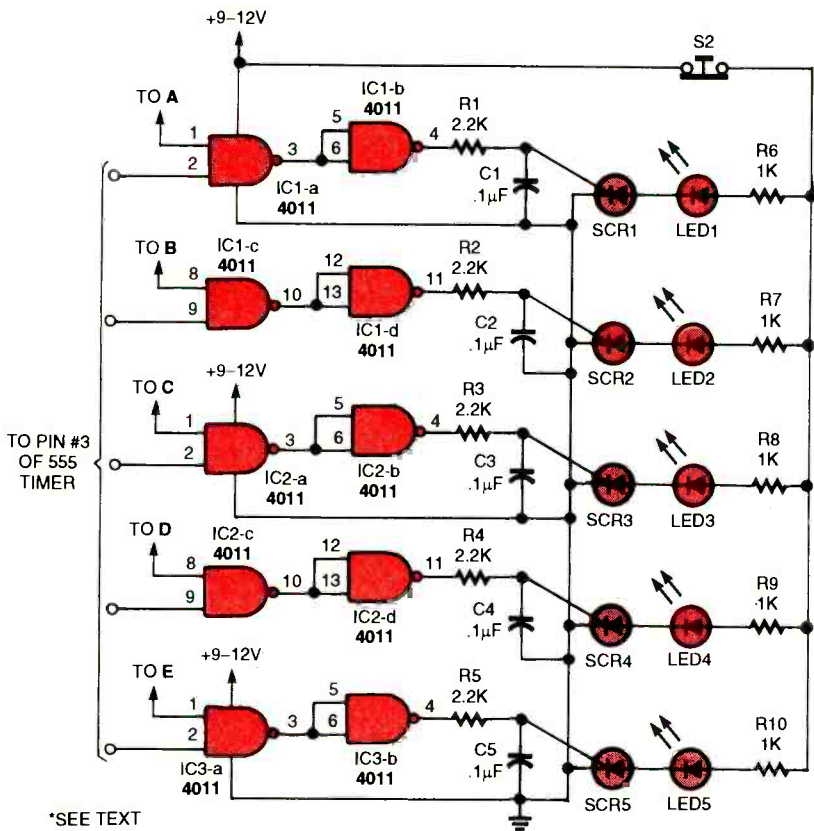

Fig. 8. The 4017's five outputs, labeled A through E, connect to the logic circuitry to complete one-half of the logic signal necessary to produce a hit output.

PARTS LIST FOR THE LOGIC CIRCUIT (FIG. 8)

SEMICONDUCTORS

IC1-IC3—4011 CMOS two-input NAND gate

LED1-LED5—Light emitting diode, any color

SCR1-SCR5—Silicon-controlled rectifier, 2N5060, 519-2N5060 (Mouser)

RESISTORS

(All resistors are 1/4-watt, 5% units.)

R1-R5—2200-ohm
R6-R10—1000-ohm

CAPACITORS

C1-C5—0.1µF, ceramic-disc

ADDITIONAL PARTS AND MATERIALS

S2—Normally-closed pushbutton switch

matter what it might be. There are many other applications for impact transducers. Put on your thinking cap, see what

you can come up with, and then let me know your ideas. See you here next month—same place, same time.

Poptronics, February 2002

IT'S NOT WORTH THE WEIGHT.

For better health and fitness, exercise.

American Heart Association

© 1992, American Heart Association

VCR Cross Reference

**NOW Find the right Part
for your VCR**

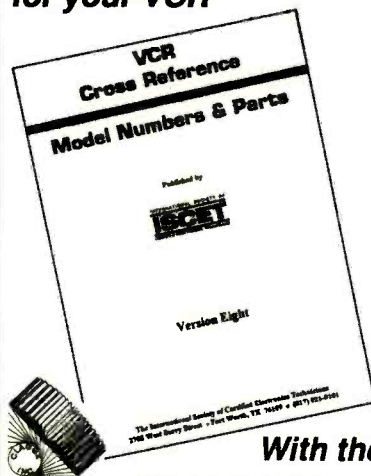

**With the
ISCET VCR
CROSS REFERENCE**

This 172-page reference contains both model and part-number cross-references updated as of Feb, 1997.

VCR's are made in a few factories from which hundreds of different brand names and model numbers identify cosmetically-changed identical and near-identical manufactured units. Interchangeable parts are very common. An exact replacement part may be available only a few minutes away from you even though the manufacturer supplier is out-of-stock. You may be able to cannibalize scrap units at no cost!

The ISCET VCR Cross Reference is pre-punched for standard loose-leaf binding. . . \$29.95 includes shipping in the United States for each Reference.

Clagg Inc.
VCR CROSS REFERENCE OFFER
P.O. BOX 12162
HAUPPAUGE, NY 11778

Name _____
Business _____
Address _____
City _____
State _____ Zip _____
Phone _____

Enclose \$29.95 for the Eighth Edition of the ISCET VCR Cross Reference including shipping for each Reference in the United States. All other countries add \$5.00 (surface mail).

The total amount of my order is \$ _____
Check enclosed—do not send cash.
or please charge my credit card.
 Visa MasterCard Exp. Date ____/____/____

Card No. _____
Signature _____

New York State residents must add applicable local sales tax to total. US funds only. Use US bank check or International Money Order. CB02

Poptronics®

SHOPPER[®]

POLARIS CAN SUPPLY YOU WITH ALL OF TODAY'S HOTTEST VIDEO TECHNOLOGY!

CALL OR GO ON-LINE TO ORDER YOUR FREE VIDEO CATALOG - 100's OF PRODUCTS - MICRO CAMERAS - WIRELESS VIDEO - LIPSTICK CAMERAS - DIGITAL VCR's
WEB CAMERA WITH BUILT-IN PAN/TILT/ZOOM CONTROLS **WEATHERPROOF DIGITAL STORAGE CAMERA**



Compact Web Camera For Online Image Monitoring and Delivery Over The Internet

Featuring a built-in Web server, powerful 10x zoom, pan/tilt, and alarm input/output capability, all in an ultra-compact unit. These Web cameras can be installed virtually anywhere and deliver high-quality images to the Internet for real-time monitoring or broadcast. Better yet, these cameras can be controlled and monitored via a standard Web browser, making it ideal for a wide variety of applications.
 Size: 122mm x 82mm x 97mm.

- ☛ Ultra-compact all-in-one web camera with built-in web server
- ☛ Monitoring and camera control possible via web browser
- ☛ 10x optical zoom and multi-angle pan/tilt capability
- ☛ 10Base-T interface for direct connection with network
- ☛ Alarm In/Out function for automatic surveillance
- ☛ Three different security levels

The SWC-40R combines a black & white video camera, digital image storage, video motion detection and an alarm interface in a compact, vandal proof enclosure. It is unique as it offers a complete CCTV surveillance system within a single compact enclosure.

NO TAPES! **SWC-40R \$849.95**

- ☛ All-in-one CCTV system
- ☛ Built-in digital image storage
- ☛ Programming and image retrieval by remote control
- ☛ Built-in video motion detection

Dimensions 5" x 4" x 4.5"

"YOUR WEB BROWSER IS YOUR REMOTE EYE!"

The FlexWatch acts as an internet camera server. No software needed in order to view your video. All you need is a web browser such as Internet Explorer or Netscape. FlexWatch includes many special functions including video quality control, pan/tilt/zoom interface and network configuration. All of them are controlled by the web browser. Features 4 video inputs - 3 external.



FLEXWATCH-100 - CALLS

CONTROL PAN / TILT AND ZOOM REMOTELY OVER THE INTERNET!

6.4" COLOR TFT-LCD MODULE
 TFT MONITORS AVAILABLE FROM 2.5" - 15"



Back Side of Module
HIGH RESOLUTION!

Our new 6.4" Color TFT Module can be used for a variety of purposes such as: custom automotive dash installations, video phone, door phone, boat installations, covert ultra-compact surveillance packages, security and more.

TFT-64M - \$319.95 Dimensions 1.5"(W) x 1.75"(H) x 0.5"(D)

COVERT COLOR SPY CAMERA

It's small sleek indestructible design and pinhole lens allow for various applications and simple installation. Comes equipped with a RCA JACK for easy connection to TV monitor or VCR. Great for covert use in any place imaginable.

25mm(W) x 17mm(D) **CM-550CP - \$79.95**

MICRO BOARD CAMERAS - MANY MODELS IN STOCK TO CHOOSE FROM!

MB-1250HRP Hi-Res Color Pinhole 5.0mm Lens 1.27" x 1.27" \$109.95

WEATHERPROOF CAMERA

Color Camera 400 TV Lines Automatic Iris
Hi-Res Color Lipstick Camera
 Length: 2.6" Diameter: 785"
WP-300C - \$159.95

LIVE VIDEO!

COLOR & B/W SUBMERSIBLE CAMERAS



CAN SEE UNDER WATER!
 B/W version comes with attached 80 meter cable (color-20 meter). Built-in white LED's give this camera a 15 meter infrared range. Heat resistant glass and water resistant design allow for rugged applications.

VIDEO CAMERA HEAD CAN BE SUBMERGED UP TO 100 FEET!
SUBCAM-BW (B/W) - \$249.95
SUBCAM-CL (COLOR) - \$299.95

2.4 GHz A/V TRANSMITTING MODULE



Makes any camera wireless! Excellent for hobbyist / remote control airplanes.

2.4GHz 4 channel video transmitting module with audio capability / power switch and antenna.
MPX-2400 - \$89.95
2.4GHz RECEIVER GFR-5002 - \$119.95
 Dimensions 1.5"(W) x 1.75"(H) x 0.5"(D)

5" COLOR WIRELESS OBSERVATION SYSTEM



Now you can enjoy peace of mind with our new wireless observation system. Comes with 5" wireless color monitor and a wireless color camera. Just Plug-&Play! Perfect for around the house or office.

2.4GHz GW-2400S - \$379.95

MICRO VIDEO HEAD "SNAKE" CAMERA

Incredibly small micro head color camera incorporates a CCD chipset. (Not CMOS). Fully adjustable focus from 0.5 inches to infinity. Automatic Iris for varying light levels.

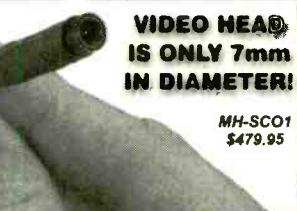

VIDEO HEAD IS ONLY 7mm IN DIAMETER!
MH-SC01 \$479.95

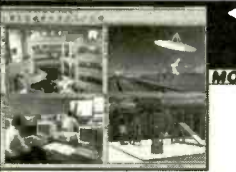

MONITOR UP TO 4 VIDEO CAMERAS SIMULTANEOUSLY THRU YOUR INTERNET CONNECTION OR OVER YOUR MODEM!

MOTION DETECTION - ALARM RECORDING - NOTIFICATION
 Highlight an area on your video screen, and the PV-140 will inform you via modem thru your telephone or pager if there is movement in that highlighted area while recording to your hard disk.

- ☑ TCP/IP
- ☑ MODEM
- ☑ LAN/WAN

PV-140.... 4 Input Digital Video Card.... \$299.95

Video can be viewed in Quad style (above), full screen mode or auto switching mode.

NEW! CREDIT CARD COMPUTER II

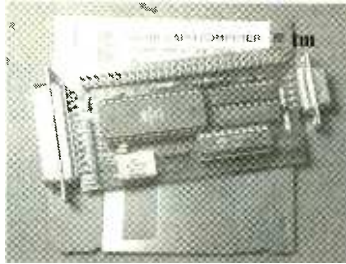

MVS PLUG-N-GO™ no cables/power supply to buy!
 Low-power RISC cpu 10x faster than PIC. Z80. 8051
 4m FLASH,ser,par,RTCC,4ch 12bit ADC,ISA104 bus
 Built-in BASIC/Assembly, other compilers available
 Friendly instructions, RS232 download (DOS/WIN)
 Eval kit (1) \$75, oem (1k) \$21, CC computer I \$14.20

640x480 VGA LCD \$27

Controller for most single/dual scan LCDs
 Works with lo-res (160x120, 320x240, etc.)
 Use with PC or SBC, standard VGA BIOS
 Source code demo shows VGA initialization
 Adaptable for other CPUs (i.e. Z80, HC11)
 oem(1k) \$27 evalkit(1) \$95 w/10"LCD \$195



LO COST MINI-PC

Includes DOS,NV mem,ADC,RAM,clock,ISA bus
 Ports for serial, parallel, LCD, keyboard
 Program in Turbo C, BASIC, MASM, etc.
 Complete, no costly development kits required
 Lowest power lowest cost PC compatible available
 XT: oem \$27 eval \$95 AT: oem \$55 eval \$195

PC WATCHDOG CARD

No More Hangups!

Reboots PC on hardware/software hang
 3 versions: RESET, TIMER, PHONE
 reset version oem \$21.30, eval kit \$75



PC SOLID STATE DISK

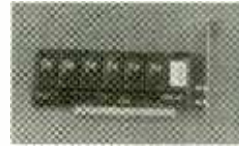

Replace mechanical drives with faster,
 more reliable, more secure solid-state.
 Use FLASH, NVRAM, UV EPROM.
 Both DIP and PCMCIA versions from
 32Kbyte (PC11) to 1Gigabyte (PCD2)
 starting at \$14.20oem(1k) \$50.00eval(1)

STAMP DRIVE !! SINGLE CHIP COMPUTER



Read/Write PC compatible hard
 disk, PCMCIA, Compact Flash.
 RS232 to ATA adapter for Stamp,
 Z80,8051,AVR,PIC,x86, ANY cpu
 - 4 gigabyte capacity
 - low power (5ma @5v)
 - baud 115.2k and above
 eval \$95,oem \$27,IDE ver. \$14.20

ZERO external components
 Built-in BASIC / Assembly
 RS232 program download
 1k flash,64ee,3irq,2timers
 15 i/o bits,ADC,20 pin DIP
 20mips faster than PIC/z80
 oem(1k) eval kit(1)

\$1.99 \$7.00



NEW! 8K SUPER CHIP

40x the BASIC pgm space
 32 i/o, 12 irq, 3 timers, bus
 8K flash, 512ee, 512nvram
 Watchdog w/ internal osc.
 40 pin DIP part #MV8515
 eval(1) \$25, oem(1k) \$7.10

SERIAL MINI-TERMINAL

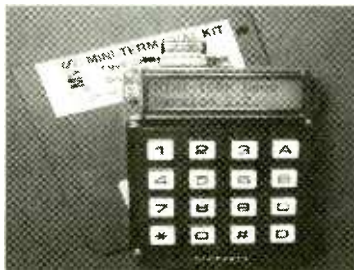

RS232 terminal for Stamp, PC, Z80, AVR etc.
 -super low current, powers from serial line
 -LED backlit LCD, visible in all conditions
 -115.2kbps, DB9 conn, simple commands
 -specify 20 customizable or 16 tactile keys
 eval(1) \$75,oem(1k) \$21.30,w/BASIC cpu \$27

WWW.STAR.NET/PEOPLE/~MVS

MVS Box 803
 Nash.,NH 03060
 (508) 792 9507



5yr Limited Warranty
 Free Shipping
 Mon-Fri 10-6 EST

**SERVING THE EMBEDDED
 COMMUNITY SINCE 1979!**

CIRCLE 296 ON FREE INFORMATION CARD

CONTROL RELAYS • LIGHTS • MOTORS

MEASURE TEMPERATURE • PRESSURE • LIGHT LEVELS • HUMIDITY

INPUT SWITCH POSITIONS • THERMOSTATS • LIQUID LEVELS

MODEL 30 \$79 <ul style="list-style-type: none"> • PLUGS INTO PC BUS • 24 LINES D-DIGITAL I/O • 8 CHANNEL • 8 BIT A/D IN • 15 BIT COUNTER • UP TO 14K SMP/SEC 	MODEL 45 \$189 <ul style="list-style-type: none"> • RS-232 INTERFACE • 8 D-DIGITAL I/O • 8 ANALOG INPUTS • 2 ANALOG OUTPUTS • 2 COUNTERS 24 BIT
MODEL 100 \$279 <ul style="list-style-type: none"> • 12 BIT 100 KHZ A/D • 4 ANALOG OUTPUTS • 3 TIMER COUNTERS • 24 DIGITAL I/O 	MODEL 150-02 ... \$179 <ul style="list-style-type: none"> • RS-232 INTERFACE • TRANS. 20 AMPS • 12 BIT A/D • OP-RO-ISOLATED • COMPLETE DSM
MODEL 40 \$109 <ul style="list-style-type: none"> • RS-232 INTERFACE • 28 LINES DIGITAL I/O • 8 ANALOG INPUTS • PWM OUTPUT 	MODEL 70 \$239 <ul style="list-style-type: none"> • RS-232 INTERFACE • 18 BIT A/D • 8.5 DIGIT • UP TO 60 SMP/SEC

Prairie Digital, Inc.
 PHONE 608-643-8599 • FAX 608-643-6754
 020 SEVENTEENTH STREET • PRAIRIE DEL SAC, WISCONSIN 53104

CIRCLE 219 ON FREE INFORMATION CARD

Graphic Interface with Touch screen control

Priced From
\$140.00
 Qty 1

ACME XRAY Main Menu

Setup #278 ACME SYSTEMS Touch Start Cycle

Time Strength Delay Status Exit

Easy Interface with PC/104, 8051, 68HC11, PIC

Laser Temperature

235 DEG F STOP CASP EXIT

Graphic display Touch screen

Serial communication (RS-232C)
 Eprom or Flash for screen storage
 Only +5VDC power required
 Easy to use development software
 Create screens by PC paintbrush
 Simple to place touch buttons software



Many Sizes Available

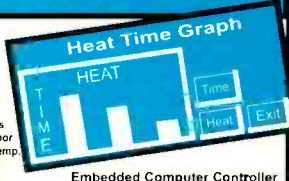

Desigtech Engineering Co.
 2001 S. Blue Island Ave.
 Chicago, IL 60608
 Phone 312-243-4700
 Fax 312-243-4776

Many Types Indoor, Outdoor
 Factory, Ext. Temp.
 CCFL, LED Available
 Embedded Computer Controller
 Also Available

www.desigtechengineering.com

The BEST is now Better!

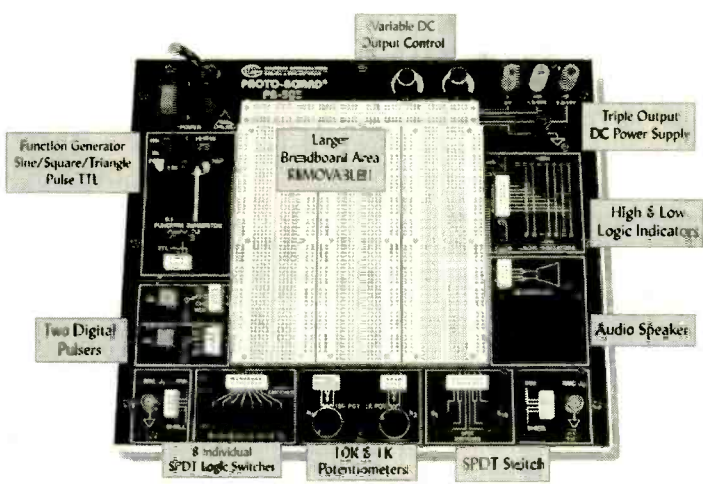

Feature-rich Circuit Design Workstation Ultra-affordable at just \$299.95 Portable Version Available for \$349.95

Our classic PB-503 the complete Proto-Board Design Workstation is newly improved. Enhancements include: an 8-Channel Logic Monitor, High & Low Buffered Logic Indicators, 8 Selectable Logic Switches, and Removable Breadboard Socket Plate. This velcro-backed socket plate allows for greater circuit design flexibility; order extra to suit your needs.

Traditional instrumentation on the unit includes continuously variable Function Generator, Triple Output DC Power Supply, along with Switches, Digital Pulsers, Potentiometers and an Audio Speaker. The highly functional PB-503 is built to last, with an industry best 3-year warranty along with a lifetime warranty on all breadboard sockets. Own the best! Order yours today.



GLOBAL SPECIALTIES
INSTRUMENTS

1466 Highland Avenue • Unit 2
 Cheshire, CT 06410
 E. 800.572.1028
 203.272.4330 FAX
www.globalspecialties.com

ALL ELECTRONICS

C O R P O R A T I O N

SHOP OUR ONLINE STORE
www.allelectronics.com

Video / RF Modulator



Converts audio and video line level signals to RF which can be inputted to any television on channel 3 or 4. Channel 3-4 selector switch. Video, audio and power inputs are through a 7 foot cable terminated with a mini-DIN plug which generally needs to be cut off so connections can be made directly to conductors in cable. We supply a hook-up diagram. Requires a 4.5 - 6 Vdc, 50 mA power supply or wall adapter (not included). **\$5.00 each**
Large quantity available. **CAT# MOD-6**

10 for \$4.50 each

Assembly with 12 Vdc Motor, Gears and Pulleys

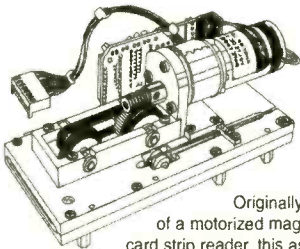

Originally part of a motorized magnetic card strip reader, this assembly is driven by one of our gear motors, either CAT# DCM-181U or DCM-182U. A worm gear turns a pair of cog pulleys linked by a cog belt. The rubber covered wheels pull a credit card past a magnetic head and two U-shaped optical sensors. Assembly includes motor, pulleys, belt, magnetic head and opto sensors. Mounted on an aluminum platform 6.25" x 2.75".

CAT # DCM-180 **\$17.95 each**

ORDER TOLL FREE
1-800-826-5432

CHARGE ORDERS to Visa, Mastercard, American Express or Discover

TERMS: NO MINIMUM ORDER. Shipping and handling for the 48 continental U.S.A. \$6.00 per order. All others including AK, HI, PR or Canada must pay full shipping. All orders delivered in CALIFORNIA must include local state sales tax. Quantities Limited. NO COD. Prices subject to change without notice.

CALL, WRITE FAX or E-MAIL for our FREE

96 Page CATALOG Outside the U.S.A. send \$3.00 postage.

MAIL ORDERS TO:
ALL ELECTRONICS CORPORATION
P.O. Box 567
Van Nuys, CA 91408
FAX (818)781-2653

e-mail allcorp@allcorp.com

Turn Your Multimedia PC into a Powerful Real-Time Audio Spectrum Analyzer

Features

- 20 kHz real-time bandwidth
- Fast 32 bit executable
- Dual channel analysis
- High Resolution FFT
- Octave Analysis
- THD, THD+N, SNR measurements
- Signal Generation
- Triggering, Decimation
- Transfer Functions, Coherence
- Time Series, Spectrum Phase, and 3-D Surface plots
- Real-Time Recording and Post-Processing modes

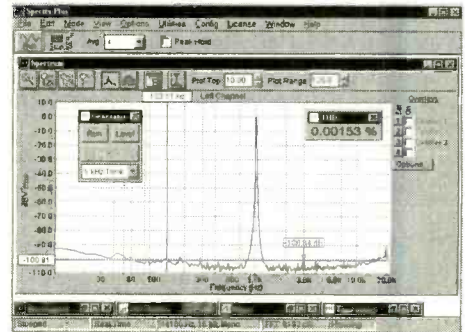

Applications

- Distortion Analysis
- Frequency Response Testing
- Vibration Measurements
- Acoustic Research

System Requirements

- 486 CPU or greater
- 8 MB RAM minimum
- Win. 95, NT, or Win. 3.1 + Win.32s
- Mouse and Math coprocessor
- 16 bit sound card

Priced from \$299

(U.S. sales only - not for export/resale)

DOWNLOAD FREE 30 DAY TRIAL!

www.spectraplus.com

PHS Pioneer Hill Software
24460 Mason Rd.
Poulsbo, WA 98370
a subsidiary of Sound Technology, Inc.



Spectra Plus
FFT Spectral Analysis System

Sales: (360) 697-3472

Fax: (360) 697-7717

e-mail: pioneer@telebyte.com

Call Today And **SAVE!** **Unbeatable PRICES!**
CABLE TV

**DESCRAMBLERS
CONVERTERS • FILTERS
VIDEO STABILIZERS**

FREE > 30 Day Trial
FREE > Product Catalog
FREE > 1 Year Warranty

100% MONEY BACK GUARANTEE



Let us point you in the right direction ...

Arrow Technologies
Omaha, Nebraska

TOLL FREE
1-800-554-ARROW
1-800-554-2776
<http://www.arrowtek.com>

MECI 340 East First Street
Dayton, Ohio 45402
Your Electronics Video Company

Tons of Electronics

Get your FREE catalog today and discover some of the best deals in electronics. We have thousands of items ranging from unique hard-to-find parts to standard production components. Call, write or fax today to start your subscription to one of the most unique catalogs in the industry, filled with super values on surplus electronic and hobbyist type items.

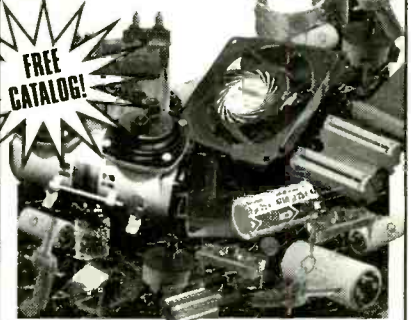

Checkout our 10,000 item on-line catalog <http://www.meci.com>

Order Toll Free Why pay more?
1-800-344-4465 Call today!
Fax Order Line
1-800-344-6324

CIRCLE 323 ON FREE INFORMATION CARD

GET HERE.

LEARN A SKILL YOU ENJOY... ...THEN FIND A JOB THAT HAS A FUTURE.

Visit
www.cie-wc.edu
for complete
course listings!

Everyone has to start somewhere.

As CIE graduates have discovered, independent-study from The Cleveland Institute of Electronics can get you where you want to be. In a secure career in electronics.



Industrial Robotics

Since 1934, CIE has been on the forefront of an ever expanding technological revolution.

ment. CIE's curriculum is unique from other independent-study schools in the respect that we not only provide hands-on training utilizing today's technology we also instill the knowledge and understanding of why technology works the way it does. This is the foundation upon which every CIE graduate can trace their success back to and in which CIE's reputation as a quality learning facility is based on.



Project Engineer

Independent study is not for everyone. But, if you have the desire, the basic intellect and the motivation to succeed, CIE can make it happen. Our learning program is patented and each lesson is designed for independent study while our instructors are available to assist you whenever you feel you need help. Simply call or e-mail us with your questions and our instructor staff will be prompt, courteous and thorough with their response.



Telecommunications

CIE offers personalized training to match your background with over ten career courses, an Associate Degree Program and a Bachelor Degree Program through our affiliation with World College. And every CIE graduate got started

in a successful career the same way you can...by sending for your free CIE course catalog and judging for yourself if CIE's for you.



Computer Programming

START HERE...



Electronics

Back then it was radio and TV, today it's computer technology, programming and the electronics that make it all possible. Today and yesterday's similarities are

uncanny... Employers are looking for qualified applicants to hire and having a hard time finding them.

Students at CIE receive the training and the education needed to get hired and to succeed in challenging fields such as computer programming, robotics, broadcast engineering, and information systems manage-

YES! Please send me more information on:

- CIE's Associate Degree Program
- CIE's 12 Career Courses

Mail coupon to:

CIE
1776 E. 17th street
Cleveland, Ohio 44114

PT30

Name _____

Address _____

City _____

State _____ Zip _____

Phone: _____

Check for G.I. Bill Details

- Active Duty
- Veteran



*It's More Than Just Training...
...It's an Education.*

1776 East 17th Street
Cleveland, OH 44114

1-800-243-6446

CIRCLE 320 ON FREE INFORMATION CARD

AM & FM LOW POWER TRANSMITTER KITS

If you are interested in building quality low power transmitters for AM, FM Stereo, and Television transmission, see our website for more information. Kits covering the frequency range of 150 KHz to 1300 MHz. are available, for Amateur, experimental Part 15 uses, hobby, and radio control use.

NORTH COUNTRY RADIO

Visit our website www.northcountryradio.com

Sales: PO BOX 53 New Rochelle N.Y. 10804 Tel 914-235-6611

Technical: PO Box 200 Hartford NY 12838 Tel 518-854-9280



"I can learn great stuff every step of the way. Radical fun!"



ROBOTIKITS®
DIRECT

MAK IT YOURSELF SOLDERING KITS

WAO II

Programmable.
Actually draws.
OWI-961K
\$69.95
87 Soldering
Components



BEAMSTER
Five-function flashlight.
OWI-209K
\$19.95
16 Soldering
Components



MOONWALKER II
Sound & Light Sensor.
OWI-979K
\$39.95
37 Soldering
Components



WE MAKE A
GREAT TEAM!

Build, Personalize & Learn

- Robotic & Electronic Kits
- Beginner to Advanced Levels
- Solar & Electricity Kits
- Award Winning Designs



ROBOTIKITS®
DIRECT

17141 Kingsview Ave. Suite B
Carson, CA 90746 USA

Phone: (310) 515-1900

Toll Free: (877) 515-6651

Fax: (310) 515-1606

E-mail: robotikitsdirect@pacbell.net

Web: www.robotikitsdirect.com

CIRCLE 256 ON FREE INFORMATION CARD

**More Features
More Power
Less Money**

Ivex Complete Power Tools include: WinDraft P350 Schematics, WinBoard P350 PCB Layout, Ivex Spice Standard Simulation and Gerber Viewer together in a complete, affordable package.

Ivex Complete Plus includes everything in the Complete package plus 650 pin versions of WinDraft and WinBoard with Ivex Spice Advanced.

Ivex 650 pin versions have no feature limitations like other low cost products on the market. Fast expert technical support, free 24 hour Knowledge Base on the web, and professional full-featured tools have made Ivex the preferred choice for designers.

For larger designs use these Ivex Products:

WinDraft unlimited \$4,95
WinBoard unlimited \$4,95

Ivex Complete Electronics CAD Package

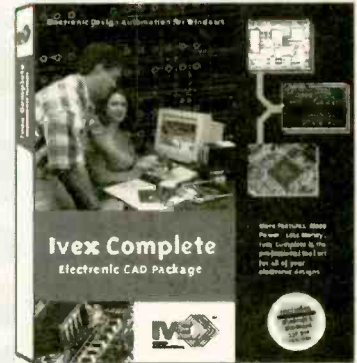
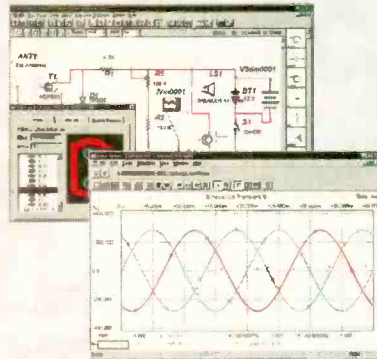

Advantages

Full-feature tools
17,000 Schematic parts
Part edit & model making
Part Search
Bill of Materials with Sort & Spreadsheet output
Hierarchy for large designs
ERC (electrical rules check)
15 Netlist outputs
7 Analysis Types
Spice Advanced includes 14 analyses
16 PCB layers
0.01 micron grid resolution
Advanced DRC
Micro via
Gerber & NC Drill report
24 hour FREE Technical Support Internet Knowledge Base
No hardware protection lock!
New: Schematic DXF output

Ivex Complete

Schematics
Simulation
PCB Layout
Gerber Viewer

\$350

Ivex Complete Plus

P650 Schematics
Adv. Simulation
P650 PCB Layout
Gerber Viewer Plus

\$550

Free board quote

pcbCite.com

The Internet source for PCB manufacturing

Visit the Ivex web site for complete product information and download full function demos.

www.ivex.com

Tel: (503) 531-3555 e-mail: sales@ivex.com

IVEX™
DESIGN
INTERNATIONAL

ADV8_4

Be an FCC LICENSED ELECTRONIC TECHNICIAN

EARN MORE MONEY



**Earn up to \$100
an hour and more!**

The Original Home-Study course prepares you for the "FCC Commercial Radiotelephone License" at home in your spare time. This valuable license is your professional "ticket" to thousands of exciting jobs in:

- Communications
- Radio-TV
- Microwave
- Maritime
- Radar
- Avionics & more

You can even start your own business!

No previous experience needed! No need to quit your job or go to school. This proven course is easy, fast and low cost!

**GUARANTEED TO PASS – You get your
FCC License or your money refunded.**

Send for FREE facts now!

Mail coupon today or call

(800) 932-4268 Ext. 240

www.LicenseTraining.com

COMMAND PRODUCTIONS
FCC LICENSE TRAINING - DEPT. 240
P.O. Box 2824 • San Francisco, CA 94126
Please rush FREE details immediately!

Name _____

Address _____

City _____ State _____ Zip _____

CIRCLE 321 ON FREE INFORMATION CARD

PICmicro® BOOKS

LEARN ABOUT MICROCONTROLLERS

Easy PIC'n - Beginner \$29.95

- Programming techniques
- Instruction set, addressing modes, bit manipulation, subroutines, loops, lookup tables, interrupts
- Using a text editor, using an assembler, using MPLAB
- Timing and counting (timer 0), interfacing, I/O conversion

PIC'n Up The Pace - Intermediate \$34.95

- Serial communication - PICmicro to peripheral chips
- Serial EEPROMS
- LCD interface and scanning keypads
- D/A and A/D conversion - several methods
- Math routines

PIC'n Techniques - Intermediate \$34.95

- 8-pin PICmicros
- Timer 1, timer 2 and the capture/compare/PWM (CCP) module
- Talking to a PICmicro with a PC using a terminal program
- Test equipment and data logger experiments

Serial PIC'n - Advanced \$49.95

- Synchronous - bit-bang, on-chip UART, RS-232
- Asynchronous - I2C (Philips Semiconductor)
- SPI (Motorola), Microwire (National Semiconductor)
- Dallas Semiconductor 1-Wire bus

PICmicro and MPLAB are trademarks of Microchip Technology Inc.

Table Of Contents And Ordering Information On Web Site

SQUARE 1 ELECTRONICS

P.O. Box 501, Kelseyville, CA 95451
Voice (707) 279-8881 Fax (707) 279-8883

<http://www.sq-1.com>

BASIC MICRO INC.

MICROCONTROLLERS MADE EASY!™

The **AT-M**



Get more from your projects! More commands, faster code execution, built in real-time graphical code debugging, no more 2k program size limits, hardware and software interrupts, multitasking, enhanced math capabilities plus much more!

BASIC Stamp II® Compatible

Built in Hardware:

- Over 300 Bytes of RAM
- 256 Bytes of Data EEPROM
- External & Internal Interrupts
- 3 10 bit A/D Converters
- 2 Capture and Compare
- Internal Adjustable Vref
- +/- External Vref
- 3 Timers
- 2 PWM
- UARTS
- I2C, SPI

Software Features:

- Graphical Debugging (ICD)
- More Software Commands
- 32 Bit Integer Math
- 32 Bit Floating Point Math
- Easy to use code editor
- BS2p Compatible Syntax
- Expanded BASIC library
- Firmware upgradeable
- Unlimited Support
- Free Software Updates
- Plus much more!

\$59.95 Complete
Available in OEM Package

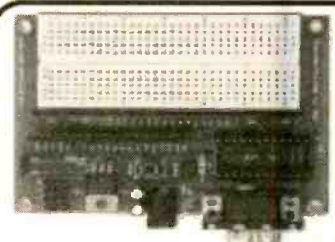

ATOM Development Board

Develop your projects the easy way
For use with Basic Micro ATOM®, OEM ATOM®, and Basic Stamp® 2 series

- Completely Assembled Board
- Solder-less Bread Board
- Built-in DB-9 Serial Connector
- Built-in Power Regulator
- Full Documentation

\$69.95 Complete
Combo with ATOM® \$119.95

Order online at <http://www.basicmicro.com>

Order by phone M-F 9AM to 5PM EST 1 (734) 425-1744

Basic Stamp is a registered trademark of Parallax Inc.

ATOM DEVELOPMENT TOOLS

RAMSEY

GET THE NEW CATALOG TODAY!

New Kits, New LPFM, New Cameras
NEW! www.ramseykits.com



35 WATT LPFM STEREO TRANSMITTER



- ✓ 35W RF output, VSWR protected
- ✓ Automatic audio & power controls
- ✓ Digital synthesized PLL
- ✓ Full front panel control
- ✓ 110/220VAC, 12VDC operation

Whether your application is export or LPFM, the PX1 has you covered. From the over-rated continuous duty power supply & power amplifier to the 2 line vacuum fluorescent display, your station will be the easiest to setup and the most reliable for continuous operation. Full microprocessor controls provide a "virtual engineer". Check out www.highpowerfm for full details.

PX1 35W Professional FM Stereo Transmitter \$1,795.95

ELECTROCARDIOGRAM HEART MONITOR



- ✓ Visible and audible display of your heart rhythm
 - ✓ Re-usable sensors included; just like visiting the hospital!
 - ✓ Bright LED "beat" indicator
 - ✓ Monitor output for oscilloscope display
- Enjoy learning about the inner workings of the heart while covering the stage by stage electronic circuit theory of ECG/EKG systems. Be heart smart and learn at the same time!

ECG1 Electrocardiogram Heart Monitor Kit \$34.95
 CECG Matching Case & Knob Set \$14.95
 AC125 110 VAC Power Adapter \$9.95
 ECGP10 Replacement Reusable Probe Patches (10-Pack) \$7.95

PLASMA GENERATOR



- ✓ Generate 2" sparks to a hand held screwdriver!
 - ✓ Build your own plasma balls!
 - ✓ 25KV at 20 KHz from a solid state source!
- Generate really impressive sparks, build your own plasma ball, light fluorescent tubes without wires! From a solid state source, generate over 25KV at 20KHz for the most dazzling displays!

PG13 Plasma Generator Kit \$59.95
 PS12 14VAC Output Power Supply \$19.95

ION GENERATOR



- ✓ Generates negative ions with a blast of fresh air!
 - ✓ 7.5KV DC negative, 400uA - that's a lot of ions!
 - ✓ Steady state DC voltage, constant current, not pulsed!
- Learn the basics of ion repulsion by building this ion generator! Creates a continuous blast of fresh air charged with a ton of ions. Perfect for pollution and air freshening; just smell those ions! Solid state wind generation; you'll be amazed!

IG7 Ion Generator Kit \$59.95
 AC125 110 VAC Power Adapter \$9.95

TOUCH-TONE TONE GRABBER



- ✓ New-built-in RJ11 phone jack
- ✓ Large memory holds over 500 numbers
- ✓ Big bold 8 digit display, auto insertion of dashes
- ✓ New-output latch jack

Dialed phone numbers on the radio, repeater codes, control codes, anywhere touch-tones are used, you can read and store them! All new design for 2002. Capture those tones with the TG2!

TG2 Tone Grabber Tone Reader Kit \$59.95
 CTG2 Matching Case & Knob Set \$14.95
 AC125 110 VAC Power Adapter \$9.95

RCA TO XLR AUDIO CONVERTER



- ✓ Connect consumer outputs to XLR inputs
 - ✓ Left & right audio gain adjustments
- So you're trying to connect consumer audio outputs with RCA connectors (unbalanced) to XLR (balanced) inputs. Always a problem...Not anymore with the R2XL!

R2XL1 Unbalanced to Balanced Audio Converter Kit \$49.95
 CR2XL Matching Case & Knob Set \$14.95
 PWR25 12VAC Power Adapter \$9.95

AUTOMATIC COLOR/BW IR CAMERA



- ✓ Color during the day, IR B&W at night!
 - ✓ Automatically turns on IR Illumination!
 - ✓ Waterproof to IP57 standards!
 - ✓ Black anodized housing with universal mount
- Best of both worlds! This video camera is a waterproof COLOR camera during the day. When the light level drops, it automatically changes to B&W and turns on its built-in IR illumination, with 10 IR LEDs. Powered by 12VDC and terminated with a professional BNC connector. B&W only model

also available if color is not needed. Both in heavy anodized black housing.
 CCD309 Color/B&W IR Waterproof Bullet Camera \$169.95
 CCD308 B&W IR Waterproof Bullet Camera \$109.95
 AC125 110 VAC Power Adapter \$9.95

MINI B&W CAMERA WITH IR ILLUMINATION



- ✓ Built in IR illumination!
 - ✓ Sees in total darkness!
 - ✓ Black aluminum housing with swivel bracket
- What a deal! This miniature B&W video camera has 6 high power IR LEDs built into it to provide illumination in total darkness! No need for external IR illuminators. Attractive black aluminum housing easily mounts at any angle with the built-in swivel bracket. Runs on 12VDC, and includes professional BNC output plug-in harness.

CCD303 Mini B&W IR Illuminated Camera \$59.95
 AC125 110 VAC Power Adapter \$9.95

Check out all our other new cameras at www.ramseykits.com!

PROFESSIONAL FM STEREO RADIO STATION



- ✓ Synthesized 88 to 108 MHz with no drift!
- ✓ Built-in mixer - 2 line inputs and one microphone input!
- ✓ High power module available for export use
- ✓ Low pass filter for great audio response

Our FM100 is used all over the world by serious hobbyists as well as churches, drive-in theaters, and schools. Frequency synthesized PLL assures drift-free operation with simple front panel frequency selection. Built-in audio mixer features LED bargraph meters to make setting audio a breeze. The kit includes metal case, whip antenna and built-in 110 volt AC power supply.

FM100 Super-Pro FM Stereo Radio Station Kit \$249.95
 FM100WT 1 Watt, Wired Export Version \$399.95

SYNTHESIZED FM STEREO TRANSMITTER



- ✓ All new design & features for 2002!
 - ✓ Fully adjustable RF output
- Our #1 kit for years has just gotten better for 2002! Totally redesigned, the FM25B has all the features you've asked for. From variable RF output, F connector RF output jack, line input, loop output, and

more. Includes case, power supply, whip antenna, audio cables.
 FM25B Synthesized FM Stereo Transmitter Kit \$129.95

AND...OUR FAMOUS MINI-KITS

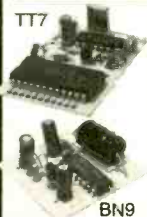

These are easy to build kits that can be used either stand-alone or as building blocks for more complex projects.

TT7 \$19.95
 TS4 Tickle-Stick Shocker \$9.95
 BN9 Super Snoop Amplifier Kit \$8.95
 BL1 LED Blinky Kit \$3.95
 TD1 Tone Encoder/Decoder Kit \$6.95
 TT7 Touch Tone Decoder Kit \$19.95
 CPO3 Code Practice Oscillator Kit \$9.95
 UT5 Universal Timer Kit \$8.95

RAMSEY
 RAMSEY ELECTRONICS, INC.

793 Canning Parkway
 Victor, NY 14564
 716-924-4560
sales@ramseykits.com



Order Today! 800-446-2295
www.ramseykits.com

VISION ELECTRONICS



- No Rolls/Jitters/Flickers/Fading
- Works on all TV's, VCR's, Beta, & Cable
- Gold Video Connectors & Cables Included
- 1 Year Warranty
- Money Back Guarantee

FREE CATALOG!



COPY RENTAL TAPES WITH OUR VIDEO STABILIZER

1-800-562-2252

2609 S. 156th Circle • Omaha, NE 68130
www.modernelectronics.com



Lynxmotion, When you're tired of playing with toys!

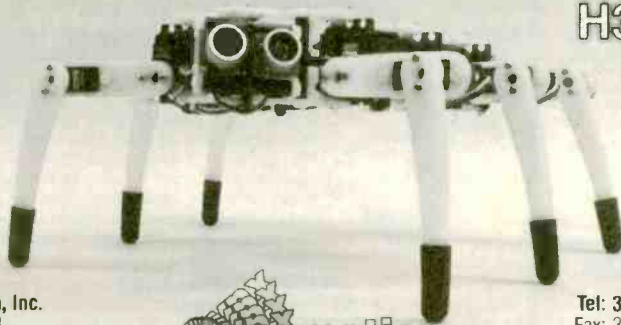

H3-KT

Lynxmotion, Inc.
PO Box 818
Pekin, IL 61555-0818
www.lynxmotion.com



Visit our website or ask for our free catalog!

Tel: 309-382-1816
Fax: 309-382-1254
sales@lynxmotion.com
tech@lynxmotion.com

HIGH QUALITY FM BROADCAST EQUIPMENT

- SINCE 1990 -

You know you want it! We've got it: LPFM & High Power, Stereo FM Transmitters, RF Amplifiers, Low Pass Filters, Antennas, Mixing Boards, Microphones, CD Players, Compressor/Limiters, Digital Reverbs, Automation Software, Studio to Transmitter Links, Emergency Alert Systems, RF Test Equipment, Kits, RF Parts, and much more. Best Prices, Highest Quality. Give Us A Call or Buy It Online...



www.progressive-concepts.com
305 SOUTH BARTLETT ROAD, STREAMWOOD, IL 60107
VOICE: (630)736-9822 FAX: (630)736-0353



LEARN A CAREER IN ELECTRONICS!

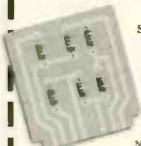

Home study. Learn to repair, service, and install TV's, VCR's, camcorders, stereos, sound and lighting systems, alarms, and more! Free career literature.

CALL 800-223-4542

Name _____ Age _____
Address _____ Phone (____) _____
City/State _____ Zip _____

The School of Electronics
Dept. ELB341, 430 Technology Parkway
PCDI, Norcross, GA 30092 • www.pcdi.com

SINGERS! REMOVE VOCALS

Unlimited, Low Cost, Instantly Available Background Music from Original Standard Recordings! Does Everything Karaoke does... Better and gives you Thompson Vocal Eliminator Free Brochure & Demo Tape. LT Sound Dept PE 7988 LT Parkway, Lithonia, GA 30058 Internet: http://www.LTSound.com 24 Hour Demo/Info Request Line (770)482-2485 - Ext 49 When You Want Something Better Than Karaoke!

Do You Repair Electronics?

Repair Databases for TV, VCR, Monitor, UL Audio, FCC, and more.

- Over 76,000 records
- Private user forums
- Live on-line chat rooms

RepairWorld.com

Electronics Corp. 1 Herald Sq. Fairborn, OH 45324 (937) 876-9876

World's Smallest 68HC11 Microcontroller Modules!

MicroStamp11™

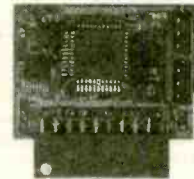

- telemetry
- microbotics
- smart toys
- animatronics
- model railroading
- home automation

- tiny, light-weight (0.5 oz.)
- 1-inch x 1.4-inch 68HC11 module
- on-board 5V regulator
- 8MHz crystal (9.83MHz on Turbo version)
- choice of 8K or 32K EEPROM
- 32K RAM + 32K EEPROM on 64K version
- plugs into your breadboard like a DIP
- SCI (UART), SPI, Output Compares, Input Captures, hardware timer, pulse accumulator
- all 14 I/O lines and 2 interrupts brought out to versatile 20-pin connector
- program in BASIC, assembler, or C
- easy code-loading with Docking Module
- Starter Packages:*
- 8K EEPROM (#MS11SP8K).....\$49
- 32K EEPROM (#MS11SP32K).....\$77
- 32K EE+32K RAM (#MS11SP64K)...\$90

* Includes MicroStamp11, manual, PC software (free-ware assembler, SBASIC compiler, MicroLoad utility, and sample programs), serial cable, Docking Module, and accessories.

Attention OEMs:

Embed MicroStamp11 modules into your product! only \$20 each (100-pc. price, 8K version)

MicroCore-1™

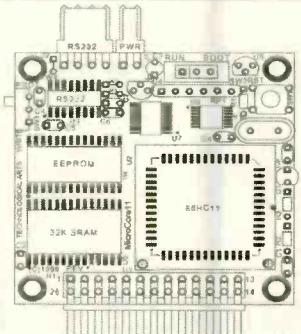

- tiny 2-inch x 2-inch 68HC11 module
- 12 inputs/outputs plus 8 analog inputs
- RS232, 5V regulator, 8MHz crystal
- 32K SRAM plus 8K or 32K EEPROM
- plugs into your breadboard like a DIP
- easy programming from any PC
- ideal for building MicroMouse robots
- now available in Turbo version (9.83MHz)
- 8K Starter Package #MC11SP8K.....\$68
- 32K Starter Package #MC11SP32K.....\$93
- Motor driver boards, LCD/keyboard/keyboard interface & prototyping cards available

Technological Arts

Many other modules & accessories available. Visit our website at:

www.technologicalarts.com

sales@technologicalarts.com

TOLL-FREE: 1-877-963-8996

Phone: (416) 963-8996

Fax: (416) 963-9179

Visa • MasterCard • Discover • Amex

CALL TOLL-FREE

(800) 292-7711
Orders Only

Se Habla Español

C&S SALES

Secure On-line Ordering @ cs-sales.com

CALL OR WRITE
FOR OUR
FREE

64 PAGE CATALOG!
(800) 445-3201

Digital Multimeters

Elenco Model M-1740

\$19.95



11 Functions:

- Freq. to 20MHz
- Cap. to 20µF
- AC/DC Voltage
- AC/DC Current
- Beeper
- Diode Test
- Transistor Test
- Meets UL-124 safety specs.

Elenco Model LCR-1810

\$89.95



- Cap. 11pF to 20µF
- Inductance 0.1µH to 20H
- Resistance 0.01Ω to 2,000MΩ
- Temperature -20°C to 750°C
- DC V-I's 0 - 20V
- Freq. up to 15MHz
- Diode/Audible Continuity Test
- Signal-Output Function

Elenco Model LCM-1950

\$65



- Large 1 3/4 Digit LCD
- Autoranging Freq. to 4MHz
- Cap. to 400µF
- Inductance to 40H
- Res. to 4,000MΩ
- Logic Test
- Diode & Transistor Test
- Audible Continuity Test

LCR Bridge

B&K Model 878

\$229



- Accurately measures capacitance, resistance, and inductance
- Measures dissipation factor of capacitors and Q of inductors.

Deluxe Soldering Stations

Elenco SL-5 Series

Electronically controlled. Ideal for professionals, students, and hobbyists. Available in kit form or assembled.

Works w/ any iron! Turn any soldering iron into a variable iron.

As Low As
\$24.95

Quantity Discounts Available



Features:

- Cushion Grip Handle
- Soldering Iron (optional) with Grounded Tip for Soldering Sensitive Devices. Easily Replaceable. Uses Long-Life, Plated Conical Tip.
- Heavy Steel, Non-Slip Base.
- Iron Holder Funnel - Reversible, left or right side.
- Steel Tray for Sponge Pad.
- Sponge Pad.

Ordering Information:

Model SL-5 - No iron. (Kit SL-5K) **\$24.95**

Model SL-5-40 - Includes 40W UL iron. (Kit SL-5K-40) **\$29.95**

Test Equipment

Elenco Four Functions in One Instrument Model MX-9300B

Features:

- One instrument with four test and measuring systems:
 - 1.3GHz Frequency Counter
 - 2MHz Sweep Function Generator
 - Digital Multimeter
 - Digital Triple Power Supply

\$450



Elenco 3MHz Sweep Function Generator with built-in 60MHz Frequency Counter Model GF-8046

\$199.95

- Generates square, triangle, and sine waveforms, and TTL, CMOS pulse.



GF-8025 - Without Counter **\$139.95**

20MHz Sweep / Function Generator with Frequency Counter Model 4040A

- 0.2Hz to 20MHz
- AM & FM Modulation
- Burst Operation
- External Frequency Counter to 30MHz
- Linear and Log Sweep



10MHz Model 4017A **\$325**
5MHz Model 4011A **\$259**
2MHz Model 4010A **\$225**

\$445
BK PRECISION

Elenco Handheld Universal Counter Model F-2800

\$99

Sensitivity:

- <1.5mV @ 100MHz
- <5mV @ 250MHz
- <5mV @ 1GHz
- <100mV @ 2.4GHz

Features: 10 digit display, 16 segment and RF signal strength bargraph. Includes antenna, NiCad battery, and AC adapter.

C-2800 Case w/ Belt Clip **\$14.95**

Elenco RF Generator with Counter (100kHz - 150MHz) Model SG-9500

\$225

Features internal AM mod. of 1kHz, RF output 100mV - 35MHz. Audio output 1kHz @ 1V RMS. SG-9000 (analog, w/o counter) **\$119**

Elenco Quad Power Supply Model XP-581

4 Fully Regulated Power Supplies in 1 Unit

\$75

4 DC Voltages: 3 fixed: +5V @ 3A, +12V @ 1A, 1 variable: 2.5 - 20V @ 2A • Fully Regulated & Short Protected • Voltage & Current Meters • All Metal Case

Elenco Power Supply Model XP-603

\$75

- 0-30VDC @ 3A Output
- 3A Fused Current Protection
- Current Limiting Short Protection
- 0.025Ω Output Impedance

Elenco 10Hz - 1MHz Digital Audio Generator Model SG-9300

\$225

Features built-in 150MHz frequency counter, low distortion and sine/square waves. SG-9200 (w/o counter) **\$119**

Elenco Model SL-30 **\$79.95**

- Tip temperature changeable from 300°F (150°C) to 900°F (480°C).
- Temperature is maintained within +10°F of its preset temperature.
- The tip is isolated from the AC line by a 24V transformer.
- The tip is grounded to eliminate static charges.

SL-10 - Same as SL-30 w/o digital display **\$54.95**

Weller® Low Cost Soldering Iron Model WLC100

- Variable power control produces 5-40 watts.
- Ideal for hobbyists, DIYers and students.
- Complete with 40W iron.

\$34.95



Elenco Oscilloscopes

Free Dust Cover and 2 Probes



S-1325 25MHz Dual Trc **\$325** S-1345 40MHz Delayed Sweep **\$519**
S-1330 25MHz Delayed Sweep **\$439** S-1360 60MHz Delayed Sweep **\$775**
S-1340 40MHz Dual Trace **\$475** S-1390 100MHz Delayed Sweep **\$815**

Deluxe 29pc. Computer Service Tool Kit **\$36.95** Elenco Model TK-1200

- Includes Soldering Iron, Solder, Long Nose Pliers, Diagonal Pliers, 11 pc. Screwdriver Bit Set, Wire Stripper, IC Inserter, IC Extractor, Screwdriver, Phillips Screwdriver, Desoldering Pump, and more!



Elenco Educational Kits

Model XK-150 Digital / Analog Trainer **\$89.95**



- 830-pin Breadboard
- 8 Data Switches
- 8 LED Buffered Readouts
- Built-in Function Generator (sine and square wave)
- Built-in Clock Generator
- Variable Power Supply

OWI Model OWI-007 Robotic Arm Trainer **\$82.50**



Model AK-700 Pulse/Tone Telephone Kit Flashing Neon Lights Great School Project **\$14.95**

Model M-1005K DMM Kit **\$18.95**

- Transistor Test
- Diode Test
- Overload Protection
- Pocket Size

Model AK-780K Two IC Radio Kit **\$9.95**



Model RCC-7K Radio Control Car Kit **\$27.95**

- 7 Functions
- Transmitter included

Model K4001 7W Amplifier **\$12.95**

Electronic Science Lab

Maxitronix 500-in-1 Electronic Project Lab Model MX-909

Everything you need to build 500 exciting electronic projects:

- Learn the basics of electronics, 500 different electronic experiments, special lighting effects, radio transmitter and receivers, sound effects, cool games and MORE!
- Includes built-in breadboard and an LCD.
- Explore amplifiers, analog and digital circuits plus how to read schematic diagrams.
- Includes 11 parts.
- Lab-style manual included.
- Requires 6 "AAA" batteries.



MX-908 - 300-in-1 Lab **\$59.95**
MX-907 - 200-in-1 Lab **\$44.95**
MX-906 - 130-in-1 Lab **\$29.95**
EP-50 - 50-in-1 Lab **\$18.95**

\$149

Guaranteed Lowest Prices **C&S SALES, INC.**

15 DAY MONEY BACK GUARANTEE

UPS SHIPPING: 48 STATES 5% (Minimum \$5.00)
OTHERS CALL FOR DETAILS
IL Residents add 8.25% Sales Tax

150 W. CARPENTER AVENUE
WHEELING, IL 60090
FAX: (847) 541-9904 (847) 541-0710
<http://www.cs-sales.com>



2 YEAR FACTORY WARRANTY

PRICES SUBJECT TO CHANGE WITHOUT NOTICE

CIRCLE 290 ON FREE INFORMATION CARD

www.americanradiohistory.com

AMAZING DEVICES

NVEN22001EVEN

See and Order from Our "Action" Web Site at www.amazing1.com

Laser Window Bounce Listener

Powerful listening system, yet simple in operation. You shine a laser at a window and intercept the reflected beam with our ultrasensitive filtered optical receiver. Vibrations on the window from internal sounds and voices are now clearly heard. Range can be up to several hundred meters depending on laser power and optics used.

LWB9 Plans for 3 Laser Window Bounce Systems.....	\$20.00
LWB6K Kit of 100' Complete for Science Project	\$129.95
LLR3K Low Cost Optical Receiver Kit.....	\$69.95
LLR30 Ready to Use Above Optical Receiver.....	\$99.95
LLR40 Higher Performance of Above Receiver/Optics.....	\$199.95
LM650P3 Visible Red 5mw Laser Module to 100'.....	\$29.95
CWL 10 10 mw Class IIIB Invisible IR Laser up to 500'.....	\$199.95

PLASMA FIRE SABERS Kits, Parts and Accessories

Duplicates effect in the motion picture epic of the century!

Specify blue, grn, pur, red or yel. Moving light appears to evaporate into space. Blades screw into handle for easy replacement

We stock all size and color blades, mauler adapters, tubes digital drivers, and parts for authentic designs. Wireless interactive sound modules change tone with motion

SAB15 Assbled with 15" Blade.....	\$39.95
SAB24 Assbled with 24" Blade.....	\$79.95
SAB24K Kit.....	\$59.95
SAB36 Assbled with 36" Blade.....	\$149.95
SAB36K Kit.....	\$129.95

Take Control!! Electronic Hypnosis



Electronic circuitry places subject under your control! Induces ALPHA relaxed mind states.

HYP2 Plans.....	\$10.00
HYP2K Kit/Plans.....	\$49.95
HYP20 Ready to Use.....	\$69.95
MIND2 Plans for Mind Control.....	\$15.00
MIND2K Kit/Plans.....	\$49.95
MIND20 Ready to Use.....	\$79.95

Pain Field Pistol

Caution! Do not aim at people!

Blast out rodents with high power ultrasonics.

Handheld and battery operated with all controls.

Rental units available.



PPP1 Plans.....	\$8.00
PPP1K Kit/Plans.....	\$49.95
PPP10 Ready to Use.....	\$79.95

Jacob's Ladder

A 1/2" arc expands to over 4" as it travels up the Jacobs Ladder evaporating in space.

- Adjustable arc control
 - Uses safe high frequency
 - Safety shock shut down
 - Full 20" ladder length
 - 110/220 vac 150 watts
- | | |
|--------------------------|----------|
| JACK3K Kit..... | \$149.95 |
| JACK30 Ready to Use..... | \$249.95 |



30" Spark Tesla Coil

Create a spectacular display of nature's own lightning. Many amazing experiments possible. See coil in action on our web site!

BTC4 Plans.....	\$20.00
BTC4K kit.....	\$899.95
BTC40 Ready to use.....	\$1199.95
Smaller Version (8-10" Sparks)	
BTC3 Plans.....	\$15.00
BTC3K Kit.....	\$349.95
BTC30 Ready to Use.....	\$449.95



Hover Board

28 pages of data related to the most revolutionary advance in transportation. Cutting edge R&D HOVER Plans and Data.....



Anti Gravity

Float an object using anelectric force field. With handbook GRA3 Plans/book.....



MINI TESLA COIL Lights 4' light tube!	
MTC1 Plans.....	\$5.00
MTC1K Kit.....	\$19.95
MTC10 Assmbld for 12 volts.....	\$34.95

6 Transmitter Kits

- Super Sensitive Ultra Clear 1 Mile+ Voice Transmitter.
- 1 Mile+ Telephone Transmitter.
- Line Powered Phone Transmitter Never Needs Batteries!
- Tracking/Homing Beacon Beeping Transmitter
- Video/Audio Rebroadcaster 1 Mi.
- TV/FM Radio Disrupter. Neat Prank! Discretion Required

Includes Hints Using Wireless Devices
COMBOX Above 6 Kits/Plans.....\$59.95
COMBOP Above 6 Plans Only.....\$10.00

4 KV HV MODULE for hovercraft, plasma guns, antigravity, pyrotechnics. 12vdc input. MINIMAX4.....\$19.95

Information Unlimited PO Box 716 Amherst N.H. U.S.A. 03031

1 800 221 1705 Orders/Catalogs Only! Fax 1 603 672 5406 Information 1 603 673 4730 Free Catalog on Request
Pay by MC, VISA, Cash, Check, MO. Add \$5.00 S&H Overseas Contact for Proforma

CIRCLE 220 ON FREE INFORMATION CARD

ELECTRONIX EXPRESS

Visit Our Website At <http://www.elexp.com>

<h3>WELLER SOLDERING STATION - MODEL WLC 100</h3> <ul style="list-style-type: none"> Variable power control (5 to 40 watts) Replaceable heating element Quality light-weight pencil iron <p style="text-align: right;">\$36⁹⁵</p> <hr/> <p style="text-align: center;">LOWEST PRICE 20MHZ</p> <div style="display: flex;"> <div style="flex: 1;"> <h3>INSTEK[®] OSCILLOSCOPE</h3> <p>MODEL GOS-620 Dual Channel - 20MHZ (INCLUDES PROBES)</p> <p style="text-align: right;">\$299⁰⁰</p> </div> <div style="flex: 1;"> <h3>INSTEK[®] FUNCTION GEN.</h3> <p>WITH INT/EXT FREQ. COUNTER</p> <p>3 MHz, Digital Display MODEL 8216 \$199⁰⁰</p> </div> </div> <hr/> <h3>ALLIGATOR LEADS</h3> <p>SET OF 10 \$2¹⁰</p> <hr/> <h3>SWITCHES</h3> <p>Mini Toggle SPDT 50¢ ea.</p> <hr/> <h3>SOLDERING IRON 3-WIRE</h3> <p>HIGH PERFORMANCE #060501 \$5²⁵</p> <hr/> <h3>HIGH QUALITY TOOLS</h3> <p>With Cushion Grips and Return Spring</p> <table border="0" style="width: 100%;"> <tr> <td>Needle Nose Pliers \$2⁹⁵</td> <td>Wire Stripper \$1⁵⁰</td> <td>Diagonal Cutter \$2⁹⁵</td> </tr> </table> <hr/> <h3>DC POWER SUPPLIES</h3> <p>MODEL HY3003 - DIGITAL DISPLAY Variable output, 0-30 VDC, 0-3 Amp \$89⁰⁰</p> <p>MODEL HY3003-3 - TRIPLE OUTPUT Two 0-30 VDC, 0-3 Amp variable outputs plus 5V 3A fixed. Digital Display. \$215⁰⁰</p>	Needle Nose Pliers \$2⁹⁵	Wire Stripper \$1⁵⁰	Diagonal Cutter \$2⁹⁵	<h3>RSR - TELECOMMUNICATIONS TRAINER</h3> <p>HANDS-ON TELEPHONY, LAN, CATV EXPERIENCE WITH ONE SELF-CONTAINED UNIT</p> <p>T-Comm Trainer (TCM-100) \$199.95 Lab Manual / Work Book 26.95 Component and Supplies Kit 37.95 Tool Kit 119.95</p> <p style="text-align: right;">Only \$199⁹⁵</p> <p style="text-align: right;">MODEL TCM-100</p> <hr/> <h3>SOLDERLESS BREADBOARD</h3> <p>830 tie points. MB102PLT model features 3 binding posts and aluminum backplate.</p> <table border="1" style="width: 100%;"> <tr> <th>Part No.</th> <th>1-9</th> <th>10+</th> </tr> <tr> <td>MB102</td> <td>5.95</td> <td>5.00</td> </tr> <tr> <td>MB102PLT</td> <td>8.95</td> <td>8.00</td> </tr> </table> <hr/> <h3>MOTION DETECTOR</h3> <p>\$2 ea. - 10 For \$15</p> <table border="1" style="width: 100%;"> <tr> <td>LM555 10 Min.</td> <td>22¢ ea.</td> </tr> <tr> <td>LM741 10 Min.</td> <td>27¢ ea.</td> </tr> <tr> <td>74LS00 10 Min.</td> <td>18¢ ea.</td> </tr> <tr> <td>7805 Regulator 10 Min.</td> <td>30¢ ea.</td> </tr> <tr> <td>2N3904 10 Min.</td> <td>6¢ ea.</td> </tr> <tr> <td>PN2222 10 Min.</td> <td>6¢ ea.</td> </tr> <tr> <td>Red LED T 1 1/4 10 Min.</td> <td>6¢ ea.</td> </tr> <tr> <td>Green LED T 1 1/4 10 Min.</td> <td>7¢ ea.</td> </tr> <tr> <td>Yellow LED T 1 1/4 10 Min.</td> <td>8¢ ea.</td> </tr> <tr> <td>Photo Cell 10 Min.</td> <td>65¢ ea.</td> </tr> <tr> <td>100K Pot, 1" Shell PC Mt. 10 Min.</td> <td>15¢ ea.</td> </tr> </table> <hr/> <h3>PRESS-N-PEEL RESISTOR KIT</h3> <p>1/4 W 5% film. 5 pieces each of 73 values. 365 pieces total. \$3⁹⁵</p> <hr/> <h3>PC Board Transfer Film</h3> <table border="1" style="width: 100%;"> <tr> <td>PNP Blue 5 Sheet</td> <td>\$9.90</td> </tr> <tr> <td>PNP Wet 5 Sheet</td> <td>9.90</td> </tr> <tr> <td>PNP Blue 20 Sheet</td> <td>28.95</td> </tr> <tr> <td>PNP Wet 20 Sheet</td> <td>28.95</td> </tr> </table>	Part No.	1-9	10+	MB102	5.95	5.00	MB102PLT	8.95	8.00	LM555 10 Min.	22¢ ea.	LM741 10 Min.	27¢ ea.	74LS00 10 Min.	18¢ ea.	7805 Regulator 10 Min.	30¢ ea.	2N3904 10 Min.	6¢ ea.	PN2222 10 Min.	6¢ ea.	Red LED T 1 1/4 10 Min.	6¢ ea.	Green LED T 1 1/4 10 Min.	7¢ ea.	Yellow LED T 1 1/4 10 Min.	8¢ ea.	Photo Cell 10 Min.	65¢ ea.	100K Pot, 1" Shell PC Mt. 10 Min.	15¢ ea.	PNP Blue 5 Sheet	\$9.90	PNP Wet 5 Sheet	9.90	PNP Blue 20 Sheet	28.95	PNP Wet 20 Sheet	28.95
Needle Nose Pliers \$2⁹⁵	Wire Stripper \$1⁵⁰	Diagonal Cutter \$2⁹⁵																																									
Part No.	1-9	10+																																									
MB102	5.95	5.00																																									
MB102PLT	8.95	8.00																																									
LM555 10 Min.	22¢ ea.																																										
LM741 10 Min.	27¢ ea.																																										
74LS00 10 Min.	18¢ ea.																																										
7805 Regulator 10 Min.	30¢ ea.																																										
2N3904 10 Min.	6¢ ea.																																										
PN2222 10 Min.	6¢ ea.																																										
Red LED T 1 1/4 10 Min.	6¢ ea.																																										
Green LED T 1 1/4 10 Min.	7¢ ea.																																										
Yellow LED T 1 1/4 10 Min.	8¢ ea.																																										
Photo Cell 10 Min.	65¢ ea.																																										
100K Pot, 1" Shell PC Mt. 10 Min.	15¢ ea.																																										
PNP Blue 5 Sheet	\$9.90																																										
PNP Wet 5 Sheet	9.90																																										
PNP Blue 20 Sheet	28.95																																										
PNP Wet 20 Sheet	28.95																																										

FREE CATALOG

MORE Low-Priced Items In Our **FREE** 256-Page Catalog

TERMS: Min. \$20 + shipping. School Purchase Orders, VISA, MC, Money Order, Prepaid. NO PERSONAL CHECKS. NO COD. NJ Residents Add 6% Sales Tax.

In NJ: 732-381-8020 365 Blair Road • Avenel, NJ 07001-2293 <http://www.elexp.com>
 FAX: 732-381-1006 **800-972-2225** email: electron@elexp.com

CIRCLE 206 ON FREE INFORMATION CARD

Start A Career With High Wages, Excellent Benefits and Job Security!!

With UCANDO's extraordinary maintenance training programs you can quickly and easily enter a high paying field as a maintenance technician for a very small investment of time and money.

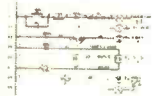

RC-M ONLY \$165 RC-M is a 15 hour training course on relay ladder logic systems. Includes a 5-part video and workbook. **Great Value!**

PLC-M ONLY \$198 PLC-M is a 32 hour training course on PLC systems. Includes (2) 4-part video's and workbook. **This training is valuable.**



HYD-M ONLY \$209 HYD-M is a 32 hour course on Fluid Dynamics. Includes (2) 4-part video's and workbook. **This Module is a must.**

SC-M ONLY \$215 SC-M is a 32 hour training course on AC & DC Servo Controllers. Includes (2) 4-part video's and workbook. **Learn everything you need about AC and DC servo Control Systems.**



Electronic Training Videos: Basic Electronics, Digital Electronics, TV Repair, LASER and Fiber Optic training videos available at very affordable prices starting at **Only \$35.00 each.**

For information or to place an order call:

1-800-678-6113

www.ucando-corp.com

UCANDO VCR Educational Products Corp., Greenville, OH

\$59 PCBs

And our layout software is **FREE!**

Download ▶ Design ▶ Send ▶ Receive

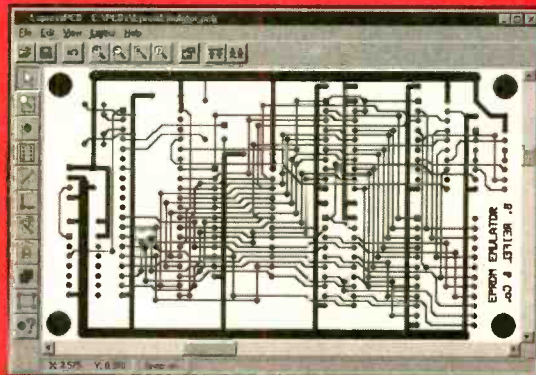

Download our **FREE** layout software
Design your two-sided plated-through PCB
Send us your design with just a click
Receive in a few business days, often under \$100

Select our MiniBoard special service and get three top quality 2.5" x 3.8" PCBs for \$59 - shipping included!



expresspcb.com



New and Pre-Owned Test Equipment

New Equipment Specials

B+K Precision 2120B - 30 MHz Oscilloscope

- * FREE Model 117B Multimeter
 - * 2 Channel, Dual-Trace
 - * 30 MHz Bandwidth
 - * TV Triggering
 - * (2) Probes Included
- Sale Price \$339.00**

AVCOM PSA-37D - Spectrum Analyzer

Satellite Downlink - Installation - Maintenance & Service

- Band 1: 10 - 1750 MHz
 - Band 2: 3.7 - 4.2 GHz
 - Carrying Case Included
 - Line or Battery Powered
 - Built-in DC Block & Power for LNA/LNB's
- Sale Price \$2,395.00**

Instek GOS-6103 - 100 MHz Analog Oscilloscope

- 100 MHz Bandwidth
 - 2 Channel, High Sensitivity
 - TV Trigger - Signal Output
 - Cursor Readout
 - Time Base Auto-range
 - (2) Probes Included
 - 2 Year Warranty
- Sale Price \$899.00**

Leader LF 941 - CATV Signal Level Meter

- TV/CATV Coverage from 46-870 MHz
 - Video/Audio Carrier Measurements
- Sale Price \$489.00**

Wavetek Meterman HD160B Digital Multimeter

- Full Sealing Against Water, Chemicals, & Fluids
 - True RMS
 - Drop-Proof to 10 feet (3.3m)
- Sale Price \$159.00**

Pre-Owned Oscilloscope Specials

Tektronix	465	100 MHz	\$499.00
Tektronix	465B	100 MHz	\$649.00
Tektronix	475	200 MHz	\$749.00
Tektronix	475A	250 MHz	\$949.00

- Professionally Refurbished
- Aligned & Calibrated to Original Specifications
- The Industry Standard of Oscilloscopes
- 1 Year Warranty - The Longest Available!!!
- See Website for Complete Specifications

See us on the Web!
www.testequipmentdepot.com

**We Buy Surplus
Test Equipment**

Test Equipment Depot
A-FOTRONIC CORPORATION COMPANY

99 Washington St. Melrose, MA 02176
(781) 665-1400 • FAX (781) 665-0780

e-mail: sales@testequipmentdepot.com

(1-800-996-3837)

TOLL FREE 1-800-99-METER



CIRCLE 322 ON FREE INFORMATION CARD

Home Automation



World's Largest Source for Home Automation!

- Voice Control
- Gadgets & Motorized Devices
- Home Theater
- Phones & Intercoms
- X10 & Lighting Control
- Home Security & Surveillance
- Home Networking & Structured Wiring

and Much More...

800-SMART-HOME
www.smarthome.com

Free 144 pg. Color Catalog!

Dealers/Resellers ask about our SmartHome PRO Dealer Program 800-949-6255

SERIAL LCDs

Serial LCDs work great with BASIC Stamps® and other microcontrollers. One-wire interface • simple serial protocol • low cost • high quality • in stock

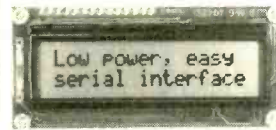

- BPI-216N**
- 2x16 text LCD
 - 2400/9600 bps
 - \$45 (non-backlit)

- SGX-120L**
- Mini graphics LCD
 - 2400/9600 bps
 - just \$99

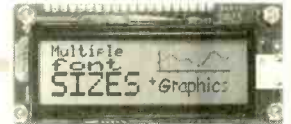

Many other models available—see www.seetron.com/

Scott Edwards Electronics, Inc.
www.seetron.com • 520-459-4802



ACTIVE

ELECTRONIC COMPONENTS DEPOT

www.activestores.com

YOUR LOCAL ONE STOP SHOP FOR ALL YOUR ELECTRONIC NEEDS!

Over 5,000 products on display for you to browse through, including:

- Electronic Components
- Test Equipment
- Soldering Supplies
- Chemicals • Tools
- Wire & Cable
- Books • Datacom
- Prototyping
- Static Control



and much more!

ACTIVE 8 Locations across the US!

BALTIMORE
TEL: (410) 863-0070
FAX: (410) 863-0075
active.baltimore@future.ca

CHICAGO
TEL: (847) 640-7713
FAX: (847) 640-7613
active.chicago@future.ca

SEATTLE
TEL: (425) 881-8191
FAX: (425) 883-6820
active.seattle@future.ca

CAMBRIDGE
TEL: (617) 864-3588
FAX: (617) 864-0855
active.cambridge@future.ca

DETROIT
TEL: (734) 525-1533
FAX: (734) 525-1015
active.detroit@future.ca

WOBURN
TEL: (781) 932-0050
FAX: (781) 933-8884
active.woburn@future.ca

CHERRY HILL
TEL: (856) 424-7070
FAX: (856) 424-7722
active.cherry.hill@future.ca

LONG ISLAND
TEL: (631) 471-5400
FAX: (631) 471-5410
active.long.island@future.ca

Activeplus
Rewards Program
Join today to save!

15% OFF ALL IN-STORE ELECTRONIC COMPONENTS
(on items not already reduced)

Limit one coupon per purchase. In-store selection only. Not valid on Test Equipment. Offer expires February 28, 2002.

Creating a New Century of Savings **U.S. SAVINGS BONDS**

For complete information about U.S. Savings Bonds, visit our Web site at www.savingsbonds.gov.

A public service of this publication



Coil Design and Construction Manual

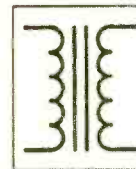

YOU CAN WIND YOUR OWN COILS?

There's no trick to it except knowing what you are doing. In a unique, 106-page book you can become expert in winding RF, IF, audio and power coils, chokes and transformers. Practically every type of coil is discussed and necessary calculations are given

with the mathematical data simplified for use by anyone. Get your copy today!

Mail coupon to:

Electronics Technology Today, Inc.
P.O. Box 240 • Massapequa Park, NY 11762-0240

Please send me my copy of *Coil Design and Construction Manual* (BP160). I enclose a check or money order for \$8.99 to cover the book's cost and shipping-and-handling expenses. NY state residents must add local sales tax.

Name _____

Address _____

City _____ State _____ ZIP _____

All orders must be paid in U.S. funds only. Sorry, no orders accepted outside of USA and Canada. Please allow 6-8 weeks for delivery.

ET06

High Tech Video System with Audio Only \$119.00!!

Complete Package ! Includes Two B/W Cameras with I.R. (night vision) & microphones
One 5.5" B/W Monitor with Built in Switcher, Two pre-wired 60 ft hook-up cables
Everything you need to be up & running in minutes with a high tech video system!!



- System Features:**
- *2 wide angle B/W cameras w I.R. & Sound
 - *5.5" B/W video monitor w built in switcher
 - *Two 60 ft. pre-wired cables
 - *View one or both cameras. Switching Time variable from 2 to 20 seconds
 - *Video easily hooks into a VCR

Complete technical details at our web site!

Removeable H.D. Racks
For IDE/Ultra DMA Hard Drives
We Sold Over 18,000 in 2000!

ONLY \$14.95 any qty.

#RH-10C-IDE

This product can be used with any 3-1/2" IDE hard drive up to 1" high. It includes an electronic keylock for safe removal and insertion. Made of ABS 707 fire-proof plastic. Use this product to protect sensitive hard drive data. Take your hard drive between work and home or even set up different users with their own hard drives that they physically insert every time they use a PC. Other models available from C.S.I. include RH10 series and RH20 series, which are interchangeable within the same interface design (IDE or SCSI). Other Models are Available. See www.web-tronics.com under "hard drive and accessories" for more details and pictures.

Removeable Hard Drive Rack with Auto Door And Cooling Fan

ONLY \$18.95 any qty.

#MR-27

Auto door on the outer frame
ABS material of outer frame. High efficiency cooling fan
Worldwide patent pulling function handle
CE Approved
Coating iron bottom cover
For IDE interface
For 1" high 3.5" HDD
Not compatible with our RH10 & RH20 series
Compatible with our RH17-IDE model.

Details at www.web-tronics.com

2GHz RF Field Strength Analyzer

Frequency Range: 100KHz to 2,060MHz
Narrow Band FM (NFM), Wide Band FM (WFM), AM and Single Side Band (SSB) Modulated Signals May Be Measured
PLL Tuning System for Precise Frequency Measurement and Tuning
LED Backlight LCD (192x192 dots)
Built-In Frequency Counter
Hand-Held and Battery Operated
All Functions are Menu Selected
RS232C for PC Interface and Printer

ONLY \$1699

#3201

CTRL - D to bookmark this site

www.web-tronics.com

Don't forget the dash

Circuit Specialists Inc.

Easy to Navigate
Includes a Search Engine That Really Works
New Items Added Constantly

In Business Since 1971

CCD B&W Board Cameras

- ASIC CCD Area Image Sensor
- Extremely Low Power Consumption
- 0.5 Lux Min Illumination
- Built-In Electronic Auto Iris for Auto Light Compensation

VM1030PA-B 30mmx30mmx25mm, Pinhole lens, 12V \$39.00 any qty.
VM1030A 30mmx30mmx26mm, Standard lens, 12V \$39.00 any qty.
VM1035A 42mmx42mmx25mm, Standard lens, 12V with back light compensation \$49.00 any qty.
VMCB21 44mmx38.5mmx28mm, with 6 infra-red LEDs, 12V \$49.00 any qty.
VM1036A 32mmx32mmx25mm, Standard lens, 12V, reverse mirror image feature \$49.00 any qty.

Detailed Specs on the Web

LOWER PRICES

Mini CCDs (B/W & Color)
Sensational NEW Design for Small Observation Cameras. Smaller and Better!

- Ultra Miniature Design
- Black & White Versions Only 25mm x 25mm
- Color Versions Only 32mm x 32mm
- Available in Standard Lens or Pinhole Lens

All Include Pre-Wired Cable Harness for Video & Power
12V Regulated Power Supply Required (120mA typical power consumption)
0.1 LUX Rating (B/W), 1 LUX (color)
CCD Area Image Sensor for Long Camera Life
Back Light Compensation Circuit
Built-In Electronic Auto Iris Lens

VMCW-H11A 32mmx32mmx30mm, Color CCD with standard lens, pre-wired cabling, 12V DC Power \$139.00 / \$129.00 5 or more
VMCW-H12A 32mmx32mmx19mm, Color CCD with pinhole lens, pre-wired cabling, 12V DC Power Input \$139.00 / \$129.00 5 or more
VMPS-718A 25mmx25mmx30mm, B/W CCD with standard lens, pre-wired cabling, 12V DC Power Input \$59.00 / \$49.00 5 or more
VMPS-250A 25mmx25mmx15mm, B/W CCD with pinhole lens, pre-wired cabling, 12V DC Power Input \$59.00 / \$49.00 5 or more
VCC-3232 32mmx32mmx30mm, CMOS COLOR, std lens, see web for specs \$79.00 / \$72.00 5 or more

Detailed Specs on the Web

LOWER PRICES

Bullet CCD Cameras B&W and Color

- Smart Rugged Metal Housing
- Extremely Low Power Consumption
- 12 Volt
- CCD Area Image Sensor for Long Camera Life
- Built-In Electronic Auto Iris for Auto Light Compensation
- No Blooming, No Burning
- 0.1 Min Lux Illumination (B&W), 1 Lux Min Lux Illumination (color)

VMBL1020 B&W, 21mm(D)x58.5mm(L) \$54.00 any qty.
VMBL1020W B&W Weatherproof, 21mm(D)x58.5mm(L) \$79.00 any qty.
VMBL1020W COLOR Weatherproof, 17mm(D)x58mm(L) \$139.00 any qty.

Detailed Specs on the Web

LOWER PRICES

COLOR CCD Mini Board Cameras

- Low Power Consumption
- 1 Lux Illumination
- Internal Synchronization
- 12Volts
- 400 TV Lines
- Built-In Electronic Auto Iris for Auto Light Compensation

VM3010PA 33mmx33mmx18mm, Pinhole lens \$99.00 any qty.
VM3011-A 45mmx40mmx24mm, Standard lens, single board \$89.00 any qty.
VM3010-A 33mmx33mmx32mm, Standard lens \$99.00 any qty.

Detailed Specs on the Web

PRICE REDUCTION

DC to AC Power Inverters !

150 watt up to 3000 watt models !

150w modified sine wave: \$29.95(G-12-015B) **Industry Best Pricing!**
300w modified sine wave: \$39.95(G-12-030)
150w pure sine wave: \$69.00(G-12-150S)
300w pure sine wave: \$109.00(G-12-300S)
800w modified sine wave: \$139.00 (G-12-800)
1000w modified sine wave: \$179.00(G-12-1000)
3000w modified sine wave(phase corrected). (G-12-3000) \$489.00

See Our Website for DETAILED Specs.!

Bench Digital Multimeter w RS232C Interface

True RMS/AC voltage & current
Digital & Analog Display
3999 Counts & 42 Segment Bar graph
Autorange & Manual Range
Data Hold, Min/Max Relative Measurement
Storage Data Display/Recall
Back Light

ADP Measurement: 400mV +/- 3% 10 Digit / 1mV DC
Continuity Test **Only \$99.00!**
Diode Test
RS232C standard interface any qty.

AC or DC power
Extensive Details @ WEB SITE

Item# CS19803R

O'Scope Offer ONLY \$299

30MHz! ONLY \$299! **\$299**

Industries Best Price!
See web for specs

#OSC-1030

- Dual Channel
- Dual Trace
- Vert Trigger
- 1 Year C.S.I. Warranty!

Manufactured for CSI by a leading O.E.M. manufacturer. See our website for detailed specifications!

3000 Series Digital R/O Bench Power Supply

←Low Cost Single Output ←3 Amp **New Lower Prices!** **AS LOW AS \$85**

High stability digital read-out bench power supply featuring constant voltage and current outputs. Short-circuit protection and current limiting protection is provided. Highly accurate LED accuracy and stable line regulation make the 3000 series the perfect choice for lab and educational use.

Line Regulation: 2x10⁻⁴ +1ma
Load Regulation: 1 x 10⁻⁴ +5mv
LED Accuracy: Voltage ±1% +2 digits
Current ±1.5% +2 digits

Wave Line Noise: ≤1mVrms
Dimensions: 291mm x 158mm x 136mm

CSI3003: 0-30v/0-3amp Digital R/O Bench PS, 1x10⁻⁴+5mv Load Regulation \$89.00 5/\$85.00

CSI 5003: 0-50v/0-3 amp Digital R/O Bench PS, 1x10⁻⁴+5mv Load Regulation \$109.00 5/\$99.00

See our web-site for many other power supply deals

Our Most Sophisticated DMM We Sold Over 700 Last Year!

with RS-232 Interface & Software, 3-1/4 Digit, 4000 Count, Auto-Ranging with Analog Bargraph

- True RMS Mode
- 10MHz Frequency Counter
- Time Mode with Alarm
- Clock and Stop Watch
- Dual Display
- 10 Location Memory
- Min, Max, Avg and Relative Mode
- Decimal Measurement
- Cap and Ind. Measurement
- Temperature Mode (C/F)
- K Type Temperature Probe Included
- Pulse Signal for Logic & Audible Test
- Continuity/Diode Test
- Logic Test
- Auto Power OFF/ "Keep On" Mode
- Fused 20A Input with Warning Beeper
- Back Light
- Data Hold/Run Mode
- Safety Design UL1244 & VDE-0411
- Protective Holster
- Silicon Test Leads

NOW ONLY \$149 Reg. \$169

More Details on our Web Site

PROTEK 506

February 2002, Poptronics

MODERN ELECTRONICS

**CABLE TV
DESCRAMBLERS**



- ★ **FREE CATALOG!**
- ★ **BEST DEALER PRICING!**
- ★ **DISCOUNTED PRICING!**
- ★ **30 DAY FREE TRIAL!**
- ★ **100% MONEY BACK GUARANTEE**

**COPY RENTAL TAPES WITH
OUR VIDEO STABILIZER**

1-800-906-6664

2609 S. 156th Circle • Omaha, NE 68130
www.modernelectronics.com



The Pocket Programmer

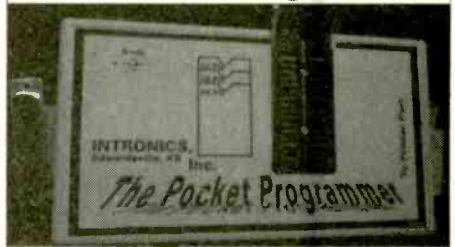

The Best just got Better!!!

The Best portable programmer that uses the printer port instead of an internal card just got Better!! Now with easier to use Windows based software that programs E(E)prom, Flash & Dallas parts. 25/27/28 & 29 series from 16K to 8Mbit. Adapters available for MCU's 874X, 875X, Pic, Atmel, PLCC packages, Bi-Prom's, 40-Pin X16 Eproms, Rom Emulator to 32K X 8 (2716-27256) and More...

Only \$149.95

Same Name, Address & Phone # for 19 Years.... Isn't it Amazing ?

Intronics, Inc.

Box 13723 / 612 Newton St.
Edwardsville, KS 66113
Tel. (913) 422-2094 Add \$7.00 COD
Fax (913) 441-1623 Add \$6.00 Shipping

WWW.IN-KS.COM Visa/MC/Amex/Disc

ORDERS: WWW.COMITEC.NET

**GALEP 4
UNIVERSAL
PROGRAMMER**

Introducing a pocket programmer with true **Universal Output**

**\$333
COMPLETE KIT**



Latest generation pocket sized programmer uses ASIC universal pin driver technology. 1300+ device library, with lifetime free updates. Programs 8/16-bit EPROM's, EEPROM's, 0-Power RAM, FLASH, Serial EEPROM's, GAL, PALCE,

microcontrollers such as 8789xxx, PIC, AVR, ST62, etc *. Low voltage devices down to 1.3V. No adapter required for DIL devices. 8 Hrs. operation on battery (AC charger included). Runs **WIN 98, NT, ME, 2000, XP** with Hex/Fuse Editor.

Remote control from other apps, (e.g. VisualBasic. Substitutes higher priced universal programmers e.g. ALL-11 (HILD) or LAB-T00L-48 (ADVANTECH) Providing virtually matching performance at only 1/3-1/5 the price. Info. / Orders, call: 619-702-4420

COMITEC DATASYSTEMS - 1951 4TH AVE, SUITE 301 - SAN DIEGO, CA 92101 - TEL: 619-702-4420 FAX: 619-702-4419

EZ-EP DEVICE PROGRAMMER - \$169.95

Check Web!! -- www.m2l.com

Fast - Programs 27C010 in 23 seconds

Portable - Connects to PC Parallel Port

Versatile - Programs 2716-080 plus EE and Flash (28F,29C) to 32 pins

Inexpensive - Best for less than \$200

- Correct implementation of manufacturer algorithms for fast, reliable programming.
- Easy to use menu based software has binary editor, read, verify, copy, etc. Free updates via bbs or web page.
- Full over current detection on all device power supplies protects against bad chips and reverse insertion.
- Broad support for additional devices using adapters listed below.

Available Adapters

EP-PIC (16C5x, 61, 62x, 71, 84)	\$49.95
EP-PIC64 (62-5, 72-4)	\$39.95
EP-PIC12 (12C50x)	\$39.95
EP-PIC17 (17C4x)	\$49.95
EP-51 (8751 C51)	\$39.95
EP-11E (68HC11 E/A)	\$59.95
EP-11D (68HC711D3)	\$39.95
EP-16 (16bit 40pin EPROMS)	\$49.95
EP-Z8 (Z86E02, 3, 4, 6, 7, 8)	\$39.95
EP-SEE2 (93x, 24x, 25x, 85x)	\$39.95
EP-750 (87C750, 1, 2)	\$59.95
EP-PEEL (ICT22v10, 18v8)	\$59.95
EP-1051 (89C1051, 2051)	\$39.95
EP-PLCC (PLCC EPROMs)	\$49.95
EP-SOIC (SOIC EPROMs)	\$49.95

Many Other Adapters Available

M²L Electronics

970/259-0555 Fax: 970/259-0777
250 CR 218 Durango, CO 81301.
CO orders add 7% sales tax
<http://www.m2l.com>

**EZ-EP
M²L ELECTRONICS**
Los Angeles, California



CLASSIFIEDS

BUSINESS OPPORTUNITIES

\$400 WEEKLY ASSEMBLING Electronic Circuit Boards/Products From Home. For Free Information Send SASE: Home Assembly-PT Box 216 New Britain, CT 06050-0216

CABLE TV

DESCRAMBLERMANIA! SAVE 80% ALL UNIVERSAL CABLE DESCRAMBLER CONVERTER MODELS! INDIVIDUAL AND BULK SALES! 1-800-246-0434 www.cableboxcentral.com

For Sale Unmodified Cable TV Converters all makes, models starting at \$35 in quantity. www.apexcabletv.com. Call 800-500-9825

MISC. ELECTRONICS FOR SALE

T&M ELECTRONICS. Large variety of electronic parts since 1966. Visit our Web site at www.tandmelectronics.com

PLANS-KITS-SCHEMATICS

Carl's Electronics - Hundreds of electronic kits, plus the latest in spy and surveillance. www.electronickits.com

WANTED

WANTED: Vacuum Tubes, Tube Amplifiers, Hickok or Military tube testers, Western Electric Items. Call Don (206) 989-3664. Leave message. tubegopher@hotmail.com

Poptronics, February 2002

HARMONY
A PARTNERSHIP WITH A HEALTHY LAND

The earth has always provided food, water, and all that we need. Today, as in the past, American Indians recognize the importance of keeping the earth healthy. Give back to the earth. Call for your free action packet.

1-800-THE-SOIL

United States Department of Agriculture
Natural Resources Conservation Service



Learn to use a Multimeter!

CIE's new Self-Paced Multimeter Course will show you how to make detailed measurements using a multimeter - even if you've never touched one before!

An electronics professional uses test instruments on a daily basis to troubleshoot and maintain various electronics equipment. None may be as important as knowing how to use a multimeter.

This new CIE micro course comes straight out of our Associate Degree program and teaches someone with no previous knowledge of multimeters the proper techniques of measuring resistance, voltage and current. This course comes equipped with both a powerful **DIGITAL and ANALOG** multimeter to use in the field for years to come.

CIE instructor assistance is available with this program so you never have to study alone and you earn a Certificate of Completion upon finishing.

In addition, this course includes an extra lab with 3 graded lessons on proper soldering techniques. Start with the basics and then move onto more advanced techniques. Learn how to inspect and repair solder joints using the included soldering iron with our easy to follow self-paced lessons.

Look at what you get!

- Digital Multimeter
- Analog Multimeter
- Soldering Iron
- 4 Graded Lessons
- Alarm Lab Kit
- Certificate of Completion

Lessons Covered for a Certificate of Completion:

- Using Your Multimeter to Measure Resistance - 5 experiments
- Working with Printed Circuit Boards - 3 experiments
- Reliable Soldering Techniques - 1 experiment
- Building a Siren with Flashing Light - 4 experiments

Learning Topics:

- How to use the Multimeter
- Multimeter Care
- Precautions
- Multimeter as an Ohmmeter
- Zeroing the Meter
- Measuring Wire Continuity
- Continuity Checks on Switches
- Measuring Lamp Continuity
- Measuring Resistance
- Resistance Scale and Ranges
- Learning the Resistor Color Code
- Marked & Measured Resistance
- Making Practical Resistance Measurements
- Measuring Resistors on a Circuit Board
- The Digital Multimeter
- Measuring Voltage
- Measuring Current
- Tools for Electronic Technicians
- Printed Circuit Boards
- Soldering to Printed Circuit Boards
- How to Repair Solder Joints
- Plus 15 more soldering topics



\$195

Course 02-069

Course includes these Student Privileges:

1. Instructor Assistance:

Use our toll-free Instructor Hot-line to access our faculty and staff if you ever need assistance with your course work. CIE's dedicated staff of instructors do more than just grade your exams; they help guide you, step-by-step, through your studies and hands-on training.

2. Priority Grading:

Exams will be graded and sent back to you within 24 hours.

3. Student Resources:

Upon enrolling, you'll receive a complimentary issue of our school newspaper "The Electron".

4. Certificate of Completion

A Certificate of Completion that's suitable for framing will be sent to you once you finish this course.

Cleveland Institute of Electronics - Bookstore
1776 E. 17th Street Cleveland, Ohio 44114
(800) 321-2155 www.ciebookstore.com

(\$15.75 shipping & handling. OH, CA & HI residents must add sales tax.)

**QUICK and PAINLESS
Programmable Robotics!**

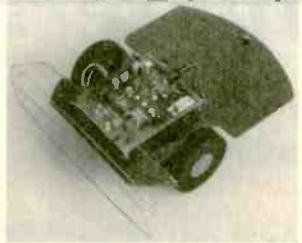

- COMES PRE-ASSEMBLED
 - PRICED LOWER THAN A KIT
 - Great Features & Expandability
 - Re-Programmable from your PC
- JUST ADD 6 AA BATTERIES AND GO!**

Blue Bell Design Inc.

www.bluebelldesign.com

PIC Programmer Kits

Super Value!
\$16.95 +S&H \$4.95
 The P16PRO can program up to 40 pin PICs including the popular 16F84 & 12C508 • Needs software (extra \$20) • Available assembled or starting from \$16.95 for the kit.

See www.electronics123.com for more info!
 The PICALL programmer can also program Atmel AVR's in addition to the PICs it can program • Free software • PICALL programmer kit at \$69.95
 See www.electronics123.com for more info!

Video Camera module Code:BB004

CMOS Camera Module, Black & White, Size: 0.63"x0.63"x0.59"H. Lens: f4.9, F2.8. EIA 320Hx240V. 0.6" DIL Package. 5 pins. Pin 3 is 1V p-p composite video (75 ohm) to monitor. \$36 + \$5 S&H

Running Lights kit Add \$6 for 8 triacs to drive light bulbs

8 LEDs with 10 push button selectable patterns. 8 speed levels! 80 combinations! \$16 + \$5 S&H

Toll Free: 1-888-549-3749 (USA & Canada)
 Tel: (330) 549-3726. Request a FREE catalog or visit us at www.electronics123.com for more products.
 Amazon Electronics, Box 21 Columbiana OH 44408

IC DEVICE PROGRAMMERS

LARGEST SELECTION OF PROGRAMMERS, ERASERS & EMULATORS
 WE ARE NEVER UNDERSOLD - FULL 30 DAY PRICE PROTECTION

PROGRAMMER SALES 800-760-3820

UNIVERSAL PROGRAMMERS

- 1195. ADVANTECH LABTOOL-48
- 895. NEEDHAMS EMP-30
- 869. EETOOLS TOPMAX
- 849. XELTEK SUPERPRO 680
- 849. XELTEK SUPERPRO 2000
- 649. ADVANTECH LABTOOL-148C
- 449. XELTEK SUPERPRO 280
- 419. NEEDHAMS EMP-20
- 419. EETOOLS MEGAMAX
- 379. XELTEK SUPERPRO LX
- 339. EETOOLS CHIPMAX

GANG PROGRAMMERS

- 299. NEEDHAMS EMP-11
- 2699. ADVANTECH LABTOOL-848 (8)
- 229. XELTEK SUPERPRO Z
- 1069. EETOOLS TOPMAX W/8 GANG
- 199. NEEDHAMS EMP-10
- 519. MEGAMAX 4G (4)

General Device Instruments

Sales (916) 393-1655 Fax (916) 392-4949

www.generaldevice.com

Top Secret Consumertronics
 In business 25+ years - established professionals
www.tsc-global.com

Exciting Hi-Tech Survival Books, Manuals, Tapes

- | | |
|--------------------------------|------------------------------|
| Stopping Power Meters \$29 | Polygraph Secrets \$29 |
| SPM Demo VHS Tape \$29 | Identity Theft Manual \$29 |
| KW-HR Meters \$29 | Credit Card Security \$29 |
| Gas & Water Security \$19 | Check & M.O. Security \$29 |
| Beyond Phone Color Boxes \$29 | ATM Manual \$39 |
| Cellphone/Cordless Guide \$49 | Mind Control \$29 |
| Pager (Beeper) Manual \$29 | Under Attack! \$29 |
| Caller ID & ANI Security \$29 | EM Brainblaster \$29 |
| Voice Mail Security \$29 | Radionics Manual \$29 |
| PBX Security \$25 | Heal Thyself! \$29 |
| Fax Machine Security \$29 | Ultimate Success Manual \$29 |
| Computer Security \$39 | Stealth Technology \$29 |
| Hacker Files (3 HD Disks) \$39 | High Voltage Devices \$29 |
| Social Engineering \$29 | Secret & Survival Radio \$29 |
| Cons & Scams Databook \$29 | Secrets Solderless BBS \$29 |
| Internet Security \$29 | The "Goldfinger" \$19 |
| Internet Frauds Databook \$29 | Casino Secrets \$29 |
| Internet Tracking/Tracing \$29 | Government Land Grab \$19 |
| Beyond Van Eck Tempest \$29 | Rockets Red Glare \$29 |
| Van Eck Demo VHS Tape \$29 | ...much more in Catalog! |
- Check, MO, VISA, MC - S/H: \$6 USPS, \$9 UPS or Canada
 Printed Catalog: \$1 with order, \$3 w/o (descriptions, policies)
Order Today 10% OFF! Consumertronics
 P.O. Box 23097, ABQ, NM 87192
 505-321-1034 Fax: 505-275-5637

PROGRAM PIC'S IN BASIC



MBASIC for PICmicro® MCU's

Ever wanted to learn how to program PICmicro MCUs? Now you can with easy to use BASIC. Our software is much simpler than C or Assembly. MBASIC for PICmicro MCUs creates a one click solution that allows you to experiment and test code changes on-the-fly! From beginner to professional, bring your projects to life quicker and easier with MBASIC for PICmicro MCUs!

New - In Circuit Graphical Debugger built in!
 Priced at \$99.95

Educational and dealer discounts available
 Order online or call 1-734-425-1744
 Basic Micro, 34391 Plymouth, Livonia, MI 48150
 See more online at <http://www.basclmicro.com>

CABLE BOX SUPPLIERS

**VISION MASTER PLUS
 W/UNIVERSAL FORMAT
 STABILIZERS PICTURE
 WORKS ANY SYSTEM!**

"DEALERS WELCOME"
 ★ LOW, LOW PRICING ★
1-888-777-9123
1-888-675-3687

microCommander.com

- View Control and Configure your micro over the Internet
- Drag and Drop embedded development tools included
- Build powerful applications with proven Components

X86 HC16 Z80

**Press-n-Peel
 Transfer Film
 PC Boards in Minutes**

1. LaserPrint*
2. Press On**
3. Peel Off
4. Etch



Use Standard Copper Clad Board
 20 Shts \$30/ 40 Shts \$50/ 100 Shts \$100
 VISA/MC/PO/CK/MO \$4 S&H/Foreign Add \$7

Techniks Inc.
 P.O. Box 463, Ringoes NJ 08551
 ph. 908.788.8249 fax 908.788.8837
www.techniks.com
 Visit Our E-Store On-Line!

Lone Star Consulting, Inc.

8900 Viscount, Suite 235
 El Paso, TX 79925
915-474-0334

Descriptions, Prices, Policies:
www.lonestartek.net

SPECIAL PROJECTS HARDWARE

Unique - Original - Made-to-Order - Special Needs
 Electronic - Computer - Phone - Energy - Security - Data
 Cards - RF - EM - Audio - Radionics - "Psychic" - Plans - more!
 Power Meters Educational Module ♦ KX Radar EmItter
 Lineman's Test Set ♦ Bug & Tap Detector & Blaster
 Shriek Module ♦ Stealth Paint "Elixer" ♦ Audio Assistor
 Multi-Use Magnetometer ♦ Omnimax Tens Stimulator
 Radionics Rife ♦ Neurophone Device ♦ Ultrasonic
 Stimulator ♦ Ultrasound Shrieker ♦ Ultrasonic Detector
 Harassing EMF Jammer ♦ EMF "Signature" Detector
 "Aura" Detector ♦ Super Conductor Detector ♦ Unseen/
 Unknown Presence Detector ♦ Subliminal Mixer/Amp
 Infrared Detector ♦ Secret Communicator ♦ Levitator
 Flash Blaster ♦ 6th. Sense Communicator - many more!
 ♦ TECHNICAL "LIFE COACHING" ♦ WEBSITE DESIGN SERVICES

AD
M
A
R
T

spyoutlet.com

Security • Surveillance • Loss Prevention

Purchase your video cameras from one of the largest importers in the U.S.

- NEW weatherproof Bullet Cameras
 - Spy Pinhole Cameras • Wireless Video
 - PC Cards • Voice Changer
 - Micro Recorders • Shotgun Mic
 - Locksmithing • Bug Detectors
 - NEW Phone Sentry Plus—defeats telephone tapping and taping
 - UV Pens & Powder • Realtime 12 hr Telephone Recording System
 - GPS Vehicle Tracking System
- And much more • Quantity discounts

www.spyoutlet.com

Printed Catalog send \$5⁰⁰

**SPY OUTLET 2468 NIA. FALLS BLVD
TONAWANDA NY 14150 (716) 695-8660**



Theremin
The PAIA Theremin uses the same heterodyne principles as the original turn of the century instrument for classic tone and adds features made possible by modern ICs. Shown with optional lectern case.

FatMan Analog MIDI Synth
A complete music synthesizer with all the big bottom and phat sound that makes analog famous. 20 knobs and controls for real-time sound sculpting. Compatible with standard MIDI sources like keyboards or computers. Desktop case or rack panel available.

Check out <http://Paia.com> for schematics, tech details, firmware source files and more...
Synthesizer Modules, Guitar Effects, Mixers, EQs, Tube PreAmps, and dozens of kits for **ELECTRONIC MUSICIANS**

PAIA Electronics info@paia.com
3200 Teakwood Lane 405.340.6300
Edmond, OK 73013 fax 405.340.6378

SMART CARDS

HIGHEST SECURITY

Complete system! Develop your own smart card applications in easy to use BASIC language



- Security Systems
- Time Cards
- Access Control
- Home, Auto, Business
- Robotics
- Data Security
- Emulation
- Theft Prevention

Smart Card Tool Kit comes complete with

- CyberMousee SmartCard Programmer
- Application Development Software
- Extensive User Manual in printed form
- 3 Blank Smart Cards

Complete system only \$79.95

We accept

VISA • Mastercard • American Express

To Order Call 1-800-773-6698 Worldwyde.Com,
33523 Eight Mile Rd # A3-261, Livonia, MI 48152
See more online at <http://www.worldwyde.com>

CABLE SECRETS!!!

Build your OWN cable box "test" devices!

Why pay \$100.00 or more for a "test" device that someone else made? Make your own! Includes complete source code and plans for the most commonly used cable boxes. Unlock all of the channels on your box!

Or start your own lucrative business!

Complete source code \$79.95
Code for individual boxes \$29.95

DSS SECRETS — Vol. 2

Step-by-step instructions on programming your own DSS access card. Unlock all channels on your own card! This is the most current information on the market! Includes software, plans, and hardware sources. Book & CD-ROM.

DSS Secrets Vol. 2 \$49.95

VISA • MasterCard • American Express

To order, call Worldwyde @ 1-800-773-6698
33523 Eight Mile Rd. #A3-261 • Livonia, MI 48152
Visit us on the web at www.worldwyde.com

A D M A R T

Solar Panels

160 mW / Sun 8 Cells

200pc \$2.⁰⁰ ea 2Kpc \$1.⁸⁰ ea 20Kpc \$1.⁷¹ ea 200Kpc \$0.⁸⁵ ea

Battery Holders

AA Singles, and Dual Side by Side

200pc \$0.⁴⁰ ea 2Kpc \$0.³⁶ ea 20Kpc \$0.³⁴ ea 200Kpc \$0.¹⁷ ea

LED's

High Intensity HPWT-DL00
Similar to Lumex type SSL-LX30448SYC

200pc \$0.⁵⁰ ea 2Kpc \$0.⁴⁵ ea 20Kpc \$0.⁴³ ea 200Kpc \$0.²¹ ea

Call 1-847-612-2739

Scrambling News

915 NW First Ave., Suite 2902,
Miami FL, 33136, 305-372-9427

Pay TV and Satellite Descrambling 2002 - New! - satellite and cable. Includes the latest information. \$19.95 plus \$1.75 shipping.

Hacking Digital Satellite Systems Video 2002 - New! - This 90 minute video focuses on the satellite television piracy business. \$29.95 plus \$ 3.50 shipping.

Scrambling News Online - Online service for those interested in satellite television news. \$59.95/year.

Pay TV and Satellite Descrambling Series CD-ROM - all 13 volumes over 300 pages, \$59.95 plus \$3.50 shipping.

Best Deal - Everything listed above for only \$99.95 plus \$3.50 shipping.

www.scramblingnews.com

SUPREME SURVEILLANCE

JUST PUBLISHED! The **EXTREME** Covert Catalog details virtually every surveillance system on the World Market today. From the FBI (and their superiors) latest anti-terrorist phone/computer/and video taps, to bargain basement devices no one knows about.

Complete specs and ordering information on hundreds of surveillance and investigative hardware and software products from 14 countries. Many, many new entries for covert audio and video supplies, computer busters, thru-wall viewers, night vision gear, fax interceptors, CIA designed lock defeaters, etc.

"Absolutely fantastic! A Tachie's dream come true. No fluff, no filler, just raw spy meat. Whata meal" - Kevin Murray, probably the top counter surveillance expert in the U.S. ECC, 8 1/2" x 11", ISBN 1-880-231-20-4, 437 pages, index. \$49.95

Intelligence Here
404 N. Mt. Shasta Blvd.
Mt. Shasta, CA 96067
Order by Phone: 866-885-8855
www.intelligencehere.com



Add \$8.00 (priority shipping). CA residents add 8% tax

PICMICRO TOOLS



ISP-PRO 3.0 All-in-one Programmer

- Uses PC Serial port (USB w/ adapter)
- Very Simple to use
- Free Software updates
- Complete with Windows IDE!
- Easy in-circuit programming
- Supports PIC, Schemix, EPIC and more!
- Firmware upgradable!
- RJ-11 / 10 Pin Header
- Includes RJ-11 Cable

Optional Items Available:
- Plastic Enclosure Scalable
- 30 Pin ZIF Adapter All-in-one
- Universal Adapter

All for
\$59.95 Complete

Solderless Development Boards

Develop your projects the easy way

- Completely Assembled Board
- In-Circuit Programmable (ICP)
- Solderless Bread Board
- Built in RS232 (w/ Max232)
- Built in Power Connector
- Removable Oscillator
- Documentation
- auto-disconnects for RB3, RB6, & RB7
- Available in several models

Starting at \$49.95

Join our online PIC forums
tons of information and help **FREE!!!**
VISA • MasterCard • American Express
Order Online or Call 1-734-425-1744
Basic Micro, 34391 Plymouth, Livonia, MI 48150
See more online at <http://www.basicmicro.com>

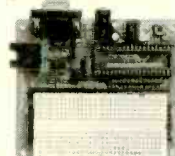

PICmicro MCU Development Tools



**EPIC Plus
PICmicro Programmer
\$59.95**

Program PICmicro MCUs in BASIC!
DOS or Windows operation (Includes Windows IDE software).
PicBasic Compiler - \$99.95
PicBasic Pro Compiler - \$249.95

Experimenter Boards

LAB-X1 for 40-pin MCUs (shown) - \$199.95
LAB-X2 for 28 or 40-pin MCUs - \$69.95
LAB-X3 for 18-pin MCUs - \$119.95

PICProto Prototyping Boards
\$8.95 to \$19.95
High-quality blank prototyping boards for PICmicro MCUs.

microEngineering Labs, Inc.



www.melabs.com

Phone: (719) 520-5323

Fax: (719) 520-1867



Box 60039, Colorado Springs, CO 80960

February 2002, Poptronics

Stepper Motor Book



Easy Step'n

- For the experimenter.
- Determine surplus stepper motor specs using simple easy to build test equipment.
- Build microcontroller-based control systems (flow charts and code examples).
- Build stepper motor drive circuits.
- Mechanical design considerations.
- 8.5x11 format. 205 pages. \$34.95

Table Of Contents: <http://www.stepperstuff.com>
 + \$5 s/h in US. VISA, MC, AM, DS, MO. Check
 CA residents please add 7% CA sales tax

SQUARE 1 ELECTRONICS

P.O. Box 501, Kelseyville, CA 95451
 Voice (707) 279-8881 Fax (707) 279-8883

<http://www.stepperstuff.com>



Visit our Website
www.blkfeather.com

- ▶ 4400 S. Robinson Avenue
- ▶ Oklahoma City, OK 73109
- ▶ FAX: (405) 616-9603
- ▶ Email: blkfea@aol.com

Or call & order today:
1-405-616-0374

PCB Production

Double side—12¢ per in²
 Four layers—20¢ in²
 Six layers—32¢ in²
 UL approved
 (with solder mask, Silkscreen
 Three weeks)

FREE Quote for 8-12L
 PCB & membrane switch
MYLYDIA INC.

Call 626-292-2686
 Fax: 626-292-2689
 E-mail: tj2@ix.netcom.com

While speeding treatments and cures for neuromuscular disorders, advances made by MDA researchers also have enhanced therapy prospects for heart disease, cancer, arthritis, Alzheimer's and AIDS.

Giving to MDA makes a world of difference.



MUSCULAR DYSTROPHY
 ASSOCIATION
 (800) 572-1717

RF Modules

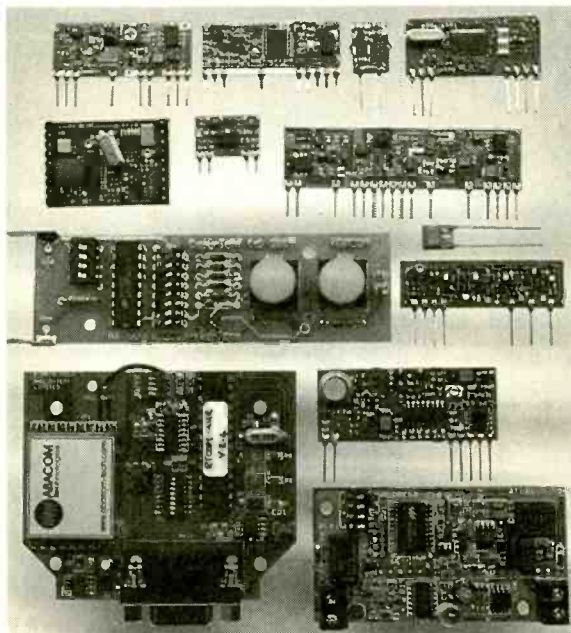

www.abacom-tech.com



Tel: +1(416)236 3858
 Fax: +1(416)236 8886
abacom@abacom-tech.com

Microprocessor Hands-On Training

The PRIMER Trainer is a flexible instructional tool featured in a Prentice Hall textbook and used by colleges and universities around the world. Ruggedly designed to resist wear, the PRIMER supports several different programming Languages including Assembler, Machine Language, C, BASIC, and FORTH. A comprehensive Instruction Manual contains over 25 lessons with several examples of program design and hardware control. The Applications Manual provides theory and sample code for a number of hands-on lab projects.

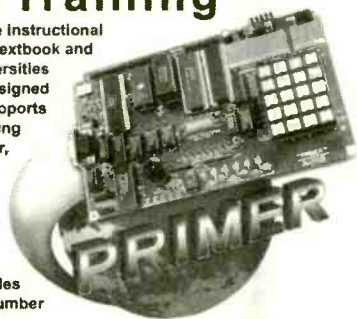

Application Projects Include:

- Scan Keypad Input & Write to a Display
- Detect Light Levels with a Photocell
- Control Motor Speed using Back EMF
- Design a Waveform Generator
- Measure Temperature
- Program EPROMs
- Bus Interface an 8255 PPI
- Construct a Capacitance Meter
- Interface and Control Stepper Motors
- Design a DTMF Autodialer / Remote Controller

The PRIMER can be purchased as an unassembled kit (\$120) or as an assembled/tested kit (\$170). Upgrades provide battery-backed RAM and PC connectivity via an RS232 serial port (shown in picture). Additional options include a heavy-duty keypad (shown in picture) and a 9V power supply - see our website. Quantity discounts are available. Satisfaction guaranteed.

Since 1985
 OVER
16
 YEARS OF
 SINGLE BOARD
 SOLUTIONS

EMAC, inc.

Phone 618-529-4525 Fax 618-457-0110
 2390 EMAC Way, Carbondale, Illinois 62901
 World Wide Web: <http://www.emacinc.com>

Gernsback Publications, Inc.

275-G Marcus Blvd. Hauppauge NY 11788

POPTRONICS® CLASSIFIED ADVERTISING ORDER FORM

Advertiser Information

Name _____
 Company _____
 Street Address _____
 City/State/Zip _____
 Telephone () _____
 Signature (required on all orders) _____

Payment Information

Charge my:
 Master Card Visa Discover
 Account No. _____
 Exp. Date _____
 Full payment enclosed. Prepayment discounts offered for multiple insertions (except on credit card orders).
 Payment for first insertion enclose; additional payments will be made prior to closing dates. Prepayment discounts not available.

Do you want any special options? (where available)

Boldface Type* Add 25% for entire ad Screened Background – Add 30%
 Special Heading – Add \$35.00

The first word of your ad and your name will be printed in boldface caps, at no additional charge. For individual boldface words, add .50¢ each.

In what month(s) would you like your ad to run?

Entire year for publications selected above.
 Jan. Feb. Mar. Apr. May. June July Aug. Sep. Oct. Nov. Dec.

Here's how to calculate the cost of your Regular or Expanded-Ad Classified:

Rate X Numbers of Words + Rate for Boldface + Rate for Screened Background = Cost per Insertion X Number of Months = Cost

Magazine	Rate	x	Number of Words (min. 15)	+ Boldface (add 25%)	+ Screened Background (add 30%)	=	Cost Per Insertion	x	Number of Months	=	Cost		
_____	_____	x	_____	_____	_____	+	_____	=	_____	x	_____	=	_____

Rates:

\$3.50 per word

Minimum 15 Words

Here's how to calculate the total cost of your advertising:

Prepayment Discount:

(Full payment must accompany order, not applicable on credit card orders)

Prepay for 6 insertions in one magazine, 5% 12 insertions in one magazine, 10%

Subtotal _____
 Less Prepayment Discount _____
TOTAL COST \$ _____

Please use a separate piece of paper to write your copy, or for any special instructions you may have.

HAVE A QUESTION? CALL: 1-631-592-6720 ext. 206

Fax signed orders with credit card information to : (631) 592-6723

GPI895

ADVERTISING INDEX

Poptronics does not assume any responsibility for errors that may appear in the index below.

Free Information Number	Page	Free Information Number	Page
- Abacom78	- IVEX Design65
- Active Electronic72	- LT Sound68
- All Electronics62	- Lone Star Consulting, Inc.76
- Amazon Electronics76	- Lynxmotion68
- Arrow Technologies62	- M ² L Electronics74
- Basic Micro Inc.66, 76, 77	323 Mendelsons62
- Black Feather Electronics78	296 Merrimack Valley Systems60
- Blue Bell Design, Inc.76	- microEngineering Labs77
290 C&S Sales, Inc.69	- Modern Electronics74
283 CadSoft, Inc.15	- MyLydia, Inc.78
- Carl Taylor Inc.76	- North Country Radio64
233 Circuit Specialists73	- PAiA Electronics77
- CLAGGK, Inc.CV3	275 Parts ExpressCV2
320 Cleveland Inst. of Electronics ..	.63, 75	- Pioneer Hill Software62
321 Command Productions66	228 Polaris Industries59
- Conitec Data Systems74	219 Prairie Digital61
- Consumertronics76	- Progressive Concepts68
- Designtech Engineering Co.61	263 Ramsey Electronics67
- EDE Spy Outlet77	256 RobotiKits Direct64
- Elect. Tech. Today46	- School of Electronics68
130 Electronic WorkbenchCV4	- Scott Edwards Electronics72
- Electronix68	- Scrambling News77
206 Electronix Express70	- Smarthome.com72
- EMAC Inc.78	- Square 1 Electronics66, 78
- Engineering Express71	- Techniks76
- General Device Inst.76	- Technological Arts68
- Global Specialties61	322 Test Equipment Depot71
220 Information Unlimited70	- UCANDO Videos71
- Intec Automation76	- Vision Electronics68
- Intelligence Here77	- Walter Malecki76
- Intronics74	- World Wyde77

ADVERTISING SALES OFFICES

Gernsback Publications, Inc.
275-G Marcus Blvd.
Hauppauge, NY 11788
Tel. 631-592-6720
Fax: 631-592-6723

Larry Steckler
 Publisher (ext. 201)
 e-mail: advertising@gernsback.com

Adria Coren
 Vice-President (ext. 208)

Ken Coren
 Vice-President (ext. 267)

Marie Falcon
 Advertising Director (ext. 206)

Adria Coren
 Credit Manager (ext. 208)

For Advertising ONLY EAST/SOUTHEAST

Marie Falcon
 275-G Marcus Blvd.
 Hauppauge, NY 11788
 Tel. 631-592-6720 x206
 Fax: 631-592-6723
 e-mail: mfalcon@gernsback.com

MIDWEST/Texas/Arkansas/ Oklahoma

Ralph Bergen
 One Northfield Plaza, Suite 300
 Northfield, IL 60093-1214
 Tel. 847-559-0555
 Fax: 847-559-0562
 e-mail: bergenrj@aol.com

PACIFIC COAST

Megan Mitchell
 9072 Lawton Pine Avenue
 Las Vegas, NV 89129-7044
 Tel. 702-240-0184
 Fax: 702-838-6924
 e-mail: mmitchell@gernsback.com

**Subscription/
 Customer Service/
 Order Entry**
 Tel. 800-827-0383
 7:30 AM - 8:30 PM CST

www.poptronics.com

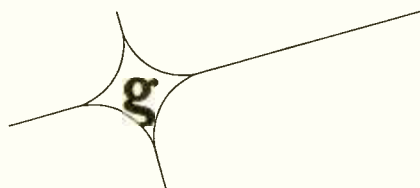

**When you buy products from
 these advertisers, please tell
 them you saw their ads in
 Poptronics® magazine.**

CD ROM based resources for learning and designing

The internationally renowned series of CD ROMs from Matrix Multimedia has been designed to both improve your circuit design skills and to also provide you with sets of tools to actually help you design the circuits themselves.

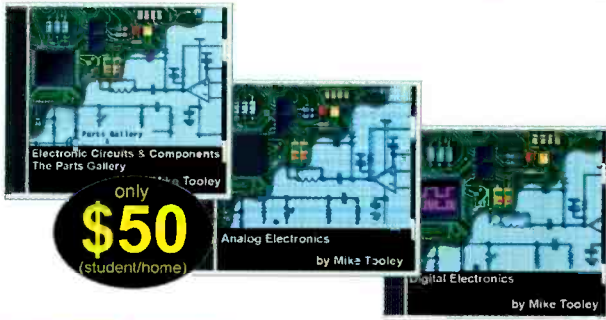

only
\$50
(student/home)

Electronic Circuits and Components provides an introduction to the principles and application of the most common types of electronic components and how they are used to form complete circuits. Sections on the disc include: fundamental electronic theory, active components, passive components, analogue circuits and digital circuits.

The **Parts Gallery** has been designed to overcome the problem of component and symbol recognition. The CD will help students to recognize common electronic components and their corresponding symbols in circuit diagrams. Quizzes are included.

Digital Electronics details the principles and practice of digital electronics, including logic gates, combinational and sequential logic circuits, clocks, counters, shift registers, and displays. The CD ROM also provides an introduction to microprocessor based systems.

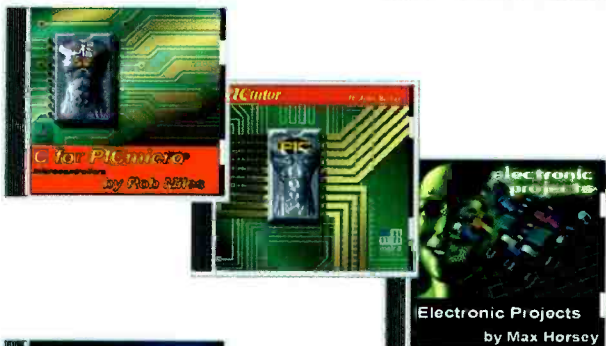

Analog Electronics is a complete learning resource for this most difficult subject. The CD ROM includes the usual wealth of virtual laboratories as well as an electronic circuit simulator with over 50 pre-designed analog circuits which gives you the ultimate learning tool. The CD provides comprehensive coverage of analog fundamentals, transistor circuit design, op-amps, filters, oscillators, and other analog systems.

Electronic Projects is just that: a series of ten projects for students to build with all support information. The CD is designed to provide a set of projects which will complement students' work on the other 3 CDs in the Electronics Education Series. Each project on the CD is supplied with schematic diagrams, circuit and PCB layout files, component lists and comprehensive circuit explanations.



PICtutor and C for PICmicro microcontrollers both contain complete sets of tutorials for programming the PICmicro series of microcontrollers in assembly language and C respectively. Both CD ROMs contain programs that allow you to convert your code into hex and then download it (via printer port) into a PIC16F84. The accompanying development board provides an unrivaled platform for learning about PIC microcontrollers and for further development work.

Digital Works is a highly interactive scalable digital logic simulator designed to allow electronics and computer science students to build complex digital logic circuits incorporating circuit macros, 4000 and 74 series logic.

CADPACK includes software for schematic capture, circuit simulation, and PCB design and is capable of producing industrial quality schematics and circuit board layouts. CADPACK includes unique circuit design and animation/simulation that will help your students understand the basic operation of many circuits.

Analog Filters is a complete course in filter design and synthesis and contains expert systems to assist in designing active and passive filters.

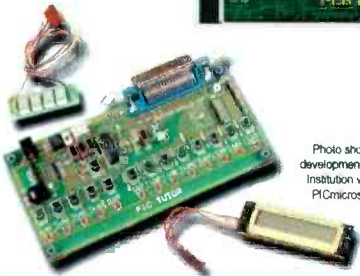

Photo shows PICmicro development kit supplied with Institution versions of C for PICmicro and PICtutor

Shareware/demo CD ROM with more than 20 programs \$4.99 refundable with any purchase.

Order Form:

Please circle the products you would like to buy on the table below, calculate the total cost, fill in the rest of the order form and send it to us. NY residents add sales tax. Please allow 6 weeks for delivery.

	Student	Institution
Electronic Cts. & Comps.	\$50	\$99
Digital Electronics	\$50	\$99
Analog Electronics	\$50	\$99
Electronic Projects	\$75	\$159
PICtutor	\$179	\$350
C for PICmicro	\$179	\$350
Digital Works	\$50	\$99
CADPACK	\$75	\$159
Analog Filters	\$75	\$159
Postage - USA	\$5	\$5
Postage - Canada	\$5	\$5

Name: _____

Address: _____

Zip: _____ Phone: _____

Card Type: _____

Mastercard, Visa, or Discover only

Card number:

I have enclosed my check for \$: _____

Signature: _____

Please charge my credit card for \$: _____

Phone your order to us on:

631-592-6721

or send your order to:

CLAGGK Inc.
PO Box 12162
Hauppauge, NY 11788

Expire date:

CL02

Order online NOW from: www.poptronics.com

Working on your next masterpiece?

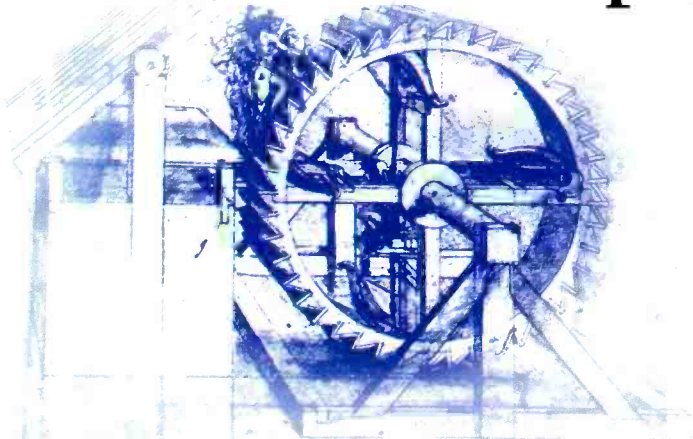

It's time for new tools.

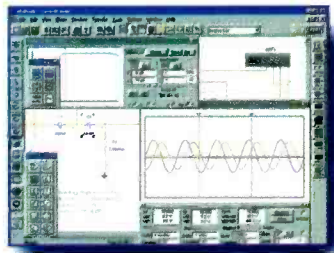

multiSIM 2001 from \$399

SCHMATIC CAPTURE, SIMULATION & PROGRAMMABLE LOGIC

- ▶ Advanced modeless schematic capture
 - ▶ Library of 16,000 parts supplied, with 12 million online
 - ▶ Analog, digital and mixed-mode simulation
 - ▶ Patented co-simulation of SPICE, VHDL and Verilog
 - ▶ Suite of "virtual instruments" including oscilloscope, wattmeter, spectrum analyzer & network analyzer
 - ▶ Design collaboration across the Internet

ultiBOARD 2001 from \$399

POWERFUL PCB LAYOUT

- ▶ Powerful & easy-to-use PCB layout & editing
 - ▶ Reroute while move (full rubberbanding)
 - ▶ 3D board visualization
 - ▶ Real-time design rule check
 - ▶ Component push & shove with springback
 - ▶ Extensive copper placement capabilities



ultiROUTE from \$399

AUTOROUTING & AUTOPLACEMENT

- ▶ Benchmark test leader with superior routing results
 - ▶ Combination of grid-based/gridless routing available
 - ▶ Highly flexible router provides complete control
 - ▶ Optimal part placement improves routing performance
 - ▶ Supports manual wire pre-placement
 - ▶ Pin and gate swap

CIRCLE 130 ON FREE INFORMATION CARD

commsIM 2001 from \$399

NETWORK & COMMUNICATIONS SIMULATION

- ▶ Powerful, yet easy-to-use fast, accurate simulation tool
 - ▶ Model & simulate end-to-end communications systems
 - ▶ Analog, digital & mixed system design capability
 - ▶ Industry-leading block libraries — channels, encoders/decoders, modulators/demodulators
 - ▶ View simulation results in various methods
 - time domain, frequency domain, xy plots, log scale, eye diagrams and power spectra

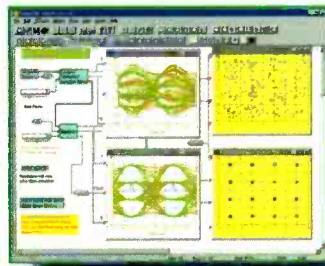

Electronics WORKBENCH

*The World's Most Popular
Electronic Design Tools*

Electronics Workbench products are used by more designers than any other software of their kind. They will help you reduce development times and produce higher quality circuits — We guarantee it, or your money back!

We offer a portfolio of products to meet all your design needs: Schematic Capture, Component Database, SPICE/VHDL/Verilog HDL/RF Simulation, PCB Layout, Autoplacement, Autorouting and now Network & Communications Simulation.

Ease-of-use continues to be one of our biggest strengths, letting you produce designs in the time it takes to install and configure most other programs.

Our unique combination of power and unrivaled ease-of-use allows us to offer this guarantee. Power means you get capabilities simply not available elsewhere, such as patented co-simulation of SPICE/VHDL/Verilog/RF all together.

That's why we are the EDA supplier of choice to over 150,000 users worldwide.

****FREE Virtual Lab with Poptronics Circuits!**

Check out the circuits from recent issues, including this month's! Tweak the circuits and see the instruments respond instantly. Download the Multisim demo with pre-built Poptronics circuits from www.electronicworkbench.com/poptronics

sales: 800.263.5552 • <http://www.electronicworkbench.com>