

Great Gift Ideas

MCM

What You Want....
Today!™

25th
year

You Must Provide this
Source Code to Receive
Discount Pricing

POP92

call toll free

1-800-543-4330

fax toll free

1-800-765-6960

customer service call toll free

1-877-626-3532

www.mcmelectronics.com

Visit our website
for other
gift ideas.

- Audio Products
- Books
- Cameras
- Car Audio and Security
- Computer Accessories
- Games
- Headphones
- Home Theater
- Joysticks
- Personal Electronics
- Radios
- Receivers
- Test Equipment
- Tools
- Tool Boxes/Cases
- More

For Someone Else
or Yourself.



Laser Leveler

- High output, high precision laser projects a 1/4" round dot up to 1,500 feet away
- Ideal for sight alignments over long distances
- Match heights in large rooms or across buildings
- Align speakers, cabinets, shelving, and electrical fixtures
- Locking on/off button allows for hands-free operation
- Operates on two "AAA" batteries included

Order # 22-4145 Reg. \$49.95

Only!
\$29.95

USB PenCam® Digital Color Camera

This pocket-sized camera functions as a PC camera, digital camera and a digital camcorder.

Includes 6' USB cable, desktop stand and multiple software programs for video and photo editing, video conferencing, video mail and camera configuration. **Specifications:** • 16Mb memory (20 pictures CIF with resolution of 352 x 288, 80 QCIF with resolution of 176 x 144) • 10 second self timer • 5.2mm effective focal length • Dimensions: 4.75" x 1" x .75" • Powered by the USB port when connected or requires two "AAA" batteries (not included) for portable use • Requires 200MHz processor, Windows 98, 32Mb RAM, video card with 2Mb RAM, CD-ROM drive and USB port

Order # 83-8554 Reg. \$89.95

Only!
\$69.95



MCM CUSTOM AUDIO 4" LCD Color Monitor Module

- Put color video anywhere
- Accepts standard composite video input
- Requires 12VDC, 500mA

Order # 60-9855 Reg. \$109.00

Only!
\$98.00



ELENCO Radio Controlled Car Kit

Expand your understanding of basic transmitters, receivers and electronic switching theories. Your Turbo King Car will be built from the ground up. Learn about gears, motors, printed circuit boards and integrated circuits. The completed car features seven remote functions, flashing top light and single channel operation. The remote control is included. Requires four "AA" and one 9V battery (not included). • Mfr. #RCC7K

Order # 80-4415 Reg. \$32.29

Only!
\$27.95



Multi Voltage Regulated Power Supply

- Ideal for any device drawing up to 2A
- Fully regulated to deliver constant DC power
- Rotary selector switch selects 3, 4½, 6, 7½, 9 and 12V
- Power projects or small battery operated devices
- Color coded binding posts make connection easy

Order # 28-2200 Reg. \$16.95

Only!
\$9.99



ZENITH Remote Control Signal Sender

- The extension unit senses Infrared signals from your remote control and converts them to radio frequency for communication with the base unit
- Base unit receives the radio frequency transmissions and converts the RF signals back to infrared signals to control your component
- Controls anything operated by infrared remote control
- Mfr. Zenith
- Suggested list \$59.95
- Limited quantities

Order #	(1-9)	(10-up)
58-6850	\$26.95	\$22.95

Source Code: POP92

Prices effective November 1 through February 2, 2002.

A Premier Farnell Company

CIRCLE 324 ON FREE INFORMATION CARD

Poptronics®

THE MAGAZINE FOR THE HANDS-ON ELECTRONICS ACTIVIST!

FEATURES

THE ELECTRONIC MOUSE TRAPJurgen Bauer 29
A new twist on a classic, this trap uses optical sensors to nab rodents.

PRODUCT REVIEWS

GIZMO® 7
The latest in consumer electronics—from MP3-camera combos to digital travel planners.

DEPARTMENTS

PROTOTYPE 12
Enjoy a glimpse into the role of ultracapacitors, and the Z-Beamlet laser.

TECHNOSCOPEElizabeth Jamison 21
From holodecks to phasers, Star Trek technology is coming of age.

SURVEYING THE DIGITAL DOMAINReid Goldsborough 25
Is the quality of the Internet declining, as fees for Web services are on the rise?

PEAK COMPUTINGTed Needleman 27
The appearance of MP3-components for entertainment is a sign of the times.

Q&ADean Huster 39
The mystery of the S-video cable is revealed.

AMAZING SCIENCEJohn Iovine 42
A how-to lesson on constructing a hexapod walker.

ROBOTICS WORKSHOPScott M. Savage 47
A robot's first steps: tracking the wall with an OOPIC.

SERVICE CLINICSam Goldwasser 55
Read this cannibal's guide to supermarket scanners.

BASIC CIRCUITRYCharles Rakes 51
You guessed it...battery-testing circuits!

TEST YOUR KNOWLEDGE 59
Have fun while you learn some important laws of electronics and physics.

AND MORE

EDITORIAL2
LETTERS3
NEW GEAR5
NEW LITERATURE11

YESTERDAY'S NEWS16
POPTRONICS SHOPPER65
ADVERTISING INDEX90
FREE INFORMATION CARD90A

Poptronics (ISSN 1526-3681) Published monthly by Gernsback Publications, Inc. 275-G Marcus Blvd., Hauppauge, NY 11788. Second-Class postage paid at Hauppauge, NY and at additional mailing offices. One-year, twelve issues, subscription rate U.S. and possessions \$24.99, Canada \$33.15 (includes G.S.T. Canadian Goods and Services Tax Registration No. R125166280), all other countries \$33.99. Subscription orders payable in U.S. funds only. International Postal Money Order or check drawn on a U.S. bank. U.S. single copy price \$4.99. Copyright 2001 by Gernsback Publications, Inc. All rights reserved. Hands-on Electronics and Gizmo trademarks are registered in U.S. and Canada by Gernsback Publications, Inc. Poptronics trademark is registered in U.S. and Canada by Poptronix, Inc. and is licensed to Gernsback Publications, Inc. Printed in U.S.A. Postmaster: Please send address changes to Poptronics, Subscription Dept., P.O. Box 459, Mount Morris, IL 61054-7629.

A stamped self-addressed envelope must accompany all submitted manuscripts and/or artwork or photographs if their return is desired should they be rejected. We disclaim any responsibility for the loss or damage of manuscripts and/or artwork or photographs while in our possession or otherwise.

As a service to readers, Poptronics publishes available plans or information relating to newsworthy products, techniques, and scientific and technological developments. Because of possible variances in the quality and condition of materials and workmanship used by readers, Poptronics disclaims any responsibility for the safe and proper functioning of reader-built projects based upon or from plans or information published in this magazine.

Larry Steckler, EHF, CET,
editor-in-chief and publisher

EDITORIAL DEPARTMENT

Chris La Morte, managing editor
Evelyn Rose, assistant editor

CONTRIBUTING EDITORS

Reid Goldsborough
Sam Goldwasser
Dean Huster
John Iovine
Elizabeth Jamison
Ted Needleman
Charles D. Rakes
Scott M. Savage
Teri Scaduto

PRODUCTION DEPARTMENT

Ken Coren, production director
Kathy Campbell, production manager
Michele L. Musé, prepress specialist

ART DEPARTMENT

Russell C. Truelson, art director
Michele L. Musé, graphic artist

CIRCULATION DEPARTMENT

Gina Giuliano, circulation manager

REPRINT DEPARTMENT

Maria Menichetti, Reprint Bookstore x235

BUSINESS AND EDITORIAL OFFICES

Gernsback Publications, Inc.
275-G Marcus Blvd.
Hauppauge, NY 11788
631-592-6720
Fax: 631-592-6723

President: Larry Steckler
Vice-President: Adria Coren
Vice-President: Ken Coren

SUBSCRIPTION CUSTOMER SERVICE/ ORDER ENTRY

800-827-0383
7:30 AM - 8:30 PM EST

Advertising Sales Offices
listed on page 90

Cover by
Michele Lyn Musé

VISIT US ON THE INTERNET AT:
www.gernsback.com
or www.poptronics.com

Since some of the equipment and circuitry described in POPTRONICS may relate to or be covered by U.S. patents, POPTRONICS disclaims any liability for the infringement of such patents by the making, using, or selling of such equipment or circuitry, and suggests that anyone interested in such projects consult a patent attorney.

mailto: popeditor@gernsback.com

In Our Thoughts and Prayers

December's issue has been in production since September 8th. The disastrous destruction of the Twin Towers on September 11th has hit home, so to speak. The office of Gernsback Publications, Inc. is located on Long Island and is approximately forty miles from the island of Manhattan. The entire staff of **Poptronics** would like to offer their condolences for all those who have suffered—either directly or indirectly—from the tragedies in Pennsylvania, D.C., and Manhattan. Our hearts especially go out to fellow New Yorkers who are in the process of recovering from these acts of terror. No one shall ever succeed in tarnishing the magnificence and style that is New York City. Thank you for the letters of sympathy and support that have been arriving from our readers from across the globe.

Sincerely,



Chris La Morte
Managing Editor

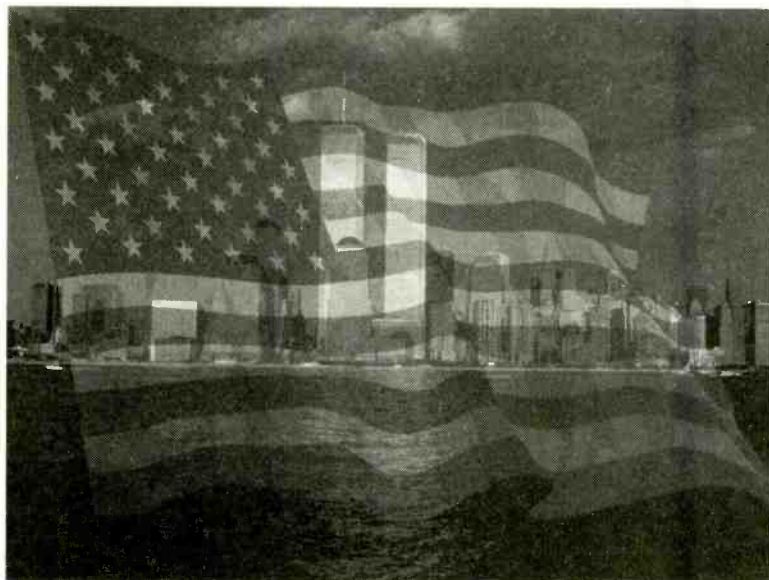

MPX 2000 Correction

In a piece as complex as “The MPX 2000” article in the July issue, there are bound to be some errors. While looking over the schematic on page 30 (mainly to see how the authors implemented their PLL unlock detector), I noticed a few minor mistakes:

- There should be a ground connection at the junction of R112 and C47.
- Transistor symbols for Q6 and Q3 should be PNP types.
- Transistor Q9 is not labeled (2N3866 RF output transistor)

C47 needs no polarity indication, but C9 should have one.

Given the complexity of this circuit and publishing pressures, it is understandable that perfection isn’t always possible. We hobbyists should all keep learning though, so when something is amiss in an article we can at least recognize that there is a problem and possibly be able to correct it as well.

I really enjoy *Poptronics* and have been a reader (including its predecessor magazines) since the 50s.

KEITH A. KUNDE, K8KK
Independence, OH

P.S. The scanned PCB images in that article are “el stinko”—don’t you agree?

Thanks for your understanding and for taking the time to write about these corrections. Other corrections for this article have already been printed in the August issue. We appreciate your keen eye and your attitude; want to come work with us??—Editor

Pumpkin Safety Light Correction

Fig. 1 shows the corrections to the schematic for “The Pumpkin Safety Light.” The schematic has pins 6, 7, and 8 tied together with the anode and cathode of D1 shorted out. It should have CH1 going to the anode of D1 and pin 6 of $\mu 1$. Also, pins 7 and 8 of U2 are connected together and connected to the cathode of D1 and C2.

Also, the input to IC1-d is published as being pin 7, but pin 7 is the ground

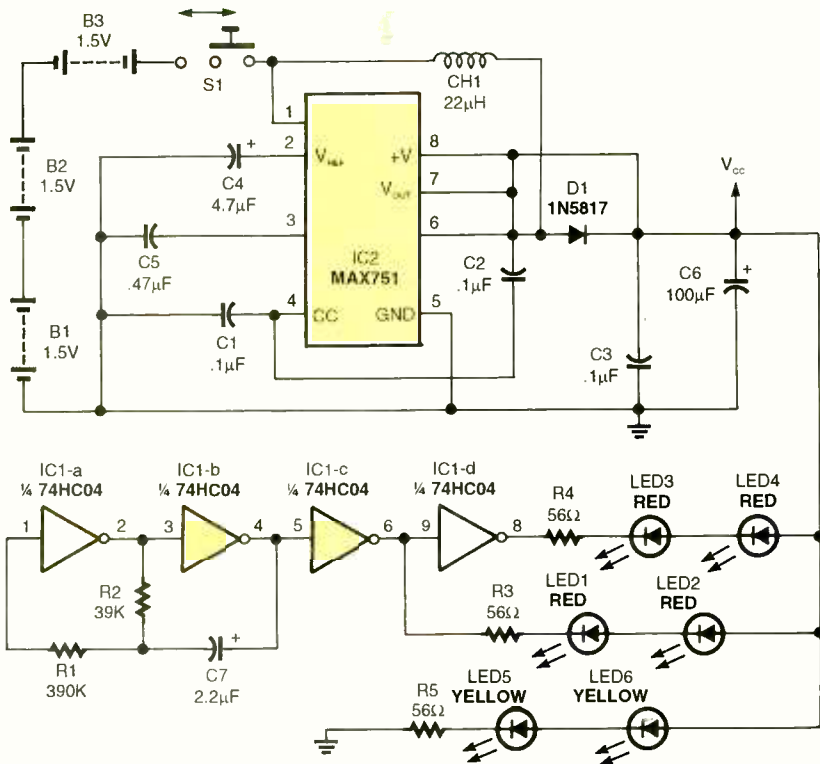

Fig. 1. Once again we bring you the schematic for the Pumpkin Safety Light. Note the changes to IC1-d and the connection of CH1.

pin for the 74HC04. It should read pin 9 as the input to IC1-d.

Reader Feedback

I read with interest the letter entitled “60-LED Watch” in the “Q&A” column in the July issue. I think the project referred to as the 60-LED clock was the same one I built around 1995. I’ve been having a problem with it lately and have tried getting in touch with the designer at his original address, but the letter was returned.

The name of the kit was a “hyper-clock” and it was designed by Leon Schmidt. His company was SkiTronix, P.O. Box 9685, Spokane, WA 99209. If any of your readers know of a more current address, I would appreciate it.

I like the new *Poptronics*, as I liked its predecessors. I suppose it is better having one magazine instead of two—instead of none at all. I would like to offer one suggestion to the writers of

projects that you publish: Offer a parts kit or at least a PCB. I don’t make my own PCBs and/or have time to hunt up a bunch of small parts, then drill a and print a case to put it all in. I’ve passed up some projects that I was quite interested in for this reason. I realize all of the designers don’t wish to get into this, but it would be nice if they could at least make a PCB available.

RICHARD FLAWS
Oswego, IL

If I were asked “How to make *Poptronics* a better magazine,” my answer would be to divide your issues into three categories: basic, technical, and expert. Then, with each issue put in a 3x5 card for simple circuits such as power supplies, LEDs and so on.

No one is an expert in electronics, they’re just simply good at what they have been exposed to.

My hobby is robotics and lasers. I attended an optical course in the US

Army in 1974, where my field was optical instrument repair. I then went on to lasers and thermal optical instruments. Your magazine has always been a tool and a technical manual for me, **except** during the past year where, I believe, it has fallen short of help.

FRANK L. PRITCHETT

Thanks for your comments and suggestions. In regard to your problem with contacting Leon Schmidt, this is the situation. The original article was published in the February 1992 issue of Radio Electronics. The address given was for the author's own P.O. Box, which he probably used for that project. Mr. Schmidt has not written for us lately, and we do not have a current address for him, unfortunately. Sorry that we cannot help you further.—Editor

Canadian Parts

I am writing about the letter from G.D. Ransford in the September "Letters" column. In addition to those suggested by the editor, here are a few places in Canada itself where parts can be purchased. HVH Technologies, at www.bvhtech.com. This Calgary-based company specializes in microcontrollers. It is tailored to the hobbyist, as small orders and related books can all be bought online.

For local electronics parts stores, check out Active Electronics at www.activestores.com. This nationally based company has small order, individually packaged products. Their Web site is run by a different company, so you will have to go to the store to find what you are looking for. It has locations in these cities: Calgary, Edmonton, Mississauga, Montreal, Ottawa, Quebec City, Toronto, Vancouver, and Winnipeg.

I hope this will help your Canadian readers.

SEAN CLARK
via e-mail

Canadian Parts II (and Other Matters)

In response to the letter from G.D. Ransford in the September "Letters" column, I suggest you take a spin up to Ottawa and check out Future/Active's Active Components retail store. Pick up a catalogue and inquire about their mail-order service. While I can't vouch personally for either, I've been shopping at

the Calgary outlet for years. They are "business-oriented" and tend not to suffer hobbyists' questions too well, but they really do retail an amazing amount of "neat stuff." Also try www.future-active.com.

I was happy to see from George Williamson's letter that he agrees with me, at least. If you did something for us "little guys" (say, reintroduce a "Reader's Circuits" column, for instance), perhaps he'll do what I did, and hint to his relatives that he would rather get a gift subscription to *Poptronics* for the holidays, instead of the usual socks and ties. Worked for me.

Now for the major "reflections" in this letter, which are on "Radio Signals From The Great Pyramid." After a couple of paragraphs, I checked the cover to make sure you hadn't time-warped me next April's issue.

But, no. Like most electronics hobbyists, I like to think of myself as an amateur scientist (not mad, just grumpy). Thus, this coprolite is so offensive on so many levels that my first draft of this letter was over five pages. As you are no doubt deluged by "backfeed" on this piece (Yes, see the November "Letters" column.—Editor), I'll just note a few of the most glaring errors.

KEEP IN TOUCH

We appreciate letters from our readers. Comments, suggestions, questions, bouquets, or brickbats... we want to hear from you and find out what you like and what you dislike. If there are projects you want to see or articles you want to submit—we want to know about them.

You can write via snail mail to:

Letters
Poptronics
275-G Marcus Blvd.
Hauppauge, NY 11788

Sending letters to our subscription address increases the time it takes to respond to your letters, as the mail is forwarded to our editorial offices.

Our e-mail address can be found at the top of the column.

Of course, e-mail is fast.

All of our columnists can be reached through the e-mail addresses at the head of each column.

And don't forget to visit our Web site: www.gernsback.com.

Yes, fieldlines will "freeze" in igneous rock, if it contains ferromagnetic minerals. However, it is rather tough to date by fieldline shifts—not only does the earth's magnetic field change polarity every few million years, but the poles themselves wander around like drunken astrologers in the meantime. About all the phenomenon proves is the "shift happens."

As to the "stone radio," I'd want to do a control experiment, hang that great iron bar from a nearby tree with a length of nylon sashcord, hammer the nail in the ground, and see if it doesn't work just as well as when hammered in some poor innocent rock! Rock's got feelings too, ya know, ya newager, ya!

As to the main premise, fooy! Is it a vacuum or isn't it? How many megawatt-hours of pumping would it take to evacuate the Pyramid, considering that it will be effervescing CO₂ by the hogshead due to several railcars of H₂SO₄ that it has to contain? Not to mention them "open vents".....aaaaaaargh!

Want to make electricity from a rock? Simple. Obtain some pyrolusite. Powder. Mix with sal ammoniac to form a thick paste. Glop into a galvanized bucket. Splork an inanimate carbon rod halfway in. Voila! You have a dry cell.

You can also get electric power from a model pyramid—with about \$200 worth of gold foil and other goodies, you can get a 14-incher to kick out ¼ volts @200 µA....cheaper to just buy batteries.

To sum up, with "hundreds" of manuscripts...a month" to choose from, why waste eight pages with some new-age pipe dreams?

On a positive note, the FM transmitter in the same issue looks interesting.

GRANT DERMODY
Calgary, Alberta, Canada

Radio Signals And The Great Pyramid

Kudos for your September article, "Radio Signals and the Great Pyramid." While this fine article explored in detail the electrical properties of rock and described several electronic devices the Great Pyramid could have been used as, it gives scant insight into reasons the Ancient Egyptians, great inventors as they were (including plywood), might have had to necessitate these inventions.

I believe that I have solved the
(Continued on page 63)

USE THE FREE INFORMATION CARD FOR FAST RESPONSE



Remote Height Meter

Have you ever been curious as to how high your power lines are? The *Biddle CHM2000 Cable Height Meter* (\$385) can detect cable heights from seven to 35 feet, without contact. Powered by a nine-volt battery, this meter can be used on phone lines, power lines, CATV and even street lights. The unit can detect the height of cables ranging from 1/4 inch to 1 inch in diameter. All measurements are to the nearest quarter-inch, with a .5% range of error. A built-in temperature-measuring port is directly connected to the microprocessor to maintain accuracy at any temperature.

JENSEN TOOLS, INC.

7815 S. 46th St.

Phoenix, AZ 85044

800-426-1194 or 602-453-3169

www.jensentools.com

CIRCLE 60 ON FREE INFORMATION CARD

Hipot Tester

The *Guardian 1030 AC/DC/IR Hipot Tester* (\$3495) allows technicians to perform dielectric withstand (hipot) tests safely and efficiently. Test voltages can be programmed in the range from 50 V_{DC} to 6k V_{DC} with a 1-volt resolution. The maximum current is limited to 10 mA. The infrared measurement range is from .1 MΩ to 50 GΩ, with test voltages from 50 to 1000 V_{DC}. The unit can be used to perform tests on transformers, electric motors, and a variety of electronic components.

QUADTECH

5 Clock Tower Place, 210 East

Maynard, MA 01754

800-253-1230

www.quadtech.com

CIRCLE 61 ON FREE INFORMATION CARD



Variable-Attenuator/Amp

Featuring a wide range of attenuation and gain, low noise and low distortion, the *Audio Attenuator-Amplifier Model 412* (\$187) can be used to condition a soundcard output to drive other units or for any audio application that requires attenuation and/or gain. Attenuation is adjustable from zero to 80 dB, and gain ranges from zero to 40 dB. Audio gain is executed by the new OPA227 and OPA228 low-noise opamps from TI's Burr-Brown Division. A full data sheet can be downloaded from the company Web site below.

TDL TECHNOLOGY, INC.

5260 Cochise Trail

Las Cruces, NM 88012

505-382-3173

www.zianet.com/tdl

CIRCLE 62 ON FREE INFORMATION CARD



Power On The Go

Every camper could use this low-cost, 125-watt inverter. The *Model 1605 115 VAC/125-watt Inverter* (\$69) provides a clean source of power for 115-volt devices; including lamps, notebook computers, and television sets. The inverter works with 12-V_{DC} batteries that are found in cars, campers, and boats. Features include a three-prong outlet, a low-battery indicator, and built-in overload-protection circuitry. The unit comes complete with a cigarette lighter adapter for easy operation.

B&K PRECISION CORP.

1031 Segovia Circle

Placentia, CA 92870

714-237-9220

www.bkprecision.com

CIRCLE 63 ON FREE INFORMATION CARD

Benchtop DC

Offering a variable range from 0 V_{DC} to 35 V_{DC}, the *Model 1744 Analog DC Power Supply* (\$645) also provides an output current ranging from 0 to 10 amps. Weighing in at only 25.8 lbs., this power supply has a front-panel-mounted analog voltmeter and ammeter that constantly monitor the output. A shorting button has been included for shorting the output while a current limit is set. Both noise characteristics and ripple are low for the power supply output, which provides excellent line and loads regulation.

B&K PRECISION CORP.

1031 Segovia Circle
Placentia, CA 92870
714-237-9220
www.bkprecision.com

CIRCLE 64 ON FREE INFORMATION CARD



Hand-Held Cap Tester

Whether you need to sort capacitors or perform an in-circuit measurement for capacitance, the *Model 3100 Capacitance Sorting Hand-Held Meter* (\$119) could simplify the job. The meter is auto-ranging with a 5000-count resolution and a frequency range of .1 pF to 50 mF. An optional RS232 serial port interface is available for integrating the Model 3100 with a computer. The unit also provides static measuring, allowing users to know the maximum, average, and minimum values—without the need for calculation.



GLOBAL SPECIALTIES

Highland Industrial Center
1486 Highland Ave., Unit 2
Cheshire, CT 06410
800-572-1028
www.globalspecialties.com

CIRCLE 65 ON FREE INFORMATION CARD

Measure Your BUT

Battery Under Test (BUT)...that is. The *Model 600 Hand-Held Battery Capacity Analyzer* (\$299) has been designed to measure both the capacity and no-load voltage of 12-volt lead-acid batteries, similar to the ones found in back-up lighting that is used in offices, hospitals, theaters, etc. No external power is needed—the device is powered by the BUT. Total analysis time is just about six seconds from the time the TEST switch is pressed. The analyzer can also be used for automotive applications, as well.

B&K PRECISION CORP.

1031 Segovia Circle
Placentia, CA 92870
714-237-9220
www.bkprecision.com

CIRCLE 66 ON FREE INFORMATION CARD

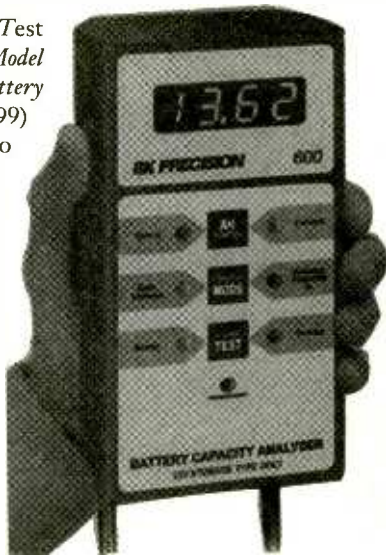

Is That A CPU In That LCR?

Why use a separate meter for measuring inductance (L), capacitance (C), and resistance (R), when you can use the *Model 3200 LCR Meter* (\$545)? This meter features dual-frequency testing (120 Hz or 1 KHz), a flexible tilt-stand, a large backlit dual display, and manual-/auto-ranging selection. Front-panel switches control data hold, L/C/R modes, and tolerance sorting. The unit is designed for the following AC-line voltages: 100, 120, 220, and 240.



GLOBAL SPECIALTIES

Highland Industrial Center
1486 Highland Ave., Unit 2
Cheshire, CT 06410
800-572-1028
www.globalspecialties.com

CIRCLE 67 ON FREE INFORMATION CARD

GIZMO®

For more information go to page 90A

or e-mail: requests@berkshire-is.com

DVD/VCR

Want DVD, but aren't ready to ditch VHS just yet? The multi-format DVD-V1000 (\$349.99) plays and records to VHS and SVHS tapes, in addition to playing DVDs, CDs, CD-Rs, MP3-encoded CDs, and VCDs. With only one output jack for both DVD and VHS, hookup is a breeze.

Samsung Electronics America, Inc., 105 Challenger Drive, Ridgefield Park, NJ 07660-0511; 201-229-4000; www.samsungusa.com.

CIRCLE 50 ON FREE INFORMATION CARD



Slim is In

Measuring less than 3½-inches deep, the PlasmaVision SlimScreen PDS-4242 (\$9999) offers a 42-inch widescreen plasma display. The 1024 × 1024-pixel panel and the digital video processor

deliver high-definition images with exceptional brightness and color reproduction. Image-enhancing technologies include a line doubler and digital noise-reduction circuitry. Extensive inputs and outputs allow the display to be connected to a PC as well as to traditional home-theater gear.

Fujitsu General America, Inc., 353 Route 46W, Fairfield, NJ 07004; www.plasmaTVnews.org.

CIRCLE 52 ON FREE INFORMATION CARD

The Anywhere Remote

Operate your home-theater components from anywhere in the house with the Remote Anywhere Range Extender (\$49.95). It converts an IR signal into an RF signal with a 150-foot range. Mount the sending unit on to the remote and plug in the receiver. Now, you're ready to control the stereo from poolside or the satellite receiver from the bedroom.

Terk Technologies Corp., 63 Mall Drive, Commack, NY 11725; 631-543-1900; www.terk.com.

CIRCLE 51 ON FREE INFORMATION CARD



Travel Planner

With the push of a button, you can download turn-by-turn travel directions for multiple trips from Rand McNally's Web site directly to the portable TripLink (\$69.95). The five-ounce device also provides the exit number, direction of travel, and distance to more than 70,000 roadside services, including gas, food, lodging, hospitals, and rest areas.

Ultradata Systems, Inc., 9375 Dielman Industrial Drive, St. Louis, MO 63132; 800-747-2605; www.randmcnally.com.



CIRCLE 53 ON FREE INFORMATION CARD

Sovereign Rule

The Sovereign DV-5900M (\$1500) is the first 400+3-disc DVD-Audio/DVD-Video/CD mega-changer. It is also the first to be equipped with

Faroudja Laboratories' progressive-scan video and line-enhancement technologies. The player provides an RS-232 port for daisy-chaining up to two more units. Kenwood's disc-

navigation system with graphical user interface lets you sort, manage, and store discs. Users can access them with cover art, title, track, artist, and genre information via online databases such as CDDB Music Recognition Service and OpenGlobe MovieDB.

Kenwood U.S.A. Corp., 2201 East Dominguez St., Long Beach, CA 90801; 800-KENWOOD; www.kenwoodusa.com.

CIRCLE 54 ON FREE INFORMATION CARD



You Can Take It With You

The *SD-PI500* portable DVD player (\$1199.99) boasts an 8-inch widescreen active-matrix LCD display. It has built-in stereo speakers as well as two head-phone jacks (one for each kid in the back seat) that use Spatializer N-2-2 Virtual Surround Sound technology. The supplied lithium-ion battery provides more than three hours of movie playback; playing CDs uses much less power. The device can be connected to a TV and stereo for home—or vacation home—use.

Toshiba America Consumer Products, 82 Totowa Road, Wayne, NJ 07470-3191; 973-628-8000; www.toshiba.com/tacp.

CIRCLE 55 ON FREE INFORMATION CARD



Ultimate Loudspeaker



Featuring both improvements and new elements, the *Signature 800* (\$20,000/pair) replaces the Nautilus 801 as the flagship model in B&W's loudspeaker line. Instead of the Nautilus's 15-inch bass driver, the 800 uses two 10-inch woofers—each driven by the proven “motor” structure. In the midrange, the familiar spherical head enclosure houses an improved version of the trademark 6-inch FST Kevlar driver. The high-frequency driver's top-end limit has been extended to 50-kHz, in step with the ultra-wideband SACD and DVD-Audio formats. The speaker is finished in Tiger's Eye veneers and fine leather.

B&W Loudspeakers of America, 54 Concord St., North Reading, MA 01864-2699; 800-370-3740; www.bw-speakers.com.

CIRCLE 57 ON FREE INFORMATION CARD

MP3 Camera

The *ViviCam 2795* (\$199.95) is a digital camera with a built-in MP3 player. Measuring just over 3½ × 3 × 1½ inches, the camera can store 29 VGA photos as JPEG images in its 2MB of flash memory, expandable with Compact Flash cards. It can also store 10 minutes of MP3 files in internal memory and up to 90 minutes with the addition of a 16-MB card. Audio clips can be

recorded in WAV format as well, and the camera can take video clips at two pictures per second.

Vivitar USA, 1280 Rancho Conejo Blvd., Newbury Park, CA 91320; 805-498-7008; www.vivitar.com.

CIRCLE 56 ON FREE INFORMATION CARD



Bass Cable

The *Tributaries Subwoofer Cable* features an integrated mono/Y output. The “Y” output allows subwoofers with two audio inputs to be connected to A/V receivers with a single mono output—a configuration said to result in uncompromised signal transfer and subwoofer performance. The cables are available in sizes ranging from 1 meter (\$45) to 8 meters (\$80); custom lengths are also available.

Tributaries, 1307 East Landstreet Road, Orlando, FL 32824-7926; 800-521-1596; www.tributariescable.com.

CIRCLE 58 ON FREE INFORMATION CARD

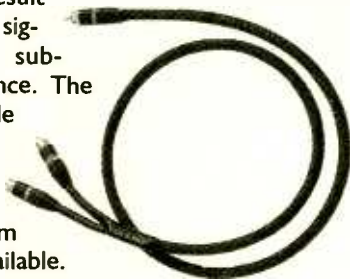

Satellite Web-Surfer

The *RCA DS 4290RE DirecTV Receiver* with UltimateTV service (\$499) allows you to watch one show, record another, and surf the Net, all at the same time. It features two satellite tuners, a 35-hour digital recorder, and Internet access via a built-in modem. You can pause live TV and create instant replays. The receiver comes with an 18-inch dual-LNB antenna and a universal remote control. A wireless keyboard is optional.

Thomson Consumer Electronics, 10330 North Meridian St., Indianapolis, IN 46290; www.rca.com.

CIRCLE 59 ON FREE INFORMATION CARD



Driver16

The *Driver16* expansion board (\$29) allows many of JK microsystems' single-board computers to convert regular TTL-level I/O lines into as many as 16 high-current outputs. Less than two inches square, the board lets users drive relays, lamps, and small motors directly. The *Driver16* Development Kit (\$39) contains a *Driver16* card and everything needed for integration with LogicFlex (pictured), Flashlite 386Ex, or V25 controllers.

JK microsystems, Inc.; 530-297-6073; www.jkmicro.com.



Power Protection

Aimed at SOHO PC users, the *Pulsar Esprit Power Cluster* 1.4-kVA uninterruptible power supply with external expandable battery modules can back up two computer servers for over 10 hours. Its suite of "Internet-grade" monitoring and communications features includes Windows 2000 integration and XML Web-based management. The modular system can be configured with power ratings from 1.4 kVA to 13.5 kVA, with prices starting at \$1584. Both USB and RS 232 connections are provided.

MGE UPS Systems, Inc.; 714-557-1636; www.mgeups.com.



PC Movie Maker

The *Intel Play Digital Movie Creator* (\$99) is an easy-to-use digital video camera and software package that lets kids use a PC to script and star in their own movies. As a standalone unit, the camera can capture up to four minutes of footage with audio or 1200 still shots; connected to the PC, its capacity is limited only by the size of the hard drive. Films can be enhanced with a library of titles, special effects, transitions, and sound files.

Intel Corp.; 502-696-8080; www.intel.com.



Mighty Micro

The *IBM Microdrives* provide high-capacity data storage to products, from cameras and PDAs to music players. About the size of a quarter, the 1-GB device can hold up to 1000 photos, 20,000 pages of text, or nearly 18 hours of digital audio music. Prices on the IBM Web site are \$199 for 340 MB, \$259 for 512 MB, and \$379 for 1-GB.

IBM Corp., 888-426-5214; www.ibm.com/storage/microdrive.



Beyond Basic

SoftWIRE 3.0 (\$495), a graphical programming extension to *Microsoft Visual Basic 6.0*, allows non-programmers to create powerful computer programs quickly, without having to write any code.

A visual debugger makes it easy to find mistakes. ActiveX DLLs allow users to create common programming functions and store them in a

large library, simplifying large project development.

SoftWIRE Technology, Inc.; 508-946-8900; www.softwiretechnology.com.

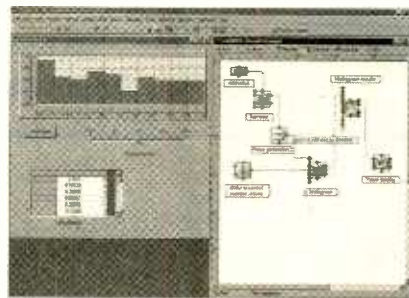

CD ROM based resources for learning and designing



The internationally renowned series of CD ROMs from Matrix Multimedia has been designed to both improve your circuit design skills and to also provide you with sets of tools to actually help you design the circuits themselves.

Electronic Circuits and Components provides an introduction to the principles and application of the most common types of electronic components and how they are used to form complete circuits. Sections on the disc include: fundamental electronic theory, active components, passive components, analogue circuits and digital circuits.

The **Parts Gallery** has been designed to overcome the problem of component and symbol recognition. The CD will help students to recognize common electronic components and their corresponding symbols in circuit diagrams. Quizzes are included.

Digital Electronics details the principles and practice of digital electronics, including logic gates, combinational and sequential logic circuits, clocks, counters, shift registers, and displays. The CD ROM also provides an introduction to microprocessor based systems.

Analog Electronics is a complete learning resource for this most difficult subject. The CD ROM includes the usual wealth of virtual laboratories as well as an electronic circuit simulator with over 50 pre-designed analog circuits which gives you the ultimate learning tool. The CD provides comprehensive coverage of analog fundamentals, transistor circuit design, op-amps, filters, oscillators, and other analog systems.

Electronic Projects is just that: a series of ten projects for students to build with all support information. The CD is designed to provide a set of projects which will complement students' work on the other 3 CDs in the Electronics Education Series. Each project on the CD is supplied with schematic diagrams, circuit and PCB layout files, component lists and comprehensive circuit explanations.

PICtutor and **C for PICmicro** microcontrollers both contain complete sets of tutorials for programming the PICmicro series of microcontrollers in assembly language and C respectively. Both CD ROMs contain programs that allow you to convert your code into hex and then download it (via printer port) into a PIC16F84. The accompanying development board provides an unrivaled platform for learning about PIC microcontrollers and for further development work.

Digital Works is a highly interactive scalable digital logic simulator designed to allow electronics and computer science students to build complex digital logic circuits incorporating circuit macros, 4000 and 74 series logic.

CADPACK includes software for schematic capture, circuit simulation, and PCB design and is capable of producing industrial quality schematics and circuit board layouts. CADPACK includes unique circuit design and animation/simulation that will help your students understand the basic operation of many circuits.

Analog Filters is a complete course in filter design and synthesis and contains expert systems to assist in designing active and passive filters.

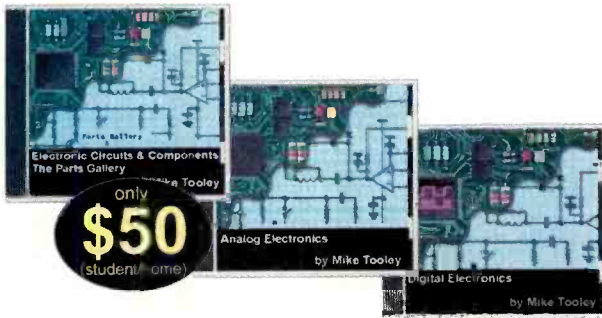

only
\$50
(student/home)

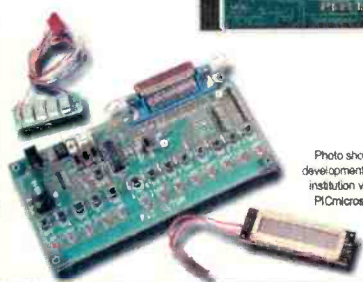

Photo shows PICmicro development kit supplied with institution versions of C for PICmicro and PICtutor

Shareware/demo CD ROM with more than 20 programs \$4.99 refundable with any purchase.

Order Form:

Please circle the products you would like to buy on the table below, calculate the total cost, fill in the rest of the order form and send it to us. NY residents add sales tax. Please allow 6 weeks for delivery.

	Student	Institution
Electronic Cts. & Comps.	\$50	\$99
Digital Electronics	\$50	\$99
Analog Electronics	\$50	\$99
Electronic Projects	\$75	\$159
PICtutor	\$179	\$350
C for PICmicros	\$179	\$350
Digital Works	\$50	\$99
CADPACK	\$75	\$159
Analog Filters	\$75	\$159
Postage - USA	\$5	\$5
Postage - Canada	\$5	\$5

Name: _____
 Address: _____
 Zip: _____ Phone: _____

Phone your order to us on:

631-592-6721

or send your order to:

CLAGGK Inc.
 PO Box 12162

Hauppauge, NY 11788

Card Type:

Mastercard, Visa, or Discover only

Card number:

Expire date:

I have enclosed my check for \$: _____

Signature: _____

Please charge my credit card for \$: _____

CL02

Order online NOW from: www.poptronics.com

NEW LITERATURE

The Art of Designing Embedded Systems

by Jack Ganssle
Newnes, Butterworth-Heinemann
225 Wildwood Ave.
Woburn, MA 01801
800-366-2665
or 781-904-2500
www.newnespress.com
\$39.95



Get better systems out faster, using the practical ideas discussed in this useful primer and handy reference. According to the author, hardware and software can't be designed in isolation. He shows readers how to get better, more integrated code and hardware designs and how to troubleshoot the inevitable bugs. This book presents a philosophy of development, instead of a cookbook of directions.

Educational Software Catalog 2001

from Tool Factory, Inc.
1929 Dorset Hill Road
East Dorset, VT 05253
800-220-8396 or 802-366-8253
www.toolfactory.com
Free

Aimed at students and teachers alike, the software products in this catalog are a cornucopia from around the world. When necessary, products have been adapted to American conventions. This 50-page full color catalog is packed with over 100 CD-ROM products, in categories such as Language Arts, Math, Social Studies, Early Learning, and History.



iMovie 2: The Missing Manual

by David Pogue
O'Reilly and Associates, Inc.
101 Morris St.
Sebastopol, CA 95472
800-998-9938
or 707-829-0515
www.oreilly.com
\$19.95



The companion to iMovie, this book covers every step of iMovie production, from choosing and using a digital camcorder to burning the finished work on CDs. In just under 400 pages, it takes neophytes from Spielberg wannabes to producers extraordinaire and shows them how to have fun doing it. A witty and entertaining read, it's packed with information and humor.

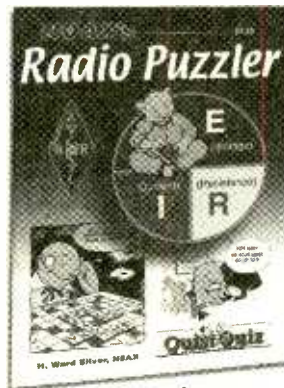

NOAX's Radio Puzzler

by H. Ward Silver, NOAX
ARRL
225 Main St.
Newington, CT 06661
888-277-5289
or 860-594-0200
www.arrl.org
\$7.95

Take some time out with the lighter side of Ham radio, with this compilation of puzzles, word games, quizzes, humorous articles, and cartoons from the pages of *QST*. There is also some previously unpublished material. This is a good book to pick up when you want to tickle your brain cells and gain a little knowledge at the same time.

A Family Affair— The R. L. Drake Story

by John Laughmiller, KB9AT
Universal Radio, Inc.
6830 Americana Parkway
Reynoldsburg, OH 43068-4113
800-431-3939 or 614-866-4267
www.universal-radio.com
\$29.95

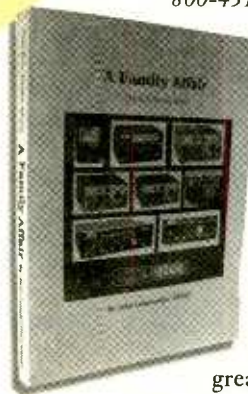

Here's the behind-the-scenes story of the famous R.L. Drake Company, focusing on the days when it was king in amateur radio. Weaving together stories of the people involved and the radios they made, the 300-page book is interesting to read and a great technical reference. It also includes a huge section of useful circuits and modifications for many Drake radios.

Business Buzz

IF YOU CAN'T BEAT 'EM ...

In an attempt to beat video pirates at their own game, five major Hollywood movie studios soon will begin providing video-on-demand over the Internet. AOL Time Warner, Sony, Viacom (Paramount Pictures), Universal, and MGM hope the move will also cut out costly middle men in video distribution and help the studios get in on the future of digital entertainment. The service will require a broadband connection, limiting its potential audience. Encryption software will let users download films to a PC's hard drive, where they will remain for up to 30 days. Once a film is accessed, however, the user will have just 24 hours to play it on the PC monitor; then it is automatically deleted. Prices for the service have yet to be announced.

HIGH-SPEED SEMICONDUCTOR

According to Motorola, its new semiconductor runs 35 times faster than current models. The secret lies in its fabrication. Gallium arsenide, which is fast but brittle, is bound together via a cushioning, spongy middle layer to silicon. The result is a semiconductor that boasts the durability and economy of silicon and the high speed of crystal components. The new semiconductor runs at 70 GHz, while today's fastest PC processors plod along at a mere 2 GHz. Motorola believes the device will lead to smaller, less expensive, and faster computers, cell phones, and telecommunications equipment.

32-BIT FLASH DSPs

Texas Instruments has unveiled the first 32-bit control digital signal processors (DSPs) with on-board Flash memory and performance up to 150 million instructions per second (MIPS). Aimed at industrial automation, optical networking, and automotive-control applications, the devices are said to deliver 12 times the performance of any existing programmable DSP controller and to reduce development time from hours to minutes. Offering a complete system-on-a-chip, the TMS320F2812 integrates 128 kilowords (kW) of Flash memory, and the TMS320F2810 includes 64 kW, for reprogramming during development and in-field software updates. Samples are scheduled for availability in the first quarter of 2002.

More Power, Mr. Sulu



What is an Ultracapacitor? The Technology

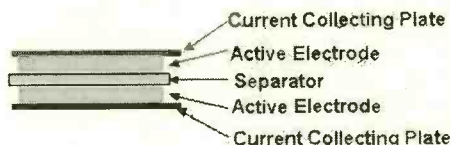
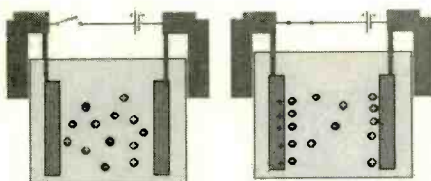

Equivalent Circuit

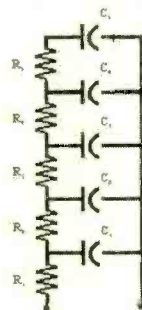

An ultracapacitor consists of two non-reactive porous collecting plates suspended within an active electrolyte. When a voltage is applied across the plates, the positive plate attracts the negative ions in the electrolyte, while the potential on the negative plate attracts the positive ions. This effectively creates two layers of capacitive storage.

Batteries can store energy for extended periods of time, but have limitations when it comes to peak-power delivery, rapid charging/discharging, and the ability to be deep cycled repeatedly. On the other hand, ordinary capacitors are capable of repeatedly providing high levels of power, but cannot store much energy. Often capacitors cannot discharge their power for more than a few microseconds. Ultracapacitors lie somewhere between batteries and capacitors in their ability to store and release energy rapidly and repeatedly.

Capacitors and Ultracapacitors

Both capacitors and ultracapacitors, also known as "super capacitors," store energy in the form of a separated electrical charge. The greater the area for storing charge and the closer the separated charges, the greater the capacitance or ability to store the charge. A conven-

tional capacitor uses a dielectric material, such as a plastic or paper film or a ceramic, to separate the charged plates. To obtain high capacitance, the flat, conductive material is wound in great lengths. Imprinting a texture on the material increases its surface area and thus its capacitance. Dielectric capacitors can be made only as thin as the available films or applied materials, thus limiting energy-storage capacity.

An ultracapacitor features a carbon-based electrode material, whose porous structure offers a much larger surface area than in a conventional capacitor—approaching 2000 square meters per gram. Its charge-separation distance is determined by the size of the ions in the electrolyte, which are attracted to the charged electrode. This provides separation distances of less than 10 angstroms, significantly smaller than with conventional dielectric materials. The combination of enormous

TYPE

surface area and extremely small charge separation provides the ability to deliver up to 100 times the energy of conventional capacitors and 10 times the power of ordinary batteries.

The Way It Works

The way an ultracapacitor stores energy electrostatically is by polarizing an electrolytic solution. Though it is an electrochemical device, a.k.a. an electrochemical double-layer capacitor, there are no chemical reactions involved in the energy-storage mechanism. This mechanism is highly reversible, allowing the ultracapacitor to be charged and discharged hundreds of thousands of times—compared to lifetimes of 500 to 1000 cycles for most batteries. Another advantage of an ultracapacitor is that it charges extremely quickly.

Applications

In applications where power determines the size of the energy-storage device, an ultracapacitor may do better. In other applications, they can be used with batteries to combine the ultracapacitor's unique characteristics with the greater energy storage of a battery. Unlike batteries, there are no caustic or toxic liquids to handle, and their shelf life is said to be almost infinite.

There is enormous potential for the use of ultracapacitors. Maxwell Technologies is one company exploring that potential. Their PowerCache ultracapacitors range in capacitance from the PC 5 with 4 farads that can deliver 1 ampere at a peak voltage of 2.7 volts up to the PC 2500, which is

rated at 2700 farads with the ability to deliver 625 amperes at 2.7 volts.

These units can be used as energy-storage systems in applications ranging from computer-memory backup devices to stationary power-generation facilities. They are ideal for quick-charge applications, such as power tools and toys, where they can be charged in seconds and then discharged over a few minutes. In uninterruptible power systems (UPS), ultracapacitors provide the power for short outages or until a generator set can come on line to provide continuous backup power. They can also be used for load-leveling with an energy-rich, power-poor energy source, such as a photovoltaic system. One interesting application is for back-up power in the "black box" recorders of airliners.

Developing Hybrids

Another possible focus for ultracapacitors is in hybrid electric vehicles (HEVs). Batteries may not be the best energy-storage devices for these HEVs because of the difference in duty cycle compared to electric vehicles. In an EV, energy is stored when the battery is charged, which is at most a few times a day; then the battery is discharged relatively slowly. Additionally, energy recouped during regenerative braking is used to keep batteries charged, but this charging is rather benign compared to the deep cycling that occurs as the battery is discharged and recharged. In a HEV, especially of the common parallel-configuration type, energy is constantly stored and used as the battery is charged by the internal combustion engine and from regenerative braking. It is then released as extra power is needed for acceleration and hill climbing. This frequent discharging and charging can be detrimental to battery life.

At this point, ultracapacitors such as PowerCache come in. These ultracapacitors are already used in General Motors' Allison Transmission Division's new E^P System parallel hybrid-electric system and the E^S System series hybrid system for trucks and buses. In the parallel E^P System, a diesel engine drives

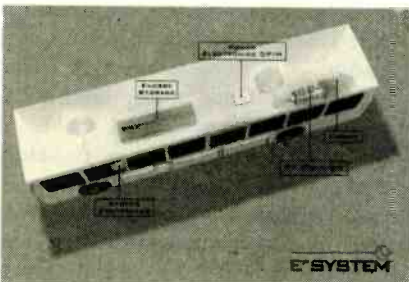

Shown here is the Allison E^P System installed in a bus.

Research Notes

SciDAC AWARDS

Under its Scientific Discovery through Advanced Computing (SciDAC) program, the U.S. Department of Energy has awarded \$57 million for this fiscal year to 51 research projects in fields including fusion energy sciences, nuclear astrophysics, and high-performance computing. SciDAC is an integrated program that will help create a new generation of scientific simulation codes. It also includes research on mathematical and computer software to allow these codes to use modern parallel computers efficiently. Another goal is developing "collaboratory" software to enable far-flung scientists to work together better, to control scientific instruments remotely, and to share data more easily.

"HYPER-THREADED" PROCESSORS

Intel's new processor design technique, named Hyper-Threading, is said to improve system performance by 30%. The multi-threading design allows a single processor to manage data as if it were two processors, by handling data instructions in parallel. Hyper-Thread processors can manage incoming data from different software applications and continuously switch from one set of data instructions to the other, every few nanoseconds, without losing track of the status of each set. This technique can also significantly improve the number of Web transactions and users that Intel-based servers can handle at the same time. Hyper-Threading is first scheduled to be introduced in Intel Xeon processors for servers in 2002.

PATENTED METAL-OXIDE PROCESS

Scientists at Brookhaven National Laboratory received a patent for a unique way of making metal oxides, a class of compounds important in nanotechnology and commonly used in catalysts. The traditional method requires processing a molten metal at high temperature, while the new technology completely avoids the liquid phase. Instead, the metal is combined with graphite and heated to form an intermediate compound. When more heat is applied, the metal is released as a vapor, which can then be oxidized into a pure metal oxide powder. By controlling the heat, scientists can vary the vapor density. They have produced powders with uniform particle sizes from 5 to 500 nanometers. Other elements can also be added to alter the electrical, optical, and magnetic properties of the final products.

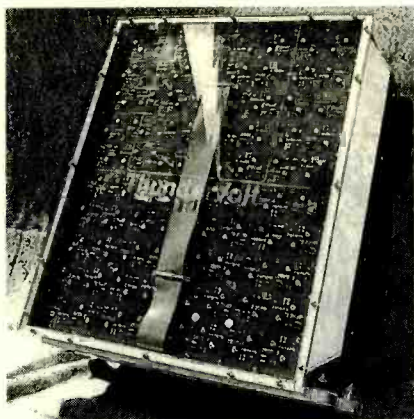

The ThunderPack ultracapacitor unit uses 149 Maxwell PowerCache ultracapacitors. A dual pack can meet the most demanding acceleration and peak power needs of large HE transit buses and trucks.

the Allison E^V Drive. This drive includes a split torque continuously variable transmission that supplies power to the wheels and a generator that supplies electricity to the PowerCache ultracapacitors. The PowerCache also stores energy from regenerative braking and rapidly releases energy when extra power is needed. In the E^S System series hybrid, the diesel engine is mated to a generator that powers the E^T Drive driving the rear wheels. Electricity is also sent to the energy-storage device.

Testing, One, Two, Three

Allison has demonstrated the E^P System in a 40-foot Gillig Phantom transit bus and a GMC C7500 TopKick truck. Future plans call for additional installations in suburban coaches, articulated buses, Class 8 trucks, and an Army Light Armored Vehicle. Two hybrid electric New Flyer buses using the E^S hybrid system are in service with the Orange County Transit Authority in Santa Ana, CA. While originally using batteries, they will be soon retrofitted with ultracapacitors. Allison expects a six-year lifetime from the Maxwell ultracapacitors. Compared to equivalent battery packs, the ultracapacitor storage device has one-third the weight and occupies one-half the volume.

Another company in this field that offers its ThunderVolt heavy-duty hybrid electric drive systems for buses, trucks, and tow tractors is ISE Research-ThunderVolt, Inc. This company also

► Martian Airplane

NASA Ames Research Center's Kitty Hawk 3 project successfully completed a high-altitude test of a prototype Mars airplane. The NASA 731 glider, nicknamed "Orville," was dropped from a balloon at an altitude of 101,000 feet. (Its predecessor, dubbed "Wilbur," aced its own low-altitude trials.) The latest prototype is a conventional looking plane, with a long, straight wing and twin tails. The remote-controlled glider has a 4-foot-long fuselage and an 8-foot wingspan.

In its future configuration, fully ready for Mars exploration, folding wings will allow it to be stored inside a spacecraft. The finished version is expected to have a propeller propulsion system capable of operating in the carbon-dioxide-laden Mars atmosphere. It will carry instruments to conduct experiments and an array of high-resolution cameras to provide close-up views of the planet's surface. "The images will be stunning," said Larry Lemke, an aerospace engineer NASA Ames who serves as Ames' project manager for advanced Mars mobility concepts. "During a Mars airplane mission, we will be able to view the planet at very close proximity, and this will convey to the public that there is a real planet out there, not just an abstract."

PT



NASA731, Orville, is prepared for a 1000-foot low altitude test to check out aircraft and data systems.

uses PowerCache ultracapacitors in its new ThunderPack. This electronically controlled energy-storage device consists of 149 Maxwell Technologies' PC2500 ultracapacitors in a fan-cooled aluminum enclosure. A single pack can store and release more than 150 kW, and a dual pack rated at 300 kW meets the acceleration and peak power needs of large HE transit buses and trucks.

Ultracapacitors may indeed be the answer to our need for efficient power storage and release.—by Bill Siuru **PT**

Z-Beamlet

Researchers at Sandia National Laboratories recently put to the test the third biggest laser on earth, known as the Z-Beamlet. In its trial run as a diagnostic tool, the laser was able to confirm that Sandia's Z machine—the world's most powerful laboratory producer of X-rays—spherically compressed a simulated fusion pellet during a firing, or "shot," of the giant accelerator. Being able to evenly compress a BB-sized pellet so that its atoms are forced to fuse is a crucial step in creating high-yield nuclear fusion.

Before the Z-Beamlet, Z researchers had to settle for electronic images of

smoother and smoother Z pinches (the tool of compression). The pinch is a vertical magnetic cylinder that with increasing smoothness impels tungsten ions toward its vertical axis at a considerable fraction of the speed of light. In the past, scientists knew only that the tool was good and that its performance was improving, but they couldn't actually see the results.

Seeing Is Believing

Project leader John Porter likens the Z-Beamlet image to "a kind of giant dental X-ray." In a burst of energy lasting a fraction of a billionth of a second, it takes a snapshot by creating a shadow on a piece of X-ray film placed behind the pellet inside the central chamber of the firing Z machine. Like a picture taken of a tooth, the shadow accurately depicts what is happening in the "mouth" of Z. The laser's light is not used to create the image; higher frequencies of light are required. The beam travels horizontally for 75 yards before making a 90-degree turn down into Z's mouth, where it is focuses to a spot about the diameter of a human hair. The pulse lasts only 300 picoseconds, creating an extremely powerful beam. The beam strikes the metal plate, causing it



This shield protects the giant Z-Beamlet's final focusing lens from debris when the Z accelerator fires. The lens is square because the beam generates a footprint that's about one square foot, which is then focused down to about 100 microns.

to release X-rays. Those X-rays, as they emanate from a single point, have the accuracy and intensity to image the pellet.

Pulsed lasers are not new, but they normally produce mere millijoules of energy in university research labs. The Z-Beamlet, however, delivers kilojoules of laser energy for its diagnostic work. (When firing, Z delivers megajoules.) The beam starts out with picojoules of energy. Researchers use an assortment of small mirrors, lenses, beam splitters, and polarizers to amplify the little beam and smooth out any spatial nonuniformity. It is then passed through a vacuum changer in which it is focused into a point source from which it opens again. The entire system is run and monitored by an elaborate computer control system. After a final smoothing from an adaptive optics system, still more energy is added to the laser pulse by flash lamps resembling fluorescent tubes.

The Inside Story

"Instead of seeing the outside of Z science—the instabilities in the compressing magnetic field—we can now see the inside, the pellet at the center of the million-degree furnace—the interior of the sun, if you will—and we can accurately describe what's happening there," said Porter. "The beam compressed the pellet by a factor of 2 and demonstrated an encouraging uniformity. Our results show we're moving in the right direction."

Uniform 3-D compression, in which almost none of the X-ray energy delivered to the pellet is wasted, is essential to the creation of controlled nuclear fusion. Weapons simulation work (the alternative to nuclear testing) conducted

on supercomputers by Sandia for the U.S. Department of Energy is expected to benefit from data from high-yield explosions. In the future, high-yield nuclear fusion will ultimately produce cheap electric power from sea water.

The Beamlet laser was originally built by Lawrence Livermore National Laboratory to serve as the scientific prototype of the National Ignition Facility (NIF). To make room for the NIF's lasers, the lab decided to remove the Beamlet. It took workers from both labs three years to reassemble the Beamlet at Sandia, at a cost of \$12.875 million. **PT**

Harnessing Quantum Weirdness

Researchers at the Massachusetts Institute of Technology believe that taking advantage of the quirky nature of certain quantum pulses—a.k.a., "quantum weirdness"—could eventually lead to a dramatically more accurate global positioning system. They named the method QPS, for quantum positioning system. Eventually, as techniques for generating certain quantum pulses improve, the QPS will become viable for applications in which high accuracy and low power are important, such as satellite positioning.

GPS, radar, sonar, and lidar all use clock synchronization for locating objects in space and time. By bouncing pulses of light or sound between two places and determining the arrival time of the pulses at the reference point, users can track objects. Of course, the accuracy of the system depends on how precisely the arrival time of the pulses can be determined.

"Our work shows that by exploiting 'quantum weirdness' one can in principle dramatically enhance the precision of such pulse-timing methods," Seth Lloyd, associate professor of mechanical engineering at MIT's Research Laboratory of Electronics, said. "Counterintuitive features of quantum mechanics such as entanglement—quantum correlations that are 'excessive,' or greater than classical—and squeezing can be employed to overcome the classical limits in these procedures."

The accuracy with which the arrival

time of a pulse of light can be determined depends on the bandwidth and the number of photons (which determines the power) in the pulse. The accuracy of conventional object-locator techniques is proportional to bandwidth of the pulse multiplied by the square root of the power in the pulse. Quantum mechanics allows accuracy to be enhanced based on how many photons can be prepared in a quantum pulse. One hundred photons gives a factor of 10 enhancement over the classical limit, while a million photons offer a thousand times better result.

It is difficult to prepare lots of photons in the requisite state. It is currently possible, however, to perform simple demonstrations of QPS using just a couple of photons. The researchers say that it might be possible to implement quantum cryptographic schemes that would block an eavesdropper from obtaining information on the position of the object in question. **PT**

Eye On The Storm

About 100 researchers from NASA, NOAA, and other agencies, assisted by Air Force "Hurricane Hunters," held a five-week study of Atlantic Ocean hurricanes this summer. Its primary goal is to produce more accurate predictions of when storms will hit land, which could decrease coastal evacuations and increase warning time. The study is expected to provide more accuracy in forecasting. Airborne researchers flew above, around, and through the storms; satellites, balloons, unmanned aircraft, and ground-based equipment were used, as well.

The study, dubbed CAMEX-4 for the Fourth Convection and Moisture Experiment, used NASA-funded aircraft and surface remote instruments to study hurricane development, tracking, intensification, and landfall impacts. Measurements were compared and validated with coincident observations from the QuikSCAT, Terra, and Tropical Rainfall Measuring Mission satellites. The resulting data, when analyzed within the context of more traditional aircraft, satellite, and ground-based radar observations, should provide additional insight to hurricane modelers and forecasters. **PT**



YESTERDAY'S NEWS

A PEEK INTO THE GERNSBACK ARCHIVES



1900

1910

1930

1940

1951

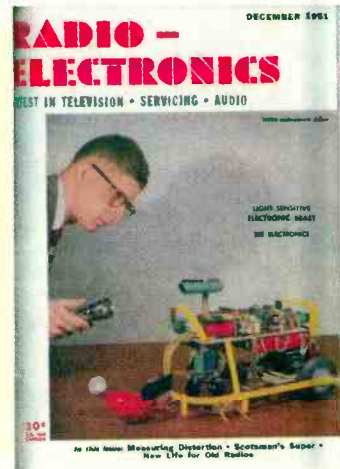

Dateline: December 1951 (50 years ago)

Using a light-sensitive Robot Squirrel named Squee, **Radio-Electronics** illustrates a new design of circuits for mechanical brains and robots—a method called Boolean algebra. The two-part article emphasizes how to calculate with and put into process this new method. Other feature articles explain different means of measuring distortion, how to build a Scotsman's Superhet, and ways of reviving old radios.

1960



Dateline: December 1971 (30 years ago)

Before Heathkits were retired from the market in the early 1990s, they had been the industry leader for an electronics era. Step-by-step, **Radio-Electronics** builds the latest Heathkit—the AR-1500 solid-state stereo receiver. Readers also learn how to build a liquid-crystal wattmeter, a sonic cleaner, and a windshield-wiper pause control. A second feature lists four more ways to use a tape recorder—in the kitchen, car, darkroom, and at a party.

1971

1980

Dateline: December 1991 (10 years ago)

Just in time for the holidays, **Popular Electronics** helps those last-minute shoppers with a guide to the perfect gift for every electronics enthusiast—manufacturers and distributors list included for easy ordering. For those who really like to get into hearing the holiday cheer, watching the classics, and lighting up parties, there are articles on how to build a music-on-hold box, a dual-band loop antenna, and even a flashing lapel pin.

1991

2000



Season's Greetings

Plug a Friend into

Poptronics[®]

*and Save \$44.89**

*This holiday season you can give an electrifying gift ... plug a friend into **Poptronics**[®] and brighten the whole new year! Whether electronics is your friend's livelihood or hobby, your gift will illuminate the whole spectrum of electronics throughout the coming year and provide a monthly reminder of your friendship.*

Poptronics[®] Magazine will keep your friend informed and up-to-date with new ideas and innovations in all areas of electronics technology ... computers, video, radio, stereo, solid-state devices, satellite TV, medical electronics, communications, robotics, and much, much more.

Poptronics[®] combines the best attributes of **Electronics Now** and **Popular Electronics**. It is the magazine for the hands-on electronics activist. We will be presenting articles on just about everything electronic—from satellite TV equipment to DVDs, gadgets and gizmos to energize your life, audio amplifiers, professional service features, PC-related projects, and much, much more.

PLUS: A selection of computer-oriented columns that explore the digital realm from the inner workings of a PC to the latest the Web has to offer. On the electronics side, there is something for everyone—from the beginner (Basic Circuitry and Q&A) to the expert. Whether your interest is fixing equipment (Service Clinic), tinkering with robots (Robotics Workshop),

or adventuring to the farthest reaches of electronics and science (Amazing Science)—**Poptronics**[®] takes you there.

SAVE \$44.89* ... OR EVEN \$89.78* ... For each gift of **Poptronics**[®] you give this holiday season, you save a full \$44.89* off the newsstand price. And as a gift donor, you're entitled to start or extend your own subscription at the same Special Holiday Gift Rate—you save an additional \$44.89*!

No need to send money ... if you prefer, we'll hold the bill till January, 2002. But you must rush the attached Gift Certificate to us to allow time to process your order and send a handsome gift announcement card, signed with your name, in time for the holidays.

So do it now ... take just a moment to fill in the names of a friend or two and mail the Gift Certificate to us in its attached, postage-paid reply envelope. That's all it takes to plug your friends into a whole year of exciting projects and new ideas in **Poptronics**[®]!

*Newsstand price—8 issues @ \$4.99 each
4 issues @ \$5.99 each

NEW LITERATURE

(continued from page 11)

Power Conversion Products

from Artesyn Technologies.
125 Newbury St.
Framingham, MA 01701
800-769-7274
or 508-628-5600
www.artesyn.com

Free

This full color, 16-page quick-select guide details all of the company's latest-generation power-conversion products. An ideal reference for electronic design engineers and system integrators to find a suitable power source for their particular application, the guide covers both AC/DC power supplies and DC/DC converters. It includes more than 300 AC/DC power supplies and DC/DC converters, 70 of which are new.



Manufacturer to Manufacturer Part Number Cross Reference

by the Engineering Staff of Sams Technical Publishing
5436 W. 78th St.
Indianapolis, IN 46268-4149
800-428-7267
www.samswebsite.com
\$39.95

This complete reference allows users to find all the possible alternative replacement parts. Part numbers from various manufacturers are cross-referenced for use in many electronic devices. The included CD-ROM helps users quickly search the massive database of parts. It's a handy cross-reference guide that provides information on using electrically compatible parts already in stock and should be part of every technician's library.

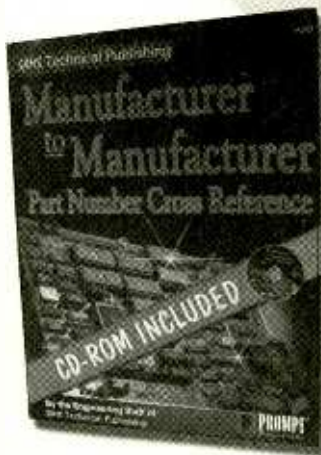

Embedded Controller Hardware Design

by Ken Arnold
Butterworth-Heinemann
225 Wildwood Ave.
Woburn, MA 01801
800-366-2665
or 781-904-2500
www.bhusa.com
\$49.95

Embedded systems incorporate microcontrollers and microprocessors in various devices and provide a degree of computer control. Designing such a system requires a familiarity with both hardware and software aspects. This book introduces readers to the design of such systems in a readable way, with the latest application-oriented information.



Power Quality Primer

by Barry Kennedy
McGraw-Hill
2 Penn Plaza, 12th Floor
New York, NY 10121
800-2MCGRAW
www.books.mcgraw-hill.com
\$75

Written in easy-to-understand language, this book explains how to prevent and solve power-quality problems. The first five chapters provide background information, followed by three chapters on diagnosing and solving power-quality problems. The last two chapters explain the economics of alternative power solutions and the latest research and development projects.

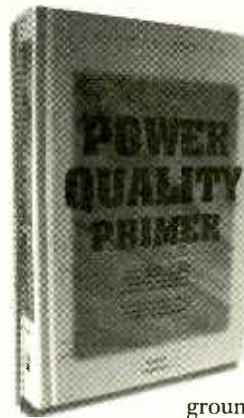

Design Patterns In Communications Software

Edited by Linda Rising
Cambridge University Press
40 W. 20th St.
New York, NY 10011-4211
800-872-7423
www.cambridge.org
\$59.95

A compendium of papers on patterns and pattern languages in communications software, this book covers everything from telecommunications to middleware distributed systems, multimedia networking, and Web technologies. Written by experts in their field, the

papers thoroughly explore this subject and provide insight into factors shaping next-generation communications software.

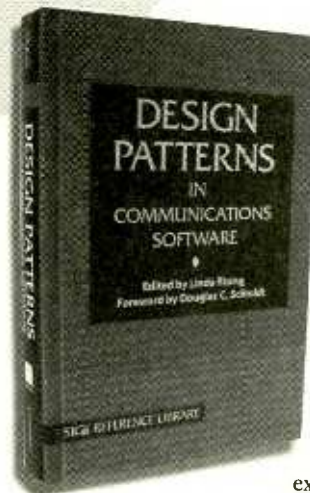

Star Trek Technology Is Here... Sort Of

The captain orders, "Take it to warp-eight, shields up!" All hands are busy "making it so." The power-transfer conduits between the warp core and the warp-engine nacelles heat up. The verterium coils begin converting the core's energy into the propulsive warp fields. Within seconds, the galaxy-class starship blasts away at a speed faster than light, taking the crew to the furthest reaches of the universe.

Sounds convincing and familiar, right? In the past thirty years, the lexicon of *Star Trek* technology has become almost commonplace; with warp speed, transporter beam, jeffries tube, subspace converter, and space-time continuum taking their place among commonly known household terms. With computer technology racing ahead at warp-like speeds, it can sometimes be difficult to tell where the fantasy ends and reality begins.

So what role does *Star Trek* technology play in America today? "Every major space program starts with an idea, and with art. It's easy to think of ideas—science-fiction writers have been doing it for years. While our imagination is virtually boundless, it takes some effort to acquire the equipment needed to back up those ideas," says Rick Sternbach, one of the authors of *Star Trek: The Next Generation Technical Manual* and the *Star Trek: Deep Space Nine Technical Manual*.

If art and imagination were indeed the catalyst for such heady ideas as warp speed, holosuites, the Federation of Planets, NASA, the computer chip, and Apollo, how close are we to reaching the heights of technological inno-



Mr. Spock demonstrates the many uses of his Vulcan food processor/juicer to Kirk and Bones. Sci-Fi inspired technology has been showing up in homes across the globe.

vation explored by the *Star Trek* series? To be sure, we are merely technological infants in the beginning stages of development.

SPACE TRAVEL

"The concept of space travel goes back to the 17th century—people have been telling stories about flying to the moon since the days of Isaac Newton," says Sternbach. While the idea of space travel has existed in the dreams of visionaries for centuries, the actual progress we have made is minuscule compared to that realized by the fantastic, yet fantasy-based United Federation of Planets.

NASA is well on its way, though. In the last half of the 20th century, NASA has taken us to the moon and back, provided us with photos of planets throughout our solar system, launched the Space Shuttle, and brought us a magnificent telescopic platform from which to view deep space—the Hubble Space Telescope.

Why has NASA so diligently researched and expanded its reach into the unknown depths of space? The Human Exploration and Development of Space program (HEDS), a subsidiary of NASA, seeks to, "bring the frontiers of space fully within the sphere of human activity to build a better future for all humankind."—NASA Web site.

The following goals of HEDS, which "...bring people and machines together to overcome the challenges of distance, time and environment," are significant:

- Send human missions to planetary and other bodies within the Solar System
- Extend scientific knowledge using the environment of space
- Provide safe and affordable human access to space
- Establish a human presence in space

Source: NASA Web site at www.nasa.gov

We feel an unquenchable desire to explore deeper into the unknown, just as early American settlers felt compelled to discover, conquer, and claim all land from coast to coast. Each year, NASA reaches a little farther into the depths of space, hoping one day to uncover its infinite mysteries.

OTHER LIFE FORMS

Perhaps one of the most commonly asked questions in space travel is "Are there other life forms?" Are there other "beings" out there, and if so, where are they? According to

Sternbach, "The question is not where are they, but *when*." Sternbach says that in all likelihood, there have been other life forms, but they could have come and gone—evolved throughout numerous civilizations and countless millennia, without our even being aware of their existence. "Based on what we see out there, there is a good chance that other life forms have evolved up to our level. How we find out about them is the hard part," Sternbach reflects.

Consider two strangers passing on a busy street, narrowly missing each other in the process and never being aware of the other's existence. The odds are favorable that our planet will "narrowly miss" an infinite number of other beings. Will we ever make contact? "It is one of my fondest hopes that *Star Trek* may help people see the importance of our present-day exploration of space. Not just the possibility of contact with alien intelligence—although I am confident that this will indeed eventually happen—but in a myriad of benefits closer to home."—Gene Roddenberry, *Star Trek: The Next Generation Technical Manual*.

SPACESHIP DEVELOPMENT

Before extended journeys far into the universe can take place, you need a spacecraft that will overcome the problems of galactic travel—time, materials, and funding, of course. In the world created by Gene Roddenberry, such a ship does indeed exist. With the Galaxy-Class Starship, it becomes possible to travel the universe. While the Federation made space travel look easy, NASA has quite a long way to go on its quest for a starship.

"Today, we are limited not by ideas but by available materials to build with," says Sternbach. The *Enterprise* is an ingenious invention created with fictional materials. The tritium and duranium that comprise the skeletal structure, the subspace radio antennas, deflection shield grid, and crystal-foam stringer—all help to maintain the ship's physical integrity and exist solely in the minds of the show's creators.

When asked about the fictional materials Sternbach helped develop for the *Star Trek* series, he replied, "The U.S. is coming up with new materials every day—we already have aluminum, titanium, and magnesium."

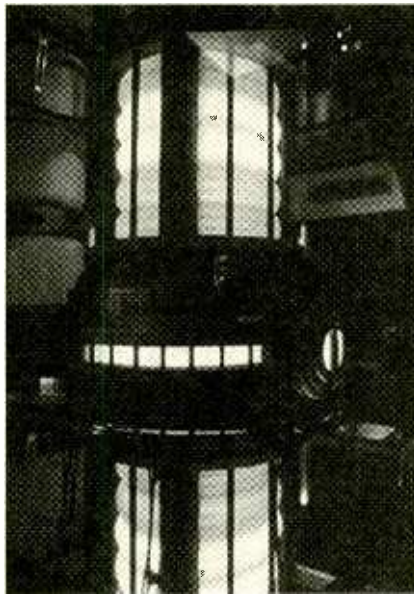

This is an image of a warp-core reactor from Star Trek: The Next Generation. Technology such as this may one day make deep space travel a possibility.

(Note the similarities to the fictional tritium, duranium and aluminum crystal-foam.) "For the 24th century, we just gave new names to similar materials we thought might eventually be discovered."

NASA is pursuing a technological thrust in the development of new materials, hoping to create "lightweight airframes, tanks, and micro-components using nanotechnology (atomically precise manipulation of matter) and ultra-high temperature ceramics."— NASA Web site. We have three hundred years to come up with some of the ground-breaking developments that have helped propel *Star Trek* to the top of television ratings. Based on current research, it might not take that long.

During powered flight, the Galaxy Class Starship maintains its structural integrity with a series of forcefields that reinforce the physical framework. This structural energy field is then distributed through a network of molybdenum jacketed waveguides, which distribute this energy throughout the spaceframe.—*Star Trek: The Next Generation Technical Manual*.

Sounds reasonable, or at least believable, right? In a fictional world 300 years in the future, this technology may very well come into existence. However, "...you can't really compare the Space Shuttle to the *Enterprise*," says Sternbach, "It just doesn't take you very far."

The Space Shuttle is also not as

strong as the *Enterprise*. "Although the Space Shuttle is protected from thermal energy during re-entry (into the Earth's atmosphere), it is actually a very fragile spacecraft," reveals Sternbach.

Although much of the latest technological development is in the conceptual stage, NASA is currently working on new types of spacecraft. According to the NASA Web site, it is the goal of the space program to "...within ten years, integrate revolutionary technologies to explore fundamentally new aerospace system capabilities and missions; and within twenty-five years, demonstrate new aerospace capabilities and new mission concepts in flight."

NASA also plans to "...aggressively explore fields with a high potential for creating advanced performance characteristics...information technology, biologically-inspired technology and nanotechnology." NASA will investigate new ways to build space vehicles, starting from the ground up by constructing them atom by atom.

WARP SPEED

Have you ever wished your car had a warp button? Think of the time you would save! According to the *Star Trek Technical Manual*, warp speed (faster than light travel) centers around the basic mechanism of continuum distortion propulsion. In the original warp-drive theories, single shaped fields, created at tremendous energy expenditure, could distort the space/time continuum enough to drive a starship.

This warp-propulsion system, the most complex component of the *Enterprise*, consists of three major assemblies:

- **The Matter/Anti-Matter Reaction Assembly**—The heart of the warp-propulsion system, also called the warp-core reactor, warp-engine core, or main engine core
- **Power-Transfer Conduit**—Constructed to constrain the plasma to the center of each nacelle and peristatically force the plasma toward the warp-engine nacelles, where the warp-field coils use the energy for propulsion
- **Warp-Engine Nacelles**—The termination point, where the actual propulsion work is done
This system has two functions: to

A BRIEF HISTORY OF NASA

1958	NASA (National Aeronautics and Space Administration) is formed as a result of the Sputnik Crisis in October, 1957.
1961-3	Human Space Flight Initiatives—Mercury's single astronaut program developed to see if a human could survive in space.
1969	Apollo-11 fulfilled President Kennedy's challenge by successfully landing Astronauts Neal Armstrong and "Buzz" Aldrin on the moon.
1981	Development of the Space Shuttle proceeds.
1986	The Space Shuttle <i>Challenger</i> explodes, causing a two-year grounding of NASA's shuttle program.
1988-98	NASA successfully launches 65 shuttle missions.
Future Shuttle Plans	
11/ 29/ 01	Endeavor—10-day mission
01/17/02	Columbia—11-day mission
02/28/02	Atlantis—9-day mission

provide enough energy for the ship's propulsion throughout space and to power the high-capacity systems, including the defense shields, phaser arrays, tractor beam, main deflector, and computer cores—*Star Trek Technical Manual*. The technical writers of *Star Trek* came up with quite an impressive model for warp technology.

How close are we to actually attaining speeds that are faster than light? NASA is currently working to "extend their reach with faster space travel." By 2015, NASA plans on reducing the time for planetary missions by a factor of two. This objective is to "...develop light, rapid space propulsion systems that will reduce travel time. Technology focus areas include small systems to travel to other planets and 'break-through' propulsion technologies to allow missions to reach other stars within a human life span."—NASA Web site.

Sternbach has doubts. He explains that our knowledge of physics is still extremely limited. "From what we do understand, it may take much more of an effort (to achieve warp speeds) than humanity can muster." Sternbach also reflected that there might never be a real need to go that fast.

COMPUTERS

If there is one area of technology we have explored that has the potential to meet and even exceed that of

the Federation, it is in the field of computers. In fact, according to the Sternbach, we may be further ahead today than the first writers of *Star Trek* ever anticipated. "We could have gone further with our *Star Trek* computer technology, when you compare it to the present day computer capabilities."

Similar to computer servers and central software-controlled hubs of today, the computer aboard the *Enterprise* is responsible for the operation of virtually every other aspect of the ship. The crew can interface with the computer via an easy-to-understand graphics display board or through voice activation. Similar technology is in existence today. The highly developed graphics of today's software is just as impressive as that aboard the *Enterprise*. Voice-activation programs, originally for the visually impaired, have also been developed.

COMMUNICATIONS

Remember Captain Kirk's old communicator in the first episodes of the *Star Trek* series? Take a look at a typical flip-top cell phone and notice the similarities. Technology has also begun to close the gap on the video-phone, more commonly used in the *Star Trek's Next Generation* series. "It's not there yet, but it's coming. It is not quite as polished, and the video quality isn't as clear as the *Star Trek* series, but give us another five to seven years,"

Sternbach promises.

With today's incredible satellite systems, fiber optics, and the Internet, we are able to communicate with anyone on the planet or even in Earth's orbit. Bring in a subspace transceiver and a personal communicator, and we'll be right there with the members of Star Fleet.

TRANSPORTERS

The act of transporting the matter of a living being from one place to another may seem far off, but scientists think they have already figured out how to transport one atom. If we can transfer one, perhaps we'll soon be able to do two, and so on. The time when we can "beam up" may seem a long way off, but the goal might very well be achieved within this century.

So what does all this mean for the future of space travel? According to Sternbach, "Apollo took us to the moon—that's as far as we've gotten. We may never attain the speed of light; it will take years and years of hard work to do it. The present day space crafts are just the beginning."

Well, until the day comes that people can take a weekend vacation to Saturn, I think I'll stick to watching the latest *Star Trek* episode. After all, "...in a fictional world, we can do anything," says Sternbach.

P

Get your copy of the CRYSTAL SET HANDBOOK

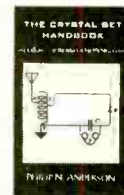

Go back to antiquity and build the radios that your grandfather built. Build the "Quaker Oats" type rig, wind coils that work and make it look like the 1920's! Only \$10.95 plus \$4.00 for shipping and handling. Clagg Inc., PO Box 12162, Hauppauge, NY 11788. USA Funds ONLY! USA and Canada—no foreign orders. Allow 6-8 weeks for delivery. MA01

ELECTRONIC GAMES

BP69—A number of interesting electronic game projects using IC's are presented. Includes 19 different projects ranging from a simple coin flipper, to a competitive reaction game, to electronic roulette, a combination lock game, a game timer and more. To order BP69 send \$4.99 clearance (includes s&h) in the US and Canada to Electronic Technology Today Inc., P.O. Box 240, Massapequa Park, NY 11762-0240. US funds only. Use US bank check or International Money Order. Allow 6-8 weeks for delivery. MA07



ELECTRONIC TECHNOLOGY TODAY INC.

P. O. Box 240 • Massapequa Park, NY 11762

INVENTORY BLOWOUT SALE



* ALL CANADIAN CHECKS MUST CLEAR THROUGH AN AMERICAN BANK

BP07 . . . 100 Radio Hookups	\$3.00	BP317 Practical Electronic Timing	\$6.99
BP36 . . . 50 Circuits Using Germanium, Silicon & Zener Diodes	\$2.99	BP320 Electronic Projects for Your PC	\$5.99
BP44 . . . IC 555 Projects	\$5.99	BP322 Circuit Source Book 2	\$6.99
BP56 . . . Electronic Security Devices	\$3.99	BP329 Electronic Music Learning Projects	\$6.99
BP64 . . . Semiconductor Technology Elements of Elect Book 3	\$5.99	BP332 A Beginners Guide to TTL Digital ICS	\$6.99
BP74 . . . Electronic Music Projects	\$3.99	BP333 A Beginners Guide to CMOS Digital ICS	\$6.99
BP76 . . . Power Supply Projects	\$3.99	BP334 Magic Electronic Projects	\$6.99
BP78 . . . Practical Computer Experiments	\$2.99	BP355 A Guide to the World's Radio Stations	\$7.99
BP80 . . . Popular Electronic Circuits	\$3.99	BP359 An Introduction to Light in Electronics	\$6.99
BP103 . . . Multi-Circuit Board Projects	\$2.99	BP367 Electronic Projects for the Garden	\$6.99
BP109 . . . The Art of Programming the IK ZX81	\$3.99	BP370 The Superhet Radio Handbook	\$6.99
BP112 . . . A Z-80 Workshop Manual	\$5.99	BP371 Electronic Projects for Experimenters	\$6.99
BP114 . . . The Art of Programming the 16K ZX81	\$3.99	BP374 Practical Fibre-Optic Projects	\$6.99
BP115 . . . The Pre-Computer Book	\$2.99	BP378 45 Simple Electronic Terminal Block Projects	\$6.99
BP124 . . . Easy Add-On Projects for the Spectrum, ZX81 & ACE	\$3.99	BP379 30 Simple IC Terminal Block Projects	\$6.99
BP143 . . . An Intro to Programming the Atari 600/800 XL	\$2.99	BP384 Practical Electronic Model Railways Projects	\$6.99
BP148 . . . Computer Terminology Explained	\$2.99	BP385 Easy PC Interfacing	\$6.99
BP154 . . . An Introduction to MSX Basic	\$3.99	BP391 Fault-Finding Electronic Projects	\$6.99
BP156 . . . An Introduction to QL Machine Code	\$3.99	BP392 Electronic Project Building for Beginners	\$6.99
BP187 . . . A Prac Ref Guide to Word Pro Amstrad PCW8256/PCW8512	\$7.99	BP393 Practical Oscillator	\$6.99
BP190 . . . More Advanced Electronic Security Projects	\$3.99	BP396 Electronic Hobbyists Data Book	\$7.99
BP194 . . . Modern OPTO Device Projects	\$3.99	BP401 Transistor Data Tables	\$7.99
BP232 . . . A Concise Introduction to MS-DOS	\$3.99	BP411 A Practical Intro to Surface Mount Devices	\$6.99
BP256 . . . An Intro to Loudspeakers and Enclosure Design	\$3.99	BP413 Practical Remote Control Projects	\$7.99
BP264 . . . A Concise Advanced User's Guide to MS-DOS	\$3.99	BP416 Practical Alarm Projects	\$6.99
BP272 . . . Interfacing PCS and Compatibles	\$5.99	BP439 Troubleshooting Your PC	\$8.99
BP290 . . . An Intro to Amateur Communications Satellites	\$5.99	PCP107 Digital Logic Gates and Flip-Flops	\$10.99
BP297 . . . Loudspeakers for Musicians	\$6.99	PCP112 Digital Electronics Projects for Beginners	\$10.99
BP299 . . . Practical Electronic Filters	\$6.99	PCP114 Advanced MIDI Users Guide	\$10.99
BP302 . . . A Concise User's Guide to Lotus 1-2-3 Release 3.1	\$5.99	ETT1 Wireless & Electrical Cyclopedia	\$4.99
BP304 . . . Projects for Radio Amateurs and S.W.L.S	\$5.99		

PRICES DO NOT INCLUDE SHIPPING & HANDLING. ALL SALES ARE FINAL, NO RETURNS

ORDER FORM

Book No.	Title	Price	No. of Copies	Cost

Name _____
 Address _____
 City _____ State _____ Zip _____

If you wish to use a Credit Card:

MasterCard Visa Expire Date _____ / _____

Card No. _____

Signature _____

Allow 6-8 weeks for order to be fulfilled.

Please return this order form to:
ELECTRONIC TECHNOLOGY TODAY, INC.
 P.O. Box 240
 Massapequa Park, NY 11762-0240

SHIPPING COSTS		Total Amount \$
\$0.01 to \$5.00 . . . \$2.00	\$20.01 to \$30.00 . . . \$5.00	30% off
\$5.01 to \$10.00 . . . \$3.00	\$30.01 to \$40.00 . . . \$6.00	Subtotal
\$10.01 to \$20.00 . . . \$4.00	\$40.01 to \$50.00 . . . \$7.00	Local NY State Sales Tax
\$50.01 and above . . . \$8.50		Add shipping cost (see table)
		TOTAL COST \$

Telephone Orders: If you wish to place your credit-card order by phone, call 631/592-6720. Automated order taking system functions 24 hours a day. Have your credit-card ready. Sorry, no orders accepted outside of U.S.A. and Canada, New York State Residents must add applicable sales tax. Offer expires 3/31/02.

ET11

The Golden Age Of The Web Is Over. Or Is It?

Sad, but true, the Internet is showing signs of change that aren't quite positive. The collapse of hordes of global dot-com ventures has rattled the market and affected the pockets of a large percentage of consumers and shareholders, both here and abroad. Now that the initial glitter has dulled, companies that once provided free services to Web-surfers are now hurting in the advertising revenue department. The result has been the implementation of fees and charges. Along with this financial dilemma, there also lurk the scams, hoaxes, false information, and general abuses of the medium. The Internet has become infested with pirates, con-artists, and the like. Let's see what Mr. Goldsborough has to say.—Editor

THE RISING COST OF FREE LUNCHES ON THE WEB

The ongoing tumble in the value of technology stocks and the subsequent drying up of venture capital for dot-coms has had dramatic repercussions for Web-empowered consumers and businesses: Many Web services that were once free now charge fees.

The formerly free Britannica.com, for instance, just began charging subscription rates of \$5 per month or \$50 per year for full access.

Britannica.com, the online version of *Encyclopædia Britannica* and other reference material at www.britannica.com, understands the Web mindset that holds to the adage "Information



Sites, such as Photopoint, have been forced to start charging for services that were once offered for free. It seems as if ad revenue is falling in the Internet market. When was the last time you clicked on a banner ad?

wants to be free." The service still provides some free information, though there are caveats.

Without subscribing, you can still access the articles in the encyclopedia—though you can read only the first two paragraphs—and all the pictures, as well, though you can see only small thumbnail versions.

Going the free route, you can still read the full text of articles about the subject you're searching for from popular magazines and the most recent 30 days of articles from the Reuters news

service. However, you'll be bombarded with pop-up ads, whereas subscribing eliminates this distraction.

Britannica.com isn't alone. The list of other one-time Web freebies whose backers now want you to open your wallet is long and includes top photo site Photopoint at www.photopoint.com, the excellent remote storage service Xdrive at www.xdrive.com, the versatile voice-mail service eVoice at www.evoice.com, the popular online payment service PayPal at www.paypal.com, and the well-regarded stock

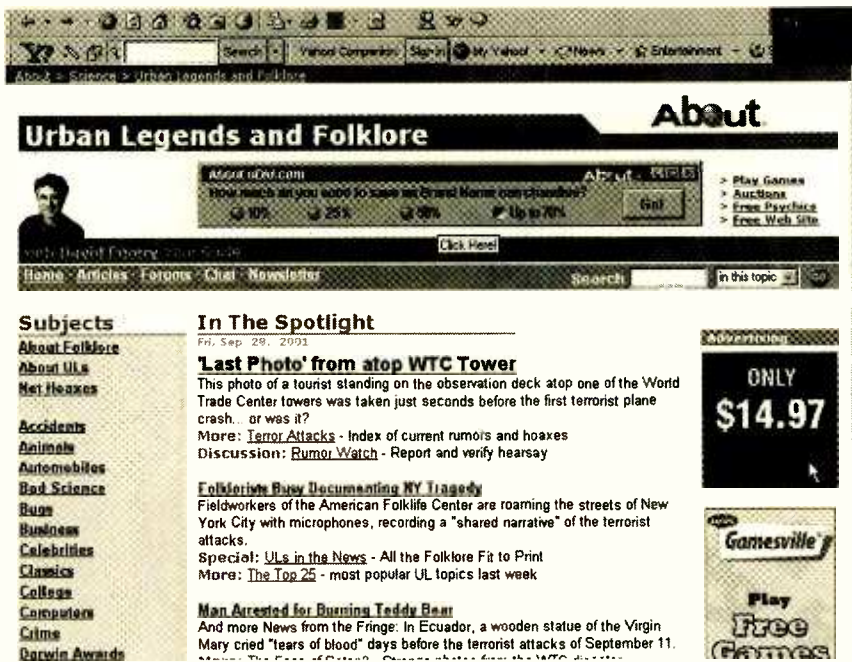

The Internet is an excellent tool for would-be scam-artists and alarmists. About.com's "Urban Legends" site is a useful tool for weeding out "digital-bologna."

tracker Company Sleuth at www.companysleuth.com

COPING WITH CHANGE

This sea change from free to pay wasn't unexpected, but can be painful nonetheless. Who likes forking over hard-earned dollars when you were previously subsidized by start-ups looking to build market share?

Without adequate revenue, many of these start-ups have gone away. It can be hugely expensive to run a Web-based service. Some photo Web sites, for instance, burn through \$500,000 to \$1 million a month to maintain their sites. There are costs that advertising alone can't cover, according to market research firm, ARS.

The harsh reality is if you're using and benefiting from a service and want it to be around in the future, you're better off paying for it than expecting a sustained free ride. When a service you or your business depends on goes under, you have to pay the occasionally large cost or undergo the often great inconvenience of switching to another service.

Many people in fact are willing to pay for information on the Web. A recent survey by the market research firm, Lyra Research, showed that 20 million people have already paid for Web content. According to the survey, 27 percent have paid for industry-spe-

cific business material, 18 percent for online database services, and 10 percent for premium music and news services. The most popular type of pay service is for adult material.

Some people argue that fee-based Web services will create a digital divide separating society into those who can afford information and those who cannot. What will likely emerge in the online world are the same kinds of tiered services that exist in the offline world.

Offline, you can choose offerings ranging from pricey ad-free newsletters to free high-quality, controlled-circulation business publications. Otherwise, you can read newsstand and subscription newspapers and magazines for free at your local library, albeit less conveniently. Similarly, you can opt for free broadcast television; or you can pay for the extra channels of cable or satellite TV.

YGWYPF

Likewise, a number of basic-level online services will undoubtedly remain free, with the only charge being greater inconvenience. You'll have to put up with distracting Web ads, and you may be inundated with annoying e-mail promotions. Some high-quality services may remain free. However, more and more frequently, such services will cost you.

The cost may be worth it. More so than in the past, on the Web today and

particularly on the Web of the future, you'll get what you pay for.

For businesses, it may be worth it to risk losing visitors by going from free to fee. Granted, it can be maddeningly difficult to persuade someone to pay for something they currently receive for free. Yet, it's better to find yourself less popular than out of cash and out of business.

On the other hand, with more and more services going under or going pay, if your service remains free, you'll stand out more. Then, you just may attract enough visitors for the ad-only model to work.

HOAXES AND SCAMS

Speaking of fees, did you know that under Bill 602P, the federal government will levy an "alternative postage fee" of five cents for every e-mail message you send? The legislation, currently pending, would compensate the U.S. Postal Service for lost business from the growing popularity of e-mail. The government would bill your Internet Service provider, which would in turn bill you.

This was the essence of an e-mail alert I recently received, with the sender urging me to write my congressman in protest and to forward the alert to everyone in my e-mail address book. Sure, it's all bogus, an Internet hoax and urban legend that's been circulating for years. These kinds of info scams do snag their victims, wasting time and draining productivity.

This is just one way that the Internet is abused as an information medium. The e-mail with the "inside" information about a stock, the Web site with "unbiased" medical advice that's silently sponsored by a pharmaceutical or herbal company, the Internet discussion group "troll" who deliberately posts inflammatory opinions to start arguments—all are examples of information abuse.

The Internet is not unique here. People, businesses, and governments have all been abusing information delivery channels. Microsoft Corp., combining elements of both old and new, embarrassed itself when it was revealed last month that a group it funded had orchestrated a nationwide campaign of "citizen" letters to government officials urging them to end their antitrust actions against the company.

Dead people, according to the *Los Angeles Times*, purportedly wrote

(Continued on page 35)

MP3s For Home Or The Road

For a while, it seemed like Napster, the music file-sharing service, was a prime reason for sales of MP3 players. With copyright infringement issues settled, Napster has pretty much waned in popularity. Even with other file-sharing peer-to-peer offerings, the focus of MP3 and other digital music formats has shifted. Now the focus is on encoding legitimately owned music to digital format, a process referred to as "ripping," or on downloading the growing amount of "non-brand-name" music that's becoming available on the Internet.

MP3 isn't the only digital music format, though it is still the most popular. Developed by the same Motion Picture Experts Group (MPEG) that developed the MPEG-1, MPEG-2, and MPEG-4 standards for encoding digital video, MP3 stands for MPEG audio Layer-3—a part of the MPEG compression system that specifically deals with audio compression. MP3 enables a single audio track in the form of a WAV file, which takes up about 32 MB of space on an audio CD, to be compressed to a digital MP3 format file of about 3 MB. This is done using a sampling rate of about 44K samples per second, and it maintains almost all of the original piece's fidelity. Lowering the sample rate reduces the ultimate file size even further. Another technique—called variable bit-rate sampling—adjusts the sampling rate dynamically according to the musical characteristics of the piece, generally increasing storage requirements a bit. It also improves the overall depth (or



Evergreen Technologies' Portable MP3 CD Player offers basic MP3/CD performance for the low price of \$99. An optional car adapter kit is also available.

dynamics) of the playback in most cases.

Microsoft has its own format, promulgated through the Windows operating system. Not surprisingly, this approach is called WMA, or Windows Media Audio. Actually, WMA provides a more compact digital file as a result of compression in comparison to MP3. A new encoding protocol from the MPEG Group, (MP3 Pro) raises the stakes again, providing better playback fidelity and a tighter compression ratio than MP3 or WMA.

Most users think of the small pocket-sized digital music players when they hear the term MP3. While these are the most popular and affordable players, with more than a dozen vendors producing several dozen models, there are some interesting alternatives. Here's a look at three of them.

YOU WILL BE ASSIMILATED

One problem with portable MP3/WMA players is that they only

play digital music files. After all, that's what they were designed to do. Another approach to digital music players takes a more inclusive path. These are CD players that not only play standard audio CDs, but can also play CD-Rs that contain MP3 files. With a capacity of 650 MB, a standard CD-R disc can hold an awful lot of 3-MB and 4-MB MP3 tracks. With CD-RW drives becoming almost ubiquitous and prices on CD-R discs down to between 25 and 40 cents each, these players provide an excellent way to take a lot of listening along on a walk or trip.

One such model is available from Evergreen Technologies. The \$99 Portable MP3 CD Player looks pretty much like every other CD Player, with a small LCD screen and a set of controls to let you select what tracks to play. It comes with a set of rechargeable batteries and an AC power supply/charger. Operating the player with a regular audio CD installed is simply a matter of choosing what track you want to play.

With a CD-R containing MP3 files, the process is just a touch more complex. For organizational neatness, it makes sense to put your MP3 files into directories. You can use the LCD panel and controls to navigate to the desired directory and select the MP3 files you wish to play. An even easier way is to use an MP3 ripper such as *Music-Match Jukebox* to create playlists and then to simply select the desired playlist using the LCD panel and controls. In our testing, ripping an audio CD into MP3 format at CD quality sampling rate produced about 79 MB of



Compaq pushes forward into the MP3 stereo component marketplace with its latest release—the IPAQ Music Center. This unit is priced at \$799 and is geared to hard-core audiophiles who prefer multi-component systems.

MP3 files. Using variable-bit-rate encoding bumped this up to a bit over 94 MB. With a 650-MB CD-R, you can fit about five complete albums on a disc. That's a lot of music.

The Portable MP3 CD Player does have a few down sides. For one thing, it does not recognize the WMA digital music file format, only the MP3 format. Also, you can't mix WAV analog files on a disc with MP3 digital files. In addition, the disc must be a CD-R, not a CD-RW; and the player will read only the first 650 MB, so using the new 700-MB capacity discs is a waste of money.

Still, for the price, the Portable MP3 CD Player, and similar units such as the Rio Volt, provide an excellent alternative to the typical portable digital music player.

MORE MUSIC!

Assuming that even the MP3/CD player doesn't satisfy your musical hunger, the newest breed of digital music jukeboxes should. Creative Labs came out with the first of these, the Nomad Jukebox, last year. With its 6-GB hard disk, it could hold over 100 hours of music and was an instant hit.

The new Neo Jukebox 2200, from IOMagic, raises the ante. This compact 5.5- × 4.75- × 1-inch portable contains a 20-GB hard disk drive to hold music files. You can store an incredible 600 albums on the Neo Jukebox 2200, more than many of us have in their entire music collections!

Using the Neo Jukebox 2200 is easy. Connect it to your PC with the included USB cable, and your PC sees the Jukebox as just another hard disk. That means you can simply drag and drop MP3 files, directories, and playlists from your PC's hard disk to the drive in the Neo Jukebox 2200.

IOMagic includes a copy of *Music-Match Jukebox* so you can rip and organize files, but you can actually use any MP3 encoder for this purpose. As with the Portable MP3 CD Player above, the Neo Jukebox 2200 only plays back MP3 files. The firmware is flash upgradeable, however, so it's likely that WMA and future file compatibility will be added.

At \$399, the Neo Jukebox 2200 is a lot more expensive than your typical MP3 player. With its humungous capacity and the ability to be hooked up to your car or home stereo, it's a worthwhile purchase.

MP3 PHONE HOME

The digital music players discussed to this point have all been more or less portable. They are all light enough and small enough to carry with you in a pocket, on a belt loop, or in your car.

The IPAQ Music Center from Compaq is a whole different story. It is not meant to be used in a portable mode and doesn't operate from batteries, only from an AC power cord. It's also much larger, at 17- × 12- × 3.7-inches, than any of the other units reviewed—designed to fit in as a component of your home audio setup.

Priced at \$799, it's also considerably more expensive than the other digital music players reviewed in this column. That additional expense, however, is justified in view of what the IPAQ Music Center offers. Compaq has positioned the IPAQ Music Center as a high-end stereo component, just like a CD changer or other audio add-on. It presupposes that you already have a receiver or other home-theater-type amplifier, existing speaker system, and a television—all within arms length of each other. The television

SOURCE INFORMATION

Compaq Computer Corp.
20555 SH 249
Houston, TX 77070
800-888-0220
www.compaq.com

Evergreen Technologies
808 NW Buchanan Ave.
Corvallis, OR 97330
541-757-0934
www.everttech.com

IOMagic Corp.
1300 East Wakeham Ave.
Santa Ana, CA 92705
714-953-3000
www.iomagic.com

isn't necessary for the operation of the IPAQ Music Center, but it is required for the initial setup. Also required, if you want to be able to correctly label the tracks as you convert them from a CD to MP3 file, is a connection to the Internet. The IPAQ Music Center has a built-in HomePNA phoneline network adapter so that you can network the unit with a PC that's hooked up to the Internet through a dial-up or broadband connection. The HomePNA network is the one fault that we found with the IPAQ Music Center, considering that garden-variety Ethernet, either wired or wireless, is much more widely used than HomePNA for home networks.

Setup is also a bit more complex than either of the other devices reviewed here. There are an intimidating number and variety of inputs and outputs on the rear panel, with both analog and optical I/O available. As mentioned earlier, you'll need a TV set and an Internet connection available before you start. Still, 15-year old Bryan had the Music Center up and running in less than a half hour.

MP3 stereo components are starting to appear slowly in the market. In addition to Compaq's IPAQ Music Center, Dell is also selling a unit manufactured for them by SONICblue, which sells the same unit under its own Rio brand.

It's too soon to tell if this type of device will become as popular as cassette and CD players have been in the past. Still, if you are heavily into MP3 music, you'll find the IPAQ Music Center well worth looking at.

The Electronic Mouse Trap

JURGEN F. BAUER

I was sitting and watching my favorite Friday night movie when out of the corner of my eye I saw something scurrying in a dark corner of the living room. I got up to have a look, but the little beastie was faster and got away. I live on a farm; and, as is the norm, field mice and shrews are a constant intrusion. I set out the spring-loaded mouse traps baited with appealing mounds of peanut butter.

The next day I checked the traps, but had caught nothing. Three days later the traps were still empty. Strange... the mound of peanut butter on one of the traps was diminishing. Looking closely at the trap, I could see teeth marks on the peanut butter. It seemed that a shrew (a very small mouse-like creature) was eating the bait without setting off the trap. The shrew obviously didn't weigh enough to set it off.

I decided to design an *Electric Mouse Trap (EMT)* that did not require weight to trigger it. The design uses easily found, square, plastic eaves, trough downspout, and glue for almost all of the assembly. Since my research showed that rodents in general will follow a wall rather than moving across open spaces, I knew where to set the traps.

Circuit Description. The prototype circuit board was hand-wired. Figure 4 is the schematic for the basic EMT. A PIC microcontroller does most of the work. An ultra-bright light-emitting diode (LED1) is pulsed by Q4, which is controlled by pin GP4 of the PIC. LED1 is current limited by R1, a 47-ohm resistor. The light output of LED1 is seen by PD1 (a large-surface photovoltaic detector) that biases Q1 to conduct. The sensitivity of PD1 is adjusted by way of R15, a 50,000-ohm trimpot. When Q1 turns ON, the base of Q2—an inverting buffer amplifier—goes low. This reaction brings the collector of Q2 and PIC pin GP3 high.

When PIC pin GP2 (which is held low) comes high,

the MOSFET (Q3) turns ON. It activates the door solenoids (SOL1 and SOL2) for .4 seconds, thus dropping the doors (more on this later).

A standard red light-emitting diode, LED2, is used to indicate if the CPU has started properly and what mode is activated—either trap-enabled, test, or count-display.

This LED is soldered to the circuit board at a height that allows it to just fit in a hole drilled into the enclosure cover.

The pushbutton (TEST/S1) is used to navigate through the different modes. The whole

circuit is powered from a 12-volt wall wart that directly supplies power to the solenoids. A 5-volt despiked fixed regulator supplies power for the rest of the electronics. Rather than using a frequency-modulated IR LED and a frequency-demodulating circuit, I opted for simplicity due to the short distance between LED1 and PD1.

The newer high-powered LEDs on the market today are so bright that they are almost laser-like. **WARNING: Do not stare directly into LED1 when it is working.**

Building a better mousetrap with the help of optical sensors

Construction. The circuit is simple enough to hand-wire. Whether you use a printed circuit board or do hand-wiring, I strongly suggest using a socket for the PIC. See Fig. 6 for the parts placement. All the electronic parts (except for LED1, PD1, D1, and D2) are mounted to the circuit board. Be careful when you handle the PIC and Q3. These parts are more static sensitive than the rest. Before applying power to your board, double-check that all the parts are oriented in the proper direction; that no solder bridges, cold joints, or missing solder joints are present; and that a short-circuit test has been performed across the power supply.

A second version (MTRAP18) of the EMT that uses a PIC16C620 with a crystal oscillator and an LCD display, 29

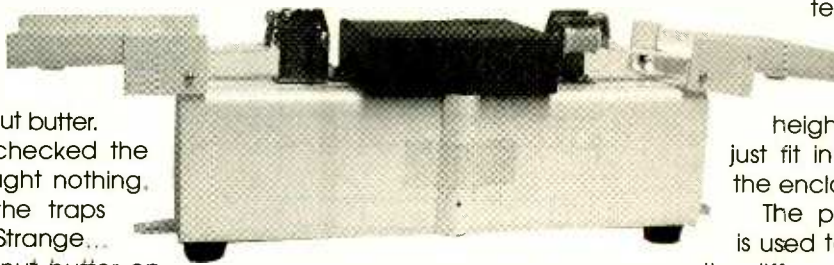

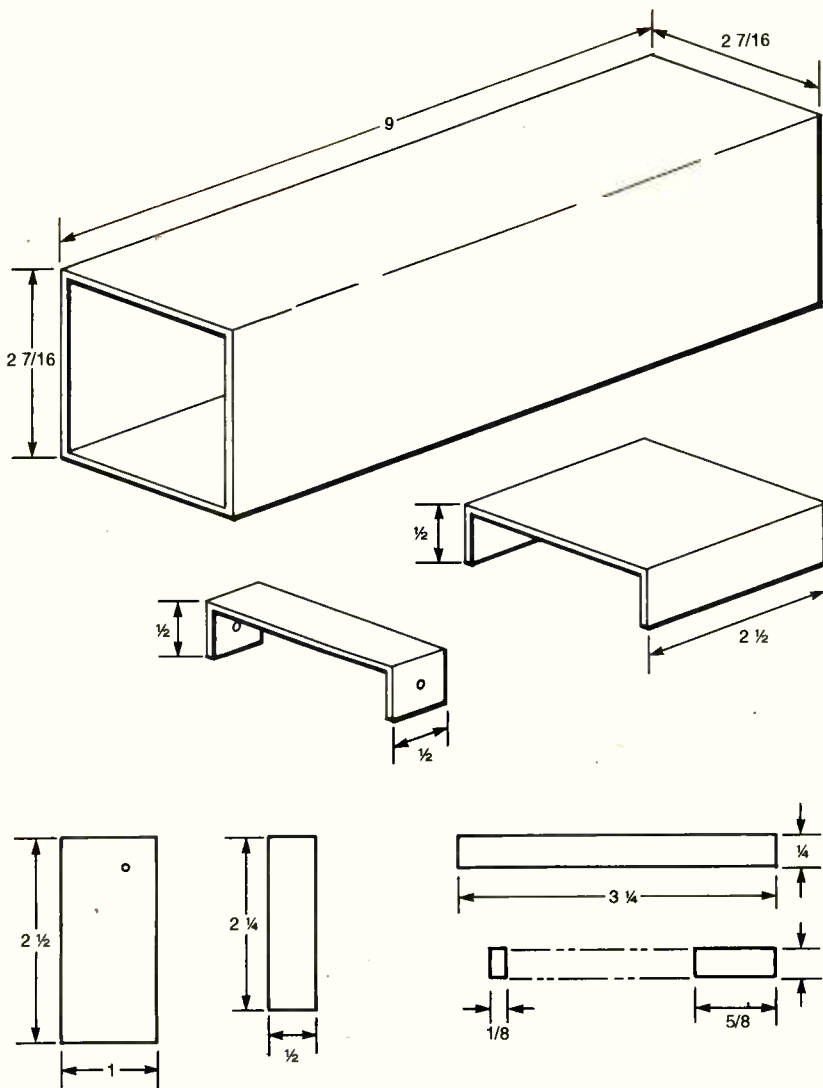

ALL DIMENSIONS IN INCHES

Fig. 1. The Electronic Mouse Trap consists of a rectangular corridor with a spring-loaded door at each end. An LED/photodetector circuit acts as a trigger. The dimensions for each plastic piece are given above.

providing a better visual feedback of the mode currently in operation, is shown in Fig. 5. This version also includes a subroutine that more easily aligns LED1 to PD1.

We will concentrate on the PIC12C671 version (MTRAP8). This PIC uses its own internal RC timing clocked at 4MHz, so no external RC or crystal oscillator is required. Figures 7 and 8 are foil patterns for the component side and solder side, respectively.

Solenoids—Part 1. The solenoids are actually 30-amp, 12-volt relays that have been modified. Take your time to modify the relays. Start by using very small side cutters—

the type used for circuit boards—and start nubbling one of the corners of the plastic casing. Continue until a small hole appears, and then you can use small needle-nose pliers to gently break off more and more of the casing. Once you have the relay coil and contacts free of the black casing, start removing the contacts. Carefully trim the plastic that holds the contacts in place. The common contact that is riveted to the moving armature must be cut off using sheet metal snips. Be very careful not to damage the coil or armature spring. Figure 3 shows what the solenoids should look like when the modification is all done.

The solenoids must be attached to a mounting bracket. Fashion two mounting brackets from .025-inch brass stock and drill all the holes shown in Fig. 3. Clean the burrs and sharp edges from the holes and bracket. The solenoids must be soldered to the brackets using a soldering gun or a very hot iron. If you use fast, high heat, you will be less likely to damage the coil or plastic parts of the solenoids. Place heat shrink or some type of insulation on the coil wires so that they can't create a short on the bracket. Set the solenoids aside for now. They will be mounted later.

Housing And Doors. If you follow Figs. 1 and 2, constructing the main housing doors and latch springs is not difficult. Figure 1 shows the dimensions of the main housing, main hinges, doors, latch springs, door hinges, and relay latch bars. All of the parts are cut from a piece of 2½ × 2½-inch square eaves, trough down-spout, about 16-inches long. This down-spout and the special adhesive to glue the parts together are available at any well-stocked hardware store.

I used a table saw to cut the main pieces for the 9- × 2 7/16- × 2 7/16- inches corridor. The piece that is left over is used for all the other parts, like the latch springs and relay-latch bars. I used a pair of sheet metal shears to cut the parts out. You can use any method that works for you. Once all the parts are cut to the proper dimensions, sand off any rough edges that may be present.

Glue the relay latches and the door hinges to the doors, as shown in Fig. 2. Use the glue sparingly, because it doesn't take much to weld the parts together. The parts will have a much better fit and move more freely if large gobs of glue are not produced. Next, glue the main hinges to the main housing as shown. The last part to glue is the latch springs. Follow the expanded view of Fig. 2.

Let these parts dry for at least two hours. The glue melts the plastic material of the two parts and then sets after evaporating the solvent. It takes at least two hours. Be sure to use the glue in a well-ventilated area.

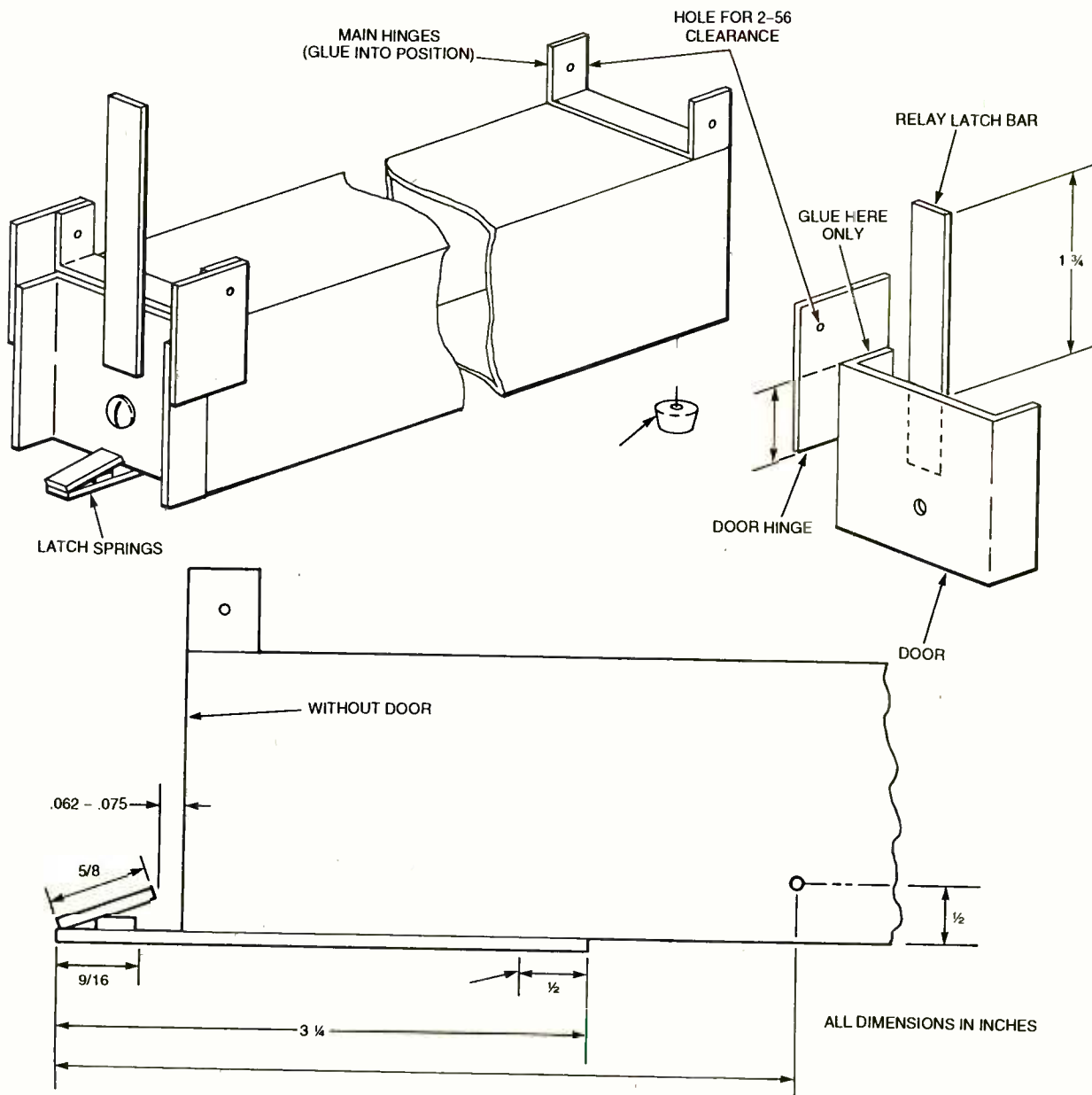

Fig 2. This figure shows how all the pieces fit together, as well as the various points where glue is needed. Be sure to follow all directions and heed all warnings related to the glue.

Read the instructions on the box and tube of glue before using.

When the glue has dried, take the assembled latch springs and glue them to the main housing. See Fig. 2. Be careful to only glue $\frac{1}{2}$ -inch on one end. Follow Fig. 2 for spacing the latch part of the spring properly. Use a piece of tape to hold the springs in place—flush against the bottom of the main housing—until dry (two hours).

Attach the $\frac{3}{8}$ -inch thick rubber feet to the bottom four corners of the main housing. The thickness of the rubber feet assures the proper functioning of the latch springs.

Figure 2 also shows the correct position of the doors on the main housing. Hold them in this position, and drill a clearance hole for a 2-56 machine screw through the center of the main hinges at all four main hinge locations. Clean the burrs from the holes, and install four 2-56 screws and nuts to hold the doors in place. Be careful not to tighten the nuts in a way that leaves the doors free-swinging. When you let the doors fall shut, the latch springs must hold the door locked until released. If the doors do not fall quickly and easily, you may have to add more weight to them. Add

a 1-32X, $\frac{1}{4}$ -inch machine screw and nut near the center bottom of the doors. Make sure that these screws do not interfere with the latch-spring operations.

Solenoids—Part 2. Now that the doors function without binding, it is time to install the solenoids on to the main housing. Start by opening one of the doors. Hold one of the solenoids in place, while referring to Fig. 3. Line up the relay latch bar just under the solenoid-moving armature, and mark the holes of the solenoid bracket onto the main housing.

Drill two 4-40 machine screw

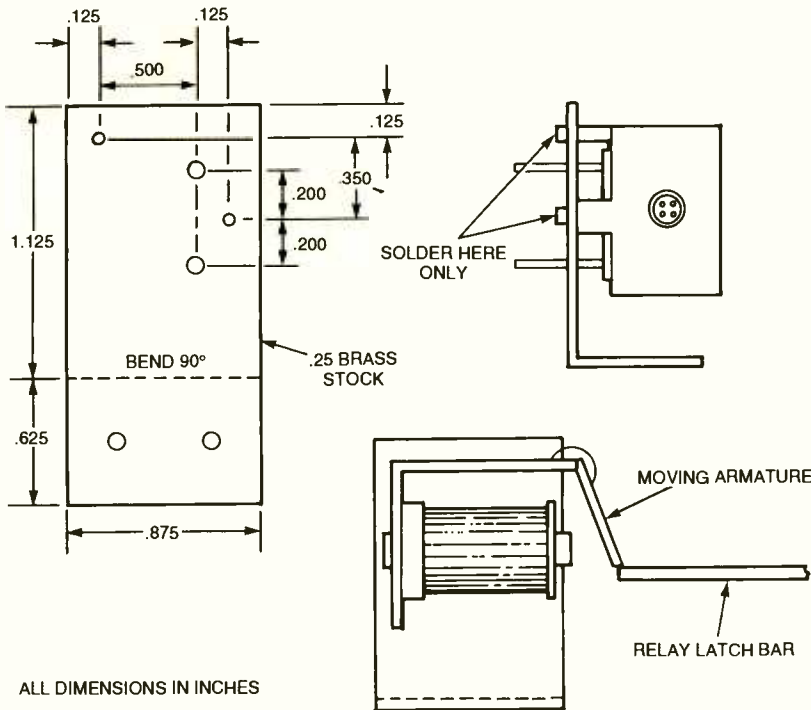

Fig. 3. Solenoids provide the control for the spring-loaded doors. This figure shows how to properly mount the two solenoids required.

clearances holes where marked, and attach the solenoid bracket. Install the nuts on the outside of the main housing. Check the operation of the solenoid by manually moving the armature to release the door. You may need to adjust the position of the solenoid or perhaps trim the

relay latch bar to get the desired result. If the solenoid release works well, then install the other solenoid for the other door in the same way.

Final Assembly. Take the circuit board enclosure, and glue it centered to the top of the main hous-

ing. Let the glue dry.

At the exact center of one side of the main housing, exactly 1/2-inch from the bottom, drill a 3/16-inch diameter hole to mount LED1 (see Fig. 2). LED1 press fits into this hole from the outside of the main housing. Do not push it all the way in. This will allow you to adjust the alignment of LED1 later, if required.

On the opposite side of the main housing, at the exact center and exactly 3/8-inch from the bottom, drill a 1/32-inch hole. At .2-inch higher, drill another 1/32-inch hole for PD1. PD1 must be installed from the inside of the main housing through the two 1/32-inch holes, with the leads outside of the housing. Note which direction the red dot on PD1 is facing.

Attach two wires to PD1 and two wires to LED1 that are long enough to be wired into the enclosure. Drill two 3/32-inch holes into the enclosure where these wires will enter.

Solder these eight incoming wires to the circuit board, following Fig. 4 (or Fig. 5 for the PIC1C620). Solder the wires from the 12-volt wall wart to the circuit board. You can install an ON/OFF switch in series with the supply, if you like. Make sure you check the polarity of the wall wart before soldering it to the circuit board.

After all the connections have

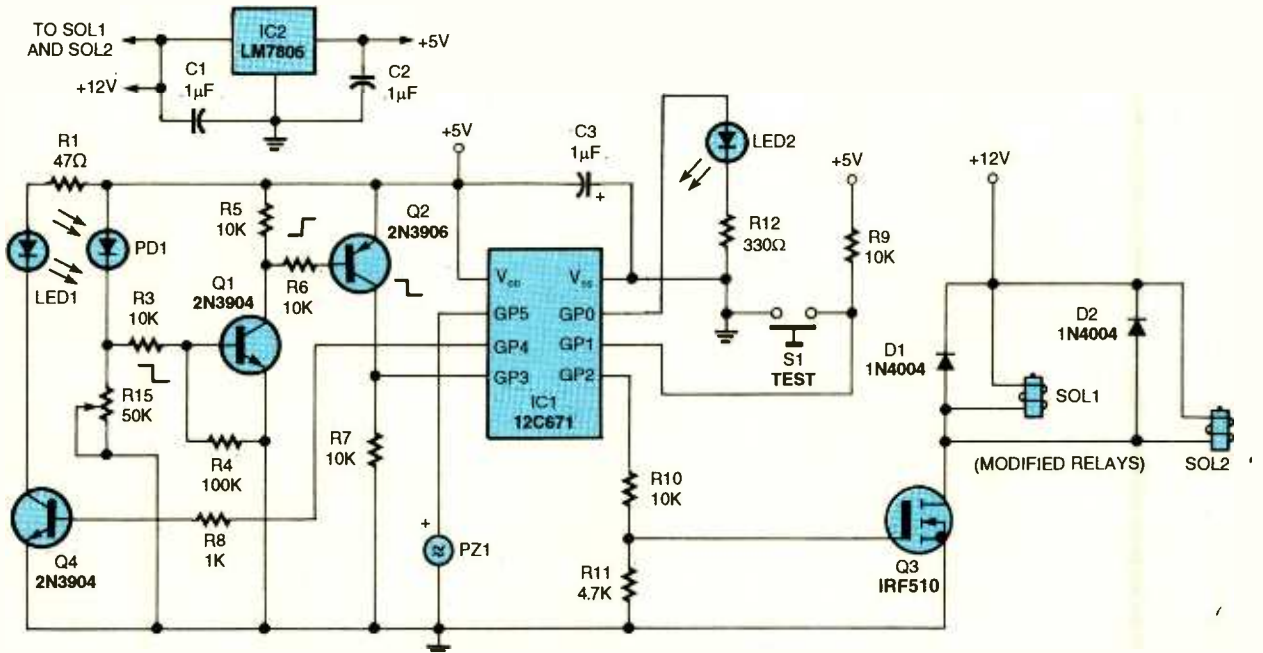

Fig. 4. The schematic above shows the circuit for the Electronic Mouse Trap. The circuit is controlled by a PIC12C671 microcontroller. Note the locations of LED1 and PD1. When an object blocks LED1's light from hitting PD1, the solenoids activate and release the doors.

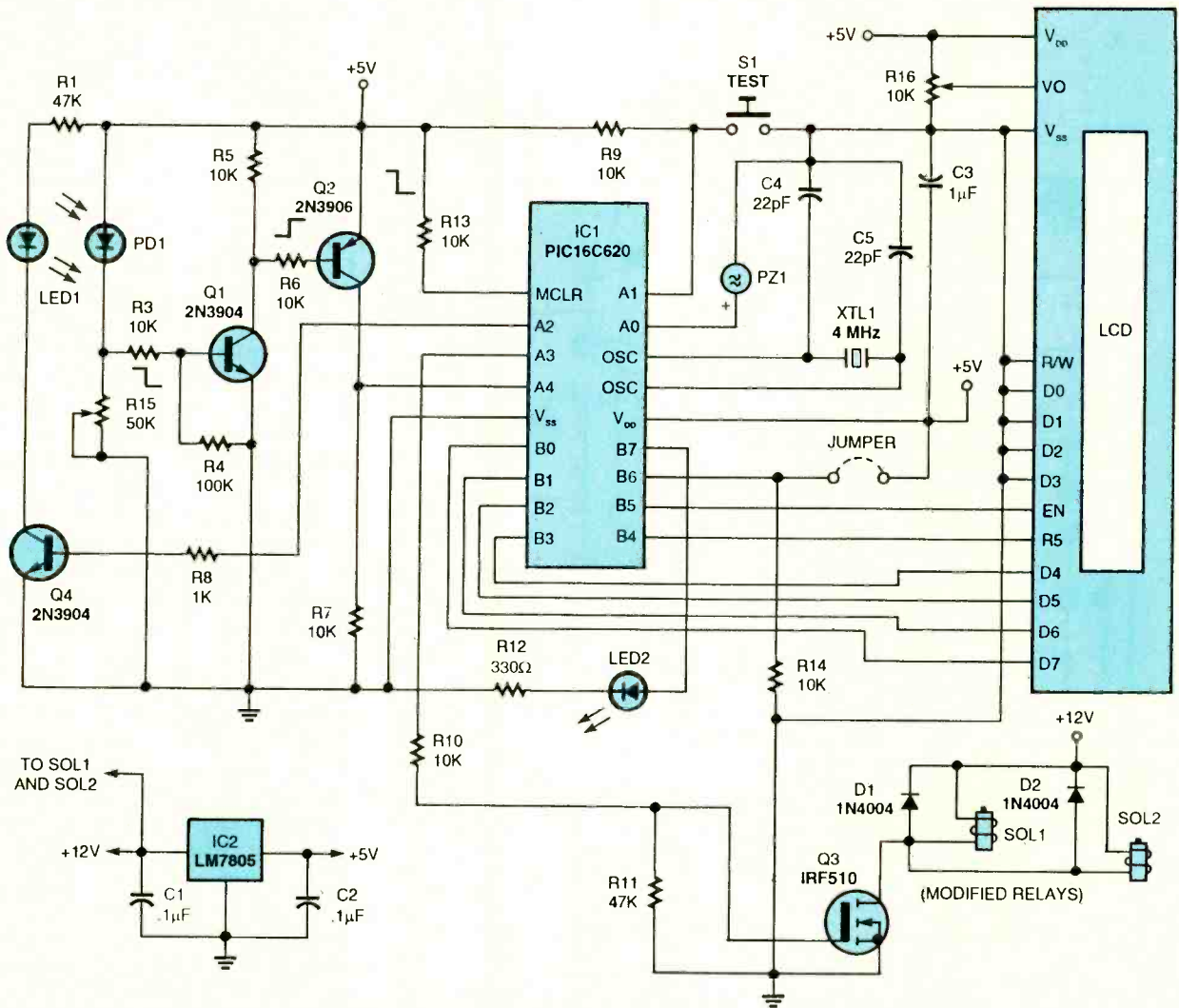

Fig. 5. This is the schematic for the upgraded Electronic Mouse Trap (MTRAP18). The modified version employs a PIC16C620 with a crystal oscillator. Another addition is an LCD display that gives a visual indicator of the trap's performance.

PARTS LIST FOR THE ELECTRONIC MOUSETRAP

SEMICONDUCTORS

IC1—Pre-programmed PIC12C761 microcontroller
 IC2—LM7805, voltage regulator, 5-volt/1-amp
 Q1, Q4—2N3904 silicon transistor
 Q2—2N3906 silicon transistor
 Q3—IRF510 N-channel MOSFET transistor
 D1, D2—1N4004 diode, general purpose rectifier
 PD1—Photodetector (Jameco #PDB-V113-ND)
 LED1—Light-emitting diode, T1- $\frac{1}{4}$, ultra-bright
 LED2—Light-emitting diode, T1, red
 PZ1—Piezo beeper, 5-volt (Jameco #76064)

RESISTORS

(All resistors are $\frac{1}{2}$ -watt, 5% carbon-film units, unless otherwise noted.)
 R1—47 ohms
 R2—not used

R3, R5, R6, R7, R9, R10, R13, R14—10,000 ohms
 R4—100,000 ohms
 R8—1000 ohms
 R11—4700 ohms
 R12—330 ohms
 R15—50,000 ohms potentiometer
 R16—10,000 ohms potentiometer (R13, R14, and R16 are used only for MTRAP18)

CAPACITORS

C1, C2—0.1 μ F, ceramic-disc
 C3—1 μ F, tantalum

ADDITIONAL PARTS AND MATERIALS

SOL1, SOL2—(2) 12-volt relays (Jameco 129349)
 S1—Pushbutton test-switch (B G Micro SWT1002)
 Enclosure (All Electronics MB73), $\frac{3}{8}$ -inch rubber feet (Jameco 126981), (4)

4-40 machine screws, (4) 4-40 nuts, (4) 2-56 machine screws, (4) 2-56 nuts. PVC glue, brass stock $\frac{3}{8}$ × 4 × .025-inches

NOTE: The following items are available from BAUER Electronics, Inc., 1805 Rte 340, St. Telesphore, Quebec, Canada, J0P 1Y0. www.bauer-electron.com: Kit of all PCB mounted parts, including pre-programmed PIC12C671, ultra-bright LED, and photo detector (no PCB, enclosure or relays), \$28.50; Pre-programmed PIC12C671 or PIC16C620; \$9.95; Ultra-bright LED, \$2.95. Please add \$5 for shipping and handling in Canada or \$10 outside of Canada. Canadian residents add appropriate PST and GST. Money orders only accepted. No credit cards, please. All prices are in US currency.

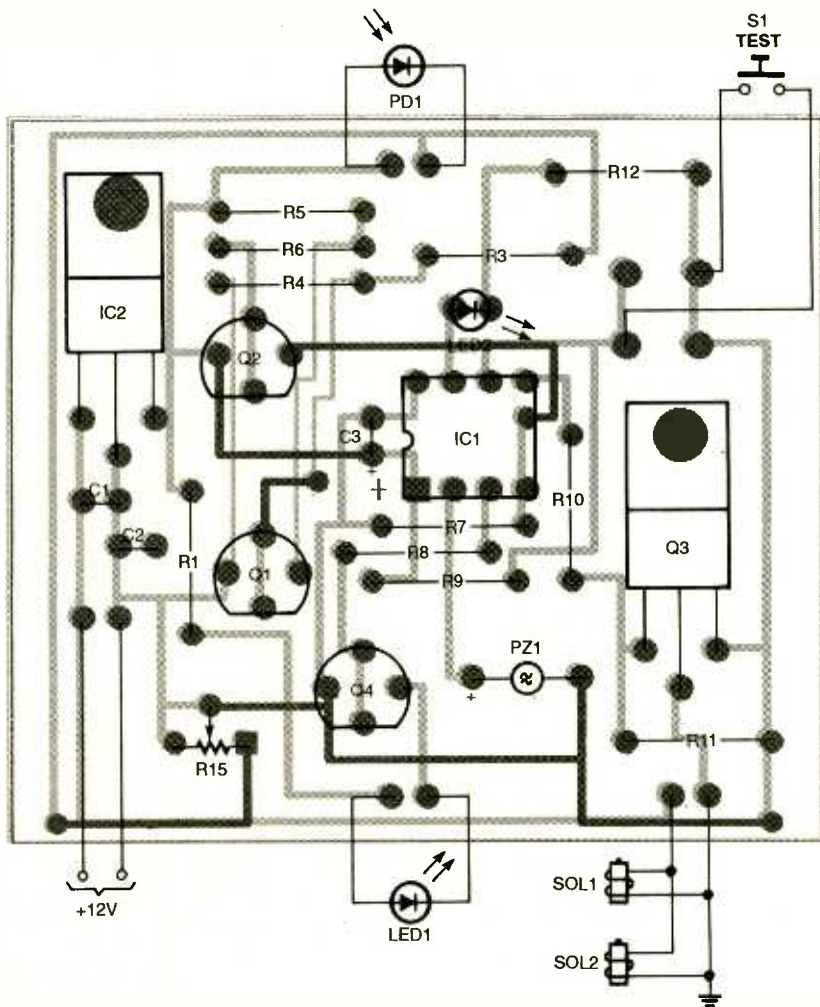

Fig. 6. Use the parts placement diagram above as a reference for constructing the Electronic Mouse Trap. Make sure to observe capacitor polarity.

been made, drill a $\frac{3}{16}$ -inch diameter hole in the enclosure cover for LED2 to show through. Drill a $\frac{1}{2}$ -inch diam-

eter hole to access the pushbutton through the cover.

By cutting two corner pieces from the leftover down-spout parts, you can fashion a cover to go over the wires coming up the two sides of the main housing from LED1 and PD1.

Testing. Once you have double-checked everything, it's time for the smoke test. First, set R15 to its maximum resistance (most sensitive). Plug the wall wart into the wall and watch LED2. It should flash three times and stay ON. LED1 should also be

flashing.

If LED2 flashes three times and turns OFF, LED1 is not flashing, and the beeper PZ1 is sounding every eight seconds, check the polarity of LED1. If the polarity is correct, then press and hold the pushbutton down. LED2 will flash three times and go OFF. You are now in the COUNT?TEST mode. LED1 will be flashing either rapidly or once in a while. If LED1 is flashing once in a while, you have to align LED1 to PD1. When LED1 is properly aligned, it will flash rapidly.

When LED1 is aligned, unplug the wall wart for five seconds to reset the PIC. Plug the wall wart back in. LED2 will flash three times and stay ON. LED1 will also be flashing. Lift the doors by unlatching the latch springs and latching the doors to the solenoids. Use a ping-pong ball or similar object and let it roll through the EMT. Do not throw the object. The EMT was designed so that it wouldn't detect a flying insect crossing the light beam (I live on a farm). Since rodents don't move at very high speeds, the PIC software timing is set for rodents and the like.

The last thing to do is to put the EMT in the area it is to be used and shut off all the lights. For the 8-pin PIC or 18-pin PIC circuits, put the EMT into TEST mode by holding the TEST button until LED2 stops flashing. Now adjust R15 until LED1 stops flashing rapidly, and then slowly adjust R15 until LED1 just starts flashing rapidly again.

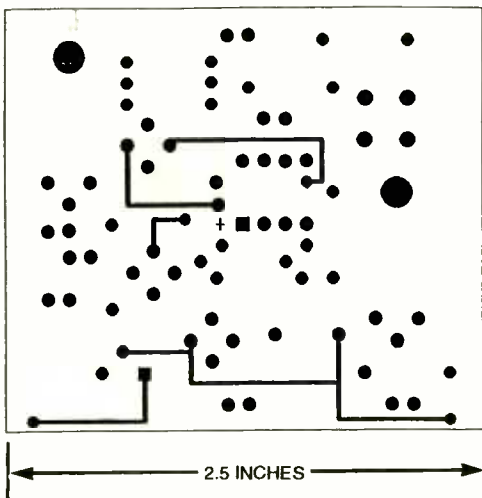

Fig. 7. This foil pattern represents the component-side copper trace.

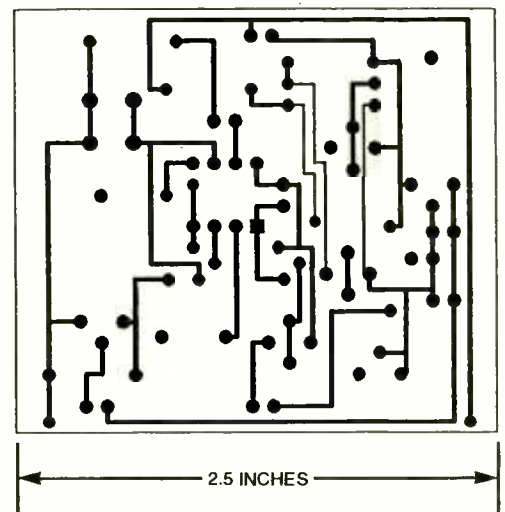
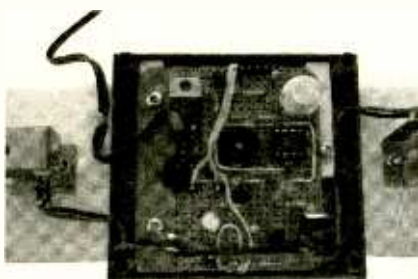

Fig. 8. Here is the solder-side foil pattern for the main PCB module.

Using The EMT. Using the EMT requires little human intervention. For the TRAP ENABLED mode, plug the wall wart into the wall, lift the two doors until they latch open on the solenoids, and wait for the beep indicating a trap event.

For the TEST mode, from the TRAP ENABLED mode, press the TEST button until LED2 stops flashing. The TEST mode allows you to monitor the rodent traffic through the EMT without activating the solenoids. If you are using the 8-pin PIC circuit, pressing the TEST button will flash LED2 the number of times an LED1 beam break was detected. If you are using the 18-pin PIC circuit, the number of beam breaks will be seen on the LCD display.



Here is a close-up view of the circuit used in the author's prototype. The voltage regulator is seen in the upper left corner, while the piezo tweeter is nearly dead center, and to its right is the PIC microcontroller that is mounted in a socket. Notice that the two servos can be seen to either side of the control box.

Conclusion. I have used the EMT for about seven months and have caught my share of field mice and shrews. I let my friends use the EMT with great success. Just remember that most of the time the critters stay parallel to a wall and, if you know where they are coming out of a hole, you can direct them through the trap by temporary cardboard barricades and walls.

The biggest problem my friends had was what to do with the rodent once it was trapped. By the way, the flashing ultra-bright LED1 does not seem to hinder or frighten away the rodents.

For the squeamish and the animal lover, I suppose you could take the creature outside and let it go far away from your property. Release it too close to your home, and the rodent will find its way in again very quickly. 

DIGITAL DOMAIN

(continued from page 26)

some of the letters. All of the letters were made to appear to be spontaneous expressions of ordinary people.

Though the Internet is not unique, it is special. As the greatest boon to information dissemination since the invention of the printing press, it's also the greatest boon to info scams. Because it's so easy to put information on the Net, it's equally easy to find false information as well.

HONING YOUR "WEB-SMARTS"

How can you protect yourself? How should you ferret out good information on the Net from bad? How do you find truth? First, don't overreact. There is much information of value to be found everywhere on the Net. You just need to think critically about what you come across. Also, check out some of the sources listed in the sidebar.

Think about the source of informa-

tion. Is it a news organization, professional or trade group, government agency, nonprofit organization, company, educational institution, advocacy group, student, or hobbyist? Different sources employ different levels of thoroughness in research and fact-checking and different levels of objectivity.

Think about why the person or organization is presenting the information. Individuals and organizations often have agendas—sometimes explicit, sometimes hidden. If you uncover the agenda and keep it in mind when evaluating the information, you'll be better able to filter out any bias.

Think about whether or not the information is paid for. Some Internet search engines place sites at the top of their listings not because of their usefulness or popularity, but because these sites have paid for top billing. Some book review sites accept payments from publishers for endorsing books without notifying readers. When in doubt, send the site an e-mail message asking about its policies.

Think about if, or how widely, the information diverges from your current understanding. If it diverges widely and may affect an important business, health, or family decision, try to verify the same information with at least two other sources. Information scientists call this the "principle of triangulation of data."

Think about whether the information is new or old. A lot of deadwood data is floating around in cyberspace at Web sites that haven't been updated in several years. If the site doesn't include a "Last updated" line or otherwise date its content, check out some of its links. If more than a couple are no longer working, the information at the site may no longer be up to date either.

Think about substance. Don't judge a Web site by its appearance alone. Looks can and do deceive, although appearance does count. A site that looks slopped together may include information that's been sloppily researched and presented.

In short, be skeptical, not cynical, about the Internet as an information resource. The watchword is "Caveat lector" —Let the reader beware.

Reid Goldsborough is a syndicated columnist and author of the book *Straight Talk About the Information Superhighway*. He can be reached at reidgold@netaxs.com or <http://members.home.net/reidgold>. 

POINT AND CLICK

About.com's Urban Legends
<http://urbanlegends.tqn.com>

Company Sleuth
www.companysleuth.com

Encyclopedia Britannica.com
www.britannica.com

Evaluating Web Resources
www2.widener.edu/wolfgang-memorial-library/webevaluation/webeval.htm

eVoice
www.evoice.com

How To Critically Analyze Information Sources
www.library.cornell.edu/okuref/research/skill26.htm

PayPal
www.paypal.com

PhotoPoint
www.photopoint.com

Thinking Critically About World Wide Web Resources
www.library.ucla.edu/libraries/college/help/critical/index.htm

vMyths.com
www.vmyths.com

Xdrive
www.xdrive.com

What Could Be Made From This?

Time to get out your breadboards and VOMs. This month we have five circuits for your experimenting pleasure. I wonder if there is a forward-thinking hobbyist who could incorporate all of these circuits into one wonder device. What device would contain an RF probe, a logic probe, an AM radio, a metronome, and an IR detector? It would either be the next Mars rover or the latest gadget from *Ronco*. And now, with no further flash, here are the circuits.

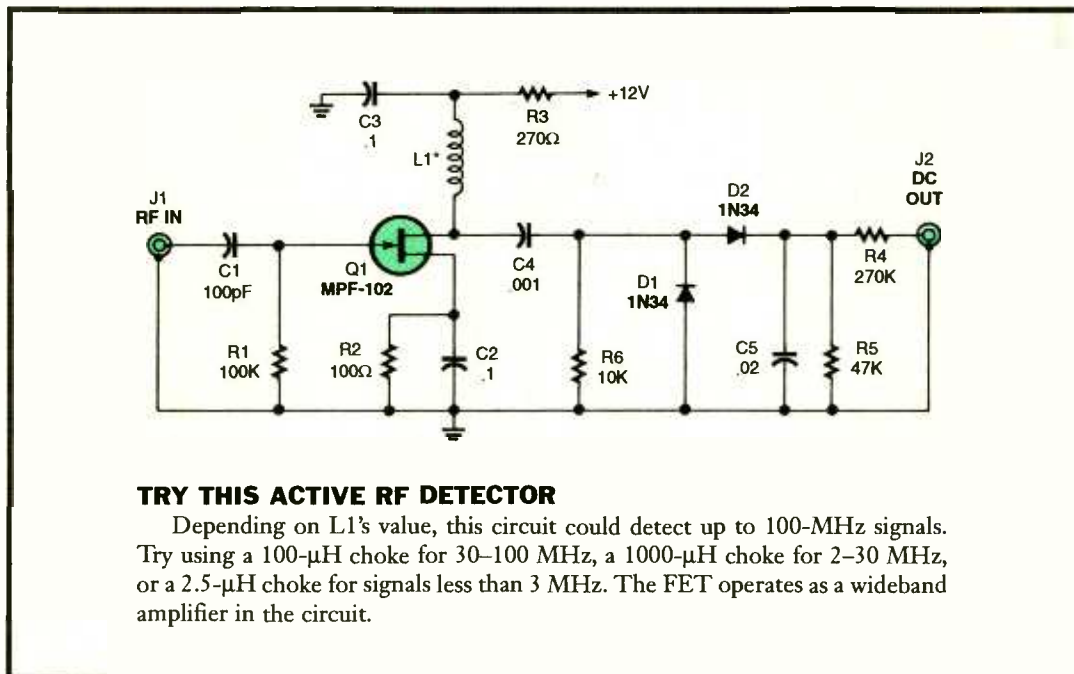

TRY THIS ACTIVE RF DETECTOR

Depending on L1's value, this circuit could detect up to 100-MHz signals. Try using a 100- μ H choke for 30–100 MHz, a 1000- μ H choke for 2–30 MHz, or a 2.5- μ H choke for signals less than 3 MHz. The FET operates as a wideband amplifier in the circuit.

Nikola Tesla (1856-1943)

The debatable father of television, radio, wireless remote control, and holder of many other patents, Tesla has captivated the minds of many. No other scientist seems to be surrounded by so much controversy and intrigue. In his time, he was often regarded as mad (in the old sense) and eccentric.

One thing is for sure; we can all thank him for his persistence in incorporating AC into our power production grid. Until Tesla came along, scientists like Edison were trying to power cities with DC. Tesla's patent for AC power was sold to George Westinghouse in 1888. Tesla may have won the battle, but as time passed, Nikola's name was obscured and Edison's fame grew.

Nikola Tesla's most famous invention was, no doubt, the Tesla Coil. To this day, backyard inventors try to improve on the original spark-gap design. Tesla's largest coil once stood at his lab at Wardenclyffe, located in Shoreham, NY.

Our founder, Hugo Gernsback, had developed an amicable rapport with the scientific genius, Tesla.

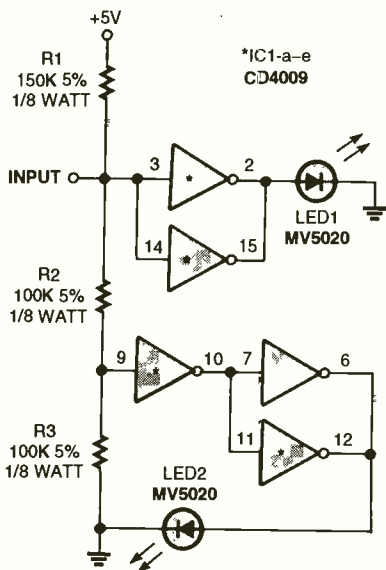

SINGLE-IC LOGIC PROBE

Using a CMOS hex-inverter chip, you can build this handy logic probe. When the probe is touched to a logic low, LED1 lights. If the probe touches logic high, then LED2 lights. Inputs less than 2 volts will have the same effect as an open; no lights will be lit.

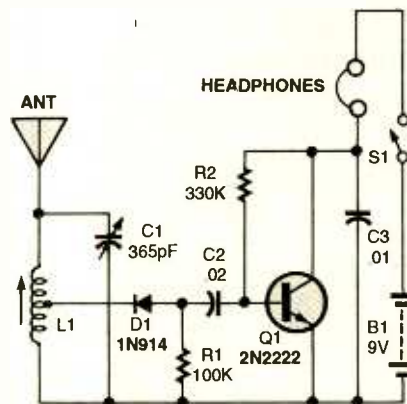

AM RADIO RECEIVER

All you need to receive AM broadcasts is a diode detector, an audio amp, and a small amount of supporting components. Inductor L1 is a variable inductor, similar to those found in a transistor radio. In this circuit, the diode strips the intelligence from the carrier; and the audio signal is amplified by transistor Q1. This is a good example of a diode used as a rectifier. In this case, the rectified signal is the AM broadcast.

Thomas Alva Edison (1847-1931)

At the age of 12, Edison built his own printing press and was producing a daily newspaper from his home, which he sold to commuters at a nearby train station. His entire life would be marked by ingenuity and creative genius. By the time of his death in 1931, he would lay claim to over a thousand patents.

Some of his accomplishments include the discovery of radio waves in 1875, the invention of both the carbon transmitter and the phonograph in 1877, the invention of a carbon-filament lamp and DC generator for incandescent electrical light in 1879, and a radio transmission method in 1855 (that he later sold to Marconi).

In 1888, Edison tried his hardest to convince George Westinghouse that AC electrical systems are both dangerous and impractical. This old-fashioned mud slinging would not work against his target—Nikola Tesla. To say these two men disliked one another is a massive understatement.

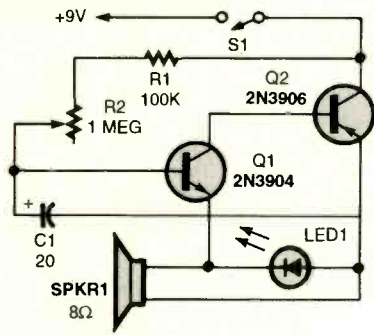

METRONOME

This oscillator circuit powers both an 8-ohm speaker and an LED. The frequency can be adjusted by varying resistor R2. The result is a thumping and flashing metronome that's perfect for any musician or even for a timer on an exercise bike. Of course, the speaker and the LED can be removed; and the variable oscillator would be ready for insertion into any circuit requiring a variable output frequency above .5Hz and below 10Hz.

Guglielmo Marconi (1874-1937)

Known as the "Father of Radio," Marconi would later share this title with none other than Nikola Tesla. Ironically, Marconi's famous trans-Atlantic broadcasts used seventeen patented Tesla devices. Regardless, Marconi was a pioneer of radio communications.

Prior to the twentieth century, Marconi had successfully engineered a wireless system capable of broadcasting from ship to shore and back again. Marconi opened the world's first radio factory, which was based in Chelmsford, England. In 1898 he founded Wireless Telegraph and Signal Company, Ltd. This company has evolved into Marconi Corp., today. Marconi spent the final years of the nineteenth century perfecting his ship-to-shore radio systems.

In 1902, while onboard the US liner, *Philadelphia*, Marconi demonstrated the effects of reflection on radio waves. He showed that the range of transmission is better at night by transmitting 2000 miles, as opposed to only 700 miles by day.

Marconi's equipment managed to transmit from England to Australia in 1918. This monumental accomplishment only hinted at the possibility of today's global communications.

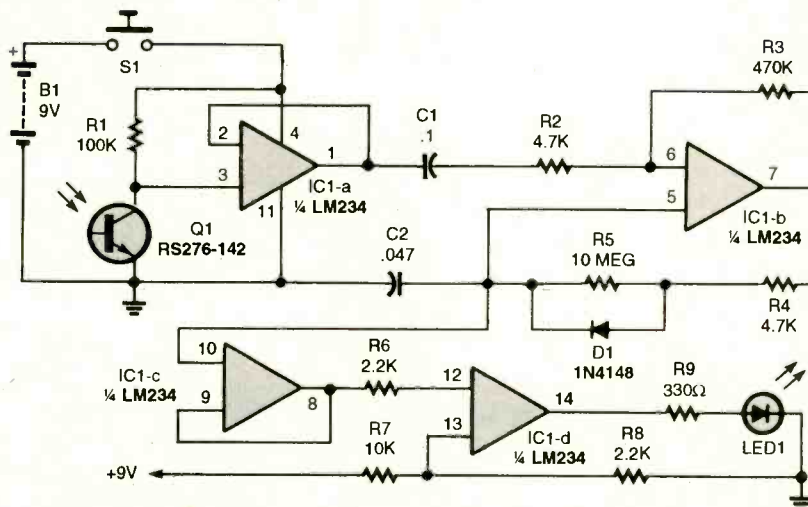

IR DETECTOR

Do you want to know if your TV remote is operational? This circuit will turn on LED1 for 2 seconds when it detects IR light pulses. Component Q1 is a phototransistor detector, and it works. It feeds the voltage-follower amp that charges C2. Capacitor C2 supplies a sample to another voltage-follower amp that powers the LED.

N.C.O.s

Q In the October 2000 issue of *Poptronics*, there is an article on numerically-controlled oscillators (NCOs) that talks about how to build them. The article by Tom Napier makes mention of NCO chips. I was wondering if you know what these chips are and who their manufacturers are.—S. G., Trafford, PA

A It's odd how NCOs, UPSs and ATMs are altogether different in modern electronics compared to their old meaning in the military, shipping industry, and banking. NCOs are the darling of the communications world. As Tom's article explains, they use a large digital word to set the frequency of a sine wave that is digitally-generated. Frequency-agile technology is the term often used to describe devices that can change their frequency at a very high rate of speed. Applications for this technology are found in spread-spectrum telephony and secure communications for military personnel. NCOs can easily frequency- or phase-modulate the output signal. In fact, Harris, the big manufacturer of broadcast transmitters, uses NCOs for their FM transmitters. They are the heart of direct digital synthesizers.

NCOs are manufactured by several companies including Intersil (HSP45102, HSP45106) and Analog Devices (AD9830, AD9832). You might be interested to know that Tom also wrote an NCO article in the October 1998 issue of *Circuit Cellar* magazine.

Conar, The Barbarian?

I've received responses from several of you kind folks regarding my plea for test equipment manuals for correspondence school kits—brands such as Conar, Bell & Howell, and Ameco (but not Heathkit). A special thanks to Jeffrey Lawrence, John Christensen, and Ralph Dominguez for their kind offers and contributions.

S-Video Jack Pins

Q I am in need of the pin-connections on an S-Video jack. Can you help me with this?—D. K., Boonton, NJ

A The S-Video standard separates the luminance and chrominance signals into two lines to reduce crosstalk and increase bandwidth and is incompatible with standard line-level video. The connector pinout, as seen from the solder lug side, is shown in Fig. 1. Pin 1 is the luminance ground; pin 2 is the chrominance ground; pin 3 is the luminance/ sync signal; and pin 4 is the chrominance signal

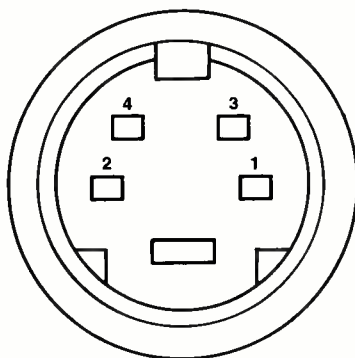

Fig. 1. The S-Video plug as viewed from the "solder tab" end, illustrating the pin locations as described in the text, is a 4-pin "mini-DIN" type of connector.

More Capacitors?

Q I was sorting components. When I got to the film and ceramic capacitors, I wasn't sure what those capacitance codes stood for. Here are the codes from four film capacitors that I wasn't sure about: "0.01K400," "0.1K400," "1.0K400," and "10K400." The next one is a two-line code: "1/10" on top and then "100 MKT" under it. I also have some capacitors that don't have a voltage rating where the first two have a two-line marking and the third is one line: "103" and then "M3E," "474M" and then "3 D," and then "224" and nothing else. The last one is three lines: ITT 7329 T, 15630V6-14, and .1UF100VDC. Do you have a guide for identifying capacitors and a guide for reading those stamped codes?—M.J., Surrey, British Columbia

A Different versions of the basic "How do I read capacitor values" question come up frequently, and this will be the fourth installment in the last two years in the "Q & A" column. Each time, we

have a new wrinkle. Perhaps we could find a way to post this information on the Gernsback Web site at www.gernsback.com.

The first four caps mentioned are 0.01, 0.1, 1 and 10 microfarads in that order, each rated at 400 volts. The "K" means a tolerance of 10%. See the March 2001 "Q & A" column for more information on tolerance letter codes. If a capacitor value is in decimal form with a value less than 1, it is ALWAYS in microfarads. If the value is in whole numbers, you have to watch the capacitor construction and the style. If it's obviously an electrolytic, the value is usually in microfarads; if not, it's in picofarads.

I'd have to actually see the next cap to determine its value, and even then, I might resort to a digital capacitor meter to make the final determination. I'll admit defeat before making an incorrect choice. My preferred guess would be that "1/10" means 1 microfarad at 10 volts while the "100MKT" is a general style number that will be found on all caps of this type regardless of the value. If you choose "100MKT" as meaning 100 volts and "M" as 20%, then you have to deal with "1/10" somehow as well as the remaining "KT". Again, the meter would be used to verify my choice. If the meter said 1.2 microfarads, I'd still put the cap in with my 1 microfarad units, going by the marked value rather than the actual reading.

The next three caps are read as shown in the previously cited columns and will be 0.01 microfarads at 20% ("M" is a bit of an educated guess here), 0.47 microfarads at 20%, and 0.22 microfarads. With that last one, I'd assume a "Z" tolerance since no other was shown, which would be -20%/+80%, typical for "bulk" capacitance used in decoupling circuits. M.J. had photos attached of these three, asking what type they were. Since the photos would not have reproduced well here, I'll describe them. All three are radial-lead, conformal-coated ("dipped") capacitors, yellowish-beige in color with the imprinting in black or red ink. These are ceramic capacitors and might be monolithic or multilayer ceramics to get a lot of capacitance into a small volume.

The last cap, as shown in the photo, is a rectangular-shaped thing, black in color with white imprinting and radial leads. It's likely a plastic dielectric, most probably polyester. The lettering on the photo was a little fuzzy, but the top line, "ITT 7329 T" likely indicates that the cap was made for ITT (International Telephone & Telegraph), maybe in week 29 of 1973. The next line is probably the ITT internal part number, a "house number" for which you'll never find out anything unless you have some company-confidential material in hand. The last line is the value and voltage rating, 0.1 microfarads at 100 volts.

Muscle Wires?

Q *I have been looking for circuit diagrams for an electronic muscle stimulator (similar to a TENS unit) and can't find anything anywhere. Do you have any idea where I could get schematics for these devices? They are used for muscle development and are especially helpful for people who can't exercise because of arthritis (which I have) or other ailments.—W.H., via e-mail*

A One reason that you can't find a schematic like that is that the companies that manufacture such units closely

guard the guts of their products because of liability issues. They don't want anyone but bonded/insured, authorized/licensed BMETs (biomedical electronic technicians) repairing any unit that connects to the body, especially if that device is connected to the electrical mains and/or puts out a current such as the device you describe.

As much as I'd like to help in that regard, the publisher and I are bound by the same code to avoid publishing information for circuits that have the potential of failing or which may be constructed of inferior or incorrect parts and could end up jeopardizing human life. Neither do we want to condone the use of non-prescribed treatments, which could be dangerous to the individual. A manufacturer's desire for profit doesn't drive up the cost of electronic medical devices as much as the liability insurance and bonding they must have to produce such things.

HOW TO GET INFORMATION ABOUT ELECTRONICS

On the Internet: See our Web site at www.poptronics.com for information and files relating to **Poptronics** and our former magazines (**Electronics Now** and **Popular Electronics**) and links to other useful sites.

To discuss electronics with your fellow enthusiasts, visit the newsgroups sci.elec.tronics.repair, sci.electronics.components, sci.electronics.design, and rec.radio.amateur.homebrew. "For sale" messages are permitted only in rec.radio.swap and misc.industry.electronics.marketplace.

Many electronic component manufacturers have Web pages; see the directory at www.hitex.com/chipdir/, or try addresses such as www.ti.com and www.motorola.com (substituting any company's name or abbreviation as appropriate). Many IC data sheets can be viewed online: www.questlink.com features IC data sheets and gives you the ability to buy many of the ICs in small quantities using a credit card. You can also get detailed IC information from www.icmaster.com, which is now free of charge although it formerly required a subscription. Extensive information about how to repair consumer electronic devices and computers can be found at www.repairfaq.org

Books: Several good introductory electronics books are available at RadioShack, including one on building power supplies.

An excellent general electronics textbook is *The Art of Electronics*, by Paul Horowitz and Winfield Hill, available from the publisher (Cambridge University Press, 800-872-7423) or on special order through any bookstore. Its 1125 pages are full of information on how to build working circuits, with a minimum of mathematics.

Also indispensable is *The ARRL Handbook for Radio Amateurs*, comprising over 1000 pages of theory, radio circuits, and ready-to-build projects, available from the American Radio Relay League, Newington, CT 06111, and from ham-radio equipment dealers.

Back issues: Copies of back issues of and past articles in **Electronics Now**, **Popular Electronics**, and **Poptronics** can be ordered on an "as available basis" from Clagck, Inc., Reprint Department, P.O. Box 12162,

Hauptpage, NY 11788; Tel: 631-592-6721. To ensure receipt of the correct material, readers must supply complete information on the article or issue that they wish to buy.

Poptronics and many other magazines are indexed in the *Reader's Guide to Periodical Literature*, available at your public library. Copies of articles in other magazines can be obtained through your public library's interlibrary loan service; expect to pay about 30 cents a page.

Service manuals: Manuals for radios, TVs, VCRs, audio equipment, and some computers are available from Howard W. Sams & Co., Indianapolis, IN 46214; (800-428-7267). The free Sams catalog also lists addresses of manufacturers and parts dealers. Even if an item isn't listed in the catalog, it pays to call Sams; they may have a schematic on file which they can copy for you.

Manuals for older test equipment and ham radio gear are available from Hi Manuals, PO Box 802, Council Bluffs, IA 51502, and Manuals Plus, 130 N. Cutler Dr., N. Salt Lake, UT 84054.

Replacement semiconductors: Replacement transistors, ICs, and other semiconductors, marketed by Philips ECG, NTE, and Thomson (SK), are available through most parts dealers (including RadioShack on special order). The ECG, NTE, and SK lines contain a few hundred parts that substitute for many thousands of others; a directory (supplied as a large book and on diskette) tells you which one to use. NTE numbers usually match ECG; SK numbers are different.

Remember that the "2S" in a Japanese type number is usually omitted; a transistor marked D945 is actually a 2SD945.

Hamfests (swap meets) and local organizations: These can be located by writing to the American Radio Relay League, Newington, CT 06111; (www.arrl.org). A hamfest is an excellent place to pick up used test equipment, older parts, and other items at bargain prices, as well as to meet your fellow electronics enthusiasts—both amateur and professional.

Find A 2-mA LED

Q *In the July 2001 issue of Poptronics, the "In-Circuit Capacitor Tester" calls for a 2-mA light emitting diode (LED). I have not been able to locate a 2-mA LED; the best I have been able to find is 15 mA. Could you advise me where I might find one?—T.R., via e-mail*

A It is a little tough to find LEDs that are rated for less than 10 mA. However, don't forget that this is the absolute MAXIMUM forward current rating, and the LED will operate on much less current, albeit sacrificing light intensity. The cap tester circuit has 3.3 mA flowing through the LED. In this light, a "2-mA low current" diode is really a little bit stressed. I'd try whatever LED you have on hand, for you won't hurt anything in the circuit if you do. I used one rated at 20 mA in a mock-up of that portion of the circuit, and it worked just fine. The Digi-Key catalog (www.digikey.com) does have low-current LEDs from Chicago Miniature, some of which are surface-mount technology that are rated at currents as low as 1.8 mA.

Luminous Intensity And The 'mcd'

Q *What does M.C.D. stand for? Is there a simple way to test the luminous intensity*

of a light emitting diode (LED)?—E.L., via e-mail

A The abbreviation “cd” stands for candela, which is the standard unit of measure of luminous intensity. The mcd is therefore a millicandela or 0.001 cd. You’ll see this unit of measure used to compare the light output of one LED versus another. It’s a measure of the overall brightness of any light source. To get more complicated, one candela produces one lumen per square meter at a distance of one meter from the source. I’m not a physicist, so this is as far as I go with these definitions!

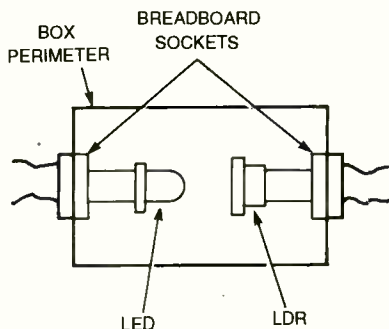

Fig. 2. This drawing shows how the solderless breadboard connectors are located on opposing sides of a light-tight box.

As far as testing for the luminous intensity, that’s no problem. With a simple circuit, you can compare LEDs of the same color or check LEDs of the same size and color to match them for intensity. You can’t build a simple circuit to provide you with the actual luminous intensity because things like calibration, standards, and light wavelength make a device too complicated for this column.

Build a light-tight box into which you can mount both the LED under test and a light-dependent resistor (LDR), otherwise known as a resistive photocell. LDRs are very sensitive to changes in light and have a huge dynamic range. I made a box of opaque black plastic. If I were to do it again, I’d use unetched printed circuit board material and solder the pieces together. Mount two little solderless breadboard connectors inside the box on opposing walls, facing each other. You can make these little connectors by sawing up an old breadboard so that you have two or more adjacent contact strips on each piece. The wires to the connectors come out through holes in the sides. Actually, I mounted two more of the solderless connectors on the outside of

the box connected to those two wires so that I had a light-tight-box breadboarding component. Light-seal everything with flat-black model paint and coat the inside of the box with the paint. The tiniest bit of light leaking in can be seen by the LDR. An “inside” view of the box is shown in Fig. 2.

Connect the LED in series with a 100-ohm, ½-watt current-limiting resistor and a variable power supply. Set the LED current for the same value for each test, e.g., 10 milliamps, by using a digital multimeter (DMM) to measure the voltage across the resistor on the 2-volt range. Current will be the measured voltage divided by the 100 ohms. With the LED directly facing the LDR and the lid on the box, measure the LDR resistance with a digital multimeter and jot the reading down. Switch to another LED and repeat the test as many times as you need. Make sure that the distance and orientation between the LED and the LDR always remains the same for each test. A width of cardboard or popsicle stick may help as a gauge.

At this point, you don’t have a glimmer of an idea what these readings mean. After you have tested ten or more LEDs, especially if they vary a lot in resistance of the LDR, you should be able to line them all up in a series circuit with a current-limiting resistor so that they have the same 10 milliamps going through each of them. Note the differences in intensity and see how far the resistance has to move to be able to see a difference. Probably your first test should be with a batch of “surplus” LEDs, since they tend to be “floor sweepings” that vary a lot in intensity and will give you a wider range of values than will a set of new prime LEDs.

Google Groups Are Active

In the July 2001 column, I had mentioned that Deja’s Usenet Archive and forum that posted to the Usenet news groups went dormant after being acquired by Google. I’m happy to report that Google Groups is alive and well and is now taking posts. It is an extremely active forum. Be forewarned that if you’re used to the Gernsback or Twisted Pair forums, you need to prepare for the possibility of ruffled feathers if you post there, because of the increased amount of “flaming” that goes on. The URL is <http://groups.google.com>.

Writing to Q&A

As always, we welcome your questions. Please be sure to include:

- (1) plenty of background material,
- (2) your full name and address on the letter (not just the envelope),
- (3) and a complete diagram, if asking about a circuit; and
- (4) type your letter or write neatly.

Send questions to Q&A, **Poptronics**, 275-G Marcus Blvd., Hauppauge, NY 11788 or to q&a@gernsback.com, but do not expect an immediate reply in these pages (because of our backlog). We regret that we cannot give personal replies. Please no graphics files larger than 100K. **P**

Introducing Robotics with Lego® Mindstorms™

For Robot Lovers. Shows how to build a variety of increasingly sophisticated computer-controlled robots using the brilliant Lego mindstorms Robotic Invention System (RIS). Covers the fundamental building techniques needed to construct strong and efficient robots. Explains to the reader how robot control programs may be simply constructed on their PC screens. Detailed building instructions are provided for all the robots featured. 270 pages, 71/2 x 10 5/7 in. **\$19.99.** Plus \$2.45 shipping in U.S. Order from CLAGGK Inc., P.O. Box 12162, Hauppauge, NY 11788 **CLX1**

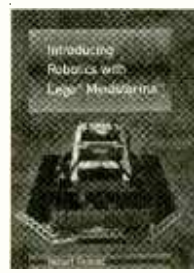

Electronic Projects 1.0

By Max Horsey

A series of ten projects to build along with audiovisual information to support hobbyists during construction. Each project is complete with schematic diagrams, circuit and PCB layout files, component lists and comprehensive text to guide the hobbyist through the project. A shareware version of CAD-PACK—schematic capture and PCB design software is also provided. Projects include a reaction timer, logic probe, egg timer and seven more. Get your own copy of this CD-ROM today. **\$75 including shipping in the U.S.** Order from CLAGGK Inc., P.O. Box 12162, Hauppauge, NY 11788. Visa, MC, Discover, OK.



CLX2

Hexapod Walker Robot

Walkers are a class of robots that imitate the locomotion of animals and insects. Walker robots have the potential to transverse rough terrain impassable by standard-wheel vehicles. It is with this in mind that robotists are developing walker robots.

Imitation Of Life

Sophisticated walkers imitate insects, crabs, and sometimes humans. Biped walkers are still a little rare, requiring balance and a good deal of engineering science. In this article we will build a six-legged walker robot.

6 Legs—Tripod Gait

Using a six-legged model, we can

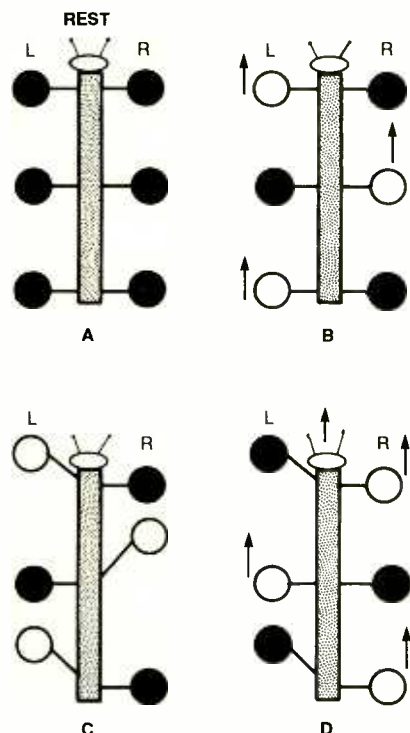

Fig. 1. The above diagram shows the tripod gait of a hexapod. There are always three feet on the ground at any given time.

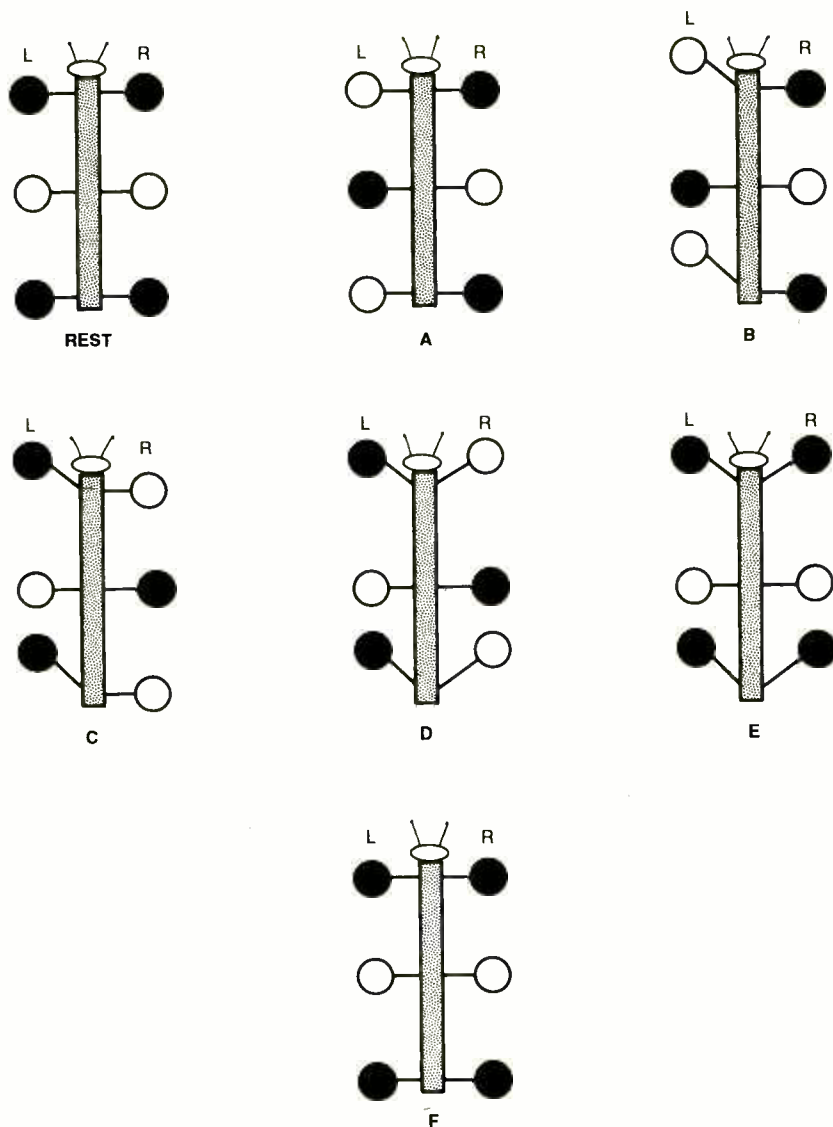

Fig. 2. Here is the walking pattern of a hexapod powered by three servos. Notice that, at rest, the center legs do not support any weight.

demonstrate the famous tripod gait used by the majority of legged creatures. In the following drawings, a dark circle means the foot is firmly planted on the ground and supporting the weight of the creature. A light circle means the foot is up and moveable.

Figure 1A shows our creature at rest. All feet are on the ground. From the resting position our creature decides to move forward. As shown in Fig. 1B, to step forward, the hexapod lifts three of its legs (represented by the white circles), leaving its weight on the remaining

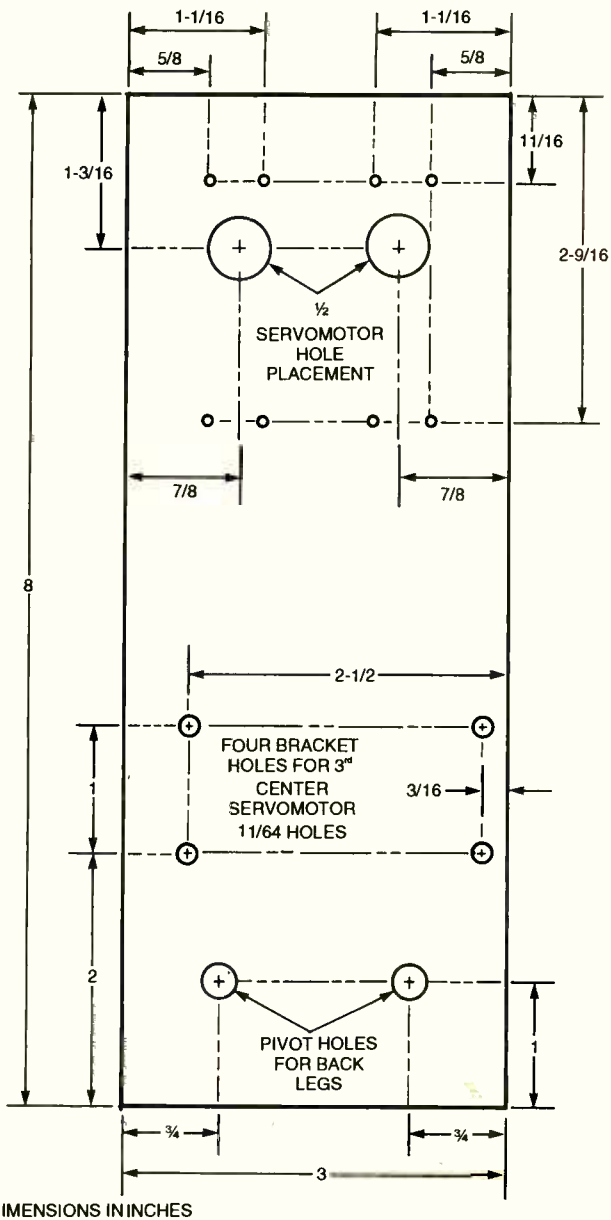

Fig. 3. The above figure can be used as a template for constructing the hexapod's body.

three legs (represented by the dark circles). Notice that the legs supporting the weight (dark circles) are in the shape of a tripod. This is a stable weight-supporting position. Our creature is unlikely to fall over. The three lifted legs (white circles) are free to move, and they move forward.

Figure 1C illustrates where the three lifted legs move. At this point, the creature's weight shifts from the stationary legs to the moveable legs, see Fig. 1D. Notice that the creature's weight is still supported by a tripod position of legs. Now the other set of legs moves forward, and the cycle repeats.

This is called a tripod gait, because a tripod positioning of legs always supports the weight.

Tri-Servomotor Walker Robot

The walker robot we will make is a compromise in design and construction, but allows us to build a walker that only requires three servomotors. Although it uses just three servomotors, it is a true tripod gait walker. The hexapod uses three HS300 (42-oz. torque) servomotors for drivers and a 16F84 microcontroller for brains.

Function

At the front of the walker are two servomotors. Each servomotor controls both the front and back legs on its side. The front leg is attached directly to the horn of the servomotor. It is capable of swinging the leg forward and backward.

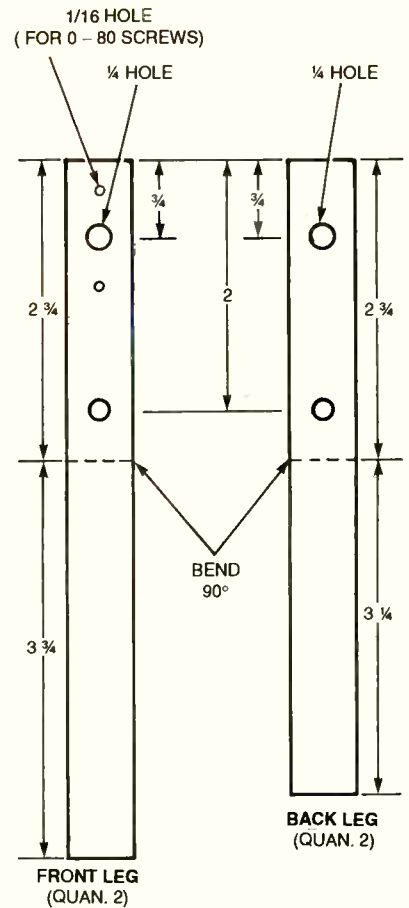

Fig. 4. Here are the guides for constructing the front and rear legs of the robot.

The back leg connects to the front leg through a linkage. The linkage makes the back leg follow the action of the front leg as it swings forward and back.

The third servomotor controls the two center legs. This servomotor rotates the center legs 20–30 degrees in a clockwise (CW) or counter clockwise (CCW) rotation. This tilts the robot to one side, either left or right.

With this information under our belt, we can now see how our robot will walk. Look at Fig. 2. We start in the rest position. Each circle represents a leg. As before, the dark circles show the weight-bearing legs. Notice in the rest position, the center legs do not support any weight. These legs are 1/8-inch shorter than the front and back legs.

In position "A," the center legs are rotated CW by about 20 degrees from center position. This causes the robot to tilt to the right. The weight distribution is now on the front and back right legs and the center left leg. This is the standard "tripod" position described earlier. Since there is no weight on the front and

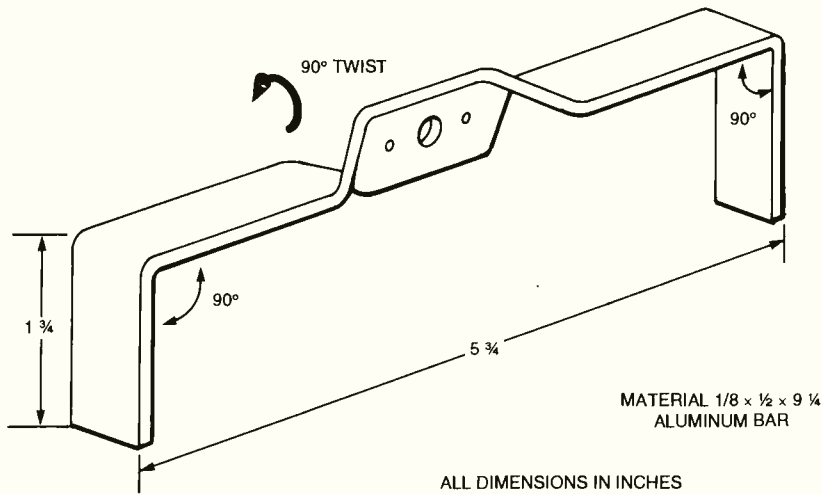

CENTER LEGS

Fig. 5. The center legs are constructed of a single piece of aluminum and are 1/8-inch shorter than both the front and rear legs.

back left legs, they are free to move forward as shown in the "B" position of Fig. 2.

In the "C" position, the center legs are rotated CCW by about 20 degrees from center position. This causes the robot to tilt to the left. The weight distribution is now on the front and back left legs and the center right leg. Since

there is no weight on the front and back right legs, they are free to move forward as shown in the "D" position.

In position "E," the center legs are rotated back to their center position. The robot is not in a tilted position so its weight is distributed on the front and back legs. In the "F" position, the front

and back legs are moved backward simultaneously causing the robot to move forward. The walking cycle then repeats.

This is the first gait pattern I tried, and it worked. There are other walking patterns you can design, develop, and experiment with. I will leave it to you to develop walking patterns for reverse (walking backward), turning left, and turning right. If you would like to see another article that continues the development of this robot, providing wall and collision sensors as well as providing the ability to walk backwards and turning, write to me in care of the magazine.

Construction

For the main body, I used a 3- × 8- × .032-inch sheet of aluminum. The servomotors are mounted to the front of the body (see Fig. 3). The servomotor holes shown in the drawing should be photocopied and taped to the aluminum sheet. The photocopy will provide accurate hole-location for mounting the servomotors.

The four 1/4 diameter holes a little past halfway down the main body are for mounting the center servomotor. These four holes are offset to the right side. This is necessary to align the servomotor's horn in the center of the body.

The bottom two holes are for mounting the pivots for the two back legs.

Use a punch to dimple the metal in the center of each hole you plan to drill. This will prevent the drill bit from walking when you drill the hole. If you don't have a punch available, use the pointed tip of a nail for a quick substitute.

The legs for the robot are made from 1/2- × 1/8-inch aluminum bar stock, see Fig. 4. There are four holes that are drilled into the two front legs. The back

LISTING 1

```
'Hexapod Walker
' The Connections
' left servo motor   Pin RB1
' right servo motor  Pin RB2
' tilt servo motor   Pin RB0

' Moves in forward direction only

start:
FOR B0 = 1 TO 60
  pulsout 0,155      ' start by tilting CW lift right side
  pulsout 1,145      ' keep left legs back
  pulsout 2,145      ' bring right legs forward
  pause 18
NEXT B0
FOR B0 = 1 TO 60
  pulsout 0,190      ' tilting CCW lift left side
  pulsout 1,200      ' bring left legs forward
  pulsout 2,145      ' keep right legs forward
  pause 18
NEXT B0
for b0 = 1 to 15
  pulsout 0, 172      ' no tilt
  pulsout 1, 200      ' keep left legs forward
  pulsout 2, 145      ' keep right legs forward
  pause 18
next b0
for B0 = 1 to 60
  pulsout 0, 172      'no tilt
  pulsout 1, 145      ' bring left legs back
  pulsout 2, 200      ' bring right legs back
  pause 18
next b0
goto start
```

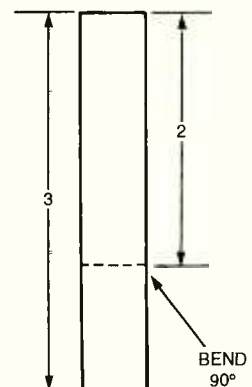

Fig. 6. Two L-shaped brackets must be constructed in order to attach the center servo to the body.

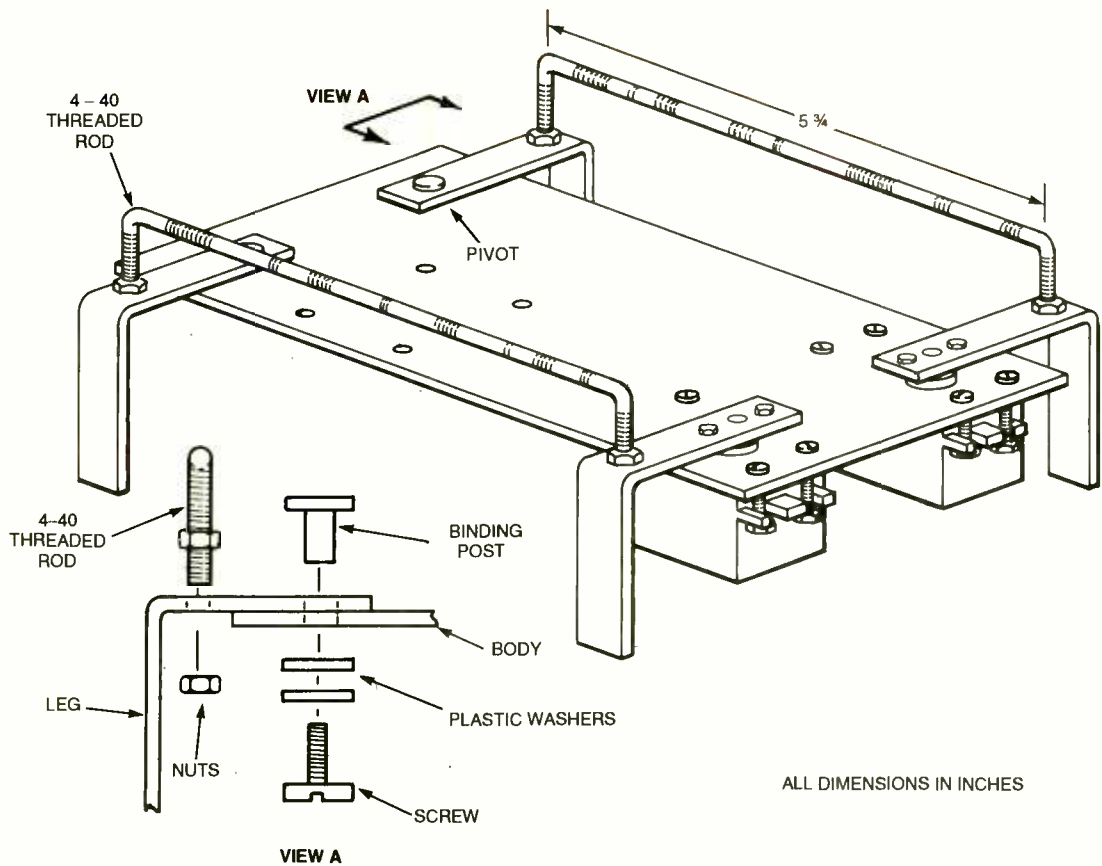

Fig. 7. The linkage system consists of two threaded rods that connect the front and rear legs, which permits synchronous movement.

legs only need two holes, one for the pivot and the other for the linkage. Also, notice that the back legs are .25 shorter than the front legs. This compensates for the height of the servomotor mounting horn on the front servomotors where the front legs are attached. Shortening the back legs makes the robot platform level.

After the holes are drilled, we need to bend the aluminum bar into shape. Secure the aluminum bar in a vise 2 3/4-inches from the end with the drilled holes. Pressure is applied to bend the

aluminum bar at a 90-degree angle. It's best to apply pressure at the base of the aluminum bar close to the vise. This will bend the leg at a 90-degree angle, while keeping the lower portion of the leg straight without any bowing of the lower portion.

The center legs are made from one piece of aluminum (see Fig. 5). The center legs are about 1/8-inch shorter than the front and back legs when mounted to the robot. When centered, the legs do not support any weight. These legs are for tilting the robot to the left or right.

The legs tilt the robot by rotating the center servomotor approximately ± 20 degrees.

To make the center legs, first drill the mounting holes in the center of the 1/8 x 1/2 x 9/16-inch aluminum bar. Secure the aluminum bar in a vise. The top of the vise should hold the aluminum bar 1/4-inch from the center of the aluminum bar. Grab the aluminum bar with pliers about 1/2-inch above the vise. Keeping a secure grip with the pliers, slowly twist the aluminum bar 90 degrees. Don't go fast, or you could easily snap the alu-

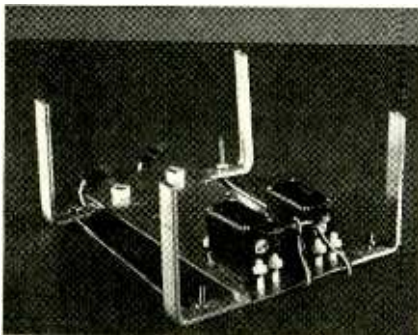

No, it's not dead...it's resting. Here you can see the underbelly of the hexapod with two servos in place.

PARTS LIST

Servomotors
16F84 Microcontrollers
Aluminum bars
Aluminum sheets
4-40 threaded rods and nuts
Plastic machine screws, nuts, and washers

Available from:
Images Company
39 Seneca Loop
Staten Island, NY 10314
718-698-8305
www.imagesco.com

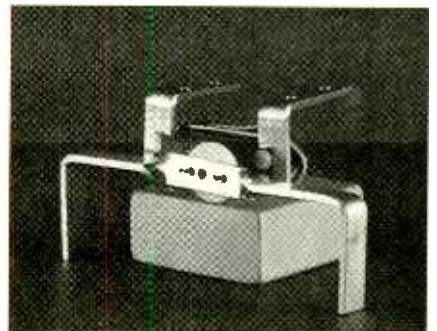

The center servo is shown here ready to be attached to the body. The center legs and the two L-brackets have been attached to the servo.

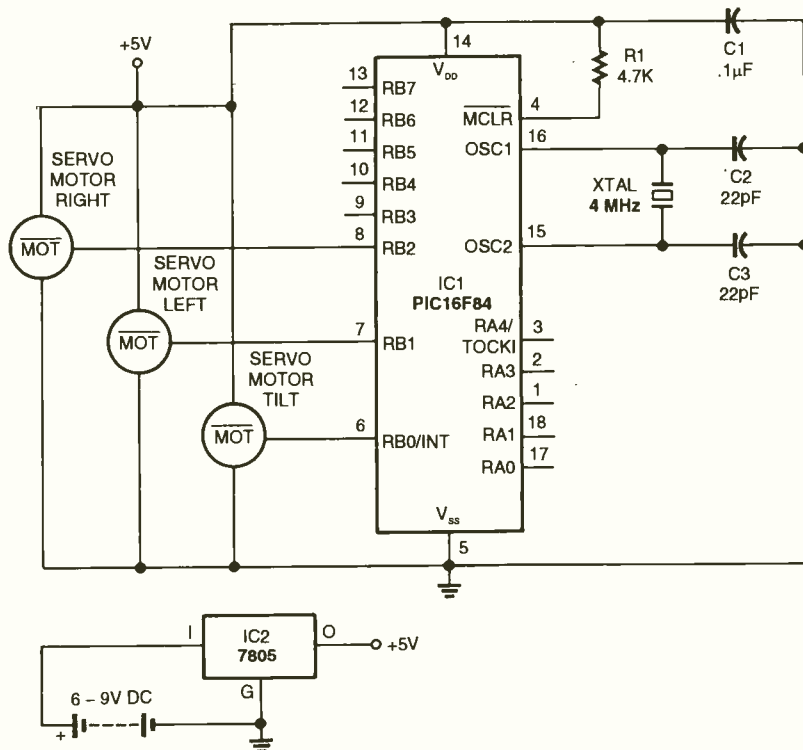

Fig. 8. At the heart of this hexapod lies a PIC16F84 with an external 4-MHz crystal linked to the oscillator pin-outs, 16 and 15.

minimum bar. Repeat the twist on the other side.

After the two 90-degree twists have been made, make the other 90-degree bend for the legs as we have done before for the front and back legs.

Mounting the Servomotors

The front servomotors are attached to the aluminum body using plastic 6-32 machine screws and nuts. The reason I am using plastic screws is that they are a little flexible, allowing the drilled holes to be slightly off center from the mounting holes on the servomotor.

The legs are attached to the servomotor's plastic horn. For this I used 0-80 machine screws and nuts. When mounting the servomotor horn on the servomotor, make sure that each leg can

swing forward and backward an equal amount from a perpendicular position.

Center Servomotor

To attach the center servomotor to the body requires two L-shaped brackets (see Fig. 6). Drill the holes and bend at a 90-degree angle.

Attach the two L-brackets to the center servomotor, using the plastic screws and nuts. Next mount the center servomotor assembly under the robot body. Align the four holes in the body with the top holes in the L-brackets. Secure with plastic screws and nuts.

Linkage

The linkage between front and back legs is made from 4-40 threaded rod (see Fig. 7). In the prototype robot, the linkage is 5¼-inches, center to center. The linkage fits inside the holes in the front and back legs. The linkage may be secured using a few 4-40 hex nuts.

The back legs must be attached to the body of the robot before you make the linkage. The pivot for the back legs is made from a ¼-inch binding post and screw. The leg is attached as shown in the close-up in Fig. 7 (View A). The plastic washers underneath the body are necessary. They fill up the space between the aluminum body and the



Here is the completed hexapod. A breadboard containing the circuit is mounted to the top of the body. The robot is controlled by a PIC16F84.

bottom of the screw. This keeps the leg close to the aluminum body without sagging. I chose plastic washers for less friction. Do not use so many washers that force is created binding the leg to the body. The joint should pivot freely.

Electronics

Figure 8 shows the schematic for the servomotors and PIC microcontroller. Notice the 6-volt battery pack is powering the microcontroller, as well as the servomotors. The battery pack uses four AA-batteries. The microcontroller circuit is built on a small solderless breadboard. The battery pack and circuit are laid on top of the aluminum body.

Microcontroller Program

The 16F84 microcontroller controls the three servomotors using just three I/O lines. This leaves ten available I/O lines and plenty of programming space left over to improve and add to this basic walker.

Not all servomotors are exactly alike and may not respond in an identical manner to the PULSOUT command. The PULSOUT commands that control the position of the servomotors you use may need to be adjusted. Adjust the numerical value of the pulsout commands to compensate for any differences with the servomotors used in your hexapod robot walker.

While this PICBasic program only provides for forward motion, a little experimentation on the part of the robotist can have this robot turning to the left or right and walking backward. A few sensor switches on the front can inform the robot when it has encountered an obstacle.

P

BUY BONDS

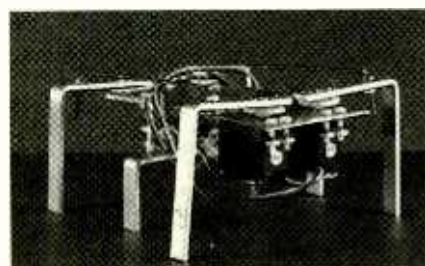

The hexapod is ready for action. Two threaded rods provide linkage for the synchronous movement of the rear and front legs.

Tracking the Wall

Last month, my article dealt with configuring a robot that needed to travel down a hallway parallel to the wall, with the ability to measure its angle to the wall. The article covered some basic trigonometric functions, the Sharp GP2D12 Infrared Distance Sensor, and programming of the OOPic's oIRRange Object. Now my robot can see and determine its angle to the wall. This angle is considered the *angle of correction*. Now comes the second step: How does one get the drive motors to respond to the angle of correction and make course corrections based upon it?

Before a formula could be devised, the mechanics of the robot needs to be evaluated. My robot uses two drive wheels, each with its own motor. One drive wheel is placed on each side of the robot, and a coaster is in the back with the weight of the batteries holding it down. Given this configuration, turns are achieved by slowing down the wheel on one side while speeding up the wheel on the other side. When both wheels turn at the same rate, the robot travels straight (see Fig. 1).

The question now was: What formula would my robot need to take the angle of correction and apply it to both of the motors so that one would speed up and one would slow down in such a way as to cause the robot to travel down the hall parallel to the wall?

Formulating The Formula

The first idea I had was to simply add the angle to one motor's speed and subtract the angle from the other motor's speed.

$$\text{RightSpeed} = \text{CurrentSpeed} - \text{CorrectionAngle}$$

$$\text{LeftSpeed} = \text{CurrentSpeed} + \text{CorrectionAngle}$$

In theory, the robot would travel straight down the hall when the robot

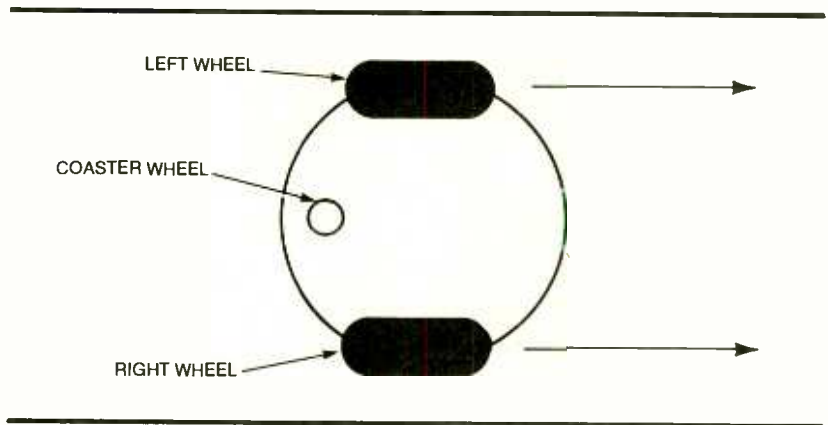

Fig. 1. When both wheels are turning at the same speed, the robot travels straight down the hall.

was parallel to the wall as shown in Fig. 2. The robot would do this because the measured angle would be 0 and would not affect the speed of either motor. Once the robot became non-parallel to the wall, the measured angle would slow down one motor and speed up the other, turning the robot back towards being parallel. Once parallel again, the motors would resume identical speeds.

After putting the robot on the floor, I quickly realized that this formula needed some additional input. Even with the

angle of correction being applied, the robot did not travel parallel to the wall. Instead, it steadily curved towards the wall and eventually ran into it. After some investigation, I discovered that one motor was turning faster than the other motor when the same voltage was being applied. This was due to the construction of the motors. These motors were tuned to run faster when they spin in a particular direction. With the configuration of my robot, one motor turned clockwise and the other needed

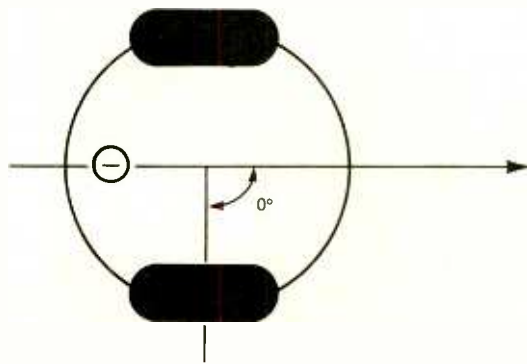

Fig. 2. When the robot is parallel to the wall, the angle of correction is 0. That angle does not affect the speed of either wheel, resulting in the robot traveling straight down the hall.

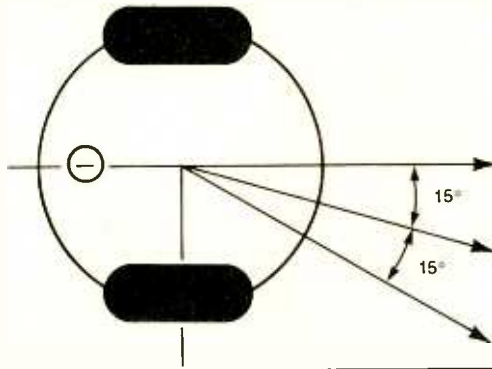

Fig. 3. Mechanical differences in the motors' speed can cause the robot to go at undesired angles.

to turn counterclockwise, because they were mounted 180° from each other. The motor that turned in reverse to make the robot go forward ran slower than its counterpart.

To describe how this caused the robot to go off course, let's suppose that the difference in speed of the motors causes the robot to have an exceptionally large turn error of 30° to the right when the motors are directed to spin at the same speed. Figure 3 shows the 30° split into two 15° sections. When the robot is at a 15° angle to the wall, the formula will direct the motors to turn left 15°. When subtracted from the turn error of 30°, it leaves the robot traveling at a 15° angle to the wall. Thus, the error angle and the angle of correction nullify each other, causing the robot to continue on course at 15°—eventually driving into the wall.

The solution to this problem was to incorporate the distance to the wall into the formula. This solution will work by generating a second angle of correction that increases in the opposite direction as the robot moves closer to the wall. The two angles of correction will be added to each other producing a new

angle of correction. This result overcomes any error angle; as the robot approaches the wall, the second angle will counteract the first, driving the robot back away from the wall.

Just as in last month's article, the angle is calculated using a little trigonometry. As shown in Fig. 4, if the robot is not in the middle of the hall, then the angle that the robot will need to turn to return to the middle can be derived. Take the ratio of the robot's offset from center and the distance to a point out in front of the robot in an Arctangent calculation, as follows:

$$[\text{Degrees2} = \text{Arctangent}(Y/X)]$$

Trigonometry Revisited

In last month's article, a detailed description of Arctangent is given. This month I will just touch on the major points. Arctangent is defined as the angle (A) that corresponds to a specific ratio created by dividing the length of the side opposite the angle (Y) by the length of the side adjacent to the angle (X). An Arctangent diagram is shown in Fig. 5.

One of the more interesting things

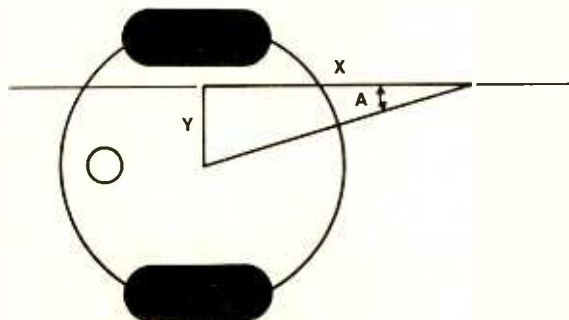

48 Fig. 4. When the robot is not in the middle, a second angle of correction can be calculated.

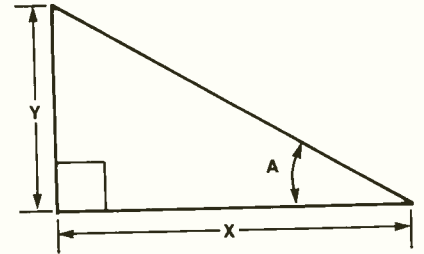

Fig. 5. Arctangent is the angle (A) that corresponds to the ratio of the length (Y) divided by the length (X).

about Arctangent that was covered last month is how the constant 55 can be substituted for the Arctangent function for angles less than 20°.

$$[\text{Degrees2} = 55 * (Y / X)]$$

may be substituted for the formula

$$[\text{Degrees2} = \text{Arctangent}(Y / X)]$$

for angles under 20°

Calculating the 2nd Correction Angle

To calculate the second angle of correction, the robot's offset from center will need to be figured out. This will be the Y value in Figs. 4 and 5. In the context that I am entering, the halls are 18 inches apart, so the middle of the hall is 9 inches from the wall. As detailed last month, the robot already has two Sharp GP2D12 Infrared Distance Sensors mounted facing the same wall. See the configuration shown in Fig. 6.

The OOPic's oIRRange Object is used to read the Sharp GP2D12 Infrared Distance Sensor and returns the measured distance in 64 steps per foot. When the robot is in the center of and traveling straight down the hall, both oIRRange Objects will have a reading of 48. This calculation was done by taking 64 steps per foot/12 inches per foot * 9 inches. However, when the robot is at an angle to the wall, the front and back are different distances to the wall. Therefore, the measurements will not be the same.

By adding the two measurements together and dividing by 2, we get the actual distance that the middle of the robot is from the wall—even if the robot is at an angle to the wall. For the angle-of-correction formula, when the robot is in the center of the hall, the offset needs to be 0. Subtract 96 (48 for each side) from the measurement before dividing it by 2. Plugging this into the formula

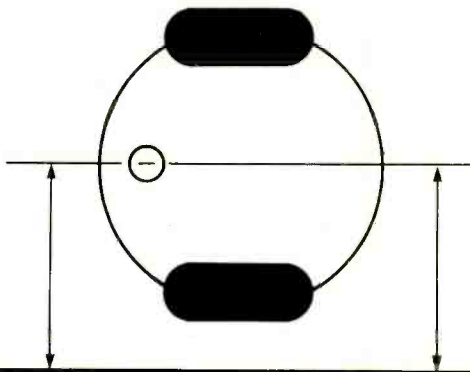

Fig. 6. Two Sharp GP2D12 Infrared Distance Sensors are mounted on the robot facing the same wall.

gives:

$$[\text{Degrees2} = 55 * (((\text{FrontDistance} + \text{BackDistance} - 96) / 2) / X)]$$

The X value in the formula is an unspecified point in front of the robot.

Any distance, within certain limits, can be used. If the distance is too small, then the robot will overcompensate for being out of center and will wind up weaving back and forth around the center of the hall. If the distance is too large, then the second angle of correction will not ade-

quately overcome any mechanical error. The correct distance really depends on the mechanics of your robot and needs to be tuned. As a starting point, I selected 20.625 inches because it allows the formula to be reduced. Using 20.625 inches at 64 steps per foot works out to be 110 (20.625 / 12 * 64). Plugging this into the formula gives:

$$[\text{Degrees2} = 55 * (((\text{FrontDistance} + \text{BackDistance} - 96) / 2) / 110)]$$

This formula can be reduced by dividing by 55.

$$[\text{Degrees2} = ((\text{FrontDistance} + \text{BackDistance} - 96) / 2) / 2]$$

which can be reduced to:

$$[\text{Degrees2} = (\text{FrontDistance} + \text{BackDistance} - 96) / 4]$$

Adding the second angle of correction to the original angle of correction will give us a final angle of correction. The formula used to do that is:

$$[\text{CorrectionAngle} = \text{Degrees1} + \text{Degrees2}]$$

Plugging the 1st angle of correction formula from last month and the formula for the 2nd angle of correction into this formula gives:

$$[\text{CorrectionAngle} = (\text{FrontDistance} - \text{BackDistance}) + ((\text{FrontDistance} + \text{BackDistance} - 96) / 4)]$$

Using the Magnevation PWMx2 Motor-Driver Board

Now that we have the formula, the next step is to get the wheels to turn under their own control. The motor controller that my robot is using is the Magnevation PWMx2 Dual DC motor controller.

This motor controller is capable of driving two DC motors rated at up to 55 volts at 3 amps with speed control, brakes, thermal overload signals, and current sense. It has a 40-pin connector on each side, which allows it to be directly connected to the OOPic's 40-pin connector, while passing all the control signals through to the 40-pin connector on the other side. It also has a 16-pin header that is configured for a standard PC joystick to be plugged into.

(Continued on page 54) 49

LISTING 1

```

c:\m1.osc
Dim M As New oUserClass("PWMX2.OSC")

Sub Main()
End Sub

NETWORK NODE(0)
+ OOPic
+ UserClass: M
+ oDcmotor: M.Right
+ oDcmotor: M.Left
  
```

LISTING 2

```

c:\m2.osc
Dim M As New oUserClass("PWMX2.OSC")
Dim F As New oIRRange
Dim B As New oIRRange
Dim A As New oByte

Const CurSpeed = 64

Sub main()
  Call IOSetup
  Do
    A = (F - B) + ((F + B - 96) / 4)
    M.Right.Value = CurSpeed - A
    M.Left.Value = CurSpeed + A
  Loop
End Sub

Sub IOSetup()
  F.IOLine = 1
  F.Operate = cvTrue
  B.IOLine = 2
  B.Operate = cvTrue
  A.Signed = cvTrue
End Sub

NETWORK NODE(0)
+ OOPic
+ UserClass: M
+ oIrange: F
+ oIrange: B
+ oByte: A
  
```

BUDGET PROJECT AND COMPUTER BOOKS

BP294—A Concise Introduction to Micro-soft Works \$6.99. You can use the word processor to your advantage to type, edit, print and save documents. This book explains how Works can be used to build up simple spreadsheet examples, edit them, save them, print them and retrieve them. It informs you how to create simple macros, and to simplify long repetitive tasks and to customize the program to your own needs.

BP350—Electronic Board Games \$6.99. Twenty novel electronic board games that you can build from the plans in this book. Whether you are interested in motor racing, searching for buried treasure on a barren island or for gold in Fort Knox, spinning the wheel of fortune, or doing a musical quiz—there is something for you to build and enjoy!

BP378—45 Simple Electronic Terminal Block Projects \$6.99. 45 easy-to-build electronic projects that can be built by an absolute beginner. Projects are assembled on terminal blocks using only a screwdriver and other simple hand tools. No soldering is required.

BP432—Simple Sensor Terminal Block Projects \$6.99. This book is the next logical step from the above book (BP378), by the same author. This is an *open sesame* to the practical world of electronics for youngsters or beginners.

BP367—Electronic Projects for the Garden \$6.99. Electronics enters the Garden! Gardeners can build simple gadgets to promote success where the elements work against you. Some of the projects are: over/under temperature monitoring, dusk/dawn switching, automatic plant watering, warming cables, etc.

BP368—Practical Electronics Musical Effect Units \$6.99. There is a constant hullabaloo for musical effects projects by the hobbyist community. This book provides practical circuits for several projects that range in complexity and are sure to work. All the circuits are easy to build and use readily-available parts.

BP385—Easy PC Interfacing \$6.99. The built-in ports in your PC provide an easy and hassle-free way of interfacing your circuits. This book provides useful PC add-on circuits including the following: Digital input/output ports; analog-to-digital and digital-to-analog converters; voltage and current measurement circuits; resistance and capacitance meters, temperature measurement interface, biofeedback monitor, and many other useful interfaces.

BP396—Electronic Hobbyists Data Book \$7.99. This book contains details of a modern five-band resistor code or an old color code for a ceramic capacitor, the formula for parallel resistance, and basic data on an NE5534AN operational amplifier.

BP129—An Introduction to Programming the ORIC-1 \$2.99. This book has been written for readers wanting to learn more about programming and how to make best use of the ORIC-1 microcomputer's many powerful features. Most aspects of the ORIC-1 are covered, the omissions being where little could usefully be added to the information provided by the manufacturer's own manual. Starting with simple commands and programs, the more complex topics such as animated graphics and using sound commands are introduced.

BP131—Micro Interfacing Circuits - Book 2 \$3.99. This book is intended to carry on from where Book 1 left off. It is primarily concerned with practical applications beyond the parallel or serial interface to the microprocessor. It is about "real world" interfacing including such topics as sound and speech generators, temperature and optical sensors, motor controllers etc. Like Book 1 the subject is not treated in a purely theoretical manner.

BP298—Concise Intro to the Macintosh System and Finder \$5.99. This book explains: The System and Finder, what they are and what they do; how to use the System and Finder to manipulate disks, files and folders; configuring and printing files from the Finder; getting the most from the system utility programs; and running MultiFinder.

BP316—Practical Electric Design Data \$7.99. A comprehensive ready-reference manual for electronic enthusiasts with over 150 practical circuits. It covers the main kinds of components (from pig-tail leads to surface mount), pinouts, specs and type selection. Basic units are defined and most used formulae explained. Five additional sections are devoted to circuit design, covering analog, digital, display, radio and power supply circuits.

BP345—Getting Started In Practical Electronics \$6.99. This book provides basic essentials for the builder and 30 easy-to-build fun projects with which every experimenter should toy. Printed-circuits designs are included to give your project the professional touch.

BP451—Troubleshooting Your PC Printer \$8.99. Explains the different printer types, their suitability for different tasks, the costs of running them, how to connect them and get the driver software running and, of course, what is most likely to go wrong and what you can do for yourself. Most important of all, it warns you of what you should quite definitely NOT try to do for yourself.

PCP112—Digital Electronics Projects \$10.99. Contains 12 digital electronics projects suitable for the beginner to build with the minimum of equipment—from instrumentation to home security, and a few "fun" projects too. With one exception, all projects are battery powered, and therefore, are completely safe for the beginner or young constructor.

PCP107—Digital Logic Gates and Flip-Flops \$10.99. This book seeks to establish a firm foundation in digital electronics. It is for the user who wants to design and troubleshoot digital circuitry with full understanding of the principles. No background other than a basic knowledge of electronics is assumed.

BP317—Practical Electronic Timing \$6.99. This book provides the time measurement theory and backs it with a wide range of practical construction projects. Each project has how-it-works theory and how to check it for correct operation.

BP325—A concise User's Guide to Windows 3.1 \$6.99. Understand what hardware specification you need to run Windows 3.1 successfully, and how to install, customize, fine-tune and optimize your system. Get into understanding the Program Manager, File Manager and Print Manager. Tips on the word processor, plus how to use Paintbrush. More on the Cardfile database with its auto-dial feature, Windows Calendar, Terminal, Notepad, etc.

BP327—DOS: One Step at a Time \$5.99. There will be times when you absolutely need to use DOS to carry out 'housekeeping' functions. This book starts with an overview of DOS, and later chapters cover the commands for handling disks, directories and files.

PCP120—Multimedia on the PC! \$14.95. Multimedia can do lots of nice things! This 184-page book helps you create your own multimedia presentation. Multimedia applications by people like you can revolutionize educational and business applications as well bring more fun, fun, fun into your leisure computer activities.

BP404—How To Create Pages for the Web Using HTML \$7.99. HTML is the language used to create documents for Web browsers such as Mosaic, Netscape and Internet Explorer. These programs recognize this language as the method used to format the text, insert images, create hypertext and fill-in forms. HTML is easy to learn and use. This book explains the main features of the language and suggests some principles of style and design. Within a few hours, you can create a personal Home Page, research paper, company profile, questionnaire, etc., for world-wide publication on the Web.

BP411—A Practical Introduction to Surface Mount Devices \$6.99. This book takes you from the simplest possible starting point to a high level of competence in working with Surface Mount Devices (SMD's). Surface mount hobby-type construction is ideal for constructing small projects. Subjects such as PCB design, chip control, soldering techniques and specialist tools for SMD are fully explained. Some useful constructional projects are included.

BP379—30 Simple IC Terminal Block Projects \$6.99. Here are 30 easy-to-build IC projects almost anyone can build. Requiring an IC and a few additional components, the book's "blackbox" building technique enables and encourages the constructor to progress to more advanced projects. Some of which are: timer projects, op-amp projects, counter projects, NAND-gate projects, and more.

BP401—Transistor Data Tables \$7.99. The tables in this book contain information about the package shape, pin connections and basic electrical data for each of the many thousands of transistors listed. The data includes maximum reverse voltage, forward current and power dissipation, current gain and forward transadmittance and resistance, cut-off frequency and details of applications.

ETT1—Wireless & Electrical Cyclopeia \$4.99. Step back to the 1920's with this reprinted catalog from the Electro Importing Company. Antiquity displayed on every page with items priced as low as 3 cents. Product descriptions include: Radio components, kits, motors and dynamos, Leyden jars, hot-wire meters, carbon mikes and more.

BP76—Power Supply Projects \$3.99. Presents a number of power-supply designs including simplified unbiased types, fixed voltage-regulated types and variable voltage stabilized designs. All are low-voltage types intended for use with semiconductor circuits. Apart from presenting a variety of designs that will satisfy most applications, the data in this book should help the reader to design his own power supplies. An essential addition to the experimenter's electronics library.

ELECTRONIC TECHNOLOGY TODAY INC.
P.O. Box 240, Massapequa, NY 11762-0240

Name _____
Address _____
City _____ State _____ Zip _____

Allow 6-8 weeks for delivery

SHIPPING CHARGES IN USA ONLY	
\$0.01 to \$5.00	... \$2.00
\$5.01 to \$10.00	... \$3.00
\$10.01 to \$20.00	... \$4.00
\$20.01 to \$30.00	... \$5.00
\$30.01 to \$40.00	... \$6.00
\$40.01 to \$50.00	... \$7.00
\$50.01 and above	... \$8.50

SORRY No orders accepted outside of USA & Canada		No. of Books Ordered <input type="checkbox"/>
Total price of books \$	_____
Shipping (see chart) \$	_____
Subtotal \$	_____
Sales Tax (NYS only) \$	_____
Amount Enclosed \$	_____

All payments must be in U.S. funds!

ET12

MORE BATTERIES TO TEST

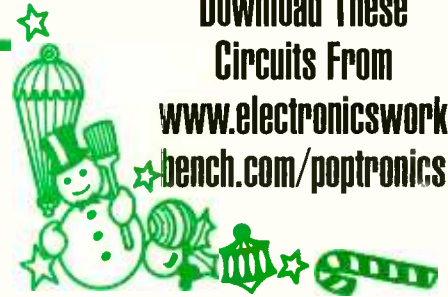

Here we are again, ready to life test a few more types of batteries to determine which brands produce the greatest output for the buck. I'm going to share information and circuitry for life testing NiCad, Nickel-Metal Hydride, and Sealed Lead-Acid batteries. NiCad batteries have been one of the most popular rechargeable power sources for many years and most likely will remain so for a long time. However, the Nickel-Metal Hydride is beginning to challenge the NiCad in many applications.

One of the most used NiCads around is the "AA" battery—normally rated from 0.6 to 0.8 amp-hour capacity. The rating is based on the amount of output current for a given operating time—in this case, one hour. Discharging the battery for one hour at a fast rate is a good method to use in determining its high-current short-term value. A ten-hour discharge at one-tenth the rated current is a good life test for medium-current-demand applications.

If the battery is to serve in a low-current, long-term application, then a discharge rate equal to 1/20th of the amp-hour rating would give an indication of which battery is best suited for the job.

Back To Basics

A sure and simple method to use in life testing NiCad AA cells is to use the basic discharge circuit shown in Fig. 1. The circuit is set up to discharge an AA battery at a rate of .6A, .06A, and .03A, depending on the batteries' end use. The maximum power dissipation of .72-watts occurs when using the 2-ohm load. A 2-ohm, 2-watt power resistor will do for R1, and the other two load resistors can be 1/2-watt units. One of the voltage-monitoring circuits discussed a couple of months back can be connected across the battery to give out an alert when the battery reaches the .9-volt discharge level.

The various life-testing circuits dis-

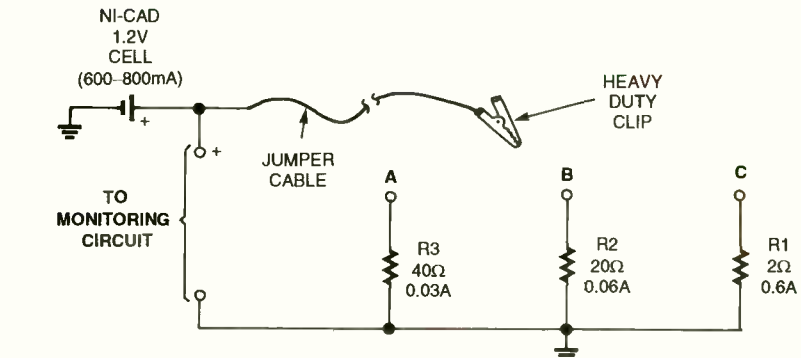

Fig. 1. This is a simple circuit for monitoring and testing the capacity of NiCad AA cells. The only components needed are inexpensive resistors.

cussed earlier that are suitable for low-voltage testing may be used for NiCads as well. However, two or more batteries should be connected in series for the transistor-driven load circuits.

Our second basic-resistance load bank, see Fig. 2, extends the life testing to include stacked NiCad up to seven series cells, which adds up to the popular 9-volt battery. However, with NiCads, the actual voltage is only 8.4 volts. Any combination battery pack made up of seven or less cells may easily be life tested with this circuit. Each row of load resistors, A, B, and C, contains seven equal-value resistors. In row "A," the resistors are 40-ohms each, which places a current drain of 30 mA for each series cell. The jumper cable connects to the position number on the load string that matches the number of series cells. The jumper cable, for a single cell, would connect to position 1 of row A for a 30-mA load, to position 1 of row B for a 60-mA load, and to position 1 of row C for a 600-mA load. The voltage-monitoring circuit connects across the battery and adjusts to correspond to the number of cells tested.

Two load banks can be used to load test two batteries at the same time to obtain a comparison quicker than sequentially using a single load bank.

PARTS LIST FOR THE "BACK TO BASICS" LOAD TESTER (FIG. 1)

RESISTORS

- R1—2-ohm, 2-watt power resistor
- R2—20-ohm, 1/2-watt
- R3—40-ohm, 1/2-watt

ADDITIONAL PARTS AND MATERIALS

Heavy-duty metal clip, #14 or 16 hook-up wire, etc.

Draining Nickel-Metal Hydride Batteries

Life testing Nickel-Metal Hydride batteries may, in most cases, follow the same procedures used in testing NiCads. Generally, the Ni-MH batteries have a much greater amp-hour current rating than the standard NiCads. A typical Ni-MH AA battery can have a 1.5-Ah rating, which is almost three times that of a standard NiCad.

The load bank in Fig. 2 may be used for testing the Ni-MH cells. However, the discharge time will be about three times longer than that of a standard NiCad cell. The load bank can be mod-

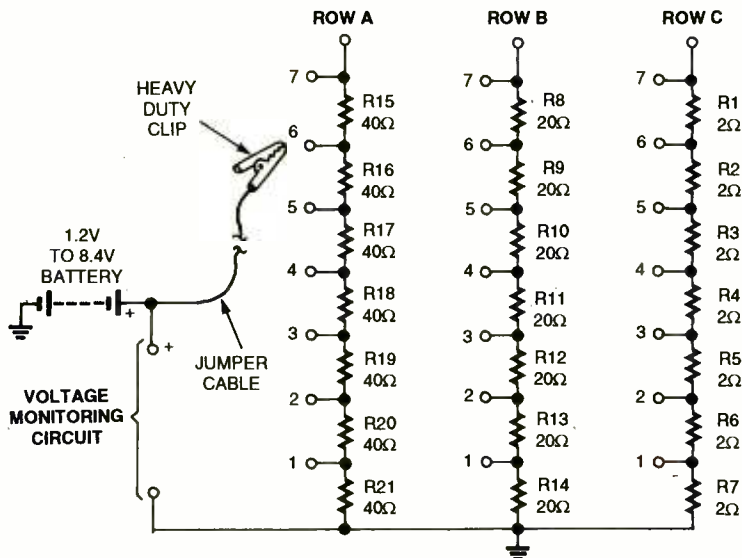

Fig. 2. The schematic above shows a battery tester capable of testing up to seven stacked NiCads. The load is adjustable for 30 mA, 60 mA, and 600 mA.

PARTS LIST FOR THE "SECOND LOAD BANK" (FIG. 2)

RESISTORS

R1-R7—2-ohm, 2-watt, power resistor
R8-R14—20-ohm, ½-watt
R15-R21—40-ohm, ¼-watt

ADDITIONAL PARTS AND MATERIALS

Heavy-duty metal clip, #14 or #16 hook-up wire, etc.

ified for higher discharge rates by reducing the values of all of the load resistors. The resistors in row "C" may be reduced to 1-ohm values to increase the discharge rate to about 1 amp. The values in row "B" may be reduced to 5 ohms each for a current drain of 240 mA, and in row "A" to 10 ohms for a 120mA drain. The actual discharge rates may be customized for life testing for a

specific load condition. Just divide the battery voltage by the desired load current. That will give the resistance value needed for the load.

Just to confuse things, I'll go ahead and mention another type of NiCad battery. That is the Hi-Capacity NiCad designed for high-current discharge usage in cordless tools, high-performance RC toys, and other high-current-demanding devices. These batteries come with amp-hour ratings of over 4 amps for the "D" cell and over 2 amps for the "C" cell. Life testing these cells at a 1-amp or higher current drain is a good way to determine their useful life. The most meaningful information obtained from life testing any battery is when it is discharged at a rate equal to its application demand. Sometimes this can be an easy task if the current demand is continuous and constant. CDs and tape players fall in this category, but cordless tools, RC toys, and many other items do not. These "do not" items are the most

difficult to match in a static-load discharge test. The preceding two columns offered circuits for dynamic load testing that could be used for these batteries. Some of the circuits may require beefing up to handle the higher currents, which may be achieved by using power transistors and higher wattage resistors.

Two Batteries/One Load

We can use the same load bank and life test two batteries at the same time, using the time-sharing circuit in Fig. 3. This method of life testing will insure that both batteries are exposed to the same load during test. This circuit is designed to discharge batteries with terminal voltages of 6 to 12 and discharge rates of 10 amps or less. The two HEXFETS are N-channel IRF540s, which should be mounted on a heat sink with at least a 25-square-inch surface area.

Here's how the two-battery, life-testing circuit operates. A single gate of a 4093 quad two-input NAND Schmitt trigger IC is connected in a square-wave oscillator circuit, operating as a clock generator for the 4017 divide-by-10 counter. The 4017 is connected in a divide-by-2 circuit, with outputs at pins 2 and 3. Each time that the 4017's clock input, pin 14, goes positive, the outputs change state. When pin 3 is high, Q1 is turned on, placing B1 across the load. When pin 2 goes high, Q2 is turned on, placing B2 across the load. The load time is exactly the same for both batteries.

PARTS LIST FOR THE "TWO BATTERIES/ ONE LOAD" (FIG. 3)

SEMICONDUCTORS

IC1—4093 CMOS IC
IC2—4017 CMOS IC
Q1, Q2—IRF540N HEXFET

RESISTORS

R1—100,000-ohm, ½-watt, 5%
R2—1-megohm potentiometer

CAPACITORS

C1—0.1-μF, ceramic disc
C2—10-μF, electrolytic

ADDITIONAL PARTS AND MATERIALS

Heat-sink material, IC sockets, etc.

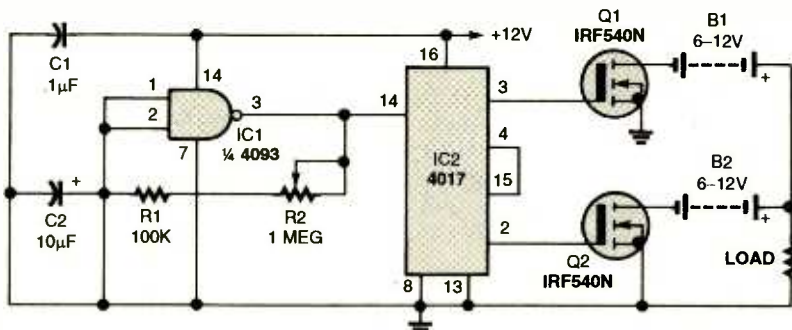

Fig. 3. Two batteries can be life tested at the same time with the circuit shown above. A NAND Schmitt trigger is at the heart of a square-wave circuit that controls the tester.

The clock rate can be varied from a few cycles per second to several seconds a cycle with R2. Changing the value of the timing capacitor, C2, can vary the clock's frequency range. A larger capacitor will lower the frequency, and a smaller value will increase the frequency.

Almost forgot to mention that the inputs of all of the unused gates on the 4093 must be tied to either ground or battery positive. This includes pins 5, 6, 8, 9, 12, and 13. If any of these inputs are left floating in the breeze, the circuit is guaranteed a visit from the CMOS ghost, which will make Mr. Murphy look like a saint. Believe me, you don't want to go there, so just do it!

Big Load Resistor

Life testing high-capacity batteries requires very low-value, high-wattage resistors to obtain the necessary load currents. A typical 12-volt battery with a 10-amp-hour rating would require a 1.2-ohm, 150-watt resistor for a one hour life test. The initial power dissipation would be slightly over 120 watts.

The biggest obstacle is the cost and availability of the power resistors. Finding a 1.2-ohm, 150-watt resistor is not an easy task. Generally, the two values available in the range needed for a 10-amp load are 1.0 and 1.5 ohms. The 1.0 ohm would draw too much current, and the 1.5-ohms would only pull about 8 amps. The 1.5-ohm resistor can be used, which will require a longer discharge time. The real kicker is the \$30.00 plus price tag for a single power resistor.

You Might Try One Of These

Let's look at some other less expensive high-wattage loads for our testing. Automotive lamps come in a wide variety of wattages, are readily available, and are generally inexpensive. These are good loads for higher current life testing. In a pinch, I used a 120-ft #16-wire extension cord for a 10-amp load on a 12-volt battery. I shorted out the cord at one end and connected the other end across the battery. The 240-ft length of #16 AWG wire just happens to be about 1.2-ohms and handles the dissipation with moderate heating.

An electric heater is another available item that can be used as a load. A typical 1500-watt portable heater has a resistive wire element that is about 9 to 12 ohms. This wire would only be useful for load currents in the range of about 1

amp. The resistive wire from a broken heater could be taken out and paralleled in sections to obtain a much lower resistance and still dissipate several hundred watts.

Sealed Lead-Acid Batteries

Sealed lead-acid batteries are very popular and are used to power all kinds of equipment. Most often, they are 6- and 12-volt batteries with an amp-hour rating of 2 to 20. However, others are available with ratings over 60 amps. These batteries are excellent power sources, which are easily maintained and offer long service life. They don't mind being heavily discharged and revived with a high-current quick charge.

The sealed lead-acid batteries may be life tested in the same way as the previous high-current batteries. A good life-testing method to use for these and other similar batteries is to discharge at a 1/10th amp-hour rate.

This lower discharge rate will help in determining the batteries' useful life after several months or years of operation. Of course, as I previously mentioned, the best load test is one that closely matches the batteries' work habit.

Well, it's about time to close shop for this visit. Be sure to tune in again next month and see what we've got cooking. 

TIPS FOR MAIL ORDER PURCHASE

It is impossible for us to verify the claims of advertisers, including but not limited to product availability, credibility, reliability and existence of warranties. The following information is provided as a service for your protection. It is not intended to constitute legal advice and readers are advised to obtain independent advice on how to best protect their own interests based upon their individual circumstances and jurisdictions.

1. **Confirm price and merchandise information** with the seller, including brand, model, color or finish, accessories and rebates included in the price.
 2. **Understand the seller's return and/or refund policy**, including the allowable return period, who pays the postage for returned merchandise and whether there is any "restocking" or "return" charge.
 3. **Understand the product's warranty**. Is there a manufacturer's warranty, and if so, is it for a U.S. or foreign manufacturer? Note that many manufacturers assert that, even if the product comes with a U.S. manufacturer's warranty, if you purchase from an unauthorized dealer, you are not covered by the manufacturer's warranty. If in doubt, contact the manufacturer directly. In addition to, or instead of the manufacturer's warranty, the seller may offer its own warranty. In either case, what is covered by warranty, how long is the warranty period, where will the product be serviced, is there a charge for service, what do you have to do to obtain service and will the product be repaired or replaced? You may want to receive a copy of the written warranty before placing your order.
 4. **Keep a copy of all transactions**, including but not limited to cancelled check, receipt and correspondence. For phone orders, make a note of the order including merchandise ordered, price, order date, expected delivery date and salesperson's name.
 5. **If the merchandise is not shipped within the promised time**, or if no time was promised, within 30 days of receipt of the order, you generally have the right to cancel the order and get a refund.
 6. **Merchandise substitution** without your express prior consent is generally not allowed.
 7. **If you have a problem with your order or the merchandise**, write a letter to the seller with all the pertinent information and keep a copy.
 8. **If you are unable to obtain satisfaction from the seller**, contact the consumer protection agency in the seller's state and your local Post Office.
- If, after following the guidelines, you experience a problem with a mail order advertiser that you are unable to resolve, please let us know. Write to Advertising Department, Gernsback Publications Inc., 275 G Marcus Blvd. Hauppauge, NY 11788**

Be sure to include copies of all correspondence.



MULTIMEDIA on the PC!

What is Multimedia? What can it do for you? It can do lots of nice things! This 184-page book helps you create your own multimedia presentation. Multimedia applications by people like you can revolutionize educational and business applications as well bring more FUN, FUN, FUN into your leisure computer activities.

Mail coupon to:

Electronics Technology Today, Inc.
P.O. Box 240
Massapequa Park, NY 11762-0240

Please send me my copy of *Multimedia on the PC* (PCP120). I enclose a check or money order for \$18.45 to cover the book's cost and shipping-and-handling expenses. NY state residents must add local sales tax.

Name

Address

City State ZIP

All orders must be paid in U.S. funds only. Sorry, no orders accepted outside of USA and Canada. Please allow 6-8 weeks for delivery.

MA02

ROBOTICS WORKSHOP

(continued from page 49)

A single 40-pin cable is connected between the 40-pin header on the PWMx2 and the OOPic. All of the functions of the PWMx2 are routed to the appropriate I/O lines on the OOPic via this cable.

To use the Magnevation PWMx2 Dual DC motor controller in an OOPic program, a single instance of the user-defined class "PWMX2" must be created as shown in Listing 1. This user-defined class creates two instances of the oDCMotor Object class, and all of the I/O configuration is automatically handled, so nothing else needs to be specified.

Listing 1 works as follows: "Dim M As New oUserClass ("PWMX2")." This line initializes a new instance of the PWMX2 user-defined object and names it "M." This object knows how to control the functions on the Magnevation PWMx2 Dual DC motor controller via properties such as Right.Value, Left.Value, Right. Brake, and so forth. The direction that the motors will

spin is specified by whether the Right.Value and Left.Value properties are positive or negative. Positive numbers will cause the motors to spin forward, and negative numbers will cause the motors to spin backward. A value of 0 will cause the motors to stop, while values of positive 127 and negative 127 will cause the motors to run at full speed forward and full speed backward respectively. The user-defined object PWMX2 can be downloaded from Magnevation's Web site.

The oIRRange program code from last month is added to this program, along with the new formulas as shown in Listing 2. This program works as follows: All of the Dim statements create instances of the objects specified. A constant value named CurSpeed is set to 64. Some set-ups are done that define which I/O lines the oIRRange objects are to use. The variable A is set to the angle of correction, which is calculated from the values of the oIRRange objects. The angle of correction along with the CurSpeed value

is applied to the speed of the Right and Left motor.

Next Month

Next month we will discuss how to simulate the robot's wall-tracking behavior with Cognitoy's *Mindrover*. In that article, a virtual circuit will be programmed into one of *Mindrover*'s 3-D virtual-reality robots—allowing the builder to test drive the entire robot and program in virtual reality before building it. Then, once the robot's behavior has been defined and tested, *Mindrover* will generate code for the OOPic, which can be downloaded to your robot.

On The Web

Both the OOPic and the Sharp IR Distance Detector are available from Acroname Robotics at www.acroname.com. More information on the OOPic can be found at www.oopic.com. Visit Magnevation's URL at www.magnevation.com. Learn about *Mindrover* at www.mindrover.com. P

FACTCARDS



**Jampacked with
information at your
fingertips**

■ ALL YOU NEED to know about electronics from transistor packaging to substitution and replacement guides. FACTCARDS numbers 34 through 66 are now available. These beautifully-printed cards measure a full three-by-five inches and are printed in two colors. They cover a wide range of subjects from Triac circuit/replacement guides to flip-flops, Schmitt triggers, Thyristor circuits, Opto-Isolator/Coupler selection and replacement. All are clearly explained with typical circuit applications.

■ WANT TO EXPAND your knowledge of electronics? Do it the easy way

by studying the Electronics Fact Cards. Do you travel to and from your job each day? Drop a handful of cards in your pocket before you leave, and the bus becomes a schoolroom! At home, you can build some of the projects and not only have fun building and using them, but learn how they work at the same time.

■ YOU'LL BE AMAZED both at how rapidly you learn with these cards, and how easy it is to understand. These new cards are available right now. Don't miss out. Send your check or money order today.

FACTCARDS—Facts at your fingertips for Experimenters and Project Builders!

Please send one copy of FACTCARDS \$1.99. Shipping \$2.00 (U.S. and Canada only).

|| Please send _____ copies of FACTCARDS. Total cost is sum of copy price and First Class postage and handling cost multiplied by number of card sets ordered.

New York residents add sales tax to total cost of each order.

Please print

Allow 6-8 weeks for the material to arrive.

(Name)

(Street Address)

(City)

(State)

(Zip)

Detach and mail today:
CLAGGK Inc.
P.O. Box 12162
Hauppauge, NY 11788

All Payment must be in U.S.
Funds!

BS168

BARCODE (UPC) SCANNERS

This month, I am going to discuss the topic of barcode scanners. Although, it is not directly repair-related, the subject should have material of interest to readers of this column. The use of the Universal Product Code (UPC) has revolutionized grocery/supermarket and other retail store checkout and inventory control. It has also been applied to other numerous applications, as varied as package routing and tracking and tagging of wild animals. There was even an aborted attempt to use similar codes to those printed in the weekly TV section to program VCRs with a hand-held barcode wand!

Barcode Primer

Some would argue that the use of such technology in supermarkets, at least, has dehumanized the buying experience and stacked the deck in favor of the merchant. Prices no longer tend to be printed on each item, and the checkout process is now

so fast that it is virtually impossible to catch mistakes should they occur. Since the price-to-item relationship is stored in a computer somewhere, there are indeed errors—but these are generally rare.

Space and other factors prevent me from going into the details of the Universal Product Code, itself. The quick summary is that the pattern of black lines familiar on virtually all products nowadays—the UPC code—has been carefully designed to be easily decoded when scanned in either direction, at an arbitrary angle, and with variable speed. There are actually many other barcodes besides the UPC—used for inventory control, tracking, and other diverse applications. (If you should need to stay in a hospital, you will be given a barcode!)

The UPC consists of 12 digits. The first digit is the type of product (0 is for groceries, 3 is for drugs, etc.), the next five digits on the left half are the manu-

facturer code, the first five digits of the right half are the product code, and the last one is a modulo check digit. Each digit, as its name implies, can have a value from 0 to 9, encoded as a set of four alternating bars and spaces, each of which may have a width of 1, 2, 3, or 4 units—called “modules.” The total width of each digit is defined to be 7, which allows for 20 unique codes—ten used for the left six digits, the other ten for the right six digits. The left six digits are coded with odd parity; the right six digits with even parity. Additional details can be found at the first Web site, below.

Here are some Web sites that have info and many links to barcode manufacturers, barcode-generating software, and other information that may be useful: www.barcode-1.com—Russ Adams’ Barcode 1 (information and links, shareware, books, specifications, discussion group, and more can be found here) and www.taltech.com—TAL Technologies (barcode and data acquisition software).

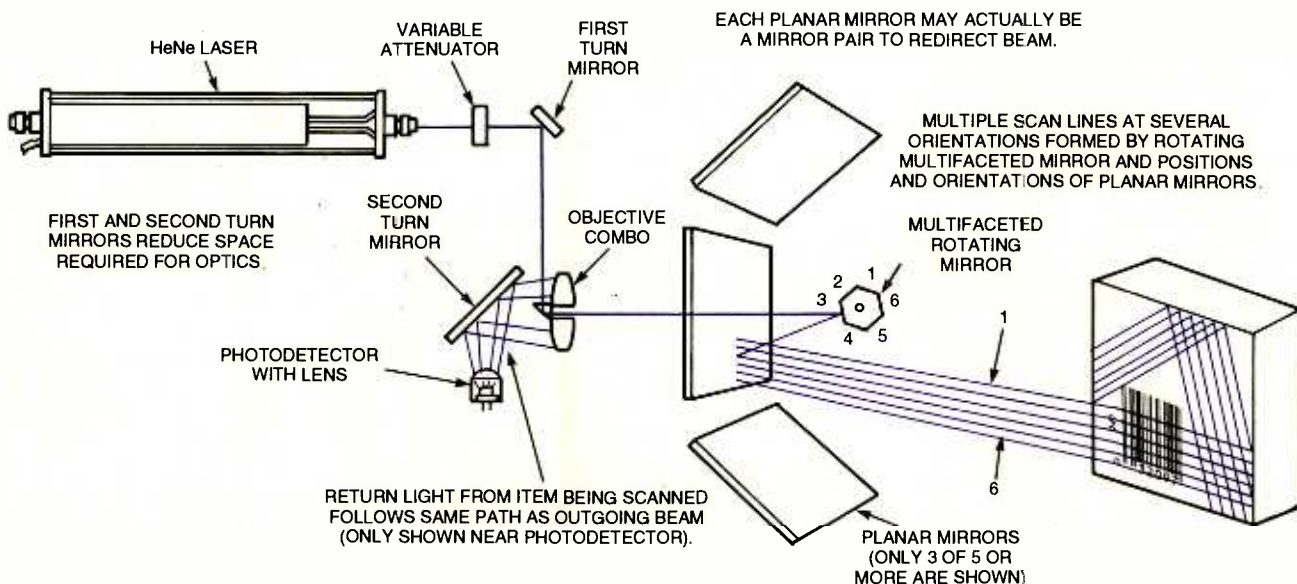

Fig. 1. Here is a diagram that shows the optical path of a typical barcode-scanner. The HeNe lasers used can often be found via wholesale and liquidation companies.



This HeNe laser is the one of the more common types found in supermarket barcode-scanners.

Scanner Anatomy

For the purposes of the discussion below, we restrict our attention to the type of equipment found at your local supermarket—the barcode scanner that is mounted under or beside the conveyor counter (and may include an electronic scale, but that is another story). While details vary, the basic architecture of these devices tends to be very similar. Once you are familiar with one model, parts identification and the optical path of any other will be almost immediately obvious. Hand-held scanners may not even use a laser, but a linear array of LEDs (one that actually uses a helium-neon laser is described below). Large industrial barcode scanners may contain a much more powerful laser and somewhat different optical path. Some of the newest barcode technology does away with the laser scanner altogether and uses a 2-D video-camera (CMOS or CCD)-based imaging system and high-speed DSP (Digital Signal Processor), instead. This technology eliminates most of the complex and costly optical and mechanical components making for a compact robust system. Currently, the electro-mechanical laser scanner is still the most common.

The basic principle is to use a collimated laser beam, rotating multifaceted mirror, several stationary mirrors, and other optics to generate a scan pattern above or beside the scanner that will intercept the UPC code printed on the item to be scanned. While the scan may appear to consist of multiple lines or a continuous pattern, it is in reality a single rapidly moving spot.

Through the glass of the scanner, it may appear that all sorts of stuff is arranged at random. However, this is not the case. Refer to Fig. 1, as you read the following descriptions (which also includes some comments on potentially useful parts that may be obtained from these units).

Lasers—The source of the beam is either a low-power helium-neon (HeNe) or diode laser. Older (and larger) scan-

ners tended to use HeNe lasers. However, size alone is no sure indication until you get to the very small (6-inch cubes or hand-held wands), which are almost always based on diode lasers (if they use a laser at all). A better test is to check the color of the beam—the light from HeNe-laser-based scanners appears orange-red (632.8 nm), while that from diode-laser-based scanners tends to be a deep red from the 670-nm wavelength—less expensive (but just as effective). Just explain that you are doing scientific research when the people in the white coats come to take you away for staring into the scanner!

HeNe lasers are typically 1 to 3 milliwatt (mW)—mostly near 1 mW, using tubes between 5 and 10 inches in length. The divergence of the raw beam from HeNe-laser tubes used in barcode scanners tends to be greater than the diffraction limit, possibly 5 to 10 mR (*milliradian*) or more. Some HeNe tubes even have a lens glued to the output mirror to mess up the beam in this way! (However, the beam quality is just as good as a similar 1 or 2 mR, 1 part in 1000 divergence tube—it just looks more like a flashlight than a laser!) Where an external lens is actually glued to the output mirror of the HeNe tube, it can probably be removed with a suitable solvent or some heat—leaving a low divergence tube. Locate the collimating lens that is present in the scanner or one of your own and use that to adjust the divergence or focus of the beam, as desired. In fact, since you can intercept the beam wherever you want, using the high divergence tube provides added flexibility to generate a very low divergence beam (e.g., 0.1 mR) with a single additional lens.

The HeNe laser power supply may be a self-contained brick or may be built on the mainboard. The former is, of course, much more desirable from the perspective of salvaging parts! In either case, turning on the laser will probably require grounding or pulling up an enable signal since, in most systems, the laser is automatically turned off after a period of inactivity.



Here is a power-supply-circuit that is used to power an HeNe laser.

Diode lasers are typically 670 nm (deep red, like older diode-laser-based laser pointers) with 5-mW maximum output. A collimating lens and possibly some other optics will be part of the diode laser assembly.

The laser-diode-driver circuit will be in close proximity to the laser diode, itself, and may be on a separate board. However, it is most likely part of the mainboard, and it is difficult to identify correct use without a schematic. A graded density filter may be used as a variable attenuator. It would be placed immediately following the laser's output to adjust the beam intensity to compensate for variations in laser power (mostly for HeNe lasers—diode lasers will have a potentiometer for this purpose).

Turning Mirror(s)—There may be one or more high-quality planar first surface-protected aluminum or dichroic mirrors to direct the beam. (If dichroic, the peak reflectivity wavelength will match that of the laser used and may possibly also be optimized for the actual reflection angle in the scanner.) Their mount will probably be adjustable in X and Y to some extent. While nowhere near the precision of a Newport MM2 mirror mount, they should be perfectly adequate for basic optics experimentation when attached to a rigid surface. Note that these mirrors do not serve any fundamental purpose—they simply fold the optical path resulting in a smaller physical package.

Main Objective Combo—The outgoing and return beams (reflection from the item being scanned) follow the same path except that the return is not a nice narrow collimated beam. The outgoing beam passes through a window inset into a large positive lens. This may include a mirror or prism to redirect the beam and the collimating/focusing lens to produce a nice small spot at the item being scanned. This is the strange part! The large lens focuses the return beam onto the photodetector (see below); and since optical quality isn't critical at this point, it is likely made from molded plastic.

Multifaceted Rotating Mirror—The collimated outgoing beam is deflected by a 3- to 6-facet polygonal mirror directly driven by a speed-regulated brushless DC motor. The motor/scanner assembly is generally a separate

module in older equipment, requiring only DC power and an enable signal to run. However, like the HeNe-power supply, newer systems usually mount it directly on the mainboard. Most of the larger barcode scanners use motors of similar quality to those in disk drives, since they may need to run continuously. However, smaller scanners may use something that looks like the core of a cheap DC fan!

Unlike those in a laser printer, the mirror facets are large, since they have to reflect the diffuse return beam as well as the tiny spot of the outgoing beam. They are fabricated as individual mirrors glued to a cast-metal wheel-type affair and are all set at slightly different angles so that each rotation of the mirror wheel results in scan lines at three to six slightly different locations depending on the number of facets.

Multiple Planar Mirrors—The final optical component before the outgoing beam hits the item being scanned is made up of several large fixed first surface mirrors. Despite their appearance of having been just plunked down at random, these have positions and orientations carefully chosen to direct the beam in a pattern providing the best chance of intercepting the UPC code with at least one scan line and resulting in approximately equal spot-scanning speed for each scan line. Depending on design, the beam may strike either one or two of these mirrors on its journey each way (out and back).

These are usually decent quality aluminumized first surface mirrors and could find all sorts of other uses. Although generally shaped as strange four-sided polygons, they can be subdivided into more useful sizes using a glass cutter from the rear or a water-cooled diamond cutoff wheel.

The outgoing beam is set up to be a small spot in the active area above or beside the scanner—the scanned item volume. However, the return from the UPC printed on the item is, in general, not in sharp focus, but is a diffuse reflection. Thus, as noted, all the mirrors have to be large to capture as much of this as possible to feed to the photodetector. The return path is the same as the outgoing path until the objective combo lens, which focuses the return beam onto the photodetector.

Photodetector—A silicon photodiode,

often of moderate area (typically 2×2 mm, good for a laser power meter) intercepts the return beam focused by the objective combo. (Some light is lost to the inset optic for the outgoing beam, but this is small.) There may be an additional focusing lens and/or red ambient light blocking filter associated with the photodetector.

Controller—A microprocessor-based system analyzes the datastream from the photodetector, isolates any section that appears to be valid data, decodes the UPC symbols, and sends the result via an RS232 line (or possibly a proprietary interface for older models) to the host computer. Handshaking assures (hopefully from the point-of-view of the store owner!) that data isn't lost.

Power Supply—Depending on the model, these supplies may plug directly into the AC line or be powered from a wall adapter.

As you can see, these full-size barcode scanners contain a virtual treasure trove of useful electronic, mechanical, and optical parts for the experimenter and hobbyist. See the document: <http://www.repairfaq.org/sam/gadget.htm>—Sam's Gadget FAQ on my Web site for more on salvaging parts from barcode scanners.

Safety Precautions

There really aren't too many safety issues with respect to these devices even though they contain a Class IIIa (1 to 3 mW) laser, and the beam may appear to be quite bright. (Note that barcode scanners systems are listed as Class II laser devices, since access to the laser and optics requires some disassembly.)

There is really no risk to the user or customer in proximity to a checkout scanner. The laser beam is moving rapidly and is low power. A rough estimate of the maximum possible eye exposure to a properly functioning scanner is about 10 microwatts or less. The only possible risk would be if the scanner motor failed for some reason, and the laser beam was stationary.

However, some if not all scanners have a safety device to shut off the laser, should the return beam not behave properly. With laser power of around 1 mW, the normal blink and aversion reflex should provide adequate protection. The perceived brightness is some-

what of an illusion due to the peak intensity and pulsed nature of the beam.

When you poke around inside a barcode scanner, there are somewhat greater risks of being dazzled because the laser beam will be stationary and collimated along portions of the optical path. However, anything more than very temporary after-images is unlikely.

For AC-line-powered units (no wall adapter), there will be some exposed 115 or 230 V_{AC} points near the line cord and on the mainboard or power supply. For HeNe-laser-based systems with the high-voltage power supply on the mainboard, there will be exposed pads with voltages up to 5 kV or more (during starting). Since these may not be clearly marked, it pays to identify them beforehand and take appropriate precautions. Those with brick-type HeNe-power supplies are usually pretty well insulated.

Then, there is the rotating mirror that can catch long hair or jewelry.

Finally, since these scanners may have seen service under less than sterile conditions with all sorts of icky and disgusting stuff passing their way, including meat and chicken parts dripping with blood, there can be all sorts of surprises in store for you from mummified mice to maggot colonies. Take appropriate precautions in your exploration and/or disassembly!

Metrologic Model MH290 Examined

This hand-held HeNe laser-based barcode scanner apparently was the source of the power supply described in the section: <http://www.repairfaq.org/sam/laserhsc.htm#hsc1>—HeNe Inverter Power Supply Using PWM Controller IC (IC-HI1) on my Web site. The entire HeNe-laser (tube and power supply) is about $1 \times 1.5 \times 5$ inches and weighs only about 3.5 ounces!

Virtually the same laser was used by Metrologic in a pre-diode laser pointer. We'll look into (well, not literally!) laser pointers in a future "Service Clinic."

Art Allen, KY1K (ballen@colby.edu), recently sent me a Model MH290 unit to examine.

The following comments on the device all come from Art. The unit I have that uses a power supply that is 100 percent identical to the schematic and PCB layout of IC-HI1 is a Metrologic Model MH290. It is labeled with a 1990 date of manufacture and says 12 V_{DC} at 550 mA on the scanner unit itself. The

wall wart that runs the system is rated at 12 V_{DC} at 1 A.

The MH290 is a hand-held unit with a trigger. You pull the trigger when you are ready to scan, and the laser starts scanning for four or five seconds and then shuts down. To attempt a second scan, you have to pull the trigger again. Inside the hand unit, there is the receiver and a second PCB to support the receive electronics and the spinning mirrors (driven by a small 15-degree-per-step stepper motor). The MH290 is smart enough to know when the laser is on and produces an error if it doesn't come on OR if it stays on longer than it should.

The MH290 connects to another unit via a 9-pin RS232 type connector; the other unit has the EEPROM and related components for decoding and interfacing to the computer itself. The MH290 hand-held scanner does not connect directly to the computer, and all power sent to the MH290 comes from this other box.

Wrapup

I hope you consider this diversion into something not directly repair-related worthwhile. I was going to add a paragraph or two on barcode scanner repair just to maintain the flavor of "Service Clinic," but decided that this would be of interest to at most three people on the planet. If you do have a barcode scanner in need of repair, deal with it in terms of the individual subsystems and troubleshoot in a systematic manner. Much more on laser-related topics can be found on my Web site, www.repairfaq.org. As always, I will be happy to reply to questions or comments via email to sam@repairfaq.org. (Sorry, I cannot answer snail mail.) See you next time. 

Poptronics

REPRINT BOOKSTORE

- | | |
|---------------------------------------------------------------------------------------------------------------------|-----------------------------------------------------------------------------------------------------------|
| <input type="checkbox"/> 229 Popular Electronics (1999 back issues) \$5.00
Write in Issues desired _____ | <input type="checkbox"/> 218 Electronics Now (1998 back issues) . \$5.00
Write in Issues desired _____ |
| <input type="checkbox"/> 228 Popular Electronics (1998 back issues) \$5.00
Write in Issues desired _____ | <input type="checkbox"/> 217 Electronics Now (1997 back issues) . \$5.00
Write in Issues desired _____ |
| <input type="checkbox"/> 227 Popular Electronics (1997 back issues) \$5.00
Write in Issues desired _____ | <input type="checkbox"/> 216 Electronics Now (1996 back issues) . \$5.00
Write in Issues desired _____ |
| <input type="checkbox"/> 226 Popular Electronics (1996 back issues) \$5.00
Write in Issues desired _____ | <input type="checkbox"/> 215 Electronics Now (1995 back issues) . \$5.00
Write in Issues desired _____ |
| <input type="checkbox"/> 225 Popular Electronics (1995 back issues) \$5.00
Write in Issues desired _____ | |
| <input type="checkbox"/> EH96 Experimenters Handbook (1996) . \$5.00 | |
| <input type="checkbox"/> EH95S Experimenters Handbook
Summer Edition (1995) . \$5.00 | |
| <input type="checkbox"/> EH94S Experimenters Handbook
Summer Edition (1994) . \$5.00 | |
| <input type="checkbox"/> EH94W Experimenters Handbook
Winter Edition (1994) . \$5.00 | |
| <input type="checkbox"/> EH94 Experimenters Handbook (1994) . \$5.00 | |
| <input type="checkbox"/> EH93 Experimenters Handbook (1993) . \$5.00 | |
| <input type="checkbox"/> HH95S Hobbyists Handbook
Spring Edition (1995) . \$5.00 | |
| <input type="checkbox"/> HH95F Hobbyists Handbook
Fall Edition (1995) . \$5.00 | |
| <input type="checkbox"/> HH94S Hobbyists Handbook
Spring Edition (1994) . \$5.00 | |
| <input type="checkbox"/> HH94F Hobbyists Handbook
Fall Edition (1994) . \$5.00 | |
| <input type="checkbox"/> HH93 Hobbyists Handbook (1993) . \$5.00 | |
| <input type="checkbox"/> HISTORY Crystal Radio History, Fundamentals
& Design . \$10.95 | |
| <input type="checkbox"/> XTAL Crystal Set Handbook . \$10.95 | |
| <input type="checkbox"/> XTALPRO Crystal Set Projects . \$14.95 | |
| <input type="checkbox"/> XTALBLD Crystal Set Building . \$15.95 | |
| <input type="checkbox"/> POP96 POPtronix Hobbyist Handbook (1996) \$5.00 | |
| <input type="checkbox"/> POP97 POPtronix Exper Handbook (1997) . \$5.00 | |
| <input type="checkbox"/> Radiocraft 1993 Projects for Hobbyists . \$5.00 | |
| <input type="checkbox"/> 219 Electronics Now (1999 back issues) . \$5.00
Write in Issues desired _____ | |
| <input type="checkbox"/> 174 Electronics Cartoons (The Best of) . \$1.99 | |
| <input type="checkbox"/> 173 From Not-Working to Networking
Troubleshooting Local-Area Networks . \$2.99 | |
| <input type="checkbox"/> 172 33 Bench-Tested Circuits . \$1.99 | |
| <input type="checkbox"/> 171 36 Time Tested Circuits . \$1.99 | |
| <input type="checkbox"/> 170 High-Voltage Project for Fun and
Science Book 1 . \$2.99 | |
| <input type="checkbox"/> 170A High-Voltage Projects for Fun and
Science Book 2 . \$2.99 | |
| <input type="checkbox"/> 169 Think Tank (133 Circuits) . \$1.99 | |
| <input type="checkbox"/> 169A Think Tank Vol. 2 . \$1.99 | |
| <input type="checkbox"/> 168 Fact Cards (#34-66) . \$1.99 | |
| <input type="checkbox"/> 168C Fact Cards (#67-99) . \$1.99 | |
| <input type="checkbox"/> 168D Fact Cards (#100-132) . \$1.99 | |
| <input type="checkbox"/> 167 Designing With IC's . \$2.99 | |
| <input type="checkbox"/> 166 Collected Works of Mohammed Ulyses
Fips (62 pages, April Fools Collection) . \$6.99 | |
| <input type="checkbox"/> 165 How to Repair CD Disc Players . \$2.99 | |
| <input type="checkbox"/> 164 Modern Electrics (April 1908) . \$1.99 | |
| <input type="checkbox"/> 160 New Ideas - 42 Circuits . \$1.99 | |
| <input type="checkbox"/> 159 Low Frequency Receiving Techniques
Building and Using VLF Antennas . \$2.99 | |
| <input type="checkbox"/> 158 Electro Importing Co. Catalog
(Circa 1918) . \$2.99 | |
| <input type="checkbox"/> 157 All About Kits . \$1.99 | |
| <input type="checkbox"/> 156 How To Make PC Boards . \$1.99 | |
| <input type="checkbox"/> 154 How To Repair VCR's . \$1.99 | |

REPRINTS REPRINTS

To order any of the items indicated above, check off the ones you want. Complete the order form below, include your payment, check or money order (DO NOT SEND CASH), payable to and mail to Claggk Inc., Reprint Department, P.O. Box 12162, Hauppauge, NY 11788.

Please allow 4-6 weeks for delivery. No COD's!

To place a credit card by phone, Visa Mastercard or Discover only. You can also order and pay by e-mail. Contact Claggk@gernsback.com for details.

CALL: 631-592-6721

To use your Visa, Mastercard or Discover, complete the following:

Bill my Visa Mastercard Discover

Card No. _____

Exp. Date _____

Signature _____

MAIL TO: Claggk Inc.

Reprint Bookstore, P.O. Box 12162, Hauppauge, NY 11788.

All payments must be in U.S. funds

SHIPPING CHARGES IN USA & CANADA

Up to \$5.00 \$2.00	\$30.01 to 40.00 \$6.00	Overseas Orders must contact CLAGGK for shipping charges.
\$5.01 to \$10.00 \$3.00	\$40.01 to 50.00 \$7.00	
\$10.01 to 20.00 \$4.00	\$50.01 and above \$8.50	
\$20.01 to 30.00 \$5.00		

Total price of merchandise \$ _____

Shipping Charge (see chart) \$ _____

Subtotal \$ _____

Sales Tax (New York State Residents only) \$ _____

Name _____ Total Enclosed \$ _____

Address _____

City _____ State _____ Zip _____

CL01



THE COLLECTED WORKS OF MOHAMMED ULLYSES FIPS

#166—By Hugo Gernsback. Here is a collection of 21 April Fools Articles, reprinted from the pages of the magazines they appeared in, as a 74-page, 8 1/2 x 11-inch book. The stories were written between 1933 and 1964. Some of the devices actually exist today. Others are just around the corner. All are fun and almost possible. Stories include the Cordless Radio Iron, The Visi-Talkie, Electronic Razor, 30-Day LP Record, Teleyeglasses and even Electronic Brain Servicing. Get your copy today. Ask for book #166 and include \$9.99 (includes shipping and handling) in the US (First Class), Canada and Overseas (surface mail), and order from **CLAGGK Inc., P.O. Box 12162, Hauppauge, NY 11788.** Payment in US funds by US bank check or International Money Order. Allow 6-8 weeks for delivery. MA05



TEST YOUR KNOWLEDGE

Try to match each law with its description.

1. Coulomb's law



A. (1) The mass of a substance liberated in an electrolytic cell is proportionate to the quantity of electricity passing through the cell. (2) When the same quantity of electricity is passed through different electrolytic cells, the masses of the substances liberated are proportionate to their chemical equivalents. (3) Also called the law of electromagnetic induction. When a magnetic field cuts a conductor, or when a conductor cuts a magnetic field, an electric current will flow through the conductor if a closed path is provided over which the current can circulate.

2. Lambert's law

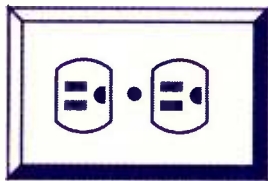

B. The strength of a magnetic field at any given point due to any element of a current-carrying conductor is directly proportional to the strength of the current and the projected length of the element, and is inversely proportional to the square of the distance of the element from the point in question.

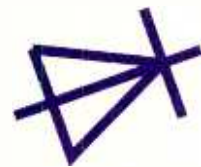

3. Kirchhoff's law

C. The voltage across an element of a dc circuit is equal to the current in amperes through the element, multiplied by the resistance of the element in ohms. Expressed mathematically as $E = I \times R$. The other two equations obtained by transposition are $I = E/R$ and $R = E/I$.

4. Laplace's law

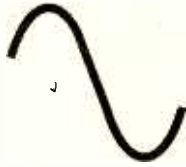

5. Ohm's law

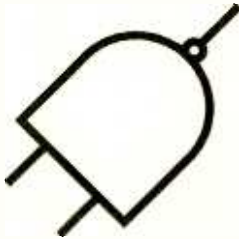

6. Wiens's law



D. The illumination of a surface on which the light falls normally from a point source is inversely proportional to the square of the distance of the surface from the source. If the normal to the surface makes an angle with the direction of the rays, the illumination is proportional to the cosine of that angle.

E. Also called law of electric charges or law of electrostatic attraction. The force of attraction or repulsion between two charges of electricity concentrated at two points in an isotropic medium is proportionate to the product of their magnitudes and is inversely proportionate to the square of the distance between them. The force between unlike charges is an attraction, and between like charges repulsion.

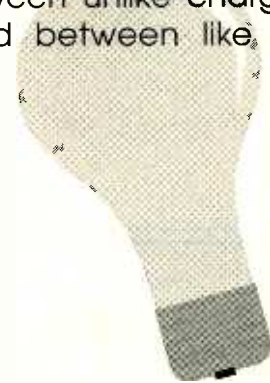

F. The current induced in a circuit due to a change in the magnetic flux through it or its motion in a magnetic field is so directed as to oppose the change in flux or to exert a mechanical force opposing the motion. If a constant current flows in a primary circuit A, and if by motion of A or the secondary circuit, B, a current is induced in B, the direction of the induced current will be such that, by its electromagnetic action on A, it tends to oppose the relative motion of the circuits.

7. Faraday's law

G. The wavelength of maximum radiation intensity is inversely proportional to the absolute temperature of a black-body, and the intensity of radiation at this maximum wavelength varies as the fifth power of the absolute temperature.



8. Lenz's law

H. (1) The current flowing to a given point in a circuit is equal to the current flowing away from that point. (2) The algebraic sum of the voltage drops in any closed path in a circuit is equal to the algebraic sum of the electromotive forces in that path. (Laws 1 and 2 are also called laws of electric networks.) (3) At a given temperature, the emissive power of a body is the same as its radiation-absorbing power for all surfaces.

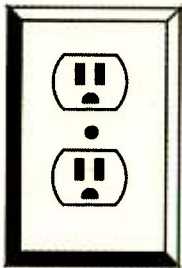

ASK WHAT YOUR COUNTRY CAN DO FOR YOU.

Your patriotism has already told you what you can do for your country. Now it's time for you to ask what your country can do for you. It's a question the Air Force Reserve loves to answer. For a commitment of as little as one week-end a month and two weeks a year, you will receive everything you need to take your life above and beyond including:

- **Challenging missions that build endurance, mental stamina and confidence**
- **Expert training on the latest systems and equipment**
 - **Great benefits that will last a lifetime**
 - **The satisfaction of serving your community and your country**

Call
1-800-257-1212



**AIR FORCE
RESERVE**
ABOVE & BEYOND

Visit our web site at www.afreserve.com

LETTERS

(continued from page 4)

"Riddle of the Ages" in my theory, "The Williams; Hydraulic Theory of Cheops", described at: www.tsc-global.com/cheops.html. In my heavily documented theory, a vertical hydraulic elevator near the pyramid's center lifted up the stones to the top level under construction. And that the Grand Gallery was actually a large water storage reservoir for powering the system.

Interestingly, the article mentions that the required temperature for electrolysis could be lowered, "by using some sort of current-carrying fluid between the electrodes." And I have experimentally determined that a column of mineralized water in a capped 10-foot PVC pipe has antenna characteristics. So why not in a 481-foot stone-encased elevator shaft?

It should be noted that the first known use of copper tube plumbing was found in Cheops. There are many other mysteries to Cheops, including how they cut 2.3 million stones with greater hardness than the known tool metals of the day.

Also, the State University of New York at Buffalo have developed crude electronic devices (e.g. diodes, temperature sensors, heat sinks/sources) from Portland cement.

JOHN J. WILLIAMS
Albuquerque, NM

I've been very disappointed in your magazine's lack of response to the power shortage in the west. I did enjoy your article in the September issue on "Radio Signals and the Great Pyramid." This is a good beginning. However, there was an exposé on "Sixty Minutes" about two years ago about a type of circuit that can be built by the hobbyist (like myself), that will help lower the consumer's power bill and usage by preventing the total power usage from registering on the power meter. According to this report, these circuits are totally legal. If you could help me find these circuits, I would be very appreciative, as the power bills really exploded last year.

Any response to the power shortage would be welcome, but these circuits would be especially welcome.

DONNA GOOLEY
North Hollywood, CA

Books that Bridge Theory & Practice

Many electronics enthusiasts discovered that the bridge from classroom theory books to hands-on project building is difficult to span at times without a handy pocket guide. Even the equipment manual to operate a gadget often makes things murkier rather than clearer. A compact text authored by a seasoned expert with hands-on knowledge and a knack of writing in an easy-to-understand style is many times more valuable than the price of ponderous theory and equipment manuals or the parts for a project that could be damaged. Here's a sampler of some titles you may want to own!

ELECTRONIC HOBBYIST DATA BOOK—The info you need to transport you from the schematic diagram to project parts. Pin-outs, color codes, truth tables, parts parameters, etc. **Order BP396- \$10.99 Includes S & H**

PRACTICAL INTRODUCTION TO SURFACE MOUNT DEVICES—A technology that spun off the automated assembly line into the grasp of experimenters and project builders. **Order BP411- \$9.99 Includes S & H**

THE PRE-COMPUTER BOOK—Aimed at the absolute beginner with little or no knowledge of computing. A non-technical discussion of computer bits and pieces and programming. **Order BP115- \$2.99 Plus \$2.00 S & H**

PRACTICAL OSCILLATOR CIRCUITS—If your budding project requires an oscillator, you can design it and build it from the many types described here in a hobbyist-friendly style. **Order BP393- \$9.99 Includes S & H**

PRACTICAL PIC MICROCONTROLLER PROJECTS—This book covers a wide range of PIC based projects. In most cases the circuits are very simple and they are easily constructed. **Order BP444- \$7.99 Includes S & H**

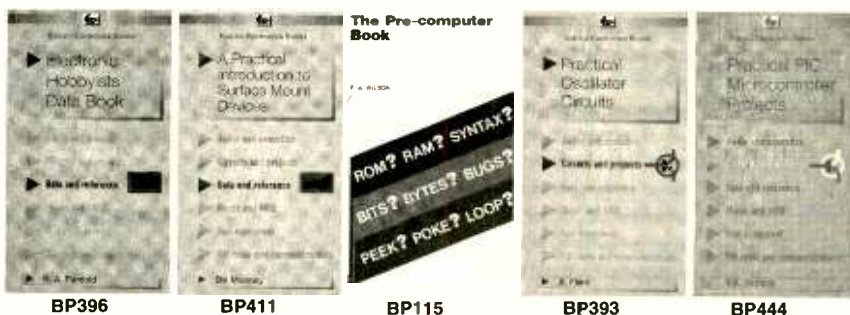

Electronics Technology Today Inc.

P.O. Box 240

Massapequa, NY 11762-0240

Number of books ordered

Amount enclosed \$ _____

Please send me the following book(s) that I checked:

- BP396 - Electronic Hobbyist Data Book—\$10.99
- BP411 - Practical Introduction to Surface Mount Devices—\$9.99
- BP115 - The Pre-Computer Book—\$2.99 + \$2.00 S & H
- BP393 - Practical Oscillator Circuits—\$9.99
- BP444 - Practical PIC Microcontroller Projects —\$7.99

Most above prices include shipping and handling

ET05

Name/Company _____

Address _____ Apt. _____

City _____ State _____ Zip _____

Sorry, no orders accepted outside the USA and Canada. All payments must be in US funds! NY state residents must include local sales tax. Allow 6-8 weeks for delivery.

RETAILERS THAT SELL OUR MAGAZINE EVERY MONTH

Arizona

Elliott Elec. Supply
1251 S. Tyndell Ave.
Tucson, AZ 85713

California

All Electronics
14928 Oxnard Street
Van Nuys, CA 91411

California Electronics
221 N. Johnson Ave.
El Cajon, CA 90202

Electronics Plus, Inc.
823 4th St.
San Rafael, CA 94901

Electronics Warehouse
2691 Main Street
Riverside, CA 92501

Ford Electronics
8431 Commonwealth Ave
Buena Park, CA 90621

HSC Electronics
5681 Redwood Drive
Rohnert, CA 94928

HSC Electronics
4837 Amber Lane
Sacramento, CA 95841

Halted Specialties Co.
3500 Ryder Street
Santa Clara, CA 95051

Kandarian Electronics
1101 19th Street
Bakersfield, CA 93301

Mar Vac Electronics
2001 Harbor Blvd.
Costa Mesa, CA 92627

Mar Vac Electronics
1759 E. Colorado Blvd.
Pasadena, CA 91106

Mar Vac Electronics
4747 Holt Blvd.
Montclair, CA 91763

Mar Vac Electronics
5184 Hollister Blvd.
Santa Barbara, CA 93111

Mar Vac Electronics
2537 Del Paso Blvd.
Sacramento, CA 95815

Mar Vac Electronics
2000 Outlet Center Dr. #150
Oxnard, CA 93030

Mar Vac Electronics
12453 Washington Blvd.
Los Angeles, CA 90066

Metro Electronics
1831 J Street
Sacramento, CA 95814

Orvac Electronics
1645 E Orangethorpe Ave.
Fullerton, CA 92631

Sav-On Electronics
13225 Harbor Blvd.
Garden Grove, CA 92643

Colorado

Centennial Elec. Inc.
2324 E. Bijon
Colorado Springs, CO
80909

Connecticut

Cables & Connectors
2315 Berlin Turnpike
Newington, CT 06111

Illinois

Tri State Elec
200 W. Northwest Hwy.
Mt. Prospect, IL 60056

Maryland

Mark Elec. Supply Inc.
11215 Old Baltimore Pike
Beltsville, MD 20705

Massachusetts

Electronic Hook-Up
104 Main St.
Milford, MA 01757

"You-Do-It" Electronics
40 Franklin Street
Neeham, MA 02494

Michigan

Purchase Radio Supply
327 East Hoover Avenue
Ann Arbor, MI 48104

The Elec. Connection
37387 Ford Road
Westland, MI 48185

Minnesota

Acme Electronics
224 Washington Avenue N.
Minneapolis, MN 55401

Missouri

Gateway Electronics
8123-25 Page Blvd.
St. Louis, MO 63130

New Jersey

Lashen Electronics Inc.
21 Broadway
Denville, NJ 07834

New York

LNL Distributing Corp.
235 Robbins Lane
Syosset, NY 11791

T&M Elec. Supply, Inc.
472 East Main Street
Patchogue, NY 11772

Unicorn Electronics
Valley Plaza
Johnson City, NY 13790

Ohio

Parts Express
725 Pleasant Valley Drive
Springboro, OH 45066

Oregon

Norvac Electronics
7940 SW Nimbus Avenue
Beaverton, OR 97005

Texas

Computers Electronics Etc.
110 E. Medical Center Blvd.
Webster, TX 77598

Electronic Parts Outlet
3753 B Fondren
Houston, TX 77063

Tanner Electronics
1301 W Beltline
Carrollton, TX 75006

Washington

Supertronix Inc.
16550 W. Valley Hwy.
Tukwila, WA 98188

*Barnes & Noble • B. Dalton • Crown Books • Tower Books • Super Stand
Borders Book Store • On Cue • Hastings • Media Play • Walden Book Store
Just About Every Major Book Store!*

If you'd like to sell our magazine in your store, please circle 180 on free information card or Contact Gina Giuliano at (631) 592-6720 ext 215

Poptronics®

SHOPPER[®]

POLARIS CAN SUPPLY YOU WITH ALL OF TODAY'S HOTTEST VIDEO TECHNOLOGY!

CALL OR GO ON-LINE TO ORDER YOUR FREE VIDEO CATALOG - 100's OF PRODUCTS - MICRO CAMERAS - WIRELESS VIDEO - LIPSTICK CAMERAS - DIGITAL VCR'S
WEB CAMERA WITH BUILT-IN PAN/TILT/ZOOM CONTROLS **WEATHERPROOF DIGITAL STORAGE CAMERA**



Compact Web Camera For Online Image Monitoring and Delivery Over The Internet

Featuring a built-in Web server, powerful 10x zoom, pan/tilt, and alarm input/output capability, all in an ultra-compact unit. These Web cameras can be installed virtually anywhere and deliver high-quality images to the Internet for real-time monitoring or broadcast. Better yet, these cameras can be controlled and monitored via a standard Web browser, making it ideal for a wide variety of applications.

Size: 122mm x 82mm x 97mm.

- Ultra-compact, all-in-one web camera with built-in web server
- Monitoring and camera control possible via web browser
- 10x optical zoom and multi-angle pan/tilt capability
- 10Base-T interface for direct connection with network
- Alarm In/Out function for automatic surveillance
- Three different security levels

6.4" COLOR TFT-LCD MODULE
 TFT MONITORS AVAILABLE FROM 2.5" - 15"



Our new 6.4" Color TFT Module can be used for a variety of purposes such as; custom automotive dash installations, video phone, door phone, boat installations, covert ultra-compact surveillance packages, security and more.

TFT-64M - \$319.95

Dimensions: 1.5"(W) x 1.75"(H) x 0.5"(D)

COVERT COLOR SPY CAMERA

It's small sleek indestructible design and pinhole lens allow for various applications and simple installation. Comes equipped with a RCA JACK for easy connection to TV monitor or VCR. Great for covert use in any-place imaginable.

25mm(W) x 17mm(D) **CM-550CP - \$79.95**

MICRO BOARD CAMERAS - MANY MODELS IN STOCK TO CHOOSE FROM!

MB-1250HRP
 Hi-Res Color Pinhole
 5.0mm Lens
 1.27" x 1.27"
\$109.95

WEATHERPROOF CAMERA

Color Camera
 400 TV Lines
 Automatic Iris

Hi-Res Color Lipstick Camera
 Length: 2.6"
 Diameter: .785"
WP-300C - \$159.95

2.4 GHz A/V TRANSMITTING MODULE



Makes any camera wireless! Excellent for hobbyist / remote control airplanes.

2.4GHz 4 channel video transmitting module with audio capability / power switch and antenna.

MPX-2400 - \$89.95

2.4GHz RECEIVER
GFR-5002 - \$119.95

Dimensions: 1.5"(W) x 1.75"(H) x 0.5"(D)



MONITOR UP TO 4 VIDEO CAMERAS SIMULTANEOUSLY THRU YOUR INTERNET CONNECTION OR OVER YOUR MODEM!

MOTION DETECTION - ALARM RECORDING - NOTIFICATION

- TCP/IP
- MODEM
- LAN/WAN

Highlight an area on your video screen, and the PV-140 will inform you via modem thru your telephone or pager if there is movement in that highlighted area while recording to your hard disk.

PV-140....4 Input Digital Video Card....\$299.95

POLARIS INDUSTRIES 800-752-3571

470 Armour Drive NE Atlanta GA 30324-3943
 Tech 404-872-0722 Fax 404-872-1038

WWW.POLARISUSA.COM

The SWC-40R combines a black & white video camera, digital image storage, video motion detection and an alarm interface in a compact, vandal proof enclosure. It is unique as it offers a complete CCTV surveillance system within a single compact enclosure.

- All-in-one CCTV system
- Built-in digital image storage
- Programming and image retrieval by remote control
- Built-in video motion detection

NO TAPES!

SWC-40R \$849.95

Dimensions 5" x 4" x 4.5"



"YOUR WEB BROWSER IS YOUR REMOTE EYE!"

The FlexWatch acts as an internet camera server. No software needed in order to view your video. All you need is a web browser such as Internet Explorer or Netscape. FlexWatch includes many special functions including video quality control, pan/tilt/zoom interface and network configuration. All of them are controlled by the web browser. Features 4 video inputs - 3 external.



LIVE VIDEO!

COLOR & B/W SUBMERSIBLE CAMERAS



CAN SEE IN THE DARK!

B/W version comes with attached 80 meter cable (color-20 meter). Built-in white LED's give this camera a 15 meter infrared range. Heat resistant glass and water resistant design allow for rugged applications.

VIDEO CAMERA HEAD CAN BE SUBMERGED UP TO 100 FEET!

SUBCAM-BW (B/W) - \$249.95
SUBCAM-CL (COLOR) - \$299.95

5" COLOR WIRELESS OBSERVATION SYSTEM



ADD UP TO 3 ADDITIONAL CAMERAS!

Now you can enjoy peace of mind with our new wireless observation system. Comes with 5" wireless color monitor and a wireless color camera. Just Plug-&-Play! Perfect for around the house or office.

2.4GHz GW-2400S - \$379.95

MICRO VIDEO HEAD "SNAKE" CAMERA

Incredibly small micro head color camera incorporates a CCD chipset. (Not CMOS). Fully adjustable focus from 0.5 inches to infinity. Automatic Iris for varying light levels.



VIDEO HEAD IS ONLY 7mm IN DIAMETER!

MH-SC01 \$479.95

Turn Your Multimedia PC into a Powerful Real-Time Audio Spectrum Analyzer

Features

- 20 kHz real-time bandwidth
- Fast 32 bit executable
- Dual channel analysis
- High Resolution FFT
- Octave Analysis
- THD, THD+N, SNR measurements
- Signal Generation
- Triggering, Decimation
- Transfer Functions, Coherence
- Time Series, Spectrum Phase, and 3-D Surface plots
- Real-Time Recording and Post-Processing modes

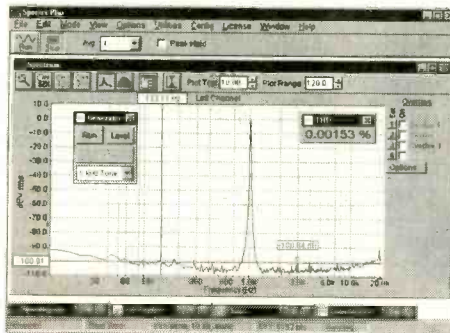

Applications

- Distortion Analysis
- Frequency Response Testing
- Vibration Measurements
- Acoustic Research

System Requirements

- 486 CPU or greater
- 8 MB RAM minimum
- Win. 95, NT, or Win. 3.1 + Win.32s
- Mouse and Math coprocessor
- 16 bit sound card

Priced from \$299

(U.S. sales only – not for export/resale)

DOWNLOAD FREE 30 DAY TRIAL!

www.spectraplus.com

PHS Pioneer Hill Software
24460 Mason Rd.
Poulsbo, WA 98370
a subsidiary of Sound Technology, Inc.



Spectra Plus
FFT Spectral Analysis System

Sales: (360) 697-3472

Fax: (360) 697-7717

e-mail: pioneer@telebyte.com

**Robot Kits, Programmable Robots,
LEGO® Robots, Living Robots,
Muscle Wires®, Home and Office
Robots, Electronic Kits & More!**

**Request our FREE
48 page catalog
with over 300 items!**

**www.RobotStore.com
800-374-5764**

Mondo-tronics Inc.

PMB-N, 4286 Redwood Hwy, Dept. 171
San Rafael, CA 94903
ph 415-491-4600 fx 415-491-4696
info@robotstore.com

CONITEC DATASYSTEMS

**TOP PERFORMANCE in a small package:
Europe's best selling multi-programmer!**

Top of the line multi-programmer in sub-\$500 category. From 20% to 80% market share in Germany in 6 years. 1300+ device output and growing fast. Europe-wide sales 10%-60% mkt share in 6 years. Minimal, 1% return quota for hardware defects. Replaces all low priced dedicated programmers e.g. PIC only or GAL only units. GALEP III also substitutes higher priced universal programmers e.g. ALL-11 (HILO) or LAB-TOOL-48 (ADVANTECH) - It provides virtually matching performance at only 1/3-1/5 the price.

Programs 8-bit and 16-bit EPROMs, EE-PROMs, 0-Power RAM's, Flash, Serial EEPROMs / GAL, PALCE, ATF/87xxx, 89xxx, PIC12/16/17Cxx/ All DIL devices without adapter! Lightning fast parallel data transfer (27C 256 read 2 sec. - prog. 8 sec!). Supports HEX, JEDEC and binary formats, with integrated hex and fuse map editor. Fully Windows compatible incl. Win 2000 / NT. Browse 1300+ supported devices on Conitec's website: www.conitec.com. 90%+ of the listed devices require no adapter!



GALEP-III
Pocket Multiprogrammer

GALEP III / cable, batt. and recharger \$333.00
PLCC adapt. / 8-bit EPROMs / 16-bit EPROMs / GALs each \$129.00

CONITEC DATASYSTEMS - 1951 4th Avenue, Suite 301 - San Diego, CA 92101 - Tel: 619-702-4420 - Info/Downloads/Orders: WWW.CONITEC.COM

Antique Electronic Supply

6221 S. Maple Ave. Tempe, AZ 85283

www.tubesandmore.com

NOS, Parts, Supplies,
Books, Speakers, Transformers,
Grill Cloth, and MORE!

Ph: 480.820.5411 • Fax: 480.820.4643 or 800.706.6789

Do You Repair Electronics?

Repair Databases for
TV, VCR, Monitor, UL
Audio, FCC, and more.

- Over 76,000 records
- Private user forums
- Live on-line chat rooms

RepairWorld.com

Electronix Corp. 1 Herald Sq. Fairport, OH 43324 (937) 78-9878

SINGERS! REMOVE VOCALS

Unlimited, Low Cost, Instantly Available
Background Music from Original Standard
Recordings! Does Everything Karaoke
does... Better and gives you the
Thompson Vocal Eliminator!
Free Brochure & Demo Tape.
LT Sound Dept PE
7988 LT Parkway, Lithonia, GA 30158
Internet: <http://www.LTSound.com>
24 Hour Demo/Info Request Line (770) 482-2485 - Ext 49
When You Want Something Better Than Karaoke!



Poptronics®

SHOPPER

Turn your hobby into a career!

Be an FCC LICENSED ELECTRONIC TECHNICIAN!



Earn up to \$100 an hour, and more!



The Original Home-Study course prepares you for the "FCC Commercial Radiotelephone License" at home in your spare time. This valuable license is your professional "ticket" to thousands of exciting jobs:

- Communications
- Radar
- Maritime
- Microwave
- Radio-TV
- Avionics & more

You can even start your own business!

No need to quit your job or go to school. This proven course is easy, fast and low cost!

SEND FOR FREE FACTS NOW!

Mail coupon today or call

(800) 932-4268 Ext. 210

Visit our Website: www.LicenseTraining.com

COMMAND PRODUCTIONS

FCC LICENSE TRAINING - DEPT. 210
P.O. Box 2824 • San Francisco, CA 94126-2824
Please rush FREE details immediately!

Name _____
Address _____
City _____ State _____ Zip _____

CIRCLE 321 ON FREE INFORMATION CARD

Home Automation



World's Largest Source for Home Automation!

- Voice Control
 - Gadgets & Motorized Devices
 - Home Theater
 - Phones & Intercoms
 - X10 & Lighting Control
 - Home Security & Surveillance
 - Home Networking & Structured Wiring
- and Much More...

800-SMART-HOME

www.smarthome.com

Free 144 pg. Color Catalog!

Dealers/Resellers ask about our SmartHome PRO Dealer Program 800-949-6255



SUPPORTS DEVICES TO 32 MEG

EPROM+

A device programming system for design, repair and experimentation

- ◆ EXCEPTIONAL POWER FOR THE PRO
- ◆ EASY-TO-USE FOR THE NOVICE
- ◆ INCLUDES STEP-BY-STEP TUTORIAL

Here's what you get: A rugged, portable programming unit including the power pack and printer port cable both of which store inside the case. A real printed user and technical manual which includes schematic diagrams for the programming unit plus diagrams for all technology family adapters.* Comprehensive, easy-to-use software which is specifically designed to run under DOS; Windows 3.1, 95 and 98 on any speed machine. The software has features which let you **READ PROGRAM, COPY and COMPARE** plus much more. You have full access to your system's disk including **LOADING and SAVING** chip data plus automatic processing of **INTEL HEX, MOTOROLA S-RECORD and BINARY** files. For detailed work the system software provides a full screen buffer editor including a comprehensive bit and byte tool kit with more than 20 functions.

Broad device support: FIRST GENERATION EPROMS (2708, TMS2716*, 25XX) SECOND GENERATION EPROMS (2716-28C080), 40 AND 42 PIN EPROMS* (27C1024-27C160) FLASH EPROMS (28F29C, 29EE, 29F), EEPROMS (2816-28C010), NV-RAMS (12XX, X2210/12) 8 PIN SERIAL EEPROMS* (24, 25, 85, 93, 95, 80011A) PLUS ER1400/MS8657* AND ER5901 BIPOLAR PROMS* (72S/82S), FPGA CONFIGURATORS (17CXXX) MICROCONTROLLERS* (874X, 875X, 87C5XX, 87C75X, 89C5X) ATMEL MICROS* (8-40) PIN 89CX051, 89SX00X (AVR) 90SX00X PIC MICROS* 8, 18, 28, 40 PIN (12CXXX-16CXXX, 16FX, 17C) MOTOROLA MICROS* (68705P/U3/R3, 6811C705, 68HC171)

\$289

*REQUIRES SNAP-IN ADAPTER (ORDER FACTORY DIRECT OR BUILD YOURSELF) \$5.00 SHIPPING • \$5.00 C.O.D. 1 YEAR WARRANTY • 30 DAY MONEY BACK GUARANTEE VISA • MASTERCARD • AMEX

ANDROMEDA RESEARCH, P.O. BOX 222, MILFORD, OH 45150
(513) 831-9708 FAX (513) 831-7562 website - www.arlabs.com

SERIAL LCDs

Serial LCDs work great with BASIC Stamps® and other microcontrollers. One-wire interface • simple serial protocol • low cost • high quality • in stock

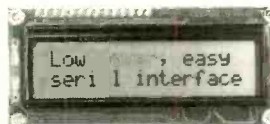

BPI-216N

- 2x16 text LCD
- 2400/9600 bps
- \$45 (non-backlit)

SGX-120L

- Mini graphics LCD
- 2400/9600 bps
- just \$99

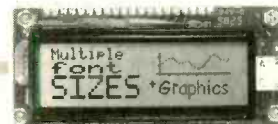

Many other models available—see www.seetron.com!

Scott Edwards Electronics, Inc.
www.seetron.com • 520-459-4802

Introducing the New **ATOM** !

More Powerful than the Basic Stamp® 2p

The "ATOM®"



Get more out of your stamp projects! More commands, faster code execution, built in hardware, real time graphical code debugging, no more 2k program size limits, interrupt driven hardware and software features, multitasking, enhanced math capabilities and much more!

The OEM "ATOM®"

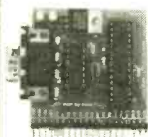

The New ATOM is fully pin compatible and software compatible with the Basic Stamp 2p® but with more power and features! Use all your existing hardware and software! **All this for only \$59.95 Complete!**

MORE POWER!

Built in Hardware:

- 3 10 bit A/D Converters
- 2 Capture and Compare
- Internal Adjustable Vref
- +/- External Vref
- 2 PWM
- UARTS
- I2C, SPI
- 3 Timers
- Interrupts External & Internal
- 256 Bytes of Data eeprom
- Over 256 Bytes of RAM

Software Features:

- Free Software
- Graphical Debugging
- More Software Commands
- 32 Bit Integer Math
- 32 Bit Floating Point Math
- Easy to use code editor
- BS2p Compatible Syntax
- Firmware upgradeable
- Unlimited Support
- Free Software Upgrades
- Plus much more!

Visit us online at <http://www.basicmicro.com>

Basic Stamp is a registered trademark of Parallax Inc.

Order online 24 hours 7 days a week visit <http://www.basicmicro.com>

Order by phone M-F, 9am to 5pm EST 1-734-425-1744

Master Card • Visa • American Express

Program PICmicros in Basic !



With our easy to use Basic Compiler. Convert easy to write BASIC programs into files that can be directly run on a PICmicro. PICmicro Basic provides a seamless Windows environment, you can write, debug and compile your BASIC program, all with one Windows application! Full Basic Stamp 2 Compatibility! Starting at \$99.95

PICmicro Programmer

Program PICmicros, Scenix SX, I2C. Microchip ICD compatible! Firmware upgradeable! Includes Windows IDE program software! Only \$59.95

With optional ZIF adapter PICSTART Plus equivalent only much faster!

PICSTART Plus and PICmicro are registered trademarks of Microchip



40 Pin ZIF Adapter

Intelligent ZIF adapter (ISP-PRO). Programs all supported PICmicros from one position! Optional case available for complete unit. Only \$69.95

Complete unit with ISP-PRO and Case Only \$129.95



Solderless Prototype Boards



The 2840 and 0818 solderless prototyping boards are designed for in-circuit programming. See code changes on-the-fly.

Choose our 2840 board for 28/40 pin PICmicros or the 0818 board for 8/18pin PICmicros. Includes RS-232 circuit, regulated power, solderless I/O connector and prototyping area. Prototyping has never been easier! Starting at only \$59.95

Getting Started Kits

Programming PICmicros has never been easier! Kits come with everything to get started! Test code changes on-the-fly without unplugging or switching cables! Starting at \$159.95

Kit Shown Includes:

- PICmicro Basic
- 2840 Dev. Board
- ISP-PRO
- Power Supply
- Serial Cable
- 10Mhz Resonator
- PIC16F876



BASIC MICRO INC.

Microcontrollers Made Easy!®

Hackers Goldmine

Worldwyde.com specializing in hard to find information

We Accept: VISA • Master Card • American Express

To Order Call 1-800-773-6698 (M-F 9am to 5pm EST)
Send Money orders to: Worldwyde.Com,
33523 Eight Mile Rd #A3-261, Livonia, MI. 48152

Order online or view our catalog at <http://www.worldwyde.com>

Electronic Kits & Projects

(Assembled or Kit)

Miniature FM Transmitter	\$11.95
FM Stereo Transmitter (Hi-Fi)	\$29.95
Deluxe Car Alarm System	\$24.95
Digital LED Thermometer	\$20.95
16 Melody Generator	\$12.95
Telephone FM BUG	\$12.95
10 LED Stereo VU-Meter	\$13.95
Digital Timer w/ LED Display	\$21.95
5 Watt Amplifier	\$12.95
50 Watt Stereo Power Amp	\$30.95
0 to 30v - 2mA to 1.5A Reg.	
DC Power Supply	\$29.95
5 to 15v - 1A Reg. DC Supply	\$15.95
Robotic Voice Imitator	\$13.95
Special All Kits Above Only.....	\$239.95

Satellite and Cable TV



Satellite Piracy \$59.95
Secrets of DISH Vol.2 .. \$59.95
Secrets of Free Cable .. \$29.95

Satellite and Cable TV piracy is at an all time high! Find out how it is being done and what the Satellite and Cable TV companies are doing about it! Sources covered for DSS, DISH and Cable TV

Component Shop

PICmicro's starting at	\$6.00
Serial Cables Only	\$4.95
Power Supply Only	\$8.95
Wire Kits Only	\$17.95

Misc parts from LEDs to Cables and more all available at our one stop shop!

Come see our online one stop component shop at <http://www.worldwyde.com>

Programmers

ALLPIC.....\$89.98
Program PIC, ATMEL, SX and serial eeproms.
Assembled with 40 pin ZIF



Smart Card Toolkit



- Security Systems
- Time Cards
- Emulation
- Robotics
- And More!

Tool Kit comes complete with:

- SmartCard Programmer
- Developer Software Package
- User Manual in printed form
- 3 Blank Smart Cards

All For Only \$79.95

PlayStation® 2 Secrets

PlayStation® 2 Secrets \$29.95
Learn the secrets of PlayStation® 2 MOD chips and how PlayStation® backups are made.

PSX2 ModChip Source Code \$49.95
(Test your own backups)

PSX2 Kit \$74.95
(Source Code & PSX2 Book, Plus 1 blank chip)

Books & CD Software

Hackers Anarchy Cook Book 2000	\$39.95
Scams&Schemes (3Vol Set)	\$24.95
Internet Fraud	\$19.95
Identity Fraud	\$19.95
Palm Utilities 2001 CD	\$14.95
Palm Games 2001 CD	\$14.95
Arcade Emulator Heaven 2001 CD	\$39.95
Game Cracker CD	\$29.95
AAA Credit Secrets	\$29.95

Hackers Corner

The Hack & Crack Bible Vol.1	\$29.95
The Hack & Crack Bible Vol.2	\$39.95
Hack & Crack Master Gold CD Vol.1	\$29.95
Hackers Tool Kit CD	\$24.95
Forbidden Knowledge Vol.2	\$14.95

We offer a wide selection of material on hacking!
Visit us online at <http://www.worldwyde.com>

NEW & IMPROVED

B² Spice A/D Version 4

Mixed-Mode Circuit Design

How We Compare

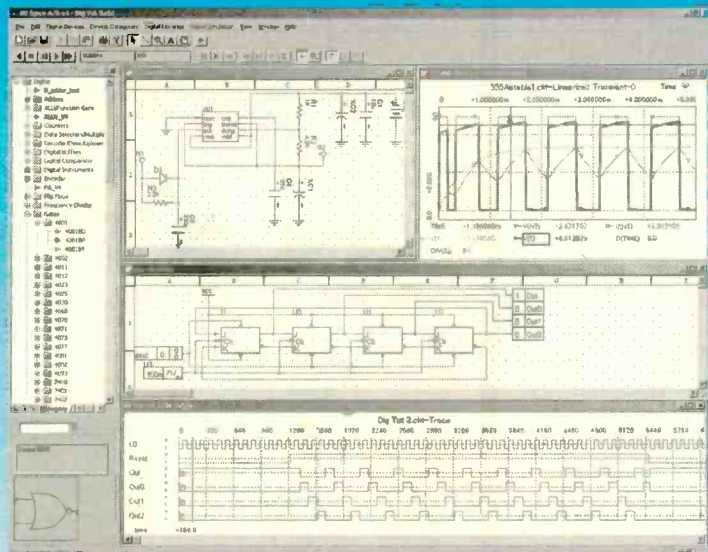

Characteristics	B ² Spice A/D V4	EWB MultiSim Personal
PRICE	\$349	\$999
Parts Database	9600	6000
Parts Search	yes	no
PCB Export	yes	yes
Symbol Editor	yes	yes
Unlimited Undo/Redo	yes	no/no redo
Spice Import	yes	yes
Subcircuits	yes	yes
Interactive Digital Simulation	yes	no
Simulations	15	8
- AC, DC, Transient	yes	yes
- Noise	yes	yes
- Fourier	yes	yes
- Sensitivity	yes	yes
- Distortion	yes	yes
- Monte Carlo	yes	no
- Parameter Sweep	yes	no
- Temperature Sweep	yes	no
- Pole Zero	yes	no
- Transfer Function	yes	no
- Worst Case	yes	no
- RF Simulation	yes	no

- Build circuits in minutes with our IMPROVED schematic editor.
- Manage files and quickly select devices with our NEW workspace window.
- Interpret simulation results with IMPROVED graphics post processor.
- Find exactly the part you need from our EXPANDED database of 9600 parts.
- Make your design a reality using our NEW export to PCB feature.

~~\$349~~

Special Introductory Price

\$299

Ends 12/31/01!

Visit our web site for a free trial.

Beige Bag Software • www.beigebag.com • 734.332.0487 • info@beigebag.com

CIRCLE 319 ON FREE INFORMATION CARD

The BEST is now Better!

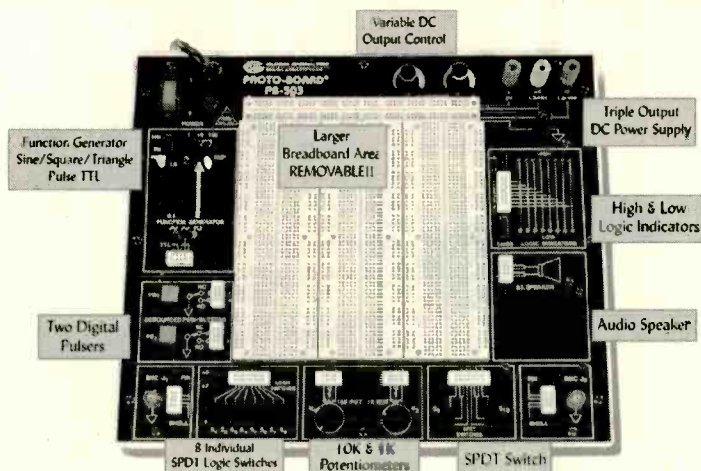

Feature-rich Circuit Design Workstation
Ultra-affordable at just \$299.95
Portable Version Available for \$349.95

Our classic PB-503 the complete Proto-Board Design Workstation is newly improved. Enhancements Include: an 8-Channel Logic Monitor, High & Low Buffered Logic Indicators, 8 Selectable Logic Switches, and Removable Breadboard Socket Plate. This velcro-backed socket plate allows for greater circuit design flexibility; order extra to suit your needs.

Traditional instrumentation on the unit includes continuously variable Function Generator, Triple Output DC Power Supply, along with Switches, Digital Pulsers, Potentiometers and an Audio Speaker. The highly functional PB-503 is built to last, with an industry best 3-year warranty along with a lifetime warranty on all breadboard sockets. Own the best! Order yours today.



GLOBAL SPECIALTIES
INSTRUMENTS

1486 Highland Avenue • Unit 2
Cheshire, CT 06410
1.800.572.1028
203.272.4330 FAX
www.globalspecialties.com

CALL TOLL FREE
(800) 292-7711
Orders Only
Se Habla Español

C&S Sales

Look For Other
Monthly Specials
On Our Website

Excellence in Service

www.cs-sales.com

D/A Trainer

Elenco Model XK-700

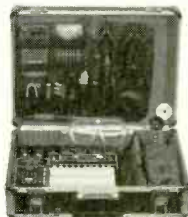

\$195

Elenco's advanced designed Digital/Analog Trainer is specially designed for school projects. It is built on a single PC board for maximum reliability. It includes 5 built-in power supplies, a function generator with continuously variable sine, triangular, and square waveforms. All power supplies are regulated and protected against shorts. The trainer is mounted in a professional technician tool case made of reinforced metal with heavy-duty handles and locks.

Soldering Stations

Weller Low Cost Soldering Iron Model WLC-100



\$34.95

- Variable power control produces 5-40 watts.
- Ideal for hobbyists, DIYers and students.
- Complete with 40W iron.

Weller Soldering Station Model WES50

50 watts of controlled power - designed for continuous production soldering.



\$119

Deluxe Electronic Soldering Station

Elenco SL-5 Series

Electronically controlled, ideal for professionals, students, and hobbyists. Available in kit form or assembled.

Works w/ any iron! Turn any soldering iron into a variable iron.

As Low As \$29.95

Ordering Information:

Model SL-5 - No Iron. (Kit SL-5K) **\$29.95**

Model SL-5-40 - Includes 40W UL Iron. (Kit SL-5K-40) **\$35.95**

*** Limited Time Offer ***
FREE SP-1A Solder Practice Kit w/ Kit Order!



Features:

- Cushion Grip Handle Soldering Iron (optional) with Grounded Tip for Soldering Static-Sensitive Devices. Easily Replaceable. Uses Long-Life, Plated Conical Tip.
- Heavy Steel, Non-Slip Base.
- Iron Holder Funnel - Reversible, left or right side.
- Steel Tray for Sponge Pad.
- Sponge Pad.

Generators & Counters

B&K 20MHz Sweep/Function Generator with Frequency Counter Model 4040

- 0.2Hz to 20MHz
- AM & FM modulation
- Burst Operation
- External Frequency counter to 30MHz
- Linear and Log sweep

\$425

10MHz Model 4017 **\$319**
 5MHz Model 4011 **\$249**
 3MHz Model 4003 **\$205**



BK PRECISION

Four Functions in One Elenco Model MX-9300B



Features:

- One instrument with four test and measuring systems:
 - 1.3GHz Frequency Counter
 - 2MHz Sweep Function Generator
 - Digital Multimeter
 - Digital Triple Power Supply - 0-3V @ 2A, 5V @ 2A, 15V @ 1A

\$450

Elenco Handheld Universal Counter Model F-2800

\$99



Features 10 digit display, 16 segment and RF signal strength bar-graph.

Includes antenna, NiCad battery, and AC adapter.
 C-2800 Case with Belt Clip **\$14.95**

Elenco RF Generator with Counter (100kHz - 150kHz) Model SG-9500



Features internal AM mod. of 1kHz, RF output 100MV - 35MHz. Audio output 1kHz @ 1V RMS.

\$225

SG-9000 **\$119.95**
 (analog, w/o counter)

Elenco Sweep Function Generator w/ built-in frequency counter Model GF-8046



\$195.95

This sweep function generator with counter is an instrument capable of generating square, triangle, and sine waveforms, and TTL, CMOS pulse over a frequency range from 0.2Hz to 2MHz.

GF-8025 - Without Counter **\$139.95**

Kit Corner

Quantity Discounts Available

over 100 kits available

Elenco Model RCC-7K

Radio Control Car Kit

\$29.95

- Fun & Easy to Assemble
- 7 Functions
- Radio Control Transmitter Included
- Also available as Model AK-870 (No Soldering) **\$24.95**



Elenco Model AK-700

Pulse/Tone Telephone Kit

\$15.95



Ideal School Project

Action Lab Kit

Model MX-902

- Safe, Solderless, Educational, and Fun!
- Easy-to-read, Illustrated, Lab-Style Manual Included
- Requires 2 "AA" Batteries
- Build your own operating motor - it's easy, it's fun, it's Safe!
- For Ages 10 and up.

\$24.95



Elenco Model AM-780K

Two IC Radio Kit

\$11.95

Also available: Model AM/FM-108K AM/FM Radio Kit **\$29.95**

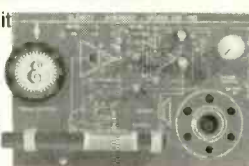

OWI Model OWI-007

Robotic Arm (Wired Control)

Teaches the basic robotic sensing and locomotion principles while testing motor skills.

\$55.95



Elenco Digital

Multimeter Kit

Model M-2665K

- Extra large 1 1/4" x 2 1/2" LCD display area.
- 34 ranges - includes capacitance, transistor testing hfe, diode testing
- 20A AC/DC current
- Overload protected

\$49.95



Guaranteed Lowest Prices

UPS SHIPPING: 48 STATES 5%
 OTHERS CALL FOR DETAILS
 IL Residents add 8.25% Sales Tax

C&S SALES, INC.

150 W. CARPENTER AVENUE
 WHEELING, IL 60090
 FAX: (847) 541-9904 (847) 541-0710

15 DAY MONEY BACK GUARANTEE
2 YEAR FACTORY WARRANTY

PRICES SUBJECT TO CHANGE WITHOUT NOTICE

CIRCLE 290 ON FREE INFORMATION CARD

SAME DAY SHIPPING

Secure on-line ordering

C&S Sales

Excellence in Service

CALL OR WRITE FOR OUR FREE

64 PAGE CATALOG!
(800) 445-3201

Elenco Oscilloscopes

Free Dust Cover and 2 Probes



S-1325	25MHz	Dual Trace	\$325
S-1330	25MHz	Delayed Sweep	\$439
S-1340	40MHz	Dual Trace	\$475
S-1345	40MHz	Delayed Sweep	\$569
S-1360	60MHz	Delayed Sweep	\$725
S-1390	100MHz	Delayed Sweep	\$895

DIGITAL SCOPE SUPER SPECIALS

DS-203	20MHz/10Ms/s Analog/Digital	\$695
DS-303	40MHz/20Ms/s Analog/Digital	\$850
DS-603	60MHz/20Ms/s Analog/Digital	\$950

Digital Multimeters

Fluke 79III



\$195

Features analog bargraph, automatic touch hold, diode test, continuity beeper, fused current inputs, lead resistance compensation, 10 ohms, and true RMS.

Elenco LCR & DMM Model LCM-1950



\$69

- Large 1", 3 3/4 digit LCD
- Autoranging frequency to 4MHz
- Capacitance to 400µF
- Inductance to 40H
- Resistance to 4000MΩ
- Logic Test
- Diode & Transistor Test
- Audible Continuity Test

Elenco Model M-1740 **\$34.95**

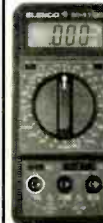

- 11 Functions
 - Freq. to 20MHz
 - Cap. to 20µF
 - AC/DC Voltage
 - AC/DC Current
 - Beeper
 - Diode Test
 - Transistor Test
 - Meets UL-124 safety spec.
- Model M-2760 - \$19.95**
(9 functions)

Dual-Display LCR Meter w/ Stat Functions B&K Model 878



\$225

Auto/manual range. Many features with Q factor. High Accuracy

Elenco LCR Meter Model LCR-1810



\$99.95

- Capacitance .1pF to 20µF
- Inductance 1µH to 20H
- Resistance .01Ω to 2000MΩ
- Temperature to 750°C
- DC Volts 0 - 20V
- Frequency up to 15MHz
- Diode/Audible Continuity Test
- Signal Output Function
- 3 1/2 Digit Display

Elenco DMM Kit Model M-1005K



\$19.95

- 18 Ranges
 - 3 1/2 Digit LCD
 - Transistor Test
 - Diode Test
 - Training Course
- M-1000B (Assembled) \$15.95**

Quantity Discounts Available

Project Labs

Elenco 50-in-1 Electronic Playground Model EP-50

Easy-to-build experiments teach you the operation of over 50 electronic circuits. Fully assembled, includes all the parts needed. No tools or soldering required! Build these exciting circuits: finger touch lamp, magnetic bridge, voltmeter, morse code alarm, electronic noisemaker, electronic kazoo, electronic keyboard, transistor radio, radio announcer, metal detector, and many more. 76 page manual teaches you about voltage, current, resistors, capacitors, transistors, diodes, transformers, speakers, and antennas. Requires one 9V battery.



\$19.95

Elenco Quad Power Supply Model XP-581

\$79.95

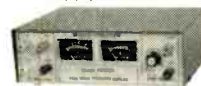

4 Fully Regulated DC Power Supplies in 1 Unit
4 DC voltages: 3 fixed - +5V @ 3A, +12V @ 1A, -12V @ 1A
1 Variable - 2.5 - 20V @ 2A

Elenco Power Supply Kit Model XP-720K

\$54.95

- 1.5VDC - 15VDC @ 1A
- -1.5VDC - -15VDC
- 5VDC @ 3A
- 6.3VAC @ 1A & 12.6VAC center tapped @ 1A



XP-720 Fully Assembled **\$85**

Elenco AC/DC Variable Power Supply Model XP-800

The XP-800 is a high current power supply with 3 variable outputs. Choose from either 0-120VAC @ 2A, 0-40VAC @ 7A, or 0-28VDC @ up to 10A. The precision LED displays allow for exact readout of volts and current. The XP-800 is ideal for Principles of Technology experiments in schools or it can be used as a bench power supply in OEM labs.



\$325

Elenco DC Power Supply Model SPL-603 3A 0-30VDC

\$79.95

The SPL-603 is a solid-state DC power supply providing the exact output voltage no matter what current you use. Output fully protected from overload.



Maxitronix 300-in-1 Electronic Project Lab Model MX-908

\$48.95

Everything you need to build 300 exciting electronic projects:

- A Transistor Radio
- Multiple Counter
- IC Organ
- Digital Light Dimmer
- Burglar Alarm
- Tone Burst Generator
- Delayed Timer
- Audio Signal Tracer
- Electronic Game
- Electronic Candle
- Optical Volume
- Voice Level Meter
- Multiplier
- and many, many more!



• Easy-to-read, illustrated, lab-style manual included.

Maxitronix 500-in-1 Electronic Project Lab Model MX-909

\$170

Everything you need to build 500 exciting electronic projects:

Learn the basics of electronics and put your knowledge to work creating 500 different electronic experiments, special lighting effects, radio transmitter and receivers, amazing electronic sound effects, cool games and MORE! Includes built-in breadboard for easy wiring and connection of components, and an LCD (Liquid Crystal Display) indicates the information during the experiments in process.

• Fact-filled, illustrated, lab-style manual included.



Tool Kits

Elenco Deluxe Electronic Tool Kit Model TK-3000 **\$79.95**

A professional technician service tool kit in a metal reinforced tool case with heavy-duty handles and locks. A removable, double-sided pallet handles most of the tools listed below with more room for tools and parts in the lower half. A special rail in the tool case will lock your meter of choice in place.

- Tools included in case:**
- Deluxe Soldering Iron, Soldering Iron Stand,
 - Diagonal Pliers, Long Nose Pliers, Deluxe Wire Stripper, Solder Ease Kit,
 - 3 pc. Nut Driver,
 - Precision Screwdriver Set, Screwdriver-Scotted 3/16",
 - Screwdriver #1 Phillips,
 - IC Extractor, Solder Pump, Safety Goggles,
 - Pocket Screwdriver, Solder Tube,
 - and Solder Wick.



Elenco Deluxe 26pc. Computer Service Tool Kit Model TK-1200

Includes everything you need to service today's computers. Tools include deluxe soldering iron, 5" needle nose pliers, reversible star bits T10, T15, reversible bit nut drivers 3/16" and 1/4", deluxe wire stripper, IC extractor, and more!

\$39.95



Xcellite® PC Repair Kit Model 99-SPC

- Ideal for repairs on all PC's.
- Anti-static chip tools protect from ESD damage.
- Convenient roll-up pouch.

\$34.95



Guaranteed Lowest Prices

C&S SALES, INC.

**15 DAY MONEY BACK GUARANTEE
2 YEAR FACTORY WARRANTY**

UPS SHIPPING: 48 STATES 5%
OTHERS CALL FOR DETAILS
IL Residents add 8.25% Sales Tax

150 W. CARPENTER AVENUE
WHEELING, IL 60090
FAX: (847) 541-9904 (847) 541-0710



PRICES SUBJECT TO CHANGE WITHOUT NOTICE

SEE US ON THE WEB

www.cs-sales.com

CIRCLE 290 ON FREE INFORMATION CARD

Lone Star Consulting, Inc.

8900 Viscount, Suite 235
El Paso, TX 79925
915-474-0334

Descriptions, Prices, Policies:
www.lonestartek.net

SPECIAL PROJECTS HARDWARE

Unique - Original - Made-to-Order - Special Needs

Electronic - Computer - Phone - Energy - Security - Data
Cards - RF - EM - Audio - Radionics - "Psychic" - Plans - more!

Power Meters Educational Module ♦ KX Radar Emitter
Lineman's Test Set ♦ Bug & Tap Detector & Blaster
Shriek Module ♦ Stealth Paint "Elixir" ♦ Audio Assistor
Multi-Use Magnetometer ♦ Omnimax Tens Stimulator
Radionics Rifle ♦ Neurophone Device ♦ Ultrasonic
Stimulator ♦ Ultrasound Shrieker ♦ Ultrasonic Detector
Harassing EMF Jammer ♦ EMF "Signature" Detector
"Aura" Detector ♦ Super Conductor Detector ♦ Unseen/
Unknown Presence Detector ♦ Subliminal Mixer/Amp
Infrared Detector ♦ Secret Communicator ♦ Levitator
Flash Blaster ♦ 6th. Sense Communicator - many more!

*TECHNICAL *LIFE COACHING* *WEBSITE DESIGN SERVICES

CABLE BOX SUPPLIERS

VISION MASTER PLUS W/UNIVERSAL FORMAT STABILIZERS PICTURE WORKS ANY SYSTEM!

"DEALERS WELCOME"

★ LOW, LOW PRICING ★

1-888-777-9123
1-888-675-3687

SCINTILLATING!

Who Are You? The Encyclopedia of Personal Identification. Insider information directly from the FBI and Customs, top graphic artists, offshore attorneys, master thieves, and professional sharks. *Who Are You?* details ID theft schemes (and prevention), how to create great documents on a home computer, get a new driver's license (suspension? No problem), open offshore or US bank accounts w/o an SS number, acquire the world's best ID, second passports, phony credit cards, read vehicle tags, much, much more. Sources, sites, suppliers, tips, tricks and techniques. 352 pages \$44.95.

Covert Catalog2000 The latest, hands-on source guide for law enforcement goodies, electronic surveillance, covert video, counter measures, entry equipment, weapons, tracking systems, computer surveillance, and more. Exact ordering info from suppliers in 13 nations! 220 Pages. \$39.95.

ORDER BOTH BOOKS — SUBTRACT \$10!!

Intelligence Here
404 N. Mt. Shasta Blvd.
Mt. Shasta, CA 96067
Order by Phone: 866-885-8855
www.intelligencehere.com
Add! \$6.00 (priority shipping). CA residents add 8% tax



NEW Easy-PC For Windows

Schematic & PCB Layout CAD



Only \$197



- True Windows Interface
- True Windows 32 bit application
- Schematic and PCB Design as standard
- Intelligent Cut, Copy and Paste - Internal & external
- Multi-level Undo and Redo
- Forward design changes - Schematic to PCB
- Integrated Autoplace
- Integrated Shape based AutoRouter (Optional Extra)
- Shape based copper pour and split power planes
- And now version 4.0 with many new features !!

Call Ohio Automation (740) 596 1023
www.numberone.com

CABLE TV REMOTES BLOW-OUT SALE



We carry all models

50pc.	100pc.	500pc.	1kpcs.
\$3.50	\$3.25	\$2.75	\$2.50

Rebellion-3 125ch. Converter		
12pc.	50pc.	100pc.
\$50.00	\$47.00	\$44.00

Magnavox Universal Remote Controls		
12pc.	50pc.	100pc.
\$4.50	\$4.00	\$3.75

Call Today Globaltech 1-(800)-582-5116
View Our On-Line Display Catalog at:
www.globaltechdistributors.com

Scrambling News

915 NW First Ave., Suite 2902,
Miami FL, 33136, 305-372-9427

Pay TV and Satellite Descrambling 2002 - New! - satellite and cable. Includes the latest information. \$19.95 plus \$1.75 shipping.

Hacking Digital Satellite Systems Video 2002 - New! - This 90 minute video focuses on the satellite television piracy business. \$29.95 plus \$ 3.50 shipping.

Scrambling News Online - Online service for those interested in satellite television news. \$59.95/year.

Pay TV and Satellite Descrambling Series CD-ROM - all 13 volumes over 300 pages, \$59.95 plus \$3.50 shipping.

Best Deal - Everything listed above for only \$99.95 plus \$3.50 shipping.

www.scramblingnews.com

spyoutlet.com

Security • Surveillance • Loss Prevention

Purchase your video cameras from
one of the largest importers
in the U.S.

- NEW weatherproof Bullet Cameras
- Spy Pinhole Cameras • Wireless Video
- PC Cards • Voice Changer
- Micro Recorders • Shotgun Mic
- Locksmithing • Bug Detectors
- NEW Phone Sentry Plus—defeats telephone tapping and taping
- UV Pens & Powder • Realtime 12 hr Telephone Recording System
- GPS Vehicle Tracking System

And much more • Quantity discounts

www.spyoutlet.com
Printed Catalog send \$5⁰⁰

**SPY OUTLET 2468 NIA, FALLS BLVD
TONAWANDA NY 14150 (716) 695-8660**

PCB Production

Double side—12¢ per in²
Four layers—20¢ in²
Six layers—32¢ in²
UL approved
(with solder mask, Silkscreen
Three weeks)

**FREE Quote for 8-12L
PCB & membrane switch**

MYLYDIA INC.

Call 626-292-2686
Fax: 626-292-2689
E-mail: tj2@ix.netcom.com

SMART CARDS

Complete system! Program your own smart
card applications in easy to use BASIC!



- Security Systems
- Time Cards
- Emulation
- Access Control - Home, Auto
- Robotics Programming
- DATA Security

Tool Kit comes complete with:

- SmartCard Programmer
- Developer Software Package
- User Manual in printed form
- 3 Blank Smart Cards

Complete system for only \$79.95

We accept
VISA • Master Card • American Express

To Order Call 1-800-773-6698 Worldwyde.Com,
33523 Eight Mile Rd #A3-261, Livonia, MI 48152
Visit us online <http://www.worldwyde.com>

SCRAMBLED VIDEO

VERSUS



THE CLEAR SOLUTION Model VSG-RFDL
.....RESTORES LOST VIDEO

R.C. Distributing Company
P.O. Box 552 South Bend, IN 46624
Phone (219) 233-3053 Fax (219) 289-1566
www.rcdistributing.com

CONTROL IT

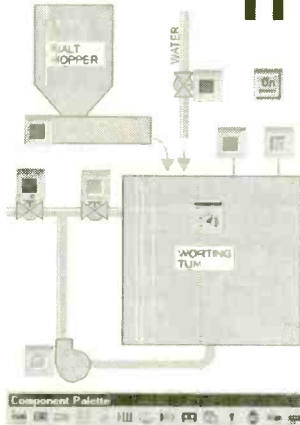

Intec Automation Inc.
www.microcommander.com

Solar Panels

160 mW / Sun 8 Cells
200pc 2Kpc 20Kpc 200Kpc
\$2.⁰⁰ ea \$1.⁸⁰ ea \$1.⁷¹ ea \$0.⁸⁵ ea

Battery Holders

AA Singles, and Dual Side by Side
200pc 2Kpc 20Kpc 200Kpc
\$0.⁴⁰ ea \$0.³⁶ ea \$0.³⁴ ea \$0.¹⁷ ea

LED's

High Intensity HPWT-DL00
Similar to Lumex type SSL-LX30448SYC
200pc 2Kpc 20Kpc 200Kpc
\$0.⁵⁰ ea \$0.⁴⁵ ea \$0.⁴³ ea \$0.²¹ ea

Call 1-847-612-2739

Stepper Motor Book



Easy Step'n

- For the experimenter.
- Determine surplus stepper motor specs using simple easy to build test equipment.
- Build microcontroller-based control systems (flow charts and code examples).
- Build stepper motor drive circuits.
- Mechanical design considerations.
- 8.5x11 format. 205 pages. \$34.95

Table Of Contents: <http://www.stepperstuff.com>
+ \$5 s/h in US. VISA, MC, AM, DS, MO, Check
CA residents please add 7% CA sales tax

SQUARE 1 ELECTRONICS

P.O. Box 501, Kelseyville, CA 95451
Voice (707) 279-8881 Fax (707) 279-8883

<http://www.stepperstuff.com>

CABLE SECRETS!!!

Build your OWN cable box "test" devices!

Why pay \$100.00 or more for a "test" device that someone else made? Make your own! Includes complete source code and plans for the most commonly used cable boxes. *Unlock all of the channels on your box!*

Or start your own lucrative business!

Complete source code \$79.95
Code for individual boxes \$29.95

DSS SECRETS — Vol. 2

Step-by-step instructions on programming your own DSS access card. *Unlock all channels on your own card!* This is the most current information on the market! Includes software, plans, and hardware sources. Book & CD-ROM.

DSS Secrets Vol. 2 \$49.95

VISA • MasterCard • AmericanExpress

To order, call Worldwyde @ 1-800-773-6698
33523 Eight Mile Rd. #A3-261 • Livonia, MI 48152

Visit us on the web at www.worldwyde.com



Theremin

The PAiA Theremin uses the same heterodyne principles as the original turn of the century instrument for classic tone and adds features made possible by modern ICs. *Shown with optional lectern case.*

9505K Kit
\$89.75

9308K Kit

\$154.00

FatMan Analog MIDI Synth

A complete music synthesizer with all the big bottom and phat sound that makes analog famous. 20 knobs and controls for real-time sound sculpting. Compatible with standard MIDI sources like keyboards or computers. *Desktop case or rack panel available.*

Check out <http://Paia.com> for schematics, tech details, firmware source files and more...

Synthesizer Modules, Guitar Effects, Mixers, EQs, Tube PreAmps, and dozens of kits for **ELECTRONIC MUSICIANS**

PAiA Electronics info@paia.com
3200 Teakwood Lane 405.340.6300
Edmond, OK 73013 fax 405.340.6378



Visit our Website
www.blkfeather.com

- ▶ 4400 S. Robinson Avenue
- ▶ Oklahoma City, OK 73109
- ▶ FAX: (405) 616-9603
- ▶ Email: blkfea@aol.com

Or call & order today:
1-405-616-0374

Top Secret Consumertronics

In business 25+ years • established professionals
www.tsc-global.com

Exciting Hi-Tech Survival Books, Manuals, Tapes

- | | |
|--------------------------------|------------------------------|
| Stopping Power Meters \$29 | Polygraph Secrets \$29 |
| SPM Demo VHS Tape \$29 | Identity Theft Manual \$29 |
| KW-HR Meters \$29 | Credit Card Security \$29 |
| Gas & Water Security \$19 | Check & M.O. Security \$29 |
| Beyond Phone Color Boxes \$29 | ATM Manual \$39 |
| Cellphone/Cordless Guide \$49 | Mind Control \$29 |
| Pager (Beeper) Manual \$29 | Under Attack! \$29 |
| Caller ID & ANI Security \$29 | EM Brainblaster \$29 |
| Voice Mail Security \$29 | Radionics Manual \$29 |
| PBX Security \$25 | Heal Thyself! \$29 |
| Fax Machine Security \$29 | Ultimate Success Manual \$29 |
| Computer Security \$39 | Stealth Technology \$29 |
| Hacker Files (3 HD Disks) \$39 | High Voltage Devices \$29 |
| Social Engineering \$29 | Secret & Survival Radio \$29 |
| Cons & Scams Databook \$29 | Secrets Solderless BBs \$29 |
| Internet Security \$29 | The "Goldfinger" \$19 |
| Internet Frauds Databook \$29 | Casino Secrets \$29 |
| Internet Tracking/Tracing \$29 | Government Land Grab \$19 |
| Beyond Van Eck Tempest \$29 | Rockets Red Glare \$29 |
| Van Eck Demo VHS Tape \$29 |much more in Catalog! |

Check, MO, VISA, MC - S/H: \$6 USPS, \$9 UPS or Canada
Printed Catalog: \$1 w/ith order, \$3 w/o (descriptions, policies)
Order Today 10% OFF! Consumertronics
P.O. Box 23097, ABQ, NM 87192
505-321-1034 Fax: 505-275-5637

PICmicro MCU Development Tools



EPIC Plus
PICmicro Programmer
\$59.95

Program PICmicro MCUs in BASIC!

DOS or Windows operation (includes Windows IDE software).
PicBasic Compiler - \$99.95
PicBasic Pro Compiler - \$249.95

Experimenter Boards

LAB-X1 for 40-pin MCUs (shown) - \$199.95
LAB-X2 for 28 or 40-pin MCUs - \$69.95
LAB-X3 for 18-pin MCUs - \$119.95

PICProto Prototyping Boards

\$8.95 to \$19.95
High-quality blank prototyping boards for PICmicro MCUs.

microEngineering Labs, Inc.

www.melabs.com
Phone: (719) 520-5323
Fax: (719) 520-1867
Box 60039, Colorado Springs, CO 80960

ADMART

December 2001, Poptronics

VISION ELECTRONICS

BEFORE

AFTER

- No Rolls/Jitters/Flickers/Fading
- Works on all TV's, VCR's, Beta, & Cable
- Gold Video Connectors & Cables Included
- 1 Year Warranty
- Money Back Guarantee

FREE CATALOG!

COPY RENTAL TAPES WITH OUR VIDEO STABILIZER

1-800-562-2252 2609 S. 156th Circle • Omaha, NE 68130
www.modernelectronics.com

EZ-EP DEVICE PROGRAMMER - \$169.95

Check Web!! -- www.m2l.com

Fast - Programs 27C010 in 23 seconds
Portable - Connects to PC Parallel Port
Versatile - Programs 2716-080 plus EE and Flash (28F, 29C) to 32 pins
Inexpensive - Best for less than \$200

- Correct implementation of manufacturer algorithms for fast, reliable programming.
- Easy to use menu based software has binary editor, read, verify, copy, etc. Free updates via bbs or web page.
- Full over current detection on all device power supplies protects against bad chips and reverse insertion.
- Broad support for additional devices using adapters listed below.

Available Adapters	Price
EP-PIC (16C5x, 61, 62x, 71, 84)	\$49.95
EP-PIC64 (62-5, 72-4)	\$39.95
EP-PIC12 (12C50x)	\$39.95
EP-PIC17 (17C4x)	\$49.95
EP-51 (8751 C51)	\$39.95
EP-11E (68HC11 E/A)	\$59.95
EP-11D (68HC711D3)	\$39.95
EP-16 (16bit 40pin EPROMS)	\$49.95
EP-Z8 (Z86E02, 3.4, 6, 7, 8)	\$39.95
EP-SEE2 (93x, 24x, 25x, 85x)	\$39.95
EP-750 (87C750, 1, 2)	\$59.95
EP-PEEL (ICT22v10, 18v8)	\$59.95
EP-105 (89C1051, 2051)	\$39.95
EP-PLCC (PLCC EPROMS)	\$49.95
EP-SOIC (SOIC EPROMS)	\$49.95

Many Other Adapters Available

M²L Electronics
 970/259-0555 Fax: 970/259-0777
 250 CR 218 Durango CO 81301
 CO orders add 7% sales tax.
<http://www.m2l.com>

BROADCAST EQUIPMENT

- SINCE 1990 -

You know you want it! We've got it! LPFM & High Power Stereo FM Transmitters, RF Amplifiers, Low Pass Filters, Antennas, Mixing Boards, Microphones, CD Players, Compressor/Limiters, Digital Reverbs, Automation Software, Studio to Transmitter Links, Emergency Alert Systems, RF Test Equipment, Kits, RF Parts, and much more. Best Prices, Highest Quality. Give Us A Call or Buy It Online...

www.progressive-concepts.com
 305 SOUTH BARTLETT ROAD, STREAMWOOD, IL 60107
 VOICE: (630)736-9822 FAX: (630)736-0353

Data Acquisition and Control

The ADR series of interfaces allow control of analog, digital and relay I/O via RS232 or RS485. Visit the web site for specs, applications and programs in VB, C, BASIC etc. (705) 671-2652

www.ontrak.net
Ontrak Control Systems Inc.

PCB Services

From Concept to Production

Schematic Development Making your designs Affordable!
 Fast Proto boards
 Production boards
 Plastic molding
 Metal cases
 Assembly

CTech Industries
 (800)259-0774
WWW.CTechindustries.com

Please give blood.
 There's a life to be saved right now.
Call 1-800 GIVE LIFE

American Red Cross

electronic components

MOUSER ELECTRONICS

(800) 346-6873 www.mouser.com

ONLINE FEATURES

- Ordering
- Product Search
- Catalog
- Spec Sheets
- Product Availability

Switzerland, Germany, France, Italy, UK, Spain, Portugal, Belgium, Netherlands, Austria, Switzerland, Czech Republic, Slovakia, Poland, Hungary, Greece, Turkey, Israel, India, China, Korea, Japan, Taiwan, Hong Kong, Singapore, Malaysia, Thailand, Philippines, Indonesia, Vietnam, Australia, New Zealand, South Africa, Middle East, Mexico, Central America, Caribbean, South America, Africa, Europe, Asia, Oceania, Americas, Global.

1-800-346-6873

MOUSER ELECTRONICS

A COMPANY

www.mouser.com

CIRCLE 205 ON FREE INFORMATION CARD

Call Today And SAVE! **Unbeatable PRICES!**

CABLE TV

**DESCRAMBLERS
 CONVERTERS • FILTERS
 VIDEO STABILIZERS**

FREE ➤ 30 Day Trial
FREE ➤ Product Catalog
FREE ➤ 1 Year Warranty

100% MONEY BACK GUARANTEE

Let us point you in the right direction ...

Arrow Technologies

Omaha, Nebraska

TOLL FREE
1-800-554-ARROW
 1-800-554-2776
<http://www.arrowtek.com>

Poptronics, December 2001

Learn PC Repair!

The Ultimate Self-Paced PC Assembly and Repair Course

This is the simplest, easiest and most complete course on how to understand, assemble, and diagnose PCs available today. It contains all the text, videos and diagnostic software you'll need to succeed.

Self-Study Course Manual

The manual is a self-study workbook that will enable you to quickly teach yourself all about computers, how they're put together and how to keep them working. Just follow the step-by-step instructions on each page.

At the end of the course you'll know how to build a PC and install & configure Microsoft Windows.

Call **(800) 321-2155**

Videos

The two videos included contain over 3 hours of the Micro 2000 engineering team teaching everything from the basics of PC assembly all the way to using the MicroScope software to troubleshoot them! Watch the pro's in action as they build a completely functional Pentium system with all the major peripherals.

Software

This course includes a Limited Edition version (25 uses) of the award winning MicroScope Diagnostic Software. Use it to build your own PC (computer not included), upgrade it and troubleshoot any problems.

www.ciebookstore.com



Only
\$99.95

Complete Course

Product #
02-020

Course includes:

- 200 + Page Training Manual
- PC Assembly & Configuration Video
- PC Diagnostic Video
- Micro-Scope Diagnostic Software (LE)
- CD-ROM - contains videos and manual

CIE Bookstore: 1776 E 17th Cleveland, OH 44114

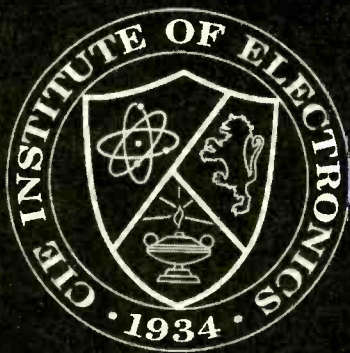

**It's almost
like being
paid to
study.**

Earn an Associate Degree in Electronic Engineering Technology...

Put your knowledge of electronics to work for you. CIE offers the most comprehensive Associate Degree program offered in electronics. Best of all you study at your own pace with the full resources of CIE just a phone call or a click of a mouse away.

It's Comprehensive and Unique. You Pay for Only the Time You Use!

You won't find a better school than CIE if you want to accomplish your goals without pesky time restrictions (commuting, 8 hour class days, etc.) at CIE you study at your own pace, even an accelerated pace. And if you're like most readers of this magazine, your electronics background can help you receive your degree in less than the maximum 8 terms allowed. Finish sooner and you can save thousands of dollars in tuition. It's almost like being paid to study.

Get all the details on CIE's Associate Degree Program, World College's Bachelor Degree Program and CIE's 10 Career Courses today!



Free Course Catalog!

(800) 243-6446

www.cie-wc.edu

For a FREE Course Catalog on all of our Programs send to CIE: 1776 E. 17th St., Cleveland, OH 44114-3679 or visit www.cie-wc.edu PT30

Name: _____

Address: _____

City: _____

State: _____ Zip: _____

Phone: _____

E-mail: _____

CIRCLE 320 ON FREE INFORMATION CARD

RAMSEY

GET THE CATALOG TODAY!
Over 100 NEW products!
www.ramseykits.com



SYNTHESIZED FM STEREO RADIO STATION

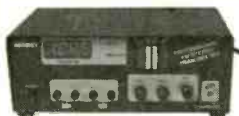

- Synthesized 88 to 108...no drift!
- Built in mixer - 2 line inputs and one microphone input!
- High power module available for export use
- Low pass filter for great audio

Our FM100 is used all over the world by serious hobbyists as well as churches, drive in theaters, and schools. The kit includes metal case, whip antenna and built-in 110 volt AC power supply.

FM100 Super-Pro FM Stereo Radio Station Kit \$249.95
FM100WT 1 Watt, Wired Export Version \$399.95

SYNTHESIZED FM STEREO TRANSMITTER



Professional quality rock stable synthesized transmitter. Dip switch settable for any frequency between 88-108 MHz. Strappable for high power output for export applications. Our most popular kit. Start your own radio station today with the FM25!

FM25 Synthesized FM Stereo Transmitter Kit \$129.95

FM STEREO TRANSMITTER



Great entry level FM broadcast kit. Thousands in use. Handy for sending music through house and yard, ideal for school projects too - you'll be amazed at the exceptional audio quality! Runs on 9V battery or 5 to 15 VDC. Add matching case and whip antenna set for great pro look.

FM10A Tunable FM Stereo Transmitter Kit \$34.95
CFM Matching Case and Antenna Set \$14.95
FMAC 12V DC Wall Plug Adapter \$9.95

RF WIRELESS LINK MODULES



- SAW Resonators for high stability - NO Drift!
- Powerful +10 dbm output
- Range up to 600'
- 433 MHz license-free band
- Sensitive superhet receiver with RF LNA
- Stable over full 3-12 VDC range
- Optional on-board 12 bit encoder/decoder using Holtek HT12 series chips. Quarter not included!

RXD433 433 MHz Receiver/Decoder Mod., Assembled \$26.95
TXE433 433 MHz Transmitter/Encoder Mod., Assembled \$24.95
RX433 433 MHz Data Receiver Mod., Assembled \$21.95
TX433 433 MHz Data Transmitter Mod., Assembled \$19.95

THE CUBES! MINIATURE VIDEO TRANSMITTERS



Wireless crystal clear reception, yet smaller than a quarter! Transmits color or B&W with fantastic quality almost like a hard wire connection to any TV or VCR tuned to cable channel 59. Crystal controlled for no frequency drift with performance that equals law enforcement models that cost hundreds more! Basic 20mW unit goes up to 300' while the

high power version can virtually double that range! Fully assembled and tested, and ready to go. Powered by a standard 9V battery. Name that Quarter!

C2000 Video Cube, Factory Assembled & Tested \$89.95
C2001 High Power Version, Assembled & Tested \$129.95

INFRA-RED VIDEO CAMERA ILLUMINATOR



Lets video cameras "see in the dark". Invisible light source to us, but lots of light to CCD B&W cameras! Illuminates the area just like light, yet cannot be seen. Draws 180mA at 12 VDC. 110VAC power adapter available.

IR1 Infra-Red Camera Illuminator Kit \$24.95
AC125 12VDC Power Supply \$9.95

ELECTRONIC PROTOTYPING SOFTWARE

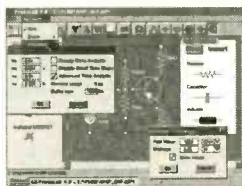

Priced for the hobbyist!

You can create and test AC and DC circuits minutes after installing this package on your PC. Start from scratch, or from the included library of pre-designed circuits. Drag and drop placement from a complete list of active and passive components. Test using a complete list of virtual instruments, Oscilloscope, voltmeter, ohmmeter, ammeter, and watt meter.

PLAB4 Electronic Prototype Software, Win95/98 \$49.95

ANALOG-DIGITAL PORTABLE LAB STATION



The COMPLETE analog-digital lab station in one. Includes function generator, clock output, power supplies, level switches, pulsers, pots, LEDs and a LARGE breadboarding area all in one! Includes a custom molded case as shown. Used through the world at universities, technical schools, and R&D labs. Available in "Learn as you Build" kit form or factory assembled and tested. A great buy either way!

ML200 Lab Station, Kit \$155.95
ML200WT Lab Station, Factory Assembled & Tested \$225.95

CABLE WIZARD CABLE TRACER



Did you ever have to identify the "other end of that cable"? No more "ohming it out" with the Cable Wizard. Simply connect the wizard transmitter to one end of the cable and use the receiver to sniff out the other end. It's as simple as that! The transmitter sends a pulsating 2 KHz signal down the cable which is heard when the receiver is close to the cable. Works with any cable including coax, telephone pairs, ethernet and more. Equipped with an RJ45 for all telco connections and clip leads for single wire connections.

WCT20 Wireless Cable Tracer Kit \$39.95
CWCT Matching Case Set for Transmitter & Receiver \$29.95
WCT20WT Factory Assembled & Tested WCT20 \$99.95

SPEEDY PERSONAL SPEED RADAR GUN



This low cost microwave radar uses the same principle found in police units costing thousands more. This has been the number one Science Fair project for years. Direct digital readout in miles/hour, kilometers/hour, or feet/second. An earphone jack allows you to actually hear the Doppler frequency shift of moving objects. Our detailed manual not only guides you through construction, but covers

the how's and why's of speed radar theory. Learn while you build. Uses two 1/2 oz coffee cans for the antenna (not included) and runs on 12 VDC.

SG7 Speedy Personal Speed Radar Kit \$99.95
AC125 12VDC Power Supply \$9.95

AND...OUR FAMOUS MINI-KITS

These are easy to build kits that can be used either stand alone or as building blocks for more complex projects.



TS4 Tickle-Stick Shocker \$9.95
BN9 Super Snoop Amplifier Kit \$8.95
BL1 LED Blinky Kit \$3.95
TD1 Tone Encoder/Decoder Kit \$6.95
TT7 Touch Tone Decoder Kit \$29.95
CPO3 Code Practice Oscillator Kit \$9.95
UT5 Universal Timer Kit \$8.95



AMAZING DEVICES

NVEN22001EVEN

See and Order from Our "Action"[®] Web Site at www.amazing1.com

Laser Window Bounce Listener

Powerful listening system, yet simple in operation. You shine a laser at a window and intercept the reflected beam with our ultrasensitive filtered optical receiver. Vibrations on the window from internal sounds and voices are now clearly heard. Range can be up to several hundred meters depending on laser power and optics used.

LWB9 Plans for 3 Laser Window Bounce Systems.....	\$20.00
LWB6K Kit of 100' Complete for Science Project.....	\$129.95
LLR3K Low Cost Optical Receiver Kit.....	\$69.95
LLR30 Ready to Use Above Optical Receiver.....	\$99.95
LLR40 Higher Performance of Above Receiver/ Optics.....	\$199.95
LM650P3 Visible Red 5mw Laser Module to 100'.....	\$29.95
CWL10 10 mw Class IIIB Invisible IR Laser up to 500'.....	\$199.95

PLASMA FIRE SABERS Kits, Parts and Accessories

Duplicates effect in the motion picture epic of the century!

Specify blue, grn, pur, red or yel.
Moving light appears to evaporate into space
Blades screw into handle for easy replacement

We stock all size and color blades, mauler adapters, tubes digital drivers, and parts for authentic designs. Wireless interactive sound modules change tone with motion

SAB15 Assbled with 15" Blade.....	\$39.95
SAB24 Assbled with 24" Blade.....	\$79.95
SAB24K Kit.....	\$59.95
SAB36 Assbled with 36" Blade.....	\$149.95
SAB36K Kit.....	\$129.95

Take Control!! Electronic Hypnosis



Electronic circuitry places subject under your control! Induces ALPHA relaxed mind states.

HYP2 Plans.....	\$10.00
HYP2K Kit/Plans.....	\$49.95
HYP20 Ready to Use.....	\$69.95
MIND2 Plans for Mind Control.....	\$15.00
MIND2K Kit/Plans.....	\$49.95
MIND20 Ready to Use.....	\$79.95

Pain Field Pistol

Caution! Do not aim at people!

Blast out rodents with high power ultrasonics.

Handheld and battery operated with all controls.

Rental units available.

PPP1 Plans.....	\$8.00
PPP1K Kit/Plans.....	\$49.95
PPP10 Ready to Use.....	\$79.95

Jacob's Ladder

A 1/2" arc expands to over 4" as it travels up the Jacobs Ladder evaporating in space.

- Adjustable arc control
 - Uses safe high frequency
 - Safety shock shut down
 - Full 20" ladder length
 - 110/220 vac 150 watts
- | | |
|--------------------------|----------|
| JACK3K Kit..... | \$149.95 |
| JACK30 Ready to Use..... | \$249.95 |

30" Spark Tesla Coil

Create a spectacular display of nature's own lightning. Many amazing experiments possible.

See coil in action on our web site!

BTC4 Plans.....	\$20.00
BTC4K kit.....	\$89.95
BTC40 Ready to use.....	\$1199.95
Smaller Version (8-10" Sparks)	
BTC3 Plans.....	\$15.00
BTC3K Kit.....	\$349.95
BTC30 Ready to Use.....	\$449.95

6 Transmitter Kits

- 1 Super Sensitive Ultra Clear 1 Mile+ Voice Transmitter.
- 2 1 Mile+ Telephone Transmitter.
- 3 Line Powered Phone Transmitter Never Needs Batteries!
- 4 Tracking/Homing Beacon Beeping Transmitter
- 5 Video/Audio Retrocaster 1 Mi.
- 6 TV/FM Radio Disrupter. Neat Prank! Discretion Required

Includes Hints Using Wireless Devices

COMBOX Above 6 Kits/Plans.....	\$59.95
COMBOP Above 6 Plans Only.....	\$10.00

4 KV HV MODULE for hovercraft, plasma guns, antigravity, pyrotechnics. 12vdc input. MINIMAX4.....\$19.95

Hover Board

28 pages of data related to the most revolutionary advance in transportation. Cutting edge R&D HOVER Plans and Data.....\$25.00

Anti Gravity

Floater an object using an electric force field. With handbook

GRA3 Plans/book.....	\$20.00
GRA3K Kit Pwr Sup.....	\$99.95
GRA30 Assmbld above.....	\$149.95

MINI TESLA COIL Lights 4' light tube!
MTC1 Plans...\$5.00 MTC1K Kit...\$19.95
MTC10 Assmbld for 12 volts.....\$34.95

Information Unlimited PO Box 716 Amherst N.H. U.S.A. 03031

1 800 221 1705 Orders/Catalogs Only Fax 1 603 672 5406 Information 1 603 673 4730 Free Catalog on Request
Pay by MC, VISA, Cash, Check, MO. Add \$5.00 S&H Overseas Contact for Proforma

CIRCLE 220 ON FREE INFORMATION CARD

2539 W. 237th Street, Bldg. F, Torrance, CA 90505
Order desk only: USA: (800) 872-8878 CA: (800) 223-9977
LA. & Technical Info: (310) 784-5488 Fax: (310) 784-7590
www.digisys.net/timeline • email: mraa@earthlink.net

TIMELINE INC.

Over 15 years and 33,000 customers and still growing

Minimum Order \$20.00. Minimum shipping and handling charge \$5.00. We accept cashiers checks, MC or VISA. No personal checks or COD's. CA residents add 8.25% sales tax. We are not responsible for typographical errors. All merchandise subject to prior sale. Phone orders welcome. Foreign orders require special handling. Prices subject to change without notice. 20% restocking fee for returned orders.

LIQUID CRYSTAL DISPLAYS

240x64 dot LCD with built-in controller.
AND 4021ST-EO. Unit is EL back-lit. \$49.⁰⁰ or 2 for \$89.⁰⁰ or OPTREX. DMF5005 (non back-lit) \$39.⁰⁰ or 2 for \$69.⁰⁰
20 character x 8 line 7xL x 2xH
The built-in controller allows you to do text and graphics.

240x128 LCD with built-in controller. \$49.⁰⁰ or 2 for \$69.⁰⁰
256x128 LCD with built-in controller. \$49.⁰⁰ or 2 for \$69.⁰⁰

Alphanumeric—parallel interface

16x1.....	\$5.00	20x2.....	\$7.00	32x2.....	\$6.00
16x1 (lg. char.).....	\$8.00	20x4.....	\$8.00	40x1.....	\$6.00
16x2.....	\$5.00	20x4 (lg. char.).....	\$10.00	40x2.....	\$8.00
16x2 (lg. char.).....	\$10.00	24x2.....	\$7.00	40x4.....	\$15.00
16x4.....	\$8.00	32x4.....	\$7.00	4x2.....	\$4.00

5V power required • Built-in C-MOS LCD driver & controller • Easy "microprocessor" interface • 98 ASCII character generator
Certain models are backlit, call for more info.

Graphics and alphanumeric—serial interface

size	Mfr.	price	size	Mfr.	price
640x480 (backlit)	Epson	\$15.00	320x240	Epson	\$20.00
640x400 (backlit)	Panasonic	\$10.00	256x128	Epson	\$15.00
640x200	Toshiba	\$10.00	240x128 (backlit)	Optrax	\$20.00
480x128 (backlit)	ALPS	\$ 8.00	240x64	Epson	\$15.00
480x128	Hitachi	\$ 6.00	160x128	Optrax	\$15.00

6" VGA LCD 640X480, Sanyo LMDK55-22 \$15⁰⁰

9.4 inch color active matrix LCD. Toshiba LTM09C011 \$49⁰⁰

9.4 inch monochrome displays. Sharp LM64P70 or LM64P723 \$29⁰⁰

MONITORS

Non-Enclosed TTL

Comes with pinout. 12V at 1.4 Amp input • Horizontal frequency 15KHz. • Ability to do 40 and 80 column.

5 inch Amber \$19.00 • 7 inch Amber \$19.00

9 inch Amber or Green \$19.00

5" COLOR MONITOR \$25.⁰⁰

- Flat Faceplate • 320 x 200 Dot Resolution • CGA & Hercules Compatible
- 12 VDC Operation • 15.75 KHz Horiz. Freq. • 60 Hz Vert. Sync. Freq.
- Open Frame Construction • Standard Interface Connector • Degaussing Coil included • Mfr. Samtron

2 for \$39⁰⁰

HACKER CORNER

57 WATT UPS SUPPLY \$39.⁰⁰ (COMES W/ 12V @ 2.2AMP BATTERY)

Unit designed to provide uninterrupted DC power in the event of loss of the primary 110/220 VAC supply. It utilizes a 12 V sealed lead acid battery as a source of power until the AC supply can be restored. It is a versatile unit which can be used in a number of different applications. The outputs are +5 VDC @ 6.5 A, +3.6 VDC @ 2.5 A, +12 VDC @ 0.8 A, -12 VDC @ .5 A, and a battery charging output of 12 VDC @ 10 A. The DC outputs are terminated in in-line connectors which interface with standard motherboard and drive connectors. Possible applications include: Robotics, scientific sensing and recording. Linux devices attached to Ethernet or Internet links, etc...

• The unit is small enough (2" x 3.5" x 8.5") to be contained in a standard PC enclosure, in place of the regular power supply - interfacing directly with the motherboard - providing an uninterrupted power supply • It can function as a DC - DC power supply furnishing multiple outputs using a 12 VDC input • The 10 Amp, 12 VDC out put can be used as a battery charger with any AC input from 100 - 240 V • The unit is a versatile 57 watt DC power supply providing +5 and 3.6VDC as well as +/- 12 VDC.

EMBEDDED 486 COMPUTER \$79.⁰⁰ 2 for \$149.⁰⁰

Complete enhanced Intel 486SX-33 based computer in ultra slim (9-7/8" x 6-5/8" x 3-1/8") case. Ideal for embedded operations or as a second computer. Features include: • One 16 bit ISA slot • 3 serial ports, plus dedicated printer port • Parallel optical coupled adapter port • Built in IBM PC/AT keyboard port • On board VGA video and port • Uses standard SIMM up to 32 MB • BIOS is PC/AT compatible
Unit has a backup Ni-Cd battery system in case of power failure (5 min. backup time) and lockable front cover to prevent floppy drive access. Mounting / interface provisions for standard 3.5" laptop floppy and 2.5 inch hard drives. Comes with very comprehensive manual.

CELL SITE TRANSCIVER \$29.⁰⁰ 2 for \$49.⁰⁰

These transceivers were designed for operation in an AMPS (Advanced Mobile Phone Service) cell site. The 20 MHz bandwidth of the transceiver allows it to operate on all 666 channels allocated. The transmit channels are 870.030-889.980 MHz with the receive channels 45 MHz below those frequencies. A digital synthesizer is utilized to generate the selected frequency. Each unit contains two independent receivers to demodulate voice and data with a Receive Signal Strength Indicator (RSSI) circuit to select the one with the best signal strength. The transmitter provides a 1.5 watt modulated signal to drive an external power amplifier. Channel selection is accomplished with a 10 bit binary input via a connector on the back panel. Other interface requirements for operation are 26 VDC (unregulated) and an 18.990 MHz reference frequency for the digital synthesizer. The units contain independent boards for receivers, exciter, synthesizer, tunable front end, and interface assembly (which includes power supplies and voltage-controlled oscillator). Service manual, schematics and circuit descriptions included.

POS & BAR CODE

MAGNETIC CARD READER \$15.⁰⁰

Includes: • 20 character dot matrix display with full alpha-numeric capability • keypad with full alpha-numeric entry • separate 7.5 VDC/0.5 Amp power supply • standard telephone interface extension cord • lithium battery and Par-cone speaker.

HP bar code wand (HBCS 2300) \$19.00

CIRCLE 325 ON FREE INFORMATION CARD

MAKIT YOURSELF ROBOTIKITS®



COMET
Sound sensor.
Actually draws.
OWI-9742
\$53.95

**BLAST OFF
INTO THE FUTURE!**

ROCKIT ROBOT
Sound and touch sensor
OWI-7769
\$24.95

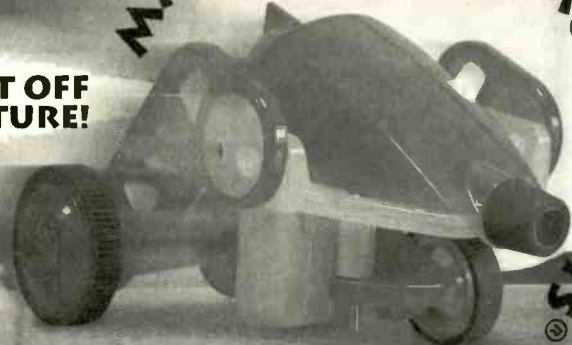

**ROBOTIKITS®
DIRECT**

WE MAKE A
GREAT TEAM!

- Build, Personalize & Learn**
- Award-winning project kits
 - Concepts of Robotics
 - Gear Drives & Sensors
 - Basic Electronics
 - Logic & Reasoning
 - Great For Workshops
 - Develops Self-Confidence

17141 Kingsview Ave. Suite B
Carson, CA 90746 USA
Phone: (310) 515-1900
Toll Free: (877) 515-6651
Fax: (310) 515-1606
E-mail: robotikitsdirect@pachell.net
Web: www.robotikitsdirect.com

**ROBOTIKITS®
DIRECT**



AM RADIO
OWI-215K
\$24.95



CIRCLE 256 ON FREE INFORMATION CARD

New and Pre-Owned Test Equipment

New Equipment Specials

B-K Precision 2120B - 30 MHz Oscilloscope

- * FREE Model 117B Multimeter
 - * 2 Channel, Dual-Trace
 - * 30 MHz Bandwidth
 - * TV Triggering
 - * (2) Probes Included
- Sale Price \$339.00**

AVCOM PSA-37D - Spectrum Analyzer

- Satellite Downlink - Installation - Maintenance & Service
- Band 1: 10 - 1750 MHz
 - Band 2: 3.7 - 4.2 GHz
 - Carrying Case Included
 - Line or Battery Powered
 - Built-in DC Block & Power for LNA/LNB's
- Sale Price \$2,395.00**

Instek GOS-6103 - 100 MHz Analog Oscilloscope

- 100 MHz Bandwidth
 - 2 Channel, High Sensitivity
 - TV Trigger - Signal Output
 - Cursor Readout
 - Time Base Auto-range
 - (2) Probes Included
 - 2 Year Warranty
- Sale Price \$899.00**

Leader LF 941 - CATV Signal Level Meter

- TV/CATV Coverage from 46-870 MHz
 - Video/Audio Carrier Measurements
- Sale Price \$489.00**

Wavetek Meterman HD160B Digital Multimeter

- Full Sealing Against Water, Chemicals, & Fluids
 - True RMS
 - Drop-Proof to 10 feet (3.3m)
- Sale Price \$159.00**

Pre-Owned Oscilloscope Specials

Tektronix	465	100 MHz	\$499.00
Tektronix	465B	100 MHz	\$649.00
Tektronix	475	200 MHz	\$749.00
Tektronix	475A	250 MHz	\$949.00

- Professionally Refurbished
- Aligned & Calibrated to Original Specifications
- The Industry Standard of Oscilloscopes
- 1 Year Warranty - The Longest Available!!!
- See Website for Complete Specifications

See us on the Web!
www.testequipmentdepot.com

**We Buy Surplus
Test Equipment**

Test Equipment Depot

A FOTRONIC CORPORATION COMPANY
99 Washington St. Melrose, MA 02176
(781) 665-1400 • FAX (781) 665-0780
e-mail: sales@testequipmentdepot.com

(1-800-996-3837)



TOLL FREE 1-800-99-METER

CIRCLE 322 ON FREE INFORMATION CARD

**More Features
More Power
Less Money**

Ivex Complete Power Tools include: WinDraft P350 Schematics, WinBoard P350 PCB Layout, Ivex Spice Standard Simulation and Gerber Viewer together in a complete, affordable package.

Ivex Complete Plus includes everything in the Complete package plus 650 pin versions of WinDraft and WinBoard with Ivex Spice Advanced.

Ivex 650 pin versions have no feature limitations like other low cost products on the market. Fast expert technical support, free 24 hour Knowledge Base on the web, and professional full-featured tools have made Ivex the preferred choice for designers.

For larger designs use these Ivex Products:

WinDraft unlimited \$495
WinBoard unlimited \$495

Ivex Complete Electronics CAD Package

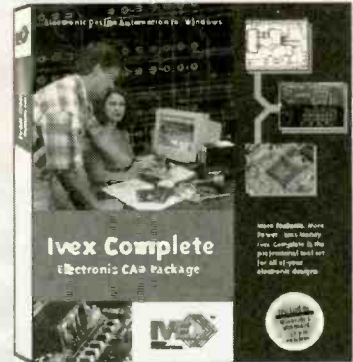
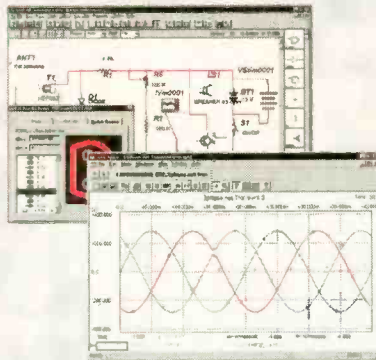

Advantages

- Full-feature tools
- 17,000 Schematic parts
- Part edit & model making
- Part Search
- Bill of Materials with Sort & Spreadsheet output
- Heirarchy for large designs
- ERC (electrical rules check)
- 15 Netlist outputs
- 7 Analysis Types
- Spice Advanced includes 14 analyses
- 16 PCB layers
- 0.01 micron grid resolution
- Advanced DRC
- Micro via
- Gerber & NC Drill report
- 24 hour FREE Technical Support Internet Knowledge Base
- No hardware protection lock!
- New: Schematic DXF output*

Ivex Complete

Schematics
Simulation
PCB Layout
Gerber Viewer

\$350

Ivex Complete

Plus

P650 Schematics
Adv. Simulation
P650 PCB Layout
Gerber Viewer Plus

\$550

Free board quote

pcbCite.com

The Internet source for PCB manufacturing

Visit the Ivex web site for complete product information and download full function demos.

www.ivex.com

Tel: (503) 531-3555 e-mail: sales@ivex.com



DESIGN
INTERNATIONAL

ADV8_4

MODERN ELECTRONICS

**CABLE TV
DESCRAMBLERS**



- ★ **FREE CATALOG!**
- ★ **BEST DEALER PRICING!**
- ★ **DISCOUNTED PRICING!**
- ★ **30 DAY FREE TRIAL!**
- ★ **100% MONEY BACK GUARANTEE**

**COPY RENTAL TAPES WITH
OUR VIDEO STABILIZER**

1-800-906-6664

2609 S. 156th Circle · Omaha, NE 68130
www.modernelectronics.com



PIC Programmer Kits



\$16.95
+S&H \$4.95*
The P16PRO: can program up to 40 pin PICs including the popular 16F84 & 12C508 • Needs software (extra \$20) • Available assembled or starting from \$16.95 for the kit.

See www.electronics123.com for more info!
The PICALL programmer can also program Atmel AVR's in addition to the PICs it can program • Free software • PICALL programmer kit at \$69.95
See www.electronics123.com for more info!

Video Camera module Code:BB004

CMOS Camera Module, Black & White, Size: 0.63"x0.63"x0.59"H. Lens: f4.9, F2.8, EIA 320Hx240V. 0.6" DIL Package, 5 pins. Pin 3 is 1V p-p composite video (75 ohm) to monitor. \$36 + \$5 S&H
8 LEDs with 10 push button selectable patterns. 8 speed levels! 80 combinations! \$16 + \$5 S&H

Add \$6 for 8 triacs to drive light bulbs

Toll Free: 1-888-549-3749 (USA & Canada)
Tel: (330) 549-3726. Request a FREE catalog or visit us at: www.electronics123.com for more products.
Amazon Electronics, Box 21 Columbiana, OH 44408

MAY THE SOURCE BE WITH YOU

Don't let the dark forces of ignorance defeat you. Tap into the source of free or low-cost government publications--the free CONSUMER INFORMATION CATALOG.

Call toll-free 1-888-8 PUEBLO
Or set your coordinates for our web site:
www.pueblo.gsa.gov

TiePieScope HS801 PORTABLE MOST

Reliability



- 50 MHz ARBITRARY WAVEFORM GENERATOR-
- 100 MHz STORAGE OSCILLOSCOPE-
- 50 MHz SPECTRUM ANALYZER-
- 6 DISPLAY MULTIMETER-
- 200 DAYS TRANSIENT RECORDER-

The HS801: the first 100 Mega samples per second measuring instrument that consists of a MOST (Multimeter, Oscilloscope, Spectrum analyzer and Transient recorder) and an AWG (Arbitrary Waveform Generator). This new MOST portable and compact measuring instrument can solve almost every measurement problem. With the integrated AWG you can generate every signal you want.

A user defined toolbar with which over 50 instrument settings quick and easy can be accessed is offered by the versatile software. An intelligent auto setup allows the inexperienced user to perform measurements immediately. Through the use of a setting file, the user has the possibility to save an instrument setup and recall it at a later moment. The setup time of the instrument is hereby reduced to a minimum.

Analyzing signals is done with an 8 bit resolution and a maximum sampling speed of 100 MHz. The input range is 0.1 Volt full scale to 80 Volt full scale. The record length is 32K/256K samples. The AWG has a 10 bit resolution and a sample speed of 25 MHz.

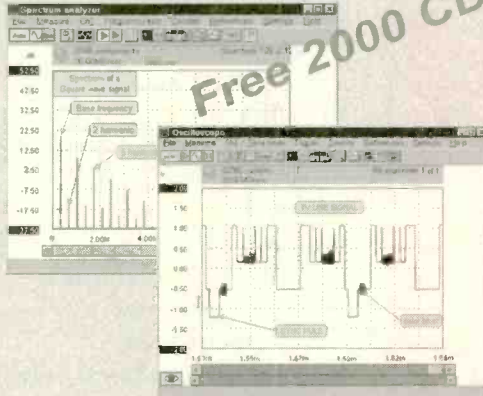

Free 2000 CD

Convince yourself and download the demo software from our web page: www.tiepie.nl. When you have questions and / or remarks, contact us via email: support@tiepie.nl. The HS801 is delivered with a user manual, two probe's, Windows and DOS software.

US dealer:
Feedback Incorporated: Tel 800-526-8783;
Fax 919-644-6470; www.fbk.com

Outside US:
TiePie engineering, P.O. BOX 290, 8600 AG SNEEK, The Netherlands.
Tel: +31 515 415 416 Fax: +31 515 418 819
Web: www.tiepie.nl

Thanks to you, all sorts of everyday products are being made from the paper, plastic, metal and glass that you've been recycling. But to keep recycling working to help protect the environment, you need to buy those products.

BUY RECYCLED.



AND SAVE.

So look for products made from recycled materials, and buy them. It would mean the world to all of us.

For a free brochure, write Buy Recycled, Environmental Defense Fund, 257 Park Ave. South, New York, NY 10010, or call 1-800-CALL-EDF.



**Start A Career With High Wages,
Excellent Benefits and Job Security!!**

With UCANDO's extraordinary maintenance training programs you can quickly and easily enter a high paying field as a maintenance technician for a very small investment of time and money.

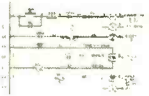

RC-M ONLY \$165 RC-M is a 15 hour training course on relay ladder logic systems. Includes a 5-part video and workbook. **Great Value!**

PLC-M ONLY \$198 PLC-M is a 32 hour training course on PLC systems. Includes (2) 4-part video's and workbook. **This training is valuable.**



HYD-M ONLY \$209 HYD-M is a 32 hour course on Fluid Dynamics. Includes (2) 4-part video's and workbook. **This Module is a must.**

SC-M ONLY \$215 SC-M is a 32 hour training course on AC & DC Servo Controllers. Includes (2) 4-part video's and workbook. **Learn everything you need about AC and DC servo Control Systems.**



Electronic Training Videos: Basic Electronics, Digital Electronics, TV Repair, LASER and Fiber Optic training videos available at very affordable prices starting at **Only \$35.00 each.**

For information or to place an order call:

1-800-678-6113

www.ucando-corp.com

UCANDO VCR Educational Products Corp., Greenville, OH

**Graphic Interface with
Touch screen control**

Priced From
\$140.00
Qty 1

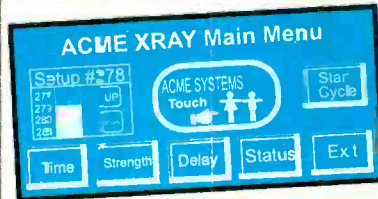

Easy Inter-face with PC/104, 8051 68HC11, PIC

Easy Operator Interface
through serial connection



**Graphic display
Touch screen**

Serial communication (RS-232C)

Eprom or Flash for screen storage

Only +5VDC power required

Easy to use development software

Create screens by PC paintbrush

Simple to place touch buttons software



Many
Sizes
Available

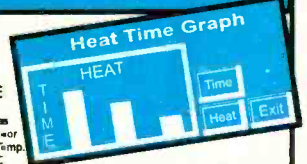

**Designtech
Engineering Co.**

2001 S. Blue Island Ave.
Chicago, IL 60608
Phone 312-243-4700
Fax 312-243-4776

Many Types
Indoor, Outdoor,
Factory, Ext. Temp.
CFL, LEC
Available

Embedded Computer Controller
Also Available

www.designtechengineering.com

Build Your Own Intelligent Robot, We Make It Easy!

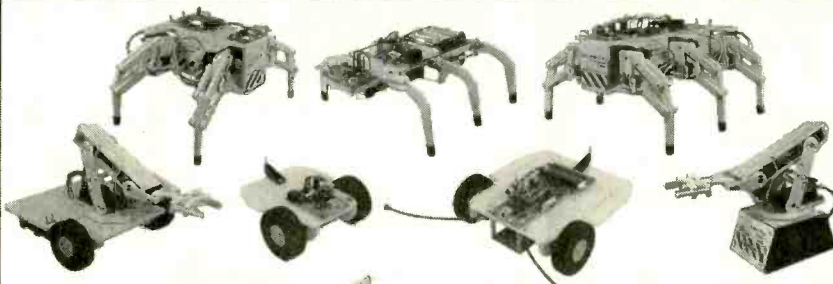

Lynxmotion, Inc.
PO Box 818
Pekin, IL 61555-0818
www.lynxmotion.com



Visit our website or ask for our free catalog!

Tel: 309-382-1816
Fax: 309-382-1254
sales@lynxmotion.com
tech@lynxmotion.com

HARMONY
A PARTNERSHIP WITH A HEALTHY LAND

The earth has always provided food, water, and all that we need. Today, as in the past, American Indians recognize the importance of keeping the earth healthy. Give back to the earth. Call for your free action packet.

1-800-THE-SOIL

United States Department of Agriculture
Natural Resources Conservation Service



MECI
Your Electronics Value Company

**Tons of
Electronics**

Get your FREE catalog today and discover some of the best deals in electronics. We have thousands of items ranging from unique hard-to-find parts to standard production components. Call, write or fax today to start your subscription to one of the most unique catalogs in the industry, filled with super values on surplus electronic and hobbyist type items.



**FREE
CATALOG!**

Checkout our 10,000 item on-line catalog <http://www.meci.com>

**Order Toll Free
1-800-344-4465**

Why pay more?
Call today!
Fax Order Line
1-800-344-6324

CIRCLE 323 ON FREE INFORMATION CARD

\$59 PCBs

And our layout software is **FREE**

- 1 Download our board layout software
- 2 Design a 2-sided circuit board 2.5" x 3.8"
- 3 Send us your layout over the Internet
- 4 We ship you 3 excellent quality boards with plated-through holes for \$59 (shipping included)

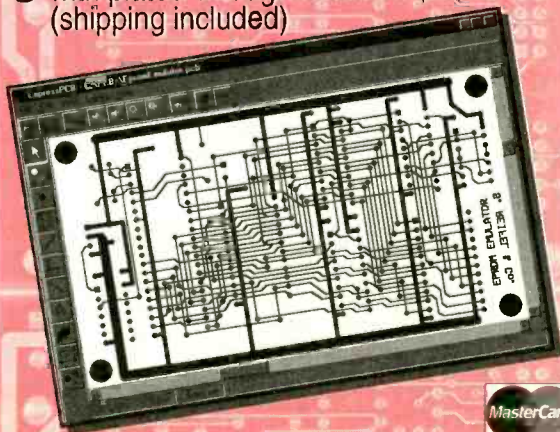

www.expresspcb.com



PICmicro® BOOKS

LEARN ABOUT MICROCONTROLLERS

Easy PIC'n - Beginner \$29.95

- Programming techniques
 - Instruction set, addressing modes, bit manipulation, subroutines, loops, lookup tables, interrupts
- Using a text editor, using an assembler, using MPLAB
- Timing and counting (timer 0), interfacing, I/O conversion

PIC'n Up The Pace - Intermediate \$34.95

- Serial communication - PICmicro to peripheral chips
- Serial EEPROMS
- LCD interface and scanning keypads
- D/A and A/D conversion - several methods
- Math routines

PIC'n Techniques - Intermediate \$34.95

- 8-pin PICmicros
- Timer 1, timer 2 and the capture/compare/PWM (CCP) module
- Talking to a PICmicro with a PC using a terminal program
- Test equipment and data logger experiments

Serial PIC'n - Advanced \$49.95

- Synchronous - bit-bang, on-chip UART, RS-232
- Asynchronous - I2C (Philips Semiconductor)
- SPI (Motorola), Microwire (National Semiconductor)
- Dallas Semiconductor 1-Wire bus

PICmicro and MPLAB are trademarks of Microchip Technology Inc.

Table Of Contents And Ordering Information On Web Site

SQUARE 1 ELECTRONICS

P.O. Box 501, Kelseyville, CA 95451
Voice (707) 279-8881 Fax (707) 279-8883

<http://www.sq-1.com>

Coil Design and Construction Manual

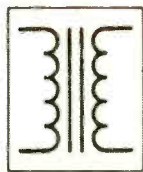

YOU CAN WIND YOUR OWN COILS?

There's no trick to it except knowing what you are doing. In a unique, 106-page book you can become expert in winding RF, IF, audio and power coils, chokes and transformers. Practically every type of coil is discussed and necessary calculations are given

with the mathematical data simplified for use by anyone. Get your copy today!

Mail coupon to:

Electronics Technology Today, Inc.
P.O. Box 240 • Massapequa Park, NY 11762-0240

Please send me my copy of *Coil Design and Construction Manual* (BP160). I enclose a check or money order for \$8.99 to cover the book's cost and shipping-and-handling expenses. NY state residents must add local sales tax.

Name _____

Address _____

City _____ State _____ ZIP _____

All orders must be paid in U.S. funds only. Sorry, no orders accepted outside of USA and Canada. Please allow 6-8 weeks for delivery.

ET06

POPTRONIX®

Online Edition

We're on the web

FREE

We are starting up, but you can watch us grow!

Projects for beginners to experts!

New Product information!

Bookstore—discover what's new!

<http://www.poptronix.com>

WE'RE WITH YOU EVERY DAY

24 HOURS A DAY! DROP IN!

WE'D LOVE TO HAVE YOU VISIT!

Enclosed Switching Power Supplies



Single, Dual & Triple Output Models
Single Output Supplies
 (5V, 12V, 15V, 25V)

Triple Output Supplies

100w, 5v/12v/-5V
 as low as \$44.00
 100w, 5V/12V/-12V
 as low as \$44.00

25 watt series **AS Low as \$20.55 ea.**
 60 watt series **AS Low as \$27.95 ea.**
 150 watt series **AS Low as \$42.95 ea.**

Dual Output Supplies

100W, 5V/12V
 100W, 5V/24V
 ...as low as \$38.00
 50W, 5V/24V
 ...as low as \$27.00ea.

See Our Web Site for Details

UL Approved
NOW IN STOCK!

Removable Hard Drive Rack

For IDE/Ultra DMA Hard Drives
 We Sold Over 14,000 in 1998!
 This product can be used with any 3-1/2 IDE hard drive up to 1" high. It includes an electronic keylock for safe removal and insertion. Made of ABS 707 fireproof plastic. Use this product to protect sensitive hard drive data, take your hard drive between work and home or even set up different users with their own hard drives that they physically insert every time they use a PC. Other models available from C.S.I. include RH10 series and RH20 series, which are interchangeable within the same interface design (IDE or SCSI). Other Models are Available. See www.web-tronics.com under "hard drive and accessories" for more details and pictures.



ONLY \$14.95
 any qty.

#RH-10C-IDE

Removable Hard Drive Rack with Auto Door And Cooling Fan

- Auto door on the outer frame
- ABS material of outer frame. High efficiency cooling fan
- Worldwide patent pulling function handle
- CE Approved
- Coating Iron bottom cover
- For IDE interface
- For 1" high 3.5" HDD
- Not compatible with our RH10 & RH20 series. Compatible with our RH17-IDE model



ONLY \$18.95
 any qty.

#MR-27
 Details at www.web-tronics.com

2GHz RF Field Strength Analyzer

- Frequency Range: 100KHz to 2.060MHz
- Narrow Band FM (NFM), Wide Band FM (WFM), AM and Single Side Band (SSB) Modulated Signals May Be Measured
- PLL Tuning System for Precise Frequency Measurement and Tuning
- LED Backlight LCD (192x192 dots)
- Built-In Frequency Counter
- Hand-Held and Battery Operated
- All Functions are Menu Selected
- RS232C for PC Interface and Printer



ONLY \$1989

#3201

CTRL - D to bookmark this site



- Easy to Navigate
- Includes a Search Engine That Really Works
- New Items Added Constantly

In Business Since 1971

Don't forget the dash

Circuit Specialists Inc.

Mini CCDs (B/W & Color)

Sensational NEW Design for Small Observation Cameras. Smaller and Better!

- Ultra Miniature Design
- Black & White Versions Only 25mm x 25mm
- Color Versions Only 32mm x 32mm
- Available in Standard Lens or Pinhole Lens

- All Include Pre-Wired Cable Harness for Video & Power
- 12V Regulated Power Supply Required (120mA typical power consumption)
- 0.1 LUX Rating (B/W), 1 LUX (color)
- CCD Area Image Sensor for Long Camera Life
- Back Light Compensation Circuit
- Built-In Electronic Auto Iris Lens

VMCW-H11A 32mmx32mmx30mm, Color CCD with standard lens, pre-wired cabling 12V DC Power \$139.00 / \$129.00 5 or more
 VMCW-H12A 32mmx32mmx19mm, Color CCD with pinhole lens, pre-wired cabling, 12V DC Power Input \$139.00 / \$129.00 5 or more
 VMPS-718A 25mmx25mmx30mm, B/W CCD with standard lens, pre-wired cabling, 12V DC Power Input \$59.00 / \$49.00 5 or more
 VMPS-250A 25mmx25mmx15mm, B/W CCD with pinhole lens, pre-wired cabling, 12V DC Power Input \$59.00 / \$49.00 5 or more
 VCC-3232 32mmx32mmx30mm, CMOS COLOR, std lens, see web for specs \$79.00 / \$72.00 5 or more

LOWER PRICES

Detailed Specs on the Web

CCD B&W Board Cameras

- ASIC CCD Area Image Sensor
- Extremely Low Power Consumption
- 0.5 Lux Min Illumination
- Built-In Electronic Auto Iris for Auto Light Compensation

VM1030PA-B 30mmx30mmx25mm, Pinhole lens, 12V \$39.00 any qty.
 VM1030A 30mmx30mmx26mm, Standard lens, 12V \$39.00 any qty.
 VM1035A 42mmx42mmx25mm, Standard lens, 12V with back light compensation \$49.00 any qty.
 VMCB21 44mmx38.5mmx28mm, with 6 infra-red LEDs, 12V \$49.00 any qty.
 VM1036A 32mmx32mmx25mm, Standard lens, 12V, reverse mirror image feature \$49.00 any qty.

Detailed Specs on the Web

LOWER PRICES

Bullet CCD Cameras B&W and Color

- Smart Rugged Metal Housing
- Extremely Low Power Consumption
- 12 Volt
- CCD Area Image Sensor for Long Camera Life
- Built-In Electronic Auto Iris for Auto Light Compensation
- No Blooming, No Burning
- 0.1 Min Lux Illumination (B&W), 1 Lux Min Lux Illumination (color)

VMBLT1020 B&W, 21mm(D)x58.5mm(L) \$54.00 any qty.
 VMBLT1020W B&W Weatherproof, 21mm(D)x58.5mm(L) \$79.00 any qty.
 VMBLTJC19BW COLOR! Weatherproof, 17mm(D)x88mm(L) \$139.00 any qty.

Detailed Specs on the Web

LOWER PRICES

COLOR CCD Mini Board Cameras

- Low Power Consumption
- 1 Lux Illumination
- Internal Synchronization
- 12Volts
- 400 TV Lines
- Built-In Electronic Auto Iris for Auto Light Compensation

VM3010PA 33mmx33mmx18mm, Pinhole lens \$99.00 any qty.
 VM3011-A 45mmx40mmx24mm, Standard lens, single board \$89.00 any qty.
 VM3010-A 33mmx33mmx32mm, Standard lens \$99.00 any qty.

Detailed Specs on the Web

PRICE REDUCTION

DC to AC Power Inverters !

150 watt up to 3000 watt models !

150w modified sine wave: \$29.95(G-12-015B) Industry Best Pricing!
 300w modified sine wave: \$39.95(G-12-030)
 150w pure sine wave: \$69.00(G-12-150S)
 300w pure sine wave: \$109.00(G-12-300S)
 800w modified sine wave: \$139.00 (G-12-800)
 1000w modified sine wave: \$179.00(G-12-1000)
 3000w modified sine wave(phase corrected), (G-12-300).....\$489.00

See Our Website for DETAILED Specs.!



Our Most Sophisticated DMM We Sold Over 700 Last Year!

- with RS-232 Interface & Software, 3-3/4 Digit, 4000 Count, Auto-Ranging with Analog Bargraph
- K Type Temperature Probe Included
- True RMS Mode
- 10MHz Frequency Counter
- Tune Mode with Alarm, Clock, and Stop Watch
- Dual Display
- 10 Location Memory
- Min, Max, Avg and Relative Mode
- Decibel Measurement
- Cap and Ind. Measurement
- Temperature Mode (C/F)
- Pulse Signal for Logic & Audible Test
- Continuity/Diode Test
- Logic Test
- Auto Power OFF/Keep ON* Mode
- Fused 20A Input with 0Warning Beeper
- Back Light
- Data Hold/Run Mode
- Safety Design UL1244 & VDE-0411
- Protective Housing
- Silicon Test Leads

NOW ONLY \$149
 Reg. \$169

More Details on our Web Site

PROTEK 506

BEST DEALS! new! NOW OFFERING



Dish Network

Direct TV

Great Equipment & Service
 See Our Website for our

Incredible Offers!
 Also Great HDTV Prices!

O'Scope Offer ONLY \$299
 30MHz! ONLY \$299!
 Industries Best Price!
 See web for specs



- Dual Channel
 - Dual Trace #OSC-1030
 - Vert Trigger
 - 1 Year C.S.I. Warranty!
- Manufactured for CSI by a leading O.E.M. manufacturer. See our website for detailed specifications!

3000 Series Digital R/O Bench Power Supply

Low Cost Single Output 3 Amp

High stability digital read-out bench power supply featuring constant voltage and current outputs. Short-circuit protection and current limiting protection is provided. Highly accurate LED accuracy and stable line regulation make the 3000 series the perfect choice for lab and educational use.

Line Regulation: 2x10⁻⁴ +1ma
 Load Regulation: 1 x 10⁻⁴ +5mv
 LED Accuracy: Voltage ±1% +2 digits
 Current ±1.5% +2 digits

Wave Line Noise: ≤1mvrms
 Dimensions: 291mm x 158mm x 136mm
CSI3003: 0-30v/0-3amp
 Digital R/O Bench PS,
 1x10⁻⁴+5mv Load
 Regulation
\$99.00 5/\$89.00



AS LOW AS \$89

CSI 5003: 0-50v/0-3 amp
 Digital R/O Bench PS,
 1x10⁻⁴+5mv Load
 Regulation
\$129.00 5/\$119.00

The Standard for checking Capacitors in-circuit



Good enough to be the choice of Panasonic, Pioneer, NBC, ABC, Ford, JVC, NASA and thousands of independent service technicians.

Inexpensive enough to pay for itself in just one day's repairs. At \$179, it's affordable.

And with a 60 day trial period, satisfaction guaranteed or money-back policy, the only thing you can lose is all the time you're currently spending on trying to repair all those dogs you've given up on.

CapAnalyzer 88A

Available at your distributor, or call 561-487-6103

Electronic Design Specialists

www.eds-inc.com

CIRCLE 210 ON FREE INFORMATION CARD

Locate shorted or leaky components or conditions to the exact spot in-circuit

Still cutting up the pcb, and unsoldering every part trying to guess at where the short is?

\$179

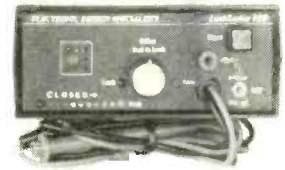

Your DVM shows the same shorted reading all along the pcb trace. LeakSeeker 82B has the resolution to find the defective component. Touch pads along the trace, and LeakSeeker beeps highest in pitch at the defect's pad. Now you can locate a shorted part only a quarter of an inch away from a good part. Short can be from 0 to 150 ohms

LeakSeeker 82B

RF Data Modules

AM Transmitter



- Sub Miniature module
- SAW Controlled
- No adjustable components
- Low current - 2.5mA
- Supply 2.5-12Vdc
- 418MHz or 433MHz
- Range up to 300ft
- CMOS TTL data input
- 7 x 11 x 4mm !
- AM-TX1-xxx \$12.60

AM Receiver



- Compact Hybrid Module
- Very stable
- CMOS TTL output
- Patented Laser Trimmed
- 5Vdc. 0.8mA (HRR6)
- 2kHz data rate
- Sensitivity -105dBm
- 38 x 12 x 2 mm
- AM-HRR6-xxx... \$16.33

FM Transceiver



- Only 23 x 33 x 11mm
- Up to 40,000bps data rate
- Up to 450ft. range.
- 5V operation
- 418MHz or 433MHz FM
- 5V CMOS logic interface
- Fast IntS enable
- Power saving feature
- Carrier Detect output
- BiM-xxx-F \$87.36

RS232 Transceiver



- 3wire RS232 interface
- 19.2Kbps half duplex
- 418MHz or 433MHz FM
- 7.5-15Vdc. 20mA
- TX/RX Status LED's
- Up to 400ft. range
- 1/4 wave ant. on board
- User data packetizing
- 58 x 40 x 15mm
- CYPHERNET \$139.30

AM Transmitter



- Range up to 250ft.
- SAW controlled stability
- Wide supply range 2-14V
- CMOS/TTL input
- Low current. 4mA typ.
- Up to 4kHz data rate
- Small: 17 x 11mm
- AM-RT5-xxx \$12.10



ABACOM
TECHNOLOGIES



tel: (416)236 3858
fax: (416)236 8866
www.abacom-tech.com
MasterCard / VISA

CONTROL MEASURE INPUT

RELAYS • LIGHTS • MOTORS
TEMPERATURE • PRESSURE • LIGHT LEVELS • HUMIDITY
SWITCH POSITIONS • THERMOSTATS • LIQUID LEVELS

MODEL 30 \$79



- PLUGS INTO PC BUS
- 24 LINES DIGITAL I/O
- 8 CHANNEL
- 8 BIT A/D/ D/A
- 12 BIT COUNTER
- UP TO 14K SMP/SEC

MODEL 45 \$189



- RS-232 INTERFACE
- 8 DIGITAL I/O
- 8 ANALOG INPUTS
- 2 ANALOG OUTPUTS
- 2 COUNTERS-24 BIT

MODEL 100 \$279



- 12 BIT 100 KHZ A/D
- 4 ANALOG OUTPUTS
- 3 TIMER COUNTERS
- 24 DIGITAL I/O

MODEL 150-02 \$179



- RS-232 INTERFACE
- TRMS, 20 AMPS
- 12 BIT A/D
- OPTO-ISOLATED
- COMPLETE DMM

MODEL 40 \$109



- RS-232 INTERFACE
- 28 LINES DIGITAL I/O
- 8 ANALOG INPUTS
- PWM OUTPUT

MODEL 70 \$239



- RS-232 INTERFACE
- 18 BIT A/D
- 8.5 DIGIT
- UP TO 60 SMP/SEC

Prairie Digital, Inc.

PHONE 608-643-8599 • FAX 608-643-6754

620 SEVENTEENTH STREET • PRAIRIE DU SAC, WISCONSIN 53593

CIRCLE 219 ON FREE INFORMATION CARD

NEW! CREDIT CARD COMPUTER II

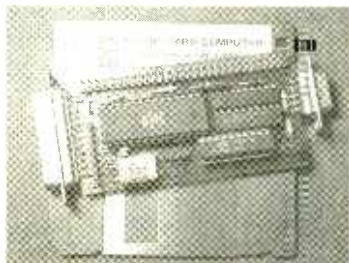

MVS PLUG-N-GO™ no cables/power supply to buy!
 Low-power RISC cpu 10x faster than PIC. Z80. 8051
 4m FLASH,ser,par,RTCC,4ch 12bit ADC,ISA104 bus
 Built-in BASIC/Assembly, other compilers available
 Friendly instructions, RS232 download (DOS/WIN)
 Eval kit (1) \$75, oem (1k) \$21, CC computer I \$14.20

640x480 VGA LCD \$27

Controller for most single/dual scan LCDs
 Works with lo-res (160x120, 320x240, etc.)
 Use with PC or SBC, standard VGA BIOS
 Source code demo shows VGA initialization
 Adaptable for other CPUs (i.e. Z80, HC11)
 oem(1k) \$27 evalkit(1) \$95 w/10"LCD \$195



LO COST MINI-PC

Includes DOS,NV mem,ADC,RAM,clock,ISA bus
 Ports for serial, parallel, LCD, keyboard
 Program in Turbo C, BASIC, MASM, etc.
 Complete, no costly development kits required
 Lowest power lowest cost PC compatible available
 XT: oem \$27 eval \$95 AT: oem \$55 eval \$195

PC WATCHDOG CARD

No More Hangups!

Reboots PC on hardware/software hang
 3 versions: RESET, TIMER, PHONE
 reset version oem \$21.30, eval kit \$75



PC SOLID STATE DISK

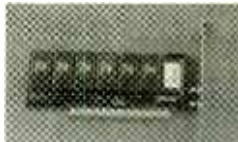

Replace mechanical drives with faster,
 more reliable, more secure solid-state.
 Use FLASH, NVRAM, UV EPROM.
 Both DIP and PCMCIA versions from
 32Kbyte (PCM1) to 1Gigabyte (PCD2)
 starting at \$14.20oem(1k) \$50.00eval(1)

STAMP DRIVE !! SINGLE CHIP COMPUTER



Read/Write PC compatible hard
 disk, PCMCIA, Compact Flash.
 RS232 to ATA adapter for Stamp.
 Z80,8051,AVR,PIC,x86. ANY cpu
 - 4 gigabyte capacity
 - low power (5ma @.5v)
 - baud 115.2k and above
 eval \$95,oem \$27,IDE ver. \$14.20

ZERO external components
 Built-in BASIC / Assembly
 RS232 program download
 1k flash,64ee,3irq,2timers
 15 i/o bits,ADC,20 pin DIP
 20mips faster than PIC/z80
 oem(1k) eval kit(1)

\$1.99 \$7.00



NEW! 8K SUPER CHIP

40x the BASIC pgm space
 32 i/o, 12 irq, 3 timers, bus
 8K flash, 512ee, 512nvram
 Watchdog w/ internal osc.
 40 pin DIP part #MV8515
 eval(1) \$25, oem(1k) \$7.10

SERIAL MINI-TERMINAL



RS232 terminal for Stamp, PC, Z80, AVR etc.

- super low current, powers from serial line
 - LED backlit LCD, visible in all conditions
 - 115.2kbps, DB9 conn, simple commands
 - specify 20 customizable or 16 tactile keys
- eval(1) \$75,oem(1k) \$21.30,w/BASIC cpu \$27

WWW.STAR.NET/PEOPLE/~MVS

MVS Box 803
 Nash.,NH 03060
 (508) 792 9507



5yr Limited Warranty
 Free Shipping
 Mon-Fri 10-6 EST

**SERVING THE EMBEDDED
 COMMUNITY SINCE 1979!**

ELECTRONIX EXPRESS

Visit Our Website At
http://www.elexp.com

WELLER SOLDERING STATION - MODEL WLC 100

- Variable power control (5 to 40 watts)
- Replaceable heating element
- Quality light-weight pencil iron

\$36⁹⁵



LOWEST PRICE 20MHZ

INSTEK[®] OSCILLOSCOPE
MODEL GOS-620
Dual Channel - 20MHZ
(INCLUDES PROBES)

\$299⁰⁰



INSTEK[®] FUNCTION GEN.
WITH INT/EXT FREQ. COUNTER

3 MHz, Digital Display
MODEL 8216 **\$199⁰⁰**



SCOPE PROBE 60 MHZ
SWITCHABLE X1, X10

\$12⁹⁵

ALLIGATOR LEADS **\$2¹⁰**
SET OF 10



DIGITAL MULTIMETER
32 Ranges - 3 1/2 Digit
MODEL MY-64 **\$27⁹⁵**
AC/DC Volt/Current, Res. Cap.,
Frequency. Rubber Holster Included



SWITCHES
Mini Toggle SPDT **50¢ ea.**



SOLDERING IRON 3-WIRE
HIGH PERFORMANCE **\$5²⁵**
#060501



PAD-234
DIGITAL/ANALOG TRAINER

Complete portable workstation. Variable and fixed power supplies, function generator, digital I/O, rugged design, high impact case.

Assembled **\$150⁰⁰** Kit **\$110⁰⁰**



HIGH QUALITY TOOLS
With Cushion Grips and Return Spring

Needle Nose Pliers \$2⁹⁵	Wire Stripper \$1⁵⁰	Diagonal Cutter \$2⁹⁵
--------------------------------------------	---------------------------------------	-----------------------------------------



DC POWER SUPPLIES

MODEL HY3003 - DIGITAL DISPLAY
Variable output, 0-30 VDC, 0-3 Amp **\$89⁰⁰**

MODEL HY3003-3 - TRIPLE OUTPUT
Two 0-30 VDC, 0-3 Amp
variable outputs plus 5V 3A
fixed. Digital Display. **\$215⁰⁰**



RSR TELECOMMUNICATIONS TRAINER
HANDS-ON TELEPHONY, LAN, CATV EXPERIENCE
WITH ONE SELF-CONTAINED UNIT

T-Comm Trainer (TCM-100) **\$199.95**
Lab Manual / Work Book **26.95**
Component and Supplies Kit **37.95**
Tool Kit **119.95**

Only \$199⁹⁵

MODEL TCM-100



SOLDERLESS BREADBOARD

830 tie points. MB102PLT model features 3 binding posts and aluminum backplate.

Part No.	1-9	10+
MB102	5.95	5.00
MB102PLT	8.95	8.00



PRESS-N-PEEL

PC Board Transfer Film

PNP Blue 5 Sheet **\$9.90**
PNP Wet 5 Sheet **9.90**
PNP Blue 20 Sheet .. **28.95**
PNP Wet 20 Sheet ... **28.95**

RESISTOR KIT
1/4 W 5% film. 5 pieces each of 73 values. 365 pieces total.

\$3⁹⁵



MOTION DETECTOR
\$2 ea. - 10 For \$15



LM555 10 Min.	22¢ ea.
LM741 10 Min.	27¢ ea.
74LS00 10 Min.	18¢ ea.
7805 Regulator 10 Min.	30¢ ea.
2N3904 10 Min.	6¢ ea.
PN2222 10 Min.	6¢ ea.
Red LED T 1 1/4 10 Min.	6¢ ea.
Green LED T 1 1/4 10 Min.	7¢ ea.
Yellow LED T 1 1/4 10 Min.	8¢ ea.
Photo Cell 10 Min.	65¢ ea.
100K Pot, 1" Shaft PC Mt. 10 Min.	15¢ ea.

FREE CATALOG

MORE Low-Priced Items In Our FREE 256-Page Catalog



TERMS: Min. \$20 + \$4.95 Ship. School Purchase Orders, VISA/MC, Money Order, Prepaid. NO PERSONAL CHECKS, NO COD. NJ Residents Add 6% Sales Tax.

In NJ: 732-381-8020 365 Blair Road • Avenel, NJ 07001-2293 http://www.elexp.com
FAX: 732-381-1006 **800-972-2225** email: electron@elexp.com

CIRCLE 206 ON FREE INFORMATION CARD

Microprocessor Hands-On Training

The PRIMER Trainer is a flexible instructional tool featured in a Prentice Hall textbook and used by colleges and universities around the world. Ruggedly designed to resist wear, the PRIMER supports several different programming Languages including Assembler, Machine Language, C, BASIC, and FORTH. A comprehensive Instruction Manual contains over 25 lessons with several examples of program design and hardware control. The Applications Manual provides theory and sample code for a number of hands-on lab projects.

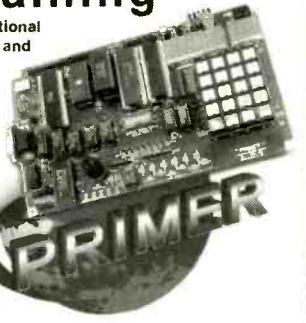

Application Projects Include:

- Scan Keypad Input & Write to a Display
- Detect Light Levels with a Photocell
- Control Motor Speed using Back EMF
- Design a Waveform Generator
- Measure Temperature
- Program EPROMs
- Bus Interface an 8255 PPI
- Construct a Capacitance Meter
- Interface and Control Stepper Motors
- Design a DTMF Autodialer / Remote Controller

The PRIMER can be purchased as an unassembled kit (\$120) or as an assembled/tested kit (\$170). Upgrades provide battery-backed RAM and PC connectivity via an RS232 serial port (shown in picture). Additional options include a heavy-duty keypad (shown in picture) and a 9V power supply - see our website. Quantity discounts are available. Satisfaction guaranteed.

Since 1985
OVER
16
YEARS OF
SINGLE BOARD
SOLUTIONS

EMAC, inc.
Phone 618-529-4525 Fax 618-457-0110
2390 EMAC Way, Carbondale, Illinois 62901
World Wide Web: <http://www.emacinc.com>

The Pocket Programmer



The Best just got Better!!!

The Best portable programmer that uses the printer port instead of an internal card just got Better!! Now with easier to use Windows based software that programs E(E)prom, Flash & Dallas parts. 25/27/28 & 29 series from 16K to 8Mbit. Adapters available for MCU's 874X, 875X, Pic, Atmel, PLCC packages, Bi-Prom's, 40-Pin X16 Eproms, Rom Emulator to 32K X 8 (2716-27256) and More...

Only \$149.95

Same Name, Address & Phone # for 19 Years.... Isn't it Amazing ?

Intronics, Inc.
Box 13723 / 612 Newton St.
Edwardsville, KS 66113
Tel. (913) 422-2094 Add \$7.00 COD
Fax (913) 441-1623 Add \$6.00 Shipping

WWW.IN-KS.COM Visa/MC/Amex/Disc

BREAST CANCER BEGINS EVEN SMALLER THAN THIS. THAT'S WHY YOU NEED A YEARLY MAMMOGRAM, ESPECIALLY AS YOU GET OLDER. MAMMOGRAMS CAN DETECT LUMPS TOO SMALL FOR YOU TO FEEL AND EARLY DETECTION MAY SAVE YOUR LIFE, SO CALL 1-800-ACS 2345.

GET A MAMMOGRAM. EARLY DETECTION IS THE BEST PROTECTION.



PARTS EXPRESS

ELECTRONICS & MORE
www.partsexpress.com



120 Watt Subwoofer Amplifier

Rated power output: 120 watts RMS into 4 ohms at 1% THD. Measured power output: 110 watts RMS into 8 ohms @ 0.1% THD. 156 watts RMS into 4 ohms @ 0.2% THD. Bass boost: 5dB @ 35Hz. Signal to noise ratio: 98dB (A-weighted). Dimensions: 8-1/4" W x 10-5/8" H x 4" D. Enclosure cut out: 7-1/4" W x 9-5/8" H. Voltage: Selectable, 115/230V, 50-60Hz, 335W.

#300-792 **\$99⁹⁵** EACH

Sound Deadening Sheets

This multi-purpose, noise reduction material actually absorbs the vibration of any solid material. You can reduce interior noise levels 3-10 dB by applying the damping sheets to the door panels, firewall, floor pan, trunk lid or any interior sheet metal panel.



Part #	Sheet Dimensions	Price (1-3)	Price (4-UP)
268-010	10" x 10"	\$1.35	\$1.25
268-015	29" x 32"	11.50	9.95
268-020	32" x 54"	17.90	16.50

Woofers

6-1/2" Woofer

◆Power handling: 50 watts RMS/75 watts max ◆Frequency response: 60-3,000 Hz ◆SPL: 86 dB 1W/1m

#290-300 (4 ohm) **\$11⁷⁰** EACH

8" Woofer

◆Power handling: 50 watts RMS/75 watts max ◆Frequency response: 60-2,500 Hz ◆SPL: 87.4 dB 1W/1m

#290-310 (4 ohm) **\$12⁹⁵** EACH

10" Woofer

◆Power handling: 70 watts RMS/100 watts max ◆Frequency response: 40-2,200 Hz ◆SPL: 87.4 dB 1W/1m

#290-320 (4 ohm) **\$15⁹⁵** EACH

12" Woofer

◆Power handling: 70 watts RMS/100 watts max ◆Frequency response: 35-1,500 Hz ◆SPL: 86.6 dB 1W/1m

#290-330 (4 ohm) **\$18⁹⁵** EACH

15" Woofer

◆Power handling: 80 watts RMS/115 watts max ◆Frequency response: 27-1,200 Hz ◆SPL: 86 dB 1W/1m

#290-340 (4 ohm) **\$27⁹⁵** EACH

YOUR #1 SOURCE FOR AUDIO, VIDEO AND SPEAKER BUILDING COMPONENTS

Piezo Tweeters

AS LOW AS **95¢** EACH

3-1/4" Piezo Tweeter

◆ Similar to KSN1005
◆ Power handling: 50 watts RMS/75 watts max
◆ Frequency response: 3,500-27,000 Hz ◆ SPL: 94 dB

#270-011 **\$1.25** (1-3) **95¢** (4-UP)

2" x 5" Piezo Horn

◆ Similar to KSN1016
◆ Power handling: 50 watts RMS/75 watts max
◆ Frequency response: 3,500-27,000 Hz ◆ SPL: 94 dB

#270-041 **\$1.25** (1-3) **95¢** (4-UP)

Piezo Horn Mid/Tweeter

◆ Similar to KSN1025
◆ Power handling: 60 watts RMS/75 watts max
◆ Frequency response: 1,800-30,000 Hz ◆ SPL: 90 dB

#280-062 **\$1.60** (1-3) **\$1.35** (4-UP)

JBL 12 Watt Stereo Amp Board

Dimensions: 4-1/2" L x 3-1/4" W x 2-1/8" H. Comes with hook-up diagram. Limited availability.

#329-030 **\$9⁹⁵** EACH

6-1/2" Two-Way System

Great for front or rear speakers in your surround system. The 6-1/2" poly-propylene woofer and 1" textile dome tweeter were specially designed with home theatre in mind.



#300-036 **\$59⁹⁵** PAIR

Speaker Surround Repair Kits

Don't throw away expensive loudspeakers just because the foam surround has dry rotted or has been punctured. With these new repair kits from Parts Express, you can save BIG bucks by repairing the foam surround and avoid costly loudspeaker replacements. Each kit contains supplies to repair two speakers and includes foam surrounds, plastic shims, four dust caps (two paper, two poly), a plastic bottle filled with 1 oz. of adhesive, 5 foam swabs for application of glue, and complete repair instructions.

Part #	Size	Price (1-3)	Price (4-UP)
260-915	6-1/2" kit	\$19.50	\$17.90
260-920	8" kit	21.90	18.95
260-925	10" kit	22.50	19.50
260-930	12" kit	23.90	20.90
260-935	15" kit	24.50	21.90
340-076	1 oz. bottle of speaker glue	5.95	5.25

LARGEST SELECTION OF SPEAKER DRIVERS IN THE COUNTRY!

Visit Us On The Web At **www.partsexpress.com**
Or Call Toll Free **1-800-338-0531**

725 Pleasant Valley Dr., Springboro, OH 45066-1*58 KEY CODE: POM
Phone: 513-743-3000 ◆ FAX: 513-743-1677 ◆ E-Mail: sales@partsexpress.com

FREE 308 PAGE CATALOG



Car Amplifier Power Stiffening Capacitors

Capacitors can be wired in parallel to increase value. One year manufacturer warranty.

Specifications: ◆ 20 VDC/24 VDC surge ◆ ESR: < .0015 ohms
◆ Tolerance: -10/+50%
◆ Temperature range: -40°C to 95°C



Part #	Value	Dimensions (Dia. x Height)	Price
STANDARD POWER CAPACITORS			
268-450	1.0 Farad	3" x 8-5/8"	\$69.95
268-455	1.5 Farad	3-1/2" x 8-5/8"	99.90
268-460	2.0 Farad	3-1/2" x 8-5/8"	138.90
DIGITAL DISPLAY POWER CAPACITORS			
268-470	1.0 Farad	3" x 10-1/4"	99.90
268-475	1.5 Farad	3-1/2" x 10-1/4"	138.90
268-480	2.0 Farad	3-1/2" x 10-1/4"	174.90

4" LCD Video Module

Customize your mobile sound system by adding video!



- ◆ High resolution
- ◆ 4" LCD flat screen color display module
- ◆ Works on a standard composite video signal
- ◆ Ideal for mounting in seat backs or custom built enclosures

Specifications: ◆ 12 VDC, 500mA ◆ Resolution (dots): 383 (Hor.) x 234 (Vert.) = 89,622 ◆ Overall dimensions (mm): 118 W x 85 H x 40 D ◆ Active area (mm): 82 W x 60 H ◆ Controls for brightness, color and tint
◆ Net weight: 3/4 lb.

#205-050 **\$99⁹⁰** EACH

DETAILED EASY TO FOLLOW INSTRUCTIONS!



Note: The speaker surround kit sizes are based on the diameter of the speaker's frame, not the diameter of the cone. For example, if your speaker frame measures 10"-10-1/2" in diameter, you would need the 10" Surround Repair Kit.

World's Smallest 68HC11 Microcontroller Modules!

MicroStamp11™

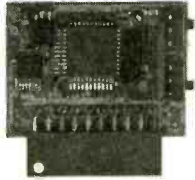

- telemetry
- microrobotics
- smart toys
- animatronics
- model railroading
- home automation

- tiny, light-weight (0.5 oz.)
- 1-inch x 1.4-inch 68HC11 module
- on-board 5V regulator
- 8MHz crystal (9.83MHz on Turbo version)
- choice of 8K or 32K EEPROM
- 32K RAM + 32K EEPROM on 64K version
- plugs into your breadboard like a DIP
- SCI (UART), SPI, Output Compares, Input Captures, hardware timer, pulse accumulator
- all 14 I/O lines and 2 interrupts brought out to versatile 20-pin connector
- program in BASIC, assembler, or C
- easy code-loading with Docking Module
- Starter Packages: *
 - 8K EEPROM (#MS11SP8K).....\$49
 - 32K EEPROM (#MS11SP32K).....\$77
 - 32K EE+32K RAM (#MS11SP64K)...\$90

* includes MicroStamp11, manual, PC software (free-ware assembler, SBASIC compiler, MicroLoad utility, and sample programs), serial cable, Docking Module, and accessories.

Attention OEMs:
Embed MicroStamp11 modules into your product only \$20 each (100-pc. price, 8K version)

MicroCore-11™

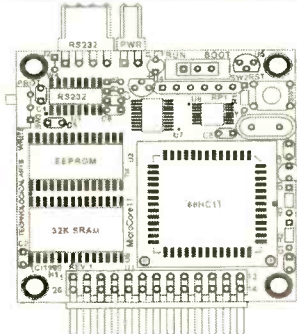

- tiny 2-inch x 2-inch 68HC11 module
- 12 inputs/outputs plus 8 analog inputs
- RS232, 5V regulator, 8MHz crystal
- 32K SRAM plus 8K or 32K EEPROM
- plugs into your breadboard like a DIP
- easy programming from any PC
- ideal for building MicroMouse robots
- now available in Turbo version (9.83MHz)
- 8K Starter Package #MC11SP8K.....\$68
- 32K Starter Package #MC11SP32K.....\$93
- Motor driver boards, LCD/keypad/keyboard interface & prototyping cards available

Technological Arts

Many other modules & accessories available.
Visit our website at:

www.technologicalarts.com
sales@technologicalarts.com
TOLL-FREE: 1-877-963-8996
Phone: (416) 963-8996
Fax: (416) 963-9179
Visa • MasterCard • Discover • Amex

ALL ELECTRONICS

C O R P O R A T I O N

SHOP OUR ONLINE STORE
www.allelectronics.com

24 Vdc, 80 mm Fan

Panaflo® DC Brushless
Model FBA08A24M
3.15" square x 1."
24 Vdc @ 0.1 Amp.
(14-27.6 Vdc) 32 CFM.
7 blade impeller.
11" pigtail leads. UL, CSA.



CAT # CF-118

\$3.00 each 10 for \$2.75
case of 100 for \$2.00 each

Motorized 10K Slide Pot

Panasonic # EVANMKP08B14
10K linear taper power fader.
100mm travel. 5 Vdc driving
motor. Operates on
2 Vdc to 5 Vdc.
0.2 seconds
travel time
at 5 Vdc.

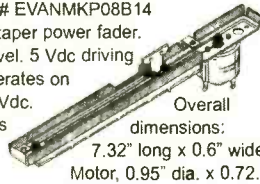

Overall
dimensions:
7.32" long x 0.6" wide.
Motor, 0.95" dia. x 0.72."

Threaded mounting holes on 5.27" centers.

CAT # MSP-10K

\$7.00 each 10 for \$6.75 each
100 for \$6.00 each

25 RPM Gearhead Motor with Brake

Globe Motors
409A582
Precision gear-
head motor
equipped with an
electric brake and
a tach or positioning sensor. Brake must be
energized to allow motor to rotate. Brake
can be easily disconnected if not required.
Motor rated at 12 Vdc, brake at 24 Vdc. No
load rating: 25 RPM @ 12 Vdc @ 130 mA.
Overall size, excluding shaft, 5.15" long x
1.52" dia. 0.25" dia. x 0.9" long shaft with a
press-fit gear. Threaded mounting holes on
gearhead face.

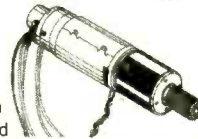

CAT# DCM-177 **\$20.95** each

ORDER TOLL FREE
1-800-826-5432

CHARGE ORDERS to Visa, Mastercard,
American Express or Discover

TERMS: NO MINIMUM ORDER. Shipping and handling for the
48 continental U.S.A. \$6.00 per order. All others including AK,
HI, PR or Canada must pay full shipping. All orders delivered
in CALIFORNIA must include local state sales tax. Quantities
Limited. NO C.O.D. Prices subject
to change without notice.

CALL, WRITE
FAX or E-MAIL
for our **FREE**
96 Page
CATALOG
Outside the U.S.A.
send \$3.00 postage.

MAIL ORDERS TO:
**ALL ELECTRONICS
CORPORATION**
P.O. Box 567
Van Nuys, CA 91408
FAX (818)781-2653

e-mail allcorp@allcorp.com

CLASSIFIEDS

BEST BY MAIL

Rates: Write National, Box 5, Sarasota, FL 34230

TEE SHIRTS! www.affirmations.com or request information on Affirmation T's from: FC&D Enterprises, PO Box 24572, Denver, CO 80224-0572

Work at home, earn \$500.00 to \$1,000.00. I did, Leslie May! Send \$5.00, no more, and self address stamp envelope to: Leslie May, P.O. Box 701, Columbia, KY 42728

BUSINESS OPPORTUNITIES

\$400 WEEKLY ASSEMBLING Electronic Circuit Boards/Products From Home. For Free Information Send SASE: Home Assembly-PT Box 216 New Britain, CT 06050-0216

EASY WORK! EXCELLENT PAY! Assemble Products At Home. Call Toll Free 1-800-467-5566 EXT. 1190.

CABLE TV

CABLE TV Descramblers. One-piece units. Scientific Atlanta, Jerrold, Pioneer, and others. Lowest Prices Around. **Precision Electronics** Houston, TX Anytime. 1-888-691-4610

DESCRAMBLERMANIA! SAVE 80% ALL UNIVERSAL CABLE DESCRAMBLER CONVERTER MODELS! INDIVIDUAL AND BULK SALES! 1-800-246-0434 www.cableboxcentral.com

TESTCHIPS, masterfiles, all makes/models, lowest prices around! Dealers, Wholesale, Retail, testchips_1@yahoo.com, <http://www.angelfire.com/movies/testchips/index.htm> 1-888-322-3886

MISC. ELECTRONICS FOR SALE

T&M ELECTRONICS. Large variety of electronic parts since 1966. Visit our Web site at www.tandmelectronics.com

PLANS-KITS-SCHEMATICS

Carl's Electronics - Hundreds of electronic kits, plus the latest in spy and surveillance. www.electronickits.com

SATELLITE EQUIPMENT

FREE Satellite TV Buyer's Guide. Best Products - Lowest Prices - Fastest Service! Dish Network, DirectTV, C/Ku-band, including 4DTV. Parts- Upgrades - Accessories! **SKYVISION** - 800-543-3025. International 218-739-5231. www.skyvision.com

AIR FORCE RESERVE

ABOVE & BEYOND

Visit our web site at
www.afreserve.com

Gernsback Publications, Inc.

275-G Marcus Blvd. Hauppauge NY 11788

POPTRONICS®

CLASSIFIED ADVERTISING ORDER FORM

Advertiser Information

Name _____
 Company _____
 Street Address _____
 City/State/Zip _____
 Telephone () _____
 Signature (required on all orders) _____

Payment Information

Charge my:
 Master Card Visa Discover

Account No. _____
 Exp. Date _____

Full payment enclosed. Prepayment discounts offered for multiple insertions (except on credit card orders).
 Payment for first insertion enclose; additional payments will be made prior to closing dates. Prepayment discounts not available.

Do you want any special options? (where available)

- Boldface Type* Add 25% for entire ad Screened Background – Add 30%
 Special Heading – Add \$35.00

The first word of your ad and your name will be printed in boldface caps, at no additional charge. For individual boldface words, add .50¢ each.

In what month(s) would you like your ad to run?

- Entire year for publications selected above.
- Jan. Feb. Mar. Apr. May. June July Aug. Sep. Oct. Nov. Dec.

Here's how to calculate the cost of your Regular or Expanded-Ad Classified:

Rate X Numbers of Words + Rate for Boldface + Rate for Screened Background = Cost per Insertion X Number of Months = Cost

Magazine	Rate	x	Number of Words (min. 15)	+ Boldface (add 25%)	+ Screened Background (add 30%)	= Cost Per Insertion	x	Number of Months	= Cost
		x		+	+	=	x	=	

Rates:

\$3.50 per word

Minimum 15 Words

Here's how to calculate the total cost of your advertising:

Prepayment Discount:

(Full payment must accompany order, not applicable on credit card orders)

Prepay for 6 insertions in one magazine, 5% 12 insertions in one magazine, 10%

Subtotal	
Less Prepayment Discount	
TOTAL COST \$	

Please use a separate piece of paper to write your copy, or for any special instructions you may have.

HAVE A QUESTION? CALL: 1-631-592-6720 ext. 206

Fax signed orders with credit card information to : (631) 592-6723

GPI895

ADVERTISING INDEX

Poptronics does not assume any responsibility for errors that may appear in the index below.

Free Information Number	Page	Free Information Number	Page
- Abacom84	- Lone Star Consulting, Inc.72
- All Electronics88	- Lynxmotion81
- Amazon Electronics80	- M ² L Electronics74
- Andromeda Research67	324 MCM Electronic	CV2
- Antique Electric Supply66	323 Mendelsons81
- Arrow Technologies74	296 Merrimack Valley Systems85
319 Beige Bag Software69	- microEngineering Labs73
- Black Feather Electronics73	- Modern Electronics80
290 C&S Sales, Inc.70	- Mondo-tronics66
- Carl Taylor Inc.72	205 Mouser Electronics74
233 Circuit Specialists83	- MyLydia72
- CLAGGK, Inc.	CV3, 10	- Ohio Automation72
320 Cleveland Inst. of Electronics75	- Ontrak Control Systems74
321 Command Productions67	- PAIA Electronics73
- Conitec Data Systems66	275 Parts Express87
- Consumertronics73	- Pioneer Hill Software66
- C-Tech Industries74	228 Polaris Industries65
- Designtech Engineering Co.81	219 Prairie Digital84
- EDE Spy Outlet72	- Progressive Concepts74
210 Electronic Design Specialists84	- RC Distributing Co.73
- Elect. Tech. Today24, 50	263 Ramsey Electronics76
130 Electronic Workbench	CV4	256 RobotiKits Direct78
- Electronix66	- Scott Edwards Electronics67
206 Electronix Express86	- Scrambling News72
- EMAC Inc.86	- Smarthome.com67
- Engineering Express82	- Square 1 Electronics73, 82
- Global Specialties69	- Technological Arts88
- Globaltech Distributors72	322 Test Equipment Depot78
220 Information Unlimited77	325 Timeline, Inc.77
- Intec Automation73	217 Tie Pie Engineering80
- Intelligence Here72	- UCANDO Videos81
- Intronics86	- Vision Electronics74
- IVEX Design79	- Walter Malecki73
- LT Sound66	- World Wyde68, 72, 73, 82, 83, 87

ADVERTISING SALES OFFICES

Gernsback Publications, Inc.
275-G Marcus Blvd.
Hauppauge, NY 11788
Tel. 631-592-6720
Fax: 631-592-6723

Larry Steckler
 Publisher (ext. 201)
 e-mail: advertising@gernsback.com

Adria Coren
 Vice-President (ext. 208)

Ken Coren
 Vice-President (ext. 267)

Marie Falcon
 Advertising Director (ext. 206)

Adria Coren
 Credit Manager (ext. 208)

For Advertising ONLY EAST/SOUTHEAST

Marie Falcon
 275-G Marcus Blvd.
 Hauppauge, NY 11788
 Tel. 631-592-6720 x206
 Fax: 631-592-6723
 e-mail: mfalcon@gernsback.com

MIDWEST/Texas/Arkansas/ Oklahoma

Ralph Bergen
 One Northfield Plaza, Suite 300
 Northfield, IL 60093-1214
 Tel. 847-559-0555
 Fax: 847-559-0562
 e-mail: bergenrj@aol.com

PACIFIC COAST

Megan Mitchell
 9072 Lawton Pine Avenue
 Las Vegas, NV 89129-7044
 Tel. 702-240-0184
 Fax: 702-838-6924
 e-mail: mmitchell@gernsback.com

**Subscription/
 Customer Service/
 Order Entry**
 Tel. 800-827-0383
 7:30 AM - 8:30 PM CST

www.poptronics.com

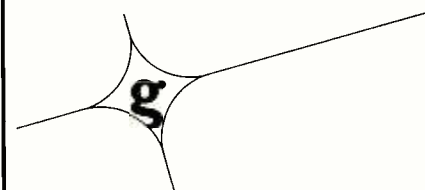

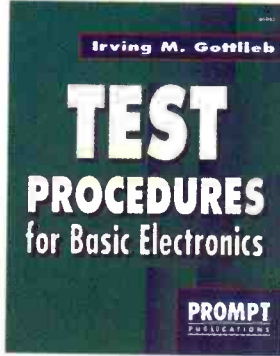

Test Procedures for Basic Electronics. #61063. -- \$19.95
 Many useful tests and measurements are covered. They are reinforced by the appropriate basic principles. Examples of test and measurement setups are given to make concepts more practical. 7 3/8 x 9 1/4", 356 pp, paperback.

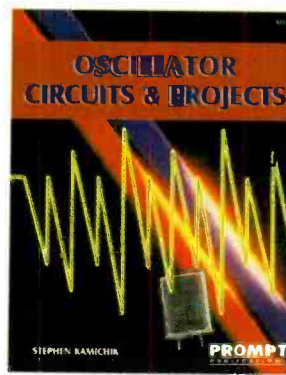

Oscillator Circuits and Projects. #61111. -- \$24.95
 A Textbook and project book for those who want to know more about oscillator circuits. You can build and enjoy the informative and entertaining projects detailed in this book. Complete information is presented in an easy-to-follow manner. 7 3/8 x 9 1/4", 249 pp, paperback.

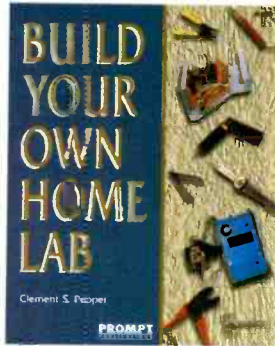

Build Your Own Home Lab. #61108 -- \$29.95
 Shows you how to assemble an efficient working home lab, and how to make it pay its own way. Includes projects for creating your own test instruments too. 7 3/8 x 9 1/4", 249 pp, paperback.

Troubleshooting and Repair Guide to TV. #61146. -- \$34.95
 Repairing and troubleshooting a TV is very simple and economical with help from the information in this book. It is the most complete and up-to-date TV repair book available, with tips on how to handle the newest circuits. 8 1/2 x 11", 263 pp, paperback.

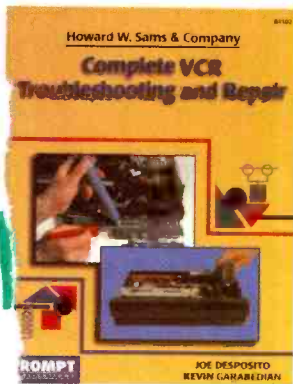
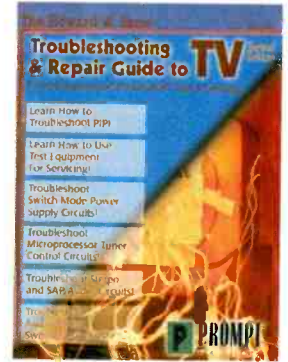

Complete VCR Troubleshooting and Repair. #61102. -- \$34.95
 Though VCRs are complex, you don't need complex tools or test equipment to repair them. This book contains sound troubleshooting procedures that guide you through every task. 8 1/2 x 11", 184 pp, paperback.



Computer Monitor Troubleshooting and Repair. #61100. -- \$34.95
 This book can save you the money and hassle of computer monitor repair by showing you how to fix it yourself. Tools, test instruments, how to find and solve problems are all detailed. 8 1/2 x 11", 308 pp, paperback.

Wholesale & Discount Buyer's Guide #WD-1. -- \$19.95
 up to 90% off list prices. Audio and equipment and materials; electronic ucts and surplus; pro recording and ecially items; computers and compoents. Source listings include complete ddress, phone, fax, e-mail and website addresses. 8 1/2 x 11", 72 pp, paperback

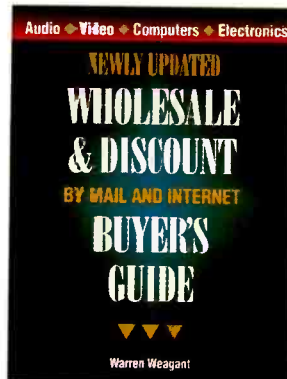

Joe Carr's Circuit Toolkit. #61181. -- \$29.95
 Easy-to-build, useful circuits from Carr's workbench to you. They will spark new ideas in your day-to-day use of circuits and help solve frustrating problems. 256 pp, paperback. Contact Jim Surface.

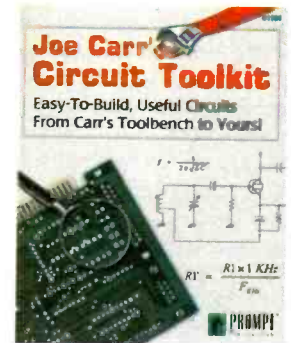

Please circle the products you would like to buy on the page above, calculate the total cost, include shipping charges, using in the form below and send it to us. Please allow 4 - 6 weeks for standard delivery.

Name: _____
 Address: _____
 Zip: _____ Telephone: _____
 I have enclosed my check for \$: _____
 Signature: _____

Please charge my credit card for \$: _____ Number: _____

Card Type: _____ Expiration Date: _____
 Mastercard, Visa or Discover only

Note: The delivery address and the address at which the credit card is registered must be the same.

Clagck Inc.
 PO Box 12162
 Hauppauge, NY 11788
 Tel: 631-592-6720
 Fax: 631-592-6723
 email: clagck@gernsback.com

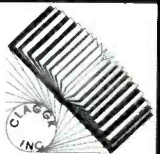

SORRY No orders accepted outside of USA & Canada No. of Books Ordered

SHIPPING CHARGES IN USA.
 CANADA ADD \$5.00
 1 Book \$ 5.00
 2 Books 8.00
 each add'l book 3.00
 2 Day UPS \$10.00 extra
 Next Day UPS \$20.00 extra

Total price of books.....\$.....
 Shipping (see chart).....\$.....
 Subtotal.....\$.....
 Sales Tax (NYS only).....\$.....
 Amount Enclosed.....\$.....
 All payments must be in U.S. funds!

The world's most popular electronics simulation software just got better! **WHY settle for second best?**

***FREE**

Virtual Lab with Poptronics Circuits

Check out the circuits from recent issues, including this month's! Tweak the circuits and see the instruments respond instantly.

Download the Multisim demo with pre-built Poptronics circuits from www.electronicworkbench.com/poptronics

BEST PRODUCT! BEST PRICE!

Electronics Workbench is recognized around the globe for developing highly advanced, yet easy-to-use electronics software. Over 150,000 users tell us that they have completed projects using Electronics Workbench in less time than it takes to even install other programs.

And now we've just released Version 6.2! If you've never tried electronics simulation, this is your chance - you can now have your very own virtual lab! Work on your own or create circuits together with others across the country - live on the internet. Start with the **FREE** Electronics Workbench/Poptronics demo and then take advantage of this best price ever when you buy. Tried other products? You owe it to yourself to experience what only the market leader can offer - there is no comparison. And if you own earlier versions of Electronics Workbench, call us now for upgrade pricing starting at just **\$149!**

Multisim Highlights

- ▶ Advanced schematic capture
- ▶ Intuitive auto & manual wiring (no toggle)
- ▶ Change circuits while simulating
- ▶ Mixed-mode SPICE analog/digital simulation
- ▶ Built-in symbol and component editor
- ▶ Parts organized into bins (no alpha lists)

Don't settle for a program that has less than:

- ▶ 6,000 parts in component database
- ▶ 9 virtual instruments & 8 powerful analyses
- ▶ Interactive design on the Internet
- ▶ OLE integration with Excel/MathCAD

Ultiboard Highlights

- ▶ Powerful & easy-to-use PCB layout & editing
 - ▶ Reroute while move (full rubberbanding)
 - ▶ Built-in autorouter
 - ▶ Real-time design rule check
 - ▶ Automatic net highlighting (selective)
 - ▶ Density histograms/placement vectors
- Don't settle for a program that has less than:**
- ▶ 3,000+ library of footprint shapes
 - ▶ Capability for boards of any shape, up to 50"x50"
 - ▶ 32 layers support
 - ▶ 1 nanometer internal resolution

multisim V6.2

Schematic Capture & Simulation

~~\$399~~ **\$299**

ultiBOARD

Powerful PCB Layout

~~\$399~~ **\$299**

or get **BOTH** products for **\$498**

Limited Time Offer
BEST price ever!

To order, or to find out why our products are the most popular in the industry, call **1-800-263-5552** or visit www.electronicworkbench.com (**FREE** demo available)



Electronics
WORKBENCH

CIRCLE 130 ON FREE INFORMATION CARD

www.americanradiohistory.com