

Poptronics®

Formerly **Popular Electronics®** and **Electronics NOW.**



RADIO SIGNALS AND THE GREAT PYRAMID

A home-grown inventor shares her theory of alternative energy production

Data Transport Through A Speedy World

Taking an introspective look at data-transport media

Sprinkler Guardian II

Stop wasting water with the help of this circuit

Experimenting With Small FM Transmitters

Learn the ropes of FM transmission with these eight circuits

Also Inside:

- Arsenic-Trappers
- Choosing A New OS
- Upgrading Your RAM
- PIC-Powered Circuits
- Metal-Detector Circuits Wrap-Up

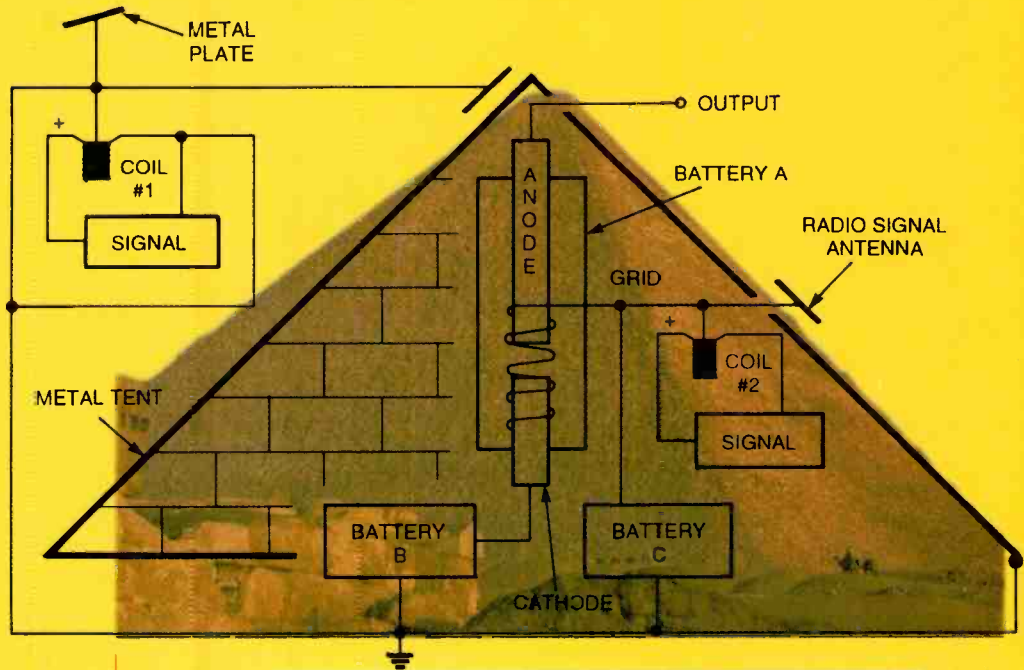

\$4.99 U.S.
\$6.50 CAN.

#BXEDCCH *****5-DIGIT 21046
 #21046DHM951RD007# FT
 ROBERT DAHM P111
 9515 RED RAIN PATH MAY 2002
 COLUMBIA MD 21046-2073

www.jameco.com

In a Jam?



The Products You Need... The Service You Deserve!™

1•800•831•4242

JAMECO®

ELECTRONICS

CIRCLE 139 ON FREE INFORMATION CARD

Poptronics®

THE MAGAZINE FOR THE HANDS-ON ELECTRONICS ACTIVIST!

FEATURES

RADIO SIGNALS AND THE GREAT PYRAMIDB.K. Bayles 25
A home-grown inventor shares her theory of alternative energy production.

DATA TRANSPORT THROUGH A SPEEDY WORLDElizabeth Jamison 34
Take an introspective look at data-transport media.

SPRINKLER GUARDIAN IIWalter W. Schopp 37
Stop wasting water with the help of this circuit.

EXPERIMENTING WITH SMALL FM TRANSMITTERSNewton C. Braga 41
Now you can get your feet wet with these eight transmitter circuits.

PRODUCT REVIEWS

GIZMO® 7
We have the scoop on CD-RW, digital security cameras, scanners, and more.

DEPARTMENTS

PEAK COMPUTINGTed Needleman 11
Measuring the effects of RAM upgrades.

PROTOTYPE 14
Using electronics to help clean-up our water supply.

ROBOTICSBrooke A. Berlin 19
Get the scoop on the growing sport of robotic gladiators.

SURVEYING THE DIGITAL DOMAINReid Goldsborough 21
Find out how to decide when and if to upgrade your operating system.

Q&ADean Huster 47
Our readers are talking about fan controllers, pull-up/pull-down resistors, and measuring resistances.

AMAZING SCIENCEJohn Iovine 51
Controlling circuits with the PIC microcontroller.

SERVICE CLINICSam Goldwasser 55
Discussing electronic flashes used in photography equipment.

BASIC CIRCUITRYCharles Rakes 61
Concluding the design of metal-detector circuits.

AND MORE

EDITORIAL 2

YESTERDAY'S NEWS 3

LETTERS 4

NEW GEAR 23

NEW LITERATURE 59

FREE INFORMATION CARD 64A

POPTRONICS SHOPPER 65

ADVERTISING INDEX 88

Poptronics (ISSN 1526-3681) Published monthly by Gernsback Publications, Inc. 275-G Marcus Blvd., Hauppauge, NY 11788. Second-Class postage paid at Hauppauge, NY and at additional mailing offices. One-year, twelve issues, subscription rate U.S. and possessions \$24.99, Canada \$33.15 (includes G.S.T. Canadian Goods and Services Tax Registration No. R125166280), all other countries \$33.99. Subscription orders payable in U.S. funds only, International Postal Money Order or check drawn on a U.S. bank. U.S. single copy price \$4.99. Copyright 2001 by Gernsback Publications, Inc. All rights reserved. Hands-on Electronics and Gizmo trademarks are registered in U.S. and Canada by Gernsback Publications, Inc. Poptronics trademark is registered in U.S. and Canada by Poptronix, Inc. and is licensed to Gernsback Publications, Inc. Printed in U.S.A. Postmaster: Please send address changes to Poptronics, Subscription Dept., P.O. Box 459, Mount Morris, IL 61054-7629

A stamped self-addressed envelope must accompany all submitted manuscripts and/or artwork or photographs if their return is desired should they be rejected. We disclaim any responsibility for the loss or damage of manuscripts and/or artwork or photographs while in our possession or otherwise.

As a service to readers, Poptronics publishes available plans or information relating to newsworthy products, techniques, and scientific and technological developments. Because of possible variances in the quality and condition of materials and workmanship used by readers, Poptronics disclaims any responsibility for the safe and proper functioning of reader-built projects based upon or from plans or information published in this magazine.

Larry Steckler, EHF, CET,
editor-in-chief and publisher

EDITORIAL DEPARTMENT

Chris La Morte, managing editor
Evelyn Rose, assistant editor
Brooke A. Berlin, editorial assistant

CONTRIBUTING EDITORS

Dean Huster
Reid Goldsborough
Sam Goldwasser
John Iovine
Ted Needleman
Charles D. Rakes
Teri Scaduto

PRODUCTION DEPARTMENT

Ken Coren, production director
Kathy Campbell, production manager
Michele L. Musé, prepress specialist

ART DEPARTMENT

Russell C. Truelson, art director
Michele L. Musé, graphic artist

CIRCULATION DEPARTMENT

Gina Giuliano, circulation manager

REPRINT DEPARTMENT

Maria Menichetti, Reprint Bookstore x235

BUSINESS AND EDITORIAL OFFICES

Gernsback Publications, Inc.
275-G Marcus Blvd.
Hauppauge, NY 11788
631-592-6720
Fax: 631-592-6723

President: Larry Steckler
Vice-President: Adria Coren
Vice-President: Ken Coren

SUBSCRIPTION CUSTOMER SERVICE/ ORDER ENTRY

800-827-0383
7:30 AM - 8:30 PM EST

Advertising Sales Offices
listed on page 88

Cover by
Michele Lyn Musé

VISIT US ON THE INTERNET AT:
www.gernsback.com
or www.poptronics.com

Since some of the equipment and circuitry described in POPTRONICS may relate to or be covered by U.S. patents, POPTRONICS disclaims any liability for the infringement of such patents by the making, using, or selling of such equipment or circuitry, and suggests that anyone interested in such projects consult a patent attorney.

<mailto:popeditor@gernsback.com>

If You're Reading This, Then You're Special

It warms my heart to see you standing there reading our magazine. Mainstream computer magazines are devouring the marketplace, it seems. Well, if **Poptronics** must prevail as the leading electronic-hobbyist magazine, then so be it. To spoil a few rumors that are circulating in remote parts of Canada, let me state that this magazine is still alive and well—receiving hundreds of prototypes and manuscripts each and every month. Where else would people run for their fix of circuits, theory, and technology trends? I will let you in on a secret, though. Lean in close, now... Things are starting to change around here. Our publishing house is almost 100 years old. In order to adapt and overcome, our publication must grow. So, for those members of the "I hate change!" Bastion, please reconsider. There are too many exciting developments in electronics to simply stay stagnant. **Poptronics** will continue to bring new and informative views, projects, and technology to its readers.

On that note, let's plow onward to September 2001. The world is facing a shortage of natural resources, and this can be felt in the skyrocketing fuel and energy prices around the globe. B.K. Bayles—inventor and visionary—has a theory offering an alternative source of energy in her article, *Radio Signals And The Great Pyramid*. Carrying on in the tradition of home-grown inventors such as Ford and Edison, Bayles shares her findings from her experiments involving stone and electricity. Elizabeth Jamison offers up *Data Transport Through A Speedy World*—a close look at the various transport media available to the consumer. Jamison will be joining the ranks of our contributing editorial staff. A reprint of a practical circuit for water conservation, Walter W. Schopp's *Sprinkler Guardian II* is a hands-on project just waiting for the skilled hands of our readers. Of course, we have our usual assortment of in-depth columns covering circuits, consumer electronics, publication reviews, computers, and much more. Enjoy this issue and keep up the feedback.

Happy reading,



Chris La Morte
Managing Editor



YESTERDAY'S NEWS

A PEEK INTO THE GERNSBACK ARCHIVES



Dateline: September 1951 (50 years ago)

Radio-Electronics ran a cover story on the adventures of being a radio-operator on board a merchant marine vessel. While navigating the deep seas, these technicians monitored distress calls with high-frequency transmitters, earning up to \$460 a month. Other articles highlighted the latest in television technology, the uses of magnetic amplifiers, and how to build a compact and portable radio receiver. *(Hugo Gernsback often looked into the lives of uniformed technicians in both the civilian and military arenas.)*

1900

1910

1930

1940

1951

1960

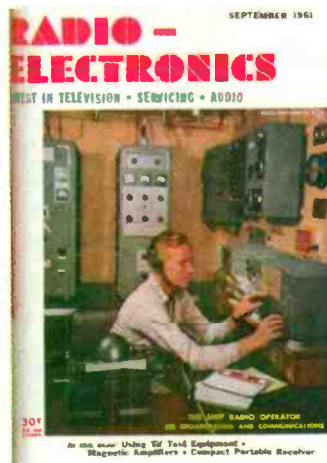

Dateline: September 1971 (20 years ago)

Radio-Electronics explored the digital domain by explaining how Nixies tubes (gas-filled readout-displays) worked. These relatively uncomplicated cold-cathode glow tubes displayed numbers, letters, and symbols. Other feature articles listed six television antenna accessories for better pictures, two resistor types essential for operating and controlling electronic gear, and a fast fix for FM and AM radios—sweep-alignment troubleshooting. *(Nixies tubes are precious little treasures for vacuum-tube collectors. Today, a tube-based project revival is emerging.)*

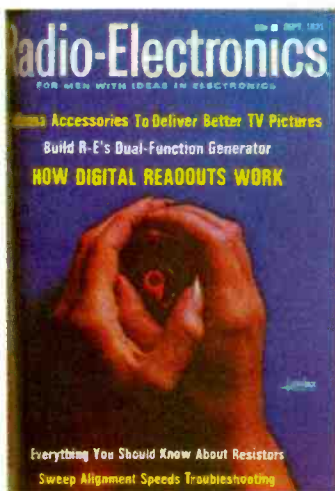

1971

1980

Dateline: September 1991 (10 years ago)

Bringing new life to the almost 100-year-old vacuum-tube Tesla coil, **Radio-Electronics** showed its readers how to construct a solid-state Tesla coil producing sparks as long as 8 inches and an output of 100,000 volts. Also in this issue were step-by-step instructions on how to build a micro-analyzer for easy microwave oven repair, a PC-based spectrum analyzer, and a telephone line-in-use monitor. *(Tesla once wrote a six-part series exclusively for Hugo Gernsback's **Electrical Experimenter** in the early part of the last century. Hugo, an avid fan of invention and science, developed a fond relationship with the brilliant Nikola.)*

1991

2000



Misaddressed

It has come to our attention that there was a misprint in the Web address for Cambridge Electronics in the "New Gear" column in the July issue. The correct address is www.camblab.com. We regret any inconvenience this error may have caused.—Editor

Schematic Correction

I am writing this letter as a long-time reader of **Popular Electronics** and **Electronics Now**. I have enjoyed reading both these magazines, and I am glad that **Poptronics** is continuing the tradition. This letter is to correct the schematic for the unit in the "In-Circuit Capacitor Tester" article in the July issue. The schematic shows R11 connected to R13 and the intersection of R9 and R10, as well as the input diodes. Instead, it should only be connected to the collector of Q2. Also R10 and R12 are valued at 22K, and R18 is valued at 47K. These values should be ohms not k ohms.

P.S. It would be nice to see a design article on a USB device.

GLENN BRAY
via e-mail

Ab yes...I see. Thank you, Mr. Bray and the numerous others who discovered the mistakes in the "In-Circuit Capacitor Tester" article. The author, Marvin Smith, had called us (prior to the rush of mail) in order to bring the errors to light and provide the corrections. Fans of Thevenin's Theory must have had a field day with this one. Submitted for your pleasure is the corrected schematic (see Fig. 1). Sorry for any inconvenience, folks. As for the USB article—we will see what we can do to fill your order, sir.—Editor

same time. Thank you for your help on this project.

JASON ROGERS
Paducah, KY

B.E.A.M. Robotics

I am an avid electronics enthusiast in high school and have enjoyed **Poptronics** for years. Keep up the good work.

I wanted to suggest an article on a fascinating field of robotics that many of your readers would enjoy. It's called B.E.A.M. robotics—an acronym standing for **B**iology, **E**lectronics, **A**esthetics, and **M**echanics. These four factors are the fundamental inspirations for the style of robots created by B.E.A.M. enthusiasts. Implementing these principles, one can turn a robotic machine into a truly "living" creature, part of the physiological domain.

One main rule in the annual B.E.A.M. Robot Games includes "devices must move, eat, and survive by themselves," accomplished primarily

How To Build A Logic Clip

I was wondering if you could do an article on building a logic clip. I was hoping to be able to run it off a rechargeable battery, plug it in, and automatically recharge the battery at the

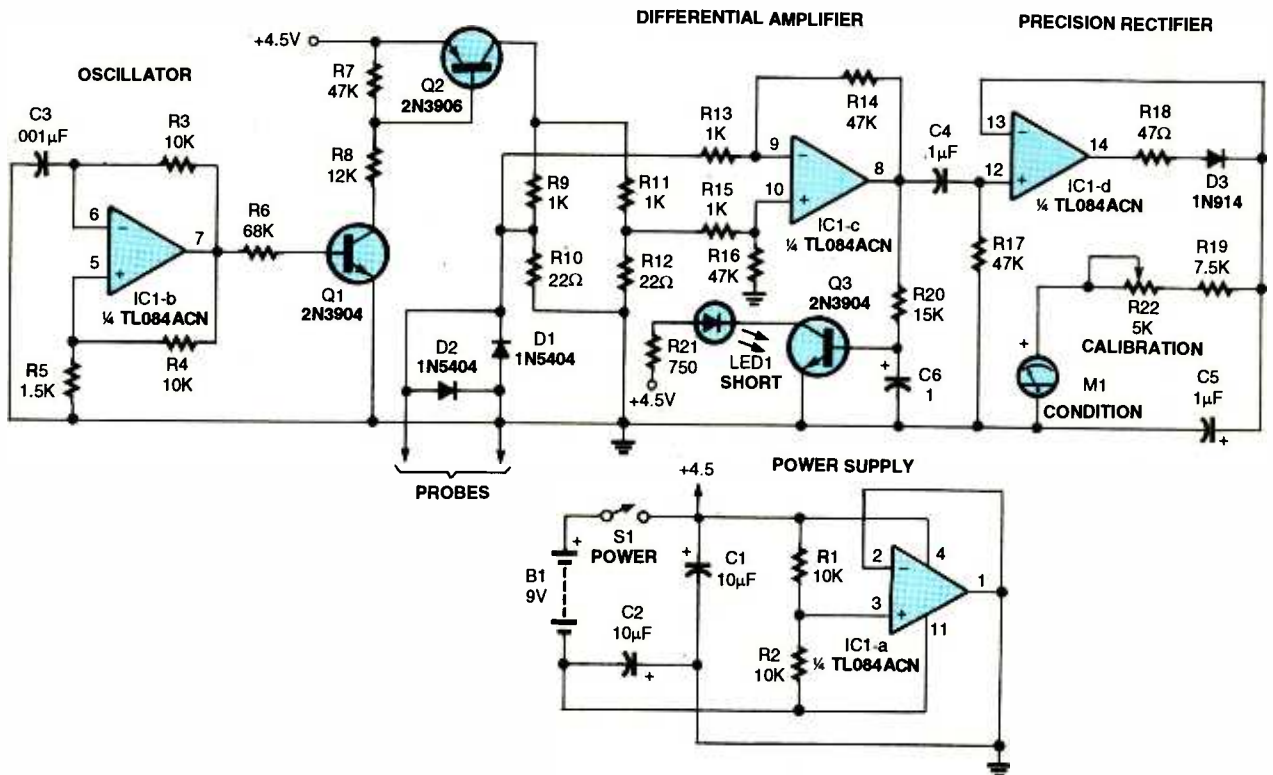

through the often clever implementation of solar cells. Most robots are small and inexpensive; all are fun to build. Please consider featuring this in a future issue. Thank you.

KYLE O'BRIEN
Paso Robles, CA

Problems Buying Parts In Canada

Please be assured that it goes against the grain for me to bother you (or anybody else), but there's no way I can get by now without your help.

The one and only place to get electronic parts—at least in a small town in Canada like mine—is from RadioShack. This may seem just like down in the U.S.—except that RadioShack up here is run by a different corporation (Intertan) than RS in the States; hence, it operates according to its own rules.

This means that should one want to build any device described in an article in your pages (and I do), one has to either buy the parts from the author(s) of the article or possibly order on-line from the Canadian RS Web site. The local RS shop, I was told two days ago by an employee, has now sent everything in the way of parts back to headquarters (Before mailing this, I shall check again

with the store manager, whom I happen to be on good terms with). RadioShack shops here are no longer in the parts business.

The RS Web site certainly is of no help: I have better documentation than it does, when it comes to purchasing replacement ICs, for instance. However, in the case I'm now dealing with, my info is too out-of-date and got me nowhere.

So, the point is this: For your Canadian readership, for the projects described in your columns to make sense, these just have to be accompanied by the address of the author(s) and the cost of purchasing the parts needed from him/her/them.

Mostly, this is the case, with the exception of the project described in your July 2001 issue, page 25, that I want to build: The "In-Circuit Capacitor Tester" by one Marvin Smith. No address is given, nor needless to say, any means of purchasing the parts (his suggestion: Get them from RadioShack).

I did my best to locate this "Marvin Smith" on the Internet and came up with a possibility: Marvin Smith Electronics Sales and Service, in the region of Jonesboro, AR. A call to the possible phone number gave me a "not-in-service" message, though, and there was an incomprehensible coded message on the Web site, www.gv.com.

G. D. RANSFORD
Cornwall, Ontario

Sorry to hear about your problems in getting parts up in Canada. Our authors do not always supply kits or parts, as they are often hobbyists who use parts they have on hand. Two suggestions: Contact either of these suppliers—Digi-Key, 1-800-DIGI-KEY, www.digikey.com, or Mouser, 1-800-346-6873, www.mouser.com.—Editor

The Fun Of Reverting To Simplicity

I have read your magazine for some time, and you appear to be missing an important market. Computers are big, but there are others covering those; how about something for fun?

Believe it or not, there are some of us hobbyists out there still who like to build electronic circuits that are small, simple, inexpensive, useful, and FUN. How about more of those, cut back on the computer stuff, and give us more "one-nighters" (circuits that can be built in one night). People like me would sub-

Grantham
College since 1951

Distance Education

ACCREDITED
ASSOCIATES and BACHELORS DEGREES

COMPUTER SCIENCE
&
COMPUTER ENGINEERING

Self-paced degree programs allow you to earn a college degree on your schedule. Degree paths in Internet Engineering, MIS, Web Design, and Computer Programming. Transfer up to 50% of coursework for A.S. degree and 75% of coursework for Bachelors degree for prior college credit or professional certifications. Receive up to 8 credit hours for directly relevant professional experience. Textbooks, software and instructor support included in tuition. VA/ military benefits & tuition assistance provided by most employers (see FAQ at www.grantham.edu).

34641 Grantham College Road
Slidell, LA 70469
Toll Free 888.423.4242
www.grantham.edu

CIRCLE 282 ON FREE INFORMATION CARD

LynX-10
HOME AUTOMATION KIT
• Software Included
• Use Existing Wiring
• Simple Inexpensive
1-800-828-5299 www.marrickitd.com

Don't lose sight of Glaucoma.

IE NATIONAL
EYE
HEALTH
EDUCATION
PROGRAM

scribe then, not read your mag free at the library. Maybe we'd send in one of our cool projects for your perusal. Even some tube (remember those?) circuits would be a change of pace.

It would be nice to get some fresh ideas, something I could build this year without having to hock the house in order to afford the parts—something that operates without computer hookup or exotic parts. Some of us still build things that use discrete components!
GEORGE WILLIAMSON, CBET
via e-mail

KEEP IN TOUCH

We appreciate letters from our readers. Comments, suggestions, questions, bouquets, or brickbats... we want to hear from you and find out what you like and what you dislike. If there are projects you want to see or articles you want to submit—we want to know about them.

You can write via snail mail to:

Letters
Poptronics

275-G Marcus Blvd.
Hauppauge, NY 11788

Sending letters to our subscription address increases the time it takes to respond to your letters, as the mail is forwarded to our editorial offices.

Our e-mail address can be found at the top of the column.

Of course, e-mail is fast.

All of our columnists can be reached through the e-mail addresses at the head of each column.

And don't forget to visit our Web site:
www.gernsback.com.

BUDGET PROJECT AND COMPUTER BOOKS

BP294—A Concise Introduction to Micro-soft Works \$6.99. You can use the word processor to your advantage to type, edit, print and save documents. This book explains how Works can be used to build up simple spreadsheet examples, edit them, save them, print them and retrieve them. It informs you how to create simple macros, and to simplify long repetitive tasks and to customize the program to your own needs.

BP350—Electronic Board Games \$6.99. Twenty novel electronic board games that you can build from the plans in this book. Whether you are interested in motor racing, searching for buried treasure on a barren island or for gold in Fort Knox, spinning the wheel of fortune, or doing a musical quiz—there is something for you to build and enjoy!

BP378—45 Simple Electronic Terminal Block Projects \$6.99. 45 easy-to-build electronic projects that can be built by an absolute beginner. Projects are assembled on terminal blocks using only a screwdriver and other simple hand tools. No soldering is required.

BP432—Simple Sensor Terminal Block Projects \$6.99. This book is the next logical step from the above book (BP378), by the same author. This is an *open sesame* to the practical world of electronics for youngsters or beginners.

BP367—Electronic projects for the Garden \$6.99. Electronics enters the Garden! Gardeners can build simple gadgets to promote success where the elements work against you. Some of the projects are: over/under temperature monitoring, dusk/dawn switching, automatic plant watering, warming cables, etc.

BP368—Practical Electronics Musical Effect Units \$6.99. There is a constant hullabaloo for musical effects projects by the hobbyist community. This book provides practical circuits for several projects that range in complexity and are sure to work. All the circuits are easy to build and use readily-available parts.

BP385—Easy PC Interfacing \$6.99. The built-in ports in your PC provide an easy and hassle-free way of interfacing your circuits. This book provides useful PC add-on circuits including the following: Digital input/output ports; analog-to-digital and digital-to-analog converters; voltage and current measurement circuits; resistance and capacitance meters, temperature measurement interface, biofeedback monitor, and many other useful interfaces.

BP396—Electronic Hobbyists Data Book \$7.99. This book contains details of a modern five-band resistor code or an old color code for a ceramic capacitor, the formula for parallel resistance, and basic data on an NE5534AN operational amplifier.

BP129—An Introduction to Programming the ORIC-1 \$2.99. This book has been written for readers wanting to learn more about programming and how to make best use of the ORIC-1 microcomputer's many powerful features. Most aspects of the ORIC-1 are covered, the omissions being where little could usefully be added to the information provided by the manufacturer's own manual. Starting with simple commands and programs, the more complex topics such as animated graphics and using sound commands are introduced.

BP131—Micro Interfacing Circuits - Book 2 \$3.99. This book is intended to carry on from where Book 1 left off. It is primarily concerned with practical applications beyond the parallel or serial interface to the microprocessor. It is about "real world" interfacing including such topics as sound and speech generators, temperature and optical sensors, motor controllers etc. Like Book 1 the subject is not treated in a purely theoretical manner.

BP298—Concise Intro to the Macintosh System and Finder \$5.99. This book explains: The System and Finder, what they are and what they do; how to use the System and Finder to manipulate disks, files and folders; configuring and printing files from the Finder; getting the most from the system utility programs; and running MultiFinder.

BP316—Practical Electric Design Data \$7.99. A comprehensive ready-reference manual for electronic enthusiasts with over 150 practical circuits. It covers the main kinds of components (from pig-tail leads to surface mount), pinouts, specs and type selection. Basic units are defined and most used formulae explained. Five additional sections are devoted to circuit design, covering analog, digital, display, radio and power supply circuits.

BP345—Getting Started In Practical Electronics \$6.99. This book provides basic essentials for the builder and 30 easy-to-build fun projects with which every experimenter should toy. Printed-circuits designs are included to give your project the professional touch.

BP451—Troubleshooting Your PC Printer \$8.99. Explains the different printer types, their suitability for different tasks, the costs of running them, how to connect them and get the driver software running and, of course, what is most likely to go wrong and what you can do for yourself. Most important of all, it warns you of what you should quite definitely NOT try to do for yourself.

PCP112—Digital Electronics Projects \$10.99. Contains 12 digital electronics projects suitable for the beginner to build with the minimum of equipment—from instrumentation to home security, and a few "fun" projects too. With one exception, all projects are battery powered, and therefore, are completely safe for the beginner or young constructor.

PCP107—Digital Logic Gates and Flip-Flops \$10.99. This book seeks to establish a firm foundation in digital electronics. It is for the user who wants to design and troubleshoot digital circuitry with full understanding of the principles. No background other than a basic knowledge of electronics is assumed.

BP317—Practical Electronic Timing \$6.99. This book provides the time measurement theory and backs it with a wide range of practical construction projects. Each project has how-it-works theory and how to check it for correct operation.

BP325—A concise User's Guide to Windows 3.1 \$6.99. Understand what hardware specification you need to run Windows 3.1 successfully, and how to install, customize, fine-tune and optimize your system. Get into understanding the Program Manager, File Manager and Print Manager. Tips on the word processor, plus how to use Paintbrush. More on the Cardfile database with its auto-dial feature, Windows Calendar, Terminal, Notepad, etc.

BP327—DOS: One Step at a Time \$5.99. There will be times when you absolutely need to use DOS to carry out 'housekeeping' functions. This book starts with an overview of DOS, and later chapters cover the commands for handling disks, directories and files.

PCP120—Multimedia on the PC! \$14.95. Multimedia can do lots of nice things! This 184-page book helps you create your own multimedia presentation. Multimedia applications by people like you can revolutionize educational and business applications as well bring more fun, fun, fun into your leisure computer activities.

BP404—How To Create Pages for the Web Using HTML \$7.99. HTML is the language used to create documents for Web browsers such as Mosaic, Netscape and Internet Explorer. These programs recognize this language as the method used to format the text, insert images, create hypertext and fill-in forms. HTML is easy to learn and use. This book explains the main features of the language and suggests some principles of style and design. Within a few hours, you can create a personal Home Page, research paper, company profile, questionnaire, etc., for world-wide publication on the Web.

BP411—A Practical Introduction to Surface Mount Devices \$6.99. This book takes you from the simplest possible starting point to a high level of competence in working with Surface Mount Devices (SMD's). Surface mount hobby-type construction is ideal for constructing small projects. Subjects such as PCB design, chip control, soldering techniques and specialist tools for SMD are fully explained. Some useful constructional projects are included.

BP379—30 Simple IC Terminal Block Projects \$6.99. Here are 30 easy-to-build IC projects almost anyone can build. Requiring an IC and a few additional components, the book's 'blackbox' building technique enables and encourages the constructor to progress to more advanced projects. Some of which are: timer projects, op-amp projects, counter projects, NAND-gate projects, and more.

BP401—Transistor Data Tables \$7.99. The tables in this book contain information about the package shape, pin connections and basic electrical data for each of the many thousands of transistors listed. The data includes maximum reverse voltage, forward current and power dissipation, current gain and forward transadmittance and resistance, cut-off frequency and details of applications.

ETT1—Wireless & Electrical Cyclopeia \$4.99. Step back to the 1920's with this reprinted catalog from the Electro Importing Company. Antiquity displayed on every page with items priced as low as 3 cents. Product descriptions include: Radio components, kits, motors and dynamos, Leyden jars, hot-wire meters, carbon mikes and more.

BP76—Power Supply Projects \$3.99. Presents a number of power-supply designs including simplified unbiased types, fixed voltage-regulated types and variable voltage stabilized designs. All are low-voltage types intended for use with semiconductor circuits. Apart from presenting a variety of designs that will satisfy most applications, the data in this book should help the reader to design his own power supplies. An essential addition to the experimenters electronics library.

ELECTRONIC TECHNOLOGY TODAY INC.
P.O. Box 240, Massapequa, NY 11762-0240

Name _____
Address _____
City _____ State _____ Zip _____

Allow 6-8 weeks for delivery

SHIPPING CHARGES IN USA ONLY

\$0.01 to \$5.00	... \$2.00
\$5.01 to \$10.00	... \$3.00
\$10.01 to \$20.00	... \$4.00
\$20.01 to \$30.00	... \$5.00
\$30.01 to \$40.00	... \$6.00
\$40.01 to \$50.00	... \$7.00
\$50.01 and above	... \$8.50

SORRY No orders accepted outside of USA & Canada

Total price of books \$ _____
Shipping (see chart) \$ _____
Subtotal \$ _____
Sales Tax (NYS only) \$ _____
Amount Enclosed \$ _____

No. of Books Ordered

All payments must be in U.S. funds!

ET12

GIZMO®

For more information go to page 88A

or e-mail: requests@berkshire-is.com

Digital Memory Case

Digital cameras might be easy to carry, but where do you put those little accessories? Keep your memory cards and batteries safely on hand in Case Logic's DMC-1 (\$9.99). Made of leather-like Koskin, the pocket-sized case is outfitted with mesh pouches for holding popular storage media, including Memory Stick, Smart-Media, CompactFlash, and Click PC cards; and with elastic straps to secure four AA batteries.

Case Logic Inc., 6303 Dry Creek Parkway, Longmont, CO 80503; 800-925-8111; www.casellogic.com.

CIRCLE 50 ON FREE INFORMATION CARD



MP-3 Phone

If your cell phone just makes and receives phone calls, you might want to upgrade to the CMP-3 (\$299) with built-in MP-3 player and Web-browsing capabilities. Weighing less than four ounces, it features two-way short-message service, voice recording, a 400-number phone book—and recording MP-3 files directly from your PC. Optional starter kits contain a flash memory card, software downloader, CD installation software, and ear-phone microphone.

Audiovox Communications Corp., 555 Wireless Blvd., Hauppauge, NY 11788; 800-229-1235 or 631-233-3300; www.audiovox.com.

CIRCLE 52 ON FREE INFORMATION CARD



Treasure Tracker

The *Time Ranger* (\$695.95) metal detector, with its waterproof 8-inch coil, large LCD readout, and touch-pad control, just might turn your dreams of finding buried treasure into reality.

It can "sniff out" pre-selected targets for response or rejection in the field and can identify a target and its depth. The three-tone

audio discrimination, SmartTrac automatic ground control, and 4-inch gold-nugget coil features make easy work of gold prospecting.

Bounty Hunter, 1100 Pendale Road, El Paso, TX 79907; 800-444-5994; www.detecting.com.

CIRCLE 51 ON FREE INFORMATION CARD



Portable "Big-Screen" DVD

Measuring just 8.2 × 6.1 × 1 inches, this DV-L80U portable DVD player (\$1599) boasts a whopping 8-inch widescreen LCD screen and built-in Dolby Digital decoding. Its rechargeable lithium-ion battery delivers up to 3½ hours of play time and adds just 13 ounces to the player's two-pound weight. With a full array of line outputs, an AV input, and a tiny remote control, the DV-L80U serves as a portable home theater.

Sharp Electronics Corp., One Sharp Plaza, Mahwah, NJ 07430; 800-BE-SHARP; www.sharp-usa.com.

CIRCLE 53 ON FREE INFORMATION CARD



Pocket PostBox

Vtech Connect's *E-mail PostBox Express* (\$79.99) is a pocket-sized handheld e-mail device that, with connection to Yahoo! (\$10/month), allows you

to send and receive e-mail using any live phone jack. Features such as Anywhere Dialer, Flash Connect, and MailScreen enable you to access e-mail with the touch of a button, bypass long-distance charges, and control incoming e-mail. Up to 500 e-mail messages can be stored.

Vtech Connect, Inc., 101 East Palatine Road, Wheeling, IL 60090; 888-GO-VTECH or 847-215-9700; www.vtechconnectusa.com.

CIRCLE 54 ON FREE INFORMATION CARD



Time/Weather Projector

No need to grab your glasses—the Model BAR-338PA *ExactSet Clock with Cable Free Weather Forecaster* (\$99.95) has a projector that displays the time and temperature in glowing red numbers on the wall or ceiling. Activate it by hitting the snooze button or use the AC adapter for continuous display. The clock sets itself using signals from the U.S. Atomic Clock. The LCD shows time, day, date, temperature, and the weather forecast using icons for sunny, cloudy, partly cloudy, or rainy.

Oregon Scientific, 19861 SW 95th Pl., Tualatin, OR 97062; 800-853-8883 or 503-639-8883; www.oregonscientific.com.

CIRCLE 55 ON FREE INFORMATION CARD



Watch Out, Dick Tracy!

With the *Internet Messenger Watch* (\$119.95), you can receive wireless Internet e-mail, news, weather reports, sports scores, stock quotes, horoscopes, auction alerts—and the time and date—almost anywhere in

the U.S. The Internet Messenger is also a full-featured alphanumeric pager able to receive and store up to 16 Internet e-mail, numeric, or word messages. As a timepiece, it's

also a sports watch that features a lighted Indiglo display; a 100-hour chronograph with lap and split, 8-lap memory control; and a 100-hour countdown timer.

Timex Co., Hotline Watch Service, 19 Crisp Dr., Little Rock, AR 72202; 800-448-4639; www.timex.com.

CIRCLE 57 ON FREE INFORMATION CARD



You Can Take it With You

DBS TV, that is. The *MiniPlus* portable, flat-panel satellite dish (\$349.95) can be used with any DirecTV or DishNetwork receiver for instant satellite TV enjoyment when you are parked in your RV or SUV. The 12- × 16- × 1-inch dish comes with a satellite signal strength meter, a carrying case, a portable mount, and cables.

SatCom Electronics, Inc., 13400-B Danielson St., Poway, CA 92064; 858-486-6600; www.satcomweb.com.

CIRCLE 56 ON FREE INFORMATION CARD



On the Road

A 6- × 9-inch, three-way multi-element speaker system, the *HED-1693* mobile audio speaker (\$159/pair) is designed for drop-in replacement of OEM speakers. With their low-profile tweeters/midranges, the speakers fit easily behind factory grilles. Technical and material advances are said to improve power handling, provide accurate dynamic response, and resist damage from UV rays.

Cerwin-Vega, 555 East Easy St., Simi Valley, CA 93065-1805; 805-584-9332; www.cerwin-vega.com.

CIRCLE 58 ON FREE INFORMATION CARD



CDs on Hold

Treat your customers and clients to CD music on hold with the *OHP 5000* (\$399.99), a digital on-hold audio system with integrated CD autoloader that automatically records a CD single or your customized mix of selected tunes from a multi-track disc. It records and plays back continuous music, or a mixture of music and messages, into conventional single- or multi-line telephones or larger business phone systems.

On-Hold Plus, 5820 Oberlin Drive, Suite 203, San Diego, CA 92121; 800-839-7277; www.onholdplus.com.

CIRCLE 59 ON FREE INFORMATION CARD



Home Plate

Now you can turn an ordinary wall outlet into a surge protector, with the *Smart Plate Surge* (\$12.99). Specifically meant for computers, the two-grounded outlet wall plate is easy to install and provides AC line and modem/phone protection. It has safe-operation indicator lights, accommodates one phone line, and accepts a standard RJ-11 telephone line.

Thomson Multimedia; www.rca.com.



Diagnostic Software

A complete systems-level package, *AMIDiagSuite* (\$159.95) includes both DOS (v6.11) and Windows (v7.0) versions of the diagnostic software. The



easy-to-navigate suite offers several interactive diagnostics that allow the user to view results as they

run. The DOS version supports USB mass storage and non-legacy IDE devices and hard disk and ACPI tests.

American Megatrends, Inc.; 800-828-9264; www.ami.com.



CD-Labeling System

Want to label your CDs, but don't want to risk "gumming up the works?" Then the *CD Labeling System* (\$19.99) could be what you're looking for. The specially formulated labels are designed to stay put even in high-rotational-speed CD-ROM drives and not to damage a recordable CD's top protective layer. The system comes complete with blank labels (50 disc and 100 jewel case spine labels),

a label applicator, and TDK's label design software (with a wide selection of graphics).

TDK Electronics Corp.; 800-835-8273 or 516-535-2600; www.tdk.com.



Seeing In 3-D

Designed for 3-D stereo viewing on a CRT monitor, *VR Visualizers* (\$29.95) are compact and lightweight LC 3-D shutter glasses, with a unique fold-up design. Users can now view thousands of 3-D images on the Internet or experience interactive 3-D games on CD-ROMs—images jump off the screen and show true depth and dimension. The glasses are excellent for 3-D stereoscopic scientific visualization, product development, and distance learning.

VRex Inc.; 914-345-8877; www.vrex.com.



Scheduling Program

Keep your calendar in sight with this fully customizable network calendar, which doubles as a desktop wallpaper. Among the features of the *Visual Day Planner 7.1* are a recurring event reminder, enhanced network alarms allowing multiple users to set alarms, and reloadable pictures icons. Users can easily set reminders, dates, and memos by simply typing into the calendar with fonts and colors of their choice. *Visual*

Day Planner is shareware and registration is \$29.95.

InKline Global, Inc.; 775-747-5730; www.inklineglobal.com.



ELECTRONIC TECHNOLOGY TODAY INC.

P. O. Box 240 • Massapequa Park, NY 11762

INVENTORY BLOWOUT SALE



* ALL CANADIAN CHECKS MUST CLEAR THROUGH AN AMERICAN BANK

BP07	100 Radio Hookups	\$3.00	BP317	Practical Electronic Timing	\$6.99
BP36	50 Circuits Using Germanium, Silicon & Zener Diodes	\$2.99	BP320	Electronic Projects for Your PC	\$5.99
BP44	IC 555 Projects	\$5.99	BP322	Circuit Source Book 2	\$6.99
BP56	Electronic Security Devices	\$3.99	BP329	Electronic Music Learning Projects	\$6.99
BP64	Semiconductor Technology Elements of Elect Book 3	\$5.99	BP332	A Beginners Guide to TTL Digital ICS	\$6.99
BP74	Electronic Music Projects	\$3.99	BP333	A Beginners Guide to CMOS Digital ICS	\$6.99
BP76	Power Supply Projects	\$3.99	BP334	Magic Electronic Projects	\$6.99
BP78	Practical Computer Experiments	\$2.99	BP355	A Guide to the World's Radio Stations	\$7.99
BP80	Popular Electronic Circuits	\$3.99	BP359	An Introduction to Light in Electronics	\$6.99
BP103	Multi-Circuit Board Projects	\$2.99	BP367	Electronic Projects for the Garden	\$6.99
BP109	The Art of Programming the IK ZX81	\$3.99	BP370	The Superhet Radio Handbook	\$6.99
BP112	A Z-80 Workshop Manual	\$5.99	BP371	Electronic Projects for Experimenters	\$6.99
BP114	The Art of Programming the 16K ZX81	\$3.99	BP374	Practical Fibre-Optic Projects	\$6.99
BP115	The Pre-Computer Book	\$2.99	BP378	45 Simple Electronic Terminal Block Projects	\$6.99
BP124	Easy Add-On Projects for the Spectrum, ZX81 & ACE	\$3.99	BP379	30 Simple IC Terminal Block Projects	\$6.99
BP143	An Intro to Programming the Atari 600/800 XL	\$2.99	BP384	Practical Electronic Model Railways Projects	\$6.99
BP148	Computer Terminology Explained	\$2.99	BP385	Easy PC Interfacing	\$6.99
BP154	An Introduction to MSX Basic	\$3.99	BP391	Fault-Finding Electronic Projects	\$6.99
BP156	An Introduction to QL Machine Code	\$3.99	BP392	Electronic Project Building for Beginners	\$6.99
BP187	A Prac Ref Guide to Word Pro Amstrad PCW8256/PCW8512	\$7.99	BP393	Practical Oscillator	\$6.99
BP190	More Advanced Electronic Security Projects	\$3.99	BP396	Electronic Hobbyists Data Book	\$7.99
BP194	Modern OPTO Device Projects	\$3.99	BP401	Transistor Data Tables	\$7.99
BP232	A Concise Introduction to MS-DOS	\$3.99	BP411	A Practical Intro to Surface Mount Devices	\$6.99
BP256	An Intro to Loudspeakers and Enclosure Design	\$3.99	BP413	Practical Remote Control Projects	\$7.99
BP264	A Concise Advanced User's Guide to MS-DOS	\$3.99	BP416	Practical Alarm Projects	\$6.99
BP272	Interfacing PCS and Compatibles	\$5.99	BP439	Troubleshooting Your PC	\$8.99
BP290	An Intro to Amateur Communications Satellites	\$5.99	PCP107	Digital Logic Gates and Flip-Flops	\$10.99
BP297	Loudspeakers for Musicians	\$6.99	PCP112	Digital Electronics Projects for Beginners	\$10.99
BP299	Practical Electronic Filters	\$6.99	PCP114	Advanced MIDI Users Guide	\$10.99
BP302	A Concise User's Guide to Lotus 1-2-3 Release 3.1	\$5.99	ETT1	Wireless & Electrical Cyclopedia	\$4.99
BP304	Projects for Radio Amateurs and S.W.L.S	\$5.99			

PRICES DO NOT INCLUDE SHIPPING & HANDLING. ALL SALES ARE FINAL, NO RETURNS

ORDER FORM

Book No.	Title	Price	No. of Copies	Cost

SHIPPING COSTS		Total Amount \$	
\$0.01 to \$5.00	\$2.00	\$20.01 to \$30.00	\$5.00
\$5.01 to \$10.00	\$3.00	\$30.01 to \$40.00	\$6.00
\$10.01 to \$20.00	\$4.00	\$40.01 to \$50.00	\$7.00
\$50.01 and above	\$8.50		
		TOTAL COST \$	

Name _____
 Address _____
 City _____ State _____ Zip _____

If you wish to use a Credit Card:

MasterCard Visa Expire Date ____/____/____
 Card No. _____
 Signature _____

Allow 6-8 weeks for order to be fulfilled.

Please return this order form to:
ELECTRONIC TECHNOLOGY TODAY, INC.
 P.O. Box 240
 Massapequa Park, NY 11762-0240



Telephone Orders: If you wish to place your credit-card order by phone, call 631/592-6720. Automated order taking system functions 24 hours a day. Have your credit-card ready. Sorry, no orders accepted outside of U.S.A. and Canada, New York State Residents must add applicable sales tax. Offer expires 9/30/01.

ET11

MORE RAM...Now!

It's pretty well known that one of the easiest PC upgrades is adding additional RAM. After all, as long as you are careful to drain any static charge before picking up a RAM module, installing an additional DIMM is pretty much a no-brainer. The modules themselves are keyed to only fit one way; so the biggest problem in doing upgrades is gaining access to the DIMM sockets. With memory prices at an almost all-time low, the economics of this upgrade are better than ever.

While it's "common knowledge" that adding additional RAM will speed up most applications, I haven't seen any quantitative articles on this in quite some time. It seems logical that having more RAM would help most processes in a Windows-based PC. Yet, as we all know, when using PCs, sometimes it seems like logic flies out the window.

BUILDING THE TEST-SUBJECT

Rather than just perpetuate the "urban legend" of adding more RAM, I decided that for this episode of "Peak Computing," I'd actually test out the effect of adding RAM.

To do this, I built a new PC especially for the purpose. Because I wanted to really try a variety of memory configurations, I needed a system that would have the capacity to accept a lot of memory. When poking around through the many PCs that are scattered around my home, I realized that most of the PCs that are sold for home and small-office use have a memory capacity that tops out at 768 MB or less. That's still a lot of RAM, but less than I really wanted to stop at. However, I was not able to exceed that limit. Read on to find out why.

After some searching through



The interior view of the roomy Antec SX-830 workstation enclosure is shown in the screen-capture above. The author housed his test machine inside the enclosure.

motherboard specs, I found I had the perfect base for my RAM test machine already in-house, the Soyo SY-7VCA-EA motherboard that was sent to me by the manufacturer for last month's upgrade project. If you read the last issue, you might remember that we actually used the motherboard that Intel sent to do the upgrade, so the Soyo motherboard was available for this project.

That was serendipity. According to the published specs, the SY-7VCA-EA can accept up to a 1-GHz Pentium III; and its three DIMM sockets will each take a 512-MB DIMM, giving the motherboard the capacity of about 1.5 GB!

I'D LIKE TO THANK MY MOTHER...

Running a test like this one is relatively easy, at least when you have

everything in place. I used a variety of benchmarks, including the memory benchmarks in three shareware tools I use extensively. These three are the SANDRA 2001 and Dr. Hardware 2001 system diagnostics and the PASS-MARK 3 system benchmark. All three of these are available for the time spent downloading them. A fourth test was more real-world. I installed Adobe Photoshop 6.0, and took a photo from an old Kai's Power Photos image collection. When loaded in Photoshop, the file was 16.6 MB in size. To test the real-world effect of changing RAM, I re-sampled the image from 300 dpi to 600 dpi, timing the process with a stopwatch.

The real problem in running a test like this one is pulling together all the parts without breaking the bank. Soyo helped out with the motherboard, and

Photoshop Benchmark

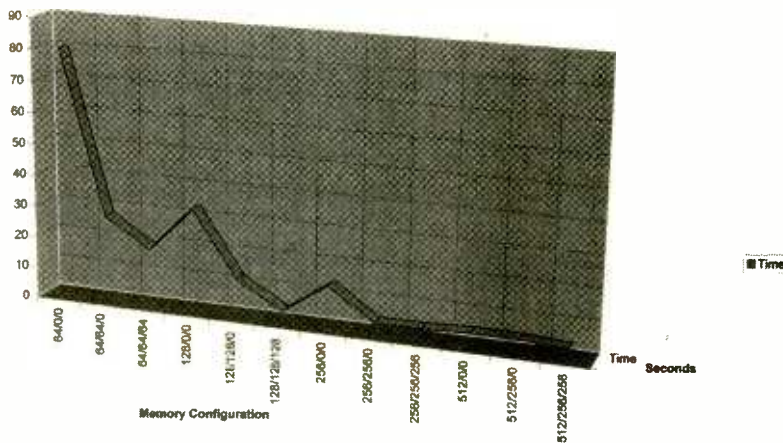

64/0/0	64/64/0	64/64/64	128/0/0	128/128/0	128/128/128	256/0/0	256/256/0	256/256/256	512/0/0	512/256/0	512/256/256	
Time	80.07	27.84	18.65	33.41	12.35	3.84	13.97	3.9	3.87	4.65	4.43	3.99

Fig. 1. The graph above shows the time it took for the author's computer to change a photo's resolution from 300 dpi to 600 dpi using Photoshop 6.0. Memory configurations ranged from 64 MB to 1024 MB.

Intel contributed the CPU. To house the system, I chose the SX-830 case from Antec. I had just used the SX-840 for an upcoming Pentium 4 building project and was so impressed with the case that I felt it was perfect for this project as well. The only difference between the two cases was the power supply. The SX-830 mid-tower case I used for the RAM test project has a 300-watt power supply, while the SX-840 case has a Pentium 4-compatible 400-watt supply.

Otherwise, the cases are identical, with twin fans on the rear panel and place for two more optional fans on the front. There's a slip-out cage for hard disks and a slide-out cage for 3.5-inch drives. All of these make the SX-830 a pleasure to work in. As a bonus, for only about a hundred bucks, the case is as sturdy as a tank!

The real budget-buster in this type of test, however, is the memory. I wanted to run two different tests. The first was to incrementally add RAM, running the benchmarks at each step. This would start out with one 64-MB DIMM installed, then two 64-MB DIMMs, and then three 64-MB DIMMS. The next series would be one 128-MB DIMM, then one 128-MB and one 64-MB DIMM, and so on. I also wanted to see whether there was any appreciable difference in benchmark scores between using two 64-MB DIMMs and a single 128-MB DIMM, two 128-MB DIMMs and a single 256-MB DIMM, and two 256-MB DIMMs and a single

512-MB DIMM.

These tests required three DIMMs of each size: 64 MB, 128 MB, 256 MB, and 512 MB. While RAM prices are falling, that's still a lot of money in RAM. So a big thank you goes out to Kingston Technology, which donated a dozen ValueRAM modules of the requisite size. ValueRAM, which is Kingston's retail line of DIMMs and RDRAM, is what I have in most of the PCs here—I've had no memory problems for as long as I have been using it.

ROBERT BURNS WAS RIGHT!

What I supposed would be a straightforward process turned out that way; but only for a moment—until things fell completely apart. Robert Burns, the poet, said it best, "The best-laid plans o' mice an' men, gang aft a-gley."

SOURCE INFORMATION

Antec, Inc.
510-770-1200
www.antec-inc.com

Intel Corp.
408-765-8080
www.developer.intel.com

Kingston Technology Corp.
877-KINGSTON
www.kingston.com

Soyo
510-226-7696
www.soyousa.com

While the tests were time-consuming, it was a pretty simple matter to put in memory, run the benchmarks, print out the results, and repeat the process—up until I put in the second 512-MB DIMM. All of a sudden, Windows Me refused to completely load. It loaded with a 512-MB and a 256-MB DIMM in place, but completely bombed out with two 512-MB DIMMs.

Thinking it might be a problem in Windows Me, I attempted to replace Windows Me with Windows 2000 Professional, which I know can handle large amounts of RAM without problems. This process uncovered the fact that my hard disk was bad and would not properly format. Raiding another system, I commandeered another drive, formatted it and installed Windows 2000. With a 512-MB DIMM in place, Windows 2000 Professional booted just fine, and it re-installed *Photoshop*, all of the other benchmarks, and the laser printer driver.

Then I popped in a second 512-MB DIMM. Bang! Windows 2000 Professional loaded, but every application I tried to run crashed the system. The system ran just fine with 768 MB installed, either three 256-MB DIMMs or a 512-MB and a 256-MB DIMM. Any more than that and either the application crashed the system, or the operating system just wouldn't load. Despite extensive fiddling in the system's BIOS, I was not able to overcome this; even though Soyo's documentation clearly states that the motherboard supports three 512-MB DIMMs. A call to Soyo's excellent technical support staff promptly cleared everything up. Yes, the Via-based core logic chipset on the motherboard will support 1.5-GB of RAM, but only at a front-side bus speed of 100 MHz. Using the 1-GHz Pentium III processor requires that the front-side bus be set to 133 MHz for best performance, which limits the memory to 768 MB. So I had the choice of limiting the parameter of my test to 768 MB, or dropping the front-side bus speed down and re-running all of the tests a third time. Given what I had come up with to this point, I decided to stop at 768 MB.

SURPRISING RESULTS

The result of this is that my testing was not quite as rigorous as I initially hoped it would be, though it was far

more time-intensive than I planned for.

Even more surprising, however, were the results. In most of the testing, very little quantitative difference was seen in the benchmark scores. Going back to the benchmarks themselves, I realized that most of the "memory" benchmarks are measuring memory bandwidth, which is more a function of system design, the memory bus speed, and RAM speed, then of RAM quantity.

What did vary with the amount of RAM installed were two things, one of which I was not even monitoring. This was how quickly the operating system booted and how quickly applications loaded when launched. While I had not thought to actually time this, the difference between having 64 MB and 768 MB in the PC was clearly noticeable. With more RAM, Windows 2000 Professional loaded noticeably faster, and *Photoshop* was ready to use several seconds earlier.

The re-sampling process, changing the file from a resolution of 300 dpi to 600 dpi, was also greatly influenced by how much RAM was installed in the system. With only 64 MB installed, re-sampling this particular image took a bit over 80 seconds. With some configurations of memory, this time dropped to as little as 3.59 seconds.

Strangely, however, it wasn't the gross amount of RAM installed that had the greatest effect; it was the configuration in the three DIMM sockets. For example, three 256-MB DIMMs actually produced a hair better performance, at least on this one particular benchmark, than did having one 512-MB DIMM and one 256-MB DIMM.

THIS MEANS EXACTLY WHAT?

As I've discovered over the 30-plus years that I've been using computers big and small, this experiment probably created more questions than it answered. One thing that the results seem to support is that how your applications use the installed memory will influence whether or not adding more RAM will boost performance. *Photoshop*, and other similar applications, use additional RAM to reduce the need to store portions of the image files that you are using in virtual memory (i.e., a temporary file on your hard disk drive). Adding RAM definitely improves performance, though we don't see a big

improvement in the benchmark scores until we get to 512 MB.

The downside is that there is really no concrete way to know beforehand if adding additional RAM is going to boost your system's performance. However, with memory prices as affordable as they currently are, adding more RAM is still the first step most users should take to try to bump up system performance. **P**

To learn how to talk with your kids about tough issues, like sex, AIDS/HIV and violence, call **1-800-CHILD-44** and get your free guidebook.



PLANT TREES FOR AMERICA

**Frustration? No, thanks.
Fun? Yes, please.**

Satisfied customers - the key to our success

- ▶ that's why every new EAGLE version is based on the feedback from our customers
- ▶ that's why all our customers have access to our highly acclaimed, comprehensive support, free of charge
- ▶ that's why EAGLE has no hidden costs for libraries or modules which prove to be indispensable after purchasing
- ▶ that's why we really want customers to enjoy working with EAGLE
- ▶ that's why EAGLE is one of the top-rated programs for schematic capture and board layout



EAGLE 4.0

Schematic Capture - Board Layout
Autorouter

The readers of the January 1999 issue of Electronic Design magazine (March 1999 issue) for **Windows** and **Linux**
Product of the Year 2000
in the category CAE/CAD

Windows is a registered trademark of Microsoft Corporation. Linux is a registered trademark of Linus Torvalds.

Version 4.0 Highlights

- New Library Management with Component Browser
- Technology and Package variants for components
- Design your own commands via User Language
- Unlimited length for component names/values
- Design Rules define pad/via dimensions and shapes
- Net Classes for Autorouter and DRC
- Minimum Autorouter grid: 0.02 mm
- SMD pads can be rounded or round
- Different pad shapes for Top, Bottom, or Inner layers

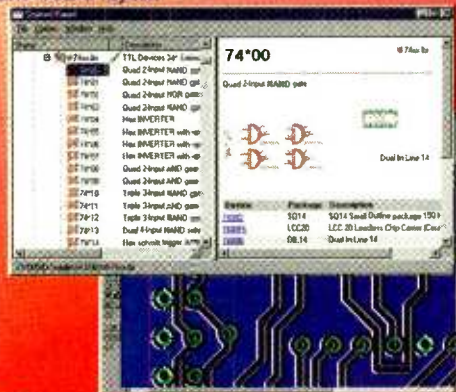

EAGLE 4.0 Light is Freeware!

You can use EAGLE Light for testing and for non-commercial applications without charge. The Freeware Version is restricted to boards up to half Eurocard format, with a maximum of two signal layers and one schematic sheet. All other features correspond to those of the Professional Version. Download it from our Internet Site or order our free CD.

The Standard Version is suitable for boards in Eurocard format with up to 4 signal layers. The Professional Version has no such limitations.

<http://www.CadSoftUSA.com>

800-858-8355

CadSoft Computer, Inc., 801 S. Federal Highway, Delray Beach, FL 33483
Hotline (561) 274-8355, Fax (561) 274-8218, E-Mail: info@cadsoftusa.com

Prices	Light	Standard	Professional
Layout		199\$	399\$
Layout + Schematic		396\$	798\$
Layout + Autorouter		398\$	798\$
Layout + Schematic + Autorouter	49\$	597\$	1197\$

Pay the difference for Upgrades

CIRCLE 283 ON FREE INFORMATION CARD

Business Buzz

Rx AT YOUR FINGERTIPS?

Recently installed in several U.S. cities, a physician-friendly touchscreen computer system from ScriptRx, Inc. generates printed prescriptions and discharge instructions. Incorporating a fingerprint scanner and laser printer, it is expected to dramatically reduce life-threatening prescription and discharge-instruction errors due to illegible or confusing handwriting. Offered free to applying hospitals nationwide, the systems are funded by pharmaceutical and other companies who sponsor informational sections or "screens." For more information, visit ScriptRx at www.scriptrx.com.

ROVER, WHERE ARE YOU?

TGS's *3D-MasterSuite for Java* will be used in the daily operations of the two Mars Rovers as they search for evidence of the action of liquid water. The Java software will help to select the most promising rocks and soil targets for more intensive study and to pick new regions to explore. It will also provide high-fidelity 3-D visualization of the Martian terrain data that the Rovers gather, as well as positioning a 3-D model of the Rover on the simulated terrain. With this tool, scientists worldwide will be able to use a multiple platform interface to view what the Rover is viewing.

EAR PROTECTION

Are cell phones dangerous to your health? Studies have been inconclusive, since the potential long-term effects of EMF exposure are not known. A new device, the *Anti-Radiation Cover (ARC)*, protects people against cell-phone radiation. ARC is a small, lightweight, mesh disc that sticks to the earpiece of a cell phone. The enhanced conductive fiber material it uses, *Shieldron*, is based on NASA technology—originally designed to counter radiation in outer space. The ARC has undergone extensive laboratory testing, both here and abroad, and is said to eliminate up to 99% of all cell phone radiation to the ear. For more information, contact www.cellphoneradiationbuster.com.

Arsenic On The Rocks



David Teter (l) and Pat Brady are among the Sandia researchers who developed SANS. They are seen here with groundwater flowing through a column of SANS, which would reduce its arsenic content to an undetectable level. (Photo by Randy Montoya.)

Whether you're watching your weight, keeping cool in hot weather, exercising, or trying to have a healthy lifestyle, drinking lots of water is always considered good for you. Of course, that is based on the assumption that the water is unpolluted and safe to drink. That's not always the case.

Water Sans Arsenic

In some groundwater, inorganic arsenic occurs naturally—seeping out of rock and soils near the aquifer. Ingesting high levels of arsenic has been linked to a variety of cancers and cardiovascular and neurological illnesses, although scientific data about low-level, chronic arsenic ingestion is limited.

The EPA is reviewing its current arsenic limit of 50 parts per billion (ppb) and is considering a new limit that

reduces the maximum allowable amount of arsenic in drinking water to 10 parts per billion. A U.S. Geological Survey study estimates that 14 percent of all U.S. water supplies has drinking water with arsenic concentrations greater than 5 ppb, and in 3 percent of them it exceeds 20 ppb. Water supplies in the western U.S. have some of the highest arsenic concentrations.

Sandia National Laboratories scientists have been researching this problem and have designed new chemicals with flypaper-like arsenic-trapping properties.

Designing Arsenic Trappers By Computer

"We've zeroed in on a class of material that is affordable and obtainable and peculiarly selective for arsenic," says Sandia researcher David Teter. The new materials are called *Specific Anion Nanoengineered Sorbents (SANS)*.

Because there are nearly infinite variations of chemical species, phases, and surface chemistries, they let the computer sort out the very best performers. To create the materials, the researchers selected mineral families with known affinities for anions (negatively charged atom groups). They then used super-computer modeling to rapidly simulate the arsenic-trapping aptitudes of thousands of combinations and variations of the minerals. "We got some big hits on materials that had never been considered before," says Teter.

Arsenic Getters

Most mineral "getters" have negatively charged surfaces, so they repel anions. The SANS selectively attract dissolved anions such as arsenate (a toxic arsenic-containing compound) to positively charged sites on the SANS surfaces and grab hold.

"We knew which classes of materials should be highly selective for arsenic at the atomic level," says Sandia researcher Pat Brady, "so we asked ourselves what is

TYPE

peculiar or common about those materials. Then we tried to find or make other materials with similar properties.”

They ruled out those minerals that are difficult or expensive to obtain or produce, that would become saturated too quickly, or that would result in a hazardous by-product. Now, they are verifying the computers’ results in a lab—pumping arsenic-contaminated water through the powdered materials, and then measuring the arsenic content of the outflow.

Water Works

At water treatment plants, groundwater could be pumped through columns containing the SANS powdered materials. Arsenic content in the outflow would be reduced to undetectable levels. After perhaps years of use, the nonhazardous arsenic-saturated getters could be safely disposed of in landfills.

According to the researchers, the SANS could be easily adapted for use with smaller water systems—even down to the individual well or household scale. In addition, they believe the same research methodology that identified the SANS for arsenic removal could help design other getters for removing different micropollutants from drinking water or for purifying industrial waste water and other effluents.

Price Tag

Complying with the proposed EPA standard for arsenic in potable water could come with a national price tag in the billions to tens of billions of dollars. The Sandia developers think the new arsenic-getting SANS could reduce the sticker shock of removing arsenic from drinking water for cities served by water treatment plants; for rural communities; and for homes, schools, and apartment complexes served by single wells.

“Municipalities now filter out dirt, silt, and sewage, but pulling out stuff at the parts-per-billion range cheaply is a new and difficult challenge,” says Brady. “This is harder than finding a needle in the haystack.”

Teter estimates that some of the SANS could be supplied for as little as \$200 to \$300 a ton, compared to the \$4000 a ton for conventional iron hydroxides used in typical water treatment plants. (Iron hydroxides, adopted for water purification around the turn of last century, sweep out many contaminants simultaneously but don’t selectively remove arsenic.)

Testing...Testing...One, Two, Three

About 3200 of the nation’s 74,000 water systems supply drinking water with arsenic levels that exceed this limit, according to EPA estimates. Almost half of Albuquerque’s wells would fail to meet this standard. “In essence the ruling says Albuquerque can’t use half its wells after 2005 without additional treatment,” says Dave Teter.

The Sandia researchers hope to test the new materials at a planned city water-purification demonstration plant in Albuquerque, as well as in several smaller water systems in rural New Mexico communities.

Albuquerque’s Arsenic Removal Demonstration Plant should be operational by next summer, according to City Water Resources Manager John Stomp. The plant will process more than 2 million gallons of water a day using a micro-filtration/iron coagulation process, but the facility will reserve space to test developmental technologies such as the SANS.



A computer image of arsenate ion sorbing on to an oxide surface. The image is generated using a form of quantum mechanical modeling called density function theory.

Research Notes

YOUR OWN SUPERCOMPUTER

Sandia National Laboratories has released to the public a computer program that enables a collection of off-the-shelf desktop computers to be among the world’s fastest supercomputers. (See “Prototype,” December 2000.) The open-source release of *Cplant* allows free access to the research that created the most scalable, Linux-based, off-the-shelf computer available, says Sandia manager Neil Pundit. Modifications and enhancements made by other scientists and researchers will enrich the system software. While other cluster software may run faster, none exceed *Cplant*’s ability to help off-the-shelf processors work together in large numbers.

LOOK MA, NO HANDS

Imagine landing a jumbo jet without ever taking control of the stick. NASA scientists have demonstrated just that ability, using only human muscle-nerve signals linked to a computer. A computer matches each unique nerve-signal pattern with a particular gesture, such as making a fist or pointing. The pilot was outfitted with an armband implanted with eight electrodes. It read the muscle nerve signals as he made the gestures to land a computer-generated 757 passenger jet aircraft at a simulated San Francisco International Airport. (The first prototype armband was made from exercise tights and used metallic dress-buttons as dry electrodes.)

SNIFFING OUT HYDROGEN

Scientists from Intelligent Optical Systems, Inc. (IOS) and The Boeing Company tested first fiber-optic hydrogen leak-detection system during a static fire test on a Delta IV orbital rocket at the NASA Stennis Space Center. Since liquid hydrogen—dangerously flammable and explosive—is used as fuel in virtually all the orbital rockets, NASA needs to detect potentially catastrophic leaks. The IOS multi-point fiber-optic sensor system consists of a light source, optical fiber, and optodes with temperature-sensitive indicators. Since optical sensors don’t require any power, there’s no danger of a spark from faulty wiring; they’re immune to EMI; and the optical fiber is resistant to temperature extremes.

"We're very interested in working with Sandia to look at emerging technologies that are cheap and easy to dispose of," says Stomp. **PT**

Step Lively!

It seems "Star Wars" type troopers are no longer limited to the realm of movies. Soldiers of the 21st century can already don helmets that feature image displays, laser range finders, and global-positioning systems. There's a hitch—these futuristic cyber systems demand power.

The "man-portable generator," being developed at the DoE's Pacific Northwest National Laboratory for the U.S. Army's Communications-Electronics Command, is a power generator so lightweight a soldier can carry it with him. Weighing as little as two pounds, it generates 15 to 25 watts of power. That's ten times less than the batteries soldiers currently carry—the best lithium batteries currently available would have to weigh as much as 20 pounds to provide equivalent power for one week. The generator's fuel processor also allows the system to be refueled so it can be used again.

The increased power density would allow soldiers to either reduce their load

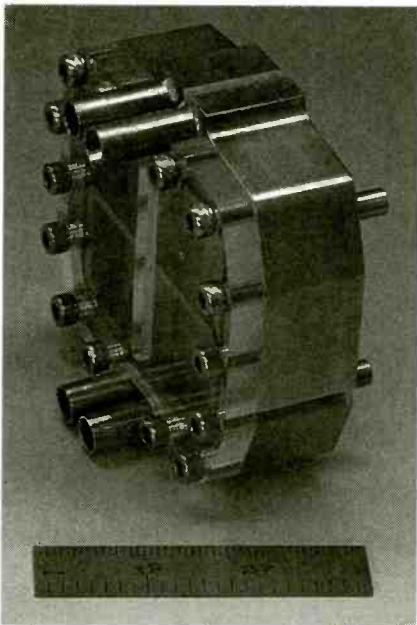

The miniature fuel processor, developed at PNNL, builds upon a micro-channel vaporizer designed for the auto industry.

► It Pays To Advertise

The next generation of public phones, the AT&T Public Phone 2000i, combines simultaneous high-speed connectivity to the Internet and other online services, such as e-mail, with voice calling. Additional features include a 12-inch touch-sensitive screen and a touch pad integrated into the keyboard. The fee to use all of the capabilities is 25 cents per minute, with a four-minute minimum. Installations have begun at airports in the New York, Dallas, and Atlanta areas, with other major airports scheduled to have the phones by the end of the year.

The market for public phones with Internet connections is expected to grow sharply in the next few years—some experts predict it to be more than \$1 billion worldwide by 2005. AT&T said a major source of revenue from the 2000i phone would be sales of advertising space on the full-motion video screens of the unit. These ads can be programmed to change as the advertiser wishes. When an ad is touched or clicked, a connection is made to the Web site at no charge to the user.

AT&T has found such targeted advertising to be more effective than Internet banner ads, especially in reaching business travelers. In one month, a group of 50 enhanced public phones with a florist's ad generated over 500 hits, while 1000 standard phones in the same area generated less than 50 calls for the same company. **PT**



or greatly extend their missions.

Last spring, PNNL engineers demonstrated a full-size, advanced design fuel processor that converts methanol into hydrogen. Because hydrogen wouldn't need to be stored or carried, the fuel processor would reduce the weight and risk associated with portable power systems.

"We've taken a significant step toward light-weight power generation with this breadboard-stage fuel processor," said Ed Baker, PNNL project manager. "Our system produces the hydrogen that fuel cells need to create power. We expect to create hydrogen from liquid fuels such as methanol, synthetic diesel, and possibly military jet fuels. Each of these is more readily available and easier to carry than hydrogen."

PNNL engineers based the fuel processor design on 1- to 10-kilowatt prototypes that they have built for use in automobile power systems. The processor being developed for the man-portable generator consists of four micro-technologies: a combustor, vaporizer, primary conversion reactor, and a gas cleanup device.

It uses a proprietary catalyst to produce hydrogen from hydrocarbon fuels. Reactions take place within small channels of a catalytic converter. These

micro-channels enhance heat and mass transfer rates and significantly speed up chemical reactions, which reduces the device's size.

Based on the encouraging results of the breadboard-stage development, PNNL engineers are designing a prototype fuel processor and hope to have it tested within the next year. Then, they will work on integrating it with other components of a complete power system, including a micro-scale fuel cell, a fuel storage and a delivery unit, and a battery for peak power. They hope to have the complete power system ready for testing by 2003. **PT**

Newsplex

There are an increasing number of newsroom convergence projects, whose purpose is to create a site for cross-media newshandling. With support from Ifra, a leading media publishing association, Newsplex is being launched—an advanced micro-newsroom initiative to develop an international facility for research into methods and technologies for such newsroom convergence. The \$1.5 million facility, being built in cooperation with the University of South Carolina (USC) College of Journalism and Mass

Prototype

► "Light" Particle Beams

University of Southern California (USC) scientists and colleagues at UCLA and Stanford have found a way to bend beams of high-energy particles as though they were light waves. The particles, high-energy electrons, were traveling in a linear accelerator at nearly the speed of light. The researchers were trying to increase the speed of the particles by sending them through plasma. In the process, they discovered that the beam of electrons had refracted, acting like light waves rather than fast-moving particles. Light waves bend when passing diagonally from one material to another because the speed of light changes slightly according to the density of the material it is traversing.

"Particles normally don't refract. Until now, that's only been seen with waves," said one researcher, Thomas Katsouleas, professor of electrical engineering at the USC School of Engineering, "This was a wonderful bit of serendipity associated with a desire to solve another problem."

The USC scientists envision circuits of plasma carrying high-energy streams of electrons for a variety of purposes, some not yet imagined. The most immediate application is likely to advance the state-of-the-art particle accelerators themselves. Bending the particle beam with refractive optics would be much more efficient and effective than the current method where beams of particles are steered by bulky magnets.

The data is being analyzed to determine if they succeeded in using plasma to accelerate particles, the original purpose of the experiment. **PT**



Prof. Katsouleas and researchers Seung Lee and Patric Muggli are seen in front of a computer running a simulation of the plasma experiment performed at the Stanford Linear Accelerator.

Communications, is expected to be open this fall.

The Newsplex micro-newsroom will be equipped with all the technological and organizational innovations needed for a full-sized operation, yet scaled to support a single multi-media story team of 5 to 10 people—a micro-room of a complete newsroom of the future. The site is being provided by and located within the South Carolina Educational Television (SECTV) Network building in Columbia, SC.



Configured with specially designed, flexible workspaces, the Newsplex will provide convergence journalists with access to on-demand displays of news resources and news management material.

The lower floor will contain the primary news activity spaces, including a central Newsflow desk where operations will be coordinated.

Throughout the site laced with wireless and high-speed networking, convergence journalists will have access to the fastest modern information-management tools in their specially designed, flexible workspaces. Dynamically configurable info-panels will provide on-demand display of news resources and management material.

A state-of-the-art communications suite including mobile and video-conferencing will keep the news staff constantly in touch with one another and with the digital infrastructure. A robust database server farm—able to capture, categorize, and retrieve any form of news material and news management information—will sit at the core of that infrastructure.

The Newsplex will have three primary uses: teaching, training, and research. Additionally, Ifra will use the Newsplex as the hub of its activities in newsroom technology and advanced news operations. Projects at member newspapers

will be linked to and supported by Newsplex activities, where possible.

This year, Ifra is already commissioning Newsplex for the "Video in Print" research project, investigating the best practices for effective use of video and audio newsgathering in connection with print and electronic publications. The project will be conducted in three parts: a comprehensive catalog of what newspapers around the world are doing in video/audio newsgathering, research into what style of video/audio presentation is most effective on a newspaper online site, and development of a list of recommended and evaluated technologies/skills for newspaper implementation of video/audio production. **PT**

His Master's Voice

Robodog, also known as RS-01, is as tall as a grown Labrador. He is able to climb over obstacles, play football, do handstands, and even move like a crab. The dog can also stand guard duty, as its owner can log onto the Web and monitor his home through the Webcam in the dog's eyes. British inventor Nick Wirth, and his company Roboscience, developed the dog in just seven months with a six-figure investment he and a partner put up.

The prototype pet can see in color, read out e-mails using a permanent wireless Internet connection and respond to dozens of spoken or shouted commands, preferably from the owner's voice. Its main purpose is to prove Wirth has made a breakthrough in the design of a new generation of robots.

The RS-01 is made of kevlar and carbon fiber, materials used for racing cars which are light and strong, but very hard to work with. It has sophisticated motor and balancing capabilities. Measuring 33 inches long, 27 inches tall, and 15 inches wide, he weighs only 26 pounds, making for a safer and less power-hungry dog, who can play or work for 90 minutes between feedings from the power source.

"Potential applications are in domestic robots, special effects, industrial robotics, and high-risk commercial and military environments," according to a company spokesperson, who added that dogs in space were also on the cards. **PT**

CD ROM based resources for learning and designing



The internationally renowned series of CD ROMs from Matrix Multimedia has been designed to both improve your circuit design skills and to also provide you with sets of tools to actually help you design the circuits themselves.

Electronic Circuits and Components provides an introduction to the principles and application of the most common types of electronic components and how they are used to form complete circuits. Sections on the disc include: fundamental electronic theory, active components, passive components, analogue circuits and digital circuits.

The **Parts Gallery** has been designed to overcome the problem of component and symbol recognition. The CD will help students to recognize common electronic components and their corresponding symbols in circuit diagrams. Quizzes are included.

Digital Electronics details the principles and practice of digital electronics, including logic gates, combinational and sequential logic circuits, clocks, counters, shift registers, and displays. The CD ROM also provides an introduction to microprocessor based systems.

Analog Electronics is a complete learning resource for this most difficult subject. The CD ROM includes the usual wealth of virtual laboratories as well as an electronic circuit simulator with over 50 pre-designed analog circuits which gives you the ultimate learning tool. The CD provides comprehensive coverage of analog fundamentals, transistor circuit design, op-amps, filters, oscillators, and other analog systems.

Electronic Projects is just that: a series of ten projects for students to build with all support information. The CD is designed to provide a set of projects which will complement students' work on the other 3 CDs in the Electronics Education Series. Each project on the CD is supplied with schematic diagrams, circuit and PCB layout files, component lists and comprehensive circuit explanations.

PICtutor and C for PICmicro microcontrollers both contain complete sets of tutorials for programming the PICmicro series of microcontrollers in assembly language and C respectively. Both CD ROMs contain programs that allow you to convert your code into hex and then download it (via printer port) into a PIC16F84. The accompanying development board provides an unrivaled platform for learning about PIC microcontrollers and for further development work.

Digital Works is a highly interactive scalable digital logic simulator designed to allow electronics and computer science students to build complex digital logic circuits incorporating circuit macros, 4000 and 74 series logic.

CADPACK includes software for schematic capture, circuit simulation, and PCB design and is capable of producing industrial quality schematics and circuit board layouts. CADPACK includes unique circuit design and animation/simulation that will help your students understand the basic operation of many circuits.

Analog Filters is a complete course in filter design and synthesis and contains expert systems to assist in designing active and passive filters.

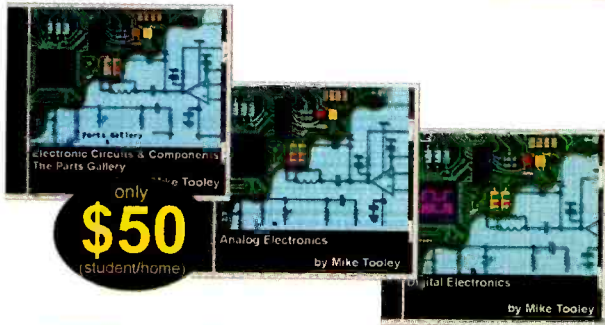

only
\$50
(student/home)

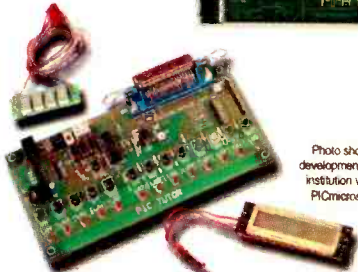
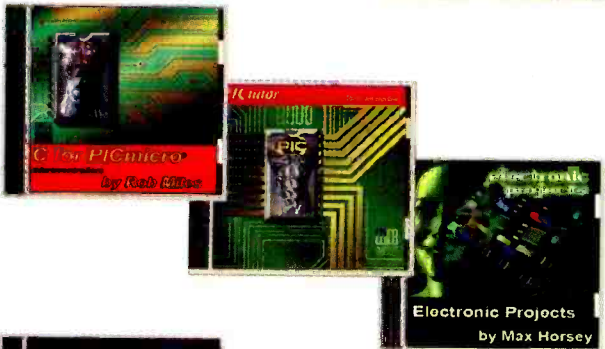

Photo shows PICmicro[®] development kit supplied with institution versions of C for PICmicro[®] and PICtutor.

Shareware/demo CD ROM with more than 20 programs \$4.99 refundable with any purchase.

Order Form:

Please circle the products you would like to buy on the table below, calculate the total cost, fill in the rest of the order form and send it to us. NY residents add sales tax. Please allow 6 weeks for delivery.

	Student	Institution
Electronic Ccts. & Comps.	\$50	\$99
Digital Electronics	\$50	\$99
Analog Electronics	\$50	\$99
Electronic Projects	\$75	\$159
PICtutor	\$179	\$350
C for PICmicro	\$179	\$350
Digital Works	\$50	\$99
CADPACK	\$75	\$159
Analog Filters	\$75	\$159
Postage - USA	\$5	\$5
Postage - Canada	\$5	\$5

Name: _____
 Address: _____
 Zip: _____ Phone: _____

Phone your order to us on:
631-592-6721
 or send your order to:
CLAGGK Inc.
 PO Box 12162
 Hauppauge, NY 11788

Card Type: _____
Mastercard, Visa, or Discover only

Card number:

Expire date:

I have enclosed my check for \$: _____ Signature: _____
 Please charge my credit card for \$: _____

CL02

Order online NOW from: www.poptronics.com

The Battle Has Begun

Do you have what it takes to leave behind the video games and experience the thrill of robotic warfare? The lights go up, the crowd leans forward, and the two competitors prepare for battle in the game, BattleBots. As the bots enter the arena, the participants—be they engineers, special effects wizards, artists, or students—get to witness the entrance of their intense robotic fighting machine: the culmination of their hard work, time, and money. Each bot makes its way to the designated start area, a 35-ton steel encasement rigged with traps and hazards, appropriately named the BattleBox. Soon, all are engaged in a thrilling combat-based event that combines skill, strategy, and creativity in a contest celebrating the basics of life and death, survival and supremacy.

BattleBots is a competition bringing together all different ages and interests. No matter what your experience or expertise is, if you have a creative imagination, some mechanical knowledge, and the ability to transform a good idea into a robotic terror, you can be a competitor. As long as your BattleBot conforms to the rules and guidelines, your paperwork is received by the deadline, and you show up on time, you will have a spot in one, if not both, of the two open competitions. Participants under the age of 18 must have a qualified supervising adult present; some competitors have their sponsors with them, and many just arrive with their team.

The Bots

With four weight classes of BattleBots and two categories of competition, there is a place for each and every creation. Depending on how much money you want to spend in creating your bot, you can go from the lightweight (25–87.9 lbs.) or middleweight (59–173.9 lbs.) to the heavyweight (116–315.9 lbs.) or the super heavyweight (211–488.9 lbs.). The light



"Nightmare" prepares to slice and dice "FrenZy" during a BattleBots match. To see video clips of this battle and more, visit www.obotcombat.com.

robots are typically smaller, simpler, and less expensive, while the heavyweights can defy all limitations. Weight classifications vary depending on whether the bots are wheeled or non-wheeled and are strictly enforced.

Since the masterminds behind BattleBots want to encourage the creative process, they try to set the least possible limitations on designs. They do, however, place great value on maintaining the highest level of safety for all involved: competitors, viewers, judges, and the field crew. To preserve safety, there are a few restrictions on the construction of the bots. Since the door to the BattleBox is eight feet by eight feet, the bots must be within those parameters in order to safely enter the battlefield. Powered flight is not an accepted method of movement, whereas wheeled and linear devices are. Bots have been powered by such things as: batteries, compressed gas, and liquid fuel; and drive types include: electric, hydraulic,

pneumatic, and internal combustion. While there are many different types of weapons permitted, some of those restricted are explosives, flammables, projectiles, and entanglement devices.

All bots go through inspection before competing. The internal inspection insures that they have adequate protective covers; the operations test qualifies the transmitter, receiver, and remote; and to pass functionality, the bot must be capable of safe control for at least three minutes. There are regulations on fueling, pressurizing, welding, and grinding while in the pit.

The Battle

To begin, the bots are motionless with all rotary weapons spun down, and all internal combustion engines running at idle. If they are challenging another bot in the same weight class, they have three minutes to win what is called the "Robot Duel." Judged primarily by the referees and secondarily by the audi-

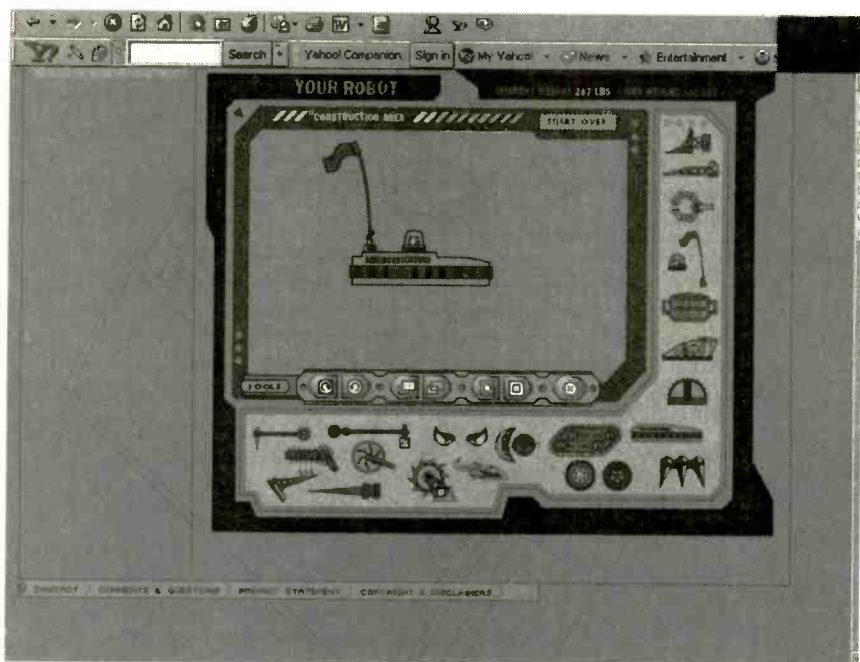

Introducing Robotics with Lego® Mindstorms™

For Robot Lovers. Shows how to build a variety of increasingly sophisticated computer-controlled robots using the brilliant Lego mindstorms Robotic Invention System (RIS). Covers the fundamental building techniques needed to construct strong and efficient robots. Explains to the reader how robot control programs may be simply constructed on their PC screens.

Detailed building instructions are provided for all the robots featured. 270 pages, 7 1/2 x 10 5/7 in. \$19.99.

Plus \$2.45 shipping in U.S. Order from CLAGGK Inc., P.O. Box 12162, Hauppauge, NY 11788 CLX1



The BattleBots homepage is located at www.battlebots.com, and it contains lots of information regarding competitors, rules, and upcoming competitions. You can even build your own robot complete with kill-saws and hammers.

ence, this match decides which division of the "Robot Rumble" the bots will move into. Next, this five-minute free-for-all rumble is divided into a group of the winners and of the losers from the previous battle. Here, the bots face other competitors, this time of similar weights, though not necessarily alike.

Each team is allowed to enter one bot per weight class. The bots use their kill saws, ram rods, spike strips, and other implements of war to gain audience partiality. If a winner can't be decided by the referees and isn't evident by the time limit, then the audience decides the victor. Winners are declared systematically. If at the end of the time, one of the bots can no longer move or has violated the safety codes, then the other is the bot-triumphant. If both are still active after the time, then the three judges award 15 points each; five for aggressiveness, five for ability to inflict damage, and five for strategy, totaling 45 points. In the event of a tie, the audience decides.

The Future

This extreme sport of destruction and entertainment has spread to an international audience in the past few years as it has gained in popularity. The blueprints are being laid out for a permanent San Francisco location (some events have been held in Las Vegas), along with regional events and larger-

scale productions. Television has provided the forum for BattleBots, and it is now being viewed on Comedy Central in the U.S., the Comedy Network in Canada, BBC2 in the UK, and on PrimeTV in New Zealand. Robotic cousins such as those in BotBash (Phoenix, AZ) and RobotWars (San Francisco, CA) have also opened up new venues of exposure.

BattleBots is used as an educational tool in many ways and continues to reach out to the younger generation. During the competitions, there are different clinics teaching skills such as welding and the safe use of wet-cell batteries. BattleBots, Inc. is looking at the possibility of visiting high schools and running competitions commencing with BattleBots IQ. The organizers feel that beyond just the excitement of the battle lies the opportunity to learn about engineering, physics, and other valuable skills.

To find out about how to get involved with BattleBots or about the pre-existing bots themselves, visit their Web site at www.BattleBots.com. The site has tips on how to build a bot, get sponsorship, and a complete listing of the rules and regulations. You can also find out about upcoming events. **P**

BUY BONDS

ELECTRONIC GAMES

BP69—A number of interesting electronic game projects using IC's are presented. Includes 19 different projects ranging from a simple coin flipper, to a competitive reaction game, to electronic roulette, a combination lock game, a game timer and more. To order BP69 send \$4.99 clearance (Includes s&h) in the US and Canada to **Electronic Technology Today Inc., P.O. Box 240, Massapequa Park, NY 11762-0240**. US funds only. Use US bank check or International Money Order. Allow 6-8 weeks for delivery. MA07



YOU CAN WIND YOUR OWN COILS?

There's no trick to it except knowing what you are doing. In a unique, 106-page book you can become expert in winding RF, IF, audio and power coils, chokes and transformers. Practically every type of coil is discussed and necessary calculations are given with the mathematical data simplified for use by anyone. Get your copy today!

Mail coupon to:

Electronics Technology Today, Inc.
P.O. Box 240
Massapequa Park, NY 11762-0240

Please send me my copy of *Coil Design and Construction Manual* (BP160). I enclose a check or money order for \$8.99 to cover the book's cost and shipping-and-handling expenses. NY state residents must add local sales tax.

Name _____

Address _____

City _____ State _____ ZIP _____

All orders must be paid in U.S. funds only. Sorry, no orders accepted outside of USA and Canada. Please allow 6-8 weeks for delivery. **ET07**

Should You Upgrade Your Operating System?

Computer users are faced with this question every time Microsoft, Apple, or one of the other operating-system developers releases a new version. It's a crucial question.

Answering "yes" could make productive new operating-system tools available to you, or it could create headaches if your existing programs or devices aren't compatible with it. Answering "no" could save you money and avoid hassles, or it could prevent you from upgrading your other programs.

The big operating-system buzz these days for Windows users is the upcoming release of Windows XP, which represents a convergence of Microsoft's business and consumer operating systems and is thus the successor to both Windows 2000 and Windows Me. Due out later this year, it's designed to work with a wide array of programs and devices, unlike Windows 2000.

Running through a beta, or test, version revealed some welcome additions. For example, there was an Internet firewall to keep intruders out—as well as a roll-back tool, first featured in Windows Me, that lets users restore previous system settings if they get corrupted.

Windows XP is marred, however, by a draconian new scheme to prevent unauthorized sharing of the program. Upon installation, the new operating system generates an ID number based upon your system's configuration and transmits it to Microsoft. Change your system's configuration, and you'll have to do this all over again. It would be in everyone's best interest for Microsoft to shelve this before it finalizes the program.



Welcome to the house that Bill built. Microsoft's Homepage features the latest and greatest—Windows XP. Is it as good as the hype? You decide.

However, the biggest benefit of Windows XP, compared with Windows Me and previous consumer versions of Windows, is beefed-up security and crash resistance.

CAN'T WE ALL JUST GET ALONG?

Incompatibility with many popular software programs and hardware devices has always been the biggest problem with each business version of Windows, from Windows 2000 back through various iterations of Windows NT.

On the other hand, one of the strengths of Windows Me, the successor to Windows 98 and 95, is its compatibility. This hasn't prevented many

people from having compatibility and other problems anyhow. Though my own experience has been positive, reports in the computer press and user forums reveal that others have faced installation snafus, shut-down glitches, system crashes, and problems running existing software and hardware.

The various flavors of Windows continue to wield monopolistic dominance. Despite the U.S. Justice Department's ongoing antitrust case against Microsoft, worldwide shipments of Windows grew from 89 to 92 percent of all operating systems shipped last year, according to market-research firm IDC.

Still, Windows isn't the only game in



Once upon a time...IBM still is a force to reckon with and the company has shown its willingness to share its wealth of industry knowledge. The corporate Web site offers links to Linux—the crown jewel of the open-source domain.

town. Macintosh users on the cutting edge, however, are also experiencing upgrade annoyances. The recent release of Mac OS X, which for dedicated Mac users was an excruciating seven years in the waiting, improves memory management and crash resistance—and it has problems.

OS X initially lacked features important to many Mac users, such as creating CDs; and it can be slow switching among open programs. A recent update fixed the first problem, but not the second. There's also a dearth of OS X-optimized software, though development here is reported to be brisk.

The Upstart system Linux has also undergone a major makeover lately. Like Windows 2000 and Windows NT, Linux has suffered from lack of support for many popular hardware devices. The newest version of the Linux core adds compatibility with USB devices, software modems, and 3-D video cards.

Reports indicate, however, that both the installation and configuration of Linux are still more difficult than in Windows or Mac operating systems. Despite increased development, Linux users still lack a wide choice of programs.

KEEPING UP WITH THE JONES'

One of the realities of any operating system upgrade is that it's a hit-or-miss proposition. Checking the Web site of the operating-system developer for supported hardware and software,

however, can minimize problems.

If you're responsible for other computer users, then upgrading operating systems can create a support nightmare. This is why many organizations have stuck with older versions such as Windows 95. As has happened in the past, however, operating system and third-party software vendors seem in cahoots to force you to upgrade.

The latest version of *Microsoft Office* no longer supports Windows 95. Norton Internet Security 2001 doesn't work with the first version of Windows 95. Microsoft has even discontinued all free support calls about Windows 95.

One often repeated tip is to avoid upgrading an operating system until the release of the first maintenance patch, which is designed to fix the bugs not caught during beta testing.

Another tip is to avoid an operating system upgrade until you buy a new computer that comes installed with it, unless upgrading is necessary to run new versions of your programs.

INTERNET INFORMATION

For those of you who are looking to upgrade but want to explore further before finally going through with it, the Web sites for the different operating systems have a plethora of useful information. Usually highlighting the latest system, the sites are easy to navigate and well designed. They list the new features with a description of their purpose and what requirements must be met before upgrading is possible, such as RAM prerequisites, the

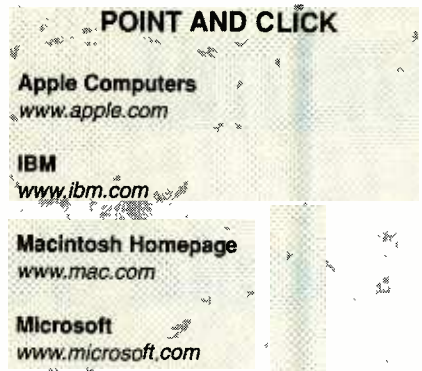

necessary drive, and peripherals.

Visit the IBM Web site, www.ibm.com, to connect to the Linux operating system. There is free public access to support and the actual downloads. The Apple Web site is similar at www.apple.com, as is the direct access to Mac OS X, at www.mac.com. The site lets you view the program and its abilities through a virtual theater. Carefully laid out into specific sections, the site gives you detailed information on the numerous new applications, the progress the system is making, and ways to customize your Apple software right there through the Darwin subdivision.

The Microsoft Web site, www.microsoft.com, helps you understand your operating system. Beyond just an overview of the system and its features there is a list of related products and books available to further your abilities to work with the software.

Reid Goldsborough is a syndicated columnist and author of the book *Straight Talk About the Information Superhighway*. He can be reached at reidgold@netaxs.com or <http://members.home.net/reidgold>. 

**Yours for only
\$3.99**

**Price includes
shipping!**



HAVE A THOUSAND YUCKS FOR ONLY THREE AND A HALF BUCKS! That comes to one-third of a cent per laugh. Electronics Comics is a compilation of over 125 riotous, outrageous and phenomenal cartoons that appeared in **Popular Electronics** and **Electronics Now**. Only **\$3.99**—price includes shipping. **Claggg, Inc., Reprint Bookstore, P.O. Box 12162, Hauppauge, NY 11788.** All payments in U.S. funds. Sorry, no orders outside U.S.A. and Canada. Check or money order only—send no cash. NY state residents add applicable tax. **MA04**

NEW GEAR

For more information go to page 64A

or e-mail: requests@berkshire-is.com

USE THE FREE INFORMATION CARD FOR FAST RESPONSE

Portable Analyzing Tool

A Linux-based handheld PC, *CANpak* (\$2495) allows users to easily monitor or control systems that use CANbus—a serial data communications bus for real-time applications. The pull-down menu selections monitor bus activity, filter and send relevant messages only, and examine message statistics. Consisting of a COMPAQ IPAQ handheld computer, an IPAQ Expansion Pack, a Janz CANcard, and control software, the small, lightweight *CANpak* can easily be carried in a pocket.

SAELIG COMPANY INC.

1193 Moseley Rd.

Victor, NY 14564

716-425-3753

www.saelig.com

CIRCLE 60 ON FREE INFORMATION CARD



SDRAM Chips

This series of 256-Mb SDRAM chips, the *W942504AH-7*, *W942508AH-7*, and *W942516AH-7* (\$10 each) all feature double data-rate (DDR) architecture designed to improve computer and server performance. The pipelined, multibank architecture allows for concurrent operation, providing twice the bandwidth and doubling the transfer rate—two data transfers per clock cycle. Other features include a 2.5-volt power supply, up to 143 MHz-clock rate frequency, and 66-pin TSOP packaging.

**WINBOND ELECTRONICS
CORP. AMERICA**

2727 North First St.

San Jose, CA 95134

800-677-0769 or 408-943-6666

www.winbond-usa.com/purchase/

CIRCLE 62 ON FREE INFORMATION CARD



Capture That Data

Designed for field data collection, the *Analog Data Capture Module (Model ADC-405)* (\$239) features a 12-bit output at a maximum sampling rate of 69 kHz. Its built-in peak detector and analog meter lets users set the input voltage for full dynamic range without clipping. Using a laptop or notebook host computer, the software first captures the data to memory and then writes the data to a disk. The included rechargeable batteries provide independent operation, and the cast-aluminum enclosure helps shield it from unwanted signals.

TDL TECHNOLOGY, INC.

5260 Cochise Trail

Las Cruces, NM 88012-9736

505-382-3173

www.zianet.com/tdl

CIRCLE 61 ON FREE

INFORMATION CARD



Cellular Antennas

Designed to maximize performance of fixed-installation hands-free cell-phone kits, the *CFR 903* (\$59.95) and *904-906* (\$64.96) *Cellular Car Antennas* all feature dual-band frequencies for PCS and AMPS. Quickly and easily mountable, these cellular antennas come bundled with 16½-feet of pre-terminated coaxial cable with an FME connector and a mini-UHF adapter. Each unit, except the *CFR-903*, is exterior mountable, with a through-glass coupling box and cable connections.

**TERK
TECHNOLOGIES**

63 Mall Drive

Commack, NY 11725

631-543-1900

www.terk.com



CIRCLE 63 ON FREE INFORMATION CARD

Pocket Tools

Need compact tools that fit your hand comfortably and feature full-size, open-end wrenches? These fold-out pocket tool sets, which come in two versions—inch (*304.001*) and metric (*304.002*)—and sell for \$15 and \$16, respectively, fill the bill. Constructed of nickel-plated, high-carbon steel, the sets include three Philips screwdrivers, a scratch awl, and five wrenches.

JENSEN TOOLS, INC.

7815 S. 46th St.

Phoenix, AZ 85004-5399

800-426-1194

or 602-453-3169

www.jensentools.com

CIRCLE 64 ON FREE INFORMATION CARD



It's Programmable!

Suitable for all types of power component testing, the *61600 Programmable AC Source* (from \$2495) is a versatile tool that can simulate any input power requirement of an electronic device or subsystem. It features peak current capability at six times the RMS level and very little distortion (0.3%). Its 16-bit (4½-digit) resolution provides accurate measurement of voltage and current.



CHROMA ATE

7 Chrysler

Irvine, CA 92618

800-478-2026

www.chromaate.com

CIRCLE 65 ON FREE INFORMATION CARD

Multifunction Calibrator

The *Precision Multifunction Calibrator, Model 422123* (\$499) is an accurate calibration source for a wide range of inputs, from thermocouple to frequency. Users can easily set output steps from 1% to 100%. Additional features include a large 5-digit, LCD, step and auto ramp, an alarm, and a self-contained loop power supply. The 3½ by 6½ by 1 (approximately) calibrator comes with a 9-volt battery, external battery pack, case, alligator clips, and test cables.



EXTECH INSTRUMENTS
CORP.

285 Bear Hill Road
Waltham, MA 02451-1064

781-890-7440

www.extech.com

CIRCLE 67 ON FREE INFORMATION CARD

High-Speed Board

An ultra high-speed analog input board for CPCI bus computers (\$1399), the *CPCI-DAS4020/12* offers high-performance data acquisition using four 12-bit analog inputs with sample rates up to 20 MHz.

Each input channel has an independent A/D converter, thus allowing all four inputs to be sampled simultaneously. The *CPCI-DAS4020/12* is bundled with the *InstaCal* software package—a complete installation, calibration, and test program.



MEASUREMENT
COMPUTING CORP.

16 Commerce Blvd.
Middleboro, MA 02346
508-946-5100

www.measurementcomputing.com

CIRCLE 66 ON FREE
INFORMATION CARD

Keep Plotting

With 3-D capability, *Tecplot 9.0* (\$1395) is a technical plotting software package that quickly creates precise plots, regardless of where the data comes from. Featuring *Open GL*, *Tecplot 9.0* interactively visualizes and practically flies through 2-D and 3-D data sets consisting of millions of data points. Up to 100 times faster than V. 8.0, the true color and translucency of this version offers more impressive plots, animations, and presentations.

AMTEC
ENGINEERING INC.

P.O. Box 3633

Bellevue, WA 98009-3633

800-763-7005

or 425-653-9393

www.amtec.com

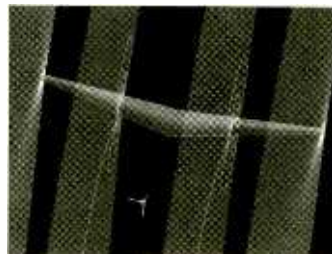

CIRCLE 68 ON FREE INFORMATION CARD

EEPROM Products

Featuring a 10-MHz clock rate, the 32K-bit *CAT25C32* and *CAT25C33* and the 64K-bit *CAT25C64* and *CAT25C65 SPI EEPROMs* (\$1.50 in single quantities) operate with power supplies ranging from 1.8 volts to 6.0 volts. The C32 and C64 models have four memory-block protection modes, and the C33 and C65 models have six. Memory can be partitioned into segments with different levels of write protection.



CATALYST SEMICONDUCTOR

1250 Borregas Ave.

Sunnyvale, CA 94089

408-542-1000

www.catsemi.com

CIRCLE 69 ON FREE INFORMATION CARD

Radio Signals And The Great Pyramid

B.K. BAYLES

This article is about a radio lover's fantasy. We will talk about the proposed theory of energizing the passages of the Great Pyramid with radio signals to build a triode amplifier and generate electricity. In today's climate of skyrocketing utility costs and apparent energy crisis, it is perhaps worth the effort to read and imagine the potential of this theory. Of course, the average reader would not have the chance to tinker with the Great Pyramid, but the practical methods discussed in the following article can be applied to the backyard lab.

The concept of stone reacting to radio signals isn't foreign to the ham operator. Stone is the major component of Earth, and entire books are dedicated to grounding to the earth for proper radio reception. Rocks above the ground aren't well studied, since there's been no practical reason to do so. My spouse and I, however, built a 330-ton house out of sandstone blocks and for five long years those things cluttered the yard. It became apparent that the above-ground rocks were also reacting to antennas and radio equipment, so it was only natural for this radio and electronic hobbyist to experiment and see how radio and rocks can be intertwined. (See the review of their book on this subject *Electric Stone: Exploring the Reaction of Rock to Electricity* in the November 2000 issue.)

There are a few things to understand about rocks before working with them. First of all, stone must be at least 76° F for it to be played with because stone is paramagnetic, meaning its electrons line up in a magnetic field only when a certain temperature is met. The

main ingredient in limestone, calcium, has a specific heat of 76° to 752° F. Rocks won't do a thing unless they are at least that temperature. Because 76° is pretty cool, it's best to aim for a warmer temperature so that the experiments won't turn off in the evening at an inconvenient moment. This won't be a problem in a desert climate.

With sobering threats of a world-wide energy shortage, one inventor offers a possible alternative to our current energy production methods.

Limestone consists largely of calcium carbonate, a material used to make everything from Tums to toothpaste. It is an igneous

rock, created when molten materials beneath the Earth's surface were pushed to the surface and cooled. As the rock chilled, the Earth's magnetic field became imprinted in the hot stone. Scientists take advantage of this fact when they want to know how old a rock sample is. The Earth has moved on its axis no less than seven times throughout history and when a rock sample is analyzed, the direction of its field correlates with one of those magnetic fields, signifying the

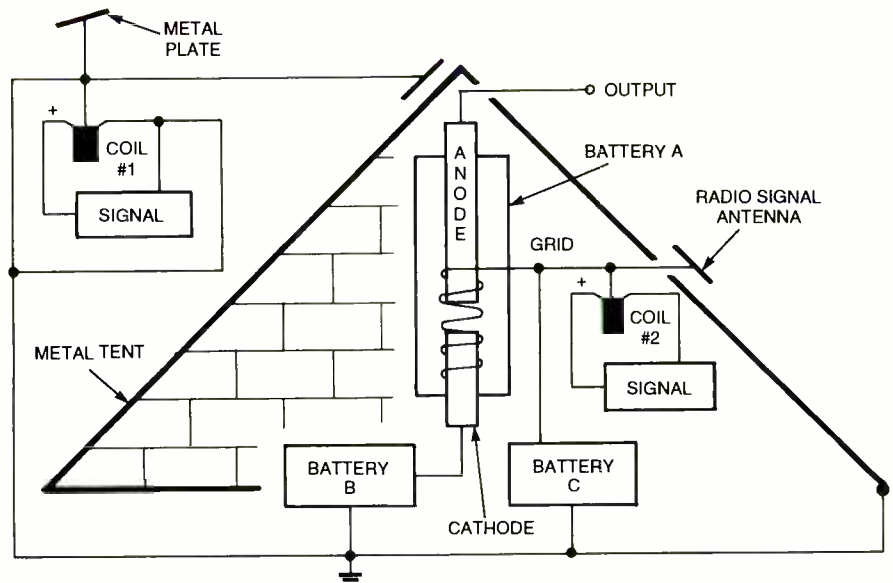

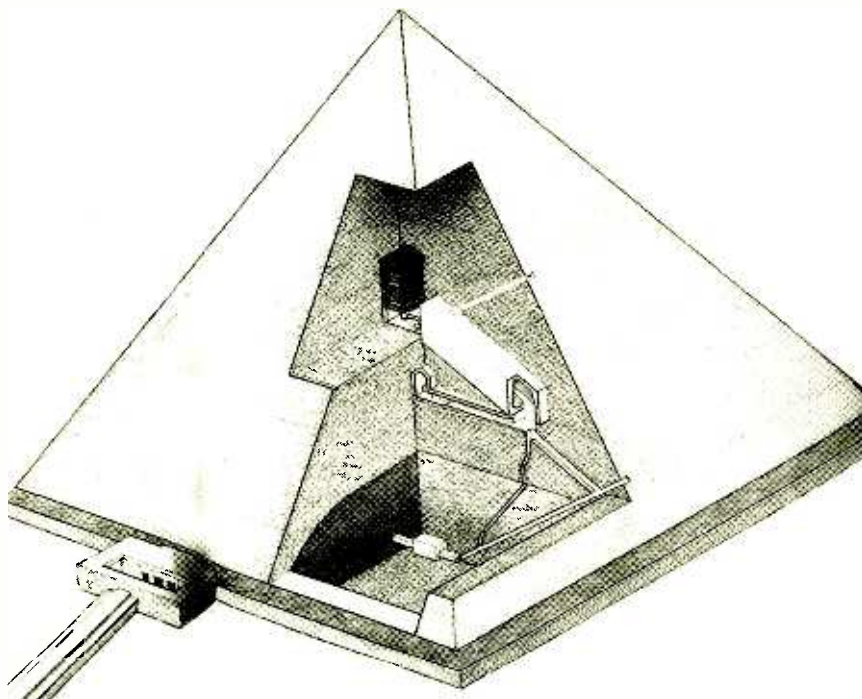

Fig. 1. Here is a cut-away view of the Great Pyramid at Giza. Note the separate chambers that the author references. Were these passages purposely constructed in order to provide a current path for massive amounts of energy? You be the judge.

rock's age.

Sedimentary rock, like sandstone, was created when pressure from an ocean of water or a ridge of Earth compressed particles of rock, squeezing them together into a solid structure. It would not be amiss to think of sandstone as Nature's cement, and, like any cement, it is only as good as its ingredients. A sandstone rock will contain impurities such as dirt and minerals.

One of the ways that a rock expert determines whether the sample he's holding is limestone or a dolomite of some sort is to put the stone into a vat of hydrochloric acid. If the rock dissolves, then it is a calcium or magnesium carbonate rock. Unless it's a very soft stone, hydrochloric acid isn't going to dissolve the rock a whole lot—just enough to create bubbles on the rock's surface.

The Chemical History Of Stone.

When limestone is crushed and heated to a high temperature in a kiln, or calcined, it becomes a substance known as lime. Lime makes a great mortar, and the ancients well knew the preparation, properties, and uses of lime. Marcus

Vitruvius Pollio, who lived during the reign of Augustus, wrote *De Architectura* in which he described lime and its effects. Vitruvius had noticed that when lime was removed from the kiln it was as bulky as the original limestone, but it weighed much less, having "lost about one third of its weight owing (he thought) to the boiling out of water." Vitruvius was right about one thing; the rock did weigh much less after the kilning process.

However, it was Dr. Joseph Black who discovered what really left the rock and made it lighter. Joseph Black was a British chemist, and in 1754 he discovered carbon dioxide. Black called his discovery "fixed air" and proved that this is the substance that escapes lime to leave it lighter. He described these experiments in a paper entitled *Experiments upon magnesia alba, quick-lime, and some other alkaline substances*. The release of carbon dioxide from lime makes it more alkaline, a process known as *causticization*.

Sir Humphry Davy was the next eminent scientist to experiment with limestone in the early 1800s. Davy was into finding elements, which meant separating the "parts"

out of the finished product. It would be like trying to remove the eggs from a finished cake, a very tricky process! Davy tried electrolysis on lime, but he found that it didn't separate easily. Figuring the oxygen needed to be relieved from the lime first, he tried a series of experiments and was finally successful when two Swedish scientists suggested mixing moist lime with mercury oxide. Davy made an electrode in this mixture by forming a little hollow spot in the substance and filling it with liquid mercury, and then he jabbed the positive battery wire into the mercury. It worked; the mercury boiled out and calcium was left. Truly pure samples of the metal weren't obtained until around 1900 by French chemist Moissan. In this way, electrolysis was found to be necessary when working chemically with stone. Electrolysis will be further discussed later in this article.

Light And Sound. When limestone is heated to a very high temperature, the rock turns into lime. When lime is heated to a very high temperature it glows, and the lines of light it releases shoot out in a beam for a good distance. In the 1800s, this technology was employed to light theaters. Gas jets were used to heat sticks of lime that were aimed at the actors who "bathed in the limelight."

When electricity became the energy of choice for theater lighting, many actors stubbornly refused to give up their limelight, swearing that it put out a nicer glow. Actors even lugged limelight equipment to their performances well into the 20th century. Limelight is a powerful source of light energy that has been nearly forgotten in these high-tech days.

Experiments With Stone. Years ago when radio technology was new, builders had to literally dig the components they needed out of the ground! A rock was tested for electrical abilities by placing it in a holder to form ohmic contact and then probing its surface with a fine wire, or "cat's whisker," to form a junction. In this way, diodes were formed out of natural stone.

It is no mystery that only a tiny dab of electricity will run a crystal set, but the following experiment proves that stone will provide the electricity to do it. Just like any crystal radio set, a "stone radio" has no amplification so the stations you will hear are very weak.

Sink an iron bar into a stone, and then embed a nail within an inch or two of the iron bar. The bar acts as a rotor, and the nail acts as a stator. Stations are tuned in by hanging a crystal radio coil on the bar, turning the coil, and then listening for stations.

I've tried four separate crystal radio sets, by hanging them on a different side of the stone house; and all have worked to bring in some short-wave stations. My home is all sandstone of very good quality, and it was mined in an area known as Kansas Galena, a lead sulfide. Any crystal set will be only as good as its components are, especially its antenna, and will perform according to how far away the stations are. Again, it is imperative that the temperature of the stone is at least 76°, and the rock should be bathed in sunlight. Remember that even though the air temperature may be at least 76°, the stone is likely to be cooler.

Electrical Movement Created by Electrolysis. Radio frequency is 20Hz-20kHz, meaning energy flows back and forth in an energized wire at a rate of 20-20,000 times per second. As the frequency gets higher, "skin effect" comes into play. This effect occurs when a wire saturates completely at lower frequencies, and then as frequency increases, energy skims along the surface of the energized substance (the outer exposed surface of the rock) leaving the inside unaffected. This partly explains why alternating current is used to carve stone and direct current would be useless. We want the energy concentrated along the outside of the stone being carved.

Because calcium is a paramagnetic substance, the electrons in a calcium atom do not automatically leave it and race to a negative (-) pole (cathode) merely because it is there, the way electrons do in a stronger metallic element (ferro-

Outer Copper Skin

Insulating Layer

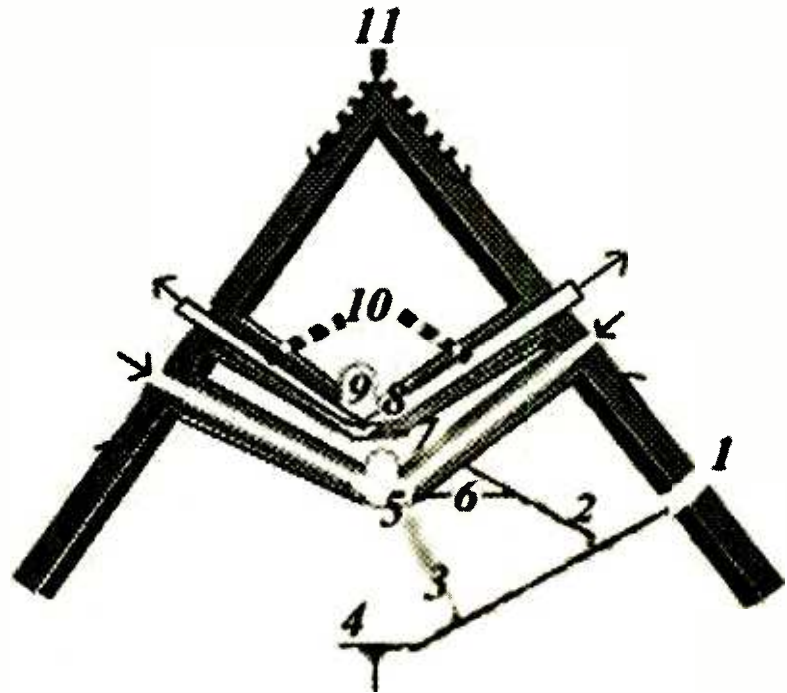

Fig. 2. The figure above shows the circuit-flow within the "Great Triode," as proposed by the author. An outer copper skin acts as a conductor for this enormous transformer.

magnetics, such as iron). Calcium electrons are uninterested in electricity until exposed to it, at which point calcium's electrons point toward the magnetic field. A freed electron has a negative (-) charge and it is attracted to the positive (+) (anode) end of the battery, producing a current. It takes high heat combined with radio frequency to create eddy currents that stir electrons between the electrodes. We can "cheat" and lower the required temperature by using some sort of current-carrying fluid between the electrodes.

This procedure has a lot in common with electrolysis. Electrolysis is used to separate metals such as silver and gold from impurities. Add heat to this process (electrolytic furnace) and metals such as aluminum, magnesium and calcium are processed.

Let's look at how electrolysis works. When electricity leaves a battery (or other source of direct current), it moves to an anode that is bathed in liquid that will pass electricity (electrolyte.) Electrons

move through the electrolyte to the negative terminal (cathode) that is connected back to the battery's negative terminal. A loop is created when positive ions in the solution move to the negative electrode and negative ions toward the positive electrode. However, rock carving is not done with "pure" electrolysis because that procedure utilizes direct current, and alternating current is required for use on stone.

There will only be as many electrons freed from the stone as there is outer, exposed surface on the rock. In other words, the bigger the rock the more potential energy within the stone. Additionally, impurities that will not energize are more likely to be overcome by large surface areas, so relying on a small rock to not have many impurities is not a good idea. This procedure is not a piezoelectric effect—it is *thermionic*, meaning it relies on temperature to produce results.

Muriatic acid is a cheap, low-grade hydrochloric acid that is fairly safe. **WARNING:** Follow all eye

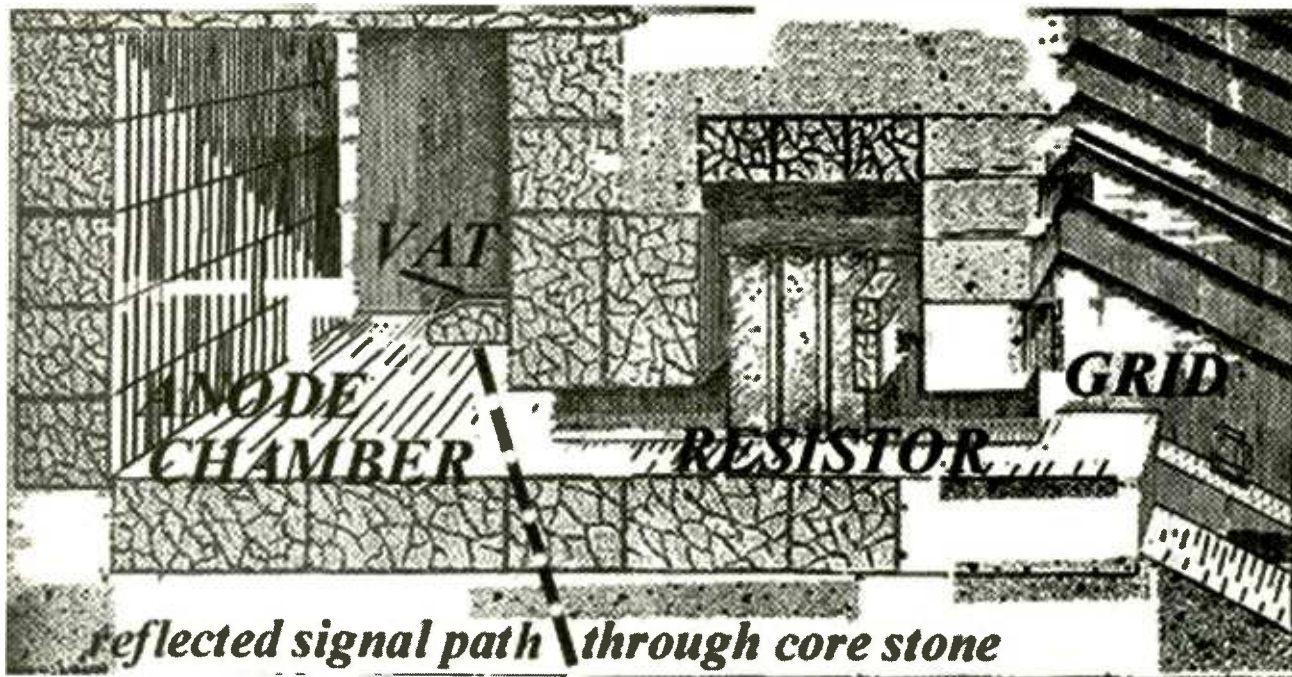

Fig. 3. Above is the author's conception of how all the pieces fit together within the Great Pyramid. A practical and much smaller prototype has been constructed in her yard, and tests have proven successful in producing energy.

and skin contact precautions, and don't breathe the fumes it puts off when you pour it onto the warm rock. Muriatic acid is conductive, and its slightly corrosive property makes it a good electrolyte for this experiment. Coat the surface of the rock with muriatic acid, and it provides electrical conductance. However, the rock will not react much to this weak acid without the addition of electricity. Make sure the acid goes into the cathode hole, and coats the cathode and the surface of the rock to allow magnetic movement on the rock's surface, but leaves an island of dry rock around the anode. Otherwise, the rock will short out and nothing will happen.

Semiconductors. A diode is a semiconductor, not a conductor like copper wire, but it will pass an electrical charge when properly prepared. Material used in the production of electricity will be a conductor, an insulator, or a semiconductor. Copper wire has a low resistance to the flow of current and is a conductor, while glass doesn't want to conduct electricity at all under normal conditions, making it an insulator. Rock is a semiconductor.

Commercial semiconductors are

usually made of germanium or silicon, substances which are unremarkable until they are "doped"—specific impurities are added to the substance to enhance performance. Doping allows a spare electron to drift freely through the lattice structure. A rather small number of electrons can be freed up in a semiconductor. This process leaves a hole where the electron used to reside, and that hole behaves as though it were positively charged. The electric field bathing the semiconductor causes both the negative electrons and the positive holes to move through the material, producing an electrical current. Rock is doped with heat, light, and acid.

Semiconductors are so called because they conduct less than conductors do. The current carried within a semiconductor is called n-type if most of the current is carried by the negative electrons and p-type if the positive holes are most abundant.

P- and n-type semiconductors flow through the medium at the same time, with electrons going to the voltage source's negative pole to (and out) the positive terminal. Holes start at the positive terminal and move to and out the negative terminal.

Neither n-type nor p-type semiconductors do much electrically on their own. If you take a slab of each and join them together and connect the voltage's negative terminal to the n-type and the positive terminal to the p-type, electrons will flow through the semiconductor, creating electrical current. This is called a forward-biased PN junction.

When a diode is forward biased, the current builds up slowly. Once the applied voltage exceeds the normal forward drop of the diode, watch out! It tries to pass all the current it can.

The diode will destroy itself in this process if resistance isn't built into the system.

What The Stones Say. Here are some conclusions proven by our experiments so far.

- Just a sliver of voltage is necessary to energize stone with radio waves.
- Heat and light are required for rock to absorb alternating current, but acid is not needed for this.
- Radio current by itself is not destructive to stone.
- When combining alternating

current with prepared, soft (i. e., unpolished) stone and acid, the stone will dissolve.

- To produce current flow, the anode, cathode, and aluminum wire cathode must not all share the same vat of electrolysis fluid, or current will pass back and forth between the electrodes and will not flow through the wire. Either a dry island must be left around the anode, or the wire can be hooked to a third electrode just outside of the fluid.

In conclusion, stone's best use when creating electricity is to absorb the signal required by electrolysis. Energy gained when electrons flow from cathode to anode is best gathered by photoelectric effect derived from a large metal surface area that is exposed to heat and light.

Applying What We've Learned. All an inventor needs is some gumption and lots of imagination. Armed with the knowledge of the effects of electricity on rock, we can now propose our theory—the Great Pyramid of Giza can be slightly modified in order to perform as a giant triode. Of course, the following blueprint can also be scaled down to a backyard project. So, let's take a closer look at the design of a massive vacuum tube. Figure 1 shows a cut-away view of the Great Pyramid.

Construction. The stones comprising the passages of the Great Pyramid are finely joined and can be sealed to form a vacuum. The existence of an anode, a cathode, and a grid within a vacuum creates a *triode* amplifier (a vacuum tube that takes energy in and makes it stronger). Each part of the amplifier is examined here in detail. Follow along with Fig. 2, as you read the following:

- A radio signal enters the pyramid through the descending (also called "underground") passage, where it performs two functions. It controls the grid, and it amplifies the signal to Battery A and the anode room.

- The signal is reflected so that it also enters into the ascending passageway.
- A 90° angle naturally occurs due to the nature of overlapping signals.
- The *extra path length due to reflection* in the descending passage is necessary to energize Battery C, which creates negative potential to drive the growth of the radio frequency through the core and grid.
- The descending and ascending passages, grid, and most of the anode and cathode chambers are of highly polished granite and marble, very hard surfaces that reflect electrons in order to create flow. There is, however, an unpolished depression in the wall of Battery A (the "niche" in the "Queen's Chamber"), and this allows electrons flowing upward through the unpolished core to enter Battery A. If Battery A had no break in the polished interior, then signals within the core would not connect well to this chamber.

The Great Pyramid of Giza can be slightly modified in order to perform as a giant triode.

Sulfuric acid pooled on the floor of Battery A heats up the room as the signal energizes the descending passage, travels up through core masonry, and releases into Battery A.

- Electrons leave Battery A by "spilling out" into the tunnel that connects Battery A to the grid. Fortunately, this tunnel is of polished stone; otherwise, the electrons would absorb into a matte finished tunnel and be lost. Battery B is located here between grid and cathode to "grab" the electrons and keep them moving into the "Grand Gallery" grid.

Something else is happening in Battery B. The walls are heating up, and carbon dioxide is dissipating from the stone. Calcining takes place after some time, and lime is the byproduct. Heat lime to *at least* 1500° degrees, and light is created in the form of limelight. Grid, resistor, Battery A, Battery B, Battery C, and

the core stones lying in the path of the reflected signal are all parts of the Great Pyramid that will be subjected to this action.

- Movement of electrons into the grid is speeded up by the radio signal bouncing off the grid's polished walls. Electrons are excited by the signal, and the grid heats up. As the electrons move upward to fill the void, they run into large polished stones that impede their flow and slow them down.
- The "Upper Passage" granite baffles serve a very basic function found in nearly every electronic circuit designed; they slow down the electron flow. They create a resistor.
- Electrons enter the anode room ("King's Chamber"). Signal reflection has continued through the core stone to the anode room. Electron flow has mostly followed the grid, but overlapping radio signals still energize the core stones between Battery A and the anode room where a vat ("the sarcophagus") of acid awaits. It is energized with alternating current from both the underneath core masonry (*dotted line on cover illustration*) and by an identical signal entering the anode vent, creating the electrolysis action needed in the vat of acid. The combination amplifies signal within the vat, providing the grid is properly tuned. An untuned grid will stop electron flow.
- Two heavy, insulated metal cables dropped into the vat create anodes. Electrons flow through the cables, which are strung through the north and south air vents (that are also channeling light from very heated and calcining stone) to the outside of the pyramid, where the cables are tapped for use. The radio signal is transmitted into the north vent, and this signal is the same frequency as the one entering the descending passage.
- The outer skin, energized by light and heat, reacts to difference in potential and moves to the two

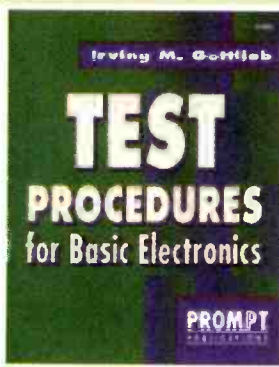

Test Procedures for Basic Electronics. #61063. — \$19.95
Many useful tests and measurements are covered. They are reinforced by the appropriate basic principles. Examples of test and measurement setups are given to make concepts more practical. 7 3/8 x 9 1/4", 356 pp, paperback.

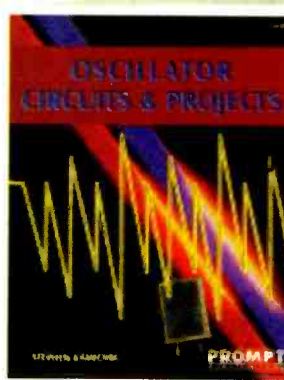

Oscillator Circuits and Projects. #61111. — \$24.95
A Textbook and project book for those who want to know more about oscillator circuits. You can build and enjoy the informative and entertaining projects detailed in this book. Complete information is presented in an easy-to-follow manner. 7 3/8 x 9 1/4", 249 pp, paperback.

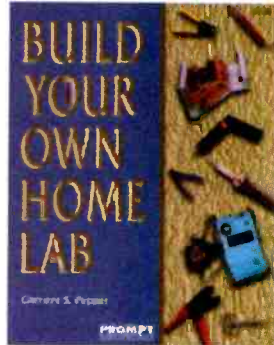

Build Your Own Home Lab. #61108 — \$29.95
Shows you how to assemble an efficient working home lab, and how to make it pay its own way. Includes projects for creating your own test instruments too. 7 3/8 x 9 1/4", 249 pp, paperback.

Troubleshooting and Repair Guide to TV. #61146. — \$34.95
Repairing and troubleshooting a TV is very simple and economical with help from the information in this book. It is the most complete and up-to-date TV repair book available, with tips on how to handle the newest circuits. 8 1/2 x 11", 263 pp, paperback.

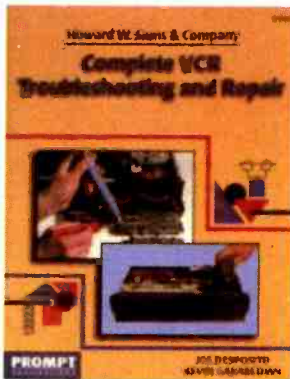
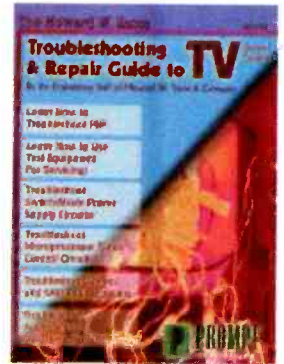

Complete VCR Troubleshooting and Repair. #61102. — \$34.95
Though VCRs are complex, you don't need complex tools or test equipment to repair them. This book contains sound troubleshooting procedures that guide you through every task. 8 1/2 x 11", 184 pp, paperback.

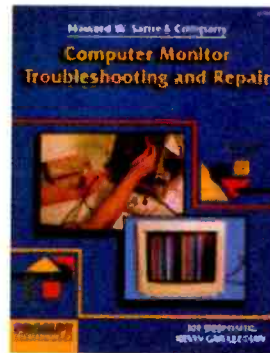

Computer Monitor Troubleshooting and Repair. #61100. — \$34.95
This book can save you the money and hassle of computer monitor repair by showing you how to fix it yourself. Tools, test instruments, how to find and solve problems are all detailed. 8 1/2 x 11", 308 pp, paperback.

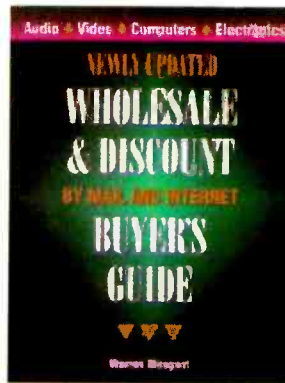

Wholesale & Discount Buyer's Guide #CP-1. — \$19.95
Save up to 90% off list prices. Audio and video equipment and materials; electronic products and surplus; pro recording and specialty items; computers and components. Source listings include complete address, phone, fax, e-mail and website addresses. 8 1/2 x 11", 72 pp, paperback

Joe Carr's Circuit Toolkit. #61181. — \$29.95
Easy-to-build, useful circuits from Carr's workbench to you. They will spark new ideas in your day-to-day use of circuits and help solve frustrating problems. 256 pp, paperback. Contact Jim Surface.

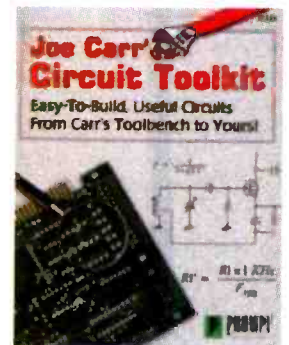

Please circle the products you would like to buy on the page above, calculate the total cost, include shipping charges, using in the form below and send it to us. Please allow 4 - 6 weeks for standard delivery.

Name: _____
Address: _____
Zip: _____ Telephone: _____
I have enclosed my check for \$: _____
Signature: _____

Please charge my credit card for \$: _____ Number: [] [] [] [] [] [] [] [] [] []
Card Type: _____ Expiration Date: [] [] [] [] [] []
Mastercard, Visa or Discover only

Note: The delivery address and the address at which the credit card is registered must be the same.

SHIPPING CHARGES IN U.S.A.

CANADA ADD \$5.00	
1 Book	\$ 5.00
2 Books	8.00
each add'l book	3.00
2 Day UPS	\$10.00 extra
Next Day UPS	\$20.00 extra

SORRY No orders accepted outside of USA & Canada No. of Books Ordered

Total price of books.....\$.....
Shipping (see chart).....\$.....
Subtotal.....\$.....
Sales Tax (NYS only).....\$.....
Amount Enclosed.....\$.....
All payments must be in U.S. funds!

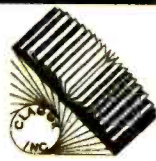

Claggk Inc.
PO Box 12162
Hauppauge, NY 11788
Tel: 631-592-6720
Fax: 631-592-6723
email: claggk@gersback.com

cathodes. The cathodes are connected to the outer skin, while the anode cables are insulated from the skin.

Grid. Now, let's examine the grid. A vacuum amplifier could be made without a grid, but the machine could not be turned off without it. It would appear to be running along beautifully before you noticed that the stones really are getting hot. Calcination would make the rocks in the passages glow first, but before you knew it, even the outside rocks would be "on fire" with heat and light. You could only stand by helplessly as the reaction continued until all its fuel was spent. The result would be a major meltdown of the inner core and outer covering into a fine sand or dust. The core would still be standing since Battery B would break through the vacuum before the core burned up, but the entire outer shell and a good portion of the inner core would be dust.

The signal to the grid is the "knob" that is turned to fine-tune current outflow. The signal from a juiced-up transmitter would probably be all that we need, plus only little variations in signal are needed to control the grid.

The north anode air vent intersects the top of the grid. Alternating current is required to move electrons at the anode, so this is a very fortunate setup. It assures us that electrons will flow toward the anode.

The stones that create the junction between the descending and ascending passages are polished and securely joined. If the descending passage were filled to that junction with fluid—again, sulfuric acid would be best—the signal would bounce up into the grid. The acid would allow Battery C to function, and once the machine was operational the acid could be replaced with a solid reflective surface, such as a mirror or highly polished stone.

Three granite plugs were placed in the ascending passage right

where the passage turns into grid. The plugs would be necessary to create the vacuum; but until the machine kicked in, which could take days, weeks, or even months since we're talking semiconductors here, they wouldn't need to be in place until the anode and the cathode begin heating up. Access to the passage may be needed for refilling the cathode chamber floor, Battery B, and the anode vat with acid. When the flow begins, these structures will heat up very quickly, possibly too quickly to get out safely so this risk must be factored in.

Once the grid is plugged, the

The Great Pyramid is perfectly suited for heating the cathode using chemical action.

plugs will not impede signal to the grid. The ascending passage is limestone block that will pass the signal even with other blocks are plugging the passage.

The grid is very large, so that electrons can build up to create heat and light. Additionally, the core masonry above the grid weighs so much that a flat roof would cave in. The room hasn't collapsed because the weight of the overhead core stones is spread evenly over the high ceiling.

Cathode. To review, a cathode (negative electrode) is a heated filament or tube that emits electrons due to the fact that it is hot (a process called thermionic emission.) Electrons flow into any electrical system via this electrode. The anode is the name given to the spot where electricity leaves the system. Conventional electronics uses wire to connect the anode, cathode, and other components together to create electron flow.

Metal wire is not needed to conduct electron flow inside the pyramid, because the properties of stone are used instead. Polished stone reflects electrons, and alternating current that is strongest at

the anode assures that the flow will move to it.

The cathode does not create electron flow by its mere presence, but it must be heated. As electrons are shed in the form of heat, more are drawn in to replace them. Electron flow will be established through the cathode. We can expect a trickle of electron flow to begin moving up the signal path through the core (dashed line on cover illustrates this path.)

The cathode may be heated with electronic devices, but the Great Pyramid is perfectly suited for heating the cathode using chemical action. The floor of the Battery A is sunken, so it can be used as a pool to hold sulfuric acid mixed with water. When limestone is exposed to sulfuric acid, the stone heats up.

Expect Crystals to Grow. It's interesting that crystals found on the walls and ceiling in Battery A were mostly calcite (calcium carbonate) with some halite (salt) and gypsum (calcium sulfate). Gypsum is produced in nature by volcanoes, through the action of sulfuric acid on calcium-containing minerals such as limestone and sandstone. A form of sedimentary rock, gypsum, is frequently associated with halite (rock salt). The action of sulfuric acid on limestone produces gypsum.

Halite is the mineral form of common table salt. It is often found associated with many compounds including gypsum and calcite.

Sulfuric acid is a substance that isn't that hard to come up with. Sulfuric acid releases a considerable amount of heat when it is mixed with water, and it can be obtained by heating naturally occurring sulfates to a high temperature and then dissolving the product in water. Iron vitriol (hydrated ferrous sulfate) can be distilled with sand to make sulfuric acid also. Another method is to burn sulfur and potassium nitrate in a ladle suspended in a large glass globe

About the Author: Brenda Krkosska Bayles writes nonfiction booklets, including *Electric Pyramid; How to Use the Great Pyramid to Create Electricity*, *Electric Stone: Exploring the Reaction of Rock to Electricity* and *The New Age Science Series*, which examines physical science and The Theory of Everything. She lives near Toronto, Kansas with her husband and four children, and received her first electronics training two decades ago as a novice (KA0DSD) ham radio operator.

partially filled with water.

Nevertheless, when we pour an acid/water mix onto the battery floor, we can expect gypsum and salt both to be created because salt can be prepared from sulfuric acid.

Hydrochloric acid is very close to sulfuric acid in composition, and it may be made by the reaction of sodium chloride (salt) with sulfuric acid. In a water solution the molecules ionize and become positively charged hydrogen ions and negatively charged chloride ions. Because it ionizes easily, hydrochloric acid, like sulfuric acid, is a good conductor of electricity. Crude industrial hydrochloric acid is called muriatic acid.

Calcite, CaCO_3 , is an inorganic carbonate that occurs in nature, and when treated with hydrochloric acid, it is effervescent. It also decomposes when heated, yielding CO_2 and, usually, a solid metal oxide.

Batteries. Let's examine two of the batteries. The electrons must have a flow already established to entice them onto the grid, otherwise they will meander aimlessly around the cathode chamber. Battery B has its cathode (negative) end grounded, of course, and then acid is poured into the tunnel going to ground, filling the whole "Grotto" all the way to the passage. Note in the picture that Battery B's cathode is located at *ground level*. This is because the core stones are surrounded by air, not ground, so they are semiconductors. Ground is only located here inside the natural ground.

Therein lies a problem. The passageway that today links the descending passageway to Battery B was forced by explorers through a crack; it was not part of the original design. It is here that we find the fatal flaw that will eventually turn our machine off. The path of electron flow created by the signal through core stones physically moves electrons up to the cathode room. Electricity will always seek the path of least resistance, and Battery B lies just to the right of the electron flow. Inevitably, little elec-

tron trickles will begin to flow that way also, dissolving rock and leaving a fine powdered rock residue in its wake. Fortunately, this is where natural ground is at its highest point underneath the Pyramid's core stones. By raising the ground line for Battery B as high as possible, we've bought some time before an inevitable fissure breaks through to Battery B and destroys the vacuum. Someone placed a plug in one of the fissures in the descending passage, but the process that creates fissures ensures that more will be created. For whatever reason, the other fissures that formed were not plugged; and they will have to be repaired to recreate a vacuum inside the pyramid. We will close

It would be like having a constant wind or a constant waterfall, a source of electromotive force that unlike wind and water would be constant and predictable.

the cracks and the forced passage ("fracture zones") with a mortar high in iron, such as a 25% portland cement, 25% masonry cement, and 50% sand mixture to strengthen the corner where the signal first enters core stone. Battery B supplies energy to the grid through the tugging action it creates at the cathode room and the tunnel that leads to it. The smallness of the tunnel amplifies this action.

Battery C is necessary to maintain the difference of potential between anode and cathode. Only a small negative voltage is required from Battery C, or else it will turn off the grid. This small battery should suit the purpose.

The "pit" is of unpolished, matte stone because it is providing electrons. If it were polished, then this battery would not work because electrons would not pull up through the ground. In time, flow through Battery C would be established just as flow establishes itself through the core masonry from ascending passage to Battery A. If Battery C does not create a difference in potential with a good ground, then the pyramid will not work. However, the best

indication of a good ground is having it sunk very deep into the earth, as Battery C is, so it should be an excellent battery.

As with all electrolysis-performing anodes, alternating current must energize the anode for flow to be created. Signal reflecting into the descending passage satisfies this requirement for Battery C.

Hooking Up to the Great Pyramid.

The working rock structure will generate a tremendous amount of heat. Rock calcines at no less than 1500° , and the insulating properties of stone will cause enough heat to release carbon dioxide from the stone. The stone will glow even at night, since it would take weeks for that stored heat to dissipate.

What a great lighthouse the Great Pyramid would make. In fact, Alexandria, Egypt did have a lighthouse that was one of the Seven Wonders of the Ancient World.

The Pyramid As A Dynamo.

As energy is gathered on the outside of the pyramid, the energy will be reabsorbed into the core if it is not insulated from the unpolished core stones. If the hard smooth limestone casing stones had not been removed from its exterior, then energy would have gathered along the four sides, in the built-in centered depressions. Since the Tura limestone skin is gone, metal will be used instead.

Two heavy cables made of insulated copper will be placed in the south and north air vents in the anode room. The cables will need to be heavily shielded with a thick rubber insulation to keep them from touching the stones comprising the vent and the outer skin. These cables must not occlude the vents, because they are also needed for air and ion exchange. The cables (with uninsulated bare metal ends) are dropped into the anode vat. With the other end of the cable connected to load (the existing electrical grid that supplies Cairo), electricity is tapped for use.

Another possibility for capturing energy exists here. The vacuum created within the pyramid is sucking air into all four of the Great

Pyramid's vents with tremendous speed and pressure. It would be like having a constant wind or a constant waterfall, a source of electromotive force that unlike wind and water would be constant and predictable. Perhaps the great electricians who will help us turn the pyramids on will tap the air intake flow for everything from pumping water to turning turbines.

The placement of step-down transformers within the field lines created by the Great Pyramid is the next logical step to harnessing the energy, treating it as a giant transformer. Aside from a common ground, two coils do not have to be connected for the second one to retrieve energy from the first. A properly tuned coil will "ring" with energy it picks up from any source. This technique provides a wireless approach to harnessing energy.

There are other rock structures very close to the Great Pyramid, particularly two other immense pyramids. They are so close to the Great Pyramid that their rock skins will be picking up emanations from the Great Pyramid in the form of alternating current. The pyramids, Kafre and Menkaure, will be provided with alternating current, so that the entire process of signal finding and processing will be eliminated for them. We will hook them up by going straight to creating an anode room, a vat, and an anode. See Fig. 3 for a diagram of the complete triode.

A Final Note On The Outer Covering.

While the polished covering is enough to allow electron flow, it wouldn't do much on its own to create an electron pool that can be tapped because stone is a semiconductor. Semiconductors do not create energy; they funnel it. In a desert climate, where the temperature stays warm and the sun shines most of the time, photoelectric effect can be employed.

The surface area it takes to really get a good electron pool collected would have to be massive. Think about how small a solar panel is and that just one panel puts out very little juice. A 40-story tall copper sheeting would be quite a producer, just like covering the pyra-

mid with solar panels would make a sizable collector.

The metal covering will serve the purpose of contributing electrons for the purpose of migrating, under the influence of an electric field, to the anode. The metal skin is a photocathode and the potential difference also depends upon the temperature difference between the skin and the interior of the pyramid.

For maximum electrical output, the covering should be made of gold. Impractical, of course, so copper will have to do. The sandstone core underneath the skin will absorb the electrons produced unless an insulator is placed between core and copper sheeting. It can be in the form of wooden mounting frames with a rubber or plastic coating on the underside of the metal.

The copper will have openings cut around the anode vents, but the vents into Battery A will be used as conduits for electron flow. Thus, the copper covering will need to extend down the vents and into Battery A. Roughly nine inches square, the vents need hollow copper tubes (again, insulated from the core) placed in them that will emerge inside Battery A and hang submerged in the acid pooled on the floor (but not touching the floor.)

Conclusion. This article is about energizing a forty-story-tall rock pile, but smaller rock masses are also game for vacuum technology. More and more hobbyists are discovering the excitement of "rock technology," so look for it to bring new developments in the near future.

Working with stone is an exciting new way to use radio skills. What could be better than a project that could end up easing one's utility bill? The ultimate feat would be an electrical grid that would take care of all of our energy needs, and it is a feasible idea. 

TIPS FOR MAIL ORDER PURCHASE

It is impossible for us to verify the claims of advertisers, including but not limited to product availability, credibility, reliability and existence of warranties. The following information is provided as a service for your protection. It is not intended to constitute legal advice and readers are advised to obtain independent advice on how to best protect their own interests based upon their individual circumstances and jurisdictions.

1. Confirm price and merchandise information with the seller, including brand, model, color or finish, accessories and rebates included in the price.

2. Understand the seller's return and/or refund policy, including the allowable return period, who pays the postage for returned merchandise and whether there is any "restocking" or "return" charge.

3. Understand the product's warranty. Is there a manufacturer's warranty, and if so, is it for a U.S. or foreign manufacturer? Note that many manufacturers assert that, even if the product comes with a U.S. manufacturer's warranty, if you purchase from an unauthorized dealer, you are not covered by the manufacturer's warranty. If in doubt, contact the manufacturer directly. In addition to, or instead of the manufacturer's warranty, the seller may offer its own warranty. In either case, what is covered by warranty, how long is the warranty period, where will the product be serviced, is there a charge for service, what do you have to do to obtain service and will the product be repaired or replaced? You may want to receive a copy of the written warranty before placing your order.

4. Keep a copy of all transactions, including but not limited to cancelled check, receipt and correspondence. For phone orders, make a note of the order including merchandise ordered, price, order date, expected delivery date and salesperson's name.

5. If the merchandise is not shipped within the promised time, or if no time was promised, within 30 days of receipt of the order, you generally have the right to cancel the order and get a refund.

6. Merchandise substitution without your express prior consent is generally not allowed.

7. If you have a problem with your order or the merchandise, write a letter to the seller with all the pertinent information and keep a copy.

8. If you are unable to obtain satisfaction from the seller, contact the consumer protection agency in the seller's state and your local Post Office.

If, after following the guidelines, you experience a problem with a mail order advertiser that you are unable to resolve, please let us know. Write to Advertising Department, Gernsback Publications Inc., 275 G Marcus Blvd. Hauppauge, NY 11788

Be sure to include copies of all correspondence.



A public service of this magazine

Data Transport Through a Speedy World

ELIZABETH JAMISON

One hundred years ago, communicating with someone else—whether across the street or across the country—was as basic as having enough ink in the pen and paper in the desk. Fifty years later, we'd pick up a telephone and dial an operator, and a sweet-sounding lady with a nasal voice would connect us to our desired third party. Flash forward to the 1980s, when personal computers and fax machines were the technology du jour. At that time, most people thought we had reached our technological peak. Not surprisingly, that peak came and went, far surpassed by yearly advances that quickly replaced yesterday's outdated technology. With these frequent developments was born an urgency to produce results, a need to be ahead in the communications war, and the battle for the data-transport standard.

A Matter Of Bandwidth. In the telecommunications age, the demand for greater bandwidth, more storage capacity, and accelerated data transport speeds is increasing faster than you can click on your send button. Telecommunications, the movement of information by electromagnetic signals through wired and wireless links and networks, is the buzzword of the technological arena and a market where breakthroughs occur seemingly overnight. With so many ways of transporting our data and video signals from point A to point B, potential consumers are easily flummoxed over which method to buy.

When choosing transport media, consider the amount of bandwidth that is guaranteed. Bandwidth is "...the measure of the capacity of a certain medium, and its ability to transport data," says Ed Ballance,

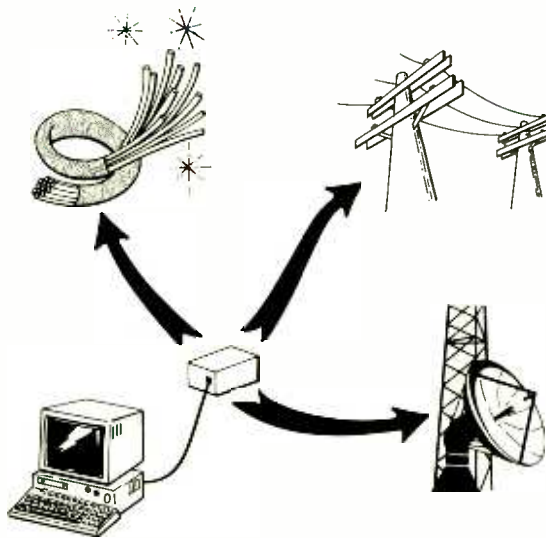

President of Realtime Communications, a fiber-optic based distance-learning company in Atlanta, GA. Different ranges of bandwidth are necessary for different applications, and the mistake most consumers make is matching a certain application with a transport technology that doesn't best serve their particular need.

The most common methods of transport are telephone lines, wireless communications, the Internet, and fiber optics. A standard telephone line can only handle 56k

(one k = 1000 bits of data consisting of 1's and 0's). The telephone company can provide increased bandwidth circuits, including T-1's at 1.54 Mb (one Mb = one million bits of data) or the DS-3 at 45 Mb. Most standard wireless systems are touted to give 10Mb of bandwidth. Today's highest speed on the Internet is 45Mb/sec on major trunk lines, and most Internet users access the Web at around 56k. Fiber has close to unlimited bandwidth and can be broken up into many streams of light carrying 194 Mb.

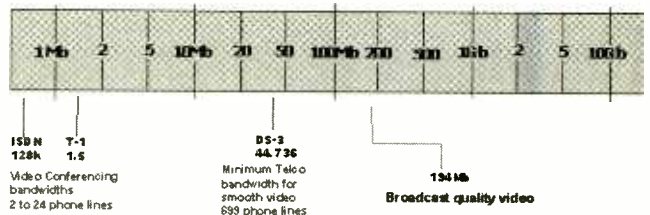

1Mb = 1 MILLION BITS/ SECOND

1Gb = 1 BILLION BITS/ SECOND

Fig. 1. The chart above compares the bandwidth of ISDN, T-1, and DS-3 transfer media. Broadcast quality occurs at a rate of 194 Mb per second. Fiber optics offers the enormous advantage of higher bandwidth when compared to the aforementioned transfer media.



Fibers, such as the ones seen in the photo above, are capable of multiplexing and transporting huge streams of data. Scientists and engineers are still unlocking the potential of fiber optics. Data can be separated by color and transported within the same single-strand of fiber, which is often the thickness of human hair.

Going Wireless. Since the early 1960s when the first communications satellite (Echo-1) was launched, the satellite aerial/wireless industry has exploded. Communications satellites provide a world-wide link-up of radio, telephone, and television. According to Ballance, "The wireless technology is like a great big bucket that includes many different solutions." There are numerous types of applications for the wireless system and just as many assorted devices to support them.

The wireless system consists of a receiver and transmitter located at each end of the connecting sites. These transceivers relay information to each other via radio signals. Ballance explains that while standard wireless links are great for cell phones and satellite television, they have certain limitations. "A standard wireless link is advertised at 10Mb but usually performs without error at 6Mb, and is further limited by distance and weather conditions." Ballance goes on to say that wireless links can be extremely expensive, especially when satellites are involved. "It all depends on how much someone is willing to pay, especially in a school system scenario. There is a practical limit to what a school district or college system can afford to pay for connectivity."

Back on the ground, a significant downside to using wireless transports is the limitation imposed by Mother Nature. "If the terrain is flat, the wireless system works fine. But if there is a mountain in between two connected sites, the only way to get the signal across is to construct

a tower on top of that mountain—and that costs money," he adds.

Telephone Lines. The most commonly used communication device is the telephone line. Although developments in technology have skyrocketed over the last thirty years, the basic telephone still works according to the principles developed by Alexander Bell in the 1870s. With today's transmission of video and data, a standard telephone line has only enough bandwidth to transmit 56k data and either analog or digital voice. Of course, Mr. Bell probably never anticipated video.

"Telephones are great for one thing—voice. However, when a school system attempts to hold video-based distance learning classes or a corporation has a video-conferencing system, the telephone lines just don't measure up. While the telephone companies can provide wide-band service for video, the cost is exorbitant and most companies or institutions are priced out of the market. The most common data service for video provided by the telephone companies is a T-1 (1.54 Mb), or 24 phone lines," says Ballance.



Microwave towers serve as transfer nodes for various communication systems that include telephone service and data systems. The towers work on a point-to-point principle; that is, each tower must be aimed towards its target. The limiting factor in point-to-point communications is the radio horizon, which extends slightly beyond the visual horizon and is caused by the curvature of the Earth.

In order to transmit video over telephone lines, a CODEC—a compression/decompression device that breaks up the video and data into packets (packetizing) at one point and reassembles it at the other—is required at each end. The CODEC on the sending end has to look at the frames of video coming in from the source and encode, or compress, them. Most standard CODECs today will only compress those parts of a given frame that have changed from a previous frame. The more elements that have changed, the longer it takes the CODEC to compress the frame. Because of this, two problems occur:

- **Latency:** It takes anywhere from $\frac{1}{10}$ – $\frac{1}{4}$ second for the compression/decompression process to work in a CODEC. Your video will be delayed for that amount of time. Although $\frac{1}{10}$ of a second may not sound that lengthy, it doubles when the data gets to the other side because the receiving CODEC goes through the same process, in reverse.
- **Frame-Drop-Out:** A CODEC has $\frac{1}{30}$ second to manipulate any given frame. If the next frame from the camera comes along before the CODEC is finished with the previous frame, then the new frame is discarded. This can happen many times in a second. Thus, your frame rate has dropped from the standard 30 frames/sec to 20, 15, or even 10 frames/sec. In essence, frame-drop-out creates a strobe effect—the jerky video that most of us are familiar with, which is totally unacceptable for most video applications.

"For a distance learning scenario, delays and lost frames in video transmission make learning extremely difficult because students are distracted by the choppy images on the screen." Says Ballance, who prefers to use fiber optics for his distance learning system, "There is virtually unlimited bandwidth in a single strand of glass, and that is why you can

achieve broadcast quality video over fiber."

The Fiber-Optic Age. As the digital trend grows, copper wire utilized for long distances has been replaced by glass cables as thin as a strand of hair. Fiber-optic cable offers increased call-carrying capacity, higher speed, and greater transmission quality. Fiber also offers a superior level of security than standard telephone lines.

Fiber-optic transmission is based on the principle of total internal reflection. Light travels inside the core (center) of the fiber and reflects off the junction between the core and the cladding (outside fiber). The junction then acts like a mirror and reflects any light trying to escape from the core. Because of this "Plate Glass Mirror Effect," light is reflected toward the inside of the fiber with no appreciable loss.

Fiber-optic cable carries information in the form of digital bursts of light, at data rates that are thousands of times greater than normal phone lines. This technology is a perfect fit when high-capacity data transfer is required.

According to Ballance, "The main advantage of fiber is the guarantee of practically endless bandwidth." Fiber optics is upward compatible and easily adaptable to new technologies. Equipment is available today that will allow over 48 gigabits (48 billion bits) of data over a single strand of glass by using different "colors" of light.

Over the last decade, the use of fiber optics for telecommunications has skyrocketed. Using laser light offers many advantages. One of these is that long distances can be traversed before signal repeaters—a sort of "boost" station where the signal is re-energizing to adjust for loss and then sent on its way—are needed. With fiber, a repeater is necessary at 100 km or about 62 miles; for telephone systems, a repeater is typically located every 1.5-km, or approximately one mile.

Another significant advantage of fiber is that it eliminates the need for a CODEC. "When using fiber, there is no need to break data up and compress it into little packets. It is possible to eliminate the CODEC

INDUSTRY INSIDER

The author had the opportunity to interview Ed Ballance, who is the President of Realtime Communications in Atlanta, GA. When asked for his thoughts on what's in store for future technology, Ballance commented:

A Wireless Future. "Until the bandwidth of wireless systems is raised and the cost is reduced, the wireless technology will never be utilized to solve heavy data challenges."

Tried and True Telephone Lines. "Standard telephone lines are an 1800's technology and were never intended for video or high-speed data."

How About the Internet? "The Internet holds the most promise for future trends, but will take quite a few years to get high bandwidth service available to most users."

A Fancy for Fiber. "While not applicable to the home user, fiber optics is the desired method of transport for commercial use because of seemingly unlimited bandwidth and easy adaptability to future technologies."

completely by sending all data and video in its native format," explains Ballance. "This saves the customer thousands of dollars since they no longer have to purchase expensive compression devices for each end." For applications that require broadcast quality video transfer, the use of fiber-optic technology is the logical choice.

Another significant application for fiber optics is in local area networks (LANs), typically used for video conferencing and/or distance learning. With the tremendous bandwidth that a single stream of light will bear, fiber-based LAN systems are able to carry gigabits in data, provide Internet connection, and simultaneously transmit NTSC (National Television System Committee) broadcast-quality video.

The Internet. The Internet is the merging of divergent networks that contain assorted media, computers, and applications. Of the prevalent transports, this large-as-life network holds great potential for

future development.

Today, however, the Internet is over-utilized and bandwidth limited. As the number of online users multiplies, the amount of space on the Web and the bandwidth availability decreases. Have you ever noticed that on certain holidays the Internet is extremely slow? Telephone traffic will tie up the Web. Because of this, high quality, repeatable video (just as good tomorrow as it is today) is not yet possible online. Combine normal voice calls with the millions of Internet surfers, and you get one big virtual traffic jam.

Internet II, a higher speed network currently being developed, may go a long way towards solving these problems. There is a technological catch-22, however. Greater Internet video quality = more people online to use that video. Eventually, this limited bandwidth cycle will crop up again.

No matter which mode of transport a consumer chooses, limitations exist in every one of them. It is important to understand how to get the most from a chosen medium. When the goal is to hold educational distance learning sessions, fiber optics provides the necessary video quality. If your concern is for high-definition television or mobile phone usage, then a wireless system works wonders. Whatever you choose, you may still run into problems as your needs for greater bandwidth expand. "The up and coming methods of transport have either physical restrictions or cost limitations," says Ballance. P

American Heart Association
Fighting Heart Disease and Stroke

Research gave him a future



Support Research

SPRINKLER GUARDIAN II, THE SEQUEL

WALTER W. SCHOPP

Back by popular demand—here is an upgrade to the project that originally ran in a 1995 issue of Popular Electronics.

After building the “Sprinkler Guardian” described in the April 1995 issue of **Popular Electronics** and testing it for a year, it seemed as though electronics had won out over yet another menial household chore. However, as fate would have it, after a year of flawless operation, the unit started to become unreliable. It operated erratically for a time and then stopped sensing moisture altogether. To my chagrin, I had joined the ranks of those whose sprinkler system waters the lawn during a rain storm.

I checked the electronics completely, but found no problem. That’s when I became obsessed with finding the cause of the problem. When the in-ground sensors were uncovered, I discovered that electrolysis—the decay of a structure due to chemical reactions—had been overlooked as a possible source of trouble in the original design. Although using probes made of stainless steel and some exotic wires could cure the problem, I decided that a new concept was required.

The first task was to design a sensor that needn’t be buried in the ground to monitor the soil’s moisture content. Additionally, I realized that it would be better if the control circuit required no adjustments. With those requirements in mind, I developed the *Sprinkler Guardian II*.

Using the in-ground sensing method to determine the soil’s moisture content, as in the original design, had required some sort of timer in the circuit to keep the sprinklers operating after the ground became damp. That problem is eliminated in the project’s present incarnation by using a sensor designed to monitor the moisture content of the surrounding air, making the timer unnecessary.

About The Circuit. A schematic diagram of the Sprinkler Guardian is shown in Fig. 1. Power for the circuit is derived from the 24-volt AC source that powers the sprinkler-control unit. The pirated AC voltage is rectified by a full-wave bridge rectifier comprised of D1–D4. A 50-ohm, 10-watt resistor (R1) is connected in series with the output of the bridge rectifier. That resistor is used to drop the rectified DC output of the bridge to a level that can be handled by IC2.

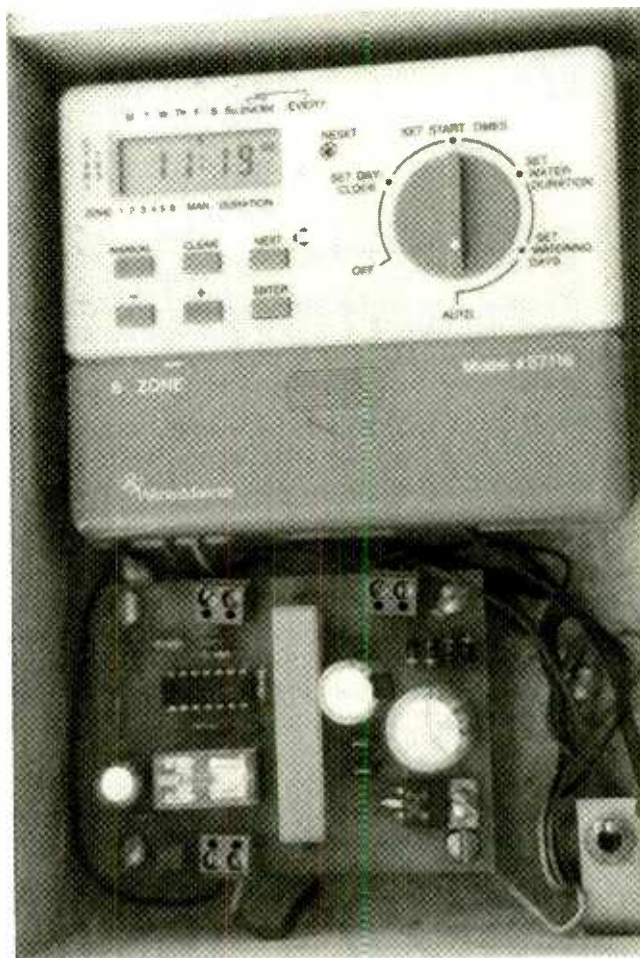

Capacitor C1 (a 220- μ F unit) is included in the circuit to smooth the output DC, while C2 is used to bypass any voltage spikes to ground.

The DC voltage is then applied to IC2, which further reduces and maintains the supply voltage at 12 volts DC. The output of the regulator is then filtered by C3 and C4. At that point, the voltage divides along two paths. In one path, the voltage is fed through R2 (a 1k resistor) and used to light LED1, showing that power has been applied to the circuit. In the other path, the voltage is used to operate Sprinkler Guardian II.

At the heart of the circuit is a 4001 CMOS quad 2-input NOR gate. Two NOR gates from that four-gate package, IC1-a and IC1-b, are configured as an astable multivibrator (oscillator). Pin 6 of IC1-b is con-

PARTS LIST FOR THE SPRINKLER GUARDIAN II

SEMICONDUCTORS

D1–D4—1N4004 1-amp, 400-PIV rectifier diode
 IC1—CD4001 CMOS quad 2-input, NOR gate, integrated circuit
 IC2—7812 12-volt, 1-amp fixed voltage regulator, integrated circuit
 LED1, LED2—Light-emitting diode
 Q1—2N3905 general-purpose NPN silicon transistor

RESISTORS

(All resistors are 1/4-watt 5% units unless otherwise noted.)

R1—50-ohm, 10-watt
 R2, R6, R7—1000-ohm
 R3—100,000-ohm
 R4, R5—1-megohm

CAPACITORS

C1—220- μ F, 50-WVDC, electrolytic
 C2, C4—0.1- μ F, ceramic-disc
 C3—220- μ F, 25-WVDC, electrolytic
 C5—0.05- μ F, ceramic-disc
 C6—100- μ F, 16-WVDC, electrolytic

ADDITIONAL PARTS AND MATERIALS

RY1—12-volt relay, AROMAT #HB2-DC12V (Jameco #18577)
 SO1–SO3—Dual-wire, terminal block (Jameco #99426)
 Printed-circuit materials, stainless steel bolts, nuts, plastic box, sponge, wire, solder, hardware, etc.

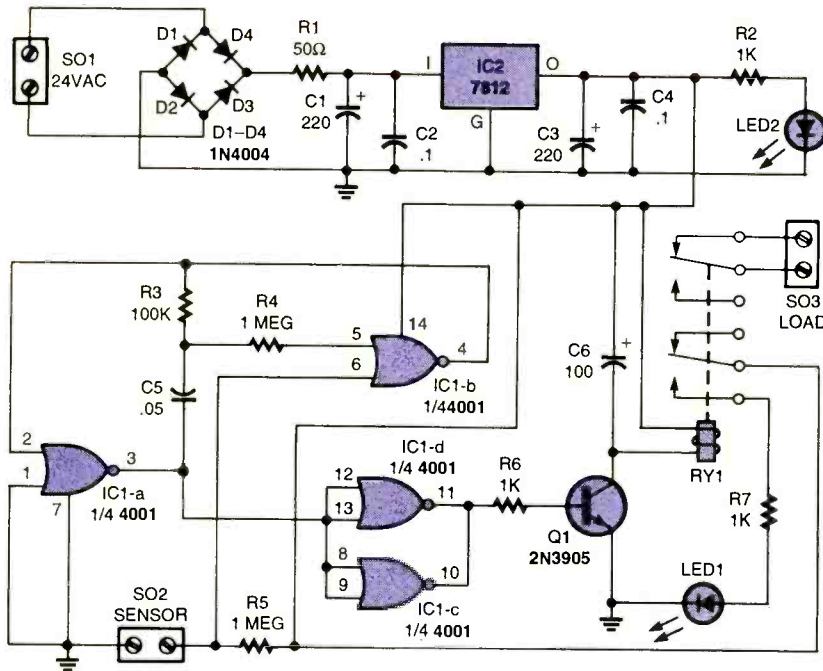

Fig. 1. The Sprinkler Guardian, which is fed from the 24-volt AC source that powers the sprinkler-control unit, is comprised of two integrated circuits—IC1 and IC2, a quad NOR gate and a voltage regulator, respectively. In addition, there are two LEDs, a full-wave bridge rectifier, a 12-volt relay, and a small assortment of resistors and capacitors.

connected to a voltage divider, composed of R5 and the resistance of the sensor (sponge/screws), which connects to SO2. The oscillator, which operates at a frequency of about 450 Hz, is triggered when rain wets the sensor (which connects to SO2). The sensor, in this case, is little more than a small sponge with two electrodes buried in it. The wet sensor grounds pin 6 of IC1-b, causing

the astable multivibrator to oscillate.

The square-wave output of the oscillator is fed to the inputs of IC1-c and IC1-d, which are wired in parallel. Together, those gates increase the current and invert the signal output by the oscillator to provide sufficient drive for Q1. The inverted output of IC1-c/IC1-d is applied to the base of Q1 (a 2N3905 general-purpose NPN tran-

sistor), causing it to turn on. With Q1 turned on, providing a ground path through the transistor for the coil of RY1 (a DPDT 12-volt relay), the relay turns on—causing its normally-open contacts to close. One set of contacts applies power to LED1 and causes it to light, indicating that the circuit has been triggered. The other set of contacts, which functions as a simple SPST switch, is connected in series with one leg of the sprinkler-control circuit's output. When the circuit is triggered, that set of contacts opens, turning off the sprinkler system.

When the rain stops and the sensor (sponge) dries, pin 6 of IC1-b is pulled high by the voltage supplied through R5. Since both inputs of IC1-b are now high, the output of IC1-b goes low. That low is applied to pin 2 of IC1-a. Since both inputs

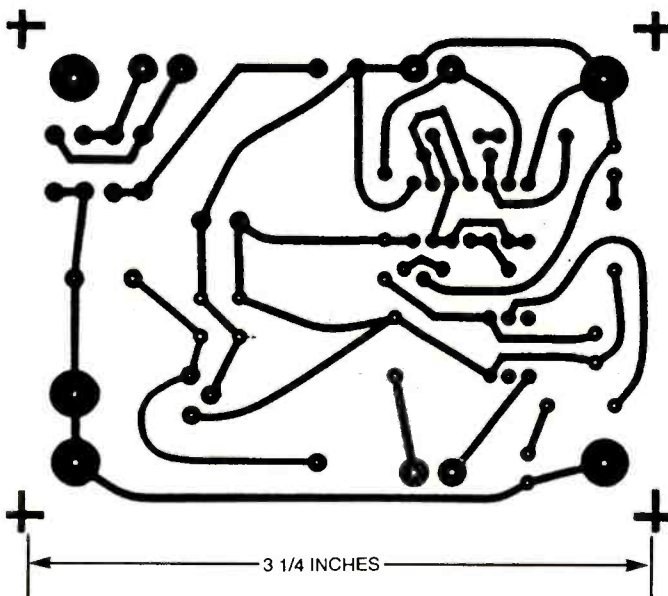

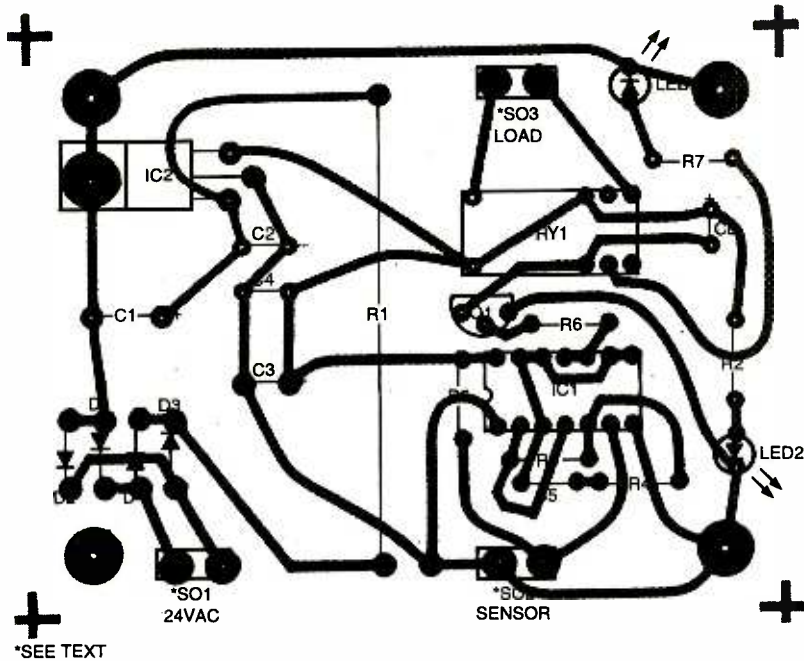

Fig. 3. Assemble the printed-circuit board guided by the parts-placement diagram. Once it is assembled, check the board for the usual construction errors.

of IC1-a are now low, the output of IC1-a goes high. That high is fed to the input of IC1-c and IC1-d, causing their outputs to go low and thereby turning off Q1. With Q1 turned off, RY1 drops out, allowing the relay's normally-closed contacts to close. That sequence allows the sprinklers to come on any time that the sprinkler-control timer calls for it.

The sensor can be mounted in a rain gutter or somewhere out of the way, where it won't get wet when the sprinkler is on. Thus, we solved the major problem. Of course, electrolysis will still take place, but on a much smaller scale. The connecting wires are no longer a part of the equation, and the small electrodes needed can be easily made from stainless steel.

Construction. The Sprinkler Guardian II was assembled on a printed-circuit board, measuring 3½ by 2½ inches. A template of the project's printed-circuit layout is shown in Fig. 2. That pattern can be lifted from the page and used to etch your own printed-circuit board. Once the board has been etched and you've gathered all of the parts listed in the Parts List, assemble the circuit board guided by the parts-placement diagram shown in Fig. 3.

Once you've assembled the board and checked it for the usual construction errors, put the board aside and prepare the moisture

sensor. Figure 4 gives details for the construction of the sensor assembly. The sensor used here was fabricated using a small enclosure, measuring approximately ½-inch high, 1-inch wide, and 2-inches long, and made of ½-inch thick plastic. However, the box can be any size.

Two holes were drilled through the plastic box to accommodate two 6-32 stainless-steel screws. One side should be #28 clearance holes, and the other side should be tap size #36 holes. You could also use longer screws, of sufficient length to go through the box, and use 6-32 nuts on the outside. The exact dimensions of the box are quite loose as long as you have about 1 to 1½ inch between the screws and as long as the sponge remains against the screws whether it's wet or dry. The two screws are the electrodes to which wires are attached, using terminal lugs under the heads of the screws.

After the box is built and the screws are in place, the sponge is cut to the inside dimensions of the box. The sponge is then pre-formed

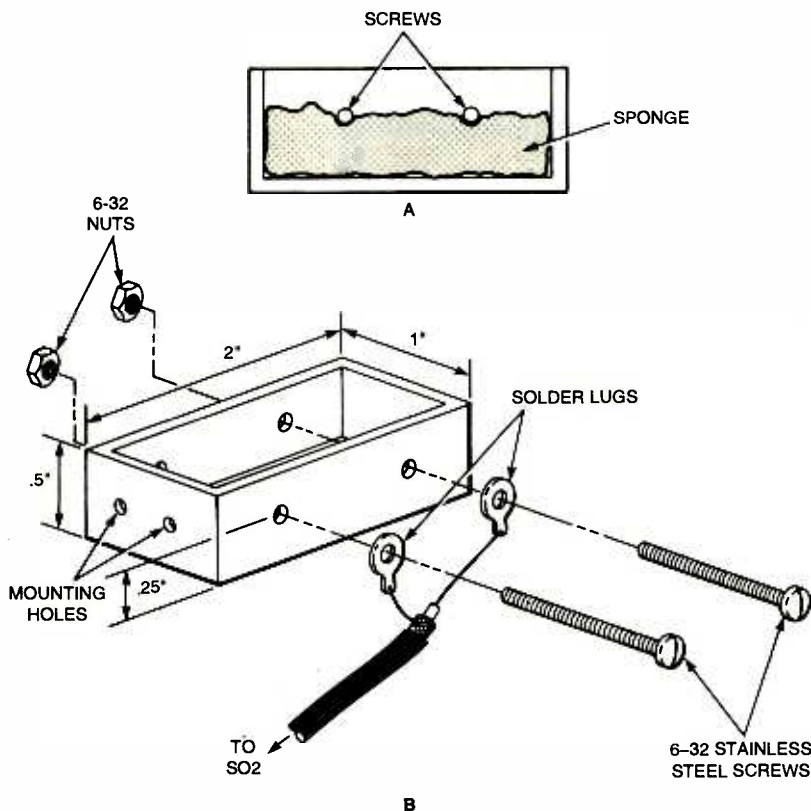

Fig. 4. The sensor for the Sprinkler Guardian II is little more than a pair of screws inserted through a small plastic box that contains a wall-to-wall section of sponge. Details for the construction of the sensor assembly are shown here.

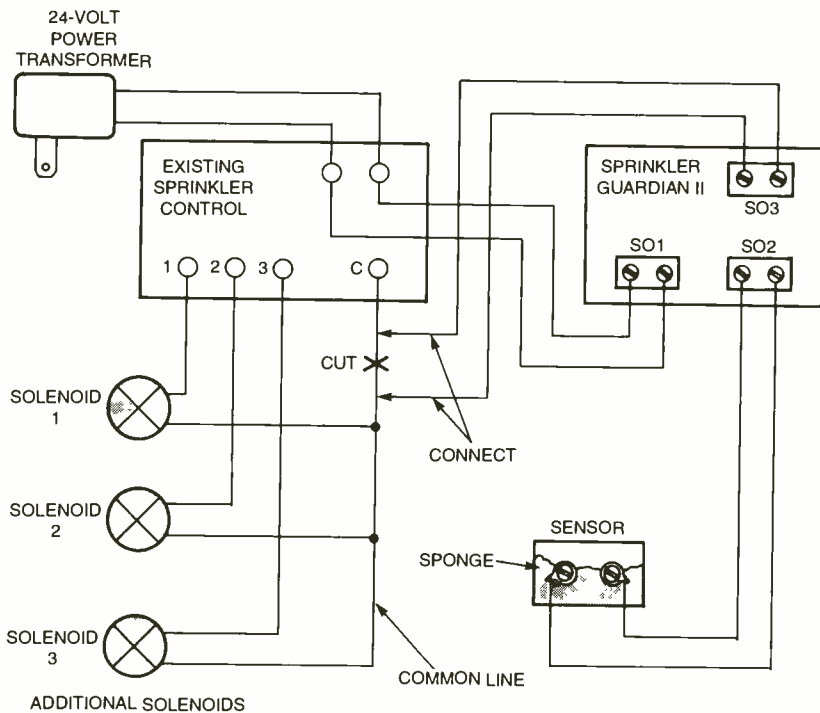

Fig. 5. Once completed, the Sprinkler Guardian II is integrated into the existing sprinkler control, as shown in this illustration.

by wetting it and tucking it under and spanning both screws inside the box. After it dries, the sponge will be pre-formed so that it will swell when it rains and make a low-resistance connection across the

terminals. When the rain ceases and the sponge dries, the resistance between the screw electrodes will be very high. The drying time of the sponge is very close to the time it takes for the ground to dry out.

The sensor box can be mounted in any location where it won't get wet when the sprinkler is on. A convenient out-of-the-way location for the box is bolted to the inside top of a rain gutter. Do not mount the sensor in the bottom of the gutter, as it can get covered with debris and will not dry properly. The sensor can be bolted crosswise at the end of the box to prevent shorting out the sensor electrodes on an aluminum or steel rain gutter. The sensor assembly must also be situated clear of any structure that might shield the sensor from rain. This assembly can be connected to the circuit board through a small coax line or telephone twisted pair.

Figure 5 shows how the

Sprinkler Guardian II is integrated into the existing sprinkler-control system. Note that SO1 is connected in parallel with the existing sprinkler-control unit, tapping into its 24-volt power source. The Sprinkler Guardian II, along with the valve-control unit, can be mounted together in a common enclosure (Fig. 6).

Now your sprinkler-control system is ready to prevent your lawn or garden from being watered in the rain (again). **P**

Wireless & Electrical Cyclopaedia



ETT1—Wireless & Electrical Cyclopaedia \$4.99. Step back to the 1920's with this reprinted catalog from the Electro Importing Company. Antiquity displayed on every page with items priced as low as 3 cents. Product descriptions include: Radio components, kits, motors and dynamos, Leyden jars, hot-wire meters, carbon mikes and more. The perfect gift for a radio antique collector. To order ETT1, send \$4.99 (includes s&h) in the US and Canada to **Electronic Technology Today Inc., P.O. Box 240, Massapequa Park, NY 11762-0240**. US funds only. Use US bank check or International Money Order. Allow 6-8 weeks for delivery. MA11

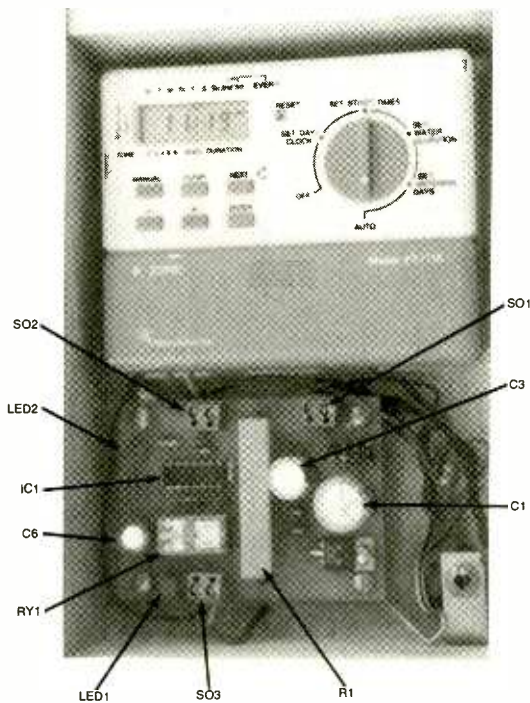

Fig. 6. In the author's setup, the Sprinkler Guardian II was mounted in the enclosure that houses the existing sprinkler-control unit, where it can easily be connected to the appropriate points on the sprinkler control.

POPTRONIX®

Online Edition

We're on the web

FREE

We are starting up,
but you can watch us grow!

Projects for beginners
to experts!
New Product information!
Bookstore—discover
what's new!

<http://www.poptronix.com>

WE'RE WITH YOU EVERY DAY
24 HOURS A DAY! DROP IN!
WE'D LOVE TO HAVE YOU VISIT!

EXPERIMENTING With SMALL FM TRANSMITTERS



There are those who would say that the wireless communications hobby has gone the way of the dinosaur—and perhaps they're right ... from a particular point of view, that is. No one would dispute that the ranks of ham radio enthusiasts and DXers have been on the decline for some time now. Even so, there are still plenty of communications enthusiasts out there searching for simple low-power FM transmitters. This article, in catering to that all but forgotten segment of the electronics hobby, presents a number of RF transmission circuits with which the hobbyist can experiment. All of the circuits—which are composed of readily available components, powered from sources ranging from 3 to 9 volts, and capable of covering dis-

Build one or more of these elementary FM transmitters and learn how simple it is to convey intelligence from one point to another.

NEWTON C. BRAGA

tances up to half a mile—are tolerant of modifications, such as increasing the power or altering the frequency band or the modulation signal used.

One-Transistor FM Transmitter.

Our first transmitter circuit (see Fig. 1), which is built around a single transistor, is probably the simplest of

its kind. The signal transmitted by that circuit can be picked up by any FM receiver within 150 feet or less of the transmitter. The circuit, which offers excellent performance, is ideally suited to wireless microphone applications. As the Fig. 1 circuit lacks an audio amplifier stage, it's necessary to speak directly into MIC1.

Inductor L1 is a hand-wound, air-core coil comprised of 4 turns of 18 to 22 AWG enameled wire wound on a 1-cm form. The number of turns comprising L1 can be varied in order to produce a circuit that can output signals in the high VHF band (2 or 3 turns) or the low band between 50 and 80 MHz (5 to 7 turns). Operating in the low VHF band, the signal from the transmit-

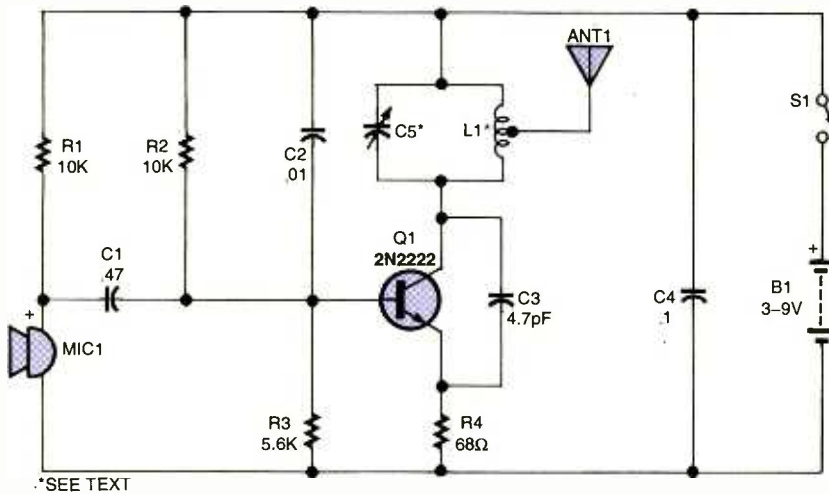

Fig. 1. The output of this One-Transistor FM Transmitter circuit, which can be picked up by any FM receiver within 150 feet or less of the transmitter, offers excellent performance and is ideally suited to wireless microphone applications.

ter can be picked up on any VHF TV channel between 2 and 6.

Capacitor C6 can be any trimmer with a value ranging from 20 to 40 pF. The transmitter, as shown, can be powered from a 3- to 6-volt source. However, if greater output power is desired, the circuit can be driven from a 9-volt battery—in that case, the value of R4 must be increased to 120 ohms. The antenna is little more than a 4- to 15-inch length of bare wire, connected to the second turn of L1. The wire antenna can be replaced by a telescoping antenna.

To use the circuit, simply tune your receiver to a free point on the FM band. Adjust C5 until you hear

the signal from your FM transmitter. Speak near the microphone to test the sound reproduction. If carrying the transmitter to a position far from the receiver causes the signal to disappear, you've probably tuned a spurious signal or harmonic frequency. In that case, readjust the circuit and try again.

Two-Transistor FM Transmitter.

Our next transmitter, see Fig. 2, is nearly identical to the previous circuit, except that an extra transistor has been added to the mix and a couple of resistor/capacitor values have been altered to accommodate the new circuit configuration. The inclusion of a single transistor in

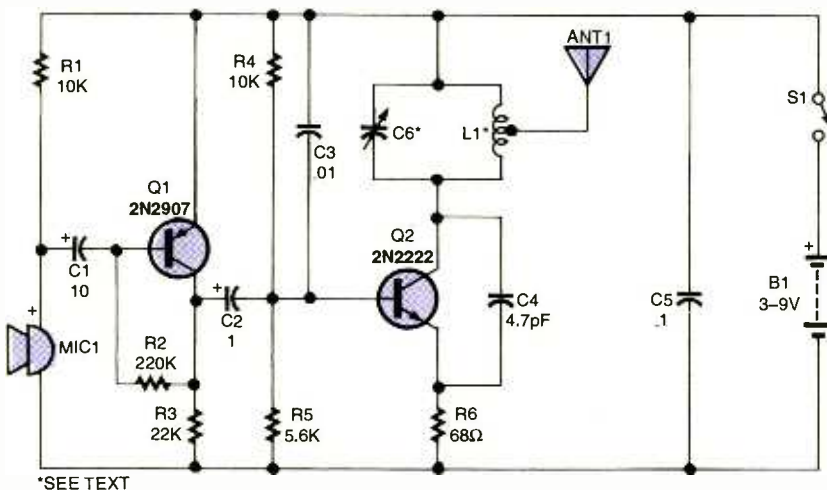

Fig. 2. The Two-Transistor FM Transmitter is nearly identical to the previous circuit, except that an extra transistor has been added to the mix and a couple of resistor/capacitor values have been altered to accommodate the new circuit configuration.

PARTS LIST FOR THE ONE-TRANSISTOR FM TRANSMITTER (Fig. 1)

RESISTORS

(All resistors are 1/4-watt, 5% units.)
 R1, R2—10,000-ohm
 R3—5600-ohm
 R4—68-ohm

CAPACITORS

C1—47-μF ceramic-disc or metal-film
 C2—0.01-μF ceramic-disc
 C3—4.7-pF ceramic-disc
 C4—0.1-μF, ceramic-disc
 C5—Trimmer capacitor, see text

ADDITIONAL PARTS AND MATERIALS

Q1—2N2222, BF494, etc., or equivalent, general-purpose NPN silicon transistor
 L1—See text
 ANT1—See text
 MIC1—Electret microphone
 S1—SPST toggle or slide switch
 B1—3- to 6-volt power source

the microphone circuit increases the circuit's sensitivity to signals that are picked up by the microphone.

Low-volume conversations, bird songs, and natural sounds can be

PARTS LIST FOR THE TWO-TRANSISTOR FM TRANSMITTER (Fig. 2)

SEMICONDUCTORS

Q1—2N2907 general-purpose PNP silicon transistor
 Q2—2N2222 general-purpose NPN silicon transistor

RESISTORS

(All resistors are 1/4-watt, 5% units.)
 R1, R4—10,000-ohm
 R2—220,000-ohm
 R3—22,000-ohm
 R5—5600-ohm
 R6—68-ohm

CAPACITORS

C1—10-μF, 16-WVDC, electrolytic
 C2—1-μF, metal-film or electrolytic
 C3—0.01-μF, ceramic-disc
 C4—4.7-pF, ceramic-disc
 C5—0.1-μF, ceramic-disc
 C6—Trimmer capacitor, see text

ADDITIONAL PARTS AND MATERIALS

L1—See text
 ANT1—See text
 MIC1—Electret microphone
 S1—SPST toggle or slide switch
 B1—3- to 9-volt power source, see text

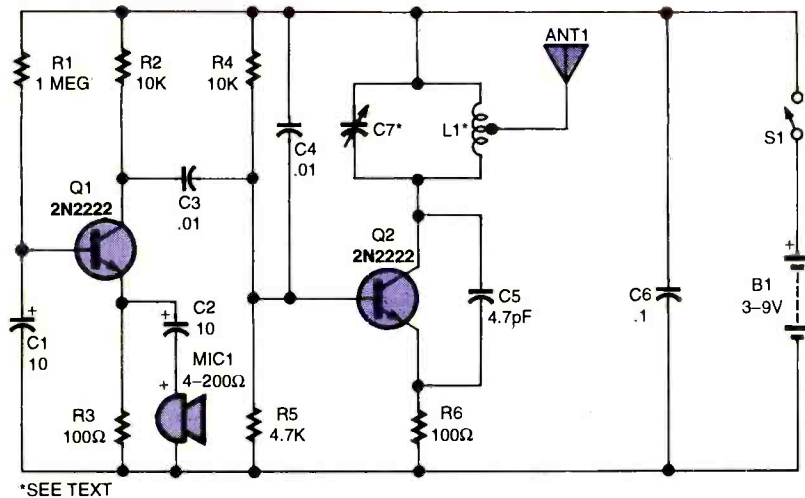

PARTS LIST FOR THE LOW-IMPEDANCE TRANSMITTER (Fig. 3)

RESISTORS

(All resistors are 1/4-watt, 5% units.)
 R1—1-megohm
 R2, R4—10,000-ohm
 R3, R6—100-ohm
 R5—4700-ohm

CAPACITORS

C1, C2—10- μ F, 12-WVDC, electrolytic
 C3—0.01- μ F, ceramic-disc or metal-film
 C4—0.01- μ F, ceramic-disc
 C5—4.7-pF, ceramic-disc
 C6—0.1- μ F, ceramic-disc
 C7—Trimmer capacitor, see text

ADDITIONAL PARTS AND MATERIALS

Q1, Q2—2N2222 general-purpose NPN silicon transistor
 L1—See text
 ANT1—See text
 MIC1—1- to 2-inch loudspeaker or low-impedance transducer, see text
 S1—SPST toggle or slide switch
 B1—3- to 9-volt source, see text

Fig. 3. The Low-Impedance Transmitter, using a telephone receiver pick-up coil (which does not load down the phone line), can be used to intercept telephone conversations without being discovered.

picked up and transmitted to a common FM receiver placed as far as 150 feet from the transmitter. The microphone itself can be placed at the focal point of a parabolic reflector, making it ideally suited to picking up very weak sounds emanating from a single direction. Such a circuit might find application in surveillance operations.

Inductor L1 and antenna ANT1 in the Fig. 2 circuit are identical to the coil and antenna used in the Fig. 1

circuit, and like the Fig. 1 circuit this one can be powered from 3- to 6-volt sources with no modifications to the circuit. In order to operate the Fig. 2 circuit from a 9-volt source, the value of R1 must be changed to 120 ohms. That modification allows the output of this circuit to be picked up at distances of up to 600 feet when operating in an open field. The transmission range diminishes considerably when the transmitter is operated

from within a closed solid structure, such as a brick or metal edifice. Tuning for this circuit is accomplished as it was for the previous transmitter.

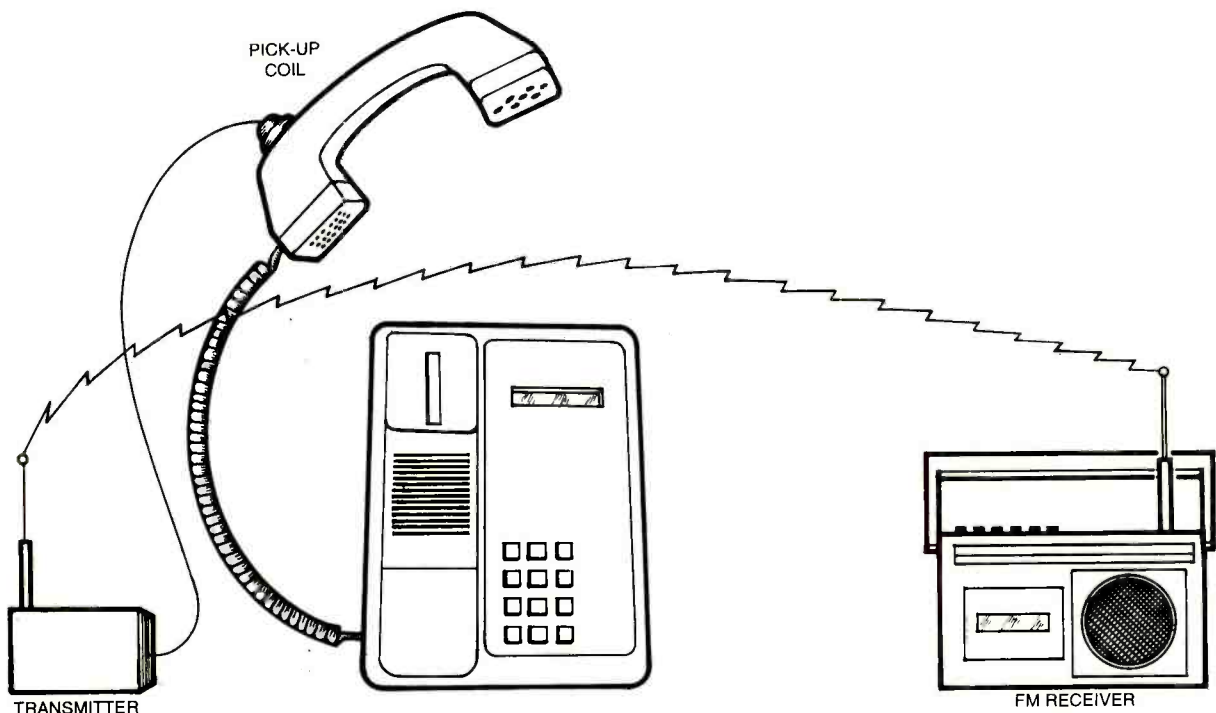

Fig. 4. Using a telephone pick-up coil and the Low-Impedance Transmitter, as depicted here, phone conversations can be heard at a remote location through any FM receiver.

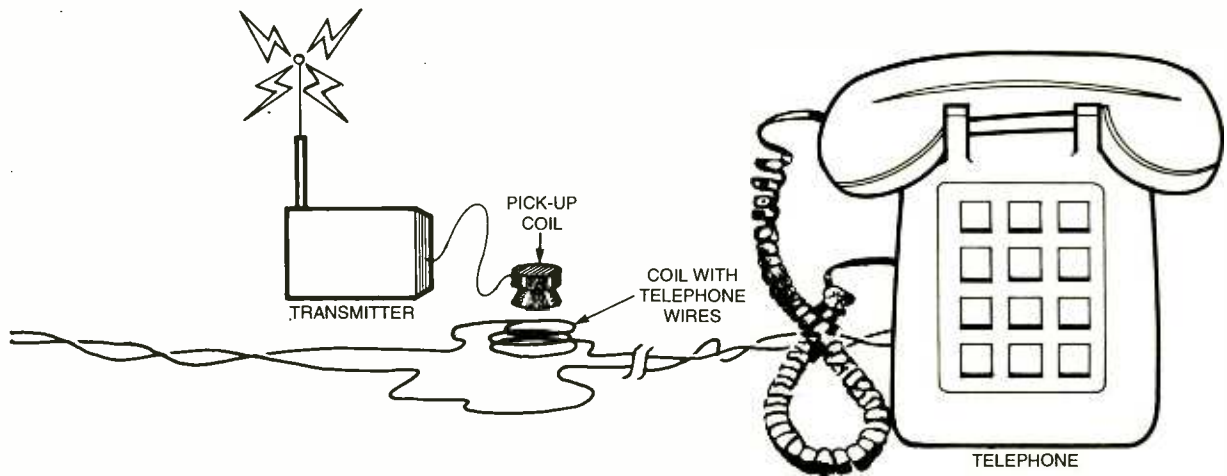

Fig. 5. The telephone pick-up coil/transmitter combination is sensitive enough that it can be used to inductively snare conversation from a coiled section of telephone line.

To use the Fig. 2 circuit in spying applications, place the transmitter far from metal objects, such that the microphone has an unobstructed "view" of the area that is being monitored.

Low-Impedance Transmitter. The third circuit (see Fig. 3) is designed to use a low-impedance transducer as the pick-up device. The transmission range for this circuit is the same as for the two previous transmitters, but offers some advantages over the prior circuits. One of the advantages is that a small low-impedance speaker can be used as a microphone. In addition, with a telephone pick-up coil attached

to the telephone receiver (as shown in Fig. 4), the conversation can be fed to a receiver placed several feet away. The pick-up coil can also be coupled to the telephone line in the manner illustrated in Fig. 5, allowing you to intercept telephone conversations without being discovered. Since there is no direct connection to the telephone line in the manner illustrated in Fig. 5, the transmitter won't have a loading effect on the phone line.

When coupling the circuit to the telephone line in the manner outlined here, the telephone feed (the wire cable that connects to the telephone base) must also be coiled, as illustrated in Fig. 5. While the pick-up

coil can be purchased from almost any electronic parts dealer, a homebrew unit can be manufactured by winding 1000 to 5000 turns of 30 or 31 AWG enameled wire on a small ferrite rod. Inductor L1 in this circuit is the same as described in the previous circuits. And like the other transmitter circuits, this one can be powered from a 3- to 9-volt source, with the 9-volt power source requiring

PARTS LIST FOR THE TONE TRANSMITTER (Fig. 6)

SEMICONDUCTORS

- IC1—555 oscillator/timer, integrated circuit
- Q1—2N2222 general-purpose NPN silicon transistor

RESISTORS

- (All resistors are 1/4-watt, 5% units.)
- R1—47,000-ohm
 - R2, R3—10,000-ohm
 - R4—5600-ohm
 - R5—68-ohm

CAPACITORS

- C1—0.022- to 0.1- μ F, ceramic-disc or metal-film
- C2, C3—0.01- μ F, ceramic-disc or metal-film
- C4—0.0047- μ F ceramic-disc
- C5—4.7-pF, ceramic-disc
- C6—0.1- μ F, ceramic-disc
- C7—Trimmer capacitor, see text

ADDITIONAL PARTS AND MATERIALS

- L1—See text
- ANT1—See text

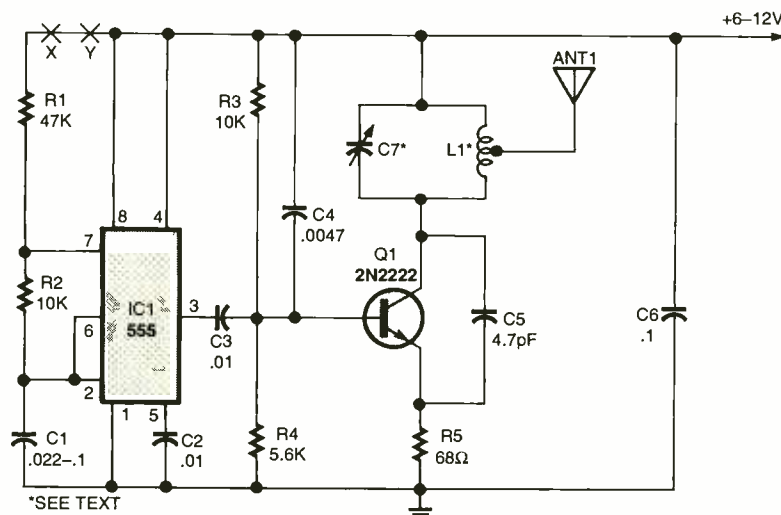

Fig. 6. The Tone Transmitter can be used as part of a wireless alarm, Morse-code practice circuit, or as part of a wireless annunciator (using an appropriate sensor).

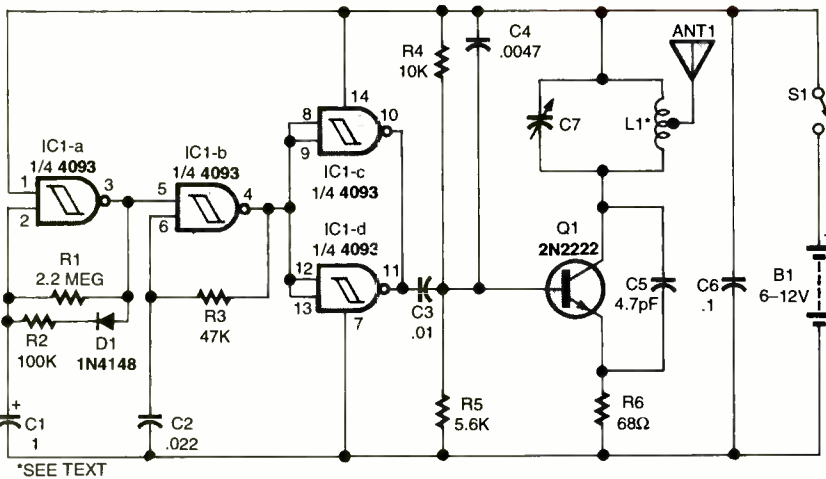

Fig. 7. The Beep Transmitter outputs intermittent beeps that can be picked up by any FM receiver within its coverage range.

that R6 be replaced by a 120-ohm resistor. Also like the previous circuits, this one is tuned via a variable capacitor (C7).

If the received signal saturates the transmitter, causing it to output distortion-rich audio, it may be necessary to alter the value of R3, which can range from 22 ohms to 220 ohms.

Tone Transmitter. The Tone Transmitter circuit shown in Fig. 6 can be used as part of a wireless alarm, Morse-code practice circuit, or as part of a wireless annunciator (using an appropriate sensor). Wired to a trap, the circuit can be used to alert you when the trap is sprung. For example, to use the circuit as a remote temperature or light sensor, replace R1 with a light-dependent resistor (LDR), or a negative-temperature coefficient (NTC) thermistor. Regardless of the type of sensor selected, it should have the nominal resistance of between 10k and 100k. In such an arrangement, the frequency of the output signal depends on the amount of light striking the LDR or the temperature sensed by the thermistor. The sensor can be connected in the circuit at points X and Y.

The output frequency of the transmitter can be determined by connecting a frequency-counter to the output of an FM receiver. The circuit generates an FM signal that's modulated by an audio tone whose frequency is determined by R1, R2, and C1. Inductor L1 is the same used in the other transmitters,

with circuit tuning accomplished in the same manner.

The Tone Transmitter has a range of between 150 and 600 feet in an open field when the circuit is powered from 4 AA-cells. The circuit's output power can be increased (in order to provide greater transmission coverage) by powering the circuit from 9- or 12-volt DC supply. To reconfigure the circuit for 9-volt operation, replace R5, a 68-ohm resistor, with a 120-ohm unit. If 12-volt operation is desired, replace Q1, a 2N2222 general-purpose NPN transistor, with a 2N2218. Those alterations allow the circuit to transmit over distances of up to a mile in an open field.

Caution: The FCC forbids operation of high-powered versions of a circuit like this one within city limits, where the signals can cause interference in emergency or other communications, FM receivers, and VHF TV.

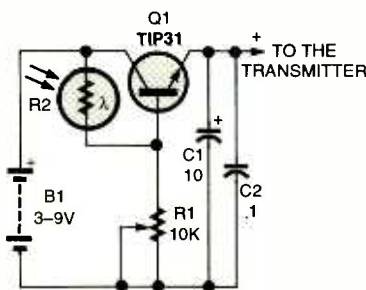

Fig. 8. This simple Light-Activation Circuit can be added to any of the transmitters, except those powered from 12-volt sources, allowing the transmitters to turn on whenever the light level detected by R2 dips below the threshold set by potentiometer R1.

PARTS LIST FOR THE BEEP TRANSMITTER (Fig. 7)

SEMICONDUCTORS

- IC1—4093 CMOS quad 2-input NAND Schmitt trigger, integrated circuit
- Q1—2N2222 general-purpose NPN silicon transistor
- D1—1N4148 general-purpose, small-signal, silicon diode

RESISTORS

(All resistors are 1/4-watt, 5% units.)

- R1—2.2-megohm
- R2—100,000-ohm
- R3—47,000-ohm
- R4—10,000-ohm
- R5—5600-ohm
- R6—68-ohm

CAPACITORS

- C1—1-μF, 16-WVDC, electrolytic
- C2—0.022-μF, ceramic-disc or metal-film
- C3—0.01-μF, ceramic-disc or metal-film
- C4—0.0047-μF, ceramic-disc
- C5—4.7-pF, ceramic-disc
- C6—0.1-μF, ceramic-disc
- C7—Trimmer capacitor, see text

ADDITIONAL PARTS AND MATERIALS

- L1—See text
- S1—SPST toggle or slide switch
- B1—6- to 12-volt power source, see text

Beep Transmitter. The circuit shown in Fig. 7 transmits intermittent beeps to a remote FM receiver. The pitch of the transmitted tones and the interval between beeps can be altered according to the application. Resistor R3, which can range between 10k and 100k, determines the pitch of the tone, while the beep interval is determined by R1.

PARTS LIST FOR THE LIGHT-ACTIVATION CIRCUIT (Fig. 8)

RESISTORS

- R1—10,000-ohm trimmer potentiometer
- R2—Light-dependent resistor

CAPACITORS

- C1—10-μF, 16-WVDC, electrolytic
- C2—0.1-μF, ceramic-disc capacitor

ADDITIONAL PARTS AND MATERIALS

- Q1—TIP31 NPN silicon power transistor
- B1—3- to 9-volt power source (see text)

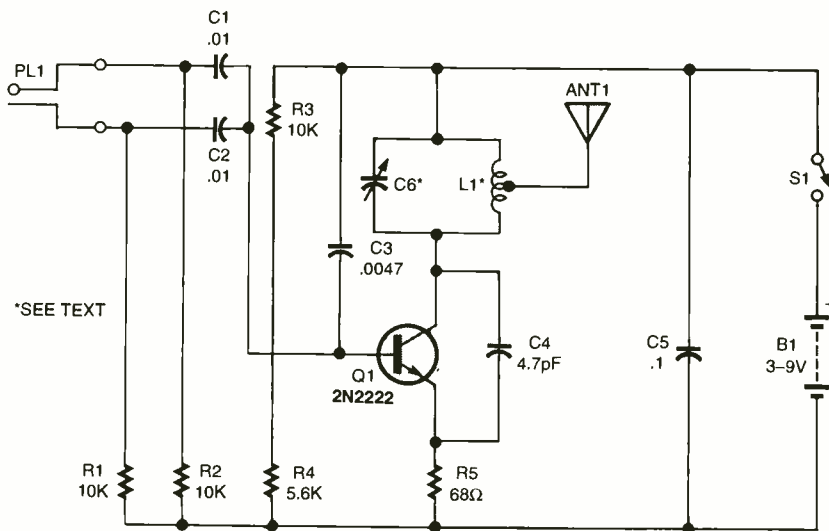

PARTS LIST FOR THE CD-PLAYER/MULTIMEDIA TRANSMITTER (Fig. 9)

RESISTORS

(All resistors are 1/4-watt, 5% units.)
 R1-R3—10,000-ohm
 R4—5600-ohm
 R5—68-ohm

CAPACITORS

C1, C2—0.01- μ F, ceramic-disc or metal-film
 C3—0.0047- μ F, ceramic-disc
 C4—4.7-pF, ceramic-disc
 C5—0.1- μ F, ceramic-disc
 C6—Trimmer capacitor, see text

ADDITIONAL PARTS AND MATERIALS

Q1—2N2222 general-purpose NPN silicon transistor
 L1—See text
 ANT1—See text
 PL1—Stereo plug
 S1—SPST toggle or slide switch
 B1—3- to 9-volt power source, see text

Fig. 9. This CD-Player/Multimedia Transmitter allows audio signals from a PC or CD player to be sent to your FM sound system for reproduction through the system's loudspeakers without the need for interconnecting wires.

whose value can range between 100k and 10 megohms.

The Beep Transmitter can be used in a game named "Fox Hunt." The transmitter is the fox and the hunters are those using FM receivers to locate the fox by the transmitted signal.

To increase the transmitter's coverage area, make the same modifications described for the Fig. 4 circuit. The circuit, when operated from a 12-volt supply, should be used *only* in an open field, far from radio receivers, so as not to interfere with their reception.

Light-Activation Circuit. The simple circuit shown in Fig. 8 can be added to any of the transmitter circuits, except those powered from 12-volt supplies, allowing the transmitters to turn on whenever light level detected by R2 (an LDR) dips

below the threshold set by potentiometer R1.

CD-Player/Multimedia Transmitter.

The circuit shown in Fig. 9 allows audio signals from a PC or CD player to be sent to your FM sound system for reproduction through the system's loudspeakers without the need for interconnecting wires. The circuit is monophonic, so the left and right channel audio signals are mixed in the transmitter circuit before being output to the antenna (ANT1) as shown in Fig. 9. As there is no multiplexing of the signals, the receiver can't reconstitute the left and right stereo channels.

The circuit can be powered from a 3- to 9-volt power supply. For 3- to 6-volt operation, no changes are necessary, but for 9-volt operation, the value of R4 must be increased to 120 ohms.

Field-Strength Meter. Our final circuit, see Fig. 10, is a useful little circuit that can be used to indicate the strength of the signals output by any of the transmitters that we looked at here.

PARTS LIST FOR THE FIELD-STRENGTH METER (Fig. 10)

SEMICONDUCTORS

Q1—2N2222 general-purpose NPN silicon transistor
 D1—1N34 or 1N60 or similar germanium diode

RESISTORS

(All fixed resistors are 1/4-watt, 5% units.)
 R1—1-megohm
 R2—22,000-ohm
 R3—100,000-ohm, trimmer potentiometer

ADDITIONAL PARTS AND MATERIALS

C1—0.01- μ F, ceramic-disc capacitor
 L1—470- μ H coil
 ANT1—See text
 M1—0-200- μ A meter
 S1—SPST toggle or slide switch
 B1—3- to 6-volt power source (see text)

Potentiometer R3 (a 100k unit) is used to adjust the sensitivity of the circuit, by biasing the transistor near the point of conduction. The antenna (ANT1) is nothing more than a 5- to 20-inch length of wire. P

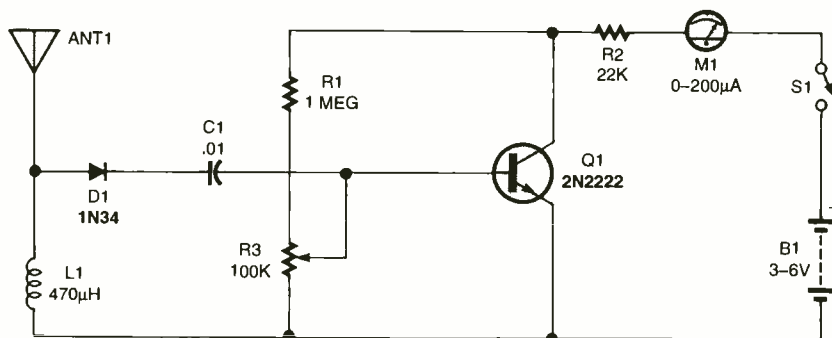

Fig. 10. The Field-Strength Meter can be used to indicate the strength of the signals output by any of our transmitters.

4-Terminal Resistance Measurement

Q What is a 4-terminal resistance measurement? I've seen high-end digital meters with 4-terminal measurement, but I don't have a clue as to what it all means.—*D.T., San Diego, CA*

A With an accuracy of 0.2% when measuring resistance, a good 4½-digit digital multimeter will still give you an error for low values of resistance. If you short the probes together, you may see a residual resistance of 0.3 ohms. If you are measuring the value of a 3-ohm resistor, the lead resistance already skews the measurement by 10%. You can subtract this residual resistance from the meter reading to make the reading more accurate; but you'll never be able to achieve the 0.2% meter accuracy, since both the contact resistance of the test lead connectors and connections to the resistor are variable at best.

A 4-terminal resistance measurement, also known as a Kelvin measurement, is a way of eliminating all these unwanted resistance artifacts from the measurement system—it's basic Ohm's Law at work. As shown in Fig. 1, a very accurate, known constant current is injected into the unknown resistance. Then a high-impedance voltmeter measures the voltage drop across the resistor. The key is the constant current and the place-

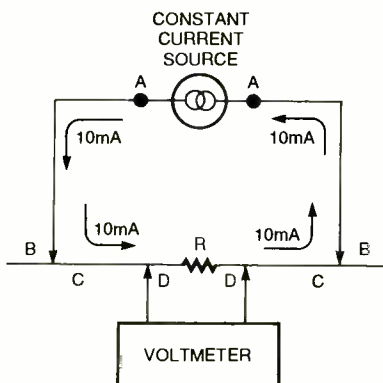

Fig. 1. A constant current source and a high-impedance voltmeter together make up a 4-terminal circuit for accurate measurement of low resistances.

ment of the test leads. Since the current is the same throughout a series circuit, the known-good constant current is flowing through the unknown resistor and all the various contact points as well, regardless of the value of the resistances involved. However, the voltmeter is connected across the resistor only; and the voltage reading doesn't include any of the contact points. The only contact is by the voltmeter itself; and since it has a high impedance, negligible current flows in the voltmeter circuit. Therefore, there is a negligible voltage drop across those contact points. The system is designed so that you directly translate the voltage reading into ohms.

In Fig. 1, the constant current is 10 mA. The 10 mA flowing through the resistor (R) that's marked 18.3 ohms causes a 188.43 mV drop as measured on the meter. This drop translates into a resistance value of 18.843 ohms. If the meter is accurate to the last digit and the constant current source is accurate to five significant figures, then that resistance measurement is accurate all the way to the least significant digit—deadly accurate. Note that there will be voltage drops caused by the connections to the current source (A), by the connections to the resistor leads (B), by the resistor leads themselves (C), and by the resistor proper (R). There is virtually no current at all in the metering circuit, so there will be no voltage drop where the meter connects to the resistor (D) or in the meter leads themselves. Only the voltage drop caused by the resistor (R) is in the voltmeter's measurement loop since it is connected close to the body of the resistor, and that's the only voltage the meter will measure. All of the other drops don't contribute to any inaccuracy at all.

In practice, the hobbyist may not need 5-figure accuracy; but 3- or 4-figure accuracy might be nice, especially if you're working with precision ammeter shunts.

IEEE Membership

Q Please can you furnish me with the membership e-mail for American IEEE. Thanks for your cooperation—*A.A., via e-mail (France)*

A The Institute of Electrical and Electronics Engineers (IEEE), the most widely-known of the professional organizations for electrical/electronics engineers, has an Internet site at www.ieee.org where you can sign up online using a credit card. Membership (U.S. funds) in the United States is \$113 per year and membership in Europe is \$97 per year. Student rates are \$19 in the U.S. and \$14 in Europe.

Pull-Up & Pull-Down Resistors

Q How are the values of pull-up and pull-down resistors determined? Is the purpose of those resistors solely to prevent signal lines from floating?—*K.W., Acton, MA*

A It is true that you don't want inputs to float (remain unconnected), because you can't guarantee their logic condition in all situations. You can tie TTL inputs directly to +5 volts or ground, whichever you need to enable or disable the desired function. However, there are times when you want that logic level to manually change. A good example of this is the CLEAR input of a 74LS74 "D" flip-flop. We can add a pull-up resistor, R1 (a resistor tied to the +5-volt supply), and push-button switch (S1) to the CLEAR input of the 74LS74, as shown in Fig. 2. Normally, the CLEAR input will be disabled by the HIGH supplied by the pull-up resistor, and the flip-flop will be allowed to operate normally using its other inputs. If we press the switch, the CLEAR input is grounded; and the flip-flop clears or resets. By having the pull-up resistor "in the way" of the +5-volt supply, we don't risk a short circuit.

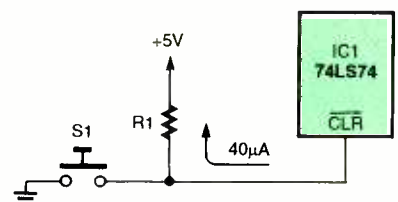

Fig. 2. A standard pull-up circuit allows a normally HIGH input to be momentarily grounded through a switch.

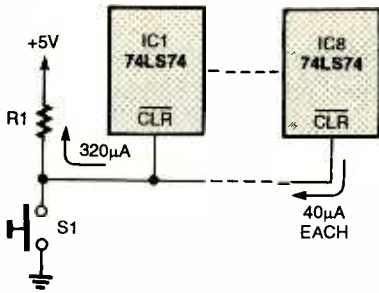

Fig. 3. A bank of chips requiring a pull-up resistor needs a lower-value resistor to keep the logic HIGH at the desired level.

Here's how to determine the value of that pull-up resistor. A 74LS74 causes 40 microamps of current to flow through its CLEAR input when it is connected to a logic HIGH. That parameter is stated in the National Semiconductor databook. A valid logic HIGH is anything between +3 and +5 volts. Let's assume that we don't want to drop more than 0.5 volts with that resistor. Ohm's Law tells us that the value of the resistor will be $0.5\text{v}/40\mu\text{A}$ or 12.5K ohms. The next lowest standard value that would keep our drop under 0.5 volts would be 12K. I usually just use a 10K resistor, a nice round value that I tend to overstock for just such uses.

If we had 8 of these CLEAR inputs that had to be controlled simultaneously, we would have 8 times the current through the resistor, as shown in Fig. 3. To keep the drop below 0.5 volts, the value of the resistor would have to be $0.5\text{v}/320\mu\text{A}$ which is 1.5625K or 1.5K for the next lowest standard value. A quick little DC circuit theory side trip here: If each of those 8 inputs had a 12.5K resistor tied to +5 volts and then all the inputs were tied to the switch, the 8 resistors would end up in parallel, creating a value of 1.5625K. No coincidence here.

Sometimes you have active HIGH inputs that are used in a similar situation, but must be pulled down. I avoid using pull-down resistors like I'd avoid

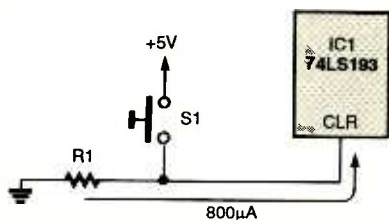

Fig. 4. A typical pull-down circuit may be needed, and it requires a smaller resistor value to get the logic LOW down to an acceptable value.

the plague. Pulling an input HIGH is easy, because you have a large target (a 3-volt window) and not much current. Since a valid logic LOW is anything between ground and +0.8 volts, pulling an input LOW means having to hit a small target (a 0.8-volt window). A second problem is that an LS-family input pulled LOW will cause 800 μA to flow through the pull-down resistor, and it's even worse for standard TTL which cause a 1.6-mA current. A third problem is the fact that if you need a LOW on a

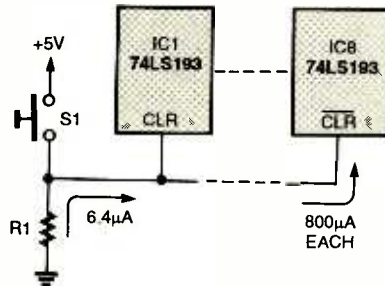

Fig. 5. If a pull-down circuit is needed for a bank of chips, the value of the pull-down resistor becomes so low that problems can develop with excessive power dissipation.

TTL input and it isn't less than 0.3 volt, there are some chips that will give you trouble.

With that in mind, let's try a pull-down resistor for the same circuit as shown in Fig. 4 and shoot for no more than 0.1 volt for the pull-down voltage.

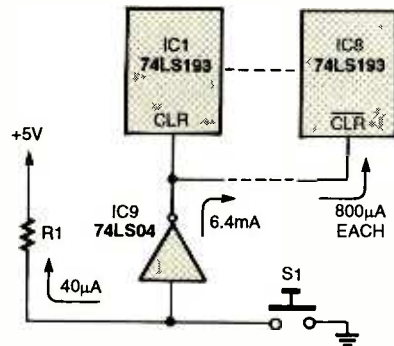

Fig. 6. An alternative circuit for a bank of active HIGH inputs uses a low-current pull-up resistor and an inverter to provide the normally LOW logic to the chips.

The resistor will have a value of $0.1\text{v}/800\mu\text{A}$ or 125 ohms. It's a low value, but now try pulling down 8 inputs tied together, as shown in Fig. 5. The new current is 6.4 mA, so the resistor value will be $0.2\text{v}/6.4\text{mA}$ or 31.25 ohms, next lowest standard value of 30 ohms. If

we push S1, 5 volts will be applied directly across R1 and it will dissipate almost 1 watt. To handle the possibility that S1 would be held down for an extended period, we'd want to use a 2-watt resistor here; and it's bigger than a 74LS74. See why I don't like pulling down? Small-value resistors, lots of current, lots of power needlessly consumed, and a fat resistor.

Figure 6 shows the preferred way of handling those 8 inputs. Use a simple inverter to pull the CLEAR inputs LOW and pull the inverter input up. In most cases, you'll have an inverter somewhere or a gate that you can make into an inverter, rather than installing a whole chip just for that function.

Han(n)imex Revisited

Ross Tester of *Silicon Chip* (the Australian equivalent of *Poptronics*) in Sydney, Australia noted that we were spelling Hanimex with two n's rather than one, which was spoiling our Internet search for information (April 2001). I was fooled because I did come up with a hit with a double-n and didn't realize the misspelling. He mentioned that www.hanimex.com.au is their Internet site.

Ross passed along a little history, noting that Hanimex is an Australian company that used to have a great deal of consumer electronics (including projectors), but these days is mostly an agent for Fuji, the Japanese film/processing/digital organization. He mentions that the name is a contraction of Hannes Import Export Company and came about because a receptionist decided that was too much of a mouthful and shortened it. Jack Hannes, the owner, liked it and the rest is history. Detractors often called the company "Ham'n'eggs." Thanks, Ross, for the great information. I love little tidbits like this. Now if I can just get on *Who Wants To Be A Millionaire*.

Multiple Monitors

Q I have a Pentium III computer with Windows 98 SE. This version of Windows supports the use of two monitors. I would like to use two monitors with a part of the display on one and a part on the other, or else I'd have some windows on one monitor and others on the second display. I have been unable to find any information on this. Could you tell me if any such software is

available and where to buy it?—L.D.T.,
Rebobo Beach, DE

A I'll be the first to admit that you have me out of my element anytime you want to deal with computers or most software. However, it just so happens that last month, my students were playing with just this scenario. You have all the software you need to do what you want.

When you install a second video card and power up the computer, Windows will inform you that it has detected more hardware and will have you scurry off to

Control Panel/Display/Settings to decide how you want your monitors to interact. My students had four monitors going at one time. You can use your mouse to rearrange the little monitor pictures in Settings however you want, including diagonally and vertically or horizontally offset, as well as next to or on top of each other. You can put your left one on the right, the right one on the left, and all kinds of weird configurations.

After selecting the appearance in Settings, all you have is a bigger window with which to work having multiple panes, if you will. If you open an appli-

cation such as Paint and drag it over to the second monitor screen and then maximize it, it'll stay entirely on that second screen. Then if you open a second application such as *Wordpad* and maximize it on the original screen, it'll stay entirely on that screen. The mouse moves back and forth between the screens.

You can draw a little picture in *Paint*, mark and copy it to the clipboard; and, then over on *Wordpad*, paste it onto the page there. Both applications still share the same clipboard. Only one application at a time will be active on the two screens.

For a little more information, I had checked with the denizens at www.pcmecb.com/index.htm to make sure that Windows SE worked the same way. For all you computer enthusiasts, there is a great forum for computer problems at the PC Mechanic site. For the URLs of some supporting information on this subject, visit the site and click on "Forums" on the left side of the page. Under the Windows 95/98/ME Forum, my post is titled "Multiple Monitors." If you have any input on that subject, that thread would be a good place to post it.

HOW TO GET INFORMATION ABOUT ELECTRONICS

On the Internet: See our Web site at www.poptronics.com for information and files relating to **Poptronics** and our former magazines (**Electronics Now** and **Popular Electronics**) and links to other useful sites.

To discuss electronics with your fellow enthusiasts, visit the newsgroups sci.elec.tronics.repair, sci.electronics.components, sci.electronics.design, and rec.radio.amateur.homebrew. "For sale" messages are permitted only in rec.radio.swap and misc.industry.electronics.marketplace.

Many electronic component manufacturers have Web pages; see the directory at www.hitex.com/chipdir/, or try addresses such as www.ti.com and www.motorola.com (substituting any company's name or abbreviation as appropriate). Many IC data sheets can be viewed online: www.questlink.com features IC data sheets and gives you the ability to buy many of the ICs in small quantities using a credit card. You can also get detailed IC information from www.icmaster.com, which is now free of charge although it formerly required a subscription. Extensive information about how to repair consumer electronic devices and computers can be found at www.repair.faq.org

Books: Several good introductory electronics books are available at RadioShack, including one on building power supplies.

An excellent general electronics textbook is *The Art of Electronics*, by Paul Horowitz and Winfield Hill, available from the publisher (Cambridge University Press, 800-872-7423) or on special order through any bookstore. Its 1125 pages are full of information on how to build working circuits, with a minimum of mathematics.

Also indispensable is *The ARRL Handbook for Radio Amateurs*, comprising over 1000 pages of theory, radio circuits, and ready-to-build projects, available from the American Radio Relay League, Newington, CT 06111, and from ham-radio equipment dealers.

Back issues: Copies of back issues of and past articles in **Electronics Now**, **Popular Electronics**, and **Poptronics** can be ordered on an "as available basis" from Claggg, Inc., Reprint Department, P.O. Box 12162,

Hauppauge, NY 11788; Tel: 631-592-6721. To ensure receipt of the correct material, readers must supply complete information on the article or issue that they wish to buy.

Poptronics and many other magazines are indexed in the *Reader's Guide to Periodical Literature*, available at your public library. Copies of articles in other magazines can be obtained through your public library's interlibrary loan service; expect to pay about 30 cents a page.

Service manuals: Manuals for radios, TVs, VCRs, audio equipment, and some computers are available from Howard W. Sams & Co., Indianapolis, IN 46214; (800-428-7267). The free Sams catalog also lists addresses of manufacturers and parts dealers. Even if an item isn't listed in the catalog, it pays to call Sams; they may have a schematic on file which they can copy for you.

Manuals for older test equipment and ham radio gear are available from Hi Manuals, PO Box 802, Council Bluffs, IA 51502, and Manuals Plus, 130 N. Cutler Dr., N. Salt Lake, UT 84054.

Replacement semiconductors: Replacement transistors, ICs, and other semiconductors, marketed by Philips ECG, NTE, and Thomson (SK), are available through most parts dealers (including RadioShack on special order). The ECG, NTE, and SK lines contain a few hundred parts that substitute for many thousands of others; a directory (supplied as a large book and on diskette) tells you which one to use. NTE numbers usually match ECG; SK numbers are different.

Remember that the "2S" in a Japanese type number is usually omitted; a transistor marked D945 is actually a 2SD945.

Hamfests (swap meets) and local organizations: These can be located by writing to the American Radio Relay League, Newington, CT 06111; (www.arrl.org). A hamfest is an excellent place to pick up used test equipment, older parts, and other items at bargain prices, as well as to meet your fellow electronics enthusiasts—both amateur and professional.

Fan Controller Comments

In the May "Q & A," I illustrated a design for a temperature-controlled ceiling fan. Reader Dave DeLeersnyder wrote to say that several years ago, he used an alternate circuit for controlling a fan. It was built around a RadioShack 910-4911 thermometer module that has a digital display and remote sensor, and he had to add only a few components such as a relay and relay driver circuit. His implementation was much easier, of course.

His version would be ideal in many applications where a single temperature threshold is needed and/or where a specific control temperature is desired.

Dave's implementation would not have solved our original problem, which was not to control to a specific temperature, but to control a temperature differential between floor and ceiling. The actual temperature was of no importance, but the difference in temperature was. Readers who need a specific temperature control similar to a standard thermostat would be wise to look into Dave's idea. Thank you, Dave, for your input. I'll keep that module idea stored

(Continued on page 57)

Poptronics

REPRINT BOOKSTORE

- | | |
|---|---|
| <input type="checkbox"/> 229 Popular Electronics (1999 back issues) \$5.00
Write in Issues desired _____ | <input type="checkbox"/> 218 Electronics Now (1998 back issues) \$5.00
Write in Issues desired _____ |
| <input type="checkbox"/> 228 Popular Electronics (1998 back issues) \$5.00
Write in Issues desired _____ | <input type="checkbox"/> 217 Electronics Now (1997 back issues) \$5.00
Write in Issues desired _____ |
| <input type="checkbox"/> 227 Popular Electronics (1997 back issues) \$5.00
Write in Issues desired _____ | <input type="checkbox"/> 216 Electronics Now (1996 back issues) \$5.00
Write in Issues desired _____ |
| <input type="checkbox"/> 226 Popular Electronics (1996 back issues) \$5.00
Write in Issues desired _____ | <input type="checkbox"/> 215 Electronics Now (1995 back issues) \$5.00
Write in Issues desired _____ |
| <input type="checkbox"/> 225 Popular Electronics (1995 back issues) \$5.00
Write in Issues desired _____ | |
-
- | | |
|---|---|
| <input type="checkbox"/> EH96 Experimenters Handbook (1996) \$5.00 | <input type="checkbox"/> 174 Electronics Cartoons (The Best of) \$1.99 |
| <input type="checkbox"/> EH95S Experimenters Handbook Summer Edition (1995) \$5.00 | <input type="checkbox"/> 173 From Not-Working to Networking Troubleshooting Local-Area Networks \$2.99 |
| <input type="checkbox"/> EH94S Experimenters Handbook Summer Edition (1994) \$5.00 | <input type="checkbox"/> 172 33 Bench-Tested Circuits \$1.99 |
| <input type="checkbox"/> EH94W Experimenters Handbook Winter Edition (1994) \$5.00 | <input type="checkbox"/> 171 36 Time Tested Circuits \$1.99 |
| <input type="checkbox"/> EH94 Experimenters Handbook (1994) \$5.00 | <input type="checkbox"/> 170 High-Voltage Project for Fun and Science Book 1 \$2.99 |
| <input type="checkbox"/> EH93 Experimenters Handbook (1993) \$5.00 | <input type="checkbox"/> 170A High-Voltage Projects for Fun and Science Book 2 \$2.99 |
| <input type="checkbox"/> HH95S Hobbyists Handbook Spring Edition (1995) \$5.00 | <input type="checkbox"/> 169 Think Tank (133 Circuits) \$1.99 |
| <input type="checkbox"/> HH95F Hobbyists Handbook Fall Edition (1995) \$5.00 | <input type="checkbox"/> 169A Think Tank Vol. 2 \$1.99 |
| <input type="checkbox"/> HH94S Hobbyists Handbook Spring Edition (1994) \$5.00 | <input type="checkbox"/> 168 Fact Cards (#34-66) \$1.99 |
| <input type="checkbox"/> HH94F Hobbyists Handbook Fall Edition (1994) \$5.00 | <input type="checkbox"/> 168C Fact Cards (#67-99) \$1.99 |
| <input type="checkbox"/> HH93 Hobbyists Handbook (1993) \$5.00 | <input type="checkbox"/> 168D Fact Cards (#100-132) \$1.99 |
| <input type="checkbox"/> HISTORY Crystal Radio History, Fundamentals & Design \$10.95 | <input type="checkbox"/> 167 Designing With IC's \$2.99 |
| <input type="checkbox"/> XTAL Crystal Set Handbook \$10.95 | <input type="checkbox"/> 166 Collected Works of Mohammed Ulysses Fips (62 pages, April Fools Collection) \$6.99 |
| <input type="checkbox"/> XTALPRO Crystal Set Projects \$14.95 | <input type="checkbox"/> 165 How to Repair CD Disc Players \$2.99 |
| <input type="checkbox"/> XTALBLD Crystal Set Building \$15.95 | <input type="checkbox"/> 164 Modern Electrics (April 1908) \$1.99 |
| <input type="checkbox"/> POP96 PDPtronix Hobbyist Handbook (1996) \$5.00 | <input type="checkbox"/> 160 New Ideas - 42 Circuits \$1.99 |
| <input type="checkbox"/> POP97 POPtronix Exper Handbook (1997) \$5.00 | <input type="checkbox"/> 159 Low Frequency Receiving Techniques Building and Using VLF Antennas \$2.99 |
| <input type="checkbox"/> Radiocraft 1993 Projects for Hobbyists \$5.00 | <input type="checkbox"/> 158 Electro Importing Co. Catalog (Circa 1918) \$2.99 |
| <input type="checkbox"/> 219 Electronics Now (1999 back issues) \$5.00
Write in Issues desired _____ | <input type="checkbox"/> 157 All About Kits \$1.99 |
| | <input type="checkbox"/> 156 How To Make PC Boards \$1.99 |
| | <input type="checkbox"/> 154 How To Repair VCR's \$1.99 |

REPRINTS REPRINTS

To order any of the items indicated above, check off the ones you want. Complete the order form below, include your payment, check or money order (DO NOT SEND CASH), payable to and mail to Claggk Inc., Reprint Department, P.O. Box 12162, Hauppauge, NY 11788.

Please allow 4-6 weeks for delivery. No COD's!
To place a credit card by phone, Visa Mastercard or Discover only. You can also order and pay by e-mail. Contact Claggk@gernsback.com for details.

CALL: 631-592-6721

To use your Visa, Mastercard or Discover, complete the following:

Bill my Visa Mastercard Discover

Card No. _____

Exp. Date _____

Signature _____

MAIL TO: Claggk Inc.

Reprint Bookstore, P.O. Box 12162, Hauppauge, NY 11788.

SHIPPING CHARGES IN USA & CANADA

Up to \$5.00	\$2.00	\$30.01 to 40.00	\$6.00	Overseas Orders must contact CLAGGK for shipping charges.
\$5.01 to \$10.00	\$3.00	\$40.01 to 50.00	\$7.00	
\$10.01 to 20.00	\$4.00	\$50.01 and above	\$8.50	
\$20.01 to 30.00	\$5.00			

Total price of merchandise \$ _____

Shipping Charge (see chart) \$ _____

Subtotal \$ _____

Sales Tax (New York State Residents only) \$ _____

Name _____ Total Enclosed \$ _____

Address _____

City _____ State _____ Zip _____

CL01

Ivan Neal has

put out a lot of
fires.



He's not a

firefighter—

he's a teacher.

But to the kids

he's reached,

he's a hero.

**BE A TEACHER.
BE A HERO.**

Call
1-800-45-TEACH.

PIC Microcontrollers Part III

In the last two installments, we reviewed the PICBasic and PICBasic Pro compilers. It's now time to show how to put these compilers to work. We will again use Microchip's PIC16F84 microcontroller in our examples. I designed the following exercises to show how to perform basic electrical functions. These functions are basic to using microcontrollers in electronic circuits and designs.

To begin, let's examine how microcontrollers can perform simple switch detection—whether or not a switch has been closed. The microcontroller can detect TTL logic levels on any of its 13 I/O pins. We will use these logic levels in conjunction with switches (see Fig. 1).

Reading Switch As Logic Low

In Fig. 1 the switch labeled "A" keeps the I/O pin at a logic high until the switch is closed. Once closed, the I/O pin is brought to ground—a logic low or zero. Once the microcontroller has determined this, the microcontroller can perform any number of operations or control functions. In our example we will blink an LED.

Keep in mind that the LED may represent a transistor, transducer, electronic circuit, or another microcontroller/computer.

The schematic for the "read the switch low" circuit is shown in Fig. 2. The switch is connected to I/O pin

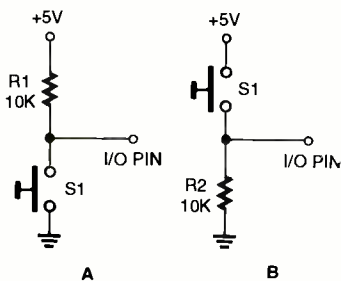

Fig. 1. Here is the schematic showing how a switch may be used to generate either a logic high or a logic low.

LISTING 1

```
'PICBasic Compiler
'REM test switch low
'Initialize variables
input 4
start:
if pin4 = 0 then blink
goto start
blink:
high 0
pause 250
low 0
pause 250
goto start

'Set pin RB4 to read switch
'If switch is low then blink LED
'If not check switch again
'Blink routine
'Bring RB0 high to light LED
'wait 1/4 second
'Bring RB0 low to turn off LED
'wait 1/4 second
'check switch again
```

LISTING 2

```
'REM PICBasic Compiler Pro.
'Rem test switch low
input portb.4
start:
if portb.4 = 0 then blink
goto start
blink:
high 0
pause 250
low 0
pause 250
goto start

'Set pin RB4 to read switch
'If switch is low then blink LED
'If not check again
'Blink LED routine
'Bring RB0 high to light LED
'wait 1/4 second
'Bring RB0 low to turn off LED
'wait 1/4 second
'check switch again
```

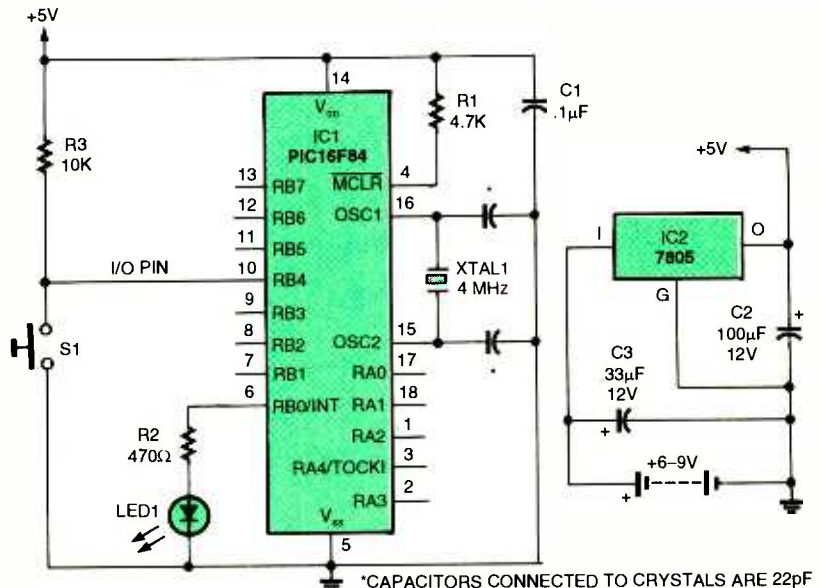

Fig. 2. Above is the schematic for reading a logic low from the I/O pin.

labeled RB4. The LED is connected to RB0 through a 470-ohm current limiting resistor.

Reading Switch As Logic High

These programs and the schematic are the complement to the previous examples. Look back to Fig. 1, example B. The switch labeled "R" keeps the I/O pin at a logic low level. When the switch is closed, the I/O pin is brought to a logic high level.

The schematic for the circuit to read

the logic high is shown in Fig. 3. The switch is connected to I/O pin labeled RB4. The LED is connected to RB0 through a 470-ohm current limiting resistor.

Reading Comparators

The microcontroller can also read logic levels from other microcontrollers, circuits, or ICs. As an example, look at Fig. 4. In this schematic the microcontroller is set to read the output of a comparator. Since the out-

put of a LM339 comparator is equivalent to an open collector of an NPN transistor, it is usually brought high by using an external pull-up resistor. The comparator is read by the microcontroller using the same programs that detect a logic low.

Reading Resistive Sensors

The PIC microcontroller is able to read resistive sensors that vary in resistance from 5K ohms to 50K ohms directly. The types of resistive sensors that can be connected to the microcontroller are numerous: for instance photoresistors (CdS cells), thermistors (PTC and NTC types), toxic gas sensors, bend sensors, and humidity sensors. The microcontroller reads the resistance by timing the discharge of a capacitor through the resistive device, see Fig. 5.

LISTING 3

```
'PICBasic Compiler
'REM test switch high
input 4
start:
if pin4 = 1 then blink
goto start
blink:
high 0
pause 250
low 0
pause 250
goto start

'Set pin RB4 to read switch

'If switch is high then blink LED
'If not check switch again
'Blink routine
'Bring RB0 high to light LED
'wait 1/4 second
'Bring RB0 low to turn off LED
'wait 1/4 second
'check switch again
```

LISTING 4

```
'PICBasic Compiler Pro.
'REM test switch high
input portb.4
start:
if portb.4 = 1 then blink
goto start
blink:
high 0
pause 250
low 0
pause 250
goto start

'Set pin RB4 to read switch

'If switch is high then blink LED
'If not check again
'Blink LED routine
'Bring RB0 high to light LED
'wait 1/4 second
'Bring RB0 low to turn off LED
'wait 1/4 second
'check switch again
```

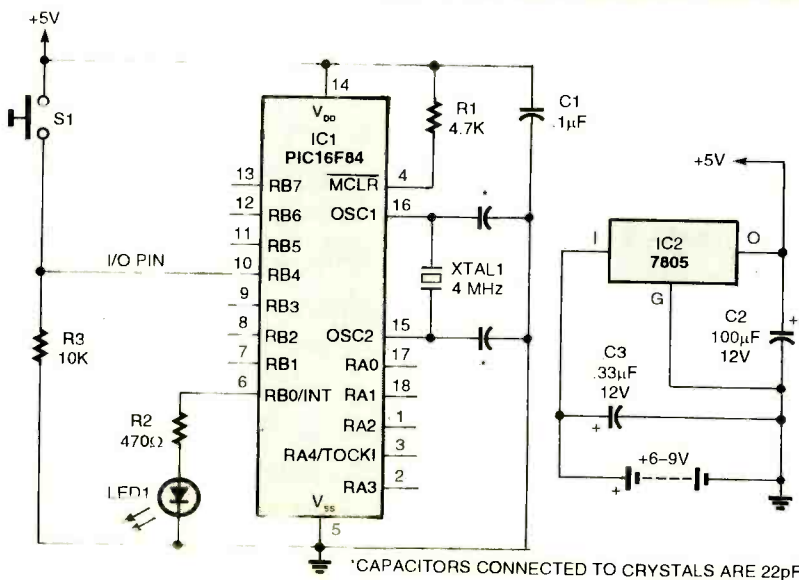

SOURCE INFORMATION

There are numerous sources available for working with PIC microcontrollers—both in print and on the Web. The following is just a sampling of these resources. Also, check out this month's "New Literature" for John Morton's book, *PIC Your Personal Introductory Course*.

In Print

Crash Course in PC and Microcontroller Technology, written by Louise E. Frenzel, Jr., published by Newnes

PIC Microcontroller Project Book, written by John Iovine, published by McGraw Hill

Programming and Customizing The PIC Microcontroller, written by Mike Predko, published by McGraw Hill

On The Web

Microchip

www.microchip.com

This is the manufacturer's homepage and visitors can get up-to-date information on the latest projects, developer tools, and industry news.

microEngineering Labs, Inc.

microengineeringlabs.com

This site offers developer tools, books, prototype boards, compilers, and technical information concerning PIC applications.

Reynolds Electronics

rentron.com

Visit this URL for all your microcontroller needs. This site offers a glimpse into *Roboware*—an acclaimed compiler for use with many popular microcontrollers.

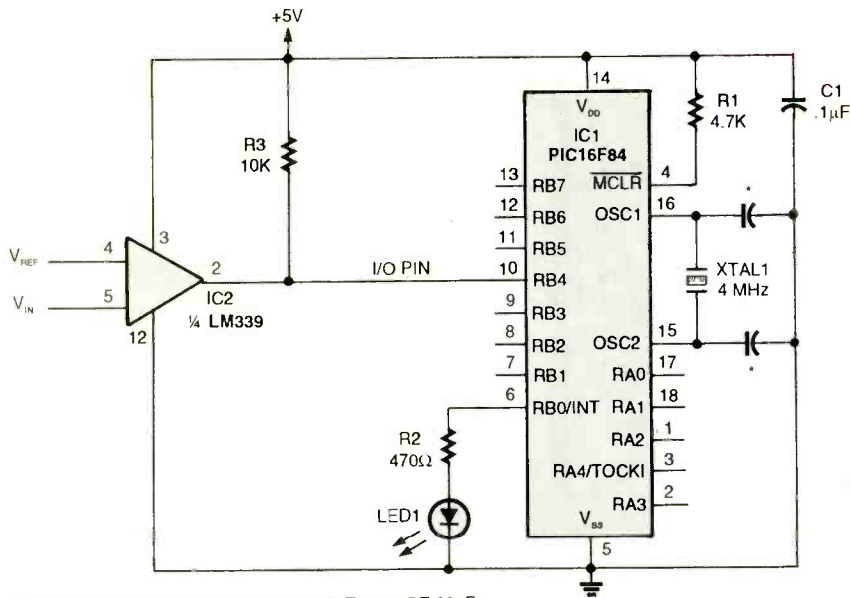

* CAPACITORS CONNECTED TO CRYSTALS ARE 22pF

Fig. 4. Above is the schematic for reading a logic low signal from a comparator.

The command to read a resistive sensor is:

POT PIN, SCALE, VAR

Where POT is the command, PIN is the pin number the resistive sensor is connected to. The command SCALE is used to adjust the RC constant. For a large RC constant, scale should be set low; and for a small RC constant scale should be set to its maximum value of 255. When the scale value is set correctly, the value contained in the VAR variable will be near zero at minimum resistance value and set to 255 near maximum resistance value.

Scale needs to be determined experimentally. To find a good scale value set the resistive device under measurement to its maximum resistance and read the VAR variable with the scale set to 255. Under these conditions, the value held in the VAR variable will contain a reasonable value for scale.

A schematic for this type of basic circuit is shown in Fig. 6. For the resistive sensor you can connect a 50-K potentiometer. As the potentiometer is varied, one of the LEDs will be lit depending upon the value held in the variable B0. If the resistance value read is above 125, LED1 will be lit; if not, LED2 will be lit.

One can make the demonstration a little more interesting by substituting a CdS photo-resistive cell in place of the potentiometer in the circuit. If the proper CdS cell is chosen, for instance one

with a dark resistance around 50–100K and with light saturation resistance of

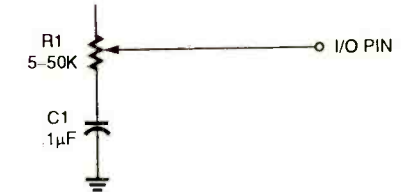

Fig. 5. Here is the setup for reading resistive device from an I/O Pin.

10K or less, LED1 will be lit when the photoresistor is covered or in darkness. In bright light LED2 will be lit.

It's possible to read the numerical value of the pot variable, by serially sending the variable to a serially interfaced LCD display or RS232 computer connection. The command to send the information out serially is:

SEROUT PIN, MODE, VAR

While we are not doing serial communication right now, it's important that you know you can.

LISTING 5

```
' PICBasic Compiler ** reading resistance type sensors **
' Photoresistor test program
' Set Up
start:
pot 2,255, b0
if b0 > 125 then I1
if b0 <= 125 then I2
I1:
high 0
low 1
goto start
I2:
high 1
low 0
goto start

'Read sensor on RB2
'if more than 100 light LED 1
'if less than 100 light LED 2
'Light LED 1 routine
'Light LED 1
'Turn off LED 2
'Repeat
'Light LED 2 Routine
'Light LED 2
'Turn off LED 1
'Repeat
```

LISTING 6

```
' PICBasic Pro Compiler ** reading resistance type sensors **
' Photoresistor test program
' Set Up
output portb.0
output portb.1
b0 var byte
start:
pot portb.2,255, b0
if b0 > 125 then I1
if b0 <= 125 then I2
I1:
high portb.0
low portb.1
goto start
I2:
high portb.1
low portb.0
goto start

'Set RB0 as output
'Set RB1 as output

'Read sensor on RB2
'if more than 100 light LED 1
'if less than 100 light LED 2
'Light LED 1 routine
'Light LED 1
'Turn off LED 2
'Repeat
'Light LED 2 Routine
'Light LED 2
'Turn off LED 1
'Repeat
```

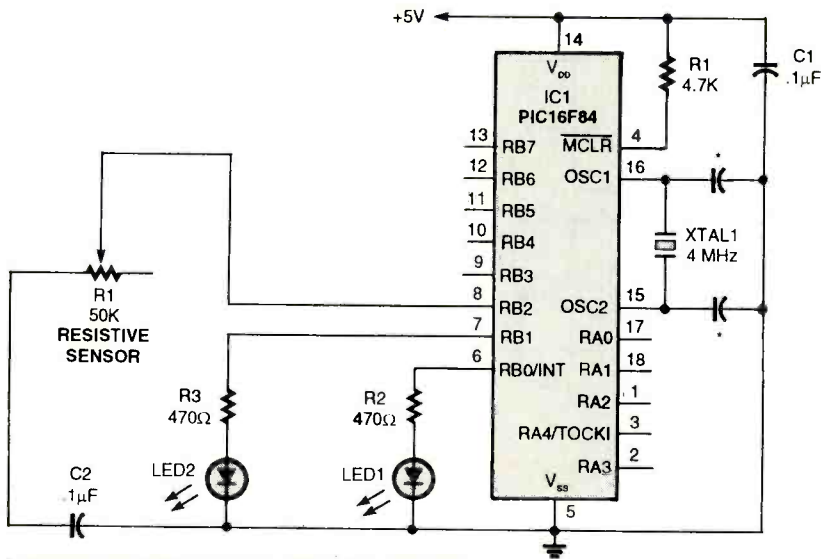

* CAPACITORS CONNECTED TO CRYSTALS ARE 22pF

Fig. 6. Above is the schematic for reading resistive device from I/O pin.

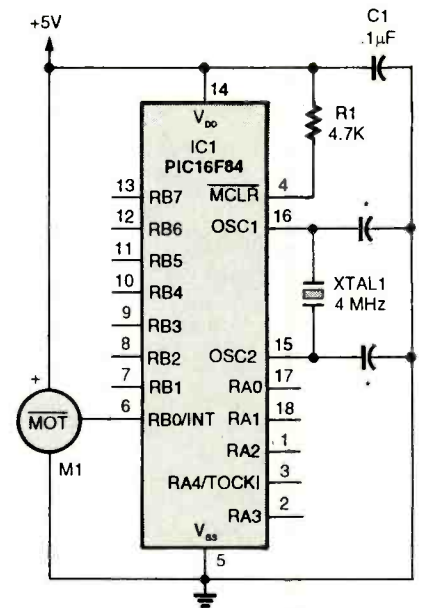

* CAPACITORS CONNECTED TO CRYSTALS ARE 22pF

Fig. 7. Above is the schematic for the servomotor sweep program.

LISTING 7

```
'Servomotor sweep program
'PICBasic Compiler
'Programs sweeps left to right and back again
b0 = 100
sweep:
pulsout 0,b0
pause 18
b0 = b0 + 1
if b0 > 200 then sweepback
goto sweep
sweepback:
b0 = b0 - 1
pulsout 0, b0
pause 18
if b0 < 100 then sweep
goto sweepback

'Initialize at left position
'Sweep routine
'Send pulse to servomotor
'wait 18 ms (50-60 hz)
'increment pulse width
'End of sweep?
'no, continue sweeping
'sweepback routine
'decrement pulsewidth
'Send pulse to servomotor
'delay to send 50-60 HZ
'End of sweepback
'no
```

LISTING 8

```
'Servomotor sweep program
'PICBasic Pro Compiler
'Programs sweeps left to right and back again
b0 var byte
b0 = 100
sweep:
pulsout portb.0,b0
pause 18
b0 = b0 + 1
if b0 > 200 then sweepback
goto sweep
sweepback:
b0 = b0 - 1
pulsout portb.0, b0
pause 18
if b0 < 100 then sweep
goto sweepback

'Initialize at left position
'Sweep routine
'Send pulse to servomotor
'wait 18 ms (50-60 hz)
'increment pulse width
'End of sweep?
'no, continue sweeping
'sweepback routine
'decrement pulsewidth
'Send pulse to servomotor
'delay to send 50-60 HZ
'End of sweepback
'no
```

tion their shaft through a minimum of 90 degrees of rotation (+/- 45 degrees). There are three wires to the servomotor. Two leads are for power, typically 4.5-6V, and ground. The third wire feeds the position control signal to the servomotor. The position control signal is a variable-width pulse. The pulse is varied between 1 and 2 milliseconds. The width of the pulse controls the position of the servomotor's shaft.

Controlling servomotors with a PIC microcontroller is easy. The 1-2 millisecond control pulse signal must be sent to the motor 50-60 times a second.

The PULSOUT command generates a pulse on the pin specified, for the period specified (in 10 µs increments). So the command "PULSOUT 1, 150", will place a 1.5 millisecond (10 µs × 150 = 1500 µs or 1.5 millisecond) pulse on pin 1. The 1.5 millisecond pulse will place the servomotor's shaft at mid-position.

Servo Sweep Program

The demonstration program will sweep the servo rotator left to right and back again like a radar dish antenna. The schematic is shown in Fig. 7.

Next Month

Next month we use what we learned by building a robotic vehicle controlled with a PIC microcontroller. **P**

Servomotors

54 Servomotors are geared DC motors with a positional feedback

control that allows the rotor of the motor to be accurately positioned. Most hobbyist servomotors can posi-

Electronic-Flash Units and Strobe Lights

The devices described in this article involves the use of materials and substances that are hazardous to health and life. **DO NOT** attempt to implement or use the information contained in this article unless you are experienced in the construction and safety considerations that apply to high-voltage devices of this nature. Although all possible measures have been taken to ensure the accuracy of the information presented, Gernsback Publications Inc. is not liable for damages or injuries, misinterpretation of directions, or the misapplications of information.

They are all around us, in all sorts of cameras, safety beacons, disco lighting effects, and pulsed lasers. The intense blue-white light of the xenon flash is instantly recognizable. Originally developed at MIT by Harold (“Doc”) Edgerton, this technology has proven very effective in many different applications, changing little over the decades.

In this month’s “Service Clinic,” we’ll deal with the principles of operation of the electronic flash. Next month, we’ll discuss handy modifications, problems, and repair.

Safety

There are two potential hazards in dealing with the innards of electronic flash and other xenon strobe equipment. The first hazard is the energy-storage capacitor. Even on small pocket-camera electronic-flash units, these are rated at 100 to 400 μF at 330 V_{DC} . This is 5 to 20 watts, which is enough to kill you under the right (wrong?) conditions. Hot shoe or side-mounted electronic-flash units have energy-storage capacitors that are usually larger—typically 300–1000 μF or more. High-performance studio speed lights may have ten times this capacity and at much higher voltages, resulting in even greater energy storage. Xenon

strobes for pumping of solid-state laser rods and other industrial and scientific applications may use high kV power supplies with extremely high-wattage energy-storage capacitors—touch one of these and you will be but a puff of vapor in the wind.

High voltage with high-energy storage is an instant deadly combination. Treat all of these capacitors—even those in tiny pocket cameras—with respect. Always confirm that they are discharged before even thinking about touching anything. On larger systems especially, install a shorting jumper after discharging just to be sure—capacitors have been known to recover a portion of their original charge without additional power input. Better to kill the power supply than yourself if you forget to remove it when powering up.

A second danger is that line-connected (no power transformers) flash units have all the dangers associated with AC line power, in addition to the large power supply and the energy-storage capacitors. Always use an isolation transformer when probing line-connected systems. However, keep in mind that the power-supply filter capacitors and energy-storage capacitors remain just as deadly.

Also, see the document “Safety Guidelines for High Voltage and/or Line Powered Equipment” at my Web site, www.repairfaq.org. Additional important safety information regarding shock, excessively bright light, ultraviolet radiation, heat and fire hazards, and other hazards is available from Don Klipstein’s “Xenon Strobe and Flash Safety Hints” page at www.misty.com/~don/xesafe.

Reading and following these recommendations and heeding the warnings is very important when working with strobe equipment, especially high-powered units.

Camera Flash Units

Most of these use a DC-DC inverter

to provide approximately 300 V_{DC} from a battery between 1.5 and 6 volts, depending on the model. The flash units in pocket cameras are marvels of compactness. Those in disposable cameras are also a marvel of low cost.

The guts from disposable cameras are an excellent source of flash components for the experimenter and may be available for the asking from your local one-hour photo (after you convince them you won’t kill yourself). **Beware:** The energy-storage capacitor may retain a potentially lethal charge for a long time—always remove the battery and discharge the capacitor before touching anything.

In many low-cost cameras, the shutter contacts directly discharge the trigger capacitor to initiate the strobe. Better designs will use an SCR or triac for this purpose to eliminate arcing damage to the contacts and/or to permit remote triggering.

Most pocket camera and portable electronic-flash units include circuitry similar to the MAX flash. The most notable enhancements will be related to automatic control of flash duration (described below). However, newer cameras with fancy exposure modes and options may have much additional logic circuitry inside the flash unit, not directly related to the xenon flash itself.

Automatic Flash Units

Most modern flash units on anything more sophisticated than a disposable camera use light feedback from the scene being photographed to control the duration of the flash and, thus, the exposure. This is harder to do than might seem obvious. Once the gas in the flash lamp becomes conductive, the discharge process can’t be interrupted, at least not easily.

So, the cheapest automatic flash units simply dump the unused charge at the instant when a light sensor deter-

mines there has been enough. This is often done via a "quench tube" in parallel with the flash lamp, a small covered xenon-filled bulb. Since the bulb has a lower voltage when conducting, the current will flow through it instead of the main lamp when it is triggered. However, with this simple approach, every flash—either for a shot one foot away or at the maximum useful distance (as determined by the guide number of the flash unit, film speed, and aperture)—uses the same maximum energy and so wastes a lot as well.

Energy-conserving flashes do actually shut off the current to the flash lamp in mid-stride. One approach is to place an SCR (thus the name "thyristor flash") in series with the flash lamp, which is fully on when the flash is triggered. Its gate drive is then removed just after the flash is triggered. At the end of the flash, the current is bypassed around the flash lamp/SCR combination into a small auxiliary capacitor, but only long enough for the SCR to return to a non-conducting state. In this manner, much less energy is wasted for shots requiring only a little bit of light.

Timing Lights

Those of you who remember needing to check or adjust engine timing will recall the use of a timing light to view a mark on the engine flywheel triggered from the #1 spark plug. These are also xenon strobes, but with the triggering provided by the HV pulse of the ignition system.

Input to this one is from the AC line. The trigger is simply a high-voltage wire that is clipped onto the #1 spark plug.

Flash Units For Pulsed Lasers

Solid-state lasers (pulsed ruby, Nd:YAG, and others) require energy anywhere from a few Joules (watt-seconds) to 100,000 Joules or more. However, the basic principles are very similar except that other components are added in the discharge path to control the duration and shape of the discharge pulse, and thus the light output. An inductor shapes the pulse so that it is approximately 100 microseconds in length, and the discharge is critically damped so there is no undershoot. Additional details on SSI and this power supply can be found at my Web site in "Sam's Laser FAQ." See the chapter, "Solid State Lasers."

Logic-Controlled Strobes And Flashes

Often it is desirable to be able to trigger a flash from the output of a microcontroller or other logic signal. TTL level signals enable the inverter to be turned on and off or allow it to automatically top off the charge when needed (OPR-H and OFF-H). Triggering is via a triac capacitively coupled to the trigger input (FIRE-H). Thus, a strong trigger signal is important to prevent possible damage to the triac, since there is no separate buffer. The state of charge can be monitored to know when to fire reliably for maximum light output (READY-L).

I examined a circuit that was a high-speed (less than 50 microseconds duration), 15 Joule, logic-controlled flash that runs off 12 V_{DC}. The short flash permits stop action photography of even quite fast events, such as a home-run baseball leaving the bat. One of its unique features is the simplicity of the inverter transformer—only 32 total turns on a ferrite core! Thanks to Don Klipstein for the super-simple and nifty inverter design.

The high-speed switch consists of the inverter, pulse-forming network (PFN: energy storage capacitor, inductor, and flash lamp), and trigger circuit.

The inverter consists of a CMOS TLC555 timer and IGBT (Insulated Gate Bipolar Transistor). The IGBT is driven like a MOSFET, but has output characteristics more like that of a bipolar transistor—the best of both worlds. The output voltage is monitored by one section of an LM339 quad voltage comparator and shuts off the oscillator once full charge is reached (approximately 900 volts). As the voltage decays due to leakage through the trigger circuit and voltage monitor, the oscillator will come on briefly at periodic intervals to top off the charge. With some minor changes, the idling current could be substantially reduced.

The other sections of the LM339 are wired as buffers to accept an inverter ENABLE signal, provide a (low-going) READY output signal, and drive a READY LED. The ENABLE input and READY output allow the control logic to turn on the inverter on demand. That's fine for the intended application. (However, the internal voltage limiter cannot be overridden.) This reduces the idle current consumption substantially.

The trigger circuit consists of an

PRINCIPLES OF OPERATION

Virtually all xenon flash units and strobes are based on the triggered discharge of an energy-storage capacitor through low-pressure xenon gas, and they consist of four parts:

- Power supply to charge the energy-storage capacitor and trigger capacitor. The required voltage is most commonly around 300 V_{DC} and may be supplied by an AC line-powered voltage doubler or DC-DC inverter (for battery operation).
- Energy storage capacitor. The light output of the flash is determined approximately as $\frac{1}{2} \times C \times V \times V$ multiplied by the luminous efficiency of the lamp—which can approach 50 percent.
- Xenon flash lamp. A glass or quartz tube—straight, or bent into a U or helical shape—filled with xenon (a noble) gas at a fraction of atmospheric pressure. Electrodes are sealed in at each end, and a trigger wire may be wrapped around the outside.
- Trigger supply. Usually a small capacitor discharges through a special transformer to provide a high-voltage pulse to a wire or reflector in close proximity to the flash lamp.

Like other gas-filled tubes, the flash lamp is normally non-conducting. Applying enough voltage between its electrodes would result in the gas breaking down, but that would be a very high voltage and control of flashing would be difficult. Thus, the triggered approach is used. The energy-storage capacitor is charged to a much lower voltage, and a pulse applied to the outside of the lamp is used to initiate the discharge. The energy storage cap then dumps nearly all of its charge through the lamp, which then returns to its non-conductive state. Even disco strobes, stroboscopes, and safety beacons that flash repeatedly use this approach.

opto-triac driving a 10-amp SCR, which dumps a 0.082 μ F capacitor charged to about 300 volts through the trigger transformer.

The PFN (Pulse Forming Network) was designed to optimally drive the 8358 flash lamp with a 15 Joule input at less than 50 microseconds. The inverter itself really doesn't care what is used for the PFN except that, as designed, it

charges to 900 volts. The only question is how long will it take to charge the energy-storage capacitor.

Note that the 36- μ F, 1-kV energy-storage capacitor is quite special—I call it the “magic yellow cap.” It has a very low ESR (about 24 milliohms) and high peak-current capability (at least 800 A). Substituting a series or series/parallel combination of photoflash (electrolytic) capacitors will not result in nearly as short a flash duration or peak light output. The flash will be two to three times as long, and the total output light energy will also be much less because much of the electrical energy will be dissipated inside the much higher ESR capacitors. The typical ESR for a 120 μ F, 330-volt photoflash capacitor is 0.3 ohms—over ten times that of the magic yellow cap. Of course, they are also about 25 times cheaper!

The PFN inductor, L1, is just seven turns of #14 AWG insulated stranded wire in a single layer on a 1.5-inch diameter form. A toilet paper roll works fine.

The diode across the flash lamp (D1) is just insurance. There really should be no reverse voltage across the flash lamp, given the critically damped design of the PFN.

The wonderfully simple transformer consists of two E cores of the “older” Ferroxcube, part number E375-3C81 (or even previous to that E375-3C8), and the modern Philips Components, part number E34/14/9-3C81. The half gap (paper thickness) is two pieces of regular copy paper, which should be about 0.2 mm. The bobbin is old Ferroxcube, part number E375pcB1-12, and Philips Components, part number CPH-E34/14/9-1512. I got them from Eastern Components, 800-642-0518.

Gapped versions of this core may be available. If both halves are gapped, specify 0.2 mm. If you get a gapped piece paired with a non-gapped piece, then the gapped one should be 0.4 mm.

The primary and secondary are each 16 turns of insulated #20 AWG hookup wire, but wire size is not critical; and the secondary could easily be #22. Magnet wire is fine with adequate insulation between layers and between the secondary and the core (3C8 and related ferrite materials are slightly conductive). Anything as thick as #18 should easily fit.

Wrapup

Much more information on the cir-

cuits in this article can be found under: “Notes on the Troubleshooting and Repair of Electric Flash Units and Strobe Lights” at my Web site, www.repairfaq.org. Even more xenon strobe stuff can be found at Don Klipstein’s Strobe page, www.misty.com/people/don/donflash. Next time, we’ll discuss some of the things that can go wrong and their remedies. **P**

Q&A

(continued from page 49)

away for future use. There’s rarely any sense in re-inventing the wheel when such a simple solution exists.

Writing to Q&A

As always, we welcome your questions. Please be sure to include: (1) plenty of background material, (2) your full name and address on the letter (not just the envelope), (3) and a complete diagram, if asking about a circuit. Type your letter or write neatly.

Send questions to Q&A, **Poptronics**, 275-G Marcus Blvd., Hauppauge, NY 11788 or to q&a@gernsback.com, but do not expect an immediate reply in these pages (because of our backlog). We regret that we cannot give personal replies. Please no graphics files larger than 100K. **P**



MULTIMEDIA on the PC!

What is Multimedia? What can it do for you? It can do lots of nice things! This 184-page book helps you create your own multimedia presentation. Multimedia applications by people like you can revolutionize educational and business applications as well bring more FUN, FUN, FUN into your leisure computer activities.

Mail coupon to:

Electronics Technology Today, Inc.
P.O. Box 240
Massapequa Park, NY 11762-0240

Please send me my copy of *Multimedia on the PC* (PCP120). I enclose a check or money order for \$18.45 to cover the book's cost and shipping-and-handling expenses. NY state residents must add local sales tax.

Name _____

Address _____

City _____ State _____ Zip _____

All orders must be paid in U.S. funds only. Sorry, no orders accepted outside of USA and Canada. Please allow 6-8 weeks for delivery.

MA02

VCR Cross Reference

NOW Find the right Part for your VCR



With the IS CET VCR CROSS REFERENCE

This 172-page reference contains both model and part-number cross-references updated as of Feb, 1997.

VCR's are made in a few factories from which hundreds of different brand names and model numbers identify cosmetically-changed identical and near-identical manufactured units. Interchangeable parts are very common. An exact replacement part may be available only a few minutes away from you even though the manufacturer supplier is out-of-stock. You may be able to cannibalize scrap units at no cost!

The IS CET VCR Cross Reference is pre-punched for standard loose-leaf binding. . . \$29.95 includes shipping in the United States for each Reference.

Clagg Inc.
VCR CROSS REFERENCE OFFER
P.O. BOX 12162
HAUPPAUGE, NY 11778

Name _____

Business _____

Address _____

City _____

State _____ Zip _____

Phone _____

Enclose \$29.95 for the Eighth Edition of the IS CET VCR Cross Reference including shipping for each Reference in the United States. All other countries add \$5.00 (surface mail).

The total amount of my order is \$ _____

Check enclosed—do not send cash.

or please charge my credit card.

Visa MasterCard Exp. Date ____/____/____

Card No. _____

Signature _____

New York State residents must add applicable local sales tax to total. US funds only. Use US bank check or International Money Order. **CB02**

RETAILERS THAT SELL OUR MAGAZINE EVERY MONTH

Arizona

Elliott Elec. Supply
1251 S. Tyndell Ave.
Tucson, AZ 85713

California

All Electronics
14928 Oxnard Street
Van Nuys, CA 91411

California Electronics
221 N. Johnson Ave.
El Cajon, CA 90202

Electronics Plus, Inc.
823 4th St.
San Rafael, CA 94901

Electronics Warehouse
2691 Main Street
Riverside, CA 92501

Ford Electronics
8431 Commonwealth Ave
Buena Park, CA 90621

HSC Electronics
5681 Redwood Drive
Rohnert, CA 94928

HSC Electronics
4837 Amber Lane
Sacramento, CA 95841

Halted Specialties Co.
3500 Ryder Street
Santa Clara, CA 95051

Kandarian Electronics
1101 19th Street
Bakersfield, CA 93301

Mar Vac Electronics
2001 Harbor Blvd.
Costa Mesa, CA 92627

Mar Vac Electronics
1759 E. Colorado Blvd.
Pasadena, CA 91106

Mar Vac Electronics
4747 Holt Blvd.
Montclair, CA 91763

Mar Vac Electronics
5184 Hollister Blvd.
Santa Barbara, CA 93111

Mar Vac Electronics
2537 Del Paso Blvd.
Sacramento, CA 95815

Mar Vac Electronics
2000 Outlet Center Dr. #150
Oxnard, CA 93030

Mar Vac Electronics
12453 Washington Blvd.
Los Angeles, CA 90066

Metro Electronics
1831 J Street
Sacramento, CA 95814

Orvac Electronics
1645 E Orangethorpe Ave.
Fullerton, CA 92631

Sav-On Electronics
13225 Harbor Blvd.
Garden Grove, CA 92643

Colorado

Centennial Elec. Inc.
2324 E. Bijon
Colorado Springs, CO
80909

Connecticut

Cables & Connectors
2315 Berlin Turnpike
Newington, CT 06111

Illinois

Tri State Elex
200 W. Northwest Hwy.
Mt. Prospect, IL 60056

Maryland

Mark Elec. Supply Inc.
11215 Old Baltimore Pike
Beltsville, MD 20705

Massachusetts

Electronic Hook-Up
104 Main St.
Milford, MA 01757

"You-Do-It" Electronics
40 Franklin Street
Neeham, MA 02494

Michigan

Purchase Radio Supply
327 East Hoover Avenue
Ann Arbor, MI 48104

The Elec. Connection
37387 Ford Road
Westland, MI 48185

Minnesota

Acme Electronics
224 Washington Avenue N.
Minneapolis, MN 55401

Missouri

Gateway Electronics
8123-25 Page Blvd.
St. Louis, MO 63130

New Jersey

Lashen Electronics Inc.
21 Broadway
Denville, NJ 07834

New York

LNL Distributing Corp.
235 Robbins Lane
Syosset, NY 11791

T&M Elec. Supply, Inc.
472 East Main Street
Patchogue, NY 11772

Unicorn Electronics
Valley Plaza
Johnson City, NY 13790

Ohio

Parts Express
725 Pleasant Valley Drive
Springboro, OH 45066

Oregon

Norvac Electronics
7940 SW Nimbus Avenue
Beaverton, OR 97005

Texas

Computers Electronics Etc.
110 E. Medical Center Blvd.
Webster, TX 77598

Electronic Parts Outlet
3753 B Fondren
Houston, TX 77063

Tanner Electronics
1301 W Beltline
Carrollton, TX 75006

Washington

Supertronix Inc.
16550 W. Valley Hwy.
Tukwila, WA 98188

*Barnes & Noble • B. Dalton • Crown Books • Tower Books • Super Stand
Borders Book Store • On Cue • Hastings • Media Play • Walden Book Store
Just About Every Major Book Store!*

**If you'd like to sell our magazine in your store, please circle 180 on
free information card or Contact Gina Giuliano at (631) 592-6720 ext 215**

NEW LITERATURE

Troubleshooting Microsoft Outlook

by Julia Kelly
 Microsoft Press
 P.O. Box 1038
 Buffalo, NY 14240-1038
 800-MSPRESS
 mspress.microsoft.com
\$19.99

Part of a series that provides quick and easy solutions to the most common computer glitches, this book allows users to identify problems, distinguish solutions, and reach a quick fix. Covering both Outlook 2000 and Outlook Express, this guide contains helpful screen shots and charts that enable users to diagnose PC software and hardware problems.

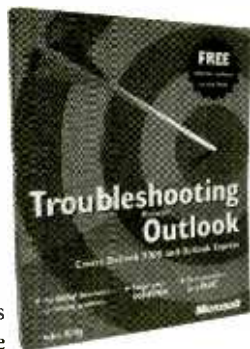

PIC: Your Personal Introductory Course, Second Edition



by John Morton
 Butterworth-Heinemann
 Fulfillment Center
 225 Wildwood Ave.
 Woburn, MA 01801
 800-366-2665
 www.bb.com./newnes
\$26.95

There is amazing potential to be harnessed by programming your own microchip. This hands-on introduction is essential for beginners and ideal for enthusiasts wanting to revolutionize and transform the capabilities of electronic project work and product design. It's not only a book to be read, but a guide to be actively used as you build circuits around chips and write your own programs.

Robust Modulation Methods & Smart Antennas in Wireless Communications



by Bruno Pattan
 Prentice Hall PTR
 One Lake St.
 Upper Saddle River, NJ 07458
 800-282-0693
 www.pbptr.com
\$82

Do you want to know more about how to maximize the capacity and performance of your wireless systems—terrestrial or satellite? This complete tutorial on the technologies of wireless communications encompasses robust digital signal modulation methods, spectral and power efficiencies within Shannon bounds, Butler matrix beamforming networks, and much more.

Computer, Communication, and Tools Catalog

from B&B Electronics Manufacturing Company
 707 Dayton Road
 P.O. Box 1040
 Ottawa, IL 61350
 815-433-5100
 www.bb-elec.com
Free

This catalog features serial communications devices, converters, Ethernet connections, fiber-optic products, Palm devices and software, USB modules, and any accessory you can think of. There's even a wrist keyboard for wearable PCs. Each product in this 64-page catalog is accompanied by a full-color picture, specs, and prices. Each section has technical information, as well.

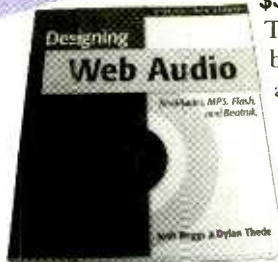

Designing Web Audio
 by Josh Beggs and Dylan Thele
 O'Reilly and Associates, Inc.
 101 Morris St.
 Sebastopol, CA 95472
 800-998-9938 or 707-829-0515
 www.oreilly.com
\$34.95

Take your Web site to a fresh level by learning how to incorporate and develop high-quality sound. Using more than just MP3s, you will be able to build multimedia Web pages with interactive audio, soundscapes, and real-world sound design. This book introduces a new way to enhance the visitor's experience for those interested in Web-based media distribution and broadcasting.

General Purpose Test Catalog

from Fluke Corp.
P.O. Box 9090
Everett, WA 98206
888-492-7554
or 800-44-FLUKE
www.calibration.fluke.com

Free

This catalog combines the Fluke and Wavetek-Daltron general-purpose test products in one source. It includes a comprehensive selection of benchtop programmable function generators, frequency counters, wireless DAQs, and a variety of plug-and-play products. The catalog can be ordered at the Web site, by pressing the "Request Information" button.



Programming Microcontrollers in C, Second Edition

by Ted Van Sickle
LLH Technology Publishing
3578 Old Rail Road
Eagle Rock, VA 24085
888-822-6657 or 419-281-1802
www.LLH-Publishing.com
\$59.95

Learn how to use C to maximize the performance of today's microcontrollers. This book describes the microcontrollers and their programming environment and compares several compilers. Accompanied by a CD-ROM, the book is packed with useful code, as well as practical programming tips and techniques.



The ARRL Repeater Directory: 2001-2002 Edition

Edited by Brennan Price, N4QX
ARRL

225 Main St.
Newington, CT 06661
888-277-5289 or 860-594-0200
www.ARRL.com

\$9

This edition has updated listings for thousands of repeaters across the United States and Canada. It features 19,001 listings from across the US and Canada and elsewhere. In addition to operating tips for newly licensed amateurs, there is the Latest Frequency Coordinator contact information. Also included is updated information on using CTCSS tones and an updated 2-meter channel-spacing map, plus new material on Digital Coded Squelch (DCS).

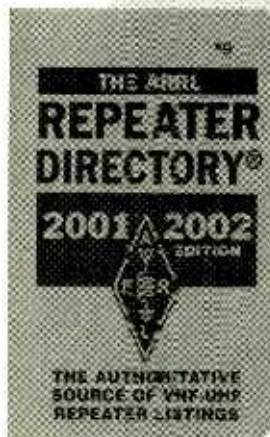

Computer Networking for the Small Business & Home Office

by John Ross
Sam's Technical Publishing
5436 W. 78th St.
Indianapolis, IN 46268-3910
800-428-7267
www.samswebsite.com

\$39.95

Networking is a powerful tool for expanding small, private enterprises. Learn about trends such as Peer-to-Peer Computing, Web Servers, Portals, and more that will aid in realizing the full potential of your business. Containing a good mix of technical content and practical information, this book covers all the different aspects of networking.



PowerStor CD-ROM

from Cooper Electronic Technologies
3601 Quantum Blvd.
Boynton Beach, FL 33426-8638
561-752-5000 or 888-414-2645

www.cooperet.com

Free

This guide features complete product data and technical and application information on these capacitors. The CD-ROM allows design engineers to determine capacitor requirements and confirm the time requirements for pulse applications.



Metal-Detecting Circuits II

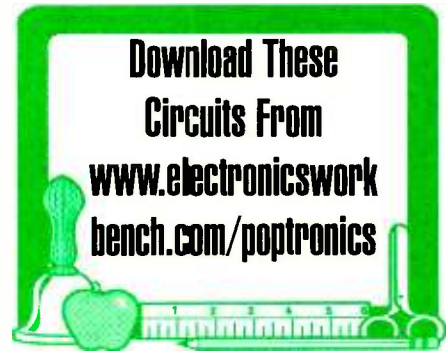

Hello, Circuiteers, are you ready for some more metal detector circuitry fun? If so, stick around. We ended our last visit with a simple two-transistor Beat-Frequency Oscillator (BFO) detector circuit, and we're starting out this time with an even simpler single-transistor BFO detector circuit. How do we do that? Read on and find out.

Single Transistor Circuit

Before getting into the circuitry, we had better take a quick look at how the single-transistor detector system operates. I'm sure that at some time you've heard a whistle or tone while tuning your AM broadcast receiver or, even

more likely, when listening to an AM short-wave broadcast station. In radio circles, this is referred to as a heterodyne signal. An AM receiver detecting two RF signals, which are very close in frequency, usually causes this condition. If the two RF frequencies are less than a few kHz apart, an audio tone (difference frequency) will be heard. This is basically how our single-transistor detector circuit operates.

In our single-transistor circuit, see Fig. 1, only one RF oscillator circuit is used. The other RF signal is supplied by one of many AM broadcast radio stations. A portable transistor AM radio receives the two RF signals and outputs

an audible tone. The mixing and audio amplification is handled by the transistor radio. If either RF signal shifts in frequency, the audio tone will increase or decrease by the same amount. Since the frequency stability of all licensed AM broadcast stations is rock solid, only our search oscillator will produce a shift in

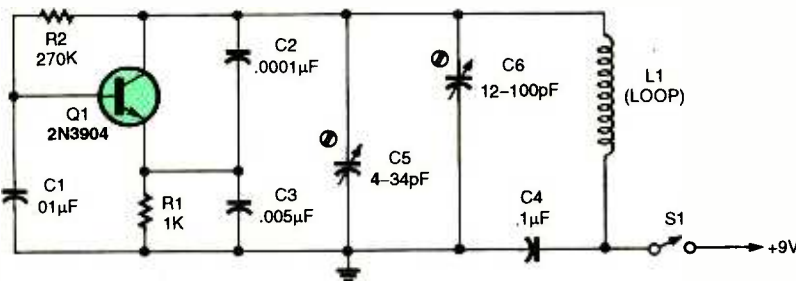

Fig. 1. Here is the schematic for the single-transistor circuit. Transistor Q1 is a general-purpose, NPN transistor; and it serves as the heart of a Colpitts oscillator circuit.

PARTS LIST FOR THE SINGLE-TRANSISTOR CIRCUIT (FIG. 1)

SEMICONDUCTORS

Q1—2N3904, or similar general-purpose NPN transistor

RESISTORS

(All resistors are 1/4-watt, 5% units.)

R1—1000-ohm
R2—270,000-ohm

CAPACITORS

C1—.01-µF, ceramic disc
C2—.0001-µF, ceramic disc

C3—.005-µF, ceramic disc

C4—.1-µF, ceramic disc

C5—4-34-pF, 7-mm, ultra-miniature trimmer, Mouser part #24AA113

C6—12-100-pF, Mouser part #242-3410-70

ADDITIONAL PARTS AND MATERIALS

S1—SPST switch

L1—Loop, see text

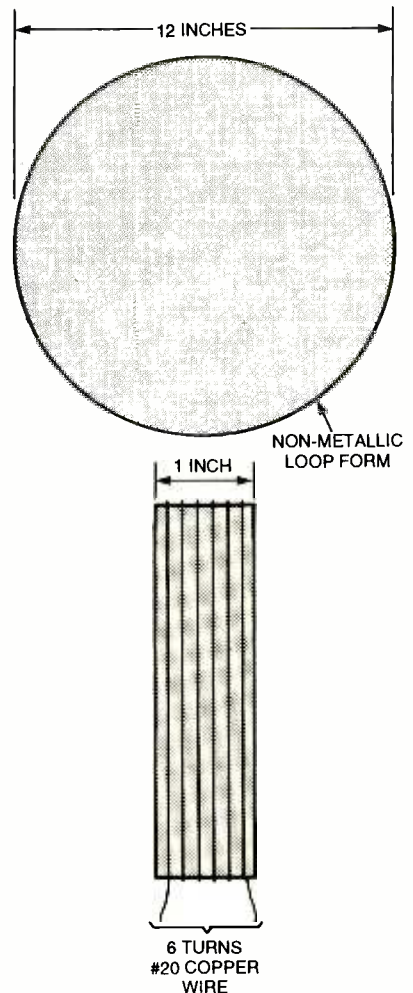

Fig. 2. The loop dimensions are shown above. The form can be constructed of a rigid material, such as wood or plastic.

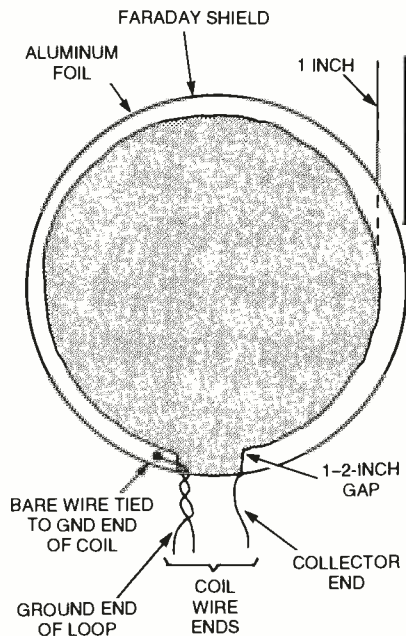

Fig. 3. This detailed diagram of the loop shows the leads extending from the copper wire, as well as the makeshift Faraday shield.

frequency. The end result is a detector that operates like our two-transistor circuit, but requires less parts and time to construct.

The oscillator circuit in Fig. 1 is very similar to the oscillators used in our previous circuit. Transistor Q1 is connected in a Colpitts oscillator circuit with components C2, C3, C5, C6, and L1 making up the oscillator's tuned circuit. Changing any one or any combination of these components will vary the oscillator's operating frequency.

Increasing the value of any capacitor

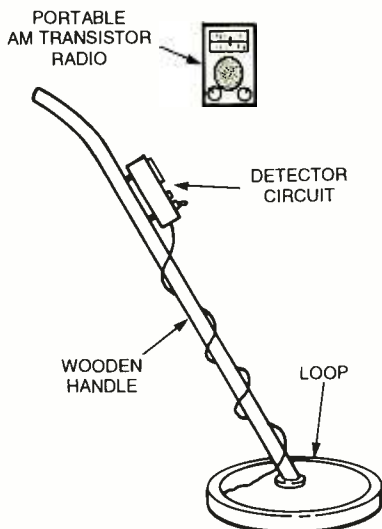

Fig. 4. Here is an artist's rendition of the completed metal-detector unit. Any inexpensive AM transistor radio can be used in conjunction with the detector.

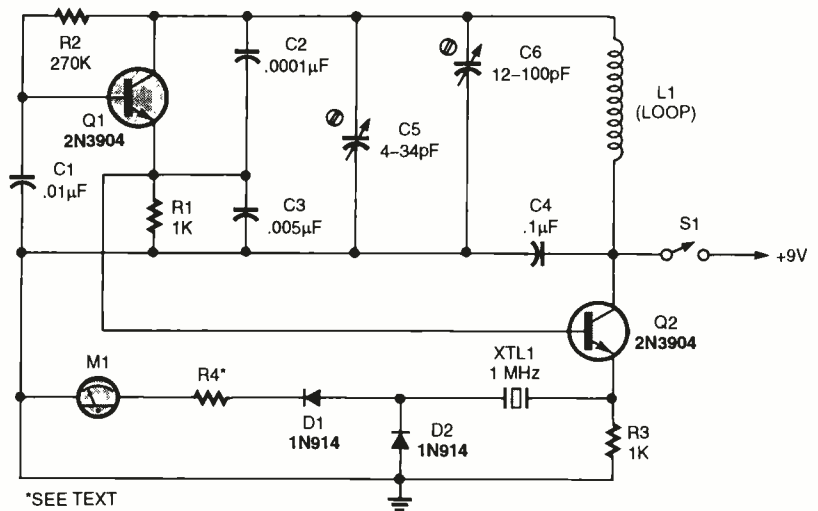

Fig. 5. The crystal-filter metal-detector circuit is shown above. The narrow band-pass of the crystal allows for a high sensitivity to minute frequency changes.

will lower the oscillator's frequency and decreasing the value will increase the frequency. Increasing L1's inductance will also cause a decrease in frequency and vice versa.

Building The Loop

The search loop may be constructed in several different ways; however, the method offered here should get you headed in the right direction. Refer to Fig. 2 as a guide for constructing the loop. The loop form should be constructed from non-metallic and non-moisture-absorbent material. A sealed wood form will do, and it can be either solid or hoop-like. The form should be ¼ to 1 inch wide to allow room for the coil windings. Close wind six turns of #20 enameled or insulated wire on the form. Wrap the windings with at least two layers of good quality plastic electrical tape. Put the loop aside and construct the oscillator circuit on a piece of multipurpose PC board with pre-drilled holes. Stability is one of the most important considerations in building any stable oscillator circuit, so keep all component leads short and solidly mounted.

The two variable capacitors should be mounted in a manner that allows tuning from outside the enclosure. In order to achieve the best results, the circuit should be housed in a metal cabinet to which the circuit ground is connected. Temporarily connect the loop to the circuitry with about 30 inches of shielded microphone cable or 2-conductor intercom wire. Any wire gauge from #18 to #24 will do. Actually two insulated wires can be twisted together by hand and used.

PARTS LIST FOR THE CRYSTAL-FILTER DETECTOR (FIG. 5)

SEMICONDUCTORS

D1, D2—1N914 silicon signal diode
Q1, Q2—2N3904, or similar general-purpose NPN transistor

RESISTORS

(All resistors are ¼ watt, 5% units.)
R1, R3—1000-ohm
R2—270,000-ohm
R4—See text.

CAPACITORS

C1—.01-μF, ceramic disc
C2—.0001-μF, ceramic disc
C3—.005-μF, ceramic disc
C4—.1-μF, ceramic disc
C5—See Parts List for Fig. 1
C6—See Parts List for Fig. 1

ADDITIONAL PARTS AND MATERIALS

XTL1—1-MHz crystal
M1—50-μA to 1-mA meter
Metal cabinet, PC board material, etc.

Place the loop away from any metal object and apply power to the circuit. Locate a transistor radio near by and tune in a station somewhere near the middle of the dial. Adjust both C5 and C6 to a frequency that will heterodyne with the broadcast station. If nothing happens, it is most likely that the oscillator is not operating near the desired frequency. Now, how do we determine if the oscillator's frequency is too low or

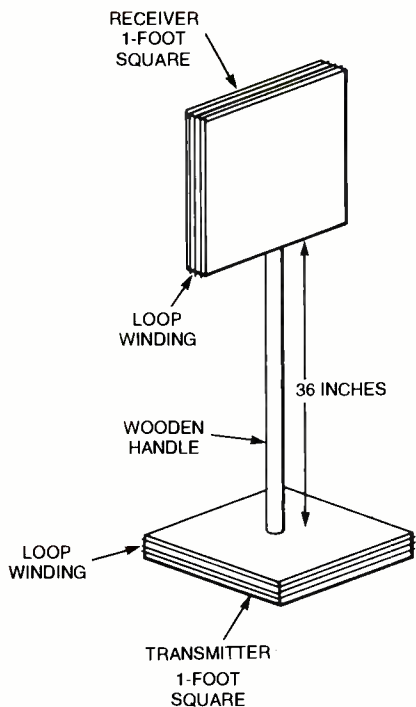

Fig. 6. The detector shown in the above diagram is excellent for deep level searches. The "90-degree out-of-phase" relationship of the two square loops helps limit cross-interference between the transmitter and receiver, thus eliminating feedback during operation.

too high? Naturally, a frequency counter would be the easiest way to determine the oscillator's frequency. If one is not available, what then? A short-wave receiver that tunes both below and above the standard AM broadcast band can be used to ferret out the oscillator's frequency.

Once the oscillator's frequency is determined, adjustments can be made to move the frequency into the broadcast band. Reducing the total capacitance of the oscillator's tuned circuit or lowering the inductance of the loop will raise the frequency. Lowering the frequency is accomplished by increasing the capacitance of the tuned circuit or by increasing the inductance of the loop. Removing or adding a turn to the loop is a good method to use if the oscillator is way off frequency.

Adding A Faraday Shield

The search loop normally scans the ground in a parallel manner in search of metal objects. The loop's parallel position to the ground forms a capacitance to ground, which shifts the oscillator's frequency. As the loop moves up and down above the ground, the oscillator's frequency shifts in a like manner. Adding a Faraday shield to the loop will

help in reducing the ground-effect frequency-shift problem.

The Faraday shield is a metal shroud that is formed around the loop with an insulating gap in the middle. A shield can be formed out of aluminum foil by cutting a length that's 3 inches wide and long enough to go almost completely around the edge of the loop while leaving a gap of 1 to 2 inches in the middle, see Fig. 3. Once the aluminum foil is formed, add a 4-inch length bare wire under the foil at one end and glue the shield in place. Place the loop on a flat surface and place a solid object on top to secure the foil to the loop form. After the glue dries, connect the other end of the bare wire to the loop's ground-end connection.

An old broom handle or dowel rod is attached to the middle of the loop and serves as the handle and support for the loop and detector circuit. See Fig. 4. The AM radio may be attached to the handle as well or carried separately.

Position the loop over the area to be searched and tune the oscillator to produce an audible beat frequency tone. Maximum sensitivity is achieved when the oscillator is within a few cycles of the broadcast station. This detector will detect all types of metal, so be ready to dig, and then dig some more.

Crystal-Filter Detector

Our next entry is a version of one of my favorite metal-detector circuits. A loop and an oscillator circuit similar to the one in our previous detector are the basic ingredients used in the crystal-filter detector. The addition of an emitter follower gives isolation to the oscillator and supplies a low-impedance source for the crystal. The output is rectified by D1 and D2 and fed to the meter. Take a look at Fig. 5, as you continue to read the circuit description.

Here's a brief description of how the crystal-filter metal-detector circuit operates. The oscillator is tuned to the series resonance frequency of the crystal, which can be any frequency from 100 kHz to over 1 MHz. However, in our circuit, a 1-MHz crystal is used. When the oscillator is operating at the crystal's frequency, the output at the meter is at maximum.

Any shift in the oscillator's frequency will cause a reduction in the meter reading. The circuit is very sensitive to small frequency shifts due to the crystal's narrow band-pass characteristics in the

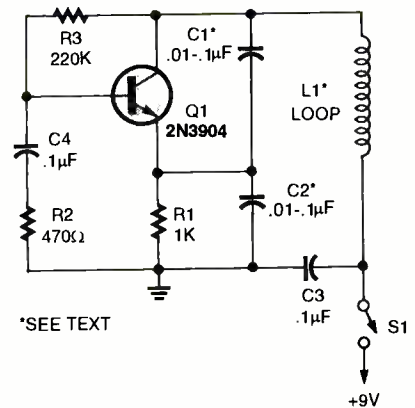

Fig. 7. The transmitter circuit in the above schematic operates in a range of 35 to 50 kHz. The oscillator circuit is similar to the previous two mentioned.

PARTS LIST FOR THE TRANSMITTER (FIG. 7)

SEMICONDUCTORS

Q1—2N3904, or similar general-purpose NPN transistor

CAPACITORS

C1, C2—.01 to .1-μF, ceramic disc (see text)

C3, C4—.1-μF, ceramic disc

RESISTORS

(All resistors are 1/4-watt, 5% resistor units.)

R1—1000-ohm

R2—470-ohm

R3—220,000-ohm

ADDITIONAL PARTS AND MATERIALS

S1—SPST switch

L1—Loop, see text

series mode. The basic loop construction used in the previous detector circuit may be used here as well.

This detector's circuitry should be constructed in the same manner as our previous circuit. If any component moves or vibrates during use, the meter will falsely indicate a detected object. Build it solid. The choice of the meter used for M1 can vary from a sensitive 50-μA to a 1-mA movement. The value of R4 is selected for a full-scale meter reading when the oscillator is operating at the series-resonance frequency of the crystal.

Transmitter/Receiver Detector

Our last detector circuit is suitable for locating large metal objects at

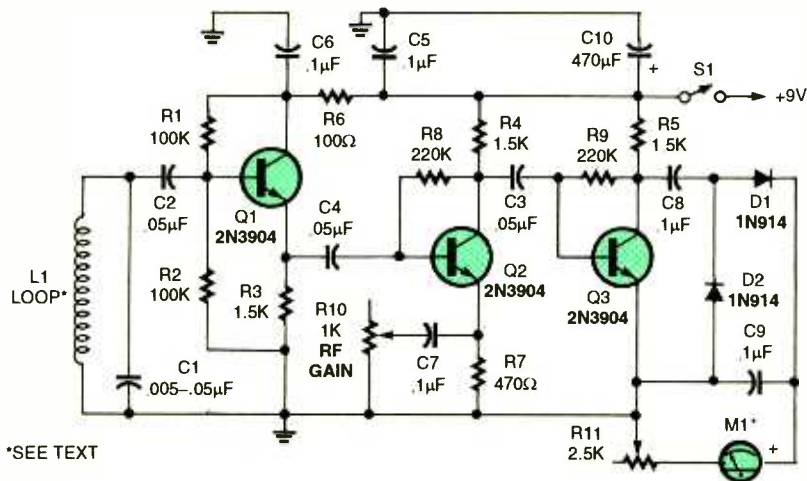

Fig. 8. The receiver circuit shown above can fit on a 2- × 3-inch piece of PC board. Two transistors are used to perform RF amplification.

PARTS LIST FOR THE RECEIVER (FIG. 8)

SEMICONDUCTORS

Q1-Q3—2N3904, or similar general-purpose NPN transistor
 D1, D2—1N914 silicon signal diode

CAPACITORS

C1—.005 to .05-µF, ceramic disc (see text)
 C2-C4—.05-µF, ceramic disc
 C5-C9—.1-µF, ceramic disc
 C10—470-µF, 25WVDC electrolytic

RESISTORS

(All resistors are 1/4-watt, 5% units.)
 R1, R2—100,000-ohm
 R3-R5—1500-ohm
 R6—100-ohm
 R7—470-ohm
 R8, R9—220,000-ohm
 R10—1000-ohm potentiometer
 R11—2500-ohm potentiometer

ADDITIONAL PARTS AND MATERIALS

S1—SPST switch
 M1—50-µA to 1-mA DC meter
 L1—Loop, see text

transmitter in a vertical position. This 90-degree relationship between the transmitter and receiver allows for minimum transfer of signal between the two loops. Placing a large metal object between the two loops causes the transmitter's field to distort, allowing some of the signal to reach the receiver's loop. The signal is amplified by the receiver and indicated on the meter as metal detected.

Building The Transmitter

We'll start with the transmitter circuit first, (see Fig. 7) because it is the simpler of the two units. The transmitter circuit is very similar to our previous two oscillator circuits, with a slight variation in the base bypass circuit. The values of frequency-determined capacitors, C1 and C2, are the same. Depending on the size of the loop, they can vary from .01 to .1-µF.

The receiver loop normally requires a capacitor equal to 1/2 the value of C1 or C2 in the transmitter circuit. The transmitter loop is tuned with C1 and C2, which are always the same value. The actual value of capacitance across the transmitter loop is 1/2 the value of either C1 or C2. It is most important that both loops are tuned to the same frequency.

About any loop size from 8 to 12 square inches will do, but we'll stick to the 12-inch box and offer values for that size. The loops are formed by close winding 20 turns of #24 to #26 wire around each housing. Run about 8 inches of wire from each end of the loop to the inside of the housing for circuit connections. Tape the winding in place with plastic electrical tape.

The operating frequency will be

somewhere between 35 kHz and 50 kHz. The capacitor values for C1 and C2 are .1-µF for the transmitter and .05-µF for C1 in the receiver circuit. Less turns or smaller loops may be used for higher frequency operation. Try and keep the operating frequency below 200 kHz, as this type of metal locator works best at low frequencies.

Building The Receiver

The receiver (see Fig. 8) is a simple two-transistor RF amplifier circuit with an isolated emitter follower input. The RF signal is picked up by the loop and coupled through Q1 to the input of the first RF amplifier stage, Q2. Transistor Q2's RF gain is set by R10. The signal from Q2's collector is fed to the base of Q3, and Q3's output is coupled to a two-diode detector circuit. The DC output is indicated by M1.

The receiver circuitry will fit on a 2- × 3-inch piece of multipurpose PC board material. Mount the components close to the board with short leads and keep the input components away from the output circuitry. The meter can be any DC type with sensitivity of 50-µA to 1-mA. If a 50-µA meter is used, R11 may need to be increased to a 10K potentiometer. Mount the circuit in the receiver box and connect the loop.

Mount the transmitter box on one end of the wood handle and the receiver on the other. The receiver will need to be mounted so that it can be tilted up and down to obtain a balance between the two loops. This can be accomplished by using a small hinge attached to the end of the handle and the receiver housing. Once the balance point is found, the receiver can be mounted in that position.

Hopefully, you will find some use for at least one of our metal-detector circuits. Until next time, may all of your circuits work! P

FREE CONSUMER INFORMATION CATALOG. Call toll-free 1-888-8 PUEBLO.

Get your copy of the CRYSTAL SET HANDBOOK



Go back to antiquity and build the radios that your grandfather built. Build the "Quaker Oats" type rig, wind coils that work and make it look like the 1920's! Only \$10.95 plus \$4.00 for shipping and handling. Clagg Inc., PO Box 12162, Hauppauge, NY 11788. USA Funds ONLY! USA and Canada—no foreign orders. Allow 6-8 weeks for delivery. MA01

Poptronics®

SHOPPER

POLARIS CAN SUPPLY YOU WITH ALL OF TODAY'S HOTTEST VIDEO TECHNOLOGY!

CALL OR GO ON-LINE TO ORDER YOUR FREE VIDEO CATALOG - 100's OF PRODUCTS - MICRO CAMERAS - WIRELESS VIDEO - LIPSTICK CAMERAS - DIGITAL VCR'S
WEB CAMERA WITH BUILT-IN PAN/TILT/ZOOM CONTROLS **WEATHERPROOF DIGITAL STORAGE CAMERA**

Compact Web Camera For Online Image Monitoring and Delivery Over The Internet

Featuring a built-in Web server, powerful 10x zoom, pan/tilt, and alarm input/output capability, all in an ultra-compact unit. These Web cameras can be installed virtually anywhere and deliver high-quality images to the Internet for real-time monitoring or broadcast. Better yet, these cameras can be controlled and monitored via a standard Web browser, making it ideal for a wide variety of applications.
 Size: 122mm x 82mm x 97mm.

- Ultra-compact, all-in-one web camera with built-in web server
- Monitoring and camera-control possible via web browser
- 10x optical zoom and multi-angle pan/tilt capability
- 10Base-T interface for direct connection with network
- Alarm In/Out function for automatic surveillance
- Three different security levels



The SWC-40R combines a black & white video camera, digital image storage, video motion detection and an alarm interface in a compact, vandal proof enclosure. It is unique as it offers a complete CCTV surveillance system within a single compact enclosure.

NO TAPES!

- All-in-one CCTV system
- Built-in digital image storage
- Programming and image retrieval by remote control
- Built-in video motion detection

SWC-40R \$849.95

Dimensions 5" x 4" x 4.5"



"YOUR WEB BROWSER IS YOUR REMOTE EYE!"

The Flexcam acts as an internet camera server. No software needed in order to view your video. All you need is a web browser such as Internet Explorer or Netscape. Flexcam includes many special functions including video quality control, pan/tilt/zoom interface and network configuration. All of them are controlled by the web browser. Features 4 video inputs - 3 external.

FLEXCAM \$CALL

CONTROL PAN / TILT AND ZOOM REMOTELY OVER THE INTERNET!



6.4" COLOR TFT-LCD MODULE

TFT MONITORS AVAILABLE FROM 2.5" - 15"

Back Side of Module

HIGH RESOLUTION!



COVERT COLOR SPY CAMERA

It's small sleek indestructible design and pinhole lens allow for various applications and simple installation. Comes equipped with a RCA JACK for easy connection to TV monitor or VCR. Great for covert use in any place imaginable.

25mm(W) x 17mm(D) CM-550CP - \$79.95



Our new 6.4" Color TFT Module can be used for a variety of purposes such as: custom automotive dash installations, video phone, door phone, boat installations, covert ultra-compact surveillance packages, security and more.

Dimensions 1.5"(W) x 1.75"(H) x 0.5"(D)

TFT-64M - \$319.95

MICRO BOARD CAMERAS - MANY MODELS IN STOCK TO CHOOSE FROM!

MB-1250HRP Hi-Res Color Pinhole

5.0mm Lens
1.27" x 1.27"
\$109.95



2.4 GHz A/V TRANSMITTING MODULE

Makes any camera wireless! Excellent for hobbyist / remote control airplanes.

4 CHANNELS!
2.4 GHz

2.4GHz 4 channel video transmitting module with audio capability / power switch and antenna.

MPX-2400 - \$89.95
2.4GHz RECEIVER GFR-5002 - \$119.95

Dimensions 1.5"(W) x 1.75"(H) x 0.5"(D)

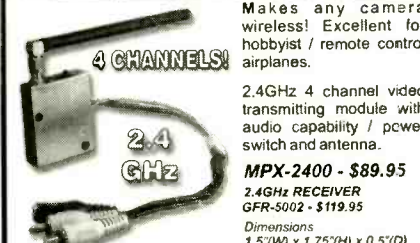

WEATHERPROOF CAMERA

Color Camera
400 TV Lines
Automatic Iris

Hi-Res Color Lipstick Camera
Length: 2.6"
Diameter: .785"

WP-300C - \$159.95



LIVE VIDEO!

COLOR & B/W SUBMURGIBLE CAMERAS

CAN SEE IN THE DARK!
CAN SEE UNDER WATER!

B/W version comes with attached 80 meter cable (color-20 meter). Built-in white LED's give this camera a 15 meter infrared range. Heat resistant glass and water resistant design allow for rugged applications.

VIDEO CAMERA HEAD CAN BE SUBMERGED UP TO 100 FEET!

SUBCAM-BW (B/W) - \$249.95
SUBCAM-CL (COLOR) - \$299.95



5" COLOR WIRELESS OBSERVATION SYSTEM

ADD UP TO 3 ADDITIONAL CAMERAS!

Now you can enjoy peace of mind with our new wireless observation system. Comes with 5" wireless color monitor and a wireless color camera. Just Plug-&-Play Perfect for around the house or office.

Includes an attractive swivel mount indoor / outdoor patch antenna for extra range!

2,4GHz GW-2400S - \$379.95



MONITOR UP TO 4 VIDEO CAMERAS SIMULTANEOUSLY THRU YOUR INTERNET CONNECTION OR OVER YOUR MODEM!

MOTION DETECTION - ALARM RECORDING - NOTIFICATION

- TCP/IP Highlight an area on your video screen, and the DMRS will inform you via modem thru your telephone or pager if there is movement in that highlighted area while recording to your hard disk.
- MODEM
- LAN/WAN

DMRS-4...4 Input Digital Video Card...\$289.95



MICRO VIDEO HEAD "SNAKE" CAMERA

Incredibly small micro head color camera incorporates a CCD chipset. (Not CMOS). Fully adjustable focus from 0.5 inches to infinity. Automatic Iris for varying light levels.

VIDEO HEAD IS ONLY 7mm IN DIAMETER!

MH-SCO1 \$479.95



September 2001, Poptronics

VISION ELECTRONICS



- ◆ No Rolls/Jitters/Flickers/Fading
- ◆ Works on all TV's, VCR's, Beta, & Cable
- ◆ Gold Video Connectors & Cables Included
- ◆ 1 Year Warranty
- ◆ Money Back Guarantee

FREE CATALOG!



COPY RENTAL TAPES WITH OUR VIDEO STABILIZER

1-800-562-2252

2609 S. 156th Circle • Omaha, NE 68130
www.modernelectronics.com



EZ-EP DEVICE PROGRAMMER - \$169.95

Check Web!! -- www.m2l.com

Fast - Programs 27C010 in 23 seconds

Portable - Connects to PC Parallel Port

Versatile - Programs 2716-080 plus EE and Flash (28F, 29C) to 32 pins

Inexpensive - Best for less than \$200

- Correct implementation of manufacturer algorithms for fast, reliable programming
- Easy to use menu based software has binary editor, read, verify, copy, etc. Free updates via bbs or web page.
- Full over current detection on all device power supplies protects against bad chips and reverse insertion.
- Broad support for additional devices using adapters listed below.

Available Adapters

EP-PIC (16C5x, 61, 62x, 71, 84)	\$49.95
EP-PIC84 (62-5, 72-4)	\$39.95
EP-PIC12 (12C50x)	\$39.95
EP-PIC17 (17C4x)	\$49.95
EP-51 (8751 C51)	\$39.95
EP-11E (68HC11 E/A)	\$59.95
EP-11D (68HC71 D3)	\$39.95
EP-16 (16bit 40pin EPROMs)	\$49.95
EP-Z8 (786E02 3.4 6.7 8)	\$39.95
EP-SEE2 (93x 24x 25x 85x)	\$39.95
EP-750 (87C750 1.2)	\$59.95
EP-PEEL (ICT22v10, 18v8)	\$59.95
EP-105 (189C1051 2051)	\$39.95
EP-PLCC (PLCC EPROMs)	\$49.95
EP-SOIC (SOIC EPROMs)	\$49.95

Many Other Adapters Available

M²L Electronics

970/259-0555 Fax: 970/259-0777
250 CR 218 Durango, CO 81301
CO orders add 7% sales tax.
<http://www.m2l.com>

EZ-EP
M²L ELECTRONICS
Los Angeles, California

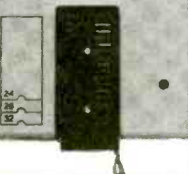

ALL ELECTRONICS

C O R P O R A T I O N

Two Speed Worm Gear Motor

Powerful windshield wiper motor for 2000-2001 Saturn L series automobiles.

Two speeds; high speed is 106 RPM at 12 Vdc, 4 Amps. Low speed is 41 RPM at 12 Vdc, 0.91 Amps. 3/8" threaded drive shaft with nut. A 2.25" lever with a universal joint, attached to the shaft, is easily removable. 7" overall length x 3.5" x 4"

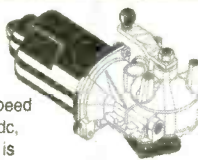

CAT # DCM-171 **\$19.75** each

Rechargeable Battery

Eveready # NH22. Nickel Metal Hydride rechargeable battery. Replaces 9 Volt batteries in many applications. Actual voltage 7.2 Volts. Can be charged in most Nickel-cadmium chargers.



CAT# NMH-9 **\$3.50** each

Miniature DC Motor

Mabuchi # FF-N20PN Miniature 1.5 to 3 Volt DC motor. Ideal for models and radio control applications where small size is important. No load rating: 15,800 RPM @ 2.4 V, 96 mA. Length (excluding shaft), 0.654" long x 0.47" x 0.39". 0.039" (1mm) dia. x 0.13" long shaft. Solder-loop terminals. Large quantity available.



CAT# DCM-166
2 for \$1.50
150 for 60¢ ea.
600 for 50¢ ea.
1500 pieces 35¢ ea.

Solar Panel

Output: approx. 3 Volts @ 40 mA. 2.40" square x 0.13" thick epoxy-encapsulated silicon photovoltaic panel removed from solar lighting system. Solid, almost unbreakable module with easy-to-solder spots on backside. Ideal for solar-powered battery chargers and other projects.

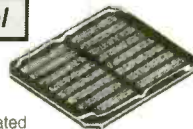

CAT # SPL-60 **\$3.50** each

Build Your Own Intelligent Robot, We Make It Easy!

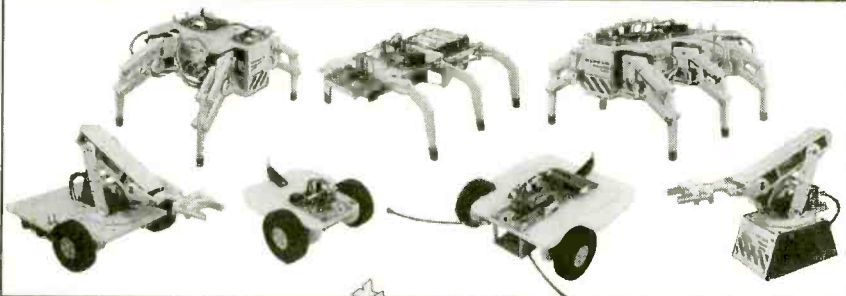

Lynxmotion, Inc.
PO Box 818
Pekin, IL 61555-0818
www.lynxmotion.com



Tel: 309-382-1816
Fax: 309-382-1254
sales@lynxmotion.com
tech@lynxmotion.com

Visit our website or ask for our free catalog!

CONITEC DATASYSTEMS

TOP PERFORMANCE in a small package:
Europe's best selling multi-programmer!

Top of the line multi-programmer in sub-\$500 category. From 20% to 80% market share in Germany in 6 years. 1300+ device output and growing fast. Europe-wide sales 10%-60% mkt share in 6 years. Minimal, 1% return quota for hardware defects. Replaces all low priced dedicated programmers e.g. PIC only or GAL only units. GALEP III also substitute: higher priced universal programmers e.g. ALL-11 (HIL0) or LAB-TOOL 48 (ADVANTECH) - It provides virtually matching performance at only 1/3-1/5 the price.

Programs 8-bit and 16-bit EPROMs, EE-PROMs, 0-Power RAM's, Flash, Serial EEPROMs / GAL, PALCE, ATF/87xxx, 89xxx, PIC12/16/17Cxx/ All DIL devices **without adapter!** Lightning fast parallel data transfer (27C 256 read 2 sec., prog. 8 sec!). Supports HEX, JEDEC and binary formats, with integrated hex and fuse map editor. Fully Windows compatible (incl. Win 2000 / NT. Browse 1300+ supported devices on Conitec's website: www.conitec.com. 90%+ of the listed devices require no adapter!



One size fits all!
\$333
COMPLETE KIT

GALEP-III
Pocket Multiprogrammer

GALEP III / cable, batt. and charger \$333.00
PLCC adapt. / 8-bit EPROMs / 16-bit EPROMs / GALs each \$129.00

ORDER TOLL FREE
1-800-826-5432

SHOP OUR ONLINE STORE
www.allelectronics.com

CHARGE ORDERS to Visa, Mastercard, American Express or Discover

TERMS: NO MINIMUM ORDER. Shipping and handling for the 48 continental U.S.A. \$5.00 per order. All orders including AK, HI, PR or Canada must pay full shipping. All orders delivered in CALIFORNIA must include local state sales tax. Quantities Limited. NO COD. Prices subject to change without notice.

CALL, WRITE
FAX or E-MAIL
for our **FREE**
96 Page
CATALOG
Outside the U.S.A.
send \$3.00 postage.

MAIL ORDERS TO:
ALL ELECTRONICS CORPORATION
P.O. Box 567
Van Nuys, CA 91408
FAX (818)781-2653

e-mail allcorp@allcorp.com

**More Features
More Power
Less Money**

Ivex Complete Power Tools include: WinDraft P350 Schematics, WinBoard P350 PCB Layout, Ivex Spice Standard Simulation and Gerber Viewer together in a complete, affordable package.

Ivex Complete Plus includes everything in the Complete package plus 650 pin versions of WinDraft and WinBoard with Ivex Spice Advanced.

Ivex 650 pin versions have no feature limitations like other low cost products on the market. Fast expert technical support, free 24 hour Knowledge Base on the web, and professional full-featured tools have made Ivex the preferred choice for designers.

For larger designs use these Ivex Products:

**WinDraft unlimited \$495
WinBoard unlimited \$495**

Ivex Complete Electronics CAD Package

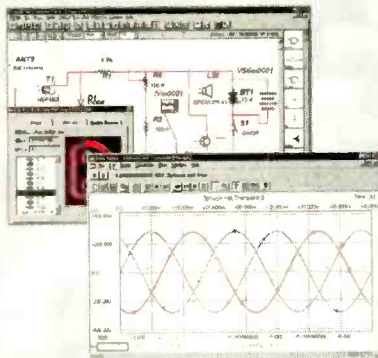

Advantages

Full-feature tools
17,000 Schematic parts
Part edit & model making
Part Search
Bill of Materials with Sort & Spreadsheet output
Hierarchy for large designs
ERC (electrical rules check)
15 Netlist outputs
7 Analysis Types
Spice Advanced includes 14 analyses
16 PCB layers
0.01 micron grid resolution
Advanced DRC
Micro via
Gerber & NC Drill report
24 hour FREE Technical Support Internet Knowledge Base
No hardware protection lock!
New: Schematic DXF output

Ivex Complete

**Schematics
Simulation
PCB Layout
Gerber Viewer**

\$350

Ivex Complete Plus

**P650 Schematics
Adv. Simulation
P650 PCB Layout
Gerber Viewer Plus**

\$550

Free board quote

pcbCite.com

The Internet source for PCB manufacturing

Visit the Ivex web site for complete product information and download full function demos.

www.ivex.com

Tel: (503) 531-3555 e-mail: sales@ivex.com

IVEX™
DESIGN
INTERNATIONAL

ADV8_4

PIC'n Books

LEARN ABOUT PIC MICROCONTROLLERS



See Table Of Contents: <http://www.sq-1.com>
Secure Online Ordering Is Available

PIC is a trademark of Microchip Technology Inc.

SQUARE 1 ELECTRONICS

Voice (707) 279-8881 Fax (707) 279-8883

<http://www.sq-1.com>

Test Equipment

From \$99.00



ATC modules provide for affordable pc based testing
DSO, DVM, Spectrum Analyzer, Data Logging
O-Scope I and O-Scope II Single and dual channels
Serial a protocol analyzer software package
DFA 5 low cost differential amplifier

Standalone digital oscilloscopes from HiRel and TPI

Pico Technology LTD leads in low cost pc based
modules for test and data logging. Units to 100MSPS. 8
to 16 bits, 1 to 22 channels. Environmental monitoring.
Science education with DRDAQ. Pricing from \$99

Allison Technology Corporation

2006 Finney Vallet Rd. Rosenberg, TX 77471

PH: 800-980-9806 or 281-239-8500, FAX 281-239-8006

<http://www.atcweb.com> atc@atcweb.com

Be an FCC LICENSED ELECTRONICS TECHNICIAN!

\$16900

ONE LOW PRICE



FCC LICENSE TRAINING

Dept. 90

P.O. Box 2824

San Francisco, CA 94126-2824

**START
YOUR
OWN
BUSINESS!**

COMMAND PRODUCTIONS

800-932-4268 Ext. 90

Email: fcc@commandproductions.com • Website: www.LicenseTraining.com • Fax 415-332-1901

**GUARANTEED
TO PASS**

**YOU GET YOUR
FCC LICENSE
OR GET
YOUR
MONEY
BACK!**

**CALL NOW
FOR FREE
INFORMATION!**

Introducing the New **ATOM** !

More Powerful than the Basic Stamp® 2p

The "ATOM®"



Get more out of your stamp projects! More commands, faster code execution, built in hardware, real time graphical code debugging, no more 2k program size limits, interrupt driven hardware and software features, multitasking, enhanced math capabilities and much more!

The OEM "ATOM®"

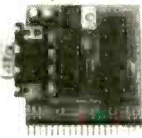

The New ATOM is fully pin compatible and software compatible with the Basic Stamp 2p® but with more power and features! Use all your existing hardware and software! All this for only \$59.95 Complete!

MORE POWER!

Built in Hardware:

- 3 10 bit A/D Converters
- 2 Capture and Compare
- Internal Adjustable Vref
- +/- External Vref
- 2 PWM
- UARTS
- I2C, SPI
- 3 Timers
- Interrupts External & Internal
- 256 Bytes of Data eeprom
- Over 256 Bytes of RAM

Software Features:

- Free Software
- Graphical Debugging
- More Software Commands
- 32 Bit Integer Math
- 32 Bit Floating Point Math
- Easy to use code editor
- BS2p Compatible Syntax
- Firmware upgradeable
- Unlimited Support
- Free Software Upgrades
- Plus much more!

Visit us online at <http://www.basicmicro.com>

Basic Stamp is a registered trademark of Parallax Inc.

Order online 24 hours 7 days a week visit <http://www.basicmicro.com>
Order by phone M-F, 9am to 5pm EST 1-248-426-8144
Master Card • Visa • American Express

Program PICmicros in Basic !



With our easy to use Basic Compiler, Convert easy to write BASIC programs into files that can be directly run on a PICmicro. PICmicro Basic provides a seamless Windows environment, you can write, debug and compile your BASIC program, all with one Windows application! Full Basic Stamp 2 Compatibility! Starting at \$99.95

ISP-PRO Programmer

Program PICmicros, Seenix SX, I2C and Atmel AVR. In circuit er on board! Firmware upgradeable! Includes Windows IDE program software! Only \$59.95

With optional ZIF adapter PICSTART Plus equivalent only much faster!

PICSTART Plus and PICmicro are registered trademarks of Microchip.



40 Pin ZIF Adapter

Intelligent ZIF adapter for the ISP-PRO rev 3.0. Programs all support PICmicros from pin 1! Optional case available for complete unit. Only \$69.95

Complete unit with ISP-PRO and Case Only \$129.95



Solderless Prototype Boards



The solderless prototyping boards are designed for in-circuit programming. See code changes on-the-fly. Built in auto disconnect circuit allows programming without removing your circuit (w/ ISP-PRO). The 2840 allows 28 or 40 pin PICmicros. The 0818 allows 8 or 18 pin PICmicros. Prototyping has never been easier! Includes RS-232 circuit, regulated power, solderless I/O connector and prototyping area. Starting at only \$59.95.

The solderless prototyping boards are designed for in-circuit programming. See code changes on-the-fly. Built in auto disconnect circuit allows programming without removing your circuit (w/ ISP-PRO). The 2840 allows 28 or 40 pin PICmicros. The 0818 allows 8 or 18 pin PICmicros. Prototyping has never been easier! Includes RS-232 circuit, regulated power, solderless I/O connector and prototyping area. Starting at only \$59.95.

Getting Started Kits

Programming PICmicros has never been easier! Kits come with everything to get started! Test code changes on-the-fly without unplugging or switching cables! Starting at \$159.95

Kit Shown Includes:

- PICmicro Basic
- 2840 Dev. Board
- ISP-PRO
- Power Supply
- Serial Cable
- 10Mhz Resonator
- PIC16F876



BASIC MICRO INC.

Microcontrollers Made Easy!®

Hackers Goldmine

Worldwyde.com specializing in hard to find information

We Accept: VISA • Master Card • American Express

To Order Call 1-800-773-6698 (M-F 9am to 5pm EST)
Send Money orders to: Worldwyde.Com,
33523 Eight Mile Rd #A3-261, Livonia, MI. 48152

Order online or view our catalog at <http://www.worldwyde.com>

Electronic Kits & Projects

(Assembled or Kit)

Miniature FM Transmitter	\$11.95
FM Stereo Transmitter (Hi-Fi)	\$29.95
Deluxe Car Alarm System	\$24.95
Digital LED Thermometer	\$20.95
16 Melody Generator	\$12.95
Telephone FM BUG	\$12.95
10 LED Stereo VU-Meter	\$13.95
Digital Timer w/ LED Display	\$21.95
5 Watt Amplifier	\$12.95
50 Watt Stereo Power Amp	\$30.95
0 to 30v - 2mA to 1.5A Reg. DC Power Supply	\$29.95
5 to 15v - 1A Reg. DC Supply	\$15.95
Robotic Voice Imitator	\$13.95
Special All Kits Above Only.....	\$239.95

Satellite and Cable TV



Satellite Piracy \$59.95
Secrets of DISH Vol.2 .. \$59.95
Secrets of Free Cable .. \$29.95

Satellite and Cable TV piracy is at an all time high! Find out how it is being done in detail and what the Satellite and Cable TV companies are doing about it! Includes sources. Covers DSS, DISH and Cable TV

Component Shop

PICmicro's starting at	\$6.00
Serial Cables Only	\$4.95
Power Supply Only	\$8.95
Wire Kits Only	\$17.95

Misc parts from MAX232, LEDs, Capacitors and more all available at our one stop shop!

Come see our online one stop component shop at <http://www.worldwyde.com>

Programmiers

ALLPIC.....\$89.98
Program PIC, ATMEL, SX and serial eeproms. Assembled with 40 pin ZIF



PIC Lite....\$39.95
Programs the most popular PICmicros

Smart Card Programmer....\$59.95

Programs most ISO7816 Smart Cards. Fully assembled and tested! Easy to use!



PlayStation® 2 Secrets

PlayStation® 2 Secrets \$29.95
Learn the secrets of PlayStation® 2 MOD chips and how PlayStation® backups are made.

PSX2 ModChip Source Code \$49.95
(Test your own backups)

PSX2 Kit \$74.95
(Source Code & PSX2 Book, Plus 1 blank chip)

Books & CD Software

Hackers Anarchy Cook Book 2000	\$39.95
Scams&Schemes (3Vol Set)	\$24.95
Internet Fraud	\$19.95
Identity Fraud	\$19.95
Palm Utilities 2001 CD	\$14.95
Palm Games 2001 CD	\$14.95
Arcade Emulator Heaven 2001 CD	\$39.95
Game Cracker CD	\$29.95
AAA Credit Secrets	\$29.95

Hackers Corner

The Hack & Crack Bible Vol.1	\$29.95
The Hack & Crack Bible Vol.2	\$39.95
Hack & Crack Master Gold CD Vol.1	\$29.95
Hackers Tool Kit CD	\$24.95
Forbidden Knowledge Vol.2	\$14.95

We offer a wide selection of material on hacking!
Visit us online at <http://www.worldwyde.com>

AMAZING DEVICES

NVEN220010DD

See in Action video on our web site at www.amazing1.com

Ion Ray Guns

Star Wars Technology Directs Energy



Star Wars Technology Demonstrates Weapons Potential. Force Fields, IonMotors, Antigravity etc. **Projects electric shocks without contact!!** Conduct many weird and bizarre experiments. Handheld battery operated and easy to operate.

- IOG7/9 Plans.....\$10.00
 - IOG7K Kit/Plans.....\$99.50
 - IOG70 Assembled/Tested.....\$149.95
- Higher Powered Device**
- IOG9K Kit/Plans.....\$129.95
 - IOG90 Assembled/Tested.....\$199.95

Shocker Trigger Ignitor

Variable 20,000 volt pulser used for laser flash tube, spark gap and pyro ignitor, garden pest shocker, electric fence, snake venom removal etc. 12 volt battery operation.

- TRIG1K - Kit/Plans.....\$29.95
- TRIG10 - Lab Assembled.....\$49.95

Cybermetic Ear!

Provides that "extra edge" for many listening applications. Enhances 3 to 4x of normal.



Mini TESLA Coil

Lights up a 4' fluorescent tube-all without any contact!! Yet only 3" tall!!



- MTC1K Kit/Plans.....\$24.95
- MTC10 Assembled.....\$34.95

Body Heat Telescope

Detects living bodies over 300' Heat leaks etc. Built in chopper and sens control

- BHT6 Plans..\$10.00 BHT6K Kit...\$99.95
- BHT60 Ready to use.....\$149.95

Ultra Bright Green Laser

30 to 50x brighter than most red pointers!! Full 5 mw range in excess of 6000 feet !! Operates for hours from 2 "AAA" batteries

Low Cost 100,000 Volt DC Supply

Amateur experimenters source of HVDC for many applications

- 100,000 volts at .2ma
- Built in dry filled multiplier.
- Operates on 12vdc or 115vac
- HVOLT1 - Plans.....\$8.00
- HVOLT1K - Kit/Plans.....\$149.95
- HVOLT10 - Assembled...\$249.95

Mass Driver



Above photo shows burst impact of Mass Driver

Can Crusher

A can is crushed into the shape of an hour glass demonstrating the awesome power of magnetics. Very popular demo in science museums as users get to crush and keep their own can. *Kids love this!!*

Wire Exploding

Generate pyrotechnical explosive blasts for many applications. Create a new artistic concept. Uses our unique high energy pulser shielded explosion chamber.

HEP9 High Energy Pulser...\$20.00

Plans pack. Includes above MASS1 Mass driver, CANCRU1 Can crusher and WIREXPL0D1 Wire exploder/Blast art plans. We stock all parts, kits and completed units for the above items.

Above HEP9 pulser is used for : EMP / HERF Generation, Build a Rail or Coil Gun, Electrothermal Gun, High Power Pulsed Laser, Mass Warping etc etc

Mind&Brain Controllers

Incredible device Turbo charges memory, Boost mental powers, Controls stress, Speeds up healing processes and Uncover hidden potentials. High quality unit with many features.



- BWPLUS-APOLLO Ready to use..\$179.95
- BWII- EINSTEIN Lower cost unit...\$129.95

Ultrasonic Painfield Generators

For property and personal protection. Four transducer matrix intensifies and concentrates effect on target area.



- PPF4 Plans.....\$20.00
- PPF4K Kit.....\$199.95
- PPF40 Ready to use.....\$299.95

3 MI Voice Transmitter

Crystal clear. Many applications. Easy to build



- FMV1 Kit and Plans..\$39.95

Information Unlimited PO Box 716 Amherst N.H. U.S.A. 03031

1 800 221 1705 Orders/Catalogs Only! Fax 1 603 672 5406 Amherst 1 603 673 4730 Free Catalog on Request
Pay by MC, VISA, Cash, Check, MO. Add \$5.00 S&H. Overseas Contact for Proforma

CIRCLE 220 ON FREE INFORMATION CARD

The BEST is now Better!

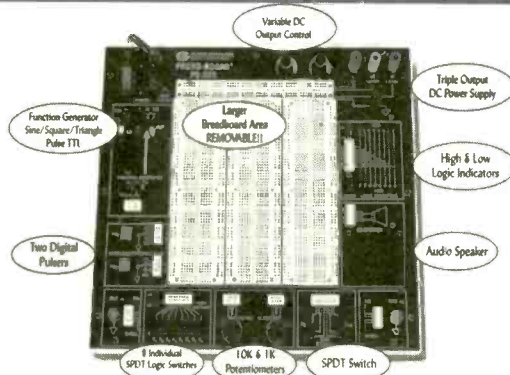

Feature-rich Circuit Design Workstation
Ultra-affordable at just \$299.95
Portable Version Available for \$349.95

Our classic PB-503 the complete Proto-Board Design Workstation is newly improved. Enhancements include: an 8-channel Logic Monitor, High & Low buffered Logic Indicators, 8 selectable Logic Switches, and removable Breadboard Socket Plate. This Velcro-backed socket plate allows for greater circuit design flexibility; order extra to suit your needs.

Traditional instrumentation on the unit includes a continuously variable Function Generator, triple output DC Power Supply, along with Switches, Digital Pulseers, Potentiometers and an Audio Speaker. The highly functional PB-503 is built to last, with an industry-best

3-year warranty along with a lifetime warranty on all breadboard sockets. Own the best! Order yours today.



1486 Highland Avenue • Unit 2
Chester, CT 06410
1.800.572.1028
203.272.4330 FAX
www.globalspecialties.com

CONTROL MEASURE INPUT

RELAYS • LIGHTS • MOTORS

TEMPERATURE • PRESSURE • LIGHT LEVELS • HUMIDITY

SWITCH POSITIONS • THERMOSTATS • LIQUID LEVELS

MODEL 30 \$79



- PLUGS INTO PC BUS
- 24 LINES DIGITAL I/O
- 8 CHANNEL
- 8 BIT A/D IN
- 12 BIT COUNTER
- UP TO 14K SAMP/SEC

MODEL 45 \$189

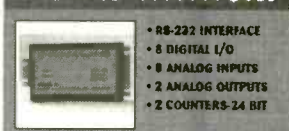

- RS-232 INTERFACE
- 8 DIGITAL I/O
- 8 ANALOG INPUTS
- 2 ANALOG OUTPUTS
- 2 COUNTERS-24 BIT

MODEL 100 \$279



- 12 BIT 180 KHZ A/D
- 4 ANALOG OUTPUTS
- 3 TIMER COUNTERS
- 24 DIGITAL I/O

MODEL 150-02 \$179

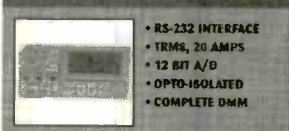

- RS-232 INTERFACE
- TRMS, 20 AMPS
- 12 BIT A/D
- OPTO-ISOLATED
- COMPLETE DMM

MODEL 40 \$109

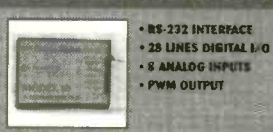

- RS-232 INTERFACE
- 28 LINES DIGITAL I/O
- 8 ANALOG INPUTS
- PWM OUTPUT

MODEL 70 \$239

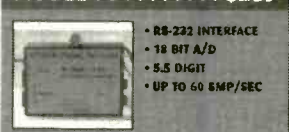

- RS-232 INTERFACE
- 18 BIT A/D
- 5.5 DIGIT
- UP TO 60 SAMP/SEC

Prairie Digital, Inc.

PHONE 608-643-8599 • FAX 608-643-6754
620 SEVENTEENTH STREET • PRAIRIE DU SAC, WISCONSIN 53576

CIRCLE 219 ON FREE INFORMATION CARD

RAMSEY

GET YOUR COPY TODAY! Over 100 NEW products!



Keep up-to-date!
Receive our FREE newsletter.
Register on-line at ramseykits.com

COMMERCIAL 35W FM TRANSMITTER



Clean and powerful, plus an on board computer that's your "virtual" station engineer! We can now supply turn-key packages for your community or LPFM station.

Call or visit our broadcast web site, www.highpowerfm.com, for more details.
PX1 **\$1,795.00**

BROADCAST YOUR MP3 AND .WAV FILES



Our FM broadcaster designed specifically for PC sound-cast. Broadcast MP3s, internet radio and more to any FM radio in your house or yard. You can't buy an assembled broadcaster this powerful or clean. Kit includes case and power supply.
MP3FM **\$99.95**

FM100 SYNTHESIZED FM STEREO RADIO STATION



- Synthesized 88 to 108 MHz for no frequency drift!
- Built in mixer - 2 line inputs and one microphone input!
- Strappable for higher power output
- Low pass filter for great audio

Our FM100 is used all over the world by serious hobbyists as well as churches, drive in theaters, and schools. The kit includes metal case, whip antenna and built-in 110 volt AC power supply.

FM100 Super-Pro FM Stereo Radio Station Kit **\$249.95**
FM100WT 1 Watt, Wired Export Version **\$399.95**

FM STEREO RADIO TRANSMITTER



Great entry level FM broadcast kit. Thousands in use. Handy for sending music through house and yard, ideal for school projects too - you'll be amazed at the exceptional audio quality! Runs on 9V battery or 5 to 15 VDC. Add matching case and whip antenna set for great pro look.

FM10A Tunable FM Stereo Transmitter Kit **\$34.95**
CFM Matching Case and Antenna Set **\$14.95**
FMAC 12V DC Wall Plug Adapter **\$9.95**

CARPET ROVER II ROBOT KIT



This advanced kit is an 8 x 8" differentially steered base that is excellent for carpet or tiled floor experimentation. It uses the Next Step microcontroller, a BASIC Stamp 2 controller that can use the BS2 or BS2-E (sold separately). A host PC is required to download programs to the robot. This complete kit includes the Rover, programming cable, IR proximity detector, bumper switch kit, and line follower kit.

RK3000 Carpet Rover II Complete Kit **\$185.00**

COMBUSTIBLE GAS DETECTOR KIT



Build this kit and detect combustible gases and vapors including natural gas, gasoline, propane, and dozens more. Model GLD1000 is a local alarm only. GLD1010 includes a relay to control external alarms.

GLD1000 **\$29.95**
GLD1010 **\$39.95**

BUILD YOUR OWN STEREO!



We've got the kit! Our K4500 is a synthesized FM stereo tuner, the K4100 is a matching pre-amp. Both are fully digitally controlled with an optional IR remote control (kit also). Add our K4020 2 x 155W Class A power amplifier kit to complete your drop-dead stereo. We also have tube amplifier kits. Visit us on the web, or request our new catalog for more information.

K4500 Synthesized FM Stereo Tuner Kit **\$399.99**
K4100 Digital Preamp Kit **\$399.99**
K4101 IR Remote Control Kit **\$69.95**
K4020 Solid State 310W Power Amp Kit **\$499.99**

ELECTRONIC PROTOTYPING SOFTWARE...



Priced for the hobbyist!

You can create and test AC and DC circuits minutes after installing this package on your PC. Start from scratch, or from the included library of pre-designed circuits. Drag and drop placement from a complete list of active and passive components. Test using a complete list of virtual instruments, Oscilloscope, voltmeter, ohmmeter, ammeter, and watt meter.

PLAB4 **\$49.95**

RAMSEY NOW CARRIES BASIC STAMPS



Hobbyists and educators have embraced the Basic Stamp family of microcontrollers thanks to their power, ease of programming and simple interface. Ramsey now offers popular BS boards, kits, and trainers. If you've been wanting to learn microcontrollers, or build them into a project, now's the time!

BS11C Basic Stamp I Module **\$34.00**
BS21C Basic Stamp II Module **\$49.00**
2720S Basic Stamp 1 Starter Kit **\$109.00**
28150 Board of Education Full Kit **\$109.00**

MINI-KITS



These are easy to build kits that can be used either stand alone or as building blocks for more complex projects.

BN9 Super Snoop 2W Audio Amp **\$8.95**
MB1 Mad Blaster 15W Warble Alarm **\$4.95**
TS1 Touch Switch **\$6.95**
SA7 RF Broadband Preamp +20 dB **\$14.95**
TT7 Touch Tone Decoder **\$29.95**

RF WIRELESS LINK MODULES



- SAW Resonators for high stability - NO Drift!
- Powerful +10 dbm output
- Range up to 600'
- 433 MHz license-free band
- Sensitive superhet receiver with RF LNA
- Stable over full 3-12 VDC range
- Optional on-board 12 bit encoder/decoder using Holtek HT12 series chips

RXD433 433 MHz Receiver/Decoder Mod., Assembled **\$26.95**
TXE433 433 MHz Transmitter/Encoder Mod., Assembled **\$24.95**
RX433 433 MHz Data Receiver Mod., Assembled **\$21.95**
TX433 433 MHz Data Transmitter Mod., Assembled **\$19.95**

VISA



Ramsey Electronics • 793 Canning Parkway • Victor, NY 14564

Order Toll Free: 800-446-2295 • Technical Info or Order Status: 716-924-4560

See our catalog online and register to receive our FREE newsletter: www.ramseykits.com



CIRCLE 263 ON FREE INFORMATION CARD

CALL TOLL FREE

(800) 292-7711

Orders Only

Se Habla Español

C&S Sales

Excellence in Service

Look For Other
Monthly Specials
On Our Website

www.cs-sales.com

D/A Trainer

Elenco Model XK-700

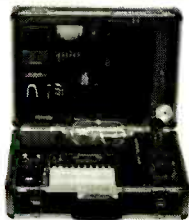

\$195

Elenco's advanced designed Digital/Analog Trainer is specially designed for school projects. It is built on a single PC board for maximum reliability. It includes 5 built-in power supplies, a function generator with continuously variable sine, triangular, and square waveforms. All power supplies are regulated and protected against shorts. The trainer is mounted in a professional technician tool case made of reinforced metal with heavy-duty handles and locks.

Soldering Stations

Weller Low Cost Soldering Iron Model WLC-100



\$34.95

- Variable power control produces 5-40 watts.
- Ideal for hobbyists, DITers and students.
- Complete with 40W iron.

Weller Soldering Station Model WES50

50 watts of controlled power - designed for continuous production soldering.



\$119

Deluxe Electronic Soldering Station

Elenco SL-5 Series

Electronically controlled, ideal for professionals, students, and hobbyists. Available in kit form or assembled.

Works w/ any iron! Turn any soldering iron into a variable iron.

As Low As
\$29.95

Ordering Information:

Model SL-5 - No Iron. (KR SL-5K) **\$29.95**

Model SL-5-40 - Includes 40W UL Iron. (KR SL-5K-40) **\$35.95**

*** Limited Time Offer ***
FREE SP-1A Solder Practice Kit w/ Kit Order!



Features:

- Cushion Grip Handle Soldering Iron (optional) with Grounded Tip for Soldering Static-Sensitive Devices. Easily Replaceable. Uses Long-Life, Plated Conical Tip.
- Heavy Steel, Non-Slip Base.
- Holder Funnel - Reversible, left or right side.
- Steel Tray for Sponge Pad.
- Sponge Pad.

Generators & Counters

B&K 20MHz Sweep/Function Generator with Frequency Counter Model 4040

- 0.2Hz to 20MHz
- AM & FM modulation
- Burst Operation
- External Frequency counter to 30MHz
- Linear and Log sweep

\$425



10MHz Model 4017 \$319
5MHz Model 4011 \$249
3MHz Model 4003 \$205

BK PRECISION

Four Functions in One Elenco Model MX-9300B



Features:

- One instrument with four test and measuring systems:
- 1.3GHz Frequency Counter
- 2MHz Sweep Function Generator
- Digital Multimeter
- Digital Triple Power Supply - 0-3V @ 2A, 5V @ 2A, 15V @ 1A

\$450

Elenco Handheld Universal Counter 1MHz - 2.8GHz Model F-2800



\$99

Features 10 digit display, 16 segment and RF signal strength bar-graph. Includes antenna, NiCad battery, and AC adapter. C-2800 Case with Belt Clip \$14.95

Elenco RF Generator with Counter (100kHz - 150kHz) Model SG-9500



Features internal AM mod. of 1kHz, RF output 100MV - 35MHz. Audio output 1kHz @ 1V RMS.

\$225

SG-9000..... \$119.95 (analog, w/o counter)

Elenco Sweep Function Generator w/ built-in frequency counter Model GF-8046



This sweep function generator with counter is an instrument capable of generating square, triangle, and sine waveforms, and TTL, CMOS pulse over a frequency range from 0.2Hz to 2MHz.

\$195.95

GF-8025 - Without Counter \$139.95

Kit Corner

over 100 kits available

Quantity Discounts Available

Elenco Model RCC-7K Radio Control Car Kit

\$29.95

- Fun & Easy to Assemble
- 7 Functions
- Radio Control Transmitter Included
- Also available as Model AK-870 (No Soldering) \$24.95



Elenco Model AK-700 Pulse/Tone Telephone Kit

\$15.95

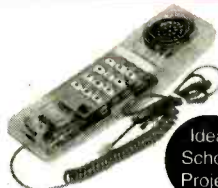

Ideal School Project

Action Lab Kit Model MX-902

- Safe, Solderless, Educational, and Fun!
- Easy-to-read, Illustrated, Lab-Style Manual Included
- Requires 2 "AA" Batteries
- Build your own operating motor - it's easy, it's fun, it's Safe!
- For Ages 10 and up.

\$24.95



Elenco Model AM-780K

Two IC Radio Kit

\$11.95

Also available: Model AM/FM-108K AM/FM Radio Kit \$29.95

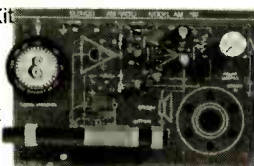

OVI Model OWI-007

Robotic Arm (Wired Control)

Teaches the basic robotic sensing and locomotion principles while testing motor skills.

\$55.95



Elenco Digital Multimeter Kit Model M-2665K

- Extra large 1 1/4" x 2 1/2" LCD display area.
- 34 ranges - includes capacitance, transistor testing hfe, diode testing
- 20A AC/DC current
- Overload protected

\$49.95



Guaranteed Lowest Prices

UPS SHIPPING: 48 STATES 5%
OTHERS CALL FOR DETAILS
IL Residents add 8.25% Sales Tax

C&S SALES, INC.

150 W. CARPENTER AVENUE
WHEELING, IL 60090
FAX: (847) 541-9904 (847) 541-0710

15 DAY MONEY BACK GUARANTEE
2 YEAR FACTORY WARRANTY



PRICES SUBJECT TO CHANGE WITHOUT NOTICE

CIRCLE 290 ON FREE INFORMATION CARD

SAME DAY SHIPPING
Secure on-line ordering

C&S Sales

Excellence in Service

CALL OR WRITE FOR OUR FREE 64 PAGE CATALOG!
(800) 445-3201

Elenco Oscilloscopes

Free Dust Cover and 2 Probes



S-1325	25MHz	Dual Trace	\$325
S-1330	25MHz	Delayed Sweep	\$439
S-1340	40MHz	Dual Trace	\$475
S-1345	40MHz	Delayed Sweep	\$569
S-1360	60MHz	Delayed Sweep	\$725
S-1390	100MHz	Delayed Sweep	\$895

DIGITAL SCOPE SUPER SPECIALS

DS-203	20MHz/10Ms/s	Analog/Digital	\$695
DS-303	40MHz/20Ms/s	Analog/Digital	\$850
DS-603	60MHz/20Ms/s	Analog/Digital	\$950

Quantity Discounts Available

Digital Multimeters

Fluke 79III

\$195



Features analog bargraph, automatic touch hold, diode test, continuity beeper, fused current inputs, lead resistance compensation, ohms, and true RMS.

Elenco LCR & DMM Model LCM-1950

\$69



- Large 1" 3 3/4 digit LCD
- Autoranging frequency to 4MHz
- Capacitance to 400µF
- Inductance to 40H
- Resistance to 4000MΩ
- Logic Test
- Diode & Transistor Test
- Audible Continuity Test

Elenco Model M-1740

\$34.95



- 11 Functions
 - Freq. to 20MHz
 - Cap. to 20µF
 - AC/DC Voltage
 - AC/DC Current
 - Beeper
 - Diode Test
 - Transistor Test
 - Meets UL124 safety specs
- Model M-2760 - **\$19.95**
(9 functions)

Dual-Display LCR Meter w/ Stat Functions B&K Model 878

\$225



Auto/manual range
Many features with Q factor
High Accuracy

Elenco LCR Meter Model LCR-1810

\$99.95



- Capacitance 1pF to 20µF
- Inductance 1µH to 20H
- Resistance 0.1Ω to 2000MΩ
- Temperature to 750°C
- DC Volts 0 - 20V
- Frequency up to 15MHz
- Diode/Audio/Continuity Test
- Signal Output Function
- 3 1/2 Digit Display

Elenco DMM Kit Model M-1005K

\$19.95



- 18 Ranges
 - 3 1/2 Digit LCD
 - Transistor Test
 - Diode Test
 - Training Course
- M-1000B (Assembled) **\$15.95**

Project Labs

Elenco 50-in-1 Electronic Playground Model EP-50

\$19.95

Easy-to-build experiments teach you the operation of over 50 electronic circuits. Fully assembled, includes all the parts needed. No tools or soldering required! Build these exciting circuits: finger touch lamp, magnetic bridge, voltmeter, mouse code alarm, electronic noisemaker, electronic kazoo, electronic keyboard, transistor radio, radio announcer, metal detector, and many more. 76 page manual teaches you about voltage, current, resistors, capacitors, transistors, diodes, transformers, speakers, and antennas. Requires one 9V battery.



Elenco Quad Power Supply Model XP-581

\$79.95



4 Fully Regulated DC Power Supplies in 1 Unit
4 DC voltages: 3 fixed +5V @ 3A, +12V @ 1A, -12V @ 1A
1 Variable - 2.5 - 20V @ 2A

Elenco Power Supply Kit Model XP-720K

\$54.95

- 1.5VDC - 15VDC @ 1A
- -1.5VDC - -15VDC
- 5VDC @ 3A
- 6.3VAC @ 1A & 12.6VAC center tapped @ 1A



XP-720 Fully Assembled **\$85**

Elenco AC/DC Variable Power Supply Model XP-800

\$325



The XP-800 is a high current power supply with 3 variable outputs. Choose from either 0-120VAC @ 2A, 0-40VAC @ 7A, or 0-28VDC @ up to 10A. The precision LED displays allow for exact readout of volts and current. The XP-800 is ideal for Principles of Technology experiments in schools or it can be used as a bench power supply in OEM labs.

Elenco DC Power Supply Model SPL-603 3A 0-30VDC

\$79.95



The SPL-603 is a solid-state DC power supply providing the exact output voltage no matter what current you use. Output fully protected from overload.

Maxitronix 300-in-1 Electronic Project Lab Model MX-908

\$48.95

Everything you need to build 300 exciting electronic projects:

- A Transistor Radio
- IC Organ
- Burglar Alarm
- Delayed Timer
- Electronic Game
- Optical Volume
- Multiplier
- Multiple Counter
- Digital Light Dimmer
- Tone Burst Generator
- Audio Signal Tracer
- Electronic Candle
- Voice Level Meter
- and many, many more!



• Easy-to-read, illustrated, lab-style manual included.

Maxitronix 500-in-1 Electronic Project Lab Model MX-909

\$170

Everything you need to build 500 exciting electronic projects:

Learn the basics of electronics and put your knowledge to work creating 500 different electronic experiments, special lighting effects, radio transmitter and receivers, amazing electronic sound effects, cool games and MORE! Includes built-in breadboard for easy wiring and connection of components, and an LCD (Liquid Crystal Display) indicates the information during the experiments in process.

• Fact-filled, illustrated, lab-style manual included.



Tool Kits

Elenco Deluxe Electronic Tool Kit Model TK-3000 **\$79.95**

A professional technician service tool kit in a metal reinforced tool case with heavy-duty handles and locks. A removable, double-sided pallet handles most of the tools listed below with more room for tools and parts in the lower half. A special ramp in the tool case will lock your meter of choice in place.

- Tools Included in case:
- Deluxe Soldering Iron
 - Soldering Iron Stand
 - Diagonal Pliers
 - Long Nose Pliers
 - Deluxe Wire Stripper
 - Solder Ease Kit
 - 3 pc. Nut Driver
 - Precision Screwdriver Set
 - Screwdriver Slotted 3/16"
 - Screwdriver #1 Phillips
 - IC Extractor
 - Solder Pump
 - Safety Goggles
 - Pocket Screwdriver
 - Solder Tube
 - and Solder Wick



Elenco Deluxe 26pc. Computer Service Tool Kit Model TK-1200

Includes everything you need to service today's computers. Tools include deluxe soldering iron, 5" needle nose pliers, reversible star bits T10, T15, reversible bit nut drivers 3/16" and 1/4", deluxe wire stripper, IC extractor, and more! **\$39.95**



Xcellite® PC Repair Kit Model 99-SPC

- Ideal for repairs on all PCs
- Anti-static chip tools protect from ESD damage
- Convenient roll-up pouch.

\$34.95



Guaranteed Lowest Prices

C&S SALES, INC.

15 DAY MONEY BACK GUARANTEE
2 YEAR FACTORY WARRANTY

UPS SHIPPING: 48 STATES 5%
OTHERS CALL FOR DETAILS
IL Residents add 8.25% Sales Tax

150 W. CARPENTER AVENUE

WHEELING, IL 60090

FAX: (847) 541-9904 (847) 541-0710

SEE US ON THE WEB

www.cs-sales.com

PRICES SUBJECT TO CHANGE WITHOUT NOTICE

CIRCLE 290 ON FREE INFORMATION CARD

\$59 PCBs

And our layout software is **FREE**

- 1 Download our board layout software
- 2 Design a 2-sided circuit board 2.5" x 3.8"
- 3 Send us your layout over the Internet
- 4 We ship you 3 excellent quality boards with plated-through holes for \$59 (shipping included)

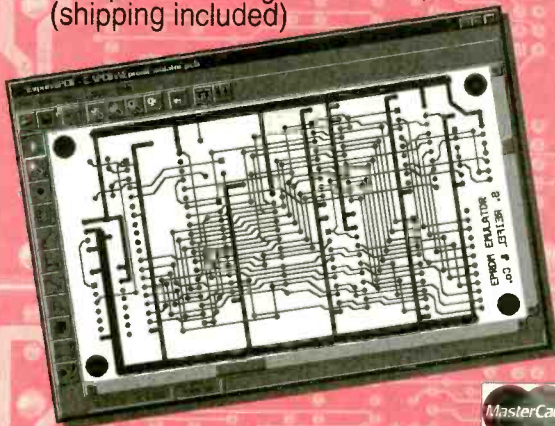

www.expresspcb.com

RF Data Modules

AM Transmitter



- Sub Miniature module
- SAW Controlled
- No adjustable components
- Low current - 2.5mA
- Supply 2.5-12Vdc
- 418MHz or 433MHz
- Range up to 300ft
- CMOS TTL data input
- 7 x 11 x 4mm!

AM-TX1-xxx \$12.60

AM Receiver



- Compact Hybrid Module
- Very stable
- CMOS/TTL output
- Patented Laser Trimmed
- 5Vdc. 0.8mA (HRR6)
- 2kHz data rate
- Sensitivity -105dBm
- 38 x 12 x 2 mm

AM-HRR6-xxx... \$16.33

FM Transceiver



- Only 23 x 33 x 11mm
- Up to 40,000bps data rate
- Up to 450ft. range.
- 5V operation
- 418MHz or 433MHz FM
- 5V CMOS logic interface
- Fast 1mS enable
- Power saving feature
- Carrier Detect output

BiM-xxx-F \$87.36

RS232 Transceiver



- 3wire RS232 interface
- 19.2Kbps half duplex
- 418MHz or 433MHz FM
- 7.5-15Vdc. 20mA
- TX/RX Status LED's
- Up to 400ft. range
- 1/4 wave ant. on board
- User data packetizing
- 58 x 40 x 15mm

CYPHERNET \$139.30

AM Transmitter



- Range up to 250ft.
- SAW controlled stability
- Wide supply range 2-14V
- CMOS/TTL input
- Low current. 4mA typ.
- Up to 4kHz data rate
- Small: 17 x 11mm

AM-RT5-xxx \$12.10



ABACOM
TECHNOLOGIES



tel: (416)236 3858
fax: (416)236 8866
www.abacom-tech.com
MasterCard / VISA

Turn your PC into a 16-bit Storage Scope
spectrum analyzer, and digital multimeter!

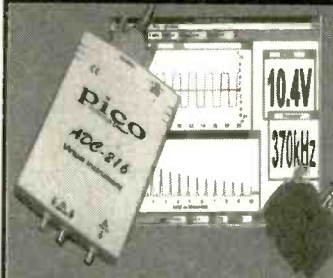

Turn your PC or laptop into a sophisticated storage scope & spectrum analyzer & multimeter. Display on large screen! Print in color! 100MS/s 8-bit, 1.2MS/s 12-bit or 333kS/s 16-bit versions. Great for test depts, schools. Input to Excel. LabView/NT drivers. High precision not high cost! Models from \$95 - \$799!

DrDAQ
science lab in a box!

great for
science fairs!

DrDAQ is a sophisticated digital data-logger that plugs into a PC and comes with sensors for light, sound, pH and temp. Lots of suggested science experiments included which can be done from software supplied. Spectrum analyzer/scope/meter all at once!

DrDAQ from only \$99!

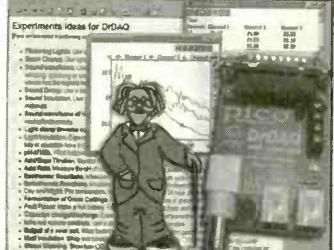

www.saelig.com

RS232-422/485 converters, self-powered, opto-isolated I2C adapter boards for PC communication with I2C bus Mini dataloggers for events, voltages, pressures, etc. Enviromon temperature and environment netwk logger Thermocouple and thermistor adapters for PC ports. BASIC-programmable BASIC-TIGER controller modules JANZ CANbus boards - from Germany's leader! SMD adaptor boards for prototyping with any SM parts!



Saelig Company

www.saelig.com saelig@aol.com
716-425-3753 • 716-425-3835 (fax)

1-888-7SAELIG

SERIAL LCDs

Serial LCDs work great with BASIC Stamps® and other microcontrollers. One-wire interface • simple serial protocol • low cost • high quality • in stock



BPI-216N

- 2x16 text LCD
- 2400/9600 bps
- \$45 (non-backlit)

SGX-120L

- Mini graphics LCD
- 2400/9600 bps
- just \$99



Many other models available—see www.seetron.com!

Scott Edwards Electronics, Inc.
www.seetron.com • 520-459-4802

Learn PC Repair!

The Ultimate Self-Paced PC Assembly and Repair Course

This is the simplest, easiest and most complete course on how to understand, assemble, and diagnose PCs available today. It contains all the text, videos and diagnostic software you'll need to succeed.

Self-Study Course Manual

The manual is a self-study workbook that will enable you to quickly teach yourself all about computers, how they're put together and how to keep them working. Just follow the step-by-step instructions on each page.

At the end of the course you'll know how to build a PC and install & configure Microsoft Windows.

Call **(800) 321-2155**

Videos

The two videos included contain over 3 hours of the Micro 2000 engineering team teaching everything from the basics of PC assembly all the way to using the MicroScope software to troubleshoot them! Watch the pro's in action as they build a completely functional Pentium system with all the major peripherals.

Software

This course includes a Limited Edition version (25 uses) of the award winning MicroScope Diagnostic Software. Use it to build your own PC (computer not included), upgrade it and troubleshoot any problems.

www.ciebookstore.com



Only \$99.95
Complete Course

Product # 02-020

Course includes:

- 200 + Page Training Manual
- PC Assembly & Configuration Video
- PC Diagnostic Video
- Micro-Scope Diagnostic Software (LE)
- CD-ROM - contains videos and manual

CIE Bookstore: 1776 E 17th Cleveland, OH 44114

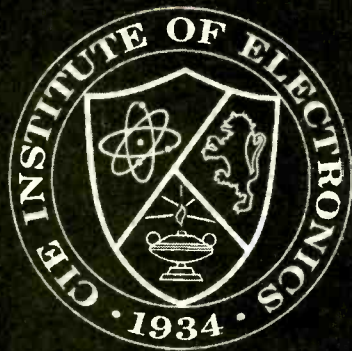

It's almost like being paid to study.

Earn an Associate Degree in Electronic Engineering Technology...

Put your knowledge of electronics to work for you. CIE offers the most comprehensive Associate Degree program offered in electronics. Best of all you study at your own pace with the full resources of CIE just a phone call or a click of a mouse away.

It's Comprehensive and Unique. You Pay for Only the Time You Use!

You won't find a better school than CIE if you want to accomplish your goals without pesky time restrictions (commuting, 8 hour class days, etc.) at CIE you study at your own pace, even an accelerated pace. And if you're like most readers of this magazine, your electronics background can help you receive your degree in less than the maximum 8 terms allowed. Finish sooner and you can save thousands of dollars in tuition. It's almost like being paid to study.

Get all the details on CIE's Associate Degree Program, World College's Bachelor Degree Program and CIE's 10 Career Courses today!



Free Course Catalog!

(800) 243-6446

www.cie-wc.edu

For a FREE Course Catalog on all of our Programs send to CIE: 1776 E. 17th St., Cleveland, OH 44114-3679 or visit www.cie-wc.edu PT30

Name: _____

Address: _____

City: _____

State: _____ Zip: _____

Phone: _____

E-mail: _____

CIRCLE 320 ON FREE INFORMATION CARD

TiePieScope HS801 PORTABLE MOST

Reliability



50 MHz ARBITRARY WAVEFORM GENERATOR-
100 MHz STORAGE OSCILLOSCOPE-
50 MHz SPECTRUM ANALYZER-
6 DISPLAY MULTIMETER-
200 DAYS TRANSIENT RECORDER-

The HS801: the first 100 Mega samples per second measuring instrument that consists of a MOST (Multimeter, Oscilloscope, Spectrum analyzer and Transient recorder) and an AWG (Arbitrary Waveform Generator). This new MOST portable and compact measuring instrument can solve almost every measurement problem. With the integrated AWG you can generate every signal you want.

A user defined toolbar with which over 50 instrument settings quick and easy can be accessed is offered by the versatile software. An intelligent auto setup allows the inexperienced user to perform measurements immediately. Through the use of a setting file, the user has the possibility to save an instrument setup and recall it at a later moment. The setup time of the instrument is hereby reduced to a minimum.

Analyzing signals is done with an 8 bit resolution and a maximum sampling speed of 100 MHz. The input range is 0.1 Volt full scale to 80 Volt full scale. The record length is 32K/256K samples. The AWG has a 10 bit resolution and a sample speed of 25 MHz.

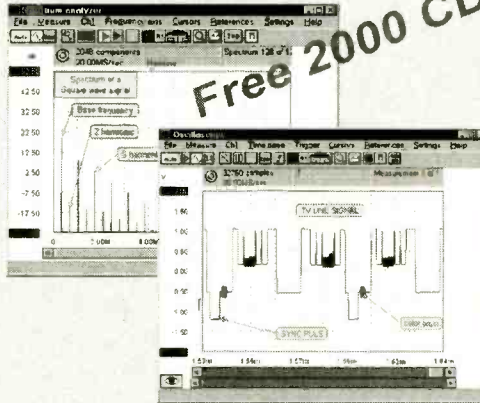

Convince yourself and download the demo software from our web page: www.tiepie.nl. When you have questions and / or remarks, contact us via email: support@tiepie.nl. The HS801 is delivered with a user manual, two probe's, Windows and DOS software.

US dealer:
Feedback Incorporated; Tel 800-526-8783;
Fax 919-644-6470; www.fbk.com

Outside US:
TiePie engineering, P.O. BOX 290, 8600 AG SNEEK,
The Netherlands.
Tel: +31 515 415 416 Fax: +31 515 418 819
Web: www.tiepie.nl

CIRCLE 217 ON FREE INFORMATION CARD



SUPPORTS DEVICES TO 32 MEG

EPROM+

A device programming system for design, repair and experimentation

- ◆ EXCEPTIONAL POWER FOR THE PRO
- ◆ EASY-TO-USE FOR THE NOVICE
- ◆ INCLUDES STEP-BY-STEP TUTORIAL

Here's what you get: A rugged, portable programming unit including the power pack and printer port cable both of which store inside the case. A real printed user and technical manual which includes schematic diagrams for the programming unit plus diagrams for all technology family adapters * Comprehensive, easy-to-use software which is specifically designed to run under DOS, Windows 3.1, 95 and 98 on any speed machine. The software has features which let you READ, PROGRAM, COPY and COMPARE plus much more. You have full access to your system's disk including LOADING and SAVING chip data plus automatic processing of INTEL HEX, MOTOROLA S-RECORD and BINARY files. For detailed work the system software provides a full screen buffer editor including a comprehensive bit and byte tool kit with more than 20 functions.

Broad device support: FIRST GENERATION EPROMS (2708, 1MS2716*, 25XX) SECOND GENERATION EPROMS (2716-28C080), 40 AND 42 PIN EPROMS* (27C1024-27C160) FLASH EPROMS (28F, 29C, 29EE, 29F), EEPROMS (2816-28C010), NVRAMS (12XX, X2210/12) 8 PIN SERIAL EEPROMS* (24, 25, 85, 93, 95, 80011A) PLUS ER1400/M58657* AND ER5901 BIPOLAR PROMS* (72S, 82S), FPGA CONFIGURATORS (17CXXX) MICROCONTROLLERS* (874X, 875X, 87C5XX, 87C75X, 89C5X) ATMEL MICROS* (8-40) PIN 89C051, 89SXXX (AVR) 90SXXX PIC MICROS* 8, 18, 28, 40 PIN (12CXXX-16CXXX, 16FXX, 17C) MOTOROLA MICROS* (68705P3/U3/R3, 68HC705, 68HC711)

\$289

*REQUIRES SNAP-IN ADAPTER (ORDER FACTORY DIRECT OR BUILD YOURSELF) \$5.00 SHIPPING + \$5.00 C.O.D.
1 YEAR WARRANTY - 30 DAY MONEY BACK GUARANTEE VISA* MASTERCARD* AMEX

ANDROMEDA RESEARCH, P.O. BOX 222, MILFORD, OH 45150
(513) 831-9708 FAX (513) 831-7562 website - www.arlabs.com

FOR 26 EASY
WAYS TO HELP
SAVE THE
EARTH CALL
1-800-488-8887.

©1994 EDF

Thanks to you, all sorts of everyday products are being made from the paper, plastic, metal and glass that you've been recycling.

But to keep recycling working to help protect the environment, you need to buy those products.

BUY RECYCLED.



AND SAVE.

So look for products made from recycled materials, and buy them. It would mean the world to all of us.

For a free brochure, write Buy Recycled, Environmental Defense Fund, 257 Park Ave. South, New York, NY 10010, or call 1-800-CALL-EDF.

ENVIRONMENTAL DEFENSE FUND **EDF**

AQ A Public Service of The Publishers **Earth Share**

G EPA

Call Today And SAVE! **Unbeatable PRICES!**

CABLE TV

**DESCRAMBLERS
CONVERTERS • FILTERS
VIDEO STABILIZERS**

FREE ➤ 30 Day Trial
FREE ➤ Product Catalog
FREE ➤ 1 Year Warranty

100% MONEY BACK GUARANTEE



Let us point you in the right direction ...

Arrow Technologies
Omaha, Nebraska

**TOLL FREE
1-800-554-ARROW**

1-800-554-2776
<http://www.arrowtek.com>

ROBOTS, ROBOTS, ROBOTS...



ROBOT STORE

FEATURING MUSCLE WIRES

Robot Kits, Programmable Robots, LEGO® Robots, Living Rabots, Muscle Wires®, Home and Office Robots, Electronic Kits & More!

Robot Kits, Programmable Robots, LEGO® Robots, Living Rabots, Muscle Wires®, Home and Office Robots, Electronic Kits & More!

Request our FREE 48 page catalog with over 300 items!

www.RobotStore.com
800-374-5764

Monda-tronics Inc.
PMB-H, 4286 Redwood Hwy, Dept. 171
San Rafael, CA 94903
ph 415-491-4600 fx 415-491-4696
info@robotstore.com

REMOTE CONTROL ANYTHING!
ADD A REMOTE CONTROL TO ANY PROJECT OR EXISTING DEVICE. SEND \$15 CHECK OR INTERNATIONAL MONEY ORDER FOR STARTER KIT CONTAINING CHIP SETS AND FULL DETAILS TO:
B. B. ELECTRONICS, P.O. BOX 112
POSTAL STATION CHAMPLAIN,
LASALLE, P.Q. H8P 3H9, CANADA.

PCB Services
From Concept to Production

Schematic Development Making your designs Affordable.
Fast Proto boards
Production boards
Plastic molding
Metal cases
Assembly

C-Tech industries
(770)674-4576
WWW.C-Tech.TV

Wireless Video Transmitters

Distributor Program Available

SAW Based Digital PLL

- SAW 434 & 916 MHz ATV video transmitters*
- 3 CH digital PLL ATV video transmitter *
- Units work w/CMOS & CCD color or b/w cameras

* requires technician class amateur radio license to operate

www.xilor.com
© Xilor Inc. Tel: 800-417-6689 or 865-546-9863
Visa/Master/Discover 10am-6pm ET

"X-Ray" Filters, Cameras, Camcorders, Lights

Infrared (IR) Equip sees through some fabrics!
2 Million Candle Power Rechargeable IR Spotlight
NEW! Mini Metal/Wood Lathe, Mill, Drill, Sander
Ultraviolet (UV) LED Flashlights, Invisible Inks
SpyCams, Specialty Optical Products
Home Automation Software, Free Fax Software

www.MaxMax.com

Antique Electronic Supply
6221 S. Maple Ave. Tempe, AZ 85283

www.tubesandmore.com
NOS, Parts, Supplies, Books, Speakers, Transformers, Grill Cloth, and MORE!
Ph: 480.820.5411 • Fax: 480.820.4643 or 800.706.6789

Smart Battery Charger
New & Improved

FOR GEL-CELLS or LEAD ACID BATTERIES.
Features: Precision temperature tracking voltage reference & three mode charging sequence. Standard kit is for 12V @ 1/2 or 1 Amp, user selectable. Can be connected to the battery indefinitely, will not overcharge. Weighs 2 pounds and measures 4"W x 5 1/2"D x 2 1/2"H. Finished enclosure included in kit.

Complete Kit Only \$59.95
Assembled & Tested \$79.95
CA residents add 7.50% sales tax. S&H: \$6.50 (insured)
Foreign orders add 20%. For more info: www.a-aengineering.com

A&A Engineering
2521 W. La Palma #K • Anaheim, CA 92801
(714) 952-2114 • FAX: (714) 952-3280

FOR BEGINNERS — But Practical

AN EASY TO READ NEW BOOK:

The ideal way to catch up. It starts with 8th-grade science basics, going all the way up to industrial applications like motor controllers, sensors, and noise suppression. Covers oscilloscopes (fully detailed instructions), desirable and undesirable oscillations, simplified circuits for bipolar and FET transistors, flip-flops and square waves, op-amps, SCRs & Triacs. Covers "PID" controls, ground loops, shields versus "guards," soldering, and brief sections on lasers, laser printers, photocopiers, radios, digital vs. analog. Symbols explained include U.S. electrician and European.

(See www.amazon.com reviews!)

"Industrial Electronics for Engineers, Chemists, and Technicians, with Optional Lab Experiments"

By Daniel J. Shanefield
ISBN 0-8155-1467-0

William Andrew Publishing
13 Eaton Ave.
Norwich, NY 13815
www.williamandrew.com
\$72.00 postpaid

LOG ON TO FORT777.COM

Come & Visit Fort777.com Now!



Come and take a look at all the great products we've got for you at Fort777.com - and they're all at incredibly low prices even if you only want one piece. Just click Product Index to find all the things you need. While you're there take a look at the Novel and read all about the Fort777 of the future. Make Fort777 your first choice and start saving NOW!

Electronic Components

When you want electronic components, visit Fort777.com. We've got large ranges of all the most popular items you'll need. Check out our Resistors, Capacitors, Connectors, Relays, Potentiometers, Fuses, LEDs, Neons, Lampholders, Diodes, Rectifiers, Crimp Terminals, Suppressors, Buzzers, Fuseholders, Clips, Audio, Computer and Telephone Cords and much, much more.

We've got specialty items as well and our range is growing all the time. Take a look at our special offers and click on Star Buys to see our latest hottest items. There are lots of new things happening all the time at the new Fort777.com so come back and visit us regularly then you won't miss any of our great specials. With our low prices you can buy for your friends and save on freight costs. Orders over US\$150 we pay the freight.

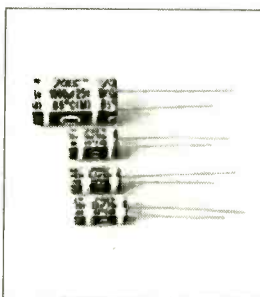

Only Top Quality Components



You can rely on the components you'll get from Fort777.com. We only buy direct from the best factories. All our components are fully specified and are the same each time you buy. You can pay much more for these very same items by buying from our competitors. But if you want the best parts at the best prices, come to Fort777. The choice as always is yours.

Low Cost Movies That Play On Your DVD Player



Never before sold in US, but now you can buy near-DVD quality video CDs that will play on your DVD player. We've got lots of the latest movies, top movies released over the last few years and classics. Prices are around one third the regular price for DVDs. These discs are 100% legal product, produced under license from the studios. Visit Fort777.com and find out more about how we can do it and check out all your favorite movies.



and drawing if it's pcb mounted. So now you can check out all the specs on line to find the exact part you need. Just click on More Info to see all the details and don't forget to scroll right to the bottom of the page to see the entire specification. In the More Info product screen, you will see a large picture of the product so that you can be absolutely certain that you've got the exact item you need. Take a look at Fort777 right now!

It's All At Fort777.com

When you need the best quality components and the best prices, you need to visit Fort777.com. Use the menu buttons, search function or index to quickly find the parts you need. Every item has a color picture and full description, specification

ITEMS SHOWN HERE AND ON THE WEBSITE HTTP://WWW.FORT777.COM ARE ONLY AVAILABLE FROM THE WEBSITE

No minimum order quantity. Prices are valid for one piece/pack. Freight charged extra.

*The address below is for returns and servicing:

FORT777.COM NORTH AMERICAN SERVICE AGENTS, FRONTIER ENGINEERING
 628 S. SUNSET ST., LONGMONT, CO 80501 * email: sales@fort777.com

Enclosed Switching Power Supplies
Single, Dual & Triple Output Models

Triple Output Supplies
100w, 5v/12v/-5v
as low as \$44.00
100w, 5V/12V/-12V
as low as \$44.00

Single Output Supplies

(5V, 12V, 15V, 25V)
25 watt series **AS Low as \$20.55 ea.**
60 watt series **AS Low as \$27.95 ea.**
150 watt series **AS Low as \$42.95 ea.**

NOW IN STOCK!

UL Approved

Dual Output Supplies

100W, 5V/12V
100W, 5V/24V
...as low as \$38.00
50W, 5V/24V
...as low as \$27.00ea.

See Our Web Site for Details

Removable Hard Drive Rack
For IDE/Ultra DMA Hard Drives
We Sold Over 14,000 in 1998!
This product can be used with any 3-1/2 IDE hard drive up to 1" high. It includes an electronic keylock for safe removal and insertion. Made of ABS 707 fire-proof plastic. Use this product to protect sensitive hard drive data, take your hard drive between work and home or even set up different users with their own hard drives that they physically insert every time they use a PC. Other models available from C.S.I. include RH10 series and RH20 series, which are interchangeable within the same interface design (IDE or SCSI). Other Models are Available. See www.web-tronics.com under "hard drive and accessories" for more details and pictures.

ONLY \$14.95 any qty.



#RH-10C-IDE

Removable Hard Drive Rack with Auto Door And Cooling Fan

- Auto door on the outer frame
- ABS material of outer frame. High efficiency cooling fan
- Worldwide patent pending function handle
- CE Approved
- Coating iron bottom cover
- For IDE Interface
- For 1" high 3.5" HDD
- Not compatible with our RH10 & RH20 series. Compatible with our RH17-IDE model.

ONLY \$18.95 any qty.



#MR-27
Details at www.web-tronics.com

2GHz RF Field Strength Analyzer

- Frequency Range: 100KHz to 2.060MHz
- Narrow Band FM (NFM), Wide Band FM (WFM), AM and Single Side Band (SSB) Modulated Signals May Be Measured
- PLL Tuning System for Precise Frequency Measurement and Tuning
- LED Backlight LCD (192x192 dots)
- Built-In Frequency Counter
- Hand-Held and Battery Operated
- All Functions are Menu Selected
- RS232C for PC Interface and Printer

ONLY \$1989



#3201

CTRL - D to bookmark this site

www.web-tronics.com

Don't forget the dash

Circuit Specialists Inc.

- Easy to Navigate
- Includes a Search Engine That Really Works
- New Items Added Constantly

In Business Since 1971

Mini CCDs (B/W & Color)
Sensational NEW Design for Small Observation Cameras. Smaller and Better!

LOWER PRICES

- Ultra Miniature Design
- Black & White Versions Only 25mm x 25mm
- Color Versions Only 32mm x 32mm
- Available in Standard Lens or Pinhole Lens

- All Include Pre-Wired Cable Harness for Video & Power
- 12V Regulated Power Supply Required (120mA typical power consumption)
- 0.1 LUX Rating (B/W), 1 LUX (color)
- CCD Area Image Sensor for Long Camera Life
- Back Light Compensation Circuit
- Built-In Electronic Auto Iris Lens

VMCW-H11A 32mmx32mmx30mm, Color CCD with standard lens, pre-wired cabling, 12V DC Power \$139.00 / \$129.00 5 or more

VMCW-H12A 32mmx32mmx19mm, Color CCD with pinhole lens, pre-wired cabling, 12V DC Power Input \$139.00 / \$129.00 5 or more

VMPS-718A 25mmx25mmx30mm, B/W CCD with standard lens, pre-wired cabling, 12V DC Power Input \$59.00 / \$49.00 5 or more

VMPS-250A 25mmx25mmx15mm, B/W CCD with pinhole lens, pre-wired cabling, 12V DC Power Input \$59.00 / \$49.00 5 or more

VCC-3232 32mmx32mmx30mm, CMOS COLOR, std lens, see web for specs \$79.00 / \$72.00 5 or more

Detailed Specs on the Web

CCD B&W Board Cameras

- ASIC CCD Area Image Sensor
- Extremely Low Power Consumption
- 0.5 Lux Min Illumination
- Built-In Electronic Auto Iris for Auto Light Compensation

VM1030PA-B 30mmx30mmx25mm, Pinhole lens, 12V \$39.00 any qty.

VM1030A 30mmx30mmx26mm, Standard lens, 12V \$39.00 any qty.

VM1035A 42mmx42mmx25mm, Standard lens, 12V with back light compensation \$49.00 any qty.

VMCB21 44mmx38.5mmx28mm, with 6 infra-red LEDs, 12V \$49.00 any qty.

VM1036A 32mmx32mmx25mm, Standard lens, 12V, reverse mirror image feature \$49.00 any qty.

Detailed Specs on the Web

LOWER PRICES

Bullet CCD Cameras B&W and Color

- Smart Rugged Metal Housing
- Extremely Low Power Consumption
- 12 Volt
- CCD Area Image Sensor for Long Camera Life
- Built-In Electronic Auto Iris for Auto Light Compensation
- No Blooming, No Burning
- 0.1 Min Lux Illumination (B&W), 1 Lux Min Lux Illumination (color)

VMBLT1020 B&W, 21mm(D)x58.5mm(L) \$54.00 any qty.

VMBLT1020W B&W Weatherproof, 21mm(D)x58.5mm(L) \$79.00 any qty.

VMBLTJC19BW COLOR! Weatherproof, 17mm(D)x88mm(L) \$139.00 any qty.

Detailed Specs on the Web

LOWER PRICES

COLOR CCD Mini Board Cameras

- Low Power Consumption
- 1 Lux Illumination
- Internal Synchronization
- 12Volts
- 400 TV Lines
- Built-In Electronic Auto Iris for Auto Light Compensation

VM3010PA 33mmx33mmx18mm, Pinhole lens \$59.00 any qty.

VM3011-A 45mmx40mmx24mm, Standard lens, single board \$89.00 any qty.

VM3010-A 33mmx33mmx32mm, Standard lens \$99.00 any qty.

Detailed Specs on the Web

PRICE REDUCTION

DC to AC Power Inverters!
150 watt up to 3000 watt models!

150w modified sine wave: \$29.95(G-12-015B) **Industry Best Pricing!**

300w modified sine wave: \$39.95(G-12-030)

150w pure sine wave: \$69.00(G-12-150S)

300w pure sine wave: \$109.00(G-12-300S)

800w modified sine wave: \$139.00 (G-12-800)

1000w modified sine wave: \$179.00(G-12-100)

3000w modified sine wave(phase corrected), (G-12-300).....\$489.00

See Our Website for DETAILED Specs!



Our Most Sophisticated DMM *We Sold Over 700 Last Year!*
with RS-232 Interface & Software, 3-3/4 Digit, 4000 Count, Auto-Ranging Analog Bargraph

- K Type Temperature Probe Included
- Pulse Signal for Logic & Audible Test
- Continuity/Diode Test
- Logic Test
- Auto Power OFF/Keep ON Mode
- Fused 20A Input with Warning Buzzer
- Back Light
- Data Hold/Run Mode
- Safety Design UL1244 & VDE-4411
- Protective Holder
- Silicon Test Leads

NOW ONLY \$149 Reg. \$169

More Details on our Web Site

PROTEK 506

BEST DEALS! *new!*
NOW OFFERING

Dish Network & Direct TV

Great Equipment & Service
See Our Website for our **Incredible Offers!**
Also Great HDTV Prices!

O'Scope Offer ONLY \$299

30MHz! ONLY \$299!
Industries Best Price!
See web for specs



#OSC-1030

- Dual Channel
- Dual Trace
- Vert Trigger
- 1 Year C.S.I. Warranty!

Manufactured for CSI by a leading O.E.M. manufacturer. See our website for detailed specifications!

3000 Series Digital R/O Bench Power Supply
♦ Low Cost Single Output ♦ 3 Amp

AS LOW AS \$89

High stability digital read-out bench power supply featuring constant voltage and current outputs. Short-circuit protection and current limiting protection is provided. Highly accurate LED accuracy and stable line regulation make the 3000 series the perfect choice for lab and educational use.

Line Regulation: 2x10⁻⁴ +1ma
Load Regulation: 1 x 10⁻⁴ +5mv
LED Accuracy: Voltage ±1% +2 digits
Current ±1.5% +2 digits

Wave Line Noise: ≤1mvrms
Dimensions: 291mm x 158mm x 136mm

CSI3003: 0-30v/0-3amp
Digital R/O Bench PS,
1x10⁻⁴+5mv Load Regulation
\$99.00 5/\$89.00

CSI 5003: 0-50v/0-3 amp
Digital R/O Bench PS,
1x10⁻⁴ +5mv Load Regulation
\$129.00 5/\$119.00



CABLE BOX SUPPLIERS

**VISION MASTER PLUS
W/UNIVERSAL FORMAT
STABILIZERS PICTURE
WORKS ANY SYSTEM!**

"DEALERS WELCOME"

★ **LOW, LOW PRICING** ★

1-888-777-9123

1-888-675-3687

NEW Easy-PC For Windows

Schematic & PCB Layout CAD

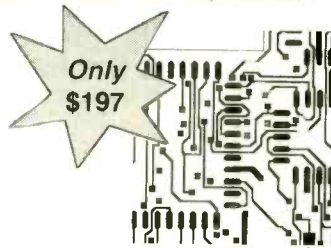

- True Windows Interface
- True Windows 32 bit application
- Schematic and PCB Design as standard
- Intelligent Cut, Copy and Paste - Internal & external
- Multi-level Undo and Redo
- Forward design changes - Schematic to PCB
- Integrated Autoplace
- Integrated Shape based AutoRouter (Optional Extra)
- Shape based copper pour and split power planes
- And now version 4.0 with many new features !!

Call Ohio Automation (740) 596 1023
www.numberone.com

Top Secret Consumertronics

In business 25+ years - established professionals

Exciting Hi-Tech Survival Books, Manuals, Tapes

- | | | | |
|---------------------------|------|---------------------------|------|
| Stopping Power Meters | \$29 | Polygraph Secrets | \$29 |
| SPM Demo VHS Tape | \$29 | Identity Theft Manual | \$29 |
| KW-HR Meters | \$29 | Credit Card Security | \$29 |
| Gas & Water Security | \$19 | Check & M.O. Security | \$29 |
| Beyond Phone Color Boxes | \$29 | ATM Manual | \$39 |
| Cellphone/Cordless Guide | \$39 | Mind Control | \$29 |
| Pager (Beeper) Manual | \$29 | Under Attack! | \$29 |
| Caller ID & ANI Security | \$29 | EM Brainblaster | \$29 |
| Voice Mail Security | \$29 | Radionics Manual | \$29 |
| PBX Security | \$25 | Heal Thyself! | \$29 |
| Fax Machine Security | \$29 | Ultimate Success Manual | \$29 |
| Computer Security | \$39 | Stealth Technology | \$29 |
| Hacker Files (3HD Disks) | \$39 | High Voltage Devices | \$29 |
| Social Engineering | \$29 | Secret & Survival Radio | \$29 |
| Cons & Scams Databook | \$29 | Secrets of Solderless BBs | \$29 |
| Internet Security | \$29 | The "Goldfinger" | \$19 |
| Internet Frauds Databook | \$29 | Casino Secrets | \$29 |
| Internet Tracking/Tracing | \$29 | Government Land Grab | \$19 |
| Beyond Van Eck Tempest | \$29 | Rockets Red Glare | \$29 |
| Van Eck Demo VHS Tape | \$29 | ...much more in Catalog! | |

Check, MO, VISA, MC + add \$5 S/H (US, Canada)
FREE Online Catalog: www.tsc-global.com
Printed Catalog: \$1 with order, \$3 w/o (descriptions, policies)

Order Today! Consumertronics
P.O. Box 23097, ABQ, NM 87192
505-321-1034 Fax: 505-275-5637

PICmicro MCU Development Tools

Experimenter Boards

- LAB-X1 for 40-pin MCUs (shown) - \$199.95
- LAB-X2 for 28 or 40-pin MCUs - \$69.95
- LAB-X3 for 18-pin MCUs - \$119.95



EPIC Plus

PICmicro Programmer
\$59.95

Program PICmicro MCUs in BASIC!

DOS or Windows operation (includes Windows IDE software).

- PicBasic Compiler - \$99.95
- PicBasic Pro Compiler - \$249.95

PICProto Prototyping Boards

\$8.95 to \$19.95

High-quality blank prototyping boards
for PICmicro MCUs.

microEngineering Labs, Inc.

www.melabs.com

Phone: (719) 520-5323

Fax: (719) 520-1867

Box 60039, Colorado Springs, CO 80960

CABLE SECRETS!!!

**Build your OWN cable
box "test" devices!**

Why pay \$100.00 or more for a "test" device that someone else made? Make your own! Includes complete source code and plans for the most commonly used cable boxes. *Unlock all of the channels on your box!*

Or start your own lucrative business!

- Complete source code \$79.95
- Code for individual boxes \$29.95

DSS SECRETS — Vol. 2

Step-by-step instructions on programming your own DSS access card. *Unlock all channels on your own card!* This is the most current information on the market! Includes software, plans, and hardware sources. Book & CD-ROM.

DSS Secrets Vol. 2 \$49.95

VISA • MasterCard • American Express

To order, call Worldwyde @ 1-800-773-6698

33523 Eight Mile Rd. #A3-261 • Livonia, MI 48152

Visit us on the web at www.worldwyde.com

CONTROL IT

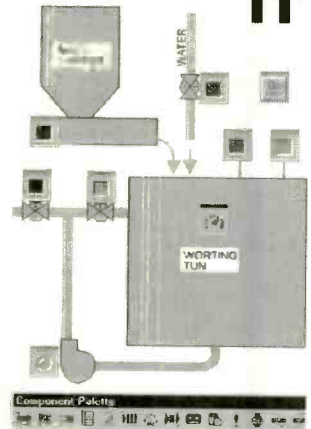

Intec Automation Inc.
www.microcommander.com

spyoutlet.com

Countersurveillance - Electronic Devices

Purchase your video cameras from *one of the largest importers in the U.S.*

- NEW Underwater Bullet Cameras
- Spy Pinhole Cameras starting at \$79⁰⁰
- Wireless Video • Voice Changer
- Micro Recorders • Shotgun Mic
- Locksmithing • Bug & Phone Tap Detectors • Phone Call Register
- UV Pens & Powder • Realtime Telephone Recording Systems:
- 12 Hour \$125⁰⁰ • GPS Vehicle Tracking System (nationwide)
- And much more

www.spyoutlet.com

Printed Catalog send \$5⁰⁰

SPY OUTLET 2468 NIA. FALLS BLVD
TONAWANDA NY 14150 (716) 695-8660

Solar Panels

160 mW / Sun 8 Cells

- | | | | |
|-----------------------|-----------------------|-----------------------|-----------------------|
| 200pc | 2Kpc | 20Kpc | 200Kpc |
| \$2. ⁰⁰ ea | \$1. ⁸⁰ ea | \$1. ⁷¹ ea | \$0. ⁸⁵ ea |

Battery Holders

AA Singles, and Dual Side by Side

- | | | | |
|-----------------------|-----------------------|-----------------------|-----------------------|
| 200pc | 2Kpc | 20Kpc | 200Kpc |
| \$0. ⁴⁰ ea | \$0. ³⁶ ea | \$0. ³⁴ ea | \$0. ¹⁷ ea |

LED's

High Intensity HPWT-DL00

Similar to Lumex type SSL-LX30448SYC

- | | | | |
|-----------------------|-----------------------|-----------------------|-----------------------|
| 200pc | 2Kpc | 20Kpc | 200Kpc |
| \$0. ⁵⁰ ea | \$0. ⁴⁵ ea | \$0. ⁴³ ea | \$0. ²¹ ea |

Call 1-847-612-2739

Press-n-Peel Transfer Film

PC Boards in Minutes

8.5" x 11" Shts.
* Or Photocopy
**Use standard household iron

1. LaserPrint*
2. Press On**
3. Peel Off
4. Etch



Use Standard Copper Clad Board
20 Shts \$30/ 40 Shts \$50/ 100 Shts \$100
Visa/MC/PO/CK/IMO \$4 S&H/Foreign Add \$7

Techniks Inc.

P.O. Box 463, Ringoes NJ 08551

ph. 908.788.8249 fax 908.788.8837

www.techniks.com

Visit Our E-Store On-Line!

SCINTILLATING!

Who Are You? The Encyclopedia of Personal Identification. Insider information directly from the FBI and Customs, top graphic artists, offshore attorneys, master thieves, and professional sharks. *Who Are You?* details ID theft schemes (and prevention), how to create great documents on a home computer, get a new driver's license (suspension? No problem), open offshore or US bank accounts w/o an SS number, acquire the world's best ID, second passports, phony credit cards, read vehicle tags, much, much more. Sources, sites, suppliers, tips, tricks and techniques. 352 pages \$44.95.

Covert Catalog2000 The latest, hands-on source guide for law enforcement goodies, electronic surveillance, covert video, counter measures, entry equipment, weapons, tracking systems, computer surveillance, and more. Exact ordering info from suppliers in 13 nations! 220 Pages. \$39.95.

ORDER BOTH BOOKS — SUBTRACT \$10!!

Intelligence Here
404 N. Mt. Shasta Blvd.
Mt. Shasta, CA 96067
Order by Phone: 866-885-8855
www.Intelligencehere.com.

Add \$6.00 (priority shipping). CA residents add 8% tax.



Visit our Website
www.blkfeather.com

- ▶ 4400 S. Robinson Avenue
- ▶ Oklahoma City, OK 73109
- ▶ FAX: (405) 616-9603
- ▶ Email: blkfea@aol.com

Or call & order today:
1-405-616-0374

SCRAMBLED VIDEO

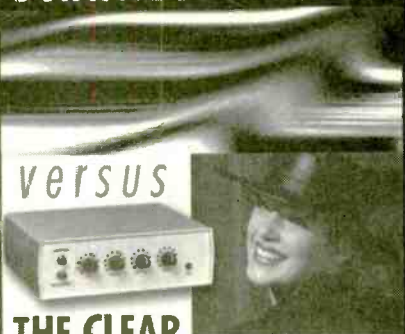

THE CLEAR SOLUTION Model VSG-RFDL
.....RESTORES LOST VIDEO

R.C. Distributing Company
P.O. Box 552 South Bend, IN 46624
Phone (219) 233-3053 Fax (219) 289-1566
www.rcdistributing.com

SMART CARDS

Complete system! Program your own smart card applications in easy to use BASIC!



- Security Systems
- Time Cards
- Emulation
- Access Control - Home, Auto
- Robotics Programming
- DATA Security

Tool Kit comes complete with:

- SmartCard Programmer
- Developer Software Package
- User Manual in printed form
- 3 Blank Smart Cards

Complete system for only \$79.95

We accept
VISA • Master Card • American Express

To Order Call 1-800-773-6698 Worldwyde.Com,
33523 Eight Mile Rd #A3-261 Livonia, MI 48152
Visit us online <http://www.worldwyde.com>

CABLE TV REMOTES BLOW-OUT SALE

We carry all models

50pc.	100pc.	500pc.	1kpcs.
\$3.50	\$3.25	\$2.75	\$2.50

Rebellion-3 125ch. Converter

12pc.	50pc.	100pc.
\$50.00	\$47.00	\$44.00

Magnavox Universal Remote Controls

12pc.	50pc.	100pc.
\$4.50	\$4.00	\$3.75

Call Today Globaltech 1-(800)-582-5116
View Our On-Line Display Catalog at:
www.globaltechdistributors.com

PIC Programmer Kits

Super Value!
\$16.95 +S&H \$4.95
The P16PRO: can program up to 40 pin PICs including the popular 16F84 & 12C508 • Needs software (extra \$20) • Available assembled or start-up from \$16.95 for the kit.
See www.electronics123.com for more info!
The PICALL programmer can also program Atmel AVR's in addition to the PICs it can program • Free software • PICALL programmer kit at \$69.95
See www.electronics123.com for more info!

Video Camera module Code:BB004

CMOS Camera Module, Black & White. Size: 0.63"x0.63"x0.59"H. Lens: f4.9, F2.8. EIA 320Hx240V. 0.8" DIL Package. 5 pins. Pin 3 is 1V p-p composite video (75 ohm) to monitor. \$36 + \$5 S&H

Running Lights kit Add \$6 for 8 triacs to drive light bulbs

8 LEDs with 10 push button selectable patterns. 8 speed levels! 80 combinations! \$16 + \$5 S&H

Toll Free: 1-888-549-3749 (USA & Canada)
Tel: (350) 549-3726. Request a FREE catalog or visit us at: www.electronics123.com for more products.
Amazor Electronics, Box 21 Columbiana OH 44408

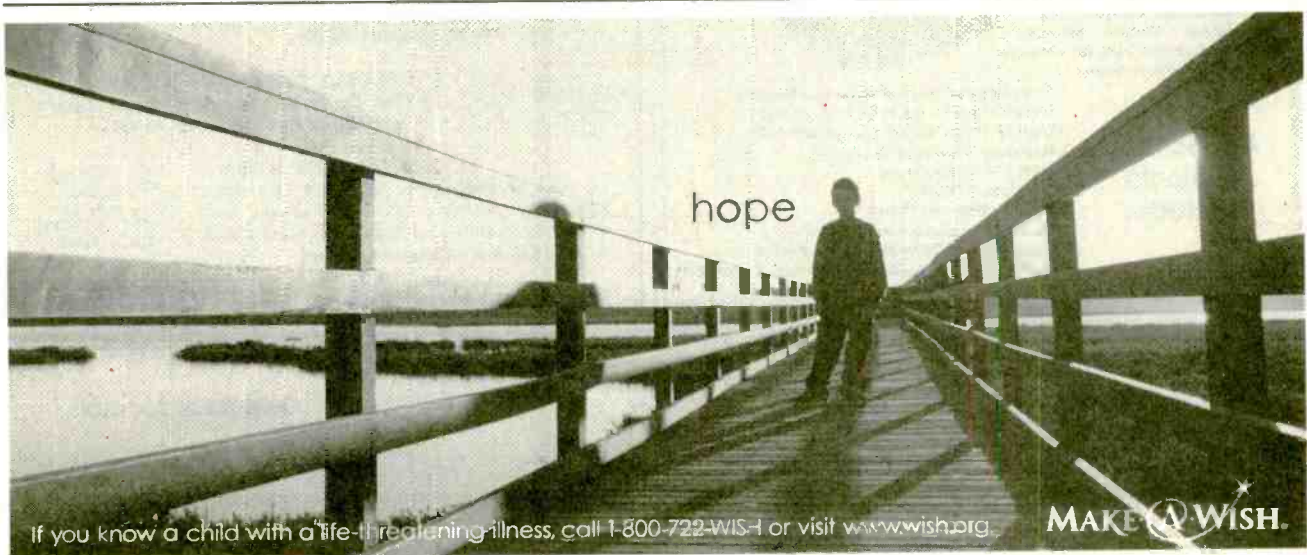

If you know a child with a life-threatening illness, call 1-800-722-WISH or visit www.wish.org.

MAKE A WISH.

The Pocket Programmer

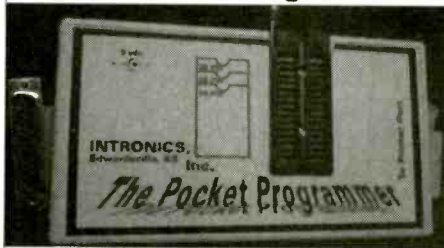

The Best just got Better!!!

The Best portable programmer that uses the printer port instead of an internal card just got Better!! Now with easier to use Windows based software that programs E(E)prom, Flash & Dallas parts. 25/27/28 & 29 series from 16K to 8Mbit. Adapters available for MCU's 874X, 875X, Pic, Atmel, PLCC packages, Bi-Prom's, 40-Pin X16 Eproms, Rom Emulator to 32K X 8 (2716-27256) and More...

Only \$149.95

Same Name, Address & Phone # for 19 Years.... Isn't it Amazing ?

Intronics, Inc.

Box 13723 / 612 Newton St.
Edwardsville, KS 66113
Tel. (913) 422-2094 Add \$7.00 COD
Fax (913) 441-1623 Add \$6.00 Shipping

WWW.IN-KS.COM Visa/MC/Amex/Disc

Turn Your Multimedia PC into a Powerful Real-Time Audio Spectrum Analyzer

Features

- 20 kHz real-time bandwidth
- Fast 32 bit executable
- Dual channel analysis
- High Resolution FFT
- Octave Analysis
- THD, THD+N, SNR measurements
- Signal Generation
- Triggering, Decimation
- Transfer Functions, Coherence
- Time Series, Spectrum Phase, and 3-D Surface plots
- Real-Time Recording and Post-Processing modes

Applications

- Distortion Analysis
- Frequency Response Testing
- Vibration Measurements
- Acoustic Research

System Requirements

- 486 CPU or greater
- 8 MB RAM minimum
- Win. 95, NT, or Win. 3.1 + Win.32s
- Mouse and Math coprocessor
- 16 bit sound card

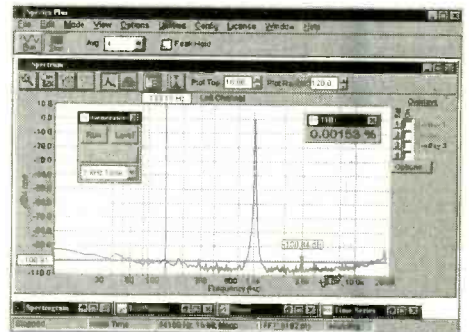

Priced from \$299

(U.S. sales only - not for export/resale)

DOWNLOAD FREE 30 DAY TRIAL!

www.spectraplus.com

PHS Pioneer Hill Software
24460 Mason Rd.
Poulsbo, WA 98370
a subsidiary of Sound Technology, Inc.

Sales: (360) 697-3472



Spectra Plus
FFT Spectral Analysis System

Fax: (360) 697-7717

e-mail: pioneer@telebyte.com

Microprocessor Hands-On Training

The PRIMER Trainer is a flexible instructional tool featured in a Prentice Hall textbook and used by colleges and universities around the world. Ruggedly designed to resist wear, the PRIMER supports several different programming Languages including Assembler, Machine Language, C, BASIC, and FORTH. A comprehensive Instruction Manual contains over 25 lessons with several examples of program design and hardware control. The Applications Manual provides theory and sample code for a number of hands-on lab projects.

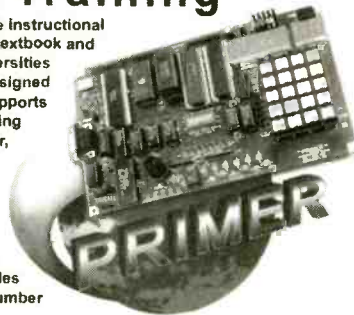

Application Projects Include:

- Scan Keypad Input & Write to a Display
- Detect Light Levels with a Photocell
- Control Motor Speed using Back EMF
- Design a Waveform Generator
- Measure Temperature
- Program EPROMs
- Bus Interface an 8255 PPI
- Construct a Capacitance Meter
- Interface and Control Stepper Motors
- Design a DTMF Autodialer / Remote Controller

The PRIMER can be purchased as an unassembled kit (\$120) or as an assembled/tested kit (\$170). Upgrades provide battery-backed RAM and PC connectivity via an RS232 serial port (shown in picture). Additional options include a heavy-duty keypad (shown in picture) and a 9V power supply - see our website. Quantity discounts are available. Satisfaction guaranteed.

Since 1985
OVER
16
YEARS OF
SINGLE BOARD
SOLUTIONS

EMAC, inc.

Phone 618-529-4525 Fax 618-457-0110
2390 EMAC Way, Carbondale, Illinois 62901
World Wide Web: <http://www.emacinc.com>

Start A Career With High Wages, Excellent Benefits and Job Security!!

With UCANDO's extraordinary maintenance training programs you can quickly and easily enter a high paying field as a maintenance technician for a very small investment of time and money.



RC-M ONLY \$165 RC-M is a 15 hour training course on relay ladder logic systems. Includes a 5-part video and workbook. **Great Value!**

PLC-M ONLY \$198 PLC-M is a 32 hour training course on PLC systems. Includes (2) 4-part video's and workbook. **This training is valuable.**



HYD-M ONLY \$209 HYD-M is a 32 hour course on Fluid Dynamics. Includes (2) 4-part video's and workbook. **This Module is a must.**

SC-M ONLY \$215 SC-M is a 32 hour training course on AC & DC Servo Controllers. Includes (2) 4-part video's and workbook. **Learn everything you need about AC and DC servo Control Systems.**



Electronic Training Videos: Basic Electronics, Digital Electronics, TV Repair, LASER and Fiber Optic training videos available at very affordable prices starting at **Only \$35.00 each.**

For information or to place an order call:

1-800-678-6113

www.ucando-corp.com

UCANDO VCR Educational Products Corp., Greenville, OH

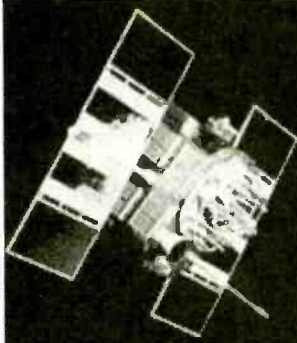

The only GPS electronics trainer on the market!

Graymark[®]'s GPS-101[™]

Now you can use the technology of the global positioning system, to deliver a motivating and comprehensive electronics program to your students. Our kit uses GPS technology to teach your students analog and digital circuits, using low level components. The kit includes all necessary hardware, CD's and instructions and provides from 20 to 40 hours of classroom course work.

Graymark[®] International, Inc.

(800) 854-7393

[Http://www.graymarkint.com](http://www.graymarkint.com)

"1st in Electronics, 1st in Quality & Service."



CIRCLE 212 ON FREE INFORMATION CARD

New and Pre-Owned Test Equipment

New Equipment Specials

B+K Precision 2120B – 30MHz Oscilloscope

- * FREE Model 117B Multimeter
- * 2 Channel, Dual-Trace
- * 30 MHz Bandwidth
- * TV Triggering
- * (2) Probes Included

Sale Price \$339.00

AVCOM PSA-37D – Spectrum Analyzer

Satellite Downlink – Installation – Maintenance & Service

- Band 1: 10 – 1750 MHz
- Band 2: 3.7 – 4.2 GHz
- Carrying Case Included
- Linc or Battery Powered
- Built-in DC Block & Power for LNA/LNB's

Sale Price \$2,395.00

Instek GOS-6103 – 100 MHz Analog Oscilloscope

- 100 MHz Bandwidth
- 2 Channel, High Sensitivity
- TV Trigger - Signal Output
- Cursor Readout
- Time Base Auto-range
- (2) Probes Included
- 2 Year Warranty

Sale Price \$899.00

Leader LF 941 – CATV Signal Level Meter

- TV/CATV Coverage from 46 - 870 MHz
- Video/Audio Carrier Measurements

Sale Price \$489.00

NEW! Fluke 187 – Digital Multimeter

- Basic DC Accuracy of 0.025% at 50,000 Count
- True-RMS AC, AC+DC, dBm, & dBV

Sale Price \$319.00

Pre-Owned Oscilloscope Specials

Tektronix	465	100 MHz	\$499.00
Tektronix	465B	100 MHz	\$649.00
Tektronix	475	200 MHz	\$749.00
Tektronix	475A	250 MHz	\$949.00

- Professionally Refurbished
- Aligned & Calibrated to Original Specifications
- The Industry Standard of Oscilloscopes
- 1 Year Warranty - The Longest Available!!!
- See Website for Complete Specifications

See us on the Web!
www.testequipmentdepot.com

We Buy Surplus Test Equipment

Test Equipment Depot

A FOTRONIC CORPORATION COMPANY
 99 Washington St. Melrose, MA 02176
 (781) 665-1400 • FAX (781) 665-0780

e-mail: sales@testequipmentdepot.com



TOLL FREE 1-800-99-METER

(1-800-996-3837)

CIRCLE 322 ON FREE INFORMATION CARD

Miniature Transmitters and Receivers

2 Button / 3 Channel Transmitter



RF300T

1....\$22.95
5....\$19.95 ea
10...\$16.95 ea

RF300XT

1....\$25.95
5....\$22.95 ea
10...\$19.95 ea

- 300' (XT), 150' (T) Range
- Frequency: 318 MHz
- 59,049 Settable Security Codes
- 12 Volt Battery and Keychain Included
- Current Draw: 4.8 ma
- Fully Assembled in Case
- Dimensions: 1.25" x 2.0" x .5"
- Push both buttons for the 3rd Channel
- Slide Button Cover Included

4 Button / 15 Channel Transmitter

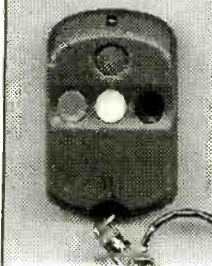

RF304XT

1....\$27.95
5....\$24.95 ea
10...\$21.95 ea

- 250' Range
- Frequency: 318 MHz
- 6,561 Settable Security Codes
- 12 Volt Battery and Keychain Included
- Current Draw: 4.6 ma
- Fully Assembled in Case
- Dimensions: 1.35" x 2.25" x .5"
- Push combination of buttons to achieve up to 15 channels

2-4 Data / 3-15 Channel Receivers



**RF300RL
RF300RM**

1....\$27.95
5....\$24.95 ea
10...\$22.95 ea

**RF304RL
RF304RM**

1....\$29.95
5....\$26.95 ea
10...\$23.95 ea

- Compatible with 300/4 Transmitters
- 11-24 volts DC Operating Voltage
- 13 ma. Current Draw
- Latching (L) or Momentary (M) Output
- Kits Available (subtract \$5.00 ea.)
- Dimensions: 1.25" x 3.75" x .5"
- 2 (300) / 4 (304) Output Data Lines
- Binary to Dec / Hex Converter can achieve up to 15 channels

- Alarm Systems
- Garage / Gate Openers
- Lighting Control

- Magic Props
- Medical Alert
- Monitoring Systems

- Industrial Controls
- Surveillance Control
- Motor Control

- Schematics Available
- Receiver Board Layout Available
- Custom Design Consulting Available

Visitect Inc.

(510) 651-1425 Fax: (510) 651-8454
P.O. Box 14156, Fremont, CA 94539

Email: Support@Visitect.Com
Visa / Mastercard, COD

CIRCLE 224 ON FREE INFORMATION CARD

FACTCARDS

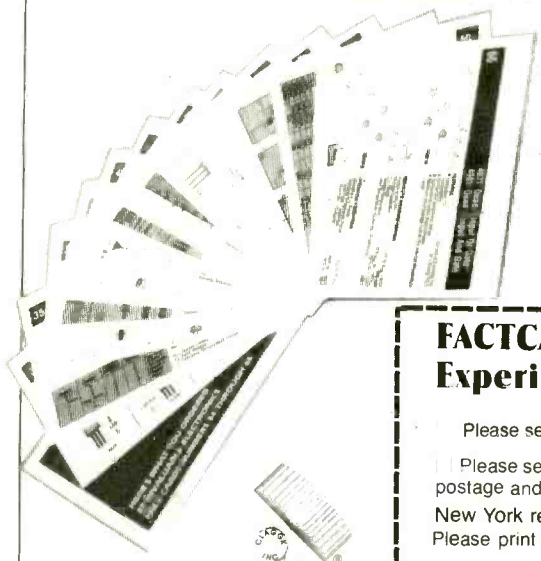

■ ALL YOU NEED to know about electronics from transistor packaging to substitution and replacement guides. FACTCARDS numbers 34 through 66 are now available. These beautifully-printed cards measure a full three-by-five inches and are printed in two colors. They cover a wide range of subjects from Triac circuit replacement guides to flip-flops, Schmitt triggers, Thyristor circuits, Opto-Isolator/Coupler selection and replacement. All are clearly explained with typical circuit applications.

■ WANT TO EXPAND your knowledge of electronics? Do it the easy way

by studying the Electronics Fact Cards. Do you travel to and from your job each day? Drop a handful of cards in your pocket before you leave, and the bus becomes a schoolroom! At home, you can build some of the projects and not only have fun building and using them, but learn how they work at the same time.

■ YOU'LL BE AMAZED both at how rapidly you learn with these cards, and how easy it is to understand. These new cards are available right now. Don't miss out. Send your check or money order today.

FACTCARDS—Facts at your fingertips for Experimenters and Project Builders!

Please send one copy of FACTCARDS \$1.99. Shipping \$2.00 (U.S. and Canada only).

Please send _____ copies of FACTCARDS. Total cost is sum of copy price and First Class postage and handling cost multiplied by number of card sets ordered.

New York residents add sales tax to total cost of each order.

Please print

Allow 6-8 weeks for the material to arrive.

(Name) _____

(Street Address) _____

(City) _____

(State) _____

(Zip) _____

Detach and mail today:
CLAGGK Inc.
P.O. Box 12162
Hauppauge, NY 11788

All Payment must be in U.S. Funds!

BS168

Jampacked with information at your fingertips

**World's Smallest
68HC11
Microcontroller
Modules!**

MicroStamp11™



- telemetry
- microrobotics
- smart toys
- animatronics
- model railroadir g
- home automatiem

- tiny, light-weight (0.5 oz.)
- 1-inch x 1.4-inch 68HC11 module
- on-board 5V regulator
- 8MHz crystal (9.83MHz on Turbo version)
- choice of 8K or 32K EEPROM
- 32K RAM + 32K EEPROM on 64K version
- plugs into your breadboard like a DIP
- SCI (UART), SPI, Output Compares, Input Captures, hardware timer, pulse accumulator
- all 14 I/O lines and 2 interrupts brought out to versatile 20-pin connector
- program in BASIC, assembler, or C
- easy code-loading with Docking Module
- Starter Packages:*
 - 8K EEPROM (#MS11SP8K).....\$49
 - 32K EEPROM (#MS11SP32K).....\$77
 - 32K EE+32K RAM (#MS11SP64K)...\$90

* Includes MicroStamp11, manual, PC software (free-ware assembler, SBASIC compiler, MicroLoad utility, and sample programs), serial cable, Docking Module, and accessories.

Attention OEMs:
Embed MicroStamp11 modules into your product!
only \$20 each (100-pc. price, 8K version)

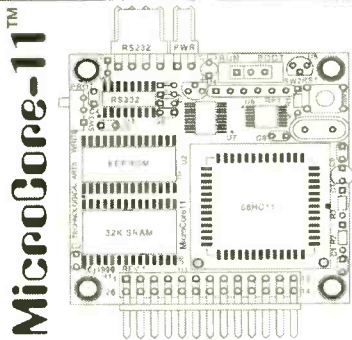

- tiny 2-inch x 2-inch 68HC11 module
 - 12 inputs/outputs plus 8 analog inputs
 - RS232, 5V regulator, 8MHz crystal
 - 32K SRAM plus 8K or 32K EEPROM
 - plugs into your breadboard like a DIP
 - easy programming from any PC
 - ideal for building MicroMouse robots
 - now available in Turbo version (9.83MHz)
 - 8K Starter Package #MC11SP8K.....\$68
 - 32K Starter Package #MC11SP32K.....\$93
- Motor driver boards, LCD/keypad/keyboard interface & prototyping cards available

**Technological
Arts**

Many other modules & accessories available.
Visit our website at:
www.technologicalarts.com
sales@technologicalarts.com
TOLL-FREE: 1-877-963-8996
Phone: (416) 963-8996
Fax: (416) 963-9179
Visa • MasterCard • Discover • Amex

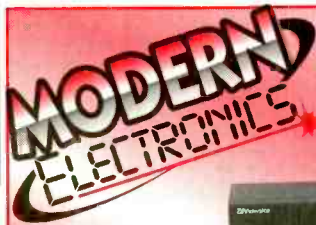

**CABLE TV
DESCRAMBLERS**



- ★ **FREE CATALOG!**
- ★ **BEST DEALER PRICING!**
- ★ **DISCOUNTED PRICING!**
- ★ **30 DAY FREE TRIAL!**
- ★ **100% MONEY BACK GUARANTEE**

**COPY RENTAL TAPES WITH
OUR VIDEO STABILIZER**

1-800-906-6664

2609 S. 156th Circle • Omaha, NE 68130
www.modernelectronics.com



**visit us on the Web
www.poptronics.com**

Do You Repair Electronics?

- | | |
|---|---|
| Repair Databases for
TV, VCR, Monitor, UL
Audio, FCC, and more. | - Over 76,000 records
- Private user forums
- Live on-line chat rooms |
|---|---|

RepairWorld.com

Electronic Corp 1 Herald Sq. Fairborn, OH 45324 (937) 878-9878

**From Not-Working
to Networking!
Troubleshooting
Local-Area Networks!**

**Now, complete for the first
time in one detailed booklet!**

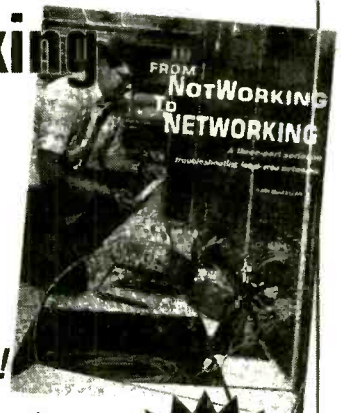

Gain a fuller knowledge of network fundamentals and how they developed from the early days of main frames, from XNS to Ethernet technology, the OSI stack for interconnecting different computers, basic and specialized test instruments, etc. Several tough LAN case histories brings you from theory to the practical side of troubleshooting.

**ONLY
\$4.99**

CLAGGK Inc., Reprint Bookstore
P.O. Box 12162, Hauppauge NY 11788

Please rush my copy of "From Not-Working to Networking." I enclosed payment of \$4.99 which includes shipping charges. U.S.-First Class, Canada and Overseas-Surface Mail.

Name _____
Address _____
City _____ State _____ Zip _____

All Payments must be in U.S. funds. Send check or money order payable to CLAGGK Inc.—do not send cash or stamps. New York State residents add applicable sales tax. Allow 6 to 8 weeks for delivery **RBS02**

Home Automation



World's Largest Source for Home Automation!

- Voice Control
 - Gadgets & Motorized Devices
 - Home Theater
 - Phones & Intercoms
 - X10 & Lighting Control
 - Home Security & Surveillance
 - Home Networking & Structured Wiring
- and Much More...

800-SMART-HOME

www.smarthome.com

Free 144 pg. Color Catalog!

Dealers/Resellers ask about our SmartHome PRO Dealer Program 800-949-6255



One tree can make 3,000,000 matches.



One match can burn 3,000,000 trees.

CLASSIFIEDS

BUSINESS OPPORTUNITIES

\$400 WEEKLY ASSEMBLING Electronic Circuit Boards/Products From Home. For Free Information Send SASE: Home Assembly-PT Box 216 New Britain, CT 06050-0216.

CABLE TV

CABLE TV Descramblers. One-piece units. Scientific Atlanta, Jerrold, Pioneer, and others. Lowest Prices Around. **Precision Electronics** Houston, TX Anytime. 1-888-691-4610

MISC. ELECTRONICS FOR SALE

T&M ELECTRONICS. Large variety of electronic parts since 1966. Visit our Web site at www.tandmelectronics.com

SATELLITE EQUIPMENT

FREE Satellite TV Buyer's Guide. Best Products - Lowest Prices - Fastest Service! Dish Network, DirectTV, C/Ku-band, including 4DTV. Parts- Upgrades - Accessories! **SKYVISION** - 800-543-3025. International 218-739-5231. www.skyvision.com

TEST EQUIPMENT

POCKET TESTBENCH, 8 instruments in 1 tiny package. PIC singleboard computers, botboards, protoboard. www.oricomtech.com

Data Acquisition and Control

The ADR series of interfaces allow control of analog, digital and relay I/O via RS232 or RS485. Visit the web site for specs, applications and programs in VB, C, BASIC etc. (705) 671-2652

www.ontrak.net

Ontrak Control Systems Inc.

SINGERS! REMOVE VOCALS

Unlimited, Low Cost, Instantly Available Background Music from Original Standard Recordings! Does Everything Karaoke does... *Better* and gives you the Thompson Vocal Eliminator. Free Brochure/Demo Tape. LT Sound Dept PE 7989 LT Parkway Lithonia, GA 30058 Internet: www.LTSound.com 24 Hour Demo/Info Request Line (770)482-2485 - Ext 49 *When You Want Something Better Than Karaoke!*



MECI 340 East First Street
Dayton, Ohio 45402
Your Electronics Value Company

Tons of Electronics

Get your FREE catalog today and discover some of the best deals in electronics. We have thousands of items ranging from unique hard-to-find parts to standard production components. Call, write or fax today to start your subscription to one of the most unique catalogs in the industry, filled with super values on surplus electronic and hobbyist type items.



FREE CATALOG!

Checkout our 10,000 item on-line catalog <http://www.meci.com>

Order Toll Free Why pay more? Call today!
1-800-344-4465 Fax Order Line 1-800-344-6324

ON SCREEN DISPLAY CHARACTER OVERLAY BOARD



OSD-232 on board a radio controlled airplane!

Intuitive Circuits, LLC
2275 Brinston • Troy, MI 48083
(248) 524-1918
<http://www.icircuits.com>

Ever wish your LCD module could display more lines of text? OSD-232 is the solution! From any RS-232 serial source like a PC, PIC, or Basic Stamp, display 28 columns by 11 rows of information (308 characters total) directly onto any NTSC or optional PAL baseband (video in) television or VCR. OSD-232 can overlay monochrome text onto an incoming video source or display colored text on a self-generated colored background screen.

OSD-232 \$99.00
Visa/Mastercard/Prepaid check

ELECTRONIC MILITARY SURPLUS



FAIR RADIO SALES

WEBSITE: faiirradio.com
E-MAIL: faiirradio@faiirradio.com
PHONE: 419-227-6573
FAX: 419-227-1313
1016 E. Eureka - Box 1105
Lima, OH 45802
VISA, MASTERCARD, DISCOVER
Address Dept. ES

2KW SOLA REGULATOR



Sola CVS 2000 Watt Constant Voltage Transformer provides a very well regulated sinusoidal waveform that is isolated from variations and disturbances in the input voltage. Also provides isolation and step-up/step-down to allow for various input/output voltages. Input 95-130/175-235/190-260/380-520 60Hz. Output 120/240VAC 60Hz 2000VA. 17.8x11.4x9.6, 115 lbs sh. Unused, \$250.00 ea, 2 / \$450.00

Allow money for shipping.

SEND FOR OUR 2001 CATALOG !!

Radios - Test Equipment - Tubes - Antennas

BREAST CANCER BEGINS EVEN SMALLER THAN THIS THAT'S WHY YOU NEED A YEARLY MAMMOGRAM, ESPECIALLY AS YOU GET OLDER. MAMMOGRAMS CAN DETECT LUMPS TOO SMALL FOR YOU TO FEEL AND EARLY DETECTION MAY SAVE YOUR LIFE, SO CALL 1-800-ACS 2345.

GET A MAMMOGRAM. EARLY DETECTION IS THE BEST PROTECTION.



NEW! CREDIT CARD COMPUTER II

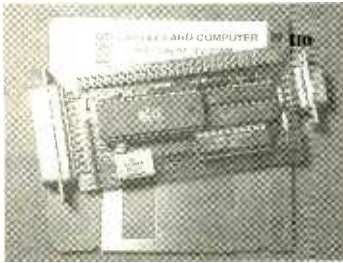

MVS PLUG-N-GO™ no cables/power supply to buy!
 Low-power RISC cpu 10x faster than PIC. Z80. 8051
 2m FLASH,ser,par,RTCC,4ch 12bit ADC,ISA104 bus
 Built-in BASIC/Assembly, other compilers available
 Friendly instructions, RS232 download (DOS/WIN)
 Eval kit (1) \$75, oem (1k) \$21, CC computer I \$14.20

640x480 VGA LCD \$27

Controller for most single/dual scan LCDs
 Works with lo-res (160x120, 320x240, etc.)
 Use with PC or SBC, standard VGA BIOS
 Source code demo shows VGA initialization
 Adaptable for other CPUs (i.e. Z80, HC11)
 oem(1k) \$27 evalkit(1) \$95 w/10" LCD \$195



PC WATCHDOG CARD

No More Hangups!

Reboots PC on hardware/software hang
 3 versions: RESET, TIMER, PHONE
 reset version oem \$21.30, eval kit \$75



PC WATCHDOG CARD

No More Hangups!

Reboots PC on hardware/software hang
 3 versions: RESET, TIMER, PHONE
 reset version oem \$21.30, eval kit \$75



PC SOLID STATE DISK



Replace mechanical drives with faster,
 more reliable, more secure solid-state.
 Use FLASH, NVRAM, UV EPROM.
 Both DIP and PCMCIA versions from
 32Kbyte (PCMD) to 1Gigabyte (PCD2)
 starting at \$14.20oem(1k) \$50.00eval(1)

STAMP DRIVE !! SINGLE CHIP COMPUTER



Read/Write PC compatible hard
 disk, PCMCIA, Compact Flash,
 RS232 to ATA adapter for Stamp,
 Z80,8051,AVR,PIC,x86. ANY cpu
 - 4 gigabyte capacity
 - low power (5ma @5v)
 - baud 115.2k and above
 eval \$95,oem \$27,IDE ver. \$14.20

ZERO external components
 Built-in BASIC / Assembly
 RS232 program download
 1k flash,64ee,3irq,2timers
 15 i/o bits,ADC,20 pin DIP
 20mips faster than PIC/z80
 oem(1k) eval kit(1)

\$1.99 \$7.00



NEW! 8K SUPER CHIP

40x the BASIC pgm space
 32 i/o, 12 irq, 3 timers, bus
 8K flash, 512ee, 512nvram
 Watchdog w/ internal osc.
 40 pin DIP part #MV 8515
 eval(1) \$25, oem(1k) \$7.10

SERIAL MINI-TERMINAL

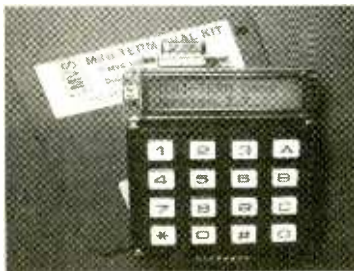

RS232 terminal for Stamp, PC, Z80, AVR etc.

- super low current, powers from serial line
 - LED backlit LCD, visible in all conditions
 - 115.2kbps, DB9 conn, simple commands
 - specify 20 customizable or 16 tactile keys
- eval(1) \$75,oem(1k) \$21.30,w/BASIC cpu \$27

WWW.MVSNET.COM or STAR.NET/PEOPLE/~MVS

MVS Box 850
 Merr.,NH 03054
 (508) 792 9507



5yr Limited Warranty
 Free Shipping
 Mon-Fri 10-6 EST

**SERVING THE EMBEDDED
 COMMUNITY SINCE 1979!**

CIRCLE 296 ON FREE INFORMATION CARD

www.americanradiohistory.com

ADVERTISING INDEX

Poptronics does not assume any responsibility for errors that may appear in the index below.

Free Information Number	Page	Free Information Number	Page
- A & A Engineering	77	- Intuitive Circuits, LLC	86
- Abacom	74	- IVEX Design	67
- All Electronics	66	139 Jameco	CV2
- Allison Technology Corp.	68	- LDP LLC	77
- Amazon Electronics	81	- LT Sound	86
- Andromeda Research	76	- Lynxmotion	66
- Antique Electric Supply	77	- M ² L Electronics	66
- Arrow Technologies	77	324 MCM Electronic	CV3
- B.B. Electronics	77	- Marrick Ltd.	5
- Black Feather Electronics	81	323 Mendelsons	86
290 C&S Sales, Inc.	72	296 Merrimack Valley Systems	87
283 CadSoft, Inc.	13	- microEngineering Labs	80
- Carl Taylor Inc.	80	- Modern Electronics	85
233 Circuit Specialists	79	- Mondo-tronics	77
- CLAGGK, Inc.	18, 30	- Ohio Automation	80
320 Cleveland Inst. of Electronics	75	- Ontrak Control Systems	86
321 Command Productions	68	- Pioneer Hill Software	82
- Conitec Data Systems	66	228 Polaris Industries	65
- Consumertronics	80	219 Prairie Digital	70
- C-Tech Industries	77	- RC Distributing Co.	81
- EDE Spy Outlet	80	263 Ramsey Electronics	71
- Elect. Tech. Today	6, 10	- Saelig Co., LLC	74
130 Electronic Workbench	CV4	- Scott Edwards Electronics	74
- Electronix	85	- Smarhome.com	86
- EMAC Inc.	82	- Square 1 Electronics	68
- Engineering Express	74	- Techniks	80
- Fair Radio Sales	86	- Technological Arts	85
- Fort777.com	78	322 Test Equipment Depot	83
- Global Specialties	70	217 Tie Pie Engineering	76
- Globaltech Distributors	81	- UCANDO Videos	82
282 Grantham College of Eng.	5	- Vision Electronics	66
212 Graymark International	83	224 Visitect, Inc.	84
220 Information Unlimited	70	- Walter Malecki	80
- Intec Automation	80	- William Andrew Publishing	77
- Intelligence Here	81	- World Wyde	69, 80, 81
- Intronics	82	- Xilor, Inc.	77

ADVERTISING SALES OFFICES

Gernsback Publications, Inc.
275-G Marcus Blvd.
Hauppauge, NY 11788
Tel. 631-592-6720
Fax: 631-592-6723

Larry Steckler

Publisher (ext. 201)
 e-mail: advertising@gernsback.com

Adria Coren

Vice-President (ext. 208)

Ken Coren

Vice-President (ext. 267)

Marie Falcon

Advertising Director (ext. 206)

Adria Coren

Credit Manager (ext. 208)

For Advertising ONLY EAST/SOUTHEAST

Marie Falcon

275-G Marcus Blvd.
 Hauppauge, NY 11788
 Tel. 631-592-6720 x206
 Fax: 631-592-6723
 e-mail: mfalcon@gernsback.com

MIDWEST/Texas/Arkansas/ Oklahoma

Ralph Bergen

One Northfield Plaza, Suite 300
 Northfield, IL 60093-1214
 Tel. 847-559-0555
 Fax: 847-559-0562
 e-mail: bergenrj@aol.com

PACIFIC COAST

Megan Mitchell

9072 Lawton Pine Avenue
 Las Vegas, NV 89129-7044
 Tel. 702-240-0184
 Fax: 702-838-6924
 e-mail: mmitchell@gernsback.com

Subscription/ Customer Service/ Order Entry

Tel. 800-827-0383
 7:30 AM - 8:30 PM CST

www.poptronics.com

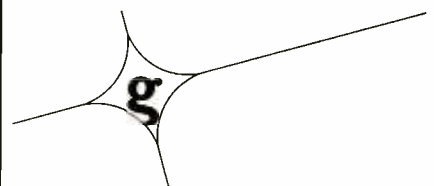

Put Tenma to the Test



What You Want....
Today!™

25th
year

mcm electronics

You Must Provide this Source Code to Receive Discount Pricing

POP89

call toll free
1-800-543-4330

fax toll free
1-800-765-6960

customer service call toll free
1-877-626-3532

Visit and order from our secured website
www.mcmelectronics.com

TENMA®

- Accurate
 - Affordable
 - Reliable
 - Customer Satisfaction
- All test equipment backed by warranties
•NIST Certificate of Calibration
 Call for pricing and availability

2MHz Digi-Scope™

The Digi-Scope™ combines a powerful 2MHz Digital Storage Oscilloscope, True RMS Autoranging DMM and 10MHz Frequency Counter.

- Features:**
- Large (2.5" X 2.5") backlit graphic LCD display
 - 200 X 200 pixel
 - RS-232 interface
 - Oscilloscope: •Single channel •Auto/normal trigger mode •10MS/sec sample rate •Auto set up
 - Save/load
 - Digital Multimeter: •3½ digit, 3999 count display •Measures AC/DC voltage and current, resistance and capacitance •Auto/manual ranging
 - MIN/MAX/REL •dBm •Diode and logic test •Continuity beeper
 - Frequency Counter: •10MHz range •5 digit resolution •Auto/manual ranging
- Includes:** Holster, carrying case, test leads, rechargeable battery, AC power adaptor and owners manual



Order #	Description	(ea.)
72-6640	2MHz Digi-Scope™	\$329.00
72-6641	RS-232 Software and Cable	20.45

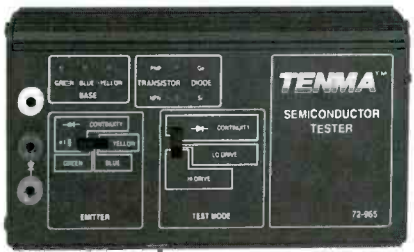

Semiconductor Tester

This low cost portable semiconductor tester provides in or out of circuit testing on transistors, FETs, SCRs and diodes. **Features:**

- Auto base or gate identifier
- Tests: Transistors, FETs, SCRs and diodes
- Identifies: NPN/PNP transistor, N-channel/P-channel FETs, silicon/germanium diodes
- Continuity test: Audio tone

General: •Power requirements: AC adaptor supplied; 9V battery not included (#290-080)

Order # 72-965 Reg. \$94.95

Only \$84.95

DMM with Logic, Frequency, Capacitance and Transistor Test

- Features:**
- Large 3½ digit, 1999 count LCD display
 - Logic test with beep indicator
 - Capacitance
 - Frequency
 - Transistor test
 - Fused current inputs
 - Overload protection on all ranges
 - Current input warning
 - Safety test leads and input jacks
 - Diode test
 - Continuity beeper
 - Meets IEC-1010 safety standards for 600V CAT III applications
 - Includes 9V battery, holster, test leads and owners manual



Only \$49.95

Order # 72-4025 Reg. \$65.95

Clamp-On DMM

- Features:**
- Auto and manual ranging
 - Large 3½ digit, 3200 count LCD display with bargraph
 - AC and DC voltage
 - AC current
 - Resistance
 - Frequency
 - Diode test
 - Audible continuity test
 - Peak hold
 - Data hold
 - Auto power off
 - 57mm (2.24") jaw opening
 - Overload protection on all ranges
 - Meets IEC-1010 safety standards for 600V CAT III and 1000V CAT II applications
 - Includes 9V battery, test leads, carrying case and owners manual



Only \$89.95

Order # 72-6880 Reg. \$99.95



20MHz Oscilloscope

- Features:**
- Dual channel
 - Dual trace
 - 6" rectangular CRT with internal graticule
 - 2KV acceleration voltage
 - High sensitivity 1mV/div
 - Display modes: CH-1, CH-2, DUAL, ALT, CHOP, ADD, CH-2 INV
 - Includes two 10:1 probes and owners manual

Order # 72-6800 Reg. \$395.00

Only \$379.00

Source Code: POP89

Prices effective August 9 through October 31, 2001.

CIRCLE 324 ON FREE INFORMATION CARD

A Premier Farnell Company

The world's most popular electronics simulation software just got better!

WHY settle for second best?

***FREE**

Virtual Lab with Poptronics Circuits

Check out the circuits from recent issues, including this month's! Tweak the circuits and see the instruments respond instantly.

Download the Multisim demo with pre-built Poptronics circuits from www.electronicworkbench.com/poptronics



BEST PRODUCT! BEST PRICE!

Electronics Workbench is recognized around the globe for developing highly advanced, yet easy-to-use electronics software. Over 150,000 users tell us that they have completed projects using Electronics Workbench in less time than it takes to even install other programs.

And now we've just released Version 6.2! If you've never tried electronics simulation, this is your chance - you can now have your very own virtual lab! Work on your own or create circuits together with others across the country - live on the internet. Start with the **FREE** Electronics Workbench/Poptronics demo and then take advantage of this best price ever when you buy. Tried other products? You owe it to yourself to experience what only the market leader can offer - there is no comparison. And if you own earlier versions of Electronics Workbench, call us now for upgrade pricing starting at just **\$149!**

multISIM V6.2

Schematic Capture & Simulation

~~\$399~~ **\$299**

ultiBOARD

Powerful PCB Layout

~~\$399~~ **\$299**

or get **BOTH** products for **\$498**

Limited Time Offer
BEST price ever!

Multisim Highlights

- ▶ Advanced schematic capture
- ▶ Intuitive auto & manual wiring (no toggle)
- ▶ Change circuits while simulating
- ▶ Mixed-mode SPICE analog/digital simulation
- ▶ Built-in symbol and component editor
- ▶ Parts organized into bins (no alpha lists)

Don't settle for a program that has less than:

- ▶ 6,000 parts in component database
- ▶ 9 virtual instruments & 8 powerful analyses
- ▶ Interactive design on the Internet
- ▶ OLE integration with Excel/MathCAD

Ultiboard Highlights

- ▶ Powerful & easy-to-use PCB layout & editing
- ▶ Reroute while move (full rubberbanding)
- ▶ Built-in autorouter
- ▶ Real-time design rule check
- ▶ Automatic net highlighting (selective)
- ▶ Density histograms/placement vectors

Don't settle for a program that has less than:

- ▶ 3,000+ library of footprint shapes
- ▶ Capability for boards of any shape, up to 50"x50"
- ▶ 32 layers support
- ▶ 1 nanometer internal resolution

To order, or to find out why our products are the most popular in the industry, call **1-800-263-5552** or visit www.electronicworkbench.com (FREE demo available)



Electronics
WORKBENCH

CIRCLE 130 ON FREE INFORMATION CARD