

www.poptronics.com

JULY 2001

Poptronics®

Formerly Popular Electronics® and **Electronics NOW**

BASIC
Downloadable Circuits
see page 57
CIRCUITRY

THE MPX 2000

Command the FM-band



In-Circuit Capacitor Tester

On-board capacitor testing is now possible

\$4.99 U.S.
\$6.50 CAN.

Also Inside:

- Heart-Sensing Flashlights
- Sizzling Sound Cards
- Pen-Sized Scanners
- Monitoring Circuits
- Troubleshooting Tips

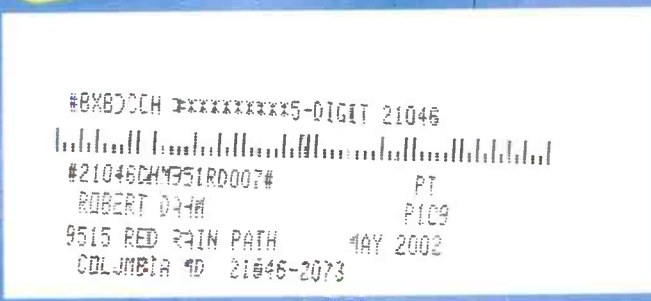

A GERNSBACH PUBLICATION

2-Channel Oscilloscope

 approved. Provides isolated channels for safe operation

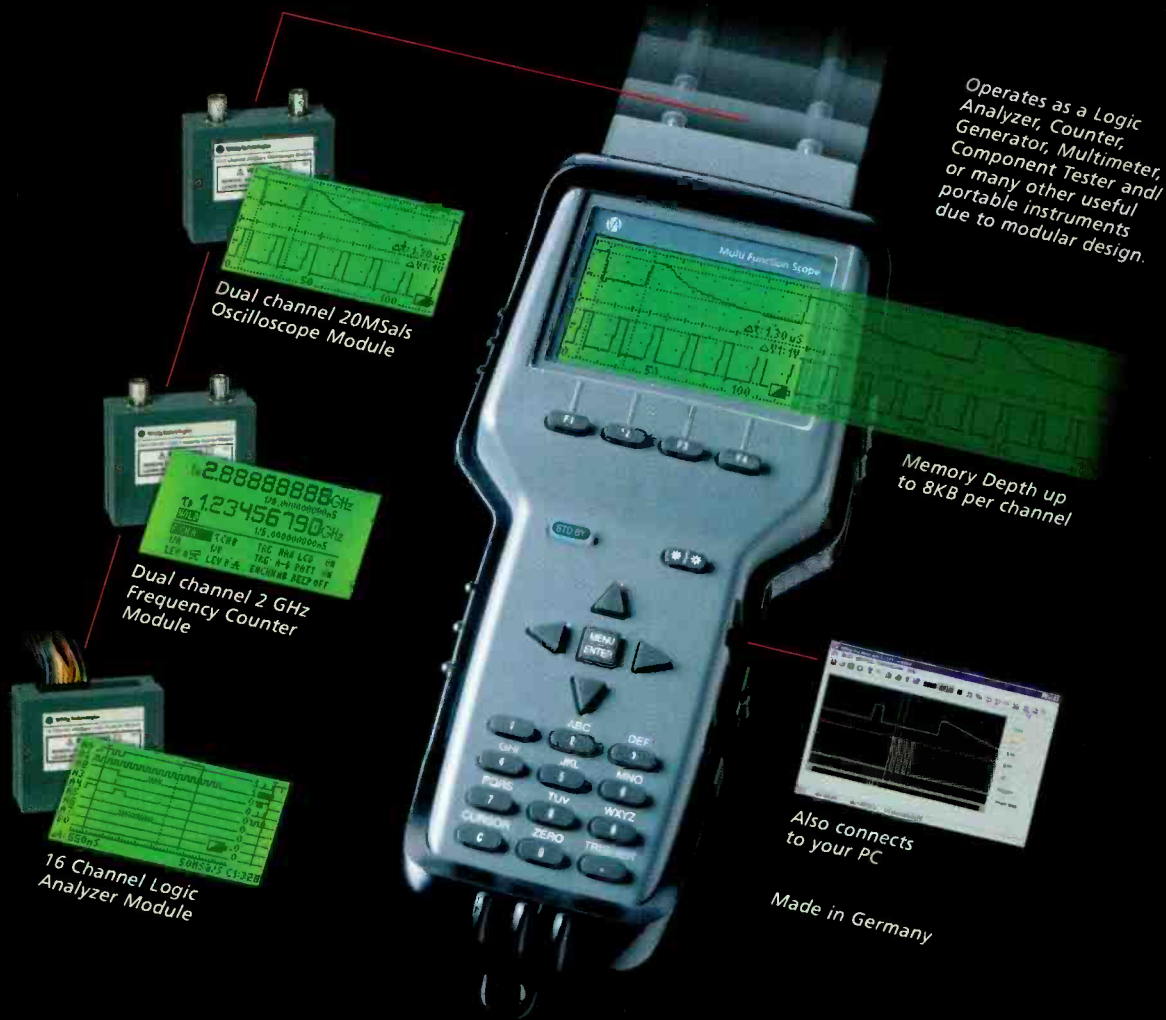

Operates as a Logic Analyzer, Counter, Generator, Counter, Component Tester and/or many other useful portable instruments due to modular design.

Dual channel 20MSa/s Oscilloscope Module

Dual channel 2 GHz Frequency Counter Module

16 Channel Logic Analyzer Module

Memory Depth up to 8KB per channel

Also connects to your PC

Made in Germany

Master Unit 22-320 with backlit display includes 20MSa/s Dual Channel Oscilloscope Module 22-321, 2 Signal 1:1/10:1 Probes, MS-Windows95/98/NT compatible, PC Serial Interface Cable, AC Adapter, Protective Rubber Boot, Manual and suitable hard-shell carrying case for US\$ 398.00, stock available.

Also downloadable free software at www.wittigtechnologies.com

Dual channel 2 GHz Frequency Counter Module 22-323 (option) features isolated channels, external and internal triggering, 9 Digits, Temperature-Compensated Time Base 10^{-9} , statistic analysis, includes Manual, MS-Windows95/98/NT compatible, US\$ 299.00, available mid 2001

Logic Analyzer Module 22-322 (option) features 16 channel, 40MSa/s, various external and internal triggering, 32Kb/channel, 16 bit event counter, includes dis-assembler for 8051 and Z80 (more in preparation), signal cables, Manual and MS-Windows95/98/NT compatible, US\$ 349.00, available mid 2001

Free shipment anywhere in the U.S. and Canada, within 5 days.



Developed by Wittig Technologies AG

Sales (516) 794 4080 or Toll-Free (800) 247 1241

Fax (516) 794 1855

sales@wittigtechnologies.com

Technical Support available by e-mail or fax, only.

support@wittigtechnologies.com

All trademarks belong to their respective owners.

 **Wittig Technologies**
www.wittigtechnologies.com

CIRCLE 140 ON FREE INFORMATION CARD

Poptronics®

THE MAGAZINE FOR THE HANDS-ON ELECTRONICS ACTIVIST!

FEATURES

THE MPX 2000.....Rudy F. Graf, KA2CWL, and William Sheets 29
The masters of construction and prose are back with another great project—an IC driven FM-transmitter.

IN-CIRCUIT CAPACITOR TESTER.....Marvin Smith 25
You too can test caps right on the board, if you build this handy device.

PRODUCT REVIEWS

Hands On Report..... 9
The Samsung ML-4500 takes its turn upon the chopping block, and, while managing to upset a Tux-man, it survives.

GIZMO®..... 15
Enhance your life with electronics ranging from CD players designed for boaters to pen scanners reminiscent of spy novels.

DEPARTMENTS

PROTOTYPE 10
Flashlights that can sense people through walls are soon to be in the hands of law-enforcement agents.

SURVEYING THE DIGITAL DOMAIN.....Reid Goldsborough 19
Cash gives way to credit, as more and more people are jumping on the virtual bandwagon with Internet trade.

PEAK COMPUTINGTed Needleman 21
Get ready for the future of PC sound—mind-blowing soundcards that deliver above and beyond the norms.

Q&A.....Dean Huster 45
Learn the difference between potentiometers and rheostats and decipher the transistor.

AMAZING SCIENCEJohn Iovine 50
All you wanted to know to start programming PICs in your home, but never thought of asking.

SERVICE CLINICSam Goldwasser 53
The fine art of troubleshooting intermittent faults is revealed by our resident servicing sensei.

BASIC CIRCUITRY.....Charles Rakes 57
Monitoring circuits of various kinds are explained, and their practical uses are explored.

AND MORE

EDITORIAL 2

LETTERS 3

YESTERDAY'S NEWS..... 4

NEW GEAR..... 5

NEW LITERATURE..... 7

POPTRONICS SHOPPER 61

ADVERTISING INDEX..... 88

FREE INFORMATION CARD 88A

Poptronics (ISSN 1526-3681) Published monthly by Gernsback Publications, Inc. 275-G Marcus Blvd., Hauppauge, NY 11788. Second-Class postage paid at Hauppauge, NY and at additional mailing offices. One-year, twelve issues, subscription rate U.S. and possessions \$24.99; Canada \$33.15 (includes G.S.T. Canadian Goods and Services Tax Registration No. R125166280); all other countries \$33.99. Subscription orders payable in U.S. funds only, International Postal Money Order or check drawn on a U.S. bank. U.S. single copy price \$4.99. Copyright 2001 by Gernsback Publications, Inc. All rights reserved. Hands-on Electronics and Gizmo trademarks are registered in U.S. and Canada by Gernsback Publications, Inc. Poptronics trademark is registered in U.S. and Canada by Poptronix, Inc. and is licensed to Gernsback Publications, Inc. Printed in U.S.A. Postmaster: Please send address changes to Poptronics, Subscription Dept., P.O. Box 459, Mount Morris, IL 61054-7629.

A stamped self-addressed envelope must accompany all submitted manuscripts and/or artwork or photographs if their return is desired should they be rejected. We disclaim any responsibility for the loss or damage of manuscripts and/or artwork or photographs while in our possession or otherwise.

As a service to readers, Poptronics publishes available plans or information relating to newsworthy products, techniques, and scientific and technological developments. Because of possible variances in the quality and condition of materials and workmanship used by readers, Poptronics disclaims any responsibility for the safe and proper functioning of reader-built projects based upon or from plans or information published in this magazine.

Larry Steckler, EHF, CET,
editor-in-chief and publisher

EDITORIAL DEPARTMENT

Chris La Morte, managing editor
Evelyn Rose, assistant editor

CONTRIBUTING EDITORS

Dean Huster
Reid Goldsborough
Sam Goldwasser
John Iovine
Ted Needleman
Charles D. Rakes
Teri Scaduto

PRODUCTION DEPARTMENT

Ken Coren, production director
Kathy Campbell, production manager
Michele L. Musé, prepress specialist

ART DEPARTMENT

Russell C. Truelson, art director
Michele L. Musé, graphic artist

CIRCULATION DEPARTMENT

Gina Giuliano, circulation manager

REPRINT DEPARTMENT

Maria Menichetti, Reprint Bookstore x235

BUSINESS AND EDITORIAL OFFICES

Gernsback Publications, Inc.
275-G Marcus Blvd.
Hauppauge, NY 11788
631-592-6720
Fax: 631-592-6723
President: **Larry Steckler**
Vice-President: **Adria Coren**
Vice-President: **Ken Coren**

SUBSCRIPTION CUSTOMER SERVICE/ ORDER ENTRY

800-827-0383
7:30 AM - 8:30 PM EST

Advertising Sales Offices
listed on page 88

Cover by
Michele Lyn Musé

VISIT US ON THE INTERNET AT:
www.gernsback.com

Since some of the equipment and circuitry described in POPTRONICS may relate to or be covered by U.S. patents, POPTRONICS disclaims any liability for the infringement of such patents by the making, using, or selling of such equipment or circuitry, and suggests that anyone interested in such projects consult a patent attorney.

<mailto:popeditor@gernsback.com>

Cybernetics!

Technology can be scary. Recently, there has been much debate over the ethics involved in genetic engineering and cybernetics—electronic implants—and whether their use should be strictly governed. Scientists proclaim that their research will give sight to the blind and cure paralysis, but CyberPunk fans are smiling to themselves. They all know that it is only a matter of time before cybernetics and genetic engineering will hit the consumer marketplace.

So, that same company that was trying to cure the sick can soon raise some research coinage by selling its latest multimedia brain-chip—complete with in-retina DVD play back and digital-to-neural encoding. Well, I polled fifty people and only two said they would even consider placing an entertainment device in their brain. I guarantee that somewhere in the world there are at least fifty people who would strap themselves into a complete cyber unit. I can see the future—**Poptronics** July 2015 features “Build Your Own Cartilage-Mounted Circuits” and “Troubleshooting Neuron-Transmitters.”

Anyway...this month we have two projects that are both practical and educational. Rudy Graf and William Sheets reveal the inner workings of the “MPX 2000.” This construction article is an excellent reference for radio enthusiasts. Marvin Smiths’ “In-Circuit Capacitor Tester” is a novice-level project that gives readers some great basic theory. These two features, combined with the regular supporting cast of contributing editors, all fit together to bring you the best in arm-chair electronics. So, what are you waiting for? Crack this issue open—or scan it into your brain-chip.

Enjoy!



Christopher La Morte
Managing Editor

Address Correction

It has come to our attention that the *Pax World Web* site mentioned in the "Prototype" section in the May issue no longer has the computer recycling tips. However, there is another site, the one for SVTC: www.svtc.org/cleancc/recycle/index.html. This site has information about recycling computers in the Bay Area and other information as well.—Editor

Memories

The January issue of *Poptronics* had two letters that really struck home. I was a **Popular Electronics** reader many years ago and recently received a subscription to *Poptronics*.

The letter from Paul Haines refers to the Nipcow scanning disc. Some of my memories include seeing a Baird TV system picture broadcast from NJ and received by the Radio Amateurs at their club house at Ohio State University in 1929 or 1930. This system used the Nipcow Disc with its problem of maintaining synchronization. The picture—only about 1 1/2 inches high—was of a girl bouncing a ball. The ball bounced rather slowly and changed shape as it bounced due to the low resolution available.

In 1949, I worked at The Asiatic Corporation. I was sent to NY to the CBS Laboratories to obtain information on the TV converter system proposed by CBS. At Asiatic, we made twelve of the electronic converter boxes that were used for demonstration at the court hearings between CBS and RCA. Of course, we all know the result of that court fight.

The other letter was from Andre Weitzenhoffer, which reminded me that I made crystal radio sets and one-tube regenerative receivers. In 1932, I received my Amateur Radio license W8HVK. I am now W8HVK with a bit of scheduled operating. I can't believe how much electronics I've forgotten since then.

ALLAN R. KESKINEN, W8HVK
Conneaut, OH

Keeping Up Tradition

Are people giving up on do-it-yourself electronics? I have been a long time fan of **Popular Electronics** and *Poptronics*—and for good reason. It

KEEP IN TOUCH

We appreciate letters from our readers. Comments, suggestions, questions, bouquets, or brickbats ... we want to hear from you and find out what you like and what you dislike. If there are projects you want to see or articles you want to submit—we want to know about them.

You can write via snail mail to:

Letters
Poptronics
275-G Marcus Blvd.
Hauppauge, NY 11788

Sending letters to our subscription address increases the time it takes to respond to your letters, as the mail is forwarded to our editorial offices.

Our e-mail address can be found at the top of the column.

Of course, e-mail is fast.

All of our columnists can be reached through the e-mail addresses at the head of each column.

And don't forget to visit our Web site: www.gernsback.com.

seems as if electronic-hobbyist magazines are falling by the wayside, but your magazine—although it has evolved—still remains on the newsstand. What happened to all my fellow inventors and hobbyists? Maybe computers have tempted them all to stray from the path. The majority of so-called hobby magazines are slanted towards home computing, and they seldom pique my interest. Your magazine always has something interesting to offer. Keep up the great work and thank you for a wonderful magazine.

MARCUS LEVY
Death Valley, CA

Hey, thanks Marcus. We here at *Gernsback* try our best to please our customers. Yes, you are right about the waning of electronics as a hobby. Chalk it up to mankind's inherent laziness, I suppose; but people are becoming less and less likely to devote their time to constructing an electronic project. More alarming is the decline of younger hobbyists. Let's not give up hope, though. Perhaps,

Grantham
College since 1951

Distance Education

ACCREDITED
ASSOCIATES and BACHELORS DEGREES

COMPUTER SCIENCE
&
COMPUTER ENGINEERING

Self-paced degree programs allow you to earn a college degree on your schedule. Degree paths in Internet Engineering, MIS, Web Design, and Computer Programming. Transfer up to 50% of coursework for A.S. degree and 75% of coursework for Bachelors degree for prior college credit or professional certifications. Receive up to 8 credit hours for directly relevant professional experience. Textbooks, software and instructor support included in tuition. VA/ military benefits & tuition assistance provided by most employers (see FAQ at www.grantham.edu).

34641 Grantham College Road
Slidell, LA 70469
Toll Free 888.423.4242
www.grantham.edu

CIRCLE 282 ON FREE INFORMATION CARD

LynX-10
HOME AUTOMATION KIT

- Software Included
- Use Existing Wiring
- Simple inexpensive

1-800-928-5296 www.marrickitd.com

robotics will be the link to bind today's youth with the wonderful world of electronics. We hope you continue to enjoy our magazines—Editor

Haves & Needs

I am the owner of a very small repair shop, which operates from home. I need to locate sources of damaged VCRs, preferably in Miami. These units are usually repaired and resold. It is my understanding that there are places in the US that sell non-working units very cheaply. Could anyone let me know where such places can be found.

KENNETH CAMPBELL
Trinidad, West Indies



YESTERDAY'S NEWS

A PEEK INTO THE GERNSBACK ARCHIVES

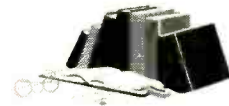

1900

1910

1930

1940

Dateline: July 1951 (50 years ago)

The cover story for **Radio-Electronics** featured an upcoming service known as Telecar. The concept involved a roving Western Union man in a station wagon, equipped with a Teletype and radio link. This mobile-messenger service was supposed to revolutionize information exchange. *(Telecar might not have been a hit, but mobile-messaging can be seen in portable computing and wireless digital-phones.)*

1951

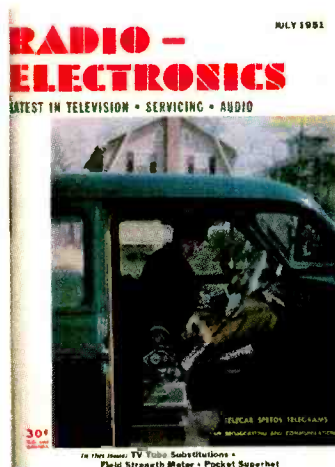

1960

1970

Dateline: July 1981 (20 years ago)

Do you remember your first cordless telephone? July 1981's **Radio-Electronics** introduced readers to the next-generation gadgets. Technology has smoothed the edges of these once bulky units and now millions of people enjoy the luxury of their cordless phones. *(Cordless phones would soon be plagued by intermod problems—interference from opposing radio sources—as users increased. The frequencies used by cordless phones were later bumped-up to near microwave range to avoid traffic clutter.)*

1981



Dateline: June 1991 (10 years ago)

How's this for practicality? "Build Your Own EKG" was the cover story for **Radio-Electronics** July 1991. A challenging construction article, this piece educated the readers on the electrical characteristics of our hearts and how pulses are measured and interpreted by medical professionals and hobbyists alike. *(Wouldn't it be great to have a feature on building your own MRI or laser-scalpel?)*

1991



2000

NEW GEAR

USE THE FREE INFORMATION CARD FOR FAST RESPONSE

Weighing Indicator

With accessible front-panel pushbuttons, the *VPI Weighing Indicators* are ideal for a wide range of weighing and force-measurement applications (VPI-SC, \$395, and VPI-LC, shown here, \$450). Measurements of force, weight, current, or voltage are displayed in five full digits; and no calibration equipment is needed to change ranges. Software is provided for easy setup.



LOAD CELL CENTRAL

Box 91
Monroeton, PA 18832
800-562-3235
www.800loadcel.com

CIRCLE 60 ON FREE INFORMATION CARD

Filter-Design Software

Version 4.0 of *Filter Express* 4.0 and its companion simulator *FilterSim* are Windows-based tools for electronic and communications-systems designers. Highly intuitive to use, the software provides rapid methods for developing and evaluating DSP filters of any kind. Free downloads are available from the Web site below.

SYSTOLIX, INC.

10 Carver Lane
Sunol, CA 94586
925-862-2542
www.systolix-dsp.com

CIRCLE 63 ON FREE INFORMATION CARD



High-Performance Power Inverter



Designed for people on the go, the compact *High Gear by Cobra* 12-V_{DC}-115-V_{AC} power inverters supply power to portable electronic devices, such as laptops and cell phones. Its Pentagon Protection system provides thermal shutdown, reverse polarity protection, and over-voltage and low-voltage shutdown; and there's a low-voltage alarm, as well.

The five models—HG PI150, HG PI300, HG PI500, HG PI1000, and HG PI2000 (numbers indicate wattage)—have prices ranging from \$54.95 to \$549.95. The *HG PI300* shown here has an MSRP of \$79.95.

COBRA ELECTRONICS CORP.

6500 W. Cortland St.
Chicago, IL 60707
773-889-3087
www.cobraelectronics.com

CIRCLE 61 ON FREE INFORMATION CARD

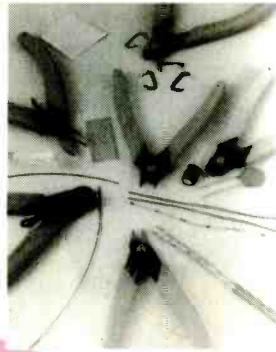

Ergonomic Hand Tools

All the *Xuron Ergonomic Hand Tools* (from \$13 each) feature the Micro-Shear flush cutter, which produces a clean, square cut. Designed for repetitive tasks, these tools have soft rubber grips and light-action springs. The tool line cuts a wide variety of substrates, and different models are capable of crimping or

forming soft and hard wire.

XURON CORP.

62 Industrial Park Rd.
Saco, ME 04072
207-283-1401
www.xuron.com

CIRCLE 62 ON FREE INFORMATION CARD

Battery In A Bag

For what you'd expect to pay for a single gel-cell 7.5 amp-hour battery alone, the #PB7A is a highly portable *Battery in a Bag* (priced at \$33.95)—perfect for providing power for your mobile radio. The padded waterproof heavy-duty nylon case has extra room inside the buckle-down lid for accessories. Its adjustable strap makes it easy to carry.

CUTTING EDGE ENTERPRISES

1803 Mission St.,
Suite PMB-546
Santa Cruz, CA
95060

800-206-0115
www.powerportstore.com

CIRCLE 64 ON FREE INFORMATION CARD



Transformers

Three new high-power international transformers (from \$225 for HPI-12 to \$245 for HPI-17) have been added to the *HPI* family.

The HPI-12 is 1250 VA and weighs 31 lbs., the HPI-15 is 1500 VA and weighs 35.7 lbs., and the HPI-17 is 1750 VA and weighs 38.5 lbs. All the HPI transformers offer "Touch-Safe" terminals and copper-foil electrostatic shields.



SIGNAL

**TRANSFORMER CO., INC.
INSILCO TECHNOLOGIES GROUP**

500 Bayview Ave.
Inwood, NY 11096
516-239-5777

www.signaltransformer.com

**CIRCLE 65 ON FREE
INFORMATION CARD**

Solder Wick

NTE Solder Wick is made from fine 100% copper wire woven together with a no-clean flux. Its fine braid promotes strong capillary action that pulls in excess solder.

The residue is halide free and non-conductive. The MSRP ranges from \$2.82 to \$24, depending on width (.075 and .098 inches) and length (5, 10, 25, and 50 feet).

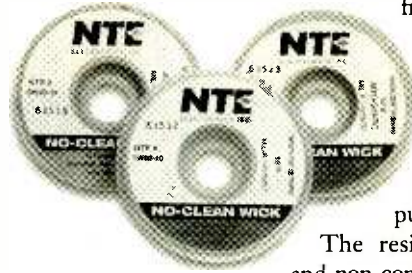

NTE ELECTRONICS

44 Farrand St.

Bloomfield, NJ 07003

800-631-1250 or 973-748-5089

www.nteinc.com

**CIRCLE 67 ON FREE
INFORMATION CARD**

Ringdown Unit

The *Quiklink Private Wire* (\$75) is a tiny, two-way automatic ringdown unit, weighing only six ounces and measuring just $\frac{1}{2}$ x $4\frac{1}{4}$ x $2\frac{3}{4}$ inches. It provides instant off-hook access between two telephone sets or equivalent devices, and it also works with computer modems and fax machines. Powered from either a 12-V_{AC} wall adapter or a 24-48-V_{DC} supply, the unit generates its own battery feed and ringing supply with selectable cadences.



CAMBRIDGE ELECTRONIC CORP.

Twenty Chester St.

Somerville, MA 02144-3005

617-629-2805

www.camelab.com

**CIRCLE 68 ON FREE
INFORMATION CARD**

Panel-Mount Surge Protector

The *SurgeArrest* panel-mount Surge-Protection Devices (SPDs) prevent damaging over-voltages from entering homes, commercial buildings, and light industrial buildings. They have surge-capacity ratings that range from 40kA to 160kA per phase (from \$319 to \$1559). The 40kA unit is compact and will fit inside most residential circuit-breaker panels. It has an LED status indicator for easy monitoring.

**A M E R I C A N
P O W E R C O N V E R -
S I O N C O R P .**

132 Fairgrounds Road
W. Kingston, RI 02889
800-877-4080

www.apcc.com

**CIRCLE 68 ON FREE
INFORMATION CARD**



DC/DC Converter

The *BTCPower SQ* (Synchronous Rectification) *Series* (\$47) units are high-efficiency quarter-brick DC/DC power converters. De-signed with a six-sided metal shield that prevents EMI, they eliminate the need for ferrite beads or other filtering devices. The shield also acts as a heat-dissipating medium with its large surface area, so neither a

heat sink nor forced air-cooling is needed.

**BROADBAND
TELCOM
POWER, INC.**

1719 S. Grand Ave.
Santa Ana, CA 92705
714-259-4888

www.btcpower.com

**CIRCLE 69 ON FREE
INFORMATION CARD**



NEW LITERATURE

20th Anniversary Catalog (No. 32-01)

from RNJ Electronics, Inc.
202 New Highway
P.O. Box 667
Amityville, NY 11701-0667
800-645-5833
or 631-226-2700
www.rnjelect.com

Free

This 166-page catalog features test instruments; tools; soldering, AV, and CCTV equipment; home-theater and satellite components; videos; and educational items. Manufacturers include B&K Precision, Panasonic, Philips, JVC, Denon, and Weller. Photos, specs, and pricing information accompany each product.



Build Your Own LINUX C Toolbox

by Jack D. Dennon
Micromethods
P.O. Box 909
Warrenton, OR 97146
503-861-1765
www.seasurf.com/~jdennon
\$16.95



This book is designed for readers who are using Linux and would like to do C language program development in this system. The programs presented here are simple but useful. The author starts with a text file-browsing program and concludes with developing a text editor. All programs are written in C for GNU C computer.

2001 Annual Index

from Sam's
Technical Publishing
5436 W. 78th St.
Indianapolis, IN
46268
800-428-7267
www.samswebsite.com
**Free Upon Request
By Phone**

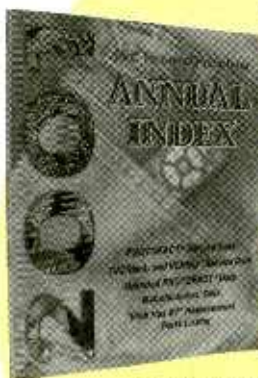

A complete index to Sam's products, this 296-page publication lists available service documentation on TVs, radios, VCRs, computers, scanners, and monitors. Brand names and model names are listed in alphanumeric order. There's also a CD-ROM version, which lists for \$15.95.

Biomimetic Sensor Technology

by Kiyoshi Toko
Cambridge University Press
40 W. 20th St.
New York, NY 10011-4211
800-872-7423
www.cup.org
\$74.95

Focusing on odor and taste sensors, this book will be a useful reference for researchers in fields from electrical engineering to food science. The introduction explores the principles of measurement and analysis. Biomimetic devices, electronic devices that mimic biological systems, are discussed in detail; in particular, the taste-sensing system developed by the author's research group.



Wholesale & Discount By Mail And Internet Buyer's Guide

by Warren Weagant
Command Productions
P.O. Box 2824
San Francisco, CA 94126
800-932-4268
www.commanproductions.com
\$19.95

No matter what you're looking to buy by mail order or on the Internet, you can get it cheaper with this buyer's guide to audio, video, computer, and electronics products. Users will find carefully screened and researched sources with the best bargain prices. The listings include complete address, phone, and Web site information.

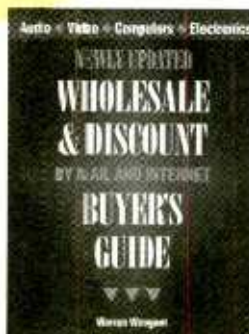

Restoring Pocket Radios

by Eric Wrobbel and Ron Mansfield
Antique Electronics Supply
480-820-5411
www.tubesandmore.com or
www.ronmansfield.com

\$24.95

Transistor pocket radios from the 50s and 60s are becoming collector's items. This tape shows viewers how to open fragile cases, avoid causing damage, and service and restore these gems. Viewers are shown how to fix scratch volume controls, service dead or weak radios, trace signals, and align circuits, and even restore lettering. There are tips on buying and using test equipment and finding parts suppliers.



The Blender Book

by Carsten Wartmann
No Starch Press
555 De Haro St., Suite 250
San Francisco, CA 94107
800-420-7240 or 415-863-9900
www.nostarch.com

\$39.95

Blender is a fast, powerful, and free 3-D graphics and animation tool that is popular with graphic and Web designers, video producers, and students. The clear, step-by-step tutorials teach users all aspects of this often tricky and non-intuitive program. The included CD-ROM offers *Blender 1.8* for all platforms; live-action image sequences; a complete texture library; and all the tutorials, scenes, and animations from the book.

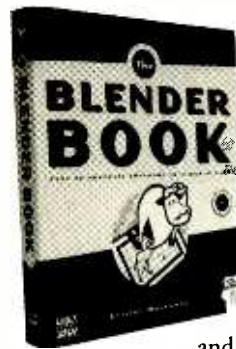

2001 Buyer's Guide

Specialized
System Consultants
2219 NW Market St.
Seattle, WA 98107
206-782-7733

www.linuxjournal.com

\$5.00

Featuring over 1500 listings of software, hardware, development tools, publications, services, and games, this comprehensive guide also contains information on infrastructure and tips on picking a distribution.

There are over ten pages of Linux vendors, ranging from 1Globe to Zzyzx Peripherals.



Radio Signal Finding

by Jim Sinclair
McGraw-Hill
2 Penn Plaza, 12th Floor
New York, NY 10121
800-2MCGRAW
www.books.mcgraw-hill.com

\$29.95

The ideal companion for ham radio operators, this book is packed with ideas and tips for everything from getting smoothly launched to isolating different signals. It includes complete coverage of the International Short-Wave Bands, as well as "extraterrestrial" signal finding—from satellites to moonbounce and Doppler Shifts.



2000 ARRL Periodicals CD

from ARRL
225 Main St.
Newington, CT 06661
888-277-5289 or 800594-0200
www.arrl.org

\$19.95

The entire year of *QST*, *QEX*, and the *National Contest Journal* are all found on this searchable CD-ROM. In addition to the complete text and illustrations for all articles, the CD includes source code for the software projects and PC board etching patterns. Minimum system requirements are Pentium processor and *Windows 95* or better.





Samsung ML4500 Laser Printer

Low-cost computer peripherals—while at the top of everyone's "to buy" list—come at a price.

Nowadays, the computer-peripheral market has become even more bloodthirsty and cutthroat. More and more vendors are competing for your hard-earned cash in an ever-tightening arena.

For example, let's look at printers. Recognized names are slashing prices to the bone, while new companies try to get a toehold in the field and other manufacturers try to expand laterally into new areas.

Such is the case with Samsung. When you hear that name, a computer monitor is one of the first images that springs to mind. Of course, Samsung makes other devices than monitors, many of which might be buried deep within your system—hard drives, CD-ROMs, and the like.

It Slices, It Dices! Samsung's ML-4500 laser printer (\$199) has been touted by some as "the first laser printer to break the \$200 barrier." Well, that's not quite true; Okidata marketed their Okilaser 4w a few years back. However, comparing the two machines would be like pitting Okidata's stripped-down "econo-box" car to Samsung's fully-loaded luxury sedan.

The ML-4500 is rated to crank out up to eight pages per minute at a "true 600 dpi." Features include a toner-saving button that will stretch the life of a toner cartridge from 2500 to 3500 sheets of text—an extra 1000 sheets. There's also a CANCEL/REPRINT button in case you clicked on the "print" command just a bit too fast. All the rest of the standard amenities that you would expect from a laser printer are

included—panel buttons, indicator lights, and a manual-feed tray for envelopes and single sheets.

Samsung's toner-cartridge design puts the toner cartridge and image drum (the heart of a laser printer) in the same housing. Whenever you replace the toner, you're get-



ting a new image drum as well—no more frustration over having to replace a scratched image drum when you thought your printing problems were due to low toner.

Now How Much Would You Pay? You would expect that Samsung would have cut a few corners in delivering a reasonably fast, substantially built, 600-dpi printer for \$200. Suprisingly, a physical on-off switch is *not* among the missing—owners of Hewlett-Packard's LaserJet "L" series (4L, 5L, and 6L) know what I'm talking about. Realizing that, of all things, an IEEE 1284-rated printer cable is *included* makes you start to question, "All right, what's the catch?" One thing that is missing is a printed manual; all documentation is in Adobe Acrobat-format

files on the included CD-ROM. However, there is a large-sheet "quick guide" to getting the ML-4500 up and running.

The unit, as it comes out of the box, is festooned with large, garish stickers advertising some of its features. Those stickers are more appropriate to a computer superstore's display aisle instead of a unit fresh out of its factory-sealed container. Depending on your personal sense of aesthetics, you'll probably be spending some time with a scraper and some adhesive solvent.

Installation under Windows is straightforward, providing you follow Samsung's instructions. Rather than following Microsoft's recommendations for a standardized user experience (have Control Panel's "Printer" applet search a CD-ROM for the appropriate driver), Samsung "reinvented the wheel" and used a customized install program that autostarts when you place the CD-ROM in a drive and close the tray.

Removing the driver is a similar "not-like-a-regular-Windows-driver" method: A special uninstall link is placed in the Start menu—cluttering up your already-overflowing Programs menu.

But Wait...There's More! Although the above impressions suggest that the ML-4500 is a unit to be ignored, that is *not* the case. With the unit hooked up and tested, printing to the first page is reasonably fast... and *quiet!* Compared to other laser printers, this unit barely whis-

(Continued on page 14)

Business Buzz

IN A FLASH

TriFlash, a 17- by 12-mm, high-capacity embedded flash-memory device from SanDisk Corp., is ideal for storing audio, video, data, and images on small portable devices, such as cell phones and MP3 players. An entire company directory, the phone book of a major city, or personal e-mail could be loaded on a TriFlash device. It has a simple three-pin serial interface and can accommodate—in the same footprint—all existing and future generations of flash memory. The device is optimized for high performance of both reads and writes and for low power consumption.

KEEPING TRACK

Houston-based Immobiliser, Inc. introduced GPS Vision, the world's first wireless vehicle tracking and control system. Using Internet and GPS technology, it allows vehicle owners to track and control their vehicles on the Internet from anywhere in the world. With just a click of the mouse, car owners receive the vehicle's street address location, digital mapping, car speed, and direction. GPS Vision gives fleet owners the ability to shut down the use of their vehicles and equipment after hours. In addition, an owner could even start a vehicle engine from a distance, even from another state. This plug-and-play system works with any model currently on the market.

GET THE PICTURE

Until the advent of high-bandwidth Digital Content Protection (HDCP) for DVI (Digital Video Interface), film studios were reluctant to release High-Definition (HD) films because of copyright-protection problems. Satellite broadcasters and consumer electronics manufacturers have shown support for and willingness to incorporate DVI with HDCP in their products. Because it's a high-bandwidth, all-digital system, DVI offers new possibilities for home-entertainment systems. DVI has the bandwidth to address each pixel in a digital TV display individually, enabling the highest possible picture quality.

Silicon Image's PanelLink is the only digital interface with enough bandwidth to accommodate uncompressed high-definition digital video. PanelLink provides scalable, end-to-end, all digital connectivity between host devices and digital displays, such as flat-panel monitors, projectors, HDTVs, and digital CRTs.

Radar-Vision

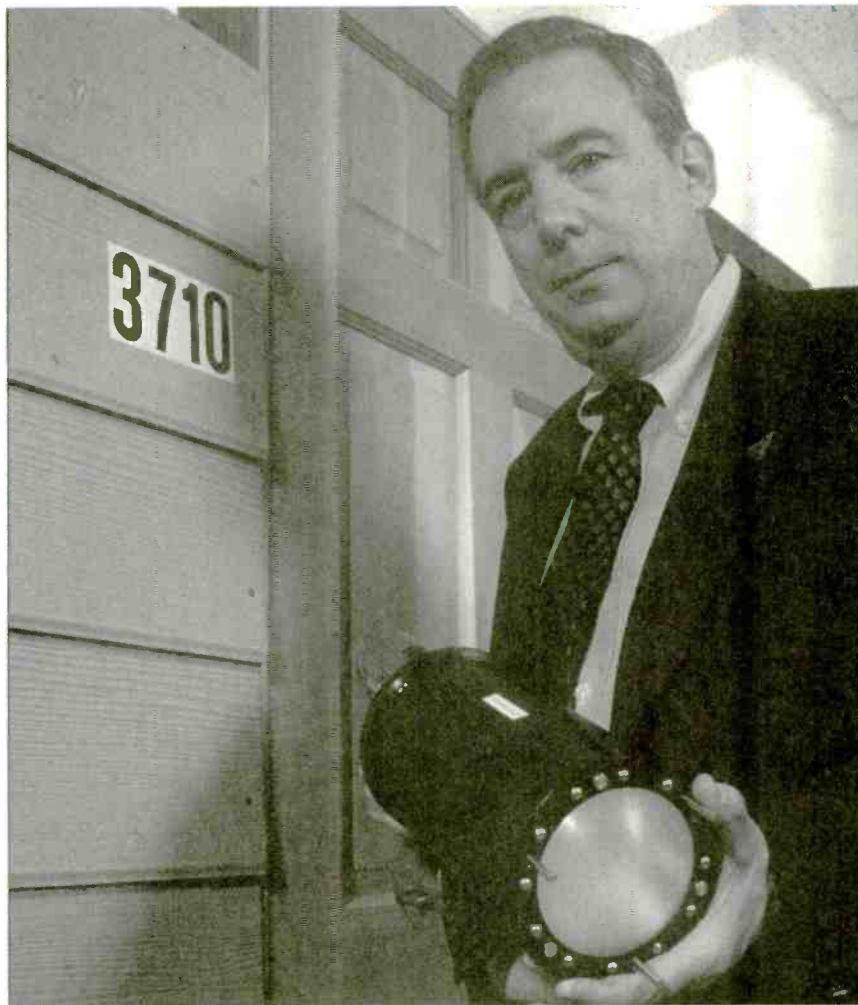

The RADAR flashlight can detect a human presence through doors and walls up to eight inches thick. (Photo by Gary Meek)

Police officers serving a warrant or searching for a suspect hiding inside a building could soon have a new tool for protecting themselves and finding the "bad guy."

The Prototype

A prototype device called the RADAR Flashlight, developed at the Georgia Tech Research Institute (GTRI), can detect a human's presence through doors and walls up to 8 inches thick. The device uses a narrow 16-degree radar

beam and a specialized signal processor to discern respiration and/or movement up to three meters behind a wall. The device can penetrate even heavy clothing to detect respiration and movements of as little as a few millimeters.

"We believe the RADAR Flashlight potentially will be useful to police officers in ambush situations," says Gene Grenaker, the GTRI principal research scientist who led the development of the device.

In its current form, the RADAR Flashlight operates in the following

TYPE

manner: The user holds the device with a pistol-grip handle, pulls a trigger, and the device runs a 3-second self-test to verify that it is properly functioning. The user sees the results as a bar graph on a small LED display built into the device. Then the user presses the device against a wall, pulls the trigger and within 3 seconds the system automatically spaces itself from the wall at a distance designed for best performance. The RADAR Flashlight's narrow radar beam sends out a pulse of electromagnetic energy and detects the return signal. That signal is read by high-speed signal processing technology that quickly delivers bar-graph results to the display. As the person on the other side of the wall breathes, the bar-graph display rises and falls with a rhythmic response.

Research that evolved into the RADAR Flashlight began at GTRI in the mid-1980s with the patenting of a frequency-modulated radar for remotely checking vital signs of soldiers wounded on the battlefield before risking medics' lives to save the injured. This early technology also was tested for its ability to monitor vital signs of soldiers clothed in chemical or biological warfare suits, without requiring them to risk contamination by removing the protective gear.

The RADAR Flashlight operates on a narrow frequency in a license-free band, Greneker adds. It can detect motion and/or respiration through brick, wood, plaster board, glass and concrete. It will not work in water or on metal structures, such as mobile homes, because these materials are electrical conductors.

For those concerned about radiation exposure from the flashlight, Greneker says the emission is very small—meeting national standards for the maximum human exposure limits. It emits about the same amount of radiation as a person receives when standing in front of a microwave-actuated door in a store.

Testing

The RADAR Flashlight is undergoing further modification and testing.

The Georgia Institute of Technology has filed a provisional patent for the device, which could become commercially available to law enforcement officials within a couple of years if the university licenses the technology to a manufacturer.

With funding in 1998 from the National Institute of Justice (NIJ), a division of the U.S. Justice Department, Greneker and his team took the RADAR Flashlight from a bulky three-part prototype to a self-contained unit that weighs about 7 pounds. The NIJ tested the device last year at the National Law Enforcement Corrections Technology Center in Charleston, S.C., and suggested further modifications. Work on those changes began this spring with additional funding from the NIJ.

"We will be modifying the RADAR Flashlight based on what law enforcement officials told us from the tests," Greneker says. "For one thing, they said it makes too much noise when it locks onto a wall (to scan). Also, for use by SWAT teams, the RADAR Flashlight needs to be operated by remote control. So we plan to put the RADAR Flashlight on a tripod at least 25 feet away from a wall and steer it by remote control to the part of the wall we're interested in scanning."

When these modifications are complete, the RADAR Flashlight will undergo more rigorous testing in various environmental conditions.



Researcher Gene Greneker and his team transformed the RADAR Flashlight from a bulky three-part prototype to a self-contained unit, weighing about seven pounds. (Photo by Gary Meek)

Research Notes

HOT AIR ENERGY

Researchers led by Steve Bauer at Sandia National Laboratories worked with Houston-based Haddington Ventures and its subsidiary Norton Energy Storage LLC to determine the feasibility of using a 2200-foot-deep inactive mine near Norton, OH, as a compressed air energy storage power plant.

"The intent is to cycle air pressure into the mine using compressors during off-peak electrical power at times like evenings and weekends to increase air pressure in the mine," Bauer says. "During the daily peak needs for electricity, air pressure will be bled off through modified combustion turbines to generate electricity." Working pressures in the "air tight" mine will range between about 1600 and 800 psi. Only two other such plants exist—both in caverns created in salt deposits. The Norton plant, expected to be on line in two years, will be the first in a limestone mine.

POWER FAILURES

Power providers who know of potential outages often can take action to ensure the "lights stay on." The Wide Area Measurement System, WAMS, continuously monitors grid performance across the Western power system. It provides operators with high-quality data and analysis tools to detect impending grid emergencies or to mitigate grid outages. Developed using technology from the DoE's Pacific Northwest National Laboratory and the Bonneville Power Administration, it soon will give this key information to California power companies.

KEEP IT COOL

A paper-thin coating of an innovative NASA material used to prevent space vehicles from burning up during reentry may soon protect your house, car, and boat from fire. Protective Ceramic Coating (PCC), invented at NASA's Ames Research Center, repels heat from virtually any surface. Wessex, Inc., in Blacksburg, VA, will develop and market the material. According to company president John Olver, "We have discovered that 99 percent of the materials in PCC will not burn; therefore, the coating inhibits the spread of flame. PCC can withstand temperatures from minus 250°F up to 3000°F without damage. It is a great material with unlimited potential."

► Clothing That Talks

France Telecom R&D has developed its first prototype communications jacket, which operates similarly to a hands-free kit. The jacket is being tested by mobile workers, such as construction workers, sportsmen, teenagers, and young students.

Ordinary in appearance, the prototype uses existing technology, providing the functions of a mobile telephone without a visible screen or keyboard. The telephone device weighing just 3.5 ounces is integrated into the lining of the jacket, with a keypad inside the flap of the jacket and microphones in the collar.

Simply pressing a button obtains a line or hangs up the phone. Numbers can be voice dialed by speaking a name or by keying in a number. The quality of the communication is as good as any mobile phone.



PT

Troubleshooting

Today, a technical challenge remains for researchers working on the RADAR Flashlight.

"We have one problem," Greneker says. "This instrument is so sensitive to motion that if you don't hold it still enough, it will detect its own self-motion. If we can overcome this, it would be the Holy Grail, and interestingly enough, we think we know how to solve this problem with additional research."

Bill Deck of the National Law Enforcement Corrections Technology Center cited the RADAR Flashlight's stability and LED display as key issues to target before the device is commercialized.

"The RADAR Flashlight has some potential," Deck said. "There is some interest from police departments. They gave us about 25 scenarios in which the device could be useful. For example, when an officer goes to serve a warrant, it could let him know that someone is standing behind the door, maybe waiting to ambush him."

Greneker says he is encouraged by interest from police departments and hopes the RADAR Flashlight will be commercialized soon.

PT

Superconductor Milestone

Researchers in the Superconductivity Technology Center of the DoE's Los Alamos National Laboratory have developed a new process for producing high-performance tape that operates at the temperature of liquid nitrogen. When scaled up to commercial production, the Los Alamos process will enable industry to manufacture long lengths of this tape—at a rate of kilometers per day—for numerous electric power applications.

Superconducting tapes can efficiently carry vast amounts of electrical current with no resistive losses. A single, one-centimeter-wide, thin foil of this superconducting tape exhibits a current density—the amount of electrical current that can be passed through a cross section of the material—of more than one million amps per square centimeter. This means a single piece of superconducting tape can carry 200 times the electrical current of an equivalent copper wire.

"Electric motors, transformers, transmission cables, and levitated trains will be some of the applications demanding hundreds of

kilometers of these flexible superconducting tapes each year," said Dean Peterson, director of the Technology Center.

The new process involved replacing cubic zirconia with magnesium oxide as the template material for the superconducting film, thereby speeding up the template deposition process by 100 times.

In 1995, Los Alamos researchers achieved world-record performance by depositing a film of a superconducting ceramic, known as yttrium barium copper oxide or YBCO, on inexpensive nickel alloy tape by first applying a buffer layer of cubic zirconia. The zirconia layer was deposited using ion beams in a process known as Ion Beam Assisted Deposition. The first beam removes material from a zirconia target and deposits it onto the nickel tape. A second ion beam, aimed at the tape, orients zirconia grains as they are deposited. Subsequent pulsed-laser deposition of YBCO on top of the aligned zirconia template allows growth of a nearly perfect crystalline superconducting film from one to six millionths of a meter thick.

Building on this Ion Beam Assisted Deposition-pulsed laser approach, Los Alamos researchers were able to produce meter lengths of YBCO superconducting tapes with critical current exceeding 100 amps.

The researchers also recently discovered that superconductor multilayers carry unprecedented amounts of current—potentially 1000 amps in a one-centimeter-wide strip through a coating only one tenth the thickness of a human hair. This new film deposition technology is now being incorporated in producing superconducting tapes with superior current-carrying ability.

PT

Keep That Computer Running

Researchers are increasingly turning to a technique called distributed computing to complete in days or weeks computing tasks that would normally take months or years. By combining the idle processing power of thousands, even millions of personal computers on the Internet, they can form a virtual

Prototype

machine more powerful than even the world's fastest supercomputers.

Recently, Stanford University launched Genome@Home to learn more about how genes work. Now that scientists have mapped the human genome, they'll need immense computing power to make sense of it.

You only use a fraction of your computer's processing power when you surf the Web or compose a letter or e-mail. When you step away, you're using none of it. So why not donate your excess to science?

That was the thinking behind the Search for Extraterrestrial Intelligence, the most popular use of distributed computing to date. Nearly three million Internet users have signed up for SETI@Home since May 1999, contributing a combined 570,000 years of computer time to analyze radio signals for evidence of alien contact. About 550,000 are active volunteers, many using multiple computers.

The SETI software works as a screen saver, kicking in when your computer's idle. Or it can be set to run in the background while you're doing other work. Either way, the computer analyzes the data, sends back results, and retrieves more signals.

Distributed computing has been around for years, initially used primarily on clusters of machines running the Linux operating system at NASA and universities. It migrated to the Net in the late 90s for such math problems as finding the longest prime number and cracking encryption.

Now, researchers are using similar techniques to design storage vessels for nuclear waste and study evolution. Medical researchers can test millions of drug combinations to fight AIDS or cancer, and learn how anomalies in protein formation cause diseases.

"It's wonderful that the common person can get involved," said Larry Rymal, who runs SETI on about 80 computers at a training center near Houston.

Still, some significant obstacles exist. By distributing the work, researchers can lose control over their data. The SETI project has had to contend with a handful of attempts to falsify data.

For a project to identify drugs that may disable mutant forms of the AIDS virus, The Scripps Research Institute

tapped Entropia, whose network had identified the world's longest known prime number.

Entropia requires FightAIDS@Home volunteers to also devote a small portion of their computers to commercial projects. Art Olson, a Scripps biology professor who runs the FightAIDS@Home project, said setting up his own network wasn't practical. By finding a commercial partner, he said, the project is able to get 1000 times the computing power

that Scripps has available in-house. The AIDS project, begun last fall, now links nearly 14,000 machines.

Some SETI users, drawn by its non-commercial nature, say they want to be careful about the projects to which they donate their spare processing time.

"A lot of people are actually prepared to spend time and share time, but not to make other people rich out of it," warned Manfred Woellner, 40, who runs a software company in North London. **PT**

**Frustration? No, thanks.
Fun? Yes, please.**



Satisfied customers - the key to our success

- ▶ that's why every new EAGLE version is based on the feedback from our customers
- ▶ that's why all our customers have access to our highly acclaimed, comprehensive support, free of charge
- ▶ that's why EAGLE has no hidden costs for libraries or modules which prove to be indispensable after purchasing
- ▶ that's why we really want customers to enjoy working with EAGLE
- ▶ that's why EAGLE is one of the top-rated programs for schematic capture and board layout

The readers of the leading German electronics magazine selected EAGLE 4.0 as **Product of the Year 2000** in the category CAE/CAD for **Windows** and **Linux**

EAGLE 4.0
Schematic Capture • Board Layout
Autorouter

- Version 4.0 Highlights**
- New Library Management with Component Browser
 - Technology and Package variants for components
 - Design your own commands via User Language
 - Unlimited length for component names/values
 - Design Rules define pad/via dimensions and shapes
 - Net Classes for Autorouter and DRC
 - Minimum Autorouter grid: 0.02 mm
 - SMD pads can be rounded or round
 - Different pad shapes for Top, Bottom, or Inner layers

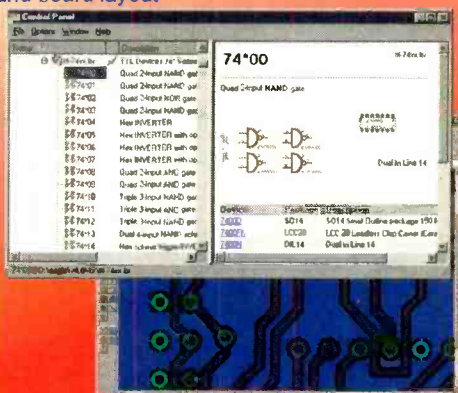

EAGLE 4.0 Light is Freeware!

You can use EAGLE Light for testing and for non-commercial applications without charge. The Freeware Version is restricted to boards up to half Eurocard format, with a maximum of two signal layers and one schematic sheet. All other features correspond to those of the Professional Version. Download it from our Internet Site or order our free CD.

The Standard Version is suitable for boards in Eurocard format with up to 4 signal layers. The Professional Version has no such limitations.

http://www.CadSoftUSA.com
800-858-8355

Prices	Light	Standard	Professional
Layout		199\$	399\$
Layout + Schematic		398\$	798\$
Layout + Autorouter		398\$	798\$
Layout + Schematic + Autorouter	49\$	597\$	1197\$

Pay the difference for Upgrades

CadSoft Computer, Inc., 801 S. Federal Highway, Delray Beach, FL 33483
Hotline (561) 274-8355, Fax (561) 274-8218, E-Mail: info@cadsoftusa.com

CIRCLE 283 ON FREE INFORMATION CARD

July 2001, Poptronics

HANDS-ON REPORT

(continued from page 9)

pers while the inner gears and motors spin up to operating speed. In fact, the loudest sound while printing is the "snap" of the paper as the end of each sheet passes through some sharp-angle bend in the paper path. Most impressive!

On the subject of paper path, note that the ML-4500 is a "top-loader"—paper goes in and comes out vertically like the aforementioned HP printers. If you have a somewhat cramped location available for your printer (such as a middle shelf), take that into consideration.

Having a 600-dpi printer is a "good thing"—until you bump up against another subtle Samsung "gotcha:" The memory on this unit is *not* expandable. Two megs will handle a basic mix of text and high-resolution pictures for a newsletter or short article, but not if you want to print large, high-resolution images. Let's do the math: for an 8- by 10-inch picture at 600 dpi, you need $(8 \times 600) \times (10 \times 600)$

bits, or 28.8 million bits. Divided by eight means you need a bit over 3.5 megabytes to store that image in the printer—quite a bit more than the two mega-bytes available.

If you're not looking to do anything super fancy, you probably will not have a problem with printer-memory shortages. However, having a printer that puts out crisp, clean pages might soon get your creative juices flowing—a good recipe for "I-should-have-bought-better" frustration.

The Little Penguin That Cried. If all you know about computer operating systems come from Redmond, WA, you can stop reading. For all the "fans of Tux" out there, gather 'round for a semi-sad tale.

One of Samsung's major advertising points for the ML-4500 is that it is "Linux compatible." That phrase is plastered all over the shipping box and even appears on the test page hardcoded into the printer's memory. Indeed, if you dig deep down into the CD-ROM, there is a Linux directory containing .rpm (RedHat

Package Manager) files and a README file with installation instructions.

Installation instructions are detailed in the README file only—the manual has not a hint about non-Windows information. For all the "Linux-friendly" hype connected with the ML-4500, you would think that Linux installation instructions would be a bit more prominent.

The install script and package files insert the ML-4500 into the Red Hat *printtool* utility and replace the version of *Ghostscript* on your machine with one that's been patched to understand the ML-4500's data

format. To explain, UNIX systems output print files to a Postscript interpreter like *Ghostscript* for translation to the data format needed by non-Postscript printers.

Things went sour when Mandrake 7.2 (the target test system) choked on the .rpm files. Apparently, Samsung uses version 4 of the .rpm format—an update not widely available on non-Red Hat distributions. Indeed, Samsung warns that only Red Hat is supported and guaranteed. That is like saying that software will only install under Windows95 OSR2 for Compaq Presario 4800-series systems built between January and June 1996. Calling something "Linux compatible" when you can only use it under Red Hat 6.1 is not exactly "compatible!"

The bottom line is that we never got the ML-4500 working under Linux. Samsung (apparently not realizing the root cause of the .rpm incompatibility) sent replacement package files, which—obviously—failed to install as well.

As this is being written, there have been reports on Usenet of successful installations under non-Red Hat Linux systems. Apparently, Samsung has posted the patch code for *Ghostscript* on their Web site, but it is difficult to locate. Armed with that file, you could patch your own copy of *Ghostscript* to work with the ML-4500. There have also been reports of ML-4500 successes under CUPS (the *Common UNIX Printing System* software that some Linux distributions are leaning towards). If you need that information, you can find the archived newsgroup messages at DejaNews'... oops, sorry, Google's newsgroup archives.

Although the ML-4500 might sound like more trouble than it's worth, it is a well-built, dependable printer that runs quietly and puts out a crisp page of 600-dpi images. If you can work around the limitations, you can't beat it for cost-effectiveness.

For more information, contact Samsung USA, Consumer Electronics, 105 Challenger Rd., Ridgefield Park, NJ 07660; 201-229-4000; www.samsungusa.com; or circle 80 on the Free Information Card. 



ML-4500

Laser Beam Printer

Excellent Performance, High Quality

- 8ppm Printing Speed
- True 800dpi Resolution
- 35Mhz RISC Processor
- 2MB Memory

Cost Saving, Convenience

- Toner Save Button
- Reprinting Button
- N-up Printing (Up to 16 Pages)
- Compact Design

Compatibility

- Windows 95/98/NT4
- Linux Compatible
- IEEE1284 Parallel

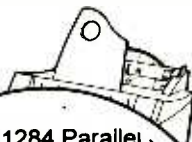

IEEE1284 Parallel
Ram Size : 2 Mbytes
Total Page Count : 21 pages
OS Version : 1.05 08-07-2000
Engine Version : V1.0.4
PrintThru Version : 1.00 06-28-2000

Ram Size : 2 Mbytes
Total Page Count : 21
OS Version : 1.05 08-07-2000
Engine Version : V1.0
PrintThru Version : 1.00 06-28-2000



<http://www.samsungprinter.com>

SAMSUNG DIGITAL
everyone's invited.

GIZMO®

Wake-Up Calls

How many times do you hit the snooze bar each morning? Sony's ICF-CD823 Snoozinator CD/Clock Radio (\$80) lets you choose your snooze time, in eight-minute intervals, for up to one hour. Its two separate wake-up times can be set for CD, radio, or alarm. The space-saving sound-stage design, though small in size, disperses the sound throughout the room.



Sony Electronics Inc., 1 Sony Drive, Park Ridge, NJ 07565; 800-222-SONY; www.sony.com.

CIRCLE 50 ON FREE INFORMATION CARD

Weather-Savvy Radar Detector

The ESD-9220WX Radar Detector (\$189) alerts you to more than speed traps. A built-in ten-channel weather radio includes NOAA Weather Alert for impending storms. The Strobe Alert warns of emergency vehicles at intersections, while the Safety Alert warns of approaching vehicles and other road hazards. As for speed traps, the ESD-9220WX detects X, K, KA, VG-2, Ultra Lyte Laser, LTI 20-20, ProLaser, and ProLaser II signals.

Cobra Electronics Corp., 6500 West Cortland St., Chicago, IL 60707; 773-889-8870; www.cobraelectronics.com.

CIRCLE 53 ON FREE INFORMATION CARD



Multi-Satellite Dish

The TRK-S22 (\$149) is an 18 × 24-inch DirecTV-approved multi-satellite dish antenna with two dual LNBS and a four-output (4 × 4) multi-switch for easy receiver hookup. The

HDTV-compatible antenna comes with mount assembly, including bracket, arm, mast, and base; clearly labeled cables for D-I-Y installation; and all necessary hardware.

Terk Technologies Corp., 63 Mall Drive, Commack, NY 11725; 631-543-1900; www.terk.com.

CIRCLE 52 ON FREE INFORMATION CARD



BeoSound 1

Boasting high style and high fidelity, the BeoSound 1 portable stereo (\$1500) is a gently curved, thin arc of light blue, accented in silver, black, green, and red. The stereo offers easy-to-use features. Its motorized antenna and CD-clamper each rise gracefully from the top of the unit at the press of a button. The FM tuner automatically searches for and stores all available radio stations. For better projection, each of the five loudspeakers is powered by its own

dedicated amp.

Bang & Olufsen America, Inc., 1200 Business Center Drive, Suite 100, Mount Prospect, IL 60056-6041; www.bang-olufsen.com

CIRCLE 51 ON FREE INFORMATION CARD

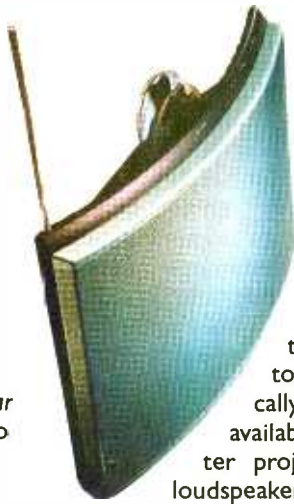

CD/MP3 Jukebox

Holding up to 240 hours of music in its 20-GB hard drive, the Cyberboy CB-200 Digital Audio Recorder and Jukebox (\$499) from CMC Magnetics Corp. sports both a Multimedia Card slot and a CD-R/CD-RW read-compatible CD-ROM drive. You can record CD tracks directly from the CD drive, store them to the hard drive as MP3 files, and then transfer them to a Multimedia Card.

Hotan Corp., 6700 Golden Gate Dr., Suite B, Dublin, CA 94568; 925-829-5311; <http://cmc.taiwanet.com>.

CIRCLE 54 ON FREE INFORMATION CARD



FRS Radios

Family Radio Service (FRS) radios, which require no licensing or service fees because they operate in the FCC-approved FRS-spectrum UHF-radio band, are increasingly popular. The easy-to-use radios provide two-way communications with a range of up to two miles. The Cherokee FR-465 (\$169.95) includes the Vitalert Emergency Communications System, which indicates when another radio has gone out of range.

Wireless Marketing Corp., 1092 National Parkway, Schaumburg, IL 60173; 847-839-0015; www.wirelessmarketing.com.

CIRCLE 55 ON FREE INFORMATION CARD



CDs on the High Seas

Designed specifically for boat installations, the MDC5110 CD marine head unit (\$199) uses clear-coated circuitry and a rust-resistant chassis built to withstand heat, wind, rain, cold, and salt water. It features a detachable faceplate that can be removed from the boat and safely stored. The unit includes a CD player, an AM/FM tuner with 18 FM and 12 AM station presets, and an amplifier.

Jensen Mobile Electronics, a Recoton Company, 2950 Lake Emma Road, Lake Mary, FL 32746; 407-333-8900; www.jensenaudio.com.

CIRCLE 57 ON FREE INFORMATION CARD



Digital Surround A/V Preamp

Designed for today's high-end home theaters, the AS-2631

5.1-channel A/V pre-amplifier (\$800)

reproduces seven independent channels—six audio channels and one subwoofer channel. It automatically detects and

decodes Dolby Digital or DTS input signal formats. There are eight different on-screen surround modes from no surround to large hall. The AS-2631 has eight audio inputs and six video inputs.

Proton U.S.A., 13855 Struikman Road, Cerritos, CA 90703-1031; 562-404-2222; www.proton-usa.com.

CIRCLE 56 ON FREE INFORMATION CARD



Digital Pics

The FinePix 4700 ZOOM digital camera (\$799) uses Fujifilm's Super CCD for vivid, colorful pictures. The digital camera also boasts a 3X aspherical optical zoom lens, a 2-inch LCD screen, a pop-up flash, a USB port, five programmed exposure modes, and the ability to capture 80 seconds of continuous AVI video with sound on its bundled 16-MB Smart-Media card.

Fuji Photo Film U.S.A., Inc., 555 Taxter Road, Elmsford, NY 10523; 800-800-FUJI; www.fujifilm.com.

CIRCLE 58 ON FREE INFORMATION CARD



Dual-Tray CD Recorder

Said to have the industry's fastest CD-to-CD-R dubbing speed, TDK's first home audio CD recorder, the DA-3826 (\$549), offers 4X recording of both full discs and individual tracks. It records on both CD-R and CD-RW discs and provides a full complement of digital and analog inputs and outputs for any music source.

TDK Electronics Corp., 901 Franklin Ave., Garden City, NY 11050; 800-835-8273; www.tdk.com.

CIRCLE 59 ON FREE INFORMATION CARD



Data-Acquisition Software

CE-Wedge (\$199) is designed for interfacing serial devices—such as bar-code scanners, calipers, micrometers, scales and other simple serial devices—to any Windows CE program. An easy-to-use data-collection program, CE-Wedge features a one-screen, one-minute set-up with complete on-line help. A free 30-day evaluation version can be downloaded from www.taltech.com/cgi-bin/lfs2k.cgi.



TAL Technologies, Inc.; 800-722-6004; www.taltech.com.

Mobile Pen-Based Scanner

The Cross :Convergence Pen (\$89.99) is a wireless scanner pen that makes it possible to scan barcodes on thousands of products as well as publications with Digital Convergence Cues. Users simply press the scan-activating button on the pen, quickly drag across any bar or product code, and a bookmark is stored for the corresponding Web page. Up to 300 codes can be scanned between uploads.



Cross Pen Computing Group, A. T. Cross Company; 401-333-1200; www.cross.com.

Don't Move That Mouse

Combining optical sensor and DSP technology with Internet and document-scrolling capability, the Targus Screen-Scroller Optical Mini Mouse (\$49.99) is an optical pointing device that can be used on any surface. The Screen-Scroller features a "Scroller Wheel," which allows users to scroll up or down without moving the mouse, and it comes with a USB connection.



Targus, Inc.; 800-242-3133 or 203-852-1102; www.targus.com.

Dazzling Video

The Digital Video Creator (just under \$200, MSRP) video-editing system with MovieStar editing and publishing software is an easy way to capture, edit, and share video with friends and family. Anyone can transform home videos into Hollywood-style movies with professional transitions, scrolling titles, and voice-over narration. Edited movies can be shared via VHS tapes, CD, e-mail or on the Web.

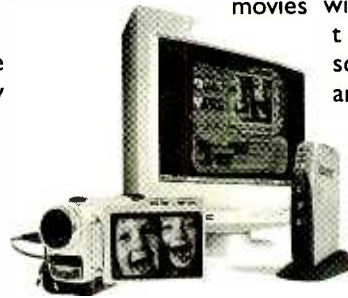

Dazzle Multimedia, Inc.; 510-360-2300; www.dazzle.com.

Multi-Function Center

The Brother MFC-7300c (ESP, \$299) combines video-capture capabilities and printing, faxing, and copying—all in color—into a compact, space-saving design. As a color printer, it provides fast print speeds, with up to 12 ppm monochrome, 10 ppm color, and up to 1200 by 1200 dpi photo-quality output. The MFC-7300c can also send either B/W or color faxes. In addition, high-quality color scanning is provided via the automated document feeder.

Brother International Corp.; 800-276-7746; www.brother.com.



Gizmo is published by Gernsback Publications, Inc., 275-G Marcus Blvd., Hauppauge, NY 11788. Senior Writers: Christopher Scott and Teri Scaduto. Copyright 2001 by Gernsback Publications, Inc. Gizmo is a registered trademark. All rights reserved.

CD ROM based resources for learning and designing

The internationally renowned series of CD ROMs from Matrix Multimedia has been designed to both improve your circuit design skills and to also provide you with sets of tools to actually help you design the circuits themselves.

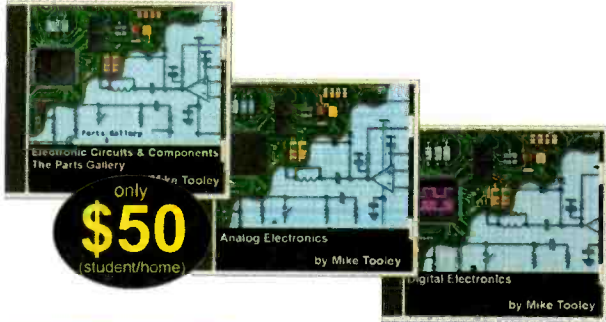

only
\$50
(student/home)

Electronic Circuits and Components provides an introduction to the principles and application of the most common types of electronic components and how they are used to form complete circuits. Sections on the disc include: fundamental electronic theory, active components, passive components, analogue circuits and digital circuits.

The **Parts Gallery** has been designed to overcome the problem of component and symbol recognition. The CD will help students to recognize common electronic components and their corresponding symbols in circuit diagrams. Quizzes are included.

Digital Electronics details the principles and practice of digital electronics, including logic gates, combinational and sequential logic circuits, clocks, counters, shift registers, and displays. The CD ROM also provides an introduction to microprocessor based systems.

Analog Electronics is a complete learning resource for this most difficult subject. The CD ROM includes the usual wealth of virtual laboratories as well as an electronic circuit simulator with over 50 pre-designed analog circuits which gives you the ultimate learning tool. The CD provides comprehensive coverage of analog fundamentals, transistor circuit design, op-amps, filters, oscillators, and other analog systems.

Electronic Projects is just that: a series of ten projects for students to build with all support information. The CD is designed to provide a set of projects which will complement students' work on the other 3 CDs in the Electronics Education Series. Each project on the CD is supplied with schematic diagrams, circuit and PCB layout files, component lists and comprehensive circuit explanations.

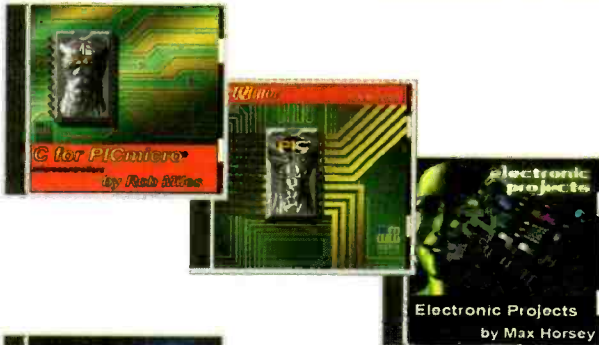

PICtutor and C for PICmicro microcontrollers both contain complete sets of tutorials for programming the PICmicro series of microcontrollers in assembly language and C respectively. Both CD ROMs contain programs that allow you to convert your code into hex and then download it (via printer port) into a PIC16F84. The accompanying development board provides an unrivaled platform for learning about PIC microcontrollers and for further development work.

Digital Works is a highly interactive scalable digital logic simulator designed to allow electronics and computer science students to build complex digital logic circuits incorporating circuit macros, 4000 and 74 series logic.



CADPACK includes software for schematic capture, circuit simulation, and PCB design and is capable of producing industrial quality schematics and circuit board layouts. CADPACK includes unique circuit design and animation/simulation that will help your students understand the basic operation of many circuits.

Analog Filters is a complete course in filter design and synthesis and contains expert systems to assist in designing active and passive filters.

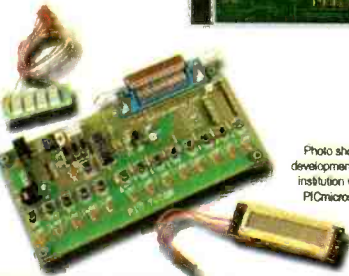

Photo shows PICmicro development kit supplied with institution versions of C for PICmicros and PICtutor

Shareware/demo CD ROM with more than 20 programs \$4.99 refundable with any purchase.

Order Form:

Please circle the products you would like to buy on the table below, calculate the total cost, fill in the rest of the order form and send it to us. NY residents add sales tax. Please allow 6 weeks for delivery.

	Student	Institution
Electronic Cts. & Comps.	\$50	\$99
Digital Electronics	\$50	\$99
Analog Electronics	\$50	\$99
Electronic Projects	\$75	\$159
PICtutor	\$179	\$350
C for PICmicros	\$179	\$350
Digital Works	\$50	\$99
CADPACK	\$75	\$159
Analog Filters	\$75	\$159
Postage - USA	\$5	\$5
Postage - Canada	\$5	\$5

Name: _____
Address: _____

Phone your order to us on:

631-592-6721



or send your order to:

CLAGGK Inc.

PO Box 12162

Hauppauge, NY 11788

Zip: _____ Phone: _____

Card Type: _____
Mastercard, Visa, or Discover only

Card number:

Expire date:

I have enclosed my check for \$: _____ Signature: _____

Please charge my credit card for \$: _____

CL02

Order online NOW from: www.poptronics.com

MONEY AND THE INTERNET

Pundits have predicted that the digital age would usher in the paperless office and the cashless society. Ironically, it seems as if computers have led to more paper, not less; and getting cash may be more convenient with computerized ATMs, but the need for paper currency is no less. Significant change is in the works—at least on the money front. Today, you can carry out transactions using your personal computer and the Internet without exchanging cash. You can buy, and you can sell, and you don't even need a credit card. Online auctions have been the catalyst behind the innovations, according to Mark Morgan, a research analyst who specializes in e-finance for the San Francisco investment bank Putnam Lovell. The biggest mover here is a little-known, meteorically growing, and controversial company named PayPal.

PAYING TABS WITH PIXELS

Out of the heart of the Silicon Valley, PayPal has vaulted in little over a year from nowhere into first place as the world's largest Internet-based payment network. More than five million people now use its PayPal service, according to a company spokesperson. This constitutes more than 10 percent of all Internet traffic in the financial services sector—more people than are served by big names such as Citibank, Wells Fargo, and Bank of America combined.

For both consumers and businesses, PayPal offers useful services and, for businesses alone, useful lessons as well. Using PayPal, at www.paypal.com, you can quickly and conveniently pay for goods or services by having money transferred from your bank account, credit card account, or PayPal money market account. The



Look out Visa and AmEx! PayPal means business—at least in cyberspace. PayPal is leading the way for fledgling on-line creditors, by allowing its over seven million users to purchase and trade, without cash, over the Net.

kicker here is that you can sell over the Internet without a credit card merchant account, which for individuals and even small businesses can be difficult or expensive to obtain.

PayPal used to promote itself as being “always free,” in its logo no less, but it now charges if you buy or sell more than specified amounts. PayPal's abruptly changing its terms of service created a storm of protest—Internet message forums were flooded with scathing complaints and calls for boycotts. It can still be a good deal, compared with other options.

In what undoubtedly is a side effect of this, the Better Business Bureau just gave PayPal an “unsatisfactory” rating. PayPal will likely weather this deluge in part because a key competitor, ExchangePath, just went belly up. However, it could have handled things better. Sure, in today's brutal dot-com

shakeout, businesses need to make money rather than just coax venture capital and grow market share. The transition from free to pay should be planned and managed. PayPal's lesson to other businesses is a common sense one: Don't promise what you may not be able to deliver.

CYBER-CREDIT COMPETITORS

PayPal isn't the only player in the “person-to-person payment” market. Ecount, based in Conshohocken, PA, is carving out space for itself by marketing to banks and credit card companies rather than directly to individuals or small businesses, says Matt Gillin, the company's CEO and president. Individuals can still sign up, at www.eaccount.com, and more than 800,000 have—often those wary of using credit cards over the Internet.



Just think of SmallOffice.com as a resource library for stay-at-home entrepreneurs—and then some. Whether you have questions, are researching demographics for customers, or are a complete novice, SmallOffice.com can point you in the right direction.

You can use the service with any merchant who accepts MasterCard payments, unlike with PayPal, which requires the merchant to have a PayPal account.

You pay for online purchases out of your Ecount, which you fund through a major credit card. The company plans to offer bank account transfers in the future. You're charged a small fee only when you add or withdraw money from your account or opt to receive a traditional plastic MasterCard debit card from the company. You withdraw funds with your credit card or MasterCard debit card or by having a check mailed to you. Other services battling for position in the online payment space include eCharge at www.echarge.com, MoneyZap at www.moneyzap.com, and c2it at www.c2it.com.

GUARDING YOUR VIRTUAL WALLET

Any electronic payment service worth its silicon makes security top priority, but you have to do your share, too. Don't use the same password for your e-cash account as your e-mail account. Recently, hackers got into the PayPal accounts of some Hotmail users by hacking their Hotmail passwords.

Also, beware of "spoo" sites with names such as PayPai that try to trick you into giving up your password. It's better to log directly onto sites such as PayPal than to go to them via possibly

bogus links in e-mail messages. E-payment companies have grandiose plans, with dollar bills flashing before their eyes. The ultimate goal: One payment system that replaces not only cash, but credit cards and checking accounts as well.

CON-ARTISTS IN CYBERSPACE

Not only can you spend money on the Web, but you can earn money, too. Can you get rich quick on the Internet? Sure, you can, if you believe the flood of e-mail messages sent by "entrepreneurs" hoping you'll invest in their enterprises. Don't believe them. Those sending this growing torrent of come-ons are almost always shysters. They often lie from the get-go. "ADDITIONAL INFORMATION REQUESTED FROM ROBERT ALLEN," shouted one recent message. I never requested any information in the first place. Typically, the appeal is to greed. "Earn \$50,000 in only 90 days!! It really works!"

Sometimes, these misguided opportunists go for your emotions, such as guilt. "Why haven't you contacted me?" pleaded one. Soon, greed dominated the message, which described a program where you can "earn millions of dollars." In scam-speak, the message righteously proclaimed, "This is NOT a get-rich-quick scam." Here's one that tried appealing to a noble ideal. "The GOLDEN rule," it began.

What's the golden rule it advocated? Making money by pitching the same con to millions of others. Sometimes the clueless people boggle the mind. "HAPPY BIRTHDAY," I was cheerfully greeted by one come-on, trying to entice me to read the message. Only the chances of my birthday falling that week were one in 52—terrible odds. You should delete all e-mail solicitations like these that you receive.

SPAM: JUNK MAIL EVOLVES

"If someone e-mails solicitations indiscriminately, delete them without reading," agrees Paul Edwards, co-author (along with his wife Sarah) of the book *Working From Home*—lawyer, lecturer, and perhaps the country's leading expert on home-based businesses. The reason is that unsolicited, untargeted bulk e-mail, called spam, has long been a violation of Internet norms. Spam uses Internet resources paid for not by the sender but by the recipient. This is why it's illegal to send junk faxes and why legislation is pending to restrict unsolicited commercial e-mail as well.

Bona fide businesses don't send spam, or if they do, they do so once and realize their mistake. Scam artists, on the other hand, send spam over and over. Don't bother asking them to take you off their list. They typically just use your e-mail response as verification that you have a working e-mail address, often selling your address to other spammers.

Unfortunately, some companies make the mistaken assumption that if you buy a product from them, they've created a "relationship" with you and are therefore entitled to e-mail you unsolicited ads. Smart companies know this angers too many customers. The best way to build an e-mail list is to ask people if they're interested in receiving e-mail from you or to buy a list of people who've already agreed to receive commercial e-mail about a particular type of product.

ON-LINE OPPORTUNITY

Many spam come-ons are for illegal pyramid schemes or similarly structured but legal multi-level marketing (MLM) companies. The difference between the two is that MLM, sometimes called network marketing, involves

(Continued on page 56)

Top-Of-The-Line Sound

A few columns back, we looked at some of the options available in speakers for your PC. There's no doubt that adding a better set of speakers will audibly improve the quality of sound that your PC produces and that the upgrade will be affordable and easy.

No matter how good the speakers are that you purchase, however, they can only be as good as the audio quality that your sound card produces. Even if you already have a decent quality sound card installed, it may not provide some of the newest features, such as 5.1-channel Dolby Digital output.

A NECESSARY UPGRADE?

Unlike video cards, where a new generation of chipsets appears every year or so and is quickly taken advantage of by game developers, sound cards are generally not a "must-have" type of upgrade. The reasons for this are pretty basic.

The most important reason is that even an inexpensive PC usually provides a very good quality of audio for most purposes. In some cases, this audio is FM synthesis; while, in others, it's software wavetable synthesis. Your current audio may be produced by either a plug-in peripheral card or by an audio chipset contained on the PC's motherboard, or it may actually be generated by the PC's CPU under the direction of the computer's core logic chipset. In fact, a PC with embedded audio—where the audio chipset is contained on the motherboard or generated by the CPU—may be difficult to upgrade or may not be upgradable at all.

DOING THE AUDIO TWO-STEP

Before considering upgrading your audio card, there are two pieces of

information you need to pull together—why do you want to upgrade and is an upgrade even possible?

The latter question is the first one to answer. Obviously, if you can't add a new audio card to your PC, the whole decision is moot. Check your manual to see what type of audio your PC provides. If it's an add-in peripheral card and if you have PCI-slots available on your motherboard, you're home free. All of the newer audio cards use the PCI-bus, so upgrading an audio card in a PC using older ISA slots is usually a waste of time and money.



Santa Cruz from Voyetra Turtle Beach features the Cirrus Logic SoundFusion Digital Signal Processor.

Even PCs with embedded audio can frequently be upgraded. You need to see whether there's a jumper on the motherboard or a setting in the system BIOS to disable the on-board audio. If there is one, you can add a new audio card. If the documentation is unclear, try checking with the PC vendor. You can also use a shareware utility such as *SANDRA* or *Dr. Hardware* to find out what type of motherboard your PC uses and then check on the motherboard manufacturer's Web site for this information.

THREE OF THE BEST

Let's take a closer look at some cutting-edge sound cards. Assuming that you can upgrade, the second question to answer is whether you should. New sound cards provide some neat features—most notably, multi-channel sound support and a variety of different outputs. If you won't take advantage of these features, why spend the money? Even an original SoundBlaster card sounds very nice when you hook up a good quality three-piece set of speakers to it.

We tested a trio of sound cards from the three most popular sound card vendors. The cards we looked at aren't the only models these vendors offer—we looked at each vendor's top-of-the-line offering. After all, why bother upgrading if you aren't going to go for the best?

To be honest, there aren't a lot of vendors left in the audio card aftermarket. While there are a number of other vendors besides these three, most of them provide OEM or "white box" cards for original installation or repair, rather than upgrading.

SANTA CRUZ

The least expensive card of the trio was the Santa Cruz from Voyetra Turtle Beach. This card is widely available for about \$80 or so, and it was the only one of three that didn't come with some type of additional patch bay or box. Of course, that's also why it is \$50 to \$100 less expensive than the other cards reviewed here.

That's about the only feature, however, that Santa Cruz lacks. The card uses a Cirrus Logic SoundFusion DSP (Digital Sound Processing) chipset, which provides hardware wavetable sound. There's 8 MB of memory avail-

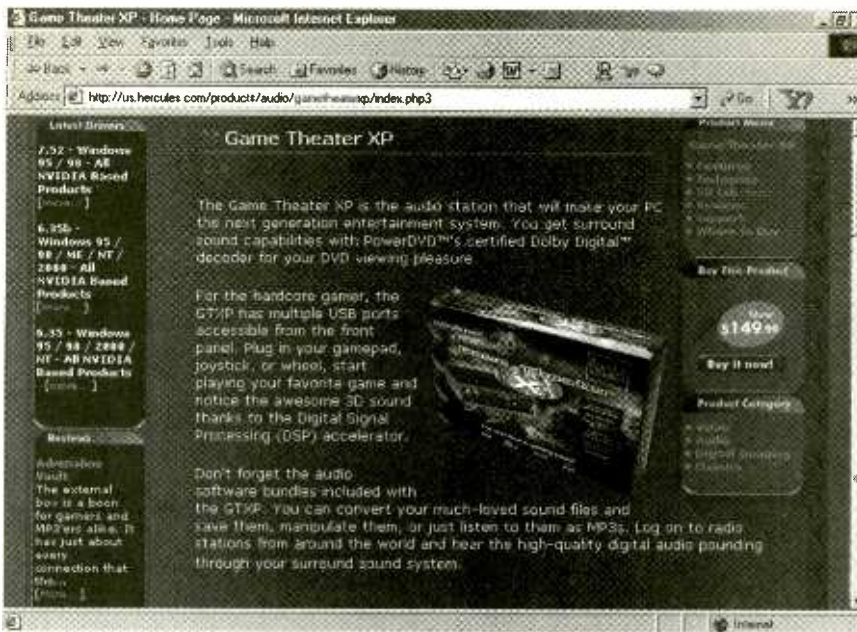

Hercules has more to offer than video cards. The Game Theater XP is also designed around a Cirrus Logic chipset, and the XP moonlights as a four-port USB hub.

able for wavetables and for the card to build effects. The primary effect, of course, as with all current audio cards, is 3-D positional sound. This quality adds considerably to the realism of both games and "live" music. Santa Cruz uses the Sensaura technology to provide this positioning. The card is also compatible with Microsoft's DirectSound 3D, as well as Aureal's A3D 1.0 and Creative Labs' EAX technologies.

Other audio effects are controllable through software. This software lets you create "environments" such as a concert hall, adjusting phasing and reverb. You can even use the DSP capabilities to provide echo canceling, which is useful if you perform voice recognition. A suite of software includes the popular *AudioStation* for playing different media types and sources, *MIDI Orchestrator* and *Digital Orchestrator* for using MIDI files and devices, *Audio View* (a WAV file editor), and several sample versions of music utilities.

While Santa Cruz doesn't provide an external patch panel, it does offer a host of output jacks. These jacks allow you to get true front- and rear-channel output, as well as digital outputs for speaker systems that provide Dolby Digital. This feature allows you to use 4.1 and 5.1 speaker sets, which are almost always equipped with Dolby Digital decoders. There's an S/PDIF input, but it's a header on the card and is only for use with a CD drive that can provide digital S/PDIF output. The

other two cards reviewed here have external S/PDIF I/O connectors, so they offer a bit more flexibility in this regard.

However, the real test of an audio card is not specifications—it's sound. All three cards were tested with the same set of speakers, Altec Lansing's new ATA-5. This is a terrific 4.1 set, with satellites each containing a mid-range driver and tweeter, along with a fairly hefty subwoofer. It provides Dolby Digital decoding for excellent front- and rear-channel separation and positioning.

Santa Cruz installed easily; but it does require several IRQs, which may present a problem if your PC is heavi-

ly loaded with peripheral cards. Other than this, installation is easy. The VersaJack—the top one on the card's rear panel—is software controlled to provide several different types of output, including AC-3 Dolby Digital. Once this was set, the ATA-5s kicked in with outstanding sound on all of the media we tested including games, music, and DVD movies. If you don't need the patch panels, the Turtle Beach Santa Cruz would be an excellent and affordable choice.

GAME THEATER XP

One notch up in price and features is the Game Theater XP from Hercules. Hercules was famous for its video cards for many years, but they went belly up a few years ago. Guillemot, the Canadian vendor that is also well known for its audio and video cards, purchased the name. Guillemot has already breathed new life into Hercules with a complete line of excellent video cards. The Game Theater XP is a top-of-the-line card for both gamers and other home users who need excellent audio quality as well as superior connectivity.

The Game Theater XP uses the same Cirrus Logic SoundFusion chipset that the Santa Cruz card employs, so its capabilities are similar. Unlike the Santa Cruz card, however, there's only one connector on the Game Theater XP. You use this connector to attach an included cable between the card and a modest-sized box that sits on your desk or on the top

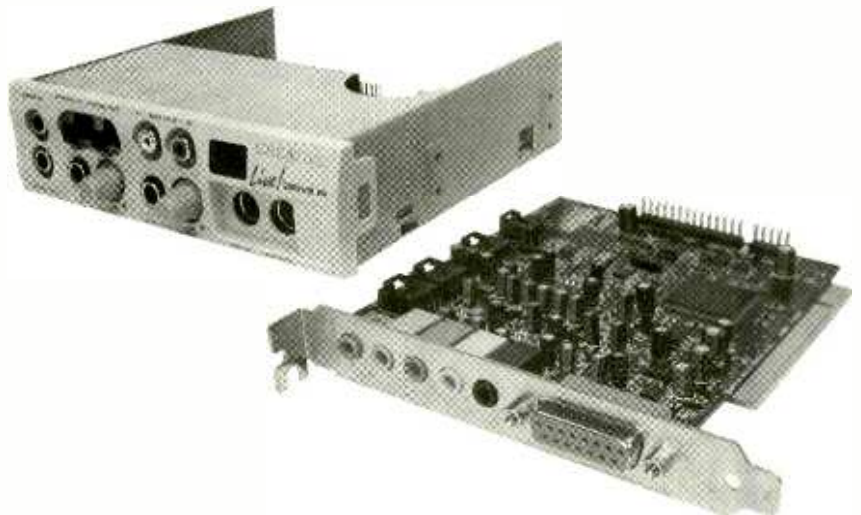

The latest and greatest product from Creative Labs is the SoundBlaster Live Platinum 5.1 Edition. The Platinum incorporates the LiveDrive II—an innovative interface that fits into a standard 5.25-inch bay.

SOURCE INFORMATION

Creative Labs, Inc.
1901 McCarthy Blvd.
Milpitas, CA 95035
408-428-6600
www.soundblaster.com
CIRCLE 110 ON FREE INFORMATION CARD

Hercules, Inc.
877-484-5536
www.hercules.com

Voyetra Turtle Beach, Inc.
5 Odell Plaza
Yonkers, NY 10701
800-233-9377
www.voyetra-turtle-beach.com
CIRCLE 111 ON FREE INFORMATION CARD

of your tower-style PC. This box, which Hercules calls a "rack," is overflowing with connectors—a game player's and audiophile's dream!

The front of the rack is deceptively sparse. There are line-in jacks, a microphone jack, and a headphone jack—the last two with volume controls. A DB-15 connector is provided for game controllers. With recent versions of Windows, including Windows 98/ME/ and Windows 2000, there are a pair of USB ports, giving you an easy place to plug in a USB peripheral.

On the rear of the "rack," there are even more connectors, including another pair of USB ports and the connector for the cable to the Game Theater XP card. There are also outputs for up to six speakers, a set of mini-DIN MIDI ports, and digital inputs and outputs.

Add in the really large collection of software, and the \$149 suggested retail price of the Game Theater XP doesn't feel excessive. As with all three of the cards we tested, sound quality and positioning from the Game Theater XP was excellent.

SOUNDBLASTER LIVE! PLATINUM 5.1

Finally, we tested the Creative Labs SoundBlaster Live! Platinum 5.1 Edition. With a retail price of just under \$200, this was the most expensive of the three.

Creative's SoundBlaster was one of the first sound cards available for the original IBM PC, and Creative Labs is the only vendor to have survived from that time. The SoundBlaster Live!, in its different incarnations, is the most popular OEM sound card—if you've recently bought a higher-end

PC, chances are good there's already a SoundBlaster Live! in it. The Live! Platinum 5.1 uses Creative's own EMU10K1 chipset, which provides hardware wavetable generation and Creative's EAX audio-effects control. As with the other cards we tested, you can adjust parameters such as reverb, chorus, and the like.

Different models of the SoundBlaster Live! are available, and the \$200 Platinum 5.1 is the most expensive. That's because this model includes LiveDrive II—a panel that fits into an open 5.25-inch drive bay and provides a number of I/O connectors on the front of the PC. Creative was the first vendor to pioneer this technology, with the original LiveDrive. Included are RCA jacks for I/O, optical connectors for using fiber-optic connections to home-theater components that support this technology (or to a Sony PlayStation 2, which also has optical connectors available), coaxial S/PDIF input and output jacks, mini-DIN MIDI connectors, and several volume controls. Unique to the LiveDrive II is a small infrared remote control that you can use to both switch between outputs and control the volume.

As with the other cards tested, the Platinum 5.1 produces outstanding quality sound and comes with a large bundle of software. Because it requires the installation of the LiveDrive, it needs an empty 5.25-inch drive bay and takes a bit longer to install. The actual installation, however, should pose no problem for any reader who has ever installed an upgrade card or disk drive.

YOU PAY YOUR MONEY...

All three of these upgrade possibilities are excellent choices to get the best sound quality at an affordable price. None of them are difficult, or particularly time-consuming, to install. Keep in mind, however, that unless you are willing to also upgrade your speakers to take advantage of the new capabilities offered (or have already done so), a less expensive upgrade might make better financial sense. 



A public service of this magazine

Personal Oscilloscope

20 MSa's Pen-Type Oscilloscope
stand-alone or connects
to your PC



world-wide smallest portable oscilloscope
Made in Germany

Pen-Type Oscilloscope V5.0 2000,
supplied items: PC-Software with
Operator's Manual on 3.5" disk, Serial
PC-Interface cable (6ft), External Trigger
Cable with clip, Ground Cable with clip,
External Power Cable
with Alligator clips **US\$ 99.99**



Software MS-DOS/Windows 3.1/95/98 compatible

Palm Software includes 6ft Serial Cable
US\$ 8.99 (Option), for Palm OS 3.5

Battery PowerPack includes two AA-size
batteries US\$ 9.99 (Option) up to 8h
continuous operation, typical alkaline

Add shipment and handling cost total
US\$ 9.99. Delivered by Express Service
within 5 days, anywhere in the U.S. and
Canada.

Developed by Wittig Technologies AG
Sales (516) 794 4080 or Toll-Free (800) 247 1241
Fax (516) 794 1855
sales@wittigtechnologies.com

Technical Support: available by e-mail or fax, only.
support@wittigtechnologies.com

All trademarks belong to their respective owners.



Wittig Technologies

www.wittigtechnologies.com

CIRCLE 141 ON FREE INFORMATION CARD

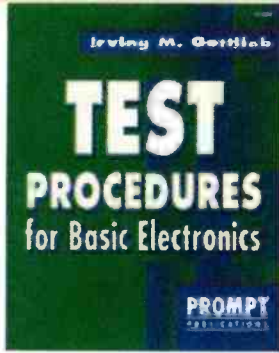

Test Procedures for Basic Electronics. #61063. — \$19.95
 Many useful tests and measurements are covered. They are reinforced by the appropriate basic principles. Examples of test and measurement setups are given to make concepts more practical. 7 3/8 x 9 1/4", 356 pp, paperback.

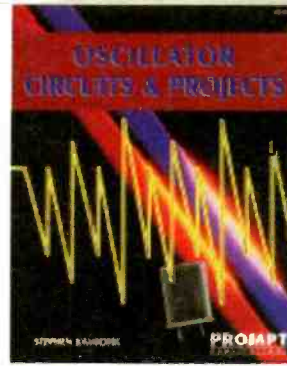

Oscillator Circuits and Projects. #61111. — \$24.95
 A Textbook and project book for those who want to know more about oscillator circuits. You can build and enjoy the informative and entertaining projects detailed in this book. Complete information is presented in an easy-to-follow manner. 7 3/8 x 9 1/4", 249 pp, paperback.

Build Your Own Home Lab. #61108 — \$29.95
 Shows you how to assemble an efficient working home lab, and how to make it pay its own way. Includes projects for creating your own test instruments too. 7 3/8 x 9 1/4", 249 pp, paperback.

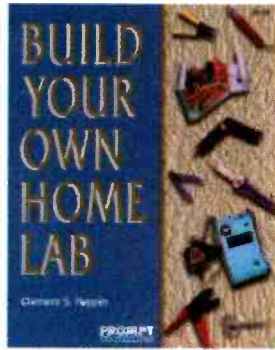

Troubleshooting and Repair Guide to TV. #61146. — \$34.95
 Repairing and troubleshooting a TV is very simple and economical with help from the information in this book. It is the most complete and up-to-date TV repair book available, with tips on how to handle the newest circuits. 8 1/2 x 11", 263 pp, paperback.

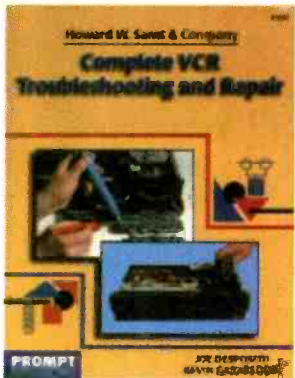

Complete VCR Troubleshooting and Repair. #61102. — \$34.95
 Though VCRs are complex, you don't need complex tools or test equipment to repair them. This book contains sound troubleshooting procedures that guide you through every task. 8 1/2 x 11", 184 pp, paperback.

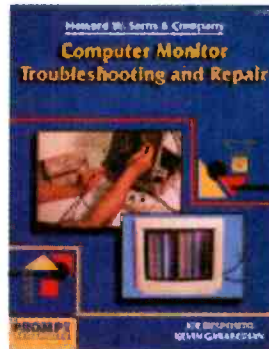

Computer Monitor Troubleshooting and Repair. #61100. — \$34.95
 This book can save you the money and hassle of computer monitor repair by showing you how to fix it yourself. Tools, test instruments, how to find and solve problems are all detailed. 8 1/2 x 11", 308 pp, paperback.

Wholesale & Discount Buyer's Guide #CP-1. — \$19.95
 Save up to 90% off list prices. Audio and video equipment and materials; electronic products and surplus; pro recording and specialty items; computers and components. Source listings include complete address, phone, fax, e-mail and website addresses. 8 1/2 x 11", 72 pp, paperback

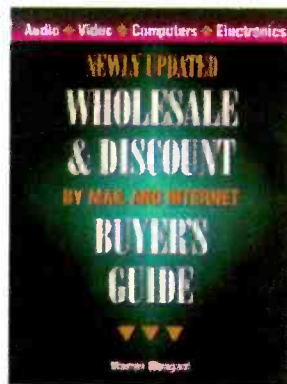

Joe Carr's Circuit Toolkit. #61181. — \$29.95
 Easy-to-build, useful circuits from Carr's workbench to you. They will spark new ideas in your day-to-day use of circuits and help solve frustrating problems. 256 pp, paperback. Contact Jim Surface.

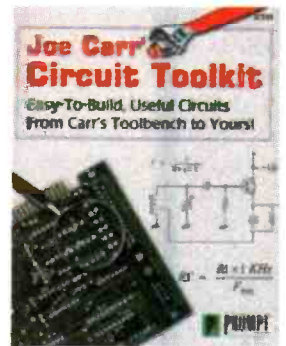

Please circle the products you would like to buy on the page above, calculate the total cost, include shipping charges, using in the form below and send it to us. Please allow 4 - 6 weeks for standard delivery.

Name: _____
 Address: _____

 Zip: _____ Telephone: _____
 I have enclosed my check for \$: _____
 Signature: _____

Please charge my credit card for \$: _____ Number:
 Card Type: _____ Expiration Date:

Note: The delivery address and the address at which the credit card is registered must be the same.

Clagg Inc.
 PO Box 12162
 Hauppauge, NY 11788
 Tel: 631-592-6720
 Fax: 631-592-6723
 email: claggk@gernsback.com

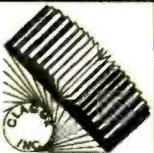

SORRY No orders accepted outside of USA & Canada No. of Books Ordered

Total price of books.....\$.....
 Shipping (see chart).....\$.....
 Subtotal.....\$.....
 Sales Tax (NYS only).....\$.....
 Amount Enclosed.....\$.....

SHIPPING CHARGES IN USA

CANADA ADD \$5.00	
1 Book	\$ 5.00
2 Books	8.00
each add'l book	3.00
2 Day UPS	\$10.00 extra
Next Day UPS	\$20.00 extra

All payments must be in U.S. funds! CL04

In-Circuit Capacitor Tester

MARVIN SMITH

I've spent a lot of time finding bad electrolytic capacitors in the TVs, VCRs, and camcorders I repaired. A few were shorted. Most had developed high Equivalent Series Resistance (ESR). That's an internal resistance in series with the capacitance. Result: The capacitor has high impedance and does not function properly. A regular capacitance meter isn't helpful because it measures only capacitance, not ESR. If you did want to measure the capacitance, the meter indication could be affected by components tied to the capacitor; to get an accurate measurement, you sometimes have to use your soldering iron to lift (isolate) the capacitor. Then if the capacitance is correct, you have to resolder it back on the board. This is a most tedious task. Some capacitance meters can't even measure above 20 μF , so you'd be stuck if you had to test a large-valued capacitor, like 470 μF . Build the *In-Circuit Capacitor Tester*, and you'll speed up your repairs by being able to test capacitors of 1 μF or above right on the circuit board.

Improving On An Old Idea. In-circuit capacitor testers are nothing new. You'll find ads for in-circuit capacitor testers—sometimes called "ESR meters"—in electronic hobby and servicing magazines; I'm sure they do a good job. However, there are advantages to the tester described here. Cost, for one—the parts cost about \$60, and most are available from RadioShack. Some of the advertised meters can't detect shorted capacitors—this one can. Some can be damaged if you don't discharge the capacitor before connecting the probes. Don't worry with this tester—back-to-back diodes across the input discharge the capacitor for you and protect the tester. To prove this feature, I connected the probes across a 470- μF capacitor charged to 150 volts with no damage; I drew quite a spark, but the meter still works! A word of caution: Even though the meter won't be damaged by charged capacitors, **DO NOT** test capacitors in units with power on—you could damage the unit

you're repairing (that would be a bad move).

When Good Electrolytics Go Bad. If you looked inside an aluminum electrolytic capacitor, you would see two foil strips and a paper insulator strip rolled into a cylindrical element. The paper insulator is soaked with a critical part of the capacitor—the moist electrolyte. Figure 1 shows an equivalent circuit of a capacitor. The ESR, which combines the resistance of the leads, the foils, and the electrolyte, is shown as a resistor in series with the capacitance. If the electrolyte dries out, the ESR increases and the capacitance decreases. The electrolyte can dry out because of high temperatures caused by high ripple currents, or a bad end seal may let it leak out. Loss of electrolyte results in an open capacitor, the most common failure. Less often, the capacitor may develop a short between the foils. The **CONDITION** meter will indicate 0 for open capacitors, and the **SHORT** LED will light for shorted ones. Some capacitors fail simply because they have reached the end of their estimated life. One manufacturer guarantees a certain line of their surface-mount capacitors for 2000 hours—that's only three months!



This technician's gadget lets you test capacitors right on the circuit board and speed up your repairs.

How The Tester Works. The tester generates a 100-mV, 100-kHz square wave with an impedance of 22 ohms across its probes. The tester doesn't measure capacitance—it displays on the **CONDITION** meter how well the capacitor bypasses this 100-kHz signal. Note that both the ESR and the capacitance must be good for the capacitor to test well. So, in effect, the tester is verifying the capacitance.

The schematic of the tester is shown in Fig. 2. The tester comprises a 14-pin quad op-amp, three transistors, three diodes, 21 resistors, six capacitors, a potentiometer, a 0-100 microammeter, a 9-volt battery, an LED, and an on/off switch.

Op-amps like to be powered by equal plus and

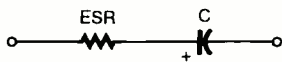

Fig. 1. Placing a resistor and capacitor in series demonstrates the principle of Equivalent Series Resistance. ESR is often the cause of faulty electrolytic capacitors.

minus voltages. A standard 9-volt battery powers the tester; however, we want ± 4.5 volts referenced to ground. Op-amp IC1-a generates the ± 4.5 volts for the tester. Resistors R1 and R2 are connected in series across the battery, and the mid-point is connected to pin 3 of IC1-a, the non-inverting input of IC1-a. The output at pin 1 of IC1-a is tied to the inverting input at pin 2 of IC1-a, and connected to ground. This does not short out the op-amp or cause high currents.

Op-amp IC1-a is connected in the negative feedback configuration, because the output is tied to the inverting input. Normally, an op-amp will adjust its output to make its input voltages equal. However, here the output is tied to ground. Therefore, the op-amp does the only thing it can—it regulates the voltage at its power supply pins to place the midpoint of R1 and R2 at 0 volts. Since $R1=R2$, half of the battery voltage is above ground and half below; thus, we have our ± 4.5 volts. Capacitors C1 and C2 suppress oscillations and provide bypassing for the ± 4.5 volts. This circuit configuration is a simple way to split a battery into equal plus and minus voltages, provided the difference in the plus and minus currents drawn by the circuitry doesn't exceed the output

current capability of the op-amp.

Op-amp IC1-b is connected as an astable-multivibrator and generates a key signal—an 8-volt peak-to-peak 100-kHz square-wave. Resistor R6 couples this to the base of Q1, the driver for Q2. The waveform at Q2-C, a 0 to +4.5-volt 100-kHz squarewave, is connected to bridge resistors R9 and R11. The voltage at the junction of R9 and R10, and at the junction of R11 and R12 is a 0 to +100-mV squarewave with an average DC value of +50 millivolts. As you'll see later, this DC offset allows us to detect shorted capacitors.

Op-amp IC1-c is a differential amplifier with its input resistors, R13 and R15, connected to the 22-ohm bridge resistors. Its gain amplifies the millivolt-level 100-kHz bridge signal to drive the CONDITION meter and the SHORT LED. The non-inverting input always sees this reference signal. The inverting input is connected to the junction of R9 and R10. The probes are connected across R10. When the probes are open, the bridge is balanced; the inputs to the differential amplifier are equal; and the CONDITION meter indicates 0. When you connect the probes across a good capacitor, it kills the AC waveform at the inverting input, but leaves the average DC value of 50 mV. The bridge is now unbalanced according to AC standards; a 3.6-volt peak-to-peak waveform appears at pin 8 of IC1-c, and the meter indicates 100. If the capacitor is shorted, the bridge is not only unbalanced AC-wise, it is now unbalanced according to DC standards—the inverting input now sees 0 volts instead of the average level of 50 mV. The 50-mV average reference signal at the non-inverting input shifts the 3.6-volt peak-to-peak waveform at pin 8 of IC1-c up to an average of +2 volts; this turns on Q3 and lights the SHORT LED. IC1-d and D3 rectify the 100 kHz signal from IC1-c to supply the DC current for the CONDITION meter.

Construction. You can choose your own enclosure, but I recommend the 4- x 6-inch hand-held case and the circuit board mentioned in the parts list. The case has a compartment for the 9-volt battery, and the

board has printed circuit pads for soldering the parts. Room is at a premium, but all parts will fit into the case if you carefully position the parts on the cover and on the board. Refer to the internal photo of the tester as a guide.

Refer to the photograph to see

PARTS LIST FOR THE IN-CIRCUIT CAPACITOR TESTER

SEMICONDUCTORS

- IC1—TL084ACN quad op-amp, integrated circuit
- Q1, Q3—2N3904 NPN transistor
- Q2—2N3906 PNP transistor
- D1, D2—1N5404 3-amp silicon rectifier diode
- D3—1N914 general-purpose silicon diode
- LED1—Light-emitting diode, 2 mA low current, red

RESISTORS

- (All resistors are 1/2-watt, 5% units.)
- R1, R2, R3, R4—10,000-ohm
 - R5—1500-ohm
 - R6—68,000-ohm
 - R7, R14, R16, R17—47,000-ohm
 - R8—12,000-ohm
 - R9, R11, R13, R15—1000-ohm
 - R10, R12—22-ohm
 - R18—47-ohm
 - R19—7500-ohm
 - R20—15,000-ohm
 - R21—750-ohm
 - R22—5000-ohm panel-mount linear-taper potentiometer (Calrad 25-301 or similar)

CAPACITORS

- C1, C2—10- μ F, 25-WVDC, electrolytic
- C3—0.001- μ F, ceramic disc
- C4—0.1- μ F, ceramic disc
- C5, C6—1- μ F, 50-WVDC, electrolytic

ADDITIONAL PARTS AND MATERIALS

- Plastic case, 4- x 6-inch (RadioShack 270-213 or Pac Tec K-HP-9VB or similar)
- PC circuit board (RadioShack 276-150 or similar)
- M1—0 to 100 microammeter (Calrad 60-166 or similar)
- S1—Miniature SPST switch (GC 35-006 or similar)
- 9-volt battery
- Knob, 1/4-inch bushing

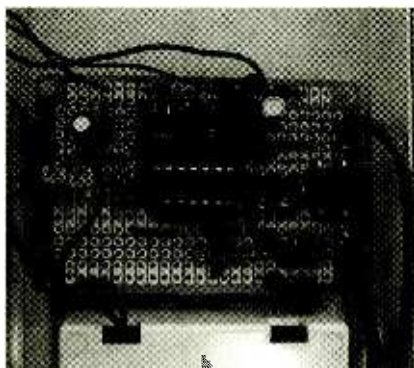

This extreme close-up shows the component placement inside the In-Circuit Capacitor Tester. Following along with the schematic, readers can even use a breadboard to construct this unit.

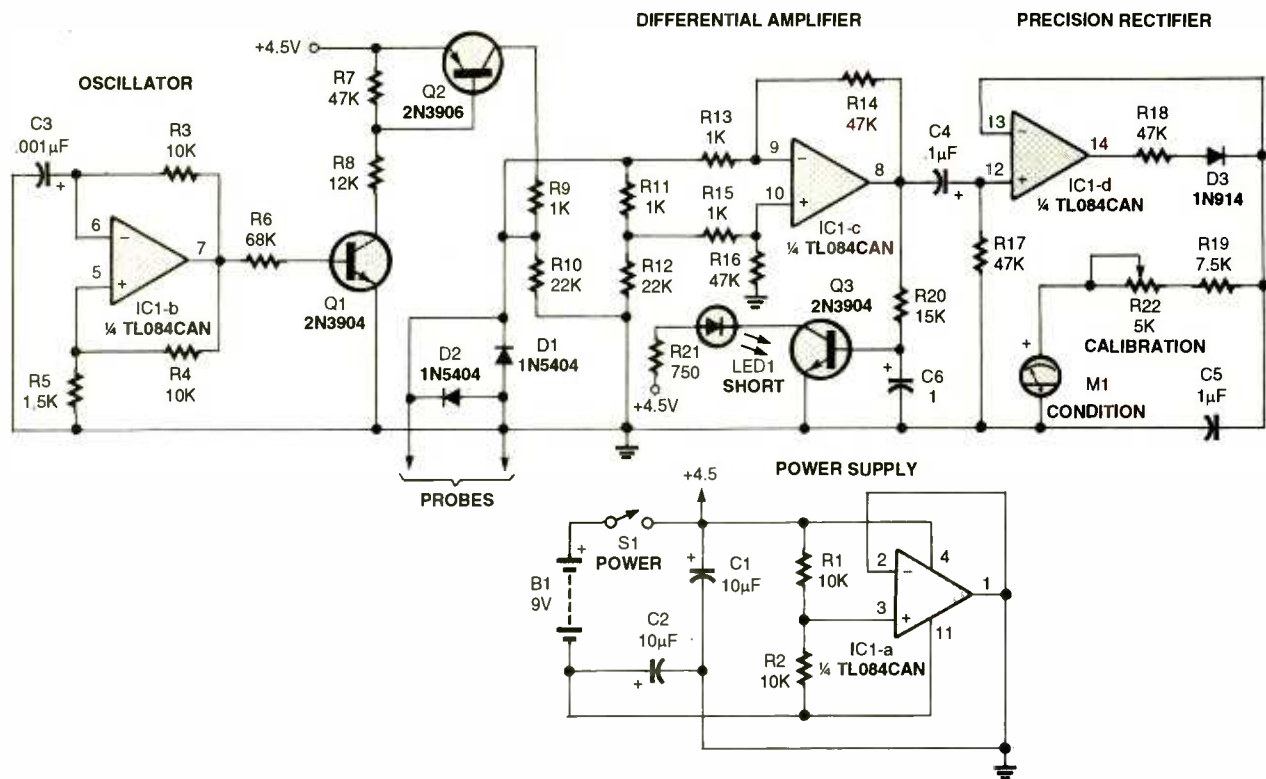

Fig. 2. The In-Circuit Capacitor Tester is simple in design and highly effective. The schematic above shows the complete circuit that is centered around a quad op-amp.

how the completed unit is assembled. The first thing to do is temporarily mount the board to the bottom of the case with a screw. You will then remove the board to mount the components. There is a pre-drilled post molded in the bottom of the case next to the battery compartment. Find a miniature screw that will self-thread the hole in the post. Center the board and position it no more than 1/8-inch from the battery compartment. This will leave room for the meter body. Mark the board hole closest to the post hole and drill out the board hole to clear the screw body. Temporarily mount the board on the bottom with the screw. With a pen or pencil, draw a circle around the head of the screw. Keep board components clear of this circle so they won't interfere with the screw when you install the completed board.

Your biggest challenge is to make the meter hole in the cover. The meter in the parts list fits in a 1 1/2-inch diameter hole. Use a hole saw to make the cleanest hole, but be sure to use a piece of wood under the cover for support. For the SHORT LED, drill a hole slightly smaller than

the diameter of the LED, and then ream or file the hole for a press fit. Use dry transfer letters for the labels on the top cover, and then spray the cover with clear acrylic to bond them. Drill two holes slightly larger than the probe leads in the bottom—1/2-inch apart and about

3/16-inch below the top edge.

When mounting the components on the board, leave the lower left area of the board free for the potentiometer. Refer to Fig. 2 for the circuit schematic. A close-up photo shows the components mounted on an experimenter's

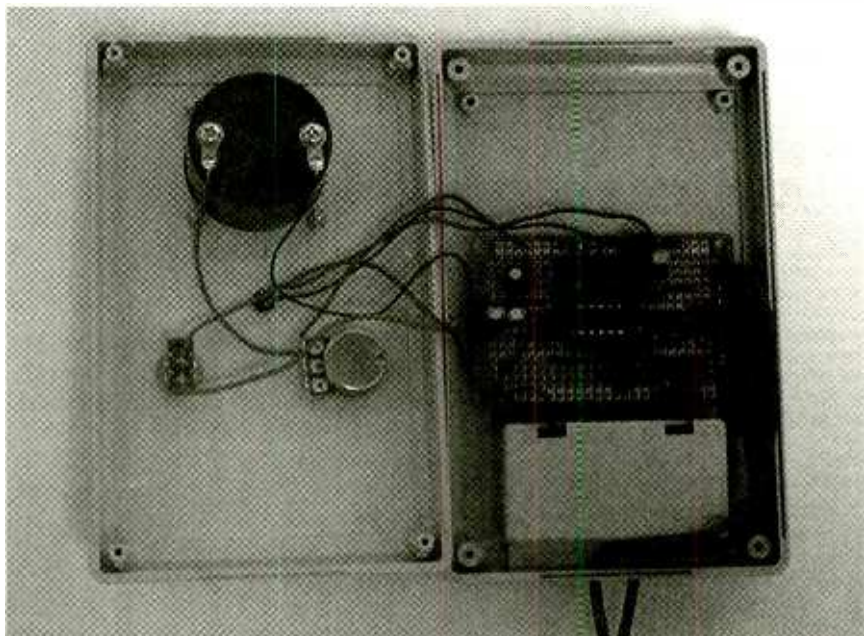

The author's prototype has been opened to reveal its inner workings. The LED, meter, calibration knob, and power switch are all mounted on the unit's cover.

5 GREAT PROJECT BOOKS

[] BP-410 35 Opto-Display Terminal Block Projects. \$6.99. If you use terminal blocks, no soldering is required to make complete this series of opto-displays that range from light-telegraphs, flashing lapel badges, magnetic detectors, plus more advanced projects including a dusk detector, games, and twinkling Christmas decorations.

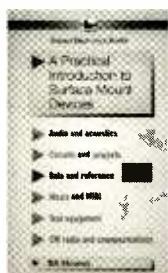
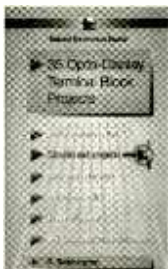

[] BP-411 Introduction to Surface-Mount Devices. \$6.99.

Surface-mount construction can be easier, faster and less costly, and even the hobbyist can produce one-of-a-kind circuits using SMDs. PCB design, chip control, soldering techniques and specialist tools are fully covered. A complete variety of construction projects are also included.

[] BP-413 Remote Control Projects. \$7.99. A wealth of circuits and circuit modules for use in all kinds of remote-control applications are provided. There are complete details for 14 novel and practical remote control projects. Also included are techniques for interfacing a PC to a remote control system.

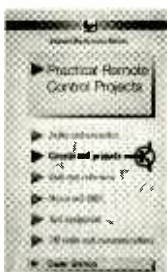

[] BP-416 Practical Alarm Circuits. \$6.99. Details of inexpensive but effective burglar alarms for the home constructor. The circuits include switch-activate alarm, FM audio alarm generator, Modulated fiber-optic loop alarm, Ultra-sonic breaking window alarm, Doppler shift ultrasonic sensor and more.

[] BP-432 Simple Sensor Terminal Block Projects. \$6.99. Sensors are the eyes, ears and noses of electronic systems. They include contact, light, heat, sound, magnetic, motion, resistance and voltage-operated devices. The projects in this book show you how you can build all of these, and if you use terminal blocks, no soldering is required. There are 31 individual projects to build and use.

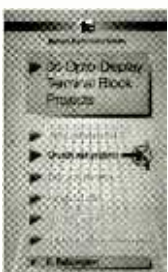

To order one of these Books send amount indicated plus \$3.00 for shipping in the U.S. and Canada only to Electronics Technology Today Inc., P.O. Box 240, Massapequa Park, NY 11762-0240. Payment in U.S. funds by U.S. bank check or International Money Order. Please allow 6-8 weeks for delivery. MA09

board. Drill larger holes for the over-size leads of D1 and D2. Use press-in terminals in the pads for D2 for soldering the probe leads. Connect the board pads with insulated solid wire; 26 gauge is a good size to use. The pads are close together, so watch for solder bridges. Because of the low-output impedance of the tester (22 ohms), the probe leads are soldered directly to terminals across D2; banana jacks would add noticeable contact resistance.

Testing. Set the POWER switch off. Rotate the CAL control counter-clockwise. Connect the 9-volt battery and insert it in the compartment. With the probes open, set the POWER switch on; the CONDITION meter should indicate 0 and the SHORT LED should be off. Touch the probes together; the meter should indicate near full scale and the SHORT lamp should come on. With the probes touching, adjust the CAL control for a meter indication of 100. If the tester doesn't do this, set the POWER switch off and check the wiring. If the wiring appears to be correct, see Table 1 and use a scope to verify the signals at these key points referenced to ground.

come on. With the probes still touching, adjust the CAL control for a meter indication of 100. You're now ready to run down those bad electrolytics. Just connect the probes across a suspect capacitor and see what the meter indicates. Polarity doesn't matter; the low 100-mV output will not forward-bias capacitors or surrounding components. In fact, both probes and their leads can be red. The meter doesn't indicate the actual current through the capacitor, but shows the *condition* of the ESR and the capacitance. Think of the meter indication as a grade for the capacitor—as in school, 100 is very good, 20 is poor. For a good grade, both the capacitance *and* ESR must be good.

You'll find that a good capacitor will not always give a full-scale indication. All capacitors have *some* ESR. Most good axial or radial capacitors above 1 μF will give a meter indication of 95 or higher. Physically small capacitors have high ESR. Some new surface-mount capacitors give an indication of around 60, so it's always best to test a known-good capacitor of the same type as the one in

TABLE 1

Test Point	Signal
IC1-1	0 V _{DC}
IC1-2	0 V _{DC}
IC1-3	0 V _{DC}
IC1-4	+4.5 V _{DC}
IC1-5	1-volt peak-to-peak 100-kHz squarewave
IC1-6	1.4-volt peak-to-peak 100-kHz triangle waveform
IC1-7	8-volt peak-to-peak 100-kHz squarewave
IC1-11	-4.5 V _{DC}
Q2-C	0 to +4.5-volt 100-kHz squarewave
Junction of R9, R10	0 to +100-mV 100-kHz squarewave
Junction of R11, R12	0 to +100-mV 100-kHz squarewave

If the above signals are correct, check the voltage at IC1-8. With the probes open, the voltage should be 0 ± 0.2 volts. Touch the probes together; the signal at IC1-8 should be a 3.6-volt peak-to-peak 100-kHz-rounded squarewave at an average level of +2 volts, and the SHORT LED should be lit.

Application. Simple. Set the POWER switch on. Touch the probes together; the SHORT lamp should

the unit under repair and see what the indication should be. A safe rule is to replace a capacitor if the meter indication is under 50. Some capacitors are obviously bad—they don't even move the meter!

The tester circuitry draws 15 mA from the 9-volt battery. At this rate, the battery should last about 30 hours. Replace the battery when you can't set the meter to 100 with the CAL control.

The MPX 2000

WILLIAM SHEETS and RUDOLF F. GRAF, KA2CWL

The *MPX 2000* is a multi-feature FM stereo transmitter that offers full coverage of the 88–108 MHz band in 100-kHz steps. This unit is intended for use by hobbyists, experimenters, and others needing a low-power short-range FM stereo transmitter. The left and right audio channels may be used independently to transmit two separate audio channels. The *MPX 2000* is also suitable for hobby Part 15 operation where a transmitter with digital frequency readout and keypad entry of frequency is desirable.

This low-powered unit is fully crystal controlled. The pilot and subcarrier signals are both generated from a quartz crystal. A phase-locked loop (PLL) system assures frequency accuracy and crystal stability; while the use of a keypad and microprocessor permit ease of frequency entry without having to set jumpers or switches, ensuring that the programmed frequency will be correctly produced.

Stereo Transmission. When FM stereo transmission was introduced back in the 1960s, there were millions of monophonic FM receivers in use. Whenever anything new is introduced into a mass market, it is desirable to maintain compatibility with existing equipment and not make it obsolete. The new stereo system had to be backwards compatible with mono FM. The new stereo transmissions had to be received by existing mono receivers as monophonic audio, much like color TV transmissions were received as black and white on the millions of black-and-white TV sets still in use. What this meant was a stereo audio format was necessary, where-

transmitted as the sum of left and right (L+R) audio channels. In addition, a signal is also transmitted that is the difference of the channels (L-R). By adding the signals, the right channel cancels, and the left channel alone appears. By subtracting the (L+R) and (L-R) signals, the left channel cancels; and the right channel similarly is now obtained. A mono receiver would reject the (L-R) component and reproduce only the (L+R) component as a mono signal.

The trouble is that the sum and difference channels (L+R) and (L-R) both are audio that occupies the baseband of 20 to 15000 Hz. Using analog meth-

then perform the adding and subtracting (called matrixing) to obtain the separate L and R channels. Then two audio channels (L and R) and two speakers can be used to obtain true stereo reproduction.

A stereo-generator system must be used to process the incoming audio channels into a form suitable for transmission by a standard FM transmitter on a standard FM channel 200 kHz wide, with 75-kHz peak deviation. The usual pre-emphasis and deviation limiting must be provided for, and the frequency response of the audio should not be degraded from standard mono transmissions. Since available deviation is limited by FCC regulations to 75 kHz, the L and R channel total audio must not exceed that for an equivalent mono channel. In addition to the pilot signal, some provision must be made for the use of auxiliary subcarriers, such as SCA transmissions on 67 or 92 kHz.

The circuitry needed for all this processing, while using quite a few components, is quite simple and straightforward. It involves only low frequencies and is easily implemented with just a few ICs and transistors. Indeed, there once existed an IC that did the whole job (BA1404 or BA1405), but this IC has suffered the fate common to many ICs—discontinuation. Thousands of hobbyist stereo FM transmitters both in kits and individual projects were constructed around the BA1404/BA1405 ICs. While they may be available in surplus for a few years, they have no future, as there is little mass-market demand for these chips. While they were OK for low-end uses, real FM stereo



Command the FM band with this do-it-yourself transmitter.

inaudible. A pilot carrier must also be transmitted to assist in demodulating this subcarrier back to audio. The stereo receiver has to extract this subcarrier and pilot signal, process them to recover the (L-R) difference signal as audio, and

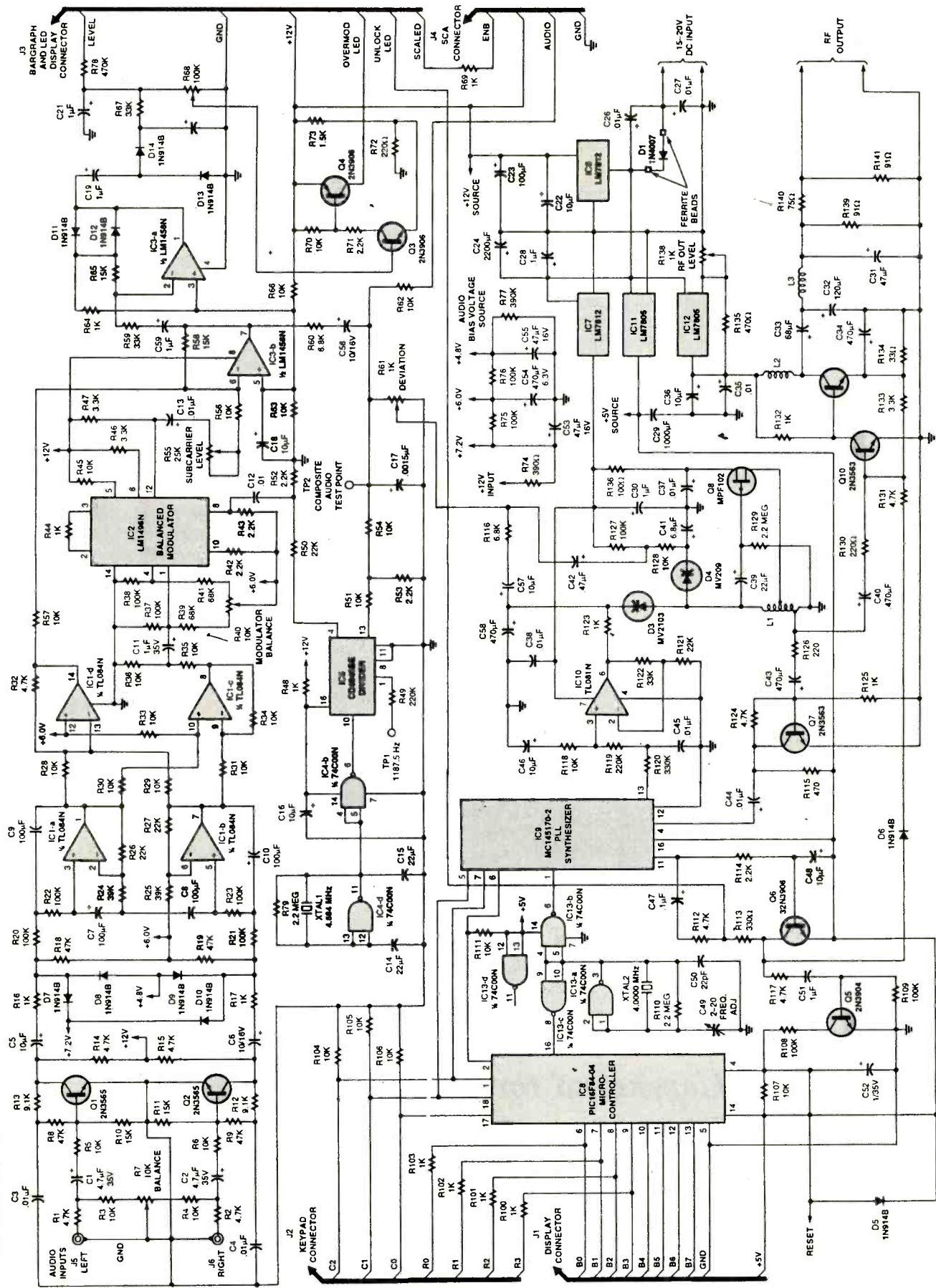

30 Fig. 1. This is the schematic diagram outlining the circuitry for the MPX 2000.

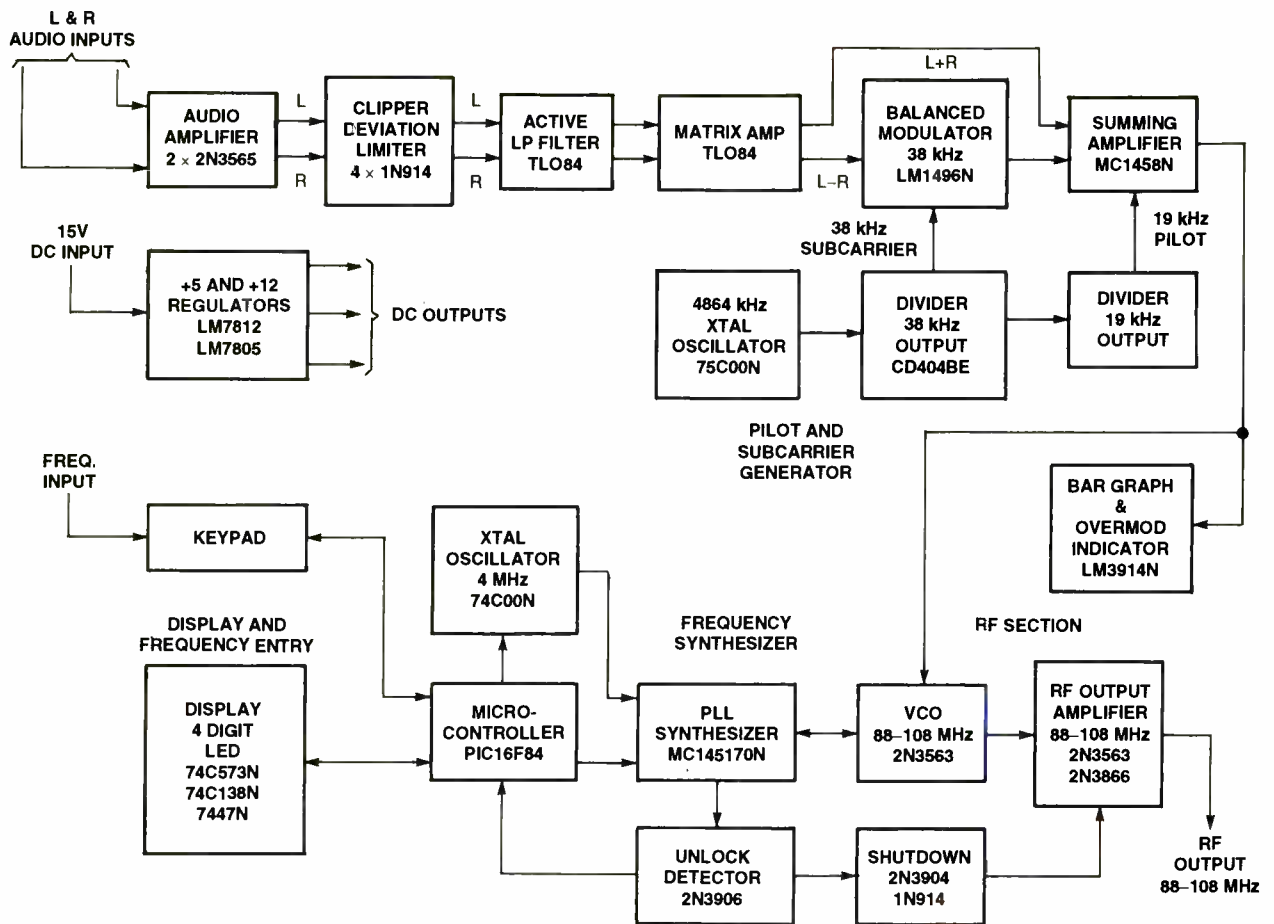

Fig. 2. A detailed block diagram—like this one depicting the signal flow within the MPX 2000—is a vital tool in designing and troubleshooting complex circuits.

demands performance and signal-to-noise ratios beyond the capabilities of these chips. Today, it is not difficult to build a stereo generator using discrete transistors and a few "classic" IC devices widely available from several manufacturers, together with a handful of resistors and capacitors that will give "broadcast quality" stereo sound to a LP hobby transmitter. In addition, all waveforms are accessible for study and for learning how the stereo system works.

Stereo Generation. The stereo generation process is as follows: The two input channels L and R (left and right) are first fed to a preamplifier where the audio is amplified and pre-emphasized. This means that higher frequencies are boosted relative to lower frequencies by a controlled amount. This improves the signal-to-noise ratio (s/n) of the received audio. In the receiver, exactly the opposite is done (de-

emphasis), which reduces high-frequency receiver noise and produces an overall improved s/n and, therefore, "cleaner" high frequencies. In US FM practice, a high-pass filter with a corner frequency of 2.1 kHz, corresponding to an R-C circuit time constant of 75 microseconds, is used. Therefore, below about 1000 Hz no alteration is made to the audio. At 1 kHz a boost of around 1 dB occurs, at 2.1 kHz a boost of 3 dB, and at 4.2 kHz a boost of 7 dB, and so on, at 6 dB per octave, until 15 kHz.

The audio then is limited in amplitude by a limiter, generally a diode peak clipper, to protect against overmodulating the transmitter. This is done for both L and R channels. Program input should be limited in frequency to 15 kHz to avoid artifacts and aliasing effects and to make the job of the lowpass filter easier. The stereo-generation process assumes that no input frequencies above 15 kHz will be present. Next,

a low-pass filter is used to reduce audio components above 15 kHz, both input and those resulting from any clipping. In European systems, a pre-emphasis time constant of 50 microseconds, corresponding to a zero at 3.15 kHz, is used instead of 2.1 kHz.

Next, the processed audio channels are added and subtracted algebraically in a matrix amplifier circuit. The L+R and L-R signals are now generated. The L+R signal is the main component of the "baseband" signal and is fed to a summing amplifier where it is combined with other components to be discussed later. The output of this summing amplifier is fed to the transmitter audio input.

The difference L-R signal must be separated in frequency from the L+R signal in order to keep them separated while being transmitted on the same channel. This is done by transforming the L-R signal into a double-sideband suppressed-carri-

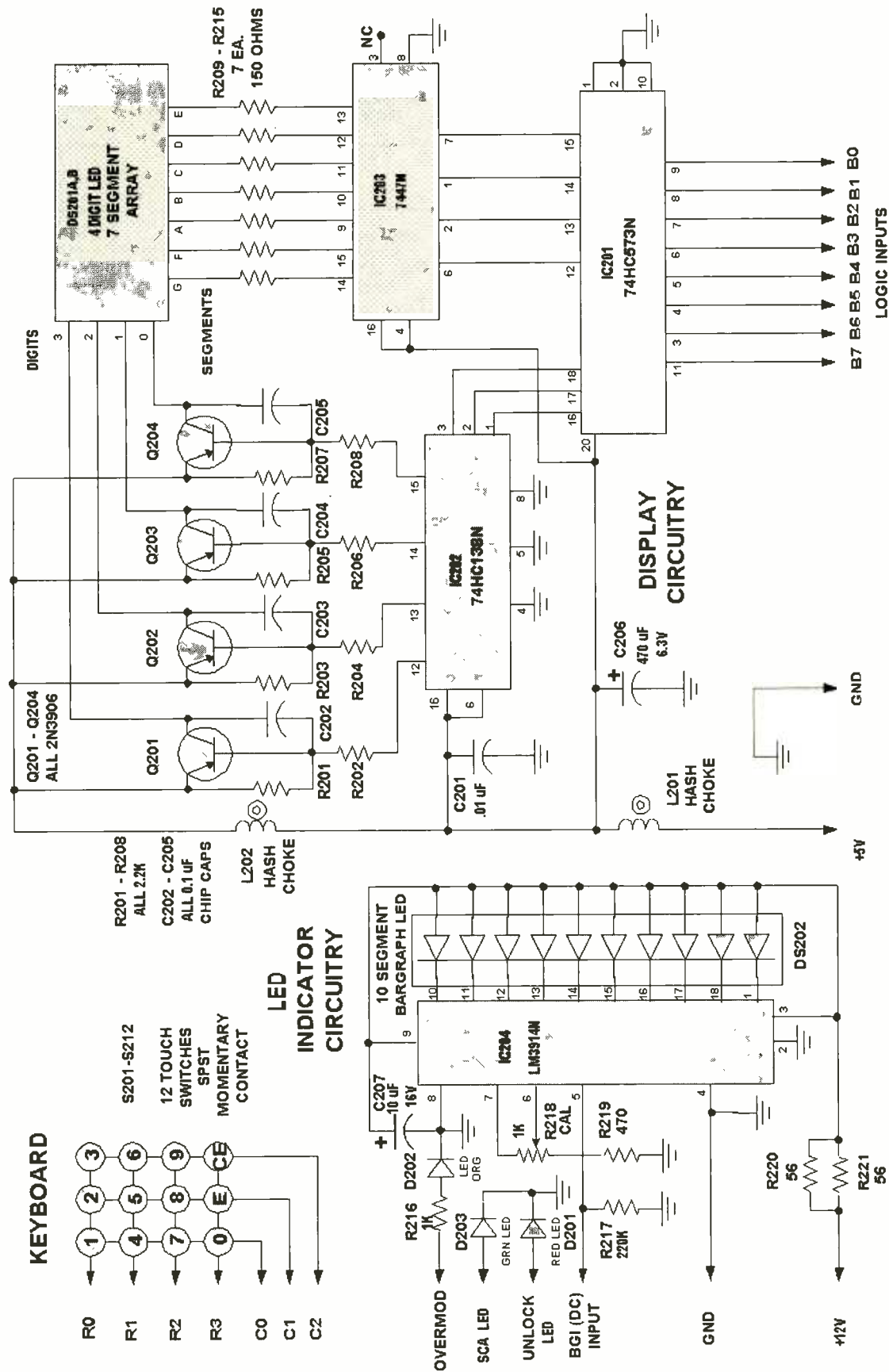

Fig. 3. This is the schematic for the display-board circuitry

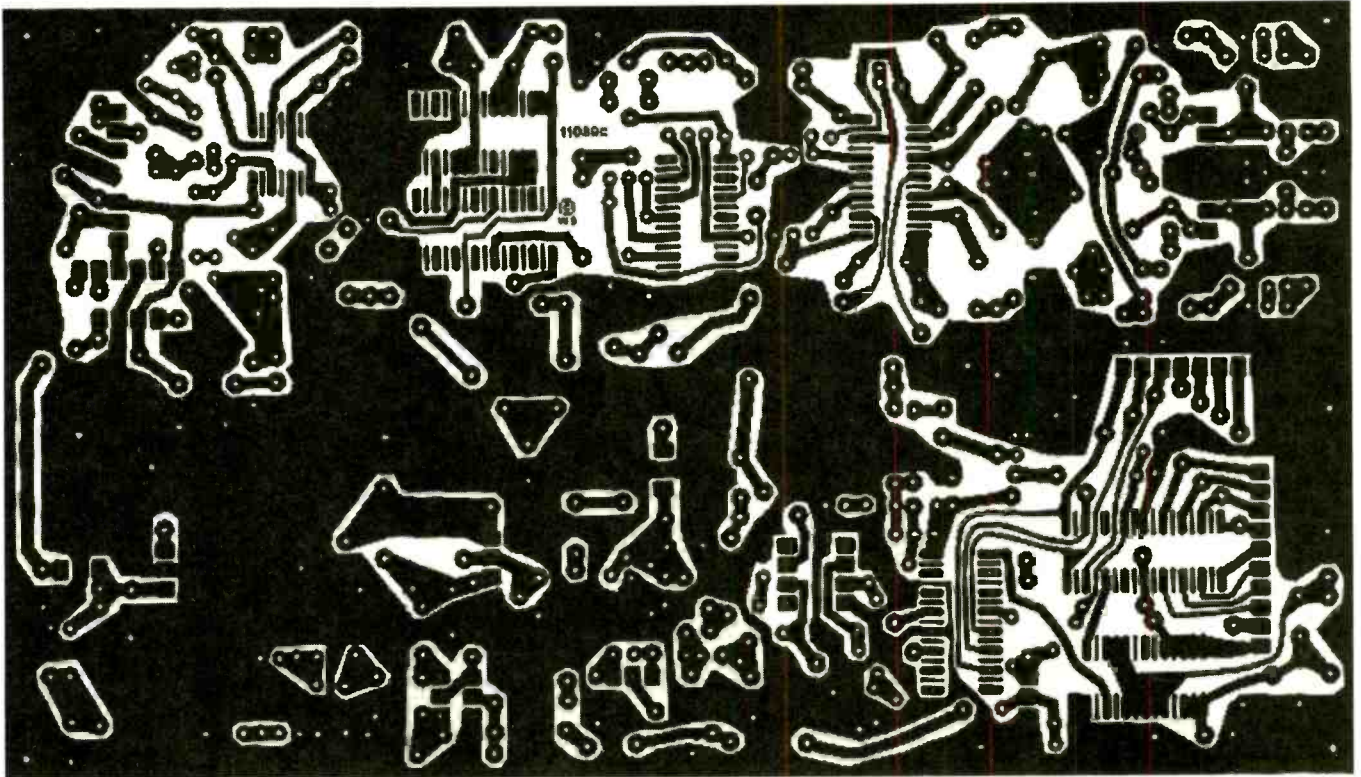

Fig. 4. Here is one of the foil patterns for the mainboard. The MPX 2000 uses a double-etched board.

er AM signal at a frequency high enough so its lowest frequency components will be far above the highest frequency components in the main L+R signal. A balanced modulator circuit is used for doing this operation. A carrier frequency of 38 kHz has been standardized for this purpose, and a pilot signal of half this frequency at 19 kHz is also generated.

The pilot signal can be doubled at the receiver and used to generate a local 38-kHz signal for demodulation of the subcarrier into L-R audio, and it can also be used to signify the presence of stereo audio. Also, the pilot carrier is used by some receivers as a signal to switch from mono to stereo and back to mono if the pilot at 19 kHz falls below a minimum level, indicating insufficient signal for good stereo reception. For TV stereo audio, 31.468 kHz and 15.734 kHz—2X and 1X the horizontal scan frequencies—can be used if the audio response is limited to about 12 kHz or so. A double-sideband suppressed-carrier signal is used because if a standard AM signal were used, the carrier at 38 kHz would “hog” a large part of the allowable deviation of 75 kHz total

permitted. This result would reduce the available deviation for the sideband components, which really carry the desired audio information the FM. In addition it would reduce the signal-to-noise ratio and contribute a filtering problem by getting rid of the carrier component at 38 kHz, while keeping the higher frequency audio components at 10–15 kHz relatively “clean.”

The audio out of the balanced modulator has components from 23 to 53 kHz. This corresponds to the sum and difference of the audio components at 0 to 15 kHz with the 38-kHz subcarrier (which is suppressed). This signal, together with the 19-kHz pilot signal, is fed to the summing amplifier. The pilot carrier and the subcarrier frequencies must be held to within one hertz or so. This is not as bad as it sounds, about 52 parts per million for the pilot carrier and 26 parts per million for the subcarrier. Since the subcarrier is referenced to the pilot, the 52-PPM tolerance at 19 kHz can easily be held with a crystal-controlled oscillator. The 38-kHz signal can be generated and then divided by two to get the 19-kHz pilot.

Although crystals for 38 kHz are available, they can be delicate

and sometimes expensive. A crystal in the 2- to 6-MHz range is, by contrast, cheaper, more rugged, and easily available. Therefore, the best approach is probably to use a crystal in the MHz range and use a CMOS divider chip to divide the higher frequency by some power of two to get 38- and 19-kHz signals. This approach is used in our MPX 2000. A 4.364 MHz crystal is used in an oscillator. Its frequency is divided by 128 to get 38 kHz and then again by two to get 19 kHz. The outputs from the divider are square waves, but the balanced modulator used to generate the subcarrier needs a square wave, anyhow. The pilot is inherently filtered by the bandwidth of the audio system. Only two common digital CMOS ICs are used in this circuit, and cost is very low.

The output from the summing amplifier has the following spectral components:

The sum of the L and R channels (L+R) consisting of audio program components up to 15 kHz. This is the part received and used by mono FM receivers.

A pilot signal at 19 kHz of sufficient 33

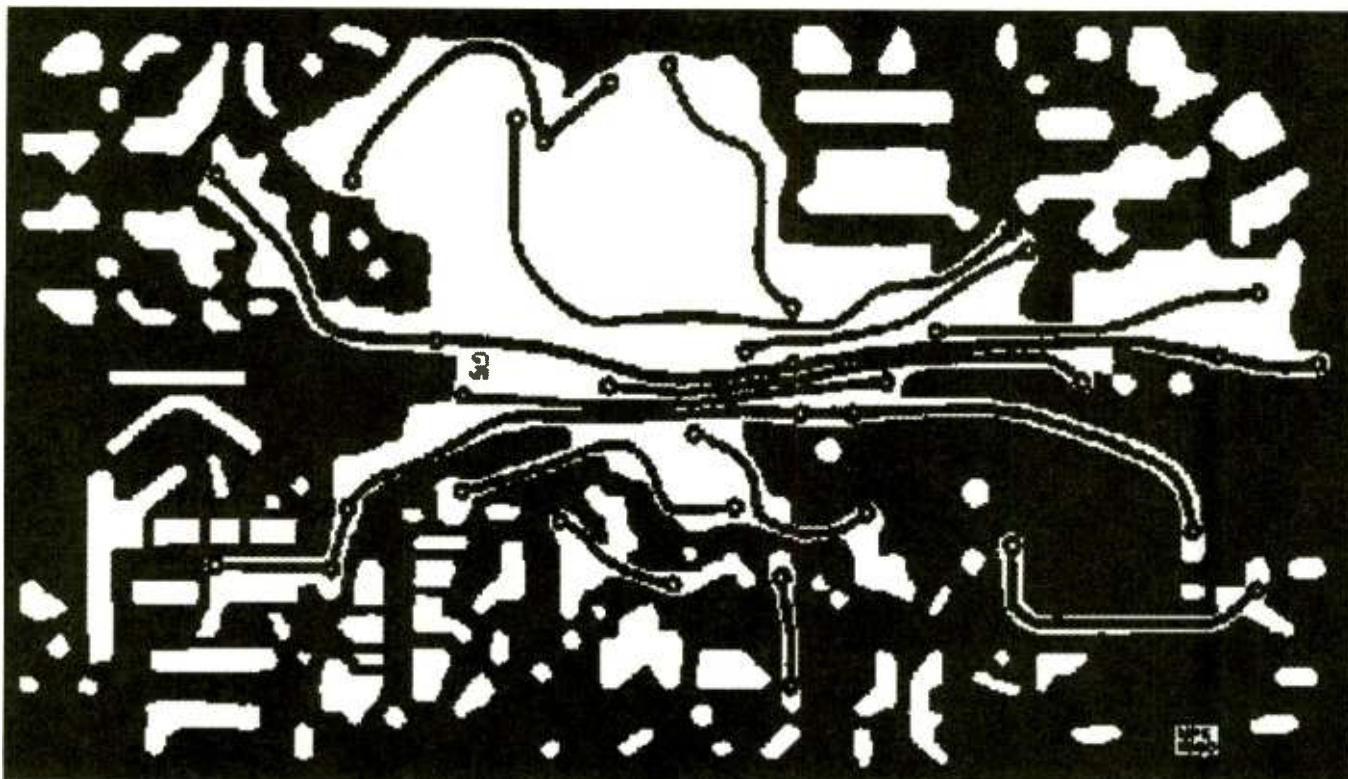

Fig. 5. This is the foil pattern for the other side of the main PC board. The double-sided design makes it easier to distribute the DC voltages needed to run the transmitter.

amplitude as to produce around 10 percent of the total deviation permitted for the transmitter. This signal is used for stereo detection and for regeneration of the 38-kHz subcarrier at the receiver

A double-sideband suppressed-carrier signal having frequency components from 23 to 53 kHz, which carry the L-R signal needed by the stereo receiver

Optionally, subcarriers at 57, 67, or 92 kHz used for data transmission or for SCA programming for use by private organizations. The MPX 2000 is ready to support this mode with an external SCA generator.

Therefore, an FM stereo transmitter must have modulation capability up to as high as 100 kHz, with reasonable flatness of frequency response. Ideally, frequency response should be flat with constant time delay vs. frequency, which implies a linear phase response vs. frequency. Distortion, both harmonic and intermodulation, should be kept low to avoid crosstalk and unwanted spurious mixing products, which interfere with audio

programming. These components may show up as noise, whistles, audio artifacts, or loss of separation. Additionally, distortion on the transmission path between transmitter and receiver must be avoided as much as possible for best stereo reception. Multi-path transmission effects that occur at VHF frequencies can cause severe distortion and ruin stereo reception. Antennas used with FM stereo transmitters and receivers must have adequate bandwidth (rarely a problem) and enough gain to ensure adequate received signal.

Circuit Signal Flow. The MPX 2000 circuitry will now be discussed. Refer to the schematic shown in Fig. 1 and the block diagram shown in Fig. 2 for this discussion. Audio input at line level (1 volt peak-to-peak at a 500- to 10,000-ohm impedance) is fed into jacks, J5 and J6, which are left- and right-audio input channels, respectively. Resistors R1 through R4, with R7, make up an input network, and R7 is used to obtain an equal audio gain for both L (left) and R (right) channels. Q1 and C1, along with resistors R5, R8, R10 and R14, all

make up the L audio preamp, which has a gain of about 5 at 1000 Hz. Gain is shaped to produce a 75-microsecond pre-emphasis standard on FM receivers used in North America. The R channel is identical (Q2 and associated components). Capacitor C5 and resistor R16 feed amplified audio into a clipper consisting of diodes D7 and D8. These are biased by voltages from the network formed by R74, R75, R76, and R77. Audio is limited to 3 volts peak-to-peak by these diodes. The R channel uses the same circuitry. The purpose of the clipping is to prevent exceeding the maximum deviation (75 kHz) with excessive audio input. The clipper acts as an audio limiter. Next, both channels are fed into a 2-pole active filter consisting of a quad op-amp, IC1, a TLO84N; resistors R20, R22, R24, and R26; and capacitors C7 and C9 (left channel). The right channel has identical circuitry. The active filters cut off at 15,000 Hz and serve to reduce aliasing distortion.

The audio signals are fed to a matrixing network using the other two sections of IC1. In one amplifier, the L and R channels are summed to produce the signal

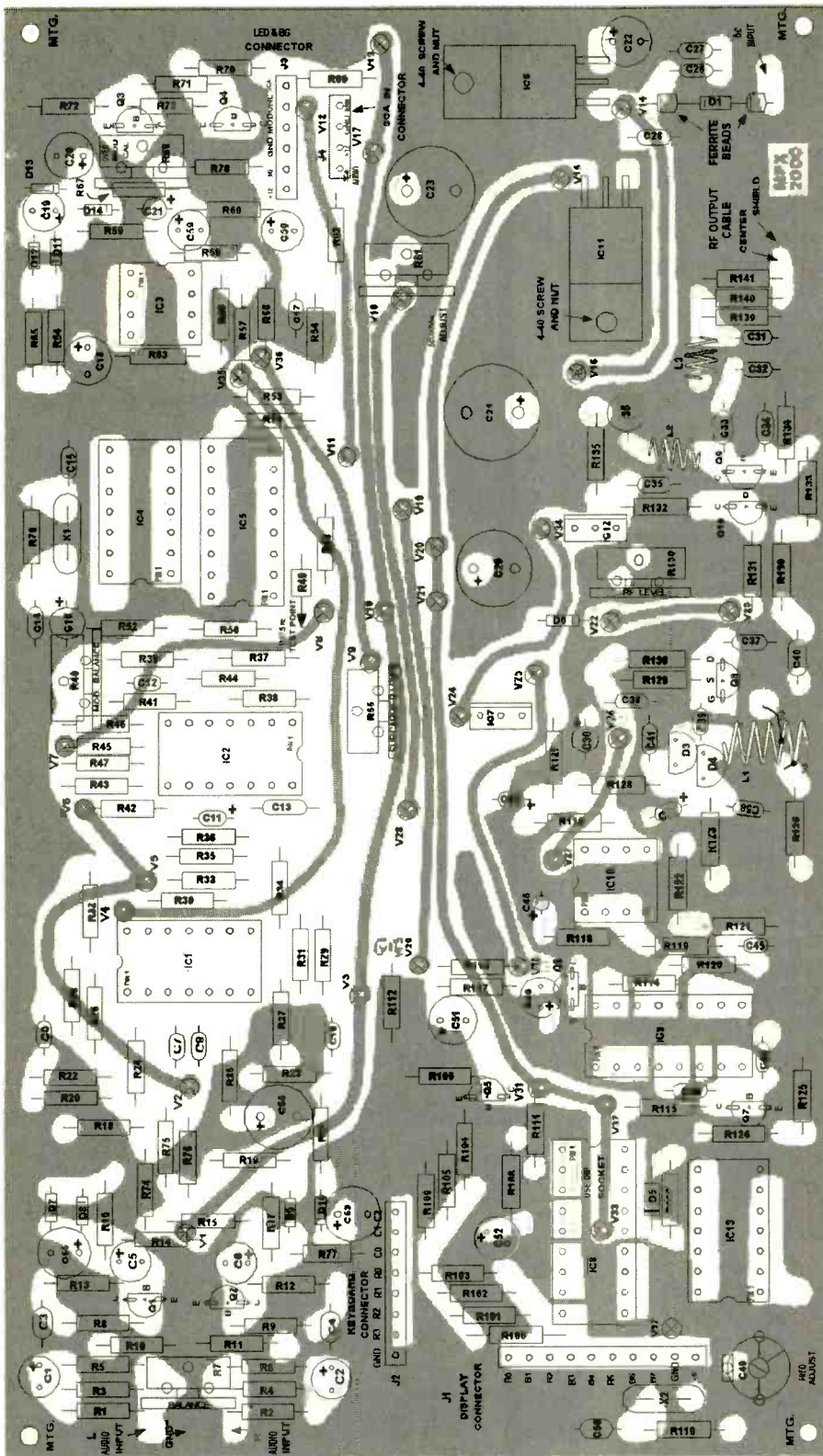

Fig. 6. When you are ready to solder components to the main board use the parts layout shown here as a guide. Pay attention to what side of the board you solder the components on.

(L+R) and the signal (L-R). Both signals are necessary for stereo generation. The signal (L+R) is the main monophonic channel that occupies the band 20 to 15,000 Hz, and

it is the signal received in a monophonic FM receiver. This allows stereo to be received as mono on an FM receiver without a stereo decoder, ensuring compatibility.

The signal (L+R) is fed to summing amplifier IC3 via R57 where it will be combined with two other signals, the subcarrier signal (L-R) and the 19 kHz pilot. The signal (L-R) is the difference between the channels. This audio signal has the same frequency components as the main signal (L+R) and cannot be transmitted in the same channel as the (L+R).

To solve this problem, the signal (L-R) is then modulated on a subcarrier at 38 kHz. The result is a double-sideband AM suppressed-carrier signal occupying a band from 23 to 53 kHz (38 kHz plus and minus up to 15 kHz). It is produced with a balanced modulator circuit, IC2, and its associated components. Audio (L-R) is fed into IC2 via R35, R36, and C11. Pins 1 and 4 of IC2 are fed DC bias via R37, R38, R39, and R41. Resistor R40 is used to balance the voltages at pins 1 and 4. Balance occurs when they are identical. Resistor R44 sets the circuit gain; and R42, R43, R45, R46, and R47 are biasing resistors for the input and output of IC2.

The 38-kHz subcarrier is inputted at pin 8, and output appears at pin 12. In the absence of input, the audio output is zero; and, in practice, R40 is adjusted to null the 38-kHz output with no L-R input. The 38-kHz signal is obtained from frequency divider, IC5, a CD4040BE. This IC is driven by a crystal oscillator/buffer at 4864 kHz, made up from two sections of a 74C00N NAND gate. Capacitors C14 and C15 and IC1 make up the oscillator circuit. In addition, a 19-kHz signal for the pilot carrier and an 1187.5-Hz signal useful for testing are obtained from the CD4040BE at pins 13 and 1, respectively. The 1187.5-Hz signal is taken off through a series resistor, R49, and can be used to test the audio section, but is otherwise not used in the system. The subcarrier output is taken off through C13 and level control R55 and is fed to summing amplifier, IC3.

The output of IC3 is the sum of (L+R) and the (L-R) signal. It is fed to network C17-R61 via R60. In addi-

tion, the 19-kHz pilot signal from IC5's pin 13 is fed to this point via attenuator R51, R53, and R54, where it is reduced to 7 to 10 percent of the peak audio level. This 19-kHz signal is used by the receiver to generate a 38-kHz subcarrier for recovery of the audio (L-R) component from the 38-kHz subcarrier signal received along with the main (L+R) signal. Adding and subtracting (L+R) and (L-R) will result in 2L and 2R, which are the individual L and R audio channels.

The signal appearing across network R17-C61 is called the baseband or composite stereo multiplex signal. This signal is fed to the transmitter modulator. In order to ensure good audio quality on the transmitted signal, some audio-level monitoring is needed. The MPX 2000 uses a 10-segment bar-graph level indicator, which consists of ten LEDs mounted side by side to simulate a solid-state meter movement. In addition, another LED is provided which lights when the peak audio level that would result in overmodulation is reached. Audio from the summing amplifier is taken via R59, fed to an op-amp, a section of IC3, and then rectified to produce a DC level corresponding to the peak audio signal. Resistor R65 sets the gain of this stage to unity; and C19, D13, D14, and C20 make up a half-wave voltage-doubler detector. Diodes D11 and D12, and resistor R64 are used to improve the linearity of the circuit at lower signal levels. They increase the gain of IC3 to permit low-level signals to overcome the 0.6 volt drop normally encountered in silicon diodes.

The audio components are removed by R67 and C21 and applied across potentiometer R68. The DC voltage is fed to the bar-graph level display via R78. A part of this voltage appearing from the wiper of R68 to ground is fed to the base of Q3. The emitter of Q3 is biased at 1.5 volt via R72 and R73. Potentiometer R68 is adjusted so that when the audio signal lights all ten segments of the bar-graph display plus 10 percent more, there will be sufficient voltage (2.2V) available at the base of Q3 to cause it to conduct. This signal turns on Q4 via R70 and R71, causing voltage to appear from the collector of Q4 to ground. This voltage is fed to an LED on the display, lighting it, and indicating overmodulation. The display panel will be described separately in another part of this discussion.

Frequency Modulation. An RF carrier that can be frequency modulated is required. It should be variable from 88 to 108 MHz to cover the entire FM broadcast band, and it must be stable within 10 kHz or better. The MPX 2000 uses a phase-locked loop (PLL) frequency synthesizer to generate all 200 channels at 100-kHz spacing, between 88.1 and 107.9 MHz—the standard FM broadcast band. The synthesizer is frequency modulated by applying audio to its voltage-controlled oscillator (VCO). Contradictory as it seems, we want the VCO to be rock stable and to vary the frequency. With proper design, this can be accomplished without any serious compromises in transmitted audio quality or synthesizer performance. The VCO is the heart of the transmitter, and the synthesizer circuitry serves to keep it exactly on the desired transmit frequency.

Free-running oscillators were used in the past for this

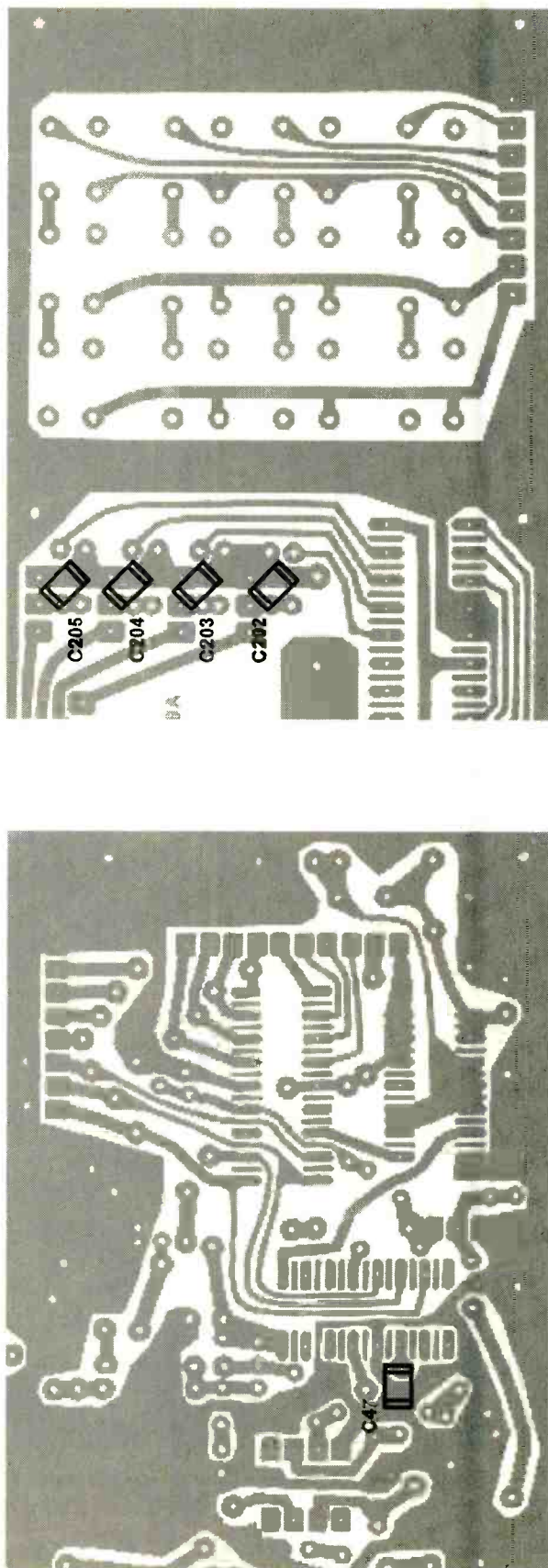

Fig. 7. These two guides show the soldering points for required chip capacitors.

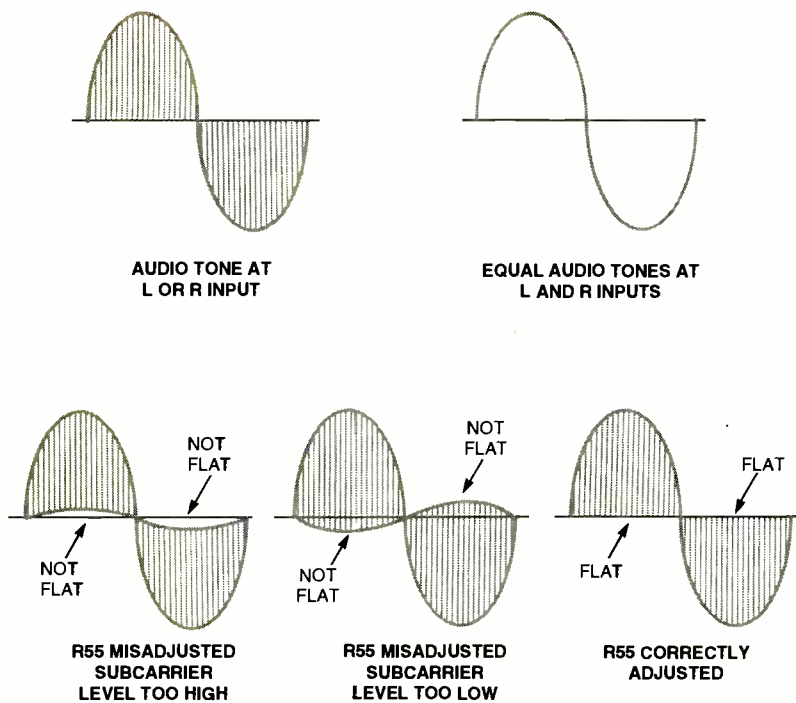

Fig. 8. These waveforms can serve as a guide for signal chasing. An oscilloscope can be used to compare the composite audio-signal to the nominal waveform shown above.

application. This approach is still used in low-end, low-cost FM transmitters. It is difficult to keep these transmitters on frequency, and, therefore, they can be hard to use, especially with digitally tuned receivers. Stability of better than 100 kHz is difficult to come by with this approach. The use of frequency synthesis eliminates this problem. The VCO output must be buffered to eliminate frequency pulling caused by varying antenna loads, proximity effects, etc.

In the MPX 2000, JFET Q8 is the VCO. Inductor L1 and the combined capacitances of tuning varactor D4 and modulator varactor D3 together make up the L-C tuned circuit that determines the transmitter frequency. JFET Q8 is biased by R129 and R136. The drain of Q8 obtains DC from R136. Feedback is from a tap on L1, which is fed to the source of Q3 via C42. Capacitor C40 and resistor R130 couple some output from the VCO to buffer amplifier circuit Q9-Q10, made up of R132, R133, R134, and C34 and C35. Inductors L2 and L3 and capacitors C33, C32, and C31 make up an RF output network and harmonic filter for the buffer amplifier. Resistors R139, R140, and R141 ensure proper ter-

mination of this network and feed RF to the antenna. Resistors R135 and R138 make up a regulator circuit to feed regulated 5.6 volts to the buffer amplifier. In case of synthesizer malfunction, a DC level from the synthesizer IC is fed to R131 and cuts off the buffer, killing the RF output and reducing the possibility of transmitting outside the FM band.

Frequency Control. Voltage from the PLL chip phase/frequency detector tunes the VCO. The PLL chip (IC9) is a Motorola MC145170-2. Inside this chip, a sample of the VCO signal is compared with a reference frequency. If they are not in phase and frequency agreement, an error voltage is generated. This is used to change the tuning voltage on the VCO to achieve frequency and phase agreement (lock). Resistor R126 and capacitor C43 feed a sample of the VCO signal to amplifier Q7. Collector resistor R115 biases Q7, and the signal to drive IC9 appears across it. Capacitor C44 couples this signal to chip IC9. Integrated circuit IC13 generates a clock signal at 4.000 MHz via XTAL1, trimmer C49, and C50. Capacitor C49 is used to adjust the frequency to exactly 4.000 MHz, which is used

both as a reference signal for the PLL synthesizer and for microcontroller IC8. Two sections of IC13 are used as buffers to provide this signal to IC8 and IC9.

The synthesizer frequency depends on several data words programmed into IC9. The needed data words are provided by IC8, a PIC16F84 microcontroller. This microcontroller has built-in software to program IC9 and to manage other tasks, such as the control of the frequency display and scanning the keypad for frequency entry. Other functions necessary are system shutdown in case of malfunction, rejection of out-of-band frequency entries, and automatically setting to the last transmitted frequency upon power-up.

When a valid frequency is entered, a voltage appears at the phase-detector output pin (13) of IC9. This voltage is fed to network R118, R119, R120, and C46. This network determines some of the loop characteristics of the synthesizer. The output of this network is fed to op-amp IC10 and then to tuning varactor D4. At lockup, this will be a steady DC voltage, varying from 3-4 volts at the low end to as much as 10 volts at the high end of the FM band.

In case of loss of lock, IC9 produces pulses at pin 11. These pulses are integrated by R114 and C48. The DC voltage turns on Q6, placing 5 volts across R113 and R112 and D6. This sequence sends a voltage to the unlock indicator LED, D201, and cuts off the RF buffer via D6 and R131. In addition, the rising voltage is coupled to the base of Q5 via R142 and C51, turning on Q5 momentarily. This action causes Q5 to conduct, resetting the microcontroller via R108 and resetting network D5-R107. Capacitive coupling is used to couple the signal to Q5 so as not to permanently reset the microcontroller; otherwise, a lockup condition will occur. Normally, resetting will be a sufficient cure if the problem is incorrect frequency entry or a "glitch," as resetting the microcontroller will reprogram IC9 with the correct data. During this process, the RF output is disabled.

Modulation is achieved by applying baseband audio from R61-C17 to varactors D3 and D4. This allows

better modulation and fewer compromises than if audio were applied to the tuning varactor D3 alone. Integrated circuit IC7 provides a regulated 12 volts to the PLL and helps filter out any noise disturbances appearing on the power supply.

The audio section is supplied with 12 volts regulated from IC6, and IC11 supplies 5 volts to the microcontroller, display logic, and PLL synthesizer IC. The use of separate regulators for audio and digital functions helps to reduce circuit noise. DC input to the MPX 2000 should be between 15 and 20 volts to allow sufficient headroom for the regulators, keeping dissipation within reasonable limits. (This can be reduced a few volts with low dropout regulators). Care must be taken to use a wall transformer that is adequately filtered so that the input voltage waveform to the MPX 2000 never gets below 15 volts. With less than 15 volts input, there will not be sufficient DC voltage to allow full VCO swing; and some of the 88–108-MHz tuning range will be lost at the high-frequency end. Also, adequate RF decoupling of the DC supply is needed to reduce the possibility of RF-induced ground hum on the transmitted signal. RF chokes may be needed in both power leads in certain situations.

Display-Board Design. Let's discuss the display-board circuitry (refer to Fig. 3 for schematics). This board contains a 4 × 3 matrix of touch switches arranged in 4 rows and 3 columns, a 4-digit multiplexed display, and the bar-graph LED and its associated driver, an LM3914 (IC204). In addition, three other LEDs that serve as overmodulation (D202), PLL unlock (D201), and SCA subcarrier ON (D203) are also on this board. The keyboard is polled periodically by the microcontroller for switch closure by applying a logic level to a row and looking to see if this level appears on one of the three columns. Each switch has a unique row and column location; and the switches are scanned sequentially, 1 through 10 (10 is represented by zero). There are two other keys, E (enter) and CE (clear entry). The desired frequency is entered, most significant digit first. Since we have four digits, the most significant digit is zero for frequencies below 100.0 MHz. This zero does not have to be entered, but it is recommended. This eliminates possible "glitches" or entry errors and fully clears the keyboard memory. When the first entry is made, two zeros appear on the display to the left of the entered digit. The leftmost is blanked on leading zeros. For example, 99.5 MHz will be displayed as 995 instead of 0995.

No changes are made in the PLL programming or the transmit frequency until the enter key is pressed. The digits appear on the display as they are entered and shift right to left. If more than four digits are entered, the leftmost will be shifted out. After the display shows the desired frequency, the E key is pressed. If it is a valid (legal FM channel) entry, the display retains it, the PLL shifts the transmitter frequency to it, and it is also stored in memory. It will come up when the MPX 2000 is powered up the next time. If an illegal entry (<88.1 or >107.9) is made, the microcontroller rejects it and simply reverts to and displays the current

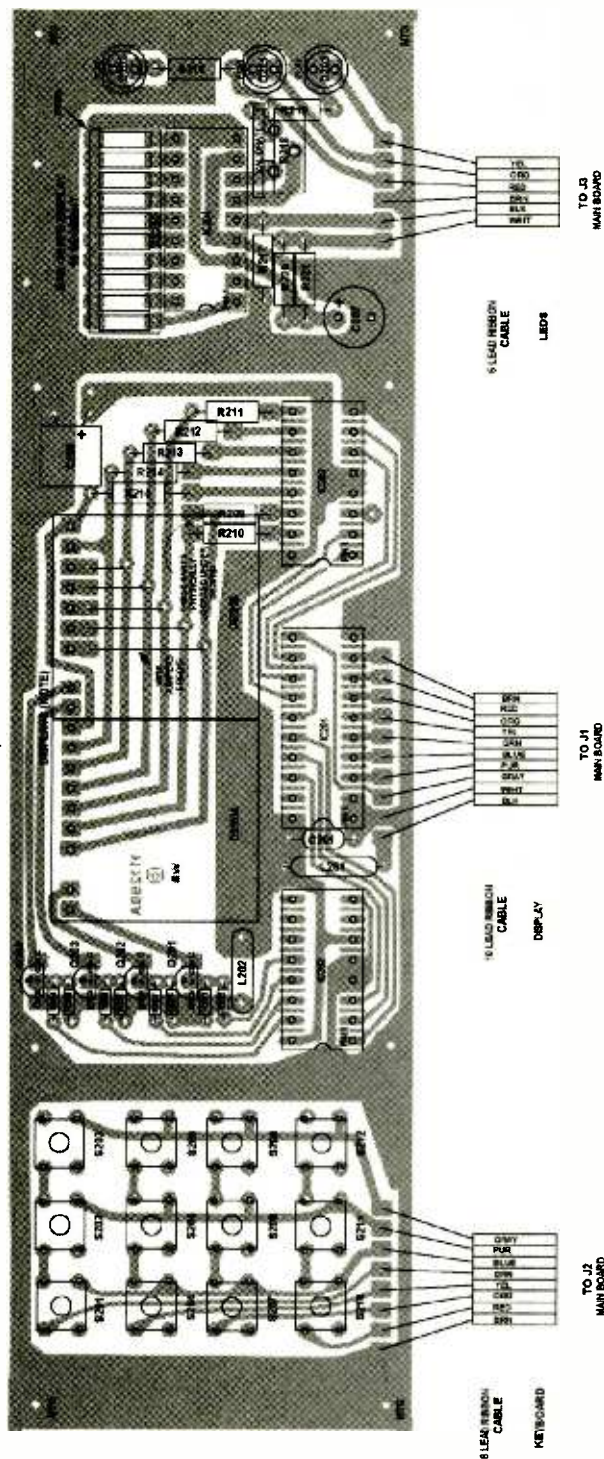

Fig. 9 This parts-placement diagram shows the display-board components' location. Pay careful attention not to apply too much stress on the cable ribbons.

frequency. If an error is made during entry, press the CE key and the current frequency once again appears. When the MPX 2000 is powered down, the current frequency is retained in memory and reappears on the next power up. No memory backup battery is needed for the microcontroller.

The display section is a conventional 4-digit multiplexed display using four seven-segment common

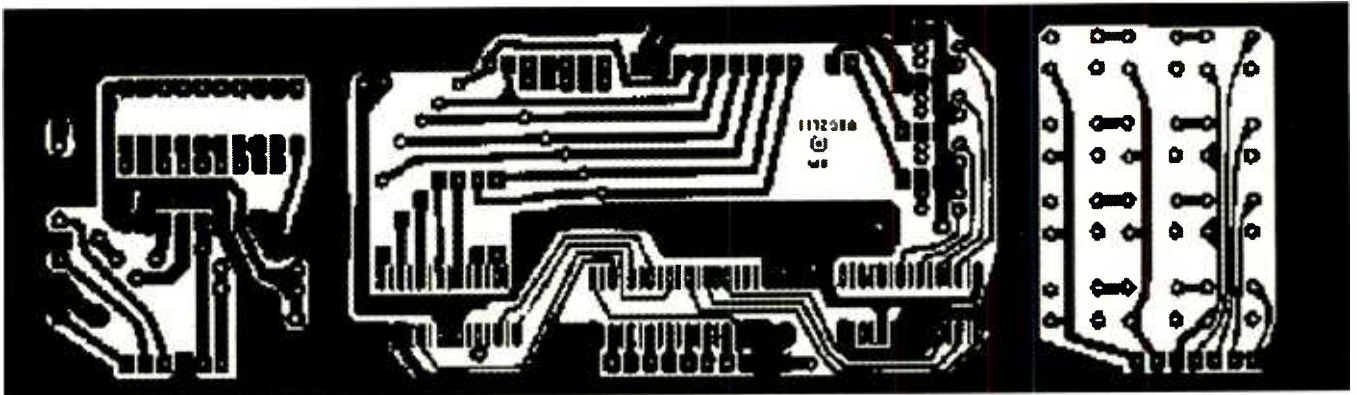

Fig. 10. Here is the display-board foil pattern. The display board is exactly half the size of the main board.

anode LED digits, driven by a 7447N TTL driver IC. Resistors R209 to R215 are current-limiting resistors for the individual segments. No decimal point is used in this display. There are eight logic inputs from the microcontroller, and those feed a 74HC573N 8-bit latch IC201. The digit data is latched into the 74HC573N by a strobe pulse from the microcontroller at the appropriate time, and this data contains the binary value of the particular digit and its position on the display. A 74HC138N decoder decodes the digit-select information, and its output turns on one of four 2N3906 switching transistors Q201-Q204, via bias resistors R201-R208. Inductors L201 and L202, along with capacitor C206, are noise-suppression chokes to reduce switching noise. The display segments are operated at 20 mA each and if an 8 is shown, 140 mA must be switched by the 2N3906 associated with that digit. Chip capacitors C202-C205 slow down switching speeds to further reduce noise spikes.

While an LED display can be noisy and can consume a lot of current, it is much brighter, has more eye appeal, and is easier to read than an LCD. LED readouts need no illumination. The display is shut down by the microcontroller about 15 seconds after the last keypad press, cutting off the display multiplexing and leaving a few segments lit on the least significant digit to serve as a power indicator. This approach eliminates residual switching noise generation and conserves current. The display can be awakened by pressing the zero key to check the current frequency

setting. It will stay on for 15 seconds and go back to sleep.

The display and multiplexing could have been handled directly by the microcontroller without the three ICs. However, the software overhead would be larger, and the current for the LED display would be too much to be directly handled. This approach was tried, but there were problems—the display was too dim, performance of the microcontroller was a little slow, and some additional “glue” circuitry was needed because of the limited number of pins available on the PIC16F84. In cases like this, a “hardware versus software” trade-off has to be made. The hardware multiplexing approach was used here as it gave the best results. A larger microcontroller could also have been employed, but this was not investigated.

The bar-graph display is conventional and uses a LM3914 linear bargraph driver (IC204). DC input from the main board is applied to pin 5 of IC204, and the sensitivity is determined by the setting of R218. Approximately 0.8 volts DC is needed to light all ten segments of LED display DS202. Resistor R218 is set so that ten segments light when the main board audio system is producing full audio level just short of limiting. This represents 100 percent modulation. Resistors R220 and R221 limit power dissipation in IC204, and C207 bypasses the V_{CC} line to the display. LED D201 is fed from the unlock detector on the main board. When it is illuminated, it indicates that the PLL is unlocked. LED D202 is powered from the main board and is illuminated when audio clipping occurs, indicating

over modulation. LED D203 is used to indicate that the optional SCA audio-subcarrier system is activated.

The MPX 2000, once programmed to a desired frequency, will operate without the display board, since its functions are mainly supervisory. The board may be disconnected during operation with no effect on the transmitted FM signal. However, it is needed for reprogramming of frequency.

Overall power requirements of the MPX 2000 are 15 to 20 volts DC at 350 mA. The display consumes much of this current. If the display is asleep, the current is about 160 mA. When the display is disconnected from the main board, current consumption drops to 125 mA. Operation below 15 volts is not recommended unless low-dropout regulators (LM2930, etc.) are substituted for the LM7812s used here. Operation above 20 volts may cause overheating of the 5-volt and 12-volt regulator ICs. Heatsinks should be fitted to these ICs if operation over 20 volts is expected. The DC input is polarity protected by D1 and accidental polarity reversal will do no harm; the MPX 2000 simply won't operate and won't draw any current until the supply polarity is corrected.

Construction. Although the MPX 2000 PC boards aren't difficult to assemble for someone with a little experience, it is important to follow a certain assembly sequence to avoid mistakes that could lead to hard-to-find problems. In particular, a number of through-hole connections (vias) are required to connect traces on both sides of the board.

Plated-through boards are great 39

MPX2000 Coil Winding Information

L1 VCO Coil

5 turns #18 bare tinned wire on 1/4 inch form. Use a metal, wood, or plastic rod, or the shank of a 1/4 inch drill bit. Remove form and space turns approximately 1 wire diameter so as to fit PC board. Coil must be wound in direction shown or taps will not come out in correct places

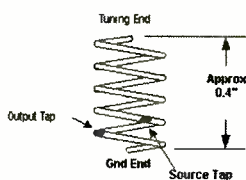

Output tap 3/4 turn from bottom
Source tap is 1.3/8 turns from bottom

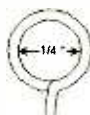

End View



Side View

L2, L3 Output Coils

4 turns #22 bare tinned wound in threads of 8-32 machine screw. Remove screw after winding and install coils in PC board

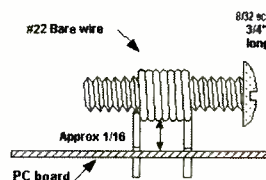

Side View

L201, L202 Hash Chokes

15 to 20 turns #24 gauge enamelled wire on 0.375" dia. Ferroxcube toroid 3E2A material. Strip insulation, tin, and mount in Display PC board



A) Each pass through hole counts as 1 turn
B) Remove enamel and tin leads as shown
C) Install in PC board tight to surface, per layout

Fig. 11. Carefully follow these instructions in order to fabricate your own coils and chokes for use in the transmitter.

for mass production of PC boards. They reduce assembly cost and facilitate soldering. However, the use of homemade boards generally precludes plated-through holes. Making a few assembly errors in constructing any new project is expected. If you must remove a component from a plated-through board, you will find it very difficult and will probably ruin the component and the PC board, as well. That is why we do not recommend the use of plated-through PC boards in this project.

The boards are best assembled and tested circuit by circuit. First, the main board can be prepared, using Figs. 4 and 5 as references for the PC-board foil patterns. Figure 6 and Fig. 7 can be used as guides for component placement on the main board. Build one section at a time, starting with the installation of jumper vias and the parts for the

power-distribution circuitry. After the power circuitry is completed, a power supply of 15 to 20 volts DC and a DC voltmeter are needed to test the circuitry—a VOM or a DVM will do. Power up the board, and using the meter check the continuity of the power-distribution circuitry. Next, the audio (MPX) circuitry can be assembled and tested. If

these test results are OK, the display board should then be assembled. At this point, the main board will have the microcontroller section installed; and this can then be tested together with the display board if desired. After this is done, the RF circuitry can be assembled. Now, the entire MPX 2000 can be checked out. At this time, the project will be operational. There are no critical adjustments to be made, and it should work the first time with the default settings given in the assembly procedure that follows, assuming that there are no mistakes.

While it is possible to simply "stuff" the PC boards and wait until after completion of assembly for testing, this is not recommended unless you are very experienced.

After completing the power-distribution circuitry, install all vias and any parts that connect to them—the regulators and DC power supply filtering and bypassing components. Check your work and make sure all connections are soldered. Connect +15 to +20 volts DC to D1 (positive lead) and the negative lead to ground on the PCB. Check for the following voltages. All voltages assume that the regulator ICs supply an exact 5 or 12 volts. Since they have a 5 percent tolerance that is acceptable for this application, remember to allow for this if the voltages are a little low or high, as they will be dependent on exact regulator voltage. Consult the parts-placement diagram for the physical location of the test points as needed. Table 1 is a list of voltages to check.

Next, inspect all V points (see parts-placement diagram) to make

TABLE 1

• Junction C26, C27, D1 (Input)	+15 to +20 V _{DC}
• Junction C28, IC6, IC11, IC12, IC7	+14.4 to +19.4 V _{DC}
• V31	+5.0 V _{DC} ±5%
• V1	+12.0 V _{DC} ±5%
• V6	+6.0 V _{DC}
• Wiper, R40	+6.0 V _{DC}
• Junction R74, R75, C53	+7.25 V _{DC}
• Junction R76, R77, C55	+4.75 V _{DC}
• Junction IC7, C30	+12.0 V _{DC}
• Junction IC12, C36	+5 to > +12.0 V _{DC} (Should vary with R138. Set for +5.6)

sure they are soldered and a clean contact exists between the traces on both sides of the board. The purpose of these tests is to make sure that all sections of the PC board will get DC power and that all signal traces are intact. Then, install the audio and MPX generator circuit components.

Audio And MPX Generator Benchcheck. Apply +15 to +20 volts as before to the DC input and check for the following voltages (Table 2). It is assumed that all voltages that you obtained were as specified in the first checkout of the PC board, before the audio components were installed. Ten percent tolerance is OK. Preset all potentiometers—except R138—to the center of rotation.

• Q1 and Q2 Collector	+3.6 V _{DC}
• IC1 Pin 4	+12.0 V _{DC}
• IC1 Pins 1, 7, 8, 14	+6.0 V _{DC}
• IC2 Pins 1, 4	+3.1 V _{DC} (varying with R40)
• IC2 Pins 2, 3	+2.4 V _{DC}
• IC2 Pins 8, 10	+5.9 V _{DC}
• IC2 Pins 6, 12	+8.5 V _{DC}
• IC2 Pin 5	+1.2 V _{DC}
• IC3 Pins 1, 7, 8, 14	+6.0 V _{DC}
• Q4 Collector	0 V _{DC}
• Q3 Collector	+12.0 V _{DC}
• Q3 Emitter	+1.5 V _{DC}
• Junction R67, R68, R78, C21	0 to +0.2 V _{DC}
• IC5-Pin 16	+7.5 to +9.0 V _{DC}

Next, set R40 so that the voltage between pins 1 and 4 of IC2 is zero. Make this adjustment with the most sensitive scale on your meter to as low as 1 mV, if possible. Using a scope and audio generator, you can apply a 1-volt peak-to-peak audio signal to the L and R inputs and trace the signals through the circuitry. This is excellent for uncovering any errors—so far. Using a source of stereo audio—such as a CD player, cassette player, or a stereo receiver—you can trace the signals through the circuitry with an audio amplifier and speaker. You will not be able to hear the pilot and the subcarrier signals (unless you are a cat or a dog), as they are above the audible range of frequencies. Refer to the waveform

diagram (Fig. 8) for audio waveforms. Adjust R7, R40, and R55 as needed to get these waveforms. If you don't have the test equipment for this procedure, then leave all potentiometer adjustments where they are. If the DC voltages were all correct and your assembly is error free, all should be OK so far.

Construction Of The Display Board.

The display board consists of three separate circuits: the keypad, LED display circuitry, and the bar-graph metering and status LEDs (see Fig. 9 and Fig. 7). These should be tested in conjunction with the microprocessor section, but some initial tests can be made on this board without it. This board is single sided and the foil pattern is shown in Fig. 10.

Insert the 12 touch switches that

make up the keypad. If you like, you can check out the keypad with an ohmmeter to see if continuity exists between a row and column when the corresponding switch is pressed.

Next, assemble the display section (center of display board). Make sure that you first install the jumpers below the site for the LED displays. You can use low profile DIP sockets here if you wish to avoid soldering the ICs directly onto the PC board. Now, install LED assembly DS201. This consists of two identical 2-digit subassemblies. Next, fabricate and install hash chokes L201 and L202. These are not critical as to inductance, and 15 to 20 turns will be OK.

Install a 20-pin socket where

DS202 is to be located. This socket MUST be used so the top of DS202 will be at the same height as DS201. Then plug DS202 in the socket making sure the rounded corner or pin 1 indicator faces the corner of the PC board. No harm will be done if DS202 is inserted backwards, except that DS202 will fail to light.

Next, install IC204, the LM3914N BG driver chip. You can use a DIP socket if you wish, as before. Install LEDs D201, D202, and D203, making sure to observe polarity. Also make sure the tops of these LEDs are the same height as DS201 and DS202. This completes the display-board assembly.

Microcontroller And Logic. First, install ten-pin header (J1) and eight-pin header (J2) as shown in the display-board parts-placement drawing. Make sure V32 and V33 are well soldered, as you will not be able to get at them after this step. Next, apply DC power to the board as before and check for +5 volts on the J1 pin shown. Remove DC power and allow a minute for the capacitors to discharge. Then, install the programmed PIC16F84 microcontroller and all related parts. The microcontroller must be programmed with the appropriate software in order to operate properly. If you are building this project from scratch, you will have to do this for the project to work. Refer to the books and data sheets published by Microchip Corporation to see how this is done. You can write your own software or, if you prefer, a preprogrammed microcontroller can be purchased from the source mentioned at the end of this article.

Make sure to install an 18-pin socket at IC8. This is required to allow easy removal of IC8 so that future changes can be made to the internal operating software if needed. You may also install a DIP socket for IC13, but this is optional. The display board can be connected to the main board using ribbon-lead cable of the kind used in PC internal cabling, and this is recommended. You can use Molex or similar connectors with 0.100-inch spacing to plug directly into the headers on the main board. However, installing these connec-

tors generally requires a special crimp tool. Alternatively, you can use solder-type connectors or "press on" types. Check out a computer parts catalog for suitable connectors.

Connectors are not absolutely needed, although it does make testing easier. However, it takes time to install these connectors and may not be worth the time and effort to do it. Once the MPX 2000 is assembled and packaged in a case, these leads will not usually have to be disconnected again. You can check out the microcontroller section now, but it requires wiring it to the display board and disconnecting it again. If the wiring is correct, there is little to go wrong here.

PLL And RF Section. This section is the last to be assembled and when completed, the MPX 2000 PC boards will be ready for final testing and installation in a case of your choosing. Once again, refer to Fig. 6 for parts-placement information. First, install all the resistors and then the capacitors, followed by transistors Q5 through Q10 and all the diodes. Next, install remaining ICs—IC9 and IC10. Again, you can use low-profile DIP sockets for IC9 and IC10, if you wish. Make sure to observe correct IC orientation. The final step is the fabrication of L1, L2, and L3. Inductor L1 is five turns of #18 tinned wire wound around a 1/4-inch mandrel. The coil (L1) is installed in the PC board with the turns spaced evenly so it fits the PC board. A tap consisting of a short wire lead soldered to the appropriate point on the PC board is then connected to the first turn of the coil as shown in Fig 11. Inductors L2 and L3 are made from four turns of #22 bare tinned wire, wound using the threads of an 8-32 screw as a mandrel. They will look like small springs when completed—the screw controls the dimensions, so you cannot go wrong. Shape the leads as shown in Fig 11. Remove the screw and install the coils in the PC board. Make sure no adjacent turns short together on L1, L2, or L3. Next, check over all work done so far for any errors. You are then ready to do final testing. The dis-

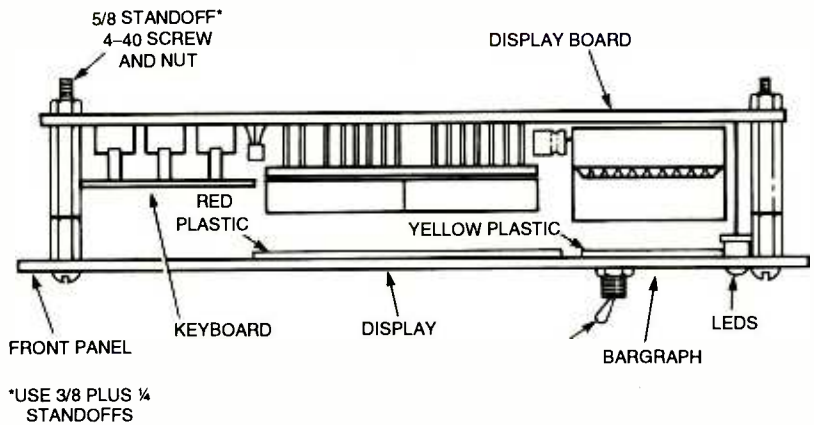

Fig. 12. Here is the front-panel design used by the authors. The container should provide adequate space for the boards to fit snugly, yet without crimping the various cables connecting the display to the main board.

play board must be connected to the main board first.

After installing all components, make sure that the ICs, diodes, and capacitors are correctly oriented. Power up the board as before and note the following:

Bar-graph display DS202 should momentarily flicker and then go out; this is normal and a good sign that things are working. The frequency display should light and either show a valid FM station frequency or three zeros. The left-most (MSB) digit is zero blanked and will not display a zero. Next, examine the keyboard layout in the display-board parts-placement diagram. It is pretty standard. Now, enter an eight, which should display as the right digit. Enter another eight, and now the two right digits should show "88." Enter a one. The display should show "881." Press the ϵ (enter) key. The display should still show "881." Next, remove DC power, and after about ten seconds reconnect power. The display should light up "881." Try entering each digit—1-9—in sequence. The newly entered digit should appear on the right and move left as new digits are entered; the fourth digit will disappear off the left side as new digits are entered. Press the ϵ key, and unless the display is showing a frequency between 881 and 1079, the display will revert to 881 or whatever valid frequency it previously showed. To reject an entry, press the $\epsilon\epsilon$ (clear entry) key; and the display will show the previous valid frequency.

Try entering a few valid FM fre-

quencies, each time pressing the ϵ key after frequency entry. Removing power and re-powering should result in retention of the frequency in memory. If the frequency displayed differs, try re-entering all four digits (i.e. 0995 for 99.5 MHz instead of 995). The leading zero is needed and does not show.

It sometimes happens that a 1 is retained in memory when a frequency of 100 MHz or more was previously entered. Entering a new frequency less than 100 MHz may not erase the fourth digit and the 1 will be retained, confusing the microcontroller. This is not a fault, but a result of suppressing the leading zero for purely aesthetic reasons, making the operator forget that it is still really there. It is best to enter 0883 rather than 883, for example, especially if the previous frequency was 100 MHz or higher. When you are done, enter "0981" as this will be needed for later testing. If all works as specified, you can assume that the microcontroller and display circuit are OK.

Next, apply an audio signal of about 1-volt p-p to the L input. The bar-graph indicator should show several lit segments. Adjust R218 on the display board so all ten segments light. Then increase the signal about ten percent and adjust the potentiometer R68 on the main board, so that D202 on the display board (to the right of DS202) just lights. Reduce audio drive and D202 should extinguish, with DS202 showing fewer segments lit as the audio input is decreased. This checks out the metering circuit.

PARTS LIST FOR THE MPX 2000

SEMICONDUCTORS

IC1—TL084N quad op-amp
 IC2—MC1496N balanced modulator/demodulator
 IC3—MC1458N dual high-performance op-amp
 IC4, IC13—74C00N quad 2-input NAND gate
 IC5—CD4040BE 12-stage binary/ripple counter
 IC6, IC7—LM7812 12V voltage regulator
 IC8—PIC16F84-04 programmable microcontroller
 IC9—MC145170-2 PLL synthesizer
 IC10—TLO81N JFET op-amp
 IC11, IC12—LM7805N voltage regulator
 IC201—74HC573N
 IC202—74HC138N
 IC203—7447N BCD-to-7-segment decoder/driver
 IC204—LM3914N voltage-level indicator
 Q1-Q3, Q5—2N3904 NPN RF-AMP DRIVER
 Q4, Q6, Q201-Q204—2N3906 PNP RF-preamp
 Q7, Q10—2N3563 IF-amp
 Q8—MPF102 JFET N-channel amp
 Q9—MPS3866 or 2N3866 oscillator, amp driver
 D1—1N4007
 D2—Not used
 D3—MV2103 or equiv.
 D4—MV209 or equiv
 D5-D14—1N914B or 1N4148
 D201—T1 ¼ red LED
 D202—T1 ¼ yellow or orange LED
 D203—T1 ¼ green LED
 DS201—Seven-segment 2-digit display
 DS202—Ten-segment bar-graph

RESISTORS

(All resistors are ¼-watt, 5% units unless otherwise noted.)
 R1, R2, R14, R15, R32, R112, R117, R124, R131—4700-ohm
 R3-R6, R28, R29-R31, R33-R36, R45, R51, R54-R57, R62-R64, R66, R67, R70, R104-R107, R111, R118, R128—10,000-ohm
 R7, R40—10,000-ohm potentiometer
 R8, R9, R18, R19—47,000-ohm
 R10, R11, R58, R65—15,000-ohm
 R12, R13—9100-ohm
 R16, R17, R44, R48, R69, R100, R101, R102, R103, R123, R125, R132, R216—1000-ohm
 R20-R23, R37, R38, R109, R127—100,000-ohm
 R24, R25—39,000-ohm
 R26, R27, R50, R121—22,000-ohm
 R39, R41—68,000-ohm

R42, R43, R52, R53, R71, R114—2200-ohm
 R46, R47, R133—3300-ohm
 R49, R119, R217—220,000-ohm
 R55—25,000-ohm potentiometer
 R59, R122—33,000-ohm
 R60, R116—6800-ohm
 R61, R138, R218—1000-ohm potentiometer
 R68—100,000-ohm potentiometer
 R72, R126, R130—220-ohm
 R73—1500-ohm
 R74, R77—390-ohm
 R75, R76, R108, R136—100-ohm
 R78—470,000-ohm
 R79, R110, R129—2.2-megohm
 R113—330-ohm
 R115, R135, R219—470-ohm
 R120—330,000-ohm
 R134—33-ohm
 R139, R141—91-ohm
 R140—75-ohm
 R201-R208—2200-ohm, ¼ Watt
 R209, R210-R215—150-ohm
 R220, R221—56-ohm
 R80—89, R137, R142—200—Not used

CAPACITORS

C1, C2—4.7-µF, 35-WVDC, electrolytic
 C3, C4, C26, C27, C43-C45—.01-µF, 10%, 50V, Mylar
 C5, C6, C16, C18, C22, C36—10-µF, 16V, electrolytic
 C11, C19, C20, C21, C30, C51, C52, C59—1-µF, 50V, electrolytic
 C12, C13, C35, C37, C38—.01-µF, 50V, GMV, ceramic-disc
 C17—.0015-µF, 10%, 50V, Mylar
 C23, C29—1000-µF, 16V, electrolytic
 C24—2200-µF, 25V, electrolytic
 C28—0.1-µF, 50-WVDC, Mylar
 C31—47-pF, 5%, NPO, ceramic-disc
 C32—120-pF, 5%, NPO, ceramic-disc
 C33—68-pF, 5%, NPO, ceramic-disc
 C34, C40, C43, C58—470-pF, GMV, ceramic-disc
 C41—6.8-pF, NPO, ceramic-disc
 C42—0.47- or 1.0-µF, 35V, tantalum electrolytic
 C44, C201, C14, C15, C39, C50—22-pF, 5%, ceramic-disc
 C46—10-µF, 6V, tantalum electrolytic
 C47, C202, C203, C204, C205—0.1-µF, 60X120, 50V, chip
 C48, C56, C57, C207, C7-C10—100-pF, 5%, NPO, ceramic-disc
 C49—2-20-pF, trimmer, 7.5 mm
 C53, C55—47-µF, 16V, electrolytic
 C54, C206—470-µF, 6.3V, electrolytic

ADDITIONAL PARTS AND MATERIALS

S201-S212—Touch switches, momentary

contact

L1, L2, L3—See text and figures
 L201, L202—Ferrite toroid 3E27

Material

XTAL1—Crystal, 4.864 MHz
 XTAL2—Crystal, 4.000 MHz
 Connector, 0.1-inch, 10 pins
 Connector, 0.1-inch, 8 pins
 IC socket, 18 pin
 IC socket, 20 pin
 Label, Keyboard
 3-feet #24 enamel wire
 2-feet #22 tinned wire
 1-foot #18 tinned wire
 Ribbon cable, 8 inches, 24 conductor
 PC board, main
 PC board, display
 Ferrite beads, 43 Material
 4-40 × ½-inch BHMS
 4-40 Hex Nut
 4-40 Lockwasher

NOTE: The following items are available from North Country Radio, PO Box 53, Wykagyl Station NY 10804-0053; www.northcountryradio.com: A complete kit of parts, consisting of all items listed on the parts list. That includes drilled and etched main and display PC boards, preprogrammed microcontroller, all resistors, capacitors, diodes and LEDs, displays, transistors, integrated circuits and all miscellaneous parts as well as a detailed theory, assembly and test manual: \$154.95 plus \$5.00 for p/h in the US.

A complete case package that includes the plastic case (NC225) shown in the photo in this article, drilled and lettered front and rear panels, all connectors, and wire and cables as needed to finish the kit, as well as all necessary instructions, \$39.95 plus \$1.00 for postage and handling if ordered with the above parts kit or \$39.95 plus \$5.00 for postage and handling if ordered separately.

Collapsible 8-section whip antenna with BNC connector and right angle adaptor \$14.00 plus \$1.00 for postage and handling if ordered with the parts kit or \$14.00 plus \$5.00 for postage and handling if ordered separately

PLEASE NOTE:

For shipment outside the US, please add \$10.50 for the first item, plus \$3.50 for each additional item ordered. NY residents must add 8.25% sales tax to the price of any of the above items

Now repeat with audio connected to the R input. No difference should be noted, and no readjustment should be needed.

Final Test and Setup. You will need a VOM or DVM, an FM stereo receiver of some kind, and a source of line-level stereo audio. The MPX 2000 is designed so that 1-volt peak to peak (0.316 volts RMS sine wave) at the input will produce the required deviation, and the audio-input level should not exceed this figure. The input impedance is approximately 10k ohms. Power up the board and check the voltages in Table 3.

gram in a frequency of 88.1 MHz. Check to see if D201 flickers and goes out. Measure the voltage at TP1. It will be around 3 to 3.5 volts. If D201 is still lit, compress the turns of L1 slightly until the voltage rises slightly and D201 goes out. Recheck at 107.9 MHz and 88.1 MHz until lock is obtained at both frequencies, indicated by D201 extinguishing. It is normal for D201 to flicker slightly when changing frequency. Should you be unable to get both 88.1 and 107.9 to lock up with one setting of L1, check to make sure you have at least 12 volts at the output of regulator IC7. If not, you can replace it or add a

cause distortion and degrade stereo separation. Adjust R55 for best separation. If you have access to an audio generator and scope, you can get an exact alignment by adjusting for the waveforms shown in the waveform diagram. Adjust audio-input level for best sound in the receiver without distortion and clipping. With this audio-input level, set R218 on the display board so that the LED bar graph shows all ten segments lit on the loudest audio peaks. Slightly increase input audio and adjust R68 so that the overmodulation LED D202 just flashes. Then back off the audio-input level so that it barely flashes on the loudest audio peaks. This sets the proper audio drive level.

Packaging. The MPX 2000 may be packaged in any suitable metal or plastic case. Remember that this is an audio device, and it also generates RF signals. For that reason, the use of shielded cables for audio input and RF output is recommended. Keep the display board as far as possible from audio lines and the main board, as it does generate some switching noise. Such noise could appear as buzz or hum on the transmitted signal until the display goes to sleep. Once programmed, the MPX 2000 will operate without the keyboard and LED frequency display as long as the frequency is not changed. We recommend that accessibility to the keyboard be limited to keep curious individuals from playing with the MPX 2000 and inadvertently changing frequency. This can be done with a removable panel or cover over the display. The LEDs indicating lock and modulation should be kept visible at all times to signal improper operation. Figure 12 can be used as a guide for front-panel design.

A good RF-ground and antenna system is essential in reducing RF-ground-induced hum, a problem with low-power FM transmitters. Simply using a wall transformer and a whip antenna plugged into the RF output jack might not provide adequate RF grounding. To check if hum is RF-induced, power the MPX 2000 from a battery. If this

(Continued on page 56)

TABLE 3

• IC9 Pin 16	+5 V _{DC}
• IC10 Pin 7	+12 V _{DC}
• IC10 Pin 6	+3 to +12 V _{DC}
• Q5 Collector	+5 V _{DC}
• Q7 Collector	+1.5 to +3.8 V _{DC}
• D4 Center pin	+3 to +12 V _{DC}
• Junction D2, D3, R128	+12 V _{DC}
• Q8 Collector	+12 V _{DC}
• Q8 Base	+5 to +7 V _{DC}
• Q8 Emitter	+4.5 to +6.5 V _{DC}
• Q10 Collector	+1.4 V _{DC}
• Q9 Emitter	+0.7 V _{DC}
• Q9 Collector	+5.6 V _{DC} (adjust R138 as required)

After this test, remove power from the MPX 2000. If any of the voltages were incorrect, you need to find the problem before proceeding further. If these voltages check out, you may proceed. Now, you can power up the MPX 2000. The numbers 981 should appear in the display and, if not, enter this frequency, as described before. On power up, the bar-graph display (DS202) and the unlock LED (D201) should both flicker and go out. Measure the voltage at TP1, pin 6 of IC10. It should be >3 and <11 volts. Now, enter a frequency of 107.9 MHz. When the E button is pressed, D201 should flicker and go out, indicating lockup of the PLL. The UNLOCK LED may take several seconds to extinguish. This is normal due to the long loop-time constants used. If D201 stays lit, check voltage at TP1. It may be 11 volts or higher. Spread the turns of L1 until this voltage drops below 10 volts and D201 goes out. Next, pro-

diode in the common leg of IC7 to raise the voltage slightly.

Once the PLL is adjusted, set up an FM receiver on 98.1 MHz or somewhere near this if 98.1 MHz is busy in your area. Enter this frequency into the MPX 2000. Then, D201 should extinguish after a few seconds, and you should hear a carrier in the receiver, as evidenced by the quieting of the receiver. Momentarily power down the MPX 2000—this is to confirm that the carrier is indeed coming from it and not from some other source. Restore power and the carrier should reappear in a few seconds when D201 extinguishes.

Next, connect audio to the L and R inputs. The bar-graph display should indicate something, and you should hear the audio in the FM receiver. The receiver's stereo indicator should be on, and the audio should sound like any other FM station. Make sure you do not apply excess audio, as this will

Of Rheostats and Potentiometers

Q I was under the impression that a rheostat has the exact same schematic symbol as a potentiometer and that both have the same wiper-over-the-fixed-resistor design. My understanding was that the rheostat simply could dump a ton more power than a pot (potentiometer) just like those big ceramic "doobickies" that take upwards of 20 or more watts (while pots were limited to maybe one watt). Now, I'm getting the impression that the above may not be the case. Could you offer any insight here?—K.B., via e-mail

A By definition, a potentiometer has three terminals—two fixed (connected to either end of the resistance element) and one movable (called the wiper) that slides across the resistance element, illustrated in Fig. 1A. Some

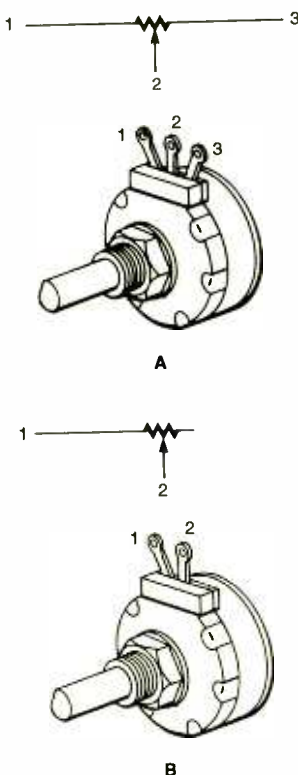

Fig. 1. Schematic symbols and representative devices show the difference between a potentiometer (A) and a rheostat (B).

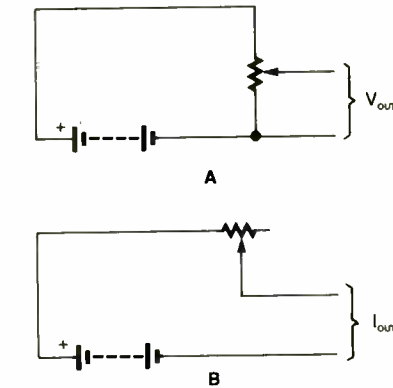

Fig. 2. Potentiometers (A) are used as voltage-control devices, while rheostats (B) are used as current-control devices.

older pots may have one or two extra fixed terminals stationed somewhere along the resistance element, and those were used for tone compensation in old radios. A rheostat has only two terminals—one fixed and the wiper, as shown in Fig. 1B. A pot is used to vary voltage in a circuit and is usually parallel-connected, as shown in Fig. 2A. A rheostat is used to vary current in a circuit and is usually series-connected, as shown in Fig. 2B.

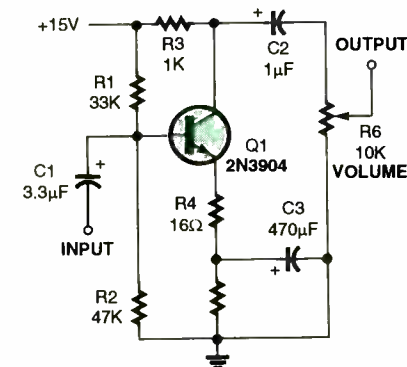

Fig. 3. A simple preamplifier uses a potentiometer (R6) as a volume control.

As you mention, rheostats tend to be high-power devices. Historical uses were for control of theater lighting and DC motors. Rheostats were also used in those cheap, battery-operated, reel-to-reel tape recorders of the early 1960s, in series with the motor, to compensate for battery drain so that the playback speed would be close to correct. Today, we have replaced

most rheostats with solid-state power-control circuits. However, the 2001 Dodge 1500 pick-up truck still has one as part of the headlight switch for controlling the dashboard-light intensity. If you have the dash lights dimmed for an extended period of time, you can feel that the area around the headlight switch gets warm, attesting to the power being dissipated by the rheostat.

One of the more common uses of a potentiometer is the volume control of a radio, where the voltage from a preamplifier is varied from zero to maximum and fed to the output amplifier, as shown in Fig. 3. These days, you'll more likely find a pot being used in the rheostat configuration in a 555-timer circuit to vary the frequency, as illustrated in Fig. 4.

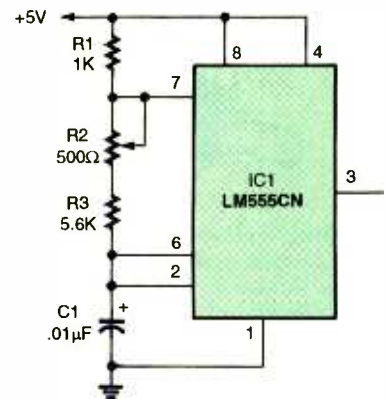

Fig. 4. This 555, wired for the astable mode, uses a potentiometer in the rheostat configuration (R2) to provide a variable timing resistance in conjunction with R3.

Of course, a pot can always be wired as a rheostat, by using only one of the fixed terminals, as shown in Fig. 5A—not the best way, since an intermittent wiper will create an open circuit. The best way is shown in Figs. 5B and 5C, where one of the fixed terminals is connected to the wiper. Now, an intermittent open wiper will be limited to the maximum resistance of the pot. Note that you'll change the rotational characteristics of the pot, depending upon which fixed terminal is connected to the wiper. In Fig. 5B, clockwise (CW) rotation decreases the resistance while, in Fig. 5C, counterclockwise (CCW) rota-

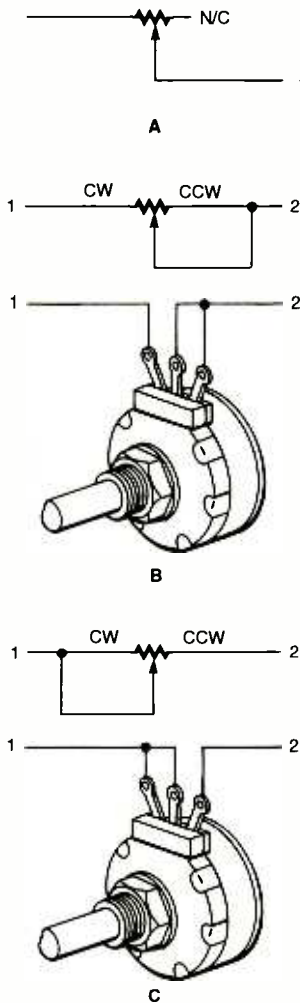

Fig. 5. Wiring a potentiometer as a rheostat as in (A) is not the best way. Wiring for a counter-clockwise increase in resistance (B) or for a clockwise increase in resistance (C) makes a big difference in the way an adjustment feels to a technician and in how the component will act in the circuit.

tion decreases the resistance.

The direction of rotation is important if you want the right feel for the adjustment. For instance, we would normally prefer that brightness, temperature, frequency, or sound level increase with a clockwise rotation.

You will be hard pressed to find a true rheostat in the Newark or Allied catalogs these days. Since both components are so similar in construction, it's more economical to always include the third terminal. That way the part is more versatile, and only one part number need be inventoried rather than two.

Web Electronics Forums

Now that I've seen the Gernsback Forum, I wonder whether there are any

other general electronics forums on the Internet.—S.S., via e-mail

There are all kinds of forums on the Internet, but I think that overall you'll find the Gernsback forum to be one of the best, if not the best. The high level of technical expertise held by the denizens of Electronic Bench and Resource Bin is buffered by their playfulness and a desire to help beginners without making them feel stupid.

The sidebar presents several forums and a few quick comments about each. I've tried to remain unbiased and only present what I see. There may be some of you who are not on the Internet and may be disgusted with the ever increasing push toward it, especially in my references for information. I assure you that I had that same frame of mind as recently as two years ago. As much of a techno-nerd as I am, it took the discovery of that plethora of forums and the goldmine of information that is out there to convince me to get an Internet account for my home computer.

As this was being written, Google had just acquired Deja's Usenet Archive, and the huge forum that posted to the Usenet news groups went dormant. When/if that one is reactivated, I'll let you know.

Semiconductor-Lead Identification

How can one identify the emitter, base, and collector leads of a transistor? I have heard that there is no standardized order of the leads. Does the coding on the transistor's housing somehow indicate the order? Is there a standardized coding for integrated circuits?—A.M., Lilburn, GA

There's a question where I can say "Yes" and "No." The closest that we have come to EBC lead standardization was with the TO-3, TO-5 and TO-18 style of metal-transistor cases. If there were three leads on the TO-5 (e.g., 2N2905) and TO-18 (e.g., 2N2222A) styles, the emitter was the lead nearest

ELECTRONICS FORUMS ON THE INTERNET

<http://209.61.188.48/Indices/33195.html>
This forum is not very active.

<http://network.wenzel.com/Hobby>
A subset of the Wenzel Associates (makers of crystal oscillators) Web page.

www.delphi.com/experimenter/start
This is a brand new forum with little activity.

www.designnotes.com/dndiscussion/designforum_toc.htm
Don't let the "design" part fool you. This forum has a lot of basic stuff on it.

www.industrycommunity.com/ee/ee-1-next1/index.html

This is more industry-related, but still has some interesting content of a general nature.

www.insidetheweb.com/mbs.cgi/mb426630

This is "Harry's Messageboard" operated out of Sweden and, though slanted toward amateur radio, has a lot of good general content.

www.nutsvolts.com/ubbcbg/Ultimate.cgi
Watch that dot before "ubbcbg"! This is a new forum hosted by what may be the only U.S. magazine competitor to Poptronics. It uses my favorite forum engine, Infopop.

www.poptronics.com
To find this forum, click on "Electronics

Forum" at the left and then on "New! Electronic Bench Preview" (or on "New Resource Bin Preview"). These are the new forums to which Gernsback is switching, and they have posting and editing capabilities unavailable on the old forums. Electronic Bench is just starting to take off and getting to be a lot of fun.

www.poptronics.com or www.gernsback.com
After clicking on "Electronics Forum," at the next page go to the bottom and click on "Electronic Bench" or "Resource Bin." These are the original forums, and they are very active still. "Editor's Board" is currently dormant, but I'm hoping that it will be revived soon since it is a great place to post timely corrections to the magazine.

<http://pub1.ezboard.com/bbasicelectronics>

I love this forum. It's probably more like our Gernsback forum than any other, with similar types of individuals participating. Their material may not be as sophisticated due to the newbie nature of many of the posters.

www.twisted-pair.com/wwwboard/wwwboard.html

Howard Sharp is interested in helping out beginners. This is a nice forum, but it isn't as active as ours. Erase the URL back to the ".com," and you'll be on his home page with some electronics tutorials.

the tab on the rim; the collector was on the opposite side; and the base was in the middle. Sometimes there was a fourth lead, and it was connected to the case. With the flat end facing you and leads pointing down, you will see most of the plastic-packaged TO-92 transistors, such as the 2N3904, run EBC, left to right. However, there are enough exceptions (usually putting the collector lead in the center) that you can't just assume that basing arrangement for a TO-92. Therefore, the best answer is to look up each transistor to determine the basing. And where to look them up? Try to find

used copies of the *D.A.T.A. Book* series of data books. They're generic listings that cover more device types than any other source. They're very specific books—there are separate ones for transistors, diodes, thyristors, linear ICs, digital ICs, memory, discontinued transistors, etc.—so it takes a lot of books to cover a lot of device types. Unless you're fabulously wealthy, you can't afford the new books. Other sources are the NTE, SK, or ECG cross-reference guides, which are definitely within the budget of anyone.

You won't always be able to use the

numbers on the transistor case to obtain information. Many times, large numbers of transistors made for a specific customer are marked with house numbers, which can only be found on the internal confidential documents of the equipment maker.

The majority of ICs are parts of families. Overall, most ICs will be either digital or analog. Digital ICs can be broken down into smaller families, such as bipolar or CMOS. They can further be defined by specific characteristics and put into families, such as 74LSxxx, 74HCTxxx, 4xxx, etc. Analog ICs are a little more difficult to categorize by type numbers and are organized into categories based upon their function, such as op-amps, voltage regulators, comparators, and audio-control circuits, to name a few. Some categories, such as power supply regulators, have families like the 78xx-, 79xx-, or LM340T-xx series.

Dual-In-line Packages (DIP) for IC housings are the most common, although Surface-Mount Technology (SMT) is the host of a whole new constellation of package types. There are several sources of data for ICs on the Internet, but I still prefer using paper versions of databooks. I can mark them up, make notes, make changes, color-code the page edges, file them in order by manufacturer or IC type, and find data much more quickly than by browsing on the Internet. My 40 running feet of shelf space that's devoted to databooks is minuscule compared to what our former columnist Don Lancaster claims to have. Old, outdated databooks are just as valuable as the newest, especially if you repair older equipment. *Never* throw old databooks away!

HOW TO GET INFORMATION ABOUT ELECTRONICS

On the Internet: See our Web site at www.poptronics.com for information and files relating to **Poptronics** and our former magazines (**Electronics Now** and **Popular Electronics**) and links to other useful sites.

To discuss electronics with your fellow enthusiasts, visit the newsgroups sci.electronics.repair, sci.electronics.components, sci.electronics.design, and rec.radio.amaieur.homebrew. "For sale" messages are permitted only in rec.radio.swap and misc.industry.electronics.marketplace.

Many electronic component manufacturers have Web pages; see the directory at www.hitex.com/chipdir/, or try addresses such as www.ti.com and www.motorola.com (substituting any company's name or abbreviation as appropriate). Many IC data sheets can be viewed online: www.questlink.com features IC data sheets and gives you the ability to buy many of the ICs in small quantities using a credit card. You can also get detailed IC information from www.icmaster.com, which is now free of charge although it formerly required a subscription. Extensive information about how to repair consumer electronic devices and computers can be found at www.repairfaq.org

Books: Several good introductory electronics books are available at RadioShack, including one on building power supplies.

An excellent general electronics textbook is *The Art of Electronics*, by Paul Horowitz and Winfield Hill, available from the publisher (Cambridge University Press, 800-872-7423) or on special order through any bookstore. Its 1125 pages are full of information on how to build working circuits, with a minimum of mathematics.

Also indispensable is *The ARRL Handbook for Radio Amateurs*, comprising over 1000 pages of theory, radio circuits, and ready-to-build projects, available from the American Radio Relay League, Newington, CT 06111, and from ham-radio equipment dealers.

Back issues: Copies of back issues of and past articles in **Electronics Now**, **Popular Electronics**, and **Poptronics** can be ordered on an "as available basis" from Clagck, Inc., Reprint Department, P.O. Box 12162,

Hauppauge, NY 11788; Tel: 631-592-6721. To ensure receipt of the correct material, readers must supply complete information on the article or issue that they wish to buy.

Poptronics and many other magazines are indexed in the *Reader's Guide to Periodical Literature*, available at your public library. Copies of articles in other magazines can be obtained through your public library's interlibrary loan service; expect to pay about 30 cents a page.

Service manuals: Manuals for radios, TVs, VCRs, audio equipment, and some computers are available from Howard W. Sams & Co., Indianapolis, IN 46214; (800-428-7267). The free Sams catalog also lists addresses of manufacturers and parts dealers. Even if an item isn't listed in the catalog, it pays to call Sams; they may have a schematic on file which they can copy for you.

Manuals for older test equipment and ham radio gear are available from Hi Manuals, PO Box 802, Council Bluffs, IA 51502, and Manuals Plus, 130 N. Cutler Dr., N. Salt Lake, UT 84054.

Replacement semiconductors: Replacement transistors, ICs, and other semiconductors, marketed by Philips ECG, NTE, and Thomson (SK), are available through most parts dealers (including RadioShack on special order). The ECG, NTE, and SK lines contain a few hundred parts that substitute for many thousands of others; a directory (supplied as a large book and on diskette) tells you which one to use. NTE numbers usually match ECG; SK numbers are different.

Remember that the "2S" in a Japanese type number is usually omitted; a transistor marked D945 is actually a 2SD945.

Hamfests (swap meets) and local organizations: These can be located by writing to the American Radio Relay League, Newington, CT 06111; (www.arrl.org). A hamfest is an excellent place to pick up used test equipment, older parts, and other items at bargain prices, as well as to meet your fellow electronics enthusiasts—both amateur and professional.

Ferrite Cores

Reader Don Pomeroy had some great comments concerning the ferrite rod with which we've been dealing. He reminds us that two-piece ferrite transformer cores are used to facilitate manufacturing, but usually at the price of some electrical performance—mostly in the ability of the core to saturate. He mentions that many of these transformer cores are deliberately manufactured with a calculated gap in the core to prevent the core from saturating during current peaks, which would otherwise distort the waveform. That was the way that the old filter chokes of the golden era of radio were made. Rather than interleaving I and E core sections as transformers do, the I and E sections are

stacked separately and then put together with the I section on top of the E section with a gap between them. Then the normal DC current would not saturate the core, and it would remain an effective reactance for the AC current.

I had given the impression in the column that the cores of transformers and inductors were always glued or clamped tightly together with virtually no gap. Not true. Thanks, Don, for that reminder.

Old Correspondence-Course Test Equipment

I've had a barrage of questions asking about manuals for test instruments that came with various correspondence courses. Some courses used Heathkit instruments (Cleveland Institute of Electronics, perhaps), and with those there are usually no problems with documentation. However, it's extremely difficult to find documentation for Conar (National Radio Institute) and Bell & Howell. I suspect that a lot of folks took those courses and then just trashed everything and put the equipment in the attic. About the only stuff we can find for Conar is the amateur radio equipment, and we find very little on their test equipment. I would be delighted if any readers would let me know if they have manuals for Bell & Howell, Conar test equipment, or any equipment that was used with courses that were not as well known as the aforementioned. I'd love to have a copy that I can distribute to those in distress.

60-LED Watch

Q I like the 60-LED watch that was discussed in *Poptronics* (December 2000). Please tell me the actual price and where I can get it.—H.S., Germany

A There's a little mix-up there. The December 2000 "Q & A" article answered a question regarding how one can build a 60-LED clock. The reader was referred to the November 1995 *Electronics Now* "Q & A" column, where such a circuit was presented as a construction project. I'm sorry, but this is not an item that is available for sale.

My Bibliography

Q I am a beginning electronics student, and I am writing to ask for your advice in locating sources of useful study materials. In my studies, I have purchased quite a few

books that contain some useful, but mostly vague, information. Since you have been in the field for many years, could you please suggest several book titles in electronics?—B.C., Milan, MI

A Suggesting a list of titles will be subjective at most, for no two readers digest information in the same way or agree on a specific author's style. Of course, I have preferred titles that I've zeroed-in on over the years. They're my favorites because the presented information is down-to-earth and practical, often is in a cookbook style, avoids a lot of unnecessary math (but you can't eliminate it entirely), and covers a lot of territory. Still, no one book can do it all,

MY BIBLIOGRAPHY

These are recommended books that I have found over the years to be excellent sources of relevant and practical information in several basic areas of electronics.

Analog Integrated Circuits

Design of Active Filters with Experiments by Howard M. Berlin, ISBN 0-672-21539-X

Design of Op-Amp Circuits with Experiments by Howard M. Berlin, ISBN 0-672-21537-3

IC Op-Amp Cookbook by Walter G. Jung, ISBN 0-672-21695-7

DC/AC Electronics

Introductory Circuit Analysis by Robert L. Boylestad, ISBN 0-02-313161-6

Digital Integrated Circuits

Digital Circuits and Systems by Douglas V. Hall, ISBN 0-07-025537-7

CMOS Cookbook by Don Lancaster, ISBN 0-672-21398-2

TTL Cookbook by Don Lancaster, ISBN 0-672-21035-7

Solid State (Transistors, Diodes, etc.)

Electronic Principles by Albert Paul Malvino, ISBN 0-07-039957-3

Introductory Electronics Devices and Circuits by Robert T. Paynter, ISBN 0-13-482993-X

Transistor Circuit Approximations by Albert Paul Malvino, ISBN 0-07-039878-X

*Textbook (more expensive), but usually there's a lab manual available for building circuits.

even in a narrow subject area. In addition to the two books recommended in the usual "How To ..." sidebar, the "My Bibliography" sidebar provides subject area, title, author, and International Standard Book Number (ISBN) for several suggested books. With the ISBN alone, you should be able to special order these books through any bookstore. In addition, a subscription to *Poptronics* with its frequent tutorials is a must. I would also suggest the various versions of the *Engineering Notebook* series by Forrest Mims, available at RadioShack.

You had a couple of thousand other questions in your letter, B.C. and thoughtfully enclosed stamps for a return answer. I collect stamps and appreciate the commemoratives. Though I yearn to answer the questions, individual replies are just impossible, considering the number of questions received.

A Scanner Without A USB Cable?

Q I have a Bearcat BC-201 (not a 210) scanner that I've had for a long time. My nephew recently bought what turned out to be a broken copy of the same exact model at a hamfest. I called Uniden Bearcat, who simply said that they never heard of that model. I bought mine when there was a takeover of Bearcat by Uniden. How can I get a schematic? I've tried all the sites in your February issue.—P.M., via e-mail

A A lot of folks reading this will be surprised that it isn't just Hewlett-Packard, Visioneer, et al., who make scanners. We might inform these individuals that, in this case, we're talking about the original scanner, a programmable radio receiver, rather than the computer peripheral. At least by trying those sites from the February column, you know where the documentation isn't.

I'd suggest getting in with the scanner crowd and see what you can find. The Strong Signals site has a forum where you could send out a distress call to individuals who are more likely to be able to help. Check them out at www.strongsignals.net/msgboard/index.html. Other readers might be interested in this site as well, for they have a parallel forum for frequencies below 30 MHz, i.e., short-wave listening. Just click on that topic at the top of the Strong Signals forum cited above. We also might have some readers who have information on this desktop radio scanner.

Repairing PC Power Supplies

Q *The world is filling up with defunct PC switching-power supplies, and their low cost makes repair uneconomical given today's high labor rates. However, I believe that I could repair them for a profit as I am retired and my labor rate is zero. The problem is the lack of documentation. I wonder if you could publish typical schematics for the different types and a brief theory of operation.*

Also, can the five-volt section of a PC supply be changed to produce 12 or 15 volts? I could rewind the transformers and replace output devices if that was all that was required.—D.C., Hudson, MA

A Since, as you mention, the PC supplies are relatively inexpensive, they come with little documentation and no factory support. There are so many manufacturers and varieties out there that it's nearly impossible for a third party such as Sams to develop service literature in that area.

There are a couple of Internet resources that might be helpful. Our own Sam Goldwasser has a posting titled, "Notes on the Troubleshooting and Repair of Small Switchmode Power Supplies." Find it at www.repairfaq.org/REPAIR/ and then click on "Small Switchmode Power Supplies."

The PC Mechanic site at www.pcmecb.com/byopc/index.htm has a forum listed on the left side of their home page. Under that forum, you can pose hardware questions to the group. I tossed yours out there, but got the "ain't worth the trouble" reply that was expected, even considering your specific situation. The comment was made there that a lot of those supplies were rejected because the design left them marginal in performance and reliability.

Modification of the supplies would almost require a schematic to find the specifics for the control circuits. Unlike linear supplies, most switchers develop their various voltages by specific turns on the transformer secondary and sampling one of those for regulation. There wouldn't be enough overhead on the primary side to just boost it up to get two or three times the voltage from the 5-volt output. It would take transformer rewinding, modifying the sampling circuit, and the changing of several capacitors to higher voltage ratings to achieve your goals. You would also have to mod-

ify any over-voltage or crowbar circuits.

Because of all those excess working supplies out there, it would be nice to find a "cookbook" method of supply modification for experimenters who want to use them in ways not conceived of by the manufacturers. Unfortunately, I'm afraid that the sheer number of supply types makes publishing something like that impractical, too. Anyone who does modify a switcher must remember to keep the supply in its original box to maintain safety.

Sidebar Correction

Thanks to reader George Ribley who noticed that the address for Manuals Plus that is referenced in the monthly "How To Get Information About Electronics" sidebar had changed. As of the May issue, we have published the new address.

On the subject of sidebars, we're looking at revamping the "How To..." and the "Writing to Q&A" sidebars. This magazine and column is for our readers, so give us your input. Do these sidebars, with their current full content, need to be in the magazine every month? Should they be trimmed down? Eliminated? Changed so that they appear only once or twice a year in their full glory and just skeletons the other months? Should the information be put on the Internet site rather than in the magazine, or would that be an impediment to readers without Internet access? Let me know what you think. Communicate!! Our address is in the "Writing to Q&A" sidebar and will still be there after any changes.

Writing to Q&A

As always, we welcome your questions. Please be sure to include:

- (1) plenty of background material,
- (2) your full name and address on the letter (not just the envelope),
- (3) and a complete diagram, if asking about a circuit; and
- (4) type your letter or write neatly.

Send questions to Q&A, **Poptronics**, 275-G Marcus Blvd., Hauppauge, NY 11788 or to q&a@gernsback.com, but do not expect an immediate reply in these pages (because of our backlog). We regret that we cannot give personal replies. Please no graphics files larger than 100K. **P**

BUY BONDS

TIPS FOR MAIL ORDER PURCHASE

It is impossible for us to verify the claims of advertisers, including but not limited to product availability, credibility, reliability and existence of warranties. The following information is provided as a service for your protection. It is not intended to constitute legal advice and readers are advised to obtain independent advice on how to best protect their own interests based upon their individual circumstances and jurisdictions.

- 1. Confirm price and merchandise information** with the seller, including brand, model, color or finish, accessories and rebates included in the price.
 - 2. Understand the seller's return and/or refund policy**, including the allowable return period, who pays the postage for returned merchandise and whether there is any "restocking" or "return" charge.
 - 3. Understand the product's warranty.** Is there a manufacturer's warranty, and if so, is it for a U.S. or foreign manufacturer? Note that many manufacturers assert that, even if the product comes with a U.S. manufacturer's warranty, if you purchase from an unauthorized dealer, you are not covered by the manufacturer's warranty. If in doubt, contact the manufacturer directly. In addition to, or instead of the manufacturer's warranty, the seller may offer its own warranty. In either case, what is covered by warranty, how long is the warranty period, where will the product be serviced, is there a charge for service, what do you have to do to obtain service and will the product be repaired or replaced? You may want to receive a copy of the written warranty before placing your order.
 - 4. Keep a copy of all transactions**, including but not limited to cancelled check, receipt and correspondence. For phone orders, make a note of the order including merchandise ordered, price, order date, expected delivery date and salesperson's name.
 - 5. If the merchandise is not shipped within the promised time**, or if no time was promised, within 30 days of receipt of the order, you generally have the right to cancel the order and get a refund.
 - 6. Merchandise substitution** without your express prior consent is generally not allowed.
 - 7. If you have a problem with your order or the merchandise**, write a letter to the seller with all the pertinent information and keep a copy.
 - 8. If you are unable to obtain satisfaction from the seller**, contact the consumer protection agency in the seller's state and your local Post Office.
- If, after following the guidelines, you experience a problem with a mail order advertiser that you are unable to resolve, please let us know. Write to Advertising Department, Gernsback Publications Inc., 500B Bi-County Blvd. Farmingdale, NY 11735.**

Be sure to include copies of all correspondence.

PIC Microcontroller Basic Compilers

A few months ago, we constructed a robot that used a PIC microcontroller for its neural intelligence (brains). The PIC microcontroller was programmed with a compiled basic program. At the time, I didn't have the space to write about the compiler or the programmer used to program the PIC chip. We are going to correct that omission.

Currently, I use the PICBasic Compiler and the PICBasic Pro Compiler for all my microcontroller work. These compilers are for writing programs for the PIC series of microcontrollers from Microchip Technology, Inc. I choose these compilers for a number of reasons.

Let Me Count The Ways

One, you can write programs in Basic. Despite all the reports for the last 20 years predicting the demise of Basic, it's still here and with good reason. It is a programming language with the shortest learning curve—beginners can easily become proficient in it.

Two, despite the fact the program is written in Basic, which is a slow interpreted language, the compiler converts the Basic language commands to the microcontroller's very fast Machine Language (ML) equivalent. The compiler saves the ML program as a .hex (hexadecimal) file. It is the .hex file that is programmed into the PIC microcontroller.

Three, it's fast. What makes this system fast is that the ML program resides in microcontroller and doesn't require any language or "token" interpretation.

Four, it's a very economical way of implementing PIC microcontrollers into your projects.

While the compiler compiles the program, we still need a programmer to take the compiled program and load it into the PIC microcontroller. The EPIC programmer does this job and is compatible with both compilers.

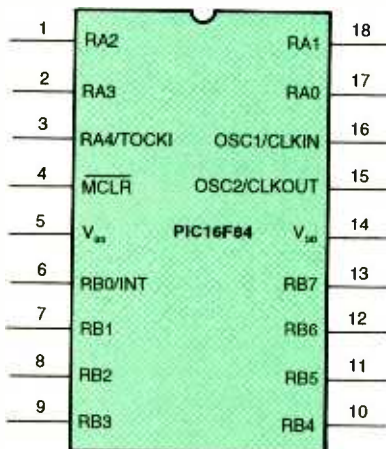

Fig. 1. PIC 16F84 Specification Sheet

You will also need a PC (compatible) computer with a printer port and DOS 3.3 or higher to program and burn PIC microcontrollers.

PIC Microcontroller 16F84

There are dozens of PIC microcontrollers from Microchip Technology, Inc. (www.microchip.com) to choose from. I chose the PIC 16F84, because it is versatile, see Fig. 1. It has 1K of on-board programming space and can be re-programmed 1000 times. Memory retention of a program, if you decide to keep it, is 40 years.

The chip has 13 I/O pins. Each pin may be configured as an input or output pin or changed on the fly as a program is running. A pin may source 20 mA maximum or sink 25 mA maximum.

PICBasic Compiler

Out of the two compilers, this month we will look at the PICBasic compiler. The PICBasic compiler is the less expensive of the two compilers with a retail price of \$99.95. In addition, you will also need the EPIC programming board and software. The EPIC retails

for \$59.95. However, if you purchase the PICBasic compiler and EPIC programmer at the same time, the cost is \$149.95. The reason we need to look at the compilers separately is that each compiler handles I/O a little differently and to do both at once will be confusing.

The first thing you need to do is to load the software on your computer's hard drive according to the instructions given with the software. To complete the instructions we are going to assume the software, both the PICBasic compiler and EPIC programming software, are saved to a directory called PBasic on your computer's hard drive.

First Basic Program

Now, we are ready to write our first program. To write programs, you need a word processor or text editor. Any word processor that can save a text file as a standard ASCII or DOS text file will suffice. Windows users can use the Notepad program. DOS users can use the Edit program.

I usually drop down from Windows into a DOS level when I write for the PICBasic compiler by opening an MS-DOS prompt window. Once in the MS-DOS window, move into the PBasic directory. Use the command "cd\PBasic" at the command line. In this example, I will be using the free EDIT program package with Windows to write the program. Start EDIT by typing "EDIT" at the command prompt. Enter the program from Listing 1 into your word processor—exactly as it is written. Use the Save function under the File menu. Name the file wink.bas.

Remember, if you are using a different word processor, it is important to save the program as an ASCII text or MS-DOS text file. The compiler (next step) requires the text file (basic source code) in a DOS or ASCII file format.

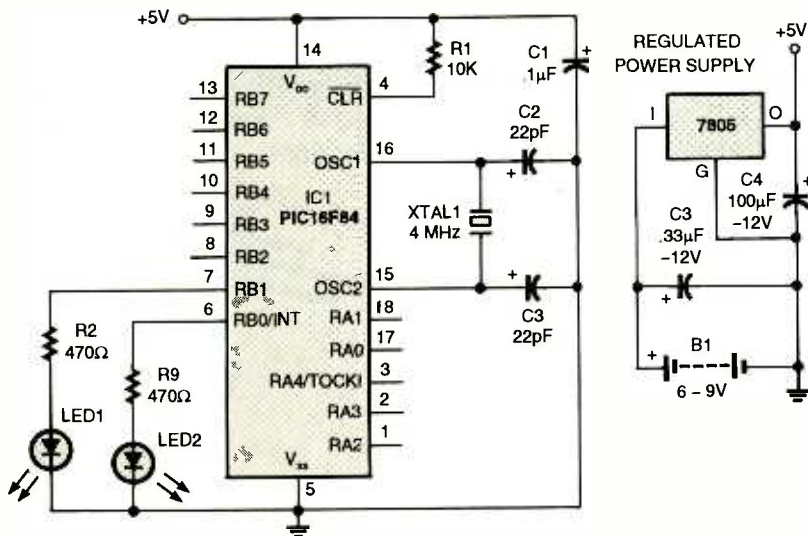

Fig. 2. The schematic above can be used to construct the PIC-controlled wink-circuit.

DOS and ASCII text files do not save any special formatting and print codes that are unique to individual word processors.

Compile

The PICBasic compiler must be run from DOS or from a MS-DOS Prompt Window within Windows. Run the PICBasic compiler from the "PBasic" directory, type this command, pbc -p16f84 wink.bas at the DOS prompt and hit the enter key. The "-p16f84" portion of the command informs the compiler to compile the program for the 16f84 microcontroller.

The compiler displays an initialization copyright message and begins processing the basic source code. If the basic source code is without errors, it will create two additional files (wink.asm— assembler source code file and wink.hex—Machine Language file). If the compiler finds any errors, a list of errors with their line numbers will be displayed. Use the line numbers in the error message to locate the line number(s) in the wink.bas text file where the error(s) occurred. The errors need to be

corrected before the compiler can compile the source code correctly. The most common errors are with basic language syntax and usage.

Programming The PIC Chip

To load our program into the PIC chip, we must connect the EPIC programming carrier board to the computer. The EPIC board connects to the printer port.

If your computer has only one printer port, disconnect the printer, if one is connected, and attach the EPIC programming board using a six-foot DB25 cable.

When connecting the programming board to the computer, make sure there are no PIC microcontrollers installed on to the board. If you have an AC adapter for the EPIC programmer board, plug it into the board. If not, attach two fresh nine-volt batteries. Connect the "Batt ON" jumper to apply power. The programming board must be connected to the printer port with power applied to the programming board before starting the software. If not, the software will not see the programming board connected to the printer port and give the error message "EPIC programmer Not Connected."

The EPIC Programming Board Software

There are two versions of the EPIC software; EPIC.exe for DOS and EPICWIN.exe for Windows. The Windows software is 32-bit; it may be used with WIN95, WIN98 and WINDOWS NT, *but not* WIN3.X. It has been my experience that Windows often likes to retain control of the printer (LPT1) port. If this is the case with your computer, the Windows EPIC program may not function properly and you may be forced to use the DOS-level program. If you receive an error message "EPIC Programmer Not Connected" when you start the EPIC windows program, you have the option of either troubleshooting the problem or using the EPIC DOS program.

Using EPIC DOS Version

At the DOS prompt inside the "PBasic" directory, type "epic" and hit enter to start the DOS version of the EPIC software. Use the mouse to click on the OPEN button or press ALT-O on your keyboard. Select the wink.hex file. When the hex file loads, you will see a list of numbers in the window on the left. This is the machine code of your program. On the right-hand side of the screen are configuration switches that we need to check before we program the PIC chip.

Let's go through the configuration switches one by one.

- Device:** Sets the device type. Set it for 8X.
- ROM Size (K):** Sets memory size. Choose 1.
- OSC:** Sets oscillator type. Choose XT for crystal.
- Watchdog Timer:** Choose On.
- Code Protect:** Choose Off.
- Power Up Timer Enable:** Choose High.

After the configuration switches are

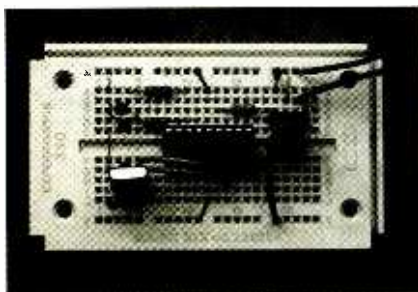

The entire circuit can be assembled on a small prototyping solderless breadboard for testing.

```

LISTING 1
LOOP: HIGH 0      TURN ON LED CONNECTED TO PIN RB0
      Low 1       Turn off LED connected to pin RB1
      *Pause 500  Delay for .5 seconds
      LOW 0       TURN OFF LED CONNECTED TO PIN RB0
      HIGH 1      TURN ON LED CONNECTED TO PIN RB1
      Pause 500   Delay for .5 seconds
      Goto loop   Go back to loop and blink & wink LED's forever
      End
  
```

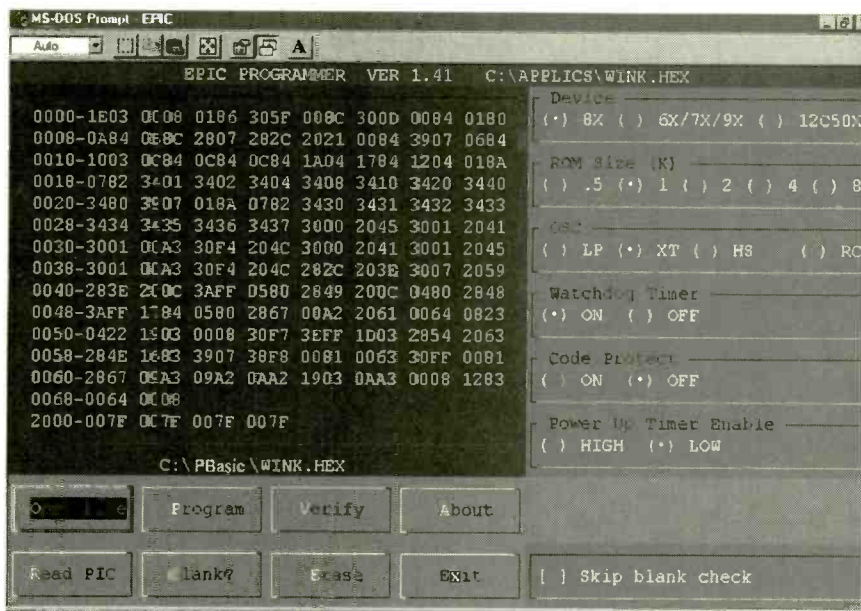

EPIC Program with wink.hex loaded and ready to be programmed into the PIC16F84.

set, insert the PIC 16F84 microcontroller into the open socket on the EPIC programming board. Click on Program or press ALT-P to program the microcontroller. The EPIC program first looks at the microcontroller chip to see if it is blank. If the chip is blank, the EPIC program installs your program into the microcontroller. If the microcontroller is not blank, you are given the options to cancel the operation or overwrite the existing program with the new program. The machine language code lines are highlighted as the PIC is pro-

grammed. When it is finished, the microcontroller is programmed and ready to run.

Testing The PIC Microcontroller

The schematic, shown in Fig. 2, illustrates how few components are needed to get your microcontroller up and running. Primarily, you need a pull-up resistor on PIN 4 (MCLR), a 4-MHz crystal with two (22-pF) capacitors, and a 5-volt power supply.

The two LEDs and two current limiting resistors connected in series with the LEDs are the output. It allows us to see that the microcontroller and program are functioning. I assembled the components on a solderless breadboard.

WINK

Apply power to the circuit. The LEDs connected to the PIC microcontroller will alternately turn on and off. Wink... wink... Now you know how easy it is to program these microcontrollers and get them up and running.

As you gain experience, using the compiler and programmer will become second nature. You won't even consider them as steps anymore. The real challenge will be in writing the best PIC basic programs possible, and that is as it should be.

SOURCE INFORMATION

PIC-LED-02
PIC EXPERIMENTORS KIT
\$25.50

Consists of:

- (1) PIC16F84, (1) 4-MHz crystal *(\$1.50),
- (2) 22-pF caps *(\$0.10 ea.), (1) 10K 1/4-watt resistor *(\$0.05), 7805 voltage regulator *(\$0.90), (1) solderless breadboard, 2.1-inch x 3.6-inch, 270 tie points *(\$8.95), (8) 470-ohm resistors *(\$0.05 ea.), (1) 10K-ohm resistor *(\$0.05), (8) Subminiature LEDs *(\$0.25 ea.), (1) push-button switch, booklet with tutorial on binary number system, logic and I/O of ports A & B.

Available from Images SI Inc., 39 Seneca Loop, Staten Island NY, 10314; 718-698-8305; fax 718-982-6145; www.imagesco.com.

*Items marked can be ordered separately.

VCR Cross Reference

NOW Find the right Part for your VCR

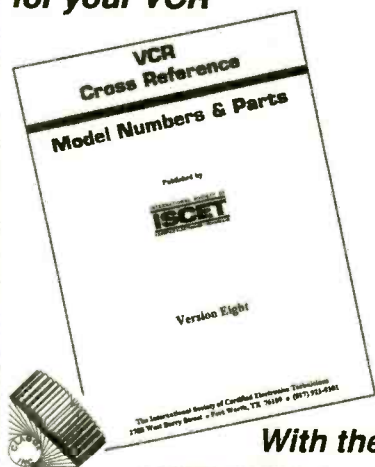

With the
ISCET VCR

CROSS REFERENCE

This 172-page reference contains both model and part-number cross-references updated as of Feb, 1997.

VCR's are made in a few factories from which hundreds of different brand names and model numbers identify cosmetically-changed identical and near-identical manufactured units. Interchangeable parts are very common. An exact replacement part may be available only a few minutes away from you even though the manufacturer supplier is out-of-stock. You may be able to cannibalize scrap units at no cost!

The ISCET VCR Cross Reference is pre-punched for standard loose-leaf binding. . \$29.95 includes shipping in the United States for each Reference.

Claggk Inc.
VCR CROSS REFERENCE OFFER
P.O. BOX 12162
HAUPPAUGE, NY 11778

Name _____
Business _____
Address _____
City _____
State _____ Zip _____
Phone _____

Enclose \$29.95 for the Eighth Edition of the ISCET VCR Cross Reference including shipping for each Reference in the United States. All other countries add \$5.00 (surface mail).

The total amount of my order is \$ _____
Check enclosed—do not send cash.
or please charge my credit card.

Visa MasterCard Exp. Date ____/____/____

Card No. _____
Signature _____

New York State residents must add applicable local sales tax to total. US funds only. Use US bank check or International Money Order. CB02

**PLANT TREES
FOR AMERICA**

TROUBLESHOOTING INTERMITTENT PROBLEMS

Everyone dreads equipment that is temperamental—working or not working depending on its mood. Behavior of faulty electronics may appear to be totally random, but, in most cases, there will be some correlation with physical, environmental, or external interference. Troubleshooting such problems is a primary cause of hair loss in engineers and technicians. Careful observation and perhaps a bit of detective work will ultimately allow a repair to be successful. Using a methodical and patient approach, it should be possible to identify the cause of trouble and repair misbehaving equipment.

Haywire Electronics

Some electronic units seem to have personalities of their own. Here are just a few examples of intermittent problems found in household electronics:

- A computer monitor that erratically loses one of its primary colors (red, green, or blue)
- TV reception that turns to slow and then returns to normal apparently at random
- A car radio or tape deck that misbehaves on rough roads
- A TV that turns itself on at maximum volume in the middle of the night
- A CD player that is prone to aborting or skipping at random times
- A microwave oven that blows its main fuse once every 10 days
- A TV that exhibits annoying herringbone patterns at certain times of day

This article deals mostly with TVs and monitors since they appear to be most prone to these sorts of problems. This is partially due to the higher power levels and associated heat generation



If you need your fix of FAQs, then set your browser to www.repairfaq.org. Sam Goldwasser's Web site offers a near-infinite database of technical info—electronic repair from soup to nuts.

inside of them, and partially due to the cost pressures that result in manufacturing quality control problems. Other equipment like VCRs and CD players also may suffer from intermittent behavior, but it is usually not due to bad soldering (though there are exceptions). The faults are often due to mechanical problems or dirty or worn internal position-sensing switch contacts.

Manufacturing Defects

Low cost no-name (or unknown name) computer monitors tend to be particularly prone to bad solder connections. However, so are many models of name brand TVs, including those from RCA/GE/Proscan and Sony. We'll touch on these at the end of this article.

Any intermittent problems with monitors that cause random sudden changes

in the picture brightness, color, size, or position are often a result of bad connections. Strategically placed bad connections can also cause parts to blow. For example, a bad connection to the SCR anode in a phase-controlled power supply can result in all the current passing through the startup resistor, blowing it as well as other components. I had a TV like this—the real problem was a bad solder joint at a pin on the flyback. Thus, erratic problems, especially where they are power or deflection related, should not be ignored!

Bad solder joints are very common in TVs and monitors due both to poor quality manufacturing as well as to deterioration of the solder bond after numerous thermal cycles and components running at high temperature. Without knowing anything about the

circuitry, it is usually possible to cure these problems by locating all bad solder connections and cleaning and reseating internal connectors. The term *cold solder joint* strictly refers to a solder connection that was either not heated enough during manufacturing, was cooled too quickly, or where part pins were moved before the solder had a chance to solidify. A similar situation can develop over time with thermal cycling where parts are not properly fastened and are essentially being held in by the solder alone. Both situations are most common with the pins of large components like transformers, power transistors and power resistors, and large connectors. The pins of the components have a large thermal mass and may not get hot enough during manufacturing. Also, they are relatively massive and may flex the connection due to vibration or thermal expansion and contraction.

Why Can't TV Manufacturers Learn To Solder Properly?

I can think of several potential reasons—all are solvable, but at higher manufacturing cost.

- Mass of large component leads (like shields) does not get adequately heated during manufacture leading to latent cold solder joints. While they may look OK, the solder never actually “wetted” the heavy pins and, therefore, did not form a good mechanical or electrical bond.
- Thermal cycles and differential thermal coefficients of circuit boards, traces, and solder. While it is not easy to do anything about the material properties, using plated through-holes or a similar mechanical via would greatly increase the surface area of the joint and prevent the formation of cracks.
- Vibration. This is also directly related to single-sided circuit boards without plated through-holes to strengthen the joints.
- Lack of adequate mechanical support (single-sided circuit boards without plated through-holes or vias).

I believe that the single most significant improvement would be by using plated through-holes, but this would add to the cost. Apparently, the consumer is not willing to pay more for better quality and reliability! Some designs have used rivlets—mechanical vias instead of

plated ones. While this is good in principle, the execution has often been flawed where cold solder joints resulted between the rivlets and the circuit board traces due to lack of adequate process control.

The Sony and RCA/GE tuner shield problem is interesting, because this could have been solved years ago at essentially no additional cost as other manufacturers—and their own repair procedures—have proven.

Attacking Intermittents

First, determine whether the problem is internal or external. The most common external causes would be electro-magnetic interference, either through the air or via the power line. We'll discuss these at another time. Suffice it to say, changing the location or electrical power source will usually help to narrow it down.

If internal, it may be physical, heat related, or mode related. Gentle whacking (yes, whacking is an acceptable diagnostic technique but don't go for the 12 pound hammer!), pressing, flexing, cable wiggling, etc., can and should be used in an attempt to confirm at least that there is a physical cause inside the unit. Doing these tests just as the problem comes or goes is the best time as whatever is marginal will be most marginal then.

If the problem appears or disappears, or does both, over a period of time after the equipment is turned on, then temperature is almost certainly a factor as the circuit board and components expand.

The most common physical problems are bad (cold) solder joints, connectors that need to be cleaned and reseated, and bad cables or cable connections. Perhaps surprisingly, though components may fail internally and result in erratic behavior, this is probably lower on the list of likely causes than those listed above. Some exceptions would be mechanical relays in audio power amplifiers, phone equipment, and elsewhere; hybrid power amplifiers; and other power devices.

The whacking, etc., can be done without taking the cover off the equipment and may or may not reveal anything. In either case, you will have to go inside. If there is an effect, then you will know that the problem IS inside, and further tests will be needed to identify the specific cause.

Once the cover is off, there still may be quite a challenge to find the specific

solder connection or contact that needs attention. Knowing something about how the actual circuit area relates to the symptoms will help narrow it down. For example, if there is a loss of vertical-deflection in a TV or computer monitor, the most likely areas to attack will be the vertical-deflection output stage and its power-supply feed.

For popular consumer electronic equipment, intermittent problems are often present in many (or even most) samples of a particular model over the course of its life. Therefore, checking a tech-tips database or asking on the USENET newsgroup *sci.electronics.repair* may reveal a common cause and an easy solution (“resolder the flyback pins”). There is a list of tech-tips databases at my Web site, www.repairfaq.org.

Assuming these don't help (or you consider letting someone else solve your problem to be cheating), a detailed visual inspection is the next step. This may be all it takes. With the unit unplugged (and after confirming that power-supply capacitors are discharged!), remove the cover.

Start with the pins on devices like power transistors, transformers, and large or high-current connectors. These are most likely to cause marginal solder connections to break apart due to thermal and physical stress. Hairline cracks at solder joints are primary causes of intermittent faults, especially in TVs and monitors with their power supply, deflection, and video circuitry that may run hot.

Make the inspection under a bright light. If your close-up vision isn't perfect, use a good magnifier—there may be hairline cracks and their visibility may be obscured by reflections from the solder joint. Use a pointed stick (not something metal if possible) to gently prod any suspicious looking pins to see if they move. Look for discolored patches on the circuit board. Such discoloration isn't in itself a problem unless it is severe. It does indicate that hot components live there or nearby and bad solder joints are very likely.

Check for tan or brown glue on the top and bottom of the circuit boards. A rigid adhesive may be used to attach various components, but some varieties decompose and become conductive with heat and age. Some very weird problems have been linked to decayed glue! So, carefully scraping it away and replacing it with non-acidic RTV Silicone or sim-

ilar adhesive may be prudent. However, I don't know how to tell which type is a problem. Check for loose or damaged cables (particularly in user-serviced equipment like PCs!).

Remove, inspect, clean (if necessary), and reseat all internal connectors. Even if they don't seem to be in an area of the circuitry that is relevant, they could be feeding a power or control signal. Check for discolored or fatigued contacts as well as physical damage to the wires and improperly made crimps. If any components (like transistors or SIMM memory modules) plug in, do the same for them.

Where a problem is found, don't assume there is only one! In many cases, bad solder connections or bad crimps are caused by poor manufacturing process control and will be repeated in many locations. So, correct what was found and then continue to inspect the entire unit. Sometimes, manufacturing is so poor that resoldering the entire board is the only solution with any chance of long-term success. An example of this was given in a previous ServiceClinic sidebar, "GE TV With 'Rivlets'"—intermittent by design!

If a suspicious area is located, it may be possible to use an ohmmeter between selected pins to determine if a connection is intermittent. To increase the chance of detecting a momentary change in resistance that may be too brief to register on a meter, connect the input of an amplified speaker (or audio amp and speaker) in parallel with the meter probes.

Taking A Closer Look

If none of the previous checks produces a breakthrough, the next step is to power up the equipment. **WARNING! Depending on the particular equipment, lethal voltages or other hazards may exist.** Make sure you understand and follow the safety guidelines published in prior Service Clinic articles and at my Web site!

Using an insulated stick, start gently prodding likely areas of the circuitry in an attempt to make the problem come and go. If you are successful, don't assume the journey is over! Pressing at a corner of the board may have an effect at the opposite side. In fact, you may find that pressing anywhere appears to have about the same effect. It may take some very, very light tapping, flexing, etc., to locate the culprit. Until a physical cause is actually located (e.g., a visibly cracked solder joint where

the pin can be seen to move!), don't assume you're home free even if the problem appears to clear up. In fact, it is very common for an intermittent problem to go away as soon as troubleshooting begins, not to reappear for several days or more—but it will reappear!

Once a particularly sensitive area is located, use a stick thin enough to just touch a single pin at a time. Sometimes, a probe with a pointed metal tip, insulated for all but the last $\frac{1}{16}$ -inch or so, will be useful as it can get into the area between the pin and solder pad where cracks may have developed but are not visible. The metal tip will bridge the gap causing a change in behavior.

If the cause is heat related, no amount of prodding (or cursing) will make the problem occur with the cover off. In this case, a heat gun (or blow dryer) may be needed to carefully warm up selected areas of the circuitry in an effort to identify the culprit. A blower with no heat may be used for cooling, or "circuit chiller" or "cold spray" may be used for more aggressive spot cooling. However, simply removing the cover may have altered something physical. For example, one of the cabinet screws may be too long and is shorting out something—this may be either from improper prior reassembly after repair or a manufacturing or design defect.

The hardest intermittent problems to locate are those that occur infrequently and for only a short time with no chance of making a measurement. There are fancy and expensive recording analyzers for just such occasions (but you can buy a nice car for what one of these costs!). However, there may be no need for such extravagance. If you have an oscilloscope and camcorder or video camera/VCR, you probably have all you need.

For a TV or monitor, point the camera at the CRT and the scope screen so that they are both in the picture and record on a six-hour tape. Then, when your event takes place, you have a permanent record! That old video camera will be perfectly adequate. It doesn't need a 100× digitally stabilized enhanced reprocessed zoom or 1/10,000th second shutter. It doesn't even need to be color! Sure, this won't capture the 1-ns glitch. For the occasional flash in the picture, it is more than adequate to eliminate a video-signal line as the source of the problem.

Don't rush this process. It may take several diagnostic sessions to finally resolve the problem. Even if you find

and fix one or more cracked solder joints, it may be worth waiting a few days to reinstall those ten shields that had to be removed in order to access the underside of the main board! However, do replace the cover so that the internal temperature will be similar to normal during extended operation.

Now the question comes up: How can the recurrence of intermittent faults be prevented? For cracked solder joints, in addition to using proper soldering techniques for repair, it should be possible to add some "reinforcements" in the form of bare wire wrapped around the pin and extending out to the circuit board trace or even to an adjacent component pin. This will be better than just using more solder. For the CTC175 etc. cases discussed below, there is also special "elastic" solder that supposedly should be used. But, there are mixed reviews on whether this really helps.

Some equipment may also benefit from a small amount of additional cooling. A small fan can be added to draw air out of the cabinet. This will improve reliability since most components are happier being cool, but it will also reduce the extent of the thermal cycles reducing the likelihood of bad solder joints developing in the future.

RCA/GE/Proscan And Sony TVs

Classic examples of an intermittent problem present in an entire product line are the RCA/GE/Proscan TV chassis starting with CTC175 and running at least through CTC187, possibly beyond. A very large percentage of these TVs have cracked solder joints in the area of the tuner/controller resulting in erratic picture and sound. If not corrected, this eventually results in bad data being written into the EPROM that stores the TV's parameters causing a total failure to turn on. Until recently, Thomson Electronics was covering at least part of the repair costs. There may also be at least one class action lawsuit pending in regards to this problem.

Some Sony TVs suffered from a similar set of bad solder joints, usually in the tuner or IF (metal) boxes. The most common location for the problem for many of these was one pin of a coil inside the IF box that always seemed to lack adequate solder. Much more information on the RCA/GE/Proscan and Sony solder problems and solutions can be found on my Web site. Other makes and models of TVs have similar prob-

lems with solder joints, but not to the extent of these.

Wrapup

That's all for now. Intermittent faults have been present since the days of the

cat's whisker radio and will be with us until something replaces electronics in the high-tech world. Until then, we will have to deal with bad soldering and other similar problems. However, in most cases, they will yield to a systemat-

ic approach of inspection and testing. I welcome comments and suggestions in regard to this and previous Service Clinics (via e-mail to sam@repairfaq.org, please—I am not able to reply to snail mail, sorry). **P**

DIGITAL DOMAIN

(continued from page 20)

legitimate products. Even so, MLM participants, called "distributors," typically make money less by selling products than by enticing other people to sell products. Distributors earn commissions of the sales of their recruits, and their recruits' recruits, and so on, with everybody scrambling to work their way up the pyramid where the big money supposedly is.

MLM has a bad reputation for good reason. The hype surrounding MLM is in direct proportion to its penchant for taking people for a ride. Most people wind up losing money on the cost of inventory, "educational" products, and travel, says Edwards. On the other hand, you can indeed use your personal computer and the Internet to help you make money from home, either full time or on the side, and many people do. Various statistics indicate that about one-third of Americans have a home office and that about one-quarter of these offices are used to support home-business activities.

Some do succeed at MLM, and if

you want to explore it as a moneymaking opportunity, recommendations from friends or colleagues are best, says Edwards. Find a company selling products you find useful. Check out the company with the Federal Trade Commission and the Better Business Bureau. Your best bets for making money with the help of your PC are



more mainstream pursuits, such as Web site creation, computer consulting, computer repair, and technical writing, says Edwards. He provides more tips at his Web site, at www.homeworks.com. Another good site, which offers particularly good advice about technology for those working in either home or small offices, is Smalloffice.com, at www.smalloffice.com. You may not get rich quick doing it the right way, but you won't lose your shirt either.

COMPUTERS AND THE ECONOMY

Perhaps the days of a cashless society are still beyond our grasp, but over the past five years, more people are participating in trade over the Internet. Although society-at-large may not yet be cash-free, the Web has proven that money does not have to physically change hands in order to make profits. The so-called Information Revolution has produced new profit-yielding opportunities and careers for folks the world over. Cyberspace may be a cashless society bustling with trade, but it is still a far cry from utopia. **P**

THE MPX 2000

(continued from page 44)

cures the hum, the problem is either a poorly filtered DC supply or RF induced hum. There is filtering built into the MPX 2000 so a pretty poor DC supply will be tolerated, but this is still not recommended. If improving the power-supply filtering does not help, the hum is most likely RF induced. In this case, you may have to experiment with antenna placement, grounding, and RF

chokes in the power leads. A metal case is helpful sometimes, as it provides some shielding and grounding via its self-capacitance.

Final Words On FM Transmission. It is important to remember that the FM band is strictly governed by federal regulations in the US. Likewise, the use of transmitters also must follow certain guidelines. In keeping with Part 15 FCC requirements, the radiated field must be kept below 250 mV per meter at 3 meters (about ten feet) from the transmitter. The

use of a six-inch whip antenna is recommended. If the receiver is close to the MPX 2000, no antenna at all will be needed. Sufficient signal will radiate from the PC board itself to be detectable, if a plastic case is used for packaging. In practice, this 250 μ V per meter at 3-meter limit will permit good reception at 50 to 500 feet from the transmitter, depending on the receiver sensitivity and its antenna system. DO NOT connect any more length of antenna than you need, or you may invite an FCC citation. **P**



Current-Monitoring Circuits

Greetings to all Circuiteers! This visit we're going to look at several AC current-monitoring circuits, including one designed for robot use. Making DC current measurements is usually an easy task. Most often it's as easy as breaking the circuit and inserting a DC current meter. Fortunately, in today's electronic world, most solid-state circuits operate at relatively low voltages, but that's not always the case when working with AC circuits. In fact, AC-operated equipment is often powered by 120 volts.

AC Or DC? That Is The Question.

Most DC current-measuring circuits monitor the voltage drop across a low-value internal resistor that is placed in series with the DC supply and load. There is always a slight power loss due to the voltage drop across the meter's internal resistor. AC current can be measured in a similar manner, as shown in Fig. 1. A sampling resistor is connected in series with the AC power source and the load. The voltage drop across the resistor can be monitored and converted into a current reading by simply using Ohm's law, $I = E/R$.

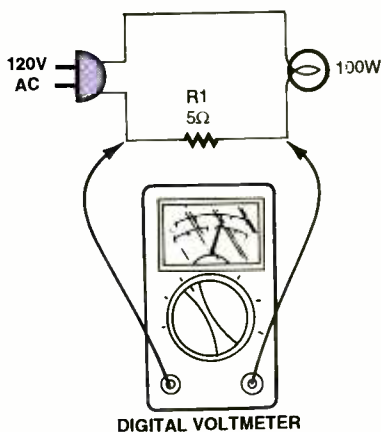

Fig. 1. Here is a simple circuit used for monitoring current. A sampling resistor is connected in series with both the power source and load.

The voltage drop across the 5-ohm resistor can easily be converted into a current value. The meter connected across the 5-ohm resistor will indicate a voltage of about 4.15 volts. The current through the 5-ohm resistor is easily found by dividing the voltage (4.15) by the resistance (5 ohms), producing a current of about .83-amps. A typical 100-watt bulb draws about .83 amps at 120 volts AC, indicating that our answer is on the money. One of the negatives in using this system of measuring current is the power loss in the 5-ohm sampling resistor, which is about 3.44 watts ($P = EI$).

Equipment Failure

Our main objective in measuring the current flow in an AC circuit is to give out an alarm when the current ceases to flow. This information can be extremely important when a circuit or piece of equipment fails. Several examples come to mind, such as an exhaust fan pulling flammable fumes from an area where a motor failure could end in a fire or explosion or an electrical heater used to keep pipes from freezing. An alarm here could save money and headaches. With a bit of head scratching, I'll bet you can come up with even better uses for AC-monitoring circuits.

A Better Way

A much better and efficient way to monitor AC current flow is to insert a current transformer in series with the power source and load. A simple example is shown in Fig. 2. Here we've taken a 6-volt, 3-amp power transformer and placed the secondary winding in series with our power source and with a 100-watt light bulb. The transformer's 120-volt primary is now the current transformer's output. This AC output can be connected to the coil of an AC relay to send an alarm when the relay drops out. This method can be used in applications

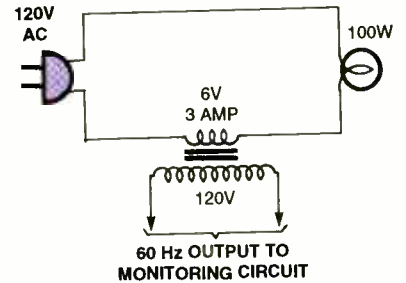

Fig. 2. A current transformer can be used to monitor current flow within a circuit. The 6-volt, 3-amp power transformer used above is ideal for low-current circuits.

where the circuit current is low and where the voltage drop across the 6-volt winding is not a problem.

An Even Better Way

A much better current transformer can be made (see the examples in Fig. 3 and Fig. 4). The current transformer in Fig. 3 is wound on an Amidon Associates,

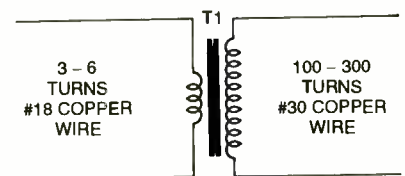

Fig. 3. Using hand-wound coils, you can make a variety of current-sensing transformers. Patience and practice are needed to wind over 200 turns of copper wire on a secondary coil.

PARTS LIST FOR AMIDON CURRENT TRANSFORMER (FIG. 3)

- AMIDON part # EA-77-375 core and bobbin can both be ordered through Amidon Associates, Inc., 2216 East Gladwick, St., Dominguez Hills, CA 90220; www.amidoncorp.com.
- Number 18 or larger enamel-covered copper wire
- Number 30 enamel-covered copper wire

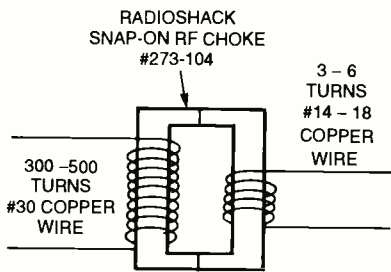

Fig. 4. Using an RF-choke form, one can hand-wind an E-core transformer. This type of transformer is more efficient at lower frequencies.

Inc. "E" bobbin and core. These run about \$3.50 for the bobbin and two cores.

The two windings are wound on the plastic bobbin and placed in the center leg of the two "E" cores. The current-sensing winding that is connected in series with the power source and load has from three to six turns of number 18 or larger copper wire. The secondary winding can be 100 turns and up to number 30 enamel-covered copper wire. The number of turns needed on the secondary depends on the primary current and the output voltage required by the monitoring-alarm circuit. Low current levels of less than 1 amp to around 3 amps require about 300 turns on the secondary and less turns for higher current levels.

The current transformer in Fig. 4 is wound on a RadioShack snap-on RF choke form. The RF choke is made up of two identical U-shaped ferrite cores. Wind three to six turns of number 14 to 18 enamel-covered copper wire on one of the "U" cores and 300 to 500 turns of number 30 enamel-covered copper wire on the other core.

More turns are required on the secondary of these cores than is required for the same output voltage produced by the "E" cores. The "E" cores are more efficient at lower frequencies. If the RadioShack cores are used, be sure to place a single layer of electrical tape over the winding area. The core's edges are sharp and could cause a break or short in the winding.

Light And Sound

The circuit shown in Fig. 5 is an AC current-monitoring circuit, complete with an audible and light alarm output. Either of the two previous current transformers may be used in this circuit. Adjusting the op-amp's gain with R6 can compensate for the difference in the transformer's output voltage. The circuit is suitable for monitoring AC current

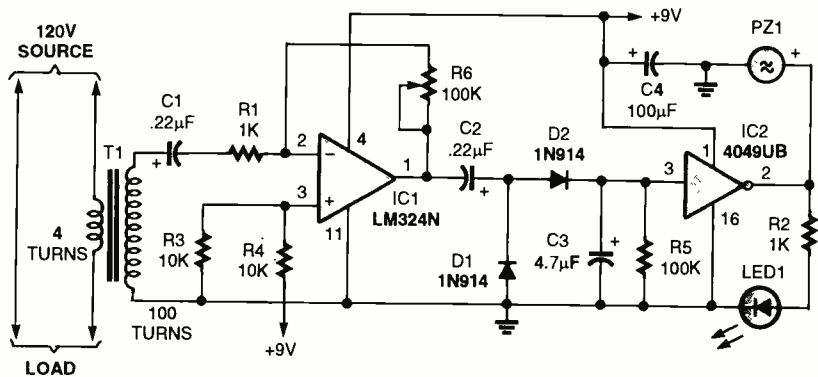

Fig. 5. Here is the schematic for an alarm circuit that incorporates light and sound. An op-amp and buffer are used for signal monitoring.

PARTS LIST FOR MONITORING-CIRCUIT WITH A/V ALERTS (FIG. 5)

SEMICONDUCTORS

IC1—LM324N quad op-amp IC
IC2—4049UB inverting buffer IC
D1, D2—1N914 silicon diode
LED1—LED (any type or color)
Pz1—Piezo sounder.

RESISTORS

(All resistors are 1/4-watt, 5% units.)
R1, R2—1000-ohm
R3, R4—10,000-ohm
R5—100,000-ohm

R6—100,000 ohm-potentiometer

CAPACITORS

C1, C2—22- μ F, ceramic-disc
C3—4.7- μ F, 25-WVDC electrolytic
C4—100- μ F, 25-WVDC electrolytic

ADDITIONAL PARTS AND MATERIALS

Current transformer (see text)
IC sockets, perfboard, etc.

levels from less than 1 amp to over 5 amps.

One op-amp of a LM324N quad op-amp package is connected in a variable-gain voltage-amplifier circuit. The gain may be varied from less than one to about 100.

The amplifier's output is connected to a DC rectifier circuit made up of D1, D2, C2, and C3. The positive DC output signal is coupled to the input of an inverting buffer IC, one of six buffers in a 4049UB IC. Current flowing in the primary of the current transformer supplies a continuous AC output voltage at the secondary and a positive voltage at the input of the 4049UB buffer. Since the IC buffer is an inverter, the output is low and neither the LED nor piezo sounder is activated.

A failure of current flow in the load circuit allows the positive voltage across C3 to discharge through R5 to near ground level taking the input of the inverter IC low. The output of the 4049UB goes from a low to a high, lighting the LED and sounding the alarm.

The op-amp's gain should be adjusted to produce a minimum of 7 volts DC at the input (pin #3) of the 4049UB, when the load current is at its lowest operating level. This will keep the alarm

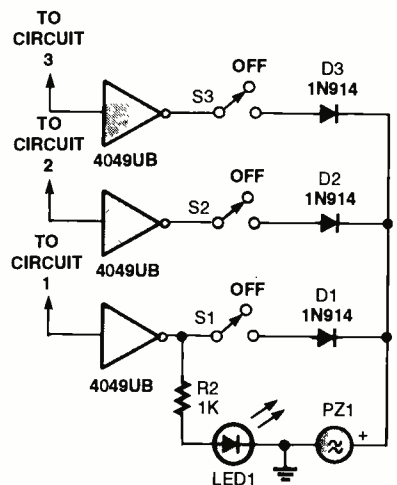

Fig. 6. Multiple occurrences of the circuit shown in Fig. 5 can be linked together using the schematic above. Several sensors can be used to form a complex alarm network.

PARTS LIST FOR ADDING ADDITIONAL STAGES (FIG. 6)

PZ1—Piezo sounder
S1—Single-pole, single-throw switch
D1—1N914 silicon diode.

from going off when the load is operating at its lowest current level.

Additional current-monitoring stages may be added by following the scheme shown in Fig. 6. The output of the 4049UB inverter, pin #2, connects to a single-pole, single-throw switch and on through a 1N914 diode to a common alarm buss with a piezo sounder as the audible alarm. The LED remains connected to the IC's output to indicate which alarm has been activated.

A Transistor-Based Alarm Circuit

Our next current-alarm circuit, see Fig. 7, takes a slightly different design approach to accomplish similar results. The circuit's only active component is a general-purpose NPN 2N3904 transistor. Current levels from about 1–10 amps can be monitored with this circuit. Either of the current transformers in Fig. 3 and Fig. 4 may be used. The cir-

cuit operation is also very simple.

With no current flowing in the current transformer's primary, the voltage output of the secondary is zero and the voltage across C1 is also zero. Q1 remains off, allowing LED1 to light. If S1 is closed, the positive voltage at the collector of Q1 will pass through D1 and R4, turning on Q2 and sounding the alarm. Normally, when current is flowing in the transformer's primary, the AC output voltage at the secondary is rectified by D1. This positive voltage charges C1 and turns Q1 on. The voltage at Q1's collector is near ground level, the LED remains dark, and no positive voltage is fed to the output buss. An interruption of the load current allows Q1 to turn off and send a positive voltage to the buss—turning on Q2 and sounding the alarm. Any number of current-monitoring circuits may be added to the alarm circuit. Connect each output through a switch

and a diode to the output buss, as shown in Fig. 7.

Either monitoring circuit can be connected to a control relay or to an optoisolator for other output applications. A high-powered sounder could be added this way to give out a more positive and far-reaching alarm. Also, the output could be coupled to an automatic shut-down circuit as a safety feature. In any case, there are many applications where a current-alarm system can save money, improve safety, and reduce down time.

Robot-Turning Zone

Our last entry this visit is a dual-current-sensing circuit that's designed to give directional output signals to a roving robot. The circuit in Fig. 8 is an updated version of the steering system for a three-wheel hound dog that I helped a young friend build for a Science Fair project over thirty years ago. The original circuit used transistors and a DC steering motor with a built-in gearing system that turned at about 5 rpm. The hound dog would follow the signal from a wire placed on the floor and travel around over the wire no matter where it went.

The secret to the dog's good nose was the 5-kHz current flowing in the wire. The output of an audio generator fed through a speaker-output transformer to the closed wire loop did the trick.

The updated version of the robot-steering circuit replaced the transistors with a single LM324N quad op-amp IC. We'll look at the "left" steering circuit since both the left and right are identical. First, let's look at the pick-up coils. L1 and L2 are coils wound on a round piece of ferrite-rod material, measuring ¼-inch diameter by 2 inches in length. The exact size isn't all that important. The ferrite rods can be salvaged from either an old TV or from just about any old transistor radio. About any ferrite rod material will work. Wind between 200 and 500 turns of #30 enamel-covered copper wire in a jumble fashion on each rod. The two coils are placed on a platform with the robot's front steering wheel (see drawings in Fig. 9 A and B). The steering motor is attached to the robot's main body, and its shaft is connected to the steering wheel platform.

Now back to the circuitry. The circuit is designed so the robot will follow a wire placed on the floor. When it is traveling in a straight line, the wire will

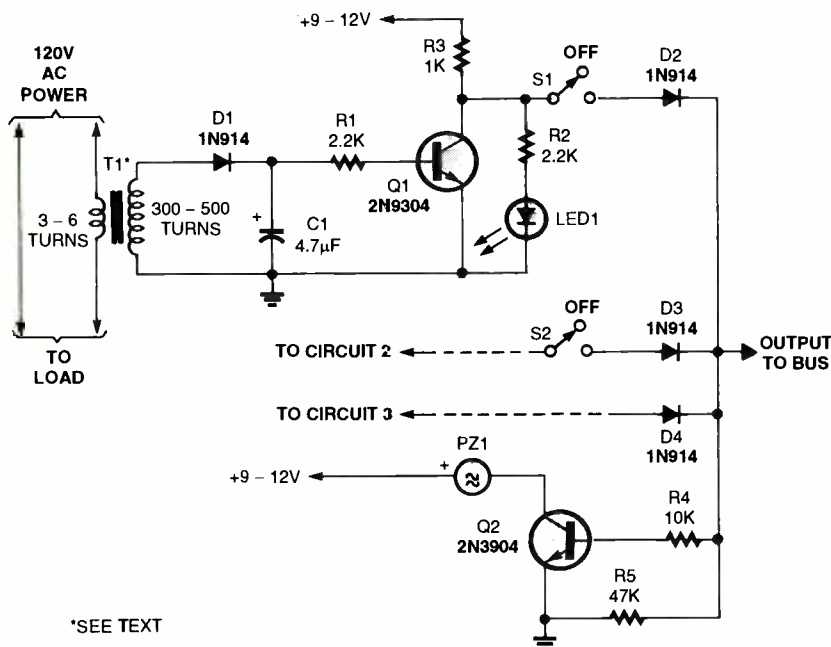

Fig. 7. Sometimes it is nice to create a circuit without ICs. Above is an alarm circuit that uses transistors as the only active components.

PARTS LIST FOR THE TRANSISTOR-BASED ALARM (FIG. 7)

SEMICONDUCTORS

Q1, Q2—2N3904 NPN general-purpose transistor

D1-D4—1N914 silicon diode

LED1—LED, any type or color

RESISTORS

(All resistors are ¼-watt, 5% units.)

R1, R2—2200-ohm

R3—1000-ohm

R4, R5—10,000-ohm

ADDITIONAL PARTS AND MATERIALS

S1, S2—Single-pole, single-throw switch

PZ1—Piezo sounder

Current transformer, see text

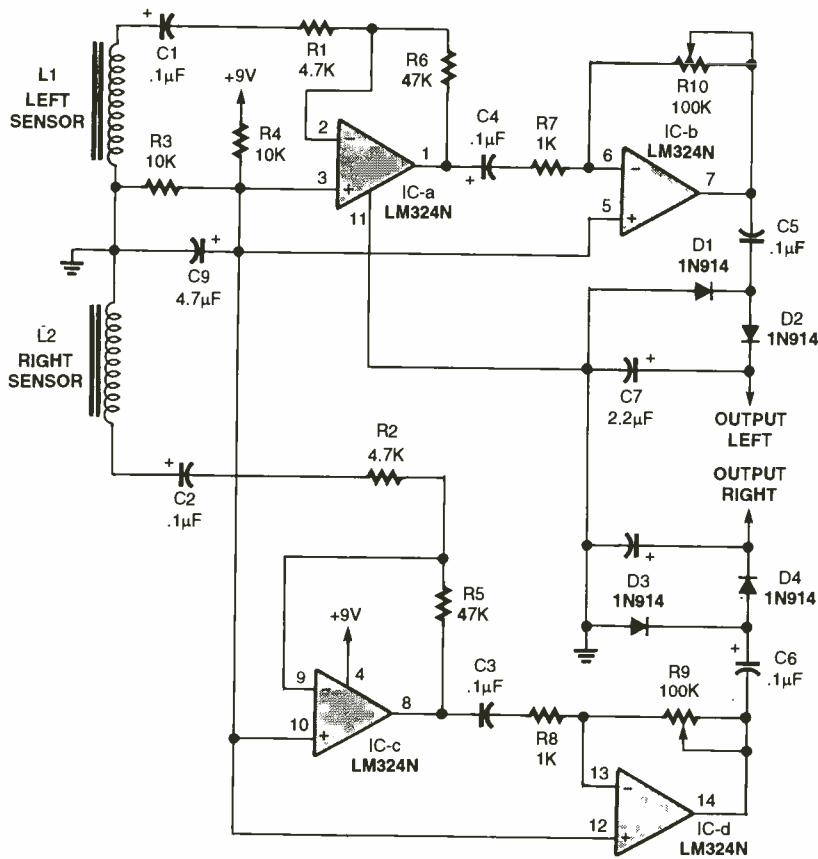

Fig. 8. Here is a circuit designed for steering a roving robot. Two pick-up coils are used as sensors that detect current flowing in copper wire.

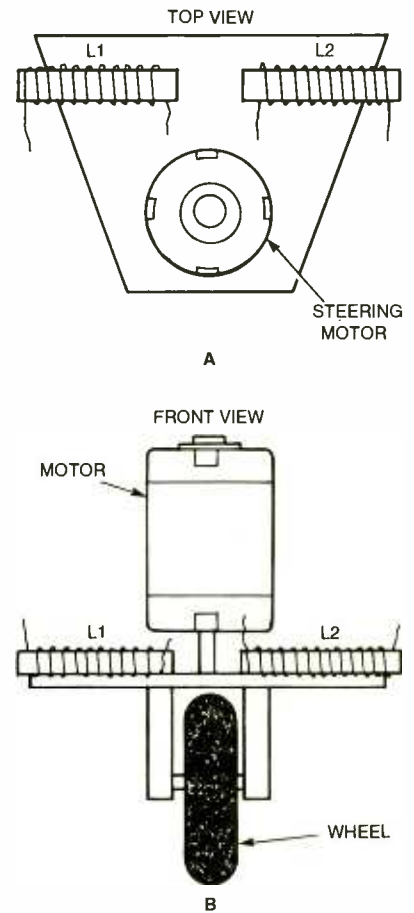

Fig. 9. A DC motor is used in conjunction with the monitoring circuit from Fig. 8 in order to control the robot's movement. The two sensing pick-ups are placed on either side of the front wheel.

PARTS LIST FOR THE ROBOT-STEERING CIRCUIT (FIG. 8)	
SEMICONDUCTORS	R9, R10—100,000-ohm pot.
IC1—LM324N quad op-amp IC	CAPACITORS
D1-D4—1N914 silicon diode	C1-C6—.1-µF, ceramic disc
RESISTORS	C7, C8—2.2-µF, 25-WVDC, electrolytic
(All resistors are ¼-watt, 5% units.)	ADDITIONAL PARTS AND MATERIALS
R1, R2—4700-ohm	Current transformer (see text)
R3, R4—10,000-ohm	
R5, R6—47,000-ohm	
R7, R8—1000-ohm	

be centered between each pick-up coil. If the robot starts to head off track towards the right, the left pick-up coil will begin to receive a stronger signal. The circuitry then sends a positive voltage to the motor steering circuit to

turn the robot back in line with the wire.

The circuit operation is simple. Amplifiers A and B amplify the audio-tone signal picked up by the coil. The amplified signal is fed to a positive DC

rectifier circuit, which supplies the steering motor with a correcting signal. The gain pots, R10 and R9, allow the circuit to be adjusted so little or no DC output occurs from either the left or right circuit when the tracking wire is centered between both coils.

I've offered this tracking circuit especially for all of you true blue experimenters who really enjoy taking a simple idea or circuit and building something useful from it.

Well, Circuiteers that's it for this visit. Go forth and build something electronic. See you here next month same station.

While speeding treatments and cures for neuromuscular disorders, advances made by MDA researchers also have enhanced therapy prospects for heart disease, cancer, arthritis, Alzheimer's and AIDS.

Giving to MDA makes a world of difference.

MDA

MUSCULAR DYSTROPHY ASSOCIATION
(800) 572-1717

Poptronics®

SHOPPER[®]

POLARIS CAN SUPPLY YOU WITH ALL OF TODAY'S HOTTEST VIDEO TECHNOLOGY!

CALL OR GO ON-LINE TO ORDER YOUR FREE VIDEO CATALOG - 100's OF PRODUCTS - MICRO CAMERAS - WIRELESS VIDEO - LIPSTICK CAMERAS - DIGITAL VCR's
WEB CAMERA WITH BUILT-IN PAN/TILT/ZOOM CONTROLS **WEATHERPROOF DIGITAL STORAGE CAMERA**

Compact Web Camera For Online Image Monitoring and Delivery Over The Internet

Featuring a built-in Web server, powerful 10x zoom, pan/tilt, and alarm input/output capability, all in an ultra-compact unit. These Web cameras can be installed virtually anywhere and deliver high-quality images to the Internet for real-time monitoring or broadcast. Better yet, these cameras can be controlled and monitored via a standard Web browser, making it ideal for a wide variety of applications.
 Size: 122mm x 82mm x 97mm.

- ☛ Ultra-compact, all-in-one web camera with built-in web server
- ☛ Monitoring and camera control possible via web browser
- ☛ 10x optical zoom and multi-angle pan/tilt capability
- ☛ 10Base-T interface for direct connection with network
- ☛ Alarm In/Out function for automatic surveillance
- ☛ Three different security levels

The SWC-40R combines a black & white video camera, digital image storage, video motion detection and an alarm interface in a compact, vandal proof enclosure. It is unique as it offers a complete CCTV surveillance system within a single compact enclosure.

- ☛ All-in-one CCTV system
- ☛ Built-in digital image storage
- ☛ Programming and image retrieval by remote control
- ☛ Built-in video motion detection

NO TAPES!

SWC-40R
\$849.95

Dimensions
5" x 4" x 4.5"



"YOUR WEB BROWSER IS YOUR REMOTE EYE!"

The Flexcam acts as an internet camera server. No software needed in order to view your video. All you need is a web browser such as Internet Explorer or Netscape. Flexcam includes many special functions including video quality control, pan/tilt/zoom interface and network configuration. All of them are controlled by the web browser. Features 4 video inputs - 3 external.

FLEXCAM
\$CALL



CONTROL PAN / TILT AND ZOOM REMOTELY OVER THE INTERNET!

LIVE VIDEO!

COLOR & B/W SUBMERGIBLE CAMERAS

CAN SEE UNDER WATER!

B/W version comes with attached 80 meter cable (color-20 meter). Built-in white LED's give this camera a 15 meter infrared range. Heat resistant glass and water resistant design allow for rugged applications.

VIDEO CAMERA HEAD CAN BE SUBMERGED UP TO 100 FEET!

SUBCAM-BW (B/W) - \$249.95
 SUBCAM-CL (COLOR) - \$299.95

CAN SEE IN THE DARK!

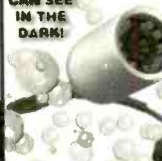

5" COLOR WIRELESS OBSERVATION SYSTEM

ADD UP TO 3 ADDITIONAL CAMERAS!

Now you can enjoy peace of mind with our new wireless observation system. Comes with 5" wireless color monitor and a wireless color camera. Just Plug-& Play Perfect for around the house or office.

Includes an attractive swivel mount indoor / outdoor patch antenna for extra range!

2.4GHz

GW-2400S - \$379.95



MICRO VIDEO HEAD "SNAKE" CAMERA

Incredibly small micro head color camera incorporates a CCD chipset. (Not CMOS). Fully adjustable focus from 0.5 inches to infinity. Automatic Iris for varying light levels.

VIDEO HEAD IS ONLY 7mm IN DIAMETER!

MH-SC01
\$479.95



6.4" COLOR TFT-LCD MODULE

TFT MONITORS AVAILABLE FROM 2.5" - 15"



HIGH RESOLUTION!

Our new 6.4" Color TFT Module can be used for a variety of purposes such as; custom automotive dash installations, video phone, door phone, boat installations, covert ultra-compact surveillance packages, security and more.

TFT-64M - \$319.95 Dimensions: 1.5"(W) x 1.75"(H) x 0.5"(D)

2.4 GHz A/V TRANSMITTING MODULE



Makes any camera wireless! Excellent for hobbyist / remote control airplanes.

2.4GHz 4 channel video transmitting module with audio capability / power switch and antenna.

MPX-2400 - \$89.95

2.4GHz RECEIVER

GFR-5002 - \$119.95

Dimensions: 1.5"(W) x 1.75"(H) x 0.5"(D)

COVERT COLOR SPY CAMERA

It's small sleek indestructible design and pinhole lens allow for various applications and simple installation. Comes equipped with a RCA JACK for easy connection to TV monitor or VCR. Great for covert use in any place imaginable.

25mm(W) x 17mm(D) **CM-550CP - \$79.95**

MICRO BOARD CAMERAS - MANY MODELS IN STOCK TO CHOOSE FROM!



MB-1250HRP
Hi-Res Color Pinhole
5.0mm Lens
1.27" x 1.27"
\$109.95

WEATHERPROOF CAMERA

Color Camera
400 TV Lines
Automatic Iris
Hi-Res Color Lipstick Camera
Length: 2.6"
Diameter: .785"



WP-300C - \$159.95

MONITOR UP TO 4 VIDEO CAMERAS SIMULTANEOUSLY THRU YOUR INTERNET CONNECTION OR OVER YOUR MODEM!

MOTION DETECTION - ALARM RECORDING - NOTIFICATION

- ✓ TCP/IP
 - ✓ MODEM
 - ✓ LAN/WAN
- Highlight an area on your video screen, and the DMRS will inform you via modem thru your telephone or pager if there is movement in that highlighted area while recording to your hard disk.

DMRS-4.....4 Input Digital Video Card.....\$289.95



Video can be viewed in Quad style (above), full screen mode or auto switching mode.

POLARIS INDUSTRIES 800-752-3571 470 Armour Drive NE • Atlanta GA 30324-3943 **WWW.POLARISUSA.COM**
 Tech 404-872-0722 • Fax 404-872-1038

Be an FCC LICENSED ELECTRONICS TECHNICIAN!

\$169⁰⁰
ONE LOW PRICE



FCC LICENSE TRAINING
Dept. 90
P.O. Box 2824
San Francisco, CA 94126-2824



**GUARANTEED
TO PASS**
YOU GET YOUR
FCC LICENSE
OR GET
YOUR
MONEY
BACK!

**CALL NOW
FOR FREE
INFORMATION!**

**START
YOUR
OWN
BUSINESS!**

COMMAND PRODUCTIONS

800-932-4268 Ext. 90

Email: fcc@commandproductions.com • Website: www.LicenseTraining.com • Fax 415-332-1901

CIRCLE 321 ON FREE INFORMATION CARD

The Standard for checking Capacitors in-circuit



Good enough to be the choice of Panasonic, Pioneer, NBC, ABC, Ford, JVC, NASA and thousands of independent service technicians.

Inexpensive enough to pay for itself in just one day's repairs. At \$179, it's affordable.

And with a 60 day trial period, satisfaction guaranteed or money-back policy, the only thing you can lose is all the time you're currently spending on trying to repair all those dogs you've given up on.

CapAnalyzer 88A

Available at your distributor, or call 561-487-6103

Electronic Design Specialists

Locate shorted or leaky components or conditions to the exact spot *in-circuit*

Still cutting up the pcb, and unsoldering every part trying to guess at where the short is?

\$179



Your DVM shows the same shorted reading all along the pcb trace. LeakSeeker 82B has the resolution to find the defective component. Touch pads along the trace, and LeakSeeker beeps highest in pitch at the defect's pad. Now you can locate a shorted part only a quarter of an inch away from a good part. Short can be from 0 to 150 ohms

LeakSeeker 82B

www.eds-inc.com

Personal Electronics



What You Want.....
Today!TM

25th
year

You Must Provide this Source Code to Receive Discount Pricing

POP87

call toll free

1-800-543-4330

fax toll free

1-800-765-6960

customer service call toll free

1-877-626-3532

KOSS Personal CD Player

•Dynamic bass boost sound •Programmable CD memory •CD track skip, search, repeat and random play •Two digit LCD display •Line out jack •Includes Koss stereo headphones and AC adaptor •Uses two "AA" batteries (not included)
•Mfr: #CDP1700

Order # ~~Reg.~~
80-4665 \$50.49

A 5" Compact Portable TV

ALARON. 5" diagonal black and white screen with flat, square, high resolution picture tube. Also features a built-in AM/FM radio. Three way power: AC adaptor (included), 12VDC power cord (included) or ten "D" cell batteries (#292-005). Built-in charging circuit for use with NiCd batteries (#292-105). Mfr. #TV-630/RWA.

Order # ~~Reg.~~
80-3705 \$51.20

From electronics that make your life more enjoyable to kits and project accessories to challenge your mind, MCM Electronics is the place for your personal electronics. Whether at work or play MCM Electronics has "What you want....Today!"



ELENCO Talking Clock Kit

This easy to build kit teaches you how electronic voices are made. The full-color manual takes you step by step through assembly. No soldering is required. Finished clock features hourly reports and rooster crow for alarm.
Mfr: #AK-220.

Order # ~~Reg.~~
80-4450 \$20.19

Only!
\$14.95



A Desk Top Clock

ALARON. •Calendar/time mode, display with calendar, year, month, date, hour, minute and second •16 cities world time display •Large LED display •Eight digit calculator function •Alarm •Convenient pen holder •Dimensions: 6" x 5 1/2" x 1 1/4" •Uses two G10 batteries (included)
•Mfr: #RY-2008

Order
#80-4695
\$8.09

Portable Radio

AM/FM/TV/Weatherband portable radio. Has headphone jack for private listening and 12 volt jack for use in car. Operates on four "AA" batteries (#292-C15). Mfr: #2150.

Order # ~~Reg.~~
80-3880 \$12.29

Only!
\$10.95



New



Only!
\$44.95



Only!
\$44.95

- Binoculars
- Boomboxes
- Cameras
- Camcorders
- CD Players
- Clocks
- Electronic Games
- Hobby Kits
- Radios
- Receivers
- Telescopes
- TVs
- VCRs

Visit and order from our secured website
www.mcmelectronics.com

Source Code: POP87

Prices effective June 8 through September 8, 2001.

CIRCLE 324 ON FREE INFORMATION CARD

A Premier Farnell Company

July 2001, Poptronics



Bookmark Location <http://www.fort777.com>

LOG ON TO FORT777.COM

Come & Visit Fort777.com Now!



Come and take a look at all the great products we've got for you at Fort777.com - and they're all at incredibly low prices even if you only want one piece. Just click Product Index to find all the things you need. While you're there take a look at the Novel and read all about the Fort777 of the future. Make Fort777 your first choice and start saving NOW!

Electronic Components When you want electronic components, visit Fort777.com. We've got large ranges of all the most popular items you'll need. Check out our Resistors, Capacitors, Connectors, Relays, Potentiometers, Fuses, LEDs, Neons, Lampholders, Diodes, Rectifiers, Crimp Terminals, Suppressors, Buzzers, Fuseholders, Clips, Audio, Computer and Telephone Cords and much, much more.

We've got specialty items as well and our range is growing all the time. Take a look at our special offers and click on Star Buys to see our latest hottest items. There are lots of new things happening all the time at the new Fort777.com so come back and visit us regularly then you won't miss any of our great specials. With our low prices you can buy for your friends and save on freight costs. Orders over US\$150 we pay the freight.



Only Top Quality Components



You can rely on the components you'll get from Fort777.com. We only buy direct from the best factories. All our components are fully specified and are the same each time you buy. You can pay much more for these very same items by buying from our competitors. But if you want the best parts at the best prices, come to Fort777. The choice as always is yours.



and drawing if it's pcb mounted. So now you can check out all the specs on line to find the exact part you need. Just click on More Info to see all the details and don't forget to scroll right to the bottom of the page to see the entire specification. In the More Info product screen, you will see a large picture of the product so that you can be absolutely certain that you've got the exact item you need. Take a look at Fort777 right now!

Low Cost Movies That Play On Your DVD Player



Never before sold in US, but now you can buy near-DVD quality video CDs that will play on your DVD player. We've got lots of the latest movies, top movies released over the last few years and classics. Prices are around one third the regular price for DVDs. These discs are 100% legal product, produced under license from the studios. Visit Fort777.com and find out more about how we can do it and check out all your favorite movies.

It's All At Fort777.com

When you need the best quality components and the best prices, you need to visit Fort777.com. Use the menu buttons, search function or index to quickly find the parts you need. Every item has a color picture and full description, specification

ITEMS SHOWN HERE AND ON THE WEBSITE [HTTP://WWW.FORT777.COM](http://www.fort777.com) ARE ONLY AVAILABLE FROM THE WEBSITE

No minimum order quantity. Prices are valid for one piece/pack. Freight charged extra.

*The address below is for returns and servicing:

FORT777.COM NORTH AMERICAN SERVICE AGENTS, FRONTIER ENGINEERING
 628 S. SUNSET ST., LONGMONT, CO 80501 * email: sales@fort777.com

AMAZING DEVICES

See in Action video on our web site at www.amazing1.com

Ion Ray Guns

Star Wars Technology Directs Energy

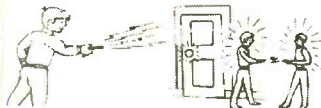

Star Wars Technology Demonstrates Weapons Potential, Force Fields, IonMotors, Antigravity etc. **Projects electric shocks without contact!** Conduct many weird and bizarre experiments. Handheld battery operated and easy to operate.

IOG7/9 Plans.....\$10.00
IOG7K Kit/Plans.....\$39.50
IOG70 Assembled/Tested.....\$149.95
Higher Powered Device
IOG9K Kit/Plans.....\$129.95
IOG90 Assembled/Tested.....\$199.95

Shocker Trigger Ignitor

Variable 20,000 volt pulser used for laser flash tube, spark gap and pyro ignitor, garden pest shocker, electric fence, snake venom removal etc. 12 volt battery operation.

TRIG1K - Kit/Plans.....\$29.95
TRIG10 - Lab Assembled.....\$49.95

Cybernetic Ear!

Provides that "extra edge" for many listening applications. Enhances 3 to 4x of normal. CYBEREAR.....\$19.95

Mini TESLA Coil

Lights up a 4' fluorescent tube-all without any contact!! Yet only 3" tall!

MTC1K Kit/Plans.....\$24.95
MTC10 Assembled.....\$34.95

Body Heat Telescope

Detects living bodies over 300' Heat leaks etc. Built in chopper and sens control

BHT6 Plans.....\$10.00 BHT6K Kit.....\$99.95
BHT60 Ready to use.....\$149.95

Ultra Bright Green Laser

30 to 50x brighter than most red pointers!! Full 5 mw range in excess of 6000 feet!! Operates for hours from 2 "AAA" batteries
LAPNGR5 Pointer.....\$Call for Price!!

Low Cost 100,000 Volt DC Supply

Amateur experimenters source of HVDC for many applications

- 100,000 volts at 2ma
- Built in dry filled multiplier.
- Operates on 12vdc or 115vac

HVOLT1 - Plans.....\$8.00
HVOLT1K - Kit/Plans.....\$149.95
HVOLT10 - Assembled.....\$249.95

Combo Tesla Coil, Jacobs Ladder, Plasma Tornado

Amazing and bizarre effects turn a normal light bulb into a spectacular plasma display!! With adjustable frequency control. Safe 12vdc input
TCL5 Plans.....\$8.00 TCL5K Kit/Plans.....\$59.95
TCL50 Assembled and Tested.....\$99.95

Mass Driver



Above photo shows burst impact of Mass Driver

Can Crusher

A can is crushed into the shape of an hour glass demonstrating the awesome power of magnetics. Very popular demo in science museums as users get to crush and keep their own can. Kids love this!!

Wire Exploding

Generate pyrotechnical explosive blasts for many applications. Create a new artistic concept. Uses our unique high energy pulser shielded explosion chamber.

HEP9 High Energy Pulser...\$20.00

Plans pack Includes above MASS1 Mass driver, CANCRU1 Can crusher and WIREXPLOD1 Wire exploder/Blast art plans. We stock all parts, kits and completed units for the above items.

Above HEP9 pulser is used for :
EMP / HERF Generation, Build a Rail or Coil Gun, Electrothermal Gun, High Power Pulsed Laser, Mass Warping etc etc

Mind&Brain Controllers

Incredible device Turbo charges memory, Boost mental powers, Controls stress, Speeds up healing processes and Uncover hidden potentials. High quality unit with many features.



BWPLUS-APOLLO Ready to use...\$179.95
BWII- EINSTEIN Lower cost unit...\$129.95

Ultrasonic Painfield Generators

For property and personal protection. Four transducer matrix intensifies and concentrates effect on target area.

PPF4 Plans.....\$20.00
PPF4K Kit.....\$199.95
PPF40 Ready to use.....\$299.95

3 MI Voice Transmitter

Crystal clear. Many applications. Easy to build
FMV1 Kit and Plans.....\$39.95

Information Unlimited PO Box 716 Amherst N.H. U.S.A. 03031

1 800 221 1705 Orders/Catalogs Only! Fax 1 603 672 5406 Information 1 603 673 4730 Free Catalog on Request
Pay by MC, VISA, Cash, Check, MO. Add \$5.00 S&H. Overseas Contact for Proforma

CIRCLE 220 ON FREE INFORMATION CARD

RF Data Modules

AM Transmitter



- Sub Miniature module
- SAW Controlled
- No adjustable components
- Low current - 2.5mA
- Supply 2.5-12Vdc
- 418MHz or 433MHz
- Range up to 300ft
- CMOS TTL data input
- 7 x 11 x 4mm!
- AM-TX1-xxx \$12.60

AM Receiver



- Compact Hybrid Module
- Very stable
- CMOS/TTL output
- Patented Laser Trimmed
- 5Vdc. 0.8mA (HRR6)
- 2kHz data rate
- Sensitivity -105dBm
- 38 x 12 x 2 mm
- AM-HRR6-xxxx... \$16.33

FM Transceiver



- Only 23 x 33 x 11mm
- Up to 40,000bps data rate
- Up to 450ft. range.
- 5V operation
- 418MHz or 433MHz FM
- 5V CMOS logic interface
- Fast 1ms enable
- Power saving feature
- Carrier Detect output
- BiM-xxx-F \$87.36

RS232 Transceiver

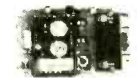

- 3wire RS232 interface
- 19.2Kbps half duplex
- 418MHz or 433MHz FM
- 7.5-15Vdc, 20mA
- TX/RX Status LED's
- Up to 400ft. range
- 1/4 wave ant. on board
- User data packetizing
- 58 x 40 x 15mm
- CYPHERNET \$139.30

AM Transmitter



- Range up to 250ft.
- SAW controlled stability
- Wide supply range 2-14V
- CMOS/TTL input
- Low current. 4mA typ.
- Up to 4kHz data rate
- Small: 17 x 11mm
- AM-RT5-xxx \$12.10



Free Catalog

tel: (416)236 3858
fax: (416)236 8866
www.abacom-tech.com
MasterCard / VISA

The BEST is now Better!

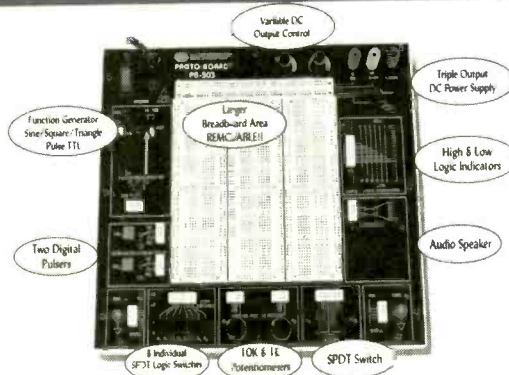

Feature-rich Circuit Design Workstation
Ultra-affordable at just \$299.95
Portable Version Available for \$349.95

Our classic PB-503 the complete Proto-Board Design Workstation is newly improved. Enhancements include: an 8-channel Logic Monitor, High & Low buffered Logic Indicators, 8 selectable Logic Switches, and removable Breadboard Socket Plate. This Velcro-backed socket plate allows for greater circuit design flexibility; order extra to suit your needs.

Traditional instrumentation on the unit includes a continuously variable Function Generator, triple output DC Power Supply, along with Switches, Digital Pulvers, Potentiometers and an Audio Speaker. The highly functional PB-503 is built to last, with an industry-best

3-year warranty along with a lifetime warranty on all breadboard sockets. Own the best! Order yours today.



1486 Highland Avenue • Unit 2
Cheshire, CT 06410
1.800.573.1029
203.772.4330 FAX
www.globalspecialties.com

SECURETEK

DIRECT FROM MANUFACTURER

"WE WILL BEAT ANY COMPETITORS PRICE"

WORLD SMALLEST
WIRELESS VIDEO CAMERA
(BLACK & WHITE OR COLOR)
TRANSMITS VIDEO UP TO 1000FT.



CAMERA SHOWN
ACTUAL SIZE

WE ALSO CARRY:

- COVERT VIDEO CAMERAS
- COUNTER-SURVEILLANCE PRODUCTS
- CUSTOM MADE VIDEO SYSTEMS
- IN HOUSE ENGINEERING DEPT.

DISTRIBUTOR
PROGRAM
AVAILABLE

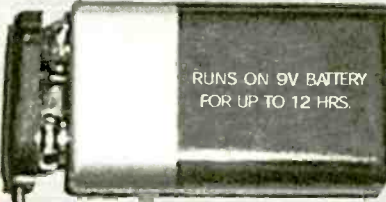

CALL FOR CATALOG:

SECURETEK

7152 S.W. 47TH STREET
MIAMI, FLORIDA 33137

TEL. 305.667.4545
FAX. 305.667.1744

www.securetek.net

Test Equipment From \$99.00



ATC modules provide for affordable pc based testing
DSO, DVM, Spectrum Analyzer, Data Logging
O-Scope I_p and O-Scope II Single and dual channels
Serial a protocol analyzer software package
DFA 5 low cost differential amplifier

Standalone digital oscilloscopes from HiRel and TPI

Pico Technology LTD leads in low cost pc based modules for test and data logging. Units to 100MSPS. 8 to 16 bits, 1 to 22 channels. Environmental monitoring. Science education with DRDAQ. Pricing from \$99

Allison Technology Corporation

2006 Finney Vallet Rd. Rosenberg, TX 77471

PH: 800-980-9806 or 281-239-8500, FAX 281-239-8006

<http://www.atcweb.com> atc@atcweb.com

Turn your PC into a 16-bit Storage Scope
spectrum analyzer, and digital multimeter!

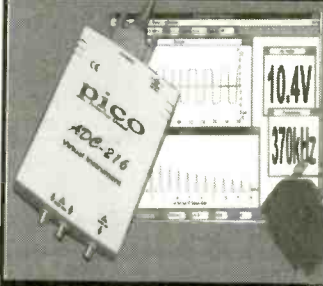

Turn your PC or laptop into a sophisticated storage scope & spectrum analyzer & multimeter. Display on large screen! Print in color! 100MS/s 8-bit, 1.2MS/s 12-bit or 333kS/s 16-bit versions. Great for test depts, schools. Input to Excel. LabView/NT drivers. High precision not high cost! Models from \$95 - \$799!

DrDAQ
science lab in a box!

great for
science fairs!

DrDAQ is a sophisticated digital data-logger that plugs into a PC and comes with sensors for light, sound, pH and temp. Lots of suggested science experiments included which can be done from software supplied. Spectrum analyzer/scope/meter all at once!

DrDAQ from only \$99!

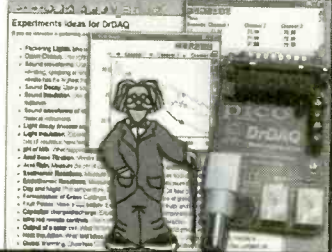

www.saelig.com

RS232-422/485 converters, self-powered, opto-isolated
I2C adapter boards for PC communication with I2C bus
Mini dataloggers for events, voltages, pressures, etc.
Enviromon temperature and environment netwk logger
Thermocouple and thermistor adapters for PC ports.
BASIC-programmable BASIC-TIGER controller modules
JANZ CANbus boards - from Germany's leader!
SMD adaptor boards for prototyping with any SM parts!



Saelig Company

www.saelig.com saelig@aol.com

716-425-3753 • 716-425-3835 (fax)

1-888-7SAELIG



SUPPORTS
DEVICES TO
32 MEG

EPROM+

A device programming system for design, repair and experimentation

- ◆ EXCEPTIONAL POWER FOR THE PRO
- ◆ EASY-TO-USE FOR THE NOVICE
- ◆ INCLUDES STEP-BY-STEP TUTORIAL

Here's what you get: A rugged, portable programming unit including the power pack and printer port cable both of which store inside the case. A real printed user and technical manual which includes schematic diagrams for the programming unit plus diagrams for all technology family adapters.* Comprehensive, easy-to-use software which is specifically designed to run under DOS, Windows 3.1, 95 and 98 on any speed machine. The software has features which let you READ, PROGRAM, COPY and COMPARE plus much more. You have full access to your system's disk including LOADING and SAVING chip data plus automatic processing of INTEL HEX, MOTOROLA S-RECORD and BINARY files. For detailed work the system software provides a full screen buffer editor including a comprehensive bit and byte tool kit with more than 20 functions.

Broad device support: FIRST GENERATION EPROMS (2708, TMS2716*, 25XX) SECOND GENERATION EPROMS (2716-28C080), 40 and 42 PIN EPROMS* (27C1024-27C160) FLASH EPROMS (28F, 29C, 29EE, 29F), EEPROMS (2816-28C010), NVRAMS (12XX, X2210/12) 8 PIN SERIAL EPROMS* (24, 25, 85, 93, 95, 80011A) PLUS ER1400/MS8657* AND ER5901 BIPOlar PROMS* (72S/82S), FPGA CONFIGURATORS (17CXXX) MICROCONTROLLERS* (874X, 875X, 87C5XX, 87C75X, 89C5X) ATMEL MICROS* (8-40) PIN 89C051, 89CXXX (AVR) 90SXXX PIC MICROS* 8, 18, 28, 40 PIN (12CXX-16CXXX, 16FX, 17C) MOTOROLA MICROS* (68705P3/13/R3, 6811C705, 6811C711)

\$289

REQUIRES SNAP-IN ADAPTER (ORDER FACTORY DIRECT OR BUILD YOURSELF) \$5.00 SHIPPING • \$5.00 C.O.D. 1 YEAR WARRANTY - 30 DAY MONEY BACK GUARANTEE VISA MASTERCARD* AMEX

ANDROMEDA RESEARCH, P.O. BOX 222, MILFORD, OH 45150
(513) 831-9708 FAX (513) 831-7562 website - www.arlabs.com

B² Spice A/D 2000

~~\$299~~

\$199

Price good through 7/30/01. Mention this ad for the special price.

Mixed-Mode Circuit Design

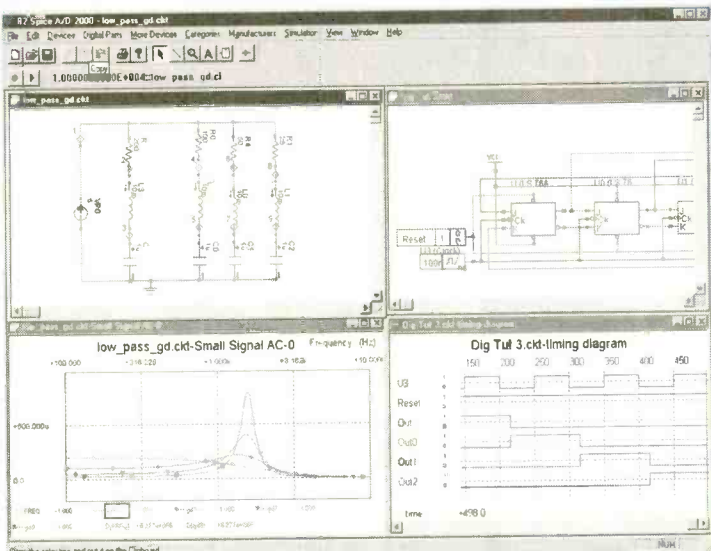

- ◆ Build complex circuits in minutes with our intuitive schematic editor.
- ◆ Turn any circuit into a functional part with just a few simple clicks.
- ◆ Interpret simulation results with customizable graphs.
- ◆ Find exactly the part you need from our database of 4500 parts.
- ◆ Run an interactive Digital Simulation and view signals in the Timing Diagram

How We Compare

Characteristics	B ² Spice A/D 2000	EWB Multisim Personal
PRICE	\$299	\$399
DC Operating point	X	X
DC Parameter Sweep	X	X
Temperature Sweep	X	-
Transient	X	X
Fourier	X	X
Parameterized transient	X	-
AC Analysis (freq sweep)	X	X
Parameterized AC Sweep	X	-
Pole Zero	X	-
Transfer function	X	-
DC Sensitivity	X	X
Distortion	X	X
Note:	X	X
DC Op. Pt. Monte Carlo	X	-
DC Sweep Monte Carlo	X	-
AC Monte Carlo	X	-
Transient Monte Carlo	X	-
Interactive, free running digital logic simulation.	X	-

Visit our web site for a free trial.

\$99 Lite Version

Beige Bag Software • www.beigebag.com • 734.332.0487 • info@beigebag.com

CIRCLE 319 ON FREE INFORMATION CARD

New and Pre-Owned Test Equipment

New Equipment Specials

B+K Precision 2120B – 30MHz Oscilloscope

- * FREE Model 117B Multimeter
 - * 2 Channel, Dual-Trace
 - * 30 MHz Bandwidth
 - * TV Triggering
 - * (2) Probes Included
- Sale Price \$339.00**

AVCOM PSA-37D – Spectrum Analyzer

- Satellite Downlink – Installation – Maintenance & Service
 - Band 1: 10 – 1750 MHz
 - Band 2: 3.7 – 4.2 GHz
 - Carrying Case Included
 - Line or Battery Powered
 - Built-in DC Block & Power for LNA/LNB's
- Sale Price \$2,395.00**

Instek GOS-6103 – 100 MHz Analog Oscilloscope

- 100 MHz Bandwidth
 - 2 Channel, High Sensitivity
 - TV Trigger - Signal Output
 - Cursor Readout
 - Time Base Auto-range
 - (2) Probes Included
 - 2 Year Warranty
- Sale Price \$899.00**

Leader LF 94† – CATV Signal Level Meter

- TV/CATV Coverage from 46 - 870 MHz
 - Video/Audio Carrier Measurements
- Sale Price \$489.00**

NEW! Fluke 187 – Digital Multimeter

- Basic DC Accuracy of 0.025% at 50,000 Count
 - True-RMS AC, AC+DC, dBm, & dBV
- Sale Price \$319.00**

Pre-Owned Oscilloscope Specials

B+K Precision	1466	10 MHz	\$185.00
Tektronix	465	100 MHz	\$499.00
Tektronix	465B	100 MHz	\$649.00
Tektronix	475	200 MHz	\$749.00
Tektronix	475A	250 MHz	\$949.00

- Professionally Refurbished
- Aligned & Calibrated to Original Specifications
- The Industry Standard of Oscilloscopes
- 1 Year Warranty - The Longest Available!!!
- See Website for Complete Specifications

See us on the Web!
www.testequipmentdepot.com

We Buy Surplus Test Equipment

Test Equipment Depot

A FOTRONIC CORPORATION COMPANY

99 Washington St. Melrose, MA 02176
(781) 665-1400 • FAX (781) 665-0780

e-mail: sales@testequipmentdepot.com

(1-800-996-3837)



TOLL FREE 1-800-99-METER

CIRCLE 322 ON FREE INFORMATION CARD

CALL TOLL FREE

(800) 292-7711

Orders Only

Se Habla Español

C&S Sales

Look For Other
Monthly Specials
On Our Website

Excellence in Service

www.cs-sales.com

D/A Trainer

Elenco Model XK-700



\$195

Elenco's advanced designed Digital/Analog Trainer is specially designed for school projects. It is built on a single PC board for maximum reliability. It includes 5 built-in power supplies, a function generator with continuously variable sine, triangular, and square waveforms. All power supplies are regulated and protected against shorts. The trainer is mounted in a professional technician tool case made of reinforced metal with heavy-duty handles and latches.

Soldering Stations

Weller Low Cost Soldering Iron Model WLC-100



\$34.95

- Variable power control produces 5-40 watts.
- Ideal for hobbyists, DIYers and students.
- Complete with 40W iron.

Weller Soldering Station Model WES50



\$119

50 watts of controlled power - designed for continuous production soldering.

Deluxe Electronic Soldering Station

Elenco SL-5 Series

Electronically controlled, ideal for professionals, students, and hobbyists. Available in kit form or assembled.

Works w/ any iron! Turn any soldering iron into a variable iron.

As Low As
\$29.95



Features:

- Cushion Grip Handle Soldering Iron (optional) with Grounded Tip for Soldering Static-Sensitive Devices. Easily Replaceable. Uses Long-Life, Plated Conical Tip.
- Heavy Steel, Non-Slip Base.
- Iron Holder Funnel - Reversible, left or right side.
- Steel Tray for Sponge Pad.
- Sponge Pad.

Ordering Information:

Model SL-5 - No iron. (Kit SL-5K) **\$29.95**

Model SL-5-40 - Includes 40W UL iron. (Kit SL-5K-40) **\$35.95**

*** Limited Time Offer ***
FREE SP-1A Solder Practices Kit w/ Kit Order!

Generators & Counters

B&K 20MHz Sweep/Function Generator with Frequency Counter Model 4040

- 0.2Hz to 20MHz
- AM & FM modulation
- Burst Operation
- External Frequency counter to 30MHz
- Linear and Log sweep

\$425



10MHz Model 4017 \$319
5MHz Model 4011 \$249
3MHz Model 4003 \$205

BK PRECISION

Four Functions in One Elenco Model MX-9300B



Features:

- One instrument with four test and measuring systems:
- 1.3GHz Frequency Counter
- 2MHz Sweep Function Generator
- Digital Multimeter
- Digital Triple Power Supply - 0-3V @ 2A, 5V @ 2A, 15V @ 1A

\$450

Elenco Handheld Universal Counter 1MHz - 2.8GHz Model F-2800



\$99

Features 10 digit display, 16 segment and RF signal strength bar-graph. Includes antenna, NiCad battery, and AC adapter. C-2800 Case with Belt Clip \$14.95

Elenco RF Generator with Counter (100kHz - 150kHz) Model SG-9500



Features Internal AM mod. of 1kHz, RF output 100MV - 35MHz. Audio output 1kHz @ 1V RMS.

\$225

SG-9000.....\$119.95 (analog, w/o counter)

Elenco Sweep Function Generator w/ built-in frequency counter Model GF-8046



\$195.95

This sweep function generator with counter is an instrument capable of generating square, triangle, and sine waveforms, and TTL, CMOS pulse over a frequency range from 0.2Hz to 2MHz.

GF-8025 - Without Counter \$139.95

Kit Corner

over 100 kits available

Quantity Discounts Available

Elenco Model RCC-7K Radio Control Car Kit

\$29.95

- Fun & Easy to Assemble
- 7 Functions
- Radio Control Transmitter Included
- Also available as Model AK-870 (No Soldering) \$24.95



Elenco Model AK-700 Pulse/Tone Telephone Kit

\$15.95



Ideal School Project

Action Lab Kit Model MX-902

- Safe, Solderless, Educational, and Fun!
- Easy-to-read, Illustrated, Lab-Style Manual Included.
- Requires 2 "AA" Batteries
- Build your own operating motor - it's easy, it's fun, it's Safe!
- For Ages 10 and up.

\$24.95



Elenco Model AM-780K

Two IC Radio Kit

\$11.95

Also available: Model AM/FM-108K AM/FM Radio Kit \$29.95

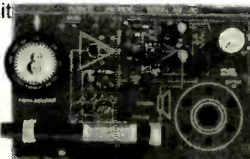

OWI Model OWI-007

Robotic Arm (Wired Control)

Teaches the basic robotic sensing and locomotion principles while testing motor skills.

\$55.95



Elenco Digital Multimeter Kit Model M-2665K

- Extra large 1 1/4" x 2 1/2" LCD display area.
- 34 ranges - includes capacitance, transistor testing hfe, diode testing
- 20A AC/DC current
- Overload protected

\$49.95



Guaranteed Lowest Prices

C&S SALES, INC.

15 DAY MONEY BACK GUARANTEE

2 YEAR FACTORY WARRANTY

UPS SHIPPING: 48 STATES 5%
OTHERS CALL FOR DETAILS
IL Residents add 8.25% Sales Tax

150 W. CARPENTER AVENUE
WHEELING, IL 60090
FAX: (847) 541-9904 (847) 541-0710



PRICES SUBJECT TO CHANGE WITHOUT NOTICE

CIRCLE 290 ON FREE INFORMATION CARD

www.americanradiohistory.com

SAME DAY SHIPPING
Secure on-line ordering

C&S Sales

Excellence in Service

CALL OR WRITE FOR OUR FREE 64 PAGE CATALOG!
(800) 445-3201

Elenco Oscilloscopes

Free Dust Cover and 2 Probes

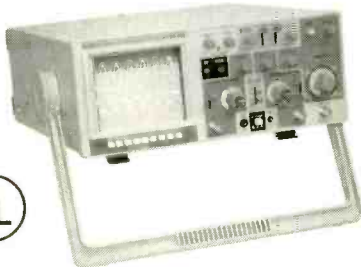

S-1325	25MHz	Dual Trace	\$325
S-1330	25MHz	Delayed Sweep	\$439
S-1340	40MHz	Dual Trace	\$475
S-1345	40MHz	Delayed Sweep	\$569
S-1360	60MHz	Delayed Sweep	\$725
S-1390	100MHz	Delayed Sweep	\$895

DIGITAL SCOPE SUPER SPECIALS

DS-203	20MHz/10Ms/s	Analog/Digital	\$695
DS-303	40MHz/20Ms/s	Analog/Digital	\$850
DS-603	60MHz/20Ms/s	Analog/Digital	\$950

Digital Multimeters

Fluke 79III

\$195



Features analog bargraph, automatic touch hold, diode test, continuity beeper, fused current inputs, lead resistance compensation, ohms, and true RMS.

Elenco LCR & DMM Model LCM-1950

\$69



- Large 1" 3 3/4 digit LCD
- Autorangeing frequency to 4MHz
- Capacitance to 400µF
- Inductance to 40H
- Resistance to 4000MΩ
- Logic Test
- Diode & Transistor Test
- Audible Continuity Test

Elenco Model M-1740

\$34.95



- 11 Functions
- Freq. to 20MHz
- Cap. to 20µF
- AC/DC Voltage
- AC/DC Current
- Beeper
- Diode Test
- Transistor Test
- Meets UL-1244 safety specs

Model M-2760 - \$19.95 (9 functions)

Dual-Display LCR Meter w/ Stat Functions B&K Model 878

\$225



Auto/manual range
Many features with Q factor
High Accuracy

Elenco LCR Meter Model LCR-1810

\$99.95



- Capacitance: 1pF to 20µF
- Inductance: 1µH to 20H
- Resistance: 0.1Ω to 2000MΩ
- Temperature to 750°C
- DC Volts 0 - 20V
- Frequency up to 15MHz
- Diode/Audible Continuity Test
- Signal Output Function
- 3 1/2 Digit Display

Elenco DMM Kit Model M-1005K

\$19.95



- 18 Ranges
- 3 1/2 Digit LCD
- Transistor Test
- Diode Test
- Training Course

M-1000B (Assembled) \$15.95

Quantity Discounts Available

Project Labs

Elenco 50-in-1 Electronic Playground Model EP-50

\$19.95

Easy-to-build experiments teach you the operation of over 50 electronic circuits. Fully assembled, includes all the parts needed. No tools or soldering required! Build these exciting circuits: finger touch lamp, magnetic bridge, voltmeter, morse code alarm, electronic noisemaker, electronic kazoo, electronic keyboard, transistor radio, radio announcer, metal detector, and many more. 76 page manual teaches you about voltage, current, resistors, capacitors, transistors, diodes, transformers, speakers, and antennas. Requires one 9V battery.



Elenco Quad Power Supply Model XP-581

\$79.95



4 Fully Regulated DC Power Supplies in 1 Unit
4 DC voltages: 3 fixed - +5V @ 3A, +12V @ 1A, -12V @ 1A
1 Variable - 2.5 - 20V @ 2A

Elenco Power Supply Kit Model XP-720K

\$54.95

- 1.5VDC - 15VDC @ 1A
- -1.5VDC - -15VDC
- 5VDC @ 3A
- 6.3VAC @ 1A & 12.6VAC center tapped @ 1A



XP-720 Fully Assembled **\$85**

Elenco AC/DC Variable Power Supply Model XP-800



The XP-800 is a high current power supply with 3 variable outputs. Choose from either 0-120VAC @ 2A, 0-40VAC @ 7A, or 0-28VDC @ up to 10A. The precision LED displays allow for exact readout of volts and current. The XP-800 is ideal for Principles of Technology experiments in schools or it can be used as a bench power supply in OEM labs.

\$325

Elenco DC Power Supply Model SPL-603 3A 0-30VDC

\$79.95

The SPL-603 is a solid-state DC power supply providing the exact output voltage no matter what current you use. Output fully protected from overload.



Maxitronix 300-in-1 Electronic Project Lab Model MX-908

\$48.95

Everything you need to build 300 exciting electronic projects:

- A Transistor Radio
- IC Organ
- Burglar Alarm
- Delayed Timer
- Electronic Game
- Optical Volume
- Multiplier
- Multiple Counter
- Digital Light Dimmer
- Tone Burst Generator
- Audio Signal Tracer
- Electronic Candle
- Voice Level Meter
- and many, many more!



• Easy-to-read, illustrated, lab-style manual included.

Maxitronix 500-in-1 Electronic Project Lab Model MX-909

\$170

Everything you need to build 500 exciting electronic projects:

Learn the basics of electronics and put your knowledge to work creating 500 different electronic experiments, special lighting effects, radio transmitter and receivers, amazing electronic sound effects, cool games and MORE! Includes built-in breadboard for easy wiring and connection of components, and an LCD (Liquid Crystal Display) indicates the information during the experiments in process.

• Fact-filled, illustrated, lab-style manual included.



Tool Kits

Elenco Deluxe Electronic Tool Kit Model TK-3000

\$79.95

A professional technician service tool kit in a metal reinforced tool case with heavy-duty handle and locks. A removable, double-sided pallet handles most of the tools listed below with more room for tools and parts in the lower half. A special ramp in the tool case will lock your meter of choice in place.

Tools included in case:

- Deluxe Soldering Iron
- Soldering Iron Stand
- Diagonal Pliers
- Long Nose Pliers
- Deluxe Wire Stripper
- Solder Ease Kit
- 3 pc. Nut Driver
- Precision Screwdriver Set
- Screwdriver Slotted 3/16"
- Screwdriver #1 Phillips
- IC Extractor
- Solder Pump
- Safety Goggles
- Pocket Screwdriver
- Solder Tube
- Solder Wick

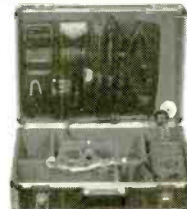

Elenco Deluxe 26pc. Computer Service Tool Kit Model TK-1200

\$39.95

Includes everything you need to service today's computers. Tools include deluxe soldering iron, 5" needle nose pliers, reversible star bits T10, T15, reversible bit nut drivers 3/16" and 1/4", deluxe wire stripper, IC extractor, and more!



Xcelite® PC Repair Kit Model 99-SPC

\$34.95

- Ideal for repairs on all PCs.
- Anti-static chip tops protect from ESD damage.
- Convenient roll-up pouch.



Guaranteed Lowest Prices

C&S SALES, INC.

15 DAY MONEY BACK GUARANTEE
2 YEAR FACTORY WARRANTY

UPS SHIPPING: 48 STATES 5%
OTHERS CALL FOR DETAILS
IL Residents add 8.25% Sales Tax
SEE US ON THE WEB

150 W. CARPENTER AVENUE
WHEELING, IL 60090
FAX: (847) 541-9904 (847) 541-0710
www.cs-sales.com



PRICES SUBJECT TO CHANGE WITHOUT NOTICE

CIRCLE 290 ON FREE INFORMATION CARD

Miniature Transmitters and Receivers

2 Button / 3 Channel Transmitter



RF300T

1....\$22.95
5....\$19.95 ea
10...\$16.95 ea

RF300XT

1....\$25.95
5....\$22.95 ea
10...\$19.95 ea

- 300' (XT), 150' (T) Range
- Frequency: 318 MHz
- 59,049 Settable Security Codes
- 12 Volt Battery and Keychain Included
- Current Draw: 4.8 ma
- Fully Assembled in Case
- Dimensions: 1.25" x 2.0" x .5"
- Push both buttons for the 3rd Channel
- Slide Button Cover Included

4 Button / 15 Channel Transmitter



RF304XT

1....\$27.95
5....\$24.95 ea
10...\$21.95 ea

- 250' Range
- Frequency: 318 MHz
- 6,561 Settable Security Codes
- 12 Volt Battery and Keychain Included
- Current Draw: 4.6 ma
- Fully Assembled in Case
- Dimensions: 1.35" x 2.25" x .5"
- Push combination of buttons to achieve up to 15 channels

2-4 Data / 3-15 Channel Receivers



**RF300RL
RF300RM**

1....\$27.95
5....\$24.95 ea
10...\$22.95 ea

**RF304RL
RF304RM**

1....\$29.95
5....\$26.95 ea
10...\$23.95 ea

- Compatible with 300/4 Transmitters
- 11-24 volts DC Operating Voltage
- 13 ma. Current Draw
- Latching (L) or Momentary (M) Output
- Kits Available (subtract \$5.00 ea.)
- Dimensions: 1.25" x 3.75" x .5"
- 2 (300) / 4 (304) Output Data Lines
- Binary to Dec / Hex Converter can achieve up to 15 channels

- Alarm Systems
- Garage / Gate Openers
- Lighting Control

- Magic Props
- Medical Alert
- Monitoring Systems

- Industrial Controls
- Surveillance Control
- Motor Control

- Schematics Available
- Receiver Board Layout Available
- Custom Design Consulting Available

Visitect Inc.

(510) 651-1425 Fax: (510) 651-8454
P.O. Box 14156, Fremont, CA 94539

Email: Support@Visitect.Com
Visa / Mastercard, COD

CIRCLE 224 ON FREE INFORMATION CARD

**MODERN
ELECTRONICS**

CABLE TV DESCRAMBLERS

- ★ FREE CATALOG!
- ★ BEST DEALER PRICING!
- ★ DISCOUNTED PRICING!
- ★ 30 DAY FREE TRIAL!
- ★ 100% MONEY BACK GUARANTEE

**COPY RENTAL TAPES WITH
OUR VIDEO STABILIZER**

1-800-906-6664

2609 S. 156th Circle • Omaha, NE 68130
www.modernelectronics.com

Build Your Own Intelligent Robot, We Make It Easy!

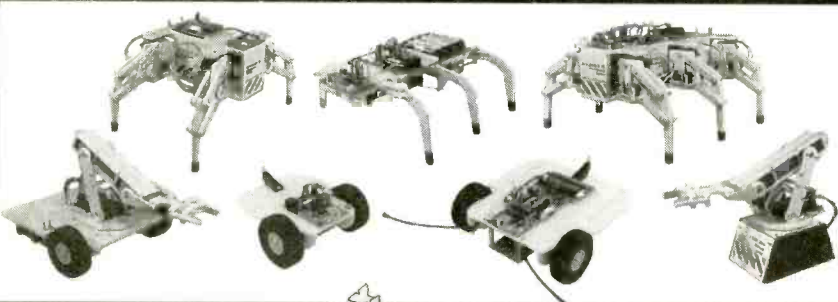

Lynxmotion, Inc.
PO Box 818
Pekin, IL 61555-0818
www.lynxmotion.com

Lynxmotion

Visit our website or ask for our free catalog!

Tel: 309-382-1816
Fax: 309-382-1254
sales@lynxmotion.com
tech@lynxmotion.com

The Pocket Programmer



The Best just got Better!!!

The Best portable programmer that uses the printer port instead of an internal card just got Better!! Now with easier to use Windows based software that programs E(E)prom, Flash & Dallas parts. 25/27/28 & 29 series from 16K to 8Mbit. Adapters available for MCU's 874X, 875X, Pic, Atmel, PLCC packages, Bi-Prom's, 40-Pin X16 Eproms, Rom Emulator to 32K X 8 (2716-27256) and More...

Only \$149.95

Same Name, Address & Phone # for 19 Years.... Isn't it Amazing ?

Intronics, Inc.

Box 13723 / 612 Newton St.
Edwardsville, KS 66113
Tel. (913) 422-2094 Add \$7.00 COD
Fax (913) 441-1623 Add \$6.00 Shipping

WWW.IN-KS.COM Visa/MC/Amex/Disc

Learn PC Repair!

The Ultimate Self-Paced PC Assembly and Repair Course

This is the simplest, easiest and most complete course on how to understand, assemble, and diagnose PCs available today. It contains all the text, videos and diagnostic software you'll need to succeed.

Self-Study Course Manual

The manual is a self-study workbook that will enable you to quickly teach yourself all about computers, how they're put together and how to keep them working. Just follow the step-by-step instructions on each page.

At the end of the course you'll know how to build a PC and install & configure Microsoft Windows.

Call **(800) 321-2155**

Videos

The two videos included contain over 3 hours of the Micro 2000 engineering team teaching everything from the basics of PC assembly all the way to using the MicroScope software to troubleshoot them! Watch the pro's in action as they build a completely functional Pentium system with all the major peripherals.

Software

This course includes a Limited Edition version (25 uses) of the award winning MicroScope Diagnostic Software. Use it to build your own PC (computer not included), upgrade it and troubleshoot any problems.

www.ciebookstore.com



Only \$99.95
Complete Course

Product # 02-020

Course includes:

- 200 + Page Training Manual
- PC Assembly & Configuration Video
- PC Diagnostic Video
- Micro-Scope Diagnostic Software (LE)
- CD-ROM - contains videos and manual

CIE Bookstore: 1776 E 17th Cleveland, OH 44114

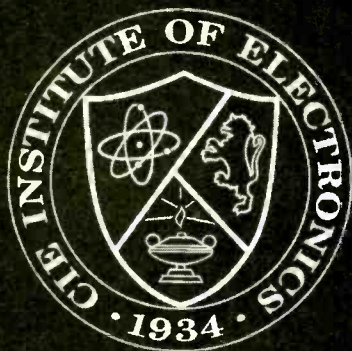

It's almost like being paid to study.

Earn an Associate Degree in Electronic Engineering Technology...

Put your knowledge of electronics to work for you. CIE offers the most comprehensive Associate Degree program offered in electronics. Best of all you study at your own pace with the full resources of CIE just a phone call or a click of a mouse away.

It's Comprehensive and Unique. You Pay for Only the Time You Use!

You won't find a better school than CIE if you want to accomplish your goals without pesky time restrictions (commuting, 8 hour class days, etc.) at CIE you study at your own pace, even an accelerated pace. And if you're like most readers of this magazine, your electronics background can help you receive your degree in less than the maximum 8 terms allowed. Finish sooner and you can save thousands of dollars in tuition. It's almost like being paid to study.

Get all the details on CIE's Associate Degree Program, World College's Bachelor Degree Program and CIE's 10 Career Courses today!



Free Course Catalog!

(800) 243-6446

www.cie-wc.edu

For a FREE Course Catalog on all of our Programs send to CIE: 1776 E. 17th St., Cleveland, OH 44114-3679 or visit www.cie-wc.edu PT30

Name: _____

Address: _____

City: _____

State: _____ Zip: _____

Phone: _____

E-mail: _____

CIRCLE 320 ON FREE INFORMATION CARD

www.americanradiohistory.com

ALL ELECTRONICS

C O R P O R A T I O N

Digital Video Tape

Panasonic DVM60. Miniature digital video cassette. 60 Minutes.
CAT # DVM-60

\$750 each
3 for **\$21.00**

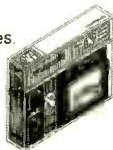

12 VDC High Efficiency Fan w/ Integrated Heatsink

Beautifully engineered assembly designed for high efficiency CPU cooling. Fan is embedded in an aluminum heatsink with many slots for maximum surface area and heat dissipation. 2.6" X 3.08" X 1.58" high. Four mounting screws on 2" X 2.5" centers.

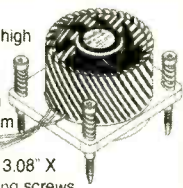

CAT # CF-103 **\$14.00** each

Miniature DC Motor

Mabuchi # FF-N20PN Miniature 1.5 to 3 Volt DC motor. Ideal for models and radio control applications where small size is important.



No load rating: 15,800 RPM @ 2.4 V, 96 mA. Length (excluding shaft), 0.654" long x 0.47" x 0.39". 0.039" (1mm) dia. x 0.13" long shaft. Solder-loop terminals. Large quantity available.

CAT# DCM-166

150 for 60c ea.
600 for 50c ea.
1500 pieces 35c ea.

2 for **\$150**

Solar Panel

Output: approx. 3 Volts @ 40 mA. 2.40" square x 0.13" thick epoxy-encapsulated silicon photovoltaic panel removed from solar lighting system. Solid, almost unbreakable module with easy-to-solder spots on backside. Ideal for solar-powered battery chargers and other projects.



CAT # SPL-60

\$350 each

ORDER TOLL FREE

1-800-826-5432

SHOP OUR ONLINE STORE

www.allelectronics.com

CHARGE ORDERS to Visa, Mastercard, American Express or Discover

TERMS: NO MINIMUM ORDER. Shipping and handling for the 48 continental U.S.A. \$5.00 per order. All others including AK, HI, PR or Canada must pay full shipping. All orders delivered in CALIFORNIA must include local sales tax. Quantities limited. NO COD. Prices subject to change without notice.

CALL, WRITE FAX or E-MAIL for our **FREE** 96 Page CATALOG. Outside the U.S.A. send \$3.00 postage.

MAIL ORDERS TO: ALL ELECTRONICS CORPORATION P.O. Box 567 Van Nuys, CA 91408 FAX (818)781-2653

e-mail allcorp@allcorp.com

Turn Your Multimedia PC into a Powerful Real-Time Audio Spectrum Analyzer

Features

- 20 kHz real-time bandwidth
- Fast 32 bit executable
- Dual channel analysis
- High Resolution FFT
- Octave Analysis
- THD, THD+N, SNR measurements
- Signal Generation
- Triggering, Decimation
- Transfer Functions, Coherence
- Time Series, Spectrum Phase, and 3-D Surface plots
- Real-Time Recording and Post-Processing modes

Applications

- Distortion Analysis
- Frequency Response Testing
- Vibration Measurements
- Acoustic Research

System Requirements

- 486 CPU or greater
- 8 MB RAM minimum
- Win. 95, NT, or Win. 3.1 + Win.32s
- Mouse and Math coprocessor
- 16 bit sound card

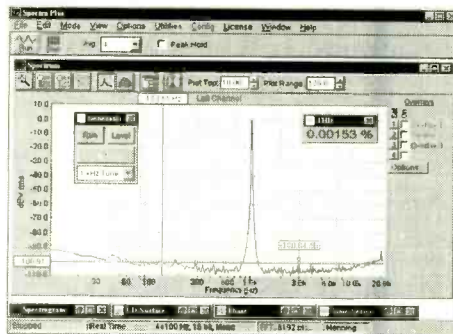

Priced from \$299

(U.S. sales only - not for export/resale)

DOWNLOAD FREE 30 DAY TRIAL!

www.spectraplus.com

PHS Pioneer Hill Software
24460 Mason Rd.
Poulsbo, WA 98370
a subsidiary of Sound Technology, Inc.



Spectra Plus
FFT Spectral Analysis System

Sales: (360) 697-3472

Fax: (360) 697-7717

e-mail: pioneer@telebyte.com

Do You Repair Electronics?

Repair Databases for TV, VCR, Monitor, UL Audio, FCC, and more.

- Over 76,000 records
- Private user forums
- Live on-line chat rooms

RepairWorld.com

Electronix Corp 1 Herald Sq, Fairborn, OH 45324 (937) 878-9878

Antique Electronic Supply

6221 S. Maple Ave. Tempe, AZ 85283

www.tubesandmore.com

NOS, Parts, Supplies, Books, Speakers, Transformers, Grill Cloth, and MORE!

Ph: 480-820-5411 • Fax: 480-820-4643 or 800-706-6788

"X-Ray" Filters, Cameras, Camcorders, Lights

Infrared (IR) Equip sees through some fabrics!
2 Million Candle Power Rechargeable IR Spotlight
Information, Equipment Examples and FAQ's
Ultraviolet (UV) LED Flashlights, Invisible Inks
SpyCams, Specialty Optical Products
Home Automation Software, Free Fax Software

www.MaxMax.com/OpticalProducts.htm

SINGERS! REMOVE VOCALS

Unlimited. Low Cost. Instantly Available Background Music from Original Standard Recordings! Does Everything Karaoke does. Better and gives you the Thompson Vocal Eliminator! Free Brochure CD Demo Tape. LT Sound Dept PE 7988 LT Parkway, Lithonia, GA 30058 Internet: <http://www.LTSound.com> 24 Hour Demo/Info Request Line (770)482-2485 - Ext 49 When You Want Something Better Than Karaoke!

CONITEC DATASYSTEMS

TOP PERFORMANCE in a small package:
Europe's best selling multi-programmer!



One size fits all!
\$333
COMPLETE KIT

Top of the line multi-programmer in sub-5500 category. From 20% to 80% market share in Germany in 6 years. 1300+ device output and growing fast. Europe-wide sales 10%-60% mkt share in 6 years. Minimal, 1% return quota for hardware defects. Replaces all low priced dedicated programmers e.g. PIC only or GAL only units. GALEP III also substitutes higher priced universal programmers e.g. ALL-11 (HILCO) or LAB-TOOL-48 (ADVANTEC1) - It provides virtually matching performance at only 1/3-1/5 the price.

Programs 8-bit and 16-bit EPROMs, EE-PROMs, 0-Power RAM's, Flash, Serial EEPROMs / GAL, PALCE, ATF/87xxx, 89xxx, PIC12/16/17Cxx/ All DIL devices **without adapter!** Lightning fast parallel data transfer (27C 256 read 2 sec. - prog. 8 sec!). Supports HEX, JEDEC and binary formats, with integrated hex and fuse map editor. Fully Windows compatible incl. Win 2000/NT. Browse 1300+ supported devices on Conitec's website: www.conitec.com. 90%+ of the listed devices require no adapter!

GALEP III / cable, batt. and recharge. **\$333.00**
PLCC adapt. / 8-bit EPROMs / 16-bit EPROMs / GALs each \$129.00

GALEP-III
Pocket Multiprogrammer

CONITEC DATASYSTEMS - 1951 4th Avenue, Suite 301 - San Diego, CA 92101 - Tel: 619-702-4420 - Info/Downloads/Orders: WWW.CONITEC.COM

PIC'n Books

LEARN ABOUT PIC MICROCONTROLLERS



See Table Of Contents: <http://www.sq-1.com>
Secure Online Ordering Is Available

PIC is a trademark of Microchip Technology Inc.

SQUARE 1 ELECTRONICS

Voice (707) 279-8881 Fax (707) 279-8883

<http://www.sq-1.com>

\$59 PCBs

And our layout software is **FREE**

- 1 Download our board layout software
- 2 Design a 2-sided circuit board 2.5" x 3.8"
- 3 Send us your layout over the Internet
- 4 We ship you 3 excellent quality boards with plated-through holes for \$59 (shipping included)

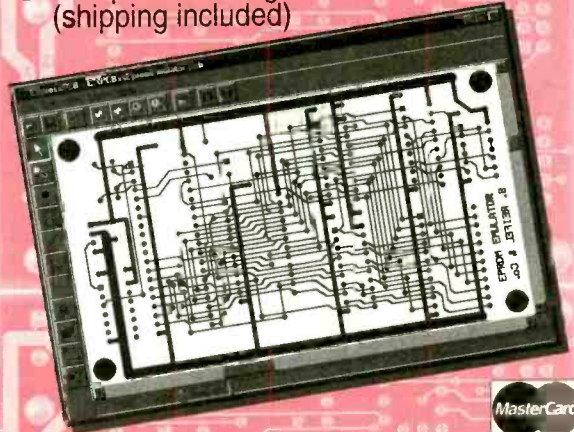

www.expresspcb.com



Visit us on the Web:
www.poptronics.com

CABLE TV BOXES

30 Day Free Trial • 1 Year Warranty
Quantity Discounts • Dealer's Welcome
Hablamos Español
www.allcableboxes.com



888.242.0539

Smart Battery Charger

New & Improved



FOR GEL-CELLS or LEAD ACID BATTERIES.
Features: Precision temperature tracking voltage reference & three mode charging sequence. Standard kit is for 12V @ 1/2 or 1 Amp, user selectable. Can be connected to the battery indefinitely, will not overcharge. Weighs 2 pounds and measures 4" x 5 1/2" D x 2 1/2" H. Finished enclosure included in kit.
Complete Kit Only \$59.95
Assembled & Tested \$79.95
CA residents add 7.50% sales tax. S&H: \$6.50 (insured)
Foreign orders add 20%. For more info: www.a-aengineering.com

A & A Engineering

2521 W. La Palma #K • Anaheim, CA 92801
(714) 952-2114 • FAX: (714) 952-3280

Call Today And **SAVE!** **Unbeatable PRICES!**

CABLE TV

**DESCRAMBLERS
CONVERTERS • FILTERS
VIDEO STABILIZERS**

FREE ➤ 30 Day Trial
FREE ➤ Product Catalog
FREE ➤ 1 Year Warranty

100% MONEY BACK GUARANTEE



Let us point you in the right direction ...

Arrow Technologies
Omaha, Nebraska

TOLL FREE
888-554-ARROW
888-554-2776



MECI 340 East First Street
Dayton, Ohio 45402
Your Electronics Value Company

Tons of Electronics

Get your FREE catalog today and discover some of the best deals in electronics. We have thousands of items ranging from unique hard-to-find parts to standard production components. Call, write or fax today to start your subscription to one of the most unique catalogs in the industry, filled with super values on surplus electronic and hobbyist type items.



FREE CATALOG!

Check out our 10,000 item on-line catalog <http://www.meci.com>

Order Toll Free Why pay more?
1-800-344-4465 Call today!
Fax Order Line
1-800-344-5324

CIRCLE 323 ON FREE INFORMATION CARD

PIC C COMPILER

A high order language with extraordinary optimization specifically designed for the PIC.



CUSTOM COMPUTER SERVICES, INC.

- Access to all PIC hardware features from C.
- Built-in libraries that work with all chips for RS232 serial I/O, I²C, discrete I/O and precision delays.
- Source code drivers and ready to run programs included for LCD modules, keypads, 24xx and 93xx serial E² proms, X10, DS1302 & NUU6355 Real Time Clocks, Dallas Touch Memory Devices, DS2223 & PCF 8570 serial SRAM, LTC1298 & PCF8591 A/D converters and more.
- Integrates with simulators/emulators such as MPLAB.

CUSTOM COMPUTER SERVICES, INC.

P.O. Box 9459 • Brookfield, Wisconsin 53008 • 908-797-0455 ext. 35 • FAX: 908-797-0459 • <http://www.ccsinfo.com/pic> • EMAIL: ccs@ccsinfo.com

```
#include <PIC16C56.h>
#define delay(clock=2000000)
#define rs232 (bmode=9600,xmit=pin_A1) rcv=pin_A2
main () {
    printf ("press any key to begin!\n");
    getch();
    printf ("1 kHz signal activated!\n");
    while (TRUE) {
        output_high (pin_B8);
        delay_us (500);
        output_low (pin_B8);
        delay_us (500);
    }
}
```

- PCB Compiler for 12 Bit OPCODE Chips.....\$ 99
- PCM Compiler for 14 Bit OPCODE Chips.....\$ 99
- PEH Compiler for 16 Bit PIC18 Chips.....\$ 99
- PCW Compiler Professional Package
- Windows IDE CD-Rom with both PCB / PCM.....\$ 350
- PIC18 PCW add on (PCW).....\$ 50

MENTION THIS AD AND RECEIVE A FREE NIGEL GARDNERS PIC C BOOK

MAY THE SOURCE BE WITH YOU

Don't let the dark forces of ignorance defeat you. Tap into the source of free or low-cost government publications--the free CONSUMER INFORMATION CATALOG.

Call toll-free 1-888-8 PUEBLO.

Or set your coordinates for our web site:

www.pueblo.gsa.gov

TiePieScope HS801 PORTABLE MOST

Reliability



- 50 MHz ARBITRARY WAVEFORM GENERATOR-
- 100 MHz STORAGE OSCILLOSCOPE-
- 50 MHz SPECTRUM ANALYZER-
- 6 DISPLAY MULTIMETER-
- 200 DAYS TRANSIENT RECORDER-

The HS801: the first 100 Mega samples per second measuring instrument that consists of a MOST (Multimeter, Oscilloscope, Spectrum analyzer and Transient recorder) and an AWG (Arbitrary Waveform Generator). This new MOST portable and compact measuring instrument can solve almost every measurement problem. With the integrated AWG you can generate every signal you want.

A user defined toolbar with which over 50 instrument settings quick and easy can be accessed is offered by the versatile software. An intelligent auto setup allows the inexperienced user to perform measurements immediately. Through the use of a setting file, the user has the possibility to save an instrument setup and recall it at a later moment. The setup time of the instrument is hereby reduced to a minimum.

Analyzing signals is done with an 8 bit resolution and a maximum sampling speed of 100 MHz. The input range is 0.1 Volt full scale to 80 Volt full scale. The record length is 32K/256K samples. The AWG has a 10 bit resolution and a sample speed of 25 MHz.

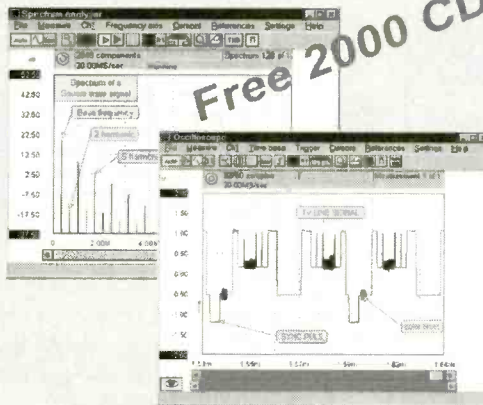

Convince yourself and download the demo software from our web page: www.tiepie.nl. When you have questions and / or remarks, contact us via email: support@tiepie.nl. The HS801 is delivered with a user manual, two probe's, Windows and DOS software.

US dealer:
Feedback Incorporated: Tel 800-526-8783;
Fax 919-644-6470; www.fbk.com

Outside US:
TiePie engineering, P.O. BOX 290, 8600 AG SNEEK, The Netherlands.
Tel: +31 515 415 416 Fax: +31 515 418 819
Web: www.tiepie.nl

© 1994 EDF

Thanks to you, all sorts of everyday products are being made from the paper, plastic, metal and glass that you've been recycling.

But to keep recycling working to help protect the environment, you need to buy those products.

BUY RECYCLED.



AND SAVE.

So look for products made from recycled materials, and buy them. It would mean the world to all of us.

For a free brochure, write Buy Recycled, Environmental Defense Fund, 257 Park Ave. South, New York, NY 10010, or call 1-800-CALL-EDF.



**More Features
More Power
Less Money**

Ivex Complete Power Tools include: WinDraft P350 Schematics, WinBoard P350 PCB Layout, Ivex Spice Standard Simulation and Gerber Viewer together in a complete, affordable package.

Ivex Complete Plus includes everything in the Complete package plus 650 pin versions of WinDraft and WinBoard with Ivex Spice Advanced.

Ivex 650 pin versions have no feature limitations like other low cost products on the market. Fast expert technical support, free 24 hour Knowledge Base on the web, and professional full-featured tools have made Ivex the preferred choice for designers.

For larger designs use these Ivex Products:

WinDraft unlimited \$4.95
WinBoard unlimited \$4.95

Ivex Complete Electronics CAD Package

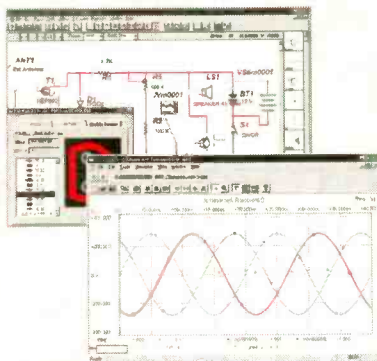

Advantages

Full-feature tools
17,000 Schematic parts
Part edit & model making
Part Search
Bill of Materials with Sort & Spreadsheet output
Heirarchy for large designs
ERC (electrical rules check)
15 Netlist outputs
7 Analysis Types
Spice Advanced includes 14 analyses
16 PCB layers
0.01 micron grid resolution
Advanced DRC
Micro via
Gerber & NC Drill report
24 hour FREE Technical Support Internet Knowledge Base
No hardware protection lock!
New: Schematic DXF output

Ivex Complete

Schematics
Simulation
PCB Layout
Gerber Viewer

\$350

Ivex Complete Plus

P650 Schematics
Adv. Simulation
P650 PCB Layout
Gerber Viewer Plus

\$550

Free board quote

pcbCite.com

The Internet source for PCB manufacturing

Visit the Ivex web site for complete product information and download full function demos.

www.ivex.com

Tel: (503) 531-3555 e-mail: sales@ivex.com

IVEX™
DESIGN
INTERNATIONAL

ADV8_4

CIRCLE 309 ON FREE INFORMATION CARD

*FREE!

CTRL - D
to bookmark
this site

www.web-tronics.com

- Don't forget the dash
- Easy to Navigate
- Includes a Search Engine That Really Works
- New Items Added Constantly

This Full-Sized Rugged Handheld 3 1/2 Digit Multimeter is *FREE with any order placed on our web site that equals or exceeds \$30.00 in merchandise value

(Or, if you prefer, purchase just the meter for our regular low price of \$29.00 + S&H)



In Business Since 1971

**Brand New!
Not a Mini Sized
Cheapie**



BASIC FEATURES:

- *Max. Display: 1999 counts (3 1/2 digits) auto polarity ind.
- * Measuring Method: Dual Slope integration A-D con system.
- * Overrange Indication: 1 appears alone on the display
- * All ranges fully protected
- * High Surge Voltage Protection (1.5KV-3KV)
- * Diode Testing with 1mA fixed current
- * Audible Continuity Test
- * Transistor Hfe Test
- * DC Voltage Ranges: 200mV, 20V, 200V, 1000V
- * AC Voltage Ranges: 200mV, 2V, 200V, 700V
- * DC Current Ranges: 20uA, 2mA, 20mA, 200mA, 2A, 20A
- * AC Curr. Ranges: 200uA, 200uA, 2mA, 20mA, 200mA, 10A
- * Resistance Ranges (ohms) 200, 20K, 200K, 2M, 20M
- * Ships with Rubber Boot, Test Leads & Instruction Booklet

Don't Forget to Enter the PROMO CODE

**Item# is: CSI TECHMETER
RUBBER HOLSTER IS INCLUDED !**

Detailed Specifications on the CSI TECHMETER can be viewed on our web site under Test Equipment

Over 8,000 items on our web site. small parts, computer boards, test equip. CCD cameras, tools & solder equipment, industrial PC supplies & MUCH MUCH MORE

The Promo Code for this offer is **DMM FREE**
Simply enter this code into the promo code field located on our on-line order form. Any order that does not include the promo code will not be eligible for the free DMM offer. See terms & conditions below

* Free DMM offer is subject to certain terms & conditions. One free DMM per customer. If qualifying order is returned for a refund, then free DMM must also be returned or purchased at the regular price of \$29.00. Offer does not apply to orders placed previously or orders placed at any time that do not reference the special promotion code contained in this add. To qualify for this promotion, your order MUST be placed on the internet. You MUST enter the promo code **DMM FREE** in the PROMO CODE field found on our on-line order form. The value of your order must equal or exceed \$30.00 to qualify. The value of the CSI TECHMETER does not apply toward this qualifying order value. For extended technical specifications & warranty statement on this product, please visit: www.web-tronics.com & view our DMM section under TEST EQUIPMENT. Item number for this DMM is: CSI TECHMETER

Poptronics, July 2001

High Performance Auto Ranging DMM *New to our DMM line-up and possibly (probably) the best DMM value anywhere!* Includes: Analog Bar Graph! Auto-Ranging! Data Hold! Temperature Probe! Frequency Test! Continuity Test! AND MORE!

Auto Ranging: For easy, precise range settings
Range Hold Control: allows for manual selection of your test range
3-3/4 Digit LCD Display: Reads up to 3260. Easy to read display.
Function Dial: Easy to use to select measurement type or turn unit off.
4 Jack Plug-ins: Safety design with different capacities for different functions.
Diode, Continuity Check Push-Button: For toggling between diode check and continuity check.
Low Battery Indicator: Advises you when it's time to change battery.
Extra Long 44" Test Leads: Helps get to hard to reach places
Screw-On Alligator Clips: Convert one or both probe tips to alligator clips
Fuse-Protected Circuitry
Built-In Stand: Makes one hand operation easier.
Shock Absorbing Rubber Carrying Case: with convenient probe storage clips and hanging tab. Helps protect the DMM from damage if accidentally dropped.

Measurements:
 DC Volts: up to 1000V
 AC Volts: up to 750V
 AMPS: up to 20 Amps (AC & DC)
Resistance: up to 30M Ohm
Continuity Check: with audible signal (signal sounds if resistance is less than 20 ohms. Display reads actual resistance).
Frequency: (1KHz to 300KHz) displays both digital and bar graph reading
Transistor hFE Test: Display shows approximate hfe value based on test condition of 10uA base current and Vce of approx. 3V.
Temperature Test: Measures from 0° to 1832° F (probe supplied)
Diode Test: Tests if diodes are shorted or open
Input Impedance: 10Mohm (Vdc/Vac)
 over 100Mohm on 300 mVdc range

ONLY \$29.95

NOW IN STOCK!

#CSI9903

Specifications Accuracy:
 Vdc: ±1.0% reading +5 digits
 Vac: ±1.5% reading +8 digits
 Adc: ±1.2% reading +5 digits
 Aac: ±1.5% reading +5 digits
 Resistance: ±1.5% reading +5 digits
 Frequency: ±3.0% reading +5 digits
 Temperature: ±1.0% reading +6 digits

equires two AAA batteries sold separately.

2GHz RF Field Strength Analyzer

- Frequency Range: 100KHz to 2.060MHz
- Narrow Band FM (NFM), Wide Band FM (WFM), AM and Single Side Band (SSB) Modulated Signals May Be Measured
- PLL Tuning System for Precise Frequency Measurement and Tuning
- LED Backlight LCD (192x192 dots)
- Built-In Frequency Counter
- Hand-Held and Battery Operated
- All Functions are Menu Selected
- RS232C for PC Interface and Printing

ONLY \$1629

#3201

CTRL - D to bookmark this site

www.web-tronics.com

Don't forget the dash

Circuit Specialists, Inc.

Easy to Navigate

- Includes a Search Engine That Really Works
- New Items Added Constantly

In Business Since 1971

Removable Hard Drive Rack
 For IDE/Ultra DMA Hard Drives

We Sold Over 14,000 in 1998!
 This product can be used with any 3-1/2" IDE hard drive up to 1" high. It includes an electronic keypad for safe removal and insertion. Made of ABS 707 fireproof plastic. Use this product to protect sensitive hard drive data, take your hard drive between work and home or even set up different users with their own hard drives that they physically insert every time they use a PC. Other models available from C.S.I. include RH10 series and RH20 series, which are interchangeable within the same interface design (IDE or SCSI). **Other Models are Available. See www.web-tronics.com under "hard drive and accessories" for more details and pictures.**

ONLY \$14.95 any qty.

#RH-10C-IDE

Removable Hard Drive Rack with Auto Door And Cooling Fan

- Auto door on the outer frame
- ABS material of outer frame. High efficiency cooling fan
- Worldwide patent pulling function handle
- CE Approved
- Coating iron bottom cover
- For IDE interface
- For 1" high 3.5" HDD
- Not compatible with our RH10 & RH20

Compatible with our RH17-IDE model

ONLY \$18.95 any qty.

#MR-27

Details at www.web-tronics.com

CCD B&W Board Cameras

- ASIC CCD Area Image Sensor
- Extremely Low Power Consumption
- 0.5 Lux Min Illumination
- Built-In Electronic Auto Iris for Auto Light Compensation

VM1030PA-B 30mmx30mmx25mm, Pinhole lens, 12V \$39.00 any qty.
VM1030A 30mmx30mmx26mm, Standard lens, 12V \$39.00 any qty.
VM1035A 42mmx42mmx25mm, Standard lens, 12V with back light compensation \$49.00 any qty.
VMCB21 44mmx38.5mmx28mm, with 6 infra-red LEDs, 12V \$49.00 any qty.
VM1036A 32mmx32mmx25mm, Standard lens, 12V, reverse mirror image feature \$49.00 any qty.

Detailed Specs on the Web

LOWER PRICES

Bullet CCD Cameras B&W and Color

- Smart Rugged Metal Housing
- Extremely Low Power Consumption
- 12 Volt
- CCD Area Image Sensor for Long Camera Life
- Built-In Electronic Auto Iris for Auto Light Compensation
- No Blooming, No Burning
- 0.1 Min Lux Illumination (B&W), 1 Lux Min Lux Illumination (color)

VMBLT1020 B&W, 21mm(D)x58.5mm(L) \$54.00 any qty.
VMBLT1020W B&W Weatherproof, 21mm(D)x58.5mm(L) \$79.00 any qty.
VMBLTJC19BW COLOR! Weatherproof, 17mm(D)x83mm(L) \$139.00 any qty.

Detailed Specs on the Web

LOWER PRICES

COLOR CCD Mini Board Cameras

- Low Power Consumption
- 1 Lux Illumination
- Internal Synchronization
- 12Volts
- 400 TV Lines
- Built-In Electronic Auto Iris for Auto Light Compensation

VM3010PA 33mmx33mmx18mm, Pinhole lens \$99.00 any qty.
VM3011-A 45mmx40mmx24mm, Standard lens, single board \$89.00 any qty.
VM3010-A 33mmx33mmx32mm, Standard lens \$99.00 any qty.

Detailed Specs on the Web

PRICE REDUCTION \$159

new! 2.4 GHz A/V Sender/Receiver System

- Wireless FM transmission of video (color or B/W) and sound (stereo or mono) up to 150 meters (line of sight)
- Directional Antenna Design optimizes performance
- Use with remote cameras or any input (satellite TV, cable etc.) where wireless transmission is desired. View on a TV set.
- Performance through walls varies depending on construction methods etc.
- Each set includes a plug-in power supply for the transmitter & receiver.
- 7 segment LED displays channel (1-4) on receiver & transmitter.

Now On Sale Order Now

CSIHTR2400 Includes One Transmitter & One Receiver with Power Supplies \$109.00
CSIHTR2400TX Extra Transmitter/Each Receiver will Monitor up to 4 Transmitters \$89.00

See more detailed specifications at www.web-tronics.com in the CCD camera section.

Our Most Sophisticated DMM *We Sold Over 700 Last Year!*

with RS-232 Interface & Software, 3-3/4 Digit, 4000 Count, Auto-Ranging with Analog Bargraph

- True RMS Mode
- 10MHz Frequency Counter
- Time Mode with Alarm, Clock, and Stop Watch
- Dual Display
- 10 Location Memory
- Min, Max, Avg and Relative Mode
- Decibel Measurement
- Cap and Ind. Measurement
- Temperature Mode (C/F)
- K Type Temperature Probe Included
- Pulse Signal for Logic & Audible Test
- Continuity/Diode Test
- Logic Test
- Auto Power OFF "Keep ON" Mode
- Fused 20A Input with Warning Beeper
- Back Light
- Data Hold/Run Mode
- Safety Design UL1244 & VDE-0411
- Protective Holster
- Silicon Test Leads

ONLY \$129 Reg. \$169

More Details on our Web Site

PROTEK 506

Mini CCDs (B/W & Color)
 Sensational NEW Design for Small Observation Cameras. Smaller and Better!

- Ultra Miniature Design
- Black & White Versions Only 25mm x 25mm
- Color Versions Only 32mm x 32mm
- Available in Standard Lens or Pinhole Lens

All Include Pre-Wired Cable Harness for Video & Power
12V Regulated Power Supply Required (120mA typical power consumption)

- 0.1 LUX Rating (B/W), 1 LUX (color)
- CCD Area Image Sensor for Long Camera Life
- Back Light Compensation Circuit
- Built-In Electronic Auto Iris Lens

VMCW-H11A 32mmx32mmx30mm, Color CCD with standard lens, pre-wired cabling 12V DC Power \$139.00 / \$129.00 5 or more
VMCW-H12A 32mmx32mmx19mm, Color CCD with pinhole lens, pre-wired cabling, 12V DC Power Input \$139.00 / \$129.00 5 or more
VMPS-718A 25mmx25mmx30mm, B/W CCD with standard lens, pre-wired cabling, 12V DC Power Input \$59.00 / \$49.00 5 or more
VMPS-250A 25mmx25mmx15mm, B/W CCD with pinhole lens, pre-wired cabling, 12V DC Power Input \$59.00 / \$49.00 5 or more
VCC-3232 32mmx32mmx30mm, CMOS COLOR, std lens, see web for specs \$79.00 / \$72.00 5 or more

Detailed Specs on the Web

LOWER PRICES

new! Low Cost Desoldering Station

ONLY \$159

Our low cost desoldering station is the perfect price/performance system for repair shops, schools & technicians. Implements Japanese made ceramic heater for high isolation, excellent insulation & fast heat-up. Temp range 300-450 deg C (572-842 deg F). Comes with high suction vacuum pump. Zero voltage switching ensures low noise & greater protection for components. **SEE DETAILS at web site under "Soldering Equipment & Supplies" ITEM # JF88**

new! O'Scope Offer **ONLY \$299**

30MHz! ONLY \$299! Industries Best Price! See web for specs

#OSC-1030

- Dual Channel
- Dual Trace
- Vert Trigger
- 1 Year C.S.I. Warranty!

Manufactured for CSI by a leading O.E.M. manufacturer. See our website for detailed specifications!

3000 Series Digital R/O Bench Power Supply
 ←Low Cost Single Output ←3Amp

High stability digital read-out bench power supply featuring constant voltage and current outputs. Short-circuit protection and current limiting protection is provided. Highly accurate LED accuracy and stable line regulation make the 3000 series the perfect choice for lab and educational use.

Line Regulation: 2x10⁻⁴ +1ma
Load Regulation: 1 x 10⁻⁴ +5mv
LED Accuracy: Voltage ±1% +2 digits
Current ±1.5% +2 digits

Wave Line Noise: ≤1mvrms
Dimensions: 291mm x 158mm x 136mm

CSI3005: 0-50v/0-3 amp Digital R/O Bench PS, 1x10⁻⁴ +5mv Load Regulation \$129.00 5/\$119.00

CSI3003: 0-30v/0-3amp Digital R/O Bench PS, 1x10⁻⁴ +5mv Load Regulation \$99.00 5/\$89.00

AS LOW AS \$89

Home Automation



World's Largest Source for Home Automation!

- Voice Control
 - Gadgets & Motorized Devices
 - Home Theater
 - Phones & Intercoms
 - X10 & Lighting Control
 - Home Security & Surveillance
 - Home Networking & Structured Wiring
- and Much More...

800-SMART-HOME
www.smarthome.com

Free 144 pg. Color Catalog!

Dealers/Resellers ask about our
SmartHome PRO Dealer Program 800-949-6255

SERIAL LCDs

Serial LCDs work great with BASIC Stamps® and other microcontrollers. One-wire interface • simple serial protocol • low cost • high quality • in stock



- SGX-120L**
- Mini graphics LCD
 - 2400/9600 bps
 - just \$99

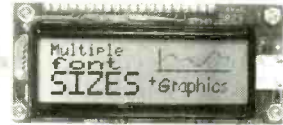

- BPI-216N**
- 2x16 text LCD
 - 2400/9600 bps
 - \$45 (non-backlit)

Many other models available—see www.seetron.com/

Scott Edwards Electronics, Inc.
www.seetron.com • 520-459-4802

While speeding treatments and cures for neuromuscular disorders, advances made by MDA researchers also have enhanced therapy prospects for heart disease, cancer, arthritis, Alzheimer's and AIDS.

Giving to MDA makes a world of difference.



MUSCULAR DYSTROPHY
ASSOCIATION
(800) 572-1717

NORTH COUNTRY RADIO

A Quality Supplier of RF, Video, and Specialty
Electronic Kits for Amateur and Experimental Use
Video Cameras and related items

Since 1986



Low Power Transmitter kits:

MPX96 PLL synthesized FM Stereo transmitter. For hobby broadcasting. Features PLL synthesis 100 KHz steps, built in stereo generator. Stable crystal controlled circuitry, no drift. DIPswitch frequency programming 88-108 MHz or 76-92 MHz for export use. Runs from 12V DC, directly interfaces with CD and tape players. Price \$78.00 Plus S/H

MPX2000 Microprocessor controlled PLL synthesized FM Stereo transmitter. PLL synthesized, no drift, for hobby broadcasting applications. Features front panel keyboard frequency entry and bright LED digital frequency readout, and memory. Operates from 15-20 V DC supply and directly interfaces with CD and tape players. Built in audio limiter and deviation metering circuitry. Features LED bar graph modulation meter. Price \$154.95 Plus S/H

AM88 Low Power AM Transmitter. PLL synthesized 100 mw AM transmitter covers the range 150 to 1710 kHz. Useful for Part 15 AM and LF broadcast experimentation, and carrier current applications. Final RF stage is high level amplitude modulated. Covers both medium and longwave AM frequencies in 1 kHz steps. Built in harmonic filters, modulation limiter and audio compressor. DIPswitch frequency programming. Price \$80.00 Plus S/H

ATV12 MK2 2 Watt Television transmitter. Operates in the 420-450 MHz Amateur band. Crystal controlled, 9-15 V DC operation. Accepts standard NTSC or PAL video. Useful for Amateur television operation or as a video transmitter in radio controlled models. Transmits standard video and audio, receivable on standard cable ready TV sets, (CH60) or use downconverter. Small 2.5 X 4 x 1 inch size, wt 2 oz. facilitates use in R/C applications. Includes 439.25 MHz xtal. REQUIRES NO-CODE AMATEUR LICENSE for USA use. Price \$122.00 Plus S/H

These are only a few of the kits we have available. We have over 30 more.

Visit our website <http://www.northcountryradio.com> for product and ordering information

Sales: Tel 914-235-6611 Email: ncradio200@aol.com Tech: Tel & Fax 518-854-9280
Fax 914-576-6051

Mail Address: Sales and Orders: PO Box 53 Wykagyl Station, New Rochelle NY 10804 U.S.A.
Tech Service: PO Box 200 Hartford NY 12838 U.S.A.



Spring 2001 Catalog is now available. Over 100 new products! Get yours today!



COMMERCIAL 35W FM TRANSMITTER



Clean and powerful, plus an on board computer that's your "virtual" station engineer! We can now supply turn-key packages for your community or LPFM station.

Call or visit our broadcast web site, www.highpowerfm.com, for more details.
PX1 **\$1,795.00**

BROADCAST YOUR MP3 AND .WAV FILES



Our FM broadcaster designed specifically for PC sound-cast. Broadcast MP3s, internet radio and more to any FM radio in your house or yard. You can't buy an assembled broadcaster this powerful or clean. Kit includes case and power supply.
MP3FM **\$99.95**

FM100 SYNTHESIZED FM STEREO RADIO STATION



- Synthesized 88 to 108 MHz for no frequency drift!
- Built in mixer - 2 line inputs and one microphone input!
- Strappable for higher power output
- Low pass filter for great audio

Our FM100 is used all over the world by serious hobbyists as well as churches, drive in theaters, and schools. The kit includes metal case, whip antenna and built in 110 volt AC power supply.

FM100 **Super-Pro FM Stereo Radio Station Kit** **\$249.95**
FM100WT **1 Watt, Wired Export Version** **\$399.95**

FM STEREO RADIO TRANSMITTER



Great entry level FM broadcast kit. Thousands in use. Handy for sending music through house and yard, ideal for school projects too - you'll be amazed at the exceptional audio quality! Runs on 9V battery or 5 to 15 VDC. Add matching case and whip antenna set for great pro look.

FM10A **Tunable FM Stereo Transmitter Kit** **\$34.95**
CFM **Matching Case and Antenna Set** **\$14.95**
FMAC **12V DC Wall Plug Adapter** **\$9.95**

CARPET ROVER II ROBOT KIT

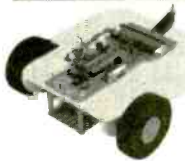

This advanced kit is an 8 x 8" differentially steered base that is excellent for carpet or tiled floor experimentation. It uses the Next Step microcontroller, a BASIC Stamp 2 controller that can use the BS2 or BS2-E (sold separately). A host PC is required to download programs to the robot. This complete kit includes the Rover, programming cable, IR proximity detector, bumper switch kit, and line follower kit.

RK3000 **Carpet Rover II Complete Kit** **\$185.00**

COMBUSTIBLE GAS DETECTOR KIT



Build this kit and detect combustible gases and vapors including natural gas, gasoline, propane, and dozens more. Model GLD1000 is a local alarm only, GLD1010 includes a relay to control external alarms.

GLD1000 **\$29.95**
GLD1010 **\$39.95**

BUILD YOUR OWN STEREO!



We've got the kit! Our K4500 is a synthesized FM stereo tuner, the K4100 is a matching pre-amp. Both are fully digitally controlled with an optional IR remote control (kit also). Add our

K4020 2 x 155W Class A power amplifier kit to complete your drop-dead stereo. We also have tube amplifier kits. Visit us on the web, or request our new catalog for more information.

K4500 **Synthesized FM Stereo Tuner Kit** **\$399.99**
K4100 **Digital Preamp Kit** **\$399.99**
K4101 **IR Remote Control Kit** **\$69.95**
K4020 **Solid State 310W Power Amp Kit** **\$499.99**

ELECTRONIC PROTOTYPING SOFTWARE...

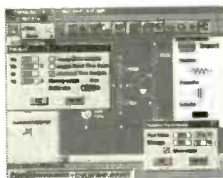

Priced for the hobbyist!

You can create and test AC and DC circuits minutes after installing this package on your PC. Start from scratch, or from the included library of pre-designed circuits. Drag and drop placement from a complete list of active and passive components. Test using a complete list of virtual instruments, Oscilloscope, voltmeter, ohmmeter, ammeter, and watt meter.

PLAB4 **\$49.95**

RAMSEY NOW CARRIES BASIC STAMPS



Hobbyists and educators have embraced the Basic Stamp family of microcontrollers thanks to their power, ease of programming and simple interface. Ramsey now offers popular BS boards, kits, and trainers. If you've been wanting to learn microcontrollers, or build them into a project, now's the time!

BS11C **Basic Stamp I Module** **\$34.00**
BS21C **Basic Stamp II Module** **\$49.00**
27205 **Basic Stamp 1 Starter Kit** **\$109.00**
28150 **Board of Education Full Kit** **\$109.00**

MINI-KITS



These are easy to build kits that can be used either stand alone or as building blocks for more complex projects.

BN9 **Super Snoop 2W Audio Amp** **\$8.95**
MB1 **Mad Blaster 15W Warble Alarm** **\$4.95**
TS1 **Touch Switch** **\$6.95**
SA7 **RF Broadband Preamp +20 dB** **\$14.95**
TT7 **Touch Tone Decoder** **\$29.95**

RF WIRELESS LINK MODULES

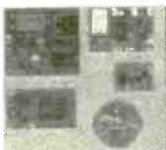

- SAW Resonators for high stability - NO Drift!
- Powerful +10 dbm output
- Range up to 600'
- 433 MHz license-free band
- Sensitive superhet receiver with RF LNA
- Stable over full 3-12 VDC range
- Optional on-board 12 bit encoder/decoder using Holtek HT12 series chips

RXD433 **433 MHz Receiver/Decoder Mod., Assembled** **\$26.95**
TXE433 **433 MHz Transmitter/Encoder Mod., Assembled** **\$24.95**
RX433 **433 MHz Data Receiver Mod., Assembled** **\$21.95**
TX433 **433 MHz Data Transmitter Mod., Assembled** **\$19.95**



Ramsey Electronics • 793 Canning Parkway • Victor, NY 14564
Order Toll Free: 800-446-2295 • Technical Info or Order Status: 716-924-4560
See our catalog online: www.ramseykits.com



CIRCLE 263 ON FREE INFORMATION CARD



CABLE TV REMOTES BLOW-OUT SALE

We carry all models

50pc. 100pc. 500pc. 1kpcs.
\$3.50 \$3.25 \$2.75 \$2.50

Rebellion-3 125ch. Converter
12pc. 50pc. 100pc.
\$50.00 \$47.00 \$44.00

Magnavox Universal Remote Controls
12pc. 50pc. 100pc.
\$4.50 \$4.00 \$3.75

Call Today Globaltech 1-(800)-582-5116
View Our On-Line Display Catalog at:
www.globaltechdistributors.com

Top Secret Consumertronics

In business 25+ years - established professionals

Exciting Hi-Tech Survival Books, Manuals, Tapes

Stopping Power Meters \$29	Polygraph Secrets \$29
SPM Demo VHS Tape \$29	Identity Theft Manual \$29
KW-HR Meters \$29	Credit Card Security \$29
Gas & Water Security \$19	Check & M.O. Security \$29
Beyond Phone Color Boxes \$29	ATM Manual \$39
Cellphone/Cordless Guide \$39	Mind Control \$29
Pager (Beeper) Manual \$29	Under Attack! \$29
Caller ID & ANI Security \$29	EM Brainblaster \$29
Voice Mail Security \$29	Radionics Manual \$29
PBX Security \$25	Heal Thyself! \$29
Fax Machine Security \$29	Ultimate Success Manual \$29
Computer Security \$39	Stealth Technology \$29
Hacker Files (3 HD Disks) \$39	High Voltage Devices \$29
Social Engineering \$29	Secret & Survival Radio \$29
Cons & Scams Databook \$29	Secrets of Solderless BBs \$29
Internet Security \$29	The "Goldfinger" \$19
Internet Frauds Databook \$29	Casino Secrets \$29
Internet Tracking/Tracing \$29	Government Land Grab \$19
Beyond Van Eck Tempest \$29	Rockets Red Glare \$29
Van Eck Demo VHS Tape \$29	...much more in Catalog!

Check, MO, VISA, MC - add \$5 S/H (US, Canada)
FREE Online Catalog: www.tsc-global.com
Printed Catalog: \$1 with order, \$3 w/o (descriptions, policies)

Order Today! **Consumertronics**
P.O. Box 23097, ABO, NM 87192
505-321-1034 Fax: 505-275-5637

CABLE BOX SUPPLIERS

VISION MASTER PLUS W/UNIVERSAL FORMAT STABILIZERS PICTURE WORKS ANY SYSTEM!

"DEALERS WELCOME"

★ LOW, LOW PRICING ★

1-888-777-9123

1-888-675-3687

Press-n-Peel Transfer Film PC Boards in Minutes

8.5" x 11" Shts.
* Or Photocopy
**Use standard household iron

1. LaserPrint*
2. Press On**
3. Peel Off
4. Etch



Use Standard Copper Clad Board
20 Shts \$30/ 40 Shts \$50/ 100 Shts \$100
Visa/MC/PO/CK/MO \$4 S&H/Foreign Add \$7

Techniks Inc.
P.O. Box 463, Ringoes NJ 08551
ph. 908.788.8249 fax 908.788.8837
www.techniks.com

Visit Our E-Store On-Line!

NEW Easy-PC For Windows

Schematic & PCB Layout CAD

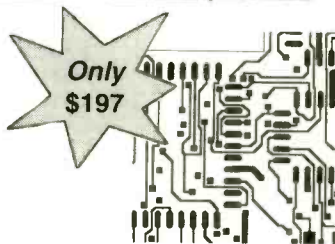

Only
\$197

- True Windows interface
- True Windows 32 bit application
- Schematic and PCB Design as standard
- Intelligent Cut, Copy and Paste - internal & external
- Multi-level Undo and Redo
- Forward design changes - Schematic to PCB
- Integrated Autoplace
- Integrated Shape based AutoRouter (Optional Extra)
- Shape based copper pour and spill power planes
- And now version 4.0 with many new features !!

Call Ohio Automation (740) 596 1023
www.numberone.com

GPS Units from Communications Surplus

Trimble SVeeSix-CM3

6 channel Differential Module &
Magnet Mt. Antenna \$49.95

Rockwell Microtracker LP

5 Channel NMEA 183 Differential
OEM Module \$49.95

Call 713-526-8000 or
1-877-878-66PS or
Fax 713-522-6309

Email commsurplus@v1.net
or www.commsurplus.com

Hack & Crack Bible II and CD-ROM

Includes all Software, Documentation!

Learn the secrets of:

- Software Serial numbers
- Timed Trial Versions
- Learn how the Pro's do it!
- Step-by-Step Guide
- The only "How to guide"

Only
\$39.95

Hack & Crack Gold CD

Get thousands of cracks
by the worlds best crackers
to crack the protection schemes
of thousands of programs
Includes tutorial library that
is a crackers dream come true!

Only
\$29.95

We accept VISA • MasterCard • American Express
To order, call Worldwyde @ 1-800-773-6698
33523 Eight Mile Rd #A3-261 • Livonia, MI 48152
Visit us on the web at www.worldwyde.com

SCRAMBLED VIDEO

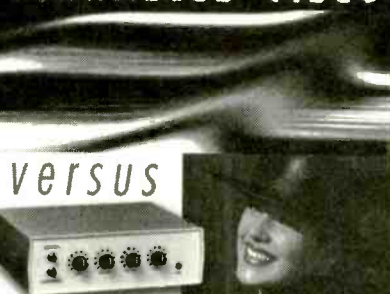

THE CLEAR
SOLUTION Model VSG-RFDL
.....RESTORES LOST VIDEO

R.C. Distributing Company
P.O. Box 552 South Bend, IN 46624
Phone (219) 233-3053 Fax (219) 289-1566

www.rcdistributing.com

PIC Programmer Kits

Super Value!
\$16.95
+S&H \$4.95*
The P16PRO: can
program up to 40
pin PICs including
the popular 16F84 &
12C508 • Needs software (extra
\$20) • Available assembled or start-
ing from \$16.95 for the kit.

See www.electronics123.com for more info!
The PICALL programmer can also program Atmel AVR's
in addition to the PICs it can program • Free soft-
ware • PICALL programmer kit at \$69.95
See www.electronics123.com for more info!

Video Camera module Code:BB004

CMOS Camera Module, Black &
White, Size: 0.63"x0.63"x0.59"H.
Lens: f4.9, F2.8, EIA 320Hx240V.
0.6" DIL Package, 5 pins. Pin 3 is 1V p-p compos-
ite video (75 ohm) to monitor. \$36 + \$5 S&H

Running Lights kit Add \$6 for 8 triacs to drive light bulbs

3 LEDs with 10 push button selectable patterns. 8
speed levels! 80 combinations! \$16 + \$5 S&H

Toll Free: 1-888-549-3749 (USA & Canada)

Tel: (330) 549-3726. Request a FREE catalog or visit us
at: www.electronics123.com for more products.
Amazon Electronics, Box 21 Columbiana OH 44408

Lone Star Consulting, Inc.

8900 Viscount, Suite 235
El Paso, TX 79925
915-474-0334

www.lonestartek.net

SPECIAL PROJECTS HARDWARE

Unique - Original - Made-to-Order - Special Needs
Electronic - Computer - Phone - Energy - Security - Data
Cars - RF - EM - Audio - Radionics - "Psychic" - Plans - more!

TECHNICAL "LIFE COACHING"

The Answer Team for Many Tech Problems
Tech Decisions - How to do Stuff - Hard-to-find Info/Stuff

WEBSITE DESIGN SERVICES

eCommerce/Personal - English/Spanish
DHTML - CSS - Flash - Scripts - Video - Images - Morphs
Scans - Audio - Scrolls - PopUps - SlideShows - Search
Forms - Secure - DB - SiteStats - SiteAudit - OCR - more!

Low Cost PICmicro Tools

New! PIC-X1
Experimenter/
Lab Board
\$49.95 to \$199.95



EPIC Pocket PICmicro
Programmer - \$59.95

Program PICmicros in BASIC!
PicBasic Compiler - \$99.95
PicBasic Pro Compiler - \$249.95

PICProto Boards make
prototyping with PICmicros
easy - \$8.95 to \$19.95

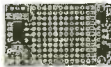

microEngineering Labs, Inc.

Box 7532 Colorado Springs CO 80933
(719) 520-5323 fax (719) 520-1867
<http://www.melabs.com>

PIC PROJECTS Book & CD-ROM

Many PIC Projects for Beginners & Experts!
Includes Software, Documentation, and PCB Layout

- LCDs
- X10 - Home Automation
- Keypads
- Serial Port Interface
- On-Screen Displays
- Robotics
- Data Logging
- Serial/Parallel
- And Many More!

Book &
CD Only
\$24.95

PIC Programmer

Programs all PIC16C55x/6x/7x/8x/9x,
PIC16F8x, and PIC12C devices.
Optional ZIF adapters for SOIC & PLCC.
Includes all necessary software.
Only \$39.95

Buy
Both for
\$59.95

We accept

VISA • MasterCard • American Express

To order, call Worldwyde @ 1-800-773-6698
21365 Randall Street • Farmington Hills, MI 48336
Visit us on the web at www.worldwyde.com/pic

SCINTILLATING!

Who Are You? The Encyclopedia of Personal Identification. Insider information directly from the FBI and Customs, top graphic artists, offshore attorneys, master thieves, and professional sharks. *Who Are You?* details ID theft schemes (and prevention), how to create great documents on a home computer, get a new driver's license (suspension? No problem), open offshore or US bank accounts w/o an SS number, acquire the world's best ID, second passports, phony credit cards, read vehicle tags, much, much more. Sources, sites, suppliers, tips, tricks and techniques. 352 pages \$44.95.

Covert Catalog2000 The latest, hands-on source guide for law enforcement goodies, electronic surveillance, covert video, counter measures, entry equipment, weapons, tracking systems, computer surveillance, and more. Exact ordering info from suppliers in 13 nations! 220 Pages. \$39.95.

ORDER BOTH BOOKS — SUBTRACT \$10!!

Intelligence Here
404 N. Mt. Shasta Blvd.
Mt. Shasta, CA 96067

Order by Phone: 866-885-8855
www.intelligencehere.com.

Add \$6.00 (priority shipping). CA residents add 8% tax



SMART CARDS

Complete system! Program your own smart
card applications in easy to use BASIC!



- Security Systems
- Time Cards
- Emulation
- Access Control - Home, Auto
- Robotics Programming
- DATA Security

Tool Kit comes complete with:

- SmartCard Programmer
- Developer Software Package
- User Manual in printed form
- 3 Blank Smart Cards

Complete system for only \$79.95

We accept

VISA • MasterCard • American Express

To Order Call 1-800-773-6698 Worldwyde.Com,
33523 Eight Mile Rd #A3-261, Livonia, MI 48152
Visit us online <http://www.worldwyde.com>

spyoutlet.com

Countersurveillance - Electronic Devices

Purchase your video cameras from
one of the largest importers
in the U.S.

- NEW Underwater Bullet Cameras
- Spy Pinhole Cameras starting at \$79.00
- Wireless Video • Voice Changer
- Micro Recorders • Shotgun Mic
- Locksmithing • Bug & Phone Tap Detectors • Phone Call Register
- UV Pens & Powder • Realtime Telephone Recording Systems:

12 Hour \$125.00 • GPS Vehicle Tracking
System (nationwide)
And much more

www.spyoutlet.com

Printed Catalog send \$5.00

SPY OUTLET 2468 NIA. FALLS BLVD
TONAWANDA NY 14150 (716) 695-8660

CABLE SECRETS!!!

Build your OWN cable box "test" devices!

Why pay \$100.00 or more for a "test" device that someone else made? Make your own! Includes complete source code and plans for the most commonly used cable boxes. Unlock all of the channels on your box!

Or start your own lucrative business!

Complete source code \$79.95
Code for individual boxes \$29.95

DSS SECRETS — Vol. 2

Step-by-step instructions on programming your own DSS access card. Unlock all channels on your own card! This is the most current information on the market! Includes software, plans, and hardware sources. Book & CD-ROM.

DSS Secrets Vol. 2 \$49.95

VISA • MasterCard • American Express

To order, call Worldwyde @ 1-800-773-6698

33523 Eight Mile Rd. #A3-261 • Livonia, MI 48152

Visit us on the web at www.worldwyde.com

CONTROL IT

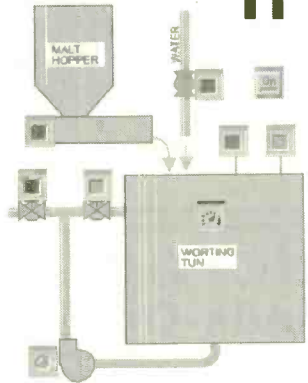

Intec Automation Inc.
www.microcommander.com

PIC MICRO TOOLS



Easy Solderless Prototyping!
On board RS-232, In Circuit
Programming. No cable or chip
swapping! Fully Documented.
Starting at Only \$39.95



ISP PRO Programmer
PIC - Scenix - Atmel - I2C - SPI
In Circuit or on board. The only
programmer you'll ever have to
buy! Only \$59.95



Program PIC's in BASIC!
Pic n' Basic Compiler \$89.95
Pic n' Basic PRO Compiler \$149.95
Includes Windows IDE with ISP PRO
programmer software built in FREE!

Combo Deal - Pic n' Basic, ISP PRO, 1802
Solderless Proto Board and PIC16F84 plus
cables and power supply all for only \$179.95

Join our online PIC forums tons
of information and help Free!

VISA • MasterCard • American Express
To Order Call 1-248-426-8144 Basic Micro
33523 Eight Mile Rd #A3-261, Livonia, MI 48152
Visit us online <http://www.basimicro.com>

Network Service Tool Set

Popular installation and service tools for networks, modems and telephones. All hand tools are professional heavy duty type.

Use the compact tester on 10BASE-T (UTP & STP), thin Ethernet (BNC), 8-position Token Ring, AT&T 258A and EIA/TIA 568A/B. Automatically scans cables for continuity, wiring sequence and polarization. Tests STP cable ground. Testing installed cables is easy with Remote Terminator and gender changers (UTP and BNC). 9V battery included.

- Coax Stripping Tool, RG-58 & RG-59
- BNC Crimping Tool, RG-58 & RG-59
- Modular Cutting/Stripping/Crimping Tool (4, 6 & 8-Position)
- Multi-Network Cable Tester
- AC Receptacle Tester
- Cable Cutter

Order No. 55625 \$197.00



PC Service Tool Set

Contains all tools needed to troubleshoot & service IBM-compatible PCs. Set includes:

- AMI Diagnostic Software
- POST Card
- Logic Probe
- Digital Multi-Meter
- AC Receptacle Tester
- Serial Adapter
- Serial & Parallel Loopback Connectors
- DIP IC Puller
- PLCC IC Puller
- Grounding Wrist Strap
- Key Top Puller

Order No. 55000 \$198.00



PC Diagnostic Tool Set

- AMI Diagnostic Software
- POST Card

Order No. 55555 \$129.00

Network Installation Tool Set

- Network Tool Set 55625 without the Multi-Network Cable Tester.

Order No. 55600 \$99.00

Call for your FREE Catalog
Graymark®

P.O. Box 2015 Tustin, CA 92781
<http://www.labvolt.com>

CALL TODAY!
800-854-7393



CIRCLE 212 ON FREE INFORMATION CARD

Microprocessor Hands-On Training

The PRIMER Trainer is a flexible instructional tool featured in a Prentice Hall textbook and used by colleges and universities around the world. Ruggedly designed to resist wear, the PRIMER supports several different programming Languages including Assembler, Machine Language, C, BASIC, and FORTH. A comprehensive Instruction Manual contains over 25 lessons with several examples of program design and hardware control. The Applications Manual provides theory and sample code for a number of hands-on lab projects.

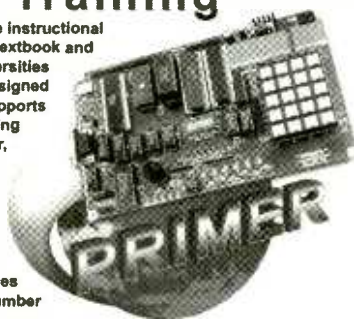

Application Projects Include:

- Scan Keypad Input & Write to a Display
- Detect Light Levels with a Photocell
- Control Motor Speed using Back EMF
- Design a Waveform Generator
- Measure Temperature
- Program EPROMs
- Bus Interface an 8255 PPI
- Construct a Capacitance Meter
- Interface and Control Stepper Motors
- Design a DTMF Autodialer / Remote Controller

The PRIMER can be purchased as an unassembled kit (\$120) or as an assembled/tested kit (\$170). Upgrades provide battery-backed RAM and PC connectivity via an RS232 serial port (shown in picture). Additional options include a heavy-duty keypad (shown in picture) and a 9V power supply -- see our website. Quantity discounts are available. Satisfaction guaranteed.

Since 1985
OVER
16
YEARS OF
SINGLE BOARD
SOLUTIONS

EMAC, inc.

Phone 618-529-4525 Fax 618-457-0110
2390 EMAC Way, Carbondale, Illinois 62901
World Wide Web: <http://www.emacinc.com>

Start A Career With High Wages, Excellent Benefits and Job Security!!

With UCANDO's extraordinary maintenance training programs you can quickly and easily enter a high paying field as a maintenance technician for a very small investment of time and money.

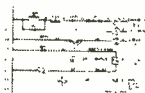

RC-M ONLY \$165 RC-M is a 15 hour training course on relay ladder logic systems. Includes a 5-part video and workbook. Great Value!

PLC-M ONLY \$198 PLC-M is a 32 hour training course on PLC systems. Includes (2) 4-part video's and workbook. This training is valuable.



HYD-M ONLY \$209 HYD-M is a 32 hour course on Fluid Dynamics. Includes (2) 4-part video's and workbook. This Module is a must.

SC-M ONLY \$215 SC-M is a 32 hour training course on AC & DC Servo Controllers. Includes (2) 4-part video's and workbook. Learn everything you need about AC and DC servo Control Systems.



Electronic Training Videos: Basic Electronics, Digital Electronics, TV Repair, LASER and Fiber Optic training videos available at very affordable prices starting at Only \$35.00 each.

For information or to place an order call:

1-800-678-6113

www.ucando-corp.com

UCANDO VCR Educational Products Corp., Greenville, OH

SINGLE CHIP COMPUTER

-ZERO external components
 -Built-in BASIC / Assembly
 -RS232 program download
 -1K flash, 64ee, 3irq, 2timers
 -15 I/O bits, A/D comparator
 -20mips, faster than pic/8051
 -20 pin DIP part #MV1200

oem (1k) **\$1.99**
 eval (1) **\$7.00**



NEW! 8K SUPER CHIP
 40x the BASIC program space!
 -32 i/o, 12 irq, 3 timers, Bus
 -8K flash, 512ee, 512nvram
 -Watchdog with internal osc.
 -40 pin DIP part #MV8515
 oem(1k) \$7.10 eval(1) \$25.00

CREDIT CARD COMPUTER



New PLUG-N-GO, no cables/power supply to buy!
 Lo-power RISC cpu 10x faster than PIC, Z80, 8051
 256k NV mem, ser, par, RTC, 4ch 50khz ADC, ISA bus
 Built-in BASIC/Assembly, other compilers avail.
 Friendly instruction set, unlike PIC or 8051
 oem (1k) price 14.20 eval kit (1) \$50.00

PC WATCHDOG CARD

No More Hangups!

Reboots PC on hardware/software hang
 3 versions: RESET, TIMER, PHONE
 reset version oem \$21.30, eval kit \$75



LO COST MINI-PC

Includes DOS, NV mem, ADC, RAM, clock, ISA bus
 Ports for serial, parallel, LCD, keyboard
 Program in Turbo C, BASIC, MASM, etc.
 Complete, no costly development kits required
 Lowest power lowest cost PC compatible available
 XT: oem \$27 eval \$95 AT: oem \$55 eval \$195

PC SOLID STATE DISK



Replace mechanical drives with faster,
 more reliable, more secure solid-state.
 Use FLASH, NVRAM, UV EPROM.
 Both DIP and PCMCIA versions from
 32Kbyte (PCMI) to 1Gigabyte (PCD2)
 starting at \$14.20oem(1k) \$50.00eval(1)

640x480 VGA LCD \$27

Controller for most single/dual scan LCDs
 Works with lo-res (160x120, 320x240, etc.)
 Use with PC or SBC, standard VGA BIOS
 Source code demo shows VGA initialization
 Adaptable for other CPUs (i.e. Z80, HC11)
 oem(1k) \$27 evalkit(1) \$95 w/10"LCD \$195



SERIAL MINI-TERMINAL

RS232 terminal for Stamp, PC, Z80, AVR etc.
 -super low-current, powers from serial line
 -LED backlit LCD, visible in all conditions
 -115.2kbps, DB9 conn, simple commands
 -specify 20 customizable or 16 tactile keys
 eval(1) \$75, oem(1k) \$21.30, w/BASIC cpu \$27



STAMP DRIVE!!

Read / Write PC compatible hard
 disk, PCMCIA, & Compact Flash.
 RS232 to ATA drive adapter for
 Stamp, 8051, AVR, PIC, Z80, x86
 ANY controller, big or small:
 -up to 4 gigabyte capacity
 -low power operation 5v 2ma
 -simple software commands
 -baud rates up to 115.2kbps
 -\$14 IDE & \$21 ISA/104 versions

oem(1k) **\$27**
 eval kit(1) **\$95**



WWW.STAR.NET/PEOPLE/~MVS

MVS Box 850
 Merr., NH 03054
 (508) 792 9507



5yr Limited Warranty
 Free Shipping
 Mon-Fri 10-6 EST

**SERVING THE EMBEDDED
 COMMUNITY SINCE 1979!**

CONTROL MEASURE INPUT

RELAYS • LIGHTS • MOTORS
TEMPERATURE • PRESSURE • LIGHT LEVELS • HUMIDITY
SWITCH POSITIONS • THERMOSTATS • LIQUID LEVELS

MODEL 30 \$79

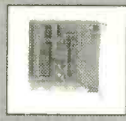

- PLUGS INTO PC BUS
- 24 LINES DIGITAL I/O
- 8 CHANNEL
- 8 BIT A/D/IN
- 12 BIT COUNTER
- UP TO 14K SMP/SEC

MODEL 45 \$189

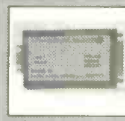

- RS-232 INTERFACE
- 8 DIGITAL I/O
- 8 ANALOG INPUTS
- 2 ANALOG OUTPUTS
- 2 COUNTERS-24 BIT

MODEL 100 \$279



- 12 BIT 100 KHZ A/D
- 4 ANALOG OUTPUTS
- 3 TIMER COUNTERS
- 24 DIGITAL I/O

MODEL 150-02 \$179



- RS-232 INTERFACE
- TRMS, 20 AMPS
- 12 BIT A/D
- OPTO-ISOLATED
- COMPLETE DMM

MODEL 40 \$109



- RS-232 INTERFACE
- 28 LINES DIGITAL I/O
- 8 ANALOG INPUTS
- PWM OUTPUT

MODEL 70 \$239



- RS-232 INTERFACE
- 18 BIT A/D
- 9.5 DIGIT
- UP TO 60 SMP/SEC

Prairie Digital, Inc.

PHONE 608-643-8599 • FAX 608-643-6754

920 SEVENTH STREET • PRAIRIE DU SAC, WISCONSIN 53478

CIRCLE 219 ON FREE INFORMATION CARD

ELECTRONIC MILITARY SURPLUS 2KW SOLA REGULATOR



Sola CVS 2000 Watt Constant Voltage Transformer provides a very well regulated sinusoidal waveform that is isolated from variations and disturbances in the input voltage. Also provides isolation and step-up/step-down to allow for various input/output voltages. Input 95-130/175-235/190-260/380-520 60Hz. Output 120/240VAC 60Hz 2000VA. 17.8x11.4x9.6, 115 lbs sh. Unused, \$250.00 ea, 2 / \$450.00

FAIR RADIO SALES

WEBSITE: faiiradio.com
E-MAIL: faiiradio@faiiradio.com
PHONE: 419-227-6573
FAX: 419-227-1313
1016 E. Eureka - Box 1105
Lima, OH 45802
VISA, MASTERCARD, DISCOVER
Address Dept. ES

Allow money for shipping.

SEND FOR OUR 2001 CATALOG !!

ON SCREEN DISPLAY CHARACTER OVERLAY BOARD



OSD-232 on board a radio controlled airplane!

Ever wish your LCD module could display more lines of text? OSD-232 is the solution! From any RS-232 serial source like a PC, PIC, or Basic Stamp, display 28 columns by 11 rows of information (308 characters total) directly onto any NTSC or optional PAL baseband (video in) television or VCR. OSD-232 can overlay monochrome text onto an incoming video source or display colored text on a self-generated colored background screen.

Intuitive Circuits, LLC
2275 Brinston • Troy, MI 48083
(248) 524-1918
<http://www.icircuits.com>

OSD-232 \$99.00
Visa/Mastercard/Prepaid check

EZ-EP DEVICE PROGRAMMER - \$169.95

Check Web!! -- www.m2l.com

Fast - Programs 27C010 in 23 seconds

Portable - Connects to PC Parallel Port

Versatile - Programs 2716-080 plus EE and Flash (28F,29C) to 32 pins

Inexpensive - Best for less than \$200

- Correct Implementation of manufacturer algorithms for fast, reliable programming.
- Easy to use menu based software has binary editor, read, verify, copy, etc. Free updates via bbs or web page.
- Full over current detection on all device power supplies protects against bad chips and reverse insertion.
- Broad support for additional devices using adapters listed below.

Available Adapters

EP-PIC (16C5x,61,62x,71,84)	\$49.95
EP-PIC64 (62-5,72-4)	\$39.95
EP-PIC12 (12C50x)	\$39.95
EP-PIC17 (17C4x)	\$49.95
EP-51 (8751 C51)	\$39.95
EP-11E (68HC11 E/A)	\$59.95
EP-11D (68HC711D3)	\$39.95
EP-16 (16bit 40pin EPROMs)	\$49.95
EP-Z8 (Z86E02,3,4,6,7,8)	\$39.95
EP-SEE2 (93x,24x,25x,85x)	\$39.95
EP-750 (87C750, 1,2)	\$59.95
EP-PEEL (IC222v10, 18v8)	\$59.95
EP-1051 (89C1051, 2051)	\$39.95
EP-PLCC (PLCC EPROMs)	\$49.95
EP-SOIC (SOIC EPROMs)	\$49.95

M²L Electronics

970/259-0555 Fax: 970/259-0777
250 CR 218 Durango, CO 81301
CO orders add 7% sales tax
<http://www.m2l.com>

EZ-EP
M²L ELECTRONICS
Los Angeles, California

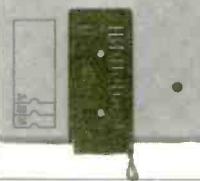

Get your copy of the CRYSTAL SET HANDBOOK



Go back to antiquity and build the radios that your grandfather built. Build the "Quaker Oats" type rig, wind coils that work and make it look like the 1920's! Only \$10.95 plus \$4.00 for shipping and handling. Clagg Inc., PO Box 12162, Hauppauge, NY 11788. USA Funds ONLY! USA and Canada — no foreign orders. Allow 6-8 weeks for delivery. MA01

TOP SECRET !

Hacking • Cracking • Satellite • Cable • Phreaking • Micros
GameBoy I/O • Smart Cards • Emulation • Hardware • Tools

Plus More! Visit us on the web!

Books & CD's:

Hackers Anarchy Cook Book 2000	\$39.95
The Hack & Crack Bible Vol.2	\$39.95
Hackers Gold CD Vol.1	\$29.00
Secrets of Dish Network Vol.1	\$49.95
DSS Secrets Vol.4 Book & CD	\$49.95
Cable Test Devices Source Code & Plans	\$79.00
PSX Secrets w/ MODCHIP Source Code ...	\$69.95
The Ultimate Phreaking Guide	\$39.95
Emulator Heaven CD	\$49.95
Game Boy I/O - Servos/Relays/Sensors	\$49.95

Hardware:

PIC, Scenix, Atmel Programmer Complete ...	\$99.00
ISO 7816 Smart Card Programmer	\$59.95
Smart Cards (from)	\$ 6.95
Prototyping Boards PIC & Scenix	\$ 9.95

VISA • Master Card • American Express
To Order Call 1-800-773-6698

Send Money orders to: Worldwyde.Com,
33523 Eight Mile Rd #A3-261, Livonia, MI, 48152
Visit us online <http://www.worldwyde.com>



- ★ No Rolls/Jitters/Flickers/Fading
- ★ Works on all TV's, VCR's, Beta, & Cable
- ★ Gold Video Connectors & Cables Included
- ★ 1 Year Warranty
- ★ Money Back Guarantee

FREE CATALOG!

COPY RENTAL TAPES WITH OUR VIDEO STABILIZER

1-800-562-2252

2609 S. 156th Circle • Omaha, NE 68130
www.modernelectronics.com



ELECTRONIC TECHNOLOGY TODAY INC.

P.O. Box 240 • Massapequa Park, NY 11762

INVENTORY BLOWOUT SALE



* ALL CANADIAN CHECKS MUST CLEAR THROUGH AN AMERICAN BANK

BP07	100 Radio Hookups	\$3.00	BP302	A Concise User's Guide to Lotus 1-2-3 Release 3.1	\$5.99
BP36	50 Circuits Using Germanium, Silicon & Zener Diodes	\$2.99	BP304	Projects for Radio Amateurs and S.W.L.S	\$5.99
BP44	IC 555 Projects	\$5.99	BP317	Practical Electronic Timing	\$6.99
BP48	Electronic Projects for Beginners	\$2.99	BP320	Electronic Projects for Your PC	\$5.99
BP56	Electronic Security Devices	\$3.99	BP322	Circuit Source Book 2	\$6.99
BP64	Semiconductor Technology Elements of Elect Book 3	\$5.99	BP329	Electronic Music Learning Projects	\$6.99
BP74	Electronic Music Projects	\$3.99	BP332	A Beginners Guide to TTL Digital ICS	\$6.99
BP76	Power Supply Projects	\$3.99	BP333	A Beginners Guide to CMOS Digital ICS	\$6.99
BP78	Practical Computer Experiments	\$2.99	BP334	Magic Electronic Projects	\$6.99
BP80	Popular Electronic Circuits	\$3.99	BP355	A Guide to the World's Radio Stations	\$7.99
BP103	Multi-Circuit Board Projects	\$2.99	BP359	An Introduction to Light in Electronics	\$6.99
BP109	The Art of Programming the IK ZX81	\$3.99	BP367	Electronic Projects for the Garden	\$6.99
BP112	A Z-80 Workshop Manual	\$5.99	BP370	The Superhet Radio Handbook	\$6.99
BP114	The Art of Programming the 16K ZX81	\$3.99	BP371	Electronic Projects for Experimenters	\$6.99
BP115	The Pre-Computer Book	\$2.99	BP374	Practical Fibre-Optic Projects	\$6.99
BP124	Easy Add-On Projects for the Spectrum, ZX81 & ACE	\$3.99	BP378	45 Simple Electronic Terminal Block Projects	\$6.99
BP143	An Intro to Programming the Atari 600/800 XL	\$2.99	BP379	30 Simple IC Terminal Block Projects	\$6.99
BP148	Computer Terminology Explained	\$2.99	BP384	Practical Electronic Model Railways Projects	\$6.99
BP154	An Introduction to MSX Basic	\$3.99	BP391	Fault-Finding Electronic Projects	\$6.99
BP156	An Introduction to QL Machine Code	\$3.99	BP392	Electronic Project Building for Beginners	\$6.99
BP187	A Prac Ref Guide to Word Pro Amstrad PCW8256/PCW8512	\$7.99	BP393	Practical Oscillator	\$6.99
BP190	More Advanced Electronic Security Projects	\$3.99	BP394	An Introduction to PIC Microcontrollers	\$7.99
BP194	Modern OPTO Device Projects	\$3.99	BP396	Electronic Hobbyists Data Book	\$7.99
BP232	A Concise Introduction to MS-DOS	\$3.99	BP401	Transistor Data Tables	\$7.99
BP245	Digital Audio Projects	\$3.99	BP411	A Practical Intro to Surface Mount Devices	\$6.99
BP256	An Intro to Loudspeakers and Enclosure Design	\$3.99	BP413	Practical Remote Control Projects	\$7.99
BP264	A Concise Advanced User's Guide to MS-DOS	\$3.99	PCP107	Digital Logic Gates and Flip-Flops	\$10.99
BP272	Interfacing PCS and Compatibles	\$5.99	PCP112	Digital Electronics Projects for Beginners	\$10.99
BP290	An Intro to Amateur Communications Satellites	\$5.99	PCP114	Advanced MIDI Users Guide	\$10.99
BP297	Loudspeakers for Musicians	\$6.99	ETT1	Wireless & Electrical Cyclopedia	\$4.99
BP299	Practical Electronic Filters	\$6.99			

PRICES DO NOT INCLUDE SHIPPING & HANDLING. ALL SALES ARE FINAL, NO RETURNS

ORDER FORM

Book No.	Title	Price	No. of Copies	Cost

SHIPPING COSTS				Total Amount \$
\$0.01 to \$5.00	\$2.00	\$20.01 to \$30.00	\$5.00	- 30% off
\$5.01 to \$10.00	\$3.00	\$30.01 to \$40.00	\$6.00	Subtotal
\$10.01 to \$20.00	\$4.00	\$40.01 to \$50.00	\$7.00	Local NY State Sales Tax
\$50.01 and above	\$8.50			Add shipping cost (see table)
				TOTAL COST \$

Name _____
 Address _____
 City _____ State _____ Zip _____

If you wish to use a Credit Card:

MasterCard Visa Expire Date _____ / _____

Card No. _____

Signature _____

Allow 6-8 weeks for order to be fulfilled.

Please return this order form to:
ELECTRONIC TECHNOLOGY TODAY, INC.
 P.O. Box 240
 Massapequa Park, NY 11762-0240



Telephone Orders: If you wish to place your credit-card order by phone, call 631/592-6720. Automated order taking system functions 24 hours a day. Have your credit-card ready. Sorry, no orders accepted outside of U.S.A. and Canada, New York State Residents must add applicable sales tax. Offer expires 9/30/01. ET11

ROBOTS,
ROBOTS,
ROBOTS...



Robot Kits, Programmable Robots,
LEGO® Robots, Living Robots,
Muscle Wires®, Home and Office
Robots, Electronic Kits & More!

Request our FREE
48 page catalog
with over 300 items!

www.RobotStore.com
800-374-5764

Mondo-tronics Inc.

PMB-N, 4286 Redwood Hwy, Dept. 171
San Rafael, CA 94903
ph 415-491-4600 fx 415-491-4696
info@rjrobotstore.com

World's Smallest 68HC11 Microcontroller Module!

MicroStamp 1™

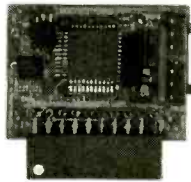

- telemetry
- microrobotics
- smart toys
- animatronics
- model railroading
- home automation

NEW Windows-based development software included free!

- tiny, light-weight (0.5 oz.) 1-inch x 1.4-inch 68HC11 module
- 5V regulator, 8MHz crystal
- choice of 8K or 32K EEPROM
- optional 32K RAM (32K EEPROM version)
- plugs into your breadboard like a DIP
- SCI, SPI, OCs, ICs, timers, & more
- all 14 I/O lines and 2 interrupts brought out to versatile 20-pin connector
- program in BASIC, assembler, or C
- easy code-loading with Docking Module
- Starter Packages:*

8K EEPROM (#MS11SP8K).....\$49
32K EEPROM (#MS11SP32K).....\$72
32K EE+32K RAM (#MS11SP64K)....\$90

* includes MicroStamp11, manual, PC software (free-ware assembler, SBASIC compiler, Smartload11 utility, and sample programs), serial cable, Docking Module, accessories.

Optional ImageCraft 68HC11 C cross-compiler for W3.119x available (# ICC11WIN)..... \$153

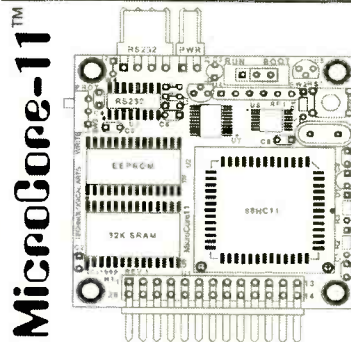

- tiny 2-inch x 2-inch 68HC11 module
 - 12 inputs/outputs plus 8 analog inputs
 - RS232, 5V regulator, 8MHz crystal
 - 32K SRAM plus 8K or 32K EEPROM
 - plugs into your breadboard like a DIP
 - easy program loading from any PC
 - motor driver & accessories available
 - ideal for MicroMouse robot competitions
- 8K Starter Package #MC11SP8K.....\$68
32K Starter Package #MC11SP32K.....\$93
Motor driver boards, LCD/keypad/keyboard interface & prototyping cards available

Technological Arts

Many other modules & accessories available.
Visit our website at:

www.technologicalarts.com
sales@technologicalarts.com
TOLL-FREE: 1-877-963-8996
Phone: (416) 963-8996
Fax: (416) 963-9179
Visa • MasterCard • Discover • Amex

CLASSIFIEDS

BUSINESS OPPORTUNITIES

\$400 WEEKLY ASSEMBLING Electronic Circuit Boards/Products From Home. For Free Information Send SASE: Home Assembly-PT Box 216 New Britain, CT 06050-0216.

CABLE TV

CABLE TV Descramblers. One-piece units. Scientific Atlanta, Jerrold, Pioneer, and others. Lowest Prices Around. **Precision Electronics** Houston, TX Anytime. 1-888-691-4610

ABSOLUTE BEST PRICES ON CABLE TV BOXES! FREE 30 DAY TRIAL! 1 YEAR WARRANTY! FREE CATALOG. 1-888-242-0539. WWW.ALLCABLEBOXES.COM

COMPUTER SOFTWARE

CONTROL Network. RS485/PIC16C74 system. GUI control panel. Plans, pcbs, software, theory. Book/disc U\$39.95. **R. Walker**, 1292 West 6th Ave, Vancouver BC V6H 1A5 Canada.

MISC. ELECTRONICS FOR SALE

T&M ELECTRONICS. Large variety of electronic parts since 1966. Visit our Web site at www.tandmelectronics.com

TinyTenna's and more! SASE to: "Shortwave Catalog", POB 87, Hanover, MI. 49241. <http://qth.com/dwm> or <http://qth.com/danger>.

SATELLITE EQUIPMENT

FREE Satellite TV Buyer's Guide. Best Products - Lowest Prices - Fastest Service! Dish Network, DirectTV, C/Ku-band, including 4DTV. Parts- Upgrades - Accessories! **SKYVISION** - 800-543-3025. International 218-739-5231. www.skyvision.com

TEST EQUIPMENT

POCKET TESTBENCH. 8 instruments in 1 tiny package. PIC singleboard computers, botboards, protoboards. www.oricomtech.com

Practical PIC Microcontroller Projects

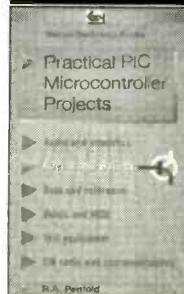

This book covers a wide range of PIC based projects, including such things as digitally controlled power supplies, transistor checkers, a simple capacitance meter, reaction tester, digital dice, digital locks, a stereo audio level meter, and MIDI pedals for use with electronic music systems. In most cases the circuits are very simple and they are easily constructed. Full component lists

and software listings are provided. For more information about PICs we suggest you take a look at BP394 -- An Introduction to PIC Microcontrollers.

To order Book #BP444 send \$7.99 plus \$3.00 for shipping in the U.S. and Canada only to Electronics Technology Today Inc., PO Box 240, Massapequa Park, NY 11762-0240. Payment in U.S. funds by U.S. bank check or International Money Order. Please allow 6-8 weeks for delivery.

ET10

Gernsback Publications, Inc.

275-G Marcus Blvd. Hauppauge NY 11788

POPTRONICS® CLASSIFIED ADVERTISING ORDER FORM

Advertiser Information

Name _____
 Company _____
 Street Address _____
 City/State/Zip _____
 Telephone () _____
 Signature (required on all orders) _____

Payment Information

Charge my:
 Master Card Visa Discover
 Account No. _____
 Exp. Date _____
 Full payment enclosed. Prepayment discounts offered for multiple insertions (except on credit card orders).
 Payment for first insertion enclose; additional payments will be made prior to closing dates. Prepayment discounts not available.

Do you want any special options? (where available)

Boldface Type* Add 25% for entire ad Screened Background – Add 30%
 Special Heading – Add \$35.00

The first word of your ad and your name will be printed in boldface caps, at no additional charge.
 For individual boldface words, add .50¢ each.

In what month(s) would you like your ad to run?

Entire year for publications selected above.
 Jan. Feb. Mar. Apr. May. June July Aug. Sep. Oct. Nov. Dec.

Here's how to calculate the cost of your Regular or Expanded-Ad Classified:

Rate X Numbers of Words + Rate for Boldface + Rate for Screened Background = Cost per Insertion X Number of Months = Cost

Magazine	Rate	x	Number of Words (min. 15)	+	Boldface (add 25%)	+	Screened + Background (add 30%)	=	Cost Per Insertion	x	Number of Months	=	Cost
		x		+		+		=		x		=	

Rates:

\$3.50 per word

Minimum 15 Words

Here's how to calculate the total cost of your advertising:

Prepayment Discount:

(Full payment must accompany order, not applicable on credit card orders)

Prepay for 6 insertions in one magazine, 5% 12 insertions in one magazine, 10%

Subtotal _____
 Less Prepayment Discount _____
TOTAL COST \$ _____

Please use a separate piece of paper to write your copy, or for any special instructions you may have.

HAVE A QUESTION? CALL: 1-631-592-6720 ext. 206

Fax signed orders with credit card information to : (631) 592-6723

GP1895

ADVERTISING INDEX

Poptronics does not assume any responsibility for errors that may appear in the index below.

Free Information Number	Page	Free Information Number	Page
- A & A Engineering	.73	- Intuitive Circuits, LLC	.84
- Abacom	.65	309 IVEX Design	.75
- All Electronics	.72	139 Jameco	CV3
- Allison Technology Corp.	.66	- LDP LLC	.72
- Amazon Electronics	.80	- Lone Star Consulting	.81
- Andromeda Research	.66	- LT Sound	.72
- Antique Electric Supply	.72	- Lynxmotion	.70
- Arrow Technologies	.73	- Marrick Limited	.3
319 Beige Bag Software	.67	- M ² L Electronics	.84
290 C&S Sales, Inc.	.68	324 MCM Electronic	.63
283 CadSoft, Inc.	.13	323 Mendelsons	.73
- Carl Taylor Inc.	.80	296 Merrimack Valley Systems	.83
133 CircuitMaker	CV2	- microEngineering Labs	.81
233 Circuit Specialists	.76	- Modern Electronics	.70
- CLAGGK, Inc.	.18, 24	- Mondo-tronics	.86
320 Cleveland Inst. of Electronics	.71	- North Country Radio	.78
321 Command Productions	.62	- Ohio Automation	.80
- Communications Surplus	.80	- Pioneer Hill Software	.72
- Conitec Data Systems	.72	228 Polaris Industries	.61
- Consumertronics	.80	219 Prairie Digital	.84
- Custom Computer Services	.74	- RC Distributing Co.	.80
- EDE Spy Outlet	.81	263 Ramsey Electronics	.79
210 Electronic Design Specialists	.62	- Saelig Co., LLC	.66
- Elect. Tech. Today	.85	- Securetek	.66
130 Electronic Workbench	CV4	- Scott Edwards Electronics	.78
- Electronix	.72	- Smarthome.com	.78
- EMAC Inc.	.82	- Square 1 Electronics	.73
- Engineering Express	.73	- Techniks	.80
- Fair Radio Sales	.84	- Technological Arts	.86
- Fort777.com	.64	322 Test Equipment Depot	.67
- Global Specialties	.65	217 Tie Pie Engineering	.74
- Globaltech Distributors	.80	- UCANDO Videos	.82
282 Grantham College of Eng.	.3	- Vision Electronics	.84
212 Graymark International	.82	224 Visitect, Inc.	.70
220 Information Unlimited	.65	140 Wittig Technologies	CV2
- Intec Automation	.81	141 Wittig Technologies	.23
- Intelligence Here	.81	- World Wide	.73
- Intronics	.70	- World Wyde	.80, 81, 84

ADVERTISING SALES OFFICES

Gernsback Publications, Inc.
275-G Marcus Blvd.
Hauppauge, NY 11788
Tel. 631-592-6720
Fax: 631-592-6723

Larry Steckler
 Publisher (ext. 201)
 e-mail: advertising@gernsback.com

Adria Coren
 Vice-President (ext. 208)

Ken Coren
 Vice-President (ext. 267)

Marie Falcon
 Advertising Director (ext. 206)

Adria Coren
 Credit Manager (ext. 208)

For Advertising ONLY EAST/SOUTHEAST

Marie Falcon
 275-G Marcus Blvd.
 Hauppauge, NY 11788
 Tel. 631-592-6720 x206
 Fax: 631-592-6723
 e-mail: mfalcon@gernsback.com

MIDWEST/Texas/Arkansas/ Oklahoma

Ralph Bergen
 One Northfield Plaza, Suite 300
 Northfield, IL 60093-1214
 Tel. 847-559-0555
 Fax: 847-559-0562
 e-mail: bergenrj@aol.com

PACIFIC COAST

Megan Mitchell
 9072 Lawton Pine Avenue
 Las Vegas, NV 89129-7044
 Tel. 702-240-0184
 Fax: 702-838-6924
 e-mail: mmitchell@gernsback.com

**Subscription/
Customer Service/
Order Entry**
 Tel. 800-827-0383
 7:30 AM - 8:30 PM CST

www.poptronics.com

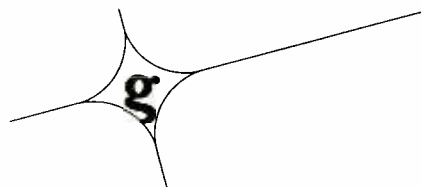

www.jameco.com

In a Jam?

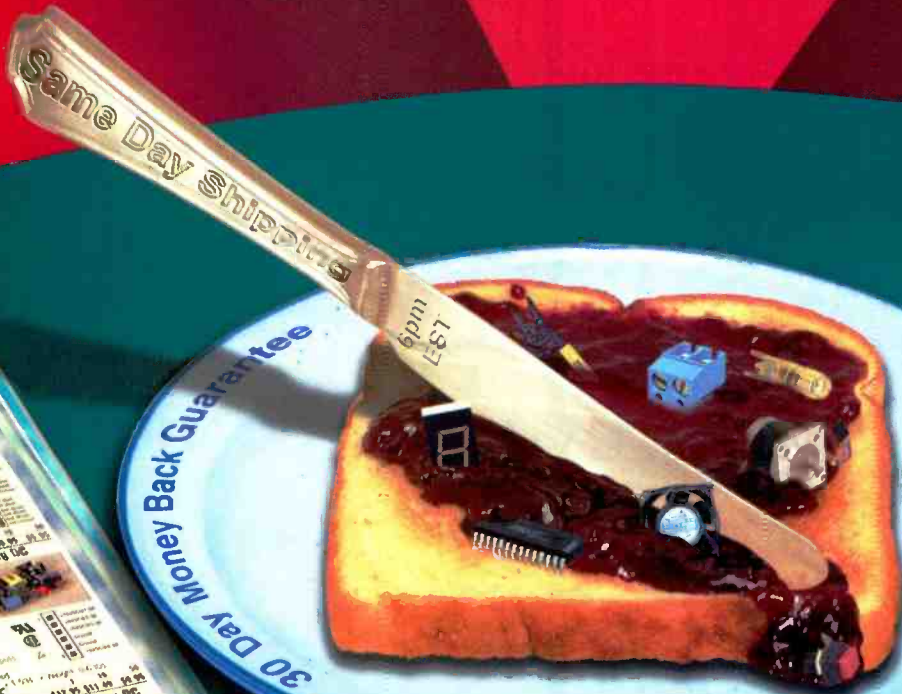

30 Day Money Back Guarantee

Complete On-Line Services

Get the Products You Need... The Service You Deserve!™

JAMECO®

ELECTRONICS

1•800•831•4242

CIRCLE 139 ON FREE INFORMATION CARD

275 G Ma

The world's most popular electronics simulation software just got better! **WHY settle for second best?**

***FREE**

Virtual Lab with Poptronics Circuits

Check out the circuits from recent issues, including this month's! Tweak the circuits and see the instruments respond instantly.

Download the Multisim demo with pre-built Poptronics circuits from www.electronicworkbench.com/poptronics

BEST PRODUCT! BEST PRICE!

Electronics Workbench is recognized around the globe for developing highly advanced, yet easy-to-use electronics software. Over 150,000 users tell us that they have completed projects using Electronics Workbench in less time than it takes to even install other programs.

And now we've just released Version 6.2! If you've never tried electronics simulation, this is your chance - you can now have your very own virtual lab! Work on your own or create circuits together with others across the country - live on the internet. Start with the **FREE** Electronics Workbench/Poptronics demo and then take advantage of this best price ever when you buy. Tried other products? You owe it to yourself to experience what only the market leader can offer - there is no comparison. And if you own earlier versions of Electronics Workbench, call us now for upgrade pricing starting at just **\$149!**

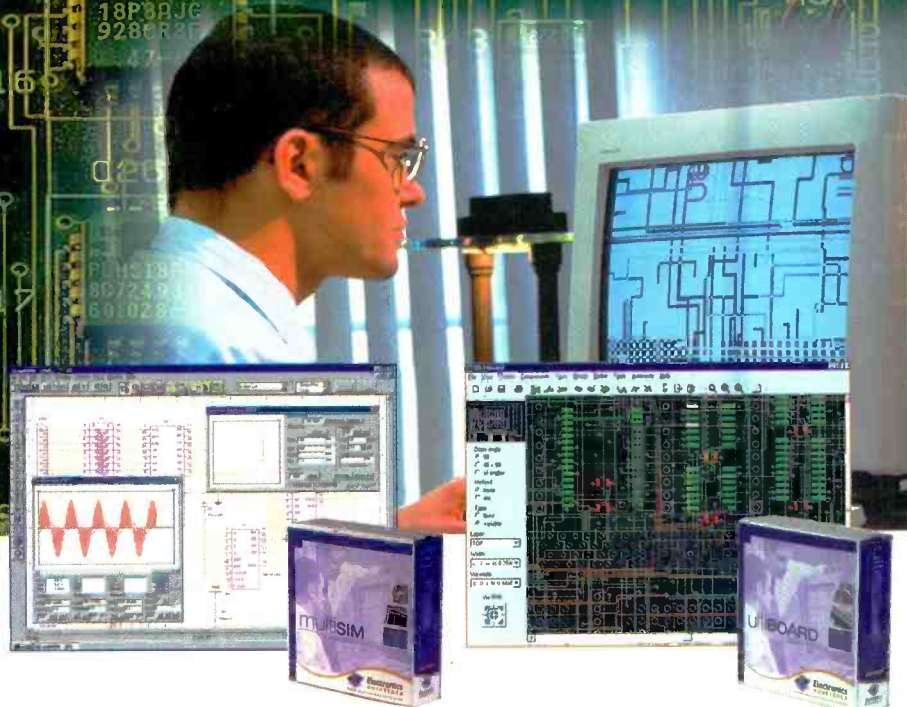

multisIM V6.2

Schematic Capture & Simulation

~~\$399~~ **\$299**

ultiBOARD

Powerful PCB Layout

~~\$399~~ **\$299**

or get **BOTH** products for **\$498**

Limited Time Offer
BEST price ever!

Multisim Highlights

- ▶ Advanced schematic capture
- ▶ Intuitive auto & manual wiring (no toggle)
- ▶ Change circuits while simulating
- ▶ Mixed-mode SPICE analog/digital simulation
- ▶ Built-in symbol and component editor
- ▶ Parts organized into bins (no alpha lists)

Don't settle for a program that has less than:

- ▶ 6,000 parts in component database
- ▶ 9 virtual instruments & 8 powerful analyses
- ▶ Interactive design on the Internet
- ▶ OLE integration with Excel/MathCAD

Ultiboard Highlights

- ▶ Powerful & easy-to-use PCB layout & editing
- ▶ Reroute while move (full rubberbanding)
- ▶ Built-in autorouter
- ▶ Real-time design rule check
- ▶ Automatic net highlighting (selective)
- ▶ Density histograms/placement vectors

Don't settle for a program that has less than:

- ▶ 3,000+ library of footprint shapes
- ▶ Capability for boards of any shape, up to 50"x50"
- ▶ 32 layers support
- ▶ 1 nanometer internal resolution

To order, or to find out why our products are the most popular in the industry, call **1-800-263-5552** or visit www.electronicworkbench.com (**FREE** demo available)



Electronics
WORKBENCH