

Virtual Lab – Real Results

Intuitive schematic capture

*Fast, accurate analog/
digital simulation*

Full-featured pcb layout

Built-in autorouting

CircuitMaker 2000 provides all the tools necessary to quickly and easily design circuits, test them in the real world and generate prototype boards – the complete virtual electronics lab solution.

With all the features you'd expect from a professional design system – plus exceptional ease-of-use, you'll spend less time learning and more time designing.

Available in both standard and professional editions, CircuitMaker 2000 gives you full design capability at a price that is simply unmatched by the competition.

CircuitMaker 2000
the virtual electronics lab™

Intuitive schematic capture

Fast, accurate analog/digital simulation

Full-featured pcb layout

Built-in autorouting

FROM
\$395

New License Price

Upgrade from \$95

*Comprehensive educational and computer-based
training packages also available*

CircuitMaker 2000
the virtual electronics lab™

Call your local CircuitMaker sales & support
center on **800 419-4242**

17140 Bernardo Center Drive, Suite 100 San Diego, CA 92128
or visit www.circuitmaker.com

Contact us for your
**Free CircuitMaker 2000
brochure and Trial CD**



Service Pack 1
now available for
FREE DOWNLOAD
from www.circuitmaker.com

CircuitMaker
the virtual electronics lab™

CircuitMaker is a registered trademark of Protel International Limited. CircuitMaker 2000 is a trademark of Protel International Limited.

CIRCLE 133 ON FREE INFORMATION CARD

www.americanradiohistory.com

Poptronics[®]

THE MAGAZINE FOR THE HANDS-ON ELECTRONICS ACTIVIST!

FEATURES

DIGITAL DOGGIESMort Collinsworth 28
Can either contender unseat, out-beg, or over-rollover the current champion, a real live dog?

THE EXECUTIVE BDMUrsula R. Kidden 31
This desktop device demonstrates some of the non-obvious aspects of working with the LEGO MINDSTORMS Robotics Invention System.

EYEBOTRobert Lang and Steve Thompson 37
Adding vision to Parallax's BOEBot might seem a simple task, but the obvious way is not always the best way.

SCIENCE-FAIR BOTJohn Bachman 43
In this piece of short fiction, two cousins need a project for the high school Science Fair.

PRODUCT REVIEWS

HANDS-ON REPORT 12
BOEBot educational kit from Parallax, Inc.

GIZMO[®] 15
Robotic toy pets, robot construction system, video-conferencing hardware, personal-organizer software, portable MP3 player, e-mail-assistant software, and screen-magnifying software.

DEPARTMENTS

PROTOTYPE 8
Robot Control via brain implants, NASA space-faring "snakebots," videophone tests, new techniques for measuring age, construction-site safety, fingerprint-recognition hardware, data-storage devices, weather prediction, Web-based skeletons, and new cleaning techniques for IC manufacturers.

NET WATCH Chris La Morte 19
In Search Of Robots: a smattering of Internet sites on our electromechanical friends.

SURVEYING THE DIGITAL DOMAIN Reid Goldsborough 21
Searching the Web for the best deal? See how easy it is with a "shopping (ro)bot."

COMPUTER BITS Ted Needleman 23
Turn a house into a giant robot with the help of some X-10 controllers.

PEAK COMPUTING Ted Needleman 25
LEGO MINDSTORMS robots are given the gift of sight with the Vision Command add-on package.

Q&A Dean Huster 47
There are many "head-scratcher" questions that are very applicable to the robotics world.

AMAZING SCIENCE John Iovine 51
Recreate an early behavioral-based robot.

ROBOTICS WORKSHOP Gordon McComb 55
Put the "fun" back in robot design and construction with CyberK'NEX.

SERVICE CLINIC Sam Goldwasser 57
What to do when your mechanical buddy goes on the "fritz."

BASIC CIRCUITRY Charles D. Rakes 61
Basic motor-control, light-sensing, and balance-sensing circuits for robots.

AND MORE

EDITORIAL 2

LETTERS 3

NEW GEAR 5

NEW LITERATURE 7

POPTRONICS SHOPPER 67

ADVERTISING INDEX 96

FREE INFORMATION CARD 96A

Poptronics (ISSN 1526-3681) Published monthly by Gernsback Publications, Inc. 275-G Marcus Blvd., Hauppauge, NY 11788. Second-Class postage paid at Hauppauge, NY and at additional mailing offices. One-year, twelve issues, subscription rate U.S. and possessions \$24.99, Canada \$33.15 (includes G.S.T. Canadian Goods and Services Tax Registration No. R125166280), all other countries \$33.99. Subscription orders payable in U.S. funds only, International Postal Money Order or check drawn on a U.S. bank. U.S. single copy price \$4.99. Copyright 2001 by Gernsback Publications, Inc. All rights reserved. Hands-on Electronics and Gizmo trademarks are registered in U.S. and Canada by Gernsback Publications, Inc. Poptronics trademark is registered in U.S. and Canada by Poptronix, Inc. and is licensed to Gernsback Publications, Inc. Printed in U.S.A. Postmaster: Please send address changes to Poptronics, Subscription Dept., P.O. Box 459, Mount Morris, IL 61054-7629

A stamped self-addressed envelope must accompany all submitted manuscripts and/or artwork or photographs if their return is desired should they be rejected. We disclaim any responsibility for the loss or damage of manuscripts and/or artwork or photographs while in our possession or otherwise.

As a service to readers, Poptronics publishes available plans or information relating to newsworthy products, techniques, and scientific and technological developments. Because of possible variances in the quality and condition of materials and workmanship used by readers, Poptronics disclaims any responsibility for the safe and proper functioning of reader-built projects based upon or from plans or information published in this magazine.

Larry Steckler, EHF, CET,
editor-in-chief and publisher

EDITORIAL DEPARTMENT

Joseph Suda, managing editor
Evelyn Rose, assistant editor
Nancy Serenita, editorial assistant

CONTRIBUTING EDITORS

Dean Huster
Reid Goldsborough
Sam Goldwasser
John Iovine
Chris La Morte
Gordon McComb
Ted Needleman
Charles D. Rakes
Teri Scaduto

PRODUCTION DEPARTMENT

Ken Coren, production director
Kathy Campbell, production manager
Michele L. Musé, prepress specialist

ART DEPARTMENT

Russell C. Truelson, art director
Michele L. Musé, graphic artist

CIRCULATION DEPARTMENT

Gina Giulliano, circulation manager

REPRINT DEPARTMENT

Nancy Serenita, Reprint Bookstore

BUSINESS AND EDITORIAL OFFICES

Gernsback Publications, Inc.
275-G Marcus Blvd.
Hauppauge, NY 11788
631-592-6720
Fax: 631-592-6723

President: **Larry Steckler**
Vice-President: **Adria Coren**
Vice-President: **Ken Coren**

**SUBSCRIPTION
CUSTOMER SERVICE/
ORDER ENTRY**

800-827-0383
7:30 AM - 8:30 PM EST

**Advertising Sales Offices
listed on page 96**

Cover by Michele Lyn Musé

VISIT US ON THE INTERNET AT:
www.gernsback.com

Since some of the equipment and circuitry described in POPTRONICS may relate to or be covered by U.S. patents, POPTRONICS disclaims any liability for the infringement of such patents by the making, using, or selling of such equipment or circuitry, and suggests that anyone interested in such projects consult a patent attorney.

<mailto:popeditor@gernsback.com>

Man's Best Mechanical Friend

Robots. That simple word—born of the 20th Century—has evoked many different emotional responses through the last few decades. From simple assistant to slave to evil persona to cute and cuddly sidekick for comic relief, robots (or at least the concept of “mechanical men”) have been with us for almost as long as we have been “civilized.”

We talk about robots, but what exactly *is* a robot? Most (if not all) of us profess to recognizing one when we see it, but can we come up with a definition that fits the bill? Let's start with some of the very obvious characteristics.

Robots move. Does that include, say, a puppet? Most everybody would say “no.” Why? Is it because puppets are made from cloth or wood instead of metal? What if I built John Iovine's BEAM-style robot (featured in this month's “Amazing Science” column) out of wood instead of metal and used an “air muscle” (from John's November 2000 column) on a crank for propulsion? Is it any less a robot if I don't use any metal?

Another “anti-puppet” argument might be because their animation comes from a human hand instead of an electric motor. Should that include clockwork-driven automatons (whose history goes back at least to the 18th Century)? That energy source can obviously be attributed to direct human effort. In a more modern vein, what about the BattleBots, whose weekly tournaments of mechanical death and destruction are seen across the globe on the Comedy Central cable network? The general name notwithstanding, are those “radio-controlled-cars-on-steroids” *really* robots?

The BattleBots illustrate another interesting point about robots: going places too dangerous for Man to tread, although, in a “sense” (pun intended), the operator is right there in the thick of it along with his mechanical “beastie”—extending our senses and presence into that “robot's Hell.” NASA has been doing just that—extending our presence in space through “telepresence”—for a couple of decades.

Unfortunately, I'm limited by the amount of space allotted to my ramblings. Defining “what is a robot” is probably impossible to do in two-thirds of a page. I'm sure that there are entire books on the subject. The whole discussion makes me think about studying the “definition of life” back in high school. Science has some set criteria for determining what life is. It always amuses me whenever a mechanical contrivance meets another item on the “meaning-of-life” checklist. Scientists usually up the ante by refining the offending definition; we don't want to admit just *anything* to our private party! Of course, we've also found organisms at the bottom of the ocean, miles from light or oxygen, but happily digesting sulfurous compounds spewing from seamounts and other cracks in the Earth's crust while grooving on the near-boiling-point temperatures. Such organisms do not fit the traditional rules for determining “is it alive,” yet they are undeniably doing just that—living.

Trying to keep Man's inventions out while admitting the most outlandish biological creations of Nature makes the balancing act more difficult all the time. I can't wait to see what happens when we finally meet up with some bonafide extraterrestrial organism that forces us to rewrite the rulebook yet again.

What do *you* think a robot is?



Joseph Suda
Managing Editor

LETTERS

mailto: letters@gernsback.com

Battlebots Inspiration

I have been watching *Battlebots* and was amazed at the ingenuity it takes to create these little metallic monsters. I was quite surprised to find that the "Net Watch" column in the January 2001 issue was discussing the designs of these metal-wrecking machines. There is plenty that goes in the creation of these Battlebots, as they use whiskers for sensing if something is near, in addition to the Piezo Bar Collision Detector. Most incredible!

Thank you for this great information. I was thinking of modifying my R.A.D. 2.0 Robot and Mega-Byte for the next Battlebot tournament, and your article gives me the inspiration!
JASON RANDALL PORTER
via e-mail

...and Puzzlement

In reference to your January 2001 "Net Watch, is there any specific reason why *Battlebots* is only aired on Comedy Central? One wonders.....

(Actually reminds me of pre-Net days when 99% of PC usage was devoted to playing video games.
SKIP CAMPISI
Jackson, NJ

Here is the skinny on why *BattleBots* is only shown on Comedy Central. *BattleBots* is actually part of BattleBots, Inc. Comedy Central owns rights for televising BattleBots competitions. You'll notice a "Comedy Central Presents" header whenever the television show is mentioned at the BattleBots Homepage (www.battlebots.com). For more information, e-mail info@battlebots.com or contact the main office at BattleBots Inc. 701 De Long Ave., Unit K, Novato, CA 94947; 415-898-7522.
CHRIS LA MORTE

Temperature Conversion Techniques

I am writing to comment on the letter entitled "Metric Temperature Conversions" in the "Letters" column in the January 2001 issue of *Poptronics*.

The year has been a trying one for

mathematics, first with the Y2K problem, and later with the election counting; but I never thought the new math (including fuzzy math) would catch up with temperature conversions. Somewhere, somehow, someone has done Mr. Love a disservice, and I hope it wasn't his college.

In the first equation, it always worked better for me if I enclosed the first term in brackets:

$$(F-32)/1.8 = C$$

In the example showing the conversion of the freezing point of water from 212° to 0°, a couple of things seem to go astray, or is this another post-election go at changing the rules? Since this was not your April issue, I know I have to take your material seriously, but this is getting a little hard. I hope you plan to expand on this.

ROBERT G. WILLIAMSON
via e-mail

KEEP IN TOUCH

We appreciate letters from our readers. Comments, suggestions, questions, bouquets, or brickbats ... we want to hear from you and find out what you like and what you dislike. If there are projects you want to see or articles you want to submit—we want to know about them.

You can write via snail mail to:

Letters
Poptronics
275-G Marcus Blvd.
Hauppauge, NY 11788

Sending letters to our subscription address increases the time it takes to respond to your letters, as the mail is forwarded to our editorial offices.

Our e-mail address can be found at the top of the column.

Of course, e-mail is fast.

All of our columnists can be reached through the e-mail addresses at the head of each column.

And don't forget to visit our Web site: www.gernsback.com.

George T. Love needs to go back to college, and this time pay attention. Air pressure has nothing to do with the conversion between Fahrenheit and Celsius. It only affects the boiling and freezing points of water. The formulas to convert are the same no matter what the pressure. Also, he claims his conversion method avoids fractions. Then what is 32/1.8 in his formula?

WHITHAM D. REEVE
via e-mail

I've been reading *Poptronics* since the Carl and Jerry days (AKA the 50s) and still really enjoy it! Here's a VERY easy way to do approximate metric temperature conversions. You can DEFINITELY do these in your head:

$$F = C \times 2 + 30$$

$$C = (F - 30) / 2$$

The results are accurate within a couple of degrees for temperatures you'd want to spend any time in.

BILL ENGLANDER
via e-mail

[We got many letters and e-mails on this subject. It appears that there's more than one way to do metric conversions. Although space prevents us from publishing all the letters, we would like to thank those who took the time to write, including Chuck Gauder, Roger Hamel, Horace Smith, and Felix Wolfe—Editor]

More Practical Projects

I agree with many of the points that Mr. Weitzenhoffer made in his letter in the January 2001 issue. I have subscribed to electronics magazines since getting out of the Navy after WWII. I still have the first three editions of *Popular Electronics* (Oct., Nov., and Dec. 1954). I must say I enjoyed them more than I do now.

Like other magazines, advertising takes up most of the magazine space now. And many of the circuits aren't practical home projects.

The "Amazing Science" column in

Accredited B.S. Degree in Computers or Electronics

by studying at Home

Grantham College of Engineering
offers 3 distance education programs:

- B.S.E.T. emphasis in Electronics
- B.S.E.T. emphasis in Computers
- B.S. in Computer Science

-Electronics Workbench multiSIM
included in our B.S.E.T. curriculums
-Approved by more than 500 Companies,
VA and Dantes, (tuition assistance avail.)

For your free catalog of our programs dial
1-888-919-8181 Ext. 15, or
<http://www.grantham.edu>

GCE

Your first step
to help yourself
better your future!



Grantham College of Engineering
34641 Grantham College Road
Slidell, LA 70460-6815

CIRCLE 282 ON FREE INFORMATION CARD

LynX-10

HOME AUTOMATION KIT

- Software Included
- Use Existing Wiring
- Simple Inexpensive

1-800-928-5299 www.marrickitd.com

the March 2000 issue featured a simple Geiger counter. After WWII, when prospecting for uranium was at its peak, there was a super simple Geiger counter circuit powered by a single D or C cell. I still have mine, which is packaged in a plastic sandwich box.

The circuit consisted of a 1B85 Geiger tube, a 3.5M resistor, eight .01mF ceramic high voltage capacitors in parallel, a micro switch, .002 mF capacitor, two 6-32 screws sharpened to points (to make a spark-gap rectifier), phone jack, and a small tube-radio audio-output transformer. I carried a surplus WWII aircraft switch that had the radium button in the handle to use as a source of radiation. It was used to check when I had enough voltage "clicked" up to fire the tube, at which point the frying sound was picked up in headphones. Now, that was a practical project.

RAYMOND E. VERSAW

via e-mail

Information on Vintage Radios/Test Equipment

In "Have and Needs" in the January issue, a reader is looking for information on a piece of General Radio test equipment. Very recently these manuals were available from their successor (whose name escapes me). However, the important thing is that at least two monthly magazines support vintage equipment sources in their ads (*Antique Radio Classified* and *Nuts and Volts*). There are also the vintage radio associations, such as an Antique Wireless Association, of which I have been a member for 29 years.

I have a very large library on antique/vintage radio and some on test equipment (like a General Radio service manual from the 1940s.) No one has everything, but I will respond to everyone who sends e-mail or a letter request with SASE.

GARY MICANEK

226 Henry Ave.

Manchester, MO 63011

Complete URLs Revisited

Your December 2000 issue had several letters under the heading "Complete URLs," in which the writers discuss their browser requiring <http://> to visit a Web site. I'm not aware of the older features of other browsers, but the current Microsoft IE V. 5.50 does not require the <http://> or, when using the shortcut below, any of the typical add-ons to a .com Web address.

To use the shortcut, click anywhere in the address box (so the existing address gets highlighted) and type in the site's name: yahoo, for example. Then press 'CTRL' + 'Enter' and the browser completes everything: <http://www.yahoo.com>.

Do you (or your readers) know how to do that with .ORG, .GOV, or other standard extensions? Using Alt or Shift + Enter doesn't seem to do anything.

JIM MORGAN

via e-mail

[I think we all know how the mainline browsers (Netscape and IE) fill in the <http://> for you. The www prefix and suffix auto fill-in was a more recent "feature" (after about 1996 or so, depending on the software) that some Web sites took advantage of. For example, if you wanted to visit the White House's Web site (www.whitehouse.gov) and typed "whitehouse," the 3.x and 4.x versions of certain browsers would fill in the

<http://www>. and start trying the various suffixes. Unfortunately, the .com suffix was the first one tried. Please don't try that variation if you are of a sensitive nature—it's a porno site! That's a prime example of why having software do your thinking for you is not necessarily a "good thing."

Incidentally, with all the discussion over Web browsers and auto-completion of URLs, I'm surprised that no one has mentioned Amaya, the browser that the W3C uses to test new Web technologies and HTML extensions.—Editor.]

We Get Letters

"Danger, Will Robinson, Danger!" In the December "Letters" column, Tony Patti had said "...once you hook the LAN up to the Internet, you have a huge new set of security issues. This problem should have been greatly stressed."

Ted Needleman replied, "I'm one of those poor souls who can't get a connection to the Net that runs faster than 28K at best, so I don't always think in Broadband terms. Also, because of the length constraints of these columns, I just can't cover all of the relevant bases."

This is a very dangerous misunderstanding of Internet security by Ted, and one that will mislead many of his readers who will rely on his expertise. Tony was quite correct: once you connect to the Internet, horrendous security issues arise for everyone, not just broadband users. Therefore, security should indeed always be greatly stressed as the number one issue, not only if space happens to allow!

Case in point: Three years ago I switched from an obscure method ("dip") I had used since the early 90s to connect to the Internet to the widely used standard "PPP" method of connecting to an ISPN—but still at a mere 28.8 bps connection speed.

Within a week, my home Linux system had been cracked wide open. I discovered a bad guy who was in the process of installing a suite of software to use to maintain control of MY system and to run an IRC server to use to talk to his buddies!

Thinking that Internet security is an obscure advanced topic that doesn't really apply to the average person is an attitude similar to those people you see smoking cigarettes while pumping gas. Sure, you might get lucky for a long time; but you can't count on such luck;

(Continued on page 42)

NEW GEAR

USE THE FREE INFORMATION CARD FOR FAST RESPONSE

Sumo Robot

The super warrior, *Sumo Robot*, is a beginner's robot kit that requires no soldering. Moving on its two tractor-style wheels, it can be controlled to assail and overpower its opponent or retreat to prepare for battle.



CIRCLE 60 ON FREE INFORMATION CARD

The robot emits an infrared sensor beam when detecting an opponent. Upon detection, it instructs the robot's brain to "charge," creating a bona fide wrestling match with another Sumo robot. Users can have their own mini-battle-bots competition, be the referee (gyoji), and decide who the grand champion (yokozuna) will be.

The Sumo Robot sells for \$49.95.

Hyper LineTracker

Looking like a creature from another planet, this cyber bug possesses a sonic tracking system. Requiring soldering and meant for the advanced



CIRCLE 62 ON FREE INFORMATION CARD

builder, the *Hyper Line Tracker* is equipped with a multitude of sensors. The phototransistors detect a black line; the tracking memory remembers its last track, and two red LEDs flash to show which side of the light sensor is activated.

The Tracker follows a course of your own design. Make a path with a black felt marker or black tape and watch how light sensors enable the robot's motors to make course corrections. By using a light emitter, light sensor circuitry, and tracking memory, it demonstrates how robots "see" a pathway.

The Hyper Line Tracker sells for \$59.95.



CIRCLE 63 ON FREE INFORMATION CARD

Appropriate for ages 10 and up, this informative and entertaining robot kit allows budding robot builders to explore the fundamentals of robotics. *RocKit Robot* is an intelligent robot with a touch/sound sensor. If it comes in contact with an object or hears a loud noise (such as hands clapping), RocKit Robot automatically reverses and then turns left before embarking on a new course.

Requiring only basic hand tools, the kit contains complete step-by-step instructions, a pre-assembled printed circuit board, a condenser microphone, and an easy-to-assemble mechanical drive system.

The RocKit Robot sells for \$24.95.

In keeping with the theme of this month's issue

Robotic Kits

ROBOTIKITSDIRECT COMPANY
17141 Kingsview Ave.
Carson, CA 90746
310-515-6800
www.owirobot.com

we are presenting four robotic kits for our readers to build



CIRCLE 61 ON FREE INFORMATION CARD

Spider III

Spider III is the third generation of this particular robot, offering advanced design and technology. Meant for the intermediate designer, this green and white "insect," which also does not require soldering, has a radical walking

style with three legs on each side.

This intelligent robot avoids interference by emitting a light beam and determines if there are obstacles in its path by the use of reflection. It then sends command signals in the form of electronic pulses to alter the rotating direction of its motor to evade these obstacles.

Spider III sells for \$59.95.

RocKit Robot

Software Diagnostics Tool

BREAKOUT IS A SOFTWARE SERIAL diagnostics tool that allows users to easily debug two-way serial communications. With this software, you can turn any PC or laptop with two serial ports into a serial breakout box (serial-line analyzer). You can check any data that is sent or received through a RS232 serial cable between any two devices or computers—a good way to troubleshoot your PC-controlled robot. Designed for Windows 95, 98, 2000, and NT, this program can also be used as a simple terminal to display data received on a single serial port.

Breakout shows you every character that is being sent or received over the serial line—including every binary, hex, or ASCII character. It will also count characters and allow you to analyze the structure of the data.

You can download Breakout for free from the taltech.com's Free Software page and use it on as many PCs as you want.

TAL TECHNOLOGIES, INC.

2027 Wallace St.

Philadelphia, PA 19130-3221

800-722-6004 or 215-763-7900

www.taltech.com

CIRCLE 64 ON FREE INFORMATION CARD

Single-Channel A/D Converter

THE **AK5370 16-BIT SINGLE-CHANNEL A/D Converter** combines advanced audio technology with a built-in USB interface for microphones on a single chip. All of the functions essential for a USB microphone—USB transceiver and programmable gain amplifier (with a range of +20 to -58 dB in 1 dB steps), controllable-from-the-host USB audio-class-command processing circuits, FIFO for isochronous transfer, and microphone bias control circuit, etc.—are on the chip. As a result of the high level of integration, there's no need for an external

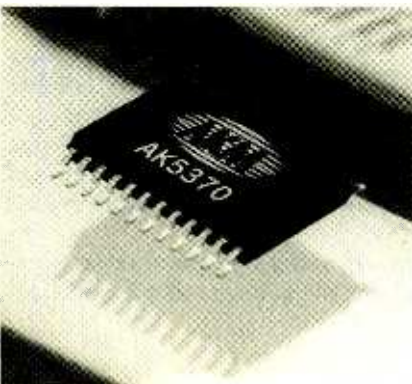

CIRCLE 65 ON FREE INFORMATION CARD

ROM or for a microprocessor, reducing the number of external components, lowering the cost, and decreasing the area required for installation. This chip could be quite useful for adding listening capability to your robot.

Other features include Mute/Volume, sampling frequency control, and ACG pin for external control; variable pre-amp; support for five sampling frequencies; bias control circuit; and operating power of 3.3 volts.

The AK5370 16-bit Single-Channel A/D Converter sells for \$14.32 in single quantities.

AKM SEMICONDUCTOR, INC.

2001 Gateway Place, Suite 650 West

San Jose, CA 95110

408-436-8580

www.akm.com

Plug-and-Play System

PROVIDING EIGHT ISOLATED AC or DC inputs and eight electromechanical relays in a single USB-compatible system, the *Switch & Sense 8* is both powerful and easy to use. The inputs monitor 24 volts AC or DC inputs, while the output relays provide 6-amp outputs at 120 volts AC or 28 volts DC. With its multiple outputs and feedback through its inputs, the device could be used to remotely control a distant robot through a PC—teleoperation.



CIRCLE 66 ON FREE INFORMATION CARD

Housed in a rugged, steel case, the system allows users to quickly add digital I/O abilities to any USB-equipped PC. With no switches or jumpers on the board, the *Switch & Sense 8* is completely plug-and-play. All software necessary to read the inputs and configure, test, and control the outputs is included.

The *Switch & Sense 8* sells for \$299.

MEASUREMENT COMPUTING

16 Commerce Blvd.

Middleboro, MA 02346

508-946-5100

www.measurementcomputing.com

Stand-Alone Sound Board

TOTALLY SELF-CONTAINED ON A 4.2- by 4.2-inch circuit board, the *DM2208A* digital sound board can play back up to 128 sound files stored in EPROM memory chips. Standard Windows .WAV files are supported. When using the 6-kHz sampling rate, up to 11 minutes of sound can be stored. One application would be to create a .WAV file on the computer, download it to the board, and use the board in your robot to make announcements.

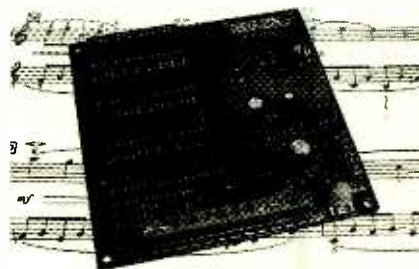

CIRCLE 67 ON FREE INFORMATION CARD

Playbacks can be activated by either contact closures or logic pulses. The built-in power amplifier can deliver 1-watt output directly into a speaker. The *DM2208A* eliminates the need for signal reprocessing.

The *DM2208A* sells for \$48 in single quantities.

ELETECH ELECTRONICS

16019 Kaplan Ave.

Industry, CA 91744

626-333-6394

www.eletech.com

Data Acquisition Module

IN A CASE ONLY SLIGHTLY LARGER than a matchbox, the *ADC-11/12* connects to the parallel port of a desktop or a laptop PC. It provides 11 channels of analog input, and it gives 1-part-in 4096 accuracy without needing a power supply.

Just load the included *Picolog* software and immediately record at 10,000 samples/second. When used with the included *Picoscope* software, the module offers all the functions of an oscilloscope

(Continued on page 66)

More advanced Robotics with Lego® Mindstorms™

by Robert Penfold
CLAGGK, Inc.
P.O. Box 12162
Hauppauge, NY 11788
631-592-6721

\$19.99 plus S&H

This book shows the reader how to extend the capabilities of the LEGO MINDSTORMS Robotic Invention System (RIS) by using LEGO's accessories and some simple home-constructed units. Vision Command is also covered, which can enable your robots to "see" and respond accordingly. Additional types of sensors are explored, including rotation, light, temperature, sound, and ultrasonic.

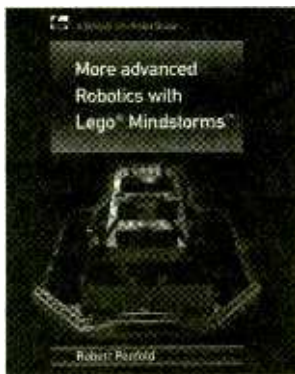

Detailed building instructions are provided for the robots, among which are rover vehicles, a virtual pet, and a robot arm. Control software for all the robots is included, together with detailed explanations of how these programs operate.

The Robot Builder's Bonanza, 2nd Edition

by Gordon McComb
McGraw-Hill
2 Penn Plaza, 12th Floor
New York, NY 10121
800-2MCGRAW
www.books.mcgraw-hill.com

\$24.95

This updated edition of our columnist Gordon McComb's popular book fea-

tures fascinating science tidbits, field-tested projects, and modular organization to make it easy for readers to invent and build their own designs. Every chapter has been revised and nine new chapters have been added. The book has everything the builder needs to get started in robotics including: where to get the parts; how much they cost; working with plastic, wood, and metal; and avoiding common mistakes.



There are over 99 experiments that can be used in different combinations to create a wide variety of robots. The author gives electronics hobbyists fully illustrated plans for 11 complete robots, as well as all new coverage of Robotix-based robots, LEGO TECHNIC-based robots, and functionoids with LEGO MINDSTORMS. Among these robots are a Minibot, Scooterbot, Roverbot, Six-Legged Walking Robot, and a Lightbot.

Dave Baum's Definitive Guide to LEGO® MINDSTORMS™

by Dave Baum
Apress
901 Grayson St., Suite 204
Berkeley, CA 94710
1-800-SPRINGER
www.apress.com

\$24.95

Inventing a robot from the ground up can be quite challenging. The author provides step-by-step instructions for building and creating an assortment of 14 sample robots. He also teaches readers how to program LEGO MINDSTORMS



robots using the system's RCX code or his own specially developed programming language Not Quite C (NQC).

The included CD-ROM contains sample programs in RCX and NQC, complete versions of several NQC-based development tools, and a preview of LEGO ROBO LAB.

Extreme Mindstorms: An Advanced Guide to LEGO® MINDSTORMS™

by Dave Baum, Michael Gasperi,
Ralph Hempel, and Luis Villa
Apress
901 Grayson St., Suite 204
Berkeley, CA 94710
1-800-SPRINGER
www.apress.com
\$29.95

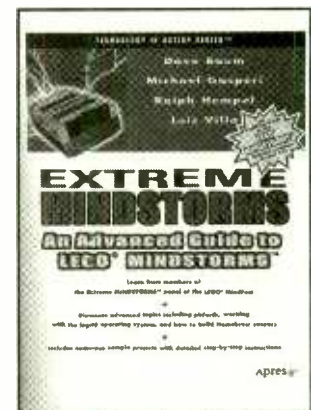

Starting with an overview of the RCX firmware and a whole chapter on the new RCX 2.0, this advanced guide con-

(Continued on page 60)

Business Buzz

IMPROVED CRANE SAFETY

VenturCom, Inc. and SK Group S.A. (Nice, France) have partnered to provide software that integrates radio, Internet, and real-time control technology to prevent crane collisions at building sites. SK Group's IP Cr@ne relies on VenturCom's RTX real-time extension for Windows NT Embedded and Windows NT/2000 to collect data on the location of other cranes or obstacles on a site, and then transmit that data in real-time via radio frequency to a PC installed within each crane. If a collision is imminent, IP Cr@ne automatically manages the motion of one or more cranes to prevent a crash. The crane-control system offers Internet connectivity, as well as live video conferencing, allowing crane operators to communicate across a site.

WE'VE GOT YOUR PRINTS

Philips Flat Display Systems (FDS) recently began volume production of a fingerprint-recognition sensor. This biometric-based security solution couples Philips FDS' flat displays with patented TactileSense technology from Who?Vision Systems, Inc. to create a thin, extremely compact sensor no larger than a postage stamp and less than 1/8-inch thick. Without the need for a light source, the TactileSense polymer generates an image of the fingerprint patterns, identifying the unique individual characteristics. The first application for the sensor will be integrated within Who?Vision's e-thenticator MS 3000 PC card to provide security for any network-connected device.

INCREASED STORAGE

Solid-State Flash Disk Modules from Simple Technology were recently introduced into the embedded mass data storage market. The miniature footprint of the Flash Disk Modules allows these products to be used as components in embedded systems, replacing or augmenting conventional IDE hard disk drives. The modules are available in 40-pin (similar in function to 2.5-inch hard disk drives), 44-pin (similar in function to 3.5-inch disk drives), and standard 144-pin SoDIMMs. Intended to plug directly into the existing IDE connector style, the modules do not require any modification to the software, and they have a capacity of up to 1 GB of storage.

Mind Over Matter

Making things move by mind power alone has long been a popular dream. It's been a staple of science fiction and fantasy in novels and on the screen. Now, researchers are beginning to make the dream into a reality.

Duke University Medical Center researchers and their colleagues have tested a neural system on monkeys that enabled the animals to use their brain signals, as detected by implanted electrodes, to control a robot arm to reach for a piece of food. The scientists even transmitted the brain signals over the Internet, remotely controlling a robot arm 600 miles away.

"It was an amazing sight to see the robot in my lab move, knowing that it was being driven by signals from a monkey brain at Duke. It was as if the monkey had a 600-mile-long virtual arm," stated Mandayam Srinivasan, director of the MIT Laboratory for Human and Machine Haptics and one of the co-authors of the paper.

Wiring the Brain

In an article in the Nov. 16, 2000, *Nature*, Miguel Nicolelis, associate professor of neurobiology, and his colleagues described how they tested their system on two owl monkeys—implanting arrays of as many as 96 electrodes, each less than the diameter of a human hair, into the monkeys' brains.

The technique they used, called "multi-neuron population recordings" was developed by co-author John Chapin, who is at the State University of New York Health Science Center, and Nicolelis. It allows large numbers of single neurons to be recorded separately, and then combines their information using a computer-coding algorithm.

In addition to Nicolelis, Srinivasan, and Chapin, other co-authors of the paper were, from Duke, Johan Wessberg, Christopher Stambaugh, Jerald Kralik, Pamela Beck, and Mark Laubach; and from MIT, Jung Kim and James Biggs.



Duke University neurobiologist Miguel Nicolelis cradles one of the two owl monkeys whose brain signals were transmitted over the Internet, remotely controlling a robot arm 600 miles away at MIT's Laboratory for Human and Machine Haptics.

The scientists' work is supported by the National Institutes of Health, National Science Foundation, Defense Advanced Research Projects Agency, and the Office of Naval Research.

The scientists implanted the electrodes in multiple regions of the brain's cortex, including the motor cortex from which movement is controlled. They then recorded the output of these electrodes as the animals learned reaching tasks, including reaching for small pieces of food.

Next, they fed the mass of neural signal data generated during many repetitions of these tasks into a computer, which analyzed the brain signals to determine whether it was possible to predict the trajectory of the monkey's hand from the signals. In this analysis,

TYPE

the scientists used simple mathematical methods to predict hand trajectories in real-time as the monkeys learned to make different types of hand movements while reaching for food.

Multiple Brain Signals

"We found two amazing things, both in earlier rat studies and in our new studies on these primates. One is that the brain signals denoting hand trajectory show up simultaneously in all the cortical areas we measured. This finding has important implications for the theory of brain coding, which holds that information about trajectory is distributed really over large territories in each of these areas—even though the information is slightly different in each area, said Nicolelis

"The second remarkable finding is that the functional unit in such processing does not seem to be a single neuron," Nicolelis added. "Even the best single-neuron predictor in our samples still could not perform as well as an analysis of a population of neurons. So, this provides further support to the idea that the brain very likely relies on huge populations of neurons distributed across many areas in a dynamic way to encode behavior.

"This system also offers a new paradigm to study basic questions of how the brain encodes information. For example, now that we've used brain signals to control an artificial arm, we can progress to experiments in which we change the properties of the arm or provide visual or tactile feedback to the animal, and explore how the brain adapts to it. Understanding such adaptation will allow us to make inferences about how the brain normally encodes information."

Computer Control

Once the scientists demonstrated that the computer analysis could reliably predict hand trajectory from brain signal patterns, they then used the brain signals from the monkeys—as processed by the computer—to allow the animals to control a robot arm moving in three dimen-

sions. They even tested whether the signals could be transmitted over a standard Internet connection, controlling a similar arm in MIT's Laboratory for Human and Machine Haptics—informally known as the Touch Lab [<http://touchlab.mit.edu/>].

Srinivasan of MIT said, "When we initially conceived the idea of using monkey brain signals to control a distant robot across the Internet, we were not sure how variable delays in signal transmission would affect the outcome. Even with a standard TCP/IP connection, it worked out beautifully."

Today, Feedback Studies

"One most provocative, and controversial, question is whether the brain can actually incorporate a machine as part of its representation of the body," Nicolelis said. "I truly believe that it is possible. The brain is continuously learning and adapting, and previous studies have shown that the body representation in the brain is dynamic. So, if you created a closed feedback loop in which the brain controls a device and the device provides feedback to the brain, I would predict that as people or animals learn to use the device, their brains will basically dedicate neuronal space to represent that device."



Arrays of as many as 96 electrodes, each less than the diameter of a human hair, were implanted into multiple regions of the owl monkey's brain's cortex, including the motor cortex from which movement is controlled. The scientists then recorded the output of these electrodes as the animals learned reaching tasks, including reaching for small pieces of food.

Research Notes

PREDICTING THE WEATHER

An experimental forecasting method called the Super Ensemble, developed by Florida State University (FSU) meteorologist—Professor T.N. Krishnamurti, shows great potential to accurately predict the path of hurricanes and other weather phenomena. Krishnamurti and his team of researchers at the FSU Real Time Hurricane Forecast Center use up to 17 tropical forecasts from around the world, supplying the data to a supercomputer similar to IBM's master chess player, Deep Blue. The computer weeds out errors in each forecast and produces a more accurate one- to six-day hurricane track and intensity forecast. The researchers worked on experimental real-time Atlantic hurricane prediction, including Hurricanes Dennis, Floyd, and Irene and were able to predict the storms' paths very accurately.

SKELETONS ON THE WEB

A new teaching tool providing a three-dimensional view of the human skeleton is available to students and the public at a Web site called www.eSkeletons.org, according to Dr. John Kappelman, a University of Texas at Austin anthropology professor. Kappelman's lab group used a combination of three-dimensional laser scanners, high-resolution X-ray computed tomography, and digital photography to capture information about each skeletal element. One of the newest technological advances on the Web site is the ability to print out 3-D files of each skeletal element as full-sized or even scaled-down replicas of the original. Future plans for the site involve adding skeletons of the chimpanzee, gorilla, and orangutan.

ULTRA-CLEAN ICs

Integrated circuits (ICs) must be ultra-clean to function properly. Now, a Georgia Institute of Technology professor has devised a new IC cleaning technique that eliminates the drying step, streamlining the fabrication process and making it more environmentally friendly. In research funded by the National Science Foundation and Los Alamos National Laboratory, Dr. Dennis Hess, a professor in the School of Chemical Engineering and an investigator at the Microelectronics Research Center, is experimenting with a liquid-phase cleaning that can be combined with vacuum processes. The technique shows promise, but needs testing in the actual manufacturing process.

Nicolelis and his colleagues will soon begin such "closed-loop" experiments, in which movement of the robot arm generates tactile feedback signals in the form of pressure on the animals' skin. Also, they are providing visual feedback by allowing the animal to watch the movement of the arm.

"If such incorporation of artificial devices works, it would quite likely be possible to augment our bodies in virtual space in ways that we never thought possible," Nicolelis said.

Tomorrow, Bionic People?

Besides experimenting with such feedback systems, Nicolelis and his colleagues are planning to increase the number of implanted electrodes, with the aim of achieving 1000-electrode arrays. They are also developing a "neurochip" that will greatly reduce the size of the circuitry required for sampling and analysis of brain signals.

According to the researchers, their recording and analysis system, in which the electrodes remained implanted for two years in one animal, could form the basis for a brain-machine interface that would allow paralyzed patients to control the movement of prosthetic limbs. In addition, the system's reliability and the long-term viability of the electrodes provide a paradigm that could eventually help paralyzed limbs to move.

"We envision that this neurochip can become an essential component of the type of hybrid-brain-machine interfaces that may one day be used to restore motor function in paralyzed patients," said Nicolelis. "These activities will serve as the backbone of a new Center for Neural Analysis and Engineering currently being created at Duke." **PT**

"Snakes" in Space

NASA engineers are developing an intelligent robot snake that may help explore other worlds and perform construction tasks in space. Able to go where no humans can venture, the robot serpent is smart enough to slither into cracks in a planet's surface, is capable of planning routes over or around obstacles, and has the ability to independently dig in loose extraterrestrial soil. The "snakebot" could be ready for space



This simple snakebot is made up of identical hinge-like modules, attached together in a chain. The test snake has a wire that carries communications and power to and from the computer brain, and it has off-the-shelf hobby motors in its hinged segments that cause it to move.

travel in five years.

Robotic serpents can "inchworm" ahead, can flip themselves backward over low obstacles, can coil, and can side-wind. "The snake will provide us with flexibility and robustness in space," said Gary Haith, lead "snakebot" engineer at NASA's Ames Research Center. "A snakebot could navigate over rough, steep terrain where a wheeled robotic rover would likely get stuck or topple."

According to Haith, the engineers constructed a simple mechanical test snake in less than a day thanks to previous work at other labs. It was made up of identical hinge-like modules, attached together in a chain.

"It is a direct model of a 'polybot' developed by Mark Yim of Xerox Palo Alto Research Center, Palo Alto, CA, with whom we are cooperating. We have slightly different electronics in our version," he said.

"The test snake has a wire that carries communications and power to and from the computer brain," Haith explained. "It has off-the-shelf hobby motors in its hinged segments that cause it to move. Each of the many motors takes a signal from the snake's main computer brain.

"The problem is it's hard to tell the snakebot what to do. It is a complex robot that must operate independently, possibly far from Earth. Work on our second snakebot is aimed at making it capable of independent behavior.

"The key part of what we are striving for in the second snakebot version and beyond is sensor-based control in which the robot uses its sensors to decide what

to do, Haith said.

"We made two little microcontrollers, tiny computers, that we put in each hinged section that also includes a motor, electronics, and gears to get the hinge to move to certain positions," he explained. The snakebot will have a main computer that will tell its little computers in each segment what to do in a higher, planning sense. The tiny computers in the segments could provide "reflexes" that take care of simple, but important jobs.

As development continues, the NASA engineers hope to simulate the snakebot in a computer program to develop computer routines that can control the robot. In addition, engineers have added strain sensors to the robot on metal ribs inside the snake. These sensors will let the snake know whether or not it is contacting anything, and where and how hard it is touching.



Gary Haith, lead "snakebot" engineer at NASA's Ames Research Center, examines the snakebot. Two little microcontrollers, tiny computers, were put in each hinged section that also included a motor, electronics, and gears to get the hinge to move to certain positions.

"We hope to write software that allows the snake to learn on its own by experience," Haith said. "Some lessons we hope it will learn are how to crawl from soft to hard surfaces, and how to go over rough surfaces that have rocks. We even hope to show that it can climb scaffolds and go into cracks. These abilities would help the robot look for fossils or water on another planet," he added.

The snakebot can save spacecraft weight because the snake-like design

enables the robot to do many tasks without much extra equipment. "Future work will enable the snake to become a mast or a grasping arm. A rover would need to have a dedicated mast and arm that would cost extra weight, money, and time."

Another advantage of the snake-based design is that the robot is field-repairable. There can be a bunch of identical spare modules included with the snake on a space mission, which would make fixing the snakebot much easier than a regular robot that needs specific parts.

"Other benefits," said Haith "are that the snakebot can crawl off a spacecraft lander and doesn't need a ramp; and the snake's moving parts can be sealed inside artificial skin to avoid exposure to the outside environment and the robot can still function, even if one joint freezes.

"In coming years, we hope to make snakebot muscles out of artificial plastic or rubber materials that will bend when electricity is applied to them," he added. "This design change will reduce the snake's weight considerably, and the robot would be very robust, like an automobile tire." **PT**

Face-To-Face Communication

At the New York World's Fair in 1965, videophones were presented to the public. The novelty of seeing the person you were talking to caused a great sensation. In the intervening years, however, such phones have not become the commercial success expected. Apparently, people preferred to be heard and not seen.

There are markets where video telephony products have made inroads, such as in video teleconferencing. Motion Media Technology, a British company, is among the leaders in this field. Recently, they announced their participation in two pilot videophone projects, one for personal communication and the other for healthcare use.

British Telecom (BT) will place Motion Media's mm225 videophone in about 120 homes where there are families with young children. Each family will be loaned up to three videophones allowing, for example, grandparents who live too far away to visit regularly with

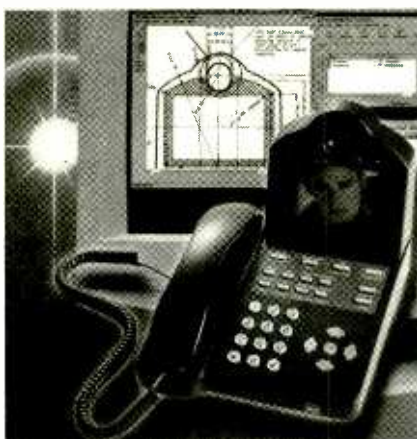

Motion Media's mm225 videophone provides excellent picture clarity and a small footprint. It is being used in two pilot projects in Great Britain.

their grandchildren. BT will monitor use of the videophones over an 18-month period. If the trial proves successful, BT will make the videophones generally available to the consumer.

"Video communications is now in regular use for business communications by companies throughout the world," said Mike Kiely, Marketing Manager at BT. "There is no reason, if the price is attractive, not to replicate this in the consumer market. The objective of the trial is to prove there is a need, measure the impact on calling patterns, and show how a network effect can be created."

The mm225 provides a footprint no larger than a standard office telephone. It provides picture clarity and frame rates fast enough to keep up with sign language for the hearing-impaired. The videophone connects to ISDN phone lines and combines the two leading international communication standards—H.320 and H.324—into a single, easy-to-use videophone.

The other project involves Motion Media's participation in a four-company consortium that combines telecare with telemedicine to provide elderly residents in Scotland with the chance to lead more independent lives. The \$1.5 million telehealth project in West Lothian, Scotland combines a compact desktop videophone with a remote surveillance unit. The equipment is installed in selected local houses of caregivers. Support staff can then monitor residents and can provide face-to-face advice and reassurance. **PT**

How Old Are You, Really?

Using a new dating method to determine the age of polar ice, Steven Goldstein, Michael Murrell, and Andrew Nunn of the DOE's Los Alamos National Laboratory Chemical Science and Technology Division have refined previous age estimates for ice samples taken from Antarctica, suggesting a far younger age for the ice.

The radiometric dating method uses mass spectrometry to make extremely sensitive measurements of minute amounts of uranium-series elements naturally present in ancient polar ice. This method compares concentrations of daughter uranium-series isotopes (uranium, radium, thorium, and protactinium) to parent isotopes in the sample. The quantities of natural radioactive elements researchers measure are in the femtogram scale (one quadrillionth of a gram).

Previous methods used were band counting and carbon-14 methods. According to Goldstein, "While both methods are fairly accurate, each has limitations. Band counting can't really account for any missing sections in the ice column, and carbon-14 is generally useful for dating back only about 40,000 years. Our method could be more widely applied on counting banding and works on a time scale well beyond that of carbon-14 dating."

The ice sampling research took place at Allan Hills, a 12-mile long group of hills located near McMurdo Station along the coast of the Ross Sea in Antarctica. Earlier published data placing the age of the ice at Allan Hills at roughly 325,000 years was based on measurements made using alpha spectrometry. Los Alamos researchers estimate that the actual age is probably less than 100,000 years.

Goldstein and his colleagues are quick to point out, however, that more samples and studies are needed to substantiate their "ice-age" determination at Allan Hills. In addition, further research is being carried out with samples from the Summit region of central Greenland. **PT**

A Hands-on Electronics REPORT

Parallax, Inc.'s BOEBot

Built from Parallax, Inc.'s Robotics Kit, the *BOEBot* (\$199) is an educational prototype. Constructing the robot helps to both explain and demonstrate the fundamental principles of robotics. The completed robot is barely the size of a VHS cassette and weighs in at two pounds. The *BOEBot* moves about on a three-wheel system. Two wheels are plastic discs attached directly to servos. A small plastic ball serves as a non-powered tail wheel.

The BOEBot Package. The "BOE" in *BOEBot* is an acronym for Board of Education—a motherboard designed by Parallax for use with the Parallax Basic Stamp II. BASIC Stamp II modules have been (and still are) in use all over the world by experimenters, hobbyists, and industry. The Basic Stamp II is a miniature circuit board shaped to look and act like a computer-on-a-chip. Designed to plug into a 24-pin IC socket, the BASIC Stamp II contains a PIC chip pre-programmed with a BASIC-language adapter and support circuitry.

Both the Board of Education and the Basic Stamp II come with the *BOEBot* kit. Together, these two items can be used for a multitude of experiments set forth in Parallax Inc.'s *Stamps in Class* curriculum. *Stamps in Class* is an excellent program developed by Parallax that offers to schools around the globe free (that's right, I said *free!*) projects (including full Basic Stamp kits) covering the various concepts of electronics. You can visit www.stampsinclass.com for more information. Of course, you don't have to be affiliated with a school in order to purchase the kit from Parallax, Inc.'s Web site.

You'll also need a PC in order to program the BASIC Stamp. A parallel cable is included in the kit for

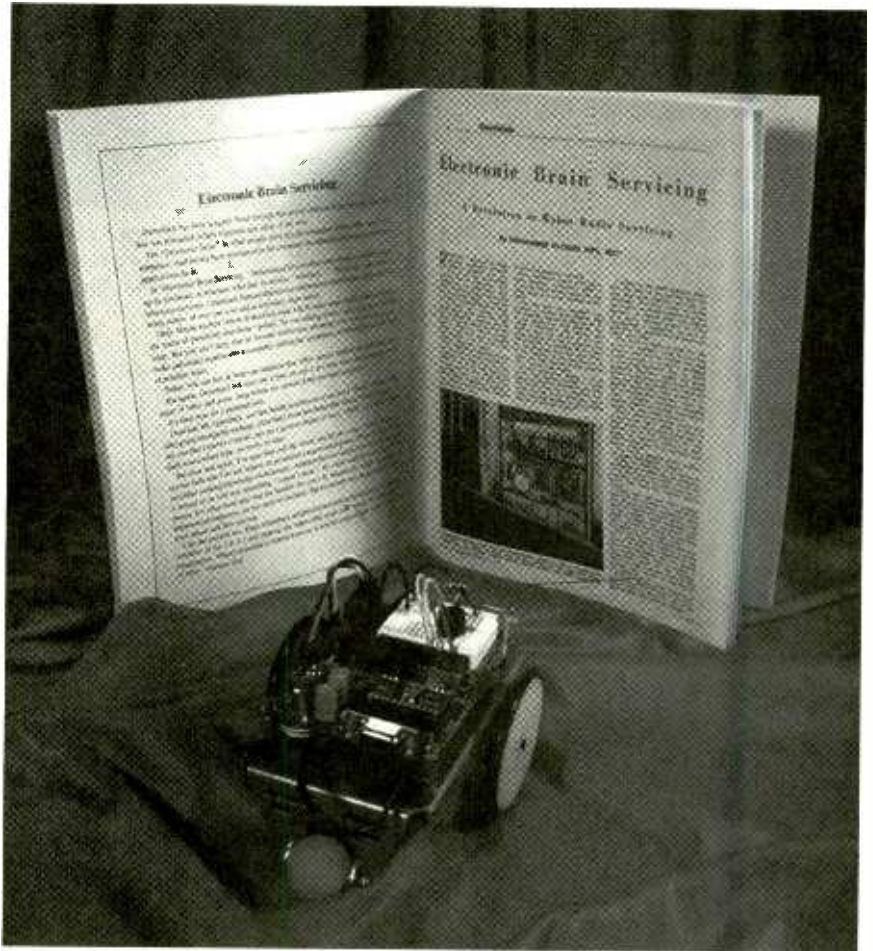

A BOEBot relaxes with a fine read in between performances. Parallax Inc.'s BOEBot can be completed and ready for experimentation in well under three hours.

data transfer between the PC and the Board of Education. The programming code is written in PBASIC, a dialect of BASIC developed by Parallax for the capabilities and features designed into BASIC Stamps. The PBASIC editor comes on the CD-ROM included with the kit and can also be downloaded for free at www.parallaxinc.com.

The *Robotics* curriculum includes a student workbook that is divided into six chapters. Each chapter carries the reader swiftly and logically through the processes of construc-

tion and programming of the *BOEBot*. Every chapter ends with practical uses of robotics, quiz questions to test comprehension of the various subject matter introduced in the text, and suggested projects that challenge the reader to embellish what they have just learned. Overall, the entire text was an easy read.

Construction. Building the *BOEBot* proved to be quite easy and rather fun—I had the robot up and running in less than one hour—thanks

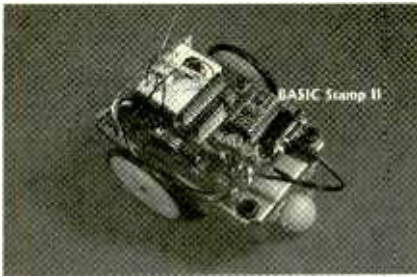

This is a close-up view of the Board of Education as it sits atop the BOEBot chassis.

to the well-written text and generous helpings of photographs, diagrams, and schematics. The first chapter's goal is to assemble the robot and calibrate the servos. Some tools (such as a #0 Phillips screwdriver and a nail clipper) were needed for certain tasks, but were not included with the kit. Each servo had to be modified in such a way as to allow for both clockwise and counterclockwise continuous motion. The "mod" requires the reader to actually take apart the servo, remove a movement restrictor, and reassemble the servo. This simple construction task immediately plunges you into the mechanics involved in creating a robot.

I only had one problem when constructing my particular BOEBot. One of the servo ports on my Board of Education was slightly blocking the path of a standoff that had to pass through the board and attach to the bottom standoff. The column-like structure formed by the two standoffs holds a "touch whisker" in place. I eventually managed to screw the standoffs together, although the upper standoff is a bit bent. Please note that Parallax will gladly repair or replace any defective product; I just did not have the time to call. After you complete the steps in Chapter One, the BOEBot is ready to program.

Circuits and Programming. The other five chapters all involve programming and simple circuit design. New concepts are introduced and explained throughout the workbook. The text successfully shows how robotics blends mechanical, electronic, and computer theories together in order to produce a somewhat intelligent machine.

Each circuit is built on the breadboard located on the Board of

Education. The various semiconductors and wires needed are included with the kit. Every circuit is shown both as a schematic and as visual wiring diagram. This simple learning technique helps with the interpretation of schematics, because the reader can see the schematics side by side with a representation of what the circuit actually looks like. Some examples of the circuits that are shown in the text include a piezo-driven low-battery indicator, touch sensors that are composed of a couple of resistors and metal

"whiskers," and an infrared transmitter/detector for navigating. The circuits, along with programming code, allow the BOEBot to interact with its environment.

Programming is introduced on a simple scale. The reader is taken by the hand and led through each listing. Every step of every program is explained in detail. I found myself growing proficient in PBASIC quite quickly. Soon I was able to substitute and embellish the listings offered by the text. The reader
(Continued on page 66)

Frustration? No, thanks. Fun? Yes, please.



Satisfied customers - the key to our success

- ▶ that's why every new EAGLE version is based on the feedback from our customers
- ▶ that's why all our customers have access to our highly acclaimed, comprehensive support, free of charge
- ▶ that's why EAGLE has no hidden costs for libraries or modules which prove to be indispensable after purchasing
- ▶ that's why we really want customers to enjoy working with EAGLE
- ▶ that's why EAGLE is one of the top-rated programs for schematic capture and board layout

EAGLE 4.0

Schematic Capture • Board Layout
Autorouter

Windows

Linux

Windows is a registered trademark of Microsoft Corporation
Linux is a registered trademark of Linus Torvalds

Version 4.0 Highlights

- New Library Management with Component Browser
- Technology and Package variants for components
- Design your own commands via User Language
- Unlimited length for component names/values
- Design Rules define pad/via dimensions and shapes
- Net Classes for Autorouter and DRC
- Minimum Autorouter grid: 0.02 mm
- SMD pads can be rounded or round
- Different pad shapes for Top, Bottom, or Inner layers

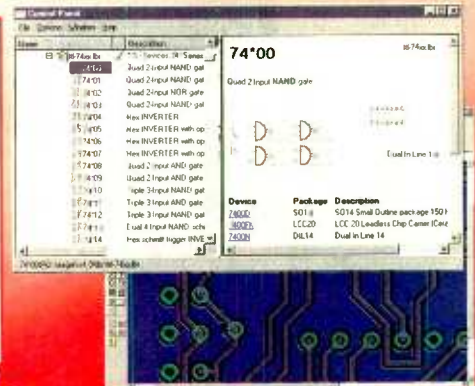

EAGLE 4.0 Light is Freeware!

You can use EAGLE Light for testing and for non-commercial applications without charge. The Freeware Version is restricted to boards up to half Eurocard format, with a maximum of two signal layers and one schematic sheet. All other features correspond to those of the Professional Version. Download it from our Internet Site or order our free CD.

The Standard Version is suitable for boards in Eurocard format with up to 4 signal layers. The Professional Version has no such limitations.

<http://www.CadSoftUSA.com>

800-858-8355

CadSoft Computer, Inc., 801 S. Federal Highway, Delray Beach, FL 33483
Hotline (561) 274-8355, Fax (561) 274-8218, E-Mail: info@cadsoftusa.com

Prices	Light	Standard	Professional
Layout		199\$	399\$
Layout + Schematic		398\$	798\$
Layout + Autorouter		398\$	798\$
Layout + Schematic + Autorouter	49\$	597\$	1197\$

Pay the difference for Upgrades

CIRCLE 283 ON FREE INFORMATION CARD

CD ROM based resources for learning and designing



The internationally renowned series of CD ROMs from Matrix Multimedia has been designed to both improve your circuit design skills and to also provide you with sets of tools to actually help you design the circuits themselves.

Electronic Circuits and Components provides an introduction to the principles and application of the most common types of electronic components and how they are used to form complete circuits. Sections on the disc include: fundamental electronic theory, active components, passive components, analogue circuits and digital circuits.

The **Parts Gallery** has been designed to overcome the problem of component and symbol recognition. The CD will help students to recognize common electronic components and their corresponding symbols in circuit diagrams. Quizzes are included.

Digital Electronics details the principles and practice of digital electronics, including logic gates, combinational and sequential logic circuits, clocks, counters, shift registers, and displays. The CD ROM also provides an introduction to microprocessor based systems.

Analog Electronics is a complete learning resource for this most difficult subject. The CD ROM includes the usual wealth of virtual laboratories as well as an electronic circuit simulator with over 50 pre-designed analog circuits which gives you the ultimate learning tool. The CD provides comprehensive coverage of analog fundamentals, transistor circuit design, op-amps, filters, oscillators, and other analog systems.

Electronic Projects is just that: a series of ten projects for students to build with all support information. The CD is designed to provide a set of projects which will complement students' work on the other 3 CDs in the Electronics Education Series. Each project on the CD is supplied with schematic diagrams, circuit and PCB layout files, component lists and comprehensive circuit explanations.

PICtutor and **C for PICmicro** microcontrollers both contain complete sets of tutorials for programming the PICmicro series of microcontrollers in assembly language and C respectively. Both CD ROMs contain programs that allow you to convert your code into hex and then download it (via printer port) into a PIC16F84. The accompanying development board provides an unrivaled platform for learning about PIC microcontrollers and for further development work.

Digital Works is a highly interactive scalable digital logic simulator designed to allow electronics and computer science students to build complex digital logic circuits incorporating circuit macros, 4000 and 74 series logic.

CADPACK includes software for schematic capture, circuit simulation, and PCB design and is capable of producing industrial quality schematics and circuit board layouts. **CADPACK** includes unique circuit design and animation/simulation that will help your students understand the basic operation of many circuits.

Analog Filters is a complete course in filter design and synthesis and contains expert systems to assist in designing active and passive filters.

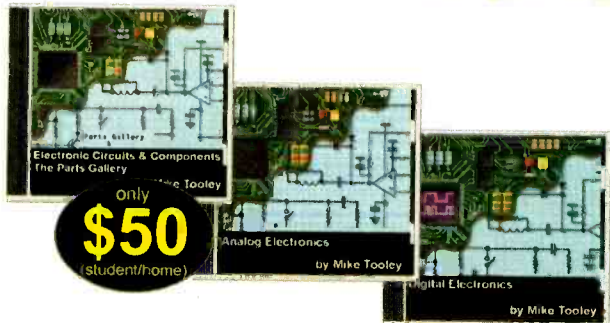

Only
\$50
(student/home)

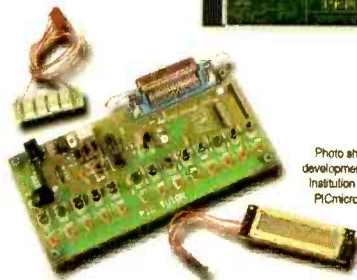

Photo shows PICmicro development kit supplied with Institution versions of C for PICmicro and PICtutor

Shareware/demo CD ROM with more than 20 programs \$4.99 refundable with any purchase.

Order Form:

Please circle the products you would like to buy on the table below, calculate the total cost, fill in the rest of the order form and send it to us. NY residents add sales tax. Please allow 6 weeks for delivery.

	Student	Institution
Electronic Cts. & Comps.	\$50	\$99
Digital Electronics	\$50	\$99
Analog Electronics	\$50	\$99
Electronic Projects	\$75	\$159
PICtutor	\$179	\$350
C for PICmicros	\$179	\$350
Digital Works	\$50	\$99
CADPACK	\$75	\$159
Analog Filters	\$75	\$159
Postage - USA	\$5	\$5
Postage - Canada	\$5	\$5

Name: _____

Phone your order to us on:

Address: _____

631-592-6721

or send your order to:

Zip: _____ Phone: _____

CLAGGK Inc.
PO Box 12162
Hauppauge, NY 11788

Card Type: _____
Mastercard, Visa, or Discover only

Expire date:

Card number:

I have enclosed my check for \$: _____

Signature: _____

Please charge my credit card for \$: _____

CL02

Order online NOW from: www.poptronics.com

GIZMO®

High-Tech Pets

Dog lovers come in two types: purebred aficionados and those who choose (whether for financial reasons or from personal preference) mutts. There are similar distinctions in the world of canine robotics. Those with a taste for ultra-high-tech gizmos, and the deep pockets to indulge it, might choose Sony's *Aibo* (model ERS-210). The second-generation robotic dog carries a \$1500 price tag (a significant reduction from its predecessor's \$2500 tag). Those who don't require AKC credentials for their real-life pets, or the cachet of the Sony label for their consumer electronics, might be more comfortable shelling out \$99 for *Rocket the Wonder Dog*, Fisher-Price's entry into the robotic-dog market.

When you first take Aibo home, "he" is like a newborn puppy, unable to stand or move on his own.

Once you begin training him, Aibo wobbles along on shaky legs, curiously examining everything around him as he starts learning. Tap a pressure-sensitive plate on top of his head when he does something wrong, or praise him by stroking his head with a steady pressure. As he "grows up," his puppyish behavior and movements change—becoming more like those of a mature dog, complete with barking, "singing" and dancing, and shaking hands. He'll chase the pink ball that's included with the robo-pet (which he can see thanks to a camera built into his nose). Aibo also has heat, touch, acceleration, and speed sensors and an infrared range finder. His 18 joints can produce a total of 250 different movements, resulting in



extremely life-like behavior.

Aibo responds to commands delivered via remote control. But if you really want to interact fully with him, some additional purchases are required. Optional Life Autonomous Application software gives Aibo voice-recognition, voice-imitation, and photo-taking capabilities. A mature unit can recognize about 50 simple words—including his own personalized name—to which he'll respond with a special electronic sound.

Rocket the Wonder Dog might not have such sophisticated electronics under his metal skin or come with a fancy birth certificate like Aibo does. But he'll come when he's called, beg for treats, and even stand on his head. He's absolutely loyal, loves to play, has big expressive eyes, and barks when he wants attention. And Rocket never chews up slippers or books, has "accidents" in the house, needs to be walked, or gets fleas.



Using Rocket's built-in voice-recognition technology, a child can imprint his voice by speaking into the Personal Puppy Trainer Headset. (Preschoolers can skip the verbal training and use simple button activation instead.) Advanced robotic technology was used to imbue Rocket with life-like behaviors and facial features that move to simulate emotions. Rocket gets excited about treats, whines and grovels when he's scolded, and "takes a nap" when no one plays with him for awhile. Like a real puppy, he has a mind of his

own, so you can never be quite sure what he'll do next.

Sony Electronics Inc., One Sony Drive, Park Ridge, NJ 07656; 888-917-7669; www.aibo.com.

CIRCLE 50 ON FREE INFORMATION CARD

Fisher-Price, Inc., 636 Girard Ave., East Aurora, NY 14052; 716-687-3000; www.fisher-price.com.

CIRCLE 51 ON FREE INFORMATION CARD





Cyber Action

Prefer to take a more hands-on approach to robotics? K'NEX Industries' *Ultra CyberK'NEX* (\$129.99) allows you to build five different Cyber creations. Then you can bring them to life and control their actions as they speak, growl, hurl missiles—in short, obey your every command.

Aimed at kids aged ten and older, the set contains all the building pieces and special Cyber components required to build a variety of cool characters. A Cyber Key brings each model to life. Once animated, it will demonstrate its own distinct personality with voice, sound effects, and actions. It also reacts

to stimuli such as sound, impact, and an infrared signal. Although the Cyber Key interface doesn't require a PC, the Ultra CyberK'NEX kit includes an Internet interface that allows you to download new personalities from the K'NEX Web site.

The five included robot designs are canine-like *Woof*, droid-style *Mectron*, *Drax* the dragon, a planet-defending vehicle called *Zap*, and the tank-like *Sarge*. The brightly colored Cyber Controller can be used to activate specific actions and set the model in "guard mode." *Mectron*, for instance, will sit quietly when the lights are off when he's in guard mode. But if someone crosses in front of him or turns on the lights, he will call out "Intruder!" and then lift his chest plate and fire foam missiles. The controller can also be used to record special routines and store them on a Programmable Cyber Key. When that key is inserted, the robot will perform those behaviors upon command. Insert the Programmable Cyber Key into the programming port, connect its cable to the parallel port of a PC, and download new personalities from the Internet.

K'NEX Industries, Inc., 2990 Bergey Road, Hatfield, PA 19440-0700; 215-997-7722; www.cyberknex.com.

CIRCLE 52 ON FREE INFORMATION CARD

Kitty Capers

Feline fanciers needn't feel left out of the robotic pet craze. Tiger Electronics offers *Meow-Chi* (\$24.99), a playful interactive cat. Just don't expect a cat's typical aloofness. *Meow-Chi* will turn his body and head from side to side, move his "arms" up and down, and shake his tail back and forth. He responds to light, sound, and touch; and he loves to dance and chase after his favorite mouse play toy (included).

According to Tiger, *Meow-Chi* uses advanced bio-rhythmic technology to create realistic emotional responses that change as you play with him. His expressive eyes mirror his feelings, letting you know if the cat is happy, sad, or angry (without any clawed up furniture). The more you interact with him, the happier he is—and he'll let you know it by singing to you. *Meow-Chi* also likes to play with other Tiger Robo-Chi pets, particularly *Poo-Chi*.

Tiger Electronics, Ltd., 980 Woodlands Parkway, Vernon Hills, IL 60061; 847-913-8100; www.tigertoys.com.



CIRCLE 53 ON FREE INFORMATION CARD

Baby Bot

No need to wait until your kids are in middle school to get them started in robotics. LEGO System's *MyBot* (\$49.99) allows children as young as 4 to get into the action.

MyBot is a cockpit-shaped microcomputer that features technology developed in consultation with the Massachusetts Institute of Technology. Children can design and build one of three interactive creations around the microcomputer and then "program" it by attaching a combination of "smart bricks" to bring their creation to life. Depending on the activity and identity bricks selected, each creation—an airplane, a racecar, or a robot—will exhibit its own distinctive behavior patterns.

For example, sound effects vary depending upon how the model is moved, so that the plane's engine whirrs when the plane climbs upward. Add an alarm brick, and the *MyBot* will sound an alarm if someone else (that pesky younger sibling, perhaps?) picks it up. An interactive LCD screen changes with different identity blocks and different movements. The action-and-reaction play encouraged by *MyBot* is an integral part of the creative learning process. The set is compatible with all LEGO DUPLO products.

LEGO Systems, Inc., 555 Taylor Road, Enfield, CT 06082; 860-762-6731; www.lego.com.

CIRCLE 54 ON FREE INFORMATION CARD



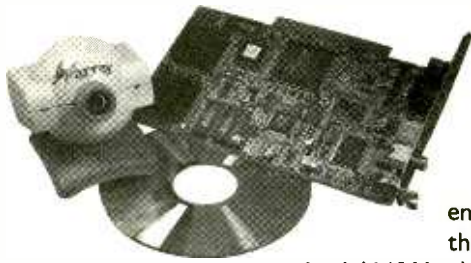

Video-Conferencing Hardware

A low-cost, PC-based video-conferencing solution, *Conferencer* (\$499) meets the video- and audio-quality requirements

for LAN/Wan business use. This PCI card, which comes with all the necessary hardware and software including camera and microphone, serves as a hardware accelerator for Microsoft's *NetMeetings* software. Simply install the Conferencer PCI card in a PC, load the software, and connect the camera for seamless, business-quality video conferencing.

Array Microsystems; 800-741-4461 or 408-399-1505; www.array.com.

CIRCLE 55 ON FREE INFORMATION CARD

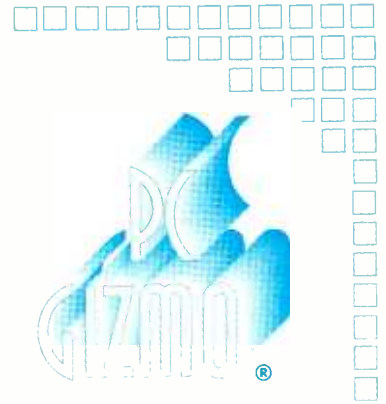

Personal Organizer Software

Take charge of your life with *RedBox Organizer 4.0* (\$39.95) from inKline Global, Inc. It has a complete suite of simple-to-use tools from a Calendar to Expenses Tracking with a highly customizable and intuitive 3-D interface. The program can quick launch your e-mails, browser, Web addresses, or other programs; and it has a phone dialer as well.



inKline Global, Inc.; 775-747-5730; www.inklineglobal.com.

The Incredible E-Mailer

Say goodbye to e-mail attachments with the help of Tool Factory, Inc.'s *The Incredible E-Mailer* (\$59.95). This amazing application works in tandem with your existing e-mail program.



Designed with the computer novice in mind, the program allows users to simply drag and drop images directly into their e-mail messages while avoiding the complications attributed to working with file attachments. Whole collages of text, drawings, and

pictures can be created within your messages and sent via your existing e-mail program.

Tool Factory, Inc.; 802-366-8253; www.toolfactory.com.

Portable MP3 Player

Weighing in at barely three ounces, *AIWA MM-VX200* (\$299) is destined to find a home in the pockets of audiophiles throughout the land. Facing stiff competition from the likes of Diamond Multimedia, AIWA has packaged their gadget with the latest features—USB port, Smart-



Media card slot, and a version of *RealJukebox* for converting MP3 files on the go.

AIWA America, Inc.; 201-512-3600; www.aiwa.com.

Supersize It!

Viewing small text on high-resolution monitors is the primary cause of computer eye-strain. Operating like a virtual magnifying glass, *BigShot Magnifier* (\$99) provides full-screen magnification for all computer users. With just one click, the software increases the size of all visible elements, providing 20 adjustable levels of enlargement from 105%

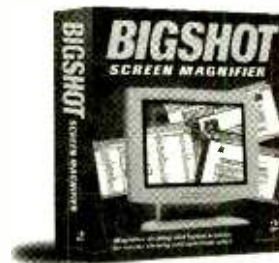

to 200%.

Ai Squared; 800-859-0270 or 802-362-3612; www.aisquared.com.

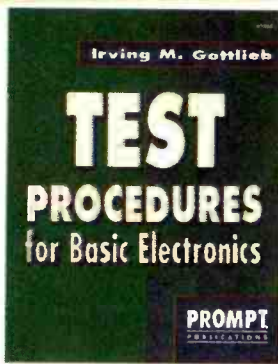

Test Procedures for Basic Electronics. #61063. — \$19.95
Many useful tests and measurements are covered. They are reinforced by the appropriate basic principles. Examples of test and measurement setups are given to make concepts more practical. 7 3/8 x 9 1/4", 356 pp, paperback.

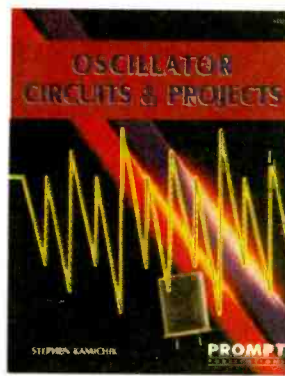

Oscillator Circuits and Projects. #61111. — \$24.95
A Textbook and project book for those who want to know more about oscillator circuits. You can build and enjoy the informative and entertaining projects detailed in this book. Complete information is presented in an easy-to-follow manner. 7 3/8 x 9 1/4", 249 pp, paperback.

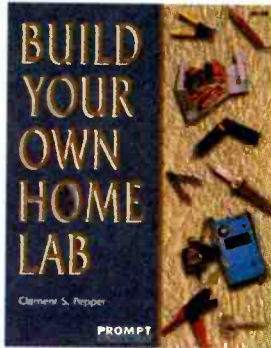

Build Your Own Home Lab. #61108 — \$29.95
Shows you how to assemble an efficient working home lab, and how to make it pay its own way. Includes projects for creating your own test instruments too. 7 3/8 x 9 1/4", 249 pp, paperback.

Troubleshooting and Repair Guide to TV. #61146. — \$34.95
Repairing and troubleshooting a TV is very simple and economical with help from the information in this book. It is the most complete and up-to-date TV repair book available, with tips on how to handle the newest circuits. 8 1/2 x 11", 263 pp, paperback.

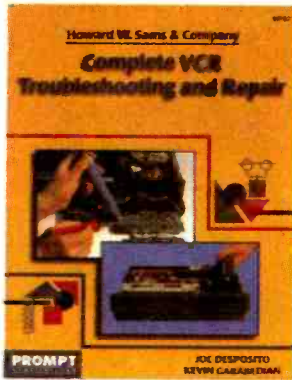
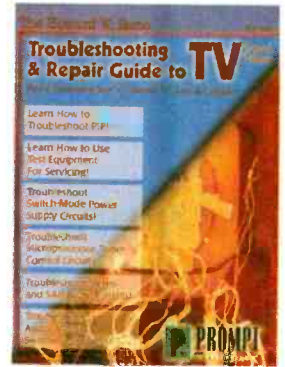

Complete VCR Troubleshooting and Repair. #61102. — \$34.95
Though VCRs are complex, you don't need complex tools or test equipment to repair them. This book contains sound troubleshooting procedures that guide you through every task. 8 1/2 x 11", 184 pp, paperback.

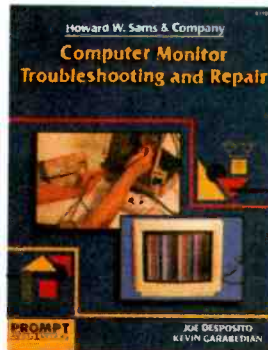

Computer Monitor Troubleshooting and Repair. #61100. — \$34.95
This book can save you the money and hassle of computer monitor repair by showing you how to fix it yourself. Tools, test instruments, how to find and solve problems are all detailed. 8 1/2 x 11", 308 pp, paperback.

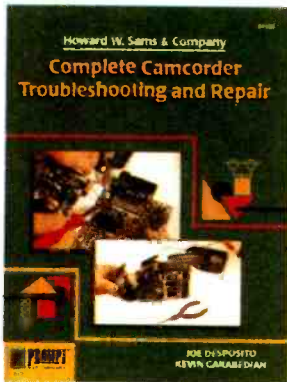

Complete Camcorder Troubleshooting and Repair. #61105. — \$34.95
Learn everything you need to know about the upkeep and repair of video camcorders. Start by examining camcorder troubleshooting procedures, then move into more advanced repair techniques. 8 1/2 x 11", 208 pp, paperback

Joe Carr's Circuit Toolkit. #61181. — \$29.95
Easy-to-build, useful circuits from Carr's workbench to you. They will spark new ideas in your day-to-day use of circuits and help solve frustrating problems. 256 pp, paperback. Contact Jim Surface.

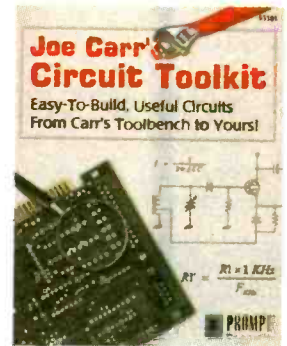

Please circle the products you would like to buy on the page above, calculate the total cost, include shipping charges, using in the form below and send it to us. Please allow 4 - 6 weeks for standard delivery.

Name: _____
Address: _____

Zip: _____ Telephone: _____
I have enclosed my check for \$: _____
Signature: _____

Please charge my credit card for \$: _____ Number:
Card Type: _____ Expiration Date:
Mastercard, Visa or Discover only

Note: The delivery address and the address at which the credit card is registered must be the same.

Clagg Inc.
PO Box 12162
Hauppauge, NY 11788
Tel: 631-592-6720
Fax: 631-592-6723
email: clagg@gemsback.com

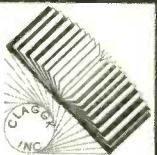

SORRY No orders accepted outside of USA & Canada

No. of Books Ordered	<input type="text"/>
Total price of books.....	\$.....
Shipping (see chart).....	\$.....
Subtotal.....	\$.....
Sales Tax (NYS only).....	\$.....
Amount Enclosed.....	\$.....

All payments must be in U.S. funds!

SHIPPING CHARGES IN USA.
CANADA ADD \$5.00

1 Book	\$ 5.00
2 Books	8.00
each add'l book	3.00
2 Day UPS	\$10.00 extra
Next Day UPS	\$20.00 extra

mailto: netwatch@gernsbuck.com

Behold, Robots: A Casual Surf in Search of Robotics

Whether for the sake of science, entertainment, or as a hobby to pass the time away, more people are becoming interested in the field of robotics. Television shows, toys for the kids, and even toys for us grownups have all been influenced by robotics as of late. Simplified technology and affordable pricing are two major factors that have helped open the door for the masses of robot-building neophytes. Robotics is no longer a science driven solely by the needs of industry.

There are numerous resources available on the Internet concerning the topic of robotics on a home-scale level. This month, let's explore three of these Web sites.

HAVE A CUP OF JAVA AT THE ROBOT CAFÉ

Point your browser to www.robotcafe.com and enter an up-and-coming hot spot for robot enthusiasts. This site may not be chock-full of cutting-edge Net technology, but it is a nifty platform geared toward searching the Web for robot resources. The site's motto sums up its focus—"Live, eat, breathe...robots."

Robotcafe.com offers a comprehensive directory ranging from toys and kits to recommended sites and breaking news. This site can be used as a portal in order to share ideas, search for information, or to simply browse the pictures within the gallery. The Web designers have succeeded in developing a user-friendly site that enables visitors to register and share their own

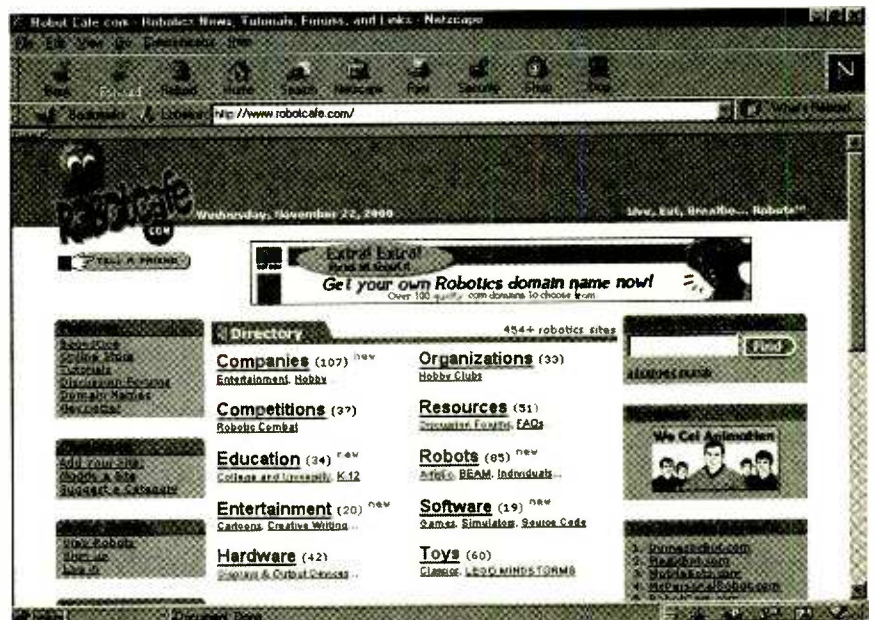

Settle down on your haunches at www.robotcafe.com. Here you can browse through pictures and sites dedicated to amateur robotics.

resources. You can even post a snapshot of your favorite creation. Perhaps your bot could be honored as Robotcafe.com's featured robot.

The big names in home creation are represented, such as the LEGO MINDSTORMS series and the Parallax kits, but there are also links to a plethora of sites developed by fledgling robot creators. Robotcafe.com is a community. The potential exists for this community to evolve into (dare I say) the Yahoo! of robotics. Beyond the blatant advertising that litters most Web sites, Robotcafe.com has managed to provide a catalyst for invention while allowing for the exchange of ideas across the globe.

After all, isn't that one of the reasons why the Internet was created?

Robotcafe.com can be used as a virtual "think tank" for the home-based engineer. The homepage allows users to link their site to www.robotcafe.com in order to expand the already ample base of informative links. What Robotcafe.com lacks in flash, it makes up for in the field of idea sharing. There is no doubt that you should add this one to your favorite sites if you have any interest in robotics.

"I, ROBOT" MEETS AIDA

In the realm of performance art, there stands one group like no other. Amorphic Robot Works (ARW) was formed in 1992 by a

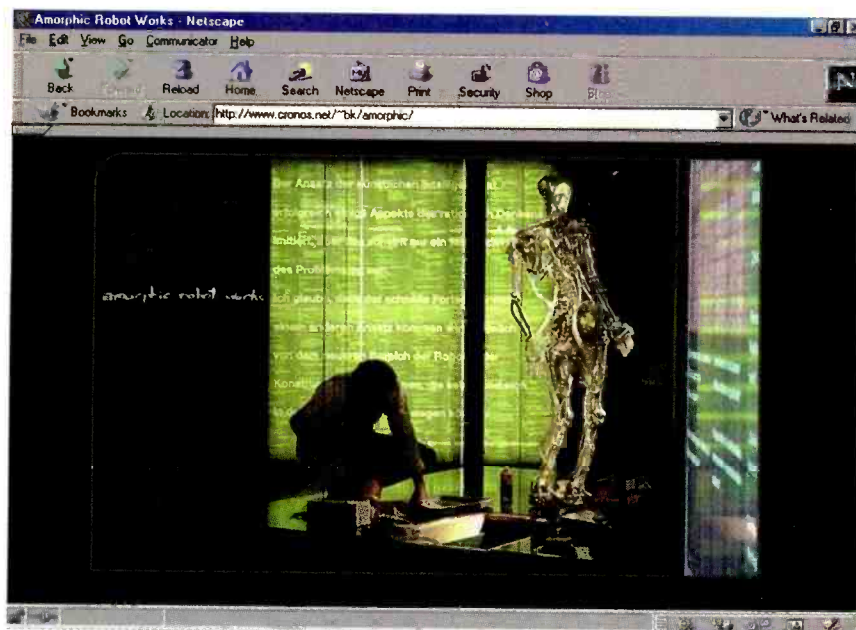

You can observe the inner workings of Amorphic Robot Works. This performance-art group has created an elaborate world of robots and music.

group of artists, engineers, programmers, and musicians. You can visit their site at www.cronos.net/~bk/amorphic/. This performance troupe has created an entire world populated by robots and driven by music. ARW is an avant-garde workshop boasting permanent interactive displays as well as live productions.

The robots are controlled by a network of software and hardware that is united by MIDI (Musical Instrument Digital Interface) signal-

ing. MIDI signals are routed through MIDI-to-voltage-control computers. Each MIDI command signal is converted into a 12-volt signal that is fed to various motors and solenoids that animate the robots. Music plays an important role by setting the mood and breathing life into the robot actors

All in all, this site is entertaining. There are numerous pictures available, including some behind-the-scenes coverage. I couldn't help but remember the old 80's video

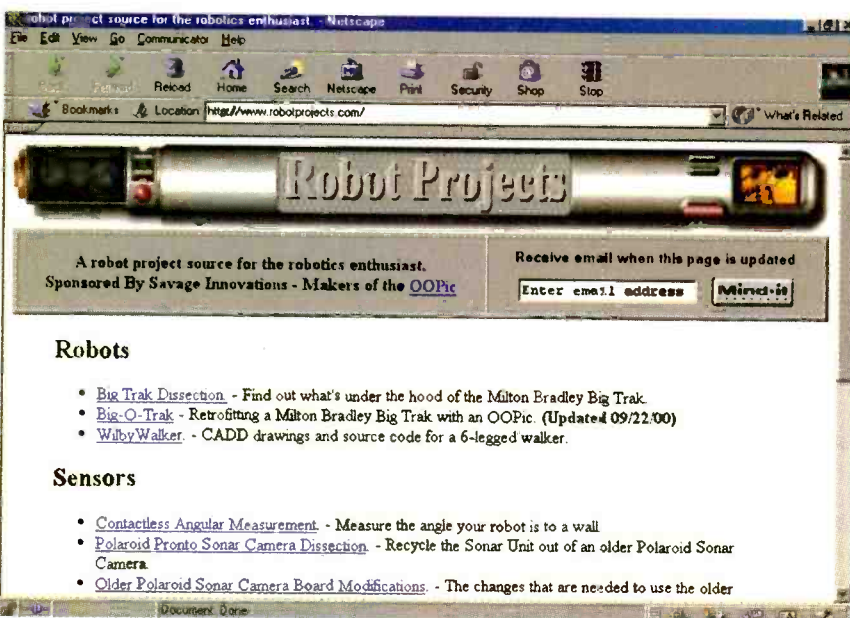

Why not see what other robot builders have been up to? Visit www.robotprojects.com for some interesting ideas and construction tips.

HOT SITES

Amorphic Robot Works
www.cronos.net/~bk/amorphic/

OOPIC
www.oopic.com

Robotcafe.com
www.robotcafe.com

Robotprojects
www.robotprojects.com

Yahoo!
www.yahoo.com

for Herbie Hancock's *Rock It as I* browsed ARW's gallery.

THE SAVAGERY OF CIRCUITRY

Savage Innovations (makers of the OOPIC) have bestowed upon the Internet yet another resource site—www.robotprojects.com. Readers should remember the OOPIC chip from Gordon McComb's "Robotic Workshop" in February 2000's **Poptronics**. Scott Savage, the man behind the chip, is sponsoring this site dedicated to robotic construction and design.

There are sections devoted to robots, sensors, speech, and works in progress. The latter section provides various dissection-photo layouts, such as the post-mortem view of our beloved friend, the Furby (see December 2000's **Poptronics** for Julian Edgar's slant on these lovable fur balls). Although the material on this site is limited, there are some amazing design notes available, especially in the sensor section. Detailed instructions are provided for salvaging sensors from old Polaroid cameras for use in home-built robots. It is also worth mentioning www.oopic.com, the home of Savage Innovation's OOPIC. A link is provided to this site via the Robotprojects site.

SHARE AND SHARE ALIKE

Thanks to the influx of "robot mania" throughout society and the Web, resources are being made available at a nearly overwhelming rate. It is heartwarming to see the Net being used as a tool for further

(Continued on page 66)

COMPUTER “BOTS” THAT Help You Shop—In Search of a Higher Intelligence

Ray Kurzweil, in his recent book *The Age of Spiritual Machines*, asked, “Can an intelligence create another intelligence more intelligent than itself?”

Kurzweil, a prominent inventor and business leader in the field of artificial intelligence, has the pedigree to make an intelligent stab at an answer. He believes that by the year 2030, due to the ongoing exponential growth of computing power, a \$1000 personal computer will achieve the full capacity of the human brain.

From one perspective, this doesn't seem so improbable. Computers today remember trillions of facts faultlessly, while many people—myself included—sometimes forget what day it is. Computers are also much quicker than the quickest intellect, able to search a multi-billion-record database in a fraction of a second.

Yet what our noggins do far better than today's fastest supercomputer is “pattern recognition,” allowing us to remember faces or appreciate the beauty of a sunset. Kurzweil boldly predicts that thirty years from now, common computers will have this capability and others, including consciousness and the ability to have emotional and even spiritual experiences.

Judging by the most visible application of artificial intelligence today—intelligent agents—I certainly wouldn't bet my PC on this. Intelligent agents are software rou-

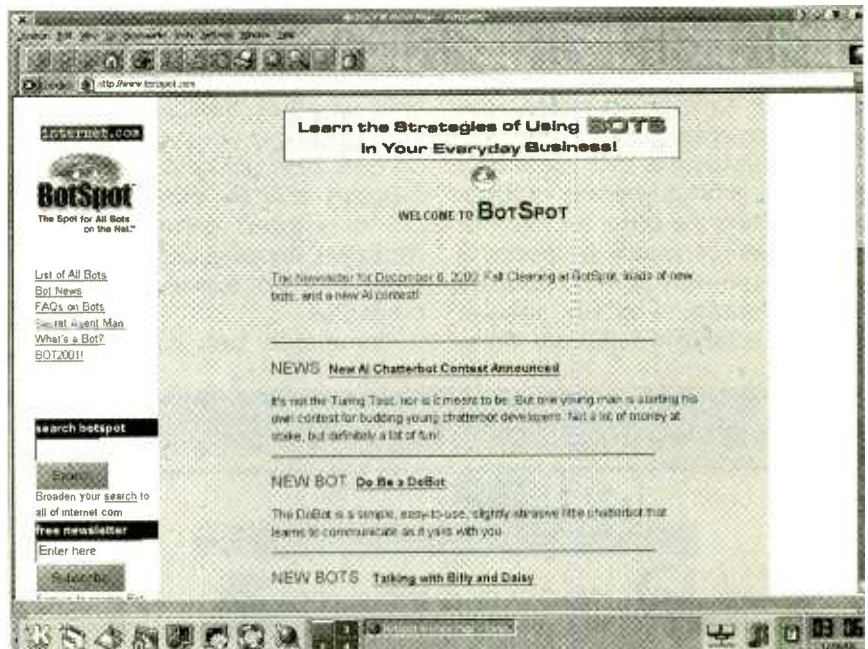

What kind of bots are out there? What's new and different today? Find out what the bot creators are cooking up with a visit to BotSpot, the Web site that will teach you more than you possibly wanted to know about bots and other artificial-intelligence personal-assistant programs.

tines designed to automatically retrieve the information you need and perform actions for you based on that information. Also called “bots” (as in robots), intelligent agents are fascinating in their potential, less so in their current incarnation.

Although bots today can perform research, chat with you, gather news, play games with you, and track stocks, many of the most popular are used by consumers and businesses for comparison shopping

over the Web; dozens are available. Like search sites, which use similar technology, most bots are free.

LET YOUR CYBER-FINGERS DO THE WALKING...

Shopping bots work simply enough. You type in the product or brand you're interested in, the bot tries to find Web merchants offering it at the lowest price, and you then surf to the merchant's site. I've

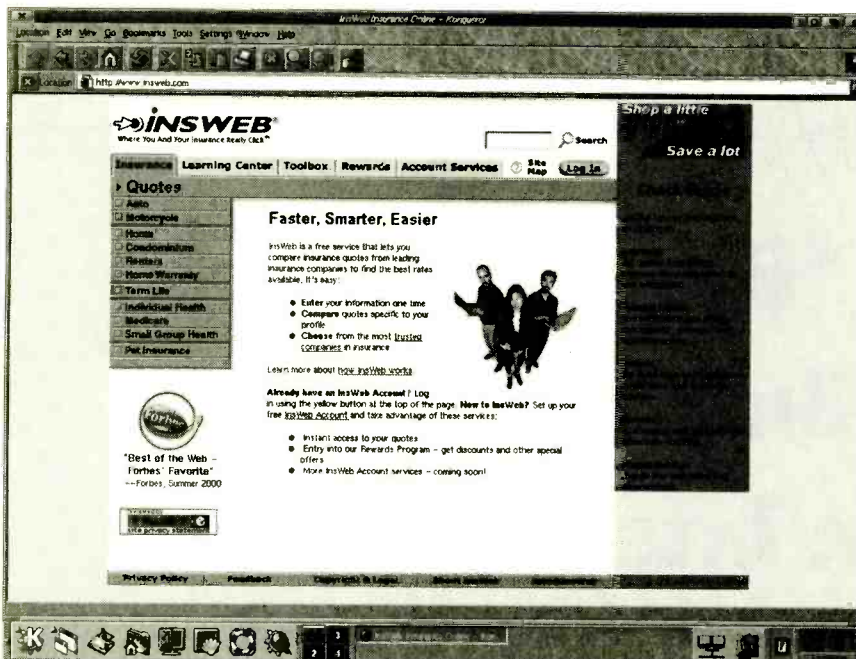

Shopping for insurance? Let InsWeb take you by the hand and guide you through the confusing jumble of insurance plans from different providers, whether it be for home, health, life, or auto.

used bots to shop for some time now, more or less successfully.

One problem is that most bots offer only product pricing information, ignoring the other factors that can make or break a shopping experience: easy site navigation, product quality, warranty, service, shipping charges, delivery time,

and whether the product is in stock. Nothing will sour you faster on bots than going to a site a bot suggests only to find—after filling out a detailed order form—that excessive shipping costs make the product more expensive than at other sites.

Sometimes, bots don't perform

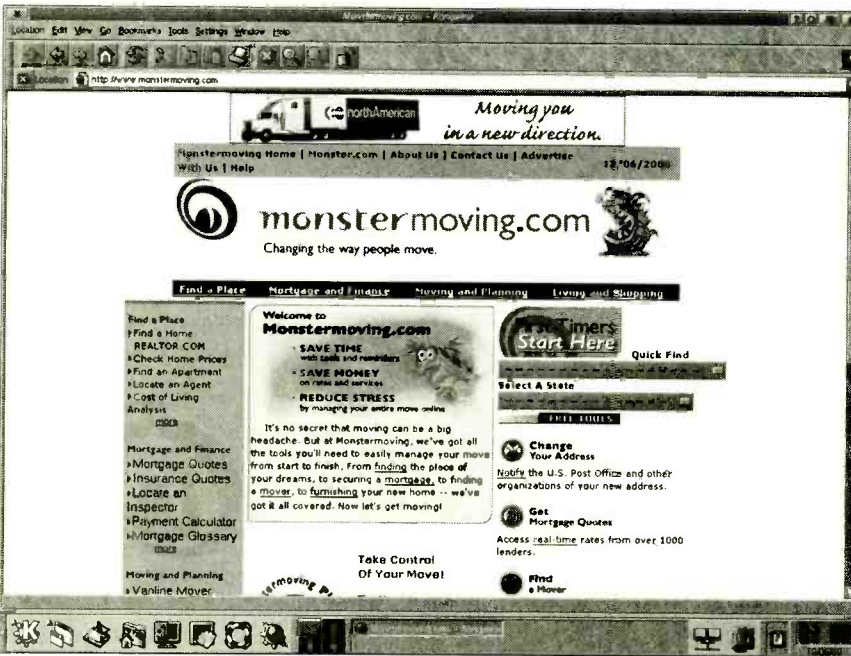

No one will argue that the single biggest, most traumatic activity that humans will do in their lives is buying a house and moving. When you're faced with that prospect, where do you turn first? Why, Monster Moving, of course! Here, you can find everything related to packing your bags in search of greener pastures from locating that dream domicile to mortgage quotes to moving companies. You can even let everyone know—bill collectors included—your new address.

POINT AND CLICK

- BotSpot**
www.botspot.com
- Bottom Dollar**
www.bottomdollar.com
- CNET Shopper**
www.shopper.com
- InsWeb**
www.insweb.com
- Monster Moving**
www.monstermoving.com
- mySimon**
www.mysimon.com
- Yahoo! Shopping**
shopping.yahoo.com

as advertised. The price a bot lists may not be the same as the price the Web merchant is actually selling the product for. On the other hand, the lowest price the bot turns up may be higher than what you'd pay in person at your local Wal-Mart.

When cyber-bargain hunting, just as in the offline world, it's good practice to be wary of a Web merchant offering a price significantly below the norm. Opt instead for sites offering a competitive price along with indications that your shopping experience will be trouble-free.

Another problem is that bots typically aren't comprehensive. It's not always their fault. Some shopping sites block bots from accessing their pricing information for fear of diminishing their brand image. Nevertheless, bots are often selective in which shopping sites they'll search and list. Some list results first from sites they have marketing affiliations with, and then from nonaffiliated sites. Others list results only from their affiliated sites. For these and other reasons, you sometimes can't find products that you know are out there.

Still, the best bots today, used judiciously, can save you money over retail without your having to leave the comfortable minty-green perch in front of your PC. Examples include general-interest bots such as mySimon at www.mysimon.com, Yahoo! Shopping at shopping.yahoo.com.

(Continued on page 66)

Mission Control

I don't usually start a column with a disclaimer, but if I don't this time, I just know I'm going to receive a whole bunch of letters. So, right up front, I'm going to tell you that this month's column is just going to scratch the surface of the topic. If there's interest, I'll come back to the topic in further depth.

Whew! That being said, this time around, with the issue theme of robotics, I want to take a look at how you can apply some simple robotics to your home. The robotics that I'm talking about are not the automatons of the Jetsons. Rather, they couple the power of the computer and hand controllers with a technology that's almost two decades old. That way, you can automate many functions in your house as well as allow your home environment to react intelligently to actions that occur in and around it. In effect, you turn your home into an intelligent "robot."

Home automation is big news these days, and that's the reason I made the up-front disclaimer that started this column off. There are several magazines published on the subject, and talking about different issues could easily fill a regular monthly column, much less the single one presented here.

To start things off, let's consider what we can do with one of the more popular home-control approaches. X-10 controllers and modules have been around a long time. RadioShack was an early supporter, and you can still find lots of X-10 stuff in the stores and catalogs. X-10 home automation started out as a set of hardware devices that controlled appliances and lights by overlaying control signals onto the

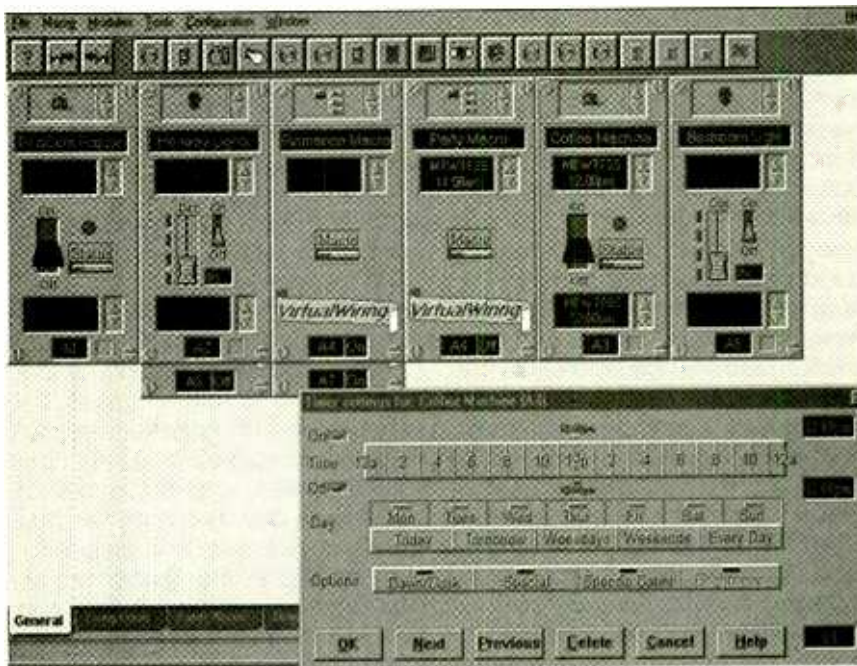

The software that comes with the ActiveHome kit makes it easy to set up controllers and sensors.

electric-power lines. The control module was plugged into an AC outlet, and a receiver controlled an appliance or light plugged into another outlet. When the proper signal was given, the AC power to the appliance outlet was toggled on or off.

This still forms the basis of the X-10 system, though the hardware has not only improved over the better part of two generations, but also expanded to include RF- and infrared-data transmission. Along the way, the simple approach has gotten a bit more complex, and today's X-10 controllers and receivers are capable of a lot more than just simple binary on-off operations. Two-way capability, with sensors reporting remote conditions, allows home control to be interactive,

rather than just timed responses.

The X-10 system started off with a few simple control products, but as other vendors took up support for the system, it has developed more into a control protocol. Notice that I did not use the word "standard." That's because there is no true "standard" other than what X-10 and other vendors have accepted to insure interoperability of components from different vendors. The X-10 "language," at various times, has undergone some modification and even extension, with some vendors promoting their own versions of X-10 "enhancements." The language has also been extended to accommodate commands that flow both ways. Today's home-control systems often have sensors that report remote conditions.

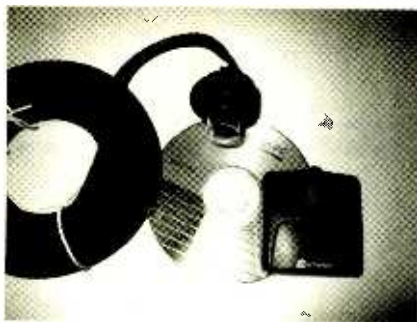

The Hawkeye motion sensor and NightWatch surveillance camera are both affordable and tiny.

What's especially interesting is the way that the X-10 system works. When a command is given, a packet is constructed and then transmitted over the appropriate media, usually the power line. This packet is very much akin, at least in concept, to those used on computer networks and the Internet. While I don't want to spend a lot of time on the packet makeup (a good description was given in the August 1999 issue of **Electronics Now**), the packet consists of a destination address (the address of the device being commanded) and the actual command. In most cases, this command remains in effect until the controller receives a second command. If you're interested in the makeup of this command structure and protocol, there's a library on X-10's Web site (ftp.x10.com) where you can download a wealth of information and documents.

Obviously, the X-10 Web site (www.x10.com) is a good place to see what's available. There are a number of good offers on this Web site that can get you started with X-10 technology for very little money. Another Web site you should definitely pay a visit to is www.hometoys.com. The HomeToys Web site is not just oriented to X-10, though there's a real wealth of X-10 information ranging from beginner to expert on the site. You can also find out about other home-automation approaches and the growing world of home networking. A download section lets you try out trial and shareware versions of control utilities, and there's even an e-zine on home automation to read.

Another terrific resource for home automation is at www.smarthome.com. This site sells home-control products from many

different vendors, and it's easy to spend hours (even with a broadband Internet connection) examining the different products available.

TAKING THE PLUNGE

It doesn't take a lot of money, or effort, for that matter, to get started with X-10 home-control equipment. X-10 offers two starter kits; each costs under \$50. The less expensive of the kits is the "Firecracker." When it was first launched, X-10 made it available for the cost of shipping—\$6. Now, there's a special price of \$39.95, \$10 off the regular price of \$49.95. The Firecracker comes with four pieces of hardware: a palm-sized controller that communicates with a Wireless Link Module using RF; a lamp module, which plugs into an AC outlet and controls a standard incandescent lamp; and the tiny Firecracker control module, which plugs into a serial COM port on your PC. At this price, however, you have to download the software from the Internet.

A step up in size, price, and capability is the \$49.95 ActiveHome kit. This kit has a 6-in-1 Universal Remote that not only controls your X-10 setup, but your TV, stereo, and cable box as well. There's also a keychain remote, the same wireless link and lamp module included in the Firecracker kit, and a transceiver module that also performs as an appliance controller so you can have the system make your coffee in the morning. A computer module is also included for your PC's serial port. A Windows-based control program—shown in the accompanying screen capture—is also included, so you don't have to download anything. This software makes it easy to poll and control the various components of the X-10 system you create.

PUNCH IT UP

A "true" robot is one that responds to stimulus. To add that capability to the X-10 system is both simple and inexpensive. X-10 offers many additional modules, but some of the neat ones that you might want to play with are the HawkEye motion sensors, and the different cameras. Pictured here are a \$29 HawkEye sensor and a \$49 NightWatch camera. The HawkEye sensor is a PIR (Passive

SOURCE INFORMATION

X10 Wireless Technology, Inc.
15200 52nd Avenue South
Seattle, WA 98188
206-241-3283
info@x10.com
www.x10.com

CIRCLE 100 ON FREE INFORMATION CARD

Infrared) type device, with a wireless RF transmitter that sends a signal to one of the wireless-link modules. The NightWatch camera includes a 60-foot cord with an RCA connector. You can plug this into a VCR or a USB adapter, letting your PC monitor the image for movement. The NightWatch is a monochrome low-lux device; it will produce an image in as little as 0.5 lux. Other cameras that X-10 offers provide color images, and some are available with wireless transmitters and receivers.

Unless you order a battery-powered camera, most of X-10's tiny video cameras are powered through a small AC supply—an obvious route for a system that communicates over AC power lines. You can order the camera with a supply that's switchable using X-10 commands, which lets you remotely scan through a number of different locations using multiple cameras with their power supplies turned on and off in rotation. X-10 will even supply kits with multiple cameras, switchable power supplies, and a controller.

The X-10 components are addictive. The Firecracker kit makes it easy to start learning the fundamentals of scripting macros that launch a sequence of operations. For example, you could use a HawkEye motion sensor to determine when you get out of bed and walk to the bathroom at night, turning on the bathroom light so you don't walk into something. If your trip to the bathroom falls at a certain time, the system could start your coffeemaker, unless it's the weekend, when the time constraint would be different.

What I like most about the X-10 system is that it's almost infinitely expandable. The only limitations are your imagination and your budget.

PEEK-A-BOO

With this issue's emphasis on robotics, the LEGO MINDSTORMS Robotic Invention System (RIS) is a natural. The RIS brings the creation of a very sophisticated level of robotic device to the point where pretty much anyone who is willing to spend a bit of time learning the system can make a robot that researchers only dreamed about just a few decades ago.

The MINDSTORMS RIS is covered elsewhere in this issue, but one of the reasons that the product—introduced some two years ago—is still enjoying terrific sales is the LEGO philosophy of making the system extendable and adaptable. LEGO has done this by introducing new MINDSTORMS products that complement the original RIS. Last year, it was the introduction of several *Star Wars*-themed kits, while this year has also seen a host of new products introduced.

I CAN SEE!

The MINDSTORMS Vision Command set is an interesting product, as it can be used either stand-alone or to give MINDSTORMS robots created with one of the Robotic Invention System kits some amazing new capabilities. In either case, you'll need a PC with a USB connection. The Vision Command's "ReadMe" file warns about some problems that have occurred with laptops and disclaims full support for the new Windows ME operating system. However, I tested Vision Command using a Compaq Presario 1600 laptop running Windows ME and experienced no problems. LEGO does warn, however, that the Pentium MMX CPU is not supported; you'll need at least a 233-MHz

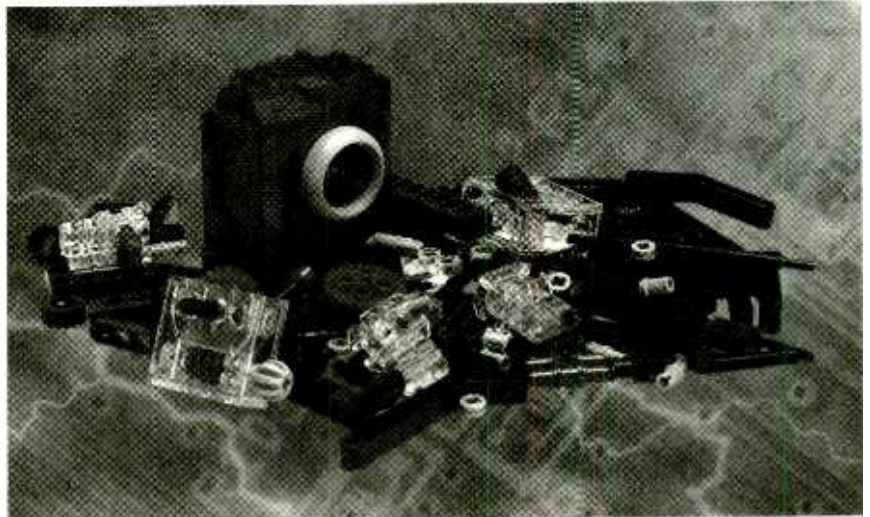

The Vision Command set consists of a small camera, a stand that you build yourself, and unique software for pattern and color recognition.

Pentium II to run the Vision Command software. You'll also need Windows 98, a USB port, a 4X CD-ROM, and an 800 × 600 SVGA display with 16-bit color. That may leave some hobbyists with slightly older PCs out of the running.

Getting Vision Command up and running is easy. The CD-ROM self-starts, and after installing the software, you will be prompted to plug the camera into a USB port. The camera itself is very small—about 2 × 2½ inches—and has a LEGO look. There's a five-meter cord that tethers the camera to your PC, a microphone for capturing audio, and a red LED that indicates when the camera is "live." The focus, while adjustable, is not remotely adjustable, so you'll have to do this by hand. There's also a small button on the camera for capturing still images.

Once the camera is attached and adjusted, the hard part kicks

in—you have to build a stand for the camera. Vision Command comes with plenty of LEGO pieces, and a "Constructopedia" provides step-by-step and part-by-part instructions for several camera-stand designs. Most of those stands are adjustable, though hand powered unless you have a motorized accessory kit.

After the stand is finished, you'll need to view the various tutorials to find out how to use the Vision Command, as the "Constructopedia" is the only printed documentation that's included.

"SMART" VISION FOR DUMMIES

The real worth of the Vision Command is that you can program the system for two things. The first is to recognize that something is happening in the camera's field of vision. You do this by dividing the camera's field of vision into zones. This is easy to do; a slider on the



A complete tutorial walks you through the process of setting up and using the system.

right side of the image superimposes a variety of zones and patterns onto the videocam's transmitted image. These patterns vary from a simple small circle and a set of multiple circles located horizontally or vertically to a sophisticated setup that lets you determine whether an object is moving across the field of vision or towards or away from the camera. You can also train the system to recognize colors. A color target, with very vivid colors, is provided, or you can use the color of an everyday object for this training.

Once an event has been detected, you can program an appropri-

ate response to that event. Of course, what's appropriate not only depends upon what you want to take place, but what resources you have to effect that response. That sounds a bit more complex than it really is. For example, if you only have Vision Command and not the RIS, you are limited to the responses—such as an audible alarm—that the software by itself offers. This response is programmed by using an on-screen building-block approach that's identical to the one employed by the RIS. Pick an action box, drop it onto a program line on the screen, and your program is created.

On the other hand, if you also have the RIS, the software adds instructions and allows you to create RCX instructions that the RIS's small computer will follow. If you build a robot with mobility, you can program Vision Command to scan an area and, when it senses an "intruder," generate an alarm and follow the intruder around. To do that, simply note when the "intrud-

er" moves to one side of the field of vision or the other or moves away (by moving into a zone at the top of the vision field). For those events, select the appropriate movement commands (turn left, right, or go forward). None of these tasks is difficult to program, especially if you follow the "training missions" contained on the disk tutorial.

TED'S WISH LIST

Vision Command, like many products, isn't perfect. For one thing, the lack of any real printed documentation is a drag. You not only have to go through the computer-based tutorials from start to finish, you'll probably have to sit through them multiple times as you get more and more experience with the system. That's part of the learning process, but it's a real pain. LEGO should consider some real documentation, perhaps in Adobe PDF format to save on "dead trees."

I would also like to see the camera come with some additional software to allow it to be used in standard TWAIN mode. You can capture video as AVI files to include in e-mails, but as long as you have a videocam connected to your USB port, it should be usable for videoconferencing.

In fact, with Webcams and other PC videocams so popular and prevalent, a separate product consisting of just the software, tuned to work with a standard TWAIN-compatible camera, would be a nice offering. Once a hobbyist had the opportunity to play with some of the Vision Command capabilities, I bet a lot more of the Robotics Invention System kits would be sold.

Still, these are minor complaints. Costing just under \$100, Vision Command is an interesting way to get started in sophisticated pattern and image recognition. Moreover, if you already have a MindStorms Robotic Invention System, it's a terrific way to get your creative juices flowing again. You can purchase the Vision Command set just about anywhere LEGO MINDSTORMS are sold. You can also visit the MINDSTORMS Web site at www.legomindstorms.com for MINDSTORMS retailers on the Web.

Electronic Projects 1.0

By Max Horsey

A series of ten projects to build along with audiovisual information to support hobbyists during construction. Each project is complete with schematic diagrams, circuit and PCB layout files, component lists and comprehensive text to guide the hobbyist through the project. A shareware version of CAD-PACK—schematic capture and PCB design software is also provided. Projects include a reaction timer, logic probe, egg timer and seven more. Get your own copy of this CD-ROM today. **\$75 including shipping in the U.S.** Order from CLAGGK Inc., P.O. Box 12162, Hauppauge, NY 11788. Visa, MC, Discover, OK.



CLX2

SOURCE INFORMATION

LEGO MINDSTORMS

52 Leveroni Court
Novato, CA 94949
415-382-4080

www.legomindstorms.com

CIRCLE 110 ON FREE INFORMATION CARD

ELECTRONIC TECHNOLOGY TODAY INC.

P. O. Box 240 • Massapequa Park, NY 11762

INVENTORY BLOWOUT SALE



* ALL CANADIAN CHECKS MUST CLEAR THROUGH AN AMERICAN BANK

BP07 . . . 100 Radio Hookups	\$3.00	BP302 A Concise User's Guide to Lotus 1-2-3 Release 3.1	\$5.99
BP36 50 Circuits Using Germanium, Silicon & Zener Diodes	\$2.99	BP304 Projects for Radio Amateurs and S.W.L.S	\$5.99
BP44 IC 555 Projects	\$5.99	BP317 Practical Electronic Timing	\$6.99
BP48 Electronic Projects for Beginners	\$2.99	BP320 Electronic Projects for Your PC	\$5.99
BP56 Electronic Security Devices	\$3.99	BP322 Circuit Source Book 2	\$6.99
BP64 Semiconductor Technology Elements of Elect Book 3	\$5.99	BP329 Electronic Music Learning Projects	\$6.99
BP74 Electronic Music Projects	\$3.99	BP332 A Beginners Guide to TTL Digital ICS	\$6.99
BP76 Power Supply Projects	\$3.99	BP333 A Beginners Guide to CMOS Digital ICS	\$6.99
BP78 Practical Computer Experiments	\$2.99	BP334 Magic Electronic Projects	\$6.99
BP80 Popular Electronic Circuits	\$3.99	BP355 A Guide to the World's Radio Stations	\$7.99
BP103 Multi-Circuit Board Projects	\$2.99	BP359 An Introduction to Light in Electronics	\$6.99
BP109 The Art of Programming the IK ZX81	\$3.99	BP367 Electronic Projects for the Garden	\$6.99
BP112 A Z-80 Workshop Manual	\$5.99	BP370 The Superhet Radio Handbook	\$6.99
BP114 The Art of Programming the 16K ZX81	\$3.99	BP371 Electronic Projects for Experimenters	\$6.99
BP115 The Pre-Computer Book	\$2.99	BP374 Practical Fibre-Optic Projects	\$6.99
BP124 Easy Add-On Projects for the Spectrum, ZX81 & ACE	\$3.99	BP378 45 Simple Electronic Terminal Block Projects	\$6.99
BP143 An Intro to Programming the Atari 600/800 XL	\$2.99	BP379 30 Simple IC Terminal Block Projects	\$6.99
BP148 Computer Terminology Explained	\$2.99	BP384 Practical Electronic Model Railways Projects	\$6.99
BP154 An Introduction to MSX Basic	\$3.99	BP391 Fault-Finding Electronic Projects	\$6.99
BP156 An Introduction to QL Machine Code	\$3.99	BP392 Electronic Project Building for Beginners	\$6.99
BP187 A Prac Ref Guide to Word Pro Amstrad PCW8256/PCW8512	\$7.99	BP393 Practical Oscillator	\$6.99
BP190 More Advanced Electronic Security Projects	\$3.99	BP394 An Introduction to PIC Microcontrollers	\$7.99
BP194 Modem OPTO Device Projects	\$3.99	BP396 Electronic Hobbyists Data Book	\$7.99
BP232 A Concise Introduction to MS-DOS	\$3.99	BP401 Transistor Data Tables	\$7.99
BP245 Digital Audio Projects	\$3.99	BP411 A Practical Intro to Surface Mount Devices	\$6.99
BP256 An Intro to Loudspeakers and Enclosure Design	\$3.99	BP413 Practical Remote Control Projects	\$7.99
BP264 A Concise Advanced User's Guide to MS-DOS	\$3.99	PCP107 Digital Logic Gates and Flip-Flops	\$10.99
BP272 Interfacing PCS and Compatibles	\$5.99	PCP112 Digital Electronics Projects for Beginners	\$10.99
BP290 An Intro to Amateur Communications Satellites	\$5.99	PCP114 Advanced MIDI Users Guide	\$10.99
BP297 Loudspeakers for Musicians	\$6.99	ETT1 Wireless & Electrical Cyclopedias	\$4.99
BP299 Practical Electronic Filters	\$6.99		

PRICES DO NOT INCLUDE SHIPPING & HANDLING. ALL SALES ARE FINAL, NO RETURNS

ORDER FORM

Book No.	Title	Price	No. of Copies	Cost

Name _____
 Address _____
 City _____ State _____ Zip _____

If you wish to use a Credit Card:

MasterCard Visa Expire Date ____/____/____
 Card No. _____
 Signature _____

Allow 6-8 weeks for order to be fulfilled.

Please return this order form to:
ELECTRONIC TECHNOLOGY TODAY, INC.
 P.O. Box 240
 Massapequa Park, NY 11762-0240

SHIPPING COSTS		Total Amount \$	
\$0.01 to \$5.00	\$2.00	\$20.01 to \$30.00	\$5.00
\$5.01 to \$10.00	\$3.00	\$30.01 to \$40.00	\$6.00
\$10.01 to \$20.00	\$4.00	\$40.01 to \$50.00	\$7.00
\$50.01 and above	\$8.50		
			TOTAL COST \$

Telephone Orders: If you wish to place your credit-card order by phone, call 631/592-6720. Automated order taking system functions 24 hours a day. Have your credit-card ready. Sorry, no orders accepted outside of U.S.A. and Canada, New York State Residents must add applicable sales tax. Offer expires 6/30/01. ET11

March 2001, Poptronics

DIGITAL DOGGIES

MORT COLLINSWORTH

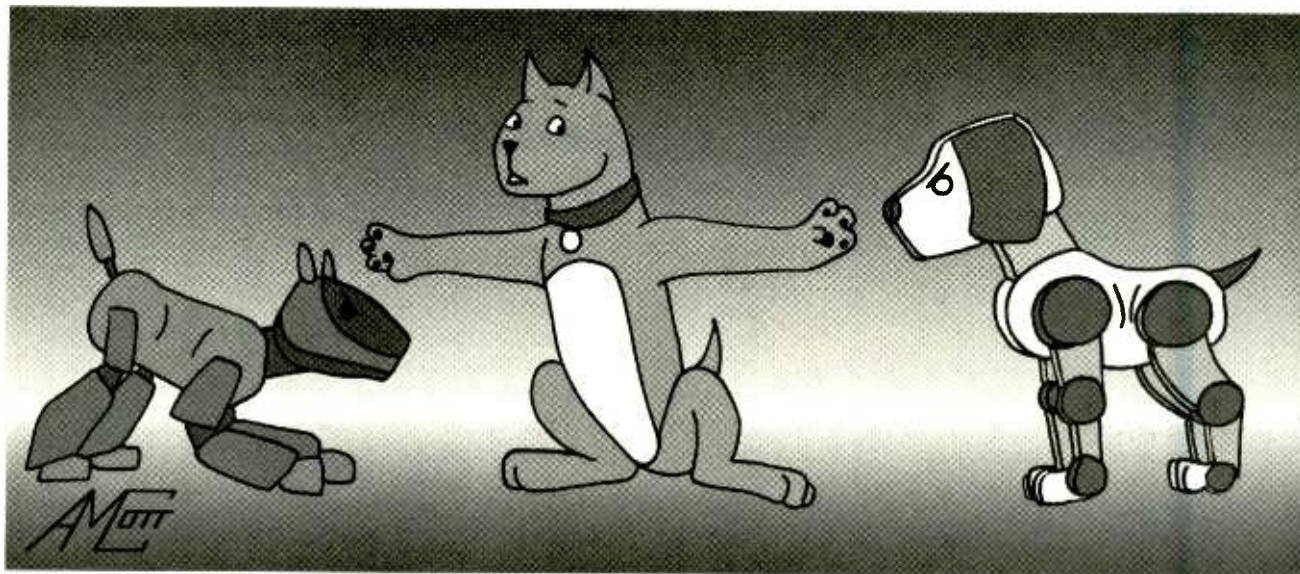

Are robotic dogs vying for the title of "Man's Best Friend?" Using my dog, Dante, as a control subject, I conducted research on comparative traits that exist between Dante and various samples from the digital-dog domain. The following is a brief report on the results found during my taxonomic investigation of one said Dante the Real Dog versus two digital contenders—Fisher-Price's Rocket the Wonder dog and Sony's AIBO ERS-210 (Sony's second generation AIBO).

Organs Or Sensors: Who Has The Real Edge?

It may seem unfair to compare an electronic circuit to an actual canine eye, but one can compare how both digital and genuine pooches register their environment. Let's examine how each subject registers video (visual) inputs. (NOTE: Rocket does not possess a video input and therefore will not be discussed in this section.)

AIBO (for the purpose of this article, AIBO shall refer to AIBO ERS-210) comes equipped with a

Complimentary Metal Oxide Semiconductor (CMOS) image sensor. The CMOS sensor captures light by means of tiny photodiodes; each photovoltaic diode corresponds to a single pixel. Tiny transistors circle each photodiode and amplify the

There's a new breed of dog in town and its name is Digital. Let's take a gander at the electronic litter and see how two digital dogs compare to the analog—fur-and-gut—mutts.

image intensity. Critics cite CMOS images as inherent to both noise and low-light sensitivity. As a result, image quality is lacking after the analog-to-digital conversion. The bonus of CMOS technology is low cost. The silicon used in producing a CMOS chip is the same as most common ICs. An infrared distance detector is mounted inside AIBO's head. This distance detector works in union with the CMOS camera. Together, both systems provide AIBO with a three-dimensional view of the world.

In comparison, Dante (who is strictly analog) uses an intricate system in order to capture images.

Whereas a CMOS chip captures light and transmits it to an analog-to-digital converter, the dog's organ absorbs light through the iris; it is reflected by a mirror-like membrane known as a *tapetum lucidum*. This membrane increases light sensitivity. Yet, the CMOS chip offers a truer array of colors. Dante's world is mostly gray and blue, with green, red, yellow, and orange all appearing to be the same

color. A canine has trouble distinguishing forms and patterns; instead a dog has keen sense of motion detection.

So, in the field of image capture there are some major differences. AIBO has a sharp resolution, but poor exposure due to coarse light response. Dante The Dog has near colorless and blurry vision, but he can detect objects in low-light conditions. An ability that AIBO has, that no ordinary dog can duplicate, is picture storage. AIBO automatically clicks one picture a day for his personal diary. These pictures can be reviewed via software. Dante cannot share his visions with



Keep up with Rocket's latest adventures at his Web site. There are some neat video demonstrations on-site.

us. One point is awarded to AIBO.

Training Your Mutt. When it comes to ease of training and fun results, Rocket the Wonder Dog scores high. The kind folks at Fisher-Price shared some information about their robot, which is geared towards young pre-teens. Rocket is programmed with voice commands by means of the Personal Puppy Trainer (PPT). The PPT contains a voice-recognition circuit chip that allows users to program the digi-dog with their own voice. This feature allows multiple users to train Rocket. Trainers can give Rocket a name to associate with his separate command listings. The PPT is a combination headset and microphone that children use to orally command Rocket. Commands are familiar dog commands, such as sit, roll over, and beg. So, if little Johnny says, "Fido, sit," then Rocket will execute the sit command for Fido. This is pretty neat for a toy that retails at just about one hundred bucks.

AIBO, on the other hand, is software driven by means of interactive software. In order to enjoy AIBO, the owner must purchase a software bundle, a Sony wireless-LAN card designed for AIBO, and a wireless-LAN card for the PC. AIBO uses IEEE 802.11b LAN standard technology and the response range

of AIBO's LAN card is approximately thirty meters. There are currently four software packages available. Those packages are:

LIFE—This program allows AIBO to mature from baby to teen and up to adult. With each passing stage, the robot begins to develop new skills and master communication with its co-inhabitants.

Party Mascot—AIBO is billed as an entertainment robot and right-

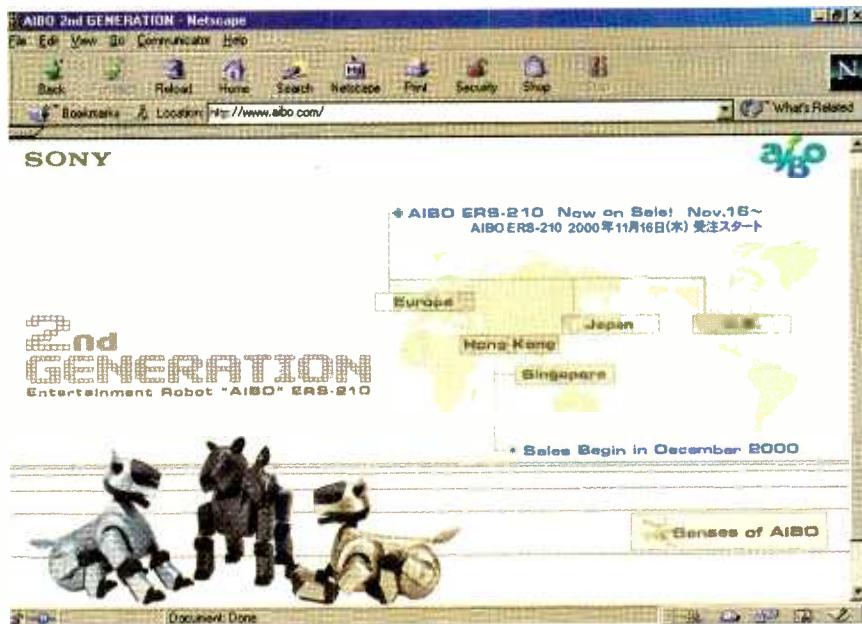

The homepage for Sony AIBO features some high-tech multimedia and plenty of information regarding specs.

fully so. This software allows the user to track the robot's growth and play up to eighteen games.

Hello AIBO—Users can even skip the growing pains and jump straight to AIBO's adulthood. This software allows owners to enjoy all of AIBO's adult characteristics.

Fun Pack—This package allows owners to view AIBO's photo journal and also offers some new quirks and traits to breathe more life into the pet. This particular package must be used in conjunction with either *Life* or *Hello AIBO*.

After the dust clears, a considerable amount of money has been spent in order to take full advantage of AIBO. The network components and one bundle of software can cost nearly \$500. This hefty price tag proves, once again, that AIBO is not just a toy—he is an investment.

Dante has gradually learned to communicate with his adopted family. Using barking and visual commands, the dog has successfully trained its owners to open doors for him. Other pets in our neighborhood seemed impressed with Dante's progress in the field of human training. As for my wife's and my training abilities, we aren't doing too bad for seven years.

Dante has a repertoire of at least ten tasks, and he is housebroken.

Cracking The Code. It was only a matter of time before a Web ring was developed for AIBO. One portal to the Web ring is www.aibonet.com. This site has a plethora of information contributed by AIBO owners from around the world. The "software" section features cracks of AIBO's database code. The prefix for AIBO files is *ODA, and a comprehensive breakdown of the code is located at www.aibonet.com/sp/gen/odafor.mat.html. There hasn't been much luck programming AIBO to perform extraordinary acts, but with the use of a software editor (found at www.aibonet.com/sp/gen/tools.html) users can delve into AIBO's memory stick and see how the pooch stores data.

AIBO.NET provides links to sites from as far away as Japan. One site that provokes interest is a Japanese site entitled AIBO x-ray. The site is located at www.nnc.ne.jp/~as212/aibo/x-p.html and offers a photo spread of AIBO's x-ray images. If you don't have a Japanese character set loaded for your browser then the text will be cryptic gibberish. Nonetheless, the pictures do not need a translation and westerners and easterners, alike, can enjoy the images.

Come On Baby, Do That Servo-motion! I remember watching in half-horror and half-amusement, as my crazy dog attempted to leap up our wooden stairs in a single bound. What a disaster... In my dog's defense: No servo-driven bot could negotiate those stairs at that speed. Yet, servos can help both Rocket and AIBO move about the home.

Rocket has a total of seven motors. He has one for each leg, one for his tail, one for his eyes, and one for his head. A touch sensor is located in his nose to alert him when he slams into walls and such. AIBO has servos to control its legs, ears, head, mouth, and tail. Both binary beasts move about on command, but neither is as nimble as a flesh and blood dog.



Training Dante takes time and patience. I am waiting for his software patch to arrive by mail.

AIBO makes use of IR distance sensors for navigation. In a sense (pun is intended), AIBO flops about the place, making adjustments based upon IR feedback. This method has been shown to be more successful than simple touch avoidance. After all, when the touch is felt, hasn't the collision occurred? IR navigation also allows AIBO to detect ledges and steep drops in order to avoid self-inflicted destruction.

Dogs use the combined efforts of image input from their eyes, inner ear balance, and tail counter balance for negotiating the terrain. It seems that age has caught up with Dante's acrobatics, but he hasn't run out of batteries in seven years and he seldom walks straight into objects (besides, clumsiness is an adorable trait).

You Get Your Money's Worth.

AIBO can be purchased at www.sonystyle.com for the high-tech price of \$1500. Rocket is avail-



Part robot, part action-hero, Rocket is seen here enjoying time with a child of Earth. Underneath all that plastic is some pretty impressive technology. Unfortunately, we couldn't get a pooch for use in the lab. Apparently, some organizations object to post-mortem dabbling involving robotic dogs.

able at toy stores everywhere for around \$100. Dante was rescued at a shelter for much less (In fact, all parties benefited in Dante's case). Each product delivers its cost and then some.

Rocket is an entertaining toy for children. He has some nifty internal robotics. Rocket cannot be modified beyond the pre-programmed commands. Oh, but who knows? I am sure some diligent readers of a mag by the name of **Poptronics** could manage to tinker with the pup.

AIBO is expensive, but comprehensive. Living up to its name (In Japanese, AIBO means companion), this entertainment robot is a masterpiece of an artificial life form. Users can interact with their purchase like a family pet. Software-driven recreation and human-to-machine bonding make AIBO a trendy possession. Information can be found both at the SONY-STYLE site and at www.aibo.com.

Dante is not for sale (my wife would kill me), but hundreds of wayward mutts are available each day at your local pounds and shelters. Although you can neither turn them off nor purchase software for upgrade purposes, the original fur and guts dog can't be beat. Yes, age does wear them down; but doesn't time get us all?

So which pet offers the bigger bang for the buck? Let's take a look at some estimated figures. After paying a generous donation to the animal shelter, the vet bill for neutering, a bill for a rabies vaccine, and a license fee, Dante's total bill was approximately \$160. Rocket costs \$99 retail and battery upkeep is less than \$20 per month. AIBO might require a small signature loan for some mid-income families. The initial cost is \$1500 plus an additional \$300 in network equipment, not to mention the \$90 charge for AIBOware's Life software. AIBO's grand total is in the neighborhood of \$2500. Of course, there is periodic maintenance charges and vet bills (My wife and I invested in puppy healthcare about two years ago and it is worth every penny). So who is the better value? That answer, of course, is up

(Continued on page 36)

The Executive BDM

URSULA R. KIDDEN

Executive toys have probably been around since before society developed the need for executives. Of course, the “executive” part of the phrase wasn’t used. We’re talking toys, here: simple devices designed to amuse and dazzle small children.

I’m sure that many people will laugh derisively over that definition—if toys are for children, then executive toys are for executive children. Indeed, the popular perception is that most executives are simply overgrown children that don’t do much from day to day except sit behind a big desk playing with pencils and paper clips as impromptu toys; the rest of the workforce struggles and toils to earn enough profits to pay the executive’s salary.

The flip side of the coin is that executives must make the “tough” decisions—decisions with far-reaching consequences. What’s more, an executive decision many times has no room for error. One small error in judgement can spell the difference between success and failure for a company. The results can range from missed opportunities to “downsizing” to the total collapse of the organization—putting everyone on the unemployment line, including the hapless executive.

Executive toys run the gambit from three-pound yo-yos (yes, I have such a beast!) to the five-steel-balls-on-string devices to spinning tops made from magnets to miniature basketball hoops that clip over the rim of the wastebasket. In general, those types of e.t.’s (executive toys) don’t want to “phone home”—their purpose here on Earth is to act as “timesinks.” In the same way a heatsink’s job is to soak up excess heat, a timesink’s primary (if not sole) job is to soak up time—time usually better spent on accomplishing something with your life. Many people (myself included) see timesinks as inherently evil. After all, it’s usually easy to replace heat; it’s darn near impossible to replace time!

When I hear the phrase “executive toy,” I don’t

think of a proverbial “time-waster.” I usually think of a device that, although whimsical in nature, actually does something—albeit in an inefficient “Rube-Goldberg”-esque way. I also see a finished project—one

in which I invested toil and time in order to complete.

The *Executive BDM* presented here is just such a device. It was built based on plans provided by Robert Penfold, author of *Introducing Robotics with Lego Mindstorms*. That book is part of Bernard Babani’s “Unofficial Guide” series (see the “Get The Book” sidebar for more info).

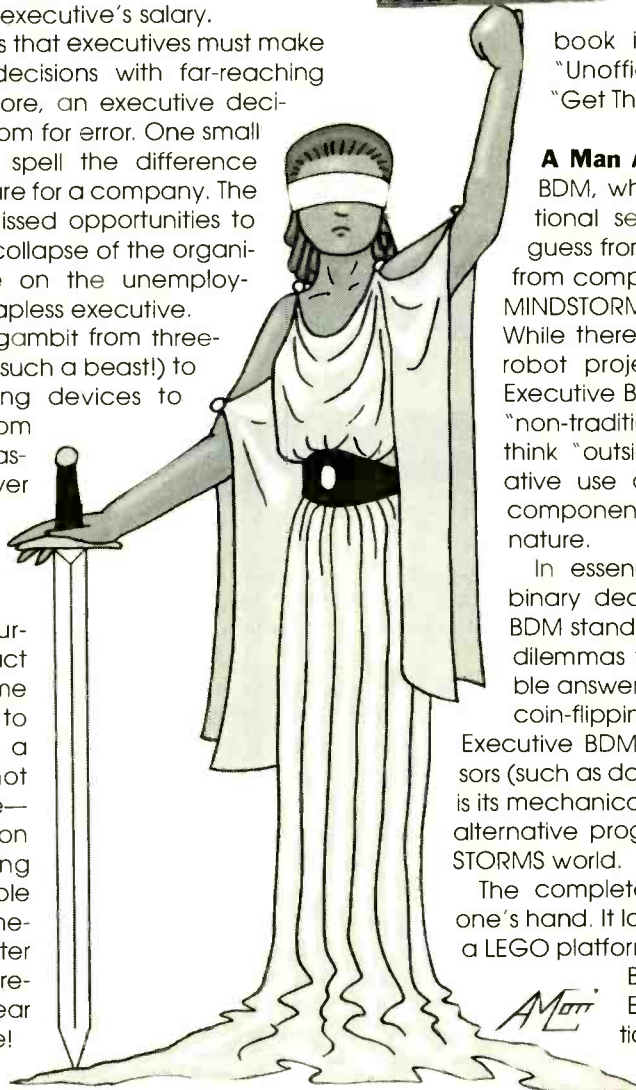
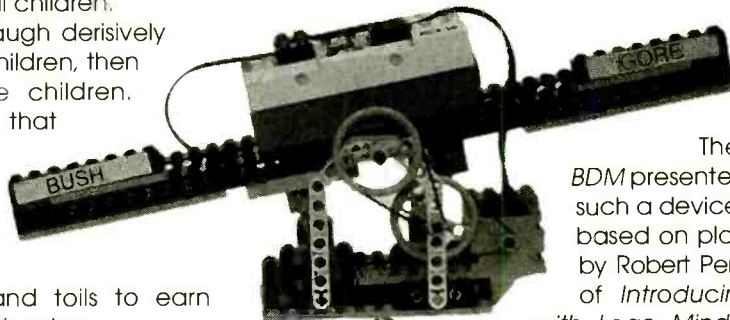

A Man And His Robot. The Executive BDM, while not a “robot” in the traditional sense, is built (if you couldn’t guess from the title of the source book) from components available in the LEGO MINDSTORMS Robotics Invention System. While there are many other “traditional” robot projects in Penfold’s book, the Executive BDM is a prime example of the “non-traditional” project that helps you think “outside the box” in terms of creative use of Robotics Invention System components for a device of a different nature.

In essence, the Executive BDM is a binary decision-maker (Oh, *that’s* what BDM stands for!) capable of solving daily dilemmas that require one of two possible answers. In a sense, it is an electronic coin-flipping device. What makes the Executive BDM stand out from its predecessors (such as dart boards and spinning arrows) is its mechanical design and innovative use of alternative programming in the LEGO MINDSTORMS world.

The completed robot fits in the palm of one’s hand. It looks like a miniature seesaw on a LEGO platform. Like the proverbial Magic 8-Ball toy, simply ask the Executive BDM a “yes/no” question and press the run button on the RCX controller. The mechanism will bobble up

and down a number of times before coming to rest; the answer can be whichever side you choose to be the "answer side": the side touching the ground or the side rising in the air.

Let's take a closer look at the mechanics involved in the project.

Big Wheels Keep On Turnin'. The Executive BDM is a miniature marvel merging both mechanics and electronics. There are over fifty LEGO parts incorporated in the robot's design. The prototype consists of a base, two arms, two mounting towers, a

seesaw platform, two touch sensors, a motor, and the LEGO MINDSTORMS RCX microcontroller.

The structure consists of a seesaw driven by a two-stage reduction drive. A pair of touch sensors are mounted to the bottom of the moving platform; their job is to tell the system when the seesaw reaches bottom and to reverse the motor. The platform relies upon the two arms for limiting its movement.

The reduction drive is used in order to prevent the device from self-destructing due to high-speed movement. It seems that the LEGO motor, like many hobby motors, packs a lot of punch for its size.

The drive system uses a small pulley on the motor's spindle to drive (via a rubber-band-like belt) a larger pulley. That pulley's axle drives, in turn, another small-pulley/large-pulley combination. The second large pulley is attached to the movable platform's axle. The motor must be reversed periodically for the rocking motion.

Although the drive system is simple and straightforward, I'm sure you're wondering what would happen if one of the sensors failed? Would the Executive BDM's motor continue to spin and eventually overheat, or perhaps break the platform into its constituent LEGO components? The situation certainly sounds similar to an arrangement once used in the computer industry. Those who might remember (fondly or otherwise) the Commodore 64 might recall the two types of

floppy drives that were available: the 1541 and the 1571. The 1571 was the higher-priced unit; it had a real floppy drive inside—including the control electronics. The 1541, on the other hand, was much more popular due to its lower cost. That cost reduction came from the elimination of the control electronics; the unit was little more than the mechanical components of a flop-

When you hear the phrase "executive toy," what image appears in your mind? If you envision a well-clothed business-type awaiting the train, fiddling with a hand-held video game, think again...

py drive. The motors, read/write heads, and sensors were directly controlled by the C64's microprocessor.

You might be wondering why I'm bringing up this dreary little tidbit of ancient computer history—I'm getting to that part. At least one program had a nasty little "copy-protection" virus intentionally buried within its code. If the program

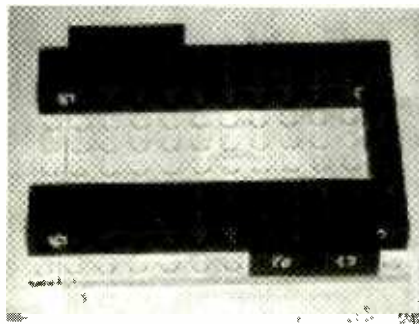

Fig. 1. Any robotics project—even one built from LEGO MINDSTORMS components—needs to start with a sturdy foundation.

detected that you were running the software from other than the original media (and therefore, using an illegal "bootleg" copy) and you had a 1541 drive, a command was issued to the drive-control routine: move the read/write head to track -5. The processor would start sending pulses to the head's stepper motor, counting each pulse. Of course, once the head moved past the track zero position, it slammed full force into the mechanism's end stop. The system would detect that the head

was not in position, pull the head back a few steps, and slam it into the stop repeatedly.

The result was a destroyed drive. If you were lucky, the head could be realigned. If not, you could always fill the drive with concrete and use it as a boat anchor.

Luckily, the worst that could happen to a LEGO-Systems-based device is that a few parts might

snap off or possibly break. Replacement parts are inexpensive and easily ordered from the manufacturer. However, I wanted to alert you to this subtle design flaw in

the Executive BDM. While a crank arrangement might be a better idea, it would be harder to have the seesaw stop at an extreme position due to inertia of the drive mechanism. I haven't experimented with such a variation, but the original design hasn't failed me yet.

Let's get back to the Executive BDM's design. The RCX "brain" is connected to the unit with only three sets of wires (oh, the beauty of LEGO). Unlike the nitty-gritty breadboard bots constructed with other kits, the LEGO MINDSTORMS line prefers to avoid the intricacies of semiconductors and circuit design. Instead, the electrical and electronic components are housed with LEGO-compatible shells that look, act, and interconnect with other LEGO pieces. When electrical wires are needed, the leads run from each device as necessary. In the Executive BDM, the two sensors have wire leads that connect to inputs "1" and "3" on the RCX; a third pair of wires connect the motor to output "A." The electrical connections are no harder than snapping one LEGO piece on top of another.

Playing With...Er, "Building" With LEGO MINDSTORMS. To build the Executive BDM, you'll need the LEGO MINDSTORMS Robotics Invention System. All the pieces and support equipment are included in that one box. I'll also assume that you're somewhat familiar with how the LEGO system works and how

the various pieces in the Robotics Invention System work. If you think that you're "too old" to be "playing" with LEGO, take heart. Reading the instructions through once and following them carefully (along with the aid of detailed photos), I managed to complete the "little bugger" in less than one hour. If I can do it, you can, too.

To describe the various LEGO pieces needed, we'll use an identification system obvious to anyone who has ever worked with any LEGO System components. An important part of the LEGO interlocking method is a series of raised bumps on the top surfaces of the pieces. If, for example, the piece in question has two rows of four bumps on it, we'll call it a "4 x 2." That being said, let's get a-building!

Like the hero of the *Horatio Alger* stories, we'll start at the bottom and work our way up. The base consists of several flat pieces and plates: a 10 x 6, a 10 x 2, a pair of 8 x 1s, and a 6 x 2. Place the 10 x 6 and the 10 x 2 to form a 10 x 8 surface. The 8 x 1s go on either end; the surface now measures 12 x 8. Place the 6 x 2 at one corner so that it runs along the 12-bump direction.

To hold the base together, gather four 12 x 1 beams and two 4 x 1 beams. Note that the beams have holes through their sides. Use a pair of pins supplied with the kit to lock two beams side by side. Another pair of pins connects the 4 x 1 beam to the right side of the doubled beam, offset by one hole (the end hole already has a pin in it). You'll need two assemblies.

Each assembly snaps onto the base plate, locking the flat pieces together. An additional 4 x 1 beam on the right side of the base plate spaces the beam assemblies apart. Note that the rear beam assembly will overhang the base plates. The 6 x 2 helps support the rear beam assembly where the 4 x 1 beam is connected. The final assembly is shown in Fig. 1.

Limiters. The next assemblies to add are the arms that limit the seesaw's travel. Again, two assemblies are required. For each assembly, place a 4 x 1 beam on top of a 6 x 1 beam so that one side of each

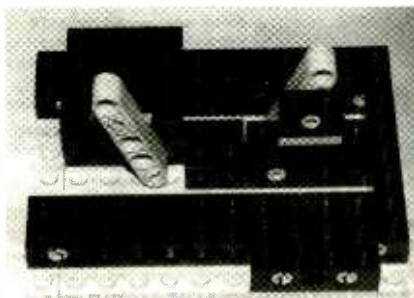

Fig. 2. These posts set the travel limit for the Executive BDM's seesaw.

piece is flush (the pieces should not be centered). A 2 x 1 plate goes on top of the 4 x 1 beam, building up additional height for the 2 x 1 beam that snaps on top of the 2 x 1 plate. Those shorter pieces are centered on the 4 x 1 beam.

A pair of 5 x 1 half-thickness girders are pinned together through their first (one end) and fourth holes. The portion of the pins that stick out on one side attach the girders to the beam assembly through the single hole in the 2 x 1 beam and the center hole of the 6 x 1 beam (note that there are five holes in a 6 x 1).

After you build a second identical unit, snap them onto the base assembly. One limiter sits against the 4 x 1 beam on the base assembly. Note from the Fig. 2 photograph how the limiters are offset and overlap each other by two bumps.

Support Towers. The support towers, while somewhat flimsy in design, support the seesaw without a prob-

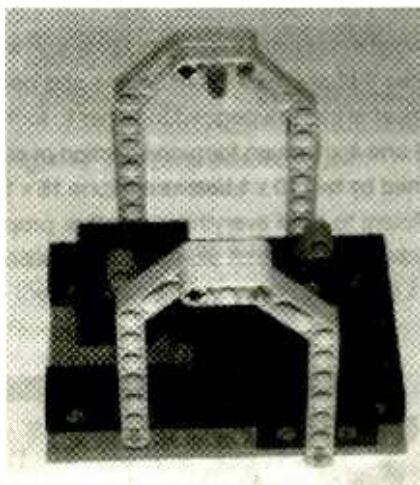

Fig. 3. The base takes on a new look with the support towers in place.

lem. They are made from a pair of yellow girders that look like they are bent at 90° and have a 45° chamfer in them. Two types of pins are used in this assembly: gray pins that are half standard pin and half axle, and black pins that are axle-like on both ends.

Study Fig. 3 to see how the pieces are positioned on the base. One of each type pin is used to connect the girders at the top where they overlap. An additional pair of gray pins connects the towers to the base. Note how the 4 x 1 beam in the base fits to one of the tower girders, acting like a spacer.

An additional gray pin fills the center hole of the rear tower. That pin will act as a pivot for the seesaw. Leave the center hole in the front tower empty for now.

Seesaw. A pair of very long beams makes the basis of the seesaw. Each beam is fabricated from six beam pieces arranged in two rows. One row consists of a 16 x 1 beam with 10 x 1 beams on either end. A pair of 16 x 1 beams butted against a 4 x 1 beam forms the second row. Each row is the equivalent of a 36 x 1 beam. Place the rows side by side and pin them together with ten pins. One pin should be used at the end of each individual piece. Don't put a pin in the center hole of the middle piece—that's where the pivots will eventually go. The completed beams form a 36 x 2 beam assembly.

Several plates hold the beams together. Turn the beams over and put a 10 x 2 plate on the bottom at each end. Have the plates overlap the end of the beams by one bump. An additional pair of 8 x 1 plates hold the beams together. Place them next to the 10 x 2 plates, spanning from one beam to the other.

Carefully turn the seesaw assembly right side up. A pair of 8 x 1 beams acts as end caps to the beams; they connect to the "lips" of the 10 x 2 plates sticking out from the ends of the main beams. For further reinforcement, put a pair of 8 x 2 plates over those end-cap beams.

The completed seesaw is shown in Fig. 4.

Two final bits of detail include the

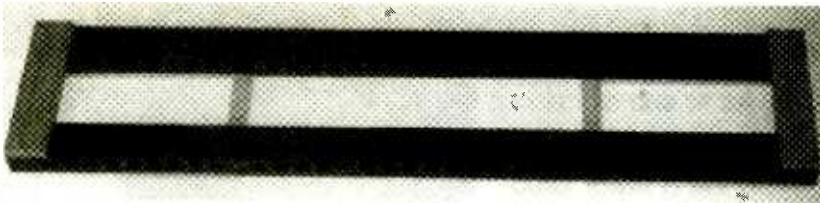

Fig. 4. The seesaw is a simple frame-like assembly made from many small parts.

decision indicators and an axle lock. Put a pair of 6×2 plates at either end of the seesaw. An 8×1 beam sits on top. Those beams will be labeled with the decision slogans you'd like to use on your Executive BDM. Mr. Penfold used "NO WAY!!!" and "GO FOR IT" in his book. Other combinations that you could use include:

- Yes/No
- True/False
- Republicans/Democrats
- Left/Right
- Stop/Go

I'm sure that you can come up with an appropriate combination for your particular application.

Any labeling method that's compatible with the plastic used in the various LEGO pieces will do nicely. Self-adhesive labels printed on a computer are neat and attractive.

The axle lock is simply a 3×1 girder connected to the inner side of one of the beams. Place the piece with one of the end holes over the central hole of the beam assembly. Pin the piece in place with a peg that has a short fitting on one end; the regular pins won't hold the girder tight.

Sensors. The two sensors (actually, touch switches) tell the Executive BDM's software when it's time to reverse the motor. Mounting them on the bottom of the seesaw, while

a bit difficult to describe, is straightforward.

Start with a 6×2 plate. Three 2×2 parts are mounted on top: two 2×2 plates and a 4×2 right-angle piece. The angled part of the 4×2 will hang down off the side of the 6×2 . To the bottom of the free section of the 4×2 , mount one end of a wire lead and a 6×2 touch sensor.

The completed sensor is shown in Fig. 5. Don't forget to build a second assembly as well.

The sensors mount to the bottom side of the seesaw assembly. Turn the seesaw over and mount the sensors. The 6×2 plates act as a mounting area; position them one bump location away from the seesaw's inner cross brace. The switch will hang down between the seesaw beams.

Motor And Drive System. Before we get to the motor and pulleys, we should mount the seesaw to the base and support towers. Take the seesaw assembly and carefully put it in place between the two support towers. The central hole of the seesaw's rear beam fits into the pivot peg we put in the rear tower.

A $3/8$ -inch (94 mm) axle slides through the central hole of the front support tower, the central hole of the front seesaw beam, the axle lock, and the rear seesaw beam. Push the axle in as far as it will go, short of pushing out the pivot pin. You might need to hold the axle lock in place so it doesn't pop out or get loose.

Rock the seesaw and verify that the touch sensors are triggered by the limiters as the seesaw reaches its maximum travel in either direction.

We're now ready to add the motor. The support base is a 10×2 plate mounted behind the front-right support-tower leg. This plate should extend beyond the end of the base by three bumps. You'll also need a 2×1 plate behind the

10×2 plate to form a flat surface for the motor.

Once you've added the motor itself, fit a small pulley (the smallest size available) to the motor's spindle. Insert a $1\frac{1}{2}$ -inch (31 mm) axle into the fifth hole up on the front-right support-tower leg. The largest size pulley goes on the "inside" half of the axle; another small pulley is pressed on the "outside" half.

A second large pulley presses onto the axle that drives the seesaw. Finish up with the drive belts: 1-inch (25 mm) diameter blue bands. Adjust the pulley's along their axles so that the drive belts are aligned. Secure the large pulley on the see-

LISTING 1

```
Private Sub Command1_Click()
With Spirit1
.InitComm
.SelectPrgm 1
.BeginOfTask 0
.SetSensorType 0, 1
.SetSensorMode 0, 1, 0
.SetSensorType 2, 1
.SetSensorMode 2, 1, 0
.SetVar 2, 4, 14
.SumVar 2, 2, 6
.On "0"
.SetRwd "0"
.Loop 2, 0
.If 0, 2, 2, 2, 0
.Off "0"
.StopAllTasks
.Else
.While 9, 2, 2, 2, 0
.EndWhile
.SetFwd "0"
.SubVar 2, 2, 1
.EndIf
.If 0, 2, 2, 2, 0
.Off "0"
.StopAllTasks
.Else
.While 9, 0, 2, 2, 0
.EndWhile
.SetRwd "0"
.SubVar 2, 2, 1
.EndIf
.EndLoop
.EndOfTask
End With
End Sub
Private Sub Command2_Click()
Spirit1.CloseComm
End
End Sub
```

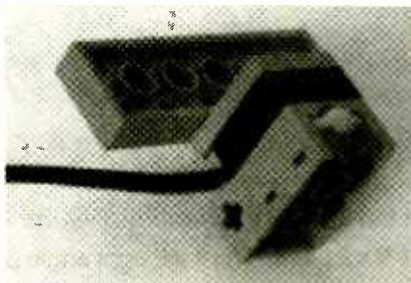

Fig. 5. This sensor is ready for mounting on the seesaw.

LEGO MINDSTORMS ON THE NET

You can visit the LEGO MINDSTORMS Web site at www.mindstorms.lego.com for up-to-date information on new products and new designs. This site is the official Web site run by LEGO.

Features include both "Master Builders" and "Master Coders" sections that offer plans and programming from LEGO in-house engineers, as well as current product descriptions.

There are numerous expansion packs available for the LEGO MINDSTORMS line. LEGO and George Lucas have teamed up to create the Darkside Developer and Droid Developer kits. In addition, you can order separate sensors for your designs. Who knows what a little reverse engineering can do to a LEGO temperature sensor? There are also links available to other LEGO MINDSTORMS fan's sites and discussion forums.

saw axle with fixing nut.

Compare your handiwork to Fig. 6; make any corrections necessary.

The "Home Stretch." The final touch on the Executive BDM is adding the RCX controller to the center of the seesaw. Be sure that the unit's weight is balanced as well as possible over the seesaw's axle.

The wires from the sensors are connected to the number 1 (left) and 3 (right) inputs on the RCX; a third wire connects the motor to the "A" output.

Since the LEGO MINDSTORMS design on wires changes polarity depending on the direction the wire bricks are plugged in, note the directions in Fig. 7, which shows the completed unit.

With construction complete, it's time to program the RCX with the Visual BASIC software.

Forty Lines Of Code And All I Got Was... Penfold uses Microsoft's Visual BASIC in lieu of LEGO RCX code. The Active X control packaged on the LEGO MINDSTORMS Robotics Invention System's CD-ROM is called "Spirit.ocx." This control allows virtually any language adaptable to the Windows environment to be used to program the

LEGO RCX microcontroller.

So what makes this robot tick? Let's examine the software shown in Listing 1 a bit closer. The program is written in Visual BASIC. Programmers unfamiliar with Visual Basic will find it fairly easy to master on rookie level.

The entire program performs only one task. The listing begins with the initializing of the two sensors as inputs. This step is followed by two commands, which are SETVAR and SUMVAR. Together, these commands create a pseudo-random number generator that allows for random outcomes. The motor-control command is incorporated inside a loop along with the random number. When a result of zero is reached, the motor stops and then reverses direction. A mirror image of the previous loop is then initiated and the motor runs in the opposite direction; hence, the unit rocks back and forth.

Get The Book

Both of Robert Penfold's books are available through the Poptronics on-line bookstore (www.gernsback.com). The original article, "Executive Toy," was published in *Introducing Robotics with LEGO MINDSTORMS*. The publisher is Bernard Babani, Ltd. of London, England.

All in all, the brains needed for the Executive BDM barely scratch the surface of the true power of the RCX microcontroller. The RCX has the ability to multitask up to ten separate jobs in parallel. Features and resources of the RCX include four timer circuits with a resolution of 100-mS each. In addition, the RCX has three 9-volt power outputs. The LEGO microcontroller is a streamlined powerhouse. Many projects that are more complicated

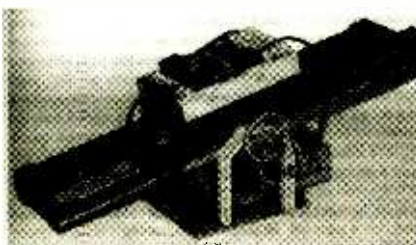

Fig. 7. Voila! The Executive BDM is ready to make the toughest of decisions.

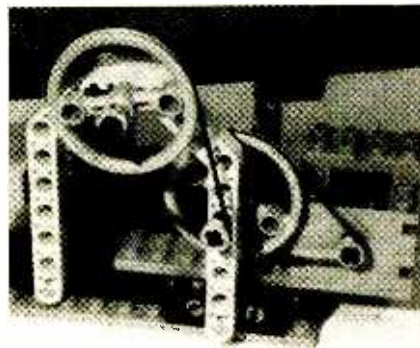

Fig. 6. Note the intricate design of the Executive BDM's drive system. The two-step reduction is evident.

can be built with it.

LEGO maintains a Web site at www.mindstorms.lego.com, where they offer a free software developer's kit in their "Master Coders" section. This kit fully explains how to use Spirit.ocx to write RCX code with Visual BASIC. Downloading that package is strongly recommended. Using both Penfold's text and the LEGO resource document, aspiring programmers can attempt to master the command set of Spirit.ocx and unlock the full potential of the RCX micro-controller.

The command set for Spirit.ocx is not complicated. For instance, in order to control the motor's direction of movement, the software uses RWD for reverse movement and FWD for forward movement. Those two commands allow the user to change the direction of the platform's movement.

The software is downloaded to the RCX via an infrared link and instructions provided in the LEGO MINDSTORMS kit.

Aspire, Adapt, Evolve. With a press of the RUN button on the "brick," the creation suddenly sprung to life and began to rock to and fro. I secretly thought to myself, "Should I apply to win the Nobel Prize for contributions to the field of robotics?" Precious time and sweat had finally paid off as my Executive BDM ground to a halt and made its first decision.

The Executive BDM is a formidable introduction to using alternative programming languages in conjunction with the LEGO MINDSTORMS Robotics Invention System. Yet, one eventually yearns to delve

into more advanced projects.

Penfold's book does offer more complex projects to whet the appetite of the fledgling engineer.

DIGITAL DOGGIES

(continued from page 30)

to the consumer (my vote is for Dante).

For Whom The Bell Tolls. Neglect is a condition each pet adapts to differently. If a child ignores Rocket for quite some time, Rocket will try to attract attention. Subtle whines and whimpers try to alert the owner of the neglect. If Rocket's calls go unanswered, then he will simply go to sleep (he actually snores on occasion). AIBO also tries to keep its owner entertained. Eventually, if no one plays with AIBO, he too goes into hibernation. In time both digital pets would run out of battery power and lay dormant on the floor.

Of course, we know what happens if real pets are neglected. There might be a nudge from a furry paw, followed by persistent barking. If a live pet is left alone for too long without care the results could be fatal. Grooming, feeding, bathing, and physical contact are necessities of life to a domesticat-

Check out this month's "New Literature" column, which reviews the book's sequel, *More Advanced Robotics with LEGO MINDSTORMS*.

ed, living pet.

Each pet, electronic or breathing, must avoid certain hazardous conditions in order to prolong its life. For instance, both AIBO and Rocket can meet an untimely demise if submerged in water. Of course the products can be sent back to the factory and either repaired or replaced per warranty. Old-fashioned dogs can survive a pleasurable jaunt in a sprinkler's spray or even a quick swim in a bay. AIBO has a built-in safety feature that turns off all servos if he is shaken violently, suffers a hard fall, is lifted off the ground, or detects his legs are stuck. When AIBO enters his self-paralysis mode, he can still interact with his environment. A simple touch on the head or a gentle squeeze of his front paws will free AIBO from suspended animation.

From A Toy Manufacturer Far, Far away...

Dr. Buzz Aldrin first welcomed Rocket to earth when he landed outside of Mars 2112 in Manhattan, during the last holiday season of the old millennium. Since his debut, Rocket has managed to multiply in numbers and occupy thousands of homes.

Designed for preschoolers and up, Rocket was created with simplicity and fun in mind. He is operated either by simple button activation or with the Personal Puppy Trainer mentioned in the text of this article.

It is a small tragedy when one loses a family pet. Children who become attached to electronic pets are instilled with a false sense of stability. A child knows if he whines enough, then he will be able to negotiate the purchase of a new toy when the current one breaks. Electronics can be fixed. Real dogs can also be fixed, but that procedure is not one of resurrection (have you ever seen a pet's expression after one of those visits to the vet?).

The Executive BDM works. It gave me a sobering (and obvious) answer to my question. Perhaps I'll ask it for the winning Lottery numbers, instead. **P**

WEB SITES

FISHER-PRICE
ROCKET THE WONDER DOG
www.fisher-price/us/rocket

SONY AIBO
www.aibo.com

The selection of digital dogs can prove to be a useful learning tool for children. Kids can develop their care-giving skills and responsible nature without consequence, while playing and interacting with their electronic pets. Those skills can later be applied to real animals and even fellow humans. After all, it is much easier learning the facts of life on a playful basis.

What's Next? It's looking like a revolution is brewing in consumer electronics. As chips keep getting smaller and more circuit dense, toys are becoming more animated and interactive. Perhaps great visionaries like Issac Asimov and Woody Allen have already shown us a glimpse into our future—Man and Robot sharing societies.

It doesn't look as if androids will hit the market this coming holiday, but the market for AI companions is developing rapidly. It is only a matter of time before the first human-type robot is introduced. Will people choose electronic children over the flesh and blood version? There would be no hospital fees, no college tuition, and no moral dilemmas to pester parents. This is all meant in jest, of course. No matter how amazing technology appears to be, there is a sharp boundary between animated plastic and organic beings. The future of dogs like Dante seems promising. **P**

AIBO's Makeover

AIBO hit the markets back in June 1999. This first generation AIBO (an acronym for Artificial Intelligence Robot and Japanese for companion) sold for \$2,500 and only 5000 were made. The 3000 units allotted to Japan sold in only twenty minutes. Artist Sorayama Hajime drew the original design. Sorayama is better known for his erotic illustrations of feminine robots.

A few physical changes were made with the second generation of AIBO. The pup no longer has droopy ears; instead he now has the conical ears of a predator. The largest technological leap for the second generation is its ability to learn and adapt from its environment and through software. The second generation AIBO may be as cute and cuddly as its kin, but now the robot has the potential to learn and mature.

Only You Can Prevent Forest Fires.

Ad
Council



EYEBOT

ROBERT LANG and STEVE THOMPSON

By now, you've probably read the "Hands-On Report" review of Parallax's BOEBot. Owning the device and teaching it to do different things brings out one of the most important aspects of an educational tool: it's fun!

We were all sitting around watching BOEBot scurry across the floor, avoiding obstacles and cats using its infrared obstacle avoidance system when it occurred to us: "Just what does a cat look like from BOEBot's perspective?" From that simple question sprang the inspiration to create the *EYEBot* project presented here: adding telepresence to the BOEBot.

Telepresence is the experience of being present at a live, real-world location remote from one's own physical location. Someone experiencing transparent telepresence would therefore be able to behave and receive stimuli—such as sight, sounds, touch, smells, and taste—as though at the remote site. The resulting vicarious interactive participation in activities, and the carrying out of physical work, will bring benefits to a wide range of users.

For any telepresence system there are three essential components: the *home-site technology* that interfaces to the user; the communication link itself, which interfaces to the home site; and the *remote-site technology* that interfaces with the communication link. We will leave the other senses—hearing, touch, smell and taste—for a later time and begin our telepresence system with the most important sense: SIGHT!

*To see or not to see;
that is the equation...*

The Basic Unit. BOEBot is a 4½ × 5 × 4-inch, 3-lb. robot kit from Parallax, Inc. The "BOE" in BOEBot stands for *Board Of Education*, which is the name of the basic device from which BOEBot is built. That core PC board is a general-purpose training kit for learning about one of Parallax's main products, the Basic Stamp II.

The Basic Stamp II is a miniature circuit board shaped to look and act like a 24-pin IC. Several surface-mount components are contained on that mini-board, including a PIC microcontroller with supporting circuitry and an electrically-erasable programmable read-only memory (EEPROM) chip. The PIC is programmed with a BASIC interpreter: a special program that reads lines of text from a BASIC program,

changes them into PIC instruction codes, and executes them—one line at a time. Any BASIC program that you write is stored in the EEPROM.

The Board Of Education adds several enhancements to make experimenting with the Basic Stamp II an easy task. A breadboard section lets you add special circuitry that interfaces with the Basic Stamp II. Provisions are also included for using either a wall-mounted power supply or a 9-volt battery. Since BOEBot needs to be completely self-contained—tether cables aren't much fun—one of

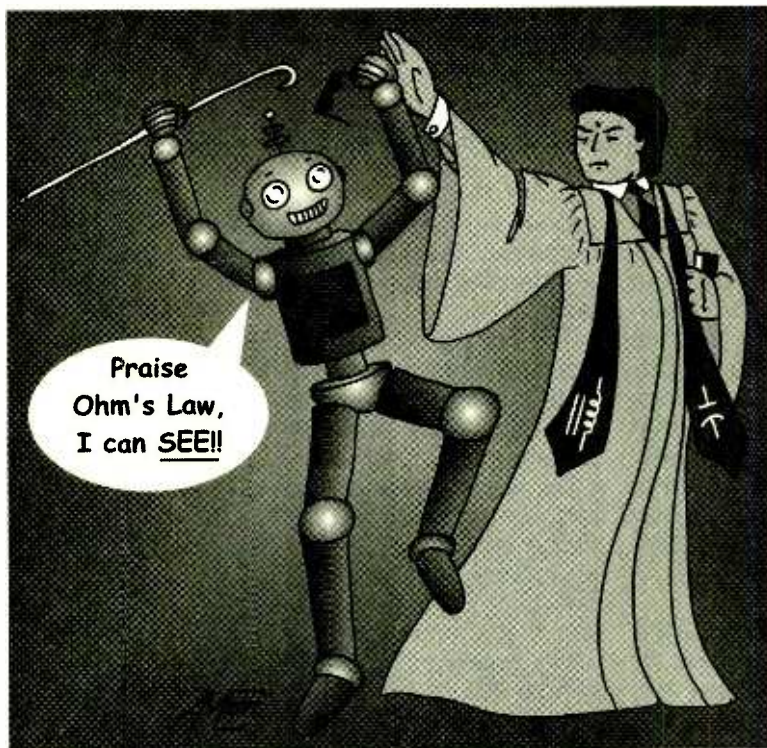

the project requirements was for no connecting cables of any kind. To that end, all power is supplied by a pack of four AA batteries.

A vision system, on the other hand, poses a new set of questions. Having EYEBot react to whatever its (his?)

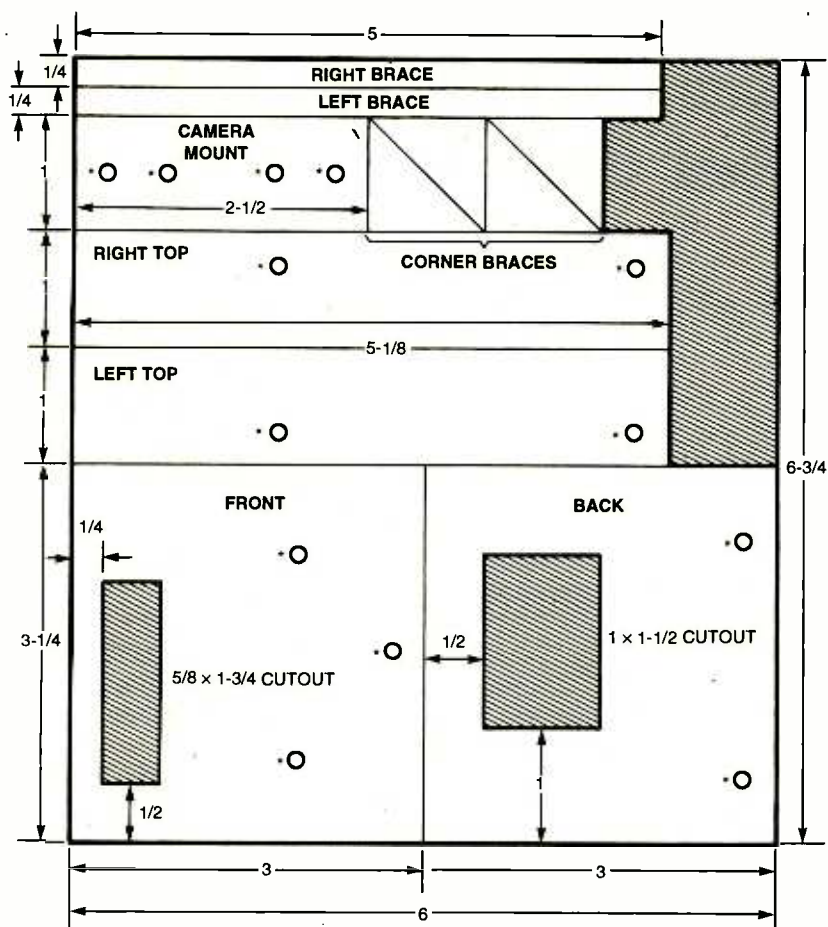

*SEE TEXT FOR HOLE LOCATIONS AND DIAMETERS
ALL DIMENSIONS IN INCHES

Fig. 1. The EYEBot's frame is made from a sheet of sign plastic. Here's how to cut out the various frame pieces with a minimum of waste.

her?) camera sees might be a bit much for the on-board Basic Stamp. Although some might point out that the LEGO MINDSTORMS Vision Command system can do just that, consider that that camera already has a digitizer and form of micro-processor inside it—adding to that system's computer-processing power.

With those restrictions in mind, our remote-site telepresence system will be based on a video camera and transmitter.

Building The EYEBot Frame. The BOEBot has a very nice chassis for making additions. Because the BOEBot is small, the camera and transmitter must be lightweight and small as well. The frame, to hold the camera and transmitter, was made from styrene plastic. A good source for styrene plastic is a local sign shop. They carry a white styrene signmaking plastic that is 0.06-inch

(about 1/16-inch) thick. The EYEBot frame requires a piece of plastic 6 x 6 3/4 inches, which costs less than a dollar.

The cutting pattern for the various frame pieces is shown in Fig. 1. Note that there are windows in the front and back panel. The front-panel window is for sensors; in our case, we were using infrared sensors—an accessory beyond the scope of this article—for collision avoidance. The back-panel window is for the serial-cable connection that's temporarily connected when downloading programs from a host PC to the BOEBot's Basic Stamp II. The rear window makes it convenient for making programming-cable connections without having to remove the EYEBot add-on unit.

To cut the sheet plastic into the various frame components, start by scoring the cut lines with an Xacto

or other hobby knife. Carefully snap the pieces along the scored line to separate each piece. The resulting cuts will be clean, straight, and sharp without any wasted material.

A good cutting order would be to start with the long cuts along the shorter (six-inch) dimension of the plastic. You can cut through the waste areas, such as the area below the left and right top pieces. The waste areas are, well, scrap that will be discarded, so you don't have to worry what happens to them.

Score and break the front/back piece to separate the two sections. Be careful when cutting the windows in those pieces—the "score/snap" technique might stress and break the finished pieces. Remember, the plastic, while lightweight and strong, can be very brittle when flexed. Repeated scoring coupled with gentle flexing will reduce the chance of ruining the piece. Another technique would be to punch or drill a suitable hole near one corner of the window and use a "nibbler" tool to cut the window to the appropriate size.

Three 1/8-inch-diameter holes—one on the front and two for the back—are needed for the appropriately-sized hardware to attach the EYEBot frame to the BOEBot. They are shown in Fig. 1 in only approximate locations. You should mark their locations based on your actual BOEBot and how high you want the frame to sit on the BOEBot. Keep in mind that you'll need enough clearance above the BOEBot's bread-board area for whatever circuitry you want to add to your experiments. The plastic is soft enough to drill by hand, gently twisting the drill bit. If you use a motorized setup (drill press, handheld electric drill, etc.), drill the holes at a low speed. Too high a spin rate on the drill will heat the plastic, resulting in melting and distortion.

Score and break the rest of the pieces to their required lengths. When cutting the triangular corner braces, follow the technique used on the front and back pieces: first break the larger rectangles, then score and break the diagonals to form the final triangles.



The completed EYEBot frame is ready for mounting on the BOEBot.

Although it's tempting to plunge ahead and put the frame together, set the pieces aside for the moment. We'll need to drill some holes for mounting the EYEBot's electronic components, a task that's easiest on individual pieces rather than a completed frame.

The EYEBot Transmitter. The link between EYEBot's camera and us is a low-power TV transmitter. We selected the TV-6 kit from Ramsey Electronics—a company that has been in this facet of hobby electronics for many years. The completed kit runs on 12 volts DC and includes a 19-inch whip antenna. The output can be tuned to any VHF TV channels between 3 and 6, giving you a good choice of frequencies that won't have to fight with a local TV station over whose signal gets to the TV first.

The transmitter accepts normal video and audio from a TV camera and generates a low-power TV signal that can be picked up by nearby TV sets. The kit instructions are well written, and the kit can be built by an "intermediate-level" hobbyist in under two hours. The only modification we made to the kit as delivered was to add a red LED and a 1000-ohm resistor as a power indicator across C8; the transmitter circuit doesn't include that "extra."

Before you start building the kit, identify the four mounting holes. Place the plastic pieces that the board will mount to (labeled "Left Top" and "Right Top"), mark the hole locations in the plastic, and drill the holes in the plastic to fit the hardware that will bolt the transmitter board to the EYEBot. The screw and nut size that you use will depend on the mounting-hole size

in your transmitter board.

As stated in the Ramsey assembly manual, "licensed TV broadcast stations and their listeners have all the rights!" As an unlicensed operator of the TV-6, you must not cause interference with them. Thus, when you tune your TV-6 to a TV channel, make sure that you use a channel that can not be picked up over the air in your area. Furthermore, do not make any modifications to the kit that might boost its output.

While we are discussing government regulation, you may have seen smaller TV transmitters advertised by Ramsey or other firms. Certainly, the smaller the transmitter, the better it would work with EYEBot. However, a recent U.S. Federal government action (U.S. Code Title 18, Section 2512) has prohibited Ramsey and others from selling a number of miniature transmitters whose "primary use" is for "surreptitious" use and not for hobby or educational use. Because of its large size and low output, the TV-6 is not on that list of prohibited products. Should you wish to find more details on this situation, visit the Ramsey Web site for more information.

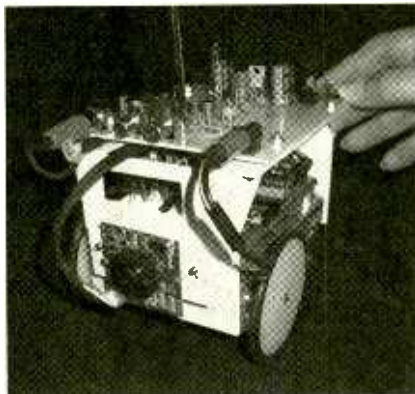

The completed EYEBot/BOEBot combination is ready to be "fired up."

Modifying The Camera. A 1/8-inch CCD-type black-and-white board camera was purchased from Electronix Express. The camera has a fixed 85-degree field of view, the equivalent of a 4-mm lens, and a 0.5-lux sensitivity; and it produces 400 lines of resolution.

A few modifications were needed. The camera comes equipped with a female RCA-type jack for video. That jack was replaced with

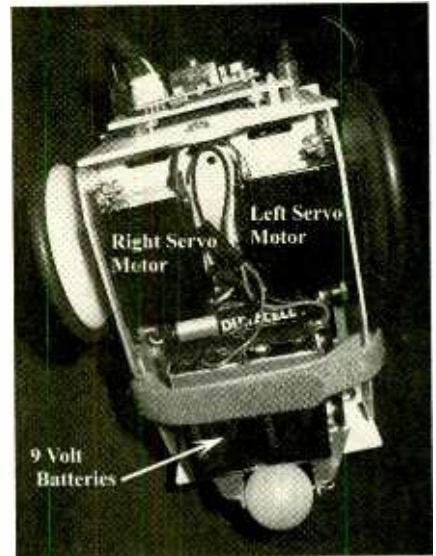

This shot of EYEBot's undercarriage shows how the camera/transmitter batteries are strapped in place with a length of Velcro tie-down material.

a male RCA plug for connecting to the transmitter. In addition, the 12-volt power connector was removed, the wire ends stripped, and those leads soldered directly across the transmitter board's large 1000- μ F electrolytic capacitor, C16. You might want to hold off on making that connection until the circuit boards are mounted to the frame. That way, you can be sure that you have enough wire to reach from one location to the other.

We can't stress enough the importance of double- (or even triple-) checking the polarities of the connections. The last thing you want to do is buy another camera because you blew up your first one with a moment of carelessness.

Center the camera board on the camera-mount plastic. Mark and drill the camera's hole locations on the plastic for 2-56 hardware. An additional pair of holes lets the camera-mount plastic piece bolt to the front plastic piece.

Bolt the camera to the mounting plate with screws and nuts. We used a piece of felt underneath the camera to provide a cushion between the camera board and the plastic.

Modifying BOEBot. The electrical current requirements for BOEBot and EYEBot combination are given in Table 1. Since a 6-volt battery pack (4 AA batteries) powers the

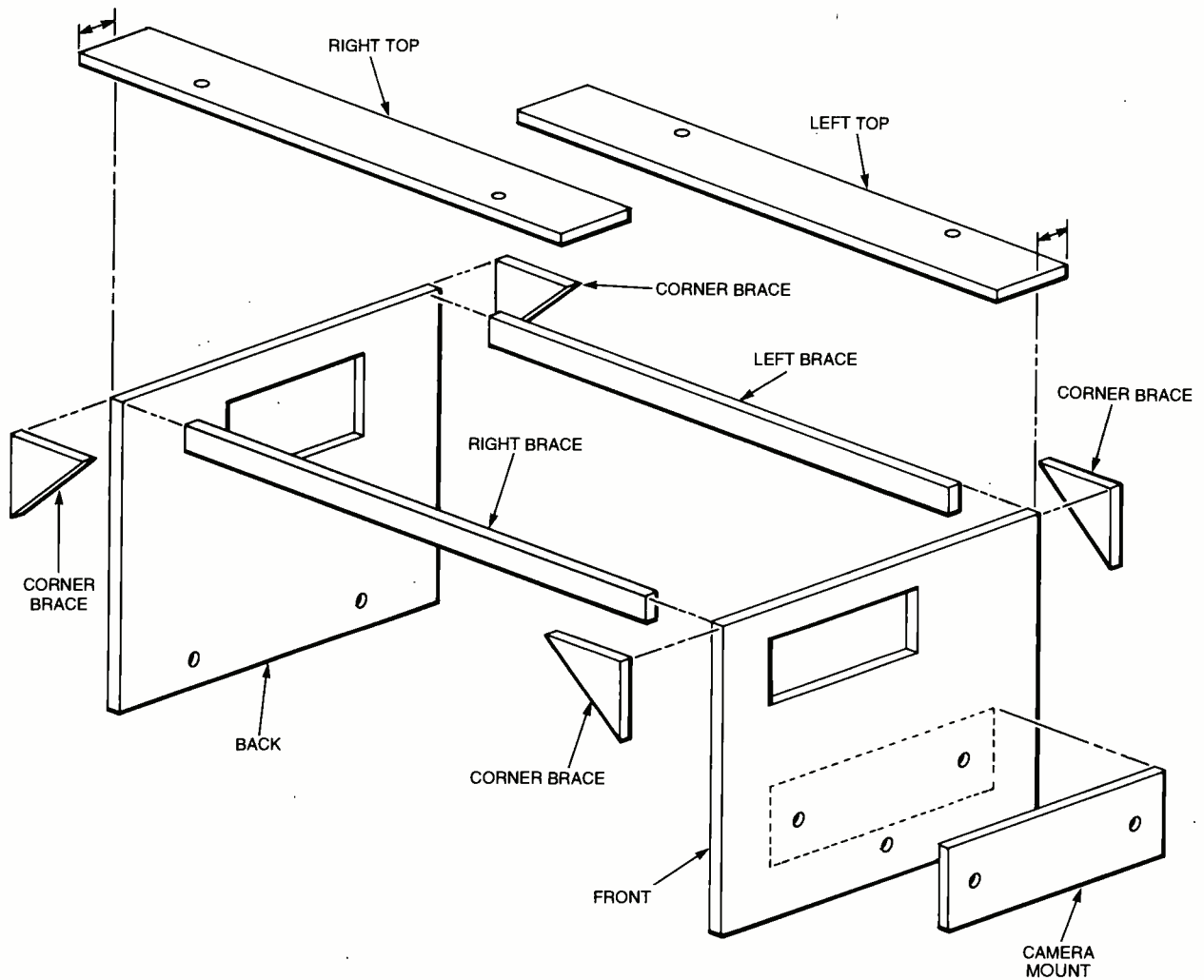

Fig. 2. The frame is glued together with plastic cement that partially melts the edges of the plastic pieces. The resulting joint is more "welded" than "glued."

standard BOEBot, our principal modification to the BOEBot was to upgrade the battery system to supply 12 volts to the EYEBot video system. However, we don't recommend that method for reasons we'll reveal later. What we recommend is to add a second battery pack consisting of two 9-volt batteries wired in parallel.

In determining where on BOEBot to add the second battery pack, we considered that the EYEBot system had the effect of raising BOEBot's center of gravity. To counteract that effect, we decided to add the new battery pack to the underside of the BOEBot, thereby maximizing the overall stability of the system. Using a bit of Velcro, we strapped the second battery pack directly beneath the original battery pack. You can see how that was done in the photographs.

Final Assembly. With everything prepared, we're ready for final assembly.

The frame is assembled with styrene plastic glue, which melts the edges of the plastic pieces together, forming a "weld" of plastic. Use the exploded drawing shown in Fig. 2 as a guide as to how the various pieces fit together. You might want to use a piece of plate glass as a work surface; it's smooth, flat, and doesn't stick to the glue.

Start with the triangular corner braces. Glue them to the corners of the front and back pieces. Use whatever method you'd like to prop the pieces at perfect right angles to the glass surface as the melted plastic edges solidify and form the weld. Once they are set, add the left and right braces.

When the braces are set, turn the frame over. Mount the top pieces to the transmitter board and glue the plastic pieces to the frame. Note from the photographs how the board is set toward the back of the frame, leaving a gap at the front.

Attach the camera to the front panel with the appropriate hardware as mentioned before. If you didn't connect the camera power leads to the transmitter, do so now.

The EYEBot frame is now mounted to the BOEBot with 6-32 screws

TABLE 1 EYEBOT CURRENT REQUIREMENTS	
COMPONENT	REQUIREMENT
BOEBot	52 mA @ 6 volts
Each Motor	12 mA @ 6 volts idle 200 mA = 325mA running
Camera	100 mA @ 12 volts
Transmitter	105 mA @ 12 volts



With EYEBot functioning properly, you can explore the world from a new perspective.

and nuts through the holes previously drilled in the plastic frame. Run a pair of wires (watch the polarities!) from the transmitter's power connection to the second battery pack under the BOEBot. The completed EYEBot unit is shown in the photographs.

Testing And Tuning. Choose an unused TV channel in your area to tune the transmitter. The TV transmitter comes with three "knobs" to be used to tune the picture: channel-adjust coil L4, video-gain potentiometer R3 (for brightness control), and bias potentiometer R7 (for best overall picture). To tune the transmitter, first obtain a basic picture by adjusting L4. Fine tune the picture by adjusting R3 and R7. These controls are interrelated, so it requires some repetition to achieve the best picture. We found that there was a trade-off between picture roll and exceeding the contrast capability of the camera. With the tuning complete, we were ready for the final test.

Turn on transmitter: OK, there's the picture! Turn on EYEBot...

Disaster? While everything described above sounds like developing the EYEBot was a simple, straightforward task, it was...until we reached that first "acid" test.

When we first tried EYEBot out, a horrible, distorted picture with interference was the result. What was causing the interference? At this point, we could only take solace in William Blake's famous quote, "the true method of knowledge is experiment."

So we tried some experiments. Initial possibilities for interference were the Basic Stamp II micro-processor or EYEBot's motors. Disconnecting the motors, we ran the micro-processor and video system; there was no interference. Turning on the motors pro-

duced the distorted picture. In addition, isolating the BOEBot and EYEBOT power supplies from each other got rid of the distortion.

Let us explain that last statement. Initially, we knew that we needed 12 volts to drive the transmitter and that the BOEBot already had 6 volts available. Essentially, we needed to add another 6-volt battery pack.

We placed the two battery packs in series. Pack No. 1 (the original set of four AA batteries) would provide six volts to the BOEBot; packs 1 and 2 (a second set of four

ABOUT THE AUTHORS

Robert Lang is a professional electrical engineer interested in robots, MIDI, and voice synthesis. He has written several articles for computer, electronics, and synthesizer magazines.

Steve Thompson is a nuclear engineer whose hobbies include the study of artificial intelligence and genetic engineering.

AA batteries) in series would provide the 12 volts needed by the EYEBot system.

With further investigation, we found that the motors were causing such a drain on the power supply when they were activated that the voltage to the transmitter was changing. We decided to isolate the motor power supply from the transmitter power supply. Although the camera and transmitter are rated for 12 volts, we found that both worked fine at 9 volts. Hence the two 9-volt batteries in parallel. This change worked fine, and the motors no longer caused interference with the transmitter.

Further reading of the BOEBot manual revealed that Parallax had changed the design of the voltage-regulator circuit because the motors were actually causing the Basic Stamp II to reset when the motors were turned on. An alternate to the two-power-supply solution might be to replace the LM7808 regulator on the transmitter board with a low-dropout LM2940 8-volt regulator. The bottom line is that the 9-volt system is working well for the moment.

What Now? Turning a BOEBot into an EYEBot was an "eye-opening" experience, to say the least. Not only was it a low-cost addition, the educational and fun aspects of experimenting with a visual telepresence system are immeasurable.

Where do we go from here? Add another sense to EYEBot? How about hearing? How about a mechanical arm (a very tiny mechanical arm, to be sure)? The possibilities are only limited by your imagination.

Here's looking at you, kid; be seeing you!

COMPONENT SOURCES

Basic BOEBot Kit
Parallax, Inc.
 599 Menlo Drive, Suite 100
 Rocklin, CA 95765
 916-624-8333
 info@parallaxinc.com
 www.parallaxinc.com

B&W Video Camera
 Item #29CVM6792, \$44.00.

Electronix Express
 A Division of R.S.R. Electronics, Inc.
 365 Blair Road
 Avenel, NJ 07001
 732-381-8020
 www.alex.com

TV Transmitter
 Kit #TV-6, \$27.95
Ramsey Electronics Inc.
 793 Canning Parkway
 Victor, NY 14564
 716-924-4560
 www.ramseyelectronics.com

LETTERS

(continued from page 4)

and the consequences of bad luck can be devastating.

My advice to readers is to avoid being complacent. Always take precautions. Windows systems that have file sharing enabled (so that their home LAN can access the same files from multiple home computers) are especially vulnerable. Don't enable file sharing unless you have taken other precautions such as using a firewall and using the programs Tony and Ted mentioned, *Black Ice* or similar from Norton and McAfee. In fact, use protective methods even if you don't enable file sharing.

(Some ISPs, like ATT AtHome, suffered bad press from security problems involving file sharing, and therefore configured their servers to screen out all file sharing. Or so you hope; no ISP is infallible.)

Increasingly popular Unix-based systems, like Linux and FreeBSD and the forthcoming Mac OS X desktop, become more vulnerable as more Internet services are enabled. My mistake was first in not having configured a software firewall, and second in having my Linux box offer a huge array (way more than I actually needed right then) of standard Internet server options, such as software servers for incoming ftp, telnet, DNS, etc. One of these had a weakness that was exploited by the bad guy to grab control of my system. All operating systems have weaknesses.

Two further points of interest: First, some readers may still be in areas where ISPs offer only Unix shell accounts. They may be interested to know that it is possible to use a shell account to actually get full Internet connectivity via a program I mentioned, "dip," that simulates the SLIP or PPP protocols in a program run from the ISP shell account. It is included in some Linux distributions, or it can be downloaded from: www.ibiblio.org/pub/Linux/system/net_work/serial/dip/dip-3.3.7n-jsi.tgz. There used to be a similar commercial program, *Tia*, for Windows users; I'm not sure if it is still available.

Second, I recommend the brand-new book *Real World Linux Security: Intrusion Prevention, Detection and Recovery* by Bob Toxen, a security consultant who has a quarter century of experience with Unix and security. See <http://www.realworld>

linuxsecurity.com.

DOUG MERRITT

via e-mail

Anyone For More HAM?

I have seen several references questioning the origin of the HAM moniker used to refer to amateur radio operators. (See "Q&A," December 2000.) I would like to add to the information available to your readers, and I will let the Web site speak for itself. Please go to <http://web2.airmail.net/gerryc/newham/nb/p9.html> for a different story.

BOB HILLMAN

via e-mail

Article Suggestion

I am interested in seeing articles covering these subjects: a very good AM antenna, a circuit that receives the NOAA severe warning signal and turns on a radio or some other device, and information concerning the small hand-cranked generators found in some portable lights or flashlights.

JACKIE DIXON

via e-mail

The Future Is Now

I am amazed at the rapid advancement of technology as shown in the "Prototype" section, entitled "Mirror of the Future" (*Poptronics*, Oct. 2000). Ultralight piezoelectric material that will be used in space telescopes and satellites will help us advance further into the space race.

The future of mankind is upon us, and this material will help us reach the next level of exploration.

JOSEPH ANTHONY SOYO

Walnut Creek, CA

DTV Won't Fly

I am in the process of updating our Telecommunications course and read your article "Looking Forward To DTV" (*Poptronics*, September 2000) with great interest. The technology is exciting, but I don't think DTV will happen in our lifetime.

As I'm sure you are aware, every improvement in the broadcast industry was done with great deliberation. The philosophy was that whatever changes are made, it cannot make existing equipment unusable. Some cases in point are

FM stereo, color TV, and AM stereo. In each case, older receivers still worked; they just couldn't derive any benefit from the new transmission features. With the DTV plan, however, this is all different. Existing equipment will not work, at least without an adapter.

If smaller television stations are anything like smaller radio stations I'm familiar with, they simply cannot afford to update to the new equipment. Similarly, probably most consumers will not be able to afford the new receiver or adapter.

Frankly, I can see attorneys' pens poised to write lawsuits on this one. Many of the lawsuits will be sponsored by large companies who will be losing huge numbers of viewers (read this as lots of advertising dollars).

Geophrey McComis, the writer, also stated that the marketplace would determine the actual technical standards. Remember the "marketplace approach" the FCC took in the AM stereo issue? Knowing they would be sued by the loser in the case of Motorola vs. Kahn-Hazeltine, the FCC didn't want to pick a standard, and AM stereo fell flat on its face. Equipment manufacturers didn't want to be caught with worthless inventory, and broadcasters didn't want to be caught with useless equipment (which had a price tag of more than \$10,000).

I believe DTV will go the way of AM stereo, quadrasonic-stereo broadcast, and Dolby broadcast.

RANDY KAEDING

Stevensville, MI

Haves & Needs

I am looking for information on how to use older 30- and 72-pin memory SIMMS, specifically on making my own circuit board to use these memory chips and on constructing a board dedicated for RAM drive purposes. It would be nice if I could find artwork for the board as well or find someone producing such a board. I would also need the software to set it up. My system uses Windows 98, but other systems would probably include Linux or Unix.

Thank you for your help.

KEN FRINK

kfrink@kcyberhighway.net

Science Fair Bot

Fiction by JOHN BACHMAN

Gotcher project yet?" Evan slid his tray next to his cousin's and clambered over the bench seat.

"Nope. No clue. You?" A mouth full of pizza filtered Od's answer.

"Naw. I'd like to do something electronic, but I don't know what."

Od could have been the model for smiley face. "How about a Van de Graaff? We could send lightning bolts across the gym and make girl's hair stand up and stuff."

"Zapster wouldn't let us do that. He's pretty unreasonable."

"Yeah. He'd never go for it." Od stuffed another slice of pizza into his oversized mouth. "Hey! I know." Crust crumbs sprayed two girls sitting across the table. The girls slid out of range while firing their best looks of disgust at Od. The looks bounced off Od unnoticed. "Let's ask Uncle Gus. He has lots of ideas."

"Do you think it's safe? Is he over that night-crawler thing yet?"

"My mom says he healed up," said Od. "Besides, that wasn't our fault, just an accident. He shouldn't have grabbed the rod while it was plugged in. She says that he has a scar on his palm and is more nervous than ever."

"Let's go to his shop after school, but be ready to run," Evan warned.

After school, the boys raced to Gus's Electronic Repair. "Good cop, bad cop," puffed Evan as they slid to a walk on the corner next to the shop. "I'll be the good cop."

"Hey, Unk!" Evan called out as they burst through the back door startling Gus, who was holding a scope probe into a TV chassis while staring at the trace. He popped off his stool as a "zap" came from the set followed by a little puff of smoke. Gus spun around wild-eyed as if the Devil had appeared in his shop.

"Sonuva...Stand still! Hands in pockets! Don't touch nothing!" He moved slowly toward the boys, who leaned toward the door anticipating a quick escape. "What kind of trouble are you two making now? Don't answer! I don't want to know." Gus held up a shaking right hand. His left automatically grasped the right, pulling it down while rubbing the scar on the palm.

"Unk, we need some help," pleaded Evan.

"Hah. Best advice I have is to turn yourselves in. The judge might go easier on you."

"No, Unk. We're not in any trouble. We have to do a science-fair project at school and don't have any ideas. Can you think

of some electronic project we could do?"

"No, now go away!"

Time for the bad cop, thought Od. He poked at the buttons on a CM2125 monitor analyzer. "What's this do, Unk? Looks new."

"Get away from there," Gus yelled, his hand shaking in the air again. His head started twitching to the right. "...I can't be involved in any more of your projects. My insurance lady said no more."

"Od, get away from that!" said Evan the good cop. Od jumped back from the bench. "You don't have to be involved, Unk. Just come up with an idea."

Gus looked nervously around the shop, then slumped to his stool. "Not involved, huh? You sure? I mean, like, you promise? Both of you? I give you an idea and you go away and I don't see you again until you graduate from reform school?"

Two heads nodded furiously.

Gus held his hand nearly still.

"Well, let's see. A science project, huh?

Electronics. Something that you won't need my help. Hmmmm. Your Uncle Ferd left an old robot here. One of those deals that he used in trade shows. It wanders around in front of the booth and talks to passers-by. You could get that going again and have fun with it. No harm in a little robot. Yeah, that's it."

"Cooooool!" sang the boys in unison.

"The battery is probably dead," said Gus looking

All they needed was a simple exhibit for the Science Fair. Preferably something that wouldn't get them in trouble...



around the shop. "Tell you what. If you leave now, I'll get it charged up and drop it off tonight. Then you do what you want and don't bother me. Deal? Which house?"

"Cooooo!" crooned the boys. Then Evan spoke up, "Better take it to Od's house, 'cause he isn't allowed to come to mine for a while."

That evening, Gus backed his van into his sister's driveway. The boys ran out to greet their new bot as Gus opened the van doors. He lowered a ramp and rolled the robot onto the driveway.

"R2D2!" screeched Od. Indeed, the bot had the same shape and size of the famous *Star Wars* robot.

Gus pushed the robot into the garage. "Come on, and I'll show you how it works."

"The charger plugs in here." Gus showed them the charger jack and on/off switch on the bot. "The battery is weak, but you should be able to get a couple of hours out of it. This hand-held control box makes him move, steers, turns the head, and raises the arms. This cable attaches it. The left arm works but not the right. Maybe you guys can figure out what's wrong. The microphone plugs in here so someone can talk through the robot. If you do it right, people think that the robot is talking."

"Cooooooooooooo!" chorused the boys.

"OK. You got it. Now don't bug me. I'm outta here." Gus hurried to his van, flipped the ramp inside and sped away. The boys already had the bot dancing around the garage.

"I'm Gnarly," Od announced through the microphone. His voice sounded mechanical and, well, "roboty." Evan raised the left arm. When he tried the right, a whirring sound came from inside the bot, but the arm did not move.

"Let's fix that arm," said Evan.

They quickly removed a side panel cover and lost the attaching hardware. "I bet this chewed up belt has something to do with it," said Od, as he pulled the remains of a pulley belt from the floor of the bot.

"Let's look at the other side," said Evan. Within minutes, all of the cover hardware was lost.

They found a similar belt strung around two pulleys to lift the left arm. Od looked around the garage. "My father must have a belt sorta like that." He pulled a used fan belt off a nail on the wall and held it against the one in the robot. "Too long." He rummaged in the toolbox, found a utility knife and cut the belt. Then he ran the cut belt around the good one and lopped off the remaining piece. "Duct tape will hold it," he

announced. They taped the ends of the belt together, installed it as tight as they could and tried the right arm. The arm raised smoothly until the duct tape joint hit the drive pulley. The slipping pulley squealed until the joint thudded past, lurching the arm skyward like a Nazi salute. "Cooooooooooooo!" warbled the boys.

"OK," answered Evan. "Let's tell Zapster tomorrow."

The next morning the boys raced to the science room before classes started. "Excuse us Mr. Zappino," said Evan. "You said you wanted to know what we were going to do for a project and we have a great one."

"OK, guys. What is it?" The Zapster's brow furrowed over the top of his glasses.

"A robot!" exclaimed Od. "A really cool robot. Like R2D2!"

"What does it do? No lasers, no guns, no saws or cutting devices of any kind. Does it move?"

"Yeah, it can walk around and it talks and it has arms and lights, and...and..."

"No moving. You'll ram something."

"Okay, Okay," offered Evan. "We'll operate on a rope so nothing can happen."

"Deal," Mr. Zappino seized the chance to tether them. "If there is a large eyehook welded to the unit, I'll take care of the rest."

"Yup. Already there," beamed Od.

On the morning of the fair, kids were busy preparing their projects for judging. Mr. Zappino dragged a large chain to the basketball net where Gnarly waited. The duct tape holding the side panels in place made him look more like the Michelin tire guy than R2D2. Od watched carefully as Zappino wrapped the chain around the post and through the eyehook on Gnarly. Then Zappino removed a combination lock from his pocket, opened the lock and hooked it around the two ends of the chain. He examined his work and walked away with a confident bounce in his gait.

Od operated the control. Gnarly groaned across the floor. "The chain is weighing him down," Od moaned. "He can hardly move."

"Let's charge his battery," suggested Evan. "Maybe he'll go better with a full charge." Evan plugged in the charger as Od examined the padlock. He was surprised when it sprung open. *It must be a trap*, he thought as he looked over his shoulder. He did not see any teachers but spotted Jocelyn Church moving

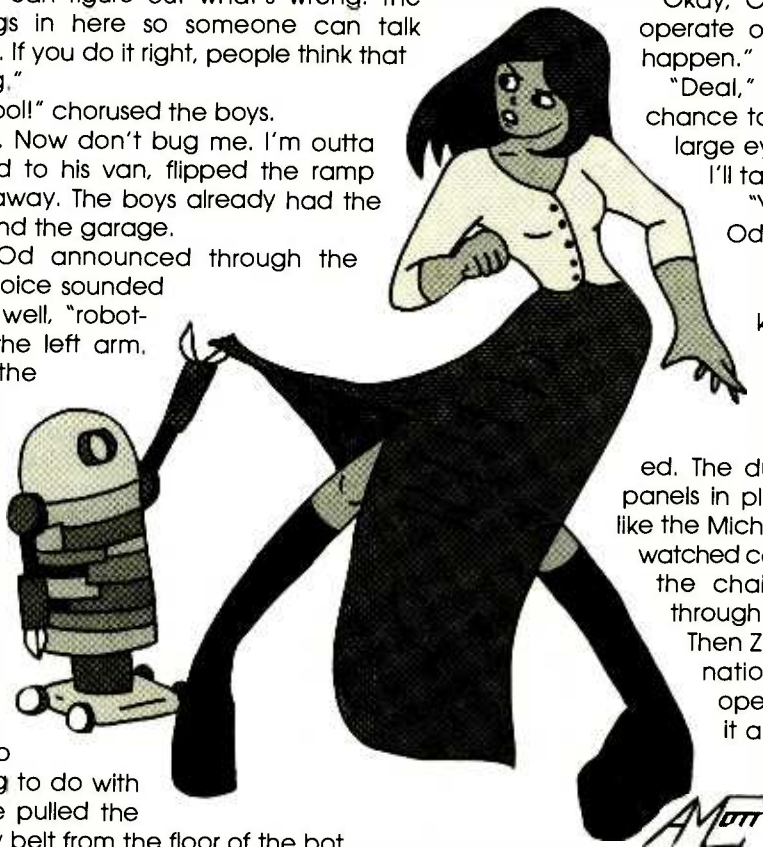

down the aisle looking at the exhibits. Jocelyn stopped with her back to Gnarly while admiring Hank Payne's ant exhibit. Od slid the lock off the chain and sent Gnarly to get Jocelyn's attention. "Hi there," Gnarly announced himself as he approached the unsuspecting girl. Od decided to have Gnarly wave at her as she turned but the right arm stopped part way up. Gnarly stopped next to Jocelyn just as his right arm shot out and up snagging her skirt and pulling it over-head. Jocelyn yanked her skirt back, toppling Gnarly.

"Stop it you perv!"
 "Hey," yelled Od.
 "That was an accident." He jumped to Gnarly and dropped the control so he could use both hands to upright the heavy robot.

"Creep," snapped Jocelyn. She stomped her Frankenstein boot on the control just as Gnarly rocked onto his wheels. Gnarly leaped

into action as if happy to be free of the ponderous chain. He plowed through the ant exhibit spilling the farm contents onto the floor, made a right turn into the snake and then the mouse exhibits. Jocelyn screeched and clomped away as fast as she could operate her new boots. Evan dove for the smashed control trailing the rampaging robot like a tail. He grabbed it but slid on the ant farm soil, looking like a calf-roper being dragged by a mechanical calf. His tugging on the cable pulled Gnarly left into the hydroelectric plant demonstration followed by the corn and effect-of-sunlight-on-plants exhibits. The hydroponics demonstration added more water to the mix.

Mr. Zappino led a group of teachers racing to the commotion. The Zapster slid past Od giving him a quick glare just as he lost his balance while passing Ms Lovely going in the opposite direction. Zappino tried some fancy arm English to keep himself upright but ended up grabbing Ms Lovely by the shoulders. They danced about a while before tumbling to the floor and sliding through the hydro/corn/plant/ponic mixture taking turns being on top. Later, the Zapster would ponder the turn of fate that caused Mrs. Zappino to arrive just as he slid to a stop like a losing mud-wrestler pinned by Ms Lovely's full body press. He had plenty of

pondering time while recuperating from the concussion resulting from the collision of his forehead with the first-place trophy.

Gnarly's bid for freedom ended when he slammed into Drage Flick's demonstration of construction techniques used in building the Sphinx.

Evan and Od fidgeted in the chairs outside Principal Farmer's office door. They did not favor any of the ideas being proposed to the principal by a room full of teachers. "I hope The Zapster's OK," Evan said quietly. "If he dies, we could be in big trouble."

"Why us?" asked Od. "It was Mrs. Zapster who nailed him with the trophy."

The office door opened, and Mr. Farmer motioned the two inside. The boys slid through the door and backed against the wall, not wanting to go any further into the room full of teachers than necessary.

"Which one of you unlocked the chain?" Farmer asked abruptly.

"Well," started Od, talking to his feet. "I was, like, just looking at the lock and it came open. Must not have been fastened all the way or something. Then things just started happening."

"Hmmm," said Farmer. "No one can point to a specific thing that you did wrong. So, I'm forced to just leave it at that. But I will assign a teacher to watch over each of you for the next project. Just to make sure."

"Can I have Ms Lovely?" asked Od. **P**

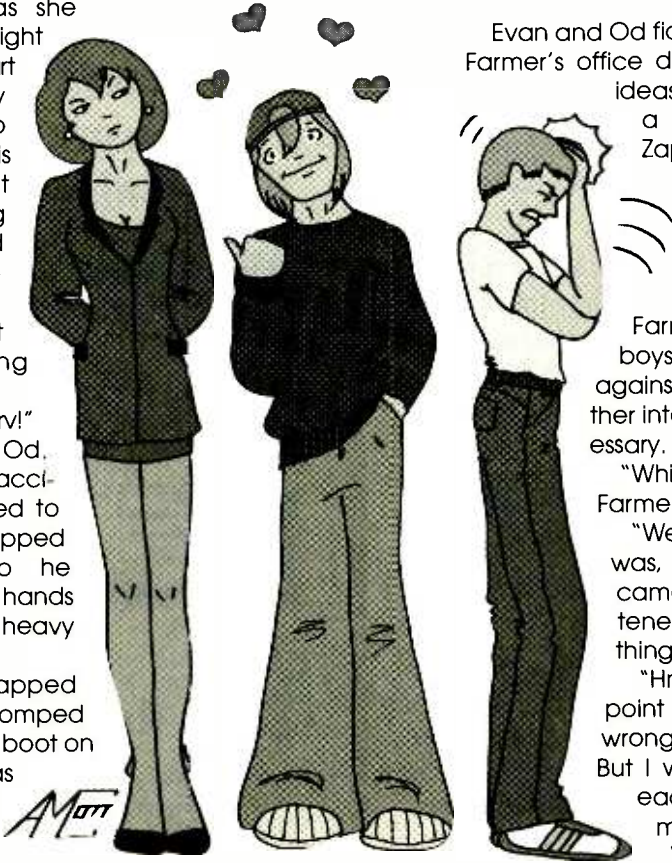

"Oddly enough, batteries were included."

The Electronics Industry is looking for a lot of good people!

Here is your chance to get in on the ground floor as an Associate CET. Is your job title "Electronics Service Technician?" Would you like to have that title? You can prove you qualify for the title with a CET Associate Certificate. It can be your career door-opener and begin your rapid advancement!

A technician or student of electronics with less than a total of four years of basic experience may take the Associate Level Exam. The exam is the basic electronics portion of the full-credit CET exam. The 75-question, multiple-choice test covers basic electronics, math, DC and AC circuits, transistors and semiconductors, instruments, measurements and troubleshooting. A successful Associate CET will receive a wall certificate valid for four years and is eligible to join ISCET as an Associate Member. ISCET is the International Society of Certified Electronics Technicians.

The ISCET Computer-Aided Associate-Level Study Guide prepares you for the Associate CET Certificate by randomly selecting sample questions with appropriate diagrams, provides multiple-choice answers, grades the test and provides a summary of your strong and weak points.

Diskette requires IBM computer or compatible with VGA color monitor, 3.5-in. drive and a hard-disk drive.

CLAGGK INC. – CET Computer-Aided Study Guide Offer
P.O. Box 12162, Hauppauge, NY 11788

YES, I want to step up to a career in servicing. Here is my order for the CET Computer-Aided Study Guide on a 3.5 diskette. I am enclosing **\$39.95** (price includes U.S. shipping and handling) in U.S. funds. Canadians and overseas add \$6.00 per order for shipping.

Bill my VISA MasterCard Expire Date / /
 USA Bank Check US or International Money Order

Card No. _____

Signature _____

Name (Please Print) _____

Address _____

City _____ State _____ Zip _____

New York residents add local sales taxes. Do not send cash. Checks drawn on US Bank and International Money Orders in US funds only. Credit card users may telephone or FAX orders. Telephone 631-592-6720 or FAX 631-592-6723. Price subject to change. Allow 6 to 8 weeks for delivery.

CB06

Proof Positive that you are a Certified Electronics Technician

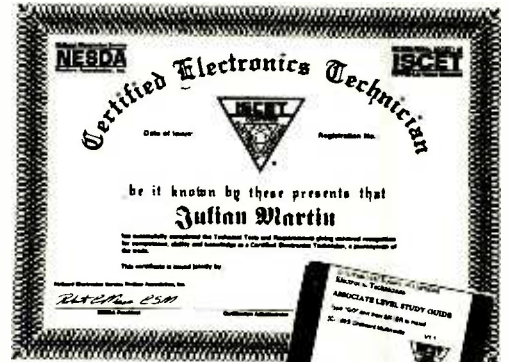

A New

Computer Software Program — ISCET Computer-Aided Associate-Level Study Guide

Prepare yourself for the 75-question CET Associate Examination. Model examinations provide the technician with a study program and introduction to the actual examinations. The model examinations are automatically graded in decimal numbers and bar graphs that can be outputted on your printer. The questions for each exam are selected randomly from a loaded data base—no two exams are exactly the same. When you answer a question, the correct answer is displayed and an explanation is given. From the print-outs you will determine whether you need more practice and in which topic areas, or if you are ready to take the real test and continue to promote your electronics career today!

Dr. Asimov, Call Your Lawmaker . . .

Kind readers: The subject of this special edition of Poptronics—robotics—took me by surprise (“How many robot-based questions does ‘Q&A’ get, anyway?”), but I found that it was amazing how many questions we get each month that potentially revolve around robotics. I hope the slight twist on this month’s column will prove helpful to you.

Robotic Detectors

Q *I’m trying to list all “detection”-type devices that exist, so when I build robots or devices, I can choose the best technology for the given application. What systems give both distance and rate of change for moving objects? What about measuring the distance to an object, even if at an angle? How about systems that actually give a picture or diagram of the object in front of it, such as when approaching a corner end-on or a small object vs. a large object?—P. J., San Rafael, CA*

A Sensory systems and artificial intelligence are probably two of the toughest areas of robotics to conquer because, we’re talking about high-order “thinking” with either one. And “systems” is the best word to use, because, at this time, sensors alone are only input devices. It takes a lot of behind-the-scenes hardware and software to make it all work. Radar, active and passive sonar, infrared (IR) proximity, charge-coupled devices (CCD), temperature, air pressure, humidity, magnetic detection, global-positioning systems (GPS), magnetic compasses, gyrocompasses, tilt, acceleration, and even “curb feelers” are all ways for a robot to sense the environment. All together, it gives robots crude sensory inputs that can’t hold a candle to their biological counterparts. Without additional hardware and software to sort it all out, our machine has rudimentary senses that would yield nothing short of confusion. Active-sonar “pings” can detect range, and if you add circuitry to detect echo amplitude, you can start to get an idea of the size of an object rela-

tive to the distance. Of course, the ability of the object to efficiently reflect the sound wave is a big factor and will foil most attempts at any kind of accuracy.

CCDs with intelligent backup are doing image recognition in industry, but the systems are expensive and still not close to human standards. I believe it was Steve Ciarcia (of *Byte* and *Circuit Cellar INK* fame) who was working on a robot back in the 1980s that used a crude CCD to recognize an electrical outlet at standard wall height so that it could zero-in on it to plug in for a meal when the batteries were getting low. A lot of experimentation was involved for that “simple” chore, and that’s where we still are today as hobbyists. I step on the dog, stub my toe on a chair, and run into the doorjamb just trying to get to the bathroom at 2 AM, and I’m fairly well-programmed for that task. Just think how hard it would be to program all those finely honed nighttime talents into a robot. The whole concept would be a good subject for a series of construction articles, and I’m sure our editor would entertain the idea of a qualified individual doing something like that.

Phoenix From The Ashes

Q *I have a Tektronix 464 oscilloscope with a bad vertical amplifier. I am looking for a source of salvaged parts, basket-case scopes for their spare-parts value, or any other constructive information that would help restore the instrument. A source for another working scope at a reasonable price is also a possibility.—R.G., Aurora, IL*

A The Tektronix 464 is a wonderful mesh-storage scope that’s great for working on those pesky robotic controllers and pulse-width-modulated (PWM) robotic motor controls. The Internet is the best way to find good technical help. You can always go to the factory in Beaverton at www.tek.com, but that’s the expensive way; we’re looking at the casket-end of the 464’s product-support life. Better yet is a site hosted by former long-time Tek employees at www.reprise.com/host/tektronix/home/defa

ult.asp. It’s a great resource site and has an active forum for your woes. Their forum is a little slow to load, which leaves you some time to reflect on your robot’s troubleshooting tree. Of course, the Gernsback forums (www.gernsback.com) are another good choice for assistance. Three other sites that are heavy with Tek subject matter include:

- margo.student.utwente.nl/~wel.tek.htm
- www.caip.rutgers.edu/~kabrs/testeq/
- www.helo.de/

Of course, your best source of “hangar queens” will be at the auctions. Check out eBay at listings.ebay.com/aw/listings/list/all/category4677/index.html and then “Search only in Test Equipment: Oscilloscopes” for “TEKTRONIX.” The screen will come alive with a variety of blue boxes for your bidding and buying pleasure. Don’t forget that your horizons are wider than you may know: except for the storage and CRT circuits, the 464 uses many of the same circuit boards and mechanical parts as the 465, 466, and 468. While you’re logged onto eBay, you might consider searching “All eBay” for “ROBOTS.”

Electronic Stethoscope

Q *I need to electronically amplify a person’s heartbeat and pulse for display on a 20-MHz analog oscilloscope or a digital-storage scope.—J.B., Basking Ridge, NJ*

A You can’t fool me, J.B. I’ll bet you really want this circuit for listening to the faint sounds of failing bearings in the robot that you’ve built! The “Think Tank” column in the January 1999 issue of *Popular Electronics* (pages 50 and 51) has a nice electronic-stethoscope circuit. It offers two levels of low-pass filtering and you could connect a scope at a couple of different points in the circuit. Don’t expect to see an electrocardiograph (ECG)-like waveform since this is an acoustical interface and is not monitoring the body’s electrical cardiac signals.

Note that there were a couple of errors on the original drawing. The pin numbers for the IC2 inputs are reversed,

and the C3/R7 junction should also be connected to pin 6 of IC2 with a dot at the “crossroads.” I’ve built this circuit, and it works really well. If you need a circuit that actually monitors the cardiac impulses, as does an ECG, I won’t be able to help you. Manufacturers of such circuits go to great lengths to insure a patient’s safety from leakage currents, and I would be irresponsible to encourage building such a circuit not knowing the reliability and performance of the components being used. I think you can understand the concern of having a cardiac patient (or a robot) connected to line-operated equipment.

Unity-Gain Automatic Fader

Q The “live” recordings I’m transferring from albums to CD have no silence between tracks. Manually fading at the end of each song to create separate tracks isn’t always very smooth. How can I build a unity-gain stereo amplifier stage with automatic fade-out (and perhaps fade-in) capabilities that would go between my amplifier and PC sound card?—J.R., Portland, OR

A I like automatic control of analog signals; the circuit in Fig. 1 was fun to design and breadboard. There’s no doubt in my mind that this circuit could be adapted for some kind of use on a robot, especially in the area of controlled acceleration and deceleration. Don’t be taken aback by the “antiquated” incandescent-lamp control. Many electronic organs used a similar design to provide smooth great- and swell-pedal control without worrying about a noisy potentiometer.

In the circuit, JFET op-amp IC1 buffers an RC timing circuit to control the current through Q1, which determines lamp intensity. Throwing S1 to the “UP” position charges C1 through R1. The voltage at the input and output of “super-follower” IC1 ramps up to 12 volts at a rate determined by the setting of R1 and the value of C1. With the switch in the “DOWN” position, C1 discharges to zero at the same rate. Two identical unity-gain amplifier circuits have a light-dependent resistor (LDR) as their variable resistor. For slower ramp times, increase the value of R1 and/or C1; faster times require smaller RC values.

Measure the resistance of your LDRs

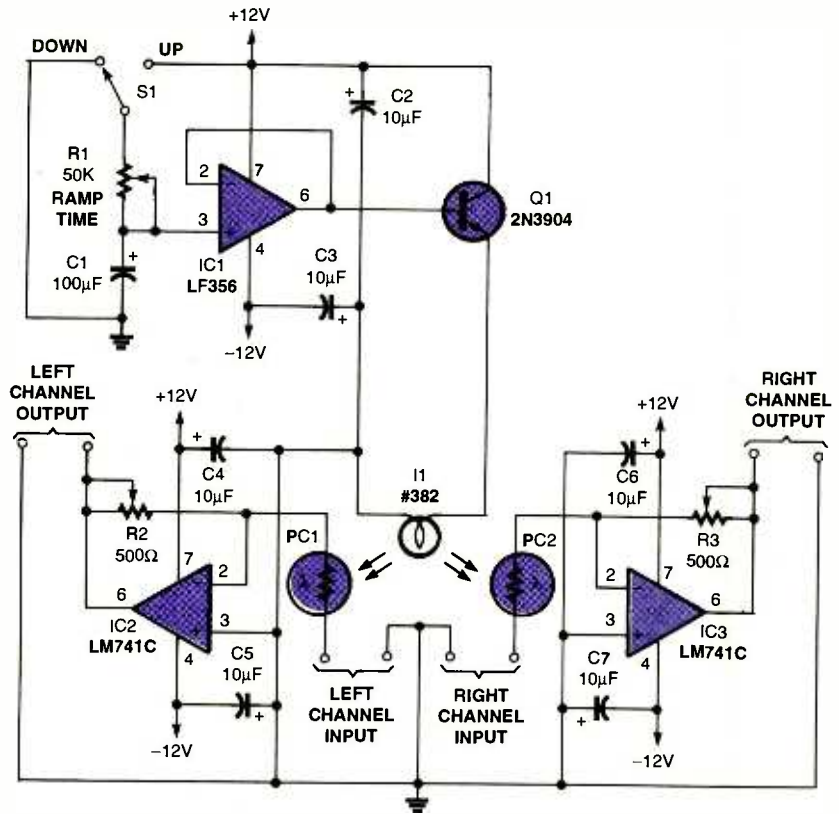

Fig. 1. This stereo unity-gain volume control features automatic ramp-up and ramp-down.

at maximum lamp brightness and select a value for R2 and R3 that is about double that value at maximum rotation. With full lamp brightness, the LDRs that I used had a resistance of about 250 ohms. Adjust feedback potentiometers R2 and R3 for unity gain in amplifiers IC2 and IC3, respectively, with the light at full brightness. At zero lamp intensity, the LDR resistance will be high enough that the op-amp gain is so low as to provide full signal attenuation. I measured about 85dB of attenuation with a 6-volt peak-to-peak input level.

Light-dependent resistors PC1 and PC2 are placed with their faces on opposing sides of I1 and mounted in an absolutely light-tight container. I like using flat-black model paint to seal light leaks. Keep things symmetrical with those three components to minimize channel differences during level changes. I chose a number 382 lamp for its low current demand at 12 volts and, well, because it’s what I had on hand. This circuit puts a maximum of about 9.5 volts on the lamp. Coupled with the voltage ramping, the lamp should last longer than your record collection.

Nearly any JFET op-amp will work for IC1; you might want to choose low-

noise op-amps for IC2 and IC3. There is probably overkill on power-supply decoupling with C2 through C7, but I tend to lean towards a conservative supply that will suffer through all.

There are other designs that could use digital attenuators or FETs as the control elements. This low-cost design comes right from the junkbox. Readers with proven alternative circuits are welcome to share them with us. We’ll publish your elegantly simple design. Just make sure that it’s YOUR design!

Tricky Capacitor Coding

Q I am looking for a list of values that correspond to the numbers on the capacitor.—D. A., Devils Lake, ND

A We’ve covered similar facets of component nomenclature in past columns, but each time, we only cover a piece of the pie. Since you’ll find a lot of those components in automation and control circuits, here’s another slice of the pie that might help with some of the cryptic markings on capacitors.

When values are marked such as “223K,” “104Z,” or “681J,” the values are read much like you read a resistor color code. The first two digits are the

first two significant figures of the value. Typically, they'll be 10, 15, 22, 33, 47, or 68. The third digit is the number of zeros to add. The resulting number is the value in picofarads. For example, "682" decodes to 68 + 00, or 6800 pF (0.0068 μ F). A letter that follows this numerical marking has nothing to do with the value, *per se*, but is the tolerance code. Table 1 lists these tolerance codes and their meaning. Note that the last five tolerances are more for "bulk" capacitance where the actual value isn't that important as long as a certain minimum value is provided. Tolerances

marked with an asterisk are the ones that you'll see most often.

You may also come across a temperature-characteristic code. Some may be a color tip on the top edge of a disc ceramic cap where, for example, black means "NP0." It could be an EIA code such as "5YP." Those codes aren't as important unless you're involved in a design where temperature coefficients play a critical role.

As noted in the April and October 2000 "Q & A" columns, European capacitors include the metric prefix within the significant figures to locate

the decimal point. I might add that larger electrolytic capacitors might be marked in millifarads (mF) in the Old World. They use both nF (nanofarads) and mF in Europe where in the U.S., for some unknown and ridiculous reason, we insist on everything being in either pF or μ F. "1n0" will be 1.0 nF, which equates to either 1000 pF or 0.001 μ F in U.S. absurdity.

Keyboard Availability of "μ" vs. "u"

Tim Wikentiew of Redford, Michigan wrote to remind us that there really is no reason to use a "u" to represent "micro" ("Q & A", April 2000) when the extended IBM character set has a "μ" invoked with <ALT>230. You must use the numeric keypad rather than the top row of numerals on the keyboard when doing this.

Tim, although most word processors, even back to WordStar 6.0 days and earlier, support the extra characters, including "omega," "pi," "lambda," and the "±" character used in Table 1, few of those carry over to Internet applications. For instance, on the Gernsback and other electronics-related forums, you can use "μ" and "±", but the Greek letter "omega" cannot be invoked, which is very infuriating since it is so commonly used in electronics.

HOW TO GET INFORMATION ABOUT ELECTRONICS

On the Internet: See our Web site at www.gernsback.com for information and files relating to **Poptronics** and our former magazines (**Electronics Now** and **Popular Electronics**) and links to other useful sites.

To discuss electronics with your fellow enthusiasts, visit the newsgroups sci.electronics.repair, sci.electronics.components, sci.electronics.design, and rec.radio.amateur.homebrew. "For sale" messages are permitted only in rec.radio.swap and misc.industry.electronics.marketplace.

Many electronic component manufacturers have Web pages; see the directory at www.hitex.com/chipdir/, or try addresses such as www.ti.com and www.motorola.com (substituting any company's name or abbreviation as appropriate). Many IC data sheets can be viewed online: www.questlink.com features IC data sheets and gives you the ability to buy many of the ICs in small quantities using a credit card. You can also get detailed IC information from www.icmaster.com, which is now free of charge although it formerly required a subscription. Extensive information about how to repair consumer electronic devices and computers can be found at www.repairfaq.org

Books: Several good introductory electronics books are available at RadioShack, including one on building power supplies.

An excellent general electronics textbook is *The Art of Electronics*, by Paul Horowitz and Winfield Hill, available from the publisher (Cambridge University Press, 800-872-7423) or on special order through any bookstore. Its 1125 pages are full of information on how to build working circuits, with a minimum of mathematics.

Also indispensable is *The ARRL Handbook for Radio Amateurs*, comprising over 1000 pages of theory, radio circuits, and ready-to-build projects, available from the American Radio Relay League, Newington, CT 06111, and from ham-radio equipment dealers.

Copies of past articles: Copies of past articles in **Electronics Now**, **Popular Electronics** (post 1996 only) and **Poptronics**

are available from our Claggk, Inc., Reprint Department, P.O. Box 12162, Hauppauge, NY 11788; Tel: 631-592-6721.

Poptronics and many other magazines are indexed in the *Reader's Guide to Periodical Literature*, available at your public library. Copies of articles in other magazines can be obtained through your public library's interlibrary loan service; expect to pay about 30 cents a page.

Service manuals: Manuals for radios, TVs, VCRs, audio equipment, and some computers are available from Howard W. Sams & Co., Indianapolis, IN 46214; (800-428-7267). The free Sams catalog also lists addresses of manufacturers and parts dealers. Even if an item isn't listed in the catalog, it pays to call Sams; they may have a schematic on file which they can copy for you.

Manuals for older test equipment and ham radio gear are available from Hi Manuals, PO Box 802, Council Bluffs, IA 51502, and Manuals Plus, PO Box 549, Tooele, UT 84074.

Replacement semiconductors: Replacement transistors, ICs, and other semiconductors, marketed by Philips ECG, NTE, and Thomson (SK), are available through most parts dealers (including RadioShack on special order). The ECG, NTE, and SK lines contain a few hundred parts that substitute for many thousands of others; a directory (supplied as a large book and on diskette) tells you which one to use. NTE numbers usually match ECG; SK numbers are different.

Remember that the "2S" in a Japanese type number is usually omitted; a transistor marked D945 is actually a 2SD945.

Hamfests (swap meets) and local organizations: These can be located by writing to the American Radio Relay League, Newington, CT 06111; (www.arrl.org). A hamfest is an excellent place to pick up used test equipment, older parts, and other items at bargain prices, as well as to meet your fellow electronics enthusiasts—both amateur and professional.

Table 1
Capacitor Tolerance Codes

Code	Tolerance
B	±0.1 pF
C	±0.25 pF
D	±0.5 pF
E	±0.25 pF
F	±1pF (small pF values)
F	±1% (most values)*
G	±2%*
H	±2.5%
J	±5%*
K	±10%*
M	±20%*
P	-0%/+100%
S	-20%/+50%
W	-0%/+200%
X	-20%/+40%
Z	-20%/+80%*

*Common tolerances (see text)

As I write this column, I'll have to convert the file to ASCII, and those characters that I've been using that look so nice on the screen as I type will be lost or converted to standard ASCII charac-

ters. Those "mistranslations" become the source of many typographical errors if I don't carefully note the presence of each one to the editors. Slips like that are very easy to overlook, especially when "µP" drops out to "mP" which would mean that my robotic controller just gained a processor that is 1000 times larger in bulk! (And you were wondering how this topic was going to relate to robots.)

[Another consideration that Dean overlooked is the conversion of text between IBM-compatibles and the Macintosh. The Mac maps the extended characters differently, complicating the "soup" with a new set of "mistranslations." What's more, typesetting Poptronics brings in a completely different Postscript font for the Greek and mathematical symbols that does not relate to the IBM or Macintosh extended characters. Even if we did start with a (hopefully) macro-virus-free word-processor-document file, those symbols still need to be translated.]

The computer industry has responded to this dilemma at least two ways: Microsoft's proprietary RTF (Rich Text Format) and the international-standards-based Unicode: a character-mapping protocol that allows for 65,536 symbols. Specific ranges of characters are reserved for certain groups of characters, such as Greek, Cyrillic, Arabic, Hebrew, mathematical, and typographical. There's even room for custom symbols in the protocol. Needless to say, standard ASCII characters are in their accustomed positions.

Recent versions of Microsoft Word and Corel WordPerfect have support for Unicode to varying degrees. Other operating systems

tend to lag in that respect. Linux, for example, has a "Unicode HOWTO" describing how to get your distribution to jump through the correct set of hoops, but applications that take advantage of that capability are far and few between.—Editor.]

STK2038II Supply Source

Q *I am trying to repair an audio system that uses a power-audio IC, STK2038II. Is that chip still available? How much does it cost?—R.N., Petrolia, Ontario*

A You can tell when I'm trying to find a parts source for a reader: It only takes two catalogs. Had I been looking for my own use, I'd still be digging! For \$11.39, you can buy the chip from Dalbani, 4225 NW 72nd Ave., Miami FL 33166; 800-325-2264; www.dalbani.com. The catalog number is STK2038II (go figure). Good luck with your repair. Wasn't that audio part of the synthesized-audio card on your modified Heathkit Hero 2000?

Reliability of Integrated Circuits

Q *These days, many commercial electronic products containing microcontrollers—like VCRs and answering machines—show some trouble, forcing the user to pull the AC plug for a minute or two to restart the device and solve the problem. Do you think that conventional ICs are more reliable and less trouble than microcontroller-based products?—G. F., Toronto, Ontario*

A This is a subjective answer if ever there was one. Overall, I'd have to say that the new equipment that is more heavily integrated is more reliable. I can give you several reasons for that opinion. First, the designers of the current crop of ICs are a lot farther up on the learning curve in the manufacturing processes that turn sand into silicon into circuits. Their yield rate is much higher, they've learned from past mistakes, and many new designs are still based on tried-and-true circuits and technologies.

Second, the implementation of the same design in smaller ICs requires far more solder connections than a design using large-scale integration. The more solder connections you have, the better the chance of having a bad connection or heat damage.

A third reason is that complex circuits constructed on the same wafer can be

made to perform better, often requiring fewer "tweaks" outside the IC, and hence, fewer non-reliable and noisy components like potentiometers. Differential amplifiers come to mind, where balance, DC offset, and a higher CMRR can be achieved better than in a discrete design. In addition, on-chip benefits help reliability, such as on-chip measurement of substrate temperature for regulating cooling or the current- and temperature-limiting circuits on linear regulators.

Although not really an advantage, a fourth reason for the better performance is in sheer quantity. The more complex devices may seem to fail more because there are more of them manufactured and because complex functions tend to invoke more problems with, as you mentioned, things like latch-up. Compare the cellular telephone of 1985 with one of 2000. You didn't see them around that much in 1985; today, everybody seems to have one, so you notice failures more. I'd say that there are probably fewer failures per thousand units, but it seems like the reliability is lower because the number of units around you is 50 times greater.

I just replaced the old simple TG&Y clock radio by my bed with a new one that has a synthesized tuner, loads of station presets, three different alarms, and all kinds of soothing sounds to lull me to sleep. I might expect the new radio to fail, not because it uses fancy ICs, but because there's just so many more things that can go wrong with it.

Writing To Q&A

As always, we welcome your questions. The most interesting ones are answered in print. Please be sure to:

- (1) include plenty of background information (we'll shorten your letter for publication);
- (2) give your full name and address on your letter (not just the envelope);
- (3) type your letter if possible, or write very neatly; and
- (4) if you are asking about a circuit, include a complete diagram.

Questions can be sent to Q&A, **Poptronics Magazine**, 275 G Marcus Blvd., Hauppauge, NY 11788, or e-mailed to q&a@gernsback.com, but please do not expect an immediate reply in these pages (because of our backlog) and please don't send graphics files larger than 100K. Due to the volume of mail, we regret that we cannot give personal replies. P

BUY BONDS

Introducing Robotics with Lego® Mindstorms™

For Robot Lovers. Shows how to build a variety of increasingly sophisticated computer-controlled robots using the brilliant Lego mindstorms Robotic Invention System (RIS). Covers the fundamental building techniques needed to construct strong and efficient robots. Explains to the reader how robot control programs may be simply constructed on their PC screens. Detailed building instructions are provided for all the robots featured. 270 pages, 7 1/2 x 10 5/7 in. \$19.99.

Plus \$2.45 shipping in U.S. Order from CLAGGK Inc., P.O. Box 12162, Hauppauge, NY 11788
CLX1

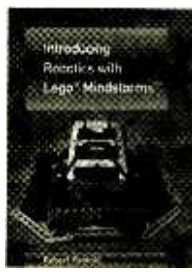

Behavioral Based Robotics

We interrupt our series on fuel cells to bring you a special two-part article on behavioral-based mobile robots. After this special robotics series, we will continue where we left off with fuel cells. This month, we will look at the beginning of behavior-based robotics. Behavior-based robotics may also be called *neural networks* or *reflexive behavior*. A behavior-based system is one of the two main approaches to implementing intelligence in robots. One approach is called *top-down* intelligence while the other is called *bottom-up* intelligence.

Although I am limiting the field of discussion to the movement (mobility) and exploration of an environment for simplicity, this is by no means a real restriction on either approach discussed. To implement intelligent control functions in a mobile robot, one must decide on which approach is better to accomplish the task. The top-down approach attempts to create an *expert system*, or program, to perform a controlled search and discover. The bottom-up approach creates an "artificial" behavior in the robot that causes it to explore and discover.

At first glance, you might not see much of a difference in either approach, but it is there and it's quite significant. If an expert system approaches a situation (or terrain) that it hasn't been programmed to handle, it immediately falters. The behavior system, on the other hand, isn't looking for any template-like "programmed" situation to calculate procedures and couldn't care less about the situation—it just goes on exploring.

What has been found over the last twenty years of robotic experimentation is that bottom-up programming (behavior-based) is successful many times when top-down programming fails.

I apologize for this simple explanation of top-down and bottom-up programming. Whole books are dedicated to this expansive subject if one is interested, but I must summarize and continue.

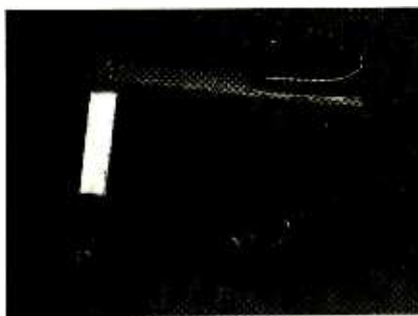

A Robotics Pioneer

One of the first pioneers in the bottom-up approach to robotics is William Grey Walter. Walter was born in Kansas City, MO in 1910. His family moved to England when he was five. He attended school in the United Kingdom and graduated from King's College, Cambridge in 1931. After graduation, he began doing

basic neurophysiological research in hospitals.

Early in his career, he became interested in the work of Ivan Pavlov, the Russian psychologist best remembered for his stimulus-response experiment on dogs—the famous "Pavlov's Dogs." In case you forgot, Pavlov rang a bell just before providing food for dogs. After a while the dogs became conditioned to salivate just by hearing the bell.

Another contemporary of Walter, Hans Berger, invented the electroencephalograph (EEG) machine. When Walter visited Berger's laboratory, he saw refinements that he could make to Berger's EEG machine. In doing so, the sensitivity of the EEG machine was improved and new EEG rhythms below 10 Hz could now be observed in the

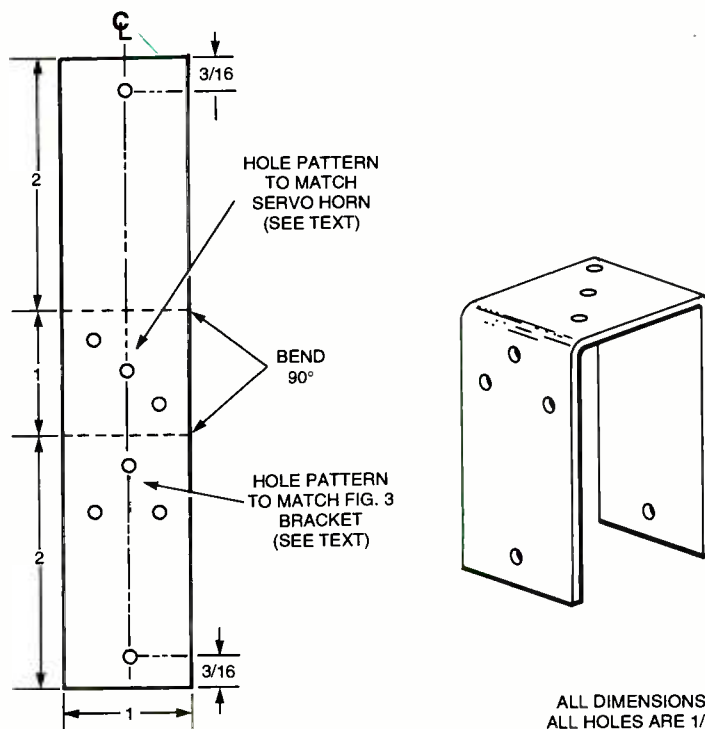
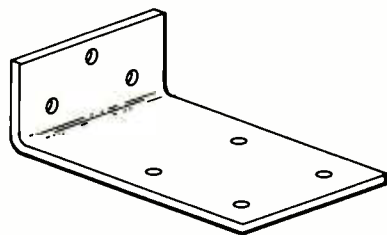
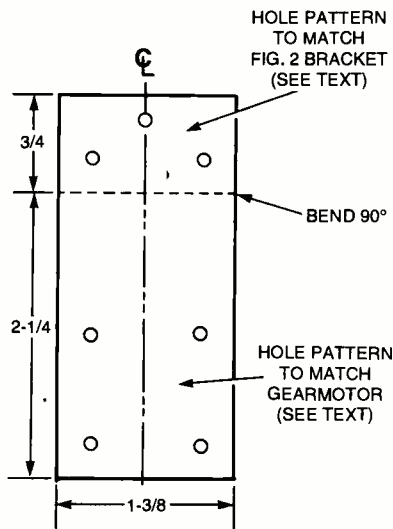

Fig. 1. The wheel frame is a U-shaped bracket formed from a piece of sheet metal. Use the servo motor and motor bracket as a guide when drilling their respective mounting holes.



ALL DIMENSIONS IN INCHES
ALL HOLES 1/8 DIAMETER

Fig. 2. The motor bracket secures the gearbox motor to the wheel frame.

human brain.

Walter's studies of the human brain led him to study the neural-network structures in the brain. The vast complexities of the biological networks were too overwhelming to map accurately or replicate. Soon he began working with individual neurons and the electrical equivalent of a biological neuron. He wondered what type of behavior could be gathered with using just a few neurons.

To answer this question, Walter built a three-wheeled turtle-like mobile robot in 1948. The robot measured 12 inches high and about 18 inches long. What makes this robot fascinating is that it exhibited interesting and complex behavior with just two electrical neurons. The first two robots were affectionately named "Elmer" (*E*lectro*M*echanical Robot) and "Elsie" (*E*lectro-mechanical robot, *L*ight *S*ensitive). Walter later renamed the style of robots *Machina Speculatrix* after observing the complex behavior they exhibited.

Remember, in 1948, the transistor had not been announced, so the electronic neurons for the robot were made using vacuum tubes. Vacuum tubes con-

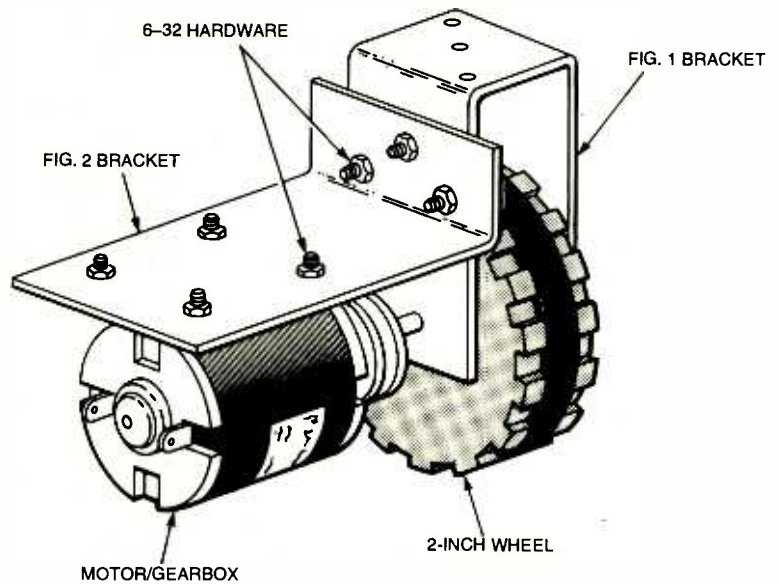

Fig. 3. Here is what the front wheel looks like when fully assembled.

sume considerably more power than today's semiconductors, and the original robot was fitted with a large rechargeable battery.

The robot's reflexes (or nervous system) consisted of two sensors connected to two neurons. One sensor was a light-sensitive resistor; the other sensor was a "bump" switch connected to the robot's outer housing.

The three wheels form a triangle. The front wheel had a motorized steering assembly that could rotate a full 360° in one direction. In addition, the front wheel also contained a drive motor for propulsion. Since the steering could continually rotate a full 360°, the drive motor's electric power came through slip rings mounted on the wheel's shaft.

The photosensitive resistor was mounted onto the shaft of the front-wheel steering/drive assembly. This insured that the photosensitive resistor was always facing in the direction that the robot was moving.

Four Modes of Operation

While primarily photovore (light-seeking) robots, Elmer and Elsie exhibited four modes of operation. It should be mentioned that the robot's steering motor and drive motor were usually active.

Search—The ambient environment is at a low light level or dark. The robot's responses set the steering motor on full speed and the drive motor on half speed.

Move—When the robot found light,

the responses were: steering motor off and drive motor at full speed.

Dazzle—Under a bright light, the responses set the steering motor to half speed and the drive motor to reverse.

Touch—The robot hit an obstacle. In response, the steering motor ran at full

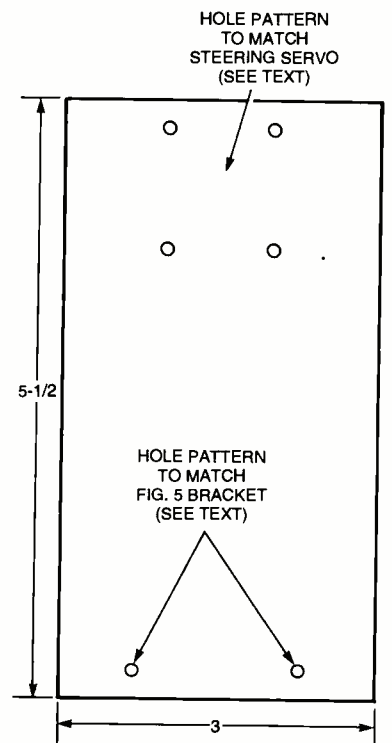

ALL DIMENSIONS IN INCHES
ALL HOLES 1/8 DIAMETER

Fig. 4. The main body of "Elmer, Jr." is a simple piece of sheet metal.

speed while reversing the drive motor.

Observed Behavior

In the 1950s, Walter wrote two *Scientific American* articles and a book titled *The Living Brain* (see the bibliography sidebar for more information). The interaction between the neural system and the environment generated unexpected and complex behaviors.

In one experiment, Walter built a hutch where Elsie could enter and recharge its battery. The hutch was equipped with a small light that would draw the robot to it as its batteries ran down. The robot would enter the hutch, and its battery would automatically be recharged. Once the battery recharged, the robot would leave the hutch to search for new light sources.

In another experiment, he fixed small lamps on each tortoise shell. The robots developed an interaction that, to an observer, appears like a kind of social behavior. The robots dancing around each other—at times attracted then repelled—reminds one of a robotic mating ritual or territory-marking behavior.

Building Walter's Tortoise

We can imitate most functions in Walter's famous tortoise. To fabricate the chassis, we need to do a little metal work. Yes you read that right, a little metal work. Working metal is made easier with a few tools such as a center punch, hand shears, nibbler, drill, vise, and hammer. See the sidebar for a brief description of the tools whose names you might not recognize at first.

Most hardware stores will carry the simple metal-working tools outlined. They will also carry the light-gauge sheet metal and aluminum bar needed to make the chassis.

I built my chassis out of $\frac{1}{8}$ - \times - $\frac{1}{2}$ -inch aluminum bar and 22- to 24-gauge stainless-steel sheet metal. Stainless steel is harder than cold-rolled steel; if I had to do it over again, I would use the cold-rolled stuff.

Elmer, Jr.'s Chassis

From the previous descriptions of Walter's devices, we know that we need two motors: one for steering and one for movement. The drive motor has an integral 100:1 gearbox. I like this particular gearbox motor because it comes with a motor-mounting bracket. I've made the motor available through my company, Images Company. See my Web site,

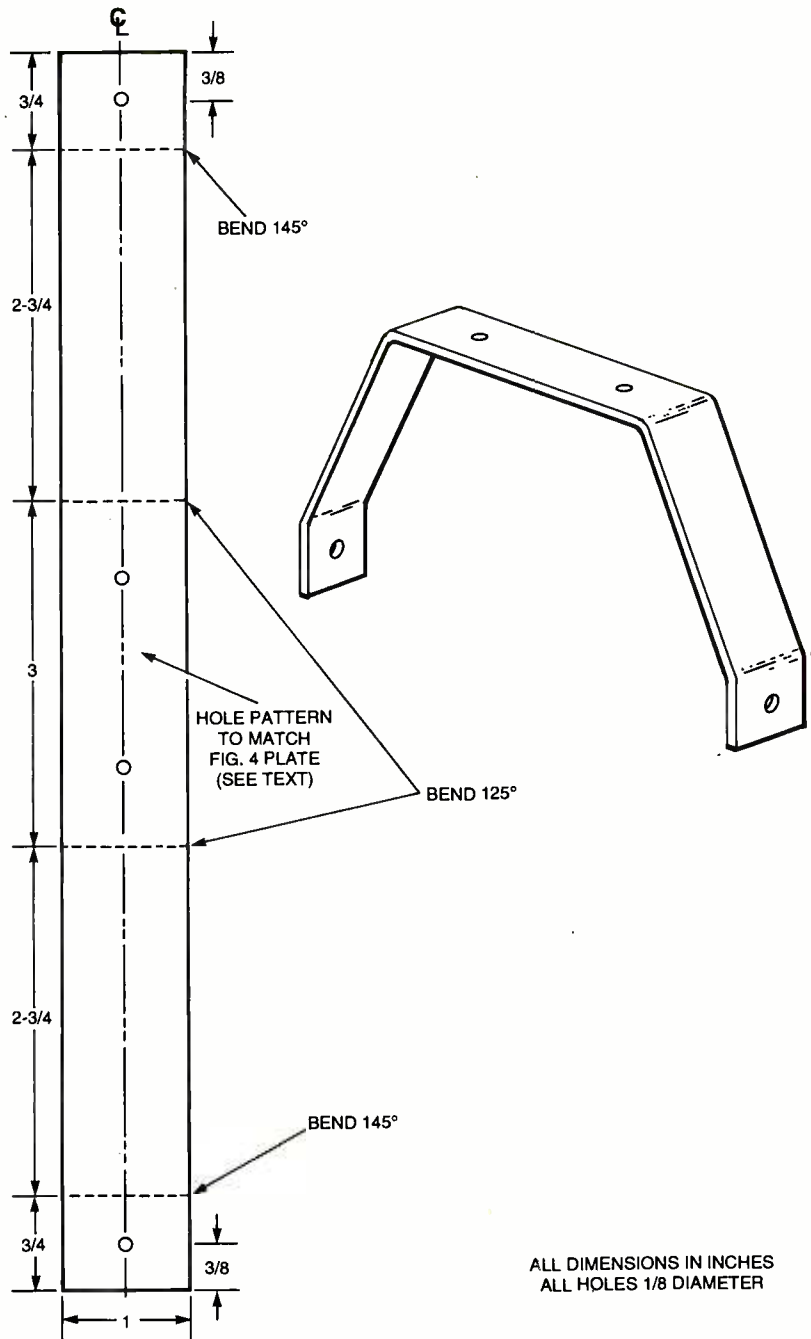

Fig. 5. This bracket supports the rear axle and wheels.

www.imagesco.com, for more details. For the steering motor, I used a standard servomotor rated at 42-inch-ounces of torque. Gather the motors together first; you'll need them to locate mounting holes on the robot frame.

Let's start with the front-wheel frame. This "U-" shaped construction is shaped from a 1- \times -5-inch piece of sheet metal. The dimensions are shown in Fig. 1. Three holes in the center area are drilled to mount the servo horn from the servomotor. To locate the holes, start by removing the servo horn from the servomotor. On

the brand I used, I loosened the horn's central screw and pulled straight up; whatever type you use might be different. Line up



The gearbox motor comes with an integral 100:1 gearbox and a convenient mounting plate.

PARTS LIST

12- × 12-inch sheet metal, 22 or 24 gauge
12-inch aluminum bar, ½ × ½ inch
Servomotor, 42-ounce-inch capacity
100:1 gearbox motor (Images Company 918D)
6-32 machine screws and nuts
0-80 machine screws and nuts

the servo horn on the bracket and mark the center of the three holes. Drill the center hole larger (⅜ inch) than the two outer holes (⅜ inch).

Drill the two ¼-inch axle holes for

Did you know...

RABBI LOEW'S GOLEM

Jewish Mysticism tells the tale of a Rabbi Loew who lived in 16th century Prague. The Rabbi created a *golem* from clay and tree limbs. Using enchantments from the *Cabala* (a compilation of ancient Hebrew texts that includes the *Zohar*) Rabbi Loew brought his automaton to life. According to legend, the *golem* would receive hand written instructions into his mouth—sort of like a code listing—and the magical robot would share the workload of the town. The residents appreciated the helping hand.

Eventually, the Rabbi taught the *golem* to read. After becoming educated through books, the *golem* began to yearn for freedom. Rumors say the incarnation soon grew jealous of the local children. "Why should I do all this work," queried the *golem*. In a blind rage, the man-made creature began to terrorize Prague. After days of tragedy, the people of Prague managed to chase the *golem* away.

This is just one of hundreds of legends that surround the use of automatons in early history. Primitive robots have been discovered throughout time. As the Industrial Revolution began to flourish, clock-like mechanisms using gears and weights combined with (then) cutting-edge steam technologies.

Whether powered by mechanical principals or unexplained mystical energies, historical records reveal a treasure horde of strange tales of early robotics.

the front wheel as shown. They are located at the ends of the metal strip. Set the bracket aside for now; we'll come back to it in a moment.

An "L-" shaped bracket mounts the drive motor to the wheel frame. As shown in Fig. 2, this is a 1½- × 3-inch piece of sheet metal. Drill a pattern of three holes where the motor bracket will mount to the wheel frame. The exact locations aren't important, as long as they fit within the area shown.

BIBLIOGRAPHY

Walter, W. Grey—"An imitation of life," *Scientific American*, May 1950
Walter, W. Grey—"A Machine that Learns," *Scientific American*, August 1951
Walter, W. Grey—*The Living Brain*, W.W. Norton, NY, 1963

Mount the bracket in a vice and make the 90° bend.

Now comes the tricky part if you're "all thumbs." Take the wheel frame with your first hand and hold the gearbox motor against it with your second hand so the gearbox motor's shaft goes through one of the axle holes. Place the motor-mounting bracket in place with your third hand (see why I said this would be tricky?) and mark the hole locations for (a) mounting the gearbox motor to the motor bracket (four holes)

TOOLS OF DESTRUCTION AND CONSTRUCTION

Center Punch—Used to make a dimple in sheet metal to facilitate drilling. Without the dimple, the drill is more likely to "walk" off the drill mark. To use, hold the center punch in the center of the hole location needed to be drilled. Hit the center punch with a hammer to make a dimple.

Drill and Hammer—Self-explanatory.

Nibbler—Used to remove (nibble) small bits of metal from a sheet. It is also used to nibble cut-outs and square holes in light-gauge sheet metal. RadioShack sells an inexpensive nibbler, which tends to break easily when overtaxed.

Shears—Used to cut sheet metal. I would advise purchasing 14-inch metal shears. Use them like a scissors to cut metal. Remember, although the action is very similar, using shears on metal is a lot harder than cutting paper.

Vise—Used to hold metal for drilling and bending.

The gearmotor mentioned in this column may be purchased from:

Images Company
39 Seneca Loop
Staten Island, NY 10314
718-698-8305
www.imagesco.com

Order Part No. 918D
\$21.95

and (b) mounting the motor bracket to the wheel frame (three holes). You can mark the locations with a pencil or felt-tipped pen with your fourth hand!

Once you've marked the holes, drill them with a ⅜-inch drill. The wheel frame can now be bent to its final U shape as shown in Fig. 1. Like the motor bracket, a vise makes a handy "poor-man's bending brake."

Mount the gearbox motor to the motor bracket and the motor bracket to the wheel frame with 6-32 hardware. Your assembly—minus the wheel—should look like Fig. 3. Mount the servo's horn to the top of the wheel frame with the servo's central screw and two additional 0-80 machine screws and nuts.

The main base is a 3- × 5½-inch piece of sheet steel. Use Fig. 4 as a guide when preparing the plate. Drill four ¼-inch holes for mounting the steering servo. You'll need to cut a rectangular hole to fit the servo. An easy way to do that is to drill a series of holes along the inside perimeter of the servomotor's hole. The holes should be large enough to admit the working jaw of a nibbling tool. When you have removed as much material as possible, finish the job with the nibbler. File the edges of the hole and mount the servomotor with 6-32 screws and nuts.

The rear-axle bracket is shown in Fig. 5. Fabricate it from a 10-inch length of ¼- × ½-inch aluminum bar. Drill the four ¼-inch holes before bending the bar. When you drill the center holes, clamp the bar to the rear of the Fig. 4 base plate and drill the holes in both items at the same time. That way, the holes will align perfectly.

After drilling the holes, mount the bar to the base with 6-32 hardware. For the rear axle, I used the wire from a metal coat hanger.

Next Month

That's it for this month. Next month, we will continue assembly and add the control electronics.

CyberK'NEX—Part Robot, Part Fun

Robotics has long been associated with toys. From model R2-D2 'bots to programmable LEGO MINDSTORMS, robots and toys continue to inspire new generations of automaton enthusiasts. As toys have become increasingly sophisticated, so have the robots; it's not unusual for a \$50 mechanical toy to have the computing power of a 1980s personal computer.

Entering the fray of robotic toys is a new line of controller-based kits from K'NEX, *CyberK'NEX*. All are based on the wildly popular K'NEX construction system, which is composed of semi-flexible rods and geometric connecting links. Because of their construction, K'NEX pieces can be used to build fairly large models, including Ferris wheels that measure several feet across. A LEGO Ferris wheel the same size would weigh as much as a small child and would likely come apart if not glued.

Let's take a closer look at the CyberK'NEX and how it can be used not only as an entertaining construction toy, but as a valuable introduction to robotics and mechanical design.

Inside the CyberK'NEX

As of this writing, K'NEX offers three CyberK'NEX kits to choose from:

- Hyper Wheels
- Cybots
- Ultra

Each kit contains a small microcontroller-based processor for operating motors, lights, and a crude voice and sound-effects system. "Behaviors" are pre-coded in modules that plug into the "Cyber Port." The \$130 *Ultra* set, which I've been experimenting with, comes with five "personality" modules plus a programmable module. More about these modules in a bit.

The *Ultra* set also offers a download

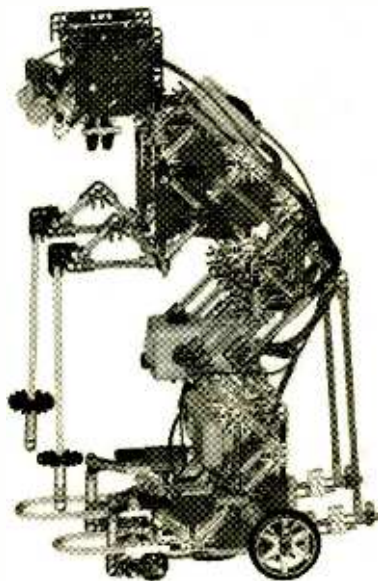

The K'NEX parts allow you to be quite elaborate in your designs. This "skier" robot is a bonus plan available from the CyberK'NEX Web site. Note the main cyber processor in the mid-section of the robot and the cyber port on the back of the robot.

programmer. The programmer connects to a PC via the parallel port (and therefore, will not work with a Macintosh or other computer that lacks a standard parallel port). So far, K'NEX only offers the ability to download personality programs for the programmable module from their Web page; a programmer's language or developer's kit is nowhere to be found. You can also program basic moves using an infrared controller, included with the *Ultra* set.

While the *Hyper Wheels* and *Cybots* sets lack the download programmer, all three kits can be controlled by most any standard infrared hand-held controller. The control is actually fairly minimal; the CyberK'NEX doesn't react to the individual buttons on the remote, but rather any modulated infrared light that is received. Each of the personalities responds differently to a button press on the remote.

K'NEX vs. LEGO

It's tempting to compare the CyberK'NEX kits to LEGO MINDSTORMS—in fact, both can be used to construct programmable robots. However, the design influences of LEGO and K'NEX are fairly different: whereas LEGO models are fairly well structured, K'NEX models are more free-form. "Bending the rules" is encouraged when working with K'NEX, whereas LEGO models are often viewed as to whether they are "pure," meaning if they contain any non-LEGO parts or use unusual construction techniques such as (horrors!) gluing.

Here's some background on the LEGO MINDSTORMS for those who are not yet familiar with it and haven't read the rest of this issue.

The LEGO MINDSTORMS uses a sophisticated programmable microcontroller for its main "brainstem." That controller can only be programmed via computer. Programs you write on your computer are downloaded to the controller (referred to as the RCX) via an infrared link. The RCX has room in its battery-backed RAM memory for up to five independent programs, each of which is capable of multi-tasked operations. Programming is accomplished using either the graphical environment that comes on the MINDSTORMS CD or with any of a number of alternative programming environments, such as *Not Quite C*.

The less expensive LEGO MINDSTORMS *Robotics Discovery Set* uses a microcontroller (referred to as the Scout) that is primarily programmed by pressing a series of buttons on the controller. "Behaviors" can be programmed to react to light or touch (provided by simple switches attached to the body of the robot). Additionally, the Scout can be programmed via computer and infrared link, though the Robotics Discovery Set lacks an "IR tower" like

the one that comes in the Robotics Invention System. If you'd like to program the Scout from your computer, you need to first obtain an IR tower for it. Towers can be purchased separately from Pitsco Lego Dacta, at www.pitsco-legodacta.com. You also need a programming environment, such as *Not Quite C* or the *PBrick* scripting language offered by LEGO (see www.legomindstorms.com for more information).

Conversely, the microcontroller (called the "cyber processor") unit used in CyberK'NEX is less robust, lacking the ability (at least so far) to download your own programs. The CyberK'NEX Ultra does have a PC-based program module, but so far that's only for programs you download from the CyberK'NEX Web site (www.cyberknex.com) or program manually using the remote-control module included in the set.

The set contains a half-dozen other pre-programmed personality modules, called "cyber keys." The keys are lollipop-sized and are designed to be inserted into a docking bay (the "cyber port"), which is connected by wire to the CyberK'NEX controller. Each key contains read-only memory for a single behavior, or in the case of the programmable cyber key, re-writable memory.

Of Sensors and Motors

Robots are best when they can interact with their environment. The Cyber-

K'NEX comes with various sensors to determine what's around it, making the system more interactive. The CyberK'NEX Ultra sports two light sensors (one infrared for receiving commands, the other for sensing changes in light, such as you walking in front of it), two push-button switches, a sound sensor, and a movement sensor. Two light-emitting diodes are also included for "eyes" or other output. The switch sensors, light sensors, and LEDs are tethered by wire; the remaining sensors are built into the main K'NEX controller. Additionally, the CyberK'NEX contains its own speaker, for both sound effects and voice.



A combination robot/hot rod (another bonus plan available from the CyberK'NEX Web site). A motor is located at the rear of the robotic vehicle; a motor-control pad is located in the "driver's" seat.

The CyberK'NEX Ultra comes with three reversible motors. The motors are attached to the main controller by way of wires that are each about a foot long. Each motor contains its own batteries (the CyberK'NEX controller has separate batteries). Each motor has its own control pad that houses the batteries for that motor and a toggle switch. The toggle switch lets you manually operate the motors. One pad has a single toggle switch for one motor; the other pad's dual toggle switch controls two motors. If you don't need access to the switches, you can mount the motor-control pad anywhere on your model. Otherwise, you need to mount them so they can be accessible.

The separate battery packs are something of a hassle. Instead of replacing an entire pack (the LEGO MINDSTORMS uses six batteries located in a single bay), you must replace batteries from three different locations. A screwdriver is required to access each battery pack.

On the other hand, by spreading out the batteries to different modules, it is possible to construct robots that lack a single, heavy "core." With some careful thought, you can locate each battery

SOURCE INFORMATION

Cyber K'NEX Main Page
www.cyberknex.com

K'NEX Home Page
www.knex.com

LEGO Mindstorms
www.legomindstorms.com

Pitsco LEGO Dacta (LEGO parts)
www.pitsco-legodacta.com

pack so that the weight of the robot is more evenly distributed. Just make sure you mount the CyberK'NEX's controller and motor-control pads so that you can readily get to them, otherwise you'll need to disassemble your creation in order to change the batteries. To be fair, some LEGO MINDSTORMS constructions also require at least partial disassembly in order to access the battery bay on the RCX or Scout units.

Fans of the LEGO MINDSTORMS may find the CyberK'NEX limited in function and design. Nevertheless, it's important to remember that the CyberK'NEX is engineered for a different kind of learning and play experience. By its nature, LEGO is more structured, and so are the robots that you can create with it. K'NEX allows for more fanciful designs; the more outrageous, the better! With just the parts included in the CyberK'NEX kit, for example, you can create foot-tall dinosaur robots.

With three motors, you can create a robot that can maneuver in all directions (for the most common design approach this requires two motors), and includes an arm, hand, or missile launcher. The missile launcher fires foam projectiles from a spring-loaded catapult. The missile launcher is controlled from one of the motors. One use of the missile-launcher is to fire upon "enemies" that the robot encounters. Of course, no harm is really done, as the missiles are fired with only minimal force, and are nothing more than soft foam (very similar to Nerf).

If the LEGO MINDSTORMS sets are for serious robotic play, the CyberK'NEX is for pure fun. You probably won't learn as much as about robot design, multi-tasking behaviors, or mechanics with CyberK'NEX as you would with LEGO MINDSTORMS. Nevertheless, you'll have just as much fun, and you'll still learn the basics of robotics. P



MULTIMEDIA on the PC!

What is Multimedia? What can it do for you? It can do lots of nice things! This 184-page book helps you create your own multimedia presentation. Multimedia applications by people like you can revolutionize educational and business applications as well! Bring more FUN, FUN into your leisure computer activities.

Mail coupon to:

Electronics Technology Today, Inc.
P.O. Box 240
Massapequa Park, NY 11762-0240

Please send me my copy of *Multimedia on the PC* (PCP120). I enclose a check or money order for \$18.45 to cover the book's cost and shipping-and-handling expenses. NY state residents must add local sales tax.

Name _____

Address _____

City _____ State _____ ZIP _____

All orders must be paid in U.S. funds only. Sorry, no orders accepted outside of USA and Canada. Please allow 6-8 weeks for delivery.

MA02

Robot Mechanics

For this special issue of **Poptronics** devoted to robots, we'll take a break from more traditional electronics repair to look at some issues related to equipment with moving parts. While VCRs qualify—including motors, sensors, and mechanics—they do not include the diverse types of parts found in robotic systems. Space limitations dictate that I restrict this discussion to the types of electromechanical systems found in items ranging from high-tech toys to more traditional low-cost robots.

Getting the Fix On Robots

An electromechanical system consists of:

- Motors.
- Actuators.
- Sensors.
- Mechanical components (linkages, gears, belts and pulleys, etc).
- Controller (microprocessor, program, and data memory, and its interfaces).
- Power drivers.
- Power supplies.
- Software or firmware.

We will be taking a look at some of those subsystems in this column.

Electromechanical systems require a broad range of skills to troubleshoot because of the interaction between software, electronics, and mechanics. Problems such as damaged mechanical parts resulting from a mobile robot falling down a flight of stairs will be obvious, although a fault associated with the lack of response from a sensor could be due to a number of causes. Therefore, a systematic approach must be taken to rule out each potential cause.

Due to allotted space, I can only touch on a few aspects of this topic. Much more information on troubleshooting and repair of individual components like motors, sensors, batteries, power supplies, semicon-

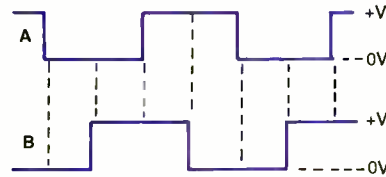

Fig. 1. Signals A and B are said to be in "quadrature-phase." Each cycle consists of four divisions. The two signals are always ninety degrees out of phase during any of the four divisions (ninety times four equals 360—one full cycle). Stepper motors make use of this signaling for precision movement.

ductors, and IR devices can be found at www.repairfaq.org.

Motors and Actuators

Two types of motors commonly used in small robots include DC Permanent-Magnet (PM) motors and stepper motors. Common electronic equipment like printers and disk drives also use stepper motors. Small PM motors are similar to high quality servomotors in how they work, but are built as cheaply as possible. They are found in all sorts of consumer-electronic equipment, toys, and hand-power tools. These motors are fairly reliable if run within their ratings.

Rotational direction and torque/speed are determined by the polarity and magnitude of the average voltage applied to them. Rotation is continuous (unlike stepper motors, see below). Speed can be quite high—tens of thousands of rpms (revolutions per minute). Some form of position feedback is needed if a system needs to move to a particular spot.

Problems with PM motors include:

- Dirt or "gunk" collecting on the commutator.
- Partially shorting the motor.
- Excessive metal-brush wear.
- Erratic operation or a totally open motor.

For typical toys and small robots, motor failures are probably less com-

mon than for motors used in applications like VCRs that may run for hours continuously.

Stepper motors rotate in discrete steps as determined by a multiphase waveform applied to their sets of field coils. One example of what such a multiphase waveform looks like is shown in Fig. 1. Although that figure depicts a different subject (which we'll obviously get to later), it does illustrate the basic waveform used with two-phase stepper motors (like those available from surplus dealers at low cost). They will hold their position with power removed (though with less torque than when power is on). Except for an initial "home" position reference, no feedback is required in stepper motors because movement to any position can be programmed by a known number of steps (assuming the rest of the mechanism has no slip).

Problems with stepper motors include:

Open or shorted windings—Check the windings with a multimeter. However, a few shorted turns might not show up but could still result in overheating or speed problems.

Dry or worn bearing—The drive shaft should rotate without binding though magnetic detents will be felt.

Demagnetized rotor—This problem might happen if the motor is disassembled, or if it is driven with a much higher input than expected. Compare the unit under test with a known good sample of the same motor. Weak or no evidence of detents compared to a good unit is one sign of a degaussed rotor.

CAUTION: Disassembling a stepper motor might demagnetize the rotor when it is removed from the stator assembly. This is, for all intents and purposes, irreversible at home. Low-cost

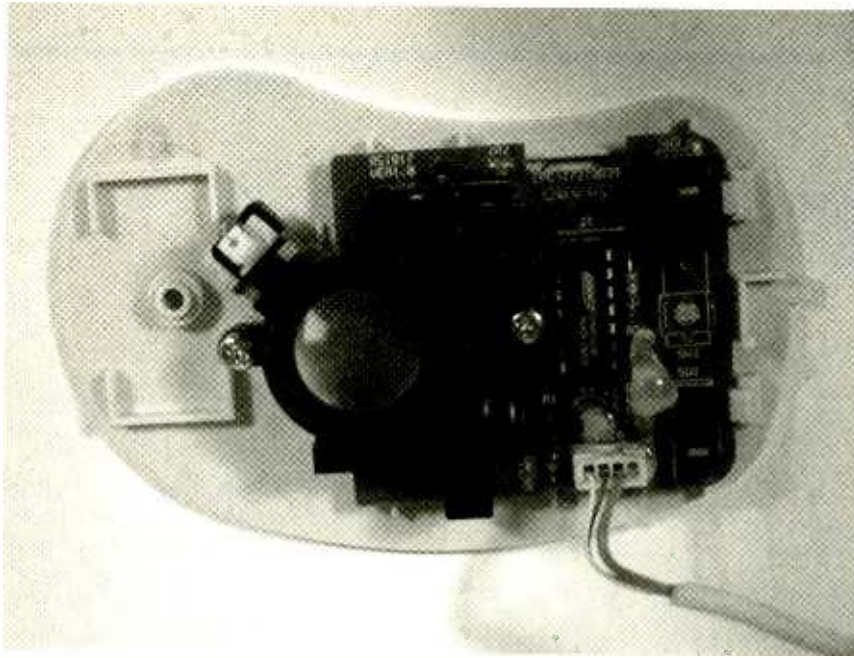

This is a close-up view of a photodiode (labeled IR2). This photovoltaic device provides the input for the optical encoder of a standard mouse (see section on "Sensors"). Two sensors are used; one detects horizontal movement of the mouse and the other detects vertical movement of the mouse

PM motors are generally not prone to this, but some high quality servomotors might be rendered useless from disassembly.

Solenoid Scenarios

Solenoids are used where only two positions of some mechanism are needed as with a robot gripper. While motors require lubrication, many solenoids do not.

Common problems with solenoids include open or shorted coils and gummed-up grease from improper lubrication that can cause binding.

Sensors

Anything that detects some physical condition can be classified as a sensor. Proximity and distance sensors are commonly used in robotics. Those might be based on physical, optical, or sonic effects.

A simple probe activating a micro-switch will detect contact with a wall or obstruction. Optical proximity sensors send a beam out (typically from an IR LED) and detect any return reflections with a photodiode or phototransistor.

Optical triangulation (used in many camcorders) and the Polaroid sonar module (used on their cameras for focusing and sold separately) can measure distance to tens of feet with moderate accuracy.

Problems with sensors can range from something as simple as a crunched microswitch or dirt on an optical lens to

electronic malfunctions, interface faults, and buggy software.

Angle sensors are also frequently employed. The most common types are variable resistors (potentiometers or rheostats), especially for inexpensive devices like toys. Optical encoders or electromagnetic types are often used on higher quality equipment. Most computer mice (ironically, not the ones called optical mice!) use optical encoders as shown in the accompanying photo.

Problems include defective LEDs or photodiodes in the encoder (optical types) or bad coils or drivers (electromagnetic types).

Speed sensors are used to monitor motor performance. For sensing the rotation of a motor or wheel, optical encoders are common. The actual speed is calculated by software. A very simple one pulse per revolution may be sufficient for some purposes, but most often the "A" and "B" (quadrature signals are shown in Fig. 1) outputs of an optical encoder are interpreted to provide both angular position and speed.

One-, two-, and three-dimensional sensors are used to bestow sight. These typically use a CCD (Charged Coupled Device) or CMOS camera with software to analyze the resulting data. A single-line CCD array is sufficient for 1-D detecting of contours or slowly scanning a scene to acquire a 2-D image.

A pair of cameras can be used to

acquire 3-D information in the form of a stereo pair. A laser-based line scanner can be used in conjunction with a single camera to acquire 3-D information directly.

Finding Sensor Bugs

Problems with any of those devices can range from a bad sensor (dead pixels or worse) and control electronics to interface or software problems.

Detailed testing is beyond the scope of this column, but the basic procedure is to attempt to localize the fault to the sensor, interface, or elsewhere by substitution if possible. Measurements of the sensor inputs and outputs can also be made. For example, when testing an optical encoder, check that the power input is correct and then look at the A and B outputs to determine if they resemble the waveforms illustrated in Fig. 1 with solid logic levels; while the shaft or wheel is rotated slowly by hand.

Note that, in many cases, problems with erratic counts from an optical or mechanical sensor producing A/B quadrature outputs are due to incorrect software or logic. There are many ways to get it correct enough to work under continuous rotation in one direction or the other, but it takes more effort (a "state-machine" approach) to work under conditions where the shaft is jiggling back and forth.

Testing of camera-type devices can be much more complex requiring detailed documentation on the sensor and its electronics, a scope or logic analyzer, and a certain amount of luck!

Controllers

Some form of programmable device generally provides the intelligence in robotic systems. The simplest often use PICs (single chip micros with built-in memory and interfaces).

More sophisticated systems may use a higher performance microprocessor or multiple processors in a distributed architecture. There is no way to cover that subject here except to emphasize the importance of recognizing that software and firmware bugs can manifest themselves in very peculiar ways.

Note that motors and other electromechanical actuators result in an electrically noisy environment that is shared by the controller. Unless this is taken into consideration in the design of the system, problems like random lockups or reboots or just plain unreliable opera-

tion are almost assured.

Power Supplies

Almost all of the toys and small robot-type devices are (or can be) powered by some form of batteries, possibly with DC-DC converters to generate multiple voltages from a single battery pack. Weak, dead, or improperly selected batteries are near the top of the list of common problems with those and other portable systems.

Movable Mechanics

Robots, almost by definition, include movement. Bearings and sliding parts can become worn, gummed-up, or damaged. Rule number one has to be:

Never force anything

If rotating a shaft doesn't result in the expected movement, find out why. Perhaps you're turning it in the wrong direction, and it's already at one end of its travel. Or, maybe something has jammed the gears.

Realize, however, that with many inexpensive devices like toys, everything is constructed as cheaply as possible; repair may simply not be possible if some key component has broken.

Fortunately, if the device is properly lubricated when constructed and it is operated in clean environments, additional attention may never be needed. However, water, dust, dirt, and sand result in the need for frequent cleaning and lubrication. That brings us to rule number two:

NEVER use lubricants such as WD-40 when working with your robot!

Sealed ball bearings should be replaced if they become excessively noisy or rough when rotated by hand. Disassembly, cleaning, and repacking might be possible, but irreversible damage to the bearing surfaces (races) could have already occurred.

Sleeve bearings (bushings) in motors could be lubricated for life, or they might need a periodic application of a couple of drops of light machine or electric-motor oil. If they are dry or dirty, complete disassembly, cleaning, lubrication, and reassembly are advised if possible. If they are excessively worn, replacement is the only option.

Slow rotating and sliding parts

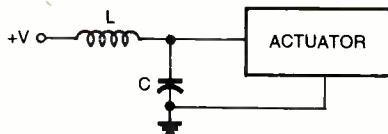

Fig. 2. This L-C circuit is being used between the power supply and an actuator. The circuit can offer some protection against system brownout. The capacitor, fed by the inductor, will release more voltage for the actuator upon each discharge. This circuit application exploits the capacitor's battery-like quality. L-C filters also absorb EMF when a coil-based actuator turns off (supply voltage is removed). Without protection, this "inductive kickback" can be several times the original supply voltage (e.g. a 12-volt system can generate spikes over 50 volts).

should be lubricated with light grease. If any are dry or tight, disassemble to permit the removal of old gummed-up grease and dirt.

Obviously, inspect for damage such as bent shafts or linkages, missing screws or cotter pins, etc.

Troubleshooting Approach

When a commercial product suddenly refuses to cooperate, mechanical or electrical problems could most likely be to blame. However, if you are attempting to troubleshoot a system you have built—and it uses a programmable processor—then software/firmware problems must be near the top of the possibilities list (especially if it had worked before). Ask yourself: "What changed?" Has the broken function been tested since the last software change or download?

Power-supply voltages can help detect faults in power distribution. The most common problem is likely to be dead or weak batteries. Make sure the voltages hold up under load. Many types of motors draw a high current when starting, decreasing as the speed picks up. Thus, just checking the voltages while at idle isn't a sufficient test. In addition to unreliable movement, a dip in a critical power supply voltage may cause the system to reboot (see our "EYEBot" feature for a practical example of that type of failure).

Determine if the controller is booting properly. If you are designing a system, adding some diagnostic LEDs or a diagnostic-terminal port will help immensely; an in-circuit software-debugging facility is even better.

When only certain operations aren't working, attempt to determine what they have in common such as shared power-supply voltages, an interface bus,

or a block of program code. Power the relevant motors or actuators from an external source (AFTER DISCONNECTING THEM!) and see if the expected motion takes place. You can also try to activate them manually to assure there is no binding of parts or other mechanical problems.

If you have spare parts available or if you can swap parts like similar motors, doing so can quickly confirm or rule out possible causes.

With moving parts, bad connections due to flexing of cables or loosening of solder joints are quite likely. Problems could only appear when something is in a particular range of positions, or they could be even more erratic.

Erratic problems can also be caused by electrical interference between electromechanical actuators and sensitive logic or analog circuitry. For a commercial system, cable shields could have become disconnected, cable routing could have changed, and power supplies could be marginal.

Here are some tips to keep in mind when building your own robot. Use separate power supplies for analog circuitry, digital circuitry, and actuators. Provide adequate bypassing (e.g., 0.1- μ F) ceramic caps on every chip as well as 22- μ F electrolytic caps scattered around each circuit board. Add some L-C filters in series with the actuators (see Fig. 2).

Use twisted pair or shielded cable for low-level sensor and similar signals. Remember: Not all commercial products are designed properly—the only important aspect to most manufacturers is whether they last beyond the warranty!

Remember when building or troubleshooting, don't jump to conclusions when problems occur. With the combination of electronics, mechanics, and software, a trivial fault in one subsystem can result in a change in behavior in unexpected places.

And So We Must Part Ways...

Robotic and other electromechanical systems make great projects. The interdisciplinary nature of these devices results in a fun and rewarding educational experience, whether designing a robot from scratch or repairing a high tech toy like a Furby.

Please e-mail any comments and/or suggestions to serviceclinic@gernsback.com. You can check out my Web site at www.repairfaq.org for all your repair and laser-optics-related questions.

NEW LITERATURE

(continued from page 7)

centrates on the steps needed to build Seeker, a light-seeking robot, and to program it in NQC. Later chapters add to Seeker's functions, using pbFORTH and legOS. The book concludes with two chapters on building both custom passive and custom powered sensors.

Each author has written material based on his specialty: Baum discusses NQC; Hempel talks about pbFORTH; and Gasperi covers numerous custom sensors. In addition, Villa explains upgrades to the MINDSTORMS built-in operating system.

High-Q Tools Catalog

from Velleman Inc.
7415 Whitelball St., Suite 117
Ft. Worth, TX 76118
817-284-7785
www.velleman-kit.com

Free



This 44-page full-color catalog contains Velleman's line of High-Q Tools, many of which will come in handy for building and maintaining your robots. It offers an extensive selection of multimeters, soldering and hand tools, oscilloscopes, enclosures, cameras and monitors, security devices and buzzers, and power supplies, among other products. There are also educational CD-ROMs and mini-kits. A color photo, description, and full specs accompany each product.

PCI Bus Demystified

by Doug Abbott
LLH Technology Publishing
3578 Old Rail Road
Eagle Rock, VA 24085
800-247-6553 or 540-567-2000
www.LLH-publishing.com

\$49.95

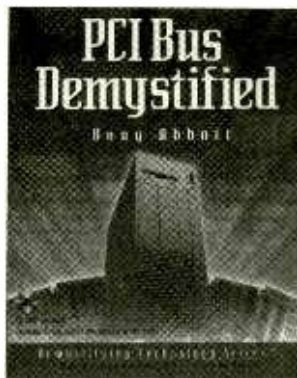

Aimed at hardware and software designers, this book is a practical guide to the PCI Bus found in every modern PC. The guide begins with an overview of key PCI Bus concepts, including commands, read-and-write transfers, memory and I/O addressing, error handling, and interrupts. It then goes on to more advanced topics, such as PCI-to-PCI bridge architecture and the PCI BIOS. (One possible design application for the PCI Bus is for developing an interface card for controlling a robot from a PC.)

The accompanying CD-ROM includes a free, fully searchable eBook version of the text. In addition, a Web site for the book (www.pcidemystified.com) covers new PCI developments, offers supplemental materials, and provides a readers' forum.

Technical Library CD-ROM 2nd Edition 2000

from Microchip Technology Inc.
2355 W. Chandler Blvd.
Chandler, AZ 85224-6199
480-786-7668
www.microchip.com/10/Sales/index.htm

Free

Updated biannually, the revised CD-ROM is a complete compilation of technical documentation on Microchip's PICmicro microcontrollers and associated development tools, KEELOQ secure data products, non-volatile memory devices, and related microperipheral products. It provides extensive information regarding Microchip product specifications, applications, programming specifications, and



user's guides. The PIC chip is one of the most popular microchips used in experimenting with robots.

Giving users the flexibility to edit, compile, emulate and program PIC-micro microcontroller devices from a single user interface, the library included the most current release of MPLAB Integrated Development Environment (IDE) software and a beta version of the MPLAB-C18 compiler. Microchip's Web site offers both text and parametric search capabilities, and the CD-ROM has text search capabilities.

The Microcontroller Application Cookbook

by Matt Gilliland
Woodglen Press
P.O. Box 871
Penn Valley, CA 95946
530-432-3816
www.parallaxinc.com
\$29.95

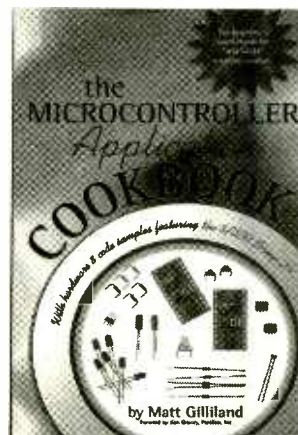

For somebody getting started with microcontrollers, designing the circuit can be the most challenging part of building a project. Sifting through timing diagrams to try to figure out how to interface an A/D converter or controlling a high-voltage circuit with a solid-state relay can be difficult.

A wide-ranging collection of 113 interface circuits designed around the BASIC Stamp II from Parallax, this book enables readers to assemble a circuit casserole from a collection of ingredients. (See the discussion of the BOE and BOEBot from Parallax elsewhere in this issue.) It provides a variety of simple circuits and interface code that can be customized for more advanced uses. Among the circuits is a motor-drive circuit for a robot. (Another robot connection.)

A RIGHT TURN!

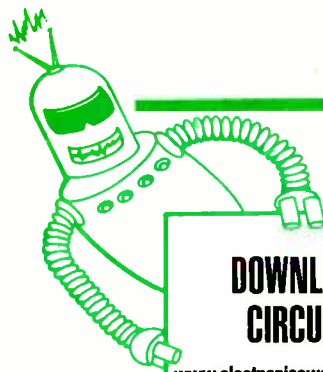

When last we talked, I was just about to start a new subject. I got word about this special issue, so let's shift gears and jump on the robot bandwagon. Don't worry—we'll hit the road running next month when we start exploring the CD4017, but, for now, let's take a closer look at some of the circuitry connected with our electromechanical friends.

Boy-oh-boy, I do like robots! Since Santa didn't deliver on my wish for a Sony AIBO this time around, I'll keep the dream alive by sharing some of my basic robot circuits with you.

No matter how simple or complicated a robot happens to be, most robots require at least one or more motors to operate.

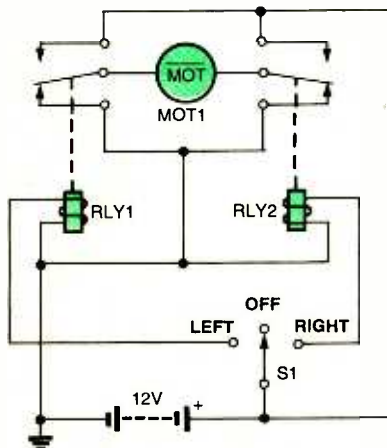

Fig. 1. Wiring a motor through a pair of relays makes for a simple direction-reversing circuit. A simple three-position switch handles logic and protection against accidental activation of both relays.

PARTS LIST FOR THE RELAY-REVERSING CIRCUIT (FIG. 1)

RLY1, RLY2—Double-pole, double-throw 12-volt relay and socket (RadioShack 275-206 or similar)

S1—Single-pole, double-throw, center-off switch

Motor, power source, etc.

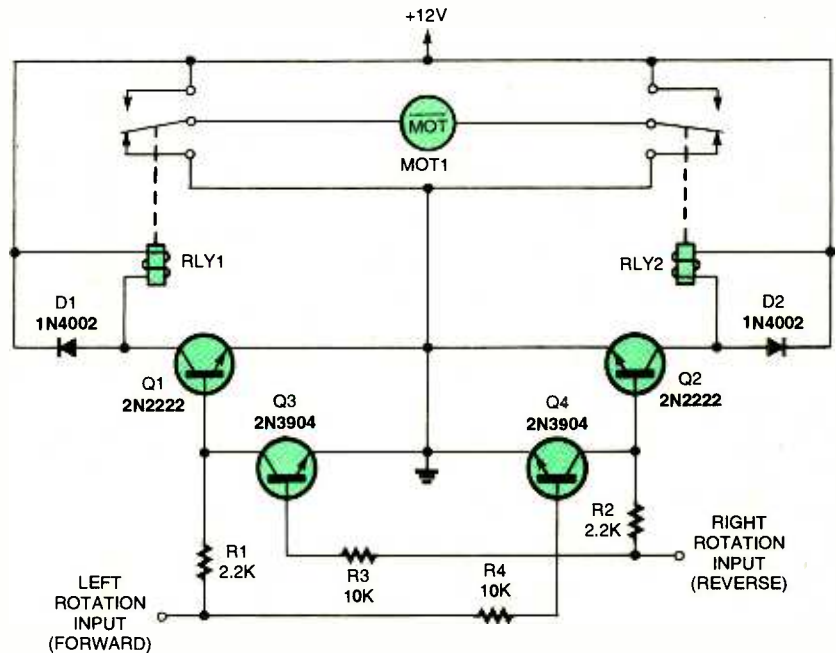

Fig. 2. If you want to control the relays of Fig. 1 with electrical signals, simply replace the switch with this transistor circuit. Note how one input automatically locks the other from activating.

PARTS LIST FOR THE TRANSISTOR-DRIVER RELAY CIRCUIT (FIG. 2)

SEMICONDUCTORS

Q1, Q2—2N2222 NPN silicon transistor

Q3, Q4—2N3904 NPN silicon transistor

D1, D2—1N4002 silicon rectifier diode

R3, R4—10,000-ohm

ADDITIONAL PARTS AND MATERIALS

RLY1, RLY2—Double-pole, double-throw 12-volt relay and socket (RadioShack 275-206 or similar)

Motor, power source, etc.

RESISTORS

(All resistors are 1/4-watt, 5% units.)

R1, R2—2200-ohm

Industrial robots demand a high degree of accuracy and are usually operated with precision stepper motors. Less expensive educational (read "fun") robots most often use small DC brush-type motors to make things move. That's what we'll look at first.

Forward And Reverse

One of the first things required in robotics is the ability to reverse the direction of movement. If a simple

wheel-driven mobile robot happens to end up in a corner or against a wall, it must be able to back up or turn away. Our first entry, see Fig. 1, is a simple motor-reversal circuit. Two 12-volt, single-pole, double-throw relays are used to control the motor's direction of travel. The motor-reversal circuit can be used to control drive motors that move the robot around or as a steering motor to guide the robot in and out of trouble.

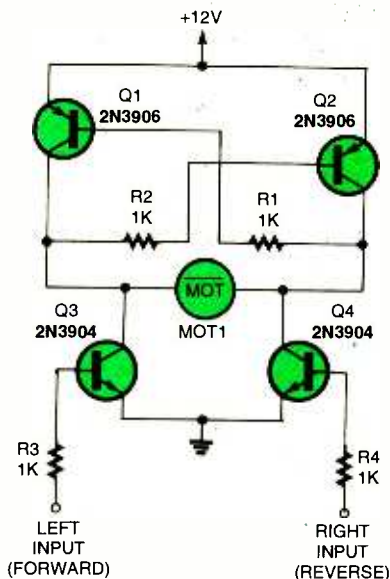

Fig. 3. A standard "H-bridge" configuration removes the mechanical contacts of a relay from the circuit, making for a more reliable circuit.

PARTS LIST FOR THE TRANSISTOR REVERSAL CIRCUIT (FIG. 3)

SEMICONDUCTORS

Q1, Q2—2N3906 PNP silicon transistor
Q3, Q4—2N3904 NPN silicon transistor

ADDITIONAL PARTS AND MATERIALS

R1-R4—1000-ohm, 1/4-watt, 5% resistors
Motor, power source, etc.

Figure 1 shows S1 in its center-off position, keeping the motor at rest. Note that the motor's terminals are also shorted out when in the non-run switch position. This is an added feature called *dynamic braking*. What's that you might say? Okay, I'll try to explain.

To state the incredibly obvious, a DC brush-type motor runs when connected to a DC source. When the voltage is removed, the motor does not stop instantly. During the time the motor is still turning without input power, the motor is acting like a generator, producing an output voltage across its terminals. Our circuit shorts those terminals as soon as the power is removed from the motor. The short places a heavy load on the "generator." A generator will normally turn easily when unloaded or when powering a light load, but if the load is suddenly increased dramatically, the force required to turn the generator will go up accordingly. Since the force required to turn a DC generator

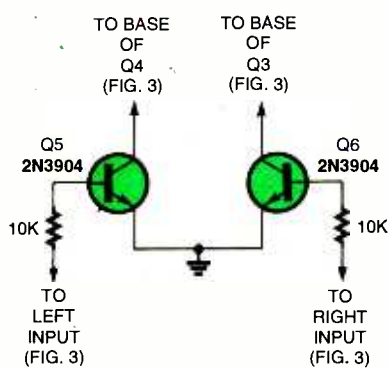

Fig. 4. If you add these transistors as indicated to the Fig. 3 circuit, you can prevent the bridge from burning out if you accidentally try to activate both directions at the same time.

PARTS LIST FOR THE PROTECTION CIRCUIT (FIG. 4)

Q5, Q6—2N3904 NPN silicon transistor
R1, R2—10,000-ohm, 1/4-watt, 5% resistor

depends on the output loading, our dead short causes it to stop almost instantly.

Adding Some Horsepower

Our second robot circuit, see Fig. 2, adds a transistor driver to each relay circuit and a dual-transistor safety circuit, which only allows one of the relays to operate at a time. If an input error occurs and both inputs are activated simultaneously, the safety circuit keeps both relays from operating. A positive

signal at the "left" input turns Q1 on, activating relay RLY1. Power flows through the relay contacts to the motor, causing it to run in the forward direction.

A positive input to the "right" input turns Q2 on, activating RLY2, supplying a reverse voltage to the motor and causing it to turn in the reverse direction. The positive input also turns Q3 on, clamping the base of Q1 to ground and keeping RLY1 from operating. The circuit can be driven with any DC source that can supply about 5 to 8 milliamps to the inputs.

Don't Need No Stinking Relays

Anyone who has worked with robots or other electromechanical systems has learned—usually the hard way—that the weakest part of any system is mechanical in nature. To increase reliability, our next motor control circuit, see Fig. 3, uses a modified "H" transistor bridge to replace the relays used in our previous two circuits.

This circuit is intended for running motors that require low run currents of 100 milliamps or less. I offered six different motor reversal circuits in the June 1999 issue of *Popular Electronics* (when the column was called "Circuit Circus") that should fill most requirements for robot motors.

Here's how the circuit operates. Transistors Q3 and Q4 are the two NPN input transistors that control the motor's rotation direction. A positive input to either transistor will cause the motor to run. Transistors Q1 and Q2 are a complementary pair of PNP transistors that

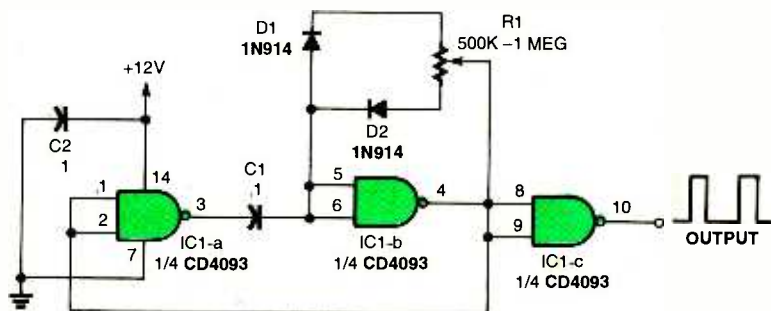

Fig. 5. A simple pulse-width modulator supplies a variable pulse width at a constant repetition rate—a good circuit for controlling the speed of a DC motor. The pulse width, set by R1, acts as the "throttle."

PARTS LIST FOR THE SPEED-CONTROL CIRCUIT (FIG. 5)

SEMICONDUCTORS

IC1—CD4093 quad 2-input NAND Schmitt trigger, integrated circuit
D1, D2—1N914 silicon signal diode

ADDITIONAL PARTS AND MATERIALS

R1—500,000-ohm to 1-megohm potentiometer
C1, C2—0.1-μF, ceramic-disc capacitor

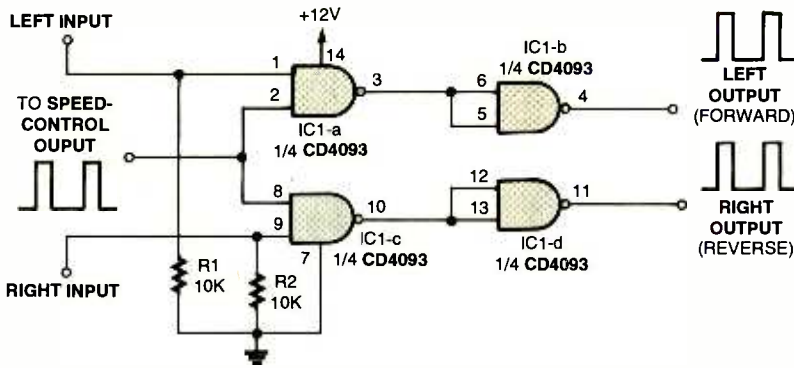

Fig. 6. Adding this circuit to the circuit in Fig. 5 lets you steer the output pulses between two different outputs—individually or together.

PARTS LIST FOR THE LEFT-AND-RIGHT SPEED-CONTROL CIRCUIT (FIG. 6)

- | | |
|--|--|
| IC1—CD4093 quad 2-input NAND Schmitt trigger, integrated circuit | R1, R2—10,000-ohm, 1/4-watt, 5% resistor |
|--|--|

complete the bridge circuit. Resistors R1 and R2 are the feedback, or base-drive, resistors for Q1 and Q2. A positive input to the base of Q3 causes it to turn on, pulling its collector—and the motor terminal connected to its emitter—to ground. At the same time, the base of Q2 is pulled to ground through R2, turning it on and connecting the motor's other terminal to the battery's positive voltage. Applying a positive voltage to the "right" input turns Q4 and Q1 on, causing the voltage across the motor to reverse and run in the opposite direction.

Adding Protection

The H-bridge motor-reversal circuit is a great way to run robot motors as long as both inputs don't get activated at the same time. If this would happen, it could damage one or all four transistors. A simple way to avoid the problem is to use a dual transistor-clamping circuit similar to the one used in Fig. 2, which only allows one input to be driven at a time. The dual-clamp circuit is shown in Fig. 4, which may be connected to the driver circuit in Fig. 3.

In the Fig. 3 circuit, a positive signal to

the "left" input also turns on Q5 in Fig. 4. The collector of Q5 clamps the base of Q4 to ground, keeping it from turning on if a positive signal at the "right" input were to occur. If both inputs happen to go positive at the same time, both Q5 and Q6 would clamp the bases of Q3 and Q4 to ground—keeping the motor-reversal circuit from operating.

Speeding Things Along

Now that we can easily change the direction of rotation of our DC motor, it would be great if we could also control its speed. The circuit in Fig. 5 will do that by driving the selected input of our motor-reversal circuit in Fig. 3. The motor-speed control is a simple variable pulse-width-oscillator circuit that allows the output's "on" time to be adjusted from about 5% to about 95%. Three gates of a quad two-input NAND Schmitt-trigger CMOS IC make up the circuit. Gates IC1-a and IC1-b form the oscillator, and IC1-c serves as a buffer-driver output.

The oscillator's frequency is determined by the values of C1 and R1. The frequency may be lowered by increasing the value of C1 and raised by decreasing C1's value. Once in a while, a DC motor will be frequency sensitive and chatter or run erratically. Usually changing the operating frequency will eliminate the problem. It is a good idea to run most DC motors at the lowest possible frequency because the armature winding is inductive, and power losses increase with frequency.

Left And Right

Our next entry, see Fig. 6, allows the speed-control circuit to operate with the motor-reversal circuit in Fig. 3 for both rotation direction and speed. A single CD4093 quad two-input NAND Schmitt-trigger CMOS IC steers the speed-control signal to the selected input of the motor-reversal circuit. Gate IC1-a directs the speed-control signal to the "left" or "forward" input of the motor-reversal circuit, and IC1-c to the "right" or "reverse" input.

A positive input to pin 1 of IC1-a activates the "left" output; a positive input to pin 9 of IC1-c activates the "right" output. The positive-input directional signals can be computer-generated or derived from other analog or digital circuitry.

Light At The End Of The Tunnel

Our next entry, see Fig. 7, introduces a simple method of robot tracking that

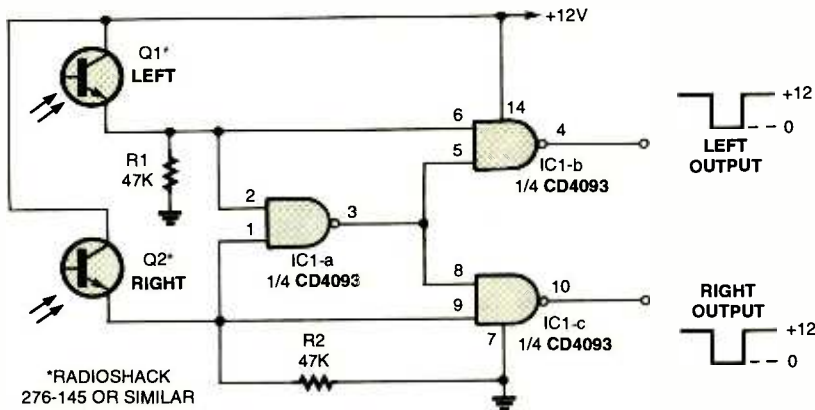

Fig. 7. A pair of phototransistors helps create a "steering" signal based on which transistor sees light.

PARTS LIST FOR THE LIGHT-SEEKING CIRCUIT (FIG. 7)

- | | |
|--|--|
| SEMICONDUCTORS | ADDITIONAL PARTS AND MATERIALS |
| IC1—CD4093 quad 2-input NAND Schmitt trigger, integrated circuit | R1, R2—47,000-ohm, 1/4-watt, 5% resistor |
| Q1, Q2—Phototransistor (RadioShack 276-145 or similar) | |

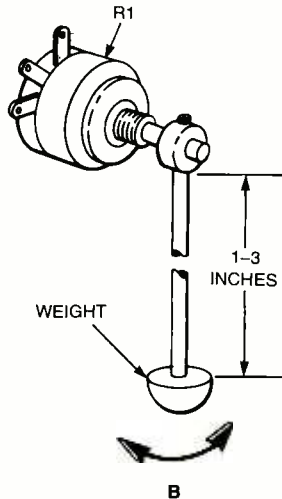
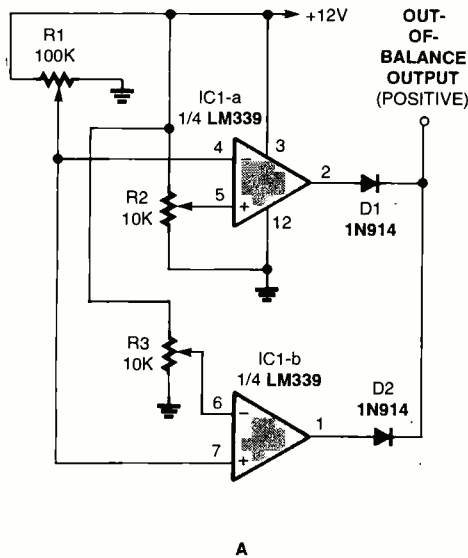

Fig. 8. Mounting a potentiometer with a pendulum-like weight gives your robot a sense of balance. If the unit is leaning too far in one direction, the circuit will output a warning signal. The clever robot builder will connect that output to a circuit that will help right the robot before it tips over.

PARTS LIST FOR THE LEVEL-SENSING CIRCUIT (FIG. 8)

IC1—LM339 quad comparator, integrated circuit
D1, D2—1N914 silicon signal diode

R1—100,000-ohm potentiometer
R2, R3—10,000-ohm potentiometer
Weight, hardware, etc.

can easily be added to your robot circuitry. This circuit uses light as the tracking source. With neither phototransistor receiving a light input, the voltage at the emitters of both phototransistors is low. The output at pin 3 of IC1-a and the outputs of both IC1-b and IC1-c are high because if either input of a NAND gate is low, its output is always high no matter what input is at the other input.

Light hitting Q1 produces a positive output at its emitter making both inputs of IC1-b high and its output low. A low output indicates that light is seen by the "left" input. If a positive output is desired, add another NAND gate wired as an inverter (both inputs tied together) to the output, which will change the low to a high output.

Light hitting Q2 produces a low at the output of IC1-c. If both phototransistors receive a light input, the outputs of both IC-b and IC1-c are high. This safety feature keeps both outputs from being turned on at the same time.

Leveling The Playing Field

Our last robot-circuit entry, see Fig. 8A, can be added to a mobile robot to help keep it from tipping over or to make corrections and readjust to a more level position. The sensor (Fig. 8B) is a

potentiometer with a hanging weight attached to the shaft on a short solid support. The potentiometer is mounted to the robot in a way that allows the weight to swing as the robot moves on an uneven surface. The output at the center terminal of the potentiometer is connected to the inputs of two LM339 quad comparators. The other two comparator inputs are connected to two potentiometers, which are used to set a voltage window for the amount of shift in the position of the weight. The window may be adjusted to allow for a normal variation in the robot's level setting.

As long as the robot remains within the normal range of the preset level, the outputs will be low. If the weight moves too far in either direction, the output will go high. Two circuit are required if both left-and-right and front-to-back positions are to be monitored. The circuit may be used to correct the uneven position of the robot by taking the output from each comparator and feeding it to a horizontal-correction circuit of your own devising.

More Robot Circuitry?

Once again, time has run out for this visit. Even though this special issue is drawing to a close, I would love to go on

with more basic robot circuits. If you would like to see more of my robot circuits, please let me know and we'll continue. You can write to me at the e-mail address at the top of this column. **P**

Did you know...

THE ORIGIN OF ROBOT

It was playwright Karel Capek who first coined the word robot in his play *R.U.R.* (Rossum's Universal Robots), which opened in Prague in 1921. The word is Czech for drudgery or slave laborer. The premise of Capek's play is the dehumanization of mankind due to technological advances.

Robotics coined by Issac Asimov, the famed author and scientist. Asimov's "Laws of Robotics" appeared in his short-story collection, *I, Robot*. The laws are as follows:

- Law Zero: A robot may not injure humanity, or, through inaction, allow humanity to come to harm.
- Law One: A robot may not injure a human being, or, through inaction, allow a human being to come to harm, unless this would violate a higher order law.
- Law Two: A robot must obey orders given to it by human beings, except where such orders would conflict with a higher order law.
- Law Three: A robot must protect its own existence as long as such protection does not conflict with a higher order law.

Joe Engelberger has been called "the father of robotics." Both Engelberger and George Devol developed the *Unimates*. Those robots were first introduced to industry in the late 50's. Devol received the patents for those robotic part transfer machines.

Later, in the mid 80's, the robotic industry boomed due to the support of the automotive industry. Scientists as far back as Nikola Tesla have been experimenting with robots.

RETAILERS THAT SELL OUR MAGAZINE EVERY MONTH

Arizona

Elliott Elec. Supply
1251 S. Tyndell Ave.
Tucson, AZ 85713

California

All Electronics
14928 Oxnard Street
Van Nuys, CA 91411

California Electronics
221 N. Johnson Ave.
El Cajon, CA 90202

Electronics Plus, Inc.
823 4th St.
San Rafael, CA 94901

Electronics Warehouse
2691 Main Street
Riverside, CA 92501

Ford Electronics
8431 Commonwealth Ave
Buena Park, CA 90621

HSC Electronics
6819 S. Redwood Drive
Cotati, CA 94931

HSC Electronics
4837 Amber Lane
Sacramento, CA 95841

Halted Specialties Co.
3500 Ryder Street
Santa Clara, CA 95051

Inland Electronic Suppliers
1012 N. Carpenter Rd.
Modesto, CA 95351

Kandarian Electronics
1101 19th Street
Bakersfield, CA 93301

Mar Vac Electronics
2001 Harbor Blvd.
Costa Mesa, CA 92627

Mar Vac Electronics
1759 E. Colorado Blvd.
Pasadena, CA 91106

Mar Vac Electronics
4747 Holt Blvd.
Montclair, CA 91763

Mar Vac Electronics
5184 Hollister Blvd.
Santa Barbara, CA 93111

Mar Vac Electronics
2537 Del Paso Blvd.
Sacramento, CA 95815

Mar Vac Electronics
2000 Outlet Center Dr. #150
Oxnard, CA 93030

Mar Vac Electronics
12453 Washington Blvd.
Los Angeles, CA 90066

Metro Electronics
1831 J Street
Sacramento, CA 95814

Orvac Electronics
1645 E Orangethorpe Ave.
Fullerton, CA 92631

Sav-On Electronics
13225 Harbor Blvd.
Garden Grove, CA 92643

Whitcomm Electronics
105 W. Dakota 106
Clovis, CA 93612

Colorado

Centennial Elec. Inc.
2324 E. Bijon
Colorado Springs, CO
80909

Connecticut

Cables & Connectors
2198 Berlin Turnpike
Newington, CT 06111

Illinois

BB&W Inc.
2137 S. Euclid Ave.
Berwyn, IL 60402

Tri State Elex
200 W. Northwest Hwy.
Mt. Prospect, IL 60056

Indiana

King of the Road Elec.
409 E. Center Rd.
Kokomo, IN 46902

Maryland

Mark Elec. Supply Inc.
11215 Old Baltimore Pike
Beltsville, MD 20705

Massachusetts

Electronic Hook-Up
104 Main St.
Milford, MA 01757

"You-Do-It" Electronics
40 Franklin Street
Neeham, MA 02494

Michigan

Norwest Electronics
33760 Plymouth Rd.
Livonia, MI 48150

Purchase Radio Supply
327 East Hoover Avenue
Ann Arbor, MI 48104

The Elec. Connection
37387 Ford Road
Westland, MI 48185

Minnesota

Acme Electronics
224 Washington Avenue N.
Minneapolis, MN 55401

Missouri

Gateway Electronics
8123-25 Page Blvd.
St. Louis, MO 63130

New Jersey

Lashen Electronics Inc.
21 Broadway
Denville, NJ 07834

New York

LNL Distributing Corp.
235 Robbins Lane
Syosset, NY 11791

T&M Elec. Supply, Inc.
472 East Main Street
Patchogue, NY 11772

Unicorn Electronics
Valley Plaza
Johnson City, NY 13790

Ohio

Parts Express
725 Pleasant Valley Drive
Springboro, OH 45066

Oregon

Norvac Electronics
7940 SW Nimbus Avenue
Beaverton, OR 97005

Texas

Computers Electronics Etc.
110 E. Medical Center Blvd.
Webster, TX 77598

Electronic Parts Outlet
3753 B Fondren
Houston, TX 77063

Tanner Electronics
1301 W Beltline
Carrollton, TX 75006

Washington

Supertronix Inc.
16550 W. Valley Hwy.
Tukwila, WA 98188

*Barnes & Noble • B. Dalton • Crown Books • Tower Books • Super Stand
Borders Book Store • On Cue • Hastings • Media Play • Walden Book Store
Just About Every Major Book Store!*

If you'd like to sell our magazine in your store, please circle 180 on free information card or Contact Gina Giuliano at (631) 592-6720 ext 215

NEW GEAR

(continued from page 6)

or spectrum analyzer. The ADC-11/12 is ideal for measuring small signal changes and could be used to measure a robot's speed, for example.

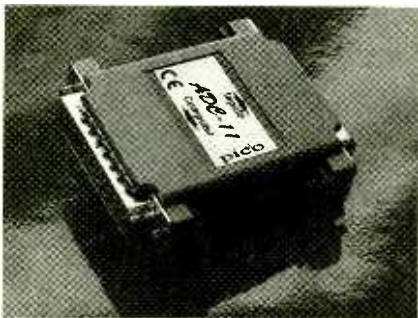

CIRCLE 68 ON FREE INFORMATION CARD

The ADC-11/12 sells for \$239.

SAELIG CO.

1193 Moseley Road
Victor, NY 14564
716-425-3573
www.saelig.com

P

HANDS-ON REPORT

(continued from page 13)

learns how to program various inputs and outputs, create and employ sub-routines, and use feedback from created circuits for complex program executions. The workbook also gives a brilliant introduction to working with Electrically Erasable Programmable Read Only Memory (EEPROM). The EEPROM chip on board the BASIC Stamp II allows for the storage of programs and data.

The final lesson is about navigation by means of IR frequency sweep. The BOEBot can move about using a couple of IR LED's and IR detectors that are placed on the breadboard and programmed with PBASIC. The programmed circuits allow the completed BOEBot to negotiate obstacles along its path. It was remarkable to see the final product move throughout my home. The appendix had some suggestions for competition including a maze challenge.

Overall Rating. Parallax's Robotics Kit is a comprehensive product

consisting of an educational workbook and all the parts needed to build a rugged BOEBot. Customer support available from Parallax is second to none. Design possibilities for BOEBot modification are practically limitless.

For more information, contact Parallax, Inc., 599 Menlo Drive, Suite 100, Rocklin, CA 95765; 916-624-8003; www.parallaxinc.com; or circle 80 on the Free Information Card.

P

NET WATCH

(continued from page 20)

research and development of robotics on a grassroots level.

The Net is reaching middle age, and it has gone through some alarming changes. With the advent of broadband technologies allowing for streaming audio and video at high bandwidths, it seems as though the Internet may be destined to transform your PC into a glorified nickelodeon machine. Yet, the electronic hobbyist—diligent and true to the cause—continues to use the Net for collaboration and exploration. Together, tech-heads and hobbyists can keep the true spirit of the World Wide Web alive.

P

DIGITAL DOMAIN

(continued from page 22)

com, and Bottomdollar at www.bottomdollar.com. Some specialized bots include CNET Shopper at www.shopper.com, Monstermoving at www.monstermoving.com, and InsWeb at www.insweb.com.

Right now, all that bots can typically do is try to find good deals for you. You have to do the rest. Work is underway though on interactive bots that can, for instance, negotiate price and other variables and place orders without your involvement. For more information on bots in general, check out BotSpot at www.botspot.com.

In short, bots, or intelligent agents, are not yet so intelligent after all. They will certainly get smarter, as will infor-

mation technology as a whole. Whether computers will outsmart us is a question of mind-boggling importance that will be answered only as the future boots up.

P

Did you know...

ROBOTS IN THE LIMELIGHT

Movie moguls have seen dollar signs in robots. The electronic actors were exploited heavily in celluloid during the 50's and have continued to play an active role in sci-fi entertainment.

Dozens of robots have achieved household celebrity status among fans. Kids today know LUCAS FILM's R2D2 and C3PO, but do they remember Robby or Robot B9 of *Forbidden Planet* and *Lost In Space* fame?

Television has also brought Dr. Who's K-9 and Dr. Theopolos's Tweekey into our homes. Even the more popular movies of our tech-jaded society have featured androids. Joan Rivers added voice to Dot Matrix of *Space Balls*, Robin Williams portrayed a family android in *Bicentennial Man*, and Arnold took a break from Hibernia in order to lend his automaton talents to *Terminator*.

Gazing back into time and seeing the world of the future according to the classic film *Metropolis*, we see how life imitated art. Time will tell if man and machine will truly coexist as they do in sci-fi tales.

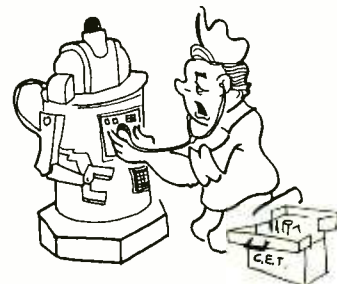

"Turn your sensor mount, and cough!"

Poptronics®

SHOPPER®

Paperback Books

GREAT BOOKS AT BUDGET PRICES

100 RADIO HOOKUPS
-#7-\$3.00

First published in May, 1923 this popular booklet went into reprint editions nine times. It is packed with circuits, theory, antenna installation and tips on consumer radio receivers that were popular in the early 1920's. Antique radio buffs and those inquisitive about the early days of radio will find this booklet an exciting, invaluable and excellent reference into the minds of early-day radio listeners. Sorry, we cannot honor the original 25-cent cover price.

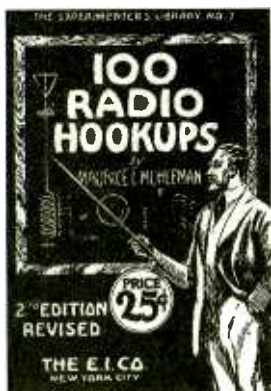

GUIDE TO THE WORLD'S RADIO STATIONS
-BP355-\$7.99

An easy-to-read guide for the casual listener and top notch QSL getter! The Guide is an essential reference work designed to steer the listener around the ever more complex radio bands. Listings cover world-wide shortwave stations with a special emphasis on international broadcasts in English. Medium and long-wave listings are also included for the US, Canada, European, Middle and Near East, and North Africa regions.

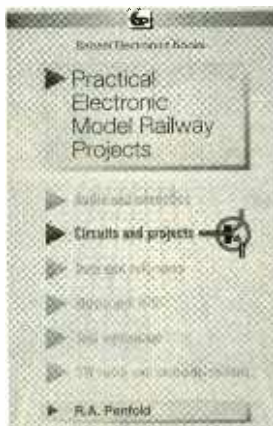
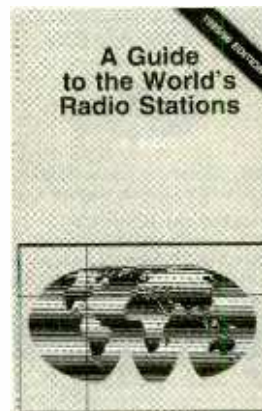

PRACTICAL ELECTRONIC MODEL RAILWAY PROJECTS
-BP384-\$6.99

Provides a number of useful but reasonably simple projects that include a constant voltage controller, automatic signals, steam whistle sound effect, two-tone horn sound effect, automatic chuffer, and a full chapter that covers how to use a computer to control a model railway layout, including controllers and signaling systems. Helps make your model railway a state-of-the-art system.

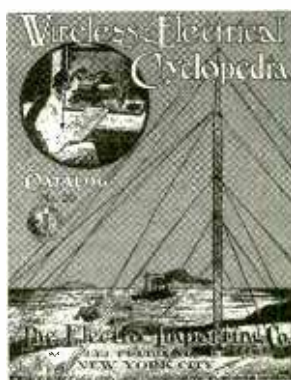

WIRELESS & ELECTRICAL CYCLOPEDIA
-ETT1-\$4.99

A slice of history. This early electronics catalog was issued in 1918. It consists of 176 pages that document the early history of electricity, radio and electronics. It was the "bible" of the electrical experimenter of the period. Take a look at history and see how far we have come. And by the way, don't try to order any of the radio parts and receivers shown, it's very unlikely that it will be available.

ELECTRONIC TECHNOLOGY TODAY INC.
P.O. BOX 240, Massapequa, NY 11762-0240

Name _____
Address _____
City _____ State _____ Zip _____

SHIPPING CHARGES IN USA AND CANADA

\$0.01 to \$5.00	\$2.00
\$5.01 to \$10.00	\$3.00
\$10.01 to 20.00	\$4.00
\$20.01 to 30.00	\$5.00
\$30.01 to 40.00	\$6.00
\$40.01 to 50.00	\$7.00
\$50.01 and above	\$8.50

SORRY No orders accepted outside of USA & Canada

Number of books ordered

Total price of merchandise	\$ _____
Shipping (see chart)	\$ _____
Subtotal	\$ _____
Sales Tax (NYS only)	\$ _____
Total Enclosed	\$ _____

All payments must be in U.S. funds!

ET01

OSCILLOSCOPE

Item # 50-6845

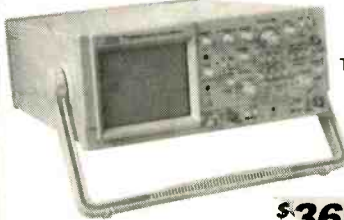

20MHz
LEXON
2-CH
FOUR
TRACE

\$369⁰⁰

Specifications:

- Brand: LEXON, Model#: CA-8020A
- 20 MHz Oscilloscope, 2 Channels 4 Trace
- Effective Screen Size: 8x10 DIV, 1 DIV = 10mm
- Accelerating Voltage: +2KV • Sensitivity: 5V
- Bandwidth: DC 0-20MHz, AC 10Hz-20MHz
- Mode: CH 1, CH 2, ALT, CHOP, ADD
- Input Coupling: DC - GND - AC • Trimming Ratio: 2.5:1 • Input Impedance: 1MOhms +/-3%, 25pF +/- 5pF • Input Resistance: 10KΩ • Voltage Requirements: 110V, 50/60Hz • Power Consumption: 40W • Dimensions: 310(W)x130(H) x 418(D) mm • Weight: Appx. 6.5 Kg
- Accessories: Power Cord, 2 Scope Probes, Manual

SWING ARM MAGNIFYING LAMP



\$34⁹⁵

Perfectly Balanced Fluorescent Lighting With a Precision Diopter Magnifier Lens.

- Spring-Balanced 45" extension arm with 3 conductor • 22W fluorescent circling tube • Available for inspection on electronic circuit board, gemstone, laboratory inspection or hobbyist to scrutinize stamp, coins extra-magnification. • Lamp is included.

Color	Voltage / Freq.	Item #
White	110V / 60Hz	54-0120

5-60W VARIABLE ELECTRONIC SOLDERING STATION

Item # 51-2005

PRO'S TOOL

Call us for tips and accessories



\$27⁰⁰

- 110V AC
- General Duty Soldering Station
- Adjustable 5 Watts to 60 Watts
- For the professional or hobbyist



DC ≈ AC COMPACT INVERTER

300W CE

Item# 40-1910



\$39⁰⁰

Common Features:

- AC output Voltage: 120V AC
- DC input Voltage: 10-15V
- Frequency ±1%, 60Hz 50Hz
- Output wave from: Modified Sine Wave
- Over load protection • Low Battery Shutdown
- Low Battery Alarm • Cooling fan • Cigarette plug
- Battery clamps • Output: •Power 300W •Surge 600W• Current:2.50A • Continuous Power: Deskfan, Laptop • 2 Outlets

Approx. Dimensions: (LxWxH)(9"x4"x2") (232x104x58mm)
Approx. Weight: (2Lbs) (0.9Kg)

This Power Inverter Handles Temporary High Surge Loads to Start Electric Motors, Water Pumps, TVs and more.

DUAL LCD DISPLAY

Item# 40-1685

\$85⁰⁰

This dual LCD display regulated power supply has been designed to provide the most often required in the laboratories, schools and production lines.



Voltage:

- Recovery Time: < 100usec
- Ripple & Noise: < 0.5mV RMS
- Output 0-30V(DC) • Load Regulation: < 0.015% + 3mV

Current:

- Output 0-3A(DC) • Load Regulation: < 0.3% + 3mA • Ripple & NOISE: < 3mA RMS
- Chassis & AC Cord: > 30 MΩ (500V DC)
- Chassis & Output Terminal: > 20MΩ (500V DC)
- Dimensions: (L:11" xW:5" xH:6") • Apprx. Weight: 8lbs

DIGITAL MULTIMETER

Item # 50-6585

UNI-T

- 9V Battery Included
- Diode Test • Input Impedance: 10MΩ
- Resistance: 200Ω-20MΩ • AC Voltage: 200mV-700V • Test Lead Probes Included
- AC/DC Current: 200 μA-20A
- Transistor Test • Continuity Buzzer • Auto Power Off • DC Voltage: 200mV-1000V • Low Battery Display • 0.5% Basic Accuracy • 3.5 Digit Max LCD Display • Dim. (H x W x D): 6.75" x 3.5" x 1.75"



\$15⁶⁹

MULTI-NETWORK CABLE TESTER

Pro's Kit QUALITY PRODUCTS

Item# 95-7695

Common Features:

- Multi-Network Cable Tester is specified to quickly test by auto scanning the wires continuity, miss-wiring and polarization in your network cables, (thin Ethernet BNC) for Item# 95-7685 only, 10Base-T(UTP/STP);356A/TIA-568A/TIA-568B/Token Ring. • By using the attached remote terminator, you can easily test the cable before or after the cables are installed. • Also allows you to test the ground of Shielded Twisted Pairs Cable.



\$49⁰⁰

CURTIS 1350 Joules

PC NETWORK SURGE PROTECTION

Item# 40-2490

\$25,000 Equipment Protection Warranty

Accommodate Power Adaptors

- Protects against surges, EMI/RFI filter minimizes line noise
- 15Amp circuit breaker
- 8 outlets & telephone protection using RJ45/RJ11
- 6ft power cord • Max. spike current: 6,500 Amps • Rated Voltage: 125V, 50/60Hz
- Built-in cable manager



\$16⁵⁰



2-device RJ11 & RJ45 data line protection - network ready

A LUMINUM FRAME TOOL CASE

Item# 50-1890



- Color: Black
- Measurements: 460x335x155mm (18" x 13" x 6")

\$17⁹⁵ Reg. \$59.00

Dalbani Receive a Free Catalog with your Order

Order Online www.dalbani.com The Ultimate Saving Source

Serving The Industry Since 1987



CALL TOLL FREE
1-800-325-2264

Poptronics, March 2001

Receive a Free Catalog with your Order

CALL TOLL FREE
1-800-325-2264

In Canada Call 1-800-667-4362

3⁹⁵ SPECIAL SHIPPING RATE

+ \$2.25 handling
Up to 5 lbs anywhere in the U.S.A.
Excluding Alaska, Hawaii & Puerto Rico



CIRCLE 316 ON FREE INFORMATION CARD

CONTROL
RELAYS • LIGHTS • MOTORS
MEASURE
TEMPERATURE • PRESSURE • LIGHT LEVELS • HUMIDITY
INPUT
SWITCH POSITIONS • THERMOSTATS • LIQUID LEVELS

MODEL 30 \$79



- PLUGS INTO PC BUS
- 24 LINES DIGITAL I/O
- 6 CHANNEL
- 8 BIT A/D/ F/H
- 12 BIT COUNTER
- UP TO 14K SMP/SEC

MODEL 45 \$189



- RS-232 INTERFACE
- 8 DIGITAL I/O
- 8 ANALOG INPUTS
- 2 ANALOG OUTPUTS
- 2 COUNTERS-24 BIT

MODEL 100 \$279



- 12 BIT 100 KHZ A/D
- 4 ANALOG OUTPUTS
- 3 TIMER COUNTERS
- 24 DIGITAL I/O

MODEL 150-02 \$179



- RS-232 INTERFACE
- TRMS, 20 AMPS
- 12 BIT A/D
- OPTO-ISOLATED
- COMPLETE DMM

MODEL 40 \$109



- RS-232 INTERFACE
- 28 LINES DIGITAL I/O
- 8 ANALOG INPUTS
- PWM OUTPUT

MODEL 70 \$239



- RS-232 INTERFACE
- 18 BIT A/D
- 5.5 DIGIT
- UP TO 60 SMP/SEC

Prairie Digital, Inc.

PHONE 608-643-8599 • FAX 608-643-6754
920 SEVENTEENTH STREET • PRAIRIE DU SAC, WISCONSIN 53578

CIRCLE 219 ON FREE INFORMATION CARD

\$59 PCBs

And our layout software is **FREE**

- 1 Download our board layout software
- 2 Design a 2-sided circuit board 2.5" x 3.8"
- 3 Send us your layout over the Internet
- 4 We ship you 3 excellent quality boards with plated-through holes for \$59 (shipping included)

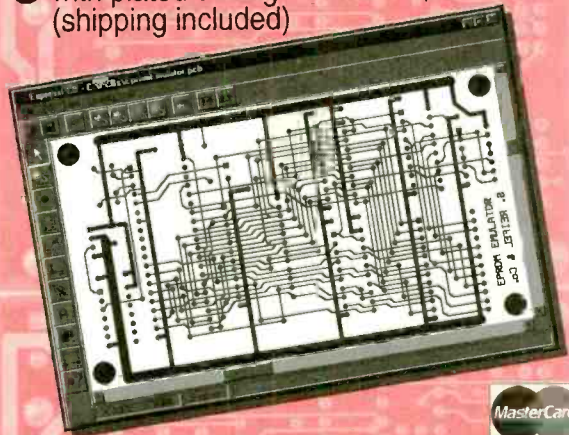

www.expresspcb.com



The Standard for checking Capacitors in-circuit



Good enough to be the choice of Panasonic, Pioneer, NBC, ABC, Ford, JVC, NASA and thousands of independent service technicians.

Inexpensive enough to pay for itself in just one day's repairs. At \$179, it's affordable.

And with a 60 day trial period, satisfaction guaranteed or money-back policy, the only thing you can lose is all the time you're currently spending on trying to repair all those dogs you've given up on.

CapAnalyzer 88A

Available at your distributor, or call 561-487-6103

Electronic Design Specialists

Locate shorted or leaky components or conditions to the exact spot in-circuit

Still cutting up the pcb, and unsoldering every part trying to guess at where the short is?

\$179



Your DVM shows the same shorted reading all along the pcb trace. LeakSeeker 82B has the resolution to find the defective component. Touch pads along the trace, and LeakSeeker beeps highest in pitch at the defect's pad. Now you can locate a shorted part only a quarter of an inch away from a good part. Short can be from 0 to 150 ohms

LeakSeeker 82B

www.eds-inc.com

CIRCLE 210 ON FREE INFORMATION CARD

www.americanradiohistory.com

World's Smallest 68HC11 Microcontroller Module!

MicroStamp11™



- telemetry
- microrobotics
- smart toys
- animatronics
- model railroading
- home automation

NEW! Windows-based development software included free!

- tiny, light-weight (0.5 oz.) 1-inch x 1.4-inch 68HC11 module
- 5V regulator, 8MHz crystal
- choice of 8K or 32K EEPROM
- optional 32K RAM (32K EEPROM version)
- plugs into your breadboard like a DIP
- SCI, SPI, OCS, ICs, timers, & more
- all 14 I/O lines and 2 interrupts brought out to versatile 20-pin connector
- program in BASIC, assembler, or C
- easy code-loading with Docking Module
- Starter Packages:*

8K EEPROM (#MS11SP8K).....\$49
32K EEPROM (#MS11SP32K).....\$72
32K EE+32K RAM (#MS11SP64K)...\$90

*Includes MicroStamp11, manual, PC software (free-ware assembler, SBASIC compiler, Smartload11 utility, and sample programs), serial cable, Docking Module, accessories.

Optional ImageCraft 68HC11 C cross-compiler for W3.119x available (# ICC11WIN)..... \$153

MicroCore-11™

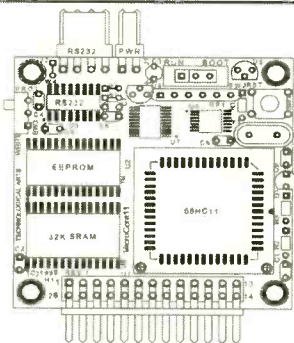

- tiny 2-inch x 2-inch 68HC11 module
 - 12 inputs/outputs plus 8 analog inputs
 - RS232, 5V regulator, 8MHz crystal
 - 32K SRAM plus 8K or 32K EEPROM
 - plugs into your breadboard like a DIP
 - easy program loading from any PC
 - motor driver & accessories available
 - ideal for MicroMouse robot competitions
- 8K Starter Package #MC11SP8K.....\$68
32K Starter Package #MC11SP32K.....\$93
Motor driver boards, LCD/keypad/keyboard interface & prototyping cards available

Technological Arts

Many other modules & accessories available. Visit our website at:
www.technologicalarts.com
sales@technologicalarts.com
TOLL-FREE: 1-877-963-8996
Phone: (416) 963-8996
Fax: (416) 963-9179
Visa • MasterCard • Discover • Amex

The Pocket Programmer Only \$129.95

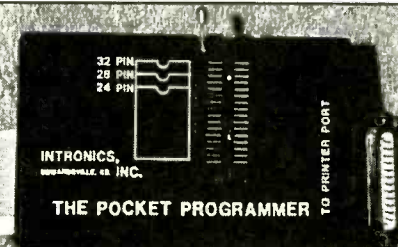

The portable programmer that uses the printer port of your PC instead of an internal card. Easy to use software that programs Eprom, EEprom, Flash & Dallas Ram. 27(C) / 28(C) / 28F / 29F / 29C & 25XX series from 16K to 8 Megabit with a 32 pin socket. Adapters available for Pic, PLCC, 5-Gang, 874X, 875X MCU's, 40-Pin X 16 & Serial Eprom's, 82/74 Prom's and Eprom Emulator to 32K X 8.

Same Name, Address & Phone # for 16 Years... Isn't it Amazing ?

Intronics, Inc.

Box 13723 / 612 Newton St.
Edwardsville, KS 66113 Add \$5.00 COD
Tel. (913) 422-2094 Add \$4.00 Shipping
Fax (913) 441-1623 Visa / Master Charge

Call Today And SAVE! **Unbeatable PRICES!**

CABLE TV

**DESCRAMBLERS
CONVERTERS · FILTERS
VIDEO STABILIZERS**

FREE ▶ 30 Day Trial
FREE ▶ Product Catalog
FREE ▶ 1 Year Warranty

100% MONEY BACK GUARANTEE



Let us point you in the right direction ...

Arrow Technologies
Omaha, Nebraska

**TOLL FREE
888-554-ARROW
888-554-2776**

ALL ELECTRONICS CORPORATION

16 Character X 2 Line LCD with Backlight

Daewoo # 16216L-5-VSO
5 x 7 dot format. 2.56" x 0.54"
viewing area. 3.15" x 1.41"
module size. LED backlight.
Includes hook-up/spec sheet.

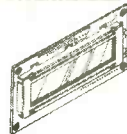

CAT # LCD-53

\$7.50
each

10 for \$6.50 each
100 for \$5.00 each

Phone Line Privacy Protector

Protects modem, fax and voice transmissions from interruption. Prevents eaves-dropping of phone conversations. The first device to answer or access a line secures the line. All of the others are denied access until the first device hangs-up. Installs between phone line and wall jack.

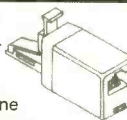

Note: You need one unit for each instrument sharing a line. CAT # TLM-20

\$1.50
each

10 for \$12.50
100 for \$90.00

Nickel-Metal Hydride AA "Flat-Top" Cells

Panasonic # HHR-11AA0. 1.2 Volt. 1100 mAh "flat-top" rechargeable AA cells. These cells are designed for use in battery packs; they do not have the raised button found on most replaceable batteries. 0.55" diameter X 1.95" long. Large quantity available. Two styles:

REGULAR-FLAT TOP
CAT # NMH-110



\$1.50
each

40pcs \$1.25 • 120pcs \$1.00
800pcs 85¢ each

SOLDER-TABBED
CAT # NMH-110T



\$1.75
each

40pcs \$1.50 • 120pcs \$1.25
800+ \$1.00 each

ORDER TOLL FREE

1-800-826-5432
SHOP OUR ONLINE STORE
www.allelectronics.com

CHARGE ORDERS to Visa, Mastercard, American Express or Discover

TERMS: **NO MINIMUM ORDER.** Shipping and handling for the 48 continental U.S.A. \$5.00 per order. All others including AK, HI, PR or Canada must pay full shipping. All orders delivered in CALIFORNIA must include local state sales tax. Quantities Limited. NO COD. Prices subject to change without notice.

CALL, WRITE FAX or E-MAIL for our FREE 96 Page CATALOG
Outside the U.S.A. send \$3.00 postage.

MAIL ORDERS TO:
ALL ELECTRONICS CORPORATION
P.O. Box 567
Van Nuys, CA 91408
FAX (818)781-2653

e-mail allcorp@allcorp.com

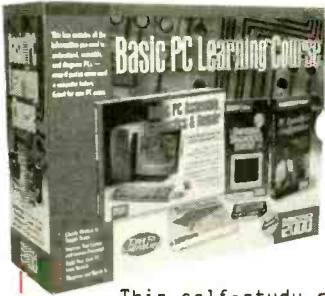

Basic PC Learning Course

This self-study course will allow you to:

- * Understand Basic PC Principles
- * Diagnose PCs and Repair PCs
- * Build PCs from Scratch

Each Course Contains:

- * A Self-Study Course Manual
- * Basic PC Assembly & Configuration Video
- * MicroScope Diagnostic Software Video
- * MicroScope Diagnostic Software - Limited Edition (25 uses)

ONLY
\$239.95

Everything you need in one box!

This is the simplest, easiest and most complete course on how to understand, assemble and diagnose PCs available today. It contains all the text, videos and diagnostic software you will need to succeed! Product number 01-920.

Call (800) 321-2155 to order or visit

www.ciebookstore.com

FCC Exam Review Course

with Certificate of Completion once finished!

Through the years Cleveland Institute of Electronics has been able to compile a great amount of information concerning the types of questions that the FCC include in their examinations.

After completing these 25 self-paced lessons you'll be ready to take the FCC exam for a General-Class License. Because of the extensive sampling of FCC type exam questions, you can look forward with confidence to passing the actual FCC exam, particularly if you heed the hints given in this course. Course includes Instructor Assistance and a Certificate of Completion. 01-FCC01\$195.00

- ✓ 25 lessons with graded exams.
- ✓ Instructor support with toll free help.
- ✓ Call (800) 321-2155

or visit www.ciebookstore.com

or mail to: **CIE Bookstore:**
1776 E. 17th St., Cleveland, OH 44114
(add \$15.75 shipping & handling)
CA, HI & OH residents must add sales tax

25 Lesson Course

1. Untuned Amplifier Circuitry
2. Tuned-Stage Operation
3. Modern Modulation Methods
4. Detection & Frequency Conversion
5. Receiving Equipment
6. Batteries, Control Motor & other Power Sources
7. Circuit Analysis
8. Frequency Modulation
9. Transmission Line & Wave Guides
10. Antennas & Wave Propagation
11. Transmitters
12. Suppressed - Carrier Modulation and Single
13. RF Amplifier Analysis
14. Microwave Communication Systems
15. Monochrome & Color TV
16. Telemetry
17. Aviation Electronics
18. Programmable Controllers
19. Digital & Data Commun.
20. Lasers in Communications & Industry
21. Commun. by Fiber Optics
22. FCC Review Lessons Part 1
23. FCC Review Lessons Part 2
24. Pointers & Practices for Passing FCC G.C. Exam Pt. 1
25. Pointers & Practices for Passing FCC G.C. Exam Pt. 2

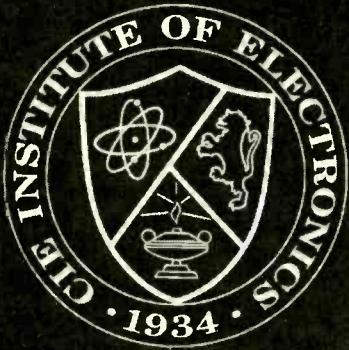

It's almost like being paid to study.

Earn an Associate Degree in Electronic Engineering Technology...

Put your knowledge of electronics to work for you. CIE offers the most comprehensive Associate Degree program offered in electronics. Best of all you study at your own pace with the full resources of CIE just a phone call or a click of a mouse away.

It's Comprehensive and Unique. You Pay for Only the Time You Use!

You won't find a better school than CIE if you want to accomplish your goals without pesky time restrictions (commuting, 8 hour class days, etc.) at CIE you study at your own pace, even an accelerated pace. And if you're like most readers of this magazine, your electronics background can help you receive your degree in less than the maximum 8 terms allowed. Finish sooner and you can save thousands of dollars in tuition. It's almost like being paid to study.

Get all the details on CIE's Associate Degree Program, World College's Bachelor Degree Program and CIE's 10 Career Courses today!



Free Course Catalog!

(800) 243-6446

www.cie-wc.edu

For a FREE Course Catalog on all of our Programs send to CIE: 1776 E. 17th St., Cleveland, OH 44114-3679 or visit www.cie-wc.edu PT30

Name: _____

Address: _____

City: _____

State: _____ Zip: _____

Phone: _____

E-mail: _____

Electronics made easy & affordable **velleman**

NEW

PERSONALSCOPE™

HPS5

The Velleman **PERSONAL SCOPE™** is a portable fully-functional oscilloscope. At the cost of a good multimeter it gives you the best possible value for the money. The **PERSONAL SCOPE™** provides you with the **high sensitivity** (down to 5mV/div) often missing in higher or similarly priced units. Together with the other scope functions it makes this the ideal tool for students, hobbyists and professionals.

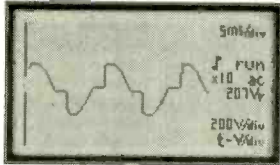

AC MAINS (e.g. phase control)

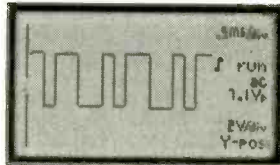

DIGITAL SIGNALS (e.g. pulse train)

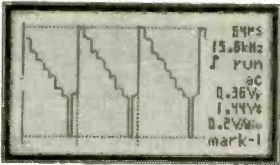

TV AND VIDEO (e.g. composite video signal)

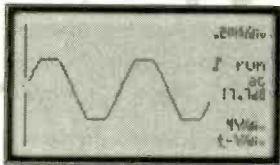

AUDIO SIGNALS (e.g. amplifier output clipping level)



SPECIFICATIONS:

- Maximum sample rate: 5MHz
- Input amplifier bandwidth: 1MHz (-3dB at 1V/div setting, 1Mohm // 20pF (standard probe)
- Vertical resolution: 8 bit (6 bit on LCD)
- LCD Graphics: 64 x 128 pixels
- dBm measurements: From -73dB tot +40dB (up to 60dB with X10 probe) ±0.5dB
- True rms AC measurement: 0.1mV to 80V (400Vrms with X10 probe) 2.5% accuracy
- Time base: 20s to 2µs / div in 22 steps
- Input sensitivity range: 5mV to 20V/div in 12 steps (up to 200V/div with X10 probe)
- Supply voltage: 9VDC / min 300mA adapter
- Batteries (in option): Alkaline type AA (5 pcs required)
NiCd/NiMH rechargeable
- Battery life: Up to 20 hours with Alkaline batteries
- Safety: Meets IEC1010-1 600V CATH, pollution degree 1
- Dimensions: 105 x 220 x 35mm (4.13"x7.95"x1.38")
- Weight: 395g (1.4oz.) (excl. batteries)



- OPTIONS:**
- Insulated measurement probe x1/x10: PROBE605
 - Adaptor for 110VAC: PS905USA

\$199.95

Probe not included



SERVICE & DEVELOPMENT



CAR DIAGNOSTICS



AUDIO TROUBLE SHOOTING

velleman

7415 Whitehall Street Suite 117
 Fort Worth, TX 76118
 (817) 284-7785 F : (817) 284-7712
 www.velleman-kit.com email : velleman@earthlink.net

Poptronics, March 2001

72 Questions ? Contact us for a list of US distributors or to get your **FREE** catalogue

CIRCLE 275 ON FREE INFORMATION CARD

DVD Movies
DVD Music

Home
Theater

BigBang
electronics

Clearance

Specialty
Items

THE SIGN OF INTELLIGENT LIFE IN THE UNIVERSE ...

Big Bang offers top-quality name-brand electronic equipment and home theater components for lower prices than anywhere else in the galaxy. Make contact today.



CALL FOR A FREE CATALOG

Toll Free 1-888-314-2620
or www.bigbangelectronics.com



TACTILE SOUND

DON'T JUST WATCH THE MOVIE - FEEL THE MOVIE.

Tactile Sound is sound you feel. It's the exhilarating rumble of F-16 afterburners, the gentle pluck of a guitar...it's every action and special effect built in to the movie's soundtrack. Now you can experience your favorite movies with your entire body.



Pioneer • Denon • MB Quart • Philips • Pioneer • Denon • MB Quart • Philips

Pronto Intelligent/Universal
Remote controls unlimited
number of components



Philips Portable DVD Player



PC Camera

MP3 Player records up to
80 hours of music

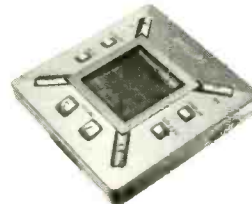

MB Quart
QLS-1030 Towers

**MODERN
ELECTRONICS**

CABLE TV DESCRAMBLERS



- ★ **FREE CATALOG!**
- ★ **BEST DEALER PRICING!**
- ★ **DISCOUNTED PRICING!**
- ★ **30 DAY FREE TRIAL!**
- ★ **100% MONEY BACK GUARANTEE**

**COPY RENTAL TAPES WITH
OUR VIDEO STABILIZER**

1-800-906-6664

2609 S. 156th Circle • Omaha, NE 68130
www.modernelectronics.com



PIC MICRO TOOLS



Easy Solderless Prototyping!
On board RS-232, In Circuit Programming. No cable or chip swapping! Fully Documented. Starting at Only \$39.95



ISP PRO Programmer
PIC - Scanix - Atmel - I2C - SPI In Circuit or on board. The only programmer you'll ever have to buy! Only \$59.95



Program PIC's in BASIC!
Pic n' Basic Compiler \$89.95
Pic n' Basic PRO Compiler \$149.95
Includes Windows IDE with ISP PRO programmer software built in FREE!

Combo Deal - Pic n' Basic, ISP PRO, 1802 Solderless Proto Board and PIC16F84 plus cables and power supply all for only \$179.95

Join our online PIC forums tons of information and help Free!

VISA • MasterCard • American Express
To Order Call 1-248-426-8144 Basic Micro
33523 Eight Mile Rd #A3-261, Livonia, MI, 48152
Visit us online <http://www.basicmicro.com>

CONITEC DATASYSTEMS

TOP PERFORMANCE in a small package:
Europe's best selling multi-programmer!



One size fits all!
\$333
COMPLETE KIT

Top of the line multi-programmer in sub-\$500 category. From 20% to 80% market share in Germany in 6 years. 1300+ device output and growing fast. Europe-wide sales 10%-60% mkt share in 6 years. Minimal, 1% return quota for hardware defects. Replaces all low priced dedicated programmers e.g. PIC only or GAL only units. GALEP III also substitutes higher priced universal programmers e.g. ALL-11 (HILQ) or LAB-TOOL-48 (ADVANTECH) - It provides virtually matching performance at only 1/3-1/5 the price.

Programs 8-bit and 16-bit EPROMs, EE-PROMs, 0-Power RAM's, Flash, Serial EEPROMs / GAL, PALCE, ATF/87xxx, 89xxx, PIC1216/17Cxx/ All DIL devices without adapter! Lightning fast parallel data transfer (27C 256 read 2 sec. - prog. 8 sec!). Supports HEX, JEDEC and binary formats, with integrated hex and fuse map editor. Fully Windows compatible incl. Win 2000 / NT. Browse 1300+ supported devices on Conitec's website: www.conitec.com. 90%+ of the listed devices require no adapter!

GALEP III / cable, batt. and recharger \$333.00
PICC adapt. / 8-bit EPROMs / 16-bit EPROMs / GALS each \$129.00

GALEP-III
Pocket Multiprogrammer

CONITEC DATASYSTEMS - 1951 4th Avenue, Suite 301 - San Diego, CA 92101 - Tel: 619-702-4420 - Info/Downloads/Orders: WWW.CONITEC.COM

FCC License Preparation

RADIOTELEPHONE LICENSE
Electronics Tech, Avionics, Marine & Radar
Homestudy - Fast - Easy & Inexpensive.
Manuels - Audio - Video - podisks - Q&As
Guarantee Pass - see at www.wptfcc.com
Details - 800-800-7555. WPT Publications
4701 NE 47ST, Vancouver, WA 98661

SINGERS! REMOVE VOCALS

Unlimited, Low Cost, Instantly Available Background Music from Original Standard Recordings! Does Everything Karaoke does... Better and gives you the Thompson Vocal Eliminator Free Brochure & Demo Tape.
LT Sound Dept PE
7988 LT Parkway, Lithonia, GA 30115
Internet - <http://www.LTSound.com>
24 Hour Demo/Info Request Line (770) 482-2485 - Ext 49
When You Want Something Better Than Karaoke!

Data Acquisition and Control

The ADR series of interfaces allow control of analog, digital and relay I/O via RS232 or RS485. Visit the web site for specs, applications and programs in VB, C, BASIC etc. (705) 871-2652

www.ontrak.net

Ontrak Control Systems Inc.

HARMONY

A PARTNERSHIP WITH A HEALTHY LAND

The earth has always provided food, water, and all that we need. Today, as in the past, American Indians recognize the importance of keeping the earth healthy. Give back to the earth. Call for your free action packet.

1-800-THE-SOIL

United States Department of Agriculture
Natural Resources Conservation Service



ELECTRONIC MILITARY SURPLUS



FAIR RADIO SALES

WEBSITE: fairradio.com
E-MAIL: fairradio@wcoil.com
PHONE: 419-227-6573
FAX: 419-227-1313

1016 E. Eureka - Box 1105
Lima, OH 45802
VISA, MASTERCARD, DISCOVER
Address Dept. ES

2KW SOLA REGULATOR



2000VA Constant Voltage Transformer by Sola #23-23-220-8. Input at 60 Hz: 95-130V at 23.5A, 175-235V at 12.6A, 190-260V at 11.6A, 380-520V at 5.8A. Output at 60Hz: 120/240V at 2000VA. 17.8x11.4x9.6, 115 lbs shipping. Unused, \$250.00; 2 for \$450.00

Allow money for shipping.

SEND FOR OUR
2000 CATALOG !!

Radios - Test Equipment - Tubes - Antennas

One tree can make
3,000,000 matches.

One match can burn
3,000,000 trees.

CABLE TV BOXES



(WE'LL BEAT ANY PRICE!)

30 DAY TRIAL* 1YR. WRNTY. *FREE CATALOG
QTY. DISCOUNTS * DEALERS WELCOME!

1-800-785-1145

HABLAMOS ESPANOL



PRIVATE CABLE SYSTEMS



Doppler Direction Finder

Track down jammers and hidden transmitters with ease! This is the famous WA2EBY DF'er featured in April 99 QST. Shows direct bearing to transmitter on compass style LED display, easy to hook up to any FM receiver. The transmitter - the object of your DF'ing - need not be FM, it can be AM, FM or CW. Easily connects to receiver's speaker jack and antenna, unit runs on 12 VDC. We even include 4 handy home-brew "mag mount" antennas and cable for quick set up and operation! Whips can be cut and optimized for any frequency from 130-1000 MHz. Track down that jammer, win that fox hunt, zero in on that downed Cessna - this is an easy to build, reliable kit that compares most favorably to commercial units costing upwards of \$1000.00! This is a neat kit!!

DDF-1, Doppler Direction Finder Kit \$149.95

Wireless RF Data Link Modules

RF link boards are perfect for any wireless control application; alarms, data transmission, electronic monitoring...you name it. Very stable SAW resonator transmitter, crystal controlled receiver - no frequency drift! Range up to 600 feet, license free 433 MHz band. Encoder/decoder units have 12 bit Holtek HT-12 series chips allowing multiple units all individually addressable, see web site for full details. Super small size - that's a quarter in the picture! Run on 3-12 VDC. Fully wired and tested, ready to go and easy to use!

RX-433 Data Receiver..... \$16.95 TX-433 Data Transmitter..... \$14.95
 RXD-433 Receiver/Decoder..... \$21.95 TXE-433 Transmitter/Encoder..... \$19.95

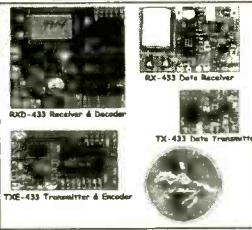

1 GHz RF Signal Generator



A super price on a full featured RF signal generator! Covers 100 KHz to 999.99999 MHz in 10 Hz steps. Tons of features; calibrated AM and FM modulation, 90 front panel memories, built-in RS-232 interface, +10 to -130 dBm output and more! Fast and easy to use, its

big bright vacuum florescent display can be read from anywhere on the bench and the handy 'smart-knob' has great analog feel and is intelligently enabled when entering or changing parameters in any field - a real time saver! All functions can be continuously varied without the need for a shift or second function key. In short, this is the generator you'll want on your bench, you won't find a harder working RF signal generator - and you'll save almost \$3,000 over competitive units!

RSG-1000B RF Signal Generator \$1995.00

World's Smallest TV Transmitters



We call them the 'Cubes'.... Perfect video transmission from a transmitter you can hide under a quarter and only as thick as a stack of four pennies - that's a nickel in the picture! Transmits color or B&W with fantastic quality - almost like a direct wired connection to any TV tuned to cable channel 59. Crystal controlled for no frequency drift with performance that equals models that cost hundreds more! Basic 20 mW model transmits up to 300' while the high power 100 mW unit goes up to 1/4 mile. Their very light weight and size make them ideal for balloon and rocket launches, R/C models, robots - you name it! Units run on 9 volts and hook-up to most any CCD camera or standard video source. In fact, all of our cameras have been tested to mate perfectly with our Cubes and work great. Fully assembled - just hook-up power and you're on the air! One customer even put one on his dog!

C-2000, Basic Video Transmitter..... \$89.95 C-2001, High Power Video Transmitter... \$179.95

CCD Video Cameras



Top quality Japanese Class 'A' CCD array, over 440 line resolution, not the off-spec arrays that are found on many other cameras. Don't be fooled by the cheap CMOS single chip cameras which have 1/2 the resolution, 1/4 the light sensitivity and draw over twice the current! The black & white models are also super IR (Infra-Red) sensitive. Add our invisible to the eye, IR-1 illuminator kit to see in the dark! Color camera has Auto gain, white balance, Back Light Compensation and DSP! Available with Wide-angle (80°) or super slim Pin-hole style lens. Run on 9 VDC, standard 1 volt p-p video. Use our transmitters for wireless transmission to TV set, or add our IB-1 Interface board kit for super easy direct wire hook-up to any Video monitor, VCR or TV with A/V input. Fully assembled, with pre-wired connector.

CCDWA-2, B&W CCD Camera, wide-angle lens \$69.95
 CCDPH-2, B&W CCD Camera, slim fit pin-hole lens. \$69.95
 CCDDC-1, Color CCD Camera, wide-angle lens \$129.95
 IR-1, IR Illuminator Kit for B&W cameras \$24.95
 IB-1, Interface Board Kit \$14.95

AM Radio Transmitter



Operates in standard AM broadcast band. Pro version, AM-25, is synthesized for stable, no-drift frequency and is settable for high power output where regulations allow, typical range of 1-2 miles. Entry-level AM-1 is tunable, runs FCC maximum 100 mW, range 1/4 mile. Both accept line-level inputs from tape decks, CD players or mike mixers, run on 12 volts DC. Pro AM-25 includes AC power adapter, matching case and bottom loaded wire antenna. Entry-level AM-1 has an available matching case and knob set that dresses up the unit. Great sound, easy to build - you can be on the air in an evening!

AM-25, Professional AM Transmitter Kit. \$129.95
 AM-1, Entry level AM Radio Transmitter Kit. . . \$29.95
 CAM, Matching Case Set for AM-1. \$14.95

Mini Radio Receivers



Imagine the fun of tuning into aircraft a hundred miles away, the local police/fire department, ham operators, or how about Radio Moscow or the BBC in London? Now imagine doing this on a little radio you built yourself - in just an evening! These popular little receivers are the nuts for catching all the action on the local ham, aircraft, standard FM broadcast radio, shortwave or WWV National Time Standard radio bands. Pick the receiver of your choice, each easy to build, sensitive receiver has plenty of crystal clear audio to drive any speaker or earphone. Easy one evening assembly, run on 9 volt battery, all have squelch except for shortwave and FM broadcast receiver which has subcarrier output for hook-up to our SCA adapter. The SCA-1 will tune in commercial-free music and other 'hidden' special services when connected to FM receiver. Add our snazzy matching case and knob set for that smart finished look!

AR-1, Airband 108-136 MHz Kit. \$29.95 FR-6, 6 Meter FM Ham Band Kit \$34.95
 HFRC-1, WWV 10 MHz (crystal controlled) Kit \$34.95 FR-10, 10 Meter FM Ham Band Kit \$34.95
 FR-1, FM Broadcast Band 88-108 MHz Kit \$24.95 FR-146, 2 Meter FM Ham Band Kit. \$34.95
 SR-1, Shortwave 4-11 MHz Band Kit \$29.95 FR-220, 220 MHz FM Ham Band Kit. \$34.95
 SCA-1 SCA Subcarrier Adapter kit for FM radio. \$27.95 Matching Case Set (specify for which kit) \$14.95

PIC-Pro Pic Chip Programmer

Easy to use programmer for the PIC16C84, 16F84, 16F83 microcontrollers by Microchip. All software - editor, assembler, run and program - as well as free updates available on Ramsey download site! This is the popular unit designed by Michael Covington and featured in Electronics Now, September 1998. Connects to your parallel port and includes the great looking matching case, knob set and AC power supply. Start programming those really neat microcontrollers now...order your PICPRO today!

PIC-1, PICPRO PIC Chip Programmer Kit \$59.95



RF Power Booster



Add muscle to your signal, boost power up to 1 watt over a freq range of 100 KHz to over 1000 MHz! Use as a lab amp for signal generators, plus many foreign users employ the LPA-1 to boost the power of their FM transmitters, providing radio service through an entire town. Runs on 12 VDC. For a neat finished look, add the nice matching case set. Outdoor unit attaches right at the antenna for best signal - receiving or transmitting, weatherproof, too!

LPA-1, Power Booster Amplifier Kit \$39.95
 CLPA, Matching Case Set for LPA-1 Kit \$14.95
 LPA-1WT, Fully Wired LPA-1 with Case \$99.95
 FMBA-1, Outdoor Mast Mount Version of LPA-1 \$59.95

FM Station Antennas

For maximum performance, a good antenna is needed. Choose our very popular dipole kit or the Comet, a factory made 5/8 wave colinear model with 3.4 dB gain. Both work great with any FM receiver or transmitter.

TM-100, FM Antenna Kit \$39.95
 FMA-200, Vertical Antenna \$114.95



Order Toll-free: 800-446-2295

Sorry, no tech info, or order status at 800 number

For Technical Info, Order Status
 Call Factory direct: 716-924-4560

RAMSEY ELECTRONICS, INC.
 793 Canning Parkway Victor, NY 14564

See our complete catalog and order
 on-line with our secure server at:
www.ramseyelectronics.com



ORDERING INFO: Satisfaction Guaranteed. Examine for 10 days, if not pleased, return in original form for refund. Add \$6.95 for shipping, handling and insurance. Orders under \$20, add \$3.00. NY residents add 7% sales tax. Sorry, no CODs. Foreign orders, add 20% for surface mail or use credit card and specify shipping method.

CIRCLE 263 ON FREE INFORMATION CARD

Turn Your Multimedia PC into a Powerful Real-Time Audio Spectrum Analyzer

Features

- 20 kHz real-time bandwidth
- Fast 32 bit executable
- Dual channel analysis
- High Resolution FFT
- Octave Analysis
- THD, THD+N, SNR measurements
- Signal Generation
- Triggering, Decimation
- Transfer Functions, Coherence
- Time Series, Spectrum Phase, and 3-D Surface plots
- Real-Time Recording and Post-Processing modes

Applications

- Distortion Analysis
- Frequency Response Testing
- Vibration Measurements
- Acoustic Research

System Requirements

- 486 CPU or greater
- 8 MB RAM minimum
- Win. 95, NT, or Win. 3.1 + Win.32s
- Mouse and Math coprocessor
- 16 bit sound card

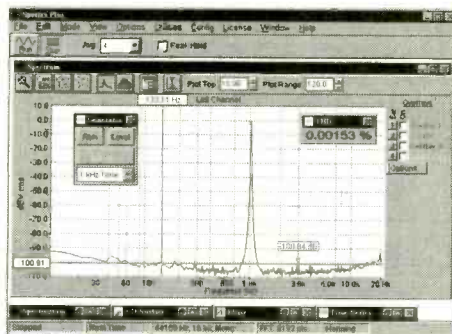

Priced from \$299

(U.S. sales only – not for export/resale)

DOWNLOAD FREE 30 DAY TRIAL!

www.spectraplus.com

PHS Pioneer Hill Software
24460 Mason Rd.
Poulsbo, WA 98370
a subsidiary of Sound Technology, Inc.

Sales: (360) 697-3472



Spectra Plus
FFT Spectral Analysis System

Fax: (360) 697-7717

e-mail: pioneer@telebyte.com

MECI 340 East First Street
Dayton, Ohio 45402
Your Electronics Value Company

Tons of Electronics

Get your FREE catalog today and discover some of the best deals in electronics. We have thousands of items ranging from unique hard-to-find parts to standard production components. Call, write or fax today to start your subscription to one of the most unique catalogs in the industry, filled with super values on surplus electronic and hobbyist type items.



Checkout our 10,000 item on-line catalog <http://www.meci.com>

Order Toll Free Why pay more?
1-800-344-4465 Call today!
Fax Order Line
1-800-344-6324

CIRCLE 323 ON FREE INFORMATION CARD

FACTCARDS

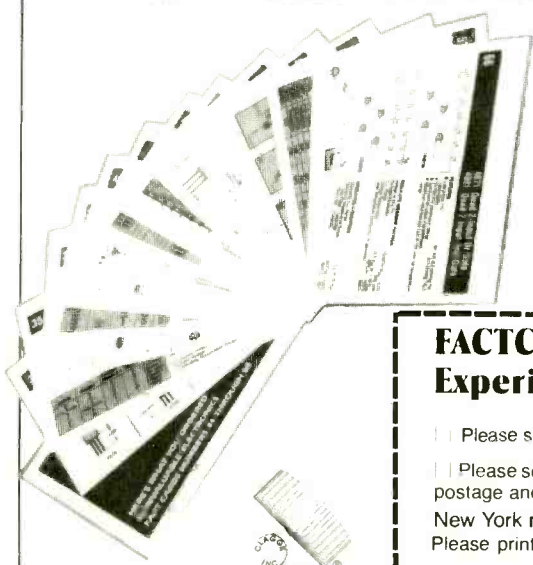

■ ALL YOU NEED to know about electronics from transistor packaging to substitution and replacement guides. FACTCARDS numbers 34 through 66 are now available. These beautifully-printed cards measure a full three-by-five inches and are printed in two colors. They cover a wide range of subjects from Triac circuit/replacement guides to flip-flops, Schmitt triggers, Thyristor circuits, Opto-Isolator/Coupler selection and replacement. All are clearly explained with typical circuit applications.

■ WANT TO EXPAND your knowledge of electronics? Do it the easy way

by studying the Electronics Fact Cards. Do you travel to and from your job each day? Drop a handful of cards in your pocket before you leave, and the bus becomes a schoolroom! At home, you can build some of the projects and not only have fun building and using them, but learn how they work at the same time.

■ YOU'LL BE AMAZED both at how rapidly you learn with these cards, and how easy it is to understand. These new cards are available right now. Don't miss out. Send your check or money order today.

Jampacked with information at your fingertips

FACTCARDS—Facts at your fingertips for Experimenters and Project Builders!

|| Please send one copy of FACTCARDS \$1.99. Shipping \$2.00 (U.S. and Canada only).

|| Please send _____ copies of FACTCARDS. Total cost is sum of copy price and First Class postage and handling cost multiplied by number of card sets ordered.

New York residents add sales tax to total cost of each order.

Please print

Allow 6-8 weeks for the material to arrive.

(Name) _____

(Street Address) _____

(City) _____

(State) _____

(Zip) _____

Detach and mail today:
CLAGGK Inc.
P.O. Box 12162
Hauppauge, NY 11788

All Payment must be in U.S. Funds!

BS168

**More Features
More Power
Less Money**

Ivex Complete Power Tools include: WinDraft P350 Schematics, WinBoard P350 PCB Layout, Ivex Spice Standard Simulation and Gerber Viewer together in a complete, affordable package.

Ivex Complete Plus includes everything in the Complete package plus 650 pin versions of WinDraft and WinBoard with Ivex Spice Advanced.

Ivex 650 pin versions have no feature limitations like other low cost products on the market. Fast expert technical support, free 24 hour Knowledge Base on the web, and professional full-featured tools have made Ivex the preferred choice for designers.

For larger designs use these Ivex Products:

WinDraft unlimited \$495
WinBoard unlimited \$495

Ivex Complete Electronics CAD Package

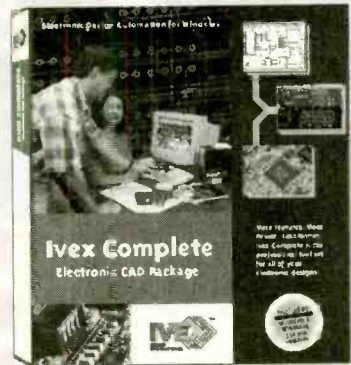
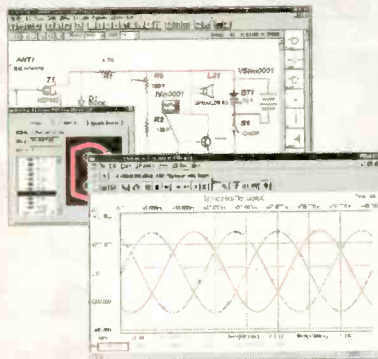

Advantages

Full-feature tools
17,000 Schematic parts
Part edit & model making
Part Search
Bill of Materials with Sort & Spreadsheet output
Hierarchy for large designs
ERC (electrical rules check)
15 Netlist outputs
7 Analysis Types
Spice Advanced includes 14 analyses
16 PCB layers
0.01 micron grid resolution
Advanced DRC
Micro via
Gerber & NC Drill report
24 hour FREE Technical Support Internet
Knowledge Base
No hardware protection lock!

Ivex Complete

Schematics
Simulation
PCB Layout
Gerber Viewer

\$350

Ivex Complete

Plus
P650 Schematics
Adv. Simulation
P650 PCB Layout
Gerber Viewer

\$550

Free board quote

pcbCite.com

The Internet source for PCB manufacturing

Visit the Ivex web site for complete product information and download full function demos.

www.ivex.com

Tel: (503) 531-3555 e-mail: sales@ivex.com

IVEX™
DESIGN
INTERNATIONAL

ADV8_3

CIRCLE 309 ON FREE INFORMATION CARD

CALL TOLL FREE
(800) 292-7711
Orders Only
Se Habla Español

C&S Sales

Look For Other
Monthly Specials
On Our Website

Excellence in Service

www.cs-sales.com

D/A Trainer

Elenco Model XK-150

\$89.95



A low cost, full-function digital/analog trainer that meets the needs of electronic training programs. Rugged construction, can be used as fixed lab equipment or be portable. An economical zipper case is available.

Soldering Stations

Weller Low Cost Soldering Iron Model WLC-100

\$34.95

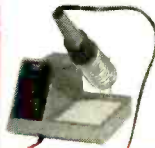

- Variable power control produces 5-40 watts.
- Ideal for hobbyists, DIYers and students.
- Complete with 40W iron.

Weller Soldering Station Model WES50

\$119

50 watts of controlled power - designed for continuous production soldering.



Deluxe Electronic Soldering Station

Elenco SL-5 Series

Electronically controlled, ideal for professionals, students, and hobbyists. Available in kit form or assembled.

Works w/ any iron! Turn any soldering iron into a variable iron.

As Low As
\$29.95

Ordering Information:

Model SL-5 - No iron. (Kit SL-5K)	\$29.95
Model SL-5-40 - Includes 40W UL iron. (Kit SL-5K-40)	\$35.95
Model SL-5-60 - Includes 60W UL iron. (Kit SL-5K-60)	\$36.95

*** Limited Time Offer ***
FREE SP-1A Solder Practice Kit w/ Kit Order!



Features:

- Cushion Grip Handle Soldering Iron (optional) with Grounded Tip for Soldering Static-Sensitive Devices. Easily Replaceable. Uses Long Life, Plated Conical Tip.
- Heavy Steel, Non-Slip Base.
- Iron Holder Funnel - Reversible, left or right side.
- Steel Tray for Sponge Pad.
- Sponge Pad.

Generators & Counters

B&K 20MHz Sweep/Function Generator with Frequency Counter Model 4040

\$445

- 0.2Hz to 20MHz
- AM & FM modulation
- Burst Operation
- External Frequency counter to 30MHz
- Linear and Log Sweep

21.5MHz Model 4070	\$129!
10MHz Model 4017	\$319
5MHz Model 4011	\$249



Four Functions in One Elenco Model MX-9300B

Features:

- One instrument with four test and measuring systems:
- 1.3GHz Frequency Counter
- 2MHz Sweep Function Generator
- Digital Multimeter
- Digital Triple Power Supply - 0-3V @ 2A, 5V @ 2A, 15V @ 1A

\$450



Elenco RF Generator with Counter (100kHz - 150kHz) Model SG-9500

\$225

Features internal AM mod. of 1kHz, RF output 100MV - 35MHz, Audio output 1kHz @ 1V RMS.



SG-9000 \$119.95 (analog, w/o counter)

Elenco Sweep Function Generator w/ built-in frequency counter Model GF-8046

\$195.95



This sweep function generator with counter is an instrument capable of generating square, triangle, and sine waveforms, and TTL, CMOS pulse over a frequency range from 0.2Hz to 2MHz.

GF-8025 - Without Counter **\$139.95**

Elenco Handheld Universal Counter 1MHz - 2.8GHz Model F-2800

\$99



Features 10 digit display, 16 segment and RF signal strength bar-graph.

Includes antenna, NiCad battery, and AC adapter.
C-2800 Case with Belt Clip \$14.95

Kit Corner

Quantity Discounts Available

over 100 kits available

Model RCC-7K

Radio Control Car Kit

\$29.95

- Fun & Easy to Assemble
- 7 Functions
- Radio Control Transmitter Included
- Also available as Model AK-870 (No Soldering) \$24.95



Model AK-700

Pulse/Tone Telephone Kit

\$15.95



Ideal School Project

Action Lab Kit

Model MX-902

- Safe, Solderless, Educational, and Fun!
- Easy-to-read, Illustrated, Lab-Style Manual Included.
- Requires 2 "AA" Batteries
- Build your own operating motor - It's easy, it's fun, it's Safe!
- For Ages 10 and up.

\$24.95



Model AM-780K

Two IC Radio Kit

\$11.95

Also available: Model AM/FM-108K AM/FM Radio Kit \$29.95

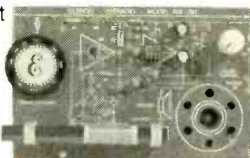

Model OWI-007

Robotic Arm (Wired Control)

Teaches the basic robotic sensing and locomotion principles while testing motor skills.

\$55.95



300-in-1

Experiment Kit

Model MX-908

- Everything you need to build 300 exciting electronic projects!
- Easy-to-read, Illustrated, Lab-Style Manual Included.
- Requires 6 "AA" Batteries
- For Ages 10 and up.

\$54.95



Guaranteed Lowest Prices

UPS SHIPPING: 48 STATES 5%
 OTHERS CALL FOR DETAILS
 IL Residents add 8.25% Sales Tax

C&S SALES, INC.

150 W. CARPENTER AVENUE
 WHEELING, IL 60090
 FAX: (847) 541-9904 (847) 541-0710

15 DAY MONEY BACK GUARANTEE
2 YEAR FACTORY WARRANTY

PRICES SUBJECT TO CHANGE WITHOUT NOTICE

CIRCLE 290 ON FREE INFORMATION CARD

SAME DAY SHIPPING

Secure on-line ordering

C&S Sales

Excellence in Service

CALL OR WRITE FOR OUR FREE

64 PAGE CATALOG!
(800) 445-3201

Elenco Oscilloscopes

Free Dust Cover and 2 Probes



S-1325	25MHz	Dual Trace	\$325
S-1330	25MHz	Delayed Sweep	\$439
S-1340	40MHz	Dual Trace	\$475
S-1345	40MHz	Delayed Sweep	\$569
S-1360	60MHz	Delayed Sweep	\$725
S-1390	100MHz	Delayed Sweep	\$895

DIGITAL SCOPE SUPER SPECIALS

DS-203	20MHz/10Ms/s	Analog/Digital	\$695
DS-303	40MHz/20Ms/s	Analog/Digital	\$850
DS-603	60MHz/20Ms/s	Analog/Digital	\$950

Quantity Discounts Available

Digital Multimeters

Fluke 87III



\$319

Features high performance AC/DC voltage and current measurement, frequency, duty cycle, resistance, conductance, and capacitance measurement.

Elenco LCR & DMM Model LCM-1950



\$69

- Large 1", 3 3/4 digit LCD
- Autorange frequency to 4MHz
- Capacitance to 400µF
- Inductance to 40H
- Resistance to 4000MΩ
- Logic Test
- Diode & Transistor Test
- Audible Continuity Test

Elenco Model M-1740



\$34.95

- 11 Functions
- Freq. to 20MHz
- Cap. to 20µF
- AC/DC Voltage
- AC/DC Current
- Beeper
- Diode Test
- Transistor Test
- Meets UL-1244 safety specs

Model M-2760 - \$19.95 (9 functions)

Dual-Display LCR Meter w/ Stat Functions B&K Model 878



\$225

Auto/manual range
Many features with Q factor
High Accuracy

Elenco LCR Meter Model LCR-1810



\$99.95

- Capacitance 1pF to 20µF
- Inductance 1µH to 20H
- Resistance 0.1Ω to 2000MΩ
- Temperature to 750°C
- DC Volts 0 - 20V
- Frequency up to 15MHz
- Diode/Audible Continuity Test
- Signal Output Function
- 3 1/2 Digit Display

Elenco DMM Kit Model M-1005K



\$19.95

- 18 Ranges
- 3 1/2 Digit LCD
- Transistor Test
- Diode Test
- Training Course

M-1000B (Assembled) \$15.95

B&K Testers

Deluxe Multi-Network Cable Tester Model 231

\$75

- Tests 10BaseT, 100BaseTx, 10Base2, RJ45, RJ11, 356A, TIA-568A, TIA-568B, and Token Ring cables.
- Detects open, short, cross, and continuity
- Tests Point-to-Point, rather than Pair-to-Pair
- Quick and easy-to-use.
- Tests cables on wall plate or patch panel up to 1,000 ft. away with the remote kit.
- Easy-to-read LED display.



Multi-Network Cable Tester Model 230

\$69

- Auto scans thin Ethernet (BNC), 10BaseT (UTP/STP), 100BaseTx, RJ45, 356A, TIA-568A, TIA-568B, and Token Ring cables in seconds.
- Detects miswiring, polarization, and continuity.
- Also tests the ground of shielded twisted pair cables.
- Tests cables before or after installation with the remote unit.
- LED display for clear indication of problems.



Remote Network Cable Tester Model 235

\$195

- Detects open, short, reversed, crossed, and split.
- Clear LED display for the fault status.
- Simple and easy-to-use.
- Test cable length: Minimum - 4 ft. (1.2m) Maximum - 492 ft. (150m).
- Identify up to 4 different cables at one end by provided remote identifiers.
- Tests: 10BaseT, 100BaseTx, 10Base2 (coax), RJ45, 356A, TIA-568A, TIA-568B, Token Ring, etc.



CCTV Cameras

Cameras have 420 lines (360 color) of resolution, 0.08 Lux, 3.6mm/F2 90° field of view. Power requirement is 12VDC @ 100mA (order SC-1).

MONOCHROME CAMERAS



SC-12 - 35mm Lens (1.25"x1.25") **\$69**

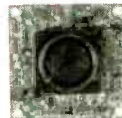

SC-15 - Pin Lens (1.25"x1.25") **\$69**

Add \$10 for lens • Add \$10 for audio

Accessories:

- SC-1 - 12V 100mA adapter **\$6.95**
- SC-2 - 50' cable with connectors **\$19.95**

COLOR CAMERAS



SC-20 Pin Lens
SC-21 3.6mm Lens
360 Lines 1.25" x 1.25"
Infrared Sensitive, Audio Included
\$109

Add \$10 for case
Call for complete catalog.

Power Supplies

Elenco Quad Power Supply Model XP-581

\$79.95



4 Fully Regulated DC Power Supplies in 1 Unit
4 DC voltages: 3 fixed - +5V @ 3A, +12V @ 1A, -12V @ 1A
1 Variable - 2.5 - 20V @ 2A

Elenco Power Supply Kit Model XP-720K

\$54.95

- 1.5VDC - 15VDC @ 1A
- 1.5VDC - -15VDC
- 5VDC @ 3A
- 6.3VAC @ 1A & 12.6VAC center tapped @1A



XP-720 Fully Assembled **\$85**

B&K High Current DC Power Supply

- Variable 3-14VDC
- Thermal Function
- Current Limiting

Model 1686 12A **\$169**
Model 1688 28A **\$249**



B&K 13.8V Fixed DC Power Supplies
Model 1680 8A **\$42**
Model 1682 15A **\$75**

Elenco DC Power Supply Model SPL-603 3A 0-30VDC

\$79.95

The SPL-603 is a solid-state DC power supply providing the exact output voltage no matter what current you use. Output fully protected from overload.



Guaranteed Lowest Prices

UPS SHIPPING: 48 STATES 5%
OTHERS CALL FOR DETAILS
IL Residents add 8.25% Sales Tax

SEE US ON THE WEB

C&S SALES, INC.

150 W. CARPENTER AVENUE
WHEELING, IL 60090

FAX: (847) 541-9904 (847) 541-0710

www.cs-sales.com

15 DAY MONEY BACK GUARANTEE

2 YEAR FACTORY WARRANTY

PRICES SUBJECT TO CHANGE WITHOUT NOTICE

CIRCLE 290 ON FREE INFORMATION CARD

TiePieScope HS801 PORTABLE MOST

Reliability



- 50 MHz ARBITRARY WAVEFORM GENERATOR-
- 100 MHz STORAGE OSCILLOSCOPE-
- 50 MHz SPECTRUM ANALYZER-
- 6 DISPLAY MULTIMETER-
- 200 DAYS TRANSIENT RECORDER-

The HS801: the first 100 Mega samples per second measuring instrument that consists of a MOST (Multimeter, Oscilloscope, Spectrum analyzer and Transient recorder) and an AWG (Arbitrary Waveform Generator). This new MOST portable and compact measuring instrument can solve almost every measurement problem. With the integrated AWG you can generate every signal you want.

A user defined toolbar with which over 50 instrument settings quick and easy can be accessed is offered by the versatile software. An intelligent auto setup allows the inexperienced user to perform measurements immediately. Through the use of a setting file, the user has the possibility to save an instrument setup and recall it at a later moment. The setup time of the instrument is hereby reduced to a minimum.

Analyzing signals is done with an 8 bit resolution and a maximum sampling speed of 100 MHz. The input range is 0.1 Volt full scale to 80 Volt full scale. The record length is 32K/256K samples. The AWG has a 10 bit resolution and a sample speed of 25 MHz.

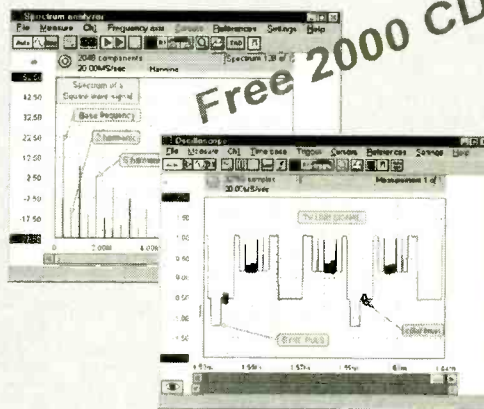

Convince yourself and download the demo software from our web page: www.tiepie.nl. When you have questions and / or remarks, contact us via email: support@tiepie.nl. The HS801 is delivered with a user manual, two probe's, Windows and DOS software.

US dealer:
Feedback Incorporated; Tel 800-526-8783;
 Fax 919-644-6470; www.fbk.com

Outside US:
TiePie engineering, P.O. BOX 290, 8600 AG SNEEK,
 The Netherlands.
 Tel: +31 515 415 416 Fax: +31 515 418 819
 Web: www.tiepie.nl

CIRCLE 217 ON FREE INFORMATION CARD

Practical PIC Microcontroller Projects

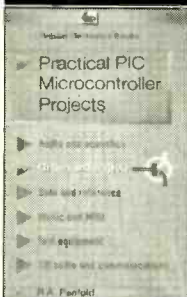

This book covers a wide range of PIC based projects, including such things as digitally controlled power supplies, transistor checkers, a simple capacitance meter, reaction tester, digital dice, digital locks, a stereo audio level meter, and MIDI pedals for use with electronic music systems. In most cases the circuits are very simple and they are easily constructed. Full component lists and software listings are provided. For more information about PICs we suggest you take a look at BP394 -- An Introduction to PIC Microcontrollers.

To order Book #BP444 send \$7.99 plus \$3.00 for shipping in the U.S. and Canada only to Electronics Technology Today Inc., P.O. Box 240, Massapequa Park, NY 11762-0240. Payment in U.S. funds by U.S. bank check or International Money Order. Please allow 6-8 weeks for delivery. ET10

An Introduction to Light in Electronics

An Introduction to Light in Electronics

F.A. WILSON

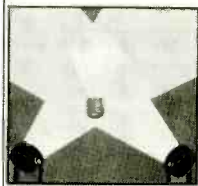

Taken for granted by us all perhaps, yet this book could not be read without it, light plays such an impressive role in daily life that we may be tempted to consider just how much we understand it. This book makes a good start into this fascinating and enlightening subject. It has been written with the general electronics enthusiast in mind.

To order Book #BP359 send \$6.99 plus \$3.00 for shipping in the U.S. and Canada only to Electronics Technology Today Inc., P.O. Box 240, Massapequa Park, NY 11762-0240. Payment in U.S. funds by U.S. bank check or International Money Order. Please allow 6-8 weeks for delivery.

ET08

©1994 EDF

Thanks to you, all sorts of everyday products are being made from the paper, plastic, metal and glass that you've been recycling. But to keep recycling working to help protect the environment, you need to buy those products.

BUY RECYCLED.



AND SAVE.

So look for products made from recycled materials, and buy them. It would mean the world to all of us.

For a free brochure, write *Buy Recycled*, Environmental Defense Fund, 257 Park Ave. South, New York, NY 10010, or call 1-800-CALL-EDF.



B² Spice A/D 2000

\$299

Mixed-Mode Circuit Design

Competitive Analysis

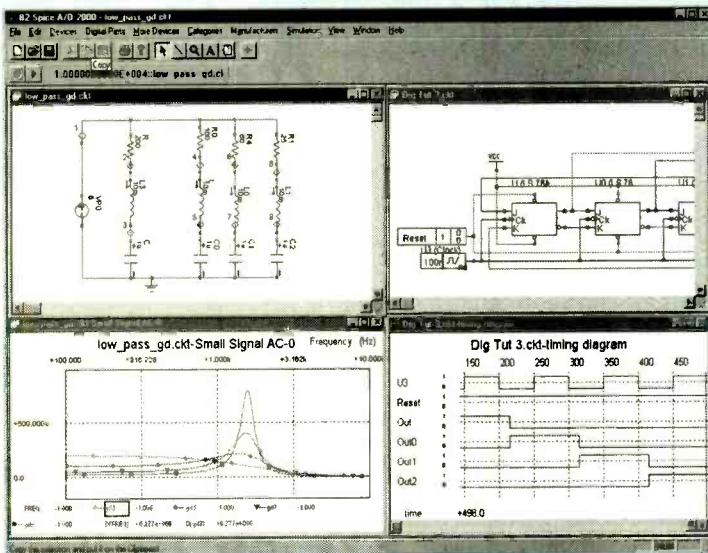

Characteristics	B ² Spice A/D 2000	EWB Multisim Personal
PRICE	\$299	\$399
DC Operating point	X	X
DC Parameter Sweep	X	X
Temperature Sweep	X	-
Transient	X	X
Fourier	X	X
Parameterized transient	X	-
AC Analysis (freq sweep)	X	X
Parameterized AC Sweep	X	-
Pole Zero	X	-
Transfer function	X	-
DC Sensitivity	X	X
Distortion	X	X
Noise	X	X
DC Op. Pt. Monte Carlo	X	-
DC Sweep Monte Carlo	X	-
AC Monte Carlo	X	-
Transient Monte Carlo	X	-
Interactive, free running digital logic simulation.	X	-

- ◆ Build complex circuits in minutes with our intuitive **schematic editor**.
- ◆ Turn any circuit into a functional part with just a few simple clicks.
- ◆ Interpret simulation results with customizable graphs.
- ◆ Find exactly the part you need from our database of **4500 parts**.
- ◆ Run an interactive **Digital Simulation** and view signals in the **Timing Diagram**

Visit our web site for a free trial.

\$99 Lite Version

Beige Bag Software • www.beigebag.com • 734.332.0487 • info@beigebag.com

Start A Career With High Wages, Excellent Benefits and Job Security!!

With UCANDO's extraordinary maintenance training programs you can quickly and easily enter a high paying field as a maintenance technician for a very small investment of time and money.



RC-M ONLY \$165 RC-M is a 15 hour training course on relay ladder logic systems. Includes a 5-part video and workbook. **Great Value!**

PLC-M ONLY \$198 PLC-M is a 32 hour training course on PLC systems. Includes (2) 4-part video's and workbook. **This training is valuable.**



HYD-M ONLY \$209 HYD-M is a 32 hour course on Fluid Dynamics. Includes (2) 4-part video's and workbook. **This Module is a must.**

SC-M ONLY \$215 SC-M is a 32 hour training course on AC & DC Servo Controllers. Includes (2) 4-part video's and workbook. **Learn everything you need about AC and DC servo Control Systems.**

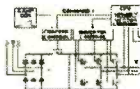

Electronic Training Videos: Basic Electronics, Digital Electronics, TV Repair, LASER and Fiber Optic training videos available at very affordable prices starting at **Only \$35.00 each.**

For information or to place an order call:

1-800-678-6113

www.ucando-corp.com

UCANDO VCR Educational Products Corp., Greenville, OH

Test Equipment From \$99.00

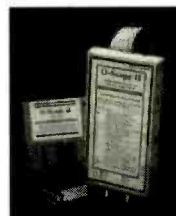

ATC modules provide for affordable pc based testing DSO, DVM, Spectrum Analyzer, Data Logging O-Scope Ip and O-Scope II Single and dual channels Serial a protocol analyzer software package DFA 5 low cost differential amplifier

Standalone digital oscilloscopes from HiRel and TPI

Pico Technology LTD leads in low cost pc based modules for test and data logging. Units to 100MSPS. 8 to 16 bits, 1 to 22 channels. Environmental monitoring. Science education with DRDAQ. Pricing from \$99

Allison Technology Corporation

2006 Finney Vallet Rd. Rosenberg, TX 77471

PH: 800-980-9806 or 281-239-8500, FAX 281-239-8006

http://www.atcweb.com atc@atcweb.com



Cable TV Remotes Blow-Out Sale

We carry all models

10pc.	50pc.	100pc.
\$3.75	\$3.50	\$3.25

300pc.	500pc.	1kpc.
\$3.00	\$2.75	\$2.50

Rebellion-3 125ch. Converter

12pc.	50pc.	100pc.
\$50.00	\$48.00	\$46.00

Globaltech 1-(800)-582-5116
View Our On-Line Display Catalog at:
www.globaltechdistributors.com

SMART CARDS

Complete system! Program your own smart card applications in easy to use BASIC!



- Security Systems
- Time Cards
- Emulation
- Access Control - Home, Auto
- Robotics Programming
- DATA Security

Tool Kit comes complete with:

- SmartCard Programmer
- Developer Software Package
- User Manual in printed form
- 3 Blank Smart Cards

Complete system for only \$79.95

We accept
VISA • Master Card • American Express

To Order Call 1-800-773-6698 Worldwyde.Com,
33523 Eight Mile Rd #A3-261, Livonia, MI. 48152
Visit us online <http://www.worldwyde.com>

Consumertronics



P.O. Box 23097
ABQ, NM 87192
505-321-1034 505-321-1033
FREE ONLINE CATALOG

www.tsc-global.com

Hi-Tech Survival: Books, Software,
SPECIAL PROJECTS on Electronics,
Computers, Internet, Phones, Energy,
Security, Financial, Medical, Cars,
Jobs, Physical Survival, Improved
Hacking, Unexplained Phenomena.
In business 25+ years!
Hardcopy Catalog: \$3 US/Canada, else \$7

NEW Easy-PC For Windows

Schematic & PCB Layout CAD

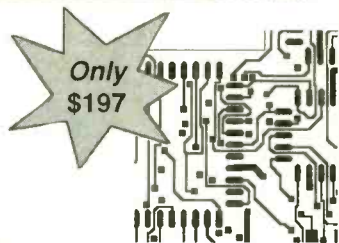

- True Windows interface
- True Windows 32 bit application
- Schematic and PCB Design as standard
- Intelligent Cut, Copy and Paste - internal & external
- Multi-level Undo and Redo
- Forward design changes - Schematic to PCB
- Integrated Autoplace
- Integrated Shape based AutoRouter (Optional Extra)
- Shape based copper pour and split power planes
- And now version 4.0 with many new features !!

Call Ohio Automation (740) 596 1023
www.numberone.com

Low Cost PICmicro Tools

New! PIC-XI
Experimenter/
Lab Board
\$49.95 to \$199.95



EPIC Pocket PICmicro
Programmer - \$59.95

Program PICmicros in BASIC!
PicBasic Compiler - \$99.95
PicBasic Pro Compiler - \$249.95

PICProto Boards make
prototyping with PICmicros
easy - \$8.95 to \$19.95



microEngineering Labs, Inc.
Box 7532 Colorado Springs CO 80933
(719) 520-5323 fax (719) 520-1867
<http://www.melabs.com>

THE Video King



Removes Distortion
Improves Color, Tint & Old Video
Creates & Restores Inverted Video
Works with PAL & NTSC Formats
Perfect for Video Duplication

R.C. Distributing Co. Phone (219) 233-3053 Fax (219) 289-1566
www.rcdistributing.com

TOP SECRET!

Hacking • Cracking • Satellite • Cable • Phreaking • Micros
GameBoy I/O • Smart Cards • Emulation • Hardware • Tools

Plus More! Visit us on the web!

Books & CD's:

Hackers Anarchy Cook Book 2000	\$39.95
The Hack & Crack Bible Vol.2	\$39.95
Hackers Gold CD Vol.1	\$29.00
Secrets of Dish Network Vol.1	\$49.95
DSS Secrets Vol.4 Book & CD	\$49.95
Cable Test Devices Source Code & Plans ..	\$79.00
PSX Secrets w/ MODCHIP Source Code	\$69.95
The Ultimate Phreaking Guide	\$39.95
Emulator Heaven CD	\$49.95
Game Boy I/O - Servos/Relays/Sensors	\$49.95

Hardware:

PIC, Scenix, Atmel Programmer Complete ...	\$99.00
ISO 7816 Smart Card Programmer	\$59.95
Smart Cards (from)	\$ 6.95
Prototyping Boards PIC & Scenix	\$ 9.95

VISA • Master Card • American Express
To Order Call 1-800-773-6698

Send Money orders to: Worldwyde.Com,
33523 Eight Mile Rd #A3-261, Livonia, MI. 48152
Visit us online <http://www.worldwyde.com>

SCINTILLATING!

Who Are You? The Encyclopedia of Personal Identification. Insider information directly from the FBI and Customs, top graphic artists, offshore attorneys, master thieves, and professional sharks. *Who Are You?* details ID theft schemes (and prevention), how to create great documents on a home computer, get a new driver's license (suspension? No problem), open offshore or US bank accounts w/o an SS number, acquire the world's best ID, second passports, phony credit cards, read vehicle tags, much, much more. Sources, sites, suppliers, tips, tricks and techniques. 352 pages \$44.95.

Covert Catalog 2000 The latest, hands-on source guide for law enforcement goodies, electronic surveillance, covert video, counter measures, entry equipment, weapons, tracking systems, computer surveillance, and more. Exact ordering info from suppliers in 13 nations! 220 Pages. \$39.95.

ORDER BOTH BOOKS — SUBTRACT \$10!!

Intelligence Here
404 N. Mt. Shasta Blvd.
Mt. Shasta, CA 96067
Order by Phone: 866-885-3655
www.intelligencehere.com

Add \$6.00 (prior to shipping). CA residents add 8% tax.

spyoutlet.com

Countersurveillance - Electronic Devices

Purchase your video cameras from
one of the largest Importers
in the U.S.

- NEW Underwater Bullet Cameras
- Spy Pinhole Cameras starting at \$79⁰⁰
- Wireless Video • Voice Changer
- Micro Recorders • Shotgun Mic
- Locksmithing • Bug & Phone Tap Detectors • Phone Call Register
- UV Pens & Powder • Realtime Telephone Recording Systems:
- 12 Hour \$125⁰⁰ • GPS Vehicle Tracking System (nationwide)
- And much more

www.spyoutlet.com
Printed Catalog send \$5⁰⁰

SPY OUTLET 2468 NIA. FALLS BLVD
TONAWANDA NY 14150 (716) 695-8660

Hack & Crack Bible II and CD-ROM

Includes all Software, Documentation!

Learn the secrets of:

- Software Serial numbers
- Timed Trial Versions
- Learn how the Pro's do it!
- Step-by-Step Guide
- The only "How to guide"

Only
\$39⁹⁵

Hack & Crack Gold CD

Get thousands of cracks by the worlds best crackers to crack the protection schemes of thousands of programs includes tutorial library that is a crackers dream come true!

Only
\$29⁹⁵

We accept VISA, MasterCard, American Express
To order, call Worldwyde @ 1-800-773-6698
33523 Eight Mile Rd #A3-261 • Livonia, MI 48152
Visit us on the web at www.worldwyde.com

Teach Yourself Embedded Control with the Most Popular 8-Bit Architecture in the World

- Kits include everything you need: hardware, integrated development environment (IDE), tutorials, software demos, and textbooks
- Developed by university professors
- Used by tech schools, colleges, & universities
- Suitable for self-paced learning
- Industrial grade PC boards
- Several 8051 platforms to choose from
- WIN 95/98/NT IDE, free web updates
- IDE includes 8051 Chip Simulator
- Program in Assembly, BASIC, and C
- Complete industrial and mechatronics demos
- Use course material to build a robot
- Textbooks include hands-on experiments
- 13 years experience in educational systems
- Complete packages starting at \$120

To download software or for more information visit

www.rigelcorp.com

Rigel Corporation, PO Box 90040
Gainesville, FL 32607

www.jm-micro.com

- PIC In-Circuit Emulator**
for the PIC16Cxx from \$295
- PIC Programmer** \$155
- 80C552 (8051) Development Training System** \$235
- 68HC11 SBC** \$120
- ROMY-16 EPROM Emulator**
from \$195
- Universal Microprocessor Simulator/Debugger (including Assembler, and Disassembler)**
\$100 each CPU

J&M Microtek, Inc.

83 Seaman Rd, W Orange, NJ 07052
Tel: (973) 325-1892 Fax: (973) 736-4567

PIC Programmer Kits

Super Value!

\$16.95
+S&H \$4.95*

The P16PRO: can program up to 40 pin PICs including the popular 16F84 & 12C508 • Needs software (extra \$20) • Available assembled or starting from \$16.95 for the kit.

See www.electronics123.com for more info!
The PICALL programmer can also program Atmel AVR's in addition to the PICs it can program • Free software • PICALL programmer kit at \$69.95
See www.electronics123.com for more info!

Video Camera module Code:BB004

CMOS Camera Module, Black & White, Size: 0.63"x0.63"x0.59"H, Lens: f4.9, F2.8, EIA 320Hx240V, 0.6" DIL Package, 5 pins, Pin 3 is 1V p-p composite video (75 ohm) to monitor. \$36 + \$5 S&H

Running Lights kit

Add \$6 for 8 triacs to drive light bulbs

8 LEDs with 10 push button selectable patterns. 8 speed levels! 80 combinations! \$16 + \$5 S&H

Toll Free: 1-888-549-3749 (USA & Canada)
Tel: (330) 549-3726. Request a FREE catalog or visit us at: www.electronics123.com for more products.
Amazon Electronics, Box 21 Columblana OH 44408

GPS Units from Communications Surplus

Trimble SVeeSix-CM3

6 channel Differential Module & Magnet Mt. Antenna \$49.95

Rockwell Microtracker LP

5 Channel NMEA 183 Differential OEM Module \$49.95

Call 713-526-8000 or
1-877-878-6695 or
Fax 713-522-6309
Email commsurplus@ev1.net
or www.commsurplus.com

CONTROL IT

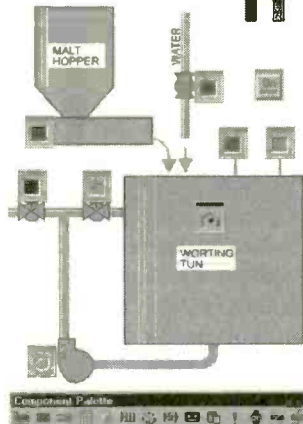

Intec Automation Inc.
www.microcommander.com

CABLE SECRETS!!!

Build your OWN cable box "test" devices!

Why pay \$1X.00 or more for a "test" device that someone else made? Make your own! Includes complete source code and plans for the most commonly used cable boxes. Unlock all of the channels on your box!

Or start your own lucrative business!

Complete source code \$79.95
Code for individual boxes \$29.95

DSS SECRETS — Vol. 2

Step-by-step instructions on programming your own DSS access card. Unlock all channels on your own card! This is the most current information on the market! Includes software, plans, and hardware sources. Book & CD-ROM. DSS Secrets Vol. 2 \$49.95

VISA • MasterCard • American Express
To order, call Worldwyde @ 1-800-773-6698
33523 Eight Mile Rd. #A3-261 • Livonia, MI 48152
Visit us on the web at www.worldwyde.com

Press-n-Peel Transfer Film

PC Boards in Minutes

8.5" x 11" Shts.
* Or Photocopy
** Use standard household iron

1. LaserPrint*
2. Press On**
3. Peel Off
4. Etch



Use Standard Copper Clad Board
20 Shts \$30/ 40 Shts \$50/ 100 Shts \$100
Visa/MC/PO/CW/MC \$4 S&H/Foreign Add \$7

Techniks Inc.

P.O. Box 462, Ringoes NJ 08551
ph. 908.738.8249 fax 908.788.8837
www.techniks.com

Visit Our E-Store On-Line!

PIC PROJECTS Book & CD-ROM

Many PIC Projects for Beginners & Experts!
Includes Software, Documentation, and PCB Layout

- LCDs
- X10 — Home Automation
- Keypads
- Serial Port Interface
- On-Screen Displays
- Robotics
- Data Logging
- Serial-Parallel
- And Many More!

Book & CD Only
\$24⁹⁵

PIC Programmer

Programs all PIC 16C55/8x/7x/8x/9x, PIC 16F8x, and P-C 2C devices. Optional ZIF adapter for 20IC & PLCC. Includes all necessary software. Only \$39⁹⁵

Buy
Both for
\$59⁹⁵

We accept
VISA • MasterCard • American Express
To order, call Worldwyde @ 1-800-773-6698
21365 Randall Street • Farmington Hills, MI 48336
Visit us on the web at www.worldwyde.com/pic

AMAZING DEVICES

NVEN8000DD

See and Order from Our "Action" Web Site at www.amazing1.com

Ion Ray Guns

Star Wars Technology Directs Energy

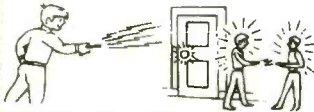

Star Wars Technology Demonstrates Weapons Potential, Force Fields, IonMotors, Antigravity etc. **Projects electric shocks without contact!** Conduct many weird and bizarre experiments. Handheld battery operated and easy to operate.

IOG719 Plans..... \$10.00
IOG7K Kit/Plans..... \$99.50
IOG70 Assembled/Tested..... \$149.95
Higher Powered Device
IOG9K Kit/Plans..... \$129.95
IOG90 Assembled/Tested..... \$199.95

Electromagnetic Gun



Propels a ball bearing using a magnetic pulse!

BBGUN1 Plans Ball Bearing Gun \$10.00

Cybernetic Ear!

Provides that "extra edge" for many listening applications. Enhances 3 to 4x of normal.

CYBEREAR \$19.95

Mini TESLA Coil

Lights up a 4' fluorescent tube-all without any contact!! Yet only 3" tall!

MTC1K Kit/Plans..... \$24.95
MTC10 Assembled..... \$34.95

Green Laser Ray Gun!

Shoots a visible ray of green light



Hand held produce up to 200 milliwatts of continuous optical power. Generates a bright visible ray of light.

LAGREEN1 Plans (All parts avail)..... \$15.00

Green Laser Pointer

Intense green with visible beam to 6000 feet!! Pen sized. Operates on 2 AAA Batteries. Call for pricing as we will not be undersold!!

Anti Gravity Rings

Non Magnetic Objects Mysteriously are set in Violent Motion. Distances up to 50 feet!!!



Objects react to a seemingly negative force where they accelerate and violently crash into one another. A real mysterious effect!! GRAVRAY1 Plans (parts available)..... \$15.00

Transistorized TESLA Coil JACOB'S Ladder Plasma Tornado

Turn a light bulb into a spectacular plasma display!! With frequency control. Safe 12vdc input
TCL5 Plans. \$8.00 TCL5K Kit/Plans..... \$59.95
TCL50 Assembled and Tested..... \$99.95

High Energy Pulsers

Charges up to 16000 J at 1-6Kv. Lossless Reactive Current Charging. Triggered Tungsten Spark Switch Programmable Energy Control

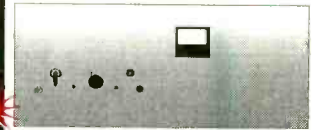

HEP9 Plans..... panel as shown above..... \$20.00
HEP90 Assembled..... \$649.95
HEP3 Plans 1KJ lower power unit..... \$15.00
HEP3K Kit with 500 J storage..... \$349.95
HEP30 Assembled above..... \$449.95

Below Projects Include HEP Plans



RAILGUN1 Plans High Vel Kinetic..... \$20.00



EGUN1 Plans Electric Gun..... \$20.00

MASS1 Plans Mass Driver/Cannon..... \$20.00

CANCRU1 Plans Can Crusher..... \$20.00

PPRO1 Plans Electrothermal Gun..... \$20.00

EMP1 Plans EMP/HERF Gun..... \$20.00

We Stock Parts for all the Above

Mind & Brain Controllers

Incredible device Turbo charges memory, Boost mental powers, Controls stress, Speeds up healing processes and Uncover hidden potentials. High quality unit with many features.



BWPLUS-APOLLO Ready to use. \$179.95
BWII- EINSTEIN Lower cost unit..... \$129.95

Burning Laser Ray Gun



Danger: Handheld Battery Operated Air Cooled. Starts Fires Over a Long Distance

LABURN1 Plans (parts avail)..... \$20.00

3 MI Voice Transmitter

Crystal clear. Many applications. Easy to build
FMV1 Kit and Plans. \$39.95

Information Unlimited PO Box 716 Amherst N.H. U.S.A. 03031

1 800 221 1705 Orders/Catalogs Only! Fax 1 603 672 5406 Information 1 603 673 4730 Free Catalog on Request

Pay by MC,VISA,Cash, Check, MO, COD. Add \$5.00 S&H plus \$5.00 if COD. Overseas Contact for Proforma

CIRCLE 220 ON FREE INFORMATION CARD

Network Service Tool Set

Popular installation and service tools for networks, modems and telephones. All hand tools are professional heavy duty type.

Use the compact tester on 10BASE-T (UTP & STP), thin Ethernet (BNC), 8-position Token Ring, AT&T 258A and EIA/TIA 568A/B. Automatically scans cables for continuity, wiring sequence and polarization. Tests STP cable ground. Testing installed cables is easy with Remote Terminator and gender changers (UTP and BNC). 9V battery included.

- Coax Stripping Tool, RG-58 & RG-59
- BNC Crimping Tool, RG-58 & RG-59
- Modular Cutting/Stripping/Crimping Tool (4, 6 & 8-Position)
- Multi-Network Cable Tester
- AC Receptacle Tester
- Cable Cutter

Order No. 55625 \$197.00



PC Service Tool Set

Contains all tools needed to troubleshoot & service IBM-compatible PCs. Set includes:

- AMI Diagnostic Software
- POST Card
- Logic Probe
- Digital Multi-Meter
- AC Receptacle Tester
- Serial Adapter
- Serial & Parallel Loopback Connectors
- DIP IC Puller
- PLCC IC Puller
- Grounding Wrist Strap
- Key Top Puller

Order No. 55000 \$198.00



PC Diagnostic Tool Set

- AMI Diagnostic Software
- POST Card

Order No. 55555 \$89.00

Network Installation Tool Set

- Network Tool Set 55625 without the Multi-Network Cable Tester.

Order No. 55600 \$99.00

Call for your FREE Catalog
Graymark®

P.O. Box 2015 Tustin, CA 92781
<http://www.labvolt.com>

CALL TODAY!
800-854-7393



CIRCLE 212 ON FREE INFORMATION CARD

www.americanradiohistory.com

LOG ON TO FORT777.COM

Come & Visit Fort777.com Now!



Come and take a look at all the great products we've got for you at Fort777.com - and they're all at incredibly low prices even if you only want one piece. Just click Product Index to find all the things you need. While you're there take a look at the Novel and read all about the Fort777 of the future. Make Fort777 your first choice and start saving NOW!

Electronic Components

When you want electronic components, visit Fort777.com. We've got large ranges of all the most popular items you'll need. Check out our Resistors, Capacitors, Connectors, Relays, Potentiometers, Fuses, LEDs, Neons, Lampholders, Diodes, Rectifiers, Crimp Terminals, Suppressors, Buzzers, Fuseholders, Clips, Audio, Computer and Telephone Cords and much, much more.

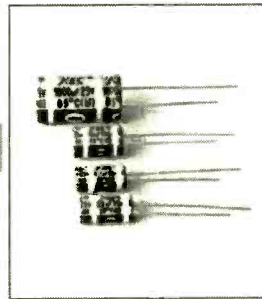

We've got specialty items as well and our range is growing all the time. Take a look at our special offers and click on Star Buys to see our latest hottest items. There are lots of new things happening all the time at the new Fort777.com so come back and visit us regularly then you won't miss any of our great specials. With our low prices you can buy for your friends and save on freight costs. Orders over US\$150 we pay the freight.

Only Top Quality Components



You can rely on the components you'll get from Fort777.com. We only buy direct from the best factories. All our components are fully specified and are the same each time you buy. You can pay much more for these very same items by buying from our competitors. But if you want the best parts at the best prices, come to Fort777. The choice as always is yours.



and drawing if it's pcb mounted. So now you can check out all the specs on line to find the exact part you need. Just click on More Info to see all the details and don't forget to scroll right to the bottom of the page to see the entire specification. In the More Info product screen, you will see a large picture of the product so that you can be absolutely certain that you've got the exact item you need. Take a look at Fort777 right now!

Low Cost Movies That Play On Your DVD Player



Never before sold in US, but now you can buy near-DVD quality video CDs that will play on your DVD player. We've got lots of the latest movies, top movies released over the last few years and classics. Prices are around one third the regular price for DVDs. These discs are 100% legal product, produced under license from the studios. Visit Fort777.com and find out more about how we can do it and check out all your favorite movies.

It's All At Fort777.com

When you need the best quality components and the best prices, you need to visit Fort777.com. Use the menu buttons, search function or index to quickly find the parts you need. Every item has a color picture and full description, specification

ITEMS SHOWN HERE AND ON THE WEBSITE [HTTP://WWW.FORT777.COM](http://www.fort777.com) ARE ONLY AVAILABLE FROM THE WEBSITE

No minimum order quantity. Prices are valid for one piece/pack. Freight charged extra.

*The address below is for returns and servicing:

FORT777.COM NORTH AMERICAN SERVICE AGENTS, FRONTIER ENGINEERING
 628 S. SUNSET ST., LONGMONT, CO 80501 * email: sales@fort777.com

VISION ELECTRONICS

BEFORE



AFTER



- +No Rolls/Jitters/Flickers/Fading
- +Works on all TVs, VCRs, Beta, & Cable
- +Gold Video Connectors & Cables Included
- +1 Year Warranty
- +Money Back Guarantee

FREE CATALOG!



COPY RENTAL TAPES WITH OUR VIDEO STABILIZER

1-800-562-2252

2609 S. 156th Circle • Omaha, NE 68130
www.modernelectronics.com



EZ-EP DEVICE PROGRAMMER - \$169.95

Check Web!! -- www.m2l.com

Fast - Programs 27C010 in 23 seconds

Portable - Connects to PC Parallel Port

Versatile - Programs 2716-080 plus EE and Flash (28F,29C) to 32 pins

Inexpensive - Best for less than \$200

- Correct implementation of manufacturer algorithms for fast, reliable programming.
- Easy to use menu based software has binary editor, read, verify, copy, etc. Free updates via bbs or web page.
- Full over current detection on all device power supplies protects against bad chips and reverse insertion.
- Broad support for additional devices using adapters listed below.

Available Adapters

EP-PIC (16C5x, 61.62x, 71.84)	\$49.95
EP-PIC64 (62-5, 72-4)	\$39.95
EP-PIC12 (12C50x)	\$39.95
EP-PIC17 (17C4x)	\$49.95
EP-51 (8751, C51)	\$39.95
EP-11E (68HC11 E/A)	\$59.95
EP-11D (68HC711D3)	\$39.95
EP-16 (16bit, 40pin EPROMs)	\$49.95
EP-Z8 (Z86E02, 3, 4, 6, 7, 8)	\$39.95
EP-SEE2 (93x, 24x, 25x, 85x)	\$39.95
EP-750 (87C750, 1, 2)	\$59.95
EP-PEEL (ICT22v10, 18v8)	\$59.95
EP-1051 (89C1051, 2051)	\$39.95
EP-PLCC (PLCC EPROMs)	\$49.95
EP-SOIC (SOIC EPROMs)	\$49.95

Many Other Adapters Available

M²L Electronics

970/259-0555 Fax: 970/259-0777
250 CR 218 Durango, CO 81301
CO orders add 7% sales tax.
<http://www.m2l.com>

EZ-EP
M²L ELECTRONICS
Los Angeles California

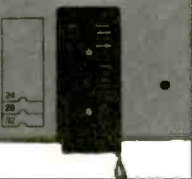

Build Your Own Intelligent Robot, We Make It Easy!

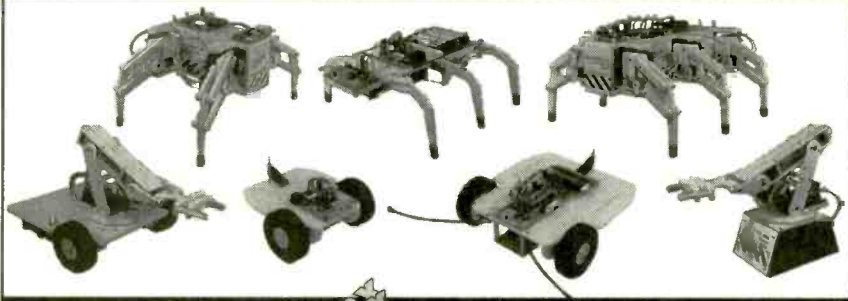

Lynxmotion, Inc.
PO Box 818
Pekin, IL 61555-0818
www.lynxmotion.com

Lynxmotion

Visit our website or ask for our free catalog!

Tel: 309-382-1816
Fax: 309-382-1254
sales@lynxmotion.com
tech@lynxmotion.com

"X-Ray" Filters, Cameras, Camcorders, Lights
Infrared (IR) Equip sees through some fabrics!
2 Million Candle Power Rechargeable IR Spotlight
Information, Equipment Examples and FAQ's
Ultraviolet (UV) LED Flashlights, Invisible Inks
SpyCams, Specialty Optical Products
Home Automation Software, Free Fax Software

www.maxmax.com/OpticalProducts.htm

Do You Repair Electronics?

Repair Databases for TV, VCR, Monitor, UL Audio, FCC, and more.

- Over 76,000 records
- Private user forums
- Live on-line chat rooms

RepairWorld.com

Electronics Corp. Herald Sq. Fairborn, OH 45324 (937) 576-9878

CABLE BOXES

• WE'LL BEAT ANY PRICE!

• 1 YR WARRANTY

• FREE CATALOG

• 30 DAY MONEY BACK GUARANTEE

WWW.CATVBOXES.COM

1-800-765-4912

ROBOTS, ROBOTS, ROBOTS...



Robot Kits, Programmable Robots,
LEGO Robots, Living Robots,
Home and Office Robots, Muscle
Wires™, Electronics and More!

**REQUEST OUR FREE
48 PAGE CATALOG
WITH OVER 400 ITEMS!**

www.RobotStore.com
800-374-5764

Mondo-tronics Inc.

PMB-N 4286 Redwood Hwy Dept. 166
San Rafael, CA 94903
ph 415-491-4600 fx 415-491-4696

SINGLE CHIP COMPUTER

- ZERO external components
 - Built-in BASIC / Assembly
 - RS232 program download
 - 1K flash, 64ee, 3irq, 2timers
 - 15 I/O bits, A/D comparator
 - 20mips, faster than pic/8051
 - 20 pin DIP part #MV1200
- oem (1k) **\$1.99**
eval (1) **\$7.00**



- NEW! 8K SUPER CHIP**
40x the BASIC program space!
- 32 i/o, 12 irq, 3 timers, Bus
 - 8K flash, 512ee, 512nvram
 - Watchdog with internal osc.
 - 40 pin DIP part #MV8515
- oem(1k) \$7.10 eval(1) \$25.00

CREDIT CARD COMPUTER



New PLUG-N-GO, no cables/power supply to buy!
Lo-power RISC cpu 10x faster than PIC, Z80, 8051
256k NV mem, ser, par, RTC, 4ch 50khz ADC, ISA bus
Built-in BASIC/Assembly, other compilers avail.
Friendly instruction set, unlike PIC or 8051
oem (1k) price 14.20 eval kit (1) \$50.00

PC WATCHDOG CARD

No More Hangups!

Reboots PC on hardware/software hang
3 versions: RESET, TIMER, PHONE
reset version oem \$21.30, eval kit \$75



LO COST MINI-PC

Includes DOS, NV mem, ADC, RAM, clock, ISA bus
Ports for serial, parallel, LCD, keyboard
Program in Turbo C, BASIC, MASM, etc.
Complete, no costly development kits required
Lowest power lowest cost PC compatible available
XT: oem \$27 eval \$95 AT: oem \$55 eval \$195

PC SOLID STATE DISK



Replace mechanical drives with faster,
more reliable, more secure solid-state.
Use FLASH, NVRAM, UV EPROM.
Both DIP and PCMCIA versions from
32Kbyte (PCMC1) to 1Gigabyt (PCD2)
starting at \$14.20oem(1k) \$50.00eval(1)

640x480 VGA LCD \$27

Controller for most single/dual scan LCDs
Works with lo-res (160x120, 320x240, etc.)
Use with PC or SBC, standard VGA BIOS
Source code demo shows VGA initialization
Adaptable for other CPUs (i.e. Z80, HC11)
oem(1k) \$27 evalkit(1) \$95 w/10"LCD \$195



SERIAL MINI-TERMINAL

RS232 terminal for Stamp, PC, Z80, AVR etc.
-super low-current, powers from serial line
-LED backlit LCD, visible in all conditions
-115.2kbps, DB9 conn, simple commands
-specify 20 customizable or 16 tactile keys
eval(1) \$75, oem(1k) \$21.30, w/BASIC cpu \$27



STAMP DRIVE!!

Read / Write PC compatible hard
disk, PCMCIA, & Compact Flash.
RS232 to ATA drive adapter for
Stamp, 8051, AVR, PIC, Z80, x86
ANY controller, big or small:
-up to 4 gigabyte capacity
-low power operation 5v 2ma
-simple software commands
-baud rates up to 115.2kbps
-\$14 IDE & \$21 ISA/104 versions

oem(1k) **\$27**
eval kit(1) **\$95**



WWW.STAR.NET/PEOPLE/~MVS

MVS Box 850
Merr., NH 03054
(508) 792 9507



5yr Limited Warranty
Free Shipping
Mon-Fri 10-6 EST

**SERVING THE EMBEDDED
COMMUNITY SINCE 1979!**

New and Pre-Owned Test Equipment

New Equipment Specials

SIMCHECK[®] IIse PLUS - Module Tester

- * Tests SIMMs/168 pin DIMMs
- * Identifies Module properties
- * Stand alone/portable
- * Built-in Serial Interface

Only \$1,995.00

AVCOM PSA-37D - Spectrum Analyzer

Satellite Downlink - Installation - Maintenance & Service

- Band 1: 10 - 1750 MHz
- Band 2: 3.7 - 4.2 GHz
- Carrying Case Included
- Line or Battery Powered
- Built-in DC Block & Power for LNA/LNB's

Only \$2,395.00

Instek GOS-6103 - Analog Oscilloscope

- 100 MHz Bandwidth
- 2 Channel, High Sensitivity
- Trigger Signal Output
- Cursor Readout
- Time Base Auto-range
- Includes Two Probes
- 2 Year Warranty

Only \$899.00

Leader LF 941 - CATV Signal Level Meter

- ✓ TV/CATV Coverage from 46 - 870 MHz
- ✓ Video/Audio Carrier Measurements

Only \$489.00

Fluke 87 IV - Digital Multimeter

- ✓ Basic DC Accuracy of 0.025% at 50,000 Count
- ✓ True-RMS AC, AC+DC, dBm, & dBV

Only \$319.00



TOLL FREE 1-800-99-METER

Pre-Owned Oscilloscope Specials

B+K Precision	1466	10 MHz	\$185.00
Tektronix	465	100 MHz	\$599.00
Tektronix	465B	100 MHz	\$729.00
Tektronix	475	200 MHz	\$829.00
Tektronix	475A	250 MHz	\$999.00

- Professionally Refurbished
- Aligned & Calibrated to Original Specifications
- The Industry Standard of Oscilloscopes
- 1 Year Warranty - The Longest Available!!!
- See Website for Complete Specifications

See us on the Web!
www.testequipmentdepot.com

We Buy Surplus Test Equipment

Test Equipment Depot

A FOTRONIC CORPORATION COMPANY

99 Washington St. Melrose, MA 02176

(781) 665-1400 • FAX (781) 665-0780

e-mail: sales@testequipmentdepot.com

(1-800-996-3837)

CIRCLE 322 ON FREE INFORMATION CARD

PIC'n Books

LEARN ABOUT PIC MICROCONTROLLERS



See Table Of Contents: <http://www.sq-1.com>
 Secure Online Ordering Is Available

PIC is a trademark of Microchip Technology Inc.

SQUARE 1 ELECTRONICS

Voice (707) 279-8881 Fax (707) 279-8883

<http://www.sq-1.com>

World Passing You By?

Are you interested in Microprocessors & Embedded Control Systems? If not you should be! Look around, just about everything these days has an embedded microprocessor in it. TVs, cars, radios, traffic lights & even toys have embedded computers controlling their actions. The Primer Trainer is the tool that can not only teach you how these devices operate but give you the opportunity to program these types of systems yourself. Examples & exercises in the Self Instruction manual take you from writing simple programs to controlling motors. Start out in Machine language, then move on to Assembler, & then continue on with optional C, Basic, or Forth Compilers. So don't be left behind; this is information you need to know!

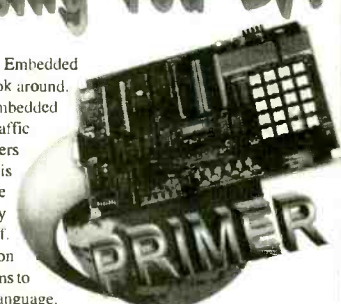

- Examples Include:**
- Measuring Temperature
 - Using a Photocell to Detect Light Levels
 - Making a Waveform Generator
 - Constructing a Capacitance Meter
 - Motor Speed Control Using Back EMF
 - Interfacing and Controlling Stepper Motors
 - Scanning Keypads and Writing to LCD/LED Displays
 - Bus Interfacing an 8255 PPI
 - Using the Primer as an EPROM Programmer
 - DTMF Autodialer & Remote Controller (New!)

The PRIMER is only \$119.95 in kit form. The PRIMER Assembled & Tested is \$169.95. This trainer can be used stand alone via the keypad and display or connected to a PC with the optional upgrade (\$49.95). The Upgrade includes: an RS232 serial port & cable, 32K of battery backed RAM, & Assembler/Terminal software. Please add \$5.00 for shipping within the U.S. Picture shown with upgrade option and optional heavy-duty keypad (\$29.95) installed. Satisfaction guaranteed.

EMAC, inc.

11 EMAC WAY, CARBONDALE, IL 62901
 618-529-4525 Fax 457-0110 BBS 529-5708
 World Wide Web: <http://www.emacinc.com>

1985 - 1998
 OVER
12
 YEARS
 OF SERVICE

Your Next Great Design Begins HERE!!

NEW!

Global Specialties brand Proto-Boards have been the standard bearer for quality in electronic circuit design workstations since 1973. The new Proto-Board Model PB-505 combines the quality and craftsmanship inherent in other Global design workstations by adding expanded features such as a rugged steel case and a large removable prototyping area. There's only one Proto-Board, and it's made by Global Specialties.



The NEW Proto-Board Model PB-505

FLEXIBLE

The new PB-505 combines four instruments, a large removable bread-board area and other commonly used components into one workstation to allow for maximum circuit design flexibility.

RELIABLE

Backed by an industry-best 3-year warranty against manufacturing defects and a lifetime warranty on breadboard sockets, the PB-505 features unparalleled craftsmanship utilizing materials of the highest integrity.

DURABLE

With its heavy-duty design and rugged steel case, the PB-505 is built to withstand the use and abuse of any laboratory environment.



GLOBAL SPECIALTIES
INSTRUMENTS

www.globalspecialties.com

1486 HIGHLAND AVE., UNIT 2, CHESHIRE, CT 06410
800-572-1028 • FAX 203-272-4330

DATA ACQUISITION & CONTROL

AFFORDABLE PLUG-IN BOARDS FOR PC's ISA BUS

ANA100 Analog I/O \$ 99



- * 8 Channel 8-Bit
- * 0 to 5 Volt Input
- * 14 TTL I/O lines
- * Analog Output
- * 400KHz Sampling

DIG100 Digital I/O \$ 39



- * 82C55 PPI
- * 24 or 48 TTL I/O Lines option
- * Selectable Base Address

ANA150 Analog/Counter... \$ 89



- * 8 Channel 8-Bit
- * 0 to 5 Volt Input
- * 3 16-Bit Counters
- * 400KHz Sampling

DIG200 Counter I/O \$ 79



- * 3 16-Bit Counters
- * 8 TTL Input lines
- * 8 TTL Output lines
- * Selectable Clock Frequency input

ANA200 Analog I/O \$ 79



- * 1 Channel 12-Bit
- * 0 to 5 Volt Input optional bi-polar
- * 100KHz / 300KHz Sampling rate
- * 24 TTL I/O lines

ANA201 Analog \$ 119



- * 8 Channel 12-Bit
- * x1, x5, x10, x50 Programmable Channel gain
- * 100KHz Sampling rate

On-Line Product Catalog at Our Web Site
<http://www.Bsof.com>
E-Mail: Sales@Bsof.com

BSOFT Software, Inc.

444 COLTON ROAD * COLUMBUS, OH 43207
PHONE 614-491-0832 * FAX 614-497-9971

HELP WANTED

COMMUNICATIONS ENGINEERING JOBS

Starting salary up to \$89,265 annually. New position. Works with City's departments such as, Police, Fire and construction.

COMMUNICATIONS TECHNICIAN

Growing company in beautiful Northwest needs people with an FCC License to install transmission equipment.

MARINE TECHNICIANS WANTED

Install radio equipment in sunny Florida on ships and boats docked in Miami area.

MAJOR AIRLINE hiring installation service technicians. No Experience required. Must have FCC license.

Outstanding positions!
\$40-\$60 per hour!
Broadcast Engineers!

PORTABLE RADIO TECHNICIAN
\$50,800 - 92,880 to start based on experience. FCC license required.

Be an FCC LICENSED ELECTRONIC TECHNICIAN!



Earn up to \$60 an hour and more!

Learn at home in spare time.
No previous experience needed!

No costly school. No commuting to class.

The Original Home-Study course prepares you for the "FCC Commercial Radiotelephone License." This valuable license is your professional "ticket" to thousands of exciting jobs in Communications, Radar, Radio-TV, Microwave, Maritime, Avionics and more...even start your own business! You don't need a college degree to qualify, but you do need an FCC License.

No Need to Quit Your Job or Go To School

This proven course is easy, fast and low cost!

GUARANTEED TO PASS - You get your FCC License or your money refunded.

Call Now for FREE Info:

800-932-4268 Ext. 90

Email: fcc@commandproductions.com

Visit our Website: www.LicenseTraining.com

Fax 415-332-1901

COMMAND PRODUCTIONS

FCC LICENSE TRAINING - DEPT. 90

P.O. Box 2824 • San Francisco, CA 94126-2824

CIRCLE 321 ON FREE INFORMATION CARD

POLARIS CAN SUPPLY YOU WITH ALL OF TODAY'S HOTTEST VIDEO TECHNOLOGY!

CALL OR GO ON-LINE TO ORDER YOUR FREE VIDEO CATALOG - 100's OF PRODUCTS - MICRO CAMERAS - WIRELESS VIDEO - LIPSTICK CAMERAS - DIGITAL VCR'S

6.4" ROOF MOUNT COLOR TFT MONITOR



Great for long trips in the car or minivan. Comes with hardware for convenient and easy roof mounting. This unit accepts video from an external video source such as DVD player, VCR, TV Tuner or video camera.

TFT-64RM - \$499.95

Dimensions: 163(H) x 148(W) x 30(D)mm

SUBMERGIBLE CAMERA



CAN SEE UNDER WATER!

CAN SEE IN THE DARK!

WEATHERPROOF DIGITAL STORAGE CAMERA

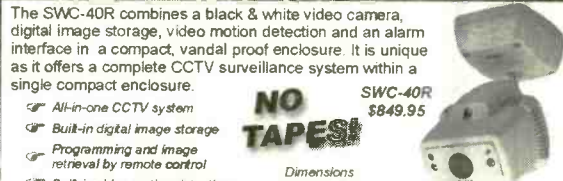

The SWC-40R combines a black & white video camera, digital image storage, video motion detection and an alarm interface in a compact, vandal proof enclosure. It is unique as it offers a complete CCTV surveillance system within a single compact enclosure.

NO TAPES!

SWC-40R \$849.95

Dimensions: 5" x 4" x 4.5"

- All-in-one CCTV system
- Built-in digital image storage
- Programming and image retrieval by remote control
- Built-in video motion detection

7" WIDE SCREEN COLOR TFT MONITOR



Comes equipped with a 7" wide screen with an aspect ratio of 16:9! Watch video from an external video source such as DVD player, VCR, TV Tuner or video camera!

REMOTE INCLUDED

TFT-7 - \$499.95

Dimensions: 187(W) x 117(H) x 36(D)mm

COVERT COLOR SPY CAMERA



It's small sleek indestructible design and pinhole lens allow for various applications and simple installation. Comes equipped with a RCA JACK for easy connection to TV monitor or VCR. Great for covert use in any place imaginable.

25mm(W) x 17mm(D) **CM-550CP - \$79.95**

"YOUR WEB BROWSER IS YOUR REMOTE EYE!"

FLEXCAM SCALL



The Flexcam acts as an internet camera server. No software needed in order to view your video. All you need is a web browser such as Internet Explorer or Netscape. Flexcam includes many special functions including video quality control, pan/tilt/zoom interface and network configuration. All of them are controlled by the web browser. This is true state of the art video monitoring technology. Users can see and feel the quality and ease. Features 4 video inputs - 3 external.

CONTROL PAN / TILT AND ZOOM REMOTELY OVER THE INTERNET!

5.6" COLOR TFT MONITOR & TV TUNER!



Now you can watch Television, CATV or even video from an external source such as a DVD player with our new 5.6" TFT-LCD monitor. Can also be used for direct camera input for video/security monitoring. Unit has three inputs: 5VHS, RCA and CATV.

TFT-56 - \$459.95

Dimensions: 9.6 x 15.6 x 4.7cm

MICRO BOARD CAMERAS - MANY MODELS IN STOCK TO CHOOSE FROM!



MB-1250HRP Hi-Res Color Pinhole 5.0mm Lens 1.27" x 1.27" \$149.95

6 CAMERA INTERNET VIDEO SERVER



Our Flexwatch will serve up to 6 video cameras to the internet which can be viewed by any web browser. No special software required! Viewer is able to control the pan, tilt and zoom functions, as well as, video quality control.

VIEW REAL TIME VIDEO! Flexwatch-500 - \$1495.95

2.4 GHz A/V TRANSMITTING MODULE



Makes any camera wireless! Excellent for hobbyist / remote control airplanes.

2.4GHz 4 channel video transmitting module with audio capability / power switch and antenna.

MPX-2400 - \$149.95

2.4GHz RECEIVER **GFR-5002 - \$119.95**

Dimensions: 1.5" (W) x .75" (H) x 0.5" (D)

WEATHERPROOF CAMERA



Color Camera 400TV Lines Automatic Iris

Hi-Res Color Lipstick Camera

Length: 2.6" Diameter: .785"

WP-300C - \$229.95

5.6" COLOR WIRELESS OBSERVATION SYSTEM



Now you can enjoy peace of mind with our new wireless observation system. Comes with 5.6" wireless color monitor and a wireless color camera. Just Plug-&Play Perfect for around the house or office.

Includes an attractive swivel mount indoor / outdoor patch antenna for extra range!

2.4GHz

GW-2400S - \$379.95

MONITOR UP TO 4 VIDEO CAMERAS SIMULTANEOUSLY THRU YOUR INTERNET CONNECTION OR OVER YOUR MODEM!



MOTION DETECTION - ALARM RECORDING - NOTIFICATION

- TCP/IP
- MODEM
- LAN WAN

Highlight an area on your video screen, and the DMRS will inform you via modem thru your telephone or pager if there is movement in that highlighted area while recording to your hard disk.

DMRS-4...4 Input Digital Video Card... \$289.95

MICRO VIDEO HEAD "SNAKE" CAMERA



Incredibly small micro head color camera incorporates a CCD chipset (Not CMOS). Fully adjustable focus from 0.5 inches to infinity. Automatic Iris for varying light levels.

VIDEO HEAD IS ONLY 7mm IN DIAMETER!

MH-SCO1 \$549.95

POLARIS INDUSTRIES 800-752-3571 476 Armour Drive NE Atlanta GA 30324-3943 Tech 404-372-0722 Fax 404-372-1038 WWW.POLARISUSA.COM

CIRCLE 228 ON FREE INFORMATION CARD

Poptronics, March 2001

Wireless & Electrical Cyclopedia



ETT1—Wireless & Electrical Cyclopedia \$4.99. Step back to the 1920's with this reprinted catalog from the Electro Importing Company. Antiquity displayed on every page with items priced as low as 3 cents. Product descriptions include: Radio components, kits, motors and dynamos, Leyden jars, hot-wire meters, carbon mikes and more. The perfect gift for a radio antique collector. To order ETT1, send \$4.99 (includes s&h) in the US and Canada to **Electronic Technology Today Inc., P.O. Box 240, Massapequa Park, NY 11762-0240.** US funds only. Use US bank check or International Money Order. Allow 6-8 weeks for delivery. **MA11**

ELECTRONIC GAMES

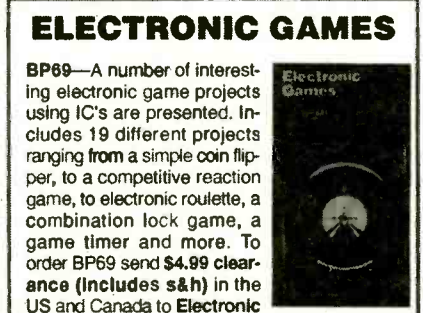

BP69—A number of interesting electronic game projects using IC's are presented. Includes 19 different projects ranging from a simple coin flipper, to a competitive reaction game, to electronic roulette, a combination lock game, a game timer and more. To order BP69 send \$4.99 clearance (includes s&h) in the US and Canada to Electronic Technology Today Inc., P.O. Box 240, Massapequa Park, NY 11762-0240. US funds only. Use US bank check or International Money Order. Allow 6-8 weeks for delivery. **MA07**

American Heart Association 

Fighting Heart Disease and Stroke

Research gave him a future



Support Research

High Performance Auto Ranging DMM New to our DMM line-up and possibly (probably) the best DMM value anywhere! Includes: Analog Bar Graph, Auto-Ranging, Data Hold! Temperature Probe, Frequency Test, Continuity Test! AND MORE!

Data Hold: Freezes reading for easy checking

Auto Ranging: For easy, precise range settings

Range Hold Control: allows for manual selection of your test range

3-3/4 Digit LCD Display: Reads up to 3260. Easy to read display.

Function Dial: Easy to use to select measurement type or turn unit off.

4 Jack Plug-ins: Safety design with different capacities for different functions.

Diode, Continuity Check Push-Button: For toggling between diode check and continuity check.

Low Battery Indicator: Advises you when it's time to change battery.

Extra Long 44" Test Leads: Helps get to hard to reach places

Screw-On Alligator Clips: Convert one or both probe tips to alligator clips.

Fuse-Protected Circuitry

Built-In Stand: Makes one hand operation easier.

Shock Absorbing Rubber Carrying Case: with convenient probe storage clips and hanging tab. Helps protect the DMM from damage if accidentally dropped.

Measures:
 DC Volts: up to 1000V
 AC Volts: up to 750V
 AMPS: up to 20 Amps (AC & DC)
 Resistance: up to 30M ohm
 Continuity Check: with audible signal (signal sounds if resistance is less than 20 ohms. Display reads actual resistance).
 Frequency: (1KHz to 300KHz) displays both digital and bar graph reading.
 Transistor hfe Test: Display shows approximate hfe value based on test condition of 10uA base current and Vce of approx. 3V.
 Temperature Test: Measures from 0° to 1832° F. (probe supplied)
 Diode Test: Tests if diodes are shorted or open

Input Impedance: 10Mohm (Vdc/Vac); over 100Mohm on 300 mVdc range.

NOW IN STOCK!

ONLY \$29.95

#CS19903

Specifications Accuracy

Vdc:	±1.0% reading +5 digits
Vac:	±1.5% reading +8 digits
Adc:	±1.2% reading +5 digits
Aac:	±1.5% reading +5 digits
Resistance:	±1.5% reading +5 digits
Frequency:	±3.0% reading +5 digits
Temperature:	±1.0% reading +6 digits

Requires two AAA batteries sold separately.

Removable Hard Drive Rack

For IDE/Ultra DMA Hard Drives

We Sold Over 14,000 in 1998!

This product can be used with any 3.5" IDE hard drive up to 1" high. It includes an electronic keylock for safe removal and insertion. Made of ABS 707 fireproof plastic. Use this product to protect sensitive hard drive data. Take your hard drive between work and home or even set up different users with their own hard drives that they physically insert every time they use a PC. Other models available from C.S.I. include RH10 series and RH20 series, which are interchangeable within the same interface design (IDE or SCSI). **Hard Drives are Available. See www.web-tronics.com under "hard drive and accessories" for more details and pictures.**

ONLY \$14.95 any qty.

#RH-10C-IDE

Removable Hard Drive Rack with Auto Door And Cooling Fan

ONLY \$18.95 any qty.

- Auto door on the outer frame.
- ABS material of outer frame, High efficiency cooling fan.
- Worldwide patent pulling function handle.
- CE Approved
- Coating iron bottom cover
- For IDE interface
- For 1" high 3.5" HDD
- Not compatible with our RH10 & RH20 series
- Compatible with the RH17-IDE model.

#MR-27

Details at www.web-tronics.com

2GHz RF Field Strength Analyzer

- Frequency Range: 100KHz to 2,060MHz
- Narrow Band FM (NFM), Wide Band FM (WFM), AM and Single Side Band (SSB) Modulated Signals May Be Measured
- PLL Tuning System for Precise Frequency Measurement and Tuning
- LED Backlight LCD (192x192 dots)
- Built-In Frequency Counter
- Hand-Held and Battery Operated
- All Functions are Menu Selected
- RS232C for PC Interface and Printer

ONLY \$1589

#3201

www.web-tronics.com

CTRL - D to bookmark this site

Don't forget the dash

Circuit Specialists, Inc.

- Easy to Navigate
- Includes a Search Engine That Really Works
- New Items Added Constantly

In Business Since 1971

CCD B&W Board Cameras

- ASIC CCD Area Image Sensor
- Extremely Low Power Consumption
- 0.5 Lux Min Illumination
- Built-In Electronic Auto Iris for Auto Light Compensation

VM1030PA-B 30mmx30mmx25mm, Pinhole lens, 12V \$39.00 any qty.

VM1030A 30mmx30mmx26mm, Standard lens, 12V \$39.00 any qty.

VM1035A 42mmx42mmx25mm, Standard lens, 12V with back light compensation \$49.00 any qty.

VMCB21 44mmx38.5mmx28mm, with 6 infra-red LEDs, 12V \$49.00 any qty.

VM1036A 32mmx32mmx25mm, Standard lens, 12V, reverse mirror image feature \$49.00 any qty.

Detailed Specs on the Web

LOWER PRICES

Mini CCDs (B/W & Color)

Sensational NEW Design for Small Observation Cameras. Smaller and Better!

- Ultra Miniature Design
- Black & White Versions Only 25mm x 25mm
- Color Versions Only 32mm x 32mm
- Available in Standard Lens or Pinhole Lens

All Include Pre-Wired Cable Harness for Video & Power

- 12V Regulated Power Supply Required (120mA typical power consumption)
- 0.1 LUX Rating (B/W), 1 LUX (color)
- CCD Area Image Sensor for Long Camera Life
- Back Light Compensation Circuit
- Built-In Electronic Auto Iris Lens

VMCW-H11A 32mmx32mmx30mm, Color CCD with standard lens, pre-wired cabling, 12V DC Power \$139.00 / \$129.00 5 or more

VMCW-H12A 32mmx32mmx19mm, Color CCD with pinhole lens, pre-wired cabling, 12V DC Power Input \$139.00 / \$129.00 5 or more

VMPS-718A 25mmx25mmx30mm, B/W CCD with standard lens, pre-wired cabling, 12V DC Power Input \$59.00 / \$49.00 5 or more

VMPS-250A 25mmx25mmx15mm, B/W CCD with pinhole lens, pre-wired cabling, 12V DC Power Input \$59.00 / \$49.00 5 or more

VCC-3232 32mmx32mmx30mm, CMOS COLOR, std lens, see web for specs \$79.00 / \$72.00 5 or more

LOWER PRICES

Detailed Specs on the Web

Bullet CCD Cameras B&W and Color

- Smart Rugged Metal Housing
- Extremely Low Power Consumption
- 12 Volt
- CCD Area Image Sensor for Long Camera Life
- Built-In Electronic Auto Iris for Auto Light Compensation
- No Blooming, No Burning
- 0.1 Min Lux Illumination (B&W), 1 Lux Min Lux Illumination (color)

VMBLT1020 B&W, 21mm(D)x55mm(L) \$49.00 any qty.

VMBLT1020W B&W Weatherproof, 21mm(D)x58.5mm(L) \$79.00 any qty.

VMBLTJC19BW COLOR Weatherproof, 17mm(D)x88mm(L) \$139.00 any qty.

Detailed Specs on the Web

LOWER PRICES

COLOR CCD Mini Board Cameras

- Low Power Consumption
- 1 Lux Illumination
- Internal Synchronization
- 12Volts
- 400 TV Lines
- Built-In Electronic Auto Iris for Auto Light Compensation

VM3010PA 33mmx33mmx18mm, Pinhole lens \$59.00 any qty.

VM3011-A 45mmx40mmx24mm, Standard lens, single board \$89.00 any qty.

VM3010-A 33mmx33mmx32mm, Standard lens \$99.00 any qty.

Detailed Specs on the Web

PRICE REDUCTION

2.4 GHz A/V Sender/Receiver System

- Wireless FM transmission of video (color or B/W) and sound (stereo or mono) up to 150 meters (line of sight)
- Directional Antenna Design optimizes performance
- Use with remote cameras or any input (satellite TV, cable etc.) where wireless transmission is desired. View on a TV set.
- Performance through walls varies depending on construction methods etc.
- Each set includes a plug-in power supply for the transmitter & receiver.
- 7 segment LED displays channel (1-4) on receiver & transmitter.

Now On Sale Order Now!

CSIHTR2400 Includes One Transmitter & One Receiver with Power Supplies \$109.00

CSIHTR2400TX Extra Transmitter/Each Receiver will Monitor up to 4 Transmitters \$89.00

See more detailed specifications at www.web-tronics.com in the CCD camera section.

Hot Air SMD Rework Station WOW! ONLY \$489

Similar Systems Cost 100s More!

ONLY \$489

#SR-979

For technicians, service/repair depots and assembly rework. We also stock a selection of nozzles for QFP, SOP & PLCC devices (see our website for selection details). Hot Air temperature variable from 100°C to 400°C (212°F to 754°F) power consumption: 275w max. Auto cooling feature cools system after shut off to extend service life of heating elements and handle. One year limited warranty from C.S.I.

Comes with QFP Nozzle (0.68" x 0.68")

O'Scope Offer ONLY \$299

30MHz! ONLY \$299! Industries Best Price! See web for specs

ONLY \$299

#OSC-1030

- Dual Channel
- Dual Trace
- Vert Trigger
- 1 Year C.S.I. Warranty!

Manufactured for CSI by a leading O.E.M. manufacturer. See our website for detailed specifications!

3000 Series Digital R/O Bench Power Supply

←Low Cost Single Output ←3Amp

AS LOW AS \$89

High stability digital read-out bench power supply featuring constant voltage and current outputs. Short-circuit protection and current limiting protection is provided. Highly accurate LED accuracy and stable line regulation make the 3000 series the perfect choice for lab and educational use.

Line Regulation: 2x10⁻⁴ +1ma
 LED Accuracy: Voltage ±1% +2 digits
 Current ±1.5% +2 digits

Wave Line Noise: 5mVrms
 Dimensions: 291mm x 158mm x 136mm (CSI3003)

CSI3003: 0-30V/0-3amp Digital R/O Bench PS, 1x10⁻⁴+5mV Load Regulation \$99.00 5/\$89.00

Our Most Sophisticated DMM We Sold Over 700 Last Year!

with RS-232 Interface & Software, 3-3/4 Digit, 4000 Count, Auto-Ranging with Analog Bargraph

- K Type Temperature Probe Included
- Pulse Signal for Logic & Audible Test
- Continuity/Diode Test
- Logic Test
- Auto Power OFF/"Keep ON" Mode
- Fused 20A Input with Warning Beeper
- Back Light
- Data Hold/Run Mode
- Safety Design UL1244 & VDE-0411
- Protective Molester
- Silicon Test Leads

NOW ONLY \$129 Reg. \$169

More Details on our Web Site

PROTEK 506

SECURETEK

DIRECT FROM MANUFACTURER

"WE WILL BEAT ANY COMPETITORS PRICE"

**WORLD SMALLEST
WIRELESS VIDEO CAMERA**
(BLACK & WHITE OR COLOR)
TRANSMITS VIDEO UP TO 1000FT.

WE ALSO CARRY:

- COVERT VIDEO CAMERAS
- COUNTER-SURVEILLANCE PRODUCTS
- CUSTOM MADE VIDEO SYSTEMS
- IN HOUSE ENGINEERING DEPT.

**DISTRIBUTOR
PROGRAM
AVAILABLE**

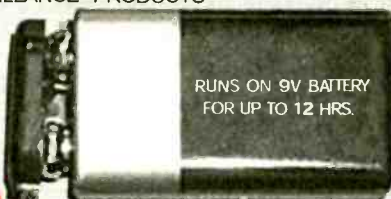

CALL FOR CATALOG:
SECURETEK

7152 S.W. 47TH STREET
MIAMI, FLORIDA 33137

TEL. 305.667.4545
FAX. 305.667.1744

www.securetek.net

RF Data Modules

AM Transmitter



- Sub Miniature module
- SAW Controlled
- No adjustable components
- Low current - 2.5mA
- Supply 2.5-12Vdc
- 418MHz or 433MHz
- Range up to 300ft
- CMOS TTL data input
- 7 x 11 x 4mm !
- AM-TX1-xxx \$12.60

AM Receiver



- Compact Hybrid Module
- Very stable
- CMOS/TTL output
- Patented Laser Trimmed
- 5Vdc. 0.8mA (HRR6)
- 2kHz data rate
- Sensitivity -105dBm
- 38 x 12 x 2 mm
- AM-HRR6-xxx... \$16.33

FM Transceiver



- Only 23 x 33 x 11mm
- Up to 40,000bps data rate
- Up to 450ft. range.
- 5V operation
- 418MHz or 433MHz FM
- 5V CMOS logic interface
- Fast 1mS enable
- Power saving feature
- Carrier Detect output
- BiM-xxx-F \$87.36

RS232 Transceiver



- 3wire RS232 interface
- 19.2Kbps half duplex
- 418MHz or 433MHz FM
- 7.5-15Vdc. 20mA
- TX/RX Status LED's
- Up to 400ft. range
- 1/4 wave ant. on board
- User data packetizing
- 58 x 40 x 15mm
- CYPHERNET \$139.30

AM Transmitter



- Range up to 250ft.
- SAW controlled stability
- Wide supply range 2-14V
- CMOS/TTL input
- Low current. 4mA typ.
- Up to 4kHz data rate
- Small: 17 x 11mm
- AM-RT5-xxx \$12.10



ABACOM
TECHNOLOGIES



tel: (416)236 3858

fax: (416)236 8866

www.abacom-tech.com

MasterCard / VISA

Miniature Transmitters and Receivers

2 Button / 3 Channel Transmitter



RF300T

1....\$22.95
5....\$19.95 ea
10...\$16.95 ea

RF300XT

1....\$25.95
5....\$22.95 ea
10...\$19.95 ea

- 300' (XT), 150' (T) Range
- Frequency: 318 MHz
- 59,049 Settable Security Codes
- 12 Volt Battery and Keychain Included
- Current Draw: 4.8 ma
- Fully Assembled in Case
- Dimensions: 1.25" x 2.0" x .5"
- Push both buttons for the 3rd Channel
- Slide Button Cover Included

4 Button / 15 Channel Transmitter

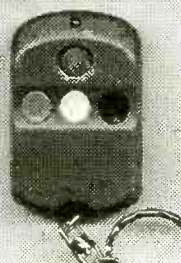

RF304XT

1....\$27.95
5....\$24.95 ea
10...\$21.95 ea

- 250' Range
- Frequency: 318 MHz
- 6,561 Settable Security Codes
- 12 Volt Battery and Keychain Included
- Current Draw: 4.6 ma
- Fully Assembled in Case
- Dimensions: 1.35" x 2.25" x .5"
- Push combination of buttons to achieve up to 15 channels

2-4 Data / 3-15 Channel Receivers



RF300RL RF300RM

1....\$27.95
5....\$24.95 ea
10...\$22.95 ea

RF304RL RF304RM

1....\$29.95
5....\$26.95 ea
10...\$23.95 ea

- Compatible with 300/4 Transmitters
- 11-24 volts DC Operating Voltage
- 13 ma. Current Draw
- Latching (L) or Momentary (M) Output
- Kits Available (subtract \$5.00 ea.)
- Dimensions: 1.25" x 3.75" x .5"
- 2 (300) / 4 (304) Output Data Lines
- Binary to Dec / Hex Converter can achieve up to 15 channels

- Alarm Systems
- Garage / Gate Openers
- Lighting Control

- Magic Props
- Medical Alert
- Monitoring Systems

- Industrial Controls
- Surveillance Control
- Motor Control

- Schematics Available
- Receiver Board Layout Available
- Custom Design Consulting Available

Visitect Inc.

(510) 651-1425 Fax: (510) 651-8454
P.O. Box 14156, Fremont, CA 94539

Email: Support@Visitect.Com
Visa / Mastercard, COD

CIRCLE 224 ON FREE INFORMATION CARD

Turn your PC into a 16-bit Storage Scope spectrum analyzer, and digital multimeter!

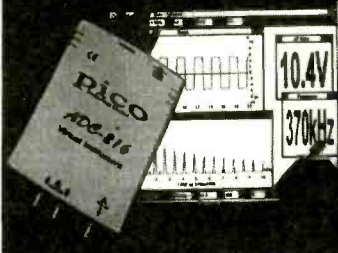

ADC216 turns your PC or laptop into a sophisticated storage scope AND spectrum analyzer AND multimeter. Display on large screen! Print in color! 100MS/s 8-bit, 1.2MS/s 12-bit or 333kS/s 16-bit versions. Great for test depts, schools. Input to Excel. LabView/NT drivers. Get very high precision without high cost!

osziFOX

handheld 20MS/s Storage Scope

osziFOX is a sophisticated digital storage scope packed into a handy, slim penlike housing. Despite its small size, osziFOX can perform like a service scope with a 20MS/s sampling rate so signals in microprocessor or audio circuits can be measured easily. A built-in backlit LCD shows the waveforms but the recorded signals can also be sent to a PC via a serial interface. Runs from 9V battery or external source. Auto, internal and external triggers. AC/DC voltmeter function too. Only \$129!

also

RS232-422/485 converters, self-powered, opto-isolated I2C adapter boards for PC communication with I2C bus mini dataloggers for events, voltages, pressures, etc. Environ temperature and environment netwk logger thermocouple and thermistor adapters for PC ports. BASIC-programmable BASIC-TIGER controller modules PCI framegrabbers - switch between 2 inputs locked! lowcost A/D adapters turn your PC into a display scope



Saelig Company

www.saelig.com saelig@aol.com
716-425-3753 • 716-425-3835 (fax)

1-888-7SAELIG

Home Automation



World's Largest Source for Home Automation!

- Voice Control
 - Gadgets & Motorized Devices
 - Home Theater
 - Phones & Intercoms
 - X10 & Lighting Control
 - Home Security & Surveillance
 - Home Networking & Structured Wiring
- and Much More...

800-SMART-HOME

www.smarthome.com

Free 144 pg. Color Catalog!

Dealers/Resellers ask about our SmartHome PRO Dealer Program 800-949-6255



EPROM+

A device programming system for design, repair and experimentation

- ◆ EXCEPTIONAL POWER FOR THE PRO
- ◆ EASY-TO-USE FOR THE NOVICE
- ◆ INCLUDES STEP-BY-STEP TUTORIAL

Here's what you get: A rugged, portable programming unit including the power pack and printer port cable both of which store inside the case. A real printed user and technical manual which includes schematic diagrams for the programming unit plus diagrams for all technology family adapters. * Comprehensive, easy-to-use software which is specifically designed to run under DOS, Windows 3.1, 95 and 98 on any speed machine. The software has features which let you READ, PROGRAM, COPY and COMPARE plus much more. You have full access to your system's disk including LOADING and SAVING chip data plus automatic processing of INTEL HEX, MOTOROLA S-RECORD and BINARY files. For detailed work the system software provides a full screen buffer editor including a comprehensive bit and byte tool kit with more than 20 functions.

Broad device support: FIRST GENERATION EPROMS (2708, TMS2716*, 25XX) SECOND GENERATION EPROMS (2716-28C080), 40 AND 42 PIN EPROMS* (27C1024-27C160) FLASH EPROMS (28F, 29C, 29EE, 29F), EEPROMS (2816-28C010), NVRAMS (12XX, X2210/12) 8 PIN SERIAL EPROMS* (24, 25, 85, 93, 95, 80011A) PLUS ER1400/M58667* AND ER5901 BIPOlar PROMS* (72S/82S), FPGA CONFIGURATORS (17CXXX) MICROCONTROLLERS* (874X, 875X, 87C5XX, 87C75X, 89C5X) ATMEL MICROS* (8-40) PIN 89CXX051, 89SXXX (AVR) 90SXXX PIC MICROS* 8, 18, 28, 40 PIN (12CXXX-16CXXX, 16FX, 17C) MOTOROLA MICROS* (68705P3/U3/R3, 68HC705, 68HC711)

\$289

*REQUIRES SNAP-IN ADAPTER (ORDER FACTORY DIRECT OR BUILD YOURSELF) \$5.00 SHIPPING • \$5.00 C.O.D. 1 YEAR WARRANTY - 30 DAY MONEY BACK GUARANTEE VISA • MASTERCARD • AMEX

ANDROMEDA RESEARCH, P.O. BOX 222, MILFORD, OH 45150
(513) 831-9708 FAX (513) 831-7562 website - www.artabs.com

SERIAL LCDs

Serial LCDs work great with BASIC Stamps® and other microcontrollers. One-wire interface • simple serial protocol • low cost • high quality • in stock

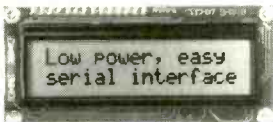

BPI-216N

- 2x16 text LCD
- 2400/9600 bps
- \$45 (non-backlit)

SGX-120L

- Mini graphics LCD
- 2400/9600 bps
- just \$99



Many other models available—see www.seetron.com!

Scott Edwards Electronics, Inc.
www.seetron.com • 520-459-4802

Poptronics

SHOPPER

ON SCREEN DISPLAY CHARACTER OVERLAY BOARD



OSD-232 on board a radio controlled airplane!

Ever wish your LCD module could display more lines of text? OSD-232 is the solution! From any RS-232 serial source like a PC, PIC, or Basic Stamp, display 28 columns by 11 rows of information (308 characters total) directly onto any NTSC or optional PAL baseband (video in) television or VCR. OSD-232 can overlay monochrome text onto an incoming video source or display colored text on a self-generated colored background screen.

Intuitive Circuits, LLC

2275 Brinston • Troy, MI 48083
(248) 524-1918

<http://www.icircuits.com>

OSD-232 \$99.00

Visa/Mastercard/Prepaid check

SAVE UP TO

60%

ON

ELECTRONIC

COMPONENTS

www.futurlec.com

LARGE RANGE

IC's, Crystals

Resistors, Capacitors

TUBES, BOOKS, TRANSFORMERS,
CAPACITORS, PARTS
and MUCH MORE!



CALL "480-820-5411" TODAY FOR
OUR FREE 80 PAGE CATALOG
FAX 480-820-4643 or 800-706-6789
www.tubesandmore.com

Get your copy of the CRYSTAL SET HANDBOOK



Go back to antiquity and build the
radios that your grandfather built.
Build the "Quaker Oats" type rig,
wind coils that work and make it
look like the 1920's! Only \$10.95
plus \$4.00 for shipping and han-
dling. Clagg Inc., PO Box 12162,
Hauppauge, NY 11788. USA
Funds ONLY! USA and Canada—
no foreign orders. Allow 6-8 weeks
for delivery. MA01

CLASSIFIEDS

AUDIO-VIDEO-LASERS

The Dynamo board, a PC Waveform-
Generator for audio, video and wireless
applications. Wireless designs available—
see www.signaldisplay.com

BUSINESS OPPORTUNITIES

\$400 WEEKLY ASSEMBLING electronic
circuit boards/products from home. For
FREE information send SASE: Home
Assembly-PT Box 216 New Britain, CT
06050-0216.

EASY WORK! EXCELLENT PAY! Assemble
Products At home. Call Toll Free 1-800-467-
5566 EXT. 1190

CABLE TV

CABLE TV Descramblers. One-piece units.
Scientific Atlanta, Jerrold, Pioneer, and others.
Lowest Prices Around. **Precision Electronics**
Houston, TX. Anytime. 1-888-691-4610

ROCK BOTTOM...DEALER...DISCOUNTS!!
125ch. VISION MASTER PLUS. "DE-
CODE'S EVERYTHING PERMANETLY".
TEST CHIPS & ACTIVATORS 1-888-675-
3687 — 201-386-1145.

**ABSOLUTE BEST PRICES ON CABLE TV
BOXES! FREE 30 DAY TRIAL! 1 YEAR
WARRANTY! FREE CATALOG.** 1-888-
242-0539 WWW.ALLCABLEBOXES.COM

CB-SCANNERS

CB Radio Modifications! Frequencies,
kits, high-performance accessories, books,
plans, repairs, amps, 10-Meter conversions.
The best since 1976! Catalog \$3. **CBCI**,
Box 1898P, Monterey, CA 93942.
www.cbintl.com

MISC. ELECTRONICS FOR SALE

T&M ELECTRONICS. Large variety of elec-
tronic parts since 1966. Visit our Web site at
www.tandmelectronics.com

E(E)Prom/Microcontroller Programmers
and Gadgets form \$19.95 & up. [http://www.
geocities.com/Xumicro](http://www.geocities.com/Xumicro)

TinyTenna's and more! SASE to: "Short-
wave Catalog", POB 87, Hanover, MI.
49241. <http://qth.com/dwm> or [http://qth.
com/danger](http://qth.com/danger).

PLANS-KITS-SCHEMATICS

AM Tube Radio Kits. TRF and Superhets. Visit
our website at www.ghostmoon.bigstep.com

SATELLITE EQUIPMENT

FREE Satellite TV Buyer's Guide. Best
Products - Lowest Prices - Fastest Service!
Dish Network, DirectTV, C/Ku-band, includ-
ing 4DTV. Parts- Upgrades - Accessories!
SKYVISION - 800-543-3025. International
218-739-5231. www.skyvision.com

From Not-Working to Networking!

Troubleshooting Local-Area Networks!

Now, complete for the first time in one detailed booklet!

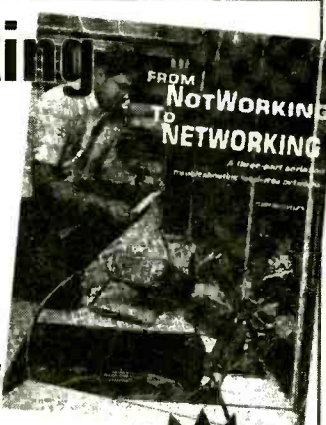

Gain a fuller knowledge of network
fundamentals and how they
developed from the early days of
main frames, from XNS to Ethernet
technology, the OSI stack for
interconnecting different computers,
basic and specialized test instruments, etc. Several
tough LAN case histories brings you from theory to
the practical side of troubleshooting.

**ONLY
\$4.99**

CLAGGK Inc., Reprint Bookstore
P.O. Box 12162, Hauppauge NY 11788

Please rush my copy of "From Not-Working to Networking." I enclosed
payment of \$4.99 which includes shipping charges. U.S.-First Class,
Canada and Overseas-Surface Mail.

Name _____

Address _____

City _____ State _____ Zip _____

All Payments must be in U.S. funds. Send check or money order payable to
CLAGGK Inc.—do not send cash or stamps. New York State residents add
applicable sales tax. Allow 6 to 8 weeks for delivery

RBS02

BUY BONDS

Gernsback Publications, Inc.

275-G Marcus Blvd. Hauppauge NY 11788

POPTRONICS® CLASSIFIED ADVERTISING ORDER FORM

Advertiser Information

Name _____
 Company _____
 Street Address _____
 City/State/Zip _____
 Telephone () _____
 Signature (required on all orders) _____

Payment Information

Charge my:
 Master Card Visa Discover
 Account No. _____
 Exp. Date _____
 Full payment enclosed. Prepayment discounts offered for multiple insertions (except on credit card orders).
 Payment for first insertion enclose; additional payments will be made prior to closing dates. Prepayment discounts not available.

Do you want any special options? (where available)

- Boldface Type* Add 25% for entire ad Screened Background – Add 30%
 Special Heading – Add \$35.00

The first word of your ad and your name will be printed in boldface caps, at no additional charge. For individual boldface words, add .50¢ each.

In what month(s) would you like your ad to run?

- Entire year for publications selected above.
 Jan. Feb. Mar. Apr. May. June July Aug. Sep. Oct. Nov. Dec.

Here's how to calculate the cost of your Regular or Expanded-Ad Classified:

Rate X Numbers of Words + Rate for Boldface + Rate for Screened Background = Cost per Insertion X Number of Months = Cost

Magazine	Rate	x	Number of Words (min. 15)	+ Boldface (add 25%)	+ Screened Background (add 30%)	= Cost Per Insertion	x	Number of Months	= Cost
		x		+	+	=	x		=

Rates:

\$3.50 per word

Minimum 15 Words

Here's how to calculate the total cost of your advertising:

Prepayment Discount:

(Full payment must accompany order, not applicable on credit card orders)

Prepay for 6 insertions in one magazine, 5% 12 insertions in one magazine, 10%

Subtotal _____
 Less Prepayment Discount _____
TOTAL COST \$ _____

Please use a separate piece of paper to write your copy, or for any special instructions you may have.

HAVE A QUESTION? CALL: 1-631-592-6720 ext. 206

Fax signed orders with credit card information to : (631) 592-6723

GPI895

ADVERTISING INDEX

Poptronics does not assume any responsibility for errors that may appear in the index below.

Free Information Number	Page	Free Information Number	Page
- Abacom92	- Intelligence Here82
- All Electronics70	- Intronics70
- Allison Technology81	- Intuitive Circuits, LLC93
- Amazon Electronics83	309 IVEX Design77
- Andromeda Research93	- J&M Microtek83
- Arrow Technologies70	- Lynxmotion86
- Big Bang Electronics73	- M ² L Electronics86
- Beige Bag Software81	323 Mendelsons76
- Bsoft Software, Inc.89	296 Merrimack Valley Systems87
283 CadSoft, Inc.13	- microEngineering Labs82
290 C&S Sales, Inc.78	- Modern Electronics74
133 CircuitMakerCV2	- Mondo-tronics86
233 Circuit Specialists91	- Ohio Automation82
- CLAGGK, Inc.14, 18, 46, 76	140 ParallaxCV3
320 Cleveland Inst. of Electronics71	- PCS, Inc.74
321 Command Productions89	- Pioneer Hill Software76
- Communications Surplus83	228 Polaris Industries90
- Conitec Data Systems74	219 Prairie Digital69
- Consumertronics82	- RC Distributing Co.82
316 Dalbani68	263 Ramsey Electronics75
- EDE Spy Outlet82	- Rigel Corporation83
210 Electronic Design Specialists69	- Saelig Co., LLC93
- Elect. Tech. Today27, 67	- Securetek92
130 Electronic WorkbenchCV4	- Scott Edwards Electronics93
- EMAC Inc.88	- Smarhome.com93
- Engineering Express69	- Square 1 Electronics88
- Fair Radio Sales74	- Techniks83
- Fort777.com85	- Technological Arts70
- Futurelec94	322 Test Equipment Depot88
- Galaxy Electronics86	217 Tie Pie Engineering80
- Global Specialties89	- UCANDO Videos81
- Globaltech Distributors82	275 Velleman72
282 Grantham College of Eng.4	- Vision Electronics86
212 Graymark Intl.84	224 Visitect, Inc.92
220 Information Unlimited84	- World Wyde74, 82, 83
- Intec Automation83		

ADVERTISING SALES OFFICES

Gernsback Publications, Inc.
275-G Marcus Blvd.
Hauppauge, NY 11788
Tel. 631-592-6720
Fax: 631-592-6723

Larry Steckler
 Publisher (ext. 201)
 e-mail: advertising@gernsback.com

Adria Coren
 Vice President (ext. 208)

Ken Coren
 Vice-President (ext. 267)

Marie Falcon
 Advertising Director (ext. 206)

Adria Coren
 Credit Manager (ext. 208)

For Advertising ONLY EAST/SOUTHEAST

Marie Falcon
 275-G Marcus Blvd.
 Hauppauge, NY 11788
 Tel. 631-592-6720 x206
 Fax: 631-592-6723
 e-mail: mfalcon@gernsback.com

MIDWEST/Texas/Arkansas/ Oklahoma

Ralph Bergen
 One Northfield Plaza, Suite 300
 Northfield, IL 60093-1214
 Tel. 847-559-0555
 Fax: 847-559-0562
 e-mail: bergenrj@aol.com

PACIFIC COAST

Megan Mitchell
 9072 Lawton Pine Avenue
 Las Vegas, NV 89129-7044
 Tel. 702-240-0184
 Fax: 702-838-6924
 e-mail: mmitchell@gernsback.com

**Subscription/
Customer Service/
Order Entry**
 Tel. 800-827-0383
 7:30 AM - 8:30 PM CST

www.poptronics.com

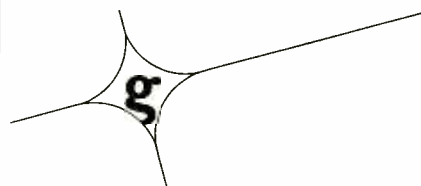

BOE-BOT: a Programmable Robot

The Boe-Bot is a BASIC Stamp-based robot designed for hobby and educational use. Some of the neat things the Boe-Bot can do is roam in a predetermined path, avoid objects using infrared sensors or whiskers, detect the edge of a table, follow another Boe-Bot, and even send or receive infrared codes to a handheld remote control. One look at the chassis and you'll find yourself at a local hobby shop buying aluminum and brass pieces to expand the capabilities of your robot to meet your desires. The Boe-Bot requires a PC running DOS or Win95/98 operating systems for programming.



Controlled by the
BASIC Stamp 2.

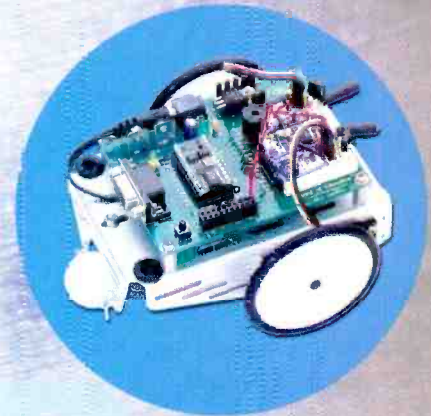

AUDIENCE	Educational and experimental.
POWER SUPPLY	Four AA's for BASIC Stamp and motor control.
ASSEMBLY TOOLS REQUIRED	Angled cutters, small phillips screwdriver, and 1/4" box-end wrench.
TIME REQUIRED TO BUILD AND PROGRAM	2 hours to build. The included Robotics! text includes many pre-written PBASIC programs.
COMPONENTS INCLUDED	LEDs, speaker, pushbutton, photoresistors, resistors and capacitors, infrared LEDs and receivers, and complete whisker kit.
USE OF BASIC STAMP I/O PINS	Components are placed on the breadboard and may be moved around. Flexible use of I/O pins.
OBJECT DETECTION	Infrared object detection and whiskers.
EXPANDABILITY	Boe-Bot has mounting holes for additional gadgets such as a camera, gripper, or line following kit. The AppMod header accepts other Parallax boards.
KIT CONTENTS	BASIC Stamp 2 module, Boe-Bot hardware, software, serial cable, Robotics! text with projects, and BASIC Stamp Manual Version 2.0. This kit includes everything you need to get started with robotics using the BASIC Stamp!

Boe-Bot Full Kit
#28132 **\$219**
3.0 lbs.

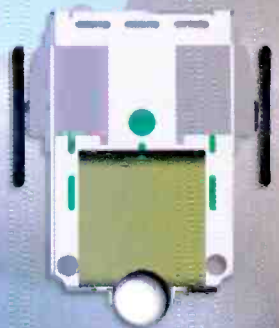

To order visit our website
at www.parallaxinc.com or
call toll-free 888/512-1024
Mon-Fri 7 a.m. - 5 p.m. PST

PARALLAX 

BASIC Stamp and the Parallax logo are registered trademarks of Parallax, Inc.

CIRCLE 140 ON FREE INFORMATION CARD

www.americanradiohistory.com

The world's most popular electronics simulation software just got better!

WHY settle for second best?

***FREE**

Virtual Lab with Poptronics Circuits

Check out the circuits from recent issues, including this month's! Tweak the circuits and see the instruments respond instantly.

Download the Multisim demo with pre-built Poptronics circuits from www.electronicworkbench.com/poptronics

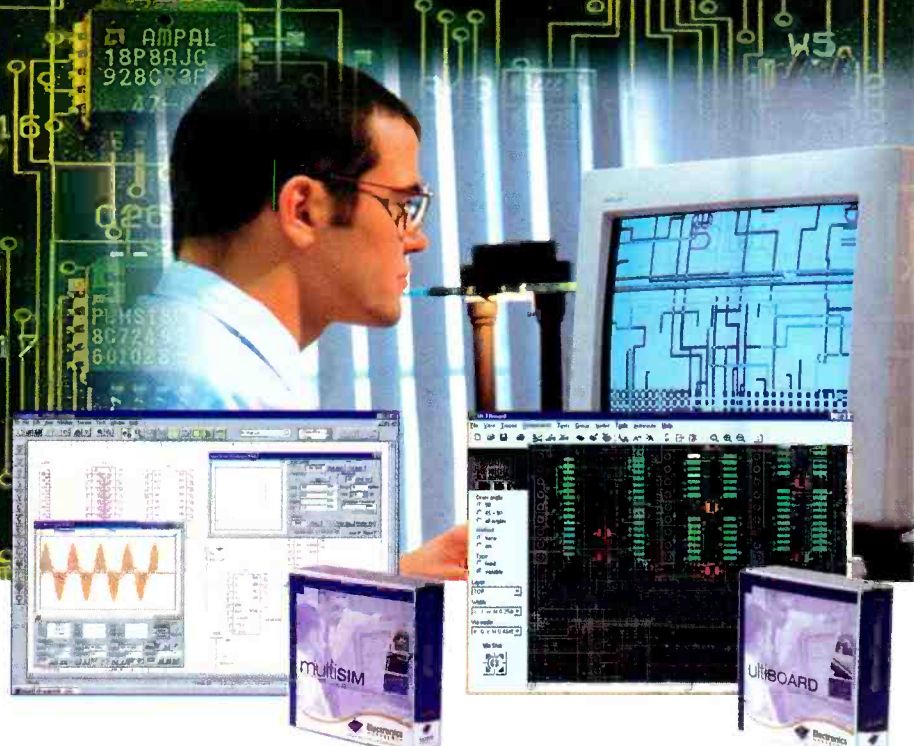

BEST PRODUCT! BEST PRICE!

Electronics Workbench is recognized around the globe for developing highly advanced, yet easy-to-use electronics software. Over 150,000 users tell us that they have completed projects using Electronics Workbench in less time than it takes to even install other programs.

And now we've just released Version 6.2! If you've never tried electronics simulation, this is your chance - you can now have your very own virtual lab! Work on your own or create circuits together with others across the country - live on the internet. Start with the **FREE** Electronics Workbench/Poptronics demo and then take advantage of this best price ever when you buy. Tried other products? You owe it to yourself to experience what only the market leader can offer - there is no comparison. And if you own earlier versions of Electronics Workbench, call us now for upgrade pricing starting at just **\$149!**

multisim V6.2

Schematic Capture & Simulation

~~\$399~~ **\$299**

ultiboard

Powerful PCB Layout

~~\$399~~ **\$299**

or get **BOTH** products for **\$498**

Limited Time Offer
BEST price ever!

Multisim Highlights

- ▶ Advanced schematic capture
- ▶ Intuitive auto & manual wiring (no toggle)
- ▶ Change circuits while simulating
- ▶ Mixed-mode SPICE analog/digital simulation
- ▶ Built-in symbol and component editor
- ▶ Parts organized into bins (no alpha lists)

Don't settle for a program that has less than:

- ▶ 6,000 parts in component database
- ▶ 9 virtual instruments & 8 powerful analyses
- ▶ Interactive design on the Internet
- ▶ OLE integration with Excel/MathCAD

Ultiboard Highlights

- ▶ Powerful & easy-to-use PCB layout & editing
- ▶ Reroute while move (full rubberbanding)
- ▶ Built-in autorouter
- ▶ Real-time design rule check
- ▶ Automatic net highlighting (selective)
- ▶ Density histograms/placement vectors

Don't settle for a program that has less than:

- ▶ 3,000+ library of footprint shapes
- ▶ Capability for boards of any shape, up to 50"x50"
- ▶ 32 layers support
- ▶ 1 nanometer internal resolution

To order, or to find out why our products are the most popular in the industry, call **1-800-263-5552** or visit www.electronicworkbench.com (**FREE** demo available)



Electronics
WORKBENCH