

Poptronics®

Formerly **Popular Electronics**® and **Electronics NOW**



“Burn” PLDs with the **ALTA PRO 2000**

Capture voltages and pulses with the **Analog Memory Module**

Filtering Against EMI/RFI

When shielding is not enough



Also Inside:

- Backup Power
- Flatbed Scanners
- Proximity Sensors
- Fuel-Cell Technology
- Connecting to Others Worldwide



\$4.99 U.S.
\$6.50 CAN.

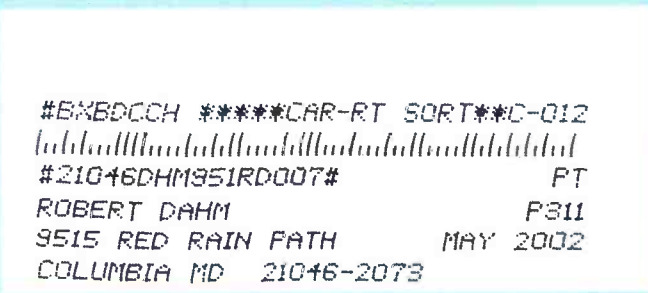



Delivering Performance With Value

e-mail: info@aventools.com • website: www.aventools.com

MICROSCOPES

System 703
Stereo Inspection Microscope
Part #26.703

Price \$270.00

- Adjustable interpupillary distance between 2.5" (65mm) and 3/4" (75mm)
- Slide mount objectives for rapid magnification change
- Provides a long working distance of 6" at 10x magnification
- Built-in illuminator with articulating arm allows infinite positioning
- Weighted stand with 9" arm is fully adjustable
- Magnification 5x, 10x, and 20x
- 5 year limited warranty



System 707
Deluxe Stereo Microscope
Part #26.707

Price \$266.00

- Selectable 20x or 40x magnification
- Bottom transmitted and overhead illuminators
- Rotary turret mounted with posture click stop for easy power change
- Precision rack and pinion focus
- 45 degree inclined eye tubes
- Working distance 3.15" at 20x
- Incandescent (12v/10w) and Halogen (12v/10w) lights



CABLETESTERS

Multi-Network Cable Tester
Part #25.102

Price \$94.50

- Quickly tests by auto scanning
- Suitable for thin ethernet (BNC) /10 Base T, (UTP/STP) /356A /TIA 568A /TIA-568B /token ring
- Use attached remot terminator to test cable before or after the cables are installed. Also allows you to test the ground of shielded twisted pair cable.



Multi-Modular Cable Tester
Part #25.022

Price \$76.82

- Quickly test by auto scanning modular cables USOC4/USOC6/USOC8 terminating with RJ45, RJ12 and RJ11 modular plug
- Comes with remote terminator, allows you to test installed cables.

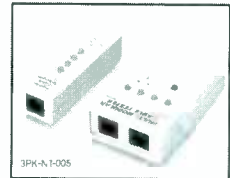

TOOLKITS



22 PC Aven Personal Computer Tool Kit
Part #15.014

Price \$75.00



22 PC Aven Basic Electronic Tool Kit
Part #15.019

Price \$59.60



73 PC Aven Master Electronic Tool Kit
Part #15.018

Price \$234.69

- Includes super drill set
- Aluminum Case



47 PC Aven Premier Compact Technicians Kit
Part #15.004

Price \$132.83



88 PC Premier Field Service Kit
Part #15.006

Price \$244.90

- Comprehensive assortment of tools for servicing electronics
- Double-sided case

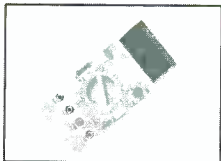

Professional Multimeter
Part #25.015

Price \$35.75

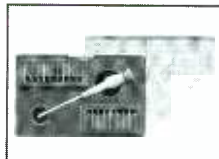

20 PC Precision Screwdriver Set With Interchangeable Blades
Part #13.714

Price \$16.64

- This useful set contains 19 assorted Slotted/Philip/Star/Hex/Ball point/Blades. Special quick release designed, make blade changes quick and easy



Digital Soldering Station
Part #17.510

Price \$132.65

- Ceramic heater unit for quick start
- Temperature adjustment: 160-480 celcius
- Six different tip sizes available as options
- Perfect for most soldering applications including SMD
- ESD Safe



Perfectly Balanced Fluorescent Lighting With A Precision 3 Diopter Magnifier Lens
Part #26.501

Price \$77.90

- 45 inch extension arm
- The shade with handle lets you bring the light where you want
- 3 diopter lens included
- Supplied with 22 watt circline tube
- Color: Ivory
- All metal construction

For your nearest distributor call: #1-800-624-8170
Fax: #1-734-973-0097 • e-mail: info@aventools.com



Visa/Mastercard Accepted

CIRCLE 295 ON FREE INFORMATION CARD

Poptronics®

THE MAGAZINE FOR THE HANDS-ON ELECTRONICS ACTIVIST!

FEATURES

29 THE ALTA PRO 2000

One secret to adding more features to projects while keeping parts count and size small is to use programmable microcontrollers and microprocessors. But there's another way to keep things small: programmable-logic devices. How do you program them? Our PLD programmer can handle the task, now or in the future. It's versatile, expandable, and obsolescence-proof.—Robert G. Brown



25 FILTERING AGAINST EMI/RFI

There are times when simple shielding is not enough to protect sensitive circuitry. How do you protect your project when you must have wires connected to it? We take a look at the different paths electromagnetic interference uses to sneak into the "inner sanctum" and spoil the party and how to protect against those intrusions.—Joseph J. Carr

37 ANALOG MEMORY MODULE

If you've tried troubleshooting ultra-fine circuit traces or twisted yourself into a knot to reach that test point deep in the heart of your TV, you know the frustration of watching where your test probes are while trying to read your meter's display. This simple add-on device grabs and holds the voltage for reading at the test site or back at the bench.—Stanley J. York

PRODUCT REVIEWS

13 GIZMO®

FSR radios, DVD/MP3 player, Game Boy holster, outdoor plant pot/speaker system, ultimate electronics carry bag, translucent "boombox," wireless modem phone jack, easy Internet-access mouse, report-writing software, magnesium-chassis notebook computer, and an all-in-one office machine.

DEPARTMENTS

8 PROTOTYPE

Cars with 42-volt automotive electrical systems, fuel cells, and other energy innovations. Also, a look at the latest research from university and private industry research labs.

17 NET WATCH

If you surf the Web, you never have enough bandwidth. Chris La Morte looks at some wideband alternatives to the "antique" analog modem.

19 SURVEYING THE DIGITAL DOMAIN

Plug into the "world community" with Reid Goldsborough's advice, including how not to spam!

21 COMPUTER BITS

When Ted Needleman's house lights go out, he can bask in the glow of his CRTs with the aid of UPSs.

23 PEAK COMPUTING

Get the "big picture" as Ted Needleman checks out the scanner scene... flatbed image scanners, that is.

45 Q&A

Introducing the "new kid on the block," Dean Huster.

49 AMAZING SCIENCE

John Iovine juices up some fuel cells.

54 SERVICE CLINIC

Tired of watching "silent" movies on your VCR? Listen to Sam Goldwasser's advice on VCR audio problems.

57 BASIC CIRCUITRY

Charles Rakes gets "up close and personal" with some more proximity sensors.

AND MORE

2	Editorial
3	Letters
5	New Gear
7	New Literature

61	Poptronics Shopper
88	Advertising Index
88A	Free Information Card

Poptronics (ISSN 1526-3681) Published monthly by Gernsback Publications, Inc. 275-G Marcus Blvd., Hauppauge, NY 11788. Second-Class postage paid at Hauppauge, NY and at additional mailing offices. One-year, twelve issues, subscription rate U.S. and possessions \$24.99, Canada \$33.15 (includes G.S.T. Canadian Goods and Services Tax Registration No. R125166280), all other countries \$33.99. Subscription orders payable in U.S. funds only. International Postal Money Order or check drawn on a U.S. bank. U.S. single copy price \$4.99. Copyright 2000 by Gernsback Publications, Inc. All rights reserved. Hands-on Electronics and Gizmo trademarks are registered in U.S. and Canada by Gernsback Publications, Inc. Poptronics trademark is registered in U.S. and Canada by Poptronix, Inc. and is licensed to Gernsback Publications, Inc. Printed in U.S.A.

Postmaster: Please send address changes to Poptronics, Subscription Dept., P.O. Box 459, Mount Morris, IL 61054-7629

A stamped self-addressed envelope must accompany all submitted manuscripts and/or artwork or photographs if their return is desired should they be rejected. We disclaim any responsibility for the loss or damage of manuscripts and/or artwork or photographs while in our possession or otherwise.

As a service to readers, Poptronics publishes available plans or information relating to newsworthy products, techniques, and scientific and technological developments. Because of possible variances in the quality and condition of materials and workmanship used by readers, Poptronics disclaims any responsibility for the safe and proper functioning of reader-built projects based upon or from plans or information published in this magazine.

Larry Steckler, EHF, CET,
editor-in-chief and publisher

EDITORIAL DEPARTMENT

Joseph Suda, managing editor
Evelyn Rose, assistant editor
Nancy Serenita, editorial assistant

CONTRIBUTING EDITORS

Dean Huster
Reid Goldsborough
Sam Goldwasser
John Iovine
Chris La Morte
Gordon McComb
Ted Needleman
Charles D. Rakes
Teri Scaduto

PRODUCTION DEPARTMENT

Ken Coren, production director
Kathy Campbell, production manager
Michele L. Musé, prepress specialist

ART DEPARTMENT

Russell C. Truelson, art director
Michele L. Musé, graphic artist

CIRCULATION DEPARTMENT

Gina Giuliano, circulation manager

REPRINT DEPARTMENT

Nancy Serenita, Reprint Bookstore

BUSINESS AND EDITORIAL OFFICES

Gernsback Publications, Inc.
275-G Marcus Blvd.
Hauppauge, NY 11788
631-592-6720
Fax: 631-592-6723

President: Larry Steckler
Vice-President: Adria Coren
Vice-President: Ken Coren

SUBSCRIPTION CUSTOMER SERVICE/ ORDER ENTRY

800-827-0383
7:30 AM - 8:30 PM EST

Advertising Sales Offices
listed on page 88

Cover by Michele Lyn Musé

VISIT US ON THE INTERNET AT:
www.gernsback.com

Since some of the equipment and circuitry described in POPTRONICS may relate to or be covered by U.S. patents, POPTRONICS disclaims any liability for the infringement of such patents by the making, using, or selling of such equipment or circuitry, and suggests that anyone interested in such projects consult a patent attorney.

<mailto:popeditor@gernsback.com>

The World's Worst Manual

A few weeks ago, I received a press release that made my initial chuckles grow to guffaws and full-blown belly laughs. Throughout the morning, I was flooded by inter-office messages from the rest of the staff begging and pleading, "Please, can we cover this somehow? Please? Please? Can we?"

The announcement that created this stir was from Jim Desmond, president of Technical Standards, Inc., a San Marcos, California documentation-services company. Rather than rehash his message, let's have Mr. Desmond speak for himself:

"Have you ever been so frustrated with a manual or set of instructions that you cursed the author and wished you had never bought the product? Do you remember the last time you used Help on your computer and every click of the mouse led to a new set of decisions?"

"Does this sound familiar? How about \$500 for your frustration? TSI is offering \$500 for the winning entry in their "Worst Manual Contest." Send a manual or set of instructions that is hard to understand, poorly written, or just plain wrong. Send it if it has bad grammar, too much legalese, is poorly translated, or has missing steps. If it is the worst entry, you will win \$500.

"We thought we would have fun with this contest. Everyone has had trouble with a manual," says Michelle Wier, Director of Operations of TSI. "That's why we started our company. People like products they understand how to use, and good technical documentation reduces the need for technical support. That's why good manuals are so important."

"You don't have to send the whole manual; excerpts of the worst parts are okay. The deadline for submissions is January 15, 2001, so check those holiday gifts for potential entries. Entries must be in English. For complete contest rules, see the TSI Web site at www.tecstandards.com."

A quick check of the **Poptronics** calendar shows that this issue hits the newsstands just after the New Year. That being the case, get busy; you've got about two weeks. Let's see if we can make a **Poptronics** reader the winner.

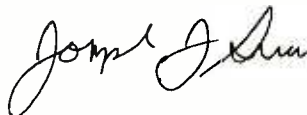

Joseph Suda
Managing Editor

LETTERS

mailto: letters@gernsback.com

Colorburst Adjustments

I offer the following corrections to the article "A Colorburst-Based Frequency Reference" in the September issue.

This circuit was presumably originally designed to use a 74LS04 for IC2, since the unused inputs are left open-circuited. This is common (though poor) practice with TTL logic, since they will rise to a logic 1 level automatically. With a high-speed CMOS 74HC04 however, it is exceedingly poor practice to do this since the near-infinite input resistance will cause the input voltages to float around in the linear- and current-drawing range of the input transistors and cause excess and variable current drain by the IC. Because of the high gain, if the input voltage floats to around the transition point, the outputs can even have an oscillation or amplified noise present. This is prevented by tying the unused inputs, pins 3, 5, 9, 11, and 13, to either ground or +5 volts. Also, the power and ground connections for IC2, which are pins 14 and 7 respectively, are not shown on the schematic.

The text mentions the possibility of extracting vertical sync from IC3, but does not say how. Vertical sync is present at pin 3, composite sync at pin 1, and odd/even field information at pin 7.

Figure 1 has a typo: 1400 IRE should read 140 IRE.

The 14.318 crystal is not adequately specified. These are available with either series-resonant or parallel-resonant calibration, and in this circuit it appears an 18-pF load-capacitance crystal should be purchased. As a fussy budget, I object to the moving piezoelectric quartz element being shown as grounded in the schematic. In reality, of course, it is just the metal surrounding can that is grounded. A preferable approach, which gives some shock resistance to the breakable crystal, is to instead mount it on a piece of double-stick foam instead of hard-fixing it to the board. Since we started doing this with our products, we have had zero problems with fractured crystals.

The 75-ohm termination of the input should, I think, be a rear-panel switch instead of a hidden internal jumper. But that's just me.

Otherwise, this was a very useful and informative issue.

CLIVE TOBIN
Tacoma, WA

Dangerous Computers

I would like to add my comments to those of Reid Goldsborough in "Surveying the Digital Domain," October 2000, in which he discusses health risks and Web computing. I have problems with focusing and blurry vision, mostly after using a fluorescent backlit LCD laptop. I have always heard it wasn't good to read under fluorescent lighting; it's got to be worse having such light staring you in the face. I don't seem to have problems with regular monitors. Now with the new monitors going LCD, what more risks are there in the future?

I don't trust putting data on the Web, which I think happens whenever you use online software. Would our National

Security Agency use software such as this?

A few months ago, I went to *kbb* and *edmund.com* to evaluate the price of a used automobile. Since then, I get at least six e-mails spams daily for automobiles and loans. If people can get your information this way, they surely can find a blueprint of your data on the Web somewhere. The best security is to have your own software and pull the phone plug when not online.....and be very careful when online.

LARRY LAYMON
Rockwood, TN

[You've got some good points—especially on the use of the Internet. However, I think that pulling the phone plug is a bit drastic, unless you have some type of computer virus or Trojan Horse that can dial out for you. The spam that you speak of is not difficult for Web sites to harvest; that type of information is routinely divulged by your browser when receiving Web-page data. If you're that concerned about privacy and security (which we all should be), look into "proxy servers;" servers that fetch Web pages for you without revealing your browser information. Some of them also handle cookies as well.—Editor.]

Editorial Remarks

Your editorial in the October issue "Whose Copyright Is It Anyway?" was interesting, but let's be fair. A "hit" song takes a lot more than the notes and lyrics. The performing artists, the recording, the arrangements, the packaging the promotion, the P/R— all go together to make a "hit." Who pays for all of that? Who "fronts" the money or takes the gamble to pay for all of these ingredients in the hopes of making a "hit?" The record producers. It's great that Napster pays the author of the song, but his song would most likely NOT be a hit without all of the investment of the record producers/labels. They ARE entitled to get paid for their "gamble."

History is full of examples of "great" songs that lay dormant until all of the ingredients came together. A classic example is "What a Wonderful World," which was a nothing song until the

KEEP IN TOUCH

We appreciate letters from our readers. Comments, suggestions, questions, bouquets, or brickbats ... we want to hear from you and find out what you like and what you dislike. If there are projects you want to see or articles you want to submit—we want to know about them.

You can write via snail mail to:

Letters
Poptronics
275-G Marcus Blvd.
Hauppauge, NY 11788

Sending letters to our subscription address increases the time it takes to respond to your letters, as the mail is forwarded to our editorial offices.

Our e-mail address can be found at the top of the column.

Of course, e-mail is fast.

All of our columnists can be reached through the e-mail addresses at the head of each column.

And don't forget to visit our Web site: www.gernsback.com.

Accredited B.S. Degree in Computers or Electronics

by studying at Home

Grantham College of Engineering
offers 3 distance education programs:

- B.S.E.T. emphasis in Electronics
- B.S.E.T. emphasis in Computers
- B.S. in Computer Science

-Electronics Workbench Professional 5.0
included in our B.S.E.T. curriculums
-Approved by more than 200 Companies,
VA and Dantes, (tuition assistance avail.)

For your free catalog of our programs dial

1-888-919-8181 Ext. 15

<http://www.grantham.edu>

GCE

Your first step
to help yourself
better your future!



Grantham College of Engineering
34641 Grantham College Road
Slidell, LA 70460-6815

CIRCLE 282 ON FREE INFORMATION CARD

Louis Armstrong recording was used in *Good Morning Vietnam*. It took the exposure, packaging, and marketing.
GORDON WOLFE
via e-mail

[Your comments are quite correct, and ones that, although a part of the first draft of the editorial, couldn't be addressed in the magazine's limited space. However, there's a deeper issue brewing under the surface. Sure, anyone who invests in something should be able to reap the rewards of their gamble. Sadly, most musicians are not a part of that mix. How many times has a band never gotten a break because the record companies want to keep the market locked up? How many times has a band been signed to a contract by one company to keep said talent away from a competitor...and never allowed to record or perform their music?]

How many times have you bought a CD because you only wanted one song, and found that the rest of the CD's content was, well, not up to par? Napster and MP3.com have both shown that there's an untapped market for selling individual songs. Does anybody remember the Personics system from the 1980s? You selected what songs or sound effects you wanted and their order. A few

hours later, your custom cassette was ready. Although it was extremely expensive (one album for the price of three), every song was a guaranteed hit. What's more, the artist and record companies were compensated. I understand that a new system, based on CD-R technology, is being developed and test-marketed.—Editor.]

Whose Copyright Is It, Anyway?

In the Editorial in the October issue, Chris Rupert's comparison of .MP3 sharing to someone scanning and posting an issue of **Poptronics** is undermined by a prior action of the RIAA. They succeeded in getting Congress to enact a tax on audio-certified CD-R media that compensates them for the copying of copyrighted material.

If someone is creating CDs from .MP3 downloads to play on standard players using one of those appliance store recorders that demands those taxed disks, then they are not stealing from RIAA. However, since most .MP3 files stay in the .MP3 format (i.e. are not downloaded to disks), the taxed disks would not fairly compensate the artist anyhow.

I would prefer to pay by the successful download (don't forget that connections fail).

I wonder why neither the RIAA nor BMG nor Sony has set up a site where honest people could download music files for a reasonable fee. I suspect it is because they fear extra copies will be made, so their all-or-nothing stance earns them nothing.

The only reason I use Napster is that the obscure stuff I like is mostly out of print; and, even if it is available, I don't want to buy 20 songs to get just one (there is no digital equivalent to the old 45 RPM single). I can't think of another industry that refuses to sell its products to a market ready, willing, and able to buy it.

DENNIS L. GREEN
Detroit, MI

[A good point on the pre-taxed CD-Rs; I didn't know that the "piracy" tax on blank cassettes was extended to the "next-generation" format.—Editor.]

Basic Circuitry Comments

I disagree with Randy Heisserman's comments on "Basic Circuitry" in the October "Letters" column. I feel that "Basic Circuitry" is okay just the way it

is. After all, it is supposed to cover the basics. In my view, the simple circuits presented in the column are little "add-ons" to larger circuits or something that could be used to prove a theory or an experiment.

By the way, there is a typo in "Q&A" in the same issue. In "Wrong Answer to Scanner Question," TRB's letter should have been cited as being in the May not the March issue.

Lastly, I want to build a battery-powered three-band equalizer for my radio. I would like to suggest this project as a future article.

RAUL ROSADO
Bronx, NY

[Thanks, Raul. We feel the same way. "Basic Circuitry" is a teaching tool for the "newbie" in all of us, no matter how experienced we are. After all, if the subjects progressed to more advanced topics, how would the next crop of novice hobbyists get up to speed? Remember, folks, every month, someone is discovering Poptronics for the first time.—Editor.]

Basic Circuitry Applause

I have always enjoyed Charles Rakes' "Basic Circuitry" column and have been a reader of your publications since 1972. Just wanted to let you know that I really enjoyed your simple test circuits in The September 2000 issue of **Poptronics**. I built them all into a small box and they add ready-to-go features to my test bench. Because I then had no further excuses, I went through the piles of semis in my junk box collected over decades and sorted them all out!

HOWARD KRAUSSE
via e-mail

Superconductor Experiment Exchange

In reading John Iovine's "Amazing Science" column, entitled "Superconductors, Part II" (**Poptronics**, September 2000), I noticed an error in his second experiment section about making a Frictionless Magnetic Bearing. The major component of friction is not from air resistance, but from some of the magnetic flux lines that are trapped in the superconductor. A demonstration to verify these flux lines is to tilt the superconductor with a floating magnet and notice that the magnet does not easily slide away.

(Continued on page 53)

NEW GEAR

USE THE FREE INFORMATION CARD FOR FAST RESPONSE

Digital Multimeter



CIRCLE 60 ON FREE INFORMATION CARD

DESIGNED TO MEET THE NEEDS of plant maintenance, electrical, control, and process technicians, the *Fluke 180 Series Digital Multimeters* provide .025% accuracy and 50,000 counts of resolution. The top-of-the-line Model 189 can store up to 1000 measurements in stand-alone operation, allowing users to log

data based on events or time, or to log the data manually. This model has a bright red two-level LED backlight, as well as an enhanced LCD with larger digits and a wide viewing angle. All measurements are available for later viewing on the meter's display that includes a real-time clock.

Both the 187 and 189 meters measure volts, ohms, amps, capacitance, and continuity, as well as temperature in Celsius and Fahrenheit. In addition to relative mode and Min/Max/Average, there's a 250- μ s Fast Min/Max capability for capturing peak transients.

The design of the 180 Series makes for ease of use and handling. The ergonomic case houses the multiple reading display that provides simultaneous readouts, such as true rms AC and DC, as well as Hertz, dB, and mV DC. The closed-case-calibration feature allows calibration adjustments to be made directly from the front panel or through the infrared port. The battery access door enables the user to change batteries and fuses without breaking the calibration seal.

The Fluke 189 can be loaded with the optional *FlukeView Forms* software, which enables users to maximize the 189's logging capability through template-driven custom reporting. This software is ideal for documenting test procedures for new equipment installation. Other accessories for the 187 and 189 include a ToolPak that provides strap and magnet hangers for hands-free use and the LockPak for locking them. The meters come complete with probe holder, test leads, and a manual (available in 16 languages).

The Fluke 180 Series Digital Multimeters range in price from \$379 for Model 187 to \$399 for Model 189.

FLUKE CORP.

P.O. Box 9090

Everett, WA 98206-9090

888-492-7550 or 425-356-5500

www.fluke.com

Audio Analyzer

CUSTOM DESIGNED FOR HOME-theater and consumer audio installations, the *SP295 SoundPro Audio Analyzer* enables users quickly and accurately to set up audio systems for concert-quality listening. Its Real-Time Analyzer tunes and balances any audio system in minutes. The Sound-Pressure-Level Meter ensures proper level balancing of each speaker and the Energy-



CIRCLE 61 ON FREE INFORMATION CARD

Time Graph identifies and corrects uneven sound dispersion.

With the SoundPro, users can test background noise level and speaker and system polarity, as well as analyze cables and connectors for opens, shorts, or crossed cables. All the output Test Generator signals needed are in one portable package.

The SP295 SoundPro Audio Analyzer has a list price of \$1995.

SENCORE INC.

3200 Sencore Drive
Sioux Falls, SD 57107
800-736-2673
www.sencore.com

Illuminated Magnifier

IDEAL FOR INSPECTIONS AND assembly applications, the *Omnivue* Illuminated Magnifier comes equipped with a 35-inch reach arm, a fully rotational lens, and two light levels. The light is meant for working areas where high or varying light levels are necessary for precision work.

For complete maneuverability in almost any working environment, the sturdy mounting platform features a 30-inch by 30-inch base that sits on four casters and a vertical pole that is 38 inches above the floor. The *Omnivue* magnifier alone can also be attached to the included clamp, which fits most workstations.



CIRCLE 62 ON FREE INFORMATION CARD

The *Omnivue* Illuminated Magnifier sells for \$331.

WALDMANN LIGHTING

9 West Century Drive
Wheeling, IL 60090
800-634-0007
www.waldmannlighting.com

Cable Analyzer

EASILY OPERATED BY ONE PERSON testing patch cords or installed cables, the *Model 240 Remote Network Cable Analyzer* includes one master unit and one remote. The small remote unit is designed to slip into the master unit to prevent loss or damage. The compact design makes it easy to carry to any job site.



CIRCLE 63 ON FREE INFORMATION CARD

A small handheld tester, the *Model 240* allows users to quickly read the status of Ethernet twisted pair cables—

testing for faults such as open circuits, shorts, crossed pairs, reversed pairs, and split pairs in seconds. Its tone generator feature can be used to trace installed cables and locate areas of discontinuity. When used with any tone generator, the *Model 240P Probe* can trace cables and locate faults, even when cables are in a bundle or are hidden. The *Probe* is equipped with a tone amplifier and an LED indicator that detects audible frequency tones for accurate tracing and identification of wires.

The *Model 240 Remote Network Cable Analyzer* and *Model 240P Probe* have suggested retail prices of \$169 and \$59, respectively.

B&K PRECISION CORP.

1031 Segovia Circle
Placentia, CA 92870-7137
800-462-9832 or 714-237-9220
www.bkprecision.com

Speech-Recognition Tools

VOICE EXTREME IS A PROGRAMMABLE, command-driven IC and set of development tools for building interactive speech applications quickly and easily. The *Voice Extreme* product line includes the *Voice Extreme IC*, full-featured Development Kit, a low-cost module, and the *Voice Extreme Speech-Recognition Toolbox*.



CIRCLE 64 ON FREE INFORMATION CARD

Voice Extreme runs a full suite of speech and audio functions, including wordspotting technology that enables a keyword or phrase to be identified from the middle of a sentence. Also included in *Voice Extreme* is speaker-independent speech recognition, which allows preprogrammed words to be recognized without training, as well as speaker-dependent (user trained) speech recognition. In addition to these standard features, there's the Windows-based *Quick*

(Continued on page 12)

Electronics—Circuit and Systems

by Owen Bishop
Newnes, Butterworth-Heinemann
225 Wildwood Ave.
Woburn, MA 01801
800-366-2665 or 781-904-2500
www.bh.com

\$34.95

Geared for a range of college courses, this textbook uses a student-centered approach. Key facts, formulae, and definitions are highlighted; and theories are supported by numerous examples.

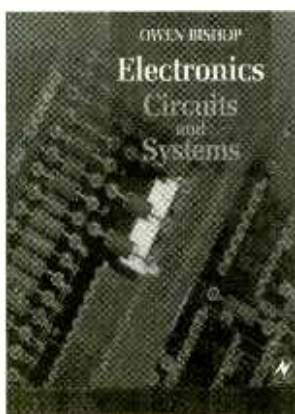

Subjects covered include circuits, FET and BJT amplifiers, and oscillators. There are also chapters on telecommunication systems, radio communications, microelectronic systems, and programming and computer routines. Each chapter ends with a problem set, which includes exam-style and multiple-choice questions.

Building Linux Clusters

by David HM Spector
O'Reilly and Associates, Inc.
101 Morris St.
Sebatopol, CA 95472
800-998-9938 or 707-829-0515
www.oreilly.com

\$44.95

One of the hottest topics in Linux today is the ability to cluster Linux machines to mimic the performance of supercomputers (costing hundreds of thousands of dollars) for a fraction of the cost. This hands-on guide introduces the basics of

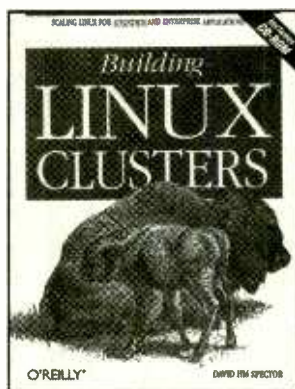

cluster installation and configuration.

In addition to a step-by-step tutorial on how to install Linux on a cluster of machines, the book explains how to customize the installation and discusses parallel programming. It also offers tips on parallelizing existing software. An included CD-ROM with Red Hat Linux customized for clustering support enables readers to build a fully functional cluster right from the box.

Modern High-End Valve Amplifiers

by Ir. Menno van der Veen
PLITRON Manufacturing Inc.
#8 601 Magnetic Drive
Toronto, Ontario
Canada M3J 3J2
416-667-9914
www.plitron.com

\$42.95 (U.S.) & S&H

Published in the UK by Elektor Electronics and distributed in North America by PLITRON Manufacturing,

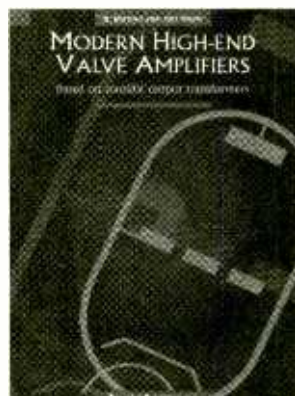

this book focuses on valve amplifiers (British)—or vacuum-tube amplifiers (American)—that are based on toroidal output transformers. It starts with elementary concepts and culminates in complete mathematical descriptions. Do-it-yourself-ers and general readers will come away with an in-depth understanding of the subject.

Interactions of output valves, transformer, and loudspeaker are fully explained. In addition, there is material on a number of special valve amplifiers and on the theory and practice of negative feedback. The schematic diagram of the valve amplifier is examined in detail, in connection with designs for amplifiers with output powers ranging from 10 to 100 watts.

Hints & Kinks for the Radio Amateur, 14th Edition

Edited by Robert Schetgen
and David Newkirk
American Radio Relay League
225 Main St.
Newington, CT 06111-1494
888-277-5289
www.arrl.org
\$12

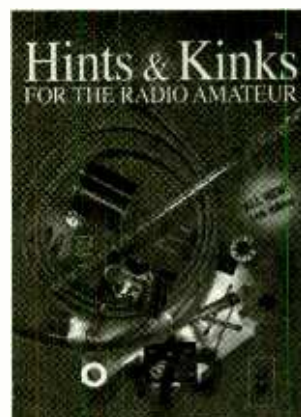

Commercial or home-brew, antenna or mike, keyer or computer—radio gear can always be made to work better and more efficiently. Hams who love to tinker with and tune their equipment also love to share their techniques with others.

(Continued on page 44)

Business Buzz

THE INTERNET-ENABLED CAR

The automotive industry is exploring the vehicle of the future. At the same time, members of the Open Services Gateway Initiative (OSGi)—an independent, non-profit corporation composed of 75 technology companies—are working to develop automotive solutions for the network delivery of managed services to the automobile, using the OSGi Specification Release 1.0 as the platform. This specification defines an open framework that enables multiple software services to be loaded and run on a services gateway. Once placed in a vehicle, an OSGi-compliant services gateway enables the delivery of managed services and information to the vehicle on demand, applications from remote door lock/unlock, on-demand navigation, and remote diagnostics to banking, entertainment, and Web browsing.

COPPER TECHNOLOGY

Two new production processes introduced by ACM Research Inc. solve major challenges in the use of copper interconnects for integrated circuits with line widths from 0.13 microns and beyond. Two prototype production tools based on these processes will enable the deposition of copper interconnects on silicon wafers down to the 0.035-micron device generation and the stress-free polishing of copper-integrated dielectrics with a value of 1.5, regardless of wafer size. Both systems are capable of operating with manual loading of 200-mm silicon wafer cassettes or automated guided vehicle loading of 300-mm wafers.

BOUNDLESS BATTERIES

Under contract to the NASA Goddard Space Flight Center, Boundless Corp. is developing a unique "structural battery" delivering twice as much power-per-kilogram as current batteries. Under the three-year contract, Boundless will build batteries for tiny satellites, or nanosats. In some space missions, dozens of inexpensive nanosats may work more reliably than one large, complex satellite. In the design, custom lithium-polymer battery panels make up the spacecraft's hull. This reduces overall vehicle weight by eliminating the stand-alone battery plus its supporting structure and enclosure.

Loaded 42-Volt Electrical Systems

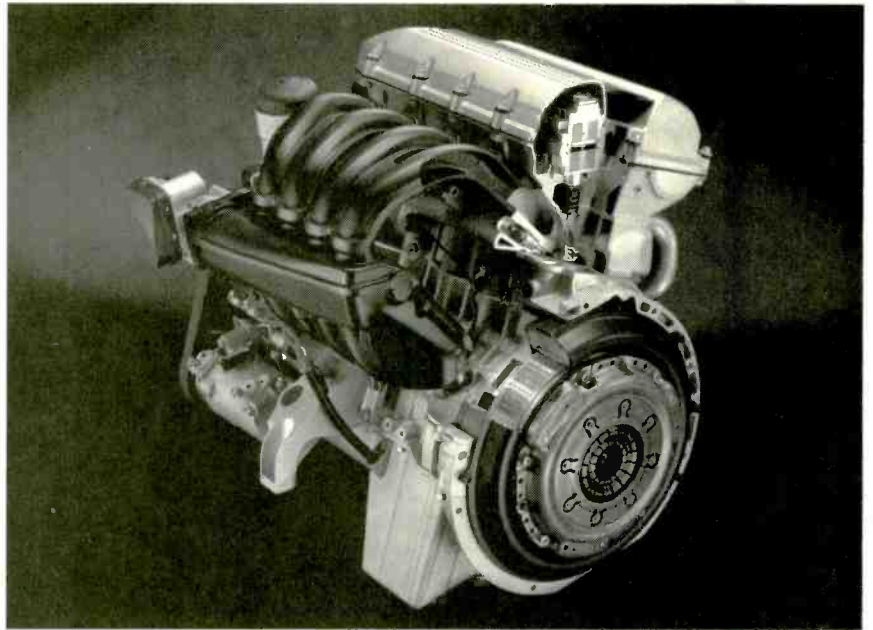

This BMW engine features a 42-volt starter/alternator that drives an electromechanical valvetrain.

Heated seats and windshields, cell phones, navigation systems, computers with Internet access, and other electrically powered items are constantly being added to vehicles. It is clear that today's nominal 14-volt DC electrical systems and 12-volt batteries will not be able to handle the power requirements of future cars, light trucks, vans, and sport utility vehicles. Current luxury vehicles typically use up to 2.8 kW of power, and this is expected to double within the next five years. Even today there are vehicles where the radio may cut out momentarily under sustained braking when the overall electrical load becomes too great. Further compounding the problem will be the many pollution-reducing technologies that will require substantial amounts of electrical power like catalytic converters that are preheated to reduce emissions at startup and electromagnetically controlled engine valvetrains.

The MIT/Industry Consortium on Advanced Automotive Electrical/Electronic

Components and Systems was established a few years ago to find solutions to these potential problems. Sponsored by the Society of Automotive Engineers, the consortium now includes 44 automakers and their suppliers. The consortium is advocating a 42-volt system with a 36-volt battery.

More Electric Power

Switching over to 42 volts could bring big changes in how things are done under the hood, besides making more electrical power available. For starters, 42-volt systems could eliminate power-robbing and heat-producing pumps, such as the belt-driven water pump and the power steering pump, as well as the air-conditioning compressor. Instead, the 42-volt system could be used for steer-by-wire power steering (See "Prototype," January 2001) and brake-by-wire power brakes, which operate and consume energy only when needed. Likewise, electrically powered air conditioning and heating would provide climate control even when the vehi-

TYPE

cle is parked with the engine off. These changes could result in a 5, 10 or even 20% reduction in engine energy consumption, which translates into more mpgs, and less emissions. These "beltless" systems would also allow designers much more flexibility in where engine parts are located, so that they could be placed just about anywhere in the vehicle—not only in already crowded engine compartments.

More Environmental Friendliness

One way to consume less fuel and reduce emissions is to shut off the engine when not needed, even for short periods, such as when waiting for a traffic light to change to green. A 42-volt electrical system would allow the use of stop-start engines that would be shut down rather than idling. One example is DynaStart developed by Mannesmann VDO AG in Germany. This combination starter and alternator, which is designed for stop-start operation, is planned for an upcoming, but yet unannounced, German production car. Siemens AG also has a 42-volt system starter-alternator-flywheel system in the works. Siemens' system will have peak output of 8 kW with up to 15 kW for brief periods. Its efficiency of over 80% is a marked improvement over current 12-volt systems with 1.5 kW output and a maximum efficiency of 70% that drops to 30% at high speed.

Are We There Yet?

The first 42-volt systems could appear in Europe as early as 2003, but a surprise introduction by Japanese automakers is definitely possible. Most likely, such systems will first appear in luxury cars, where power demands are the greatest and customers are more willing to pay extra for new technology. Initially, dual or hybrid systems would probably be used. There would be 42 volts available for power steering, power brakes, and air conditioning, while 14 volts could still be available for lighting and AM/FM/stereo systems. DC-to-DC converters would be used on 14/42-volt

systems to transform 42-volt currents to 14-volt for lights and other low-power applications. However, one manufacturer, BMW, says it would use 42 volts exclusively and as early as 2004.

Switching to 42 volts requires changing virtually every electric component from connectors and wiring to alternators and switches. This overall change would provide an added benefit, since wiring cable bulk and weight can be reduced by half or two-thirds because the lower current of the higher-voltage system means smaller diameter wiring.

—by Bill Siuru

PT

Powering The Future: Fuel Cell Research

The energy source that powered the Space Shuttle, Apollo, Skylab, and Gemini spacecraft might one day operate your portable phone, your car, and your neighborhood's electric power plant. This source—the fuel cell—is a primary focus of a new research center at the Georgia Institute of Technology. The Center for Innovative Fuel Cell and Battery Technologies will take a multidisciplinary approach to fuel cell and battery-related research, said center director Dr. David Parekh.

A fuel cell is an electrochemical device that operates much like a battery. (Also see the discussion of fuel cells in the "Amazing Science" column.) It combines hydrogen fuel with oxygen to produce electricity and heat, releasing water as a byproduct. Fuel cells are a clean, environmentally friendly, versatile, reliable, and efficient power source. Research is being conducted worldwide in this area with the goal of developing more sustainable energy sources. Additionally, recent research at Georgia Tech on fuel cells and related electrochemical devices has led to the invention of several processes that enable waste streams from commercial chemical manufacturing to be profitably recycled

Research Notes

WHERE ARE THE HOTSPOTS?

Researchers at Penn State's Microsystems Design Laboratory have developed a new energy estimation tool, called SimplePower, that not only evaluates a system-on-a-chips' power consumption faster than other available techniques but also points out the power-hungry "hotspots" in both hardware and software so that designers can fix them. Software is becoming an important aspect of emerging embedded systems and the study of the integrated impact of software and hardware optimization needs to be supported with new tools. SimplePower uses a "generic" chip—the instruction set of SimpleScalar, which is a suite of publicly available tools to simulate modern microprocessors. In addition, SimplePower is based on input transitions rather than input statistics. The developers are planning to make the prototype package available at www.cse.psu.edu/~mdl.

CHEAP CHIPS

Engineering faculty at The University of Texas at Austin have created a process with the potential to make the smallest, fastest, and cheapest computer chips. The new method uses simple molds and is the only one based on reactions that occur at low pressure and room temperature. They call their process "Step and Flash Imprint Lithography." Standard microlithography procedures involve projection printers with lenses that weigh nearly a ton. The Texas team's procedure is based on production of a rigid, transparent, quartz template and the use of ultraviolet light.

3-D PROTEINS

Five New York research institutions have joined together to develop high-speed methods to decipher the three-dimensional structure of proteins. The member institutions are Albert Einstein College of Medicine, Brookhaven National Laboratory, Mt. Sinai School of Medicine, The Rockefeller University, and Weill College of Cornell University. Proteins—long chains of building blocks called amino acids that fold into compact yet flexible shapes—carry out virtually all of life's essential functions through chemical reactions. It would take decades to determine every three-dimensional structure of every protein encoded by the human genome; therefore, scientists in the consortium plan to focus primarily on disease-related proteins.



Georgia Tech researcher Jessica Johnson examines a fuel cell—an electrochemical device that operates like a battery.

to provide fresh feed to the manufacturing plants.

Georgia Tech's center will focus on fuel cell and battery technology for wireless telecommunications, ultra-low emission vehicles, and distributed stationary power supplies. Key industry partners will be invited to join the center to share their technology needs and collaborate on open and proprietary research projects.

Georgia Tech researchers hold numerous patents in fuel cell and battery technology areas. Their contributions to fuel cell and battery

technologies include developing of thin-film electrolytes and mixed-conducting electrodes, extending the technology for use with electrochemical membrane devices, and providing enabling technologies for compact, small-scale or micro proton exchange membrane fuel cells. Battery research at Georgia Tech has also led to advances in the development of an advanced room-temperature, sodium-based battery for high power and energy density and modeling of battery power sources for electric and hybrid-electric vehicle designers and users.

For more information on the Georgia Tech center and this research, go to www.fcbt.gatech.edu.

In related developments in fuel-cell research, Pacific Northwest National Laboratory and the National Energy Technology Laboratory are investigating putting clean, affordable solid-oxide fuel cells on the market in the next ten years. The two laboratories are heading a new industry-government-university consortium called the Solid-State Energy Conversion Alliance (SECA). Their goal is to develop a fuel cell that runs on abundant fossil fuels, such as natural gas, gasoline, and military fuel.

Members of SECA believe they can reduce fuel-cell costs through mass production of a versatile, miniature, five-kilowatt fuel-cell module. The earliest possible applications will be in auxiliary power to operate heaters, air conditioners, and other accessories in various types of vehicles and in complex electronics on military equipment. Researchers also foresee modules that are "stackable," so units can be combined to accommodate larger power needs. **PT**

Energy Innovations

An expert panel focus group from Battelle and several DOE laboratories (including Pacific Northwest, Brookhaven, and Oak Ridge National Laboratories, and the National Renewable Energy Laboratory) has identified the top ten most economically significant energy innovations expected by the year 2010.

Their forecasted advances cover everything from fuel to fuel cells, and from solar energy to energy farms:

- Energy super utilities will emerge. Oil companies will become energy companies and auto companies will become formidable influences in the energy industry.
- Hybrid vehicles with mileages of seventy-miles-per-gallon will come out. The first generation of these vehicles is already here in a sporty Honda two-seater.
- Computers, the Internet, and Global Positioning Systems will increase

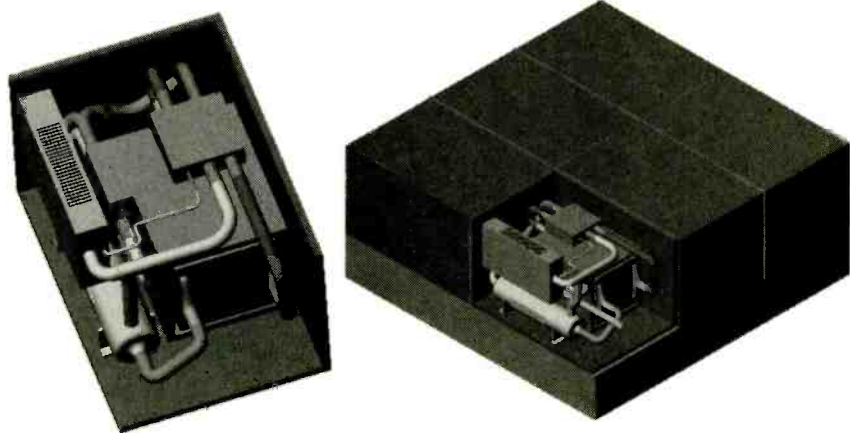

A proposed 5-kW solid-oxide fuel cell module (left) under development at Pacific Northwest National Laboratory and the National Energy Technology Laboratory will be used by itself or combined ("stackable") with other identical modules (right) to meet a variety of energy needs.

transportation efficiency and lead to smart energy management systems.

- The current national power grid may be on the way out. Power may be generated locally for neighborhoods and individual residences and businesses, via micro-turbines, internal combustion engines, and fuel cells.
- Fuel cells will become increasingly popular for transportation and for portable and stationary power generation over the next decade.
- Chemical engineering processes will be developed to transform hydrocarbon compounds from gases to liquids, permitting more flexible use and storage of fuels.
- Next-generation batteries will be based on lithium-polymer technology and have about three times as much energy capability as batteries today, helping with the transition to hybrid and electric vehicles.
- The use of bio-engineered crops for fuels will be expedited by the genetic revolution that permits crop cultivation to produce fuels such as ethanol on energy farms. According to Dr. Steve Millert, Thought Leader and manager of Batelle's forecasts, "We will grow gasoline, so to speak, to lessen our dependence on imported oil. With advances in DNA engineering, we will be able to grow energy as well as food crops."
- Substantial improvements are expected in using solar energy for the heating and cooling of buildings and in the development of efficient photovoltaic cells.
- Geologists have discovered rich deposits of frozen natural gas crystals on the ocean bottom. It is believed that this energy source will emerge in the next decade to add to our natural gas production.

PT



Books that Bridge Theory & Practice

Many electronics enthusiasts discovered that the bridge from classroom theory books to hands-on project building is difficult to span at times without a handy pocket guide. Even the equipment manual to operate a gadget often makes things murkier rather than clearer. A compact text authored by a seasoned expert with hands-on knowledge and a knack of writing in an easy-to-understand style is many times more valuable than the price of ponderous theory and equipment manuals or the parts for a project that could be damaged. Here's a sampler of some titles you may want to own!

ELECTRONIC HOBBYIST DATA BOOK—The info you need to transport you from the schematic diagram to project parts. Pin-outs, color codes, truth tables, parts parameters, etc. **Order BP396- \$10.99 Includes S & H**

PRACTICAL INTRODUCTION TO SURFACE MOUNT DEVICES—A technology that spun off the automated assembly line into the grasp of experimenters and project builders. **Order BP411- \$9.99 Includes S & H**

THE PRE-COMPUTER BOOK—Aimed at the absolute beginner with little or no knowledge of computing. A non-technical discussion of computer bits and pieces and programming. **Order BP115- \$2.99 Plus \$2.00 S & H**

PRACTICAL OSCILLATOR CIRCUITS—If your budding project requires an oscillator, you can design it and build it from the many types described here in a hobbyist-friendly style. **Order BP393- \$9.99 Includes S & H**

PRACTICAL PIC MICROCONTROLLER PROJECTS—This book covers a wide range of PIC based projects. In most cases the circuits are very simple and they are easily constructed. **Order BP444- \$7.99 Includes S & H**

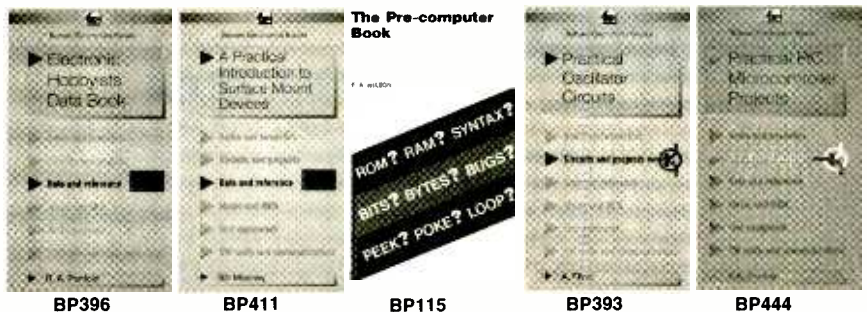

Electronics Technology Today Inc.
P.O. Box 240
Massapequa, NY 11762-0240

Number of books ordered

Amount enclosed \$ _____

Please send me the following book(s) that I checked:

- BP396 - Electronic Hobbyist Data Book—\$10.99
- BP411 - Practical Introduction to Surface Mount Devices—\$9.99
- BP115 - The Pre-Computer Book—\$2.99 + \$2.00 S & H
- BP393 - Practical Oscillator Circuits—\$9.99
- BP444 - Practical PIC Microcontroller Projects —\$7.99

Most above prices include shipping and handling

ET05

Name/Company _____

Address _____ Apt. _____

City _____ State _____ Zip _____

Sorry, no orders accepted outside the USA and Canada. All payments must be in US funds! NY state residents must include local sales tax. Allow 6-8 weeks for delivery.

NEW GEAR

(continued from page 6)

Synthesis Tool, which allows developers to quickly convert and compress .wav files for use as synthesized responses to verbal commands.

The Voice Extreme Speech-Recognition Kit has an MSRP of \$395, and individual chips are \$8 each.

SENSORY INC.

521 East Weddell Drive
Sunnyvale, CA 94089-2164
408-744-9000
www.Voice-Extreme.com

Pulse Generator

THE 10-MHZ PULSE GENERATOR (Model 4010) is designed to permit precise tailoring of pulse repetition rates and duty cycles over a wide range through the independent setting of pulse width and pulse spacing. Both pulse width and pulse spacing are continuously variable over five decade ranges from 50 ns to 5 ms, with variable adjust.

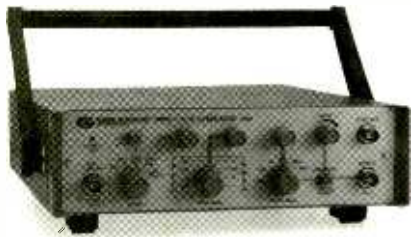

CIRCLE 65 ON FREE INFORMATION CARD

Features include a wide pulse rate (1 Hz to 10 MHz), a fast pulse rate (up to 10 MHz), seven crystal-derived spot frequencies, a low rise and fall time, and a manual triggering facility. The easy-to-use front panel provides a normal/inverted output-polarity pushbutton switch and special sync output.

The 10-MHz Pulse Generator (Model 4010) has a list price of \$355.

GLOBAL SPECIALTIES

1486 Highland Ave., Unit 2
Cheshire, CT 06410
800-572-1028
www.globalspecialties.com

Computer-Based Measurement Platform

THE PXI-1011 PXII/COMPACTPCI Platform is a 12-slot chassis that combines SCXI™ signal-conditioning tech-

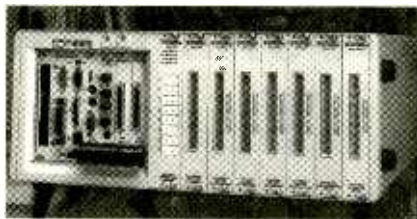

CIRCLE 66 ON FREE INFORMATION CARD

nology with the PXI/CompactPCI module instrumentation platform. This combination platform gives users a computer-based measurement and automation platform for developing integrated systems.

The rugged, low-noise PXI-1011 chassis integrates four PXI/CompactPCI slots with eight SCXI slots. The chassis is designed for developing high-channel count systems that solve data-acquisition, test and measurement, and industrial-control applications. In this system, users can measure up to 256 channels of temperature, pressure, strain, voltage, current, or frequency. In test and measurement applications, designers can select up to three different instruments to analyze.

The PXI-1011 PXII/CompactPCI Platform sells for \$2795.

NATIONAL INSTRUMENTS

11500 N Mopac Expwy.
Austin, TX 78759-3504
800-258-7022
www.ni.com

Circuit-Board Software

THE 32-BIT SUPERPCB VERSION 4.0 has been extensively rewritten to allow a 10X improvement in resolution, which enables designers to work with the latest surface-mount parts. Users can specify object dimensions and positions down to 1/10 mil. The drawing scale can be set in a range from 20 to 5000% scale.

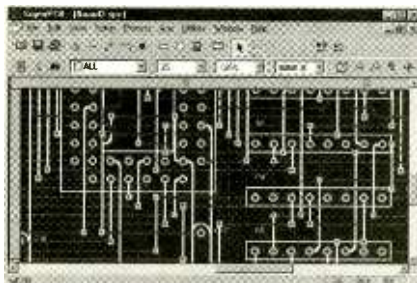

CIRCLE 67 ON FREE INFORMATION CARD

Among the new features are a backup timer, multiple levels of undo, easy-to-see animated markers for search, and a library utility for copying parts. The

new Voice-Response feature announces program status (file loaded, error conditions, etc.). The Multiple-Document Interface (MDI) allows users to open more than one artwork file at a time or open a library part for editing along with an artwork file.

SuperPCB Version 4.0 (the full version) sells for \$549. (Other versions, including an introductory version, are also available.)

MENTAL AUTOMATION, INC.

5415 136th Place, S.E.
Bellevue, WA 98006
425-641-2141
www.mental.com

**Yours for only
\$3.99
Price includes
shipping!**



HAVE A THOUSAND YUCKS FOR ONLY THREE AND A HALF BUCKS! That comes to one-third of a cent per laugh. Electronics Comics is a compilation of over 125 riotous, outrageous and phenomenal cartoons that appeared in **Popular Electronics** and **Electronics Now**. Only \$3.99—price includes shipping. Claggk, Inc., Reprint Bookstore, P.O. Box 4099, Farmingdale, NY 11735-0793. All payments in U.S. funds. Sorry, no orders outside U.S.A. and Canada. Check or money order only—send no cash. NY state residents add applicable tax. MA04

POPTRONIX®

Online Edition

We're on the web

FREE

We are starting up,
but you can watch us grow!

Projects for beginners
to experts!
New Product information!
Bookstore—discover
what's new!

<http://www.poptronix.com>

WE'RE WITH YOU EVERY DAY
24 HOURS A DAY! DROP IN!
WE'D LOVE TO HAVE YOU VISIT!

GIZMO®

DVD + MP3

Aiwa's XD-DV370 (\$300) is a full-featured DVD player that offers built-in MP3 decoding, allowing it to play MP3-encoded CDs. MP3 music files that have been dubbed uncoded onto a CD-R or CD-RW disc can be played back on the XD-DV370. The DVD player also features a 96-kHz/24-bit audio D/A converter; a 10-bit video D/A converter; digital coaxial and optical outputs; dual stereo RCA outputs; and component, S-video and composite-video outputs. Four forward-search speeds, four reverse-search, four forward slow-play, and three reverse slow-play speeds are provided. The deck offers X4 and X16 zoom levels and a multi-language on-screen display.



Aiwa America, Inc., 800 Corporate Drive, Mahwah, NJ 07430; 201-512-3600; www.aiwa.com.

CIRCLE 50 ON FREE INFORMATION CARD



Talk the microTALK

Cobra's *microTALK* two-way radios provide a safe and fun way for kids and parents to communicate in shopping malls, amusement parks, or just around the neighborhood. The durable, sporty design makes the *microTALK* radio a good choice for use in outdoor activities such as camping, hiking, skiing, and fishing. The radios sport a distinctive, athletic design and are available in a wide range of colors. Each unit comes with a belt-clip holster that also functions as a desk stand for at-home or at-work use.

The *microTALK* FRS (Family Radio Service) units provide clear, two-way communications for up to two miles and access to all 14 available communications channels. A backlit LCD is easy to see at night. Convenience features include incoming "call alert," which allows one *microTALK* user to ring another simply by pushing the "call" button, and "roger beep" to indicate the completion of one user's transmission and signals the other user to talk.

Prices for the *microTALK* line range from \$89.95/pair for the FRS 110-2 to \$129.95 each for the FRS-315 WX "Platinum Mist" (pictured here), which provides access to 10 NOAA weather channels for 24-hour weather reports anywhere in the United States. They also include Cobra's WeatherAlert feature that works with NOAA emergency alert broadcasts to warn of impending severe weather.

Cobra Electronics Corp., 6500 West Cortland St., Chicago, IL 60707; 773-889-8870; www.cobraelec.com.

CIRCLE 51 ON FREE INFORMATION CARD

"Game Boy" Tether

When you think of expensive things that children tend to lose, items like eyeglasses, retainers, and jackets immediately come to mind. Toys—especially favorite ones that are taken everywhere—also tend to disappear without warning.

Help your kids keep the reigns on their Game Boy Colors with the *Hip Clip* (\$7.99) from Nyko. The holster-style holder fastens securely to a backpack or belt for hands-free transport, allowing gamers to bring their portable game anywhere without worrying that it will be lost or dropped. The *Hip Clip* comes in four translucent colors (light blue, light purple, frosted clear, and smoke) and is made of durable, scratch-resistant material that provides protection for the stored Game Boy Color. Now, if you could just find a way to keep those glasses and retainers from being misplaced ...

Nyko Technologies, Inc., 2311 South Cotner Ave., Suite D, Los Angeles, CA 90064; 888-445-NYKO; www.nyko.com.



CIRCLE 52 ON FREE INFORMATION CARD

Garden Sounds



You won't be listening to buzzing bees or chirping birds if your garden takes root in *Omniplanters* (\$900/pair) from Rockustics. Each 24-inch diameter, 20-inch-high planter has a built-in, high-fidelity speaker system that provides 360 degrees of dynamic, omnidirectional sound to your deck or patio. The speakers deliver a lift at higher frequencies for maximum dissipation in the open air with a special non-parallel internal design feature said to minimize unnatural resonance.

The Omnipanter is made of terra cotta or granite gray polyethylene. The speakers are completely waterproof and weatherproof. Loudspeaker components made of fiber-reinforced polymer composite resist rain, frost, snow, and ice. The planters provide adequate drainage for live plants.

Rockustics Inc., 5080 Paris St., Denver, CO 80239; 800-875-1765; www.rockusticsinc.com.

CIRCLE 53 ON FREE INFORMATION CARD

Street-Smart Travel Case

The compulsively organized, as well as those of us who just hope we remembered to throw in everything we might need, will appreciate the *MegaMedia Computer/Electronics Bag* (\$179.95) from RoadWired. With 36 compartments and pockets, the case is specially designed to hold and protect a portable computer or PDA and assorted other gear—digital camera, cell phone, MP3 player, memo recorder—and all the media and accessories that go with them.

The lightweight, streamlined bag is designed to keep more delicate and expensive items toward the center. The main computer section has fully adjustable padded divider panels and a double-padded floor. It holds any notebook computer measuring up to 14 × 12 × 2½ inches, with room for a looseleaf binder, too. Three panels fan out from the main space to provide easy access to additional electronic devices, media and supplies, and file folders. Each panel features elasticized organizers, mesh pockets, and other storage accommodations. The bag also offers a removable travel-document organizer, a secret compartment for stashing emergency cash or keys, and a top-opening design that allows easy on-the-shoulder access to all contents. Fully loaded, the MegaMedia case measures only seven inches in depth.

RoadWired, 235 Middle Road, Henrietta, NY 14467; 716-334-6969; www.roadwired.com.

CIRCLE 54 ON FREE INFORMATION CARD



Translucent Boombox

Now you can "see" your music as well as hear it. The Jeep *Translucent Series Boombox* (\$199.95) introduces an innovative translucent casing that shows off the technology. Water- and shock-resistant, this portable entertainment center features a multi-function CD player; AM/FM stereo tuner with Weather Band, bass boost, and tone control; and a larger amplifier for superior sound quantity.

The rugged and durable casing with its tread design houses a sleek CD compartment with the Jeep signature "X" mark. The Boombox uses eight "D" batteries (not included). It comes in three translucent colors: flame red, aqua, and sport yellow.

Kash N' Gold Ltd., One Trade Zone Court, Ronkonkoma, NY 11791; 800-354-8785 or 631-981-1600; www.jeep.com.

CIRCLE 55 ON FREE INFORMATION CARD





Wireless Modem Phone Jack

The wireless TL96597GE *InstaJack* (\$89.99) simply plugs into any AC outlet and instantly provides access to your phone line for connecting computers, fax machines, Web TV boxes,

and modems. Caller-ID-compatible, it works with all personal computers, notebook computers, and Macintosh and TV Internet boxes with either internal or external modems.

Jasco Products Company; 800-654-8483 or 405-752-0710; www.jascoproducts.com.

CIRCLE 56 ON FREE INFORMATION CARD



Catch That Mouse!

The IBM *ScrollPoint Pro Mouse* (\$39.95) enables users to surf the Web more comfortably, offering one-touch access to the Internet with 400 step-per-inch accuracy. Designed with a modern contoured shape and sure-grip rubberized sides, the ScrollPoint Pro is available in antique sage and slate blue. Its programmable third button is preset as the back browser control and automatically returns to the previous link in the browser.



IBM, 1-888-SHOP-IBM; www.ibm.com/shop.

CIRCLE 57 ON FREE INFORMATION CARD

Built to Survive

A rugged notebook computer that weighs 12 pounds and has a sealed magnesium alloy die-cast chassis, the A760 (\$4495) is designed to withstand extreme temperatures, is shock- and vibration-resistant, and is water-, dust-, and dirt-proof. The non-glare LCD display of the A760 is available with a daylight-readable display or a direct-sunlight readable display. When it's very dark, the optional backlit keyboard makes it easier to send or retrieve information.

GETAC Inc.; 949-699-2888; www.getacusa.com.

CIRCLE 59 ON FREE INFORMATION CARD

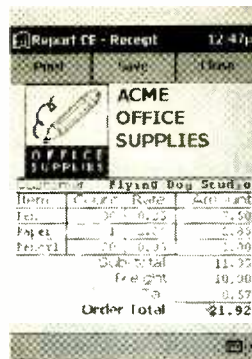
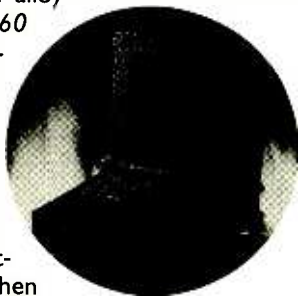

can also include lines, bit-map images, drawings, and signatures. Syware; 617-497-1300; www.syware.com.

CIRCLE 58 ON FREE INFORMATION CARD

Multi-Purpose Office Machine

Need one machine for the home office or small office that does it all? The *HP OfficeJet G Series* all-in-one printer/scanner/copier/fax machines provide photo-realistic color printing, high-quality flatbed color scanning, stand-alone color faxing, and color copying. The devices can be operated from any PC within a networked office and feature USB connectivity.

The HP OfficeJet G55 pictured here is expected to retail for \$499, and other models with additional features have higher prices.

Hewlett-Packard Company; 888-999-4747; www.hp.com/all-in-one.



CIRCLE 68 ON FREE INFORMATION CARD

February 2001, Poptronics

CD ROM based resources for learning and designing



The internationally renowned series of CD ROMs from Matrix Multimedia has been designed to both improve your circuit design skills and to also provide you with sets of tools to actually help you design the circuits themselves.

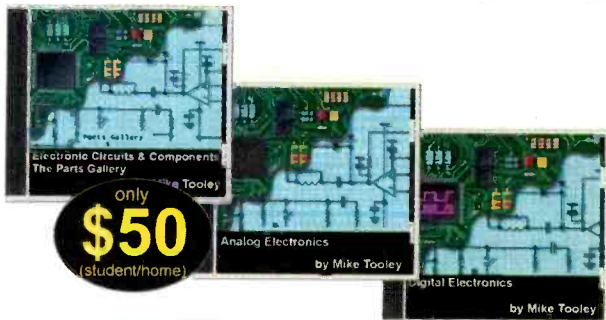

only
\$50
(student/home)

Electronic Circuits and Components provides an introduction to the principles and application of the most common types of electronic components and how they are used to form complete circuits. Sections on the disc include: fundamental electronic theory, active components, passive components, analogue circuits and digital circuits.

The Parts Gallery has been designed to overcome the problem of component and symbol recognition. The CD will help students to recognize common electronic components and their corresponding symbols in circuit diagrams. Quizzes are included.

Digital Electronics details the principles and practice of digital electronics, including logic gates, combinational and sequential logic circuits, clocks, counters, shift registers, and displays. The CD ROM also provides an introduction to microprocessor based systems.



Analog Electronics is a complete learning resource for this most difficult subject. The CD ROM includes the usual wealth of virtual laboratories as well as an electronic circuit simulator with over 50 pre-designed analog circuits which gives you the ultimate learning tool. The CD provides comprehensive coverage of analog fundamentals, transistor circuit design, op-amps, filters, oscillators, and other analog systems.

Electronic Projects is just that: a series of ten projects for students to build with all support information. The CD is designed to provide a set of projects which will complement students' work on the other 3 CDs in the Electronics Education Series. Each project on the CD is supplied with schematic diagrams, circuit and PCB layout files, component lists and comprehensive circuit explanations.



PICtutor and C for PICmicro microcontrollers both contain complete sets of tutorials for programming the PICmicro series of microcontrollers in assembly language and C respectively. Both CD ROMs contain programs that allow you to convert your code into hex and then download it (via printer port) into a PIC16F84. The accompanying development board provides an unrivaled platform for learning about PIC microcontrollers and for further development work.

Digital Works is a highly interactive scalable digital logic simulator designed to allow electronics and computer science students to build complex digital logic circuits incorporating circuit macros, 4000 and 74 series logic.

CADPACK includes software for schematic capture, circuit simulation, and PCB design and is capable of producing industrial quality schematics and circuit board layouts. **CADPACK** includes unique circuit design and animation/simulation that will help your students understand the basic operation of many circuits.

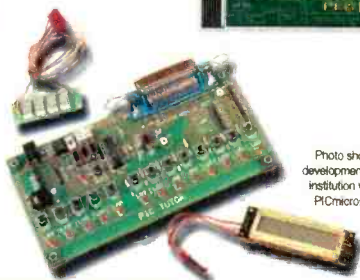

Photo shows PICmicro[®] development kit supplied with institution versions of C for PICmicro[®] and PICtutor

Analog Filters is a complete course in filter design and synthesis and contains expert systems to assist in designing active and passive filters.

Shareware/demo CD ROM with more than 20 programs \$4.99 refundable with any purchase.

Order Form:

Please circle the products you would like to buy on the table below, calculate the total cost, fill in the rest of the order form and send it to us. NY residents add sales tax. Please allow 6 weeks for delivery.

	Student	Institution
Electronic Ccts. & Comps.	\$50	\$99
Digital Electronics	\$50	\$99
Analog Electronics	\$50	\$99
Electronic Projects	\$75	\$159
PICtutor	\$179	\$350
C for PICmicros	\$179	\$350
Digital Works	\$50	\$99
CADPACK	\$75	\$159
Analog Filters	\$75	\$159
Postage - USA	\$5	\$5
Postage - Canada	\$5	\$5

Name: _____

Address: _____

Zip: _____ Phone: _____

Card Type: _____

Mastercard, Visa, or Discover only

Card number:

I have enclosed my check for \$: _____

Signature: _____

Please charge my credit card for \$: _____

Phone your order to us on:

631-592-6721

or send your order to:

CLAGGK Inc.
PO Box 12162
Hauppauge, NY 11788

Expire date:



mailto:netwatch@gernsback.com

BANDWIDTH: How Wide is Yours?

The days of the analog/digital 56K modem are numbered. On the forefront of Internet access, there stand the behemoths of wider bandwidth: ISDN/DSL, the baud-busting radio-frequency cable modems, and evolving fiber-optic technologies. Each one has its positive and negative traits, yet fiber optics is predicted to be the leader of data transfer. Some of us remember when Commodore Vic-20s were the toys of the elite and the online frontier was explored at speeds such as 75 and 300 bits per second—oh, have we advanced. Now with connection speeds well over fifty times faster, Net surfers have the audacity to bicker and whine, "My connection is too slow!" Let's examine two faster alternatives to accessing the Internet: ISDN and cable modems.

DECISIONS, DECISIONS

There are several factors to consider when comparing data-transfer technologies, including cost, ease of use, availability, and bandwidth. Bandwidth is a major variable in predicting data-transfer speed on the Net. Perhaps, it looks as if analog phone lines have reached their limit of 56 Kbps, but this does not render the existing commercial-telephone infrastructure obsolete. *Internet Services Digital Network* (ISDN) technology uses the same copper-wire network, which is the backbone of commercial-telephone networks. The ISDN signal passes through a series of digital adapters and signal routers located in a central-office-switch facility, is transmitted to another central office via copper wire, and then is

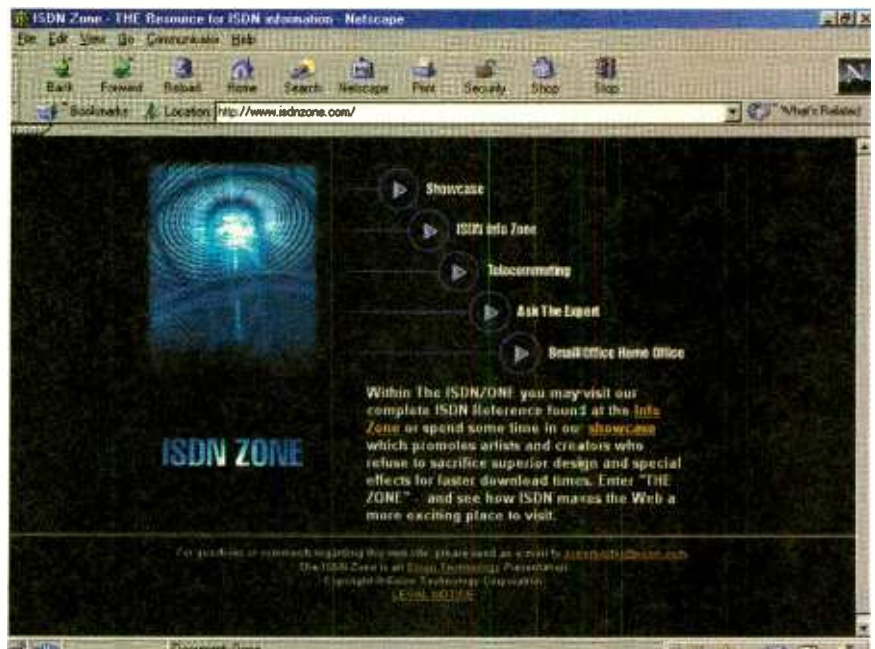

Welcome to ISDN Zone! This site will get you up to date with Integrated Services Digital Networks.

brought into the subscriber's home. Digital signals riding an analog path over a long distance are susceptible to noise, which is why a subscriber can not be more than four miles from the central office. There are two types of ISDN commonly available—*Basic-Rate Interface* (BRI) and *Primary-Rate Interface* (PRI).

The BRI line is a modest change from a 56K modem. Cruising at a bandwidth of 144 Kbps, the BRI line contains three channels: two B (bearer) channels, each with a bandwidth of 64 Kbps; and one D (data) channel with a 16-Kbps bandwidth.

The hefty PRI consists of 23 B channels with a bandwidth of 64 Kbps and one 64-Kbps D channel. The total multiplexed bandwidth of

PRI is 1536 Kbps. European PRI networks add an extra 7 B channels, resulting in a 1984-Kbps bandwidth.

ISDN, with its multiple channels, gives the user the option of using multiple communication devices across the same wires. For instance, a telephone and a computer can be used simultaneously across the same line, yet each device thinks it has a line all to itself.

THE NEED FOR SPEED

Another option to consider is a cable modem. Cable modems are becoming a mainstay in homes all around the country. Local cable companies provide Internet access via the same coaxial cable used for cable television. Some cable-based systems reach 36 Mbps.

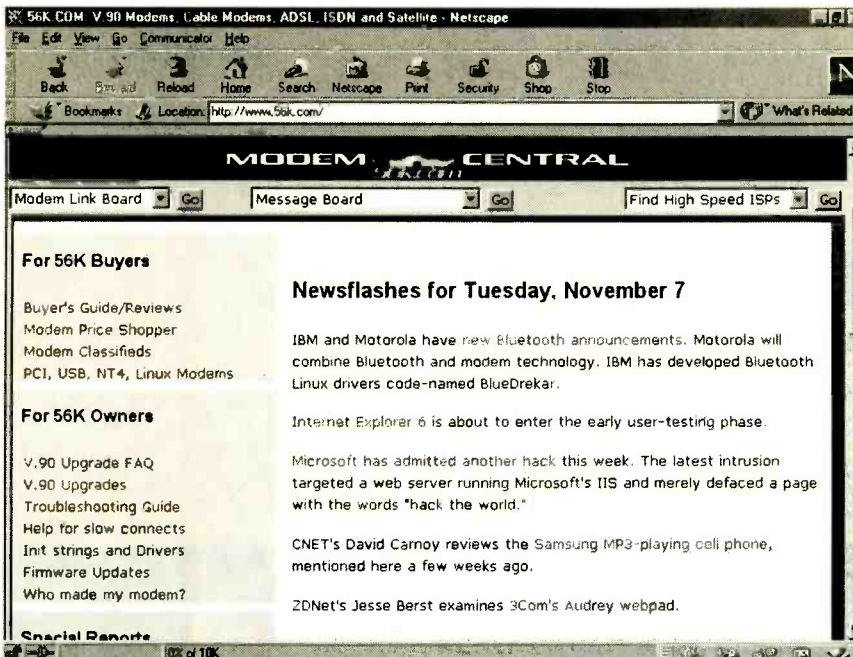

The last bastion of analog users, 56k.com is the place for phone line modem enthusiasts.

Offering the convenience of a 24-hour connection at less than \$50 a month, local cable companies are becoming inundated with subscribers wanting lightning fast downloads.

Data transfer on cable is often called *upstream* (uploading) and *downstream* (downloading). Using a cable connection, upstream rates can reach 128 Kbps, while downstream rates near the 30-Mbps mark.

WANT TO LEARN MORE?

Don't be discouraged if you are an analog user. Some tech heads predict that more than 50 percent of home users will still use 56K-phone modems in the coming decade. The reason: It is still the cheapest and easiest way to access the Net. Here are some sites offering information about ISDN, cable, and traditional 56K-phone access.

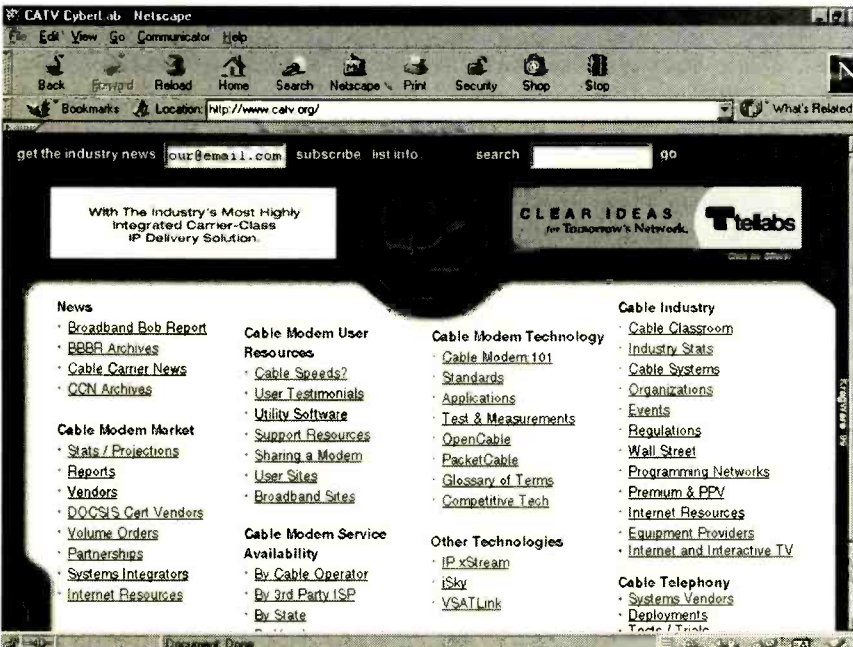

All you ever wanted to know about cable modems, but were embarrassed to ask: Let the CATV CyberLab cater to your cable desires.

HOT SITES

56k.com
www.56k.com

catv.org
www.catv.org

isdn.com
www.isdnzone.com

ISDNZONE.COM—An excellent resource site for information regarding ISDN connecting can be found at www.isdnzone.com. Everything from technical information explaining how ISDN functions to sections on service and prices is available on this helpful site. A showcase section highlights cutting-edge Web sites, which show off the advantage of high-speed connections as they relate to multimedia on the Web.

CATV.ORG—Whether you want to compare your current connection to that of a cable modem or you want to learn more about the way a cable modem works, this site will guide you. There is a section on user resources that includes sites and software, another section with links to service providers, and a crash course in cable modems. You can even impress your friends by memorizing the glossary of cable terms listed at catv.org.

56K.COM—For those of us who are still traveling along the information superhighway aboard the analog express, there is [56k.com](http://www.56k.com). This Web site has useful items designed solely for phone-line modems. Recent press releases pertaining to 56K tech issues, links to modem manufacturers, command string files, and the latest drivers are all here at your fingertips. There is also a primer section, which explains the intricacies of analog to digital modems.

There are some pretty nifty options available for Internet access. A good deal of information is on the Web, so why not compare the numbers for yourself. Perhaps it is time to take the transfer-medium leap towards higher speed and quality. Contact your local cable and telephone companies and see what they have to offer.

REACH OUT AND TOUCH With Technology

For the past four thousand years humans have relied on technology to communicate with one another over distance. Using papyrus, paper, smoke, drumbeats and electrons, we've exchanged messages about matters both mundane and profound.

During the "old" days of the online world (five years ago), the main choices for sharing knowledge or experiences and asking questions were somewhat limited. Some options were:

- Local bulletin-board systems run by individuals
- Discussion forums/chat rooms found on commercial services (e.g. CompuServe and America Online)
- E-mail based discussion groups
- Usenet newsgroups
- Internet Relay Chat

All of those methods are still around, but they've been supplemented by services that can be useful for both business and recreation. The popularity of all those discussion services counters the notion that, above all else, people value content on the Internet.

According to Andrew Odlyzko, who heads an AT&T Labs information science research department, people most value communication. In his recent paper "Content Is Not King" (www.research.att.com/~amo/doc/networks.html), Odlyzko writes that people will be more likely to pay for tools that enhance communication than for text, music, movies, and other content.

Yet, aside from your hardware

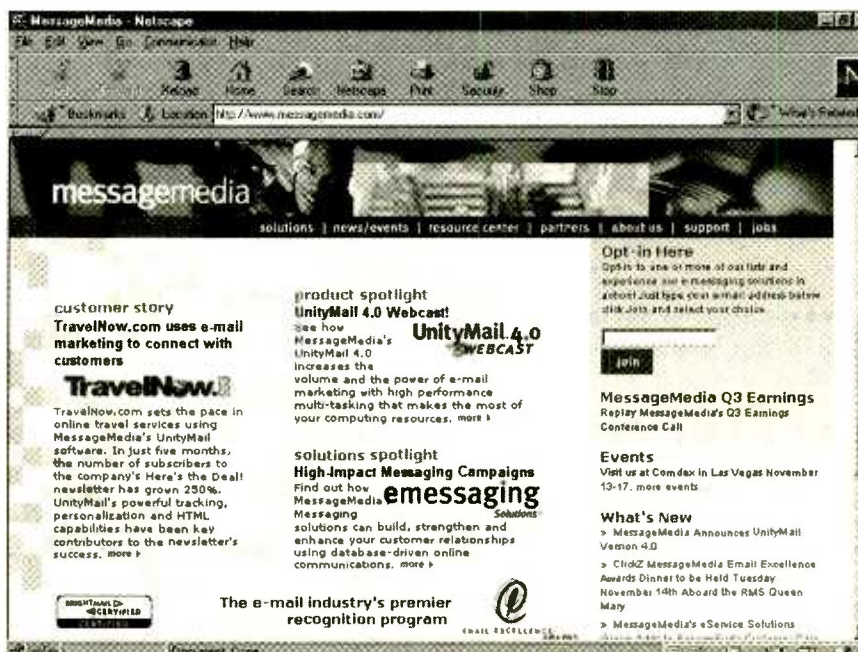

You can find all sorts of programs for jazzing up your e-mail at www.messagemedia.com.

and Internet connection, most communications services are free—at least for consumers. On the other hand, discussion tools for businesses range from free to pricey.

VIRTUAL SOIREE

TalkCity (www.talkcity.com) is one of the best free Web-based discussion forums. It has fashioned itself into a full-fledged virtual community, with discussion-centered neighborhoods for people of various ages and interests, "real-time" chats, e-mail, private clubs, home pages, shopping, and special events.

If you have your own Web site, whether it's business or hobby related, you can create a discussion-

centered community. In order for message boards and chat services to be effective, your site needs a significant amount of traffic. To minimize the effects of drive-by postings and angry debates ("flame wars"), you also need to actively manage discussions.

Discussion software that you run in-house ranges from the free *HyperNews* (www.hypernews.org) to the more sophisticated O'Reilly *WebBoard* at webboard.oreilly.com. The latter costs \$1799.

Alternately, you can outsource your site's community features by using a free service such as Yahoo Clubs (clubs.yahoo.com) or more feature-laden tools such as those from Prospero Technology at



Wireless hand-held technology finds a fun and affordable home at www.cybiko.com. Chat or play games with friends up to 300 feet away.

www.prosperotechnologies.com. The set-up fee for the latter starts at \$5000 and monthly fees start at \$500.

INSTANT MESSAGING

The Web isn't the only locale where new discussion developments have occurred. Free instant-messaging programs, such as *ICQ* (web.icq.com), have achieved widespread popularity, particularly among young people. Use the program to check if a "bud" is online, fire off a "Wassup," message, get a quick response, and rap away. There's no delayed gratification here.

Instant-messaging programs have also gotten down to business. Nowadays, they typically provide tools for collaborating with others on work projects, including working on the same document, sharing the same program, transferring files, and browsing the Web.

With instant-messaging programs, however, you have to control how accessible you are to prevent them from turning into a nuisance or a time sink. Security can also be a concern with business use. In response, fee-based programs such as *Lotus Sametime* (www.lotus.com/sametime) provide beefed-up features and in-house controls. Pricing for *Sametime*

starts at \$6028 for the server and \$19 per user.

CHATTING ON THE RUN

Cutting the tether to your desktop PC is the latest rage in on-line communications. The Palm VII hand-held PC (www.palm.com) has led the way. It's priced at \$449, with wireless Internet service starting at \$9.99 per month.

A less expensive but more limited option in wireless communication is the new Cybiko handheld (www.cybiko.com). Priced at \$129 and targeted primarily toward teenagers, it lets you carry out text-based conversations with other Cybiko users who are within 150 feet indoors or 300 feet outdoors.

PSYCHOLOGY AND CYBER CHAT

If you're in business, it's smart to pay heed to consumers who are heavily into digital communication. Active on-line users, or "e-fluentials," are thought to influence the attitudes and behavior of about eight other people. Off-line, a typical person influences just two others, according to a new study from Burson-Marsteller, a New York City public relations agency.

If you're a consumer, it's smart to keep in mind that on-line com-

POINT AND CLICK

Bacon's MediaSource
www.bacons.com

Cybiko
www.cybiko.com

Direct Contact Newswire
www.owt.com/dircon

HyperNews
www.hypernews.com

ICQ
web.icq.com

Lotus Sametime
www.lotus.com/sametime

Message Media
www.messagemedia.com

O'Reilly WebBoard
www.webboard.oreilly.com

Palm VII
www.palm.com

PostMasterDirect.com
www.postmasterdirect.com

Prospero Technologies
www.prosperotechnologies.com

TalkCity
www.talkcity.com

Yahoo Clubs
www.clubs.yahoo.com

munication has its limitations. As pop psychologist Dr. Joyce Brothers told me once in a phone interview, "Computers can be used in positive ways to increase our contacts, friendships, and understanding. But they don't replace face-to-face contact, the touch of a hand."

THE FRESH "SENT" OF E-MAIL

We might not be able to hold hands with the PC, but in exchange we have...e-mail. Since the inception of e-mail, we have had the power to reach across the globe and connect. Unfortunately, some of the customs of "snail mail" were inherited by e-mail; so we have

(Continued on page 52)

MORE POWER, MR. SCOTT!

It might surprise you to learn that a good percentage of computer-related “glitches” are not really the fault of bad components, operating-system errors, or programming mistakes. Instead, they happen because of a momentary power interruption, brownout, or outright power failure.

While we live in one of the more technologically advanced countries, our power-delivery superstructure has unfortunately not kept pace with the need for lots of reliable power. Given how much we use and rely on sensitive electronic equipment these days, that’s not an especially reassuring situation.

The sophisticated switching-power supplies in today’s PCs can accept a pretty wide variation in input voltages. The brownouts that are increasingly familiar to most of us, especially during the summer months, don’t always send your PC into a tailspin. Applications are also a lot better at automatically creating backup files and recovering them after an unexpected shutdown.

Even with those “safety nets,” I’ve experienced more than my share of watching a shrinking dot of light on my CRT and the accompanying sinking feeling in my stomach after the lights suddenly went off.

POWER PROBLEM SOLVED

Several years ago, I decided enough was enough. I earn my living with my PC; and even if I don’t lose important files due to a power failure, my time is better spent working than trying to recover backups. Although (or perhaps because) I live in a rapidly growing suburban area, power failures and summer brownouts are becoming



The APC Back-Office Pro provides both USB and serial connections to your PC for an orderly shutdown of your applications.

more—rather than less—frequent.

My answer was to add an Uninterruptible Power Supply, or UPS, to every PC in the house. The UPS is very different from the popular “surge protector,” though every UPS on the market also offers surge protection as an additional feature. Unlike a power-protection strip, which has its MOS (Metal Oxide Semiconductor) device to drain a very high voltage power spike to ground, a UPS is designed to supply a constant voltage to your equipment—regardless of what is happening at the AC power outlet.

With a UPS, if the voltage from the AC outlet drops below a pre-determined level, the device disconnects the output outlets from the AC wall outlet. Then the UPS converts the DC voltage from a rechargeable lead-acid battery to the expected line voltage, powering the devices that are connect-

ed to protected outlets, such as PCs. Overvoltages and voltage dips on the power line are also adjusted for by Automatic-Voltage-Regulation (AVR) circuitry. The result is a generally clean 115-volt AC sine wave, regardless of how far out of spec or noisy the power-line voltage gets.

All of those functions are taken care of automatically. In fact, the difficulty involved in setting up a UPS is that the unit is generally delivered with one or both battery leads disconnected. Before you plug the unit into the wall, you usually have to open up the case and connect the battery lead.

SIZE MATTERS!

Picking the correct size UPS is probably the most challenging part of making the purchase. There are more than a half-dozen vendors of home-and office-oriented UPS systems, and many of them just put something like “good for Pentium III workstation” on the box. UPS ratings are generally provided in Volt-Amp (VA) capacity and/or watts. Common ratings for UPS systems sold in office-supply and computer stores run from 300 VA to more than 2000 VA.

How much capacity is enough? There is, unfortunately, no set answer. It really depends on what you have hooked up to the UPS and how long you’ll need the system to run in a worst-case scenario. For small-office and home use, the purpose of a UPS is not to provide enough power to last through a bad blackout, but rather to allow you to finish what you are doing and shut down your applications and PC in an orderly manner.

A handy tool for determining

the capacity needed can be found on the Web site of American Power Conversion Corp, or APCC (www.apcc.com). An interactive UPS "sizer" asks what you will be connecting and how long you need the UPS to run during a power failure, and it will then suggest a model.

APCC and Belkin Components both have reputable track records in the UPS field. Triplight and Blackout Buster are other popular brands, though I have no personal experience with either one.

Two of the units we use are real monsters—the APCC Smart-UPS 1400 and Belkin's Regulator Pro NetUPS 1400. As you might guess from their monikers, both units have very hefty 1400-VA capacities and are really meant for network servers. The APCC Smart-UPS 1400 in my office has two complete PC systems (CPUs, monitors, and external Zip drive) plugged into it.

The other hefty UPS—the Belkin Regulator Pro NetUPS 1400—is attached to the second most heavily configured system in the house, which adds a scanner, speaker system, and a network hub.

Neither one of these devices is inexpensive; both cost in the neighborhood of \$500–\$600. The APCC Smart-UPS 1400 has an SNMP network card installed, so that any PC on my network can check the unit's status—a feature that bumps up the price a bit. On the upside, while Belkin and APCC rate this size unit as having a run time of between seven minutes and a half-hour at full and half load respectively, connecting a smaller-draw workstation to the UPS really boosts the run time. We connected a 600-MHz PC with a 145-watt power supply and 15-inch CRT monitor to each device, booted up a DVD movie, made sure the UPS batteries were fully charged, and then pulled the UPS plug out of the wall. The APCC Smart-UPS 1400 ran for an hour and twenty-nine minutes before giving up the ghost, while the Belkin Regulator Pro NetUPS 1400 ran for an hour and nine minutes before shutting down. That's not only enough time for an orderly shutdown, but also enough time to finish a payroll run if you're using



The Smart-UPS 1400 kept our test system running for almost an hour and a half.

the system for a business.

Other PCs in the house are attached to somewhat less expensive UPS models. We have a mix of APCC BackOffice UPS-Pro 500s and Belkin Regulator Gold 500 models. Both of those models are in the \$150 range, and both provide at least ten minutes of run time with most PC configurations that are connected to them. We usually have an inkjet printer plugged in as well, so we allow a maximum of five minutes before shutting down.

All of the UPS systems we use come with software and cables so the UPS can control the PC's shutdown. That's a good idea if you frequently run applications unattended. That way, the application is shut down systematically, even if you are not there.

SOURCE INFORMATION

American Power Conversion Company

132 Fairgrounds Rd.
West Kingston, RI 02892
800-800-4272
www.apcc.com

CIRCLE 100 ON FREE INFORMATION CARD

Belkin Components

501 West Walnut St.
Compton, CA 90220
800-2-BELKIN
www.belkin.com

CIRCLE 101 ON FREE INFORMATION CARD

DON'T BE CAUGHT UNPREPARED

Most UPS vendors make a big deal about how their units also provide surge protection against lightning strikes. Most of the major players in this market, including APCC and Belkin, boast that they will pay up to \$100,000 to replace any equipment that's damaged by a lightning strike when connected to one of their units.

This sounds great, but I've also heard horror stories about connected equipment that's been fried by a spike from a telephone line or even by an EMP picked up by a long network-cable run. I don't know if these are just "urban legends," but common sense dictates good backup procedures even when your PCs are attached to a UPS.

SOMETHING TO PONDER

UPS systems really make a lot of sense regardless of how you use your PC. They don't have to be as hefty and expensive as the ones I use. APCC and other vendors make inexpensive units in the shape of a fat power strip in the \$50 to \$60 range. That's about twice what a decent surge protector costs, but a UPS gives you a lot more power protection for the money and at least a couple of minutes to perform a routine shut down of your applications and PC in the event of a power failure.

However, don't be tempted to skimp on a UPS. I've seen them on sale for as little as \$40. At that price, you aren't really getting much in the way of either features or capacity. Spend a bit more and get a lot more, especially in the area of confidence, even in areas with poor and unreliable power. Like everything else in the computer industry, you not only get what you pay for, you *don't* get what you *don't* pay for. 

Don't lose sight of Glaucoma.



National Eye Institute, National Institutes of Health, Public Health Service,
U.S. Department of Health and Human Services

SUPER DUPER SCANNERS

Along with getting ever easier to use, each new generation of flatbed scanner gets better. Simple product design and the graphical nature of computer applications are two variables making a scanner a "must-have" peripheral.

This time around, we'll look at a trio of scanners with very different capabilities, feature sets, and prices. None of the three, however, is priced out of reach of a serious user.

SCANNERS 101

Before we get to the specifics, it's probably a good idea to review some basics. All flatbed scanners work the same way, at least conceptually. A glass platen is used to position an original document facing towards the interior scan mechanism. This arrangement allows the scanning of a bound original, such as a page in a book or magazine.

During the scan process, a beam of light is bounced off the document and reflected onto a sensing array. Depending on the construction of the scanner, there is either a mirror or a light source and/or sensor array mounted on the moving platform that is propelled by a stepper motor down the glass platen. Sensor elements may be either CCDs (Charge-Coupled Device) or CISs (Contact-Image Sensor), and the light source can be either cold-cathode fluorescent tubes or LEDs. The combination of a fluorescent-light source and CCD sensor still provides the best color fidelity, while LED/CMOS-based scanners use less

power and can be very thin units.

Scans are processed in the three primary colors (red, blue, and green) for each imaged pixel. The number of imaging sensors per inch in the scan array determines the horizontal imaging resolution, while the ability of the stepper motor to move the

the color of the actual imaged pixels surrounding the unknown pixel.

Finally, in addition to the scanner's resolution, it's also important to consider the unit's color depth and interface. *Color depth* is a measure of how accurately a scanner can resolve color differences. At a minimum, a scanner will offer 24-bit

color depth, which is actually 8 bits of data for each pixel for each of the primary colors (red, blue, and green). Color resolution and accuracy are directly proportional.

Be aware, however, that even a scanner with 48-bit color resolution passes only 24-bits of color data to most applications. Those are the most significant 24 bits; the bits the scanner electronics are most sure about. The remaining bits are discarded. All the scanners reviewed here have 42-bit color depth, and all of them pass on the most significant 24 bits.

Common scanner interfaces include USB, parallel port, and SCSI. Many scanners that have USB and/or SCSI can be used with either a PC or Apple Mac.

CANON N1220U

With an estimated street price of \$199, the Canon N1220U offers only a USB interface. The USB not only makes data transfers fast (an important consideration when the optical resolution is as high as 1200 × 2400 dpi), but it also eliminates



Epson's Perfection 1640SU offers the highest optical resolution in its price class.

scan vertically in small increments determines the vertical resolution. The combination of those two factors is the scanner's actual optical resolution. Today's scanners range from 300 × 300 to 1200 × 2400 dpi in optical resolution. Increased resolution, helpful for scanning small objects (like 35mm slides) and making enlargements, uses a software technique called *interpolation*. This technique involves making an educated guess about the pixels that lie between imaging sensors, based on

the need for an AC power transformer. The scanner, which uses an LED light source and CIS array, draws so little power that it's easily powered by the USB interface itself. The N1220U is a perfect accompaniment to a laptop computer, because you can scan even when you're not near an AC outlet.

bumps the price up a bit to \$299. This scanner is also available in two more expensive models, the 1640SU Photo, which costs \$399 and includes a transparency unit, and the 1640SU OFFICE, which costs \$499 and substitutes an automatic document feeder for the transparency unit.

That sounds like a lot of money,

takes quite a while, even on a high-end PC.

The Perfection has dual interfaces. Most users will take advantage of the USB interface, as it offers easy plug-and-play installation. Others, such as graphics professionals and many Macintosh users, will appreciate the SCSI interface that's also offered.



The Microtek ScanMaker V6USL offers the consumer scanning of legal-size document, as well as a transparency adapter for scanning slides.

Unlike some of the first Canon scanners to use this type of sensor and light source, our test scanner produced scans that were dead-on accurate and showed none of the slight color drift of the earlier CIS models. The N1220U offers 1200- \times 2400-dpi optical resolution.

Finally, the N1220U is great looking! It stands just over an inch high and has an unusual (but very cool-looking) metallic finish that Canon calls "Champagne." Canon includes lots of software; most of that is PC oriented. These include the ScanGear's CS-U TWAIN driver, ArcSoft's PhotoStudio 2000 and PhotoBase, ScanSoft's OmniPage OCR, and a copy of Adobe Photoshop 5.0 LE. For Mac users, there's the Canon Plug-in Module CS-U for the Mac Operating System.

EPSON PERFECTION 1640SU

The Epson Perfection 1640SU

but the Perfection 1640SU has the highest optical resolution in its class—an amazing 1600 \times 3200 dpi. It accomplishes that resolution by incorporating a CCD sensor array with 1600 elements per inch and a specially designed stepper motor that Epson calls a "Microstep Drive." Keep in mind, however, that taking advantage of this resolution means really large image file sizes. We scanned several 3.5- \times 5- and 4- \times 6-inch photos at the highest optical resolution and filled several hundred megabytes of hard disk space. That's not really a problem with the huge 20 GB and larger hard disks that many users now have, and a CD-R/RW disc can still hold a number of images, even at this resolution. It does, however, have a direct impact on how long the image takes to load into an application such as Photoshop. Resampling or adjusting the size and resolution of a 100-MB image

SOURCE INFORMATION

Canon Computer Systems, Inc.

2995 Red Hill Ave.
Costa Mesa, CA 92626
800-OK-CANON
www.ccsi.canon.com

CIRCLE 110 ON FREE INFORMATION CARD

Epson America, Inc.

301 Edgewater Pl. #120
Wakefield, MA 01880
800-463-7766
www.epson.com

CIRCLE 111 ON FREE INFORMATION CARD

Microtek Lab, Inc.

3715 Doolittle Dr.
Redondo Beach, CA 90278
800-654-4160
www.microtekusa.com

CIRCLE 112 ON FREE INFORMATION CARD

For all of its high-end features, the Perfection 1640SU is really easy to use. Epson has a TWAIN driver, and there's a scan button on the front lip of the scanner that can also launch the scan utility.

As with most scanners these days, the Perfection comes with a bundle of software. The bundle includes Adobe's PhotoDeluxe and Photoshop LE, ScanSoft's TextBridge Pro OCR, and ArcSoft's PhotoPrinter, which allows you to print various combinations of print sizes.

MICROTEK SCANMAKER V6USL

The least expensive of the trio at \$149, the ScanMaker V6USL also has the lowest optical resolution, at 1200 \times 600 dpi. Although that seems somewhat low when compared to the Epson Perfection's 1600- \times 3200-dpi resolution, we found the ScanMaker V6USL's resolution just fine for most uses. Microtek throws in a transparency adapter, which the company calls a "LightLid 35." This is actually a small bar that contains an addi-

(Continued on page 36)

Filtering Electronics Circuits Against EMI/RFI

JOSEPH J. CARR

Electronic circuits must perform two different functions at the same time—they must respond to desired signals, and they must reject undesired signals. Unfortunately, today's world is full of a variety of interfering signals, all grouped under the headings *electromagnetic interference* (EMI) or *radio-frequency interference* (RFI). These interference sources can ruin the performance of—or even destroy—otherwise well-functioning electronic circuits. Most circuits are designed so that they do respond properly to desired signals. Nevertheless, many devices fail miserably, because they also respond to undesired signals in an inappropriate manner. Let's take a look at some of the techniques that you can use to EMI/RFI-proof your electronic devices and circuitry.

Shielding Is Not Enough. The first step in protecting against EMI/RFI is to shield the circuitry. The most common method is to place the entire circuit inside a metallic enclosure that prevents both external EMI/RFI fields from interacting with the internal circuits and internal fields from doing the opposite. However, even with a well-shielded circuit, power and signal leads must still enter and/or leave the enclosure. As a result, the shield is not perfect and some sort of filtering is needed.

Basic Types of Filters. Filters come in various types, but perhaps the most useful way of categorizing them is by passband: low-pass, high-pass, bandpass, and notch filters are the four basic classes.

Low-pass filters (LPF)—The low-pass frequency response shown in Fig. 1A passes all frequencies below a critical preselected cut-off fre-

quency (F_c), and attenuates those above F_c . The cut-off frequency is usually defined as the point at which the gain falls off -3 dB from the mid-band response or (if the response is uneven) the response at a defined frequency. The cut-off is not abrupt, but rather will fall off at a given slope. This roll-off above F_c is usually defined in terms of decibels per decade (a 10:1 frequency change) or decibels per octave (a 2:1 frequency change). Low-pass filters that produce this kind of response curve are used to attenuate EMI/RFI signals above F_c .

Electromagnetic and radio-frequency interference may keep electronic devices from performing properly. In many instances, adding simple filter circuits can fix the problems. Here are some techniques you need to know about.

High-pass filters (HPF)—

The high-pass response shown in Fig. 1B is exactly the opposite of the low-pass response. This kind of filter passes frequencies above F_c , but attenuates those frequencies below F_c . Again,

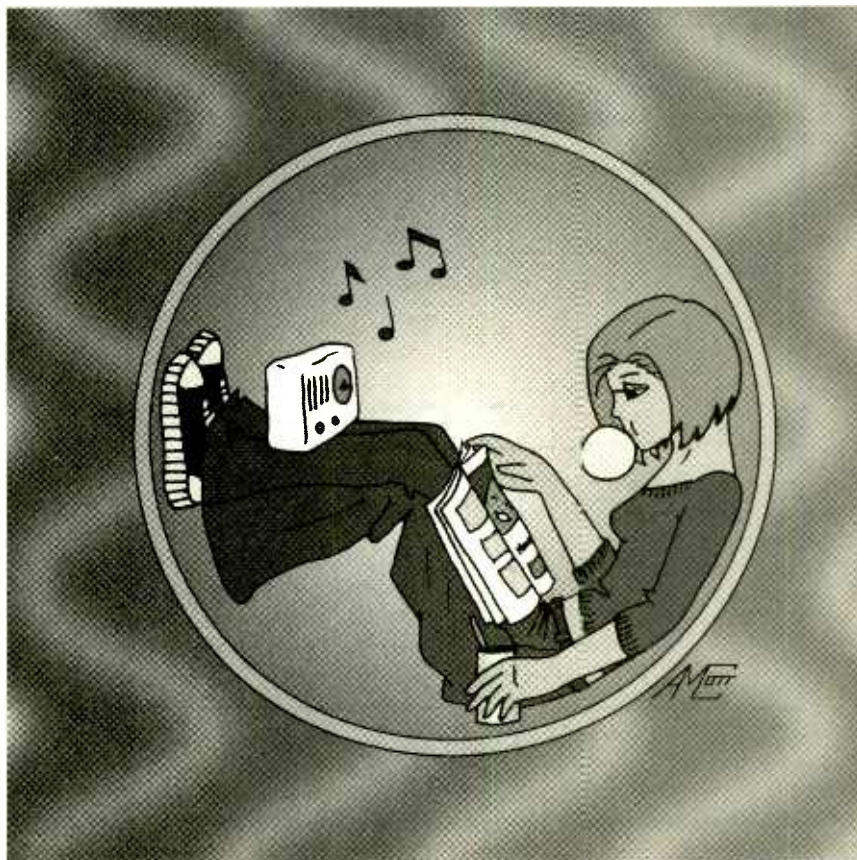

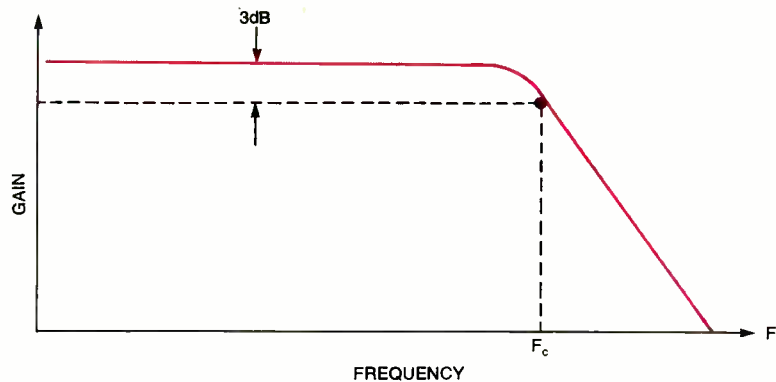

A

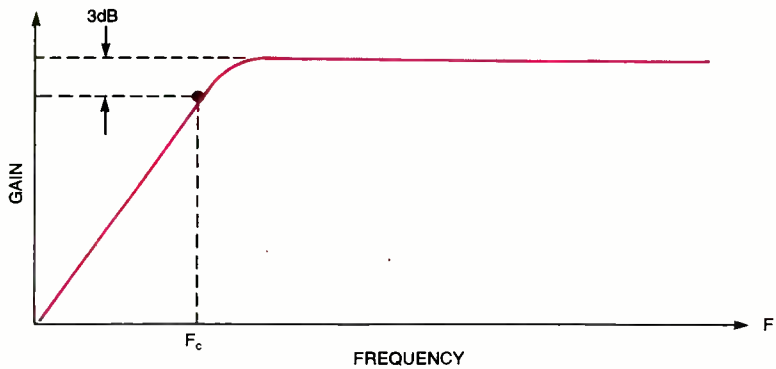

B

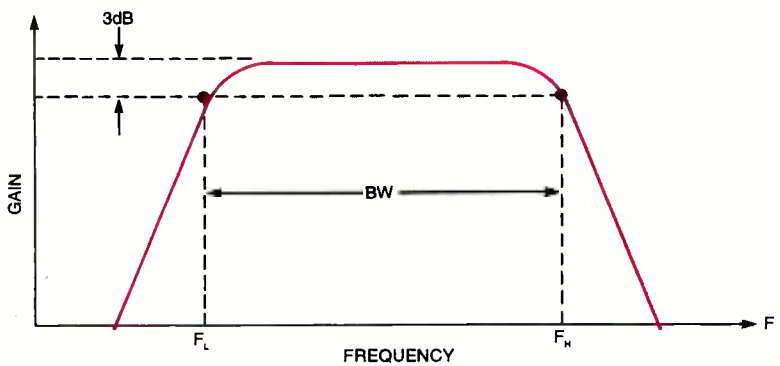

C

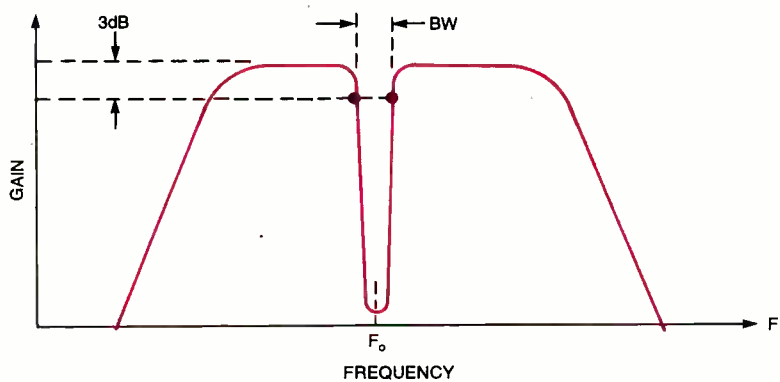

D

there is a roll-off slope below F_c .

Bandpass filters (BPF)—The bandpass-filter response shown in Fig. 1C is essentially overlaid LPF and HPF responses. There are two cut-off frequencies: a lower limit (F_L) and an upper limit (F_H), both of which are defined at -3 -dB points. The bandwidth (BW) of the BPF is defined as the difference between -3 dB points:

$$BW = F_H - F_L$$

In most cases, the BPF will have a center frequency (F_0) specified. The "Q" or "quality factor" of the BPF is defined as the ratio of the center frequency to bandwidth, or:

$$Q = F_0 / BW$$

where Q is dimensionless, and the two other terms are expressed in the same units.

Notch Filter—The notch filter response shown in Fig. 1D has a very high attenuation at a specific frequency within the circuit's passband, but passes the other frequencies. In Fig. 1D, the notch is superimposed over a BPF response, although it may also be found with LPF, HPF, or wideband (flat) responses. The notch filter is used to take out a specific interfering frequency. For example, if 60-Hz AC power-line interference is terribly bothersome, then a notch filter might be used.

Filter Circuits for EMI/RFI. Filter circuits can be active or passive, but in this article, we are going to look only at the passive varieties. Such filters are made of combinations of resistors, capacitors, and inductors. Those combinations include RC, LC, and RLC varieties.

Figure 2 shows simple resistor-capacitor (RC) networks in both low-pass and high-pass filter configurations. Note that the two circuits are similar except for the reversal of the two types of components. The cut-off frequency of these circuits is found from:

$$F_c = \frac{1}{2\pi RC}$$

Fig. 1. Here are the filter-response characteristics for low-pass (A), high-pass (B), bandpass (C), and notch (D) filters.

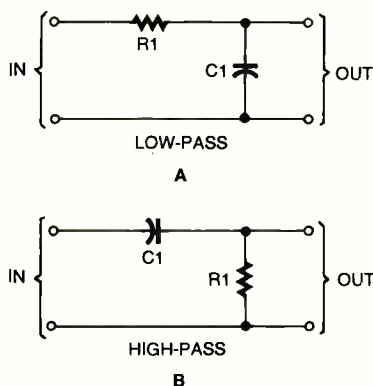

Fig. 2. Resistor-capacitor (RC) low-pass and high-pass filter circuits look similar; only their elements are reversed.

where F_c is the cut-off frequency in Hertz (Hz), R is the resistance in ohms, and C is the capacitance in farads. These circuits provide a frequency roll-off beyond F_c of -6 dB per octave, although a sharper roll-off can be obtained by cascading two or more sections of the same circuit.

Figure 3 shows four different Chebychev filters (two LPF and two

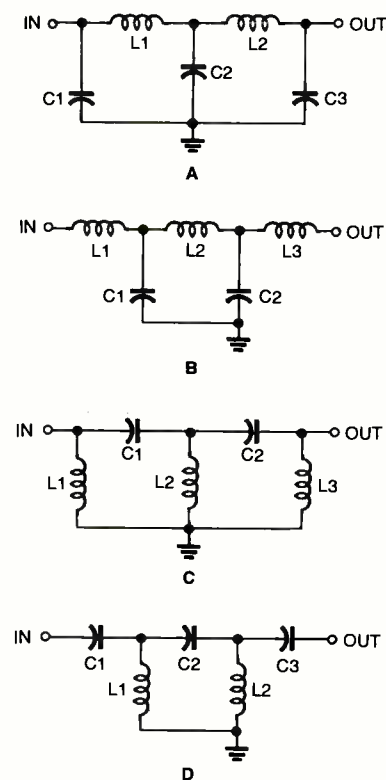

Fig. 3. Including an inductor in a filter circuit yields four basic combinations: a low-pass pi configuration (A), a low-pass tee configuration (B), a high-pass pi-configuration (C), and a high-pass tee configuration (D).

HPF). These filters include low-pass and high-pass "Pi" configurations (Figs. 3A and 3C) and low-pass and high-pass "Tee" configurations (Figs. 3B and 3D). Note how the circuits got their characteristic names: schematically, they look like the Greek symbol π or the letter "T."

Each of these filter circuits is a "five-element" circuit; i.e. they each have five L or C components. Fewer (e.g. three-element) and greater (e.g. seven- and nine-element) numbers of elements are also used. Fewer elements deliver a poorer frequency roll-off, while more elements produce a sharper roll-off. Sets of component values are given for each circuit in Tables 1 through 4. Those component values are normalized for a 1-MHz cut-off frequency. To find the required values for any other frequency, divide those values by the desired frequency in megahertz. For example, to make a high-pass Tee-configuration filter for, say, 4.5 MHz, take the values of Table 4 (for Fig. 3D) and divide by 4.5 MHz:

$$L1 = 5.8 \text{ mH} / 4.5 \text{ MHz} = 1.29 \text{ mH}$$

$$L2 = L1$$

$$C1 = 2776 \text{ pF} / 4.5 \text{ MHz} = 617 \text{ pF}$$

$$C2 = 1612 \text{ pF} / 4.5 \text{ MHz} = 358 \text{ pF}$$

$$C3 = C1$$

If the desired frequency is less than 1 MHz, then it must still be expressed in MHz: 100 kHz = 0.1 MHz and 10 kHz = 0.01 MHz.

RC EMI/RFI Protection. Some circuits—especially those that operate at low frequencies—use RC low-pass filtering for EMI/RFI protection. Consider the differential amplifier shown in Fig. 4. This circuit is representative of a number of scientific- and medical-instrument amplifier-input networks. A medical electrocardiogram (ECG) amplifier, for example, is basically a differential amplifier with a high gain (1000 to 2000) and a low-frequency response (0.05 to 100 Hz). It picks up the human heart's electrical activity from skin electrodes on

Some circuits—especially those that operate at low frequencies—use RC low-pass filtering for EMI/RFI protection.

the surface. A number of problems affect the ECG's recording, other than the obvious 60-Hz problem. The ECG is often used in the presence of strong radio-frequency (RF) fields from electrosurgery machines (as discussed in the November 2000 issue of **Poptronics**). These "electronic scalpels" produce very strong fields at frequencies

L1	10.9 μ H
L2	10.9 μ H
C1	3650 pF
C2	6287 pF
C3	3650 pF

L1	9.12 μ H
L2	15.7 μ H
L3	9.12 μ H
C1	4365 pF
C2	4365 pF

L1	6.94 μ H
L2	4.03 μ H
L3	6.94 μ H
C1	2321 pF
C2	2321 pF

L1	5.8 μ H
L2	5.8 μ H
C1	2776 pF
C2	1612 pF
C3	2776 pF

between 500 kHz and 3 MHz. The ECG circuit must also survive high-volt-

age DC jolts from a charge from a defibrillator machine if a patient's heart goes into ventricular fibrillation (a fatal type of arrhythmia, or irregular heartbeat). The defibrillator machine "jump starts" the heart

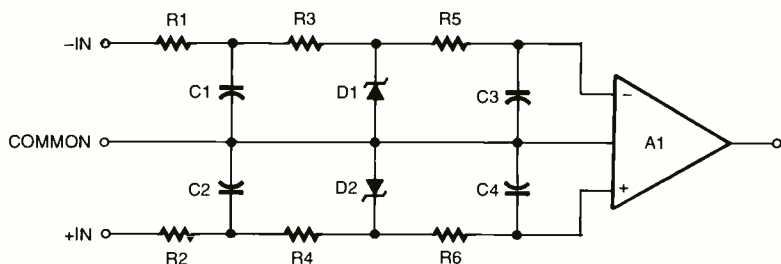

Fig. 4. The right combination of RC filtering and high-voltage protection provide excellent protection for low-frequency circuits such as electrocardiogram (ECG) amplifiers.

with a set of short-duration voltage spikes ranging from hundreds of volts to several kilovolts, depending on the particular waveform design and energy setting. Those potentials might be applied directly across the ECG amplifier, placing it at risk.



A

CIRCUIT SYMBOLS

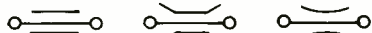

B

Fig. 5. A feedthrough capacitor passes an AC signal through a shielded enclosure.

Figure 4 contains both RF filtering and a means for limiting the defibrillator jolt. The resistors and capacitors form a three-stage cascade RC filter, one for each input of the differ-

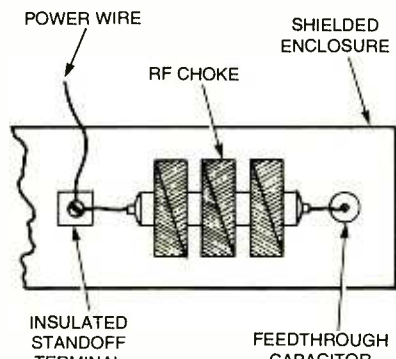

Fig. 6. In this example, an external RF choke is mounted outside a shielded enclosure; the feedthrough capacitor passes the signal to the inner circuit.

ential amplifier. Those components will filter the RF component. Typical values range from 100,000 ohms to 1 megohm for the resistors, and 100 pF to 0.01 μ F for the capacitors. High-voltage protection is provided by a

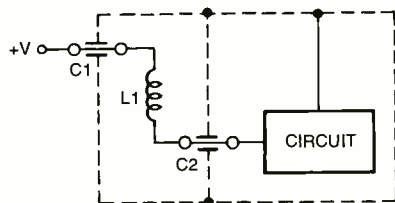

Fig. 7. If you have an extra-sensitive circuit, you can use a secondary shield within the main shield. Feedthrough capacitors pass the signal through the shields.

combination of the input resistors and a pair of Zener diodes (D1 and D2) shunting the signal and common lines. In some older ECG amplifiers, NE-2 neon lamps were used in place of the Zener diodes.

Feedthrough Capacitors. One efficient way to reduce the effects of EMI/RFI that pass into a shielded

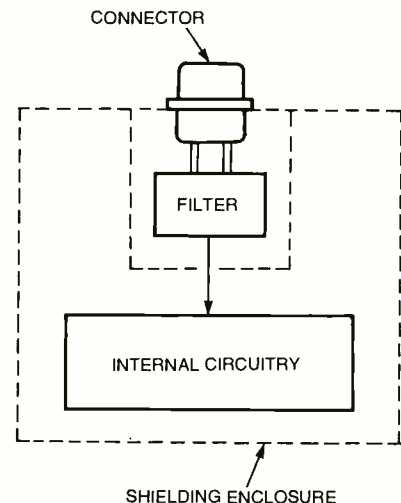

Fig. 8. Commercially-available connector/EMI-filter combinations are readily available, reducing parts count, design time, and troubleshooting.

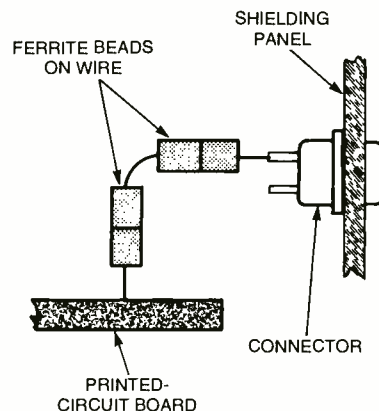

Fig. 9. Ferrite beads can act as an RF choke to protect circuits from interference picked up by connector pins.

compartment via power and signal lines is to use a feedthrough capacitor (see Fig. 5). Such capacitors typically come in 500-pF, 1000-pF, and 2000-pF values. Both solder-on and screw-on (see Fig. 5A) versions are available. In some catalogs, those capacitors are referred to as "EMI filters" rather than "feedthrough capacitors." I may be a cynic, but the "EMI" designation seems to add considerably to the price without any apparent advantage over straight feedthrough capacitors. Figure 5B shows several different forms of circuit symbols used for feedthrough capacitors in circuit diagrams.

FILTER CALCULATOR

If you are interested in designing filter circuits with specific responses, an Excel spreadsheet is available to assist you with the math. The basic filters shown in Fig. 3 are modeled up to nine elements. Point your browser to ftp.gernsback.com/pub/pop/filter_tables.xls to download.

There are several different ways to use a feedthrough capacitor. One is to simply pass it through the shielded compartment wall and attach the wires to each side. In other cases, additional resistors or inductors are used to form a low-pass filter. Figure 6 shows one approach in which a radio-frequency choke (RFC) is mounted outside the shielded compartment. This method is often used for TV and cable-box tuners. One end of the RFC is connected to the feed-through capacitor; the other

(Continued on page 48)

Programmable-Logic Devices are a snap to “burn” with **THE ALTA PRO 2000 PLD PROGRAMMER**

*Frustrated that you can't build that latest “cool”
project because you lack a PLD programmer?
Sweat not, for this easy-to-build device is the answer to your prayers!*

ROBERT G. BROWN

Back in May 1994, **Electronics Now** published my construction article on programmable-logic devices (PLDs). Since then, I've

gotten feedback from hundreds of readers and still get requests—almost seven years later—for kits. Of course, time moves on, and the old programmer is showing its age and limitations.

Those two reasons alone make it high time to update the “old gal.” Therefore, I'm pleased to present a new PLD programmer, the *Alta Pro 2000*. This next-generation programmer is designed to be more flexible than the old unit and can program many more devices. The hardware has the capability to program both 5-volt and 3.3-volt devices (although no 3.3-volt devices have companion support—yet!). At this writing, it can program the following devices from Lattice, National Semiconductor, SGS Thomson, Atmel, and ICT:

- GAL1GV8A/B/C/D
- GAL20V8A/B/C/D
- GAL22V10A/B/C/D
- ATF16V0B/C
- ATF20V8B
- ATF22V10B/C
- PEEL22CV10A+

Of course, that list may be added to from time to time. Check for the latest device list at www.alta-engineering.com. I've also posted the interface specification

for the Alta Pro 2000 so others can create programs to handle different devices. Unfortunately, I've had to sign non-disclosure agreements with the PLD manufacturers in developing the Alta Pro 2000's software, so I can *not* publish

source code or give out programming algorithms. If you're wondering why a semiconductor manufacturer would want to apparently prevent potential buyers from programming and using their devices, you'll have to ask them.

Theory Of Operation. Most programmable devices require one or more “super voltages”—a voltage (often referred to as V_{pp}) used to

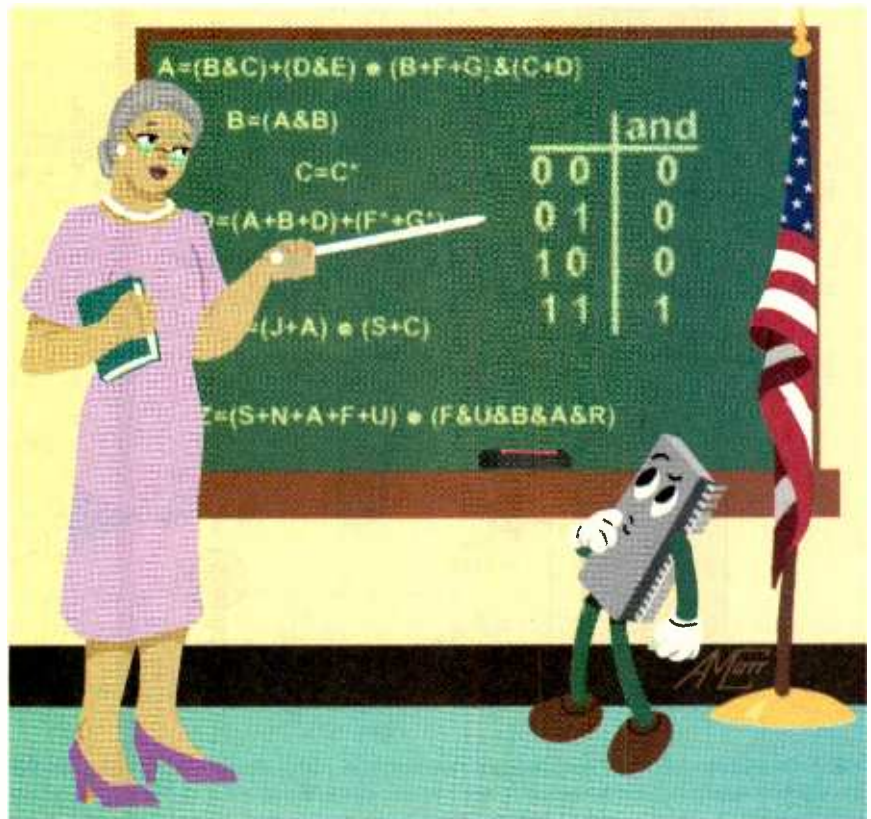

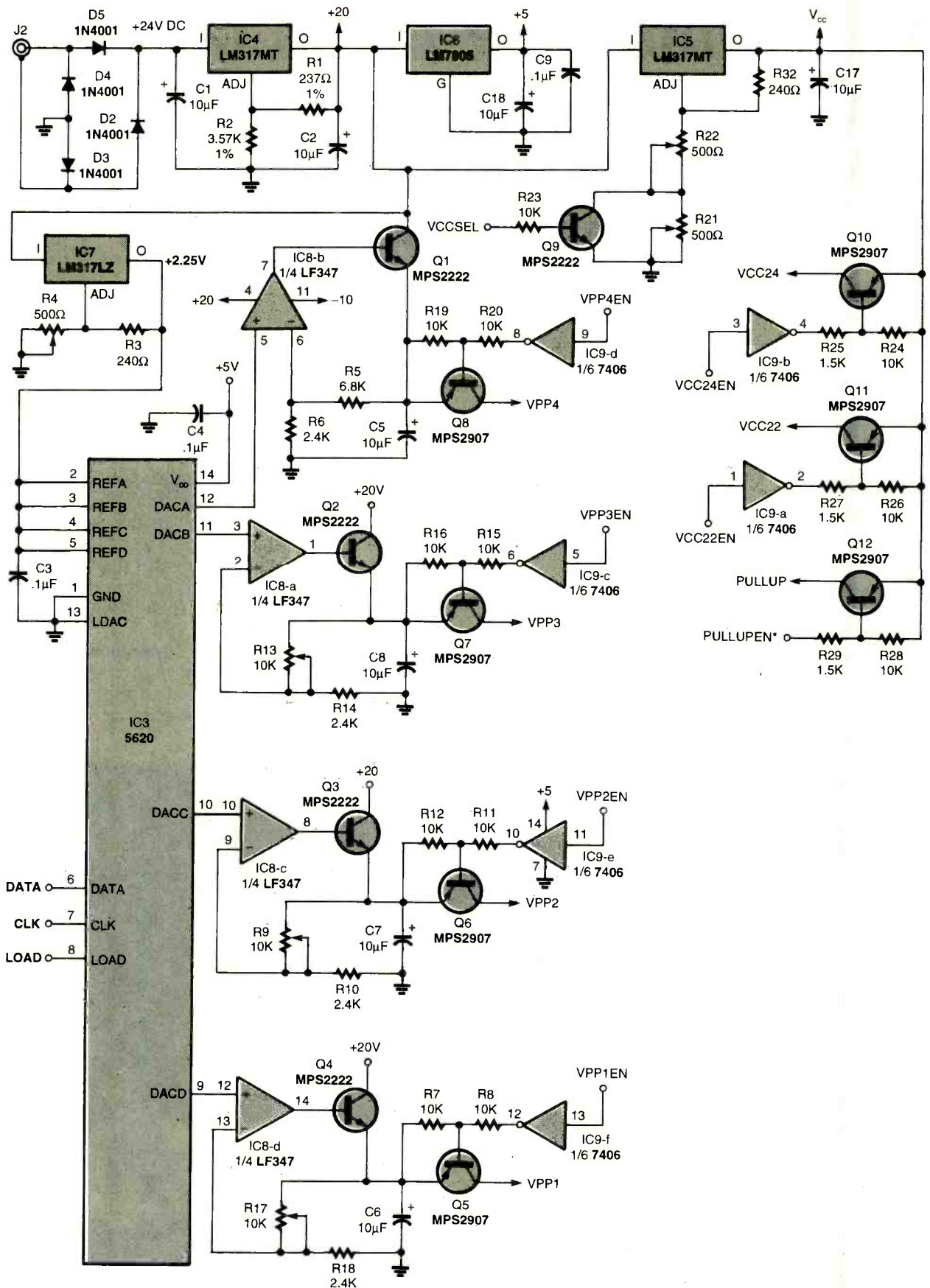

Fig. 1. The Alta Pro 2000 PLD programmer is designed for flexibility and non-obsolence. Besides the different supply voltages generated by the various voltage regulators, a digital-to-analog converter can create any programming voltage needed by any device—past, present, or future.

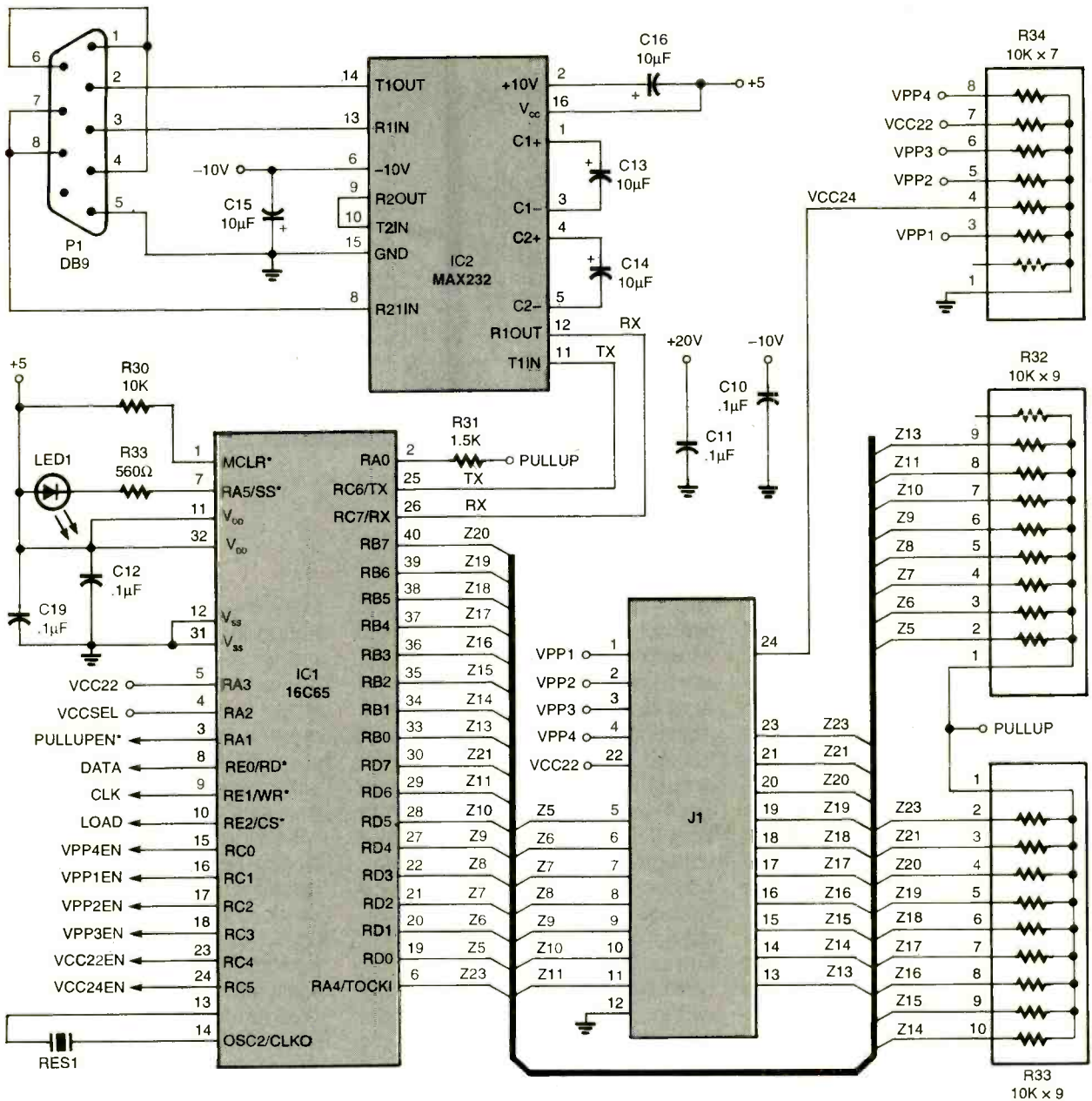

Fig. 2. The on-board PIC microcontroller takes commands from a host PC and manipulates the signals going to a ZIF socket holding the PLD being programmed.

put the chip into a "programming mode" or to store an electrical charge during the programming process. That voltage is usually higher than the device's normal operating voltage. For example, a standard 5-volt GAL22V10 requires a V_{pp} in the range of 10 to 16.5 volts on pin 2 during programming. In addition to controlling the super voltage, the device programmer must have precise control over the power (V_{ee}) and the logic-level signals supplied to the device.

Let's take a closer look at the Alta Pro 2000's circuitry; the schemat-

ic diagram can be found in Figs. 1 and 2. The unit has the capability of generating four simultaneous V_{pp} signals on pins 1, 2, 3 and 4 of the ZIF socket, J1. The voltage on each of those pins can be varied from zero to 17 volts. Generation of the super voltages starts with IC3, a TLC5620 quad 8-bit serial digital-to-analog converter (DAC).

As the name implies, the TLC5620 contains four DACs and uses a serial interface rather than a parallel interface. The use of a serial interface reduces the pin count and allows for a smaller package. The TLC5620 requires a

reference voltage for each DAC; pin 2 is the reference voltage for DAC "A," pin 3 for DAC "B," pin 4 for DAC "C," and pin 5 for DAC "D." In this design, all of the DACs use the same reference voltage—about 2.25 volts as set by IC7. The TLC5620 has a built-in buffer amplifier for each DAC. The amplifier has a selectable gain of either one or two. When the gain is one, the buffered DAC output has a range of zero up to the reference voltage. When the gain is two, the DAC output can reach two times the reference voltage. The Alta Pro 2000 always uses

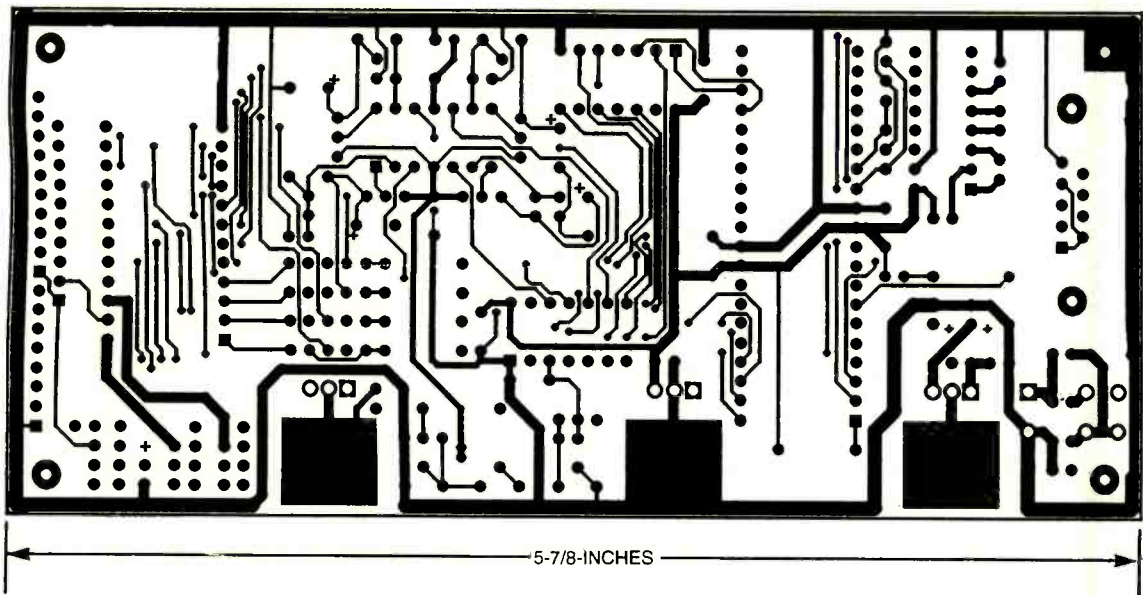

Fig. 3. The Alta Pro 2000 is best built on a PC board. Here is the foil pattern for the component side of such a board.

the 2X range.

Three pins are used for writing to the TLC5620: pin 6 is the data pin, pin 7 is the clock, and pin 8 is the load pin. To write to the DAC, an 11-bit command is clocked into the TLC5620 one bit at a time. The TLC5620 accepts each bit from the data line on the falling edge of the clock line. The first two bits select the DAC—00 for DAC A, 01 for B, 10 for C, and 11 for D. The third bit selects the range (buffer-amp gain)—0 for a gain of one and 1 for a gain of two. The final eight bits are the value to be written to the DAC, most significant bit first. After the 11 bits are clocked into the TLC5620, the load signal is pulsed low and the DAC output is updated.

Since the DAC output only goes up to about 4.5 volts on a gain setting of 2, we must amplify the voltage further to get a valid super voltage. I'll only describe the amplifier circuit for DAC A; note from Fig. 1 that the other three amplifiers are similar. The output of DAC A (IC3 pin 12) is fed into pin 5 of IC8-b, which is the non-inverting input of an LF347 quad op-amp. The op-amp is configured in a very standard non-inverting configuration with the addition of pass transistor Q1 on its output. The pass transistor has no effect on the gain of the circuit, but increases the op-amp's output-current ability. In effect, this part of the circuit is a voltage regu-

lator—the output voltage is controlled by the input to the op-amp. As with any standard non-inverting op-amp circuit, the voltage gain is equal to the value of the feedback resistor (R5) divided by the value of the input resistor (R6) plus 1. In this case, the gain is about 3.8. With an input voltage of about 4.5 volts from DAC A, the maximum output voltage is about 17 volts. During calibration, the DAC reference voltage (supplied by IC7) is adjusted with R4 to give 17.0 volts at the output of IC8-b.

Transistor Q8 acts as a simple switch. When the enable signal (VPP4EN) at pin 9 of IC9-d is a logic high, the inverter's output (pin 8) goes low. Grounding the base of Q8 turns it on and connects the super voltage to pin 4 of the ZIF socket, J1. Otherwise, the voltage on pin 4 of J1 is pulled down to ground by one of the 10K resistors in resistor network R34 (see Fig. 2).

The outputs of the other three DACs are all handled in basically the same manner as the output of DAC A. The one difference is that the feedback resistor in the non-inverting op-amp circuit is variable. This allows each circuit to be adjusted individually, compensating for component tolerances and matching the 17-volt maximum output among all four DACs.

Power Supply. The Alta Pro 2000's

power-input circuit was designed around the output of a 24-volt AC wall transformer connected to J2. Diodes D2-D5 form a full-wave bridge rectifier; any ripple is smoothed by C1. You could substitute a DC supply without affecting performance as long as there is a 24-volt DC level at the input of IC4.

The input voltage is regulated by IC4 to 20 volts. That voltage is used directly by some of the analog circuits in addition to voltage regulators IC5-IC7. The only fixed-voltage regulator, IC6, supplies 5 volts for the digital-logic components. Variable-voltage regulator IC5 provides either 3.3 or 5 volts to the device in the programming socket. The VCCSEL signal, when high, turns Q9 on, effectively shorting R21. The voltage output of IC5 is then set by R32 and R22. That potentiometer is adjusted for a 3.3-volt output. When VCCSEL is low, R21 is in series with R22, increasing the output voltage (as adjusted by R22) to 5 volts. We've already discussed the role of IC7's output and how it is adjusted by R4.

The Alta Pro 2000 communicates with a PC using an RS-232 serial port. A MAX232 level translator, IC2, handles the voltage shift needed when working with the RS-232 protocol. The reason I'm mentioning the serial interface chip in this section is that it takes power from the 5-volt supply and, using two internal charge pumps, creates +10

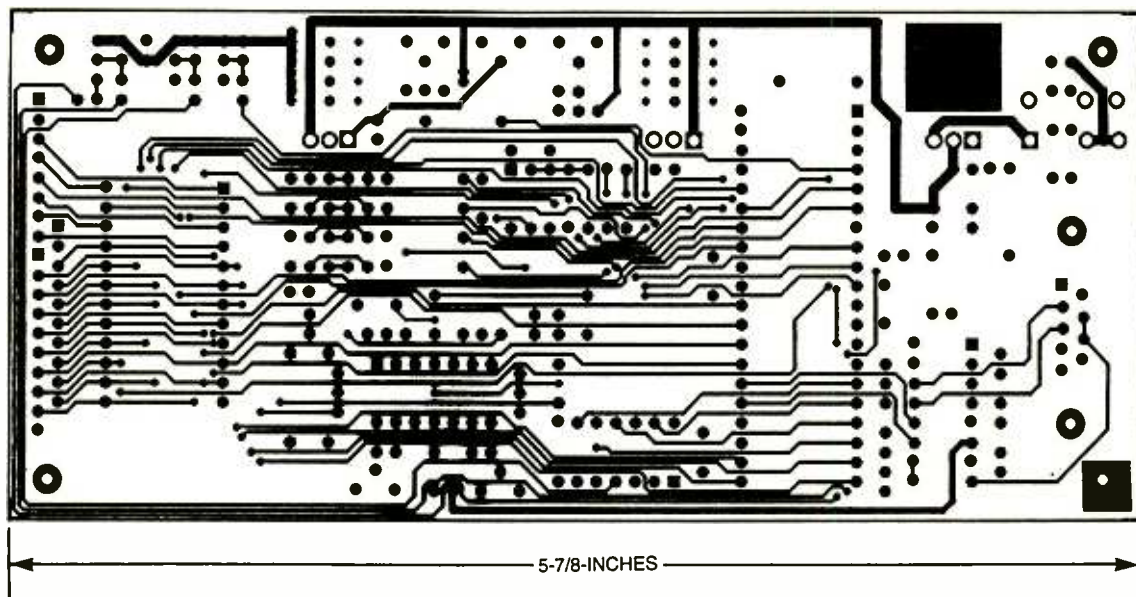

Fig. 4. The board design for the Alta Pro 2000 is double-sided. Getting this solder-side pattern to align with the component-side pattern will test the mettle of any seasoned hobbyist.

and -10 volts from the 5-volt supply. The chip produces the proper RS-232 signal levels using those voltages. In addition, the -10-volt supply produced by IC2 is used for the negative supply of IC8; the LF347 op-amp works best with a split-type power supply.

The Central "Brain." The on-board intelligence of the Alta Pro 2000 is in IC1, a PIC16C65A microcontroller. This is an expanded 40-pin version of the smaller PIC processors featured in many projects. The PIC16C65A has a built in UART for serial communications and 33 I/O (input/output) pins divided among five ports (designated PORT A through PORT E). Two of the I/O pins from PORT C (bits 6 and 7 on pins 25 and 26) are used for the serial port transmit and receive signals. The PIC's software takes commands from a host PC to configure, read, and write data among the rest of the I/O pins. We'll take a look at each pin's function on a port-by-port basis.

Port E—Three bits are used to control IC3. All of the pins for port E are configured as outputs. The functions of these three signals were previously covered.

Port C—Bits 6 and 7 of this eight-bit port carry the transmit and receive signals to and from IC2. The

remaining six bits are all configured to be outputs. Bits 0 through 3 are used to enable the various V_{pp} signals to pins 1, 2, 3, and 4 of J1. Bit 4 is the VCC22EN signal that enables the supply voltage to pin 22 of J1. When this signal is a logic high at pin 1 of IC9, the output at pin 2 is low, which turns on Q11 and connects the supply voltage (either 3.3 or 5 volts) to pin 22 of J1. Bit 5 is the VCC24EN signal that works the same way for pin 24 of J1.

Port A—Bit 5 of this six-bit port lights LED1 when it is low. Bit 2 supplies the VCCSEL signal. When low, the supply voltage for J1 is 5 volts; a logic high changes the supply voltage to 3.3 volts. Bit 3, configured as an input, reads the logic level on pin 22 of J1. Bit 1 controls the PULLUPEN* signal. When PULLUPEN* is low, it turns on Q12. The switched voltage from Q12 (the V_{CC} voltage as determined by VCCSEL) is applied to the common pin of resistor networks R35 and R36. This provides a pull-up to the correct voltage on pins 5-11, 13-21, and 23 of J1. When not at a low logic level, bit 1 is "tri-stated" (no voltage level whatsoever), which turns off Q12 and removes the pull-up voltage. Bit 0 is connected to the PULLUP signal through R31. When the pull up on J1 is disabled, this bit can be set to a logic low level to provide a pull down on the aforementioned J1

pins. When not active, bit 0 is tri-stated so it doesn't interfere with the pull-up signals.

Note that I haven't mentioned Bit 4's function, because that will bring us to...

Ports B and D—Together with bit 4 of port A, ports B and D are used to provide logic-level control and status for pins 5-11, 13-21, and 23 of J1. Since the Alta Pro 2000 has the ability to program both 5-volt and 3.3-volt devices, it must be capable of working with either 5 or 3.3 volts for a logic-high level. For that reason, those signals are either configured individually to a logic-low level or tri-stated; they are never set to a logic-high level. If a logic-high level is needed on a pin, that bit is tri-stated and the pull-up resistors in R35 or R36 pull the pin up to the proper voltage level. The status of any J1 pin can be read by reading the port.

Communications. A protocol defines the communication between the PC and the Alta Pro 2000. There are commands that the PC can send to control all of the signals coming from the PIC16C65A, which, in turn, controls everything else on the board. For example, the PC can send either the command "5E" (hexadecimal notation) that tells the PIC to turn on the LED or "5F" that tells the PIC to turn off the LED.

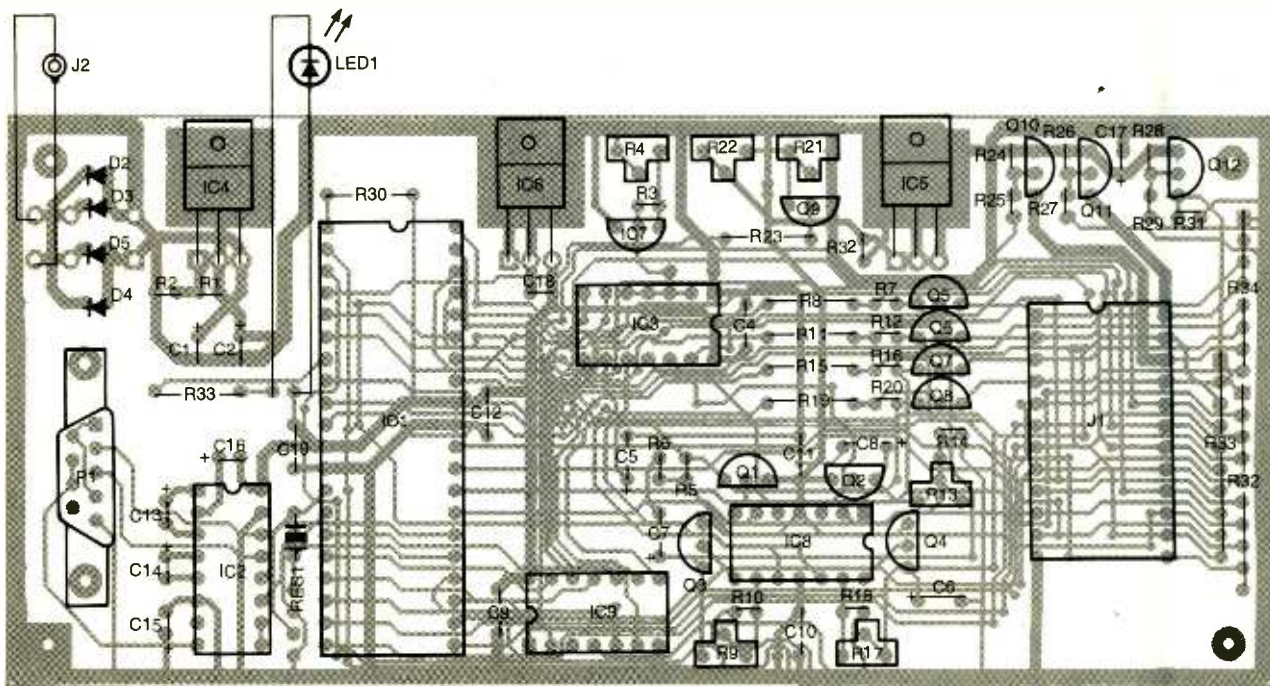

Fig. 5. Once you have an etched board, this parts-placement diagram will guide you in locating the components. Due to its compact size, many axial components are mounted vertically.

Other commands are more than one byte because they include data as part of the command. For example, the command 34 followed by the data byte FF tells the Alta Pro 2000 to write the value FF to the VPP4 DAC.

If you are interested in the complete protocol, it is defined in the file APPROCOL.TXT. That file is available for download from the Gernsback FTP site as part of the complete Alta Pro 2000 software package; more on that later.

Building The Alta Pro 2000. It is best to build the Alta Pro 2000 on a double-sided PC board with plated-through holes. Since the board is quite dense, a professionally made board with a solder mask and silk screen might be easier. A PC board is available from the source given in the Parts List. For those that would like to make their own board, foil patterns are shown in Figs. 3 (component side) and 4 (solder side).

You should use a clean, low-wattage soldering iron with a fine point. Assembling the board works best if you start with the resistors that lie flat on the board (such as R8, R11, R15, R19, etc.) and work your way through the components that stand higher off the board. Note that

most of the resistors—as well as the diodes—must be installed standing up. Use sockets for all of the ICs and J1. We'll plug the ICs into their sockets as we test the board to prevent any defective parts or construction errors from destroying the semiconductors. Similarly, we'll plug the ZIF socket used for J1 into a standard 24-pin DIP socket to prevent damaging one of the most expensive components in the Alta Pro 2000.

Note that a horizontal, or "lay-down," style of potentiometer is recommended for R13. Using that style will make later adjustments easier.

When installing IC6, use a clip-on heatsink. The voltage regulator should be mounted so that the heatsink hangs about 1/2 inch over the board edge. The other regulators (IC4 and IC5) use bolt-on heatsinks. They should be mounted the same way—the heatsinks touching the board with a 1/2-inch overhang.

If you want, you can solder the leads from the 24-volt power source directly to the board. However, a coaxial connector that matches the plug on the end of the transformer makes using and transporting the Alta Pro 2000 easier. If you are using a DC supply, keep in mind that you don't have to worry about voltage polarity; the diode bridge will han-

dle that chore.

Once everything is assembled, carefully inspect the board for construction errors such as bad solder joints or solder bridges. Inspection is a very important step since there are many different voltages on the board. A solder bridge from a higher-voltage to a lower-voltage signal can easily destroy a component—and I speak from experience!

Testing Your Handiwork. You should carefully bring up the board in the step-by-step manner described here. Start with all of the IC sockets empty and adjust all of the trim pots to their center position. First, check the supply voltages. Turn on



The Alta Pro 2000's PC board is mounted to the lid of the case using screws and spacers. You might need an additional IC socket to raise the ZIF socket to the proper height.

(or plug in) the power. Looking at the board with the DB9 connector on the left and, using the DC volts setting on your meter, measure the voltage at the rightmost pin on IC4 (referenced to ground). It should read in the range of 24 to 30 volts. Next, check the voltage at the center pin of IC4; it should read about 20 volts. You should also find 20 volts on pin 4 of IC8. The following locations should read 5 volts between them:

- IC1 pins 32 and 31
- IC1 pins 11 and 12
- IC2 pins 16 and 15
- IC3 pins 14 and 1
- IC9 pins 14 and 7

The voltage at pins 2, 3, 4, and 5 of IC3 should all be the same and read about 2.5 volts. Adjust R4 to get a reading of about 2.25 volts on those pins. Set the voltage at the center pin of IC5 to about 3 volts using R22 and, if needed, R21. Finally, test the LED by running a jumper from IC1 pin 7 to ground.

The LED should light. If all of those tests pass, then you should power down. If not, you should correct the problem before going ahead.

Install IC2 into its socket and turn on the power. Check the voltage at IC8 pin 11. It should be at about -6 to -11 volts. If it isn't, check the circuit around IC2. Power down the unit.

You're now ready to install IC1. However, it must be programmed with the PIC software from the Alta Pro 2000 software package. You can download that package from the Gernsback FTP site; the URL is ftp.gernsback.com/pub/pop/alta_pro_2000.zip. Unzip the file and "burn" the PIC software into IC1 using an appropriate PIC programmer. The software package includes a "packing list" text file describing the contents and purpose of each file in the package.

When IC1 has been programmed, install it and IC9 in their respective sockets. Connect the system to a convenient COM port on your PC. Turn on the unit, and from a DOS



The completed Alta Pro 2000 is ready to program any mainstream PLD. With knowledge of the Alta Pro 2000's interface protocol, programming requirements of a particular PLD, and a little skill in writing programs for the PC, the Alta Pro 2000 will never become obsolete...at least, not for a good long time.

window on your PC (you must have Windows95 or later) run the *apdiag* program followed by the COM port number you are using:

APDIAG <com port number (1-4)>

Although the host programs (the ones run on the PC) are DOS-based, they require a 32-bit operating system. If you try to use an older version of MS-DOS, you will simply be greeted by the error mes-

PARTS LIST FOR THE ALTA PRO 2000

SEMICONDUCTORS

- IC1—16C65A microcontroller, integrated circuit
 IC2—MAX232CPE or MAX232ACPE RS-232 translator, integrated circuit
 IC3—TLC5620CN quad digital-to-analog converter, integrated circuit
 IC4, IC5—LM317MT adjustable voltage regulator, integrated circuit
 IC6—LM7805 5-volt fixed voltage regulator, integrated circuit
 IC7—LM317LZ adjustable voltage regulator, integrated circuit
 IC8—LF347 quad op-amp, integrated circuit
 IC9—7406 open-collector hex inverter, integrated circuit
 Q1-Q4, Q9—PN2222 NPN silicon transistor
 Q5-Q8, Q10-Q12—PN2907 PNP silicon transistor
 LED1—Light-emitting diode, any color
 D1—Not used
 D2-D5—1N4001 silicon rectifier diode

RESISTORS

- (All resistors are 1/4-watt, 5% units unless otherwise noted.)
 R1—237-ohm, 1%
 R2—3570-ohm, 1%
 R3, R32—240-ohm

- R4, R21, R22—500-ohm potentiometer, PC-mount
 R5—6800-ohm
 R6, R10, R14, R18—2400-ohm
 R7, R8, R11, R12, R15, R16, R19, R20, R23, R24, R26, R28, R30—10,000-ohm
 R9, R17—10,000-ohm potentiometer, vertical PC mount
 R13—10,000-ohm potentiometer, horizontal PC mount
 R25, R27, R29, R31—1500-ohm
 R33—560-ohm
 R34—10,000-ohm, 7-element resistor network, common return
 R35, R36—10,000-ohm, 9-element resistor network, common return

CAPACITORS

- C1, C2, C5-C8—10- μ F, 25-WVDC, electrolytic
 C3, C4, C9-C12, C19—0.1- μ F, ceramic-disc
 C13-C16—10- μ F, 16-WVDC, electrolytic
 C17, C18—10- μ F, 6-WVDC, tantalum electrolytic

ADDITIONAL PARTS AND MATERIALS

- J1—24-pin IC socket

- J2—Coaxial power connector, cable-mount
 P1—DB9 male connector, PC-mount
 RES1—10-MHz ceramic resonator
 Heatsinks (clip-on for IC6, bolt-on for IC4 and IC5), 24-pin zero-insertion-force (ZIF) socket, 24-volt AC or DC, 400-mA wall-mounted transformer, DB9 female-to-female cable, case, hardware, wire, etc.

Note: The following items are available from Alta Engineering, 58 Cedar Lane, New Hartford, CT 06057-2905; 860-489-8003; alta@ieee.org; www.alta-engineering.com: Software on 3 1/2-inch disk, \$10; Blank PC board, \$35; Kit of board, all PC-mounted components, and software, \$109; Kit of board, components, software, and case, \$139; Kit of board, components, software, case, power supply, and cable (US only), \$159. If you reuse the ZIF socket from the old Alta Engineering PLD programmer, save \$20 on any of the complete kits. Please include \$5 for shipping and handling in the US; \$10 shipping and handling outside the U.S. CT residents must add appropriate sales tax. VISA/MC accepted.

sage, "This program requires 32-bit Windows."

If you have specified the correct COM port number and the program has established communications with the Alta Pro 2000, you will see a menu displayed. If the program can not establish communication with the programmer, you will get an error message. You will need to turn off the Alta Pro 2000 and check the cabling, verify the COM port number, and so on until you've corrected the problem.

Once you have communications with the Alta Pro 2000, you'll need to run several tests. First, using menu options 1 and 2, verify that you can turn the LED on and off. Next, select menu option 3, follow the instructions, and check and set the V_{CC} supplies. After that, select option 5 (skip option 4 for now) and follow the instructions for the port test (Ports A, B, and D refer to the ports on the 16C65A). Note that the tests for Port B and Port D are automated. If any of the test fail, you will need to solve the problem before continuing. You can use the low-level tests from option 6 to help with your troubleshooting.

If you've passed all the tests so far, power down the Alta Pro 2000, exit the *apdiag* program, and insert the last two ICs, IC3 (TLC5620CN) and IC8 (LF347).

Power up the Alta Pro 2000 and start the *apdiag* program again. Repeat the tests from above. Assuming that they all pass, select option 4 and follow the instructions for setting up the programming voltages (V_{pp}). If there are problems, you will need to track them down and correct them by following the signal path from the DAC output through to J1. If everything is OK, the Alta Pro 2000 is ready for use.

Install the unit in a suitable case. I mounted mine on the lid rather than at the bottom using screws, nuts, and long spacers. If you are using a metal case, be sure that the heatsinks for IC4 and IC5 do not touch the panel. The heatsink for IC6 should lay flat against the panel and will press up against the panel. Use nylon washers between the board and the nuts so that the nuts do not short any of the traces

on the bottom of the board.

A zero-insertion-force socket mounts in J1. You might find that a second 24-pin IC socket is needed between the ZIF socket and J1 so that the ZIF socket clears the panel.

Programming PLDs. To use the programmer, connect the unit to a serial port on your PC, power up the PC, power up the Alta Pro 2000, and start the program from a Windows95 or later DOS window with the command

```
altapro <x>
```

where x is the com port number connected to the Alta Pro 2000. A simple menu will be displayed. Before placing a chip in the ZIF socket, select the device type using menu option 1 (not having the correct device selected could burn out the chip).

The remaining menu selections should be self-explanatory. They allow you to read/write JEDEC files and load, program, and verify devices. If the device has a User Electronic Signature (UES), it is displayed for both the main and verify buffer in ASCII format.

That covers the details of the Alta Pro 2000. If you are new to programmable-logic devices, you should read some introductory articles such as the one that I wrote in the May 1994 issue of **Electronics Now**. Be sure to visit my Web site at www.altapro-engineering.com for the latest information on the Alta Pro 2000, including an updated device list and any last-minute changes or additions. There are also links to PLD manufacturers so you can get data sheets and free development tools. If you have questions, you can reach me by e-mail at alta@ieee.org. 

PEAK COMPUTING

(continued from page 24)

tional light source. You mount the slide or filmstrip to the LightLid 35, place it on the scan platen, and set the TWAIN driver for transparent media rather than reflective. Then the ScanMaker V6USL will let you

scan slides and film as well as paper originals.

To be honest, the quality of the scans when used in this mode, while acceptable, is not as good as using a specialized film scanner. At the same time, this feature comes free with a scanner that is, in other respects, an excellent value.

Like the Epson, the ScanMaker V6USL provides both USB and SCSI interfaces, making it usable with both PCs and Macs. A "Go" button offers single-touch scanning, and the scanner comes with a very nice bundle of software including *Photoshop LE*, *OmniPage LE OCR*, *PageKeeper* document-management software, and Microtek's easy-to-use *ScanWizard* TWAIN driver. Just to make the V6USL an even better value, it will scan documents up to legal size (8.5 x 14 inches).

TOO MANY FEATURES?

The three scanners presented here are all upscale models. You can get a basic scanner with 600 x 300-dpi resolution, for as little as \$50 after a mail-in rebate. If you haven't used a flatbed scanner before, starting with one of these inexpensive models may be the best way to get your feet wet. Then, after you have some experience, you may be in a better position to decide exactly what features you really want and need. 

Practical PIC Microcontroller Projects



This book covers a wide range of PIC based projects, including such things as digitally controlled power supplies, transistor checkers, a simple capacitance meter, reaction tester, digital dice, digital locks, a stereo audio level meter, and MIDI pedals for use with electronic music systems. In most cases the circuits are very simple and they are easily constructed. Full component lists

and software listings are provided. For more information about PICs we suggest you take a look at BP394 -- An Introduction to PIC Microcontrollers.

To order Book #BP444 send \$7.99 plus \$3.00 for shipping in the U.S. and Canada only to Electronics Technology Today Inc., P.O. Box 240, Massapequa Park, NY 11762-0240. Payment in U.S. funds by U.S. bank check or International Money Order. Please allow 6-8 weeks for delivery.

ET10

Capture voltages for easy measurement with the ANALOG MEMORY MODULE

Having difficulty keeping your eyes on your probe tips and meter at the same time? An “extra set of eyes” is on the way!

STANLEY J. YORK

Do you work with SMDs, SOICs, or other surface-mount components? Do you have to troubleshoot these circuits down to component level because of their small size?

If you do, then chances are you get nervous when you have to do any troubleshooting or make any adjustments on circuits using those tiny devices. It is so easy to slip off the pins on those small ICs and short out adjacent pins when you have to take your eyes off the probes to look at your voltmeter. What's more frustrating is that you could damage an otherwise functioning part, making a simple troubleshooting task a major rebuilding chore. I know, because I have done it myself. Wouldn't it be nice if you could just touch the pins you want to measure, remove the probes, and then read the meter?

If you need such a tool, then the *Analog Memory Module* presented here is just the add-on “technician's helper” you've been looking for. This is a circuit that you can use in conjunction with your present DVM or Simpson-type meter to capture and hold an analog voltage level automatically every time you touch the probes to the circuit under test. You can then remove the probes and read your meter in safety. As a bonus, you don't need a third hand to press a “sample” button. In addition to analog-voltage reten-

tion, the circuit also captures pulse-amplitude readings without the need for you to go to the bother of dragging out your oscilloscope (if you have one) and try to set it up to catch the pulse on the first

Memory Module's schematic diagram is shown in Fig. 1; refer to it during the following discussion. The circuit is built around two commonly available ICs, a quad op-amp (LM324, IC1) and one section of a quad bilateral CMOS switch (CD4066, IC2). As you will see, the circuit is quite straightforward and could be described as a self-triggering sample-and-hold circuit.

In operation, the two voltage probes are connected to circuit ground (J1) and one point of the resistor-divider string (R1, R2, and R3) to reduce the input signal level to a safe value for the op-amp. The input signal is then fed via R4 to the non-inverting input of IC1-a. That op-amp acts as a unity-gain buffer for the following stages. The output from IC1-a is then split three ways:

Branch 1—The first branch feeds the inverting input of IC1-b through R5, which acts as a pulse generator. Note

there are no feedback elements in this stage, so the gain is equal to the open-loop gain of the op-amp. The positive input is tied to approximately one volt above ground via resistor divider R6 and R7. Op-amp IC1-b thus serves as a comparator, generating an output pulse each time pin 6 rises above pin 5. These



attempt.

The finished unit fits in a shirt pocket, simplifying the juggling of test equipment should you have to work in a confined area.

Circuit Description. The Analog

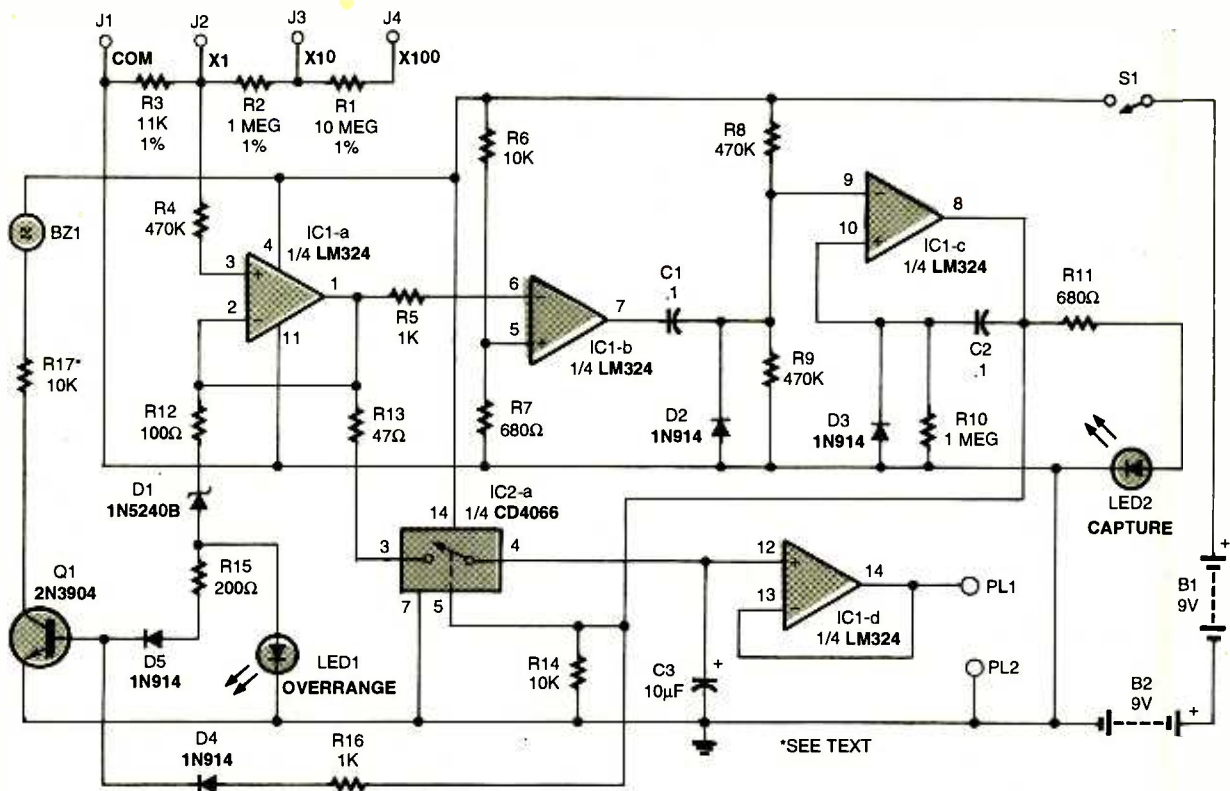

Fig. 1. The Analog Memory module is a basic self-triggering sample-and-hold circuit that can measure and capture DC voltages up to 1000 volts.

pulses are then AC coupled through C1 to the inverting input of IC1-c, which is wired as a simple one-shot monostable multivibrator. Diode D2 clips the negative-going portion of the pulse, preventing IC1-c's input from latching up. Resistor R10, along with C2, sets the time constant for the one shot. Each time the one-shot triggers, LED2 will emit a brief flash, indicating a signal capture.

Branch 2—The second branch from IC1-a goes to one input of the CMOS bilateral switch (IC2), which (in its untriggered state) presents a very high impedance (several megohm) to the signal. When the gate is triggered by IC1-c and the switch closes, the impedance across the device drops quickly to a very low value—typically a few tens of ohms. That lets capacitor C3 charge rapidly through R13 to the value of the incoming signal. When the one-shot times out, the CMOS switch opens again, preventing the charge on C3 from leaking off. The charge on the capacitor is then buffered by IC1-d before being

presented to output terminal PL1. A convenient ground reference, PL2, accompanies PL1. The time constant of the R13/C3 combination is chosen for the fastest response time to signal change and best voltage retention. Here, the time constant is about one millisecond.

The time that the capture "window" is open to allow the capacitor to charge should be several times this value. In this circuit, the window is open for about 50 milliseconds, allowing the capacitor voltage to get within a few millivolts of the voltage on pin 1 of IC1-a.

At the same time that the window is open and LED2 is flashing, a pulse will also be driven into the base of Q1 via D4 and R16. When Q1 conducts, BZ1 sounds a short beep. The end result is that whenever a reading is successfully captured, the circuit will give both an audible and visual indication.

Branch 3—The third branch from IC1-a drives Q1 via R12, D1, R15, and D7. This branch will not do anything for a normal reading, but will become active only if the signal

presented to IC1-a is too high, and therefore out of range. If that signal is over about 11 volts, Zener diode D1 will conduct. The current flow will light LED1 and turn Q1 on, sounding the buzzer.

How can you tell if the buzzer is alerting you to a successful capture of an overvoltage condition if you can't look at the LEDs? Simple—if the buzzer emits a long sound when trying to take a reading, then the signal is out of range and the voltage at PL1 is probably wrong; a short chirp means a successful capture.

With two 9-volt batteries powering the Analog Memory Module, full-range readings are accurate in the normal 0-10-, 0-100-, or 0-1000-volt ranges. The LM324 output can go within a volt or so of the supply rails, suggesting that the reading range could be extended beyond those presented here. Nevertheless, it was decided to limit the output range to something convenient and to be in line with commonly available instruments.

Construction. Before you start construction, look at the Parts List to make sure you have everything you need. It is very frustrating to find half way through a project that a certain part is the wrong size or value. Also, at this stage, make sure that the components you are using will fit on the board and inside the case you have selected. If you have to use a part different than those specified, you should allow for changes on the board before you start construction, which might be difficult or impossible after assembly has started.

The prototype Analog Memory Module was built on a piece of RadioShack perfboard with special copper-trace patterns etched on one side. The following instructions relate to that method of construction. If you wish, you may certainly build the unit on a printed-circuit board. However, designing such a board is beyond the scope of this article and is left up to the reader.

The suggested component layout is shown in Fig. 2, with the wire interconnects shown in Figs. 3 and 4. Note how some components are mounted vertically while others are mounted horizontally. The diagram indicates which way to place the bodies of the vertical components. Most of the signal diodes are mounted vertically; they are mounted with their bands (cathode end) pointing up, away from the board.

One construction method is to install and solder the wires and small components first, working your way up to the larger devices. That way allows you to press the board down on a piece of soft foam rubber during soldering. That holds the components flat to the board while you solder them in place, resulting in professional-looking workmanship.

You could also install all components, "clinching" (folding over) and trimming their leads so that they lock into the board. You can then install the jumper wires without the occasional aggravation of undoing a connection that was soldered too early.

However you decide to build your board, check your work when

you are done for the "usual suspects" of poor workmanship: bad solder joints, solder "bridges," missing components, incorrect values, polarized components installed backwards, and so on. It's usually a good idea to do this check after you've rested for a while. Any experienced electronics hobbyist can tell stories of looking over their work the next day and wondering, "How could I have been that sloppy?"

(Editor's note—Since it is a CMOS device, good design practice dictates that you should also ground all of IC2's unused input pins. Although the author's prototype works as advertised, it is always better to err on the side of safety.)

Once you are satisfied with your work, put a dab of RTV silicone insulation on R1's leads and solder connections. This resistor might see 1000 volts; the extra insulation will minimize the possibility of high-voltage creep or arc-over on the surface of the board.

Case Preparation. If you use both the board and plastic box recommended in the Parts List, you should have no problem fitting one inside the other. However, if you chose a different box or used different components, you should check to make sure that you have enough room to install the board, buzzer, batteries, and terminals.

Prepare the case while the RTV on the board is curing. On the author's prototype, the LEDs, S1, and the circuit board were mounted on the lid; the various jacks were placed on the ends. You can see the general layout in Fig. 5. When marking the holes for the circuit board, try to keep the board as far to one end as you can without the board interfering with the lip of the case and lid. You should also mount the board over the batteries, leaving room for S1's body at the "empty" side of the case.

A drilling guide for the terminals is

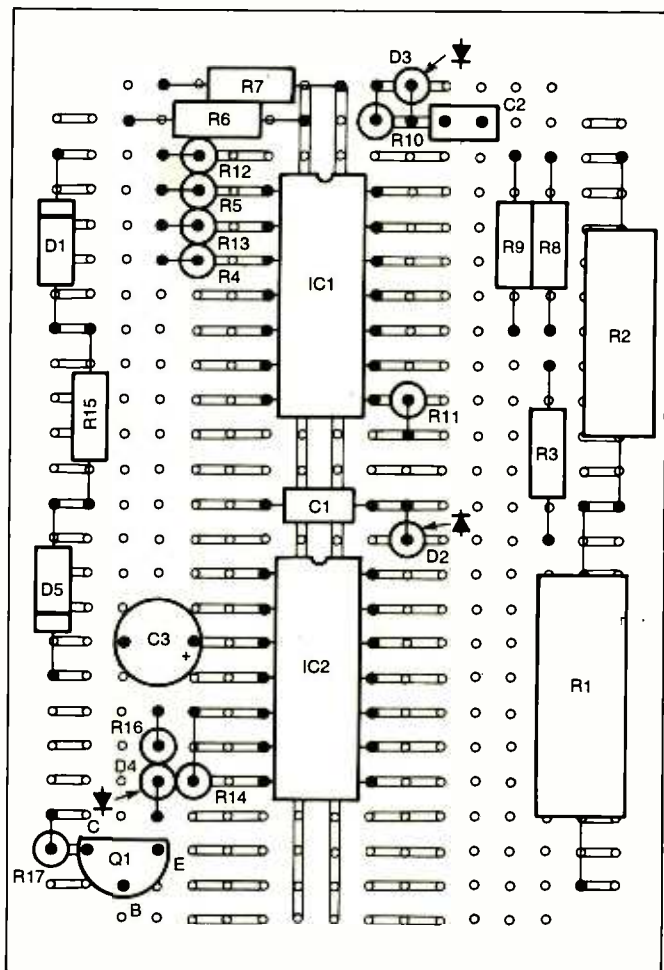

Fig. 2. The Analog Memory Module uses a plain experimenter's perfboard.

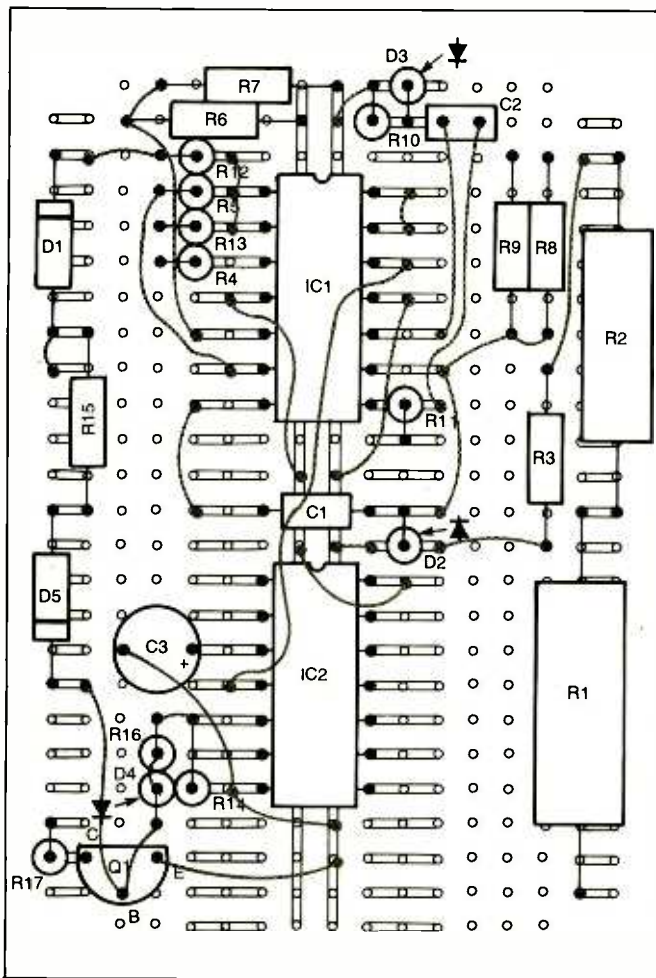

Fig. 3. Adding jumpers to the perfboard is as easy as "connecting the dots."

shown in Fig. 6. Those jacks mount on the ends of the case. You might have to adjust the hole size to the particular jacks that you're using. Remember, J4 could potentially go up to 1000 volts, so try to allow as much space as you can around that terminal. Finish the outside of the case by applying press-on lettering to identify the terminals and LEDs.

The battery clips are mounted on a piece of plastic that measures $1\frac{1}{2} \times \frac{3}{8} \times \frac{3}{4}$ -inch in size. Drill and tap three 4-40 holes through the block as shown in Fig. 7. Mount the battery clips on one side of the block using short 4-40 screws. Place the assembly in the bottom of the box as shown in Fig. 5 and use another short screw through the small hole to hold the block in place at the end of the box.

Install the probe terminals next with solder lugs underneath the nuts. If you are careful and choose

the right drill size, the LEDs can be press fit in place; a small dab of RTV can act as a "safety net."

The buzzer is small enough that it can be glued in the bottom of the case. Placing the buzzer near J1 is a good spot, leaving plenty of room to get the batteries in and out.

Mount the board to the top of the box using nylon screws only and test fit in the box to make sure you have adequate clearance around the high-voltage terminals. The use of nylon screws here cannot be overemphasized since the high-voltage end of R1 is very close to one of the nuts that hold the board in place.

Finish up the final assembly by installing all the wiring to the various switches, connectors, and battery clips (see Fig. 8). Use heatshrink tubing on all the terminals. As an extra precaution, the wire carrying the high voltage from J4 to the board

should have a length of heatshrink tubing around it as well.

Testing And Calibration. To test the unit, you will only need a regular DVM or Simpson-type moving-coil meter.

Begin testing the board by installing one of the batteries and only one pole of the other battery; use your meter (set to a low-current range) to complete the circuit and measure current draw. Switch the unit on.

You might hear a short beep from the buzzer and one of the LEDs might briefly flash. After a couple of seconds, the current draw should be less than about 10 mA (in my units, typical current draw at this stage was about 5 mA with no LEDs on). There should be no LEDs illuminated, and the buzzer should be quiet. If you see much more current than this, you should turn the unit off and investigate. There might be a diode installed backwards or a wrong resistor value somewhere. Also, make sure that there are no solder bridges or other short circuits.

If everything checks out, turn the unit off, remove the meter probes, and connect the batteries properly. Insert the meter probes into J1 (black) and J2 (red). Set the DVM to the ten-volt range and plug the Analog Memory Module into the DVM (PL2 goes to the common input and PL1 goes to V_{in}). Turn the unit on.

The green "capture" LED may briefly flash, and the buzzer may emit a short beep. The DVM should be indicating no voltage or, at least, very little. If you see a high reading or if the voltage slowly rises on the meter, you may have a leaky CMOS switch or a bad op-amp. Replace those parts as needed before you go any further.

Touch the red test probe to the positive end of B1. The green "capture" LED should glow for about 50 milliseconds or so, and the buzzer should beep. The DVM should read the battery voltage (about 9 volts, depending on the health of the Analog Memory Modules batteries). The red "overrange" LED should remain off.

Now touch the red probe to the

PARTS LIST FOR THE ANALOG MEMORY MODULE

SEMICONDUCTORS

- IC1—LM324 quad op-amp, integrated circuit
 IC2—CD4066 quad CMOS bilateral switch, integrated circuit
 Q1—2N3904 NPN silicon transistor
 LED1—Light-emitting diode, red
 LED2—Light-emitting diode, green
 D1—1N5240B 10-volt, 1/2-watt Zener diode
 D2–D5—1N914 silicon switching diode

RESISTORS

(All resistors are 1/2-watt, 5% units unless otherwise noted.)

- R1—10-megohm, 1%, 2-watt
 R2—1-megohm, 1%, 1-watt
 R3—111,000-ohm, 1%
 R4, R8, R9—470,000-ohm
 R5, R16—1000-ohm
 R6, R14—10,000-ohm
 R7, R11—680-ohm
 R10—1-megohm
 R12—100-ohm
 R13—47-ohm
 R15—200-ohm
 R17—10,000-ohm (see text)

CAPACITORS

- C1, C2—0.1- μ F, ceramic-disc
 C3—10- μ F, 25-WVDC, electrolytic

ADDITIONAL PARTS AND MATERIALS

- J1–J4—Banana jacks (to suit voltage probes)
 PL1, PL2—Banana plugs (to fit meter)
 S1—Single-pole, single-throw toggle switch
 BZ1—Buzzer (RadioShack 273-059 or similar)
 B1, B2—9-volt battery
 Battery holders (RadioShack 270-326 or similar), battery connectors (RadioShack 270-325 or similar), plastic enclosure (RadioShack 270-222 or similar), perfboard (RadioShack 276-150 or similar), wire, meter probes, 14-pin IC sockets, 4-40 \times 1/4-inch spacers, 4-40 flat-head nylon screws, 4-40 nuts, etc.

positive end of B2. This time, in addition to the green "capture" LED, the red "overrange" LED and buzzer also come on and stay on as long as the probe is trying to read an 18-volt level. Touch the red

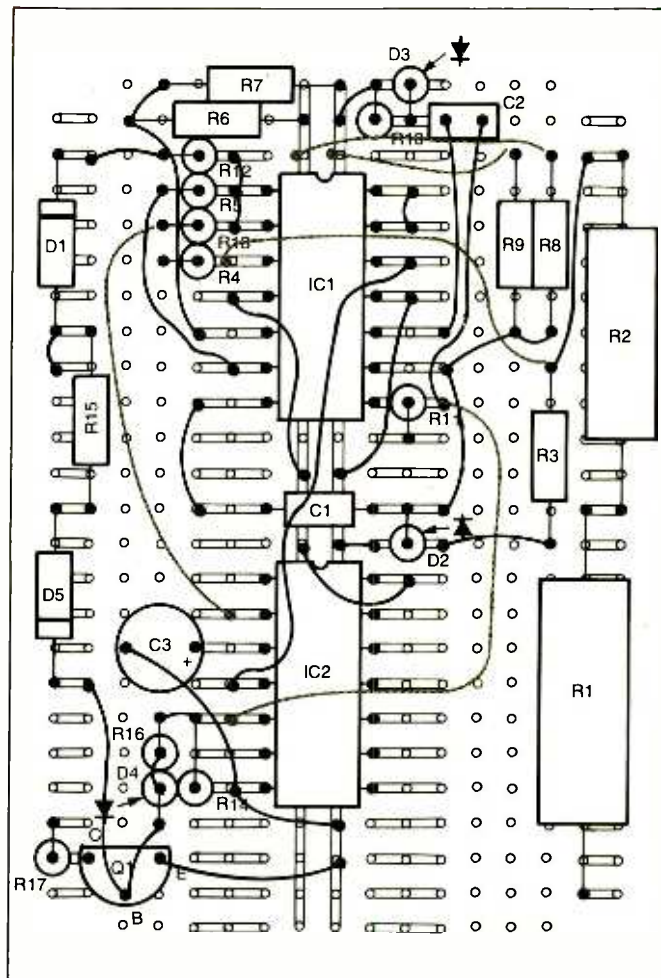

Fig. 4. Here are the rest of the jumper locations. You might want to ground the unused inputs on IC2 for added circuit stability.

probe to the previous test point and notice once again that the green LED comes on, but not the red one, and that the reading on the DVM returns to 9 volts or so. Move the red test probe to J3 (X10 position) and try the 18-volt test again. You should now obtain a normal reading without the over-range indication; the meter should read about 18 volts (1.8×10).

If you have access to a pulse generator, you can test the pulse-capture feature. Keep in mind that pulses must be longer than the 50 millisecond capture window designed into the circuit. Set up the pulse generator for a 100-millisecond single shot and the peak amplitude to some known level. Connect the pulse generator's output to the appropriate input jacks on the Analog Memory Module and your DVM to the module's outputs. Turn everything on and trigger the pulse

generator. The Analog Memory Module should capture the pulse and display the amplitude on your DVM. Adjusting the pulse amplitude and triggering another pulse should capture and display the new value. Let's see you do that without the Analog Memory Module!

One final test before closing up the case is to compare the indicated voltage with the actual input voltage. A 3½-digit DVM is adequate for this test. If you use a Simpson-type meter, you should try to use the lowest voltage range available that will cover about 9 volts.

Measure and note—as accurately as you can—B2's voltage with the meter. Measure the voltage with the Analog Memory Module on the X1 range and compare the two readings. They should be identical (within a few millivolts, anyway). Any large difference should be investigated. You might have a bad op-

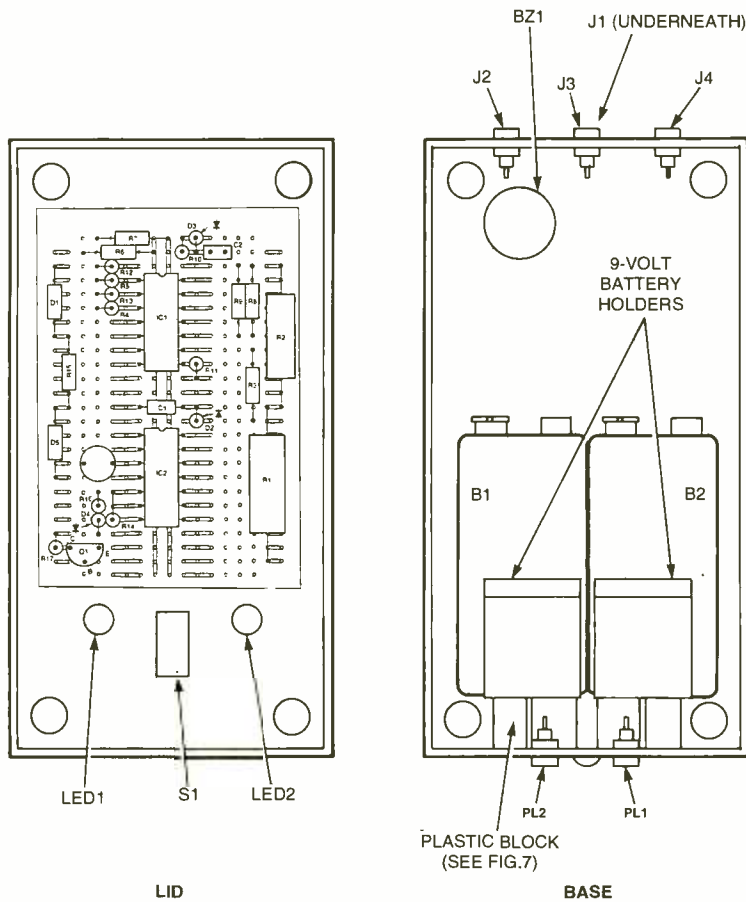

Fig. 5. The circuit board mounts on the case lid along with the controls and indicators. The main part of the case is reserved for bulky items like batteries and buzzers.

amp, a leaky CMOS switch or capacitor, or you may have a wiring error or wrong resistor value somewhere. If the readings are the same, switch to the X10 range and repeat the test, using both batteries.

If your unit passes this test OK, then you can go ahead and close

it up. Make sure, when you do the final assembly, that you have adequate clearance around high-voltage resistor R1 and that the batteries cannot slip and touch the input or output terminals.

Using The Module. This device is good only on DC voltages within the range of 0-1000 volts, which should cover most situations likely to occur in your garage or hobby shop. There are, however, some suggested modifications at the end of this article that might extend the usefulness of the device.

In normal day-to-day use, you need only to connect your test probes to the input terminals and connect your DVM (set to the 10-volt range) to the output terminals. Each time you touch the test probes to a test point, the one-shot in the module is triggered and updates the reading on your DVM regardless of whether it is higher or lower than the previous reading. I found on one of my units that I

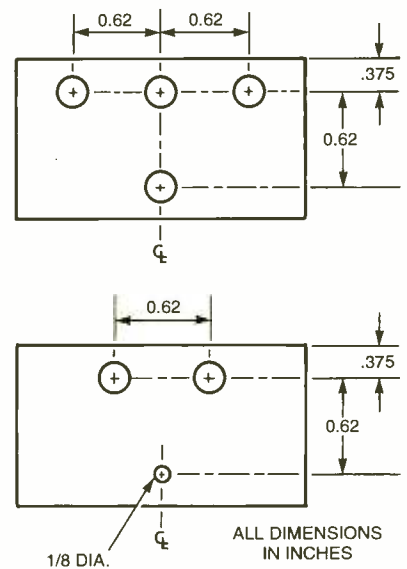

UNMARKED HOLES ARE 1/4 DIA.

Fig. 6. The author's prototype has the connectors mounted on the ends of the case. One end is for the input jacks; the other is for the outputs (and for mounting the battery clips).

sometimes had to stab the probe twice to get an accurate reading. If you find that you are getting inaccurate readings, it is probably because the timing is not exactly right between the CMOS gate opening and the charge building up on the capacitor. You may want to try stabbing the probe twice to see if your final reading is closer.

You don't necessarily have to connect the DVM to the device until after you take the reading. If you are in a cramped position—the back of a TV set, for example—you can take the reading with just the Analog Memory Module, go back to your workbench, and plug in your DVM. The unit has quite a

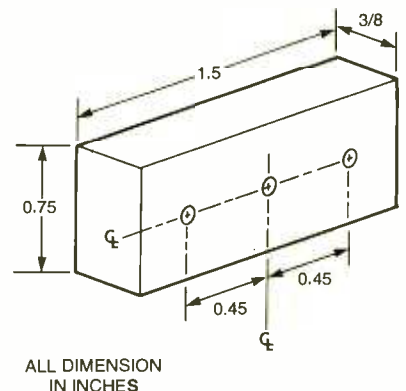

Fig. 7. This small plastic block holds the battery clips.



The completed Analog Memory Module is ready to make your life easier.

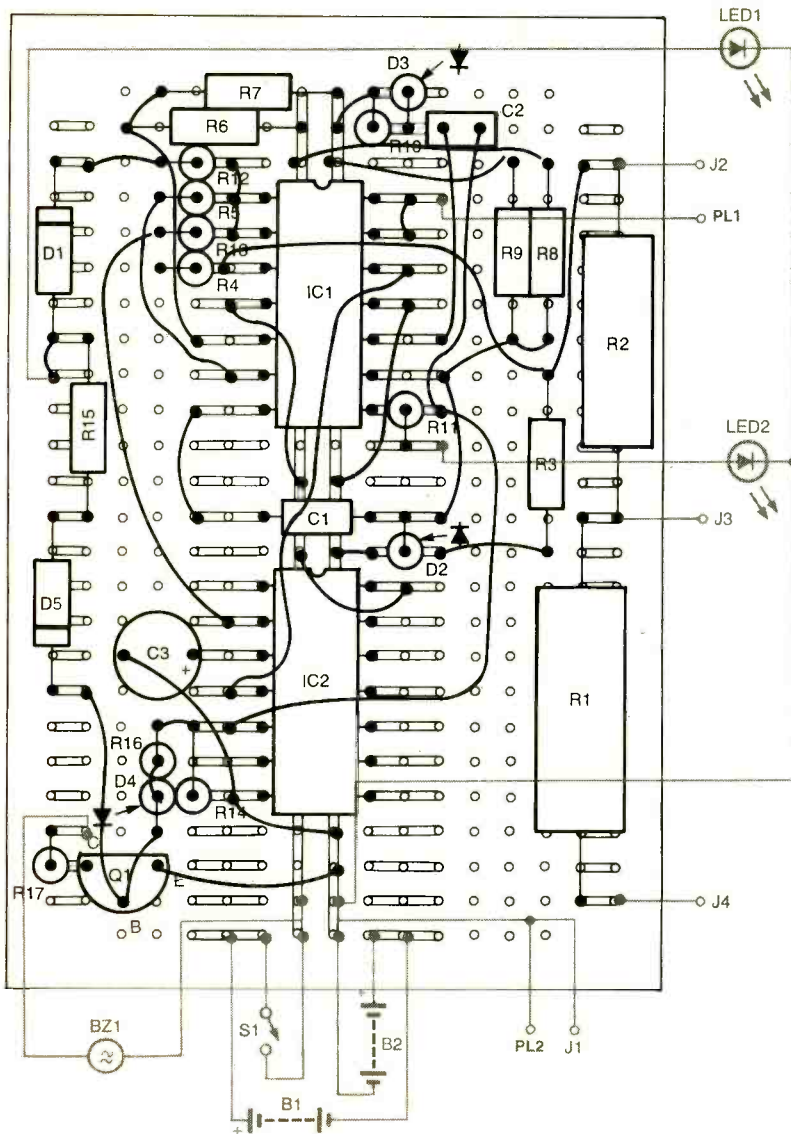

Fig. 8. When everything is mounted in the case, make the final wiring connections as shown here.

memory, and should retain the last reading for a couple of minutes if you were careful when building it and used good quality components.

Modifications And Suggestions.

Although the Analog Memory Module is a valuable addition to your tool box, there are a few modifications you may want to consider.

To capture a fast or narrow pulse, it will be necessary to reduce the sample-and-hold circuit's time constant (IC2 and associated components) and the capture-window opening time. To do that, reduce the value of R13 or C3 to give the circuit a fast timing cycle and reduce the gate time on the CMOS switch by changing the values of R10 and C2 in the one-shot

circuit. In any event, the window opening time must be shorter than the expected pulse width. Be careful when experimenting with these values, because they also affect the memory-retention time.

To make the unit a universal AC/DC module, some means of converting the AC signal to a DC level equal to the RMS value must be devised—a modification that is beyond the scope of this article. However, you could experiment with a different attenuator string and a rectifier arrangement or perhaps a precision-rectifier circuit using an op-amp. That would require more input terminals or an AC/DC switch.

A word on the buzzer: You might find that the suggested buzzer is too

loud. That is why R17 is in the circuit—to tone the buzzer down. You may adjust the value of R17 to give the buzzer a comfortable sound level.

I have built several units for myself and friends. We've used them with everything from old Simpson meters to the latest digital offerings. Once you start to use the Analog Memory Module, you'll find that troubleshooting those SOICs or SMDs is not so bad after all. P

An Introduction to Light in Electronics

An Introduction to Light in Electronics

F. A. WILSON



Taken for granted by us all perhaps, yet this book could not be read without it, light plays such an impressive role in daily life that we may be tempted to consider just how much we understand it. This book makes a good start into this fascinating and enlightening subject. It has been written with the general electronics enthusiast in mind.

To order Book #BP359 send \$6.99 plus \$3.00 for shipping in the U.S. and Canada only to Electronics Technology Today Inc., P.O. Box 240, Massapequa Park, NY 11762-0240. Payment in U.S. funds by U.S. bank check or International Money Order. Please allow 6-8 weeks for delivery.

ET08



YOU CAN WIND YOUR OWN COILS?

There's no trick to it except knowing what you are doing. In a unique, 106-page book you can become expert in winding RF, IF, audio and power coils, chokes and transformers. Practically every type of coil is discussed and necessary calculations are given with the mathematical data simplified for use by anyone. Get your copy today!

Mail coupon to:

Electronics Technology Today, Inc.
P.O. Box 240
Massapequa Park, NY 11762-0240

Please send me my copy of *Coil Design and Construction Manual* (BP160). I enclose a check or money order for \$8.99 to cover the book's cost and shipping-and-handling expenses. NY state residents must add local sales tax.

Name _____

Address _____

City _____ State _____ ZIP _____

All orders must be paid in U.S. funds only. Sorry, no orders accepted outside of USA and Canada. Please allow 6-8 weeks for delivery. **ET07**

www.americanradiohistory.com

February 2001, Poptronics

43

NEW LITERATURE

(continued from page 7)

Reprinted from *QST*, these collected columns are full of helpful tips on all ham subjects, from hand-held transceivers to antennas, from batteries to computers, and from digital modes to microphones. There are hundreds of ideas, projects, and techniques that will help readers solve problems, improve skills, and have more fun on the air.

Millennium Catalog

from C&S Sales

150 W. Carpenter Ave.

Wheeling, IL 60090

800-292-7711 (orders)

or 847-541-0710 (information)

www.cs-sales.com

Free



This 62-page full-color catalog includes products from Fluke, Elenco, Hitachi, and B&K Precision, among others. A color photo, full specs, description, and price information accompany each product.

It offers an extensive selection of capacitance meters, function generators, multimeters, oscilloscopes, power supplies, soldering irons, and hand tools, among other products. There are numerous kits: educational, robotic, solar, and solderless, as well as books and videotapes.

Practical Acoustics

by Stephen Kamichik

Prompt Publications

Howard W. Sams & Company

2647 Waterfront Parkway, East Drive

Indianapolis, IN 46214-2041

800-428-7267

www.hwsams.com

\$29.95



A full understanding of acoustics—the physics of sound—requires learning about both theory and practice. The book is a two-part in-depth study of the science of acoustics. The first part covers the theory, from acoustical waves and decibels to speakers and underwater acoustics. The second part contains eight chapters of projects, including speaker enclosures and a graphic equalizer.

It is a useful learning tool for the beginner, a resource for anyone who wants to refresh and update their knowledge, and a handy reference for anyone in the field.

DeForest: Father of the Electronics Revolution

by Maurice H. Zouary

1st Book Library

2511 West Third St., Suite 1

Bloomington, IN 47404

800-839-8640 (or-email pat@1stbooks.com)

www.1stbooks.com

\$14.14 plus S&H (discount price through Web site only, higher price at bookstores and amazon.com)

This 400-page “documentary in print and graphics” explores the beginnings of the electronics industry—how Lee



DeForest's invention of the Electron Tube Amplifier in 1906 changed the world. This book takes readers into his early research career—his failures, successes, and breakthroughs, looking at his pioneering in wireless telegraphy and his groundbreaking inventions.

The author owned and operated a library of stock footage of rare film starting from 1898, including early vintage films with soundtracks. After thorough and painstaking investigation, he discovered that those sound-on-film productions were the original production negatives of DeForest Phonofilms, produced between 1920 and 1927. (Exclusive examples of original DeForest sound-on-film productions in 35-mm blow-ups are included in the book.) This discovery led him to delve into DeForest's life and work and to his conclusion that Dr. DeForest should be recognized as the Father of Modern Electronics.

Car Stereo Speaker Projects Illustrated

by Dan Ferguson

McGraw-Hill

2 Penn Plaza, 12th Floor

New York, NY 10121

800-2MCGRAW

www.books.mcgraw-hill.com

\$29.95

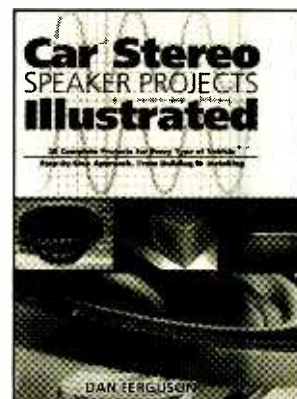

Speakers are the pivotal ingredients in any sound system. This heavily illustrated, step-by-step guide puts leading-edge auto speakers within anyone's grasp, with 20 complete speaker projects for all kinds of vehicles.

Using up-to-date designs and techniques, the author explains how to build and install speakers that put recording-

(Continued on page 56)

Changing Of The Guard

Q Why are YOU the new moderator of the "Q & A" column?—D.H., Harviell, MO

A I was wondering the same thing. I may still be wondering next year. Let's make that the first question this month.

After a great "term of office" by Michael Covington, I'll be taking the reins of the "Q&A" column beginning this month. I'm going to have to read the columns I write to find out why Larry Steckler and Joseph Suda selected me as the person to succeed Mike.

A hobbyist since 1960 (when I was in the fifth grade), I made electronics my profession—first as a technician and then as a teacher. Between the U.S. Navy and Tektronix, Inc., I spent 12 years on the bench as a test-equipment-repair and calibration technician. I began teaching electronics in 1982 at the Francis Tuttle Vo-Tech Center (now the Bruce Gray Technology Center) in Oklahoma City. After 15 years there, I moved to a teaching position in south-east Missouri.

My hobby started when I used a wood-burning iron to resurrect a three-transistor radio that I'd found in the trash. Over the years, I built a series of Knight-Kit and Heathkit test instruments and communications gear. I also built one of the first MITS Altair 8800 computers introduced in **Popular Electronics** back in January 1974. I love finding an application that can be satisfied with an electronic circuit and then designing, building, and testing that circuit.

I'm a stickler for the appearance of the finished product. Over the past several years, I've been finding great enjoyment in the restoration of antique radios and test equipment.

If I have one major fault, it would be that I'm frugal when it comes to my projects. Because I have a huge stock of TTL ICs and discrete semiconductors, I'll design a circuit using those components rather than using a microproces-

sor of some kind. The acme of this frugality came when I built a "Tektronix" 212 handheld oscilloscope and a 465DM44 portable scope, both constructed completely from discarded, defective circuit boards.

go low.—A. G., Ann Arbor, MI

Binary-to-Bargraph Converter

Q Is there an IC that converts a binary input into a bargraph-like output? It would be similar to a 3-to-8 decoder except that the output of lower order would stay low as the binary input is increased in value. A binary 111 would cause all of the outputs to

A In a follow-up e-mail, A.G. independently came up with a solution identical to ours, as shown in Fig. 1. A cascading AND-gate structure at the output of a standard decoder gives us the bargraph display we need. If the binary input is 011, IC1-d will go low, disabling every AND gate under it and causing the respective LEDs to remain on. A four-bit circuit would require a 74154 and three 7408 AND-gate ICs. At that point, one might instead consider programming a pair of EPROMs for the proper logic and, depending upon the application, buffering the outputs.

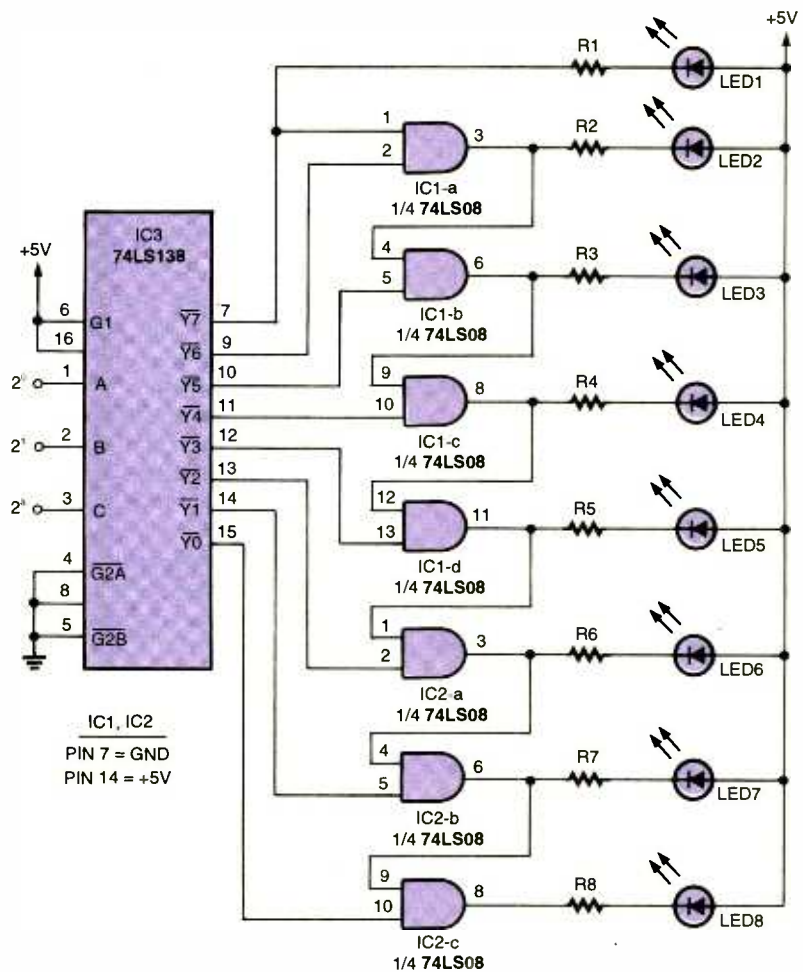

Fig. 1. This binary-to-bargraph decoder uses cascading AND gates. The circuit is easy to expand by continuing the obvious scheme with a larger decoder such as a 74LS154 and more gates or by using an EPROM as suggested in the text.

A DMM On A Car Battery

Q How could I get to use my DMM on a car? The idea seemed simple enough, using a 12- to 9-volt adapter to connect my meter to the cigarette-lighter socket. When I try to do that, my DVM display shows "1" when I ground the negative lead and check a power line on the car's electrical system. What's going on?—M.H., Toronto, Ontario

A The manufacturer of a line-operated digital multimeter (DMM) designs the instrument with the input leads isolated from the power supply and earth ground so that they can be reversed with no ill effects.

The hand-held DMM has inherent isolation in a plastic box. However, when you open up the battery compartment and connect the DMM right to the auto's electrical system, no longer is there any isolation between meter and the device under test—the car. Since you don't know how the supply and measurement section are interconnected internally, it's very possible that you are subjecting the DMM to the electrical equivalent of the mythical snake eating itself tail-first. In fact, I wouldn't be surprised if the display went a little nuts if you connected only one of the leads to ground or the hot wire. Moral of the story: drop \$3 on a decent 9-volt alkaline battery and keep the car out of the innards of the meter. With the new battery installed, you might check the meter for any damage that may have occurred.

Finding Manuals

Q You're my last resort. I was given a 1608A Impedance Bridge and a 1900A Wave Analyzer, both from General Radio, but I have no manuals or schematics. Where do you look for manuals? Are the instruments worth keeping and of what use would they be to a ham?—L.M., Eden Prairie, MN

A Top-notch, lab-grade test equipment has been hitting the surplus shelves at bargain-basement prices over the past several years. However, manuals are rarely supplied with them, leaving a hobbyist without operating or maintenance information for some really complex instruments. There are several Internet resources for test equipment manuals. For less popular instruments, such as the GR brand, you have to

INTERNET RESOURCES FOR MANUALS AND INSTRUCTION SHEETS

bama.sbc.edu (downloadable—vintage equipment)
w7fg.com
www.acadia.net/guest/michelle (consumer electronics)
www.agtannenbaum.com/catalog.html
www.circuitarchive.co.uk/hewath.htm (downloadable Heathkit manuals and schematics)
www.columbiaelectronics.com/index.htm (military communications)
www.falls.igs.net/~testequipment/manuals.html (rental)
www.hi-manuals.com
www.manualman.com
www.manualsplus.com
www.nostalgiaair.org/NostalgiaAir/schematics/tei (downloadable—antique electronics)
www.one-electron.com/filing_cab.html (specific links to schematics)
www.sarrio.com/sarrio/rsfinal1.html
www.surplussales.com
www.tiac.net/users/mgasman (audio and video)
www.treasurechestcorp.com (consumer electronics)
www.vacuumtube.com/schemati.htm (vintage hi-fi)
www.vacuumtubes.com/manuals.html (tube testers)

search them all. For purchase, the 1608A manual can be found at *Manual Man* and the 1900A at *A.G. Tannenbaum*; both are available for rent from W.J. Ford. The manuals will explain how these instruments can be used in ham radio for your specific situation.

The "How to Get Information" sidebar that accompanies each "Q&A" column is only a starting point. Many of our readers might be interested in a more comprehensive list of Internet sites, where you can find manuals and schematics for nearly anything having to do with test equipment, consumer electronics, communications, or antique electronics. I've listed some of those resources in the accompanying sidebar. Most have their manuals for sale; a few dealing with antique electronics are downloadable; and one has manuals that you can rent for a short time, copy, and return.

Readers, let us know if you have other manual sources.

What happened to C.R.E.I.?

Q In the May 2000 issue, you answered a letter regarding the current location of

National Technical Schools. I graduated from "CREI" (Capitol Radio Electronics Institute) in 1949 and have made my way in electronics through all the changes for 50 years. Not only did CREI teach me the state of the art in electronics as of 1949, but, more important, they taught me how to teach myself. Whatever happened to CREI? They also advertised in your magazine.—E.F., Macon, GA

A CREI, located in the Washington, DC, area, not only had on-campus educational facilities, but they had the finest electronics-correspondence curriculum in the industry. While most correspondence schools pushed the test equipment and television kits that came with their courses, CREI was minimal on "hardware" and emphasized their detailed electronics-technology curriculum.

Capitol Radio Engineering Institute, like most institutions with "radio" in their names, realigned with current technology in the late 1970s and changed their name to Capitol College. They are now located at 11301 Springfield Road, Laurel, MD 20708; www.capitol-college.edu.

Dueling Radios

Q I'm in a situation where I'm forced to reside in a very confined area, and the men in this place all have problems that we have termed "Riding the Radio." There are a lot of radios within this confined area, each with an external antenna attachment. In such close proximity, the radios tend to rebel at our feeble attempts to pick up any station other than the local one. It seems that at approximately every 10 MHz, we get interference that literally locks out all reception. If one person wants to listen to 102.3 and someone else close by wants to listen to 92.5, then we are constantly at war with each other over our stations. What is the cause of this interference? Can it be stopped? Can I scavenge parts from another radio to fix the problem?—K.K., Tennessee Colony, TX

A Most inexpensive AM and FM radios have a local oscillator that is offset from the incoming station's frequency by 10.7 MHz (FM) or 455 kHz (AM). This local oscillator is like a little radio station in itself, mixing with the incoming carrier to form sum and difference frequencies. When one radio is in close proximity to another, these signals can be stronger than that of the radio station you're trying to receive. You'll notice

that the two stations in question are offset by approximately the 10.7 MHz offset mentioned earlier. The automatic-frequency control of an FM radio tends to pull the tuning over to the stronger signal, and there goes your reception.

One possible solution is to turn off the AFC if you have control of that. If your neighbors are listening to FM, you can switch to AM and probably take care of the immediate problem. Of course, if there are a lot of folks on AM in close confinement, you will have similar trouble. Relocating the radio on a different wall and/or with a different orientation

might help. Wrapping the radios in aluminum foil and grounding the foil to a cold-water pipe also may help, although you need to be careful doing that if the radio is a "hot-chassis" type with exposed metal parts. Switching to a modern synthesized radio could be the end of your problems, but that may also be an unreasonable solution. Beyond that, how about listening to cassettes?

Obviously, the solution cannot involve any "contraband" items, of which the aluminum foil may be one. Maybe some of our readers have some solutions to the "dormitory" radio duels.

HOW TO GET INFORMATION ABOUT ELECTRONICS

On the Internet: See our Web site at www.gernsback.com for information and files relating to **Poptronics** and our former magazines (**Electronics Now** and **Popular Electronics**) and links to other useful sites.

To discuss electronics with your fellow enthusiasts, visit the newsgroups sci.electronics.repair, sci.electronics.components, sci.electronics.design, and rec.radio.amateur.homebrew. "For sale" messages are permitted only in rec.radio.swap and misc.industry.electronics.marketplace.

Many electronic component manufacturers have Web pages; see the directory at www.hitex.com/chipdir/, or try addresses such as www.ti.com and www.motorola.com (substituting any company's name or abbreviation as appropriate). Many IC data sheets can be viewed online: www.questlink.com features IC data sheets and gives you the ability to buy many of the ICs in small quantities using a credit card. You can also get detailed IC information from www.icmaster.com, which is now free of charge although it formerly required a subscription. Extensive information about how to repair consumer electronic devices and computers can be found at www.repairfaq.org

Books: Several good introductory electronics books are available at RadioShack, including one on building power supplies.

An excellent general electronics textbook is *The Art of Electronics*, by Paul Horowitz and Winfield Hill, available from the publisher (Cambridge University Press, 800-872-7423) or on special order through any bookstore. Its 1125 pages are full of information on how to build working circuits, with a minimum of mathematics.

Also indispensable is *The ARRL Handbook for Radio Amateurs*, comprising over 1000 pages of theory, radio circuits, and ready-to-build projects, available from the American Radio Relay League, Newington, CT 06111, and from ham-radio equipment dealers.

Copies of past articles: Copies of past articles in **Electronics Now**, **Popular Electronics** (post 1996 only) and **Poptronics**

are available from our Claggk, Inc., Reprint Department, P.O. Box 12162, Hauppauge, NY 11788; Tel: 631-592-6721.

Poptronics and many other magazines are indexed in the *Reader's Guide to Periodical Literature*, available at your public library. Copies of articles in other magazines can be obtained through your public library's interlibrary loan service; expect to pay about 30 cents a page.

Service manuals: Manuals for radios, TVs, VCRs, audio equipment, and some computers are available from Howard W. Sams & Co., Indianapolis, IN 46214; (800-428-7267). The free Sams catalog also lists addresses of manufacturers and parts dealers. Even if an item isn't listed in the catalog, it pays to call Sams; they may have a schematic on file which they can copy for you.

Manuals for older test equipment and ham radio gear are available from Hi Manuals, PO Box 802, Council Bluffs, IA 51502, and Manuals Plus, PO Box 549, Tooele, UT 84074.

Replacement semiconductors: Replacement transistors, ICs, and other semiconductors, marketed by Philips ECG, NTE, and Thomson (SK), are available through most parts dealers (including RadioShack on special order). The ECG, NTE, and SK lines contain a few hundred parts that substitute for many thousands of others; a directory (supplied as a large book and on diskette) tells you which one to use. NTE numbers usually match ECG; SK numbers are different.

Remember that the "2S" in a Japanese type number is usually omitted; a transistor marked D945 is actually a 2SD945.

Hamfests (swap meets) and local organizations: These can be located by writing to the American Radio Relay League, Newington, CT 06111; (www.arrl.org). A hamfest is an excellent place to pick up used test equipment, older parts, and other items at bargain prices, as well as to meet your fellow electronics enthusiasts—both amateur and professional.

Power-Supply Connections

Q I have a Deltron RF20-1.5S power supply and would like to know what the symbols on the rear panel for the remote control mean.—S. G., San Leandro, CA

A Todd Reichenbach of Deltron was kind enough to fax some data for the RP series, which is similar. "B-" is the negative output and "S-" is the negative sense; these are normally linked together. "V-" is the voltage programming. "B+" is the positive output, "S+" is the positive sense, and "V+" is the voltmeter positive; these three are normally linked together. "N" and "I" are for current programming and are normally linked together. "G" is chassis ground.

Power supplies with "sense" inputs can be used to deliver the intended voltage directly to the load, compensating for any IR drop in the connecting leads—especially important with long wires carrying high current. In this case, instead of running just two wires from the supply to the load, you would break the connection between the "B-" and "S-" and the "B+" and "S+" at the supply and connect the load with four wires. The far ends of the "B+" and "S+" wires would be connected together at the positive side of the load; the same is done to the far ends of the "B-" and "S-" wires at the negative side of the load. The actual current-carrying conductors on the "B-" and "B+" terminals need to be heavier to minimize voltage drop. The two voltage sensing conductors on the "S-" and "S+" terminals can be of a smaller gauge since they don't carry the load current.

In this remote-sensing configuration, the power supply adjusts its voltage so that the output voltage you select will appear at the load. The voltage at the supply output itself will be higher to compensate for the IR drop on the lines. If you want the programming information or manual, contact Deltron, Inc., P.O. Box 1369, North Wales, PA 19454; sales@deltroninc.com.

2360 JRC?

Q I have a Smith-Corona 5A-1 typewriter with two blown ICs in the power supply. Those eight-pin DIPs are marked "2360D JRC." I haven't been able to find anything on them through catalogs or the Internet. Can you or other readers help?—B.M., Greensboro, NC

A JRC may be the giveaway here, standing for Japan Radio Company. Their 2360 and 2360A are DC-to-DC converters in eight-pin DIP packages. You can find them at www.njr.com/products.

And Are These FETs?

Q I have a serial interface with two transistors that I can't identify even after searching dozens of stores, Web sites, and catalogs. The manufacturer's logo makes me think that Harris Semiconductor is the manufacturer. The part number of the first is VN0610L; the other is VP0808L. Any help or cross-references would be great.—

E. E., Clermont, FL

A We immediately recognized the "VN" from VN10KN FETs. You have a couple of enhancement-mode MOSFETs there, and you can find the data on them on Siliconix's site at www.vishay.com/brands/siliconix/.

Writing To Q&A

As always, we welcome your questions. The most interesting ones are answered in print. Please be sure to:

(1) include plenty of background information (we'll shorten your letter for publi-

cation);

(2) give your full name and address on your letter (not just the envelope);

(3) type your letter if possible, or write very neatly; and

(4) if you are asking about a circuit, include a complete diagram.

Questions can be sent to Q&A, **Poptronics Magazine**, 275 G Marcus Blvd., Hauppauge, NY 11788, or e-mailed to q&a@gernsback.com, but please do not expect an immediate reply in these pages (because of our backlog) and please don't send graphics files larger than 100K. Due to the volume of mail, we regret that we cannot give personal replies. **P**

ELECTRONIC CIRCUITS

(continued from page 28)

goes to some other point in the external circuit. A stand-off insulator is shown here—a common method on TV/cable tuners—but other approaches are used as well. It is very important to keep the RFC-to-feedthrough-capacitor lead length as short as possible to limit additional pick-up beyond the filtering components.

Another approach is shown in Fig. 7. This method uses a separate shielded compartment inside the main shielded enclosure. Feed-through capacitors C1 and C2 carry the signal (DC or a low-frequency signal) into and out of the filter compartment. An inductor, L1, is part of the filtering, so the combination L1-C1-C2 forms a low-pass pi-configuration filter. The inductor may also be an RF choke, but the effect is the same.

One caution is in order: if LC filters are used on both input and output signal lines of a circuit, make sure they resonate on different frequencies. This will prevent them from forming a tuned-input/tuned-output oscillator if the circuit being protected has sufficient gain at the filter's resonant frequency.

Connectors with built-in filtering (Fig. 8) are also available. These products are usually described as *EMI-filtering connectors*. Although most of them are designed to work with 120/220-volt AC power lines, others are available that work at higher frequencies.

One last approach is shown in Fig. 9. This application is a little harder to see because the "filtering" is performed by using a set of one or more ferrite beads slipped over the wire from the connector pin to the circuit board. Ferrite beads surrounding a wire act like a small value RF choke, so they will filter (typically) VHF/UHF frequencies. It is common to see these beads on RF equipment, but they are also found on digital devices as well.

General Guidelines. Thus far, we've looked at a number of different filtering approaches to protecting equipment. Now let's consider the general guidelines:

Always shield the circuit—A circuit that is not shielded cannot be adequately protected by filtering. There is simply too much chance of direct pick-up of the EMI/RFI source by the components and wires of the circuit. In addition, filtering of EMI/RFI generators (such as transmitters) will not help much if the device is not shielded.

Apply filtering to the DC power lines—Power-supply lines entering or leaving the circuit's shielded enclosure are virtual invitations for stray signals to enter your device and "crash the party."

Use the minimum filtering necessary—Overkill is not necessary for accomplishing the level of protection required. It does no good to add one more section of filtering

when the job is done properly, but does add cost, complexity, and opportunities for failed components (which will keep the service technician busy, if nothing else).

Use the minimum values of capacitance or inductance—If it is necessary to filter signal-input and -output lines, choose values that are consistent with the degree of protection needed. Keep the cut-off frequency well away from the frequencies the circuit normally uses. The filtering will affect those frequencies as well as the undesired frequencies, so it is necessary to select values that minimize the effect on desired frequencies while maximizing the effect on undesired frequencies.

Final Notes. Filtering the DC power and signal lines entering or leaving a shielded circuit will go a long way towards eliminating any EMI/RFI problems that occur. There are, other active-filter techniques that can be used, but that subject can (and does) take up entire books. After all, the KISS principle—keeping it simple and stupid—increases reliability in the long run. Isn't that what we set out to accomplish in this article? **P**

**Get your copy of the
CRYSTAL SET HANDBOOK**



Go back to antiquity and build the radios that your grandfather built. Build the "Quaker Oats" type rig, wind coils that work and make it look like the 1920's! Only \$10.95 plus \$4.00 for shipping and handling. Clagg Inc., PO Box 12162, Hauppauge, NY 11788. USA Funds ONLY! USA and Canada—no foreign orders. Allow 6-8 weeks for delivery. MA01

Fuel Cells

We're going to start a short series on fuel cells. This month, we'll look at the status of fuel-cell technology, and we'll discuss how to construct a few different types of fuel cells in later columns.

Fuel cells came into public awareness in the early 1960s when NASA determined that fuel cells would be an ideal power source for America's spacecraft. Not only did fuel cells generate electric power, their waste product was drinkable water for the astronauts. The American space program, starting with Gemini series of spacecraft, had fuel cells as an integral part of the power supply.

That connection with space flight certainly promoted a high-technology aura around fuel cells. The truth of the matter is that fuel cells are not new devices. William Grove constructed the first electric-power-generating fuel cell back in the 1830s.

A Short History

The history of the fuel cell actually begins in 1786 when Galvani (an Italian anatomist) discovered that a dead frog's leg would twitch when touched with two different metals at the same time.

In 1800, Alessandro Volta replaced the frog legs with a cloth soaked with salt water. He placed alternating discs of zinc and silver separated by a wet salt-soaked cloth and created the first battery (Volta's "pile"). Within a few weeks of this discovery, the English scientists William Nicholson and Sir Anthony Carlisle performed the first electrolysis demonstration, breaking water down into oxygen and hydrogen.

The next step occurred in 1838, when William Grove demonstrated that the electrochemical dissociation of water is reversible. Grove trapped hydrogen and oxygen in an electrolytic cell in a way that the gases remained in contact with the solution and the platinum gas-generating electrodes. After electrolyzing the water, Grove disconnected the battery. A meter connected to the two electrodes showed an electrical potential of about one volt.

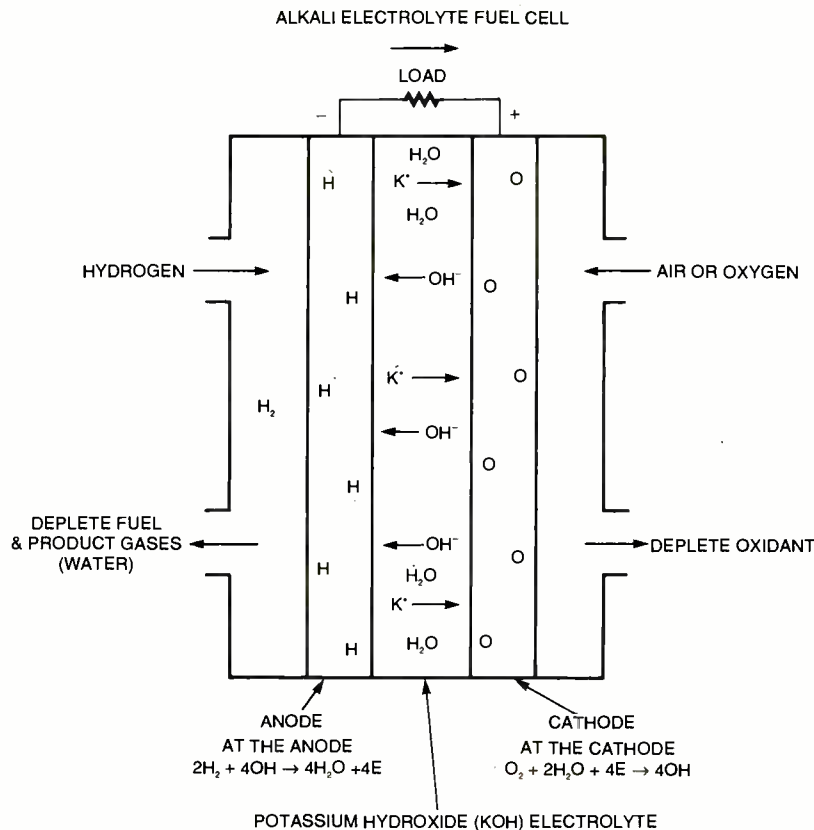

Fig. 1. Here is a cross-section of a typical fuel cell.

Batteries With A Fuel Tank

Fuel cells and batteries are both electrochemical devices that convert chemical energy into electrical energy. In a battery, the chemical reactants are stored internally. When the reactants are exhausted, the battery is replaced (or in some cases recharged). Fuel cells use reactants (fuel) stored externally. As long as there is fuel, a fuel cell will (in theory at least) continue to generate electricity.

Figure 1 is the schematic of an alkali fuel cell. We'll be building such a cell when we're ready to "get our hands dirty." This is the type of fuel cell used in U.S. spacecraft. The first oddity that you might notice is that the anode is labeled "-" and the cathode is labeled "+" When I first started looking at fuel cell schematics, I found this confusing. Actually, I thought it

was a mistake, but after looking at a few dozen schematics with the same error, I realized it couldn't be a mistake. Accordingly, I checked the definition of cathode in Oxford's Dictionary of Current English. It reads in part:

Cathode—1. negative electrode in an electrolytic cell. 2. positive terminal of a battery.

I only bring this up so that you don't become confused when studying other schematics of fuel cells, since all the schematics I've seen so far follow this convention.

We'll go over the actual electrochemical mechanism involved in generating electricity when we build this fuel cell.

Fuel-Conversion Efficiency

The internal-combustion engine—ubiquitous in our culture and civilization—is a common measuring stick of fuel efficiency. Something that uses fuel more efficiently than an internal combustion engine is good, something less efficient is bad.

Here is where fuel cells shine. They have efficiency that is two to three times greater than the internal-combustion engine. Why is a fuel cell so much more efficient? An internal-combustion engine burns fuel, so the fuel is first converted into heat, and then into mechanical energy. The thermodynamics efficiency of a heat engine is given by the *Carnot cycle*, which states that even under ideal conditions, a heat engine can not convert all the supplied heat energy into mechanical force.

A fuel cell chemically converts the reactants into electricity without any intermediate heat-to-mechanical energy step. That's the fuel cell's "ace in the hole," yielding efficiencies that exceed the Carnot limit. A fuel-cell car will get much better mileage per "gallon" of hydrocarbon as compared to an internal-combustion engine.

Fuel cells are also more environmentally friendly than traditional fuel burners. When using hydrogen and oxygen as fuel, the fuel cell produces electricity, water, and heat.

The Electric Car

Many people assume that rechargeable batteries will be the power source for electric vehicles (EV). Fuel cells, however, are better candidates. Rechargeable batteries are heavy and require a substantial amount of recharging time. Fuel cells, on the other hand, are smaller and lighter; they generate electricity as long as they are supplied with fuel.

When a fuel cell starts running low, it can be simply refilled with fuel, much like today's automobile. A fuel-cell-powered vehicle will be able to get back on the road quickly as compared to waiting for batteries to recharge.

Fuel-cell technology is at the forefront of the technology for the new "zero-emission" cars that soon will be required by some states. For example, ten percent of all the new vehicles sold in California after 2003 must be zero-emission vehicles.

I've Seen the Future...Is it Hydrogen?

The vast majority of fuel cells are hydrogen/oxygen based. The hydrogen

can be a pure gas, a liquid, or a gaseous hydrocarbon. Hydrocarbons are more energy dense than pure hydrogen and provide longer run times. Some examples of liquid hydrocarbons are methanol, ethanol, and gasoline. Examples of gaseous hydrocarbons are methane and propane.

The argument against using hydrogen gas is the storage difficulty due to the tank size needed for reasonable run times or trip distances between refills. Alternatives to large storage tanks may be found in *hydrides*, materials that can absorb, store, and release large quantities of hydrogen gas. More work and development needs to be performed with hydrides before they are of practical use.

Using Energy-Dense Hydrocarbons

I've already mentioned hydrocarbons as an alternative fuel-cell fuel. The trick is in releasing the hydrogen from the fuel. One way is *reforming* the fuel to release hydrogen gas from the hydrocarbon. Steam and high temperatures, for instance, reform natural gas.

A new gasoline-based fuel processor and fuel cell was developed under a partnership that included the U.S. Department of Energy, Arthur D. Little, Plug Power L.L.C., Los Alamos National Laboratory, and Ballard Power Systems. The advantage of this new system is that it can use the existing gasoline-station infrastructure for fuel distribution. The fuel cell runs 100 times cleaner than a conventional engine with 50% less greenhouse-gas emissions and doubled fuel efficiency. This technology is being held back because high-volume manufacturing technologies still need to be developed to reduce overall cost. In addition, performance and durability tests remain to be completed. What good is a clean engine if you need a new one every few months?

The other alternative is to use the hydrocarbon directly in the fuel cell. Ray Gorte, head of chemical engineering at the University of Pennsylvania, recently developed an experimental solid-oxide fuel cell. This new fuel cell only delivers about one-tenth the power of a hydrogen-oxygen cell and is sensitive to sulfur. Sulfur essentially poisons the cell, so gasoline would need another cleaning step to reduce its sulfur content.

Other Applications

Fuel cells have other uses than the automotive field. For example, fuel cells can supplement power stations. The

need for an additional 1.7 trillion kilowatt-hours of electric power is forecast over the next 20 years. Hopefully, the higher efficiency of fuel cells over traditional "burned" fuels will help meet those needs in a more environmentally friendly way.

Other power-generation uses include remote site power and backup and primary power generation for industrial buildings, hospitals, and possibly private homes. Because the fuel cell is more efficient than traditional burned fuels, reliance on imported energy can be reduced.

We can "think small" with fuel cells as well. Just about anything that uses a battery can benefit from fuel-cell technology. A few applications already in the works are an aluminum/air fuel cell for cellular phones and a fuel cell for laptop computers.

If Not Now, When?

With all the wonderful attributes of fuel cells, where are they? Why don't we see them in our laptop computers, video cameras, and cell phones? While fuel-cell technology has improved much over the last decade, they still are not competitive (read: cost-effective) with existing technologies.

One of the more advanced fuel-cell designs uses a membrane material from DuPont called *Nafion*. The raw material costs about \$100 per square foot. Reducing existing membrane cost and developing other membrane materials are on a high-priority list for creating competitive fuel cells. Additionally, fuel-cell electrodes are typically coated or plated with platinum—an expensive metal.

We'll start seeing fuel-cell technology in the automotive industry. All of the major automobile companies have ongoing fuel-cell research and development programs. The list of industrial companies working on fuel-cell technology reads like a "Who's Who" of science research. There is much enthusiasm and support for continued research and development of fuel cells. Recently, President Clinton and Congress allocated \$100 million for the continued development of fuel-cell technology.

With this basic knowledge under our belt, we can start building different types of fuel cells. We will also build a bug battery. The bug battery is really a fuel cell that uses microorganisms to generate fuel for the fuel cell.

See you then.

P

RETAILERS THAT SELL OUR MAGAZINE EVERY MONTH

Arizona

Elliott Elec. Supply
1251 S. Tyndell Ave.
Tucson, AZ 85713

California

All Electronics
14928 Oxnard Street
Van Nuys, CA 91411

California Electronics
221 N. Johnson Ave.
El Cajon, CA 90202

Electronics Plus, Inc.
823 4th St.
San Rafael, CA 94901

Electronics Warehouse
2691 Main Street
Riverside, CA 92501

Ford Electronics
8431 Commonwealth Ave
Buena Park, CA 90621

HSC Electronics
6819 S. Redwood Drive
Cotati, CA 94931

HSC Electronics
4837 Amber Lane
Sacramento, CA 95841

Halted Specialties Co.
3500 Ryder Street
Santa Clara, CA 95051

Inland Electronic Suppliers
1012 N. Carpenter Rd.
Modesto, CA 95351

Kandarian Electronics
1101 19th Street
Bakersfield, CA 93301

Mar Vac Electronics
2001 Harbor Blvd.
Costa Mesa, CA 92627

Mar Vac Electronics
1759 E. Colorado Blvd.
Pasadena, CA 91106

Mar Vac Electronics
4747 Holt Blvd.
Montclair, CA 91763

Mar Vac Electronics
5184 Hollister Blvd.
Santa Barbara, CA 93111

Mar Vac Electronics
2537 Del Paso Blvd.
Sacramento, CA 95815

Mar Vac Electronics
2000 Outlet Center Dr. #150
Oxnard, CA 93030

Mar Vac Electronics
12453 Washington Blvd.
Los Angeles, CA 90066

Metro Electronics
1831 J Street
Sacramento, CA 95814

Orvac Electronics
1645 E Orangethorpe Ave.
Fullerton, CA 92631

Sav-On Electronics
13225 Harbor Blvd.
Garden Grove, CA 92643

Whitcomm Electronics
105 W. Dakota 106
Clovis, CA 93612

Colorado

Centennial Elec. Inc.
2324 E. Bijon
Colorado Springs, CO
80909

Connecticut

Cables & Connectors
2198 Berlin Turnpike
Newington, CT 06111

Illinois

BB&W Inc.
2137 S. Euclid Ave.
Berwyn, IL 60402

Tri State Elex
200 W. Northwest Hwy.
Mt. Prospect, IL 60056

Indiana

King of the Road Elec.
409 E. Center Rd.
Kokomo, IN 46902

Maryland

Mark Elec. Supply Inc.
11215 Old Baltimore Pike
Beltsville, MD 20705

Massachusetts

Electronic Hook-Up
104 Main St.
Milford, MA 01757

"You-Do-It" Electronics
40 Franklin Street
Neeham, MA 02494

Michigan

Norwest Electronics
33760 Plymouth Rd.
Livonia, MI 48150

Purchase Radio Supply
327 East Hoover Avenue
Ann Arbor, MI 48104

The Elec. Connection
37387 Ford Road
Westland, MI 48185

Minnesota

Acme Electronics
224 Washington Avenue N.
Minneapolis, MN 55401

Missouri

Gateway Electronics
8123-25 Page Blvd.
St. Louis, MO 63130

New Jersey

Lashen Electronics Inc.
21 Broadway
Denville, NJ 07834

New York

LNL Distributing Corp.
235 Robbins Lane
Syosset, NY 11791

T&M Elec. Supply, Inc.
472 East Main Street
Patchogue, NY 11772

Unicorn Electronics
Valley Plaza
Johnson City, NY 13790

Ohio

Parts Express
725 Pleasant Valley Drive
Springboro, OH 45066

Oregon

Norvac Electronics
7940 SW Nimbus Avenue
Beaverton, OR 97005

Texas

Computers Electronics Etc.
110 E. Medical Center Blvd.
Webster, TX 77598

Electronic Parts Outlet
3753 B Fondren
Houston, TX 77063

Tanner Electronics
1301 W Beltline
Carrollton, TX 75006

Washington

Supertronix Inc.
16550 W. Valley Hwy.
Tukwila, WA 98188

*Barnes & Noble • B. Dalton • Crown Books • Tower Books • Super Stand
Borders Book Store • On Cue • Hastings • Media Play • Walden Book Store
Just About Every Major Book Store!*

**If you'd like to sell our magazine in your store, please circle 180 on free
information card or Contact Gina Giuliano at (631) 592-6720 ext 215**

DIGITAL DOMAIN

(continued from page 20)

"luxuries" such as bulk mailing and chain letters. In addition, new hazards are among us. Never before had little Johnny been afraid to open his birthday card and become infected by a virus. Nowadays, one false move while checking your e-mail could set off The Apocalypse—just kidding.

I WOULD NOT EAT TEN "MEGS" OF SPAM

If you're on line, you've undoubtedly received "spam"—unsolicited, untargeted bulk e-mail. Typically they are ads for illegal "Make Money Fast" pyramid schemes, pornographic pay Web sites, quack healthcare remedies, or other come-ons of interest only to the gullible or desperate.

Spam, which conjures up images of fatty, low-cost luncheon meat (a trademark of Hormel, Inc.) and Monty Python skits, is nearly universally reviled, the most notable exceptions being the marketers who must manage to snag at least a few unwitting victims to make their seamy endeavors appear worthwhile.

Unlike postal junk mail, spam places most of the cost burden on recipients and the larger infrastructure. That's why it has long been a violation of Internet norms and why respectable businesses refrain from it. Spam has been the focus of court cases that have been hugely expensive for spammers caught in the act and the subject of proposed federal legislation.

E-MARKETS

You might therefore think that e-mail is the last tool you should use for marketing and public relations. Not necessarily.

Using e-mail, organizations can reach out to prospects, and organizations as well as individuals can reach out to the media, without incurring the wrath of those you're trying to influence. You just have to know what you're doing.

With e-mailing marketing, the golden rule is receiving permission: You need recipients' permission to use their e-mail in-boxes.

You can do this yourself by offering visitors to your Web site the option of receiving e-mailings from you. To entice people to receive—and continue to receive—your commercial messages, you should provide useful, noncommercial content along with your marketing material.

Another option is to contract with an "opt-in" bulk e-mail company. Opt-in companies compile lists of people who have opted to receive e-mail about specific types of products or services. These companies will rent their lists to you or carry out an entire marketing campaign for you.

nonprofit organization, or community.

Just as with advertising-oriented e-mail, you have to be careful with public relations e-mail. Many journalists are already overwhelmed with e-mail from readers, sources, colleagues, and spammers.

The trick here is to send your e-mail to only those journalists who can use it and to design it for their purposes.

KEEPING TABS IN A VIRTUAL WORLD

Though it can be time-consuming, the best way to compile a list of journalists' e-mail addresses is manually. A number of companies



Let the experts at Prospero Technologies help you design your very own virtual community.

PostMasterDirect.com, at www.postmasterdirect.com, is the largest opt-in service, with more than 3000 lists, from accounting to wood-working. It creates its lists from visitors to Web sites it has partnered with, such as CNET and CBS Sportsline. It charges 10 to 30 cents per name, which includes e-mail delivery, with a \$1000 minimum.

MEET THE PRESS... IN DIGITAL

You can also use e-mail to get publicity through newspapers, magazines, radio, and television, whether it's about your new product or a development involving your school,

can provide lists for you, however, which you can search through for journalists covering your area.

The best low-cost option is Direct Contact Newswire, at www.owt.com/dircon. The service used to rent out its lists of journalists' e-mail addresses but stopped after receiving complaints that too many messages journalists received were poorly targeted and irrelevant.

Direct Contact Newswire handles the entire process for you, including choosing the most relevant media targets. The cost is 10 cents per name with a \$50 minimum. The service can also send press releases by fax and write the

release for you.

The best high-end option is Bacon's MediaSource, at www.bacons.com. This is a list of comprehensive information about 65,000 media outlets and 450,000 editorial contacts, 75 percent of which have e-mail addresses.

You can rent the list through Bacon's Web site, where it's updated daily, or on CD-ROM, where it's updated quarterly. The cost for either option is \$1895 for an annual subscription. Bacon's will also carry out an e-mail

media campaign for you for a fee of 55 cents per name with a \$50 minimum.

Whether you're e-mailing to prospects or media targets, you're better off using specialized software than your regular e-mail program; especially if you're doing the work yourself and contacting more than a couple of dozen recipients. Programs such as MailKing and UnityMail, both found at www.messagemedia.com, automate the process of getting your message out.

IT'S A SMALL WORLD

PCs have offered portals of communication to anyone fortunate enough to obtain one. We can all dream of what the future holds for human interaction via electronic medium. Today we see the emergence of technologies—such as fiber-optic and satellite-link networks—that will revolutionize communications. Who knows? Today we have the Internet, and years from now we may indeed have an Inter-planetary net. **P**

LETTERS

(continued from page 4)

These trapped flux lines can either be dragged through the superconductor, or they can break away and possibly be expelled or trapped in another region. The combination provides an unusual and possibly useful frictional system.

An important experiment that could be performed with the magnet and superconductor is to tie a string to the magnet along with a mass about ten times that of the magnet. Make it into a pendulum where the magnet swings over the superconductor (not yet cooled below the transition temperature) with about a 1/4-inch clearance. While the pendulum swings, cool the superconductor below transition temperature and watch the magnet stop. The added mass prevents the magnet from floating. Compare this with replacing the superconductor with a piece of copper and observe the difference in motion due to eddy currents at both room and liquid nitrogen temperatures.

DOUG KIRVEN, Ph.D.
Durham, NC

Flux pinning was described in Part I of the superconductor article (**Poptronics**, July 2000). Fluxing pinning, as explained in Part I, is responsible for the rare earth magnet being held levitating above the superconductor without flipping off the superconductor. An enhanced flux pinning superconductor was described that will also suspend a rare earth magnet below the superconductor, in addition to levitating a rare earth magnet above itself.

Regarding the demonstration of the frictionless magnetic bearing, though I think flux pinning may indeed produce

some minuscule drag on a rotating magnet, I don't believe it is an appreciable force. I feel the pendulum experiment you described is flawed if you try to use it to demonstrate rotational drag. Here's why. The force needed either to stop the magnet pendulum (in your experiment) or just to hold the rare earth magnet levitating (Meissner Effect) above the superconductor (horizontal or tilted) is appreciable. If this appreciable force were converted to "generate drag" on the magnet levitating above the superconductor, it would become difficult to rotate the magnet at all. In essence, the levitating rare earth magnet would resist any rotation. But this is not the case. It is very easy to rotate the magnet, and once the magnet begins rotating, it rotates for quite a long time. My conclusion is that if flux-pinning force were creating a rotational drag as you described, the magnet would not rotate so readily or do so for so long.

Literature I read on superconductors

describes the magnetic bearing experiment as frictionless. If there were an appreciable drag generated by flux pinning, I would have expected to encounter some mention of it in superconductor literature.

The pendulum experiment you described demonstrates the flux-pinning force. I do not see any rotational drag coefficient demonstrated.

As for the eddy currents, I don't see the relevance.

In closing, if you could point to any literature that mentions rotation drag created by flux pinning or if you have another potential experiment, I will be happy to look into it and revise my ideas, if necessary.

JOHN IOVINE

Seeing Stars

I enjoyed Ted Needleman's "Computer Bits" column about NexStar 5 in the November issue. As a veteran amateur astronomer and relatively new owner of a Meade LX-200, I too am enjoying computerized astronomy.

What Ted learned, of course, is that just as a binoculars doesn't make you a bird watcher, a telescope doesn't make you an astronomer. I tell people they "must" learn their way around the sky with the unaided eye or with binoculars before purchasing any kind of telescope; otherwise it's impossible to know if the telescope is set up correctly. Also, it's vital to understand that telescopic views are very different from space-probe photos.

Two books I particularly recommend are *365 Starry Nights* by Chet Raymo and *The Backyard Astronomer's Guide* by Dickinson and Dyer. Clear skies.

MICHAEL A. COVINGTON
via e-mail

Introducing Robotics with Lego® Mindstorms™

For Robot Lovers. Shows how to build a variety of increasingly sophisticated computer-controlled robots using the brilliant Lego mindstorms Robotic Invention System (RIS). Covers the fundamental building techniques needed to construct strong and efficient robots. Explains to the reader how robot control programs may be simply constructed on their PC screens. Detailed building instructions are provided for all the robots featured. 270 pages, 7 1/2 x 10 5/7 in. **\$19.99.**

Plus \$2.45 shipping in U.S. Order from CLAGGK Inc., P.O. Box 12162, Hauppauge, NY 11788

CLX1

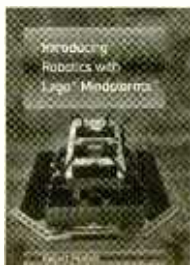

VCR Audio Problems

This month, we're going to look into audio problems, so let's dig right in.

Silent Movies

Has this happened to you? It's a rainy day and you decide to sit home and watch a favorite movie, perhaps an old copy of *Fritz the Cat*, but after pressing play on your VCR you notice there is something wrong with the audio track. Many of us have experienced the nuisance of missing or corrupted audio on VHS playback. The following are some troubleshooting tips for repairing audio problems inherent to some VHS systems.

Can you hear anything? If *all* audio is missing, visually check the external connections—particularly if you use RCA jacks. Also, try switching between channels 3 and 4 if you use the VCR's RF output. Adjusting the fine-tuning control (if any) on your TV can sometimes remedy a minor audio problem. Are all the cables connected correctly? Are all the switches properly set? Simple operator errors are the bane of many a technician.

Does the audio problem happen only during playback? If you know that the tape is in good condition and the audio is good, carefully touch each of the terminals on the audio/control (A/C) head with the tip of a small screwdriver (CAUTION: Insulate all except the tip of the screwdriver to prevent shorts). The A/C head is the stationary head to the right of the video drum, near the location where tape re-enters the cassette. If the audio circuits are working, the audio-head terminal should produce a buzz from the speaker. A constant buzz during playback may be indicative of a dirty A/C head. The A/C head can be cleaned with an alcohol-moistened cotton swab gently rubbed near the top where the audio tracks are located. DON'T touch the video heads with alcohol. Other possible causes of degraded audio include debris within or misalignment of the tape path. These ailments can promote a loss of contact



Carefully clean the tape path with an alcohol-moistened cotton swab. Do not touch the video heads with alcohol.

between the tape and the audio head in the vicinity of audio tracks. If there was no initial buzz during the circuit test, then something in the audio circuit is most probably bad. Double-check that there is no audio switch or a mode-select toggle that might be wrong. Mechanical switches can often be flipped back and forth a couple of times in order to clean the contacts. Beyond this, additional testing will be needed requiring a service manual with schematic.

Poor Audio on Hi-Fidelity Systems

There can be several non-electronic causes for poor quality sound during playback. Periodically, the audio head needs to be cleaned. Cleaning tapes may not always be effective tools. It is more effective to use cotton swabs and isopropyl alcohol or head-cleaning solution for head cleaning. You might as well clean the tape guides while you are at it—a speck of dirt can cause the tape to wander and produce erratic sound.

There are cases when the audio/control head needs to be aligned. Usually an azimuth adjustment (the angle the head gap makes with respect to the direction of the tape's long axis) can cure an audio glitch. You can make this adjustment if you are so inclined. Before you adjust the azimuth, a test for proper alignment would be to record and then play back a tape on this machine—regardless of how

far off the azimuth adjustment may be. The recording should sound good, at least as good as one can expect from the linear audio track.

Sometimes, the audio head (and other parts) needs to be degaussed. An inexpensive audiotape head demagnetizer can be purchased at your local electronics store. Turn on the demagnetizer and move it slowly near all metallic parts that the tape contacts (e.g., the guides, levers, erase and audio/control head). Stay away from the video heads because some demagnetizers are powerful enough to damage heads. Make sure the demagnetizer you use has no sharp ends to damage anything. You can cover the tool with electrical tape if in doubt.

The audio head could be worn. If the poor sound quality really bugs you, audio heads can be easily replaced. New heads are not cheap because generic replacements are rarely available. After the head install, an alignment will be needed. Another possibility is that tape-path problems can cause bad tape versus head contact. Make sure the path is clean and free of foreign objects.

Expectations for audio quality on the linear audio tracks on non-high fidelity VCRs should be realistic. The worst sound quality often stems from a stereo VCR in EP mode. This poor rendition is due partly to the stereo tracks being less than half as wide as non-stereo tracks. Best results can be achieved with a combination of SP tape speed and a non-stereo signal. Even this solution yields comparatively poor music quality.

What's the Buzz?

Do you hear an annoying hum or buzz on your one-channel deck? Performing the following "screwdriver and short tests" can help to narrow down a one-channel low audio problem:

You should be able to locate the L and R channels by the buzz resulting from signal pickup from the screwdriver-test mentioned previously. If the bad



Take time to familiarize yourself with the patch panel of your VCR. Inspect connectors and switches for cleanliness and proper functioning.

channel doesn't respond at about the same level as the good one, there is probably an electronics problem present rather than need for an A/C head alignment (though a bad A/C head coil is still possible).

If you can locate the signal ground for the A/C head, then CAREFULLY short the output pin of the bad channel head to ground. The hum/buzz should disappear when the short is induced if there is a head or alignment problem. If the hum is not cancelled, there is an electronics problem for that channel.

Does Your Audio Flutter?

While the general quality of VHS linear audio is almost always mediocre, there should not be excessive flutter resulting in a wavering pitch. Certainly, it should not be noticeable for vocal on audio tracks. How bad music sounds will depend on your expectations as well. Here are some possible causes for flutter:

- Dirty/gummed-up stationary guides or A/C head
- Lack of lubrication of the capstan or roller guides
- Excessively tight idler or other clutch
- Bad capstan motor, especially if direct drive type, or motor driver
- Bad pinch roller/bearing
- Video head drum (upper cylinder) that is mounted off-center or that has excessive run out or wobble
- Servo-system problems
- Power-supply problems
- 'Stiction' between tape and lower cylinder
- Unrealistic expectations of linear audio quality

Hey, My New Tape Has No Audio!

Have you just produced a recorded tape and are wondering why the non-

Hi-Fidelity audio is not working? Have pre-recorded tapes or tapes recorded on this VCR worked prior to the problem developing? Do the new recordings have no sound whatsoever? Let's examine some possible faults.

Make sure your tape isn't bad. Yes, I know, this is unlikely, but very old tapes tend to lose oxide along the edges where the linear audio goes. If the previous audio is erased but you now have silence, the problem could be that the erase function is working but no new audio is being recorded on the tape. Check any audio-mode or dubbing switches for proper settings. If you are using the RF input, see if the RCA connectors are firmly inserted into the jacks. Sometimes, dirt or bad connections on the RCA inputs will trick the VCR into thinking you really want to use those instead of the RF. Pushing an RCA plug in and out a few times might clean the jack.

If you are using the RCA inputs, make sure the audio cable is plugged into the proper jack on the VCR and that there is an audio signal from the source (plug into an amplifier or another VCR to test).



Don't be afraid to take a close look inside your VCR.

Has Anyone Seen My Audio?

Sometimes tapes play fine, but audio is missing to the TV and/or when making recordings using the VCR's tuner. If this is your dilemma ask yourself, "How is the TV connected?" Is it through the RF/antenna input? If it is connected through the RCA jacks, it could be a TV/cable problem. Bypass the VCR and check for sound. As for the RF connection, this could be caused by many factors.

There may either be an incorrect source-select or dubbing-mode setting. There may even be a dirty set of contacts on a related switch. Check your instruction manual, and cycle and/or clean the contacts of any suspect switch-

es. Unplug the VCR for a few minutes to reset the controller—it may be in a weird mode. Dirty contacts on the RCA audio in jack may be guilty—some decks automatically assume you want to record from there if anything is plugged in. Maybe a device, like a CD player, was left plugged into the jack several months ago when you last used it! Usually, inserting an RCA plug into the jack a couple of times will clean the contacts at least well enough to confirm whether or not this is the problem. There is often a separate cable for both audio and video between the tuner and the main board inside a VCR deck. Reseat this board and test it. If the problem stems from an electronic fault resulting in the circuit not selecting the audio the maintenance will require a schematic.

"Out, Out, Damn Audio..."

If the old audio track is unchanged when rerecording on a previously recorded tape, i.e., you get the new video but old audio, first check that any dubbing switches are set correctly. Do you get a mixture of old and new audio? There could be a problem with the audio-erase head (part of the A/C head stack) or its circuitry. Clean the audio/control head. Check for dirt or tape oxide on or around the audio/control head. Beyond these procedures, testing will probably require a schematic. However, if you can locate the connections to the audio-erase head, use an ohmmeter to test for continuity of the coil. If you have access to an oscilloscope, check for the high-frequency erase signal during record.

Why Does My VCR Squeal Like A Stuck Pig?

The most common cause for a squealing noise is a tired or weak belt that is slipping. The need for lubrication is less likely. If a squeal is heard (along with the VCR perhaps aborting the operation) when entering play or record mode, a slipping loading belt is the usual cause. If a squeal is heard during fast-forward or rewind, then the drive belt may be slipping. A squeal or whine during play or record (perhaps intermittently when the video-head drum is spinning) could be the warning sign of a worn video-head drum bearing or a dirty and/or improperly positioned static brush (more on this in a moment). It may be time for a good cleaning, rubber parts replacement, and lubrication.

Whining or buzzing from the audio during playback of tapes not recorded on the troubled VCR may indicate a badly misadjusted A/C head. The linear audio heads are picking up the ends of the video tracks due to the A/C head being too low. A whine from the audio (of the TV) while using the VCR may indicate bad grounding of the internal shields, or other bad connections due to electronic problems.

High Pitched Whine From Inside A VCR

Your first thoughts are probably of an expensive repair to a motor bearing or replacement lower cylinder. If there is a high-pitched whine coming from inside the VCR when in play, record, or other mode, which spins the video heads, you may simply have a dirty or improperly positioned antistatic brush. There is usually a metal strip with a carbon contact pressing against the center of the video-drum spindle either above or below the deck. In rare instances, the brush may be *between* the upper and lower cylinders, requiring more disassembly. Gently press on this strip or lift it off of the spindle while you hear the sound. If the whine disappears, cleaning and slight repositioning of the strip should be all you need to do. Do not remove this strip—it is needed to ground the rotating drum to prevent static buildup and video noise problems. You may find that if you measure the resistance between the brush to the chassis that it is far from zero ohms—perhaps in the tens or hundreds of thousands or higher. This is perfectly normal (as long as it isn't infinity!) because static doesn't take much current flow to be eliminated.

VCRs Need TLC

With a little tender loving care and some basic preventive maintenance, you and your VCR should enjoy a pleasant auditory experience. Remember, when troubleshooting any device, first start off with a thorough visual inspection. Look for the obvious "no brainers," like cable connections and switch settings, and if the problem still persists continue troubleshooting in a routine manner. P

NEW LITERATURE

(continued from page 44)

studio-quality sound on the road. Construction techniques for a subwoofer filter, simple crossover strategies, and ways to squeeze peak performance from the sound system are covered. Design tools—including spreadsheets, Thiele-Small parameter measurement techniques, and shareware—are also explained.

Police Call: 2001 Edition

by Gene Hughes
Hollins Radio Data
 P.O. Box 35002
 Los Angeles, CA 90035
www.policecall.com
\$12.99 plus S&H

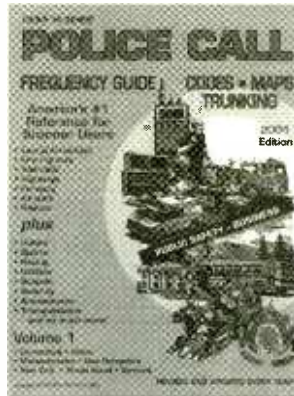

Considered "the scanner user's bible," the 2001 edition is the largest ever and is also available on CD-ROM. The nine regional volumes contain over 35,000 frequencies. Volume I, pictured here, covers New York and New England.

In addition to emergency agencies such as Police and Fire, the books list two-way frequencies for aircraft, federal government, transportation, sports, entertainment, and more. Scanner enthusiasts will find that the first chapter, "Listener's Guide," is packed with helpful information. P

5 GREAT PROJECT BOOKS

[] BP-410 35 Opto-Display Terminal Block Projects. \$6.99. If you use terminal blocks, no soldering is required to make complete this series of opto-displays that range from light-telegraphs, flashing lapel badges, magnetic detectors, plus more advanced projects including a dusk detector, games, and twinkling Christmas decorations.



[] BP-411 Introduction to Surface-Mount Devices. \$6.99. Surface-mount construction can be easier, faster and less costly, and even the hobbyist can produce one-of-a-kind circuits using SMDs. PCB design, chip control, soldering techniques and specialist tools are fully covered. A complete variety of construction projects are also included.

[] BP-413 Remote Control Projects. \$7.99. A wealth of circuits and circuit modules for use in all kinds of remote-control applications are provided. There are complete details for 14 novel and practical remote control projects. Also included are techniques for interfacing a PC to a remote control system.



[] BP-416 Practical Alarm Circuits. \$6.99. Details of inexpensive but effective burglar alarms for the home constructor. The circuits include switch-activate alarm, FM audio alarm generator, Modulated fiber-optic loop alarm, Ultra-sonic breaking window alarm, Doppler shift ultrasonic sensor and more.

[] BP-432 Simple Sensor Terminal Block Projects. \$6.99. Sensors are the eyes, ears and noses of electronic systems. They include contact, light, heat, sound, magnetic, motion, resistance and voltage-operated devices. The projects in this book show you how you can build all of these, and if you use terminal blocks, no soldering is required. There are 31 individual projects to build and use.

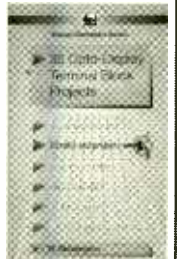

To order one of these Books send amount indicated plus \$3.00 for shipping in the U.S. and Canada only to Electronics Technology Today Inc., P.O. Box 240, Massapequa Park, NY 11762-0240. Payment in U.S. funds by U.S. bank check or International Money Order. Please allow 6-8 weeks for delivery. MA09

BUY BONDS

Visit our
 Web Site at:
www.gernsback.com

Closing In On More Proximity Circuits



Last month, we were on the circuit train in the middle of a proximity-sensor-circuit odyssey. Before we could complete our adventure, we ran out of time and space. Now that we have a full head of steam, let's race down the "high irons" in the search of more fun proximity circuits.

Noise As A "Good Thing"

Our first entry this visit is a proximity-sensor circuit (Fig. 1) that puts to use the nasty noise and AC trash that's all around us. A 741 op-amp IC is the master operating component in this circuit. The amplifier's gain is set to near maximum with a 10-megohm feedback resistor connected between the negative input at pin 2 and the amp's output at pin 6. The metal pick-up sensor is connected to the input at pin 2 and must be located very close to the IC circuitry.

The amp's output feeds a detector/rectifier circuit, which supplies a positive drive voltage to the base of the 2N3904 NPN transistor. The transistor lights the LED when an object is detected. A sensor for this type of noise pick-up circuit need not be any larger than a half-dollar coin. If the pick-up is too large, the ambient noise can cause false triggering.

To activate this circuit, simply place a finger on or very near the sensor. Of course, if you try to use this circuit in an area where no electrical power is present, it will most likely fail to operate.

Cut The Noise

We can also use the same 741 op-amp in a circuit that does not require any outside signal source. This somewhat unusual proximity-sensor circuit (Fig. 2) places the 741 op-amp in a high-frequency oscillator circuit that is operating near its maximum frequency. The 741 op-amp has an internal feedback capacitor that

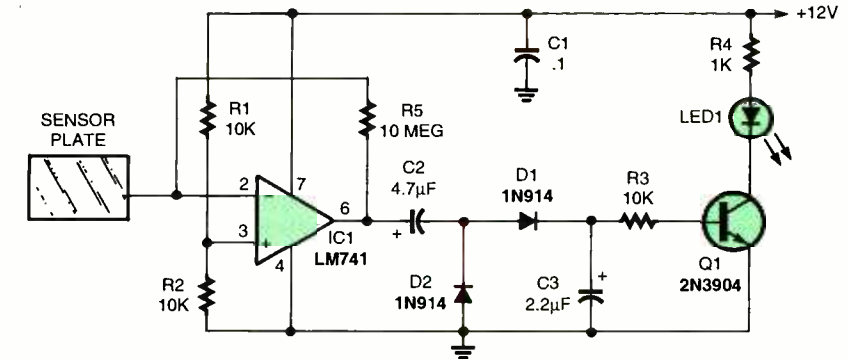

Fig. 1. This circuit, using an LM741 op-amp, works the same way as last month's LM567-based circuit.

PARTS LIST FOR THE NOISE-TRIGGERED SENSOR (FIG. 1)

SEMICONDUCTORS

IC1—LM741 op-amp, integrated circuit
Q1—2N3904 NPN silicon transistor
LED1—Light-emitting diode, any color
D1, D2—1N914 silicon signal diode

RESISTORS

(All resistors are 1/4-watt, 5% units.)
R1—R3—10,000-ohm
R4—1000-ohm

R5—10-megohm

CAPACITORS

C1—0.1-μF, ceramic-disc
C2—4.7-μF, 25-WVDC, electrolytic
C3—2.2-μF, 25-WVDC, electrolytic

ADDITIONAL PARTS

AND MATERIALS
Sensor plate, wire, hardware, etc.

limits its maximum operation frequency. As the frequency increases, the op-amp's gain decreases until it reaches a gain figure that is just slightly greater than one.

If we crank up the frequency to that limit, the feedback path becomes very load sensitive—exactly what is needed in any load-type proximity-sensor circuit.

The oscillator's frequency-determinate components are C1, C3, R6, and R7. Feedback resistors R5 and R9 set the gain. The op-amp's bias is set, with R2 and R3, to produce a DC output on pin 6 at one-half the supply voltage, with the advantage of being independent of the actual supply voltage. Operating the output at one-half supply lets us use the maximum available output-voltage swing. Supply

voltages between 9 and 16 volts will do.

The oscillator's output at pin 6 feeds the rectifier circuit made up of D1, D2, C4, and C6. The rectifier's positive output turns Q1 on and lights the LED.

For maximum sensitivity, adjust R9 to the point where the LED just begins to glow. A 4- by 6-inch metal sensor plate, isolated from surrounding objects, can easily detect your hand at a distance of two to three inches. Larger plates will detect larger objects at greater distances. The size of the sensor plate is limited to the maximum surface area that allows circuit oscillation. Sensor objects that are too large or too close to a ground mass can keep the circuit from oscillating. The sensor's negative supply should

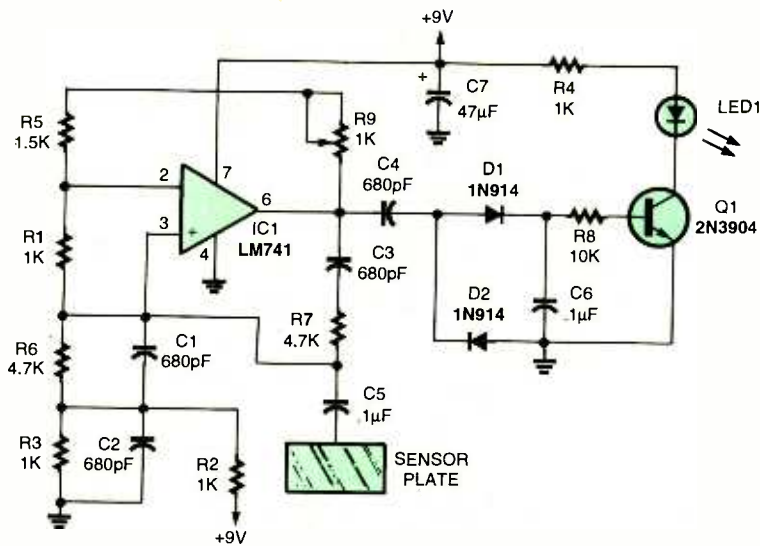

Fig. 2. This circuit senses changes in the background noise, only it provides its own noise.

PARTS LIST FOR THE "NOISELESS" PROXIMITY SENSOR (FIG. 2)

SEMICONDUCTORS

IC1—LM741 op-amp, integrated circuit
 D1, D2—1N914 silicon signal diode
 Q1—2N3904 NPN silicon transistor
 LED1—Light-emitting diode, any color or size

RESISTORS

(All resistors are 1/4-watt, 5% units unless otherwise noted.)
 R1—R4—1000-ohm
 R5—1500-ohm
 R6, R7—4700-ohm
 R8—10,000-ohm
 R9—1000-ohm potentiometer

CAPACITORS

C1—C4—680-pF, ceramic-disc
 C5, C6—0.1-μF, ceramic-disc
 C7—47-μF, 25-WVDC, electrolytic

ADDITIONAL PARTS AND MATERIALS

Pickup plate material, IC socket, etc.

circuit, suitable for alarm systems and commercial applications. The circuit is a Hartley oscillator with a variable-feedback gain control.

The RC frequency-determinate components used in our previous sensor are replaced with a hand-wound

inductor. The oscillator's frequency is determined by the inductance of L1, its internal capacitance, and the load capacitance of the sensor plate. The feedback gain needed to obtain and sustain oscillation is set with R5. The oscillator's output signal is coupled through C5 to a rectifier circuit that supplies a positive bias to turn Q2 on, lighting the LED. The circuit's set-up procedure is very similar to our previous circuit. With R5 set to its maximum resistance value, slowly rotate the potentiometer until the LED just begins to glow. That is the sensor's most sensitive setting.

Any center-tapped inductor with an inductance value between 0.1 mH and 100 mH will work in the circuit. The coil used in our circuit was "jumble wound" on a 1-inch plastic tube with about 120 turns of 28-gauge enamel-covered copper wire. At the 60th turn, make a tap and continue winding for another 60 turns. Since the actual inductance value isn't critical, any similar size tubing will do for the form; the wire size can vary as well.

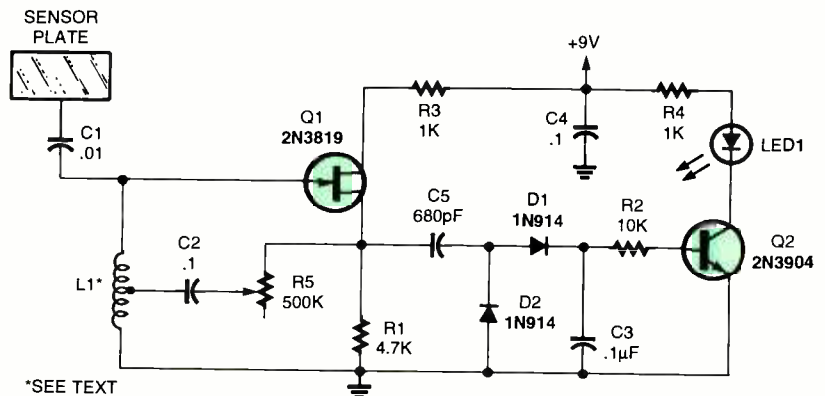

Fig. 3. By replacing the op-amps of Fig. 2 with a field-effect transistor and coil, we have a Hartley-oscillator-based sensing circuit. See the text for details on winding L1.

PARTS LIST FOR THE FET-BASED SENSOR CIRCUIT (FIG. 3)

SEMICONDUCTORS

Q1—2N3819 N-type field-effect transistor
 Q2—2N3904 NPN silicon transistor
 LED1—Light-emitting diode, any type or color
 D1, D2—1N914 silicon diode

RESISTORS

(All resistors are 1/4-watt, 5% units unless otherwise noted.)
 R1—4700-ohm
 R2—10,000-ohm

R3, R4—1000-ohm
 R5—500,000-ohm potentiometer

CAPACITORS

C1—0.01-μF, ceramic-disc
 C2—C4—0.1-μF, ceramic-disc
 C5—680-pF, ceramic-disc

ADDITIONAL PARTS AND MATERIALS

1-inch plastic-coil form, 28-gauge enameled copper wire, etc.

be connected to ground or to any large metal object that offers capacitance to ground.

FET-based Systems

Our next step takes us to another load-sensitive proximity-sensor circuit (Fig. 3), which uses a 2N3819 N-type FET as the active device. This is a very stable and sensitive proximity-sensor

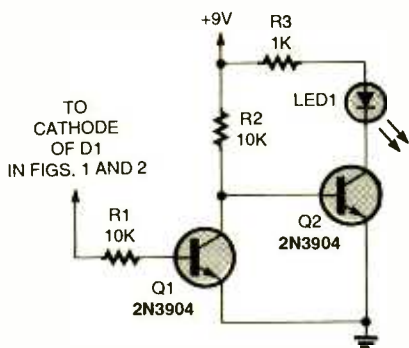

Fig. 4. If you need to invert the output of the previous two circuits, this simple add-on circuit will do the job.

PARTS LIST FOR THE OUTPUT INVERTER (FIG. 4)

SEMICONDUCTORS

Q1, Q2—2N3904 NPN silicon transistor
LED1—Light-emitting diode, any type or color

RESISTORS

(All resistors are 1/4-watt, 5% units.)
R1, R2—10,000-ohm
R3—1000-ohm

Inversions | snoisrevnl

Our next entry, see Fig. 4, allows our previous two circuits to operate with an inverted output function. Rather than have the LED turn off when an object is detected, this circuit inverts the output so that the LED turns on. The inverter circuit connects to the cathode of D1 in either of the previous two circuits. The positive output at D1 turns Q1, in Fig. 3, on. This grounds Q2's base, keeping it turned off and the LED dark. When the sensor circuit detects an object, the output at D1 goes low, allowing Q1 to turn off and Q2 to turn on, lighting the LED. The LED indicator can be replaced with a relay or an optoisolator to control other circuitry.

I Heard That!

The next stop on the "Basic Circuitry Train" is at Echo Bend, where we'll look at a sound-operated proximity sensor. Again, the versatile LM567 phase-locked loop IC is placed in service, performing a dual function in our ultrasonic proximity-sensor circuit shown in Fig. 5. The LM567 is connected in a tone-decoder circuit that produces an output when the proper tone is received. The LM567 is also operating as a tone

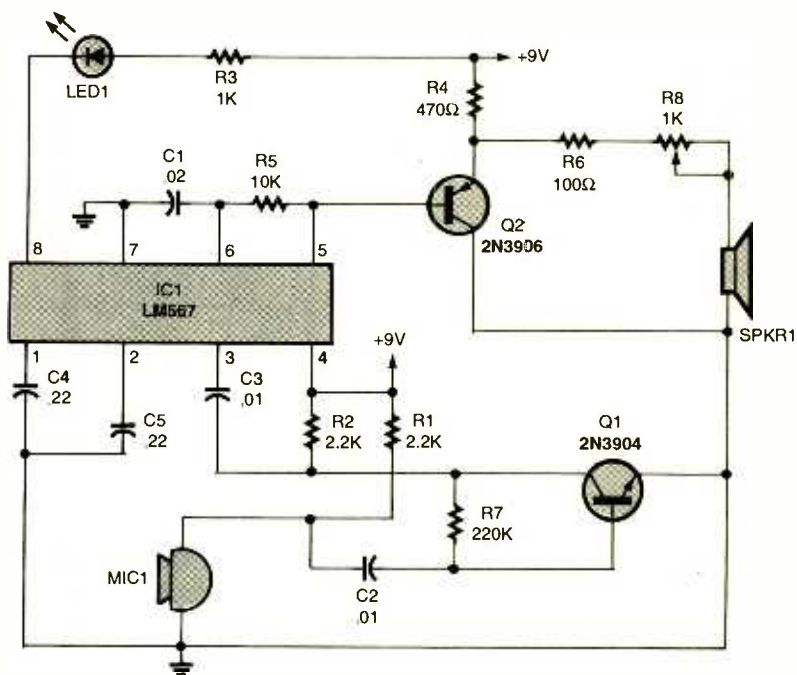

Fig. 5. Similar to radar or sonar, this circuit bounces an ultrasonic signal off the object being detected. If you don't mind the shrieking whistle, you can use audio-frequency tones for detection.

PARTS LIST FOR THE SOUND-BASED SENSOR (FIG. 5)

SEMICONDUCTORS

IC1—LM567 tone-decoder, integrated circuit

Q1—2N3904 NPN silicon transistor

Q2—2N3906 PNP silicon transistor

LED1—Light-emitting diode, any type or color

RESISTORS

(All resistors are 1/4-watt, 5% units unless otherwise noted.)

R1, R2—2200-ohm

R3—1000-ohm

R4—470-ohm

R5—10,000-ohm

R6—100-ohm

R7—220,000-ohm

R8—1000-ohm potentiometer

CAPACITORS

C1—0.02-μF, ceramic-disc

C2, C3—0.01-μF, ceramic-disc

C4, C5—0.22-μ, ceramic-disc

ADDITIONAL PARTS AND MATERIALS

Piezo speaker (RadioShack 40-1383 or similar), electret microphone element (RadioShack 270-090 or similar), IC socket, etc.

transmitter that generates the very tone the receiver section is designed to receive. Only two external transistors and a few components are necessary to complete the sensor circuit.

The transmitter portion of the circuit sends out a high frequency audio signal through the piezo speaker. The receiver's pickup, an electret-microphone element, detects the reflected tone signal and sends it to Q1 for amplification. From there, the amplified signal goes on to the input of the LM567. The piezo speaker and the microphone element are positioned as shown in Fig. 6.

Any object placed in front of the microphone and speaker that reflects a

sufficient amount of the signal back to the microphone will activate the circuit and light the LED. The circuit can be set up to sense objects at distances from a few inches to over a foot.

Here's how the circuit operates. The LM567's internal oscillator frequency is set by C1 and R5. The actual operating frequency isn't critical so long as it falls somewhere between 14 kHz and 20 kHz. If the frequency is too high, the electret microphone's output will be reduced and the operating range will suffer. If you don't mind listening to the high-frequency sound, the circuit will work fine at a much lower frequency. The LM567's internal oscillator pro-

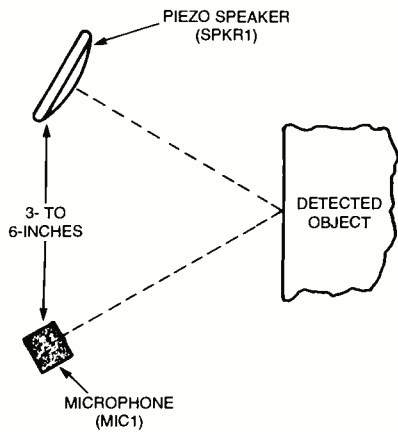

Fig. 6. Note that the reflected sound waves behave just like light bouncing off a mirror—the exiting angle equals the entering angle.

duces a squarewave output at pin 5. That signal is isolated from the LM567 by Q2 operating as an emitter follower, which sends the signal to the piezo speaker. The speaker's output level is set with R8.

Transistor Q1 is connected as a common-emitter amplifier that increases the reflected tone signal to a level sufficient for the LM567's input circuitry to detect and lock on.

The circuit is an easy one to set up and adjust. Select the type and size of object that you want to detect and place it in front of the speaker and microphone. Adjust R8 until the LED lights. The range of operation will depend mainly on the object used as a reflector.

This is an excellent experimenter's circuit. The operating frequency can be varied by replacing R5 with a 20,000-ohm potentiometer, and the value of C1 can be changed as well. Larger values of either component lower the operating frequency and small values increase the frequency.

Finding Iron Giants

Our last proximity-sensor circuit on this trip is only turned on by a moving ferrous object. The ferrous proximity-sensor circuit, see Fig. 7, uses a hand-made pickup coil to detect and produce a low-frequency output signal when a ferrous-metal object is moved by its pole piece.

The coil is wound with about 200 turns of 28-gauge enamel-covered copper wire on a 1/4-inch diameter by 1-inch long soft-iron bolt. The coil may be jumbled or layer wound; either way will work just fine.

Two op-amps of an LM324 quad op-amp IC are used to amplify the weak signal generated by the pickup coil. The

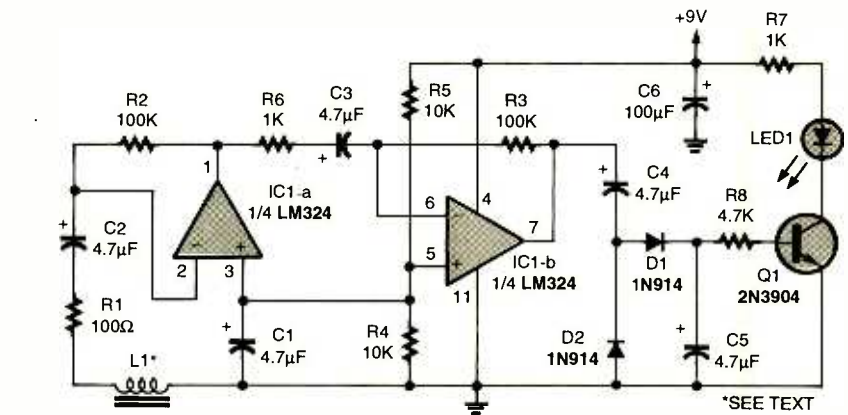

Fig. 7. Any large piece of iron passing near L1 will distort the Earth's magnetic field, creating a weak signal that's amplified by IC1.

PARTS LIST FOR THE IRON-SENSING CIRCUIT (FIG. 7)

SEMICONDUCTORS

IC1—LM324 quad op-amp, integrated circuit

Q1—2N3904 NPN silicon transistor

LED1—Light-emitting diode, any type or color

D1, D2—1N914 silicon signal diode

RESISTORS

(All resistors are 1/4-watt, 5% units.)

R1—100-ohm

R2, R3—100,000-ohm

R4, R5—10,000-ohm

R6, R7—1,000-ohm

R8—4,700-ohm

CAPACITORS

C1—47-µF, 25-WVDC, electrolytic

C2—C5—4.7-µF, 25-WVDC, electrolytic

C6—100-µF, 25-WVDC, electrolytic

ADDITIONAL PARTS AND MATERIALS

Iron bolt, 28-gauge enamel-covered copper wire, IC socket, etc.

amplified signal is coupled to a rectifier circuit made up of C4, C5, D1, and D2. The rectifier's positive output turns Q1 and the LED on when a ferrous object pass by the pickup coil. The LED only remains on for a very brief period, depending on the speed of the moving ferrous object. The head end of the bolt should be used as the pickup point.

The circuit's sensitivity can be increased by winding additional turns on the coil or by increasing the value of either R2 or R3. If the amplifier's gain is

increased too much, the circuit can become unstable and go into a self-oscillating mode.

If the circuit is operated in an area where strong AC fields are present, a 0.1 to 0.22-µF capacitor may be connected across the pickup coil to help reduce interference from those signals.

The circuit could actually be used in a model-train layout to signal when a train wheel or car passes by or used on an assembly line to count certain types of parts as they move past the sensor.

Help Me Out Here, Audience...

That's the last stop for the Circuit Train for now, but before leaving, I would like to ask a favor of you. I intended to include several proximity circuits using the high sensitive IR detectors found in security lights, but have not located a source for just the IR detector. I don't want to use surplus items here because of available supply and differences in actual detector devices. If you can help with a suggested source, send an e-mail message or write to me at: Charles D. Rakes, P.O. Box 445, Bentonville, AR 72712.

See you here next month!

9 out of 10 mice prefer the Consumer Information Catalog online. Catch it at www.pueblo.gsa.gov.

U.S. General Services Administration

Poptronics®

SHOPPER

POLARIS CAN SUPPLY YOU WITH ALL OF TODAY'S HOTTEST VIDEO TECHNOLOGY!

CALL OR GO ON-LINE TO ORDER YOUR FREE VIDEO CATALOG - 100's OF PRODUCTS - MICRO CAMERAS - WIRELESS VIDEO - LIPSTICK CAMERAS - DIGITAL VCR'S

6.4" ROOF MOUNT COLOR TFT MONITOR



Great for long trips in the car or minivan! Comes with hardware for convenient and easy roof mounting. This unit accepts video from an external video source such as DVD player, VCR, TV Tuner or video camera.

TFT-64RM - \$499.95

Dimensions: 168(H) x 1-8(W) x 30(D)mm

7" WIDE SCREEN COLOR TFT MONITOR



Comes equipped with a 7" wide screen with an aspect ratio of 16:9! Watch video from an external video source such as DVD player, VCR, TV Tuner or video camera!

REMOTE INCLUDED

TFT-7 - \$499.95

Dimensions: 187(W) x 1-7(H) x 36(D)mm

5.6" COLOR TFT MONITOR & TV



Now you can watch Television, CATV or even video from an external source such as a DVD player with our new 5.6" TFT-LCD monitor. Can also be used for direct camera input for video/security monitoring. Unit has three inputs: SVHS, RCA, and CATV.

TFT-56 - \$459.95

Dimensions: 9.6 x 15.6 x 4.7cm

2.5" COLOR TFT FLAT SCREEN MODULE



Our new color 2.5" TFT module can be used for a variety of purposes such as: custom automotive dash installations, boat installations, cover ultra-compact surveillance packages, and more.

UNIT IS ONLY 5.8mm THICK!

TFT-M25 - \$149.95

Dimensions (WxHxD): 61.6 x 49.3 - 5.8mm

DAY / NIGHT LIPSTICK COLOR CAMERA



Our new weatherproof day/night color camera can view in total darkness at a distance up to 10 meters. Comes enclosed in a water tight aluminum housing and equipped with a 3.6mm lens for a viewing angle of 60 degrees.

ILC-300

\$239.95

COVERT COLOR SPY CAMERA



It's small sleek indestructible design and pinhole lens allow for various applications and simple installation. Comes equipped with a RCA JACK for easy connection to TV monitor or VCR. Great for covert use in any place imaginable.

25mm(W) x 17mm(D) **CM-550CP - \$79.95**

MICRO BOARD CAMERAS - MANY MODELS IN STOCK TO CHOOSE FROM!



MB-1250HRP
Hi-Res Color
Pinhole
5.0mm Lens
1.27" x 1.27"
\$149.95



Hi-Res Color Camera
MB-1060C
3.6mm Lens
480 TV Lines
High Resolution
SHVS Digital Y/C
\$159.95

WEATHERPROOF DIGITAL STORAGE CAMERA

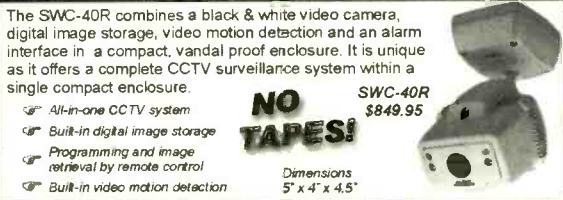

The SWC-40R combines a black & white video camera, digital image storage, video motion detection and an alarm interface in a compact, vandal proof enclosure. It is unique as it offers a complete CCTV surveillance system within a single compact enclosure.

- All-in-one CCTV system
- Built-in digital image storage
- Programming and image retrieval by remote control
- Built-in video motion detection

NO TAPES!

SWC-40R

\$849.95

Dimensions
5" x 4" x 4.5"

"YOUR WEB BROWSER IS YOUR REMOTE EYE!"

The Flexcam acts as an internet camera server. No software needed in order to view your video. All you need is a web browser such as Internet Explorer or Netscape. Flexcam includes many special functions including video quality control, pan/tilt/zoom interface and network configuration. All of them are controlled by the web browser. This is true state of the art video monitoring technology. Users can see and feel the quality and ease. Features 4 video inputs - 3 external.



Flexcam
\$CALL

CONTROL PAN / TILT AND ZOOM REMOTELY OVER THE INTERNET!

6 CAMERA INTERNET VIDEO SERVER

Our Flexwatch will serve up to 6 video cameras to the internet which can be viewed by any web browser. No special software required! Viewer is able to control the pan, tilt and zoom functions, as well as, video quality control.



VIEW REAL TIME VIDEO! Flexwatch-500 - \$1495.95

5.6" COLOR WIRELESS OBSERVATION SYSTEM



ADD UP TO 3 ADDITIONAL CAMERAS!

Now you can enjoy peace of mind with our new wireless observation system. Comes with 5.6" wireless color monitor and a wireless color camera. Just Plug-&Play Perfect for around the house or office.

SPECIAL PRICE LIMITED TIME ONLY!
GW-2400S - \$349.95

WORLDS SMALLEST TRANSMITTING WIRELESS CAMERA

Camera is so small it can be mounted in wall clocks, exit signs, briefcases, picture frames or even a baseball cap! Connects to a 9V battery and will operate up to 6 hours. 70 lines of resolution.

OPERATING RANGE IS APPROXIMATELY 400 FT.



2.4GHz



RECEIVER



CAMERA TRANSMITTER

2.4GHz Wireless Receiver GFR-5002 - \$119.95 **NAT-9 Color Camera - \$289.95**
NAT-5 B/W Camera - \$249.95



MONITOR UP TO 4 VIDEO CAMERAS SIMULTANEOUSLY THRU YOUR INTERNET CONNECTION OR OVER YOUR MODEM!

MOTION DETECTION - ALARM RECORDING - NOTIFICATION

Highlight an area on your video screen, and the DMRS will inform you via modem thru your telephone or pager if there is movement in that highlighted area while recording to your hard disk.

- ✓ TCP/IP
- ✓ MODEM
- ✓ LAN/WAN

DMRS-4... 4 Input Digital Video Card... \$289.95

Video can be viewed in Quad split (above), full screen mode or auto switching mode.

POLARIS INDUSTRIES 300-752-3571 470 Armour Drive NE Atlanta GA 30324-3943 Tech 404-872-0722 Fax 404-872-1038 WWW.POLARISUSA.COM

CIRCLE 228 ON FREE INFORMATION CARD

RAMSEY

Doppler Direction Finder

Track down jammers and hidden transmitters with ease! This is the famous WA2EBY DF'er featured in April 99 QST. Shows direct bearing to transmitter on compass style LED display, easy to hook up to any FM receiver. The transmitter - the object of your DF'ing - need not be FM, it can be AM, FM or CW. Easily connects to receiver's speaker jack and antenna, unit runs on 12 VDC. We even include 4 handy home-brew "mag mount" antennas and cable for quick set up and operation! Whips can be cut and optimized for any frequency from 130-1000 MHz. Track down that jammer, win that fox hunt, zero in on that downed Cessna - this is an easy to build, reliable kit that compares most favorably to commercial units costing upwards of \$1000.00! This is a neat kit!



DDF-1, Doppler Direction Finder Kit \$149.95

Wireless RF Data Link Modules

RF link boards are perfect for any wireless control application; alarms, data transmission, electronic monitoring...you name it! Very stable SAW resonator transmitter, crystal controlled receiver - no frequency drift! Range up to 600 feet, license free 433 MHz band. Encoder/decoder units have 12 bit Hottek HT-12 series chips allowing multiple units all individually addressable, see web site for full details. Super small size - that's a quarter in the picture! Run on 3-12 VDC. Fully wired and tested, ready to go and easy to use!

RX-433 Data Receiver..... \$16.95 TX-433 Data Transmitter..... \$14.95
RXD-433 Receiver/Decoder..... \$21.95 TXE-433 Transmitter/Encoder..... \$19.95

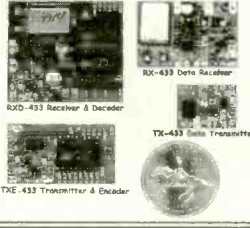

World's Smallest TV Transmitters



We call them the 'Cubes'... Perfect video transmission from a transmitter you can hide under a quarter and only as thick as a stack of four pennies - that's a nickel in the picture! Transmits color & B&W with fantastic quality - almost like a direct wired connection to any TV tuned to cable channel 59. Crystal controlled for no frequency drift with performance that equals models that cost hundreds more! Basic 20 mW model transmits up to 300' while the high power 100 mW unit goes up to 1/4 mile. Their very light weight and size make them ideal for balloon and rocket launches, R/C models, robots - you name it! Units run on 9 volts and hook-up to most any CCD camera or standard video source. In fact, all of our cameras have been tested to mate perfectly with our Cubes and work great. Fully assembled - just hook-up power and you're on the air! One customer even put one on his dog!

C-2000, Basic Video Transmitter..... \$89.95 C-2001, High Power Video Transmitter..... \$179.95

CCD Video Cameras



Top quality Japanese Class 'A' CCD array, over 440 line line resolution, not the off-spec arrays that are found on many other cameras. Don't be fooled by the cheap CMOS single chip cameras which have 1/2 the resolution, 1/4 the light sensitivity and draw over twice the current! The black & white models are also super IR (Infra-Red) sensitive. Add our invisible to the eye, IR-1 illuminator kit to see in the dark! Color camera has Auto gain, white balance, Back Light Compensation and DSP! Available with Wide-angle (80°) or super slim Pin-hole style lens. Run on 9 VDC, standard 1 volt p-p video. Use our transmitters for wireless transmission to TV set, or add our IB-1 Interface board kit for super easy direct wire hook-up to any Video monitor, VCR or TV with A/V input. Fully assembled, with pre-wired connector.

CCDWA-2, B&W CCD Camera, wide-angle lens \$69.95
CCDPH-2, B&W CCD Camera, slim fit pin-hole lens \$69.95
CCDCC-1, Color CCD Camera, wide-angle lens \$129.95
IR-1, IR Illuminator Kit for B&W cameras \$24.95
IB-1, Interface Board Kit \$14.95

AM Radio Transmitter



Operates in standard AM broadcast band. Pro version, AM-25, is synthesized for stable, no-drift frequency and is setable for high power output where regulations allow, typical range of 1-2 miles. Entry-level AM-1 is tunable, runs FCC maximum 100 mW, range 1/4 mile. Both accept line-level inputs from tape decks, CD players or mike mixers, run on 12 volts DC. Pro AM-25 includes AC power adapter, matching case and bottom loaded wire antenna. Entry-level AM-1 has an available matching case and knob set that dresses up the unit. Great sound, easy to build - you can be on the air in an evening!

AM-25, Professional AM Transmitter Kit. \$129.95
AM-1, Entry level AM Radio Transmitter Kit. . . \$29.95
CAM, Matching Case Set for AM-1. \$19.95

Mini Radio Receivers



Imagine the fun of tuning into aircraft a hundred miles away, the local police/fire department, ham operators, or how about Radio Moscow or the BBC in London? Now imagine doing this on a little radio you built yourself - in just an evening! These popular little receivers are the nuts for catching all the action on the local ham, aircraft, standard FM broadcast radio, shortwave or WWV National Time Standard radio bands. Pick the receiver of your choice, each easy to build, sensitive receiver has plenty of crystal clear audio to drive any speaker or earphone. Easy one evening assembly, run on 9 volt battery, all have squelch except for shortwave and FM broadcast receiver which has subcarrier output for hook-up to our SCA adapter. The SCA-1 will tune in commercial-free music and other 'hidden' special services when connected to FM receiver. Add our snazzy matching case and knob set for that smart finished look!

AR-1, Airband 108-136 MHz Kit \$29.95 FR-6, 6 Meter FM Ham Band Kit \$34.95
HFRC-1, WWV 10 MHz (crystal controlled) Kit \$34.95 FR-10, 10 Meter FM Ham Band Kit \$34.95
FR-1, FM Broadcast Band 88-108 MHz Kit \$24.95 FR-146, 2 Meter FM Ham Band Kit \$34.95
SR-1, Shortwave 4-11 MHz Band Kit \$29.95 FR-220, 220 MHz FM Ham Band Kit \$34.95
SCA-1 SCA Subcarrier Adapter kit for FM radio. . . \$27.95 Matching Case Set (specify for which kit) \$14.95

PIC-Pro Pic Chip Programmer



Easy to use programmer for the PIC16C84, 16F84, 16F83 microcontrollers by Microchip. All software - editor, assembler, run and program - as well as free updates available on Ramsey download site! This is the popular unit designed by Michael Covington and featured in Electronics Now, September 1998. Connects to your parallel port and includes the great looking matching case, knob set and AC power supply. Start programming those really neat microcontrollers now...order your PICPRO today!

PIC-1, PICPRO PIC Chip Programmer Kit \$59.95

Order Toll-free: 800-446-2295
Sorry, no tech info, or order status at 800 number
For Technical Info, Order Status
Call Factory direct: 716-924-4560

RAMSEY ELECTRONICS, INC.

793 Canning Parkway Victor, NY 14564

See our complete catalog and order on-line with our secure server at:
www.ramseyelectronics.com

1 GHz RF Signal Generator

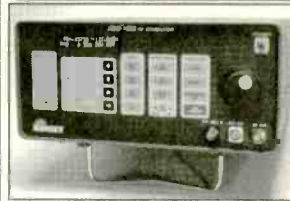

A super price on a full featured RF signal generator! Covers 100 KHz to 999.99999 MHz in 10 Hz steps. Tons of features; calibrated AM and FM modulation, 90 front panel memories, built-in RS-232 interface, +10 to -130 dBm output and more! Fast and easy to use, its

big bright vacuum fluorescent display can be read from anywhere on the bench and the handy 'smart-knob' has great analog feel and is intelligently enabled when entering or changing parameters In any field - a real time saver! All functions can be continuously varied without the need for a shift or second function key. In short, this is the generator you'll want on your bench, you won't find a harder working RF signal generator - and you'll save almost \$3,000 over competitive units!

RSG-1000B RF Signal Generator \$1995.00

Super Pro FM Stereo Transmitter



Professional synthesized FM Stereo station in easy to use, handsome cabinet. Most radio stations require a whole equipment rack to hold all the features we've packed into the FM-100. Set freq with Up/Down buttons, big LED display. Input low pass filter gives great sound (no more squeals or swishing from cheap CD inputs!) Limiters for max 'punch' in audio - without over mod, LED meters to easily set audio levels, built-in mixer with mike, line level inputs. Churches, drive-ins, schools, colleges find the FM-100 the answer to their transmitting needs, you will too. Great features, great price! Kit includes cabinet, whip antenna, 120 VAC supply. We also offer a high power export version of the FM-100 fully assembled with one watt of RF power, for miles of program coverage. The export version can only be shipped if accompanied by a signed statement that the unit will be exported.

FM-100, Pro FM Stereo Transmitter Kit \$249.95
FM-100WT, Fully Wired High Power FM-100. \$399.95

FM Stereo Radio Transmitters

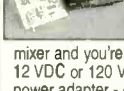

No drift, microprocessor synthesized! Great audio quality, connect to CD player, tape deck or mike mixer and you're on-the-air. Strappable for high or low power! Runs on 12 VDC or 120 VAC. Kit includes snazzy case, whip antenna, 120 VAC power adapter - easy one evening assembly.

FM-25, Synthesized Stereo Transmitter Kit \$129.95

Lower cost alternative to our high performance transmitters. Great value, easily tunable, fun to build. Manual goes into great detail about antennas, range and FCC rules. Handy for sending music thru house and yard, ideal for school projects too - you'll be amazed at the exceptional audio quality! Runs on 9V battery or 5 to 15 VDC. Add matching case and whip antenna set for nice 'pro' look.

FM-10A, Tunable FM Stereo Transmitter Kit. \$34.95
CFM, Matching Case and Antenna Set \$14.95
FMAC, 12 Volt DC Wall Plug Adapter \$9.95

RF Power Booster

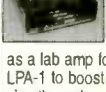

Add muscle to your signal, boost power up to 1 watt over a freq range of 100 KHz to over 1000 MHz! Use as a lab amp for signal generators, plus many foreign users employ the LPA-1 to boost the power of their FM transmitters, providing radio service through an entire town. Runs on 12 VDC. For a neat finished look, add the nice matching case set. Outdoor unit attaches right at the antenna for best signal - receiving or transmitting, weatherproof, tool LPA-1, Power Booster Amplifier Kit \$39.95
CLPA, Matching Case Set for LPA-1 Kit \$14.95
LPA-1WT, Fully Wired LPA-1 with Case \$99.95
FMBA-1, Outdoor Mast Mount Version of LPA-1 \$59.95

FM Station Antennas



For maximum performance, a good antenna is needed. Choose our very popular dipole kit or the Comet, a factory made 5/8 wave colinear model with 3.4 dB gain. Both work great with any FM receiver or transmitter.

TM-100, FM Antenna Kit \$39.95
FMA-200, Vertical Antenna \$114.95



ORDERING INFO: Satisfaction Guaranteed. Examine for 10 days, if not pleased, return in original form for refund. Add \$6.95 for shipping, handling and insurance. Orders under \$20, add \$3.00. NY residents add 7% sales tax. Sorry, no CODs. Foreign orders, add 20% for surface mail or use credit card and specify shipping method.

The Best In Electronics Anywhere In The Galaxy!

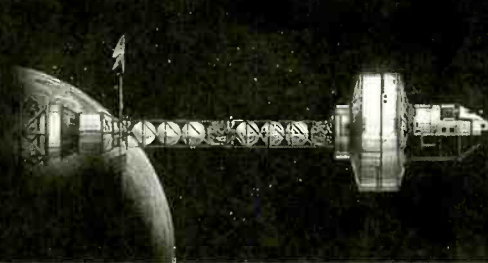

Fort 777

HTTP://WWW.FORT777.COM

Complete Intruder Alarm System with PIR

- ◆ PIR motion sensor protects your home or office.
- ◆ Magnetic contacts for doors/windows.
- ◆ 100dB siren.
- ◆ Many features.



WHOLE SET ONLY \$24.95

Solar Panel includes Battery Charger

- ◆ Free energy from the sun. Output 3V, 6V, 9V or 12V.
- ◆ Charge your mobile phone, personal stereo, toys etc.



ONLY \$14.95

Huge Range of Electronic Components

Visit our website and check out our huge range of high quality, fully specified electronic components at very low prices:

- ◆ Resistors from 9¢ per pack of 10.
- ◆ Ceramic Capacitors from 15¢ per pack of 5.
- ◆ Electrolytic Capacitors from 4¢ each.
- ◆ Fuses from 99¢ per pack of 10.
- ◆ Relays e.g. 12V coil, 10A at 125VAC \$1.25.
- ◆ Potentiometers just 59¢ each.

Optical Cable



- ◆ For CD players, DVD etc. Also available with MD-type plug at one end.
- ◆ Both types **ONLY \$3.99**
- ◆ Adapters & optical splitters also available.

Phone Line Cords



- ◆ UL listed.
- ◆ White or silver-gray.
- ◆ 6ft, 12ft, 25ft or 50ft.
- ◆ 6 ft. **ONLY \$0.49**

SVHS Cords



- ◆ Gold-plated.
- ◆ 6ft or 12ft.
- ◆ 6ft **ONLY \$1.49**
- ◆ 12ft **ONLY \$1.99**

Weatherproof Krypton Lantern



- ◆ Powerful spotlight.
- ◆ Krypton beam.

ONLY \$2.99

Diodes & Rectifiers

- ◆ 1N4001 to 1N4007 25¢/pk 10.
- ◆ 1N914/1N4148 25¢/pk 10.
- ◆ 6A Rectifiers 25¢ each.
- ◆ Bridge Rectifiers 1.5A, 50V to 400V 25¢ each.
- ◆ Zener Diodes 0.5W, 2.7V to 24V 6¢ each.

Suppressor 130VAC 15¢ each

Dynamo and Solar Rechargeable Radio

- ◆ Includes flashlight.
- ◆ Siren.

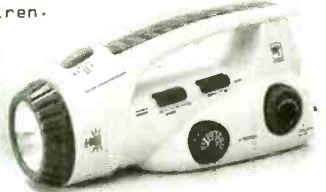

- ◆ Built-in ni-cad rechargeable batteries.
- ◆ AM/FM radio with high sensitivity.

ONLY \$29.95

Listen to Distant Conversations

Personal sound amplifier has powerful microphone and twin earpiece for comfortable, discreet listening



ONLY \$9.95

* This device is not suitable for persons with hearing difficulties.

Huge Range of Connectors

- ◆ 3/32" Mono Plug Plastic 25¢. Metal 49¢.
- ◆ Stereo Plug Plastic 79¢. Metal 99¢.
- ◆ 1/8" Mono Plug Plastic 35¢. Metal 49¢.
- ◆ Stereo Plug Plastic 49¢. Metal 59¢.
- ◆ 1/4" Mono Plug Plastic 49¢. Metal 75¢.
- ◆ Stereo Plug Plastic 59¢. Metal 69¢.
- ◆ BNC Crimp Plug RG58 or RG59 35¢.
- ◆ BNC Terminator Plug 1/2W 59¢.
- ◆ BNC Plug to RCA Socket Adapter 59¢.
- ◆ RCA Plug to BNC Socket Adapter 69¢.
- ◆ F Plug Twist/Crimp RG6/RG59 19¢.
- ◆ F Plug Gold Crimp 25¢. Twist 29¢.
- ◆ Insulated Crimp Terminals -from 19¢/pk 10.

Huge Range of LEDs at Great Prices.

Items shown here and on the website <http://www.fort777.com> are only available from the website

No minimum order quantity. Prices are valid for one piece/pack. Freight charged extra. *The address below is for returns and servicing:

FORT777.COM NORTH AMERICAN SERVICE AGENTS, FRONTIER ENGINEERING, 628 S. SUNET ST., LONGMONT, CO 80501 * email: sales@fort777.com

HELP WANTED

COMMUNICATIONS ENGINEERING JOBS

Starting salary up to \$89,265 annually. New position. Works with City's departments such as, Police, Fire and construction

COMMUNICATIONS TECHNICIAN

Growing company in beautiful Northwest needs people with an FCC License to install transmission equipment.

MARINE TECHNICIANS WANTED
Install radio equipment in sunny Florida on ships and boats docked in Miami area.

MAJOR AIRLINE hiring installation service technicians. No Experience required. Must have FCC license

Outstanding positions!
\$40-\$60 per hour!
Broadcast Engineers!

PORTABLE RADIO TECHNICIAN
\$50,800 - 92,880 to start based on experience. FCC license required.

Be an FCC LICENSED ELECTRONIC TECHNICIAN!



No costly school. No commuting to class. The Original Home-Study course prepares you for the "FCC Commercial Radiotelephone License." This valuable license is your professional "ticket" to thousands of exciting jobs in Communications, Radar, Radio-TV, Microwave, Maritime, Avionics and more...even start your own business! You don't need a college degree to qualify, but you do need an FCC License.

No Need to Quit Your Job or Go To School

This proven course is easy, fast and low cost!

GUARANTEED TO PASS - You get your FCC License or your money refunded.

Call Now for FREE Info:

800-932-4268 Ext. 90

Email: fcc@commandproductions.com

Visit our Website: www.LicenseTraining.com

Fax 415-332-1901

COMMAND PRODUCTIONS

FCC LICENSE TRAINING - DEPT. 90

P.O. Box 2824 • San Francisco, CA 94126-2824

CIRCLE 321 ON FREE INFORMATION CARD

CONTROL

RELAYS • LIGHTS • MOTORS

MEASURE

TEMPERATURE • PRESSURE • LIGHT LEVELS • HUMIDITY

INPUT

SWITCH POSITIONS • THERMOSTATS • LIQUID LEVELS

MODEL 30 \$79



- PLUGS INTO PC BUS
- 24 LINES DIGITAL I/O
- 8 CHANNEL
- 8 BIT A/D IN
- 12 BIT COUNTER
- UP TO 14K BPP/SEC

MODEL 45 \$189



- RS-232 INTERFACE
- 8 DIGITAL I/O
- 8 ANALOG INPUTS
- 2 ANALOG OUTPUTS
- 2 COUNTERS-24 BIT

MODEL 100 \$279



- 12 BIT 190 KHZ A/D
- 4 ANALOG OUTPUTS
- 3 TIMER COUNTERS
- 24 DIGITAL I/O

MODEL 150-02 \$179



- RS-232 INTERFACE
- TRM48, 28 AMPS
- 12 BIT A/D
- OPPO-ISOLATED
- COMPLETE DMN

MODEL 40 \$109



- RS-232 INTERFACE
- 28 LINES DIGITAL I/O
- 8 ANALOG INPUTS
- PWM OUTPUT

MODEL 70 \$239



- RS-232 INTERFACE
- 18 BIT A/D
- 5.5 DIGIT
- UP TO 60 BPP/SEC

Prairie Digital, Inc.

PHONE 608-643-8599 • FAX 608-643-6754

820 SEVENTEENTH STREET • PRAIRIE DU SAC, WISCONSIN 53678

CIRCLE 219 ON FREE INFORMATION CARD

DATA ACQUISITION & CONTROL

AFFORDABLE PLUG-IN BOARDS FOR PC's ISA BUS

ANA100 Analog I/O \$ 99



- 8 Channel 8-Bit
- 0 to 5 Volt Input
- 14 TTL I/O lines
- Analog Output
- 400KHz Sampling

DIG100 Digital I/O \$ 39



- 82C55 PPI
- 24 or 48 TTL I/O Lines option
- Selectable Base Address

ANA150 Analog/Counter... \$ 89



- 8 Channel 8-Bit
- 0 to 5 Volt Input
- 3 16-Bit Counters
- 400KHz Sampling

DIG200 Counter I/O \$ 79



- 3 16-Bit Counters
- 8 TTL Input lines
- 8 TTL Output lines
- Selectable Clock Frequency Input

ANA200 Analog I/O \$ 79



- 1 Channel 12-Bit
- 0 to 5 Volt Input
- optional bi-polar
- 100KHz / 300KHz Sampling rate
- 24 TTL I/O lines

ANA201 Analog \$ 119



- 8 Channel 12-Bit
- x1, x5, x10, x50 Programmable Channel gain
- 100KHz Sampling rate

On-Line Product Catalog at Our Web Site

<http://www.Bsof.com>

E-Mail: Sales@Bsof.com

BSOFT Software, Inc.

444 COLTON ROAD * COLUMBUS, OH 43207

PHONE 614-491-0832 * FAX 614-497-9971

DVD Movies
DVD Music

Computers

Home
Theater

BigBang
electronics

Auctions

THE SIGN OF INTELLIGENT LIFE IN THE UNIVERSE ...

Big Bang offers top-quality name-brand electronic equipment and home theater components for lower prices than anywhere else in the galaxy. Make contact today.

CALL FOR A FREE CATALOG

Toll Free 1-888-314-2620

or www.bigbangelectronics.com



TACTILE SOUND

DON'T JUST WATCH THE MOVIE - FEEL THE MOVIE.

Tactile Sound is sound you feel. It's the exhilarating rumble of F-16 afterburners, the gentle pluck of a guitar...it's every action and special effect built in to the movie's soundtrack. Now you can experience your favorite movies with your entire body.



Pioneer • Denon • MB Quart • Philips • Pioneer • Denon • MB Quart • Philips



Rewritable CD Rom

Pronto Intelligent/Universal Remote controls unlimited number of components



PC Camera

MP3 Player records up to 80 hours of music



HandsFree Cell Phone Holder/Charger

February 2001, Poptronics

SERIAL MINI-TERMINAL



\$21.30

oem(1k) eval(1)
 w/LCD+KPAD \$21.30 \$75.00
 +BASIC CPU \$27.00 \$95.00
 CHIP ONLY \$7.10 \$25.00

Complete RS232 terminal for PC motherboard, Z80, PIC, STAMP, HC11, AVR. ANY controller with a serial port!

- Super low-current, powered from serial signals
- LED backlit hi-contrast, visible under all conditions
- Baud rates to 115.2k and built-in DB9 connector
- Available with 20 customizable or 16 tactile keys
- NV memory for user configurable fonts/keycodes
- Simple commands and no initialization required

SINGLE CHIP COMPUTER!

\$1.99
 OEM (1K)
 EVAL KIT
 (1) \$7.00

- Zero External Components
- Built-in BASIC / Assembly
- RS232 Program Download
- 1K flash, 64ee, 3irq, 2timers
- 15 I/O bits, A/D comparator
- 20mips, faster than pic/8051
- 20 pin DIP part #MV1200



NEW! 8K SUPER CHIP

Improved BTERP with 40 times the BASIC program capacity

\$5.40 OEM (1k) - 40 pin DIP part #MV8515 - 32 I/O, 12 irq, 3 timers, bus
 EVAL \$19 - 8K flash, 512 ee, 512 nvram - Watchdog with internal osc.

READ / WRITE PC COMPATIBLE HARD DRIVE, PCMCIA, COMPACT FLASH...

\$27 STAMP-DRIVE !!

- OEM (1k) price, Eval Kit \$95
 Inexpensive RS232 interface for Stamp, AVR, HC11, PIC, Z80, x86... any controller, big or small:
- up to 4 gigabyte capacity
 - low power operation (5v 2ma)
 - simple software commands
 - baud rates up to 115.2kbps
 - easy file transfer to/from PC
 - control or datalogging apps



CREDIT CARD COMPUTER

\$14.20 OEM (1000 pc.) price
 EVAL KIT (Qty 1) \$50

- Includes:
- serial and parallel
 - 256kbit nvmem
 - A to D converter
 - ISA/PC104 bus
 - BASIC and ASSY
 - Calendar/Clock

NEW, improved version with ...
PLUG-N-GO™ !!!

COMPLETE! No cables or power supply to buy.



\$95 UNIVERSAL PROGRAMMER



FLASH, EPROM, NVRAM, EEPROM to 8meg (27080). Adapters for micros, PLCC, etc.. Parallel port version for notebooks. FAST and EASY TO USE.

PC SOLID STATE DISK



\$21 OEM (1k), EVAL \$75
 FLASH, NVRAM, ROM
 256K-16M DIP/PCMCIA

LCD VGA \$27



OEM (1k), eval \$95
 640x480 controller
 use with PC or SBC

PC WATCHDOG!

NO MORE HANGUPS..
 Reboots PC on hardware or software hangup..
 oem \$21, eval \$75



WWW.STAR.NET/PEOPLE/~MVS

MVS Box 850
 Merr., NH 03054
 (508) 792 9507



5yr Limited Warranty
 Free Shipping
 Mon-Fri 10-6 EST



\$27 MINI PC

oem(1k) price, evalkit(1) \$95
 Complete with DOS, ser, par, memory, and PC bus

Ivex Complete Electronics CAD Package

**More Features
More Power
Less Money**

Ivex Complete Power Tools include: WinDraft P650 Schematics, WinBoard P650 PCB Layout, and Ivex Spice Standard Simulation together in a complete, affordable package.

Ivex 650 pin versions have no feature limitations like other low cost products on the market. Fast expert technical support, free 24 hour Knowledge Base on the web, and professional full-featured tools have made Ivex the preferred choice for designers.

**For larger designs
use these Ivex Products:**

WinDraft unlimited	\$495
WinBoard unlimited	\$495
Ivex Spice Advanced	\$299
Ivex View unlimited	\$99

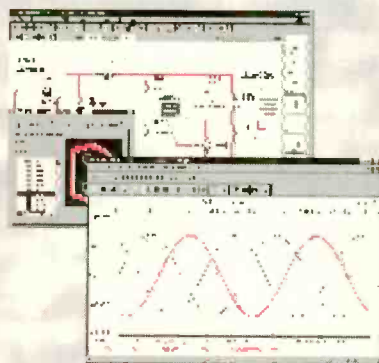

Advantages

- Full-feature tools
- 14,000 Schematic parts
- Part edit & model making
- Part Search
- Bill of Materials with Sort & Spreadsheet output
- Hierarchy for large designs
- ERC (electrical rules check)
- 15 Netlist outputs
- 7 Analysis Types
- Only \$200 to add 7 advanced analyses
- 16 PCB layers
- 0.01 micron grid resolution
- Advanced DRC
- Micro via
- Gerber & NC Drill report
- 24 hour FREE Technical Support Internet Knowledge Base
- No hardware protection lock!

Ivex Complete

Schematics
Simulation
PCB Layout **\$399**

Ivex Complete Plus

Schematics
Simulation
PCB Layout
Gerber Viewer **\$449**

Free board quote

pcbCite.com

The Internet source for PCB manufacturing

Visit the Ivex web site for complete product information and download full function demos.

www.ivex.com

Tel: (503) 531-3555 e-mail: sales@ivex.com

IVEX™
DESIGN
INTERNATIONAL

ADV8_1

CIRCLE 309 ON FREE INFORMATION CARD

CALL TOLL FREE
(800) 292-7711
Orders Only
 Se Habla Español

C&S Sales

Look For Other
 Monthly Specials
 On Our Website

Excellence in Service

www.cs-sales.com

D/A Trainer

Elenco Model XK-150

\$89.95



A low cost, full-function digital/analogue trainer that meets the needs of electronic training programs. Rugged construction, can be used as fixed lab equipment or be portable. An economical zipper case is available.

Soldering Stations

Weller Low Cost Soldering Iron
 Model WLC-100

\$34.95



- Variable power control produces 5-40 watts.
- Ideal for hobbyists, DIYers and students.
- Complete with 40W iron.

Weller Soldering Station
 Model WES50

\$119

50 watts of controlled power - designed for continuous production soldering.



Deluxe Electronic Soldering Station

Elenco SL-5 Series

Electronically controlled, ideal for professionals, students, and hobbyists. Available in kit form or assembled.

Works w/ any iron! Turn any soldering iron into a variable iron.

As Low As
\$29.95



Features:

- Cushion Grip Handle Soldering Iron (optional) with Grounded Tip for Soldering Static-Sensitive Devices. Easily Replacable. Uses Long Life, Plated Conical Tip.
- Heavy Steel, Non-Slip Base.
- Iron Holder Funnel - Reversible, left or right side.
- Steel Tray for Sponge Pad.
- Sponge Pad.

Ordering Information:

Model SL-5 - No Iron. (KIT SL-5R)	\$29.95
Model SL-5-40 - Includes 40W UL Iron. (KIT SL-5K-40)	\$35.95
Model SL-5-60 - Includes 60W UL Iron. (KIT SL-5K-60)	\$36.95

*** Limited Time Offer ***
 FREE SP-1A Solder Practice Kit w/ Kit Order!

Generators & Counters

B&K 20MHz Sweep/Function Generator with Frequency Counter Model 4040

\$445

- 0.2Hz to 20MHz
- AM & FM modulation
- Burst Operation
- External Frequency counter to 30MHz
- Linear and Log sweep

21.5MHz Model 4070 \$129!
 10MHz Model 4017 \$319
 5MHz Model 4011 \$249



BK PRECISION

Four Functions in One
 Elenco Model MX-9300B

\$450

Features:

- One instrument with four test and measuring systems:
 - 1.3GHz Frequency Counter
 - 2MHz Sweep Function Generator
 - Digital Multimeter
 - Digital Triple Power Supply - 0-3V @ 2A, 5V @ 2A, 15V @ 1A



Elenco Handheld Universal Counter
 1MHz - 2.8GHz
 Model F-2800

\$99



Features 10 digit display, 16 segment and RF signal strength bar-graph. Includes antenna, NiCad battery, and AC adapter.
 C-2800 Case with Belt Clip \$14.95

Elenco RF Generator with Counter
 (100kHz - 150kHz) Model SG-9500

\$225

Features internal AM mod. of 1kHz, RF output 100MV - 35MHz. Audio output 1kHz @ 1V RMS.



SG-9000 \$119.95
 (analog, w/o counter)

Elenco Sweep Function Generator
 w/ built-in frequency counter Model GF-8046

\$195.95

This sweep function generator with counter is an instrument capable of generating square, triangle, and sine waveforms, and TTL, CMOS pulse over a frequency range from 0.2Hz to 2MHz.



GF-8025 - Without Counter **\$139.95**

Kit Corner

Quantity Discounts Available

over 100 kits available

Model RCC-7K

Radio Control Car Kit

\$29.95

- Fun & Easy to Assemble
- 7 Functions
- Radio Control Transmitter Included
- Also available as Model AK-870 (No Soldering) \$24.95



Model AK-700

Pulse/Tone Telephone Kit

\$15.95



Ideal School Project

Action Lab Kit
 Model MX-902

- Safe, Soliderless, Educational, and Fun!
- Easy-to-read, Illustrated, Lab-Style Manual Included.
- Requires 2 "AA" Batteries
- Build your own operating motor - It's easy, it's fun, it's Safe!
- For Ages 10 and up.

\$24.95



Model AM-780K

Two IC Radio Kit

\$11.95

Also available:
 Model AM/FM-108K
 AM/FM Radio Kit
 \$29.95

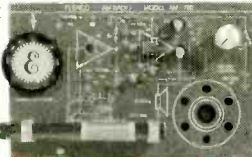

Model OWI-007

Robotic Arm
 (Wired Control)

Teaches the basic robotic sensing and locomotion principles while testing motor skills.

\$55.95



300-in-1

Experiment Kit
 Model MX-908

\$54.95

- Everything you need to build 300 exciting electronic projects!
- Easy-to-read, Illustrated, Lab-Style Manual Included.
- Requires 6 "AA" Batteries
- For Ages 10 and up.



Guaranteed Lowest Prices

UPS SHIPPING: 48 STATES 5%
 OTHERS CALL FOR DETAILS
 IL Residents add 8.25% Sales Tax

C&S SALES, INC.

150 W. CARPENTER AVENUE
 WHEELING, IL 60090
 FAX: (847) 541-9904 (847) 541-0710



PRICES SUBJECT TO CHANGE WITHOUT NOTICE

15 DAY MONEY BACK GUARANTEE
2 YEAR FACTORY WARRANTY

CIRCLE 290 ON FREE INFORMATION CARD

SAME DAY SHIPPING
Secure on-line ordering

C&S Sales

Excellence in Service

CALL OR WRITE FOR OUR FREE

64 PAGE CATALOG!
(800) 445-3201

Elenco Oscilloscopes

Free Dust Cover and 2 Probes



S-1325	25MHz	Dual Trace	\$325
S-1330	25MHz	Delayed Sweep	\$439
S-1340	40MHz	Dual Trace	\$475
S-1345	40MHz	Delayed Sweep	\$569
S-1360	60MHz	Delayed Sweep	\$725
S-1390	100MHz	Delayed Sweep	\$895

DIGITAL SCOPE SUPER SPECIALS

DS-203	20MHz/10Ms/s Analog/Digital	\$695
DS-303	40MHz/20Ms/s Analog/Digital	\$850
DS-603	60MHz/20Ms/s Analog/Digital	\$950

Quantity Discounts Available

Digital Multimeters

Fluke 87111



\$319

Features high performance AC/DC voltage and current measurement, frequency, duty cycle, resistance, conductance, and capacitance measurement.

Elenco LCR & DMM Model LCM-1950



\$69

- Large 1" 3 3/4 digit LCD
- Autorange frequency to 4MHz
- Capacitance to 400µF
- Inductance to 40H
- Resistance to 4000MΩ
- Logic Test
- Diode & Transistor Test
- Audible Continuity Test

Elenco Model M-1740



\$34.95

- 11 Functions
- Freq. to 20MHz
- Cap. to 20µF
- AC/DC Voltage
- AC/DC Current
- Beeper
- Diode Test
- Transistor Test
- Meets UL-1244 safety specs

Model M-2760 - \$19.95
(9 functions)

Dual-Display LCR Meter w/ Stat Functions B&K Model 878



\$225

Auto/manual range
Many features with Q factor
High Accuracy

Elenco LCR Meter Model LCR-1810



\$99.95

- Capacitance: 1pF to 20µF
- Inductance: 1µH to 20H
- Resistance: 0.1Ω to 2000MΩ
- Temperature to 750°C
- DC Volts 0 - 20V
- Frequency up to 15MHz
- Diode/Audible Continuity Test
- Signal Output Function
- 3 1/2 Digit Display

Elenco DMM Kit Model M-1005K



\$19.95

- 18 Ranges
- 3 1/2 Digit LCD
- Transistor Test
- Diode Test
- Training Course

M-1000B (Assembled) \$15.95

B&K Testers

Deluxe Multi-Network Cable Tester Model 231

\$75

- Tests 10BaseT, 100BaseTx, 10Base2, RJ45, RJ11, 356A, TIA-568A, TIA-568B, and Token Ring cables.
- Detects open, short, cross, and continuity.
- Tests Point-to-Point, rather than Pair-to-Pair
- Quick and easy-to-use.
- Tests cables on wall plate or patch panel up to 1,000 ft. away with the remote kit.
- Easy-to-read LED display.



Multi-Network Cable Tester Model 230

\$69

- Auto scans thin Ethernet (BNC), 10BaseT (UTP/STP), 100BaseTx, RJ45, 356A, TIA-568A, TIA-568B, and Token Ring cables in seconds.
- Detects miswiring, polarization, and continuity
- Also tests the ground of shielded twisted pair cables.
- Tests cables before or after installation with the remote unit.
- LED display for clear indication of problems.

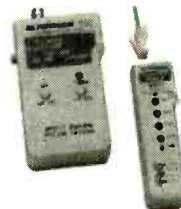

Remote Network Cable Tester Model 235

\$195

- Detects open, short, reversed, crossed, and split.
- Clear LED display for the fault status.
- Simple and easy-to-use.
- Test cable length: Minimum - 4 ft. (1.2m) Maximum - 492 ft. (150m).
- Identify up to 4 different cables at one end by provided remote identifiers.
- Tests: 10BaseT, 100BaseTx, 10Base2 (coax), RJ45, 356A, TIA-568A, TIA-568B, Token Ring, etc.



CCTV Cameras

Cameras have 420 lines (360 color) of resolution, 0.08 Lux, 3.6mm/F2 90° field of view. Power requirement is 12VDC @ 100mA (order SC-1).

MONOCHROME CAMERAS



SC-12 - 35mm Lens (1.25"x1.25") **\$69**

SC-15 - Pin Lens (1.25"x1.25") **\$69**

Add \$10 for lens • Add \$10 for audio

Accessories:

SC-1 - 12V 100mA adapter **\$6.95**

SC-2 - 50' cable with connectors **\$19.95**

COLOR CAMERAS

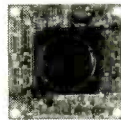

SC-20 Pin Lens

SC-21 3.6mm Lens

360 Lines 1.25" x 1.25"

Infrared Sensitive, Audio Included

\$109

Add \$10 for case

Call for complete catalog.

Power Supplies

Elenco Quad Power Supply Model XP-581

\$79.95



4 Fully Regulated DC Power Supplies in 1 Unit
4 DC voltages: 3 fixed - +5V @ 3A, +12V @ 1A, -12V @ 1A
1 Variable - 2.5 - 20V @ 2A

B&K High Current DC Power Supply

- Variable 9-14VDC
- Thermal Function
- Current Limiting

Model 1686 12A **\$169**
Model 1688 28A **\$249**



B&K 13.8V Fixed DC Power Supplies
Model 1680 6A \$42
Model 1682 15A \$75

Elenco Power Supply Kit Model XP-720K

\$54.95

- 1.5VDC - 15VDC @ 1A
- -1.5VDC - -15VDC
- 5VDC @ 3A
- 6.3VAC @ 1A & 12.6VAC center tapped @ 1A

XP-720 Fully Assembled **\$85**



Elenco DC Power Supply Model SPL-603 3A 0-30VDC

\$79.95

The SPL-603 is a solid-state DC power supply providing the exact output voltage no matter what current you use. Output fully protected from overload.



Guaranteed Lowest Prices

UPS SHIPPING: 48 STATES 5%
OTHERS CALL FOR DETAILS
IL Residents add 8.25% Sales Tax
SEE US ON THE WEB

C&S SALES, INC.

150 W. CARPENTER AVENUE
WHEELING, IL 60090
FAX: (847) 541-9904 (847) 541-0710
www.cs-sales.com

15 DAY MONEY BACK GUARANTEE
2 YEAR FACTORY WARRANTY



PRICES SUBJECT TO CHANGE WITHOUT NOTICE

CIRCLE 290 ON FREE INFORMATION CARD

Any waveform you want!



Berkeley Nucleonics Corp. Model 625A

New Features:

- ✓ 21.5 MHz
- ✓ .01 Hz steps
- ✓ multi-unit phaselock

● Synthesized Signal Generator

Clean sinewaves DC-21.5 MHz, .001% accuracy!
.01 Hz steps. DC Offset. RS232 remote control.

● Arbitrary Waveform Generator

40 Megasamples/Second. 32,768 points. 12 bit DAC

● Function Generator

Ramps, Triangles, Exponentials & more to 2 MHz!

● Pulse Generator

Digital waveforms with adjustable duty cycle

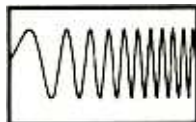

DC to 21.5 MHz linear and log sweeps

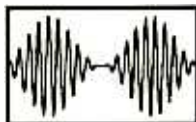

Int/Ext AM, SSB, Dualtone Gen.



Int/Ext FM, PM, BPSK, Burst

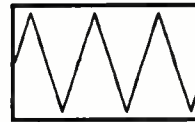

Ramps, Triangles, Exponentials

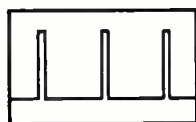

Pulse Generator



Noise

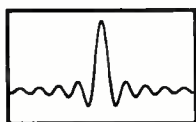

Arbitrary Waveforms



Unlimited Possibilities!

Berkeley Nucleonics Corp.

3060 Kerner Blvd. Suite 2
San Rafael, CA 94901-5418

Tel (415) 453-9955

www.berkeleynucleonics.com

Fax (415) 453-9956

CIRCLE 311 ON FREE INFORMATION CARD

The Standard for checking Capacitors in-circuit



Good enough to be the choice of Panasonic, Pioneer, NBC, ABC, Ford, JVC, NASA and thousands of independent service technicians.

Inexpensive enough to pay for itself in just one day's repairs. At \$179, it's affordable.

And with a 60 day trial period, satisfaction guaranteed or money-back policy, the only thing you can lose is all the time you're currently spending on trying to repair all those dogs you've given up on.

CapAnalyzer 88A

Available at your distributor, or call 561-487-6103

Electronic Design Specialists

www.eds-inc.com

Locate shorted or leaky components or conditions to the exact spot in-circuit

Still cutting up the pcb, and unsoldering every part trying to guess at where the short is?

\$179



Your DVM shows the same shorted reading all along the pcb trace. LeakSeeker 82B has the resolution to find the defective component. Touch pads along the trace, and LeakSeeker beeps highest in pitch at the defect's pad. Now you can locate a shorted part only a quarter of an inch away from a good part. Short can be from 0 to 150 ohms

LeakSeeker 82B

Thanks to you, all sorts of everyday products are being made from the paper, plastic, metal and glass that you've been recycling. But to keep recycling working to help protect the environment, you need to buy those products.

BUY RECYCLED.



AND SAVE.

So look for products made from recycled materials, and buy them. It would mean the world to all of us.

For a free brochure, write Buy Recycled, Environmental Defense Fund, 257 Park Ave. South, New York, NY 10010, or call 1-800-CALL-EDF.



TiePieScope HS801 PORTABLE MOST

Reliability



The HS801: the first 100 Mega samples per second measuring instrument that consists of a MOST (Multimeter, Oscilloscope, Spectrum analyzer and Transient recorder) and an AWG (Arbitrary Waveform Generator). This new MOST portable and compact measuring instrument can solve almost every measurement problem. With the integrated AWG you can generate every signal you want.

A user defined toolbar with which over 50 instrument settings quick and easy can be accessed is offered by the versatile software. An intelligent auto setup allows the inexperienced user to perform measurements immediately. Through the use of a setting file, the user has the possibility to save an instrument setup and recall it at a later moment. The setup time of the instrument is hereby reduced to a minimum.

Analyzing signals is done with an 8 bit resolution and a maximum sampling speed of 100 MHz. The input range is 0.1 Volt full scale to 80 Volt full scale. The record length is 32K/256K samples. The AWG has a 10 bit resolution and a sample speed of 25 MHz.

- 50 MHz ARBITRARY WAVEFORM GENERATOR-
- 100 MHz STORAGE OSCILLOSCOPE-
- 50 MHz SPECTRUM ANALYZER-
- 6 DISPLAY MULTIMETER-
- 200 DAYS TRANSIENT RECORDER-

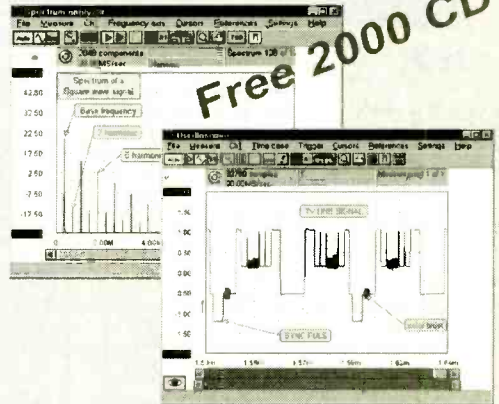

Convince yourself and download the demo software from our web page: www.tiepie.nl. When you have questions and / or remarks, contact us via email: support@tiepie.nl. The HS801 is delivered with a user manual, two probe's, Windows and DOS software.

US dealer:
Feedback Incorporated, Tel 800-526-8783;
Fax 919-644-6470; www.fbk.com

Outside US:
TiePie engineering, P.O BOX 290, 8600 AG SNEEK,
The Netherlands.
Tel: +31 515 415 416 Fax: +31 515 418 819
Web: www.tiepie.nl

CIRCLE 217 ON FREE INFORMATION CARD

ALARMS - ACCESS CONTROL - SECURITY CAMERAS - RECORDERS - OVER 50 BRANDS TO CHOOSE FROM!

\$38 BOARD CAMERAS

\$69 C/C'S MOUNT CAMERAS

WIRELESS **\$89**

REAL TIME QUADS **\$145**

www.cctvco.com

OUTDOOR BULLETS **\$79**

WIRELESS

MINI DOME **\$59**

MONITORS

CCTV OUTLET
INTERNATIONAL DISTRIBUTORS

1-800-323-8746

World's Smallest 68HC11 Microcontroller Module!

MicroStamp11™



- telemetry
- microrobotics
- smart toys
- animatronics
- model railroading
- home automation

NEW Windows-based development software included free!

- tiny, light-weight (0.5 oz.) 1-inch x 1.4-inch 68HC11 module
- 5V regulator, 8MHz crystal
- choice of 8K or 32K EEPROM
- optional 32K RAM (32K EEPROM version)
- plugs into your breadboard like a DIP
- SCI, SPI, OCs, ICs, timers, & more
- all 14 I/O lines and 2 interrupts brought out to versatile 20-pin connector
- program in BASIC, assembler, or C
- easy code-loading with Docking Module
- Starter Packages: *

8K EEPROM (#MS11SP8K).....\$49
32K EEPROM (#MS11SP32K).....\$72
32K EE+32K RAM (#MS11SP64K)...\$90

* includes MicroStamp11, manual, PC software (free-ware assembler, SBASIC compiler, Smartload11 utility, and sample programs), serial cable, Docking Module, accessories.

Optional ImageCraft 68HC11 C cross-compiler for W3.119x available (# ICC11WIN)..... \$153

MicroCore-11™

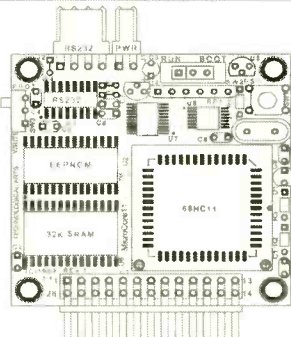

- tiny 2-inch x 2-inch 68HC11 module
 - 12 inputs/outputs plus 8 analog inputs
 - RS232, 5V regulator, 8MHz crystal
 - 32K SRAM plus 8K or 32K EEPROM
 - plugs into your breadboard like a DIP
 - easy program loading from any PC
 - motor driver & accessories available
 - ideal for MicroMouse robot competitions
- 8K Starter Package #MC11SP8K.....\$68
32K Starter Package #MC11SP32K.....\$93
Motor driver boards, LCD/keyboard/keyboard interface & prototyping cards available

Technological Arts

Many other modules & accessories available.
Visit our website at:
www.technologicalarts.com
sales@technologicalarts.com
TOLL-FREE: 1-877-963-8996
Phone: (416) 963-8996
Fax: (416) 963-9179
Visa • MasterCard • Discover • Amex

ALL ELECTRONICS

C O R P O R A T I O N

Nickel-Metal Hydride AA "Flat-Top" Cells

Panasonic # HHR-11AA0. 1.2 Volt, 1100 mAh "flat-top" rechargeable AA cells. These cells are designed for use in battery packs; they do not have the raised button found on most replaceable batteries. 0.55" diameter X 1.95" long. Large quantity available. Two styles:

REGULAR-FLAT TOP
CAT # NMH-110



\$1.50 each
40pcs \$1.25 • 120pcs \$1.00
800pcs 85¢ each

SOLDER-TABBED
CAT # NMH-110T



\$1.75 each
40pcs \$1.50 • 120pcs \$1.25
800+ \$1.00 each

Single Output Switching Power Supply 12 Vdc 2.5 A

12 VDC 2.5 AMP

Qualcomm # TAACA0011 (Kingpro# KAD-0303). DC coax power plug, 2.1mm I.D., 5.5mm O.D., center positive. Wall plug style. Ferrite bead on output cord for EMI filtering.



CAT # PS-1225

\$10.00 each
10 for \$9.25
100 for \$8.50

6 RPM Gear Motor

Molon # CHM-1205-5
Powerful 12 Vdc, 6 RPM gear-head motor. Gearbox is 3" x 2.75" x 0.83". Drive motor and shaft are both on the same side of the gearbox. Shaft is 3.3" long. Top of shaft is 0.37" square. Base is 0.5" dia. Motor draws 130 mA at 12 Vdc, no load. Motor protected by removable rubber cover.

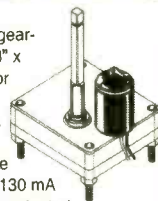

CAT # DCM-164 **\$12.00** each

ORDER TOLL FREE
1-800-826-5432
SHOP OUR ONLINE STORE
www.allelectronics.com
CHARGE ORDERS to Visa, Mastercard, American Express or Discover

TERMS: NO MINIMUM ORDER. Shipping and handling for the 48 continental U.S.A. \$5.00 per order. All others including AK, HI, PR or Canada must pay full shipping. All orders delivered in CALIFORNIA must include local state sales tax. Quantities Limited. NO COD. Prices subject to change without notice.

CALL, WRITE
FAX or E-MAIL
for our **FREE**

96 Page
CATALOG
Outside the U.S.A.
send \$3.00 postage.

MAIL ORDERS TO:
ALL ELECTRONICS
CORPORATION
P.O. Box 567
Van Nuys, CA 91408
FAX (818)781-2653

e-mail allcorp@allcorp.com

Call Today And
SAVE! **Unbeatable
PRICES!**

CABLE TV

**DESCRAMBLERS
CONVERTERS • FILTERS
VIDEO STABILIZERS**

FREE ➤ 30 Day Trial
FREE ➤ Product Catalog
FREE ➤ 1 Year Warranty

100% MONEY BACK GUARANTEE



Let us point you in
the right direction ...

Arrow
Technologies
Omaha, Nebraska

TOLL FREE
888-554-ARROW
888-554-2776

The Pocket Programmer Only \$129.95

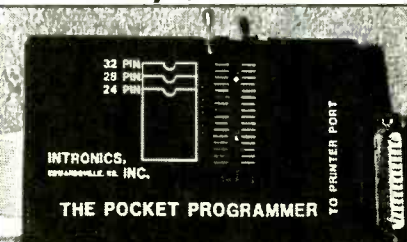

The portable programmer that uses the printer port of your PC instead of an internal card. Easy to use software that programs Eprom, EEprom, Flash & Dallas Ram. 27(C) / 28(C) / 28F / 29F / 29C & 25XX series from 16K to 8 Megabit with a 32 pin socket. Adapters available for Pic, PLCC, 5-Gang, 874X, 875X MCU's, 40-Pin X 16 & Serial Eprom's, 82/74 Prom's and Eprom Emulator to 32K X 8.

**Same Name, Address & Phone #
for 16 Years... Isn't it Amazing ?**

Intronics, Inc.

Box 13723 / 612 Newton St.
Edwardsville, KS 66113 Add \$5.00 COD
Tel. (913) 422-2094 Add \$4.00 Shipping

Fax (913) 441-1623 Visa / Master Charge



Basic PC Learning Course

This self-study course will allow you to:

- * Understand Basic PC Principles
- * Diagnose PCs and Repair PCs
- * Build PCs from Scratch

Each Course Contains:

- * A Self-Study Course Manual
- * Basic PC Assembly & Configuration Video
- * MicroScope Diagnostic Software Video
- * MicroScope Diagnostic Software - Limited Edition (25 uses)

ONLY
\$239.95

Everything you need in one box!

This is the simplest, easiest and most complete course on how to understand, assemble and diagnose PCs available today. It contains all the text, videos and diagnostic software you will need to succeed! Product number 01-920.

Call (800) 321-2155 to order or visit

www.ciebookstore.com

FCC Exam Review Course

with Certificate of Completion once finished!

Through the years Cleveland Institute of Electronics has been able to compile a great amount of information concerning the types of questions that the FCC include in their examinations.

After completing these 25 self-paced lessons you'll be ready to take the FCC exam for a General-Class License. Because of the extensive sampling of FCC type exam questions, you can look forward with confidence to passing the actual FCC exam, particularly if you heed the hints given in this course. Course includes Instructor Assistance and a Certificate of Completion. 01-FCC01 \$195.00

- ✓ 25 lessons with graded exams.
- ✓ Instructor support with toll free help.
- ✓ Call (800) 321-2155

or visit www.ciebookstore.com

or mail to: CIE Bookstore:

1776 E. 17th St., Cleveland, OH 44114

(add \$15.75 shipping & handling)

CA, HI & OH residents must add sales tax

25 Lesson Course

1. Untuned Amplifier Circuitry
2. Tuned-Stage Operation
3. Modern Modulation Methods
4. Detection & Frequency Conversion
5. Receiving Equipment
6. Batteries, Control Motor & other Power Sources
7. Circuit Analysis
8. Frequency Modulation
9. Transmission Line & Wave Guides
10. Antennas & Wave Propagation
11. Transmitters
12. Suppressed - Carrier Modulation and Single
13. RF Amplifier Analysis
14. Microwave Communication Systems
15. Monochrome & Color TV
16. Telemetry
17. Aviation Electronics
18. Programmable Controllers
19. Digital & Data Commun.
20. Lasers in Communications & Industry
21. Commun. by Fiber Optics
22. FCC Review Lessons Part I
23. FCC Review Lessons Part 2
24. Pointers & Practices for Passing FCC G.C. Exam Pt. I
25. Pointers & Practices for Passing FCC G.C. Exam Pt. 2

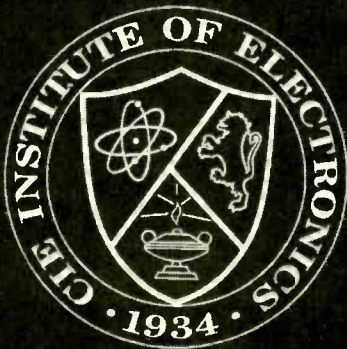

It's almost like being paid to study.

Earn an Associate Degree in Electronic Engineering Technology...

Put your knowledge of electronics to work for you. CIE offers the most comprehensive Associate Degree program offered in electronics. Best of all you study at your own pace with the full resources of CIE just a phone call or a click of a mouse away.

It's Comprehensive and Unique. You Pay for Only the Time You Use!

You won't find a better school than CIE if you want to accomplish your goals without pesky time restrictions (commuting, 8 hour class days, etc.) at CIE you study at your own pace, even an accelerated pace. And if you're like most readers of this magazine, your electronics background can help you receive your degree in less than the maximum 8 terms allowed. Finish sooner and you can save thousands of dollars in tuition. It's almost like being paid to study.

Get all the details on CIE's Associate Degree Program, World College's Bachelor Degree Program and CIE's 10 Career Courses today!



Free Course Catalog!

(800) 243-6446

www.cie-wc.edu

For a FREE Course Catalog on all of our Programs send to CIE: 1776 E. 17th St., Cleveland, OH 44114-3679 or visit www.cie-wc.edu PT30

Name: _____

Address: _____

City: _____

State: _____ Zip: _____

Phone: _____

E-mail: _____

PATRIOT SECURITY SERVICES



LOSS THEFT VANDALISM

OVER 10 YEARS EXPERIENCE

- Wide range of CCTV Systems
- Surveillance Equipment
- Custom Security Systems
- Time Lapse VTR Instant Replay
- Retail Loss Prevention
- Locks & Hardware
- Security Guard & Patrol Service
- Escorts
- Executive Protection
- Gate Entrance
- Foot Patrol
- Vehicle Patrol

FREE SURVEY & ESTIMATES

Sales • Installation • Service • Repair

Lowest Possible Rates

Residential • Commercial • Industrial

1-800-579-5329

Based in NY • 631-884-2517

Licensed by the NY State Dept. of State

THE BEST HOME WEATHER STATION EVER MADE.

Davis unleashes its Vantage Pro wireless weather station! Revolutionary thinking, with professional quality, accuracy, and performance.

Forecasts 30 different weather conditions, shows over 80 graphs, and sounds up to 70 weather alarms. All in a display that's easy to read and use. It's the best value you'll find anywhere!

BRAND NEW!
\$595.00

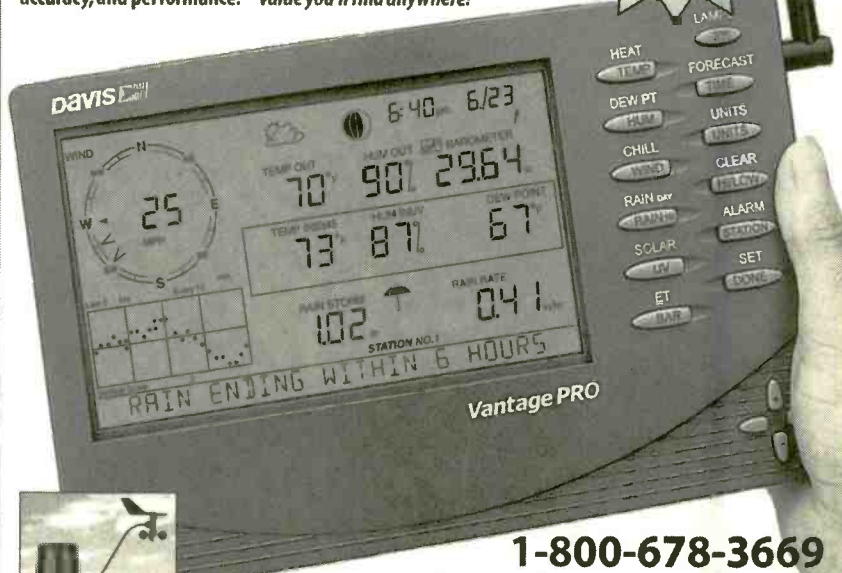

POE0102

1-800-678-3669

CALL TODAY FOR YOUR FREE CATALOG!

Davis Instruments

www.davisnet.com
3465 Diablo Ave., Hayward, CA 94545

MECI

340 East First Street
Dayton, Ohio 45402

Tons of Electronics

Get your FREE catalog today and discover some of the best deals in electronics. We have thousands of items ranging from unique hard-to-find parts to standard production components. Call, write or fax today to start your subscription to one of the most unique catalogs in the industry, filled with super values on surplus electronic and hobbyist type items.



FREE CATALOG!

Check out our 10,000 item on-line catalog <http://www.meci.com>

Order Toll Free Why pay more?
1-800-344-4465 Call today!
Fax Order Line
1-800-344-6324

Turn Your Multimedia PC into a Powerful Real-Time Audio Spectrum Analyzer

Features

- 20 kHz real-time bandwidth
- Fast 32 bit executable
- Dual channel analysis
- High Resolution FFT
- Octave Analysis
- THD, THD+N, SNR measurements
- Signal Generation
- Triggering, Decimation
- Transfer Functions, Coherence
- Time Series, Spectrum Phase, and 3-D Surface plots
- Real-Time Recording and Post-Processing modes

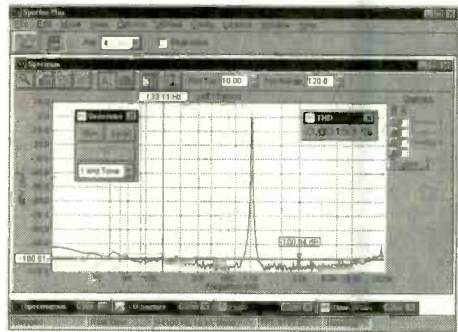

Applications

- Distortion Analysis
- Frequency Response Testing
- Vibration Measurements
- Acoustic Research

System Requirements

- 486 CPU or greater
- 8 MB RAM minimum
- Win. 95, NT, or Win. 3.1 + Win.32s
- Mouse and Math coprocessor
- 16 bit sound card

Priced from \$299

(U.S. sales only – not for export/resale)

DOWNLOAD FREE 30 DAY TRIAL!

www.spectraplus.com

PHS Pioneer Hill Software
24460 Mason Rd.
Poulsbo, WA 98370
a subsidiary of Sound Technology, Inc.



Spectra Plus
FFT Spectral Analysis System

Sales: (360) 697-3472

Fax: (360) 697-7717

e-mail: pioneer@telebyte.com

**ROBOTS,
ROBOTS,
ROBOTS...**

**ROBOT
STORE**

MONDO•TRONICS



FEATURING MUSCLE WIRES™



3000+ - The World's Biggest Collection of Robot Kits, Books, Parts & More!

**Robot Kits, Programmable Robots,
LEGO Robots, Living Robots,
Home and Office Robots, Muscle
Wires™, Electronics and More!**

**REQUEST OUR FREE
48 PAGE CATALOG
WITH OVER 400 ITEMS!**

**www.RobotStore.com
800-374-5764**

Mondo-tronics Inc.

**PMB-N 4286 Redwood Hwy Dept. 166
San Rafael, CA 94903
ph 415-491-4600 fx 415-491-4696**

**MODERN
ELECTRONICS**

**CABLE TV
DESCRAMBLERS**



- ★ **FREE CATALOG!**
- ★ **BEST DEALER PRICING!**
- ★ **DISCOUNTED PRICING!**
- ★ **30 DAY FREE TRIAL!**
- ★ **100% MONEY BACK GUARANTEE**

**COPY RENTAL TAPES WITH
OUR VIDEO STABILIZER**

1-800-906-6664

2609 S. 156th Circle • Omaha, NE 68130
www.modernelectronics.com



Build Your Own Intelligent Robot, We Make It Easy!

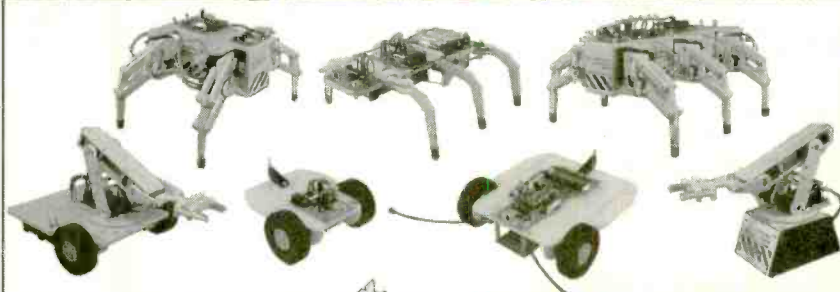

Lynxmotion, Inc.
PO Box 818
Pekin, IL 61555-0818
www.lynxmotion.com



Visit our website or ask for our free catalog!

Tel: 309-382-1816
Fax: 309-382-1254
sales@lynxmotion.com
tech@lynxmotion.com

CONITEC DATASYSTEMS

**TOP PERFORMANCE in a small package:
Europe's best selling multi-programmer!**



One size fits all!
\$333
COMPLETE KIT

Top of the line multi-programmer in sub-\$500 category. From 20% to 80% market share in Germany in 6 years. 1300+ device output and growing fast. Europe-wide sales 10%-60% mkt share in 6 years. Minimal, 1% return quota for hardware defects. Replaces all low priced dedicated programmers e.g. PIC only or GAL only units. GALEP II; also substitutes higher priced universal programmers e.g. ALL-11 (HLO) or LAB-TOOL-48 (ADVANTECH) - It provides virtually matching performance at only 1/3-1/5 the price.

Programs 8-bit and 16-bit EPROMs, EE-PROMs, 0-Power RAM's, Flash, Serial EEPROMs / GAL, PA_CE, ATF/87xxx, 89xxx, PIC12A/G/17Cxx/ ALLDIL devices **without adapter!** Lightning fast parallel data transfer (27C 256 read @ sec. - prog. 8 sec!). Supports HEX, JEDEC and binary formats, with integrated hex and fuse map editor. Fully Windows compatible incl. Win 2000 / NT. Browse 1300+ supported devices on Conitec's website: www.conitec.com. 90%+ of the listed devices require no adapter!

GALEP-III
Pocket Multi-programmer

CONITEC.DATASYSTEMS - 1951 4th Avenue, Suite 301 - San Diego, CA 92101 - Tel: 619-702-4420 - 11ty/Downloads/Orders: WWW.CONITEC.COM

EZ-EP DEVICE PROGRAMMER - \$169.95

Check Web!! -- www.m2l.com

Fast - Programs 27C010 in 23 seconds

Portable - Connects to PC Parallel Port

Versatile - Programs 2716-080 plus EE and Flash (28F, 29C) to 32 pins

Inexpensive - Best for less than \$200

- Correct implementation of manufacturer algorithms for fast, reliable programming.
- Easy to use menu based software has binary editor, read, verify, copy, etc. Free updates via bbs or web page.
- Full over current detection on all device power supplies protects against bad chips and reverse insertion.
- Broad support for additional devices using adapters listed below.

Available Adapters

EP-PIC (16C5x, 61, 62x, 71, 84)	\$49.95
EP-PIC64 (62-5, 72-4)	\$39.95
EP-PIC12 (12C50x)	\$39.95
EP-PIC17 (17C4x)	\$49.95
EP-51 (8751 C51)	\$38.95
EP-11E (68HC11 E/A)	\$59.95
EP-11D (68HC711D3)	\$39.95
EP-16 (16bit 40pin EPROMs)	\$49.95
EP-Z8 (28E02, 3, 4, 6, 7, 8)	\$39.95
EP-SEE2 (93x, 24x, 25x, 85x)	\$39.95
EP-750 (87C750, 1, 2)	\$59.95
EP-PEEL (IC22v10, 18v8)	\$59.95
EP-1051 (89C1C51, 2051)	\$39.95
EP-PLCC (PLCC EPROMs)	\$49.95
EP-SOIC (SOIC EPROMs)	\$49.95

Many Other Adapters Available

M²L Electronics

970/259-0555 Fax: 970/256-0777
250 CR 218, Durango, CO 81301
CO orders add 7% sales tax.
<http://www.m2l.com>

EZ-EP
M²L ELECTRONICS
Los Angeles, California

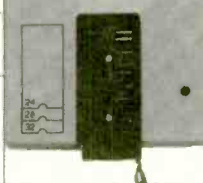

February 2001, Poptronics

suburban ELECTRONICS

- Large Selection of Batteries
Replacement Batteries for
Camcorders, Cell Phones, Laptops, etc.
- Semi-Conductors, Transistors
& Integrated Circuits
- Soldering Equipment
Soldering & Desoldering
Stations
- Satellite Antenna Accessories
Splitters, Diplexers & Amplifiers
- Electronic Tools, Tool Kits
& Tool Cases
- Test Equipment
Oscilloscopes,
Power Supplies &
Power Invertors

To get a free catalog,
visit us on the web at
www.suburban-elect.com
or call us at
1-800-341-5353

Temperature
Controlled
Soldering Station
SEW-351 \$69.95



OSCILLOSCOPE BLOW OUT

- B&K #2190A 100 MHz \$899.00
- B&K #2160A 60 MHz \$599.00
- Goldstar #OS9020P 20 MHz \$299.00

TEST EQUIPMENT

- B&K #5390 True RMS Hand-held Digital Multi-meter \$149.00
- SRV-5 5-Amp Isolated Variable Transformer 0-130V \$99.95

Pro's Electronic
Tool Kit
Includes
Tools & Case
SEW-900 \$189.95



2539 W. 237th Street, Bldg. F, Torrance, CA 90505
Order desk only: USA: (800) 872-8878 CA: (800) 223-9977
L.A. & Technical Info: (310) 784-5488 Fax: (310) 784-7590
www.digisys.net/timeline • email: mrao@earthlink.net

TIMELINE INC.

Over 15 years and 32,000 customers and still growing

Minimum Order: \$20.00. Minimum shipping and handling charge \$5.00. We accept cashiers checks, MC or VISA. No personal checks or COD's. CA residents add 8.25% sales tax. We are not responsible for typographical errors. All merchandise subject to prior sale. Phone orders welcome. Foreign orders require special handling. Prices subject to change without notice. 20% restocking fee for returned orders.

LIQUID CRYSTAL DISPLAYS

240x64 dot LCD with built-in controller.

AND 4021ST-EO. Unit is EL back-lit. \$49.⁰⁰ or 2 for \$89.⁰⁰ or
OPTREX DMF5005 (non back-lit) \$39.⁰⁰ or 2 for \$69.⁰⁰

20 character x 8 line 7XL x 2XH The built-in controller allows you to do text and graphics.

240x128 LCD with built-in controller. \$49.⁰⁰

256x128 LCD with built-in controller. \$49.⁰⁰

Alphanumeric—parallel interface

16x1	\$5.00	20x2	\$7.00	32x2	\$6.00
16x1 (lg. char.)	\$8.00	20x4	\$8.00	40x1	\$6.00
16x2	\$6.00	20x4 (lg. char.)	\$10.00	40x2	\$8.00
16x2 (lg. char.)	\$10.00	24x2	\$7.00	40x4	\$15.00
16x4	\$8.00	32x4	\$8.00	4x2	\$4.00

5V power required • Built-in C-MOS LCD driver & controller • Easy "microprocessor" interface • 98 ASCII character generator • Certain models are backlit, call for more info.

Graphics and alphanumeric—serial interface

size	Mfr.	price	size	Mfr.	price
640x480 (backlit)	Epson	\$15.00	320x240	Epson	\$20.00
640x400 (backlit)	Panasonic	\$10.00	256x128	Epson	\$15.00
640x200	Toshiba	\$10.00	240x128 (backlit)	Optrex	\$20.00
480x128 (backlit)	ALPS	\$ 8.00	240x64	Epson	\$15.00
480x128	Hitachi	\$ 6.00	160x128	Optrex	\$15.00

6" VGA LCD 640X480, Sanyo LMDK55-22 \$15⁰⁰

9.4 inch color active matrix LCD. Toshiba LTM09C011 \$49⁰⁰

9.4 inch monochrome displays. Sharp LM64P70 or LM64P723 \$29⁰⁰

MONITORS

Non-Enclosed TTL

Comes with pinout. 12V at 1.4 Amp input • Horizontal frequency 15Khz. • Ability to do 40 and 80 column.
5 inch Amber \$19.00 • 7 inch Amber \$19.00
9 inch Amber or Green \$19.00

5" COLOR MONITOR \$29.⁰⁰

- Flat Faceplate • 320 x 200 Dot Resolution • CGA & Hercules Compatible
- 12 VDC Operation • 15.75 KHz Horiz. Freq. • 60 Hz Vert. Sync. Freq.
- Open Frame Construction • Standard Interface Connector • Degaussing Coil included • Mfr. Samtron



2 for \$40⁰⁰

HACKER CORNER

Rockwell "Jupiter" GPS Receiver \$69⁰⁰

Miniature (2.75" x 1.5" x .25") 12 channel receiver engine. Supports NMEA 0183 and binary protocols. Supports DGPS input in both protocols. Compatible with active and passive antennas. "Keep-Alive" reduced power capability. Standard 2mm 2x10 interface connector. Complete manual and interface documentation available. Compatible with most laptop software using NMEA interface. Suitable for wide range of GPS applications including: Handheld GPS, Automotive / Marine / Aviation Applications, Amateur APRS and Packet.

EMBEDDED 486 COMPUTER \$79.⁰⁰ 2 for \$149⁰⁰

Complete enhanced Intel 486SX-33 based computer in ultra small (9-7/8" x 6-5/8" x 3-1/8") case. Ideal for embedded operations or as a second computer. Features include: • One 16 bit ISA slot • 3 serial ports plus dedicated printer port • Parallel optical coupled adapter port • Built in IBM PC/AT keyboard port • On board VGA video and port • Uses standard SIMM up to 32 MB • BIOS & PC/AT compatible

Unit has a backup Ni-Cd battery system in case of power failure (5 min. backup time) and lockable front cover to prevent floppy drive access. Mounting / interface provisions for standard 3.5" laptop floppy and 2.5 inch hard drives. Comes with very comprehensive manual.

CELL SITE TRANSCEIVER \$29⁰⁰ 2 for \$49⁰⁰

These transceivers were designed for operation in an AMPS (Advanced Mobile Phone Service) cell site. The 20 MHz bandwidth of the transceiver allows it to operate on all 666 channels allocated. The transmit channels are 870.030-889.980 MHz with the receive channels 45 MHz below those frequencies. A digital synthesizer is utilized to generate the selected frequency. Each unit contains two independent receivers to demodulate voice and data with a Receive Signal Strength Indicator (RSSI) circuit to select the one with the best signal strength. The transmitter provides a 1.5 watt modulated signal to drive an external power amplifier. Channel selection is accomplished with a 10 bit binary input via a connector on the back panel. Other interface requirements for operation are 26 VDC (unregulated) and an 18.990 MHz reference frequency for the digital synthesizer. The units contain independent boards for receivers, exciter, synthesizer, tunable front end, and interface assembly (which includes power supplies and voltage-controlled oscillator). Service manual, schematics and circuit descriptions included.

Portable Micro Terminal \$99⁰⁰ or 2 for \$149⁰⁰

- Flip up LCD display (9-16 VDC) • Can communicate with any computer having RS 232 port • Can communicate with another Microterminal • Use by itself as electronic notepad
- Onboard microprocessor, data RAM (32K) and Video RAM (64K) • Complex built in diagnostics and set up capabilities • Original intention for POS applications • Display size 40 x 16 (256 x 128 pixels) • Dimensions: 6.3" W, 11" L, 2" H. (With LCD up height is 7.1")

POS & BAR CODE

MAGNETIC CARD READER \$15.⁰⁰

Includes: • 30 character dot matrix display with full alpha-numeric capability • keyboard with full alpha-numeric entry • separate 7.5 VDC/0.5 Amp power supply • standard telephone interface extension cord • lithium battery and flat-iron speaker.

HP bar code wand (HBCS 2300) \$19.00

Poptronics, February 2001

B² Spice A/D 2000

\$299

Mixed-Mode Circuit Design

Competitive Analysis

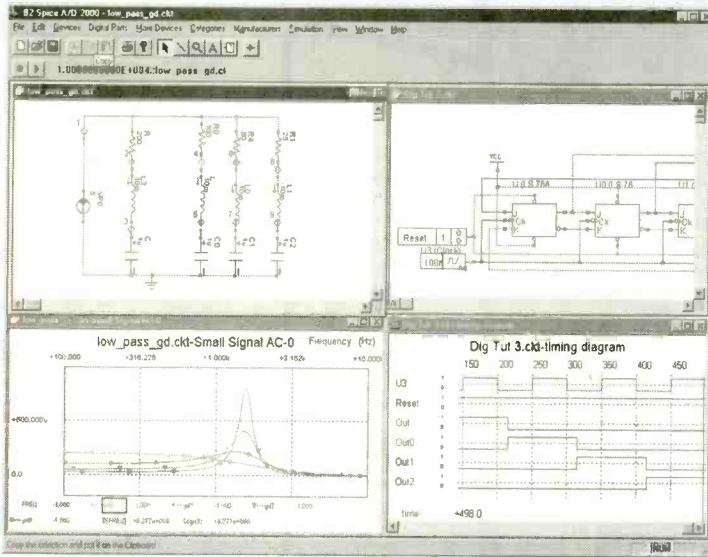

Characteristics	B ² Spice A/D 2000	EWB Multisim Personal
PRICE	\$299	\$399
DC Operating point	X	X
DC Parameter Sweep	X	X
Temperature Sweep	X	-
Transient	X	X
Fourier	X	X
Parameterized transient	X	-
AC Analysis (freq sweep)	X	X
Parameterized AC Sweep	X	-
Pole Zero	X	-
Transfer function	X	-
DC Sensitivity	X	X
Distortion	X	X
Noise	X	X
DC Op. Pt. Monte Carlo	X	-
DC Sweep Monte Carlo	X	-
AC Monte Carlo	X	-
Transient Monte Carlo	X	-
Interactive, free running digital logic simulation.	X	-

- Build complex circuits in minutes with our intuitive schematic editor.
- Turn any circuit into a functional part with just a few simple clicks.
- Interpret simulation results with customizable graphs.
- Find exactly the part you need from our database of 4500 parts.
- Run an interactive Digital Simulation and view signals in the Timing Diagram

Visit our web site for a free trial.

\$99 Lite Version

Beige Bag Software • www.beigebag.com • 734.332.0487 • info@beigebag.com

CIRCLE 319 ON FREE INFORMATION CARD

PIC'n Books

LEARN ABOUT PIC MICROCONTROLLERS

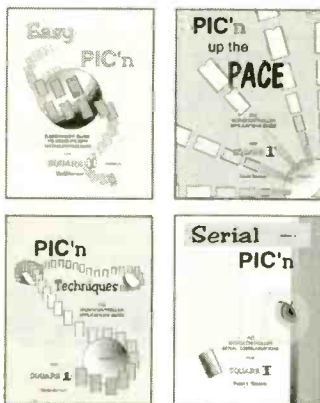

See Table Of Contents: <http://www.sq-1.com>
Secure Online Ordering Is Available

PIC is a trademark of Microchip Technology Inc.

SQUARE 1 ELECTRONICS

Voice (707) 279-8881 Fax (707) 279-8883

<http://www.sq-1.com>

RF Data Modules

AM Transmitter



- Sub Miniature module
- SAW Controlled
- No adjustable components
- Low current - 2.5mA
- Supply 2.5-12Vdc
- 418MHz or 433MHz
- Range up to 300ft
- CMOS TTL data input
- 7 x 11 x 4mm !
- AM-TX1-xxx \$12.60

AM Receiver



- Compact Hybrid Module
- Very stable
- CMOS/TTL output
- Patented Laser Trimmed
- 5Vdc, 0.8mA (HRR6)
- 2kHz data rate
- Sensitivity -105dBm
- 38 x 12 x 2 mm
- AM-HRR6-xxx... \$16.33

FM Transceiver



- Only 23 x 33 x 11mm
- Up to 40,000bps data rate
- Up to 450ft. range.
- 5V operation
- 418MHz or 433MHz FM
- 5V CMOS logic interface
- Fast 1mS enable
- Power saving feature
- Carrier Detect output
- BiM-xxx-F \$87.36

RS232 Transceiver



- 3wire RS232 interface
- 19.2Kbps half duplex
- 418MHz or 433MHz FM
- 7.5-15Vdc, 20mA
- TX/RX Status LED's
- Up to 400ft. range
- 1/4 wave ant. on board
- User data packetizing
- 58 x 40 x 15mm
- CYPHERNET \$139.30

AM Transmitter



- Range up to 250ft.
- SAW controlled stability
- Wide supply range 2-14V
- CMOS/TTL input
- Low current, 4mA typ.
- Up to 4kHz data rate
- Small: 17 x 11mm
- AM-RT5-xxx \$12.10



ABACOM TECHNOLOGIES



tel: (416)236 3858
fax: (416)236 8866
www.abacom-tech.com
MasterCard / VISA

AMAZING DEVICES

NVEN800EVEN

See and Order from Our "Action" Web Site at www.amazing1.com

Laser Window Bounce Listener

Powerful listening system, yet simple in operation. You shine a laser at a window and intercept the reflected beam with our ultrasensitive filtered optical receiver. Vibrations on the window from internal sounds and voices are now clearly heard. Range can be up to several hundred meters depending on the output power of the laser used.

LWB9 Plans for 3 Laser Window Bounce Systems.....	\$20.00
LWB6K Kit of 100' Complete for Science Project.....	\$129.95
LLR3K Low Cost Optical Receiver Kit.....	\$69.95
LLR30 Ready to Use Above Optical Receiver.....	\$99.95
LLR40 Higher Performance of Above Receiver/Optics.....	\$199.95
LM650P3 Visible Red 5mw Laser Module to 100'.....	\$29.95
CWL 10 to 10mw Class IIIB Invisible IR Laser up to 500'.....	\$299.95

PLASMA FIRE SABERS

Kits, Parts and Accessories
Duplicates effect in the motion picture epic of the century!

Specify blue, grn, pur, red or yel.
Moving light appears to evaporate into space
Blades screw into handle for easy replacement

We stock all size and color blades, mauler adapters, tubes digital drivers, and parts for authentic designs. **Wireless interactive sound modules change tone with motion**

SAB15 Assbled with 15" Blade..	\$49.95	SAB15K Kit..	\$29.95
SAB24 Assbled with 24" Blade..	\$79.95	SAB24K Kit..	\$59.95
SAB36 Assbled with 36" Blade..	\$149.95	SAB36K Kit..	\$129.95

TAKE CONTROL Using Electronic Hypnosis



Electronic circuitry places subject under your control! Induces ALPHA relaxed mind states.

HYP2 Plans.....	\$10.00
HYP2K Kit/Plans.....	\$49.95
HYP20 Ready to Use.....	\$69.95
MIND2 Plans for Mind Control.....	\$15.00
MIND2K Kit/Plans.....	\$49.95
MIND20 Ready to Use.....	\$79.95

6 Transmitter Kits

- 1 Super Sensitive Ultra Clear 1 Mile+ Voice Transmitter.
- 2 1 Mile+ Telephone Transmitter.
- 3 Line Powered Phone Transmitter Never Needs Batteries!!
- 4 Tracking/Homing Beacon Beeping Transmitter
- 5 Video/Audio Rebroadcast 1 Mi.
- 6 TV/FM Radio Disrupter. Neat Prank! Discretion Required

Includes Hints Using Wireless Devices	
COMBOX Above 6 Kits/Plans.....	\$59.95
COMBOP Above 6 Plans Only.....	\$10.00

4 KV HV MODULE for hovercraft, plasma guns, antigravity, pyrotechnics. 12vdc input. MINIMAX4. \$19.95

Pain Field Pistol

Caution! Do not aim at people!

Blast out rodents with high power ultrasonics.

Handheld and battery operated with all controls.

Rental units available.

PPP1 Plans.....	\$8.00
PPP1K Kit/Plans.....	\$49.95
PPP10 Ready to Use.....	\$79.95

Jacob's Ladder

A 1/2" arc expands to over 3' as it travels up the Jacobs Ladder evaporating in space.

- Adjustable arc control
- Uses safe high frequency
- Safety shock shut down
- Full 20" ladder length
- 110/220 vac 150 watts

JACK3K Kit.....	\$149.95
JACK30 Ready to Use.....	\$249.95

30" Spark Tesla Coil

Create a spectacular display of nature own lightning. Many amazing experiments possible. See coil in action on our web site!

BTC4 Plans.....	\$20.00
BTC4K Kit.....	\$899.95
BTC40 Ready to use.....	\$1199.95
Smaller Version (8-10" Sparks)	
BTC3 Plans.....	\$15.00
BTC3K Kit.....	\$349.95
BTC30 Ready to Use.....	\$449.95

MICRO MINI Lights 4' fluorescent tubel
MTC1 Plans...\$5.00 MTC1K Kit...\$19.95
MTC10 Assbled for 12 volts...\$34.95

Hover Board

28 pages of data related to the most revolutionary advance in transportation. Cutting edge R&D HOVER Plans and Data.....

Anti Gravity

Float an object using an electric force field. With handbook GRA3 Plans/book.....\$20.00
GRA3K Kit Pwr Sup.....\$99.95
GRA30 Assbled above.....\$149.95

Information Unlimited PO Box 716 Amherst N.H. U.S.A. 03031

1 800 221 1705 Orders/Catalogs Only! Fax 1 603 672 5406 Information 1 603 673 4730 Free Catalog on Request
Pay by MC,VISA,Cash, Check, MO, COD. Add \$5.00 S&H plus \$5.00 if COD. Overseas Contact for Proforma

CIRCLE 220 ON FREE INFORMATION CARD

ELECTRONIX EXPRESS

Visit Our Website At <http://www.elexp.com>

WELLER SOLDERING STATION - MODEL WLC 100
• Variable power control (5 to 40 watts)
• Replaceable heating element
• Quality light-weight pencil iron
\$3695

LOWEST PRICE 20MHZ
INSTEK OSCILLOSCOPE
MODEL GOS-620
Dual Channel - 20MHZ
(INCLUDES PROBES)
\$29900

SCOPE PROBE 60 MHZ
SWITCHABLE X1, X10
\$1295

DIGITAL MULTIMETER
32 Ranges - 3 1/2 Digit
MODEL MY-64
AC/DC Volt/Current, Res. Cap., Frequency. Rubber Holster Included
\$2795

PAD-234 DIGITAL/ANALOG TRAINER
Complete portable workstation. Variable and fixed power supplies, function generator, digital I/O, rugged design, high impact case.
Assembled **\$15000** Kit **\$11000**

INSTEK FUNCTION GEN.
WITH INT/EXT FREQ. COUNTER
3 MHz, Digital Display
MODEL 8216 **\$19900**

ALLIGATOR LEADS
SET OF 10 **\$210**

SWITCHES
Mini Toggle SPDT 50¢ ea.

SOLDERING IRON 3-WIRE
HIGH PERFORMANCE
#060501 **\$525**

HIGH QUALITY TOOLS
With Cushion Grips and Return Spring
Needle Nose Pliers **\$295**
Wire Stripper **\$150**
Diagonal Cutter **\$295**

DC POWER SUPPLIES
MODEL HY3003 - DIGITAL DISPLAY
Variable output, 0-30 VDC, 0-3 Amp **\$8900**
MODEL HY3003-3 - TRIPLE OUTPUT
Two 0-30 VDC, 0-3 Amp variable outputs plus 5V 3A fixed. Digital Display. **\$21500**

RSR TELECOMMUNICATIONS TRAINER
HANDS-ON TELEPHONY, LAN, CATV EXPERIENCE
WITH ONE SELF-CONTAINED UNIT
T-Comm Trainer (TCM-100) \$199.95
Lab Manual / Work Book 26.95
Component and Supplies Kit 37.95
Tool Kit 119.95
Only \$19995
MODEL TCM-100

SOLDERLESS BREADBOARD
830 tie points, MB102PLT model features 3 binding posts and aluminum backplate.
Part No. 1-9 10+
MB102 5.95 5.00
MB102PLT 8.95 8.00

MOTION DETECTOR
\$2 ea. - 10 For \$15

LM555 10 Min.....	22¢ ea.
LM741 10 Min.....	27¢ ea.
74LS00 10 Min.....	18¢ ea.
7805 Regulator 10 Min.....	30¢ ea.
2N3904 10 Min.....	6¢ ea.
PN2222 10 Min.....	6¢ ea.
Red LED T 1 3/4 10 Min.....	6¢ ea.
Green LED T 1 3/4 10 Min.....	7¢ ea.
Yellow LED T 1 3/4 10 Min.....	8¢ ea.
Photo Cell 10 Min.....	65¢ ea.
100K Pot., 1" Shaft PC Mt. 10 Min.....	15¢ ea.

PRESS-N-PEEL
PC Board Transfer Film
PNP Blue 5 Sheet \$9.90
PNP Wet 5 Sheet 9.90
PNP Blue 20 Sheet 28.95
PNP Wet 20 Sheet 28.95
\$995

FREE CATALOG
MORE Low-Priced Items In Our **FREE** 256-Page Catalog

TERMS: Min. \$20 + shipping. School Purchase Orders, VISA/MC, Money Order, Prepaid. NO PERSONAL CHECKS, NO COD. NJ Residents Add 6% Sales Tax.

In NJ: 732-381-8020 365 Blair Road • Avenel, NJ 07001-2293 <http://www.elexp.com>
FAX: 732-381-1006 **800-972-2225** email: electron@elexp.com

CIRCLE 205 ON FREE INFORMATION CARD

"The Sound Bridge" FM Stereo Wireless Transmitter

The Sound Bridge is a mini FM wireless transmitter that can be used to broadcast stereo sound from any audio source like portable CD players, TVs, electronic games, CD-ROM, even computer soundcards, to your home stereo receiver! Simply plug the unit's audio connector (includes 3.5mm mini stereo plug and standard 1/4" stereo plug) into the headphone or audio output jack of the device you want to broadcast, tune your stereo receiver to 90 MHz (can be adjusted from 89 to 95.5 MHz), and stereo sound is now being broadcast over your sound system with excellent sound quality. Requires two "AAA" batteries, not included. Limited availability.



#249-220 **\$14⁹⁵** EACH

201 PanaVise Jr.

This mini vise is an invaluable bench top companion for the home hobbyist. PV Jr. uses the famous PanaVise design that turns, tilts, and rotates for a full range of movement. Ideal for soldering, gluing, and general work. Features jaws that open to 2-7/8", both vertical and horizontal grooves to hold work, and a fine adjustment knob. Net weight: 1-1/4 lbs.

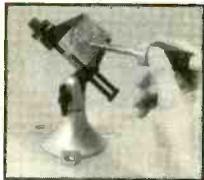

#365-300 **\$19⁹⁵** EACH

DMM and LCR Meter

In addition to functions found in regular DMMs, this meter can also measure inductance in 5 ranges (4mH, 40mH, 400mH, 4H, 40H), capacitance in 5 ranges (4nF, 40nF, 400nF, 4uF, 400uF), frequency in 4 ranges (4kHz, 40kHz, 400kHz, 4MHz), TTL logic test, diode test and transistor hFE test. 5 AC/DC ranges up to 1000V (AC750V), 3 AC/DC current ranges up to 10A and 7 resistance ranges up to 4000 M ohms. Includes test leads, battery, spare fuse, and manual. Net weight: 1 lb.



#390-513 **\$85⁹⁰** EACH

30W Stereo Amplifier Kit

This small amplifier is constructed around the TDA1521 IC, capable of delivering 2x15W RMS (4 ohm) or 2x10W RMS (8 ohm). The IC is thermally and short circuit protected. THD: .07% (1W/1KHz). Frequency response: 7 to 60,000Hz (-3dB). Requires 2x12 VAC, 2A transformer, our #129-050. Net weight: 1 lb.



#320-212 (Kit) **\$29⁹⁵** EACH

#320-213 (Assembled/Tested) ... **\$44⁹⁵** EACH

If you haven't received a copy of our current 284 page catalog... have one added to your order or give us a call and we will send one out to you immediately.



Dayton Loudspeaker Co. 6-1/2" Round Coaxial System

Designed for the home and office, these 6-1/2" round in-walls are ideal for ceiling installations, or for use as rear channel surround speakers.

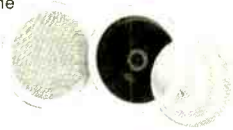

#300-408 **\$69⁹⁵** (1-3 PRS) **\$62⁷⁵** (4PRS-UP)

D25 Multimedia Speaker System

Two amplified, magnetically shielded speakers with bass, treble, volume and mute controls. Headphone jack and heavy duty 9V, 1 Amp power supply.



#299-510 Compare To **\$29⁹⁵** **\$9⁹⁵** EACH

Color Video Camera With Audio

- ◆ Single chip 1/3" format camera
- ◆ 310 TV line resolution
- ◆ Built-in audio
- ◆ Focusable lens
- ◆ Automatic gain control
- ◆ Auto white balance
- ◆ Pick-Up device: 1/3" CMOS
- ◆ Light sensitivity: 10 Lux
- ◆ Lens: 4.3mm
- ◆ S/N Ratio: >38dB
- ◆ Power: 8-12VDC, 30mA (9VDC adaptor included)



#335-485 **\$99⁹⁵** (1-3) **\$95⁵⁰** (4-UP)

5" LCD Monitor With Audio

- ◆ Perfect for any portable or fixed audio/video monitoring application
- ◆ True high resolution display: 224,640 dots
- ◆ Durable plastic housing with tilting display
- ◆ Stereo sound with built-in speakers and headphone jack
- ◆ Over 60% more viewing area than a 4" screen
- ◆ Controls for power, volume, tint, brightness and color
- ◆ Video inversion switch for roof mount applications



NEW

#205-060 Suggested Resale **\$299⁹⁵** EACH Regularly **\$219⁸⁰** EACH

Introductory Price **\$199⁹⁵** EACH

LARGEST SELECTION OF SPEAKER DRIVERS IN THE COUNTRY!

Visit Us On The Web At **www.partsexpress.com**
Or Call Toll Free **1-800-338-0531**

725 Pleasant Valley Dr., Springboro, OH 45066-1158 KEY CODE: POM
Phone: 513-743-3000 ◆ FAX: 513-743-1677 ◆ E-Mail: sales@partsexpress.com

PIC PROJECTS Book & CD-ROM

Many PIC Projects for Beginners & Experts!
Includes Software, Documentation, and PCB Layout

- LCDs
- X10 - Home Automation
- Keypads
- Serial Port Interface
- On-Screen Displays
- Robotics
- Data Logging
- Serial-Parallel
- And Many More!

Book &
CD Only
\$24.95

PIC Programmer

Programs all PIC16C55x/57x/7x/8x/9x, PIC 16F8x, and PIC12C devices. Optional ZIF adapters for SOIC & PLCC. Includes all necessary software.
Only \$37.95

Buy
Both for
\$59.95

Accept
VISA • MasterCard • American Express
To order, call Worldwide @ 1-800-773-6698
21365 Randall Street • Farmington Hills, MI 48336
Visit us on the web at www.worldwide.com/pic

PIC Programmer Kits

Super Value!
\$16.95
+S&H \$4.95*
The P16PRO can program up to 40 pin PICs including the popular 16F84 & 12C508 • Needs software (extra \$20) • Available assembled or starting from \$16.95 for the kit.

See www.electronics123.com for more info!
The PICALL programmer can also program Atmel AVR's in addition to the PICs it can program • Free software • PICALL programmer kit at \$69.95
See www.electronics123.com for more info!

Video Camera module Code:BB004

CMOS Camera Module, Black & White, Size: 0.63"x0.63"x0.59"H. Lens: f4.9, F2.8, EIA 320Hx240V. 0.3" DIL Package, 5 pins. Pin 3 is 1V p-p composite video (75 ohm) to monitor. \$36 + \$5 S&H

Running Lights kit Add \$6 for 8 triacs to drive light bulbs

8 LEDs with 10 push button selectable patterns. 8 speed levels! 80 combinations! \$16 + \$5 S&H

Toll Free: 1-888-549-3749 (USA & Canada)
Tel: (330) 549-3726. Request a FREE catalog or visit us at: www.electronics123.com for more products.
Amazon Electronics, Box 21 Columblana OH 44408

spyoutlet.com

Countersurveillance - Electronic Devices

Purchase your video cameras from one of the largest Importers in the U.S.

- NEW Underwater Bullet Cameras
- Spy Pinhole Cameras starting at \$79.00
- Wireless Video • Voice Changer
- Micro Recorders • Shotgun Mic
- Locksmithing • Bug & Phone Tap Detectors • Phone Call Register
- UV Pens & Powder • Realtime Telephone Recording Systems: 12 Hour \$125.00 • GPS Vehicle Tracking System (nationwide) And much more

www.spyoutlet.com
Printed Catalog send \$5.00

SPY OUTLET 2468 NIA. FALLS BLVD
TONAWANDA NY 14150 (716) 695-8660

THE Video King



Removes Distortion

- Improves Color, Tint & Old Video
- Creates & Restores Inverted Video
- Works with PAL & NTSC Formats
- Perfect for Video Duplication

R.C. Distributing Co. Phone (219) 233-3053 Fax (219) 289-1566
www.rcdistributing.com



Cable TV Remotes Blow-Out Sale

We carry all models

10pc.	50pc.	100pc.
\$3.75	\$3.50	\$3.25

300pc.	500pc.	1kpc.
\$3.00	\$2.75	\$2.50

Rebellion-3 125ch. Converter

12pc.	50pc.	100pc.
\$50.00	\$48.00	\$46.00

Globaltech 1-(800)-582-5116
View Our On-Line Display Catalog at:
www.globaltechdistributors.com

Low Cost PICmicro Tools

New! PIC-X1
Experimenter/
Lab Board
\$49.95 to \$199.95



EPIC Pocket PICmicro
Programmer - \$59.95

Program PICmicros in BASIC!
PicBasic Compiler - \$99.95
PicBasic Pro Compiler - \$249.95

PICProto Boards make
prototyping with PICmicros
easy - \$8.95 to \$19.95



microEngineering Labs, Inc.

Box 7532 Colorado Springs CO 80933
(719) 520-5323 fax (719) 520-1867
<http://www.melabs.com>

Hack & Crack Bible II and CD-ROM

Includes all Software, Documentation!

Learn the secrets of:

- Software Serial numbers
- Timed Trial Versions
- Learn how the Pros do it!
- Step-by-Step Guide
- The only "How to guide"

Only
\$39.95

Hack & Crack Gold CD

Get thousands of cracks by the worlds best crackers to crack the protection schemes of thousands of programs. Includes tutorial library that is a crackers dream come true!

Only
\$29.95

We accept VISA • MasterCard • American Express
To order, call Worldwide @ 1-800-773-6698
33523 Eight Mile Rd #A3-261 • Livonia, MI 48152
Visit us on the web at www.worldwide.com

www.jm-micro.com

PIC In-Circuit Emulator

for the PIC16Cxx from \$295

PIC Programmer \$155

80C552 (8051) Development

Training System \$235

68HC11 SBC \$120

ROMY-16 EPROM Emulator

from \$195

Universal Microprocessor

Simulator/Debugger (including

Assembler, and Disassembler)

\$100 each CPU

J&M Microtek, Inc.

83 Seaman Rd, W Orange, NJ 07052
Tel: (973) 325-1892 Fax: (973) 736-4567

CONTROL IT

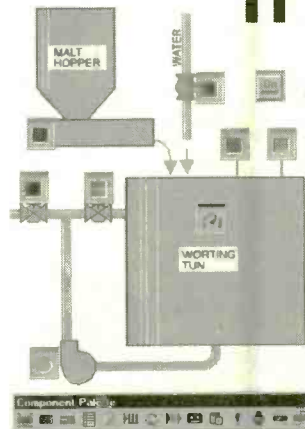

Intec Automation Inc.
www.microcommander.com

SMART CARDS

Complete system! Program your own smart card applications in easy to use BASIC



- Security Systems
- Time Cards
- Emulation
- Access Control - Home, Auto
- Robotics Programming
- DATA Security

Tool Kit comes complete with:

- SmartCard Programmer
- Developer Software Package
- User Manual in printed form
- 3 Blank Smart Cards

Complete system for only \$79.95

We accept

VISA • MasterCard • American Express

To Order Call 1-800-773-6698 Worldwyde.Com,
33523 Eight Mile Rd #A3-261, Livonia, MI 48152
Visit us online <http://www.worldwyde.com>

CABLE SECRETS!!!

Build your OWN cable box "test" devices!

Why pay \$100.00 or more for a "test" device that someone else made? Make your own! Includes complete source code and plans for the most commonly used cable boxes. Unlock all of the channels on your box!

Or start your own lucrative business!

Complete source code \$79.95
Code for individual boxes \$29.95

DSS SECRETS — Vol. 2

Step-by-step instructions on programming your own DSS access card. Unlock all channels on your own card! This is the most current information on the market! Includes software, plans, and hardware sources. Book & CD-ROM.

DSS Secrets Vol. 2 \$49.95

VISA • MasterCard • American Express

To order, call Worldwyde @ 1-800-773-6698
33523 Eight Mile Rd. #A3-261 • Livonia, MI 48152
Visit us on the web at www.worldwyde.com

Consumertronics

P.O. Box 23097

ABQ, NM 87192

505-321-1034 505-321-1033

FREE ONLINE CATALOG



www.tsc-global.com

Hi-Tech Survival: Books, Software.

SPECIAL PROJECTS on Electronics, Computers, Internet, Phones, Energy, Security, Financial, Medical, Cars, Jobs, Physical Survival, Improvised Hacking, Unexplained Phenomena.

In business 25+ years!

Hardcopy Catalog: \$3 US/Canada, else \$7

SCINTILLATING!

Who Are You? The Encyclopedia of Personal Identification. Insider information directly from the FBI and Customs, top graphic artists, offshore attorneys, master thieves, and professional sharks. *Who Are You?* details ID theft schemes (and prevention), how to create great documents on a home computer, get a new driver's license (suspension? No problem), open offshore or JS bank accounts w/o an SS number; acquire the world's best ID, second passports, phony credit cards, read vehicle tags, much, much more. Sources, sites, suppliers, tips, tricks and techniques. 352 pages \$44.95.

Covert Catalog2000 The latest, hands-on source guide for law enforcement goodies, electronic surveillance, covert video, counter measures, entry equipment, weapons, tracking systems, computer surveillance, and more. Exact ordering info from suppliers in 13 nations! 220 Pages. \$39.95.

ORDER BOTH BOOKS — SUBTRACT \$10!!

Intelligence Here

404 N. Mt. Shasta Blvd.
Mt. Shasta, CA 96067

Order by Phone: 866-885-8855
www.intelligencehere.com

All \$6.00 (priority shipping). CA residents add 8% tax



Teach Yourself Embedded Control with the Most Popular 8-Bit Architecture in the World

- Kits include everything you need: hardware, integrated development environment (IDE), tutorials, software demos, and textbooks
- Developed by university professors
- Used by tech schools, colleges, & universities
- Suitable for self-paced learning
- Industrial grade PC boards
- Several 8051 platforms to choose from
- WIN 95/98/NT IDE, free web updates
- IDE includes 8051 Chip Simulator
- Program in Assembly, BASIC, and C
- Complete Industrial and mechatronics demos
- Use course material to build a robot
- Textbooks include hands-on experiments
- 13 years experience in educational systems
- Complete packages starting at \$120

To download software or for more information visit

www.rigelcorp.com

Rigel Corporation, PO Box 90040
Gainesville, FL 32607

NEW Easy-PC For Windows

Schematic & PCB Layout CAD

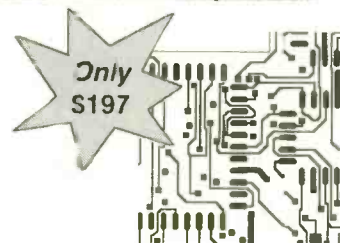

Only \$197

- True Windows interface
- True Windows 32 bit application
- Schematic and PCB Design as standard
- Intelligent Cut Copy and Paste - internal & external
- Multi-level Undo and Redo
- Forward design changes - Schematic to PCB
- Integrated Autopace
- Integrated Shape based AutoRouter (Optional Extra)
- Shape based copper pour and split power planes
- And now version 4.0 with many new features !!

Call Ohio Automation (740) 596 1023
www.numberone.com

Press-n-Peel Transfer Film

PC Boards in Minutes

8.5" x 11" Shts.
* Or Photocopy
** Use standard household iron

1. LaserPrint*
2. Press On**
3. Peel Off
4. Etch



Use Standard Copper Clad Board
20 Shts \$30/ 40 Shts \$50/ 100 Shts \$100
Visa/MC/PO/CK/MO \$4 S&H/Foreign Add \$7

Techniks Inc.

P.O. Box 463, Ringoes NJ 08551
ph. 908.788.8249 fax 908.788.8837

www.techniks.com

Visit Our E-Store On-Line!

TOP SECRET I

Hacking • Cracking • Satellite • Cable • Phreaking • Micros
GameBoy I/O • Smart Cards • Emulation • Hardware • Tools

Plus More! Visit us on the web!

Books & CD's:

Hackers Anarchy Cook Book 2000	\$39.95
The Hack & Crack Bible Vol.2	\$39.95
Hackers Gold CD Vol.1	\$29.00
Secrets of Dish Network Vol.1	\$49.95
DSS Secrets Vol.4 Book & CD	\$49.95
Cable Test Devices Source Code & Plans	\$79.00
PSX Secrets w/ MODCHIP Source Code	\$69.95
The Ultimate Phreaking Guide	\$39.95
Emulator Heaven CD	\$49.95
Game Boy I/O - Servos/Relays/Sensors	\$49.95

Hardware:

PIC, Scenix, Atmel Programmer Complete ...	\$99.00
ISO 7816 Smart Card Programmer	\$59.95
Smart Cards (from)	\$ 6.95
Prototyping Boards PIC & Scenix	\$ 9.95

VISA • MasterCard • American Express

To Order Call 1-800-773-6698

Send Money orders to: Worldwyde.Com,
33523 Eight Mile Rd #A3-261, Livonia, MI 48152
Visit us online <http://www.worldwyde.com>

PIC MICRO TOOLS



Easy Solderless Prototyping!
On board RS-232. In Circuit
Programming. No cable or chip
swapping! Fully Documented.
Starting at Only \$39.95



ISP PRO Programmer
PIC - Scenix - Atmel - I2C - SPI
In Circuit or on board. The only
programmer you'll ever have to
buy! Only \$59.95



Program PIC's in BASIC!
Pic n Basic Compiler \$89.95
Pic n Basic PRO Compiler \$149.95
Includes Windows IDE with ISP PRO
programmer software built in FREE!

Combo Deal - Pic n Basic, ISP PRO, 1602
Solderless Proto Board and PIC16F84 p us
cables and power supply all for only \$179.95

Join our online PIC forums tons
of information and help Free!

VISA • MasterCard • American Express

To Order Call 1-248-426-8144 Basic Micro
33523 Eight Mile Rd #A3-261, Livonia, MI 48152
Visit us online <http://www.basicmicro.com>

Home Automation



World's Largest Source for Home Automation!

- Voice Control
 - Gadgets & Motorized Devices
 - Home Theater
 - Phones & Intercoms
 - X10 & Lighting Control
 - Home Security & Surveillance
 - Home Networking & Structured Wiring
- and Much More...

800-SMART-HOME
www.smarthome.com

Free 144 pg. Color Catalog!

Dealers/Resellers ask about our
SmartHome PRO Dealer Program 800-949-6255

SUPPORTS DEVICES TO 32 MEG

EPROM+

A device programming system for design, repair and experimentation

- ◆ EXCEPTIONAL POWER FOR THE PRO
- ◆ EASY-TO-USE FOR THE NOVICE
- ◆ INCLUDES STEP-BY-STEP TUTORIAL

Here's what you get: A rugged, portable programming unit including the power pack and printer port cable both of which store inside the case. A real printed user and technical manual which includes schematic diagrams for the programming unit plus diagrams for all technology family adapters. * Comprehensive, easy-to-use software which is specifically designed to run under DOS, Windows 3.1, 95 and 98 on any speed machine. The software has features which let you READ, PROGRAM, COPY and COMPARE plus much more. You have full access to your system's disk including LOADING and SAVING chip data plus automatic processing of INTEL HEX, MOTOROLA S-RECORD and BINARY files. For detailed work the system software provides a full screen buffer editor including a comprehensive bit and byte tool kit with more than 20 functions.

Broad device support: FIRST GENERATION EPROMS (2708, TMS2716*, 25XX) SECOND GENERATION EPROMS (2716-28C080), 40 AND 42 PIN EPROMS* (27C1024-27C160) FLASH EPROMS (28F29C,29EE,29F), EEPROMS (2816-28C010), NVRAMS (12XX,X2210/12) 8 PIN SERIAL EPROMS* (24, 25, 85, 93, 95, 8001A) PLUS ER1400/MS8657* AND ER5901 BIPOLAR PROMS* (72S/82S), FPGA CONFIGURATORS (17CXXX) MICROCONTROLLERS* (874X, 875X, 87C5XX, 87CT5X, 89C5X) ATMEL MICROS* (8-40) PIN 89C0051, 89C5XXX (AVR) 90SXXX PIC MICROS* 8, 18, 28, 40 PIN (12CXX-16CXXX, 16FX, 17C) MOTOROLA MICROS* (68705P3U3/R3, 68HC705, 68HC711)

\$289

*REQUIRES SNAP-IN ADAPTER (ORDER FACTORY DIRECT OR BUILD YOURSELF) \$5.00 SHIPPING + \$5.00 C.O.D.
1 YEAR WARRANTY - 30 DAY MONEY BACK GUARANTEE VISA*MASTERCARD*AMEX

ANDROMEDA RESEARCH, P.O. BOX 222, MILFORD, OH 45150
(513) 831-9708 FAX (513) 831-7562 website - www.arlabs.com

ON SCREEN DISPLAY CHARACTER OVERLAY BOARD



OSD-232 on board a radio controlled airplane!

Ever wish your LCD module could display more lines of text? OSD-232 is the solution! From any RS-232 serial source like a PC, PIC, or Basic Stamp, display 28 columns by 11 rows of information (308 characters total) directly onto any NTSC or optional PAL baseband (video in) television or VCR. OSD-232 can overlay monochrome text onto an incoming video source or display colored text on a self-generated colored background screen.

Intuitive Circuits, LLC
2275 Brinston • Troy, MI 48083
(248) 524-1918
<http://www.icircuits.com>

OSD-232 \$99.00
Visa/Mastercard/Prepaid check

PCBoards PCB Artwork Made Easy!

PRINTED CIRCUIT DESIGN SOFTWARE

For Windows and DOS
Layout - Autorouting - Schematic - Circuit Simulation

Visit our Website @ www.pcboards.net

For free DEMO and Information

PCBoards (800)473-7227
2110 14th Ave. South (205)933-1122
Birmingham, AL 35205

Perfect for the Pro or Hobbyist!

FCC License Preparation

RADIOTELEPHONE LICENSE
Electronics Tech, Avionics, Marine & Radar
Homestudy--Fast-Fasy & inexpensive.
Manuels-Audio-Video-podisks-Q&As
Guarantee Pass-see at www.wptfcc.com
Details-800-800-7555.WPT Publications
4701 NE 47ST, Vancouver, WA.98661

TUBES, BOOKS, TRANSFORMERS, CAPACITORS PARTS and MUCH MORE!



CALL *480-820-5411* TODAY FOR
OUR FREE 80 PAGE CATALOG
FAX 480-820-4643 or 800-706-6789

www.tubesandmore.com

Do You Repair Electronics?

- Repair Databases for TV, VCR, Monitor, UL Audio, FCC, and more.
- Over 76,000 records
- Private user forums
- Live on-line chat rooms

RepairWorld.com

Electronics Corp 1 Herald Sq. Fairborn, OH 45324 (937) 878-9878



- ★ No Rolls/Jitters/Flickers/Fading
- ★ Works on all TV's, VCR's, Beta, & Cable
- ★ Gold Video Connectors & Cables Included
- ★ 1 Year Warranty
- ★ Money Back Guarantee

FREE CATALOG!

COPY RENTAL TAPES WITH OUR VIDEO STABILIZER

1-800-562-2252

2609 S. 156th Circle • Omaha, NE 68130
www.modernelectronics.com



CABLE BOXES

• WE'LL BEAT ANY PRICE!

- 1 YR WARRANTY
- FREE CATALOG
- 30 DAY MONEY BACK GUARANTEE

WWW.CATVBOXES.COM

1-800-765-4912

High Performance Auto Ranging DMM New to our DMM line-up and possibly (probably) the best DMM value you will find. **Auto Ranging**, **Range Hold**, **Temperature Probe**, **Frequency Test**, **Continuity Test**, **AND MORE!**

Measures:
 DC Volts: up to 1000V
 AC Volts: up to 750V
 AMPS: up to 20 Amps (AC & DC)
 Resistance: up to 30M ohm
 Continuity Check: with audible signal (signal sounds if resistance is less than 20 ohms. Display reads actual resistance).
 Frequency: (1KHz to 300KHz) displays both digital and bar graph reading.
 Transistor hfe Test: Display shows approximate hfe value based on test condition of 10uA base current and Vce of approx. 3V.
 Temperature Test: Measures from 0° to 1932° F (probe supplied).
 Diode Test: Tests if diodes are shorted or open.
 Input Impedance: 10Mohm (Vdc/Vac); over 100Mohm on 300 mVdc range

Auto Ranging: For easy, precise range settings
Range Hold Control: allows for manual selection of your test range
3-3/4 Digit LCD Display: Reads up to 3260. Easy to read display.
Function Dial: Easy to use to select measurement type or turn unit off.
4 Jack Plug-ins: Safety design with different capacities for different functions.
Diode, Continuity Check Push-Button: For toggling between diode check and continuity check.
Low Battery Indicator: Advises you when it's time to change battery.
Extra Long 44" Test Leads: Helps get to hard to reach places
Screw-On Alligator Clips: Convert one or both probe tips to alligator clips.
Fuse-Protected Circuitry
Built-In Stand: Makes one hand operation easier.
Shock Absorbing Rubber Carrying Case: with convenient probe storage clips and hanging tab. Helps protect the DMM from damage if accidentally dropped.

ONLY \$299.50

NOW IN STOCK!

#CSI9903

Specifications Accuracy
 Vdc: ±1.0% reading +5 digits
 Vac: ±1.5% reading +8 digits
 Adc: ±1.2% reading +5 digits
 Aac: ±1.5% reading +5 digits
 Resistance: ±1.5% reading +5 digits
 Frequency: ±3.0% reading +5 digits
 Temperature: ±1.0% reading +6 digits
 Requires two AAA batteries sold separately.

Removable Hard Drive Rack
 For IDE/Ultra DMA Hard Drives

ONLY \$149.50 any qty.

We Sold Over 14,000 in 1998!

This product can be used with any 3-1/2 IDE hard drive up to 1" high. It includes an electronic keylock for safe removal and insertion. Made of ABS 707 fireproof plastic. Use this product to protect sensitive hard drive data, take your hard drive between work and home or even set up different users with their own hard drives that they physically insert every time they use a PC. Other models available from C.S.I. include RH10 series and RH20 series, which are interchangeable within the same interface design (IDE or SCSI). Other Models are Available. See www.web-tronics.com under "hard drive and accessories" for more details and pictures.

#RH-10C-IDE

Removable Hard Drive Rack with Auto Door And Cooling Fan

ONLY \$189.50 any qty.

- Auto door on the outer frame
- ABS material of outer frame, High efficiency cooling fan
- Worldwide patent pulling function handle
- CE Approved
- Coating iron bottom cover for IDE interface
- For 1" high 3.5" HDD
- Not compatible with our RH10 & RH20
- Compatible with our RH17-IDE model.

#MR-27

Details at www.web-tronics.com

2GHz RF Field Strength Analyzer

ONLY \$1589

- Frequency Range: 100KHz to 2.06GHz
- Narrow Band FM (NFM), Wide Band FM (WFM), AM and Single Side Band (SSB) Modulated Signals May Be Measured
- PLL Tuning System for Precise Frequency Measurement and Tuning
- LED Backlight LCD (192x192 dots)
- Built-in Frequency Counter
- Hand-Held and Battery Operated
- All Functions are Menu Selected
- RS232C for PC Interface and Printer

#3201

CTRL - D to bookmark this site

www.web-tronics.com

Don't forget the dash

Circuit Specialists Inc.

Easy to Navigate
 Includes a Search Engine
 That Really Works
 New Items Added Constantly

In Business Since 1971

CCD B&W Board Cameras

- ASIC CCD Area Image Sensor
- Extremely Low Power Consumption
- 0.5 Lux Min Illumination
- Built-In Electronic Auto Iris for Auto Light Compensation

VM1030PA-B 30mmx30mmx25mm, Pinhole lens, 12V \$39.00 any qty.
VM1030A 30mmx30mmx26mm, Standard lens, 12V \$39.00 any qty.
VM1035A 42mmx42mmx25mm, Standard lens, 12V with back light compensation \$49.00 any qty.
VMCB21 44mmx38.5mmx28mm, with 6 infra-red LEDs, 12V \$49.00 any qty.
VM1036A 32mmx32mmx25mm, Standard lens, 12V, reverse mirror image feature \$49.00 any qty.

Detailed Specs on the Web

LOWER PRICES

Mini CCDs (B/W & Color)
 Sensational NEW Design for Small Observation Cameras. Smaller and Better!

- Ultra Miniature Design
- Black & White Versions Only 25mm x 25mm
- Color Versions Only 32mm x 32mm
- Available in Standard Lens or Pinhole Lens

ALL include Pre-Wired Cable Harness for Video & Power
 12V Regulated Power Supply Required (120mA typical power consumption)
 0.1 LUX Rating (B/W), 1 LUX (color)
 CCD Area Image Sensor for Long Camera Life
 Back Light Compensation Circuit
 Built-In Electronic Auto Iris Lens

VMCW-H11A 32mmx32mmx30mm, Color CCD with standard lens, pre-wired cabling 12V DC Power \$139.00 / \$129.00 5 or more
VMCW-H12A 32mmx32mmx19mm, Color CCD with pinhole lens, pre-wired cabling, 12V DC Power Input \$139.00 / \$129.00 5 or more
VMPS-718A 25mmx25mmx30mm, B/W CCD with standard lens, pre-wired cabling, 12V DC Power Input \$59.00 / \$49.00 5 or more
VMPS-250A 25mmx25mmx15mm, B/W CCD with pinhole lens, pre-wired cabling, 12V DC Power Input \$59.00 / \$49.00 5 or more
VCC-3232 32mmx32mmx30mm, CMOS COLOR, std lens, see web for specs \$79.00 / \$72.00 5 or more

Detailed Specs on the Web

Bullet CCD Cameras B&W and Color

- Smart Rugged Metal Housing
- Extremely Low Power Consumption
- 12 Volt
- CCD Area Image Sensor for Long Camera Life
- Built-In Electronic Auto Iris for Auto Light Compensation
- No Blooming, No Burning
- 0.1 Min Lux Illumination (B&W), 1 Lux Min Lux Illumination (color)

VMBL T1020 B&W, 21mm(D)x55mm(L) \$49.00 any qty.
VMBL T1020W B&W Weatherproof, 21mm(D)x58.5mm(L) \$79.00 any qty.
VMBL TJC198W COLOR! Weatherproof, 17mm(D)x88mm(L) \$139.00 any qty.

Detailed Specs on the Web

LOWER PRICES

COLOR CCD Mini Board Cameras

- Low Power Consumption
- 1 Lux Illumination
- Internal Synchronization
- 12Volts
- 400 TV Lines
- Built-In Electronic Auto Iris for Auto Light Compensation

VM3010PA 33mmx33mmx18mm, Pinhole lens \$99.00 any qty.
VM3011-A 45mmx40mmx24mm, Standard lens, single board \$89.00 any qty.
VM3010-A 33mmx33mmx32mm, Standard lens \$99.00 any qty.

Detailed Specs on the Web

PRICE REDUCTION

Hot Air SMD Rework Station WOW! ONLY \$489
 Similar Systems Cost 100s More!

ONLY \$489

#SR-979

For technicians, service/repair depots and assembly network. We also stock a selection of nozzles for QFP, SOP & PLCC devices (see our website for selection details). Hot Air temperature variable from 100°C to 400°C (212°F to 754°F) power consumption: 275w max. Auto cooling feature cools system after shut off to extend service life of heating elements and handle. One year limited warranty from C.S.I.
 Comes with QFP Nozzle (0.68" x 0.68")

O'Scope Offer ONLY \$299

30MHz! ONLY \$299!
 Industries Best Price!
 See web for specs

#OSC-1030

- Dual Channel
- Dual Trace
- Vert Trigger
- 1 Year C.S.I. Warranty!

Manufactured for CSI by a leading O.E.M. manufacturer. See our website for detailed specifications!

2.4 GHz A/V Sender/Receiver System

- Wireless FM transmission of video (color or B/W) and sound (stereo or mono) up to 150 meters (line of sight)
- Directional Antenna Design optimizes performance
- Use with remote cameras or any input (satellite TV, cable etc.) where wireless transmission is desired. View on a TV set.
- Performance through walls varies depending on construction methods etc.
- Each set includes a plug-in power supply for the transmitter & receiver.
- 7 segment LED displays channel (1-4) on receiver & transmitter.

Now On Sale Order Now

CSIHTR2400 Includes One Transmitter & One Receiver with Power Supplies \$109.00
CSIHTR2400TX Extra Transmitter/Each Receiver will Monitor up to 4 Transmitters \$89.00

See more detailed specifications at www.web-tronics.com in the CCD camera section.

3000 Series Digital R/O Bench Power Supply
 ←Low Cost Single Output ←3Amp

AS LOW AS \$89

High stability digital read-out bench power supply featuring constant voltage and current outputs. Short-circuit protection and current limiting protection is provided. Highly accurate LED accuracy and stable line regulation make the 3000 series the perfect choice for lab and educational use.

Line Regulation: 2x10⁻⁴ +1ma
 LED Accuracy: Voltage ±1% +2 digits
 Current ±1.5% +2 digits
 Wave Line Noise: ≤1mVrms
 Dimensions: 291mm x 158mm x 136mm (CSI3003)

CSI3003: 0-30v/0-3amp Digital R/O Bench PS, 1x10⁻⁴+5mv Load Regulation \$99.00 5/\$89.00

Our Most Sophisticated DMM We Sold Over 700 Last Year!

with RS-232C Interface & Software, 3-3/4 Digit, 4000 Count, Auto-Ranging with Analog Bargraph

- True RMS Mode
- 10MHz Frequency Counter
- Time Mode with Alarm, Clock, and Stop Watch
- Dual Display
- 10 Location Memory
- Min, Max, Avg and Relative Mode
- Decibel Measurement
- Cap and Ind. Measurement
- Temperature Mode (C/F)
- K Type Temperature Probe Included
- Pulse Signal for Logic & Audible Test
- Continuity/Diode Test
- Logic Test
- Auto Power: OFF/Keep ON Mode
- Fused 20A Input with Warning Beeper
- Back Light
- Data Hold/Run Mode
- Safety Design UL1244 & VDE-0411
- Protective Holder
- Silicon Test Leads

NOW ONLY \$129
 Reg. \$169

More Details on our Web Site

PROTEK 506

SECURETEK

DIRECT FROM MANUFACTURER

"WE WILL BEAT ANY COMPETITORS PRICE"

WORLD SMALLEST
WIRELESS VIDEO CAMERA
(BLACK & WHITE OR COLOR)
TRANSMITS VIDEO UP TO 1000FT.



CAMERA SHOWN
ACTUAL SIZE

WE ALSO CARRY:

- COVERT VIDEO CAMERAS
- COUNTER-SURVEILLANCE PRODUCTS
- CUSTOM MADE VIDEO SYSTEMS
- IN HOUSE ENGINEERING DEPT.



RUNS ON 9V BATTERY
FOR UP TO 12 HRS.

DISTRIBUTOR
PROGRAM
AVAILABLE

CALL FOR CATALOG:

SECURETEK

7152 S.W. 47TH STREET
MIAMI, FLORIDA 33137

TEL. 305.667.4545

FAX. 305.667.1744

www.securetek.net

Your Next Great Design Begins HERE!!

NEW!

Global Specialties brand Proto-Boards have been the standard bearer for quality in electronic circuit design workstations since 1973. The new Proto-Board Model PB-505 combines the quality and craftsmanship inherent in other Global design workstations by adding expanded features such as a rugged steel case and a large removable prototyping area. There's only one Proto-Board, and it's made by Global Specialties.



The NEW
Proto-Board
Model PB-505

FLEXIBLE

The new PB-505 combines four instruments, a large removable bread-board area and other commonly used components into one workstation to allow for maximum circuit design flexibility.

RELIABLE

Backed by an industry-best 3-year warranty against manufacturing defects and a lifetime warranty on breadboard sockets, the PB-505 features unparalleled craftsmanship utilizing materials of the highest integrity.

DURABLE

With its heavy-duty design and rugged steel case, the PB-505 is built to withstand the use and abuse of any laboratory environment.



GLOBAL SPECIALTIES
INSTRUMENTS

www.globalspecialties.com

1486 HIGHLAND AVE., UNIT 2, CHESHIRE, CT 06410
800-572-1028 • FAX 203-272-4330

New and Pre-Owned Test Equipment

New Equipment Specials

SIMCHECK[®] Hse PLUS – Module Tester

- * Tests SIMMs/168 pin DIMMs
- * Identifies Module properties
- * Stand alone/portable
- * Built-in Serial Interface

Only \$1,995.00

AVCOM PSA-37D – Spectrum Analyzer

Satellite Downlink – Installation – Maintenance & Service

- Band 1: 10 – 1750 MHz
- Line or Battery Powered
- Band 2: 3.7 – 4.2 GHz
- Built-in DC Block & Power for LNA/LNB's
- Carrying Case Included

Only \$2,395.00

Instek GOS-6103 – Analog Oscilloscope

- 100 MHz Bandwidth
- Time Base Auto-range
- 2 Channel, High Sensitivity
- Includes Two Probes
- Trigger Signal Output
- 2 Year Warranty
- Cursor Readout

Only \$899.00

Leader LF 941 – CATV Signal Level Meter

- ✓ TV/CATV Coverage from 46 - 870 MHz
- ✓ Video/Audio Carrier Measurements

Only \$489.00

Fluke 87 IV – Digital Multimeter

- ✓ Basic DC Accuracy of 0.025% at 50,000 Count
- ✓ True-RMS AC, AC+DC, dBm, & dBV

Only \$319.00

Pre-Owned Oscilloscope Specials

B+K Precision	1466	10 MHz	\$185.00
Tektronix	465	100 MHz	\$599.00
Tektronix	465B	100 MHz	\$729.00
Tektronix	475	200 MHz	\$829.00
Tektronix	475A	250 MHz	\$999.00

- Professionally Refurbished
- Aligned & Calibrated to Original Specifications
- The Industry Standard of Oscilloscopes
- 1 Year Warranty - The Longest Available!!!
- See Website for Complete Specifications

See us on the Web!

www.testequipmentdepot.com

We Buy Surplus
Test Equipment

Test Equipment Depot

A FOTRONIC CORPORATION COMPANY

99 Washington St. Melrose, MA 02176

(781) 665-1400 • FAX (781) 665-0780

(1-800-996-3837)

TOLL FREE 1-800-99-METER

e-mail: sales@testequipmentdepot.com



CIRCLE 322 ON FREE INFORMATION CARD

World Passing You By?

Are you interested in Microprocessors & Embedded Control Systems? If not you should be! Look around, just about everything these days has an embedded microprocessor in it. TVs, cars, radios, traffic lights & even toys have embedded computers controlling their actions. The Primer Trainer is the tool that can not only teach you how these devices operate but give you the opportunity to program these types of systems yourself. Examples & exercises in the Self Instruction manual take you from writing simple programs to controlling motors. Start out in Machine language, then move on to Assembler, & then continue on with optional C, Basic, or Forth Compilers. So don't be left behind; this is information you need to know!

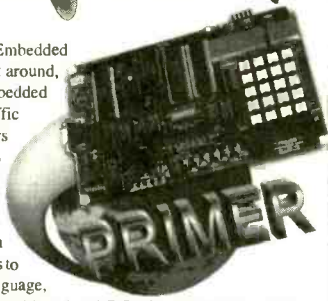

Examples Include:

- Measuring Temperature
- Using a Photocell to Detect Light Levels
- Making a Waveform Generator
- Constructing a Capacitance Meter
- Motor Speed Control Using Back EMF
- Interfacing and Controlling Stepper Motors
- Scanning Keypads and Writing to LCD/LED Displays
- Bus Interfacing an 8255 PPI
- Using the Primer as an EPROM Programmer
- DTMF Autodialer & Remote Controller (New!)

The PRIMER is only \$119.95 in kit form. The PRIMER Assembled & Tested is \$169.95. This trainer can be used stand alone via the keypad and display or connected to a PC with the optional upgrade (\$49.95). The Upgrade includes: an RS232 serial port & cable, 32K of battery backed RAM, & Assembler/Terminal software. Please add \$5.00 for shipping within the U.S. Picture shown with upgrade option and optional heavy-duty keypad (\$29.95) installed. Satisfaction guaranteed.

EMAC, inc.

11 EMAC WAY, CARBONDALE, IL 62901
618-529-4525 Fax 457-0110 BBS 529-5708
World Wide Web: <http://www.emacinc.com>

1985 - 1998
OVER
12
YEARS
OF SERVICE

Start A Career With High Wages, Excellent Benefits and Job Security!!

With UCANDO's extraordinary maintenance training programs you can quickly and easily enter a high paying field as a maintenance technician for a very small investment of time and money.

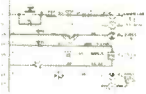

RC-M ONLY \$165 RC-M is a 15 hour training course on relay ladder logic systems. Includes a 5-part video and workbook. Great Value!

PLC-M ONLY \$198 PLC-M is a 32 hour training course on PLC systems. Includes (2) 4-part video's and workbook. This training is valuable.



HYD-M ONLY \$209 HYD-M is a 32 hour course on Fluid Dynamics. Includes (2) 4-part video's and workbook. This Module is a must.

SC-M ONLY \$215 SC-M is a 32 hour training course on AC & DC Servo Controllers. Includes (2) 4-part video's and workbook. Learn everything you need about AC and DC servo Control Systems.



Electronic Training Videos: Basic Electronics, Digital Electronics, TV Repair, LASER and Fiber Optic training videos available at very affordable prices starting at Only \$35.00 each.

For information or to place an order call:

1-800-678-6113

www.ucando-corp.com

UCANDO VCR Educational Products Corp., Greenville, OH

\$59 PCBs

And our layout software is **FREE**

- 1 Download our board layout software
- 2 Design a 2-sided circuit board 2.5" x 3.8"
- 3 Send us your layout over the Internet
- 4 We ship you 3 excellent quality boards with plated-through holes for \$59 (shipping included)

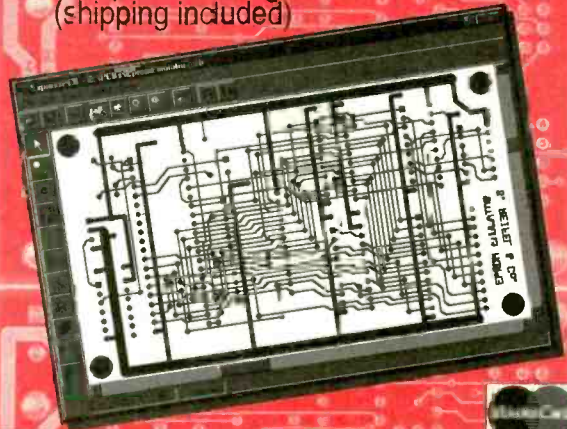

www.expresspcb.com



Visit us on the web:
www.poptronics.com

SERIAL LCDs

Serial LCDs work great with BAS C Stamps® and other microcontrollers. One-wire interface • simple serial protocol • low cost • high quality • in stock



BPI-216N

- 2x16 text LCD
- 2400/9600 bps
- \$45 (non-backlit)

- SGX-120L**
- Mini graphics LCD
 - 2400/9600 bps
 - just \$99



Many other models available—see www.seetron.com/

Scott Edwards Electronics, Inc.
www.seetron.com • 520-459-4802

Data Acquisition and Control

The ADR series of interfaces allow control of analog, digital and relay I/O via RS232 or RS485. Visit the web site for specs, applications and programs in VB, C, BASIC etc. (705) 671-2652

www.ontrak.net

Ontrak Control Systems Inc.

"X-Ray" Filters, Cameras, Camcorders, Lights
Infrared (IR) Equip sees through some fabrics!
2 Million Candle Power Rechargeable IR Spotlight
Information, Equipment Examples and FAQ's

Ultraviolet (UV) LED Flashlights, Invisible Inks
SpyCams, Specialty Optical Products
Home Automation Software, Free Fax Software

www.maxmax.com/OpticalProducts.htm

Poptronics SHOPPER

CABLE TV BOXES



(WE'LL BEAT ANY PRICE!)

30 DAY TRIAL* 1YR. WRNTY. *FREE CATALOG
QTY. DISCOUNTS * DEALERS WELCOME!

1-800-785-1145

HABLAMOS ESPANOL



PRIVATE CABLE SYSTEMS

SINGERS! REMOVE VOCALS

(Unlimited, Low Cost, Instantly Available
Background Music from Original Standard
Recordings! Does Everything Karaoke
does... Better and gives you the
Thompson Vocal Eliminator™!
Free Brochure & Demo Tape.
LT Sound Dept PE
7988 LT Parkway, Lithonia, GA 30058
Internet: <http://www.LTSound.com>
24 Hour Demo/Info Request Line (770) 482-2485 - Ext 49
When You Want Something Better Than Karaoke!



From Not-Working to Networking!

Troubleshooting Local-Area Networks!

Now, complete for the first
time in one detailed booklet!

Gain a fuller knowledge of network fundamentals and how they developed from the early days of main frames, from XNS to Ethernet technology, the OSI stack for interconnecting different computers, basic and specialized test instruments, etc. Several tough LAN case histories brings you from theory to the practical side of troubleshooting.

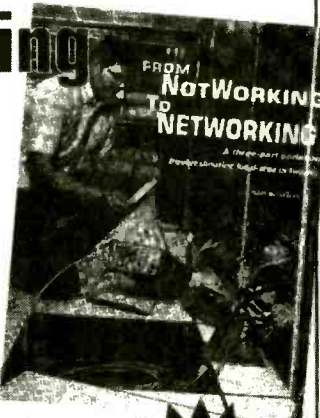

**ONLY
\$4.99**

CLAGGK Inc., Reprint Bookstore
P.O. Box 12162, Hauppauge NY 11788

Please rush my copy of "From Not-Working to Networking." I enclosed payment of \$4.99 which includes shipping charges. U.S.-First Class, Canada and Overseas-Surface Mail.

Name _____

Address _____

City _____ State _____ Zip _____

All Payments must be in U.S. funds. Send check or money order payable to CLAGGK Inc.—do not send cash or stamps. New York State residents add applicable sales tax. Allow 6 to 8 weeks for delivery

RBS02

CLASSIFIEDS

BUSINESS OPPORTUNITIES

\$400 WEEKLY ASSEMBLING electronic circuit boards/products from home. For FREE information send SASE: Home Assembly-PT Box 216 New Britain, CT 06050-0216.

EASY WORK! EXCELLENT PAY! Assemble Products At home. Call Toll Free 1-800-467-5566 EXT. 1190

CABLE TV

CABLE TV Descramblers. One-piece units. Scientific Atlanta, Jerrold, Pioneer, and others. Lowest Prices Around. **Precision Electronics** Houston, TX Anytime. 1-888-691-4610

ROCK BOTTOM...DEALER...DISCOUNTS!! 125ch. VISION MASTER PLUS. "DECODE'S EVERYTHING PERMANETLY". TEST CHIPS & ACTIVATORS 1-888-675-3687 — 201-386-1145.

Pay TV and Satellite Descrambling, Volume 12. Latest fixes used to receive all cable and satellite programming, EK-1, blockers, etc. \$18.95. Pay TV series Vol. 1-12 CD-ROM \$59.95. Hacking Digital Satellite Systems Video IV \$29.95. Scrambling News Online includes piracy \$59.95/yr. Everything listed here only \$99.95. Free catalog. Scrambling News, 305-372-9427. www.scramblingnews.com

CB-SCANNERS

CB Radio Modifications! Frequencies, kits, high-performance accessories, books, plans, repairs, amps, 10-Meter conversions. The best since 1976! Catalog \$3. CBCI, Box 1898P, Monterey, CA 93942. www.cbciintl.com

PLANS-KITS-SCHEMATICS

AM Tube Radio Kits. TRF and Superhets. Visit our website at www.ghostmoon.bigstep.com
FPGA Prototyping Kits: Lowest cost, easiest to use. 200,000 gates and free design software! www.BurchED.com.au

SATELLITE EQUIPMENT

FREE Satellite TV Buyer's Guide. Best Products — Lowest Prices — Fastest Service! Dish Network, DirectTV, C/Ku-band, including 4DTV. Parts—Upgrades—Accessories! **SKYVISION** - 800-543-3025. International 218-739-5231. www.skyvision.com

SECURITY

DSC SECURITY Systems and surveillance camera equipment. Do it yourself and SAVE. Camera's, Monitors, VCR's, Motion Detectors, Glassbreak Detectors, Control Panel's, Sirens, Contacts, more. www.a1security.com
Do it Yourself Security Products. CCTV, Lens, Time Lapse Recorder's and repair. www.TREESTONE.com

TEST EQUIPMENT

Browse our Web site and check out the "Monthly Special". **TDL Technology, Inc.** www.zianet.com/tld

Gernsback Publications, Inc.

275-G Marcus Blvd. Hauppauge NY 11788

POPTRONICS® CLASSIFIED ADVERTISING ORDER FORM

Advertiser Information

Name _____
 Company _____
 Street Address _____
 City/State/Zip _____
 Telephone () _____
 Signature (required on all orders) _____

Payment Information

Charge my:
 Master Card Visa Discover
 Account No. _____
 Exp. Date _____
 Full payment enclosed. Prepayment discounts offered for multiple insertions (except on credit card orders).
 Payment for first insertion enclose; additional payments will be made prior to closing dates. Prepayment discounts not available.

Do you want any special options? (where available)

- Boldface Type* Add 25% for entire ad Screened Background – Add 30%
 Special Heading – Add \$35.00

The first word of your ad and your name will be printed in boldface caps, at no additional charge. For individual boldface words, add .50¢ each.

In what month(s) would you like your ad to run?

- Entire year for publications selected above.
 Jan. Feb. Mar. Apr. May. June July Aug. Sep. Oct. Nov. Dec.

Here's how to calculate the cost of your Regular or Expanded-Ad Classified:

Rate X Numbers of Words + Rate for Boldface + Rate for Screened Background = Cost per Insertion X Number of Months = Cost

Magazine	Rate	x	Number of Words (min. 15)	+	Boldface (add 25%)	+	Screened Background (add 30%)	=	Cost Per Insertion	x	Number of Months	=	Cost
_____	_____	x	_____	+	_____	+	_____	=	_____	x	_____	=	_____

Rates:

\$3.50 per word

Minimum 15 Words

Here's how to calculate the total cost of your advertising:

Prepayment Discount:

(Full payment must accompany order, not applicable on credit card orders)

Prepay for 6 insertions in one magazine, 5% 12 insertions in one magazine, 10%

Subtotal _____
 Less Prepayment Discount _____
TOTAL COST \$ _____

Please use a separate piece of paper to write your copy, or for any special instructions you may have.

HAVE A QUESTION? CALL: 1-631-592-6720 ext. 206

Fax signed orders with credit card information to : (631) 592-6723

GPI895

ADVERTISING INDEX

Poptronics does not assume any responsibility for errors that may appear in the index below.

Free Information Number	Page	Free Information Number	Page
- Abacom	77	- Intuitive Circuits, LLC82
- All Electronics	72	309 IVEX Design67
- Amazon Electronics80	- J&M Microtek80
- Andromeda Research82	- Lynxmotion75
- Arrow Technologies72	- M ² L Electronics75
295 AVEN Tools	CV2	323 Mendelsons74
311 Berkeley Nucleonics70	296 Merrimack Valley Systems66
- Big Bang Electronics65	- microEngineering Labs80
319 Beige Bag Software77	- Modern Electronics75
- Bsoft Software, Inc.64	- Mondo-tronics75
290 C&S Sales, Inc.68	- Ohio Automation81
- CCTV Outlet71	275 Parts Express79
233 Circuit Specialists83	- Patriot Security Services74
- CLAGGK, Inc.	CV3, 16	- PC Boards82
320 Cleveland Inst. of Electronics73	- Pioneer Hill Software74
321 Command Productions64	228 Polaris Industries61
- Conitec Data Systems75	219 Prairie Digital64
- Consumertronics81	- RC Distributing Co.80
- Davis Instruments74	263 Ramsey Electronics62
- EDE Spy Outlet80	- Rigel Corporation81
210 Electronic Design Specialists70	- Securetek84
130 Electronic Workbench	CV4	- Scott Edwards Electronics85
205 Electronix Express78	- Smarthome.com82
- EMAC Inc.85	- Square 1 Electronics77
- Engineering Express85	- Suburban Electronics76
- Fort777.com63	- Techniks81
- Global Specialties84	- Technological Arts72
- Globaltech Distributors80	322 Test Equipment Depot84
282 Grantham College of Eng.4	217 Tie Pie Engineering71
220 Information Unlimited78	242 Timeline76
- Intec Automation80	- UCANDO Videos85
- Intelligence Here81	- Vision Electronics82
- Intronics72	- World Wyde80, 81

ADVERTISING SALES OFFICES

Gernsback Publications, Inc.
275-G Marcus Blvd.
Hauppauge, NY 11788
Tel. 631-592-6720
Fax: 631-592-6723

Larry Steckler
 Publisher (ext. 201)
 e-mail: advertising@gernsback.com

Adria Coren
 Vice President (ext. 208)

Ken Coren
 Vice-President (ext. 267)

Marie Falcon
 Advertising Director (ext. 206)

Adria Coren
 Credit Manager (ext. 208)

For Advertising ONLY EAST/SOUTHEAST

Marie Falcon
 275-G Marcus Blvd.
 Hauppauge, NY 11788
 Tel. 631-592-6720 x206
 Fax: 631-592-6723
 e-mail: mfalcon@gernsback.com

MIDWEST/Texas/Arkansas/ Oklahoma

Ralph Bergen
 One Northfield Plaza, Suite 300
 Northfield, IL 60093-1214
 Tel. 847-559-0555
 Fax: 847-559-0562
 e-mail: bergenrj@aol.com

PACIFIC COAST

Megan Mitchell
 9072 Lawton Pine Avenue
 Las Vegas, NV 89129-7044
 Tel. 702-240-0184
 Fax: 702-838-6924
 e-mail: mmitchell@gernsback.com

**Subscription/
Customer Service/
Order Entry**
 Tel. 800-827-0383
 7:30 AM - 8:30 PM CST

www.POPTRONICS.COM

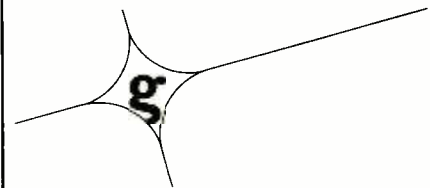

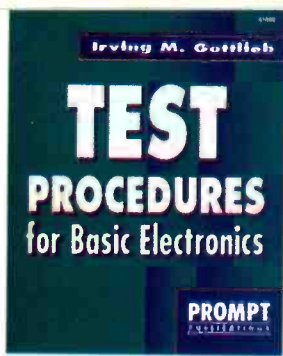

Test Procedures for Basic Electronics. #61063. -- \$19.95
 Many useful tests and measurements are covered. They are reinforced by the appropriate basic principles. Examples of test and measurement setups are given to make concepts more practical. 7 3/8 x 9 1/4", 356 pp, paperback.

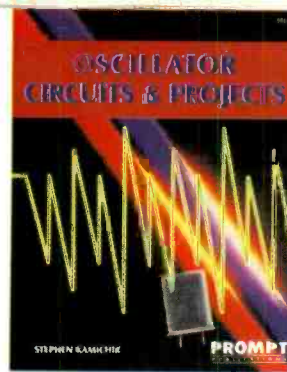

Oscillator Circuits and Projects. #61111. -- \$24.95
 A Textbook and project book for those who want to know more about oscillator circuits. You can build and enjoy the informative and entertaining projects detailed in this book. Complete information is presented in an easy-to-follow manner. 7 3/8 x 9 1/4", 249 pp, paperback.

Build Your Own Home Lab. #61108 -- \$29.95
 Shows you how to assemble an efficient working home lab, and how to make it pay its own way. Includes projects for creating your own test instruments too. 7 3/8 x 9 1/4", 249 pp, paperback.

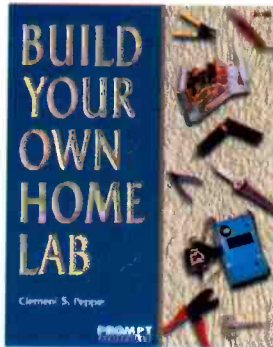

Troubleshooting and Repair Guide to TV. #61146. -- \$34.95
 Repairing and troubleshooting a TV is very simple and economical with help from the information in this book. It is the most complete and up-to-date TV repair book available, with tips on how to handle the newest circuits. 8 1/2 x 11", 263 pp, paperback.

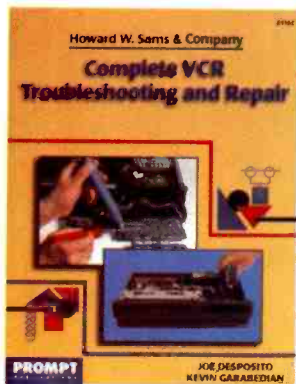

Complete VCR Troubleshooting and Repair. #61102. -- \$34.95
 Though VCRs are complex, you don't need complex tools or test equipment to repair them. This book contains sound troubleshooting procedures that guide you through every task. 8 1/2 x 11", 184 pp, paperback.

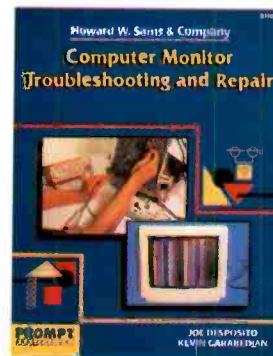

Computer Monitor Troubleshooting and Repair. #61100. -- \$34.95
 This book can save you the money and hassle of computer monitor repair by showing you how to fix it yourself. Tools, test instruments, how to find and solve problems are all detailed. 8 1/2 x 11", 308 pp, paperback.

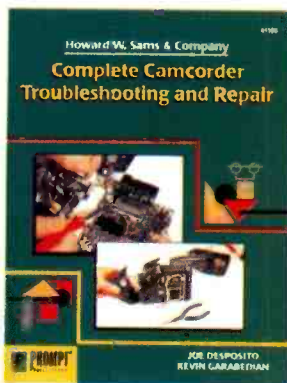

Complete Camcorder Troubleshooting and Repair. #61105. -- \$34.95
 Learn everything you need to know about the upkeep and repair of video camcorders. Start by examining camcorder troubleshooting procedures, then move into more advanced repair techniques. 8 1/2 x 11", 208 pp, paperback

Joe Carr's Circuit Toolkit. #61181. -- \$29.95
 Easy-to-build, useful circuits from Carr's workbench to you. They will spark new ideas in your day-to-day use of circuits and help solve frustrating problems. 256 pp, paperback. Contact Jim Surface.

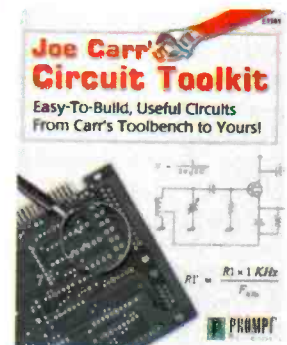

Please circle the products you would like to buy on the page above, calculate the total cost, include shipping charges, using in the form below and send it to us. Please allow 4 - 6 weeks for standard delivery.

Name: _____
 Address: _____
 Zip: _____ Telephone: _____
 I have enclosed my check for \$: _____ Signature: _____

Please charge my credit card for \$: _____ Number: _____
 Card Type: _____ Expiration Date: _____
 Mastercard, Visa or Discover only

Note: The delivery address and the address at which the credit card is registered must be the same.

Claggg Inc.
 PO Box 12162
 Hauppauge, NY 11788
 Tel: 631-592-6720
 Fax: 631-592-6723
 email: claggg@gernsback.com

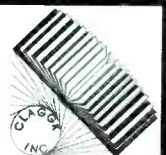

SORRY No orders accepted outside of USA & Canada No. of Books Ordered

SHIPPING CHARGES IN USA.
 CANADA ADD \$5.00

1 Book	\$ 5.00
2 Books	8.00
each add'l book	3.00
2 Day UPS	\$10.00 extra
Next Day UPS	\$20.00 extra

Total price of books.....	\$.....
Shipping (see chart).....	\$.....
Subtotal.....	\$.....
Sales Tax (NYS only).....	\$.....
Amount Enclosed.....	\$.....
All payments must be in U.S. funds!	

The world's most popular electronics simulation software just got better!

WHY settle for second best?

***FREE**

Virtual Lab with Poptronics Circuits

Check out the circuits from recent issues, including this month's! Tweak the circuits and see the instruments respond instantly.

Download the Multisim demo with pre-built Poptronics circuits from www.electronicworkbench.com/poptronics

BEST PRODUCT! BEST PRICE!

Electronics Workbench is recognized around the globe for developing highly advanced, yet easy-to-use electronics software. Over 150,000 users tell us that they have completed projects using Electronics Workbench in less time than it takes to even install other programs.

And now we've just released Version 6.2! If you've never tried electronics simulation, this is your chance - you can now have your very own virtual lab! Work on your own or create circuits together with others across the country - live on the internet. Start with the **FREE** Electronics Workbench/Poptronics demo and then take advantage of this best price ever when you buy. Tried other products? You owe it to yourself to experience what only the market leader can offer - there is no comparison. And if you own earlier versions of Electronics Workbench, call us now for upgrade pricing starting at just **\$149!**

Multisim Highlights

- ▶ Advanced schematic capture
- ▶ Intuitive auto & manual wiring (no toggle)
- ▶ Change circuits while simulating
- ▶ Mixed-mode SPICE analog/digital simulation
- ▶ Built-in symbol and component editor
- ▶ Parts organized into bins (no alpha lists)

Don't settle for a program that has less than:

- ▶ 6,000 parts in component database
- ▶ 9 virtual instruments & 8 powerful analyses
- ▶ Interactive design on the Internet
- ▶ OLE integration with Excel/MathCAD

multisim V6.2

Schematic Capture & Simulation

~~\$399~~ **\$299**

ultiBOARD

Powerful PCB Layout

~~\$399~~ **\$299**

or get **BOTH** products for **\$498**

Limited Time Offer
BEST price ever!

To order, or to find out why our products are the most popular in the industry, call **1-800-263-5552** or visit www.electronicworkbench.com (**FREE** demo available)



Electronics
WORKBENCH

CIRCLE 130 ON FREE INFORMATION CARD