

FREE "VIRTUAL WORKBENCH" CIRCUITS FOR DOWNLOAD  
More info at [www.electronicsworkbench.com/poptronics](http://www.electronicsworkbench.com/poptronics)

[www.poptronics.com](http://www.poptronics.com)

SEPTEMBER 2000

# Poptronics®

Formerly *Popular Electronics*® and *Electronics NOW*



## DIGITAL TELEVISION

A behind-the-scenes look at the upcoming broadcast standard

Calibrate your equipment with a **Video-Signal Generator**  
For NTSC- or PAL-signal standards

An accurate frequency reference  
Based on television's **Colorburst Signal**

### Also Inside:

- Playing with Superconductors
- Fixing VCRs
- Upgrading Celeron Computers
- Free Encyclopedias
- Putting Paper on Plastic

\$4.99 U.S.  
\$5.99 CAN.

19T

# Virtual Lab – Real Results

*Intuitive schematic capture*

*Fast, accurate analog/  
digital simulation*

*Full-featured pcb layout*

*Built-in autorouting*

CircuitMaker 2000 provides all the tools necessary to quickly and easily design circuits, test them in the real world and generate prototype boards – the complete virtual electronics lab solution.

With all the features you'd expect from a professional design system – plus exceptional ease-of-use, you'll spend less time learning and more time designing.

Available in both standard and professional editions, CircuitMaker 2000 gives you full design capability at a price that is simply unmatched by the competition.

**CircuitMaker<sup>2000</sup>**  
the virtual electronics lab™

Intuitive schematic capture

Fast, accurate analog/digital simulation

Full-featured PCB layout

Built-in autorouting

FROM  
**\$395**

New License Price

Upgrade from \$95

*Comprehensive educational and computer-based  
training packages also available*

**CircuitMaker<sup>2000</sup>**

the virtual electronics lab™

Call your local CircuitMaker sales & support  
center on **800 419-4242**

or visit [www.circuitmaker.com](http://www.circuitmaker.com)

Contact us for your Free  
CircuitMaker 2000 brochure



**CircuitMaker**

the virtual electronics lab™

CircuitMaker and CircuitMaker 2000 are registered trademarks of Protel International Limited.

CIRCLE 133 ON FREE INFORMATION CARD  
[www.americanradiohistory.com](http://www.americanradiohistory.com)

# Poptronics®

THE MAGAZINE FOR THE HANDS-ON ELECTRONICS ACTIVIST!

## FEATURES

### 36 VIDEO-SIGNAL GENERATOR FOR NTSC OR PAL

Working with video equipment can mean the occasional readjustment to your equipment to be sure that everything is in top-notch condition. With this simple circuit, aligning a television for proper color reproduction is a snap. What's more, the same circuit can output NTSC- or PAL-format signals by changing a handful of simple parts.  
—Thomas Gould



### 43 LOOKING FORWARD TO DTV

In just a few short years, your television set is going to explode! While that description is more figurative than literal, the day is fast approaching where today's TVs will stop working, never to display a soap opera or newscast again. What we're referring to is the coming of digital television, or DTV. With all of the controversy surrounding the rollout of the new broadcast standard, we take a look behind the scenes at the technology that gives DTV its edge. After all, aren't you curious how they plan to squeeze a high-definition picture and 6-channel surround sound into the same bandwidth of today's television signals? In this first of two parts, we discuss video and audio encryption and compression.  
—Geophrey McComis

### 51 A COLORBURST-BASED FREQUENCY REFERENCE

How many times have you tried to set up a frequency counter or an oscilloscope only to be frustrated by a lack of a stable, accurate frequency standard? With this circuit, such a reference standard is no farther away than the closest television-broadcast signal.—Thomas Gould

## PRODUCT REVIEWS

### 3 GIZMO®

Indoor/outdoor speakers, electronic spelling dictionary, home-theater transmitter, USB-to-printer adapter, PCMCIA adapter for desktop PCs, Minidisc player, radar-detector/compass/safety-alert system, interactive television, inkjet printer, home-theater bundle.

## DEPARTMENTS

### 6 PEAK COMPUTING

Ted Needleman digs deep into an old Celeron-based system in an attempt to breathe new life into an aging warhorse.

### 9 COMPUTER BITS

On the home front, Ted Needleman gets around to squeezing tons of papers onto CD-Rs.

### 12 SURVEYING THE DIGITAL DOMAIN

Reid Goldsborough strikes it rich with free Web-design services and free on-line encyclopedias.

### 17 PROTOTYPE

Detecting smashed atoms, detecting land mines, detecting nuclear weapons, detecting cholera outbreaks from space, cockpit retrofit, kiddy phones, and network-service standards.

### 21 Q&A

Michael Covington offers answers to the latest batch of perplexing questions.

### 55 AMAZING SCIENCE

Experience chills and thrills as John Iovine performs some cool superconductor experiments.

### 58 ROBOTICS WORKSHOP

In this "lost episode," Gordon McComb reveals the hidden secrets of the BasicX microcontroller.

### 62 SERVICE CLINIC

Sam Goldwasser takes control of VCR control-system problems.

### 65 BASIC CIRCUITRY

All aboard with Charles Rakes as he builds simple circuits to test components. Download the circuits from [www.electronicsworkbench.com/poptronics](http://www.electronicsworkbench.com/poptronics) and play with a "virtual workbench" on your computer.

## AND MORE

2	Editorial
26	Letters
28	New Gear
30	New Literature

71	Poptronics Shopper
106	Advertising Index
106A	Free Information Card

Poptronics (ISSN 1526-3681) Published monthly by Gernsback Publications, Inc. 275-G Marcus Blvd., Hauppauge, NY 11788. Second-Class postage paid at Hauppauge, NY and at additional mailing offices. One-year, twelve issues, subscription rate U.S. and possessions \$24.99, Canada \$33.15 (includes G.S.T. Canadian Goods and Services Tax Registration No. R125166780), all other countries \$33.99. Subscription orders payable in U.S. funds only, International Postal Money Order or check drawn on a U.S. bank. U.S. single copy price \$4.99. Copyright 2000 by Gernsback Publications, Inc. All rights reserved. Hands-on Electronics and Gizmo trademarks are registered in U.S. and Canada by Gernsback Publications, Inc. Poptronics trademark is registered in U.S. and Canada by Poptronix, Inc. and is licensed to Gernsback Publications, Inc. Printed in U.S.A.

Postmaster: Please send address changes to Poptronics, Subscription Dept., P.O. Box 459, Mount Morris, IL 61054-7629

A stamped self-addressed envelope must accompany all submitted manuscripts and/or artwork or photographs if their return is desired should they be rejected. We disclaim any responsibility for the loss or damage of manuscripts and/or artwork or photographs while in our possession or otherwise.

As a service to readers, Poptronics publishes available plans or information relating to newsworthy products, techniques, and scientific and technological developments. Because of possible variances in the quality and condition of materials and workmanship used by readers, Poptronics disclaims any responsibility for the safe and proper functioning of reader-built projects based upon or from plans or information published in this magazine.

Larry Steckler, EHF, CET,  
editor-in-chief and publisher

## EDITORIAL DEPARTMENT

Joseph Suda, managing editor  
Evelyn Rose, assistant editor  
Nancy Serenita, editorial assistant

## CONTRIBUTING EDITORS

Joe Black  
Michael A. Covington, N4TMI  
Reid Goldsborough  
Sam Goldwasser  
John Iovine  
Gordon McComb  
Ted Needleman  
Charles D. Rakes  
Teri Scaduto

## PRODUCTION DEPARTMENT

Ken Coren, production director  
Kathy Campbell, production manager  
Michele L. Musé, prepress specialist

## ART DEPARTMENT

Russell C. Truelson, art director

## CIRCULATION DEPARTMENT

Gina L. Gallo, circulation manager

## REPRINT DEPARTMENT

Nancy Serenita, Reprint Bookstore

## BUSINESS AND EDITORIAL OFFICES

Gernsback Publications, Inc.  
275-G Marcus Blvd.  
Hauppauge, NY 11788  
631-592-6720  
Fax: 631-592-6723

President: Larry Steckler  
Vice-President: Adria Coren  
Vice-President: Ken Coren

## SUBSCRIPTION CUSTOMER SERVICE/ ORDER ENTRY

800-827-0383  
7:30 AM - 8:30 PM EST

Advertising Sales Offices  
listed on page 106

Cover by Michele Lyn Musé

VISIT US ON THE INTERNET AT:  
[www.gernsback.com](http://www.gernsback.com)

Since some of the equipment and circuitry described in POPTRONICS may relate to or be covered by U.S. patents, POPTRONICS disclaims any liability for the infringement of such patents by the making, using, or selling of such equipment or circuitry, and suggests that anyone interested in such projects consult a patent attorney.

mailto: [popeditor@gernsback.com](mailto:popeditor@gernsback.com)

## The Evil Eye

At this point in our little planet's timeline, the majority of us have been exposed to the "evil that is television"—a.k.a. "the Boob Tube"—for most (if not all) of our lives. Whether you think that it is truly a "vast wasteland" or one of the wonders of the 20<sup>th</sup> Century, you have to agree that television—perhaps even more than the airplane—has had a profound effect on the world in the last 100 years...well, closer to 80, actually.

You can even find the occasional tribal-owned TV in a communal meetinghouse in Brazil or equatorial Africa. Aiming the satellite dish is easy; just place it on the ground in a clearing and point it straight up!

How many of us can survive without television today? I'll bet that even those that swear they don't watch a single second of it have taken a glance at a screen in a bar, delicatessen, or even a storefront display. Locally, some of the major commuter-railroad stations have televisions on the platforms tuned to a local cable-news channel.

I must count myself in that group of non-watchers. While I will occasionally watch something of interest when visiting friends or relatives, I have not watched television on a regular basis in over four years. Where I live, my only options are cable and satellite—I'm too far "over the event horizon" to pick up any major stations from New York City. That includes the transmitter atop the World Trade Center—a structure that can be seen on a clear day from the mountains in western Pennsylvania!

My housing board won't approve mounting a dish to their roof, and I'm *still* waiting for cable-modem-based Internet access. Besides, I don't think I would have the time to watch anything; I'm afraid that it would just become another "time sink."

However, I don't feel that television, by and large, is a complete "vast wasteland." Sure, there is lots of drivel out there that I, as an American citizen, feel embarrassed to see foisted on the rest of the world. Yet there are many wonderful gems to be had if you know where to look. One example that has stuck with me for over 20 years is a scene from "WKRP in Cincinnati." In that scene, actor Tim Reid is trying to convince a young teenager to stay in school. A bet is made that the kid will stay if the atom can be explained to him in two minutes. The next 90 seconds was probably some of the most powerful scriptwriting that I've seen in a comedy show that didn't try to lean on manipulating an emotional response from the viewers.

Remember that as we prepare for each new technology that will "propel TV into the 21<sup>st</sup> Century" (an incredibly overused cliché), we'll probably still find that the title of Bruce Springsteen's song, "57 Channels And Nothing's On" will be just as valid. As computer designers learned back in the late 1970s, the greatest design is worthless if there's no content to back it up. You don't necessarily need new technology to fix non-technological problems.

When Neil Armstrong pulled that ring 31 years ago to raise the curtain on the show with the highest Neilson ratings in the history of the medium, what type of camera did NASA—having only one chance to get it right—select for its reliability to function in the hostile environment of space?

A 1920s-style Baird mechanical system—rotating chopper disc, punched holes, and all.



Joseph Suda  
Managing Editor

# GIZMO®

## Indoor/Outdoor Speakers

Turn your deck into a concert hall with the *Northridge Series* all-weather bookshelf speakers from JBL. Models N24AW (\$249/pair) and N26AW (\$299/pair) both feature design principles and technologies used in JBL's professional recording-studio monitors. Uniquely designed tweeters with domes made from 75% titanium deposited on a lightweight substrate are said to provide excellent transient response, clarity, and resolution, along with increased power handling. The tweeters work in conjunction with JBL's Elliptical Oblate Spheroidal (EOS) waveguide, which directs the sound toward the listening area and away from the side walls for a wider sound field with more precise imaging. Woofers and midrange drivers use paper cones specially treated to dampen internal resonances, which are said to provide a smooth frequency response and allow higher volume playback without distortion. FreeFlow port technology uses a specially shaped bass port tuned to the woofer and cabinet for extended low-frequency response and improved efficiency. The speakers, which are weather-proofed for outdoor use, are finished in off-white, allowing them to be placed unobtrusively in a variety of outdoor locations—patio, balcony, terrace, or deck. Model N26AW measures 1 1/4 inches high by 10 3/4 inches wide by 7 1/8 inches deep; Model N24AW is slightly smaller.



JBL Consumer Products, 250 Crossways Park Drive, Woodbury, NY 11797; 516-496-3400; [www.jbl.com](http://www.jbl.com).

CIRCLE 50 ON FREE INFORMATION CARD



## Pocket-Sized Speller

Ease the back-to-school blues with Franklin's *Model SA-206 Spelling Ace with Thesaurus* (\$24.95). The portable writer's aid provides automatic spelling corrections for more than 110,000 words. The built-in thesaurus features more than 500,000 synonyms and antonyms. The "Confusables" feature distinguishes between frequently misused sound-alike words such as "their," "there," and "they're." The Spelling Ace also offers word games, a crossword-puzzle solver, and a Scrabble word-building feature. You can create and store your own personal word lists for individual use and for use in the word games.

Franklin Electronic Publishers, One Franklin Plaza, Burlington, NJ 08016-4907; 609-386-2500; [www.franklin.com](http://www.franklin.com).

CIRCLE 51 ON FREE INFORMATION CARD

## Home-Theater Transmitter

You can wirelessly broadcast audio/video programs and computer music throughout your house—eliminating the hassle and expense of running wires from room to room—with the *Leapfrog WaveMaster 20* (\$99.99) from Terk. The wireless A/V distribution system uses the 2.4-GHz frequency band to transmit video and stereo audio signals from a source component or a PC to remote TVs or stereo systems located anywhere in the house. The signal is said to provide clear, reliable reception up to 100 feet away, penetrating walls, doors, ceilings, and floors.

WaveMaster 20 consists of a transmitter located at the signal source and a receiver located at the remote TV or stereo system. Up to three additional receiver modules (\$69.99 each) can be added to expand the system's multi-room capabilities. WaveMaster 20 is compatible with all audio and video components and analog-output PCs. It features both RF and RCA coaxial jacks for connection to any type of TV, and all necessary cables and connectors are provided.

The system provides options not possible with conventional A/V distribution systems. For example, a single DVD player in the living room could be used to send movies to every TV in the home—or even outside the home. With no wires involved, you can set up a TV on the patio to watch a ball game during a barbecue. And it is no longer necessary to place a PC near a stereo system for high quality playback of MP3 music.

Terk Technologies, 63 Mall Drive, Commack, NY 11725; 631-543-1900; [www.terk.com](http://www.terk.com).

CIRCLE 52 ON FREE INFORMATION CARD



## USB-to-Printer Cable



If your computer already has a USB port, this handy USB-to-Centronics cable lets you easily connect that port to a printer with a standard Centronics connector. It looks simple; it is simple; but it sure does a great job.

Want to add a second printer without the need for a switch box? This accessory does the job. Once connected, you select your printer using your word-processor software.

Keyspan, a division of InnoSys, Inc., 3095 Richmond Parkway, Suite 207, Richmond, CA 94806; 510-222-0131; [www.keyspan.com](http://www.keyspan.com).

CIRCLE 53 ON FREE INFORMATION CARD

## PCMCIA Card Drive for Desktop PCs

Want to be able to use PCMCIA interface devices with your desktop PC? Quatech makes it possible with their *PCD2-F/PCI* card reader (\$135 List Price.) The interface installs in a standard 3.5-inch floppy drive bay and requires a single PCI expansion slot. With an adapter, it can also be installed into a 5.25-inch bay. Once in place, it provides two PCMCIA sockets that can accommodate all PCMCIA devices including memory cards, ATA hard-disk cards, modems, and a variety of other PCMCIA I/O devices.

Quatech, Inc., 662 Wolf Ledges Parkway, Akron, OH 44311; 800-553-1170; [www.quatech.com](http://www.quatech.com).



CIRCLE 54 ON FREE INFORMATION CARD



## Personal MiniDisc Player

Casio's XG-3 personal MiniDisc player (\$129) is a pocket-sized device that sports a contemporary, industrial design. It's equipped with a 40-second anti-shock buffer to ensure skip-free play even when the player is bumped or jostled. A backlit remote control and headset are included. The rechargeable nickel metal hydride battery provides up to six hours of play.

Casio Communications, Inc., 20665 Manhattan Place, Torrance, CA 90501; 310-618-9910; [www.casio.com](http://www.casio.com).

CIRCLE 55 ON FREE INFORMATION CARD

## Radar Detector/"Navigator"

You can be sure you're going the right way and that no speed traps are in the immediate vicinity with the *LRD777* radar detector (\$219.99) from Uniden. The sleekly styled unit will detect X, K and Ka Superwide, and Laser and Ultralyte Laser (L2) radar guns. It also features a built-in digital navigator compass with LCD readout to keep you moving in the right direction. The *LRD777* is also equipped with the Safety Warning System, which alerts drivers to potentially hazardous conditions (construction or accident sites and fast-moving ambulances or fire trucks). The detector boasts a highway/city switch, stay-set electronic memory, audio mute, and seven audio and visual alerts. A voice alert lets you know which band is being detected. The *LRD777* is said to be VG2 undetectable. Not only does it guard against VG2 detection devices, but it also sounds a warning when approaching a VG2 device in use.

Uniden America Corporation, 4700 Amon Carter Blvd., Ft. Worth, TX 76155; 817-858-3300; [www.uniden.com](http://www.uniden.com).



CIRCLE 56 ON FREE INFORMATION CARD



Interactive TV from AOL enables consumers to enhance their television experience using AOL's interactive content and convenient easy-to-use features. Consumers watch TV using their existing signal. They can choose from a range of additional interactive features and content—including e-mail, instant messaging, and chat; plus a program guide that makes finding programs easier—all provided through an add-on easy-to-use set-top box and a wireless keyboard or universal remote control.

Service will be provided initially in Phoenix, Sacramento, and Baltimore. The set-top box is made by Philips Electronics and will be sold exclusively at Circuit City Stores. The service will be offered at \$14.95 per month to current AOL members and \$24.95 per month to non-members.

AOLTV, 22000 AOL Way, Dulles, VA 20166; [www.aol.com](http://www.aol.com).

CIRCLE 57 ON FREE INFORMATION CARD

## Economy Ink-Jet Printer

An easy-to-use color printer, the HP DeskJet 640/648C has a list price of only \$119. Yet it prints quickly—up to six pages per minute (ppm) for black text, and up to 3 ppm for color. The unit incorporates a dual-print-cartridge system so users can print in black and color without swapping print cartridges. The color-print system uses four colors. Replacement cartridges are \$27 for the HP No. 20 black and \$29 for the HP No. 49 color cartridge. For photo printing, an optional HP C1816A Photo Cartridge priced at \$33 is available.

HP ColorSmart III automatically selects the optimal color or grayscale for better reproduction. It includes HP SmartFocus that automatically sharpens details in low-resolution images downloaded from the Internet by synthesizing a higher-resolution image.

Hewlett-Packard Company, 300 Hanover St., Palo Alto, CA 94304; 800-752-0900; [www.hp.com](http://www.hp.com).

CIRCLE 58 ON FREE INFORMATION CARD



## Streamlined Home Theater

JVC's TH-A10 DVD Executive Home Theater System (\$1700) provides the functionality of a roomful of separate components, minus the tangle of wires and complex operation. Featuring brushed-aluminum cabinets, futuristic styling, and uncluttered single-wire connections, the entire system comes in one box. That box full of goodies includes a 200-watt six-channel amplifier that's built into the system's powered subwoofer, an all-in-one central unit that combines a DVD/VCD/CD player and an FM/AM tuner, and five full-range satellite speakers. A full complement of inputs and outputs (including digital audio outputs, and composite and S-VHS video inputs and outputs) allows you to connect a VCR, satellite receiver, cable box, MD or tape recorder.

A single-wire connects the amp/subwoofer to the main unit; color-coded speaker wires further simplify installation. To keep things simple, the TH-A10 provides auto-power-on and auto-speaker settings. Two remotes—one full-function, multi-brand universal and one simplified—are included. The system also has AV CompuLink and Enhance CompuLink, which allow various JVC components to work together as one system.

JVC Americas Corp., 1700 Valley Road, Wayne, NJ 07470; 973-315-5000; [www.jvc.com](http://www.jvc.com).

CIRCLE 59 ON FREE INFORMATION CARD



## UPGRADING A CELERON

I recently had a friend ask me if he could upgrade his Celeron-based PC simply by plugging in a Pentium III CPU. It seems that the digital-photography applications that he had gotten interested in recently were taking longer than he felt comfortable with. He was torn between simply going out and purchasing a new system, with a Pentium III in place, and upgrading his existing Gateway G400, a Celeron machine. With a 400-MHz Intel Celeron CPU, 64MB of RAM, a moderately large hard disk, and a great video card, this system seemed like a prime candidate for a plug-and-play CPU upgrade.

Most users assume that if a CPU will actually fit into the motherboard of a PC, it can be used. In investigating and performing this upgrade for my friend, I found that it's not quite this cut-and-dried. There are a number of factors that determine whether this kind of an upgrade is even possible.

### IT'S NOT ALWAYS EASY FITTING IN

The first thing to determine is whether or not an upgrade CPU will even fit in the system that you want to punch up. Celeron CPUs generally come in a variant of the PGA (pin-grid-array) package used on previous Intel CPUs going back to the 80386. When Intel moved from the original Pentium, Pentium Pro, and Pentium MMX processors, it adopted a new form factor, packaging the Pentium II in an SECC (single-edge-contact cartridge) rather than a PGA-style case. This cartridge had contacts along a single edge, somewhat similar, at least in



*The Celeron processor from Intel uses a chip-like package to carry the microdie. To fit it into a Slot 1 motherboard, a special adapter PC board must be used.*

concept, to an add-in peripheral card. The processor mounted to the motherboard in a new type of socket, called Slot 1. When the Pentium III came out, it used the Slot 1 packaging as well.

Things changed, however, when Intel decided to bring out the

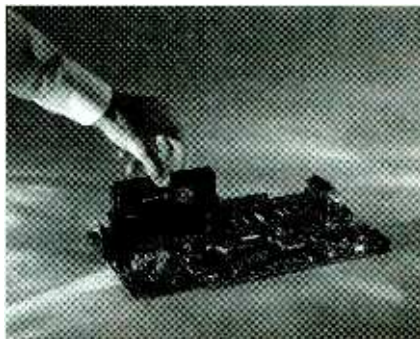

*Intel's non-entry-level processors from the Pentium II and up are packaged in a special plastic case with a single edge for making the electrical connections. Installing these processors is just like installing a peripheral board like a video or sound card. In fact, the package actually has a PC board with the microprocessor and L2 cache chips mounted directly on it; the electrical connections are circuit-board traces.*

Celeron processor. The processor itself is mounted in a PGA-style package. When the Celeron was initially introduced, motherboards capable of using the Celeron were all based on the Slot 1 processor socket. The solution used in all of the earlier Celeron systems was an adapter card onto which the Celeron CPU itself was mounted. This adapter card, in turn, was plugged into the Slot 1 socket on the motherboard.

This was the case with the Gateway system that we wanted to upgrade—it had a Slot 1 socket. We were able to obtain a 550-MHz Pentium III from Intel in the Slot 1 package format. At the time of writing, this CPU was the slowest Slot 1-style Pentium III processor that Intel was still producing. You can get slower CPUs, or even Pentium II processors, but they will not be current production chips.

More recent systems often feature a motherboard with a socket capable of accommodating the Celeron in its native packaging without the need for an adapter card. This is called the Socket 370. The very latest releases of Intel's Pentium III CPUs are also available in Socket 370 format, though the existence of a Socket 370 on the motherboard doesn't automatically indicate that you can simply plug in a Pentium III CPU and expect it to work.

### DRIVE THAT BUS FASTER AND FASTER

Let me repeat what I just said: Even if you can get hold of a compatible Pentium III CPU, the existence of a Slot 1 socket on the



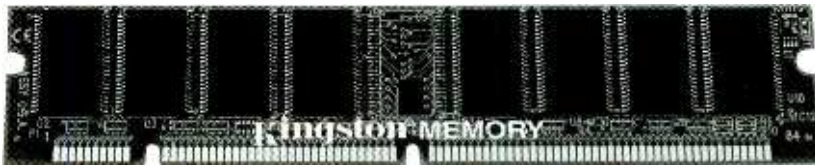

If you're upgrading your Celeron-based system to a Pentium III, you're probably going to need to replace the memory with higher-speed units, like this DIMM from Kingston Technology.

motherboard doesn't mean it will work. There are three other factors that have to fall into place: bus speed, memory speed, and core-logic support. Let's take the last factor first.

A computer's core logic really controls a lot of what takes place under the hood. In most cases, it's very tightly tied to the specific processor family that will be used in the computer. The core-logic chipset that Intel developed for the Pentium II, and later upgraded for the Pentium III, is the 440BX. The previous core-logic set, the 440EX, did not support some of the features that the Pentium III introduced. In addition, there have been several recent additional variants of the 440 chipset, such as the 440ZX. Just to muddy the waters even further, some motherboard vendors eschew using the Intel core-logic chipset entirely and use a chipset from another vendor, such as Via Technology, instead.

Even if your motherboard has a 440BX chipset, it doesn't mean that the motherboard will support anything but the Celeron that's plugged into it currently. Even if it does, there are two final hurdles to overcome—bus speed and RAM speed.

Bus speed is an important consideration. The speed at which a PC's PCI and AGP busses operate are pretty much fixed, though the AGP bus, used for graphics cards, can vary from 1X to 4X. The bus that will determine your processor upgrade success is the front-side bus, which ties together the CPU and system RAM. All Celeron processors are designed to operate at a 66-MHz front-side bus speed. This, in turn, means that vendors have often equipped the computer with RAM modules rated at the 66-MHz speed, called PC66 RAM.

The Pentium III (and some Pentium II CPUs as well) was designed for a front-side bus speed of 100-MHz. If

the motherboard in your Celeron PC can't be adjusted to run the front-side bus at that faster speed, you're pretty much wasting your money plugging a Pentium III into the motherboard socket. Besides, if the motherboard can be run with a

100-MHz front-side bus, you will have to replace the PC66 RAM modules with memory, called PC100 RAM, that can operate at the faster speed.

## BECOMING AN ACE PC DETECTIVE

The first, and most critical part of the upgrade process, is finding out if your motherboard has the capability of supporting what you want to do. That requires that you know what kind of motherboard is installed in your PC. The easiest way to get this information, when it works, is

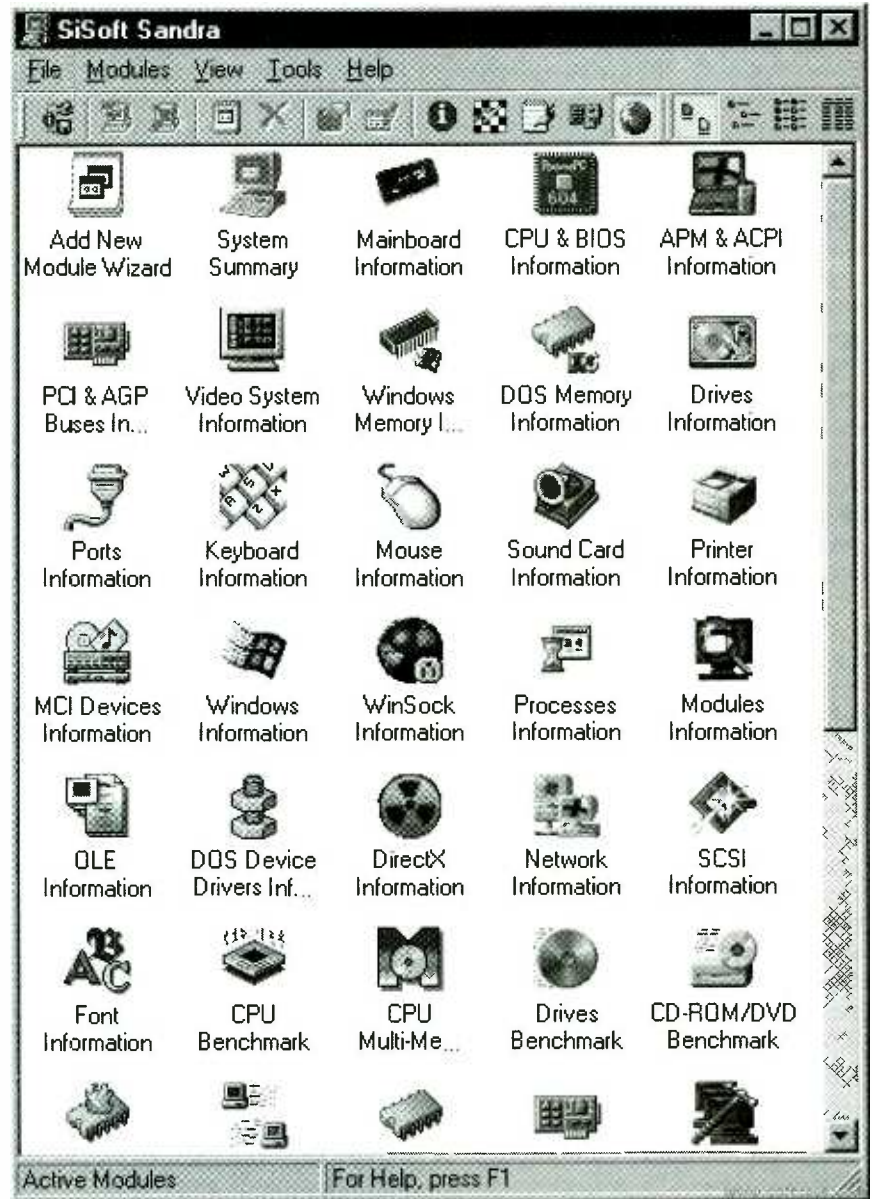

Sandra is an example of system-interrogating utilities that can tell you more than you probably want to know about what's inside your computer. Such software is handy if you're helping someone else who might not have the manuals or other pertinent information concerning what they have; it sure beats cracking open the case and peering inside with a flashlight!

with a shareware utility called *Sandra*. This utility is available for downloading at a variety of download Web sites. If you can't find one easily, point your Web browser to the developer's Web site—[www.sissoftware.demon.co.uk/Sandra](http://www.sissoftware.demon.co.uk/Sandra). The newest version, *Sandra2000*, takes a while to download, but can give you a lot of useful information about your system.

Once downloaded, run the utility and click on the MAINBOARD icon. If you're lucky, under the heading <SYSTEM MAINBOARD> you'll find the motherboard manufacturer, as well as the model number. Don't be too surprised if the motherboard manufacturer is not the same as the vendor of your PC. There are actually about a half-dozen motherboard vendors that supply about 90% of all the motherboards used in today's PCs. If *Sandra* doesn't provide this information for your system, take a bright flashlight and look at the motherboard, starting at the edges. Often, there will be a vendor's logo or other identifying information printed directly on the motherboard. As a last ditch effort, you can call up the vendor of your PC and see if they can identify the motherboard model and supplier for you. We were lucky on our first shot; *Sandra* identified our motherboard as a model RC440BX manufactured by Intel.

If you're lucky enough to find out that you have an Intel or other major-manufacturer motherboard, getting information on it is easy. Many vendors, such as BioStar, Tyan, ASUS, and MicroStar, maintain fairly detailed motherboard information on their Web sites. Intel has complete motherboard manuals in PDF format, even for older motherboards. You just have to know where to look. Point your browser to [developer.intel.com](http://developer.intel.com) and you can find not only the required motherboard manuals, but the latest BIOS upgrade for those motherboards (assuming that they have a flash-upgradeable BIOS), and information on the different Intel core-logic chipsets. After downloading the manual for our RC440BX, we were delighted to learn that not only would the motherboard support a Pentium III up to 550-MHz, but that

## VENDOR INFORMATION

Intel Corporation  
[www.intel.com](http://www.intel.com)

Kingston Technology  
[www.Kingston.com](http://www.Kingston.com)

there weren't even any motherboard jumpers that needed to be set. The motherboard will, upon booting, automatically determine the type of CPU and RAM installed and set the front-side bus to the appropriate speed.

You might not be quite so lucky. Even if your motherboard will support the necessary upgrades in the CPU and memory, you may have to move one or more jumpers on the motherboard to set the system for the CPU and memory you wish to install.

Armed with this information, performing the actual upgrade was almost anticlimactic. We removed the older PC66 DIMMs and replaced them with the two Kingston DIMMs, which took less than a minute, as

## PUTTING IT TO THE TEST

To give you an idea of the benefit of the upgrade we discussed, we benchmarked the Gateway both before and after completing the upgrade. We used two different sets of benchmarks, the ones contained in *Sandra* (CPU in MIPS and FPU in MFLOPS as well as CPU Integer MMX and Floating Point FPU multimedia benchmarks), and an integrated benchmark called the *PassMark*, from [www.passmark.com](http://www.passmark.com). As evident from the scores in the table, the biggest boost was in the area of multimedia floating-point operations. In real-world terms, the system simply ran much better on most applications, with noticeably faster booting, and much quicker response on the graphics applications that were the initial reason for the upgrade.

### BENCHMARK 400-MHz Celeron 550-MHz Pentium III

SANDRA:		
CPU (in MIPS)	1067	1336
FPU (in MFLOPS)	530	663

SANDRA MULTIMEDIA:		
CPU Integer CPU	1217	1556
Floating Point FPU	568	2073

PassMark:		
Composite Rating	35.6	40.9

**LynX-10**  
**HOME AUTOMATION KIT**

- Software Included
- Use Existing Wiring
- Simple Inexpensive

1-800-928-5299 [www.marrickitd.com](http://www.marrickitd.com)

did removing the Celeron and replacing it with the 550-MHz Pentium III. Booting up the system to be sure that everything was operating correctly, we were heartened to see the BIOS recognize the new memory and CPU correctly.

## NO EASY DECISION

With all of the above, you can see that there is no cut-and-dried answer to whether a Celeron can be upgraded to a P-III. The most likely candidates for such an upgrade are the very newest systems. These frequently already offer Socket 370 support for a Pentium III, the correct front-side bus speed, memory that's fast enough to work with a Pentium III, and core logic support for the processor switch. At the same time, "catch-22" comes into play. If the system already supports a P-III and you're feeling chaffed by a Celeron, why did you buy it with the less powerful CPU in the first place?

The best candidate for the CPU transplant is exactly the type of PC that we performed our upgrade on: One that's about 12 to 18 months old and can support the requisite upgrade components, but still has peripherals such as a decent video card and nice-sized hard disk. That's what makes the upgrade cost-effective to do.

Assuming that your proposed system meets these requirements, the economics are pretty attractive. A brand new 550-MHz Pentium III PC, such as an eMachines' eMonster 550, costs about \$700 at the time this column was written. The total cost for our upgrade was under \$300—about \$200 for the 550-MHz Pentium III CPU, and the two 64MB Kingston PC100 DIMM modules, can be purchased on sale for about \$50 a piece.

If, however, you have to start replacing your hard disk and video card in the upgrade process, you're probably better off forgetting the upgrade and just buying a new PC. **■**

## Big Honk'in Filing Cabinet

I have to admit to being something of a packrat. It causes almost physical pain for me to throw out something that I think might have the slightest chance of being used in the future. As the mess continued to build over the years, my better half convinced me to periodically go through the morass. Then, if I haven't made use of the "saved" software or hardware within a reasonable period of time, to either give it away, throw it out, or give it to my ever-curious teen-aged twins to disassemble (then throw it out.) What constitutes a "reasonable" time largely depends on the volume of stuff awaiting disposal, though I actually do make use of some of the stuff I save.

The one exception to this time-based disposal rule are the periodicals in which I have something published. Over the last 22 years, I've always intended to take my article or review out, put it in a loose-leaf, and throw away the magazine. A bit over 2000 articles, etc., and just over 2 million words later, and I have about a half-dozen 33-gallon storage bins in the basement, all filled with magazines and papers.

### SUCCESS BREEDS SUCCESS?

Emboldened by my wife's success in convincing my boys to work on the great record-to-CD project, I felt it was time to finally tackle putting those bins of paper into tear-sheet format. But rather than just winnowing down the amount of paper, I wanted to put the saved material into some sort of searchable format. Obviously, the answer was to scan the material into a PC,



*The complete setup fits very comfortably on a standard computer desk.*

process it in some way, and store the results on CD-Rs. With a projected shelf-life of 30 years, a CD-R is a terrific storage media.

The physical setup was easy—as shown in the accompanying photo. The cornerstone of the project is a new Visioneer OneTouch 8600 scanner. I love Visioneer's scanners; they don't cost an awful lot and have great features for the price. The OneTouch 8600 has a set of buttons; each programmed for a different task such as scanning, copying, or even faxing. The optical resolution is 600 × 1200 dpi, much higher than I actually needed for this project. Another feature that I like is the built-in hardware JPG compression. Many scanners, including this one, use JPG as the native file format for scanning, as it provides smaller output files. Even when saving in a different file format, I've found that the OneTouch 8600 scans a page very quickly, a "must-have" feature with over 2000 articles and probably 5000 or so pages needing to be scanned!

The actual PC platform is not very important, though the actual image processing after the scan is finished is improved by a more

powerful PC. The system that I set up for this project uses an eMonster 550 from eMachines, simply because it was here being reviewed. The eMonster 550 has a 550-MHz Pentium III, 64MB of RAM, and a 15GB hard disk, so it actually works very nicely on this type of project. A Mitsubishi LCD52 flat-panel monitor is a pleasure to work on, and takes up very little space. Off to the side, where it doesn't appear in the picture, is an Epson Stylus Photo 1270 printer, which offers terrific print resolution and can take paper as large as 13 × 19. I find having this large-format printer available very handy if I want to print two facing pages on a piece of 11- by 17-inch paper.

Since the eMonster 550 has a DVD drive, rather than a CD-R/RW burner, I connected a Micro Solutions "bantam backpac" parallel-port CD-RW drive to the eMonster 550. It's not the fastest burner that I have here (that honor goes to an HP 9310i, which can burn a CD-R at 10X), but the bantam backpac reliably burns even the cheap CD-Rs that I buy at 4X, which is fast enough for most of my needs.

Finally, off on the right side of the set-up is a BusStation from Belkin. This is a modular solution that allows you to add a variety of additional ports to your PC. As set up right now, it provides seven additional USB ports and a 10BASE-T Ethernet adapter. The additional USB ports are handy, as both the scanner and printer are USB devices. The Ethernet adapter lets me easily connect the eMonster 550 to the 100BASE-T network that I have in the house. If I want to scan

something on the Visioneer scanner and access it from another PC, I just string a patch cord from the Belkin adapter to the Ethernet hub. The Belkin adapter runs only at the slower 10BASE-T speed because that's as fast as the USB-interfaced BusStation can transfer data back and forth to the PC over the USB connection.

## ONE FALSE START

Once I had the hardware set up, the next step was to decide on the software. Initially, I wanted to use *Adobe Capture 2.0*. This application was originally developed for Windows95, though it works under Windows98 just fine. *Capture 2.0* automatically converts the scanned pages into PDF format. PDF, or portable document format, was developed by Adobe to maintain the original characteristics of an imaged page, while reducing the size of the stored document. *Capture 2.0* includes a "dongle" (a type of hardware "key" that unlocks the software) that mounts on the PC's parallel port. You can still use the printer, as the dongle has a pass-through. This software/hardware combination permits the conversion of up to 20,000 pages, after which you need to purchase another 20,000-page license.

PDF is a great format for this type of project, as it maintains a lot of information behind the converted document. You can instruct *Capture 2.0* to automatically OCR the document while converting it to PDF format, or simply convert an image.

Unfortunately, while *Capture 2.0* is a great product, it is really targeted at a corporate user, where the "rent-the-service" and not "buy-the-software" approach would make sense. I wanted to complete this project with products that were both easy to use, and which would operate well across a wide range of equipment. On my first test platform, a 600-MHz Micron Millennium Max with 128MB, I kept running out of memory while operating *Capture 2.0*. Converting documents into PDF format was time-consuming.

It was time to put "Plan B" into effect.

While PDF is a convenient format, there is certainly no lack of

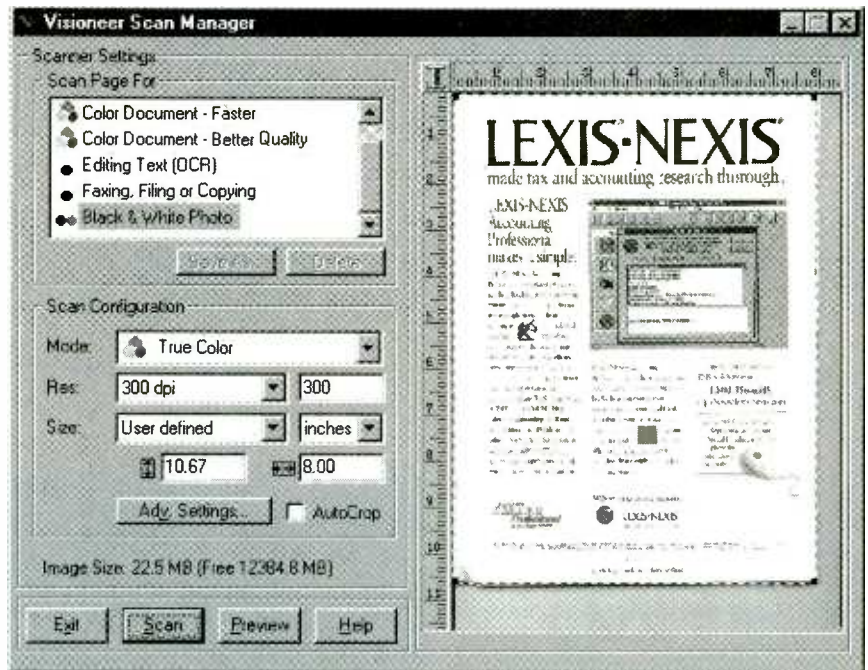

The TWAIN driver that comes with the Visioneer OneTouch 8600 has lots of controls, but it's easy to just scan a page in.

document-management software around—mostly from the same company—ScanSoft. Previous columns have detailed two of ScanSoft's premier products—*Pagis Pro* and *PaperPort*. More recently, the vendor has also purchased Caere, which produces the well-regarded *PageKeeper* as well as *OmniPage* OCR software.

*PaperPort* was originally devel-

oped by Visioneer. Visioneer continues to provide *PaperPort* with its scanners; the OneTouch 8600 already had *PaperPort* included in the box—in fact, on the same CD as the TWAIN driver. Since *PaperPort* is easy to install and operate and has the ability to let you enter and attach keywords to an imaged page, I decided to go with it, at least as an initial approach.

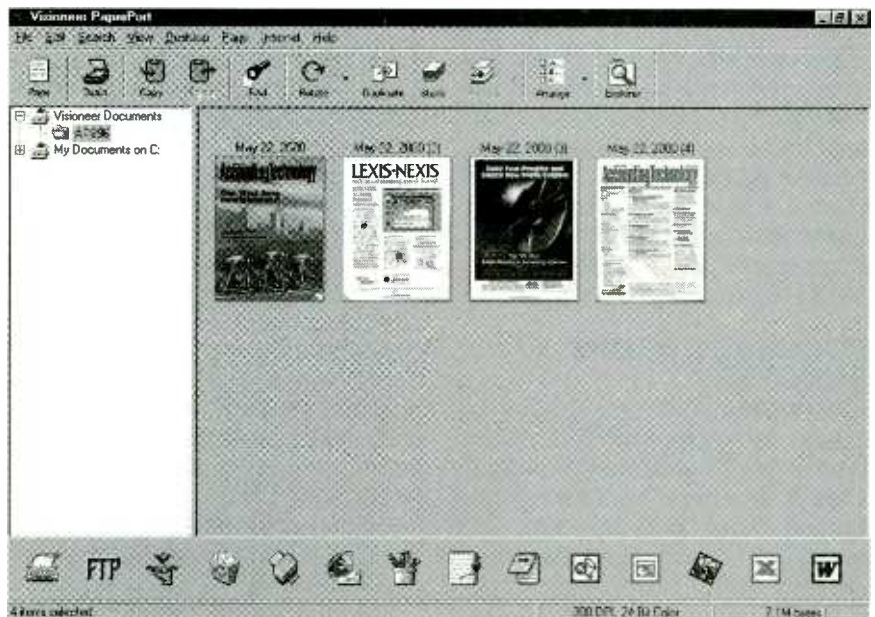

By creating a folder in the Explorer-like window in the left panel, the images that are scanned and displayed on the desktop are automatically named and stored. You can click on an image and add keyword information to make later retrieval easier.

## VENDOR INFORMATION

**Adobe Systems Incorporated**  
345 Park Ave.  
San Jose, CA 95110-2704  
800-833-6687  
[www.adobe.com](http://www.adobe.com)

**Belkin Components**  
501 West Walnut St.  
Compton, CA 90220  
310-898-1100  
[www.belkin.com](http://www.belkin.com)

**eMachines, Inc.**  
14350 Myford Rd. Bldg. 100  
Irvine, CA 92606-1002  
714-481-2828  
[www.e4me.com](http://www.e4me.com)

**ScanSoft Inc.**  
9 Centennial Dr.  
Peabody, MA 01960  
800-654-1187

**Visloneer**  
34800 Campus Dr.  
Fremont, CA 94555  
510-608-0300  
[www.visioneer.com](http://www.visioneer.com)

*PaperPort* stores page images in its own format, though it does permit you to export the image into a number of more familiar formats such as TIF, JPG, and BMP. To make sure that enough image information was captured in the initial scan, I set the TWAIN driver to 300 dpi and 24-bit color. This results in pretty large files for the images, but with a 15GB hard disk and 650MB CD-Rs, I wasn't too worried about running out of room.

Setting up simply requires that you create a new folder for each magazine. Subfolders can be created for each issue. The Visioneer operates quickly; I was able to scan about a page a minute once I got the hang of it.

Later, I'll probably export the files into another format—I still want to eventually convert them to PDF documents. However, that's another column, and I still have to work out the economic details with my "Scan Team." For the short term, I'll just make sure that I burn a copy of the *PaperPort* software and store it with the scanned images. That way, I can be certain that I can access and print out my "tear sheets" even if I have to reinstall *PaperPort* to do so. P



## DIALING FOR DOLLARS.

Buy a Wavetek™ multimeter and get a cash rebate of up to \$15, which makes this quite possibly the world's best multimeter value. But hurry. This offer expires when 2000 does.

**Official Wavetek Rebate Form**  
Rebates: \$5 on any Wavetek XL meter, \$10 on all XTs and \$15 on all HD B Series models purchased from 7/1/2000 to 12/31/2000 only. (1) Fill out this rebate form and attach your purchase receipt. (2) Mail to: Wavetek Rebate Offer, PO Box 8013 Walled Lake, MI 48390 Deadline: Rebate request must be postmarked by 12/31/2000.

Name \_\_\_\_\_  
Address \_\_\_\_\_  
City \_\_\_\_\_ State \_\_\_\_\_ Zip \_\_\_\_\_  
Model Number of Wavetek Multi meter \_\_\_\_\_  
Serial Number \_\_\_\_\_  
Name of Distributor \_\_\_\_\_

Terms and Conditions: Allow 6 to 8 weeks for delivery. Company employees and families, parents, children and their spouses, company affiliates, subsidiaries, distributors or representatives, its advertising agencies, rebate supplier and any other company involved with this rebate offer are not eligible. Offer good only in the USA and Canada. Void where prohibited, taxed or otherwise restricted. Rebate offer may not be transferred. Only indicated proofs of purchase will be accepted. Rebates are not available directly from your local Wavetek distributor or retailer. [www.wavetekstools.com](http://www.wavetekstools.com) Or write 3045 Belboa Ave. San Diego, CA 92123. Wavetek is a trademark of Wavetek, Wavel & Galteman, Inc. (WWG) and is used by Fluke Corp under a transitional license agreement. Fluke is not affiliated with WWG. Ad no. 01271

**WAVETEK**

CIRCLE 150 ON FREE INFORMATION CARD

## FREE SERVICES: FROM ENCYCLOPEDIAS TO BUILDING WEB SITES

How good is free? The no-cost Internet bandwagon continues to accelerate, with Web sites, Web storage space, Web-based software programs, and Internet service providers offering services completely free of charge. Some Web sites even let you build your Web site for free, then host it for free as well.

I've tested most of the major Web-site-creation tools that you have to pay for, including *Macromedia Dreamweaver* (the hottest HTML editor among professional Web designers) and *Microsoft Front-Page* (the most popular product, but one that forces you to use other Microsoft products to take full advantage of it). I wanted to find out how well the free tools compare with the pay tools. So, using Homestead ([www.homestead.com](http://www.homestead.com)), a free service that I had heard and read good things about, I created a Web site for sinus sufferers called "Sinusitis FAQ;" you can view it at [www.sinusitis.homestead.com](http://www.sinusitis.homestead.com).

Like similar services such as GeoCities ([www.geocities.com](http://www.geocities.com)) and Tripod ([www.tripod.com](http://www.tripod.com)), Homestead is targeted more to home users than business people. Because of that slant, I was surprised to find e-commerce tools available. You can, for instance, add a shopping cart to your site and even accept credit-card payments. Creating a site with Homestead is straightforward. You can start with one of the

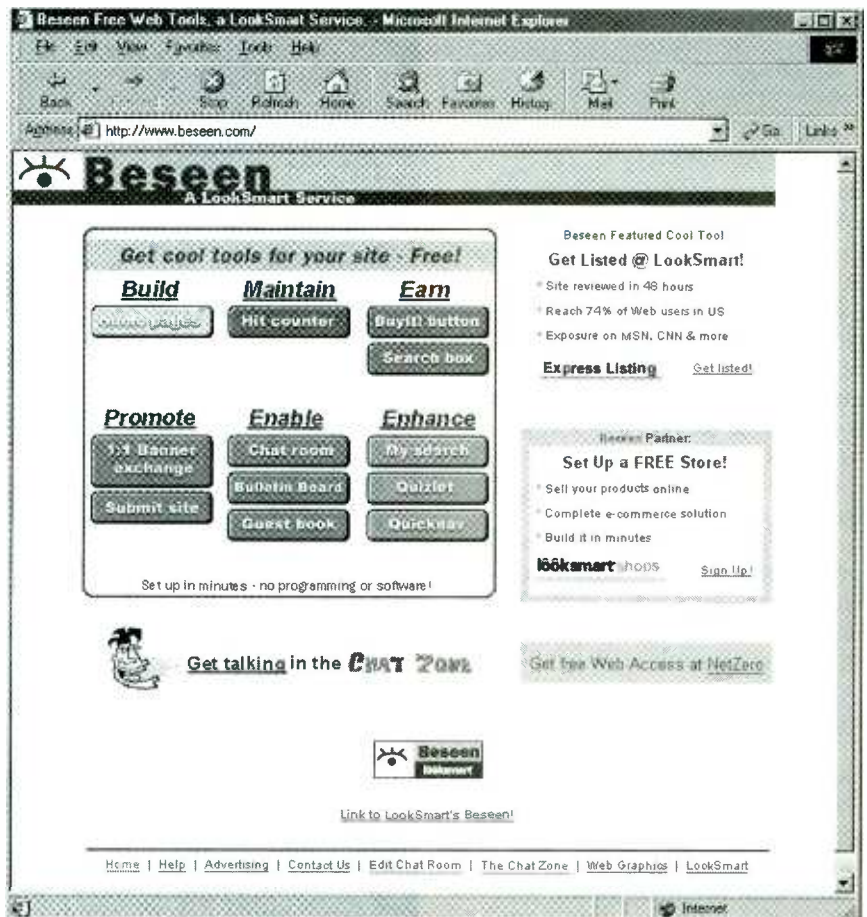

Having a Web page is only half the fun nowadays; interactivity is the second part of the equation. Sites such as Beseen let you incorporate chat rooms and message boards on your site.

supplied templates and customize it for your purposes by dragging and dropping elements right onto the page. Among other things, you can

add graphics, sound, and video; provide chat and polling services; and offer local weather forecasts. Still, free comes with its limitations. Building a



The venerable Encyclopædia Britannica has a Web presence that is two parts research tool, one part current news. That approach makes a lot of sense if you think about it. Knowledge is not static; print-edition encyclopedias are out of date and behind the times before they even come off the printing press.

Web site from a Web site is slow going, you have much less control and versatility compared with pay packages, and your site must display a banner ad at the bottom of each page.

Whether you use a service such as Homestead or conventional tools, there are plenty of other free offerings to enhance any type of Web site. Most offer free basic services and pay upgrades; some are ad supported. It's best to resist the temptation to filch material from other sites, easy as it may be. Some sites even offer a wide selection of purloined copyrighted music and art. Stick to the up-and-up, and you'll avoid legal hassles.

## DIGITAL EYE-AND-EAR CANDY

Let's take a quick look at some of the sites that offer various "bells and whistles" to turn your Web site into a slick multimedia-savvy work of art or—if you go overboard—an eyesore-creating blight on the digital landscape.

ArtToday ([www.arttoday.com](http://www.arttoday.com)) provides access to more than 40,000 high-quality, fully licensed Web graphics, free of charge.

Various levels of pay access offer more clip art as well as photos, fonts, and sounds.

Partners in Rhyme ([www.partnersinrhyme.com](http://www.partnersinrhyme.com)) provide a large library of public-domain sound effects and royalty-free background music. The site also includes a helpful audio tutorial. Page Talk ([www.pagetalk.com](http://www.pagetalk.com)) lets you put a button on your site that visitors can click to hear your voice. You just copy a few lines of HTML to add to your site's source code, then phone a toll-free number and record a message of 20 seconds or less. It's totally free, and you don't even need a functioning sound card!

iSyndicate ([www.isyndicate.com](http://www.isyndicate.com)) lets you add to your site syndicated written, graphical, audio, or video content from more than 800 different sources, including big names such as *Time* and Merrill Lynch. Some of the content is free, some costs.

If your site includes a lot of content, whether created in-house or out, one helpful, professional touch is to provide visitors with an internal search engine. Atomz.com ([www.atomz.com](http://www.atomz.com)) lets you add either a

simple or sophisticated search engine to your site and sends you a periodic report on visitor searches. The service is free for sites with fewer than 500 pages.

JavaScript can help make your site more dynamic, and you don't have to be a programmer to use it. JavaScriptSource ([javascript.internet.com](http://javascript.internet.com)) offers more than 500 free scripts you can cut and paste into your site's HTML. Examples include pull-down menus and scrolling messages.

Interactivity is the Internet's greatest strength, and you can now add it to your Web site, free of charge. Beseen ([www.beseen.com](http://www.beseen.com)) can outfit your site with a message board or chat room. SpellChecker.net ([www.spellchecker.net](http://www.spellchecker.net)) gives visitors the option of spell checking their messages.

Creating forms that visitors can fill out is no easy matter. Response-O-Matic ([www.response-o-matic.com](http://www.response-o-matic.com)) makes it easy—using a supplied template, you just fill in the blanks. Whenever a visitor completes a form, the service sends you e-mail with the information.

If you're building a Web site as a storefront, instead of using a service such as Homestead where this is a sideline, you're better off using a specialized service. Bigstep.com ([www.bigstep.com](http://www.bigstep.com)) provides "wizards" that walk you through the time-consuming process of setting up sophisticated e-commerce features, such as catalogs and reports. The service is free, though you're charged fees if you accept credit-card payments.

## ENCYCLOPEDIAS WANT TO BE FREE

Encyclopedias have traditionally been regarded by academics as second-rate sources of information or collections of summaries that are short on depth and authority; works that you'd be embarrassed to cite in a paper or presentation. Using primary sources—firsthand accounts and opinion—is the gold standard. With the Internet making dubious firsthand information available with a few clicks of the mouse, encyclopedias aren't looking so bad after all. In contrast to the rumors, gossip, hoaxes, exaggerations, falsehoods, and mistakes that you can find on the Net, encyclopedias are a bas-



Searching through the different on-line encyclopedias can be time-consuming and frustrating. Internet Oracle gives you quick and easy access to many different publications from one convenient page.

tion of professionally-written and -edited material that for the most part is accurate and trustworthy.

Change is again rousing the once sleepy world of encyclopedias, making them more accessible than ever. The leader here is the unlikeliest of trailblazers, the formerly staid and even fusty *Encyclopædia Britannica*.

This British-born but now American-owned *grande dame* of reference works, the last of the top encyclopedias to embrace multimedia CD-ROMs, is the first to make its entire content available free on the Web.

At Britannica.com ([www.britannica.com](http://www.britannica.com)), you can freely search through any of 76,000 articles—

3000 more than in the 32-volume printed set, which is still available for a cool \$1250. Incidentally, *Encyclopædia Britannica* has another Web site at [www.eb.com](http://www.eb.com) that's targeted toward libraries, schools, and other institutions and carries subscription fees.

To compete in the frenzied and future-oriented dot-com world, Britannica.com is giving away more than the wide-ranging content of its unparalleled encyclopedia. It also offers fresh material every day—news, weather, sports, features about pop culture and other topics, and 125,000 selected links to other Web sites. "We want people to visit us every day," says spokesperson Tom Panelas. To succeed, the company needs frequent visitors. Its business model is based on advertising and e-commerce (the company sells educational tools such as telescopes and science kits).

Britannica.com is at the vanguard, with other encyclopedias likely to follow, if kicking and screaming. "As print encyclopedias were overwhelmed by CD-ROMs, CD-ROM encyclopedias may be overwhelmed by the Web," says David Card, an analyst for Jupiter Communications, an Internet research

## POINT AND CLICK

**ArtToday**  
[www.arttoday.com](http://www.arttoday.com)

**Atomz**  
[www.atomz.com](http://www.atomz.com)

**Beseen**  
[www.beseen.com](http://www.beseen.com)

**Bigstep**  
[www.bigstep.com](http://www.bigstep.com)

**Compton's Encyclopedia Online**  
[www.comptons.com/index\\_retail.html](http://www.comptons.com/index_retail.html)

**Electric Library's Encyclopedia**  
[www.encyclopedia.com](http://www.encyclopedia.com)

**Encyclopædia Britannica**  
[www.britannica.com](http://www.britannica.com) (free)  
[www.eb.com](http://www.eb.com) (subscription)

**Funk & Wagnall's Encyclopedia**  
[www.funkandwagnalls.com](http://www.funkandwagnalls.com)

**GeoCities**  
[www.geocities.com](http://www.geocities.com)

**Grolier Multimedia Encyclopedia Online**  
[gme.grolier.com](http://gme.grolier.com)

**Homestead**  
[www.homestead.com](http://www.homestead.com)

**InfoPlease**  
[www.infoplease.com](http://www.infoplease.com)

**Internet Oracle**  
[www.internetoracle.com/encyclop.htm](http://www.internetoracle.com/encyclop.htm)

**iSyndicate**  
[www.isyndicate.com](http://www.isyndicate.com)

**JavaScriptSource**  
[javascript.internet.com](http://javascript.internet.com)

**Library Spot**  
[www.libraryspot.com](http://www.libraryspot.com)

**Metacrawler**  
[www.metacrawler.com](http://www.metacrawler.com)

**MSN Encarta**  
[encarta.msn.com](http://encarta.msn.com)

**Page Talk**  
[www.pagetalk.com](http://www.pagetalk.com)

**Partners in Rhyme**  
[www.partnersinrhyme.com](http://www.partnersinrhyme.com)

**Resource Central**  
[www.kalama.com/~mariner](http://www.kalama.com/~mariner)

**Response-O-Matic**  
[www.response-o-matic.com](http://www.response-o-matic.com)

**SpellChecker**  
[www.spellchecker.net](http://www.spellchecker.net)

**Tripod**  
[www.tripod.com](http://www.tripod.com)

**Virtual Reference Desk**  
[www.refdesk.com](http://www.refdesk.com)

**World Book Online**  
[www.worldbookonline.com](http://www.worldbookonline.com)



firm in New York City.

Microsoft, the company that has succeeded by trying to eat everyone else's lunch, has taken baby steps here. At MSN Encarta ([encarta.msn.com](http://encarta.msn.com)), you get free access to a concise encyclopedia of 16,000 abridged articles and a world atlas. Access to the 42,000 articles in the unabridged encyclopedia still costs \$50 a year, or \$40 a year if you recently bought an Encarta CD-ROM.

The other major encyclopedias are even slower out of the gate. Grolier Multimedia Encyclopedia Online ([gme.grolier.com](http://gme.grolier.com)) weighs in at \$60 a year. World Book Online ([www.worldbookonline.com](http://www.worldbookonline.com)) will set you back \$50 a year, and Compton's Encyclopedia Online ([www.comptons.com/index\\_retail.html](http://www.comptons.com/index_retail.html)) consumes \$40 a year. None of these offer free abridged versions, though all the pay encyclopedias offer free trial periods ranging from one week to one month.

Fortunately, you have other free offerings to choose from. Funkand Wagnalls.com ([www.funkandwagnalls.com](http://www.funkandwagnalls.com)) offers the complete content of the unabridged *Funk & Wagnalls Encyclopedia*, along with a dictionary, thesaurus, atlas, and animal encyclopedia. In addition, there is a media gallery where you can access photos, animations, music, and speeches.

Electric Library's Encyclopedia.com ([www.encyclopedia.com](http://www.encyclopedia.com)) offers only an abridged encyclopedia, the *Concise Columbia Electronic Encyclopedia*. For more depth, it also includes links to related Web sites and articles from Electric Library, a compendium of three million articles from magazines, newspapers, and other sources. Access to Electric Library, however, costs \$60 a year.

Nothing beats an almanac for quick facts on everyday items, which is the forte of InfoPlease.com ([www.infoplease.com](http://www.infoplease.com)). It offers almanacs on general topics, entertainment, sports, and kids' interests as well as an encyclopedia and a dictionary, all free of charge.

Big companies may be staking claim to the Web, but there's still room for home-grown efforts. Internet Oracle ([www.internetoracle.com](http://www.internetoracle.com))

provides a convenient, free launch pad to search through 23 general and specialized encyclopedias and other reference works, plus links to dozens of other reference sources; think of it as the Metacrawler (a multiple-search-engine search engine at [www.metacrawler.com](http://www.metacrawler.com)) of encyclopedias.

Resource Central ([www.kaiama.com/~mariner](http://www.kaiama.com/~mariner)) is a similar site, offering links to 40 encyclopedias, 60 dictionaries, and numerous other reference sources. Library Spot ([www.libraryspot.com](http://www.libraryspot.com)) and Virtual Reference

Desk ([www.refdesk.com](http://www.refdesk.com)) also deserve bookmarks.

You still wouldn't want to quote encyclopedias in a doctoral dissertation, but for quickly finding reliable information to help you with your work, home, or school life, they're hard to beat. With the trailblazing efforts behind *Encyclopædia Britannica*, free access to them is a trend that will be hard to stop.

"Free is awfully compelling," says Rob Enderle, an analyst for Giga Information Group, a market research firm in Santa Clara, CA. **P**

**Get Ready!  
Get Set!  
Go!**

**Design a board with the EAGLE freeware version, and see how fast you will be productive.**

Boards designed under EAGLE are found in patient monitoring equipment, chip cards, electric razors, hearing aids, automobiles and industrial controllers. They are as small as a thumbnail or as large as a PC motherboard. They are developed in one-man businesses or in large industrial companies. EAGLE is being used in many of the top companies.

The crucial reason for selecting EAGLE is not usually the very favorable price, but rather the ease of use. On top of that comes the outstanding level of support, which at CadSoft is always free of charge, and is available without restriction to every customer. These are the real cost killers!

**EAGLE 3.5 Light is Freeware!**

You can use EAGLE Light for testing and for non-commercial applications without charge. The Freeware Version is restricted to boards up to half Eurocard format, with a maximum of two signal layers and one schematic sheet. All other features correspond to those of the Professional Version. Download it from our Internet Site or order our free CD.

If you decide in favor of the Commercial Light Version, you also get the reference manual and a license for commercial applications. The Standard Version is suitable for boards in Eurocard format with up to 4 signal layers (max. 99 schematic sheets). The Professional Version has no such limitations.

<http://www.CadSoftUSA.com>

800-858-8355

CadSoft Computer, Inc., 801 S. Federal Highway, Delray Beach, FL 33483  
Hotline (561) 274-8355, Fax (561) 274-8218, E-Mail: [info@cadsoftusa.com](mailto:info@cadsoftusa.com)



**EAGLE 3.5**

Schematic Capture • Board Layout  
Autorouter

for Windows 95/NT

and Linux

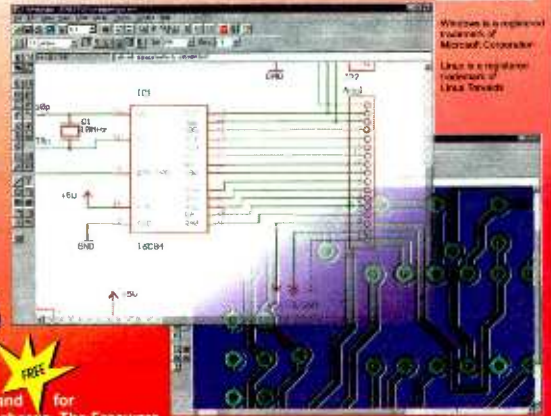

Prices	Light	Standard	Professional
Layout		199\$	399\$
Layout + Schematic		399\$	799\$
Layout + Autorouter		399\$	799\$
Layout + Schematic + Autorouter	49\$	597\$	1197\$

Pay the difference for Upgrades

# CD ROM based resources for learning and designing



The internationally renowned series of CD ROMs from Matrix Multimedia has been designed to both improve your circuit design skills and to also provide you with sets of tools to actually help you design the circuits themselves.



only  
**\$50**  
(student/home)

**Electronic Circuits and Components** provides an introduction to the principles and application of the most common types of electronic components and how they are used to form complete circuits. Sections on the disc include: fundamental electronic theory, active components, passive components, analogue circuits and digital circuits.

**The Parts Gallery** has been designed to overcome the problem of component and symbol recognition. The CD will help students to recognize common electronic components and their corresponding symbols in circuit diagrams. Quizzes are included.

**Digital Electronics** details the principles and practice of digital electronics, including logic gates, combinational and sequential logic circuits, clocks, counters, shift registers, and displays. The CD ROM also provides an introduction to microprocessor based systems.



**Analog Electronics** is a complete learning resource for this most difficult subject. The CD ROM includes the usual wealth of virtual laboratories as well as an electronic circuit simulator with over 50 pre-designed analog circuits which gives you the ultimate learning tool. The CD provides comprehensive coverage of analog fundamentals, transistor circuit design, op-amps, filters, oscillators, and other analog systems.

**Electronic Projects** is just that: a series of ten projects for students to build with all support information. The CD is designed to provide a set of projects which will complement students' work on the other 3 CDs in the Electronics Education Series. Each project on the CD is supplied with schematic diagrams, circuit and PCB layout files, component lists and comprehensive circuit explanations.

**PICtutor and C for PICmicro microcontrollers** both contain complete sets of tutorials for programming the PICmicro series of microcontrollers in assembly language and C respectively. Both CD ROMs contain programs that allow you to convert your code into hex and then download it (via printer port) into a PIC16F84. The accompanying development board provides an unrivaled platform for learning about PIC microcontrollers and for further development work.



**Digital Works** is a highly interactive scalable digital logic simulator designed to allow electronics and computer science students to build complex digital logic circuits incorporating circuit macros, 4000 and 74 series logic.

**CADPACK** includes software for schematic capture, circuit simulation, and PCB design and is capable of producing industrial quality schematics and circuit board layouts. **CADPACK** includes unique circuit design and animation/simulation that will help your students understand the basic operation of many circuits.

**Analog Filters** is a complete course in filter design and synthesis and contains expert systems to assist in designing active and passive filters.

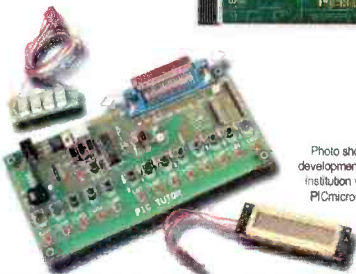

Photo shows PICmicro development kit supplied with institution versions of C for PICmicro and PICtutor

**Shareware/demo CD ROM with more than 20 programs \$4.99 refundable with any purchase.**

## Order Form

Please circle the products you would like to buy on the table below calculate the total cost, fill in the rest of the order form and send it to us. Please allow 6 weeks delivery.

	Student	Institution
Electronic Ccts. & Comps.	\$50	\$99
Digital Electronics	\$50	\$99
Analog Electronics	\$50	\$99
Electronic Projects	\$75	\$159
PICtutor	\$179	\$350
C for PICmicro	\$179	\$350
Digital Works	\$50	\$99
CADPACK	\$75	\$159
Analog Filters	\$75	\$159
Postage - USA	\$0	\$0
Postage - Canada	\$5	\$5

Name: \_\_\_\_\_

Phone your order to us on:

631-592-6721

Address: \_\_\_\_\_

or send your order to:

CLAGGK Inc.,  
275-G Marcus Blvd.,  
Hauppauge, NY 11788

Zip: \_\_\_\_\_ Phone: \_\_\_\_\_

Card Type: \_\_\_\_\_

Mastercard, Visa, or Discover only

Card number:

Expire date:

I have enclosed my check for \$: \_\_\_\_\_

Signature: \_\_\_\_\_

Please charge my credit card for \$: \_\_\_\_\_

CL02

Order online NOW from: [www.gernsback.com/poptronics](http://www.gernsback.com/poptronics)

# Prototype

## Smashing Atoms

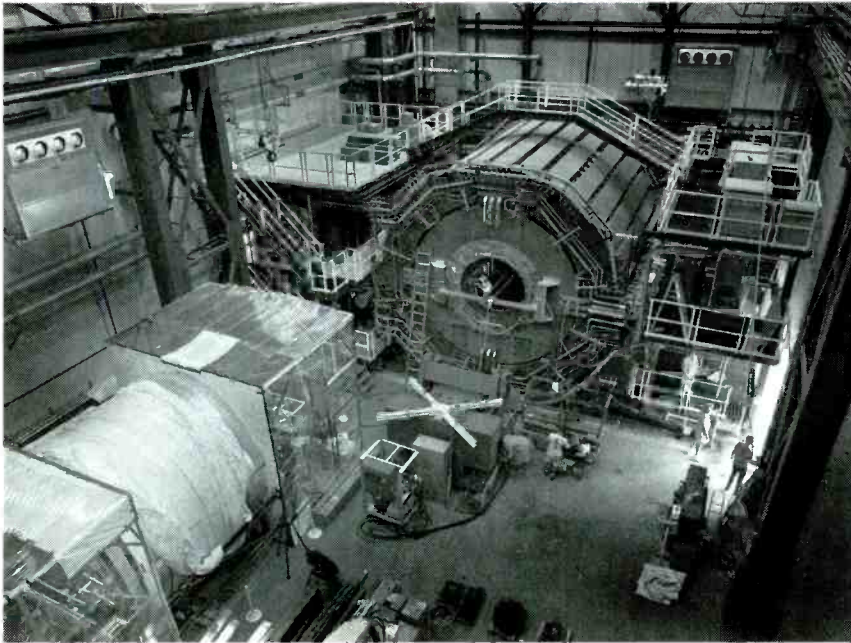

The STAR detector at Brookhaven's Relativistic Heavy Ion Collider (RHIC). STAR will track and analyze the thousands of particles that may be produced by each gold ion collision inside the detector. As big as a house, STAR will search for signatures of the form of matter that RHIC aims to create: the quark-gluon plasma.

Scientists at the U. S. Department of Energy's (D.O.E.) Brookhaven National Laboratory have begun detecting head-on collisions between gold nuclei in the Relativistic Heavy Ion Collider (RHIC), the world's biggest and newest particle accelerator for studies in nuclear physics. The first spectacular images of particles streaming from a collision point were produced by the STAR detector on June 12<sup>th</sup>. High-energy collisions were also seen by the PHOBOS detector the following day.

The collider aims to recreate the conditions of the early universe to gain insights into the fundamental nature of matter. Scientists will use data collected during the collisions to explore the particles known as quarks and gluons that

make up protons and neutrons. The high temperature and densities achieved in the collisions should, for a fleeting moment, allow the quarks and gluons to exist "freely" in a soup-like plasma, a state of matter that is believed to have last existed millionths of a second after the Big Bang, when the universe was first formed.

"Detailed studies of the properties of the quark-gluon plasma—such as temperature, energy and particle densities, and entropy—are essential to really understand and describe this unique form of matter," said Satoshi Ozaki, Associate Laboratory Director for RHIC. There may be other important implications for understanding why the universe has its current structure and where it's going.

### Earlier Experiments

"Brookhaven National Laboratory is the only facility in the world where physicists can do this kind of research," said Laboratory Director John Marburger. Previous studies with lower-energy collisions at CERN, the European laboratory for particle physics in Switzerland, hinted at the existence of quark-gluon plasma. "But RHIC will produce far more definitive results and allow detailed studies of the quark-gluon plasma," Marburger said.

The five-year program of heavy-ion collision experiments at CERN were the highest energy, man-made heavy-ion collisions yet. A similar round of experiments at somewhat lower energy was carried out with gold ion beams at Brookhaven's Alternating Gradient Synchrotron (AGS) in 1993.

Direct measurements, such as detecting electromagnetic signals from a quark-gluon plasma, are only possible now at the much higher collision energies at RHIC (ten times more powerful than CERN) and, at a future date, at CERN's Large Hadron Collider. The higher temperatures in RHIC's collisions allow the quark-gluon plasma to



A view of the superconducting magnets at RHIC. As gold particles zip along the collider's 2.4-mile-long tunnel at nearly the speed of light, 1740 of these magnets guide and focus the particle beams.

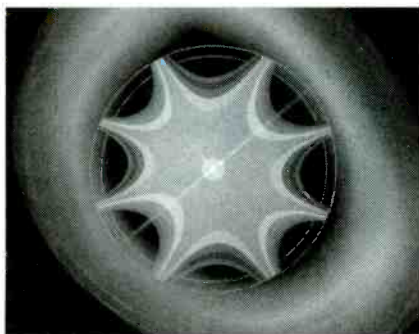

A representation of the magnetic field created by one of the superconducting magnets in the collider. RHIC collides speeding heavy ions and polarized protons in an effort to re-create a state of matter not seen since moments after the Big Bang.

linger long enough for the kinds of direct observations that are not possible with the CERN's experiments.

## Unique Facility

RHIC's unique capabilities stem from its size and dual-ring design. Inside the underground accelerator tunnel are actually two separate accelerator rings, each 2.4 miles in circumference and composed of some 1740 superconducting magnets. These magnets guide ions of gold atoms—gold nuclei that have been stripped of their electrons—around each of the circular rings in opposite directions at nearly the speed of light. The ions are then stored circulating in the rings at near light speed and allowed to collide at points where the two rings cross.

In this first run, RHIC scientists and engineers achieved collisions with beam energies of about 30 billion electron volts (GeV) per nucleon (proton or neutron)—four times more energetic than the collisions at CERN. Eventually the Brookhaven scientists will accelerate the ion to collide at energies of 100 GeV per nucleon in each beam—resulting in collisions approximately ten times more energetic than those at CERN.

## Particle Pressure Cooker

With all that energy concentrated in a space about the size of an atomic nucleus, the colliding ions, for a tiny fraction of a second, will reach a temperature one hundred thousand times hotter than the core of the sun—hot enough to “melt” the ions into their component quarks and gluons. By studying the data from millions of these

high-energy collisions, RHIC scientists will be able to gather definitive evidence that quark-gluon plasma was formed and begin to understand its properties.

Thousands of particles are emitted following each head-on collision. Sophisticated detectors have been constructed at four of six collision points around the ring to gather and decipher the enormous volumes of data that are recorded regarding the properties of these emitted particles. Two large detectors, PHENIX and STAR, are several stories tall. The other detectors, BRAHMS and PHOBOS, are smaller and more specialized. Scientists analyzed data collected by these detectors during continuous runs in the collider throughout the summer. The first results from those analyses are expected to be released some time at the beginning of next year.

## Local and International Cooperation

RHIC construction began in 1991 and was completed in 1999. Much of the work was done in collaboration with local industry, including the Northrop-Grumman Corp., which manufactured many of the superconducting magnets at its Long Island facility. The experimental program was developed by nearly 1000 scientific collaborators at nearly 100 research institutions representing 19 different countries.

Funded by the U. S. D.O.E. and constructed by Brookhaven Lab, the RHIC complex builds upon Brookhaven's pre-existing chain of accelerators—the Tandem Van de Graaff accelerator, the Booster, and the AGS. RHIC relies on these other machines to accelerate and inject ions into its collider rings at an energy of about 10 GeV per nucleon.

As Satoshi Ozaki stated when the collider experiments began in June, “This moment represents the culmination of many years of hard work, and now all the pieces are in place. We have just detected the most spectacular subatomic collisions ever witnessed by humankind, and are launching a new era for the study of nuclear matter.”

PT

## Buried Danger

More than one million land mines are buried throughout the world causing some 26,000 injuries and deaths each year. But existing mine detectors do

not work under all conditions and have particular difficulty finding small anti-personnel mines that are made mostly from plastic.

“Detecting land mines is a very difficult thing to do,” said Dr. Waymond Scott, associate professor in the Georgia Institute of Technology's School of Electrical and Computer Engineering. “Every existing method for mine detection has conditions under which it will work well and conditions under which it will fail.”



Dr. Waymond Scott displays samples of inert land mines used in research, while researcher Christoph Schroeder adjusts radar used to detect soil displacement.

By simultaneously using sound waves to create tiny soil disturbances and precision radar to measure the resulting movement, Scott and collaborators Peter Rogers, Gregg Larson, James Martin, and George McCall—all of the School of Mechanical Engineering—have developed a new method for detecting land mines buried in soil. They used a transducer to create seismic waves that travel through the soil containing land mines. This special class of elastic waves causes the soil and everything buried in it to be displaced slightly. That tiny movement in the surface of the soil—less than one micrometer—can be detected by electromagnetic waves from a small radar system that scans just above the surface of the soil.

The technique differentiates mines

from other buried objects such as rocks or sticks because of the different mechanical properties of the mine. The interactions and unique resonance created by the waves interacting with the mine's hollow shell and complex trigger and explosive mechanisms make it stand out from solid objects.

Using a pit containing 50 tons of damp sand, the researchers have demonstrated they can detect seven different types of buried mines. The deactivated weapons range from small antipersonnel mines just a few inches in diameter planted near the surface to much larger antitank mines buried more deeply.

Before the technique can be practical, however, the researchers have to solve many problems. First, the wave interaction must be studied in many different soil types and environmental conditions. The detection process must also be made much faster. Researchers are investigating non-contact wave sources, such as an electric arc, loudspeaker, microwave, laser, and water jet, instead of the transducer now being used. The system will also have to be made portable and robust enough to work reliably under rough field conditions. However, it will be years before the acoustic electromagnetic detection technique can be used to locate and remove land mines worldwide.

Ultimately, Scott expects this method to be combined with other technologies, such as detectors that sniff the chemicals given off by explosives in the mines, existing metal detectors, and ground-penetrating radars. He believes only a combination of methods will offer reliable results over a wide range of devices and conditions. **PT**

## Gotcha: Detecting Nuclear Weapons

**S**cientists at the U.S. Department of Energy's Pacific Northwest National Laboratory have developed a device that can detect nuclear detonations by analyzing the atmosphere for traces of radioactive material. ARSA, the Automated Radioxenon Sampler/Analyzer analyzes air samples for radioactive xenon, or radioxenon, that seeps from underground nuclear explosions, the most common testing method today but the most

## ► Glass Cockpit

**The Space Shuttle Atlantis has been equipped with flat display technology. The Boeing- and Honeywell-designed Multifunction Electronics Display Subsystem (MEDS) uses an active matrix liquid crystal (AMLCD) display from Philips Flat Display System (FDS). The MEDS is known as a glass cockpit.**

**NASA expects to replace the traditional CRT displays and numerous mechanical gauges within all of its space shuttle cockpits with Philips FDS' more advanced AMLCDs, as part of a Boeing/Honeywell instrumentation retrofit program.**

**According to Matt Medeiros, Philips FDS' chairman and CEO, the replacement of traditional CRT displays in instrumentation equipment with AMLCDs is widespread in new and existing commercial aircraft. AMLCDs offer a number of advantages over CRT displays, including reduced dimensions (6.71 by 6.71 inches), lower power consumption, improved optical performance, and a longer lifecycle.** **PT**

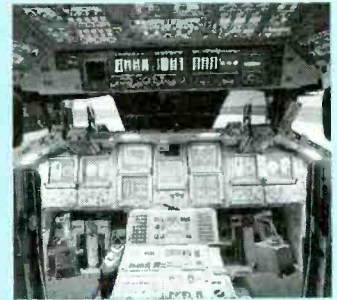

NASA Shuttle Atlantis flat glass display cockpit, provided by Honeywell and Philips Flat Display Systems.

difficult to detect. ARSA has a detection sensitivity 10 to 100 times more sensitive than other detection systems. In addition, it is the only completely automated radioactive xenon monitor. The greater sensitivity was accomplished by increasing the sample size—ARSA can sample 12,000 liters/day.

In its first international demonstration in Freiburg, Germany, ARSA proved it could measure short-lived isotopes produced by underground nuclear testing. In the Freiburg test, ARSA detected a short-lived radioactive isotope called xenon-135 that was produced by European nuclear power plants and also is emitted during underground tests.

This device provides greater sensitivity, full automation, near real-time reporting, and novel nuclear radiation detectors. ARSA collects air samples,

and then processes them to trap the radioactive xenon on cold charcoal. After the system purifies the radioactive xenon, it is transferred to a nuclear counting system. The different isotopes of xenon are automatically measured, and the results are automatically passed to a data center by a direct communication link. ARSA can be accessed by modem and programmed remotely.

When it's completely developed in early 2001, ARSA will be licensed to a commercial company that will sell it to countries attempting to fulfill radionuclide monitoring duties under the Comprehensive Nuclear Test Ban Treaty. **PT**

## Insight From Space

**N**ASA is providing new insights from space that may help health officials predict outbreaks of deadly water-borne cholera, a bacterial infection of the small intestine that can be fatal to humans. Scientists have learned how to use satellites to track blooms of tiny floating plant and animal plankton that carry cholera bacteria by using satellite data on ocean temperatures, sea height, and other climate variables.

Researchers from the University of Maryland Biotechnology Institute (UMBI), NASA Ames Research Center, and the International Centre for Diarrhoeal Disease Research in Bangladesh worked together on the satellite experiments. They published their results in a paper

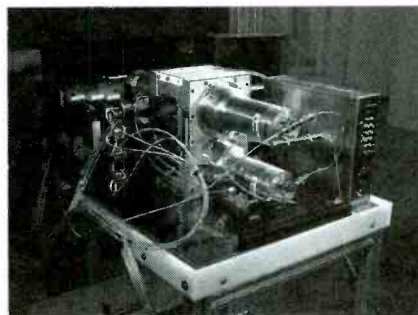

A beta-coincidence spectrometer plays an integral role in detecting evidence of underground nuclear explosions, as part of the Automated Radioxenon Sampler/Analyzer (ARSA).

in the Proceedings of the National Academy of Sciences.

"These experiments fulfill our hypothesis that cholera is associated with environmental conditions," said Dr. Rita Colwell, founder and former president of UMBI, currently director of the National Science Foundation, and one of the paper's co-authors.

The authors found that rising sea temperatures and ocean height near the coast of Bangladesh in the Bay of Bengal from 1992 to 1995 often preceded sudden growth, or "blooms," of plankton and outbreaks of cholera. The scientists correlated years of hospital cholera records from Bangladesh with sea temperatures and ocean height data that came from a variety of satellites and surface observations. Similar application of risk analysis developed by NASA using satellite data has also been used in the study of diseases such as malaria, Lyme disease, and Rift Valley fever.

"When such a model for Bangladesh is extended to the global scale, it may serve as an early warning system, enabling effective deployment of resources to minimize or prevent cholera epidemics in cholera-endemic regions," according to Brad Lobitz, principal author of the paper and a contract scientist at NASA, Ames.

Scientists not only can measure water temperatures and ocean height, but also can measure colors that indicate plankton and chlorophyll over a large sea area, Lobitz explained. Tracking sea temperatures from ships and by other direct measurement is too expensive to be practical, he added.

Sea height is important because tides reach further inland to affect more people who may drink or bathe in brackish water carrying cholera. "In most years Bangladesh has two cholera outbreaks," Lobitz said. "These are in the spring and fall." The authors discovered that the sea surface temperatures show an annual cycle similar to the cholera-case data.

All the remote-sensing satellite data are in the public domain, available on the Web. The researchers used data from three Earth-observing satellites in the study: a National Oceanographic and Atmospheric Administration weather satellite, the SeaWiFS instrument aboard the SeaStar (OrbView-2) satel-

lite, and the U. S.-French TOPEX/Poseidon oceanography satellite.

Data from SeaWiFS and TOPEX/Poseidon are provided through NASA's Office of Earth Sciences, which is studying how natural and human-induced changes affect the Earth's global environment. **PT**

## "My, How You've Grown!"

**A** new concept in phones for children, the "First Phone," divides the stages of a phone's use into three phases, according to a child's age and size. The concept was designed by John Payne, who thought of the idea because "no phone fit my child's face...when you wanted to share a phone call, you constantly had to move the phone so the kid could hear and speak at the same time."

Payne devised the first phase for the pre-school child. To share a phone conversation with the child, such as when a grandparent calls, a parent can push a button so the youngster can take part without switching phones. When the call is over, a signal is sent to the microprocessor, which would prohibit outside service until activated when the adult sends another signal.

In Phase II, for a school-age child, the pre-set buttons would convert to speed dial buttons to specific friends or family members whose pictures would appear next to the button. It would be possible to have a picture of a fire- or police officer next to a button for an emergency.

The only outgoing calls would be made to the specific people who are pictured on the phone.



The First Phone is a child-sized phone that grows with the youngster. **PT**

In the final phase, the phone could be extended to become an inch longer. The older child would graduate to having the phone operate like any other cordless phone, except for the fact that it would be smaller than a regulation-sized phone. For further details, check out [www.ipmg-inc.com/1559jp/index.html](http://www.ipmg-inc.com/1559jp/index.html). **PT**

## OSGi Specification

**T**he Open Services Gateway Initiative (OSGi) recently released the official OSGi specification, which defines an open standard that enables multiple software services to be loaded and run on a services gateway such as a set-top box, cable modem, DSL modem, PC, or dedicated residential gateway.

More than 60 leading technology companies are now part of the OSGi organization, an independent, non-profit corporation working to define and promote open standards for the delivery of multiple services over wide-area networks to local networks and devices.

"The OSGi specification delivers a critical piece of the home and small business networking puzzle," said John Barr, president of OSGi, and director, Systems Architecture and Technology for Personal Area Networks, Motorola. "It creates a platform-independent delivery vehicle for value-added network services and a means for integrating the various networks in the home or small business into a unified system. And, it enables new business opportunities for network operators—cable operators, Telcos, and ISPs—to offer services from multiple ASPs to their subscriber base. A variety of OSGi-compliant products and services will be available later this year, thanks to the strong support of our rapidly growing membership."

The OSGi specification is designed to complement and enhance virtually all residential networking standards and initiatives, such as Bluetooth, CAL, CEBus, Convergence, emiNET, HAVi, HomePNA, HomePlug, HomeRF, Jini technology, LonWorks, UPnP, and VESA. In the same way, the specification leverages the value of existing wireline and wireless networks while providing flexibility toward cable, WCDMA, xSDL, and other high-speed access technologies. **PT**

## How To Get A Circuit Custom-Designed

Many people write to Q&A because they need a circuit specially designed for some particular purpose. If the answer would interest large numbers of our readers, we answer the question in print; otherwise we can't use it.

So what do you do if you need a circuit custom-designed? The answer seems to be a well-kept secret: Hire a consultant. There are quite a few individuals who will, for a price, design and build custom electronic equipment. Some people that we know of who do this include:

- Howard Franklin, P.E., Digital Circuits Design, 66 Blue Forest Drive, North York, Ontario, Canada M3H 4W5, www.digitalcircuitsdesign.com
- Rich Grise, Entheos Engineering, 1845 S. Grand Ave. Suite 3, San Pedro, CA 90731, richgrise@vel.net

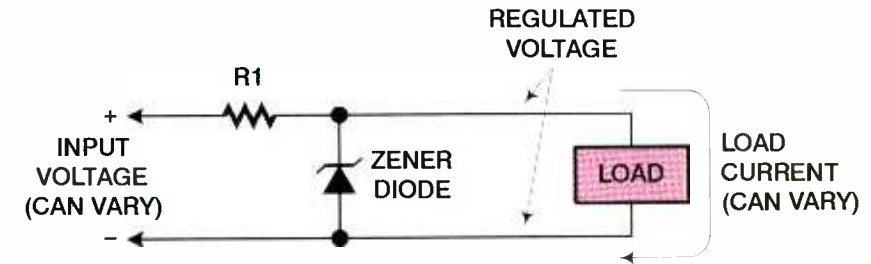

Fig. 1. A Zener shunt regulator is used mostly for low currents (a few milliamps or less). The Zener diode consumes the current not sent to the load.

- Rising Technologies, Inc., 8737 W. Fond du Lac Ave. Suite 7, Milwaukee, WI 53225, risingtechnologies.bizland.com (help with designing and manufacturing new products)
- And, of course, your author at Covington Innovations, 285 Saint George Drive, Athens, GA 30606, www.CovingtonInnovations.com (relatively small projects only)

Bear in mind that this magazine cannot vouch for any of these companies; caveat

emptor. You can find microcontroller consultants through chip manufacturers such as Microchip (www.microchip.com).

Many engineers and teachers do a bit of custom-design work on the side; ask around locally. Expect to pay anywhere from \$20 to \$100 per hour depending on the consultant's expertise and whether, for legal reasons, you need to have a licensed P.E. (Professional Engineer) who can sign safety certifications. Remember that the more experienced designers work faster, so

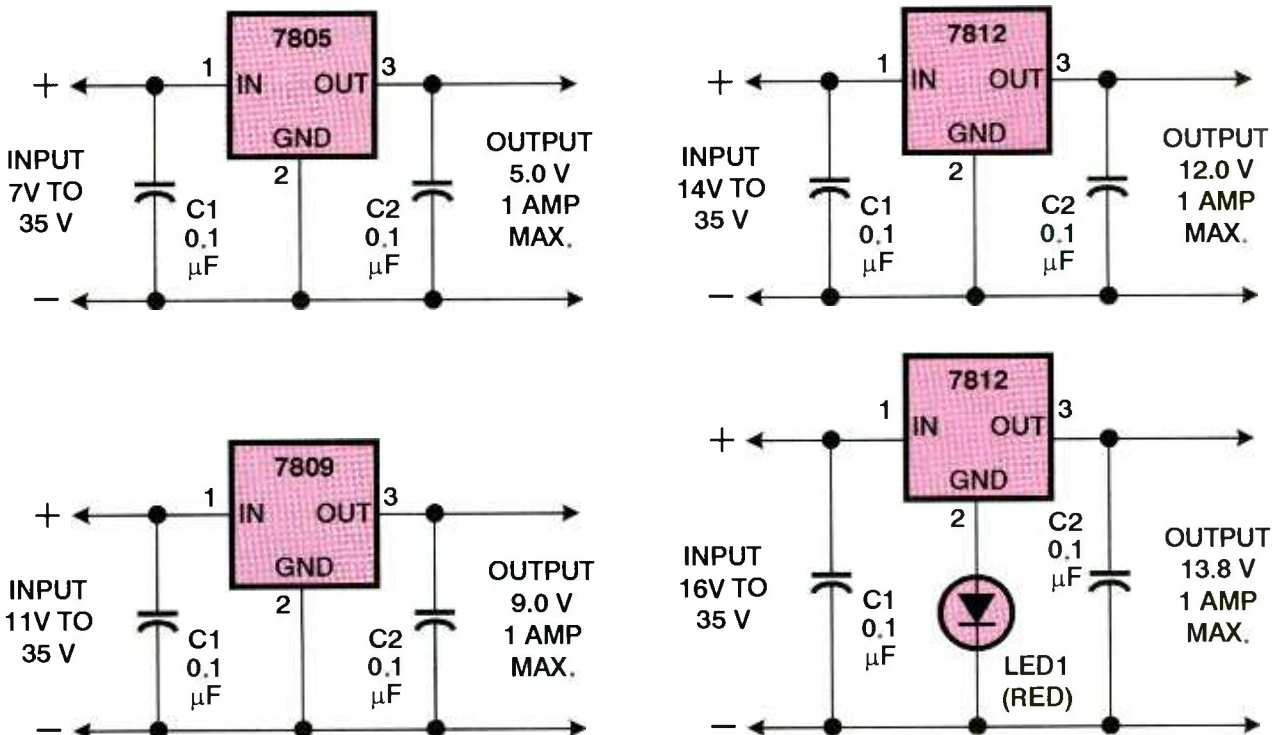

Fig. 2. Series regulators block the extra voltage rather than absorbing it; less power is wasted. The IC shuts down if it overheats. Capacitor C1 is needed only if the power-supply filter capacitors are not nearby; C2 is optional for better regulation.

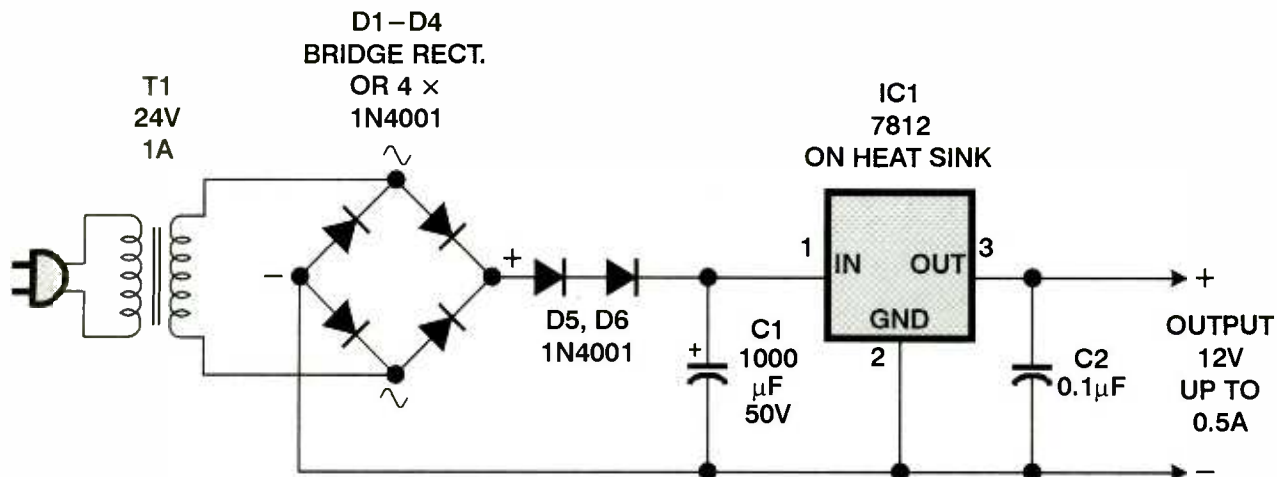

Fig. 3. Here is a complete 12-volt power supply using a 24-volt transformer. See the text for an explanation and suggested improvements.

the lowest hourly rate may not be the cheapest way to get a project done. Hiring a local hobbyist or teacher is also a possibility, especially if you're building a one-of-a-kind gadget that doesn't have to be manufacturable.

## How To Regulate Voltage

**Q** I would like to know how to find the proper resistor to use with a Zener diode in a shunt regulator. I'm building a 12-volt, 1/2-amp (max.) power supply using a 24-volt AC transformer.—B. E., Gordon, AL

**A** See Fig. 1 for the circuit and the accompanying sidebar for the formulae to do the calculations. Yours is a relatively high-power circuit, and a series regulator would work better, but let's do the calculations for a Zener first.

Your 24-volt AC transformer will probably give about 32 volts across the filter capacitor, since  $24 \text{ volts rms} = 24 \times 1.414 = 33.9 \text{ volts peak}$ , and then you'll lose about two volts in the bridge rectifier.

This voltage may be 10% high under a light load (i.e., 35 volts) and 10% low under heavy load or low line voltage (that's 29 volts). I'll assume that you'll use a filter capacitor that lets it drop a further 5 volts between the peaks of the AC voltage. That means that the voltage going into your regulator will range from 24 to 35 volts.

I'll also assume that your load draws anywhere from 0 to 0.5 ampere, i.e., the regulator should still work with the load disconnected.

Plugging the values into the first formula,  $R1 \text{ comes out to } 24 \div (0.5 + 0.001) = 47.9 \text{ ohms}$ . Use the nearest lower standard value, which is 47 ohms.

Now calculate the wattage of R1. That's  $(35 - 12)^2 \div 47 = 11.2 \text{ watts}$ . Use a 47- or 50-ohm, 20-watt wirewound resistor, and expect it to get hot.

Finally, choose the diode. Obviously this is a 12-volt Zener diode; its wattage, calculated with the last formula, is  $12 \times (0.5 + 0.001) = 6.01 \text{ watts}$ . Such diodes exist, but they're big and require heat sinks. The ten-watt ECG5188A, available from most replacement-parts distributors, is an example.

Now you see why a high-power Zener regulator isn't such a good idea. You'll have as much as 20 watts of electricity going to waste, turning to heat in the resistor and the diode. That's more than the power consumed by the load itself.

Let me suggest, instead, that you use an LM7812 integrated-circuit series regulator. Unlike Zeners, these regulators don't soak up excess current; instead, they block it, like a self-adjust-

ing variable resistor. As a result, they waste a lot less power. What's more, they regulate a lot better. A Zener will stabilize your voltage within a few percent; an IC will stabilize it so well that you probably won't detect any variation.

Figure 2 shows how to use some familiar series regulators. Note especially the trick of using a red LED to boost a 12-volt regulator to 13.8 volts. This is handy when powering car radios, CBs, and the like, because most cars actually deliver about 13.8 volts when the engine is running.

Even an IC voltage regulator dissipates some power as heat. Specifically:

$$\text{Dissipation (watts)} = \text{Voltage drop} \times \text{Current (amps)}$$

For example, if you're regulating 35 volts down to 12 volts and the load is drawing 0.5 ampere, you have a dissipation of  $(35 - 12) \times 0.5 = 7 \text{ watts}$ , and your

### DESIGNING A ZENER-SHUNT REGULATOR

These formulae are for the circuit shown in Fig. 1. They assume that at least 1 mA must flow through the diode for stability. The currents are in amps, resistance is in ohms, and power is in watts.

$$R1 \text{ Resistance} = \frac{\text{minimum input voltage}}{\text{maximum current load} + 0.001}$$

$$R1 \text{ Wattage} = \frac{(\text{maximum input voltage} - \text{regulated voltage})^2}{R1 \text{ resistance}}$$

$$\text{Diode voltage} = \text{Regulated voltage}$$

$$\text{Diode Wattage} = \text{Diode voltage} \times (\text{maximum load current} + 0.001 - \text{minimum load current})$$



## HOW TO GET INFORMATION ABOUT ELECTRONICS

**On the Internet:** See our Web site at [www.gemsback.com/poptronics](http://www.gemsback.com/poptronics) for information and files relating to **Poptronics** and our former magazines (**Electronics Now** and **Popular Electronics**) and links to other useful sites.

To discuss electronics with your fellow enthusiasts, visit the newsgroups *sci.elec.tronics.repair*, *sci.electronics.components*, *sci.electronics.design*, and *rec.radio.ama.teur.homebrew*. "For sale" messages are permitted only in *rec.radio.swap* and *misc.industry.electronics.marketplace*.

Many electronic component manufacturers have Web pages; see the directory at [www.hitex.com/chipdir/](http://www.hitex.com/chipdir/), or try addresses such as [www.ti.com](http://www.ti.com) and [www.motorola.com](http://www.motorola.com) (substituting any company's name or abbreviation as appropriate). Many IC data sheets can be viewed online: [www.questlink.com](http://www.questlink.com) features IC data sheets and gives you the ability to buy many of the ICs in small quantities using a credit card. You can also get detailed IC information from [www.icmaster.com](http://www.icmaster.com), which is now free of charge although it formerly required a subscription. Extensive information about how to repair consumer electronic devices and computers can be found at [www.repairfaq.org](http://www.repairfaq.org)

**Books:** Several good introductory electronics books are available at RadioShack, including one on building power supplies.

An excellent general electronics textbook is *The Art of Electronics*, by Paul Horowitz and Winfield Hill, available from the publisher (Cambridge University Press, 800-872-7423) or on special order through any bookstore. Its 1125 pages are full of information on how to build working circuits, with a minimum of mathematics.

Also indispensable is *The ARRL Handbook for Radio Amateurs*, comprising over 1000 pages of theory, radio circuits, and ready-to-build projects, available from the American Radio Relay League, Newington, CT 06111, and from ham-radio equipment dealers.

**Copies of past articles:** Copies of past articles in **Electronics Now**, **Popular Electronics** (post 1995 only) and **Poptronics**

are available from our Claggg, Inc., Reprint Department, P.O. Box 12162, Hauppauge, NY 11788; Tel: 631-592-6721.

**Poptronics** and many other magazines are indexed in the *Reader's Guide to Periodical Literature*, available at your public library. Copies of articles in other magazines can be obtained through your public library's interlibrary loan service; expect to pay about 30 cents a page.

**Service manuals:** Manuals for radios, TVs, VCRs, audio equipment, and some computers are available from Howard W. Sams & Co., Indianapolis, IN 46214; (800-428-7267). The free Sams catalog also lists addresses of manufacturers and parts dealers. Even if an item is not listed in the catalog, it pays to call Sams; they may have a schematic on file which they can copy for you.

Manuals for older test equipment and ham radio gear are available from Hi Manuals, PO Box 802, Council Bluffs, IA 51502 and Manuals Plus, PO Box 549, Tooele, UT 84074.

**Replacement semiconductors:** Replacement transistors, ICs, and other semiconductors, marketed by Philips ECG, NTE, and Thomson (SK), are available through most parts dealers (including RadioShack on special order). The ECG, NTE, and SK lines contain a few hundred parts that substitute for many thousands of others; a directory (supplied as a large book and on diskette) tells you which one to use. NTE numbers usually match ECG; SK numbers are different.

Remember that the "2S" in a Japanese type number is usually omitted; a transistor marked D945 is actually a 2SD945.

**Hamfests (swap meets) and local organizations:** These can be located by writing to the American Radio Relay League, Newington, CT 06111; ([www.arrl.org](http://www.arrl.org)). A hamfest is an excellent place to pick up used test equipment, older parts, and other items at bargain prices, as well as to meet your fellow electronics enthusiasts—both amateur and professional.

LM7812 regulator IC will need a good heat sink. Below 2 watts, it would not need a heat sink.

Finally, Fig. 3 shows a complete design for the power supply that you want to build. I've added two extra 1N4001 diodes ahead of the filter capacitor; they reduce the voltage slightly to ensure that it won't exceed the 35-volt absolute maximum rating of the IC. With your transformer, D5 and D6 may not be necessary; make measurements to be sure.

The 1000- $\mu$ F filter capacitor is chosen as follows. Because you have such a good voltage regulator and the input voltage is so much higher than its maximum, you

can afford to have a lot of ripple in the rectifier output. But excessively large ripple levels can burn out filter capacitors. As a compromise, I decided to allow just over 3 volts of ripple (peak-to-peak). The actual amount of ripple depends on the transformer resistance and some other parameters that are usually unknown, but you can choose filter capacitors with this approximate formula:

$$\text{Capacitance } (\mu\text{F}) = (6800 \times \text{Load current (amps)}) \div \text{Ripple (volts)}$$

For 3 volts of ripple at 0.5 ampere of load current, that's 1133  $\mu$ F; 1000 is

close enough. This is for 120 Hz, with a bridge rectifier; use twice the capacitance if the ripple frequency is 60 Hz.

Finally, a word to the wise. A 24-volt transformer is a bit much if you want an output of 12 volts. An 18-volt transformer with a somewhat larger filter capacitor would let the regulator run cooler. A 12.6-volt transformer is probably not quite enough.

## Adding IrDA

**Q** Jameco ([www.jameco.com](http://www.jameco.com)) sells an infrared transceiver that I can hook up to my desktop PC to communicate with my laptop. I can't see why it should cost \$50, so I'd like to make my own. Can I?—F. G., Ozone Park, NY

**A** See the installment of this column that appeared in the September, 1999, issue of **Electronics Now**; if you don't have it, it is available from our Reprint Bookstore. Note that both our circuit and Jameco's transceiver require your motherboard to have an IrDA port built in.

## Need Philips Radio Circuit

**Q** Would it be possible for you to supply me with circuit diagrams of a Philips medium-wave and shortwave radio purchased in 1948 in London? The model or serial number is 812LW.—P. J. Perold, Rietboonstreet 13, Florida-Lake, Transvaal (Gauteng), South Africa 1209

**A** We do not perform this service, but we are publishing your name and address in the hope that a reader can help. Also, write to Sams Technical Publishing, 5436 West 78<sup>th</sup> St., Indianapolis, IN 46268; they may have something on file.

## Need Superhet Schematic

**Q** I need a schematic diagram for a super-heterodyne radio receiver using transistors rather than integrated circuits.—A. A., Khartoum, Sudan

**A** For plans for building your own, see this magazine (which was then called *Radio-Electronics*), December, 1964, pp. 28-30. Some of the parts may be hard to find nowadays; your best bet might be to buy a kit, although we don't quite know where to send you to get one in the Sudan. Check the ads in this magazine and request catalogues from the companies that have radio-related products. If you have access to the Internet, you can try searching for electronic kits.

## Interruptions Wanted

**Q** I have Call Waiting on my telephone, and it used to be that when a call would come in, my modem would drop its connection and my phone would ring. This is what I want to happen, but for some reason my modem no longer does this. I do not have the Call Waiting defeat code (#70) installed. I have tried adjusting the S10 modem code, and it still won't drop out. Can you suggest something else to try or an in-line circuit to detect the Call Waiting beeps and disconnect the modem?—J. L. S., Indianapolis, IN

**A** Most people have the opposite problem; they don't want to be interrupted. We tell them to have their computer dial #70 before every call. But you say yours is definitely not doing this.

Detecting the Call Waiting beeps with a separate circuit might be fairly complicated because the modem signal itself covers such a broad frequency spectrum.

Instead, let's fix the original problem by reconfiguring the modem. You haven't said anything about your computer, but I'll take a wild guess and sup-

pose it's running Windows98. Right-click on the "My Computer" icon and choose "Properties," then "Device Manager." Click on the modem and look at its properties. Under "Connection, Advanced," choose "View Log" and see what commands are actually being sent to your modem. If something is actually dialing #70 or setting the S10 register after all, you'll have to track it down and change it. You may also have to add "S10=1" to the optional extra commands. That tells the modem to hang up after 1 second of lost carrier.

## Transformers And Black Boxes

**Q** I have more than 30 unlabeled transformers at home, some with 115-volt and some with 230-volt primaries and various secondary voltages such as 6.3, 12.6, and 18 volts. How can I test them to determine the correct voltage for each transformer?

*Also, what is a "Black Box"? Back in the 1980s, I recall having to buy a "Black Box" to attach an HP-IB plotter to an IBM computer.—M. T., Kastel Kambelovac, Croatia*

might be remembering one of their products.

Now for the transformers. You can always use a transformer on a lower voltage than it was designed for, so you can use 230-volt transformers on 115 volts without problems; but since you're in a 230-volt country, you probably won't be able to use the 115-volt transformers. The problem, then, is to determine the correct primary voltage of each transformer that you are testing.

Here's how to do it. First use an ohmmeter to identify the primary; that's the winding with the highest resistance. Then apply 230-volt power to the primary with a small light bulb (maybe 10 watts) in series with it. If the bulb glows brightly, you're applying too much voltage, and it must be a 115-volt winding. If the bulb glows dimly or not at all, you've found a 230-volt primary, and you can measure the voltages of the other windings.

There is *one* way to use 115-volt transformers with a 230-volt supply. You can take two identical transformers (they must be identical) and put the primaries in series. Put the secondaries in series too, taking care with the phasing so that the voltages add rather than subtract. To check the phasing, hook one secondary wire from each transformer together. Take the other wires and briefly touch them together. If you get a large spark, the transformers are out of phase with each other; swap the secondary wires and all should be fine.

## Writing To Q&A

As always, we welcome your questions. The most interesting ones are answered in print. Please be sure to:

- (1) include plenty of background information (we'll shorten your letter for publication);
- (2) give your full name and address on your letter (not just the envelope);
- (3) type your letter if possible, or write very neatly; and
- (4) if you are asking about a circuit, include a complete diagram.

Questions can be sent to Q&A, **Poptronics Magazine**, 275 G Marcus Blvd., Hauppauge, NY 11788, or e-mailed to [q&a@gersback.com](mailto:q&a@gersback.com), but please do not expect an immediate reply in these pages (because of our backlog) and please don't send graphics files larger than 100K. Due to the volume of mail, we regret that we cannot give personal replies. **P**

### PIRATE RADIO AND VIDEO, EXPERIMENTAL TRANSMITTER PROJECTS

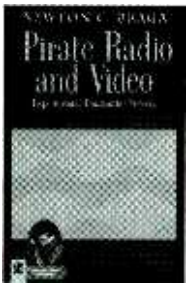

Newton C. Braga

Now that the FCC has changed the laws governing pirate radio and video stations, more and more people across the country are starting broadcasts from their homes. By reading about and building the over thirty projects in *Pirate Radio and Video*, you can construct your

own station with a minimum investment for maximum learning. With projects for UHF, VHF, AM and FM transmitters, this book covers the gamut of popular bands and outputs. Written with the electronics hobbyist in mind, each project includes basic diagrams, complete instructions as well as advice on how to make each project work best for you.

#### Four Ways to Order within North America:

- Call: 1-800-366-2665 or 781-904-2500
- Fax: 1-800-446-6520 or 781-933-6333
- E-Mail: [orders@bhusa.com](mailto:orders@bhusa.com)
- Mail: Newnes Press,

Fulfillment Center, 225 Wildwood Avenue, Woburn, MA 01801



**Newnes**

CIRCLE 170 ON FREE INFORMATION CARD

**A** Taking the easy question first, "black box" is American slang for any small piece of equipment; it doesn't mean anything definite. The idea is that you did not worry about how the box did what it did; it just did it. From anyone's point of view, it didn't matter if the box contained an infinite number of monkeys banging on typewriters, as long as the outputs responded correctly to the inputs. However, a wide variety of computer communication adapters are made by Black Box Corporation, 1000 Park Drive, Lawrence, PA 15055-1018 U.S.A.; [www.blackbox.com](http://www.blackbox.com). You



## "PICy" Corrections

There appear to be a couple of errors in the schematic diagram for the article "The PIC Replicator" (*Poptronics*, May 2000) on page 30. The 28-pin programming target shows two instances of pin 28; I believe the first one reading from the left should be pin 20. Also on the 28-pin target, pin 8 needs to be connected and grounded (as shown this line is open, although the foil patterns are okay). The 18-pin target does not require pin 8; again, the foil patterns are correct. One other omission is the connection from pin 13 of the 25-pin connector to pin 1 of IC3, correct as shown on the foil pattern but not on the schematic.

As the 48-pin universal ZIF sockets are fairly costly, a suggestion for anyone building this from scratch is to use dedicated .600-inch wide ZIF sockets for the 40-pin and 28-pin devices and a universal 28-pin socket for the 8-pin and 18-pin PICs. This should cut the socket cost in half or less. I plan to use just two sockets, making the 40-pin and 28-pin PICs share the 40-pin socket with a DPDT switch to take care of the changes, and a 28-pin universal for the others. My changes are shown in Fig. 1.

On an entirely different subject, you were asking how readers liked the new format, replacing EN and PE with *Poptronics*. I was aghast at the choice of name and considered canceling my subscription to *Popular Electronics* when I first heard of this. When I realized I would also lose *Electronics Now*, I relented. I still don't like the name, but I'll get used to it; the content makes it worthwhile.

ALAN MILLARD  
Sechell, BC, Canada

## Sparks from the Tesla Coil

I wanted to build the Tesla Coil described in the July 2000 issue of *Poptronics*. However, I found a few errors in the article. The first was a typo: Capacitors C3 and C4 are listed as 0.1  $\mu\text{f}$  (0.02  $\mu\text{f}$  when connected in parallel) in the Parts List and 0.01  $\mu\text{f}$  in the article. I believe they should be 0.01  $\mu\text{f}$ .

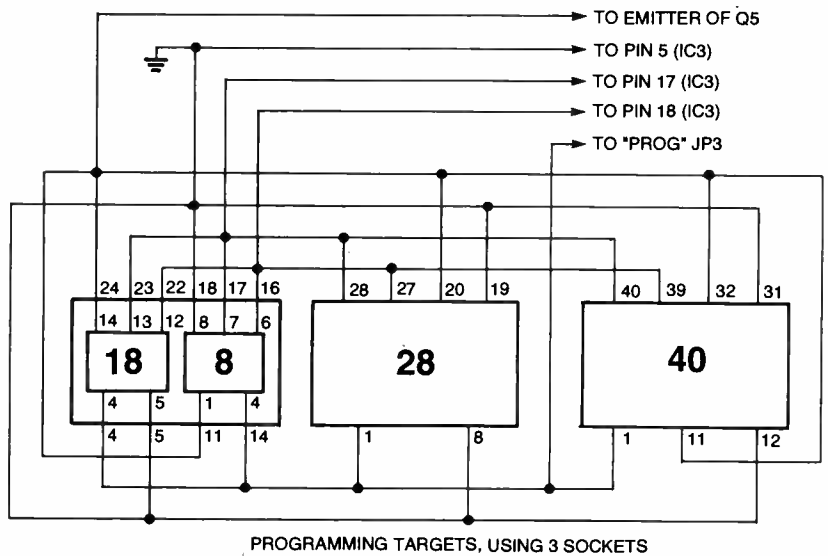
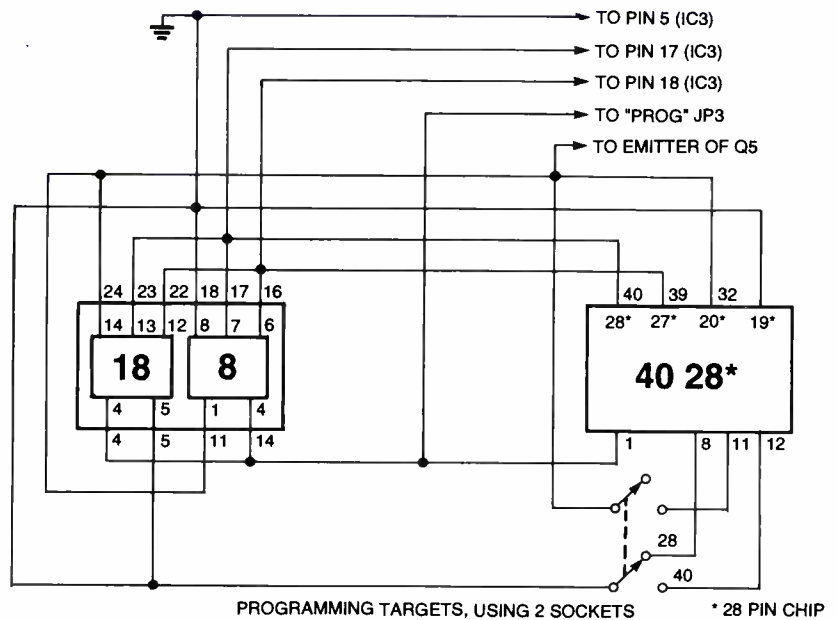

Fig. 1. This suggested schematic diagram shows how you can use less-expensive sockets in the PIC Replicator (*Poptronics*, May 2000).

The second error was far more serious. The schematic diagram shows a 10-amp fuse connected directly across the 110-volt input power. A mighty fast fuse blower, but it could be hazardous. The third error, which could be a direct result of the second one, shows that there is no 110-volt power being supplied to the four transformers.

I probably could guess at a correction to these errors, but since this project has an input power of more than several hundred volt-amperes I would feel more comfortable finding out the correct information.

A final comment: I've noted that there are more corrections being printed. Is it my imagination?

JOSEPH HLAVIN  
via e-mail

[Thanks for pointing out the mix-up in the schematic diagram. Note, however, that the wiring diagram (Fig. 7) on page 38 is correct. As of press time, over two dozen letters, faxes, and e-mails have flooded the office pointing this out. We might ask why the intense response when other errors sometimes go for years before being noticed, but the answer should be self-evident to the astute reader.

As to the amount of corrections being printed—perhaps. While not having any mistakes is the ideal situation, we certainly aren't going to withhold any corrections. At one point a few years ago, the **Popular Electronics** staff received a letter of complaint concerning a lack of error corrections.

Sometimes, you just can't win!—Editor]

After reading the July issue of **Poptronics**, I was amazed at the thrills one could receive from Nikola Tesla's invention—the Tesla Coil. Nikola Tesla was a genius, right up there with Albert Einstein.

All throughout your magazine I receive insightful information. There is plenty of useful information in this issue, especially in the article "Call Alert." I get plenty of annoying calls around dinnertime, and I also get plenty of annoying spam e-mails. Where do these people come from?

Anyway, keep up the good work. I will be looking forward to your next issue.

PATRICIA MARY ROBERTS  
via e-mail

[One little-publicized trick with telemarketers is to interrupt them with the phrase, "I am not interested. Please put me on the list not to be called." That second sentence is a result of the deal that the Direct Marketing Association made with Congress to prevent Federal regulation of telephone solicitors. Once you use the magic phrase, "put me on the list," they are not to call you ever again, or face stiff penalties. You can also contact the Direct Marketing Association for the procedure to make that request global instead of having to tell each telemarketing company individually. Most telemarketers are professional enough to record your request and leave it at that, but there is the occasional obnoxious character. In that case, demand to speak to their supervisor.

Since I've started this regime, the number of unsolicited calls that I get has dropped

by orders of magnitude.

As for e-mail, take a look at *ChooseYourMail* at [www.chooseyourmail.com](http://www.chooseyourmail.com). They have a deal called the "Spam Recycling Center." Simply forward your UCE (unsolicited commercial e-mail) to them with the full headers, and they will forward the offending material to the proper authorities for "handling." Consult your mail software's documentation for instructions on how to include all headers in the forwarded message.

While I still get the occasional "get-rich-quick," "mortgage-your-home," or pornography-related trash in my personal mailbox, it does tend to remain at a minimum.—Editor]

## And Speaking of "Call Alert"

The article "Call Alert" by Raymond Buck in the July issue of **Poptronics** seems to describe a useful device. However, there are errors in the connections between J2, J3, J4, RY1, BR1, R1, and R2 in the schematic (the PC board

## KEEP IN TOUCH

We appreciate letters from our readers. Comments, suggestions, questions, bouquets, or brickbats ... we want to hear from you and find out what you like and what you dislike. If there are projects you want to see or articles you want to submit—we want to know about them. And now there are more ways than ever to contact us at **Poptronics**.

You can write via snail mail to:

Letters  
**Poptronics**  
275-G Marcus Blvd.  
Hauppauge, NY 11788

Please note the above address is the snail-mail way to get the quickest response. Some readers send letters to our subscription address, and although the mail is forwarded to our editorial offices, it does increase the time it takes to answer or publish your letters.

The e-mail address can be found at the top of the column.

Of course, e-mail is fast.

Check your favorite columns, too. All of our columnists can be reached through the e-mail addresses at the head of each column.

And don't forget to visit our Web site: [www.gernsback.com](http://www.gernsback.com).

## Frontier Engineering LLC

Over 20,000 components & electronic products to choose from:

[www.freng.com](http://www.freng.com)

628 S Sunset Longmont CO 80501

Tel 303 776 6242 Fax 303 776 6080

US Distributor for Maplin Electronics

seems to be correct). The board has J2 directly connected to J3, also to RY1, BR1, R1, and R2. In fact, J4 is connected to J2 and J3 through the normally closed contacts of RY1. This is how the circuit is described in the article.

Any telephone device that has input and output jacks should be cross-wired. That is, if the terminals on the jacks are numbered 1, 2, 3, and 4, (usually only 2 and 3 are used in a single-line phone), terminal 2 on the input jack should be connected to terminal 3 on the output jacks, and terminal 3 on the input jack should be connected to terminal 2 on the output jacks.

This is done correctly on Mr. Buck's PC board, but not on the published schematic.

BILL STILES, CET  
via e-mail

This is the first time I've ever responded to an article, although I have enjoyed your magazine for years.

I enjoyed the "Call Alert" article in the July issue, but I have some questions. The first has to do with the requirements for certified telephone interface. Does this meet the impedance requirements? Also, since each device is like another telephone, is there a limit as to how many you can put on one phone line?

Is there a way to detect the beep that is sent when a fax message is incoming and then switch it over to a fax machine? What is the frequency, period, and repetition rate of the fax tone?

Our RadioShack fax machine monitors for quite a period (about 60 seconds) and then starts its protocol routine. When the answering machine hangs up after a call, the fax machine, which has been listening, decides it's time to go into action. The phone company then tells us to "Hang up if we want to make a call" at the same time we are going through the fax protocol. It's real annoying.

Any help would be appreciated.  
JEFFREY W. KENDALL  
Sebastopol, CA

(Continued on page 68) 27

USE THE FREE INFORMATION CARD FOR FAST RESPONSE

## Function Generator

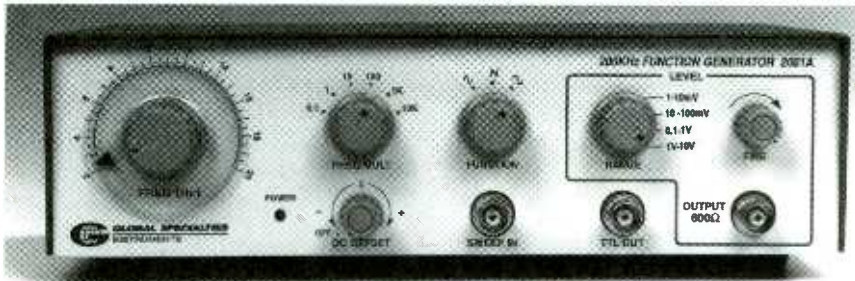

CIRCLE 60 ON FREE INFORMATION CARD

IDEAL FOR SUCH APPLICATIONS as audio testing; scope sweep drive; and measuring filter response curves, amplifier rolloffs, and transmission characteristics; the *Model 2001A Function Generator* offers accuracy, low sine-wave distortion, and flexibility of design. Additional uses are found in troubleshooting communications, telephony, speech processing, D/A and A/D systems, designing analog/digital/control circuitry, and servicing video games and VCRs.

The *Model 2001A* features a continuously variable frequency range from 2Hz to 200kHz in six decade ranges; variable DC offset; sine, square, triangle, and TTL outputs; variable duty cycle; DC offset controls; and a total harmonic distortion of less than 1%. Other features include sweepable 100:1 with  $\pm 10$ -volt input, high and low level variable 50- and 600-ohm output, and 1mV to 10V P-P output.

The easy-to-use front panel has a large frequency vernier dial marked in 45 divisions and six decade ranges. The frequency multiplier and function switch are located nearby. Also on the front panel are dials for level range, level fine, and DC offset. In addition, there are connectors for Output, TTL Output, and Sweep Input, and a power-on LED indicator.

The function generator measures approximately 9½ by 3 by 6¼ inches and weighs 4 pounds. It comes complete with a BNC-to-BNC cable and an instruction manual.

The *Model 2001A Function Generator* sells for \$185.

### GLOBAL SPECIALTIES

1486 Highland Ave., Unit 2  
Cheshire, CT 06410  
800-572-1028  
www.globalspecialties.com

## Digital Audio Processor

THE *DIVA* DIGITAL AUDIO PROCESSOR, an eight-channel programmable 24-bit digital audio enhancement system, enables home-theater designers to correct for room acoustics and compensate for program variations. It is designed to improve imaging, bass production, midrange, and treble detail, as well as overall system balance. *Diva* implements fully independent, digital domain sound processing, and uses dual 24-bit Motorola chips, capable of 160 MIPS. It offers EQ over the entire audio band from 20 Hz to 20 kHz.



CIRCLE 61 ON FREE INFORMATION CARD

Users can adjust each of the *Diva's* processing functions either through the remote control or the front panel. The slider control on the front panel lets you cut a certain frequency band by up to 15dB or boost it by up to 6 dB. On the back of the *Diva* is an RS-232 control port and RCA in- and out-jacks for seven channels plus a subwoofer.

The MSRP for the *Diva* is \$8900.  
**AUDIOCONTROL**  
22410 70<sup>th</sup> Avenue West

Mountlake Terrace, WA 98043  
425-775-8461  
www.audiocontrol.com

## PCI D/A Board

FEATURING D/A CONVERTERS with 2.5-, 5-, and 10-volt output ranges, both unipolar and bipolar, the *CPCI-520 Four-Channel Analog Output Board* is configured in a single-slot 3U board outline. Any channel may be selected for 4–20 mA precision current loops in active mode, without requiring external current loop excitation. Each D/A channel of the *CPCI-520* may be set for any of the ranges with five ranges set for 12-bit resolution. The  $\pm 10$ V and 4–20 mA ranges have 16-bit resolution.

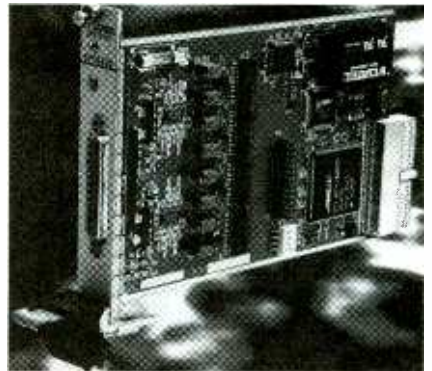

CIRCLE 62 ON FREE INFORMATION CARD

All channels update simultaneously when a sample clock is received, either from the on-board programmable timebase or from an external user-supplied clock input. The timebase has a range of 50 microseconds to 3.3 seconds. A spare 16-bit timer/counter is included.

The price of the *CPCI-520 Four-Channel Analog Output Board* is \$595.  
**DATel, INC.**  
11 Cabot Blvd.  
Mansfield, MA 02048  
508-339-3000  
www.datel.com

## Digital-Power Meter

IDEAL FOR USE IN PRODUCTION test setups and in research and development, the *CP-300 Series Digital-Power*

Meters are a family of high-performance units for single-phase power measurement. With a basic accuracy of  $\pm 0.1\%$ , these units cover a wide range from 10 Hz to 100 kHz. They measure voltage, current, watt, and frequency, which are simultaneously displayed, allowing relationships to be easily seen. The units also measure apparent power, reactive power, and power factor.

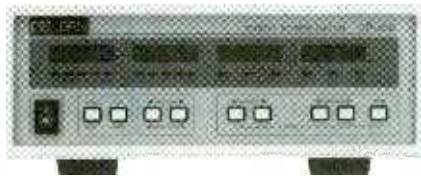

CIRCLE 63 ON FREE INFORMATION CARD

The standard RS-232 interface makes it possible to output all data to a computer. This makes these units suitable for automated test systems.

The CP-300 Series of Digital-Power Meters range in price from \$1100 to \$1350.

#### MID-EASTERN INDUSTRIES

100 School St.  
Bergenfield, NJ 07621-2915  
201-385-0500  
www.mideastind.com

### Network Protector

DESIGNED TO PROTECT YOUR network from damaged nodes, power loss on a node, and power-supply-voltage surges, the 4850FS Port Isolator automatically removes any RS-485 device without valid data from the network. Its 2000 VRMS isolation protects the rest of the network from damaging ground loops and power supply fluctuations. Transient Voltage Suppressors on the line side provide added protection against short voltage spikes.

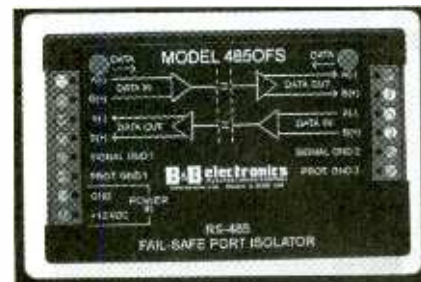

CIRCLE 64 ON FREE INFORMATION CARD

The 4850FS Port Isolator works with both two-wire half-duplex and four-wire full-duplex systems, and it supports baud rates up to 460 kbps. The compact (3.8 by

2.4 by 1.0 inches) unit installs easily at each device needing protection. During installation and troubleshooting, LEDs indicate activity on the network.

The 4850FS Port Isolator has a price of \$114.95 direct from the manufacturer.

#### B&B ELECTRONICS MANUFACTURING CO.

707 Dayton Rd.  
Ottawa, IL 61350  
815-433-5100  
www.bb-elec.com

### Flexible Current Probe

THE FLEXPROBE MODEL 24-2000 IS a current measure probe that plugs into digital multimeters, oscilloscopes, data loggers, and chart recorders. The probe has dual measurement ranges of 200A and 2000A. Its output is 10 mV/A on the 200A range and 1mV/A on the 2000A range.



CIRCLE 65 ON FREE INFORMATION CARD

Capable of getting into tight or difficult places, the 24-inch flexible sensor is designed to fit around large or small conductors (up to 8 inches in diameter). It is ideal for measuring AC current in a group of conductors. The probe operates for a minimum of 720 hours from its internal battery.

The FlexProbe Model 24-2000 current measure probe sells for \$179.

#### AEMC INSTRUMENTS

99 Chauncy St.  
Boston, MA 02111  
617-451-0227  
www.aemc.com

### InfraRed Thermometer

THE HANDHELD INFRARED THERMOMETER (Model 42525) measures non-contact surface temperatures in two ranges. From 14° to 230°F (-10° to 110°C), the thermometer has an accuracy of 0.1°. From 14° to 662°F (-10° to 350°C), its accuracy is 1°. The compact instrument (measuring 7.7 by 4.7 by 2.3 inches and weighing 9.6 ounces) has a convenient pistol grip for better aim. Its built-in laser pointer targets the area to be measured.



CIRCLE 66 ON FREE INFORMATION CARD

The Model 42525 offers a large 4-digit LCD display of temperature and functions. Other features include selectable °C/°F temperature units, Record/ Recall of Min/Max readings, relative temperature measurement display, and Data Hold.

The Handheld Infrared Thermometer (Model 42525) sells for \$169.

#### EXTECH INSTRUMENTS CORP.

285 Bear Hill Road  
Waltham, MA 02451  
781-890-7440  
www.extech.com

### Soldering Devices

THESE COMPONENT STENCILING Kits and Component Stencils offer a new method to apply solder paste when reworking area array devices. This approach applies the solder paste directly to the solder balls on the component, not the PCB. This eliminates spot stencil access concerns on densely populated boards, allows for a precise amount of solder paste to be applied to each solder ball, and eliminates paste smearing under the stencil on the PCB.

The kits and stencils are available in a variety of component sizes that cover most standard array geometries. Each kit comes complete with a squeegee.

Component Stenciling Kits and Component Stencils sell for \$500 and \$100, respectively.

#### PACE, INC.

CIRCLE 67 ON FREE INFORMATION CARD

8993 Brewers Court  
Laurel, MD 20723-1990  
888-535-PACE  
www.paceusa.com

## Master Sourcebook

from Jensen Tools Inc.  
7815 S. 46<sup>th</sup> St.  
Phoenix, AZ 85044  
800-426-1194 or 602-453-3169  
www.jensentools.com

### Free

This 300-page full-color catalog contains thousands of products from leading manufacturers, including many items that are new to the industry. It offers an extensive selection of tool kits; test equipment; hand, power and specialty tools; wire and cable; soldering equipment; computer and LAN products; diagnostics; workstations; shop supplies; field accessories; and much more.



Jensen has recently expanded their own line of telecom test equipment to include telephone test sets, tone generators and tracers, and the JTS-45 Test Set. There are over 160 Jensen tool kits, as well as the option of designing a custom kit with the Create-A-Kit Process.

## The Physics of Semiconductors

by Kevin F. Brennan  
Cambridge University Press  
40 West 20<sup>th</sup> St.  
New York, NY 10011-4211  
800-872-7423  
www.cup.org  
**\$54.95**

This book describes the key elements of quantum mechanics, statistical mechanics, and solid-state physics necessary for understanding modern semiconductors and their applications to optoelectronic devices. Theoretical results are illustrated

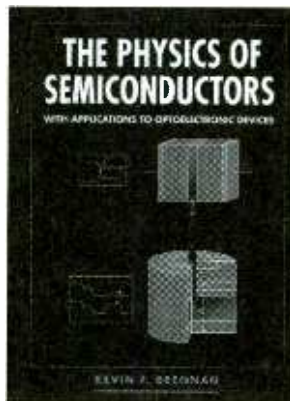

ed with reference to real devices, such as photodiodes, flat-panel displays, and MOSFETs.

There is a thorough treatment of solid-state physics, covering electron motion, electron-phonon interactions, and recombination processes. Actual applications, ranging from simple junctions to the latest electroluminescent devices, complete the book.

## Applied Operating System Concepts, 1<sup>st</sup> Edition

by Avi Silberschatz, Peter Galvin, and Greg Gagne  
John Wiley & Sons, Inc.  
605 Third Ave.  
New York, NY 10158-0012  
212-850-6336  
www.wiley.com  
**\$80.95**

This is the first book to provide a precise introduction to the principles of operating systems with numerous contemporary code examples, exercises, and programming projects. Real code examples



are presented using the Java language. It uses Java technology to introduce difficult concepts like processes, process synchronization, and semaphores.

The book describes the role of threads in modern operating systems and Java and provides material for writing multithreaded programs. In addition, there are also chapter-long case studies of UNIX, Linux, and Windows NT.

## The ARRL Handbook For Radio Amateurs 2000

edited by R. Dean Straw, N6BV  
American Radio Relay League  
225 Main St.  
Newington, CT 06111-1494  
888-277-5289 or 860-594-0200  
www.arrl.org  
**\$32**

An invaluable resource for projects for all levels of building experience, the 77<sup>th</sup> edition of this handbook is also an essential source of reference material. In addition, it provides a thorough foundation in electronics and communications theory for hams, students, engineers, and technicians.

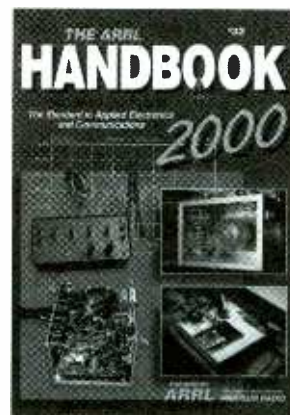

The new projects in this edition include a 1500-watt linear amplifier for 6 meters, an extremely versatile two-radio computer-controlled switchbox, and sophisticated output filters for power amplifiers. There is also an expanded section on HF mobile antennas and thorough coverage of PSK31. The companion software can be downloaded from the ARRL Web site. **P**



# Work with NTSC or PAL EQUIPMENT WITH THIS SWITCHABLE



*With a few simple component changes and jumper settings, this video-signal generator can put out NTSC or PAL calibration signals.*

THOMAS GOULD

If you've ever worked with video equipment for any length of time, you either have already, or soon will, come up against a foreign video standard. Of the three major types of video signals—NTSC, PAL, and SECAM, the foreign standard that you'll most likely encounter will be one of the first two.

Setting up and calibrating television equipment can be time-consuming without the right tools. One

of the most indispensable of those is a video-signal generator—a great source of color-video signal for TV alignment.

Do you have a need for a very inexpensive source of color video? Then look no farther than the NTSC/PAL Signal Generator presented here. As the name implies, this project can generate a composite color-video signal in either NTSC or PAL formats. Features of the device include full-field color bars, black, or any full-screen color. You can also convert a computer TTL (digital) or RGB (analog) video signal to color-composite video. The complete project can be used for that television-repair problem, testing that new video circuit, amateur television, home-video production, or just to learn more about

the color-composite video signal.

The NTSC/PAL Signal Generator can be built for under \$100. Before we get into the construction details, let's first look at the "dirty details" of video-signal standards. We'll start with...

**The NTSC Signal.** Some might say that since the NTSC composite-video signal will soon become obsolete with the introduction of the new digital-television (DTV) standard, we can forget about it. In my opinion, however, although the FCC would like to see it disappear, it looks like it will still be with us for a while. Even when DTV replaces NTSC, the receivers will still have to generate an NTSC-like signal internally for the display monitor.

Let's review the video system

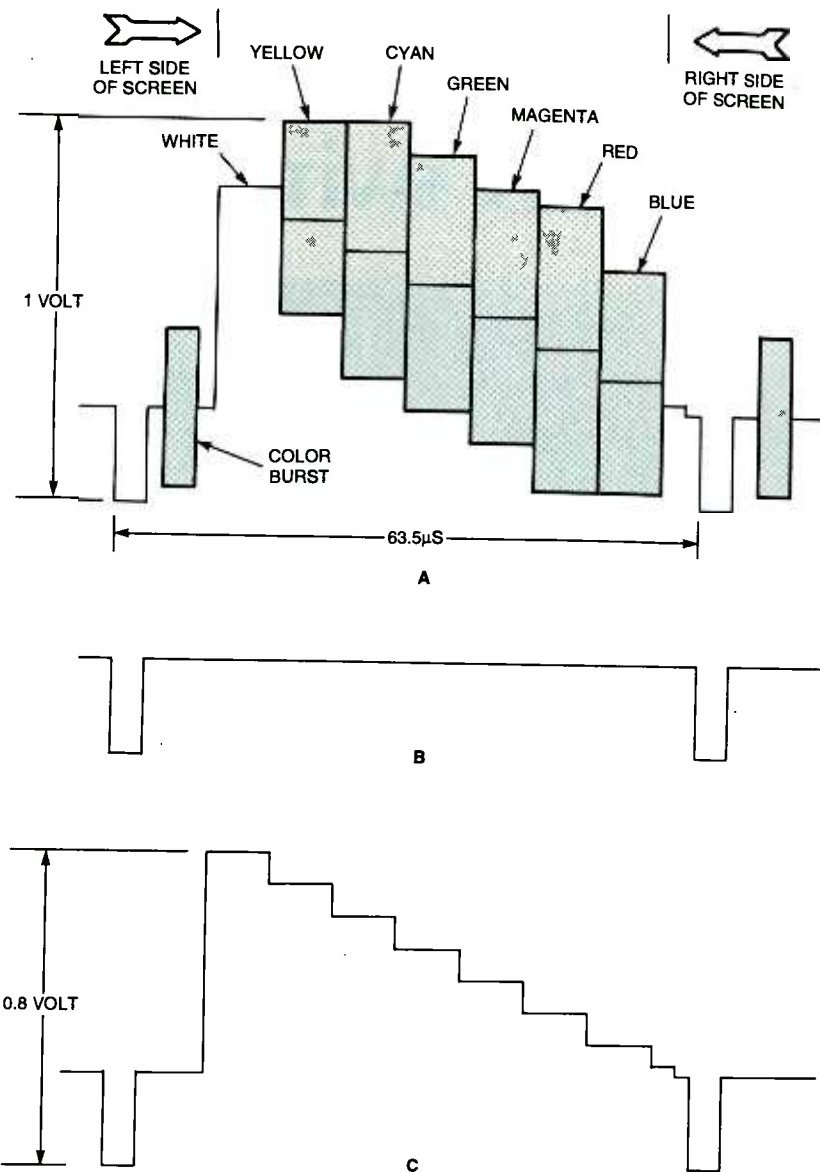

Fig. 1. In a color-video signal, the composite signal (A) has a colorburst component that sets the standard for the various colors. Each color is a frequency and phase difference in relation to that reference. A synchronization signal (B) tells the television when to start displaying the next line of video. If the television is a black-and-white model, the phase-differentiated colors are averaged to create a brightness signal (C). Note how the various color frequencies in (A) have a high end and a low end. The average of those peaks sets the brightness level for that hue.

standards for color encoding and decoding that the NTSC (National Television Systems Committee) released in 1953.

The picture on a color TV is actually formed by three electron beams, one each for red, green, and blue. Those beams are scanned left to right over the screen, striking phosphors that glow the three different colors when electrically charged. When they reach the end of the line, they start at the next lower line. As these beams are scanned, the current that drives them is

changed to create the lighter and darker hues. The final mixes of colors formed by the glowing phosphors on the picture tube face form the image that you view.

Figure 1A shows the video signal during the time that it takes the electron beams to make one horizontal scan across the screen. The composite-video signal is encoded with three components that the receiver needs to reproduce a complete color picture. The three basic components are the scanning-control information (*synchro-*

nizing pulses), black-and-white information (luminance), and color information (chroma).

### Synchronizing

information consists of a series of pulses. The vertical-synchronizing circuit controls the TV's horizontal-scan rate pulse, running at 15,750 Hz. The horizontal-scan circuit returns to the left side of the screen to start a new line. A different pulse, at a 60-Hz rate, signals when the vertical-scanning circuit should return to the top of the screen to start a new frame.

In the NTSC system, each frame contains 525 lines. The vertical rate is actually 30 frames per second; it takes two trips down the screen to complete one frame. The process of returning to start a new scan is called *retrace* or *flyback*.

### Black-And-White Information.

The luminance information determines the instantaneous brightness of the electron beams as they are scanned over the screen. In fact, this signal is all that is used for the single electron beam in a black-and-white TV set. Note that the signal is considered "negative-going." If we normalize the signal to a standard one-volt range, bright white is up near the one-volt level. As the voltage drops, the picture gets darker and darker until it reaches the black level. Another noteworthy item is that the black level is not all the way down at zero volts; that level is reserved for the sync signals. That way, the sync signals are considered "blacker than black," and won't accidentally show up on the screen as the TV's control circuitry sweeps the beams back to their horizontal or vertical starting points. Thus, the waveform shown in Fig. 1A would appear to a black-and-white TV as the waveform shown in Fig. 1C. The resulting picture would be a set of vertical bars of decreasing brightness from left to right.

In the science and math of television, the luminance signal is designated by the letter "Y." In the NTSC color system, the Y signal is made from the red, green, and blue signals by an additive technique: 30% of the red signal, 59% of

# Distance Education ...

Nearly 70 years of experience with over 150,000 graduates worldwide. At CIE you get a proven, patented, learning method to achieve your career and educational goals.

Choose from a Bachelor or Associate Degree/LO Career Courses or over 30 Micro Courses.

Toll-Free Faculty Assistance and 24 hour priority grading. At CIE you're just a phone call away for one-on-one assistance.

Enroll on-line. Visit CIE's web site at [www.cie-wc.edu](http://www.cie-wc.edu) and take a look at all of our educational offerings and services. You can even take a first lesson.

Visit CIE's Bookstore's web site at [www.ciebookstore.com](http://www.ciebookstore.com) and review our Micro Course offerings and Supplemental Training programs, plus thousands of books, software, tools, test equipment, study guides and videos.

It truly is your one stop training resource center.

## We wrote the book on it ...Since 1934



If you're looking to earn a degree, complete a career course, or upgrade your current skills, CIE's independent study programs may be the right answer for you.

Find out more about CIE by logging on to [www.cie-wc.edu](http://www.cie-wc.edu). In addition to the online enrollment form you'll find everything you need to know about CIE like detailed course descriptions, VA and DANTES benefits, a sample lesson, tuition prices, financial assistance, and it's all just a click away at [www.cie-wc.edu](http://www.cie-wc.edu).

### Call For A Free Catalog

# 1-800-243-6446



*A school of thousands. A class of one. Since 1934.*

Enroll On-line [www.cie-wc.edu](http://www.cie-wc.edu) Shop On Line [www.ciebookstore.com](http://www.ciebookstore.com)

**YES!** I am interested  
Please send me a catalog. PT17

Name: \_\_\_\_\_

Address: \_\_\_\_\_

City: \_\_\_\_\_ State: \_\_\_\_\_ Zip: \_\_\_\_\_

Phone: \_\_\_\_\_

1776 E. 17th St. • Cleveland, OH 44114

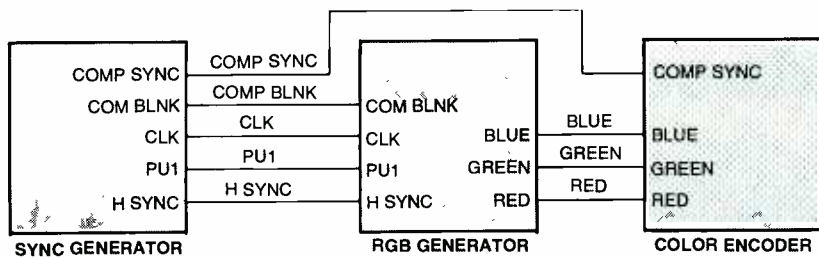

Fig. 2. The NTSC/PAL Signal Generator consists of three sections: a sync generator, an RGB generator, and a color encoder.

the green signal, and 11% of the blue are added together to form the Y signal. Those ratios are based on the human eye's ability to perceive different colors.

The luminance signal can also be expressed as

$$Y = 0.30R + 0.59G + 0.11B$$

where R, G, and B are the voltages of the red, blue, and green signals, respectively. The combination of different color-signals' amplitudes is what determines the various shades of gray in a monochrome receiver. The ability of a receiver to determine a corresponding level of gray from color levels is an important feature for compatibility between color and monochrome TVs; the black-and-white signals can be obtained from the three primary-color signals. In Fig. 1A, you can see the relationship between the color signals and the resulting black-and-white signal.

**Color Information.** The color information that's ignored in a black-and-white TV is made up of the red, blue, and green signals required to drive the picture tube *minus* the luminance signal. Those "color-difference" signals are designated as *R-Y* (red minus Y) and *B-Y* (blue minus Y). Color-difference signals are used solely for color reproduction. A special matrix circuit in the receiver can extract a *G-Y* (green minus Y) signal from the *B-Y* and *R-Y* signals. The advantage of changing the color signals into color-difference signals is that the three color signals become two.

The *R-Y*, *B-Y*, and *G-Y* signals are decoded at the receiver by adding the Y signal back to each of the difference signals. A 3.58-MHz *subcarrier* sent by the transmitter is used in the receiver to reproduce the original color information. The frequency and phase angle of the 3.58-MHz subcarrier in the

receiver must be the same as that in the transmitter for proper color reproduction. Synchronization is performed by transmitting a small sample of the 3.58-MHz subcarrier during the horizontal-sync pulse. That color-sync interval is also known as the *colorburst*. The receiver locks on to the colorburst signal and uses it as a reference to reproduce the red, green, and blue primary-color components. The instantaneous phase, relative to the colorburst, determines the tint, and the relative amplitude determines the color saturation. The sample is sent with each horizontal line to keep the receiver's colorburst signal in phase with the transmitter's colorburst signal. In the early days of color TV, the colorburst circuits in the televisions tended to shift and wander from the needed frequency and phase, even within the short 63 microsecond interval to the next horizontal line. The result on the screen is colors that were, well, not quite accurate. That is one of the reasons that NTSC earned the scornful description, "Never Twice the Same Color." The odd fact is that NTSC works perfectly in a video or closed-circuit environment, but can exhibit the varying-hue problem in a broadcast environment—the medium for which it was designed.

**Friendly PAL Encoding.** Not all of the world's TV receivers work in the same way. Different countries use different types of broadcast system, most of which are to varying extents incompatible with each other.

In Europe, two different standards are used for color (or *colour*) television: PAL (Phase-Alternating Line) and SECAM (Sequential Color and Memory). Although one usually associates PAL with Great Britain, Germany actually developed that standard in the early 1960s. SECAM, a French-designed system—designed mainly for political reasons to protect their domestic-manufacturing companies—is primarily used in (surprise!) France and parts of Europe, including countries in and around the original Soviet Union. In the same vein as the long-standing joke about what NTSC stands for, the most common facetious acronym for SECAM is "System Essentially

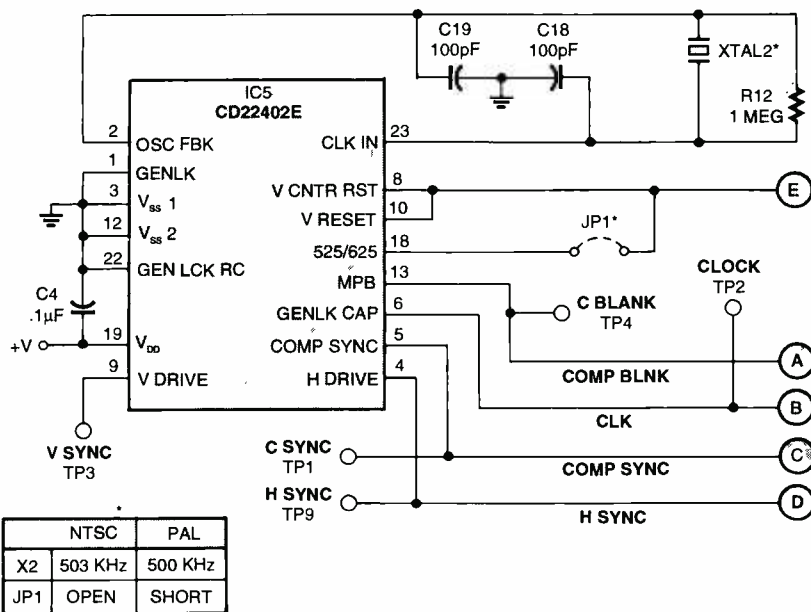

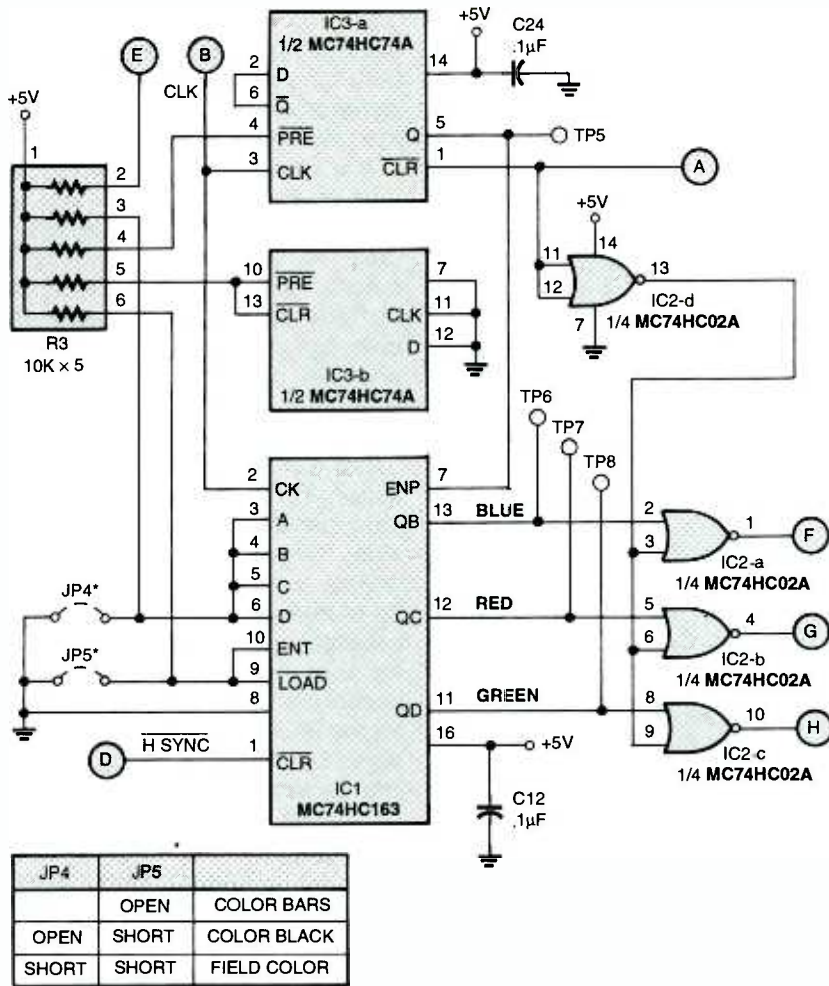

Fig. 4. The RGB generator creates digital signals that correspond to the red, green, and blue signals that make up the NTSC/PAL Signal Generator's color bars.

Contrary to American Method." That play on words points out one of the "features" of SECAM that resulted in its adoption by Eastern-Block countries: a political motive to encourage incompatibility with Western transmissions.

Various flavors of those two 625-line, 25-frame systems are scattered throughout South America, Australia, India, China, Argentina, Brazil, and most of Africa. In fact, over half of the countries in the

world use one of those two systems. However, we're going to talk only about PAL. Variations on the PAL system include PAL B, G, H; PAL I; PAL D; PAL N; and PAL M.

The PAL standard uses a wider channel bandwidth than NTSC, which allows for better picture quality. The extra 100 available lines add significant detail and clarity to the video picture, but the 50 fields per second (compared to 60 fields in the NTSC system) means

that a slight flicker can sometimes be noticed.

That frame rate has to do with early set designs. Back then, the wall-outlet power-supply frequency was a timing source for the screen display. That was done for two reasons: to eliminate rolling "hum bars" on the TV picture caused by the differences between the frequencies and to solve an enormous flicker problem with TV studio cameras during broadcasts.

Because of the two main power frequencies widely used around the world—50 Hz and 60 Hz—the world's TV systems are divided into those two distinct camps: 50 Hz/25 frames and 60 Hz/30 frames.

However, the 50-Hz/60-Hz problem wasn't what spurred the development of PAL. The hue-change problem in NTSC is what did it. To overcome the shifts in the color sub-carrier phase of its signal, a modified version of NTSC appeared where the sub-carrier phase was reversed on each second line. Hence, the reason for calling the new system "Phase-Alternating Lines." PAL has earned its own range of derogatory definitions, including "Pictures At Last," "Pay for Added Luxury" (referring to the cost of the delay-line circuitry), and "People Are Lavender." PAL has been adopted by a few 60-Hz countries, most notably Brazil.

Further, there are differences in sound encoding between countries using the same frequency bands. For example, within 50-Hz PAL UHF transmissions, audio signals can be at a 5.5-MHz offset (system G), or at a 6-MHz offset (system I). Note, the same type of differences exists between the Middle Eastern versions of SECAM (MESECAM) and the Eastern Bloc (OIRT) version.

In view of the differences

TABLE 1  
TELEVISION BROADCAST STANDARDS

SYSTEM	PAL B, G, H	PAL I	PAL D	PAL N	PAL M	NTSC M
Line/Field	625/50	625/50	625/50	625/50	525/60	525/60
Horizontal Frequency	15.625 kHz	15.625 kHz	15.625 kHz	15.625 kHz	15.750 kHz	15.734 kHz
Vertical Frequency	50 Hz	50 Hz	50 Hz	50 Hz	60 Hz	60 Hz
Color Sub-Carrier Frequency	4.433618 MHz	4.433618 MHz	4.433618 MHz	3.582056 MHz	3.575611 MHz	3.579545 MHz
Video Bandwidth	5.0 MHz	5.5 MHz	6.0 MHz	4.2 MHz	4.2 MHz	4.2 MHz
Sound Carrier	5.5 MHz	6.0 MHz	6.5 MHz	4.5 MHz	4.5 MHz	4.5 MHz

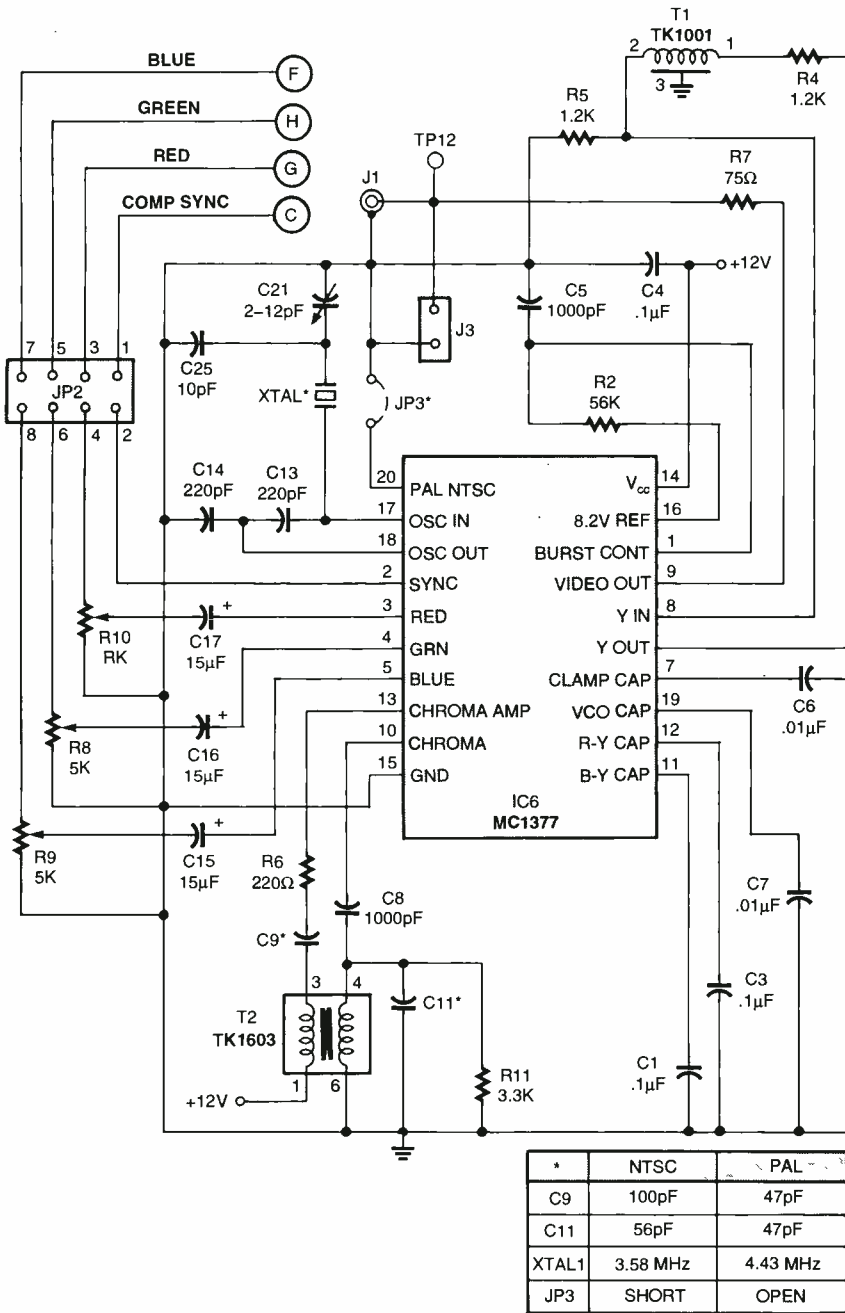

Fig. 5. The color encoder combines the color-bar signals and the sync signals to create a composite color-video signal. With the change of just a few components, the same circuit can generate NTSC- or PAL-format video.

between NTSC and PAL, there is one additional area where PAL has an advantage: movies. Since 25 frames per second is very close to the international film standard of 24 frames per second, film is more easily converted to the PAL video systems.

With NTSC television, things are more difficult; the 24 frame-per-second film rate must be converted to 30 frames per second. This is done by scanning some film frames

twice at regular intervals—a bit of an awkward procedure, but it works. See Table 1 for a comparison of the various PAL formats and NTSC.

**How It Works.** The NTSC/PAL Signal Generator uses some established components because they are readily available and very inexpensive. The block diagram in Fig. 2 shows the main sections of the complete NTSC/PAL Signal Generator

and how they interconnect to each other. The three main sections of the project are the sync generator, the RGB generator, and the color encoder.

The sync generator creates the sync-timing signals that we discussed earlier. The RGB generator uses the sync-oscillator timing to create the red-, green-, and blue-pattern signals that create the color-bar pattern. Finally, the color encoder combines the sync and RGB signals to create the composite-color-video waveform.

The sync generator circuit is shown in Fig. 3. The heart of the sync generator is IC5, which provides the composite-sync timing signals: composite-sync, composite-blanking, and buffered sync-oscillator outputs. The sync-generator uses a 504-kHz ceramic resonator as a base oscillator (500 kHz for the PAL version) and divides that signal by 32 for the horizontal sync. The oscillator is further divided to derive the vertical-sync-timing signals. Those signals are all combined into the composite-sync signal, which is sent to IC6, an MC1377 color-encoder IC.

The RGB generator (Fig. 4) is built around IC1, IC2, and IC3. Those ICs make up the red, green, and blue digital-video signal that drive the video-encoder section to make the color bars. The buffered sync-oscillator from IC5 is divided by IC3-a, resulting in a 252-kHz clock (250 kHz in the PAL version) for IC1, a four-bit counter. The IC1 outputs that divide by 4, 8, and 16 become the non-inverted blue, red, and green signals respectively. Those signals are inverted by the gates IC2-a, IC2-b, and IC2-c. The fourth gate, IC2-d, is used to blank the color outputs as needed.

The color encoder (Fig. 5) takes those digital blue, red, and green signals and through R8, R9, and R10, brings their voltages down to about 700 mV. The resulting waveforms are shown in Fig. 6.

The color signals are fed to IC6, a Motorola MC1377. This device takes the separate red, green, and blue video signals and combines them with the composite-sync signal to generate a composite video signal. The colorburst reference is set

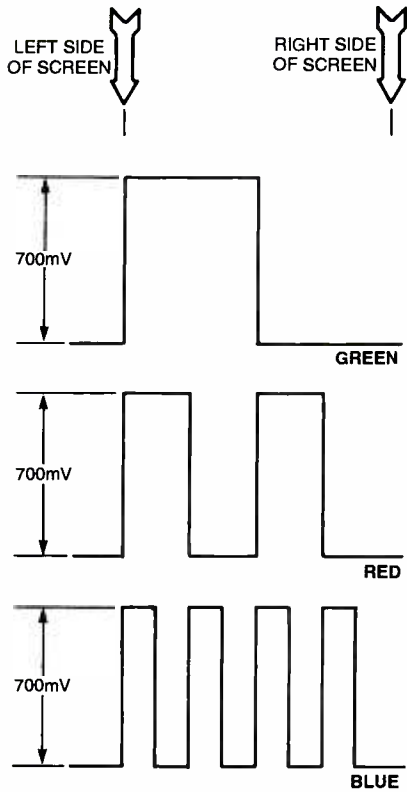

Fig. 6. To create red, blue, and green, a squarewave of the proper frequency and amplitude is used.

by XTAL1. The exact frequency needed for the oscillator can be fine-tuned by C12 to be exactly 3.579545 MHz (4.433618 MHz for PAL). The combination of R2 and C5 sets the timing for the insertion of the colorburst signal on the back porch of the composite-video signal. The values used set the burst timing to approximately 0.4 microseconds after the horizontal-sync pulse with a burst width of 0.6 microseconds.

The network of T2, C9, R6, C8, C11, and R9 provide bandpass filtering for the chroma component. Components R4, T1, and R5 provide a delay for the luminance channel (-Y) to compensate for the internal delay of the chroma signal. The final output signal appears at J1 and J3.

The power supply for the NTSC/PAL Signal Generator is shown in Fig. 7. There is nothing fancy or complex about it. Direct current from a 15- to 18-volt wall-mounted adapter connects to J2. The voltage is first regulated to 12 volts by IC4, then to 5 volts by IC7. Note that IC7's input comes from the regulated output of IC4 instead of from the power input directly. That makes for a cool-

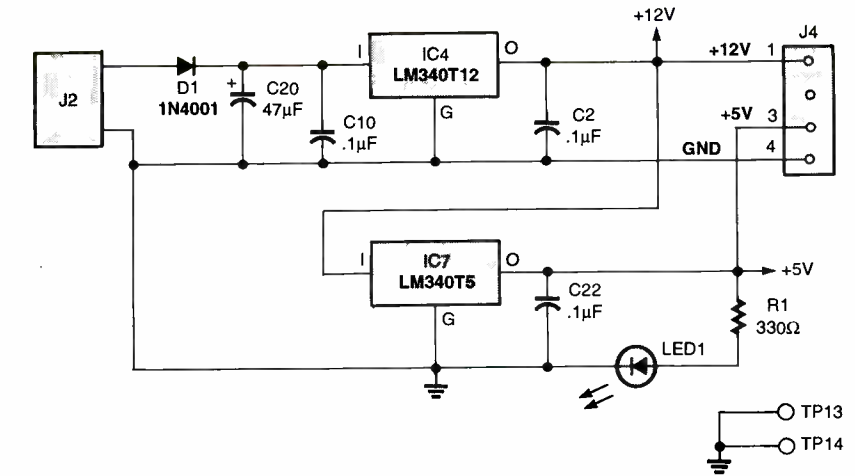

Fig. 7. A simple pair of three-terminal voltage regulators power the NTSC/PAL Signal Generator.

er-running regulator as well as a more stable regulated voltage. The supply voltages are also made available to J4, a four-pin connector. If you are using this project as part of a larger setup and have

regulated 5- and 12-volt sources available, you can simply connect them to J4 and dispense with the power-supply components of Fig. 7. Conversely, you can power external devices from J4 as long as you don't

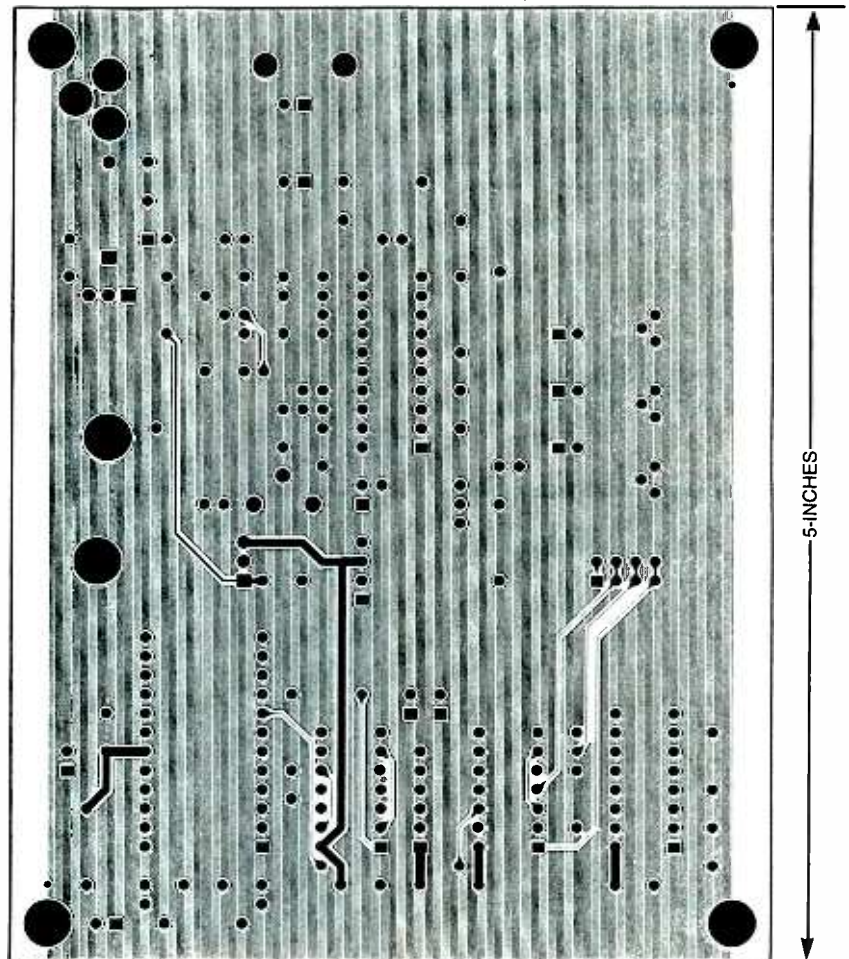

Fig. 8. The NTSC/PAL Signal Generator is best built on a PC board. Here is the foil pattern for the component side of the board.

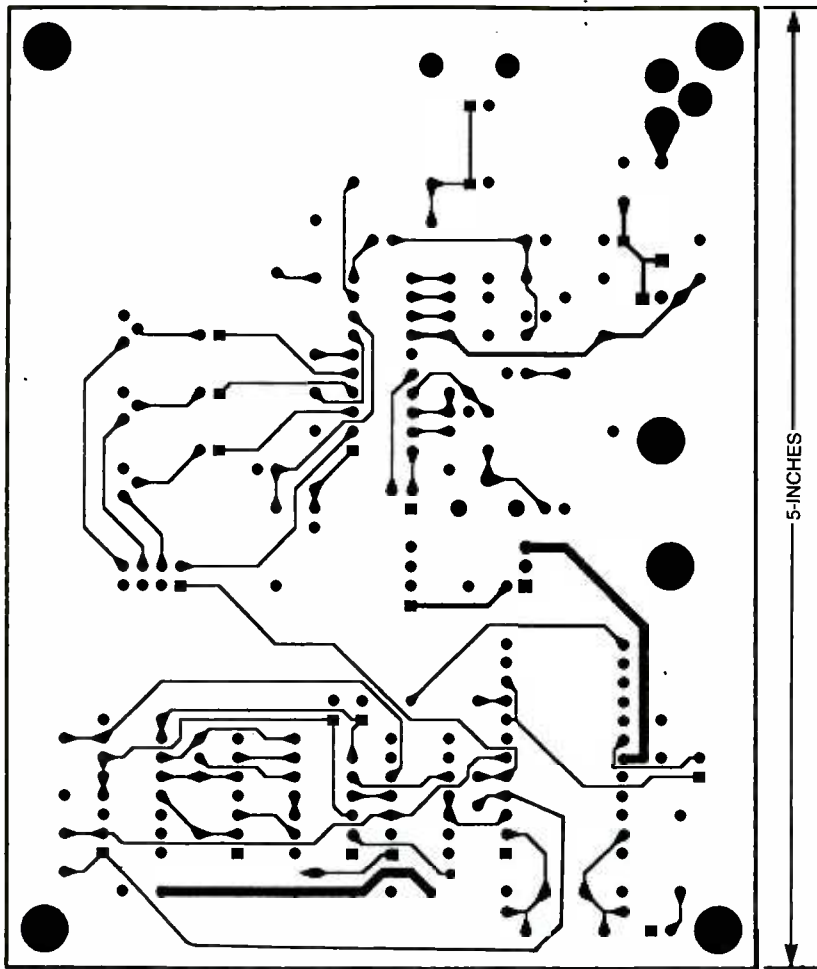

Fig. 9. Here is the solder side foil pattern for the NTSC/PAL Signal Generator.

exceed the maximum current rating of IC4 or IC7.

A simple light-emitting diode (LED1) and a current-limiting resistor (R1) indicate when power is applied to the unit.

**Construction.** Because of the high frequencies involved, use a printed-circuit board when building the NTSC/PAL Signal Generator. A double-sided design has been provided in Fig 8 (component side) and Fig. 9 (solder side). If you don't want to etch and drill your own board—double-sided boards can be very difficult to make in your basement or home workshop—you can purchase one from the source given in the Parts List.

Another requirement of the PC board is the use of "ground planes" to help contain the high-frequency signals. The top-side pattern (Fig. 8) shows just such a design feature.

Construction is straightforward. If

you're using a purchased board or one made from the foil patterns, follow the parts-placement diagram shown in Fig. 10 for component location. When installing the components, a good rule of thumb is to start with the smallest items first and work your way up to the large devices. It's much easier to install a small resistor without a lot of large capacitors and transformers in the way!

Another consideration has to do with static-sensitive devices such as ICs. Install those items, whenever possible, last. As you handle the board, you could be generating small amounts of static electricity that could damage some of the more sensitive components. Installing those items last will limit the chances of damaging them before applying power for the first time. Doing whatever you can to avoid "dead" components will certainly make troubleshooting any construction errors easier should the unit not work as expected.

As its name implies, the NTSC/PAL Signal Generator can be built in one of two "flavors:" NTSC or PAL. Note that there are a few components that need different values depending on which version you want to construct. Now is the time to make a decision as to which one

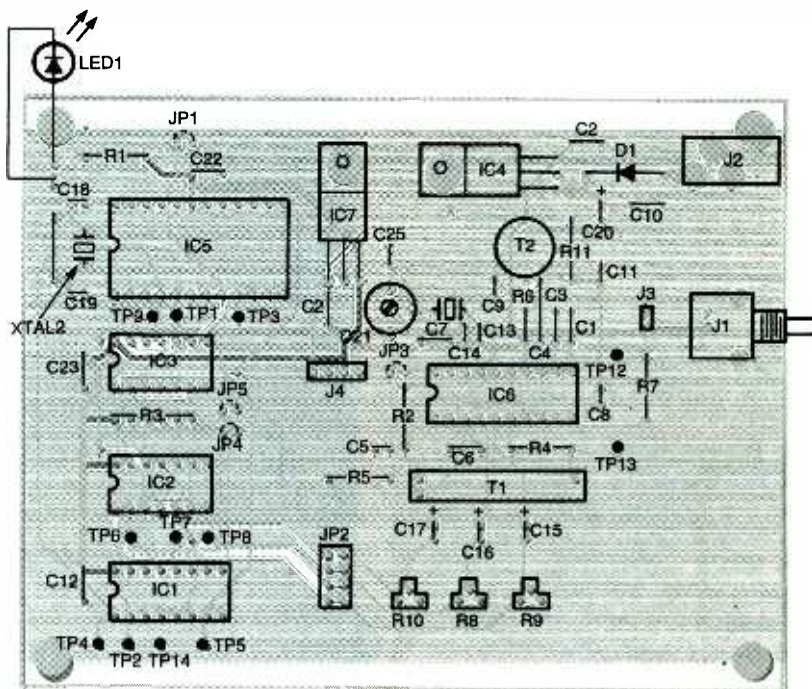

Fig. 10. With a properly designed board, the NTSC/PAL Signal Generator is a snap to build.



to build. Of course, you can build one of each if you have need for both types of units. If you do, be sure to keep track of which one is which so you don't start mixing values between the two versions. Nothing can be more frustrating than finding that you used the PAL crystal on the NTSC circuit!

As you install the various components, double-check their value and polarity for parts that are polarity sensitive, such as electrolytic capacitors and semiconductors. Installing those parts backwards could result in damage to both them and the components around them when power is applied. For example, a well-known result of applying wrong-polarity power to an electrolytic capacitor results in a violent explosion of the device, spraying dangerous chemicals all over you and your workbench.

When you've installed all of the parts, check your work over for wrong values, missing parts, cold or missing solder joints, solder splashes that short together adjacent traces, or any other common workmanship errors that occur when building a project such as this. Don't forget to install the appropriate jumper blocks, especially the four across JP2.

Once you're satisfied with your work, it's time to test your creation.

**Testing.** Before applying power, we'll start testing the NTSC/PAL Signal Generator with some basic resistance checks; that will help avoid "smoking" the unit if something is wrong.

Measure the resistance between the power inputs of J2. The reading should be over 2000 ohms. If it isn't, check to see if there are any shorts between the power and ground connections. If you etched your own board, check to see if an incomplete etching left a few "spider webs" of unetched copper between adjacent traces.

Connect a source of 15-18-volt DC power to J2; the NTSC/PAL Signal Generator needs about 70 mA or so of current.

Set R8, R9 and R10 to their mid-range position. If you are the impatient type and have access to an oscilloscope, you can go right to TP12 (the video-output test point)

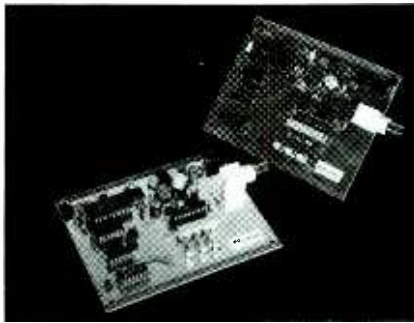

The completed NTSC (left) and PAL (right) Signal Generators are ready to be mounted in a case and put to work on your workbench.

and see what you get. If you are lucky, you will have a video signal that probably needs some adjustments. If that is the case, you can proceed directly to the video-adjustments section. The rest of us mortals will have to progress slowly through the following steps to isolate the problem.

**Troubleshooting.** The first item to check in any troubleshooting scenario is the power supply. Verify that you have 5 volts at the following locations:

## PARTS LIST FOR THE NTSC/PAL SIGNAL GENERATOR

### SEMICONDUCTORS

IC1—74HC163 counter, integrated circuit  
 IC2—74HC02quad 2-input NOR gate, integrated circuit  
 IC3—74HC74 dual D-type flip-flop, integrated circuit  
 IC4—LM340T-12 12-volt fixed regulator, integrated circuit  
 IC5—CD22402E sync generator, integrated circuit  
 IC6—MC1377P color encoder, integrated circuit  
 IC7—LM340T-5 5-volt fixed regulator, integrated circuit  
 LED1—Light-emitting diode, green  
 D1—1N4001 silicon-rectifier diode

### RESISTORS

(All resistors are 1/4-watt, 5%, unless otherwise indicated.)  
 R1—330-ohm  
 R2—56,000-ohm  
 R3—10,000-ohm, 5-unit resistor network  
 R4, R5—1200-ohm  
 R6—220-ohm  
 R7—75-ohm  
 R8-R10—5000-ohm potentiometer  
 R11—3300-ohm  
 R12—1-megohm

### CAPACITORS

C1-C4, C10, C12, C22, C23—0.1- $\mu$ F, ceramic-disc  
 C5, C8—1000-pF, ceramic-disc  
 C6, C7—0.01- $\mu$ F, ceramic-disc  
 C9—100-pF (NTSC) or 47-pF (PAL), ceramic-disc (see text)  
 C11—56-pF (NTSC) or 47-pF (PAL), ceramic-disc (see text)  
 C13, C14—220-pF, ceramic-disc  
 C15-C17—15- $\mu$ F, 16-WVDC, electrolytic

C18, C19—100-pF, ceramic-disc  
 C20—47- $\mu$ F, 16-WVDC, electrolytic  
 C21—2-12 pF variable  
 C24—not used  
 C25—10-pF, ceramic-disc

### ADDITIONAL PARTS AND MATERIALS

J1—BNC connector, printed-circuit mount  
 J2—Coaxial power connector, printed-circuit mount  
 J3—2-pin connector, printed-circuit mount  
 J4—4-pin connector, printed-circuit mount  
 JP1, JP3-JP5—2-pin jumper connector  
 JP2—8-pin (2  $\times$  4) jumper connector  
 T1—TK1001 400-ns delay line  
 T2—TK1603 transformer  
 TP1-TP9, TP12-TP14—Test-point pin  
 TP10, TP11—not used  
 XTAL1—3.58-MHz (NTSC) or 4.43-MHz (PAL) crystal (see text)  
 XTAL2—503-kHz (NTSC) or 500-kHz (PAL) ceramic resonator (see text)  
 12-volt DC wall-mounted transformer, jumper blocks, case, wire, hardware, etc.

**Note:** The following items are available from Gekco Labs, P.O. Box 642, Issaquah, WA 98027-0642; 425-392-0638; Fax: 425-392-8227; Complete kit of all parts, instructions and circuit board (VG1-KIT-NTSC/PAL), \$99; circuit board only (VG1-PCB), \$29; Assembled and tested unit (VG1-ASY-NTSC/PAL), \$139; aluminum case (VG1-CASE), \$29. Please specify NTSC or PAL version for kits and assembled units. Please add \$8 shipping with any order. WA residents please add 8.6% sales tax. MC, VISA, AMEX, and personal checks accepted.

IC1, pin 16  
IC2, pin 14  
IC3, pin 14  
IC5, pin 19

In addition, check for a 12-volt supply at pin 14 of IC6.

Next, verify that there is a 504-kHz (500-kHz for PAL), TTL-level (about 5 volts peak-to-peak) squarewave on pin 6 of IC5. Check for a TTL-level composite-sync signal on pin 5 of IC5 or TP1 as well. There should also be a TTL-level blanking signal on pin 13 of IC2 or on TP4.

There should be a divided-down 252/250-kHz signal at pin 5 of IC3. Check to make sure that there are also divided-down signals on IC1 at pins 13, 12, and 11. You can also reach those signals on TP6, TP7, and TP8.

In the color-encoder section, take a close look at the various signals going into and coming out of IC6. You should see a TTL-level composite-sync signal similar to Fig. 1A at pin 2. In addition, there should be approximately 1-volt peak-to-peak signals at pins 3, 4, and 5. Check for a 3.58-MHz (or 4.43-MHz) oscillator signal on pins 17 and 18. Make sure that pin 16 is 8.2 volts DC. Check for a ramp-like signal at pin 1. There should be a chroma signal at pins 10 and 13 and a luminance signal at pins 6 and 8. If all of those tests are okay, you should have a signal like Fig. 1A at pin 9, except that it will be approximately 2 volts peak-to-peak.

**Video-Level Adjustments.** If you have an oscilloscope available, look at pin 4 of IC 6 and adjust R8 for a 1-volt peak-to-peak reading. Adjust R10 for a 1-volt peak-to-peak reading at pin 3; R9 gets the same treatment for the signal appearing on pin 5.

Connect the scope probe to video-output test point TP12 and terminate J3 into a 75-ohm load. Verify that the composite signal is at 1 volt peak-to-peak. If it isn't, adjust R8, R9, and R10 for the proper peak level and null out the chroma on the white bar (the first bar after the horizontal sync).

If you don't have an oscilloscope, hook up a monitor to J2 and do all of the above-mentioned adjustments, looking at the left-

## The Relative Merits of TV Systems

The differences between NTSC and PAL are not quite as clear-cut as one might at first imagine. While NTSC has a reputation for poor color accuracy, this is only true of broadcast television; as a video format, it has some distinct advantages over the other systems. All television systems are a compromise; many efforts have been made over the years to address the shortcomings in each of the systems.

### NTSC Advantages

**Higher Frame Rate**—Use of 30 frames per second (really 29.97) reduces visible flicker.

**Atomic Color Edits**—With NTSC, it is possible to edit at any 4 field boundary point without disturbing the color signal.

**Less Inherent Picture Noise**—Almost all pieces of video equipment achieve better signal-to-noise characteristics in their NTSC form than in their PAL version.

### NTSC Disadvantages

**Lower Number of Scan Lines**—Reduced clarity on large-screen TVs, line structure more visible.

**Smaller Luminance Signal Bandwidth**—Due to the placing of the color sub-carrier at 3.58MHz, picture defects such as moire, cross-color, and dot interference become more pronounced because of the greater likelihood of interaction with the monochrome picture signal at the lower sub-carrier frequency.

**Susceptibility to Hue Fluctuation**—Variations in the color-subcarrier phase cause shifts in the displayed color, requiring that the TV receivers be equipped with a hue adjustment to compensate.

**Lower Gamma Ratio**—The gamma value for NTSC is set at 2.2 as opposed to the slightly higher 2.8 defined for PAL. This means that PAL can produce pictures of greater contrast.

**Undesirable Automatic Features**—Many NTSC TV receivers feature an auto-tint circuit to make hue fluctuations less visible to uncritical viewers. This circuit changes all colors approximating to flesh tone into a "standard" fleshtone, thus hiding the effects of hue fluctuation. This does mean however that a certain range of color shades cannot be displayed correctly by these sets. Better models often have this "feature" switchable; cheaper sets do not.

most white color bar. If the red, green, and blue video levels are set up properly, the white bar should be at full brightness and

### PAL Advantages

**Greater Number of Scan Lines**—More picture detail.

**Wider Luminance Signal Bandwidth**—The placing of the color subcarrier at 4.43 MHz allows for a larger bandwidth of monochrome information than with NTSC.

**Stable Hues**—Due to reversal of sub-carrier phase on alternate lines, any phase error is balanced by an equal and opposite error on the next line, correcting the original error. In early PAL implementations, the human eye's color-sense abilities provide the averaging effect; today, a delay line is used.

**Higher Gamma Ratio**—The gamma value for PAL is set at 2.8 as opposed to the lower 2.2 figure of NTSC. This permits a higher level of contrast than on NTSC signals. This is particularly noticeable when using multi-standard equipment; the contrast and brightness settings need to be changed to give a similar look to signals of the two formats.

### PAL Disadvantages

**More Flicker**—Due to the lower frame rate, flicker is more noticeable on PAL transmissions; particularly so for people used to viewing NTSC/525 signals.

**Lower Signal-to-Noise Ratio**—The higher bandwidth requirements cause PAL equipment to have slightly worse signal-to-noise performance than its equivalent NTSC version.

**Loss of Color-Editing Accuracy**—Due to the alternation of the phase of the color signal, the phase and the color signal only reach a common point once every 8 fields/4 frames. This means that edits can only be performed accurately to within 4 frames (8 fields).

**Variable Color Saturation**—Since PAL achieves accurate color through canceling out phase differences between the two signals, the act of canceling out errors can reduce the color saturation while holding the hue stable. Fortunately, the human eye is far less sensitive to saturation variations than to hue variations, so this is very much the lesser of two evils.

white. If not, adjust R8, R9, and R10 for the overall brightness and a pure white bar.

(Continued on page 50)

# LOOKING FORWARD TO DTV

*An advanced peek at television's (not too distant) future. First of two parts.*

GEOPHREY J. MCCOMIS

**W**hat do you know about video? If you're a typical electronics enthusiast, you probably know a thing or two about NTSC. If you're a videophile, you may have a good idea of what "PLUGE" stands for. If you know what a "color frame" is, you might be a video guru. Well, hold on to your merit badges—it's all about to change!

In 1953, the FCC adopted the NTSC color-video standard. Here in the USA, television's core technology hasn't changed much since—until now. In December 1996, the FCC announced its acceptance of the Advanced-Television-Systems Committee's (ATSC) Digital-Television (DTV) standard. It later revealed a changeover plan that has already brought DTV to within reach of 60% of American television households, with the complete termination of analog broadcasting targeted for 2006. So how will TV look and sound, and how will it work in the next century?

As adopted, the standard describes how the new system will work without dictating its looks. DTV broadcasts occupy the same 6-MHz channels that have been used for NTSC, but instead of a single analog program, they will deliver a full bouquet of digital-programming options. A given channel may offer anything from a single program in multiple formats to a constellation of unrelated audio, video, and data signals.

The ATSC document that describes the standard was almost entirely incorporated into FCC rules. The only item omitted was a chart that

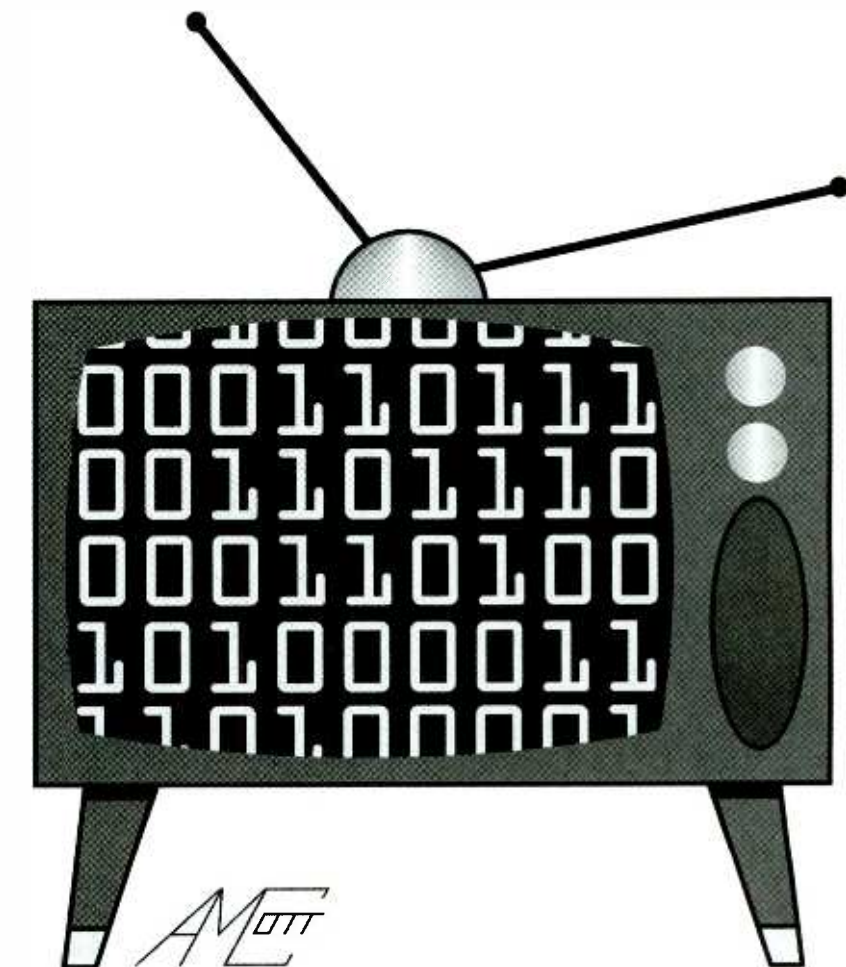

would have constrained the number of compression formats. In practice, this means that the demands of the marketplace and program-content developers will determine the available aspect ratios, resolutions, frame rates, and scanning formats. A DTV channel may carry anything from a single HDTV program (High-Definition TV, featuring a resolution of 1920 by 1080 pixels)

to three or more standard definition programs (approximately equal in resolution to NTSC).

For better or worse, the new broadcasts will not be compatible with today's television sets. Although you won't be able to build a digital set anytime soon, you can enjoy a good look at the new technologies that make DTV a true creature of the 21<sup>st</sup> century.

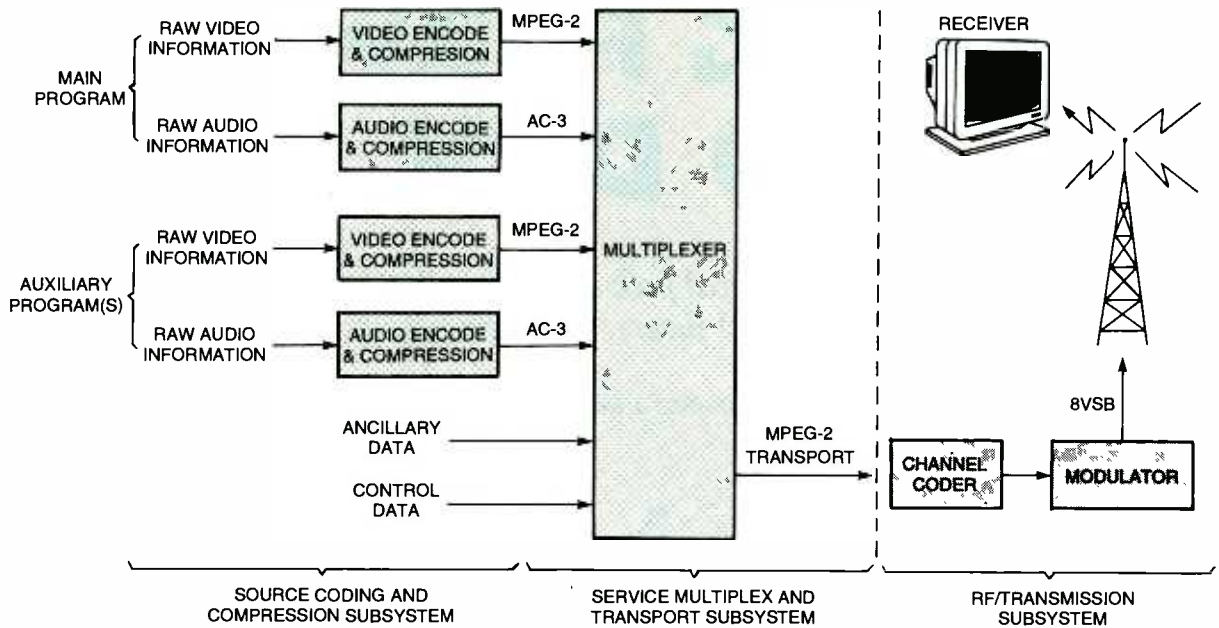

Fig. 1. The DTV terrestrial-broadcast system consists of three subsystems: Source Coding and Compression, Service Multiplex and Transport, and RF/Transmission.

**System Overview.** Figure 1 portrays an overview of DTV. It consists of three basic subsystems: source coding and compression, service multiplex and transport, and RF/transmission. At the source coding and compression stage, audio and video are coded into digital samples and crunched according to Dolby AC-3 and MPEG-2 audio- and video-compression schemes, respectively. Together with some control data, they are then multiplexed and parceled into a single MPEG-2 data stream. Finally, error-correction information is added, and the combined data is modulated and transmitted. For open-air DTV broadcasting, a modulation mode known as 8 VSB—a vestigial-sideband-modulation scheme with eight discrete amplitude levels—is used. With a 6-MHz channel bandwidth, the system can deliver about 19 Mbps of combined program data.

**Video Compression.** Delivering an HDTV program within a 19-Mbps data stream requires the use of severe compression; video data must be reduced by a factor of fifty-to-one or more. To achieve this reduction, DTV utilizes the Main Profile subset of the MPEG-2 video-compression standard from the Moving Picture Experts Group.

The MPEG-2 protocol describes a

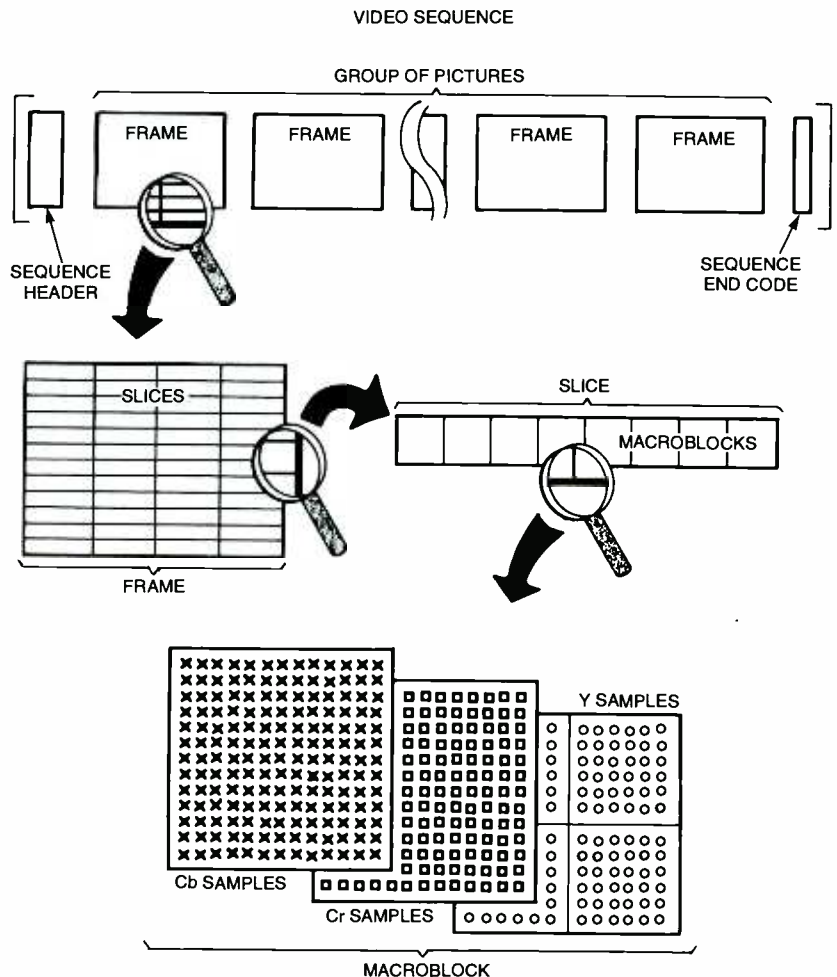

Fig. 2. An MPEG-video sequence is built up from blocks, macroblocks, slices, frames, and groups of pictures (GOPs, which are optional).

series of video-compression techniques that are designed to reduce the amount of data required to represent a video sequence without the compression being noticeable.

Figure 2 provides an overview of how video information is organized in MPEG-2. The largest organizational units are called *video sequences*. These may be of any length down to a single frame or picture. Each video sequence consists of a *group of pictures (GOP)*, the next organizational layer. GOPs may also be of any length, but are not mandatory divisions and may be omitted entirely.

Frames (or pictures) are like the frames in NTSC video: a frame is one complete still image. Common frame rates for MPEG video streams include 60, 59.94, 30, 29.97, and 24 frames per second. Both interlaced and progressive-scanning types are supported.

An NTSC frame is comprised of two interlaced fields that are combined in the television receiver to form a single image on the screen. The two fields are called the *even field* and the *odd field*. The even field sends scan lines 2, 4, 6, and so on, while the odd field sends—if you haven't guessed by now—scan lines 1, 3, 5, etc. Since it takes  $\frac{1}{60}$  of a second to send one field, only 30 frames per second are possible. In a progressive-scan frame, *all* of the scan lines are sent in order within one field. The result, on televisions that can handle the bandwidth, is a picture that can rival a computer screen in terms of sharpness. You might be wondering why NTSC doesn't allow progressive scan. The answer is simple: we're talking early 1950s technology. The systems back then didn't have the "horsepower" to create such a picture. In fact, a 525-line frame was considered the ultimate state-of-the-art in available picture-display technology at the time.

Another subtle point about NTSC frames is that they are transferred in real time; that is, the time needed to send them is identical to the time needed to either scan or display them. As a result, an NTSC frame represents a period of time spanning about  $\frac{1}{60}$  of a second.

MPEG frames are processed as singular points in time like a series of snapshots. In this regard, they are similar to the frames of motion-

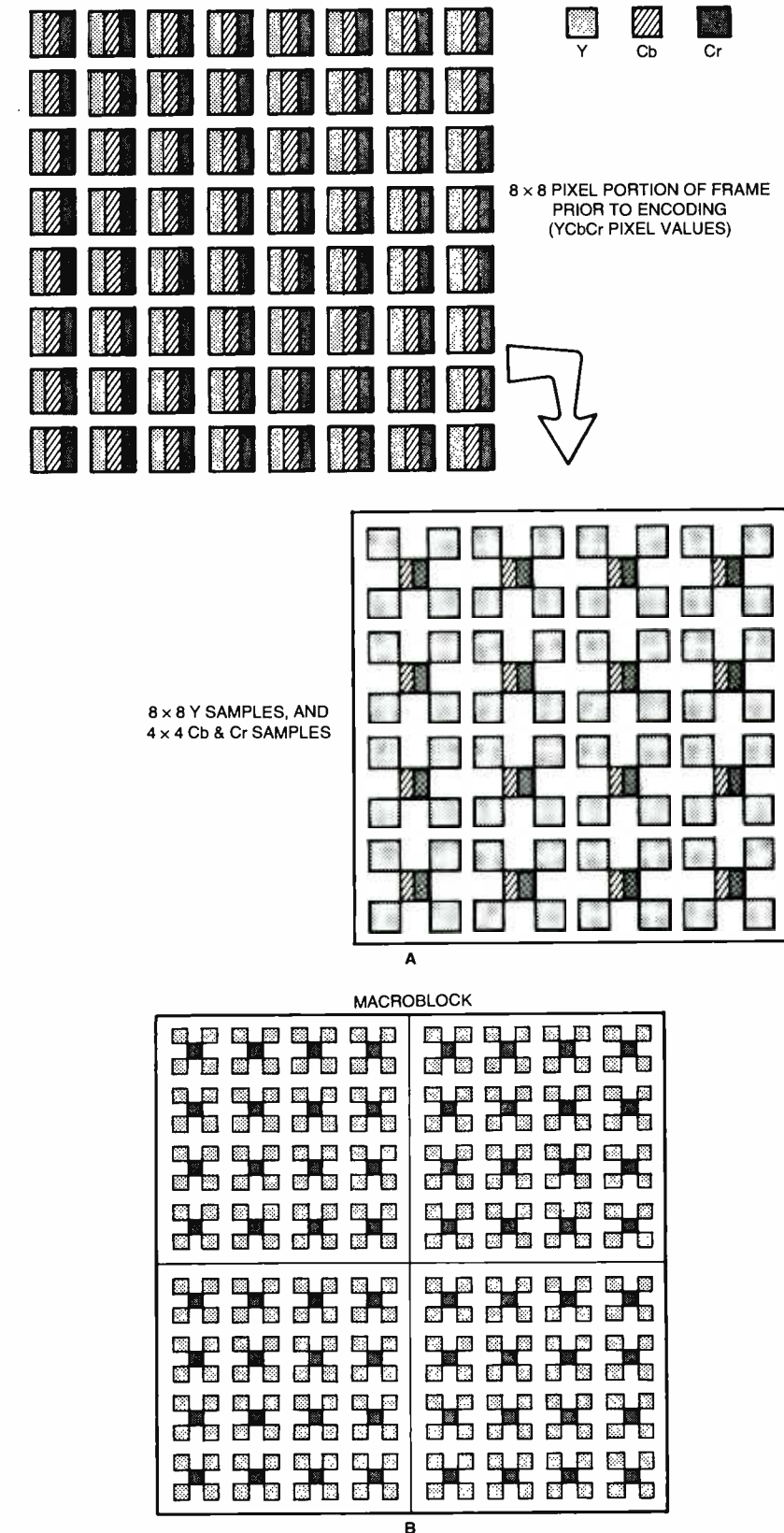

Fig. 3. Blocks and macroblocks are the foundation units of MPEG picture formation.

picture film—hardly a surprise considering that MPEG comes from the motion-picture industry. An MPEG frame exists in memory

as an instant of time, even if it will ultimately be parceled out a line at a time to a scanning-display device.

**Anatomy of an MPEG Frame.** To understand the composition of an MPEG video frame, start by imagining a single video picture prior to encoding. Think of this picture as a matrix of *pixels* (short for picture elements), like a computer's display. Each pixel contains information on the red, green, and blue (RGB) portions of its color.

Before MPEG encoding, the RGB pixel values are converted to YCbCr values. Just like NTSC, luminance (Y) corresponds to the combined red, green, and blue ratios that result in perceived shades of gray, or brightness levels. The Cb and Cr items are the *color-difference* values: Cb for the blue content and Cr for the red content. All together, the three signals convey a pixel's color characteristics. The relative values follow the standard color-video formula  $Y = 0.30R + 0.59G + 0.11B$ .

At the beginning of the encoding process, the YCbCr values are grouped into  $8 \times 8$  blocks of samples as shown in Fig. 3A. For every Y-pixel value, a Y sample will be encoded. But the Cb and Cr values are averaged so that every four Cb or Cr values become a single sample. This loss of color resolution represents the first compression gain resulting in data savings. It is not objectionable because human vision is more sensitive to high-resolution luminance information than to the corresponding color information. Since four luminance samples are encoded for every Cb and Cr pair, four blocks of luminance samples, one block of Cb samples, and one block of Cr samples (from a common picture region) are grouped to form a single *macroblock* (Fig. 3B).

Now that we have an understanding of macroblocks, look back at Fig. 2. The macroblocks are further grouped with horizontally adjacent macroblocks to form *slices*. While slices constitute horizontal rows of picture information, they are unlike scan lines in that they are 16 samples high, and there can be several slices in a row.

**Squeezing Out The Excess.** Video is loaded with redundant information. MPEG compression combats

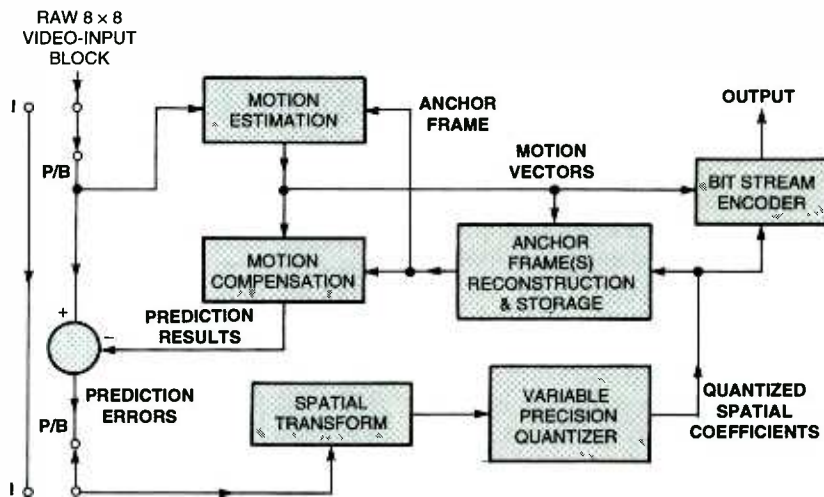

Fig. 4. The MPEG encoder-prediction loop forms the heart of MPEG video encoding.

redundancy on two fronts: spatial (or *intraframe*) and temporal (or *interframe*). Spatial redundancy exists within a frame when significant portions of the picture look the same, such as when an object or background contains large areas of the same pattern, color, or luminance. Temporal redundancy exists from frame to frame when an object or background does not change in appearance or position over time.

The MPEG encoder may select one of three methods to represent a given frame in a sequence: *intraframe* coding (I frame), *predicted* coding (P frame), or *bidirectionally predicted* coding (B frame). While I frames are fully self-contained, P frames are encoded with reference to previous frames (areas of a P frame will be predicted from a previous frame). This eliminates the need to resend similar information from frame to frame. B frames are predicted bidirectionally with reference to previous and/or subsequent frames.

Prediction is MPEG's primary means of "squashing out" temporal redundancy. While P frames use only forward-prediction and intraframe coding, B frames can also take advantage of backward prediction and bi-directional prediction. In both cases, the coding decision is made on a macroblock level. Within a single B frame, for example, you might find different macroblocks encoded in each of the four possible ways (intra-, forward,

backward, and bi-directional).

Bi-directional prediction requires that the frame transmission order be different from the display order. The I- or P-type frames may serve as *anchor frames* (or "referred-to" frames) for other P or B frames, but the anchor frames must be available at the decoder *before* the predicted frames that will refer to them.

I frames are uniquely important to the decoding process. Since P and B frames refer to information from other frames, a decoder cannot be properly initialized until it encounters an I frame. In addition, any errors that find their way into the anchor frames can propagate through a series of P or B frames until replaced by some intraframe-coded blocks. For those reasons, special consideration is given to the use of intraframe coding within the video stream. For example, any given macroblock must be intraframe coded at least once in any 132 consecutive frames. While not required, it is recommended that I frames should be sent at least once every 0.5 second to allow for acceptable channel-change times. It would be annoying if you had to wait two seconds to see the picture after changing channels on your TV.

To see how the rest of the encoding process works, take a close look at the encoder-prediction loop shown in Fig. 4. Bear in mind that the decision to use I-, P-, or B-type coding is made separately for each macroblock, outside of this loop. Remember that the opera-

tions found here are carried out one block at a time, with the six blocks of any given macroblock that's processed sequentially.

Begin by imagining that an I frame is processed. Since I frames use no prediction, the "switches" are thrown toward the "I" terminal, letting every block of the I frame bypass the prediction part of the loop. Every I frame passes directly to the spatial-transform function.

The heart of the spatial transform is a process called the *discrete-cosine transform* (DCT). The DCT accepts a block as a matrix of gray-scale or color values in two-dimensional space, and then represents it as a matrix of spatial frequencies spanning the same region. In this way, blocks that initially contain similar values or regular patterns may be fully expressed as blocks containing few spatial-frequency coefficients. This is how multiple expressions of spatially redundant content are filtered out of the video stream.

Transforming blocks into the spatial-frequency domain presents the encoder with yet another opportunity to trim bits. The variable-precision quantizer adjusts the number of spatial-frequency bits according to what we can see. Terms occupying critical regions of the spectrum are given more bits, while precision is reduced for frequencies to which our vision is less sensitive or where the presence of one frequency will mask another.

The processed intraframe-coded block bits pass from the quantizer to the bit-stream encoder, where they will be bundled and sent on to the transport subsystem. Note that they are also passed to the anchor-frame(s) section.

Anchor-frame reconstruction and storage will play a vital role in the coding of subsequent P and B frames. Reconstruction means undoing what was done by the quantizer and spatial-transform functions. This is necessary because the decoded information will *not* be identical to the original. The encoder must work from the same reference information that the decoder will use to recover the predicted frames. Remember that predicted frames are encoded and decoded by *reference* to anchor frames.

**"P-processing" P Frames.** Now that every block of our initial I frame has been processed and there is a complete copy of the same decoded frame in the anchor-frame-storage buffer, we are ready to consider the encoding of a P frame.

P frame blocks go first to the motion-detection function, where they are compared to the corresponding blocks from the anchor frame. The motion detection's job is to answer the question, "What can I do to this anchor block to make it most resemble the block that I want to predict?" The answer can only do two things to the block: moving it *x* units horizontally and/or *y* units vertically. Each unit is half the width and height of a pixel. Due to the presence of temporal redundancy (similar information from frame to frame), this process of copying blocks from one frame into another and shifting them slightly does a fair job of conveying a new frame without actually sending the entire frame.

Unfortunately, fair is not always good enough. To the rescue come the motion-compensation and difference functions. Motion compensation takes the referenced block from the anchor frame and shifts it according to the motion vectors, reproducing the predicted block. The difference function compares the predicted block to the actual block and outputs any prediction errors that it finds. The prediction errors are sent to the spatial transform and quantizer functions, and ultimately to the bit-stream encoder. Therefore, the end of the process conveys our P-coded block as a reference to the corresponding block from a previously transmitted frame, modified by

motion vectors and transformed/quantized-prediction errors. In practice, this results in a substantial reduction of information, especially if the prediction errors are few.

Simultaneously, the same information is gathered by the anchor-frame section, where our encoded P frame is decoded to serve as a reference for future frames—and so the process continues.

Finally, the bit-stream encoder has a few "bit-squishing" tricks up its sleeve. The result of the spatial-transform and quantization functions is most often a matrix containing zeros interspersed with a few isolated frequency coefficients. The encoder has a choice of two ordering schemes for scanning the matrix sectors. It picks the one that results in the greatest clustering of coefficients separated by the longest runs of zeros. It then applies run-length and Huffman coding to the scanned data.

Run-length coding takes a string of zeros followed by some non-zero value and produces a run-amplitude pair (two numbers (*n*, *v*) such that *n* is the number of zeros, and *v* is the value that ended the run). In Huffman coding, data values that are statistically likely to occur are represented by variable length code words—the greater the probability of occurrence, the shorter the assigned code word. In this way, the bulk of the information is conveyed using the shortest possible codes.

At the end of the video-source-encoding process, picture data are punctuated by organizational data, then forwarded to the transport subsystem.

**Audio Compression.** Like its masterful video processing, DTV's manipu-

**TABLE 1**  
**DTV Audio-Service Options**

Service Name	Type	Number of Channels
Complete Main (CM)	Main	1 to 5.1
Music and Effects (ME)	Main	1 to 5.1
Visually Impaired (VI)	Associated	1 to 5.1
Hearing Impaired (HI)	Associated	1 to 5.1
Dialog (D)	Associated	1 or 2
Commentary (C)	Associated	1 to 5.1
Emergency (E)	Associated	1
Voice Over (VO)	Associated	1

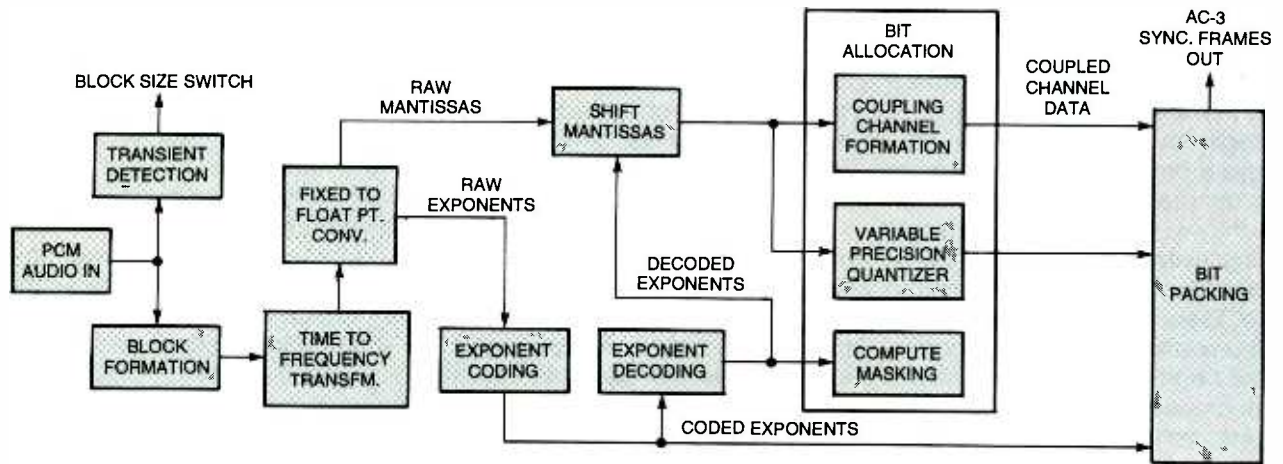

Fig. 5. AC-3 encoding involves a complex series of transformations for each processed channel. Bit allocation and bit packing is carried out globally, at the confluence of individual channels.

lation of audio is no mere sleight-of-hand. The new system will harness Dolby Labs' powerful AC-3 compression technology to deliver up to six main audio channels per program and/or a host of associated services.

AC-3 has been popularized for its promise to bring "5.1"-channel sound to home-theater audiences, as it has to moviegoers since 1992. The 5.1 channel designation refers to the availability of separate left, right, center, left surround, right surround, and subwoofer channels. Not as well known is the fact that AC-3 is an extremely versatile multi-channel-coding scheme. As implemented for DTV, it is capable of compressing anywhere from one to six discrete channels into a single audio-bit stream.

Table 1 details the DTV audio-service options. Of those options, *Complete Main* (CM) is most commonly provided, carrying all of the normal program sound in multiple channels. *Music and Effects* (ME) is essentially the same, but without dialog. This is primarily intended to facilitate multi-language programming and may be accompanied by one or more separate *Dialog* (D) services. The *VI* option includes descriptive information for visually impaired viewers. *HI* adds dialog enhancement, offering increased intelligibility for the hearing impaired. *Commentary* (C) service is intended to convey supplemental audio—potentially enhancing but not essential to the program. The *VI*, *HI*, and *C* service types may each be

provided as a single-channel augmentation to CM or as a full alternative multi-channel mix. When the *emergency* (E) service is present, all other audio is muted to allow for priority insertion of essential messages. *Voice Over* (VO) is similar, but rather than muting other program elements, VO attenuates them by as much as 24 dB, then muscles its way into the center channel of the audio mix.

As with video compression, the real goal of audio compression is to reduce the amount of program data without compromising quality. At their original sampling frequency of 48 kHz, the main service's 5.1 channels would typically require 5.184 Mbps to convey everything. Instead, they will be compressed into no more than 384 kbps (a ratio of 13.5 to 1).

**Taking A "Byte" Out Of Sound.** To learn how AC-3 compression works, follow the block diagram of the encoding process as shown in Fig. 5 during the following discussion.

Audio enters the process as pulse-code-modulation (PCM) samples. PCM involves sampling a signal at fixed intervals in time and recording the instantaneous magnitude of the signal at each sampling point. The recorded samples are conveyed as digital words or codes. If you've ever worked with sound files on a computer, you've worked with PCM audio. For DTV, the samples are commonly 16- to 18-bits long, but may be as long as 24 bits.

Within the encoder, blocks of

PCM samples are converted into blocks of frequency coefficients that represent the spectral content of the signal—like the display of a very high-resolution spectrum analyzer. When audio data are transformed from time domain (PCM) to frequency domain and back again, special care must be taken to avoid certain audible distortions, especially *blocking artifacts* and *time smearing*.

Blocking artifacts occur at the borders between transformed blocks of samples. To eliminate them, the AC-3 process does away with borders entirely. Figure 6 illustrates the overlap and window functions that achieve this effect. Initially, PCM samples are grouped into blocks of 256, which are then duplicated and regrouped into 50%-overlapping pairs. The pairs are multiplied by windowing coefficients, such that the samples at either end of a pair are multiplied by nearly zero, while those in the middle are multiplied by one. Between those extremes, values of coefficients taper logarithmically. The windowed blocks are then transformed. Since the windowing process effectively cross fades from block to block, blocking artifacts are eliminated.

For every 512 windowed-PCM samples that it receives, the transform function outputs 256 coefficients, indicating the signal's relative power level at each of 256 narrow frequency bands during the 10.66-millisecond time interval spanned by the block of input samples. That's how the transform counter-



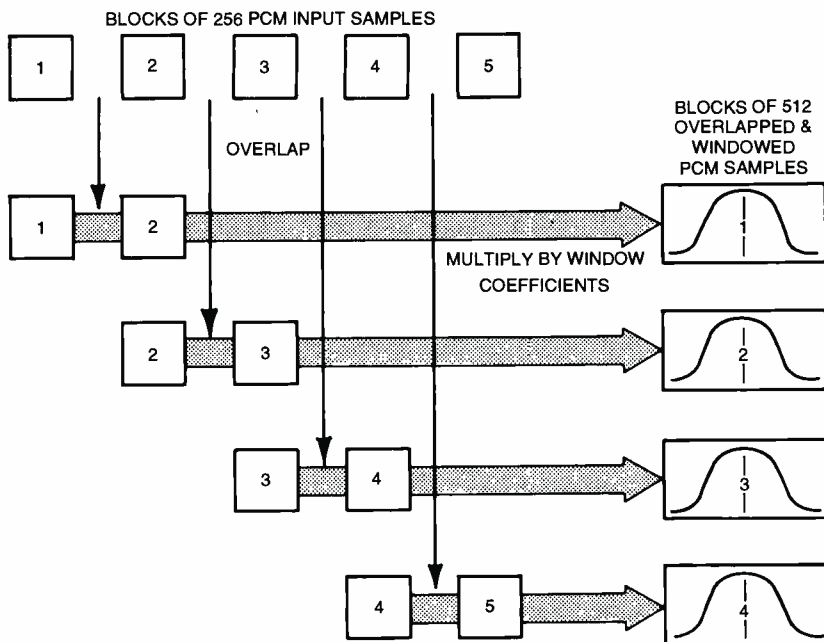

Fig. 6. AC-3 uses a clever technique to prepare blocks of PCM samples for transformation to the frequency domain. This approach effectively cross fades from one group of samples to the next, eliminating blocking artifacts.

acts the blocking function's doubling of samples. The number of frequency bands is a measure of the transform's spectral resolution, while the shortness of the time interval indicates its temporal resolution.

Later in the bit allocation routine, the encoder will save bits by neither attempting to represent sounds nor by hesitating to create noise that humans can't hear, thanks to the principle of *masking*. Masked sound is perceptually obscured by the audible part of the signal. However, in attempting to utilize masking at a temporal resolution of 10.66 mS, strong transients may result in audible distortion.

The trouble with transients is that their duration may be significantly shorter than the evaluation period, so that noise becomes audible before or after the transient that the encoder assumes will mask it—that's *time smearing*.

If the temporal resolution were doubled, so that each block of transform coefficients represented 5.33 mS of audio, then any such noise would fall within the temporal masking period of the transient and would not be perceivable. Unfortunately, that would double the amount of audio data, wrecking the compression economy.

Transient detection and block-

size switching (Fig. 5) are the solution to that quandary. In the presence of a transient, AC-3 splits the blocks into two shortened blocks, transforming each separately. The transform for a short block produces only 128 frequency coefficients, so ultimately within the same number of transform coefficients, the spectral resolution is halved in exchange for doubling the temporal resolution.

To summarize the process thus far, after the time-to-frequency transform, we find blocks (or twin short blocks) of 256 frequency coefficients. Those blocks represent the spectral content of an equal number of PCM samples, spanning a time interval of 10.66 milliseconds. If we afford equal precision to both the time and frequency domains (16-bit coefficients for 16-bit samples), there is no data reduction so far.

**Sound As Numbers.** Raw frequency coefficients are initially represented as fixed-point binary numbers (a set number of digits follow the decimal point). These are converted to floating-point binary pairs. In a floating-point number, one number indicates the quantity of zeros to the right of the decimal point (the *negative exponent*), and another

number is comprised of the remaining digits (the *mantissa*). As an example, the coefficient 0.00000 00010110110 would be represented with an exponent of 1000 (binary 8 for 8 zeros) and a mantissa of 10110110. Hereafter, the exponents and mantissas will be encoded separately.

Although exponents and mantissas follow separate paths, they will remain organized in blocks. By the end of the encoding process, groups of six blocks will combine to form larger organizational units called *synchronization frames*. Within a sync frame, a great deal of information will be shared. As you consider the operations leading up to the sync-frame formation, remember that each coefficient belongs to a unique frequency bin (or slot) within a specific transformed block. Blocks of coefficients retain this original association despite the manipulation to which they will be subjected.

Transform coefficients possess certain exploitable qualities that are not obvious at first. Chief among these is the fact that within a block, the magnitude of adjacent exponents rarely differs by more than 2. As a result, exponents can be coded differentially using one of only five possible increments (-2, -1, 0, 1, or 2). The first exponent in a block (the zero Hz or DC term) is represented as an absolute, and all subsequent exponents are coded as the *delta* (difference) between the current and previous terms. In this way, groups of three exponents can be conveyed in no more than seven bits.

The encoder will attempt to economize even more by applying each delta to as many exponents as possible. To this end, the exponent coding operation may select one of several exponent-coding strategies, depending on the extent to which the spectral content of the program varies across a sync frame. If the spectrum is relatively consistent, the first block will have one delta assigned to each exponent. The remaining five blocks will then reuse the same exponent set. Alternatively, if the spectrum is less stable, deltas may be shared across groups of two or four adjacent

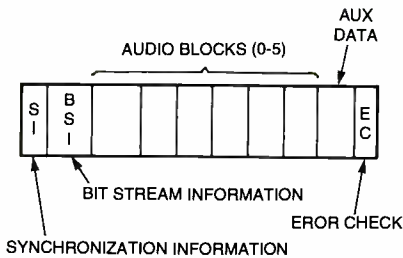

Fig. 7. The sync frame is AC-3's primary organizational unit.

exponents within a single block. In any case, exponent sharing is only permitted within the six blocks of a sync frame. Note that no data is shared across frames. Using these techniques, AC-3 typically achieves an impressive 2.5-coded exponents per bit.

In the process of exponent coding, the value of an exponent may be reduced to allow for the use of a more efficient strategy. In that case, the mantissa is required to take on leading zeros so that the whole coefficient is not changed. As shown in Fig. 5, decoded exponents are used to shift the mantissas, compensating for altered exponents.

**Fitting The Available Space.** Sync frames carry a limited number of bits that are divided amongst the various channels. Coded exponents are packed first. The bit-allocation routine apportions the remaining bits so that psychoacoustically-critical information is conveyed with the greatest precision.

The encoder's bit-allocation routine employs a mathematical model of the human auditory system. The same model is used in the receiver when the bit stream is decoded. In both instances, decoded exponents serve as a rough spectral representation of the audio program. This is used to compute a "masking threshold" across the signal's spectrum. Since any noise below this threshold will be obscured by the audible signal, the encoder can quantize mantissas with just enough precision to keep the quantization

## SIGNAL GENERATOR

(continued from page 42)

Once the NTSC/PAL Signal Generator is tested, adjusted, and working, place the completed unit in an appropriately-sized metal case.

noise inaudible. When the mantissas are unpacked at the receiver, the decoder uses the same masking calculation to determine which quantizer was used.

If the number of bits encoding all of a program's channels still exceed the available bit pool, the encoder may resort to *channel coupling*. Above a frequency of about 2 kHz, we perceive directionality based not on the actual waveforms that we hear, but on the ear-to-ear difference in the fine spectral envelope. AC-3 takes advantage of this effect by combining the high-frequency content of selected channels while preserving the channels' original envelopes. The encoder determines the frequency at which coupling should begin and which channels will participate. It then forms a separate coupling channel.

When coupling is active, coupling coordinates for each original channel carried in block zero of every frame. They contain the envelope information, indicating the extent to which the coupling channel data should be applied to any other channel. If the envelopes are relatively consistent across a frame, then the same coordinates will be applied to all six blocks, but they may be updated as often as every block.

In the end, the sync frame (see Fig. 7) packages the encoded audio together with the synchronization and bit-stream information needed to properly parse and unpack the data, as well as auxiliary data and error-check fields. Each of a sync frame's six audio blocks carries coded exponents and/or mantissas for all of the program's channels, plus the coupling channel (when active). Every block spans 10.66 mS, but since the time intervals were overlapped during block formation, a complete frame encompasses only 32 mS of audio.

**Dynamic Range.** Finally, another

**Using the Signal Generator.** The NTSC/PAL Signal Generator outputs color bars when JP5 is open, but by shorting JP5, you can generate color black video (black video with a color-burst signal). By shorting JP4 as well, any full-screen color can be created by adjusting R8, R9, and R10. Be

careful to keep the overall video level to the 1-volt peak-to-peak standard.

aspect of DTV's unparalleled audio versatility may prove to be challenging for broadcasters. With old-fashioned NTSC, audio has occupied a very narrow dynamic range. In contrast, AC-3 will afford DTV programs a dynamic range in excess of 100 dB. Since this is a far greater range than most receiving systems can reproduce, it would seem to be important to know what the nominal program level should be.

In fact, no standard program level has been defined. Producers are free to set a program's average level anywhere within the overall dynamic window, allowing plenty of headroom for powerful sound effects and ample clearance from nuance to noise floor.

Instead of conforming to a standard level, AC-3 sync frames include two special indicators in the BSI field: one for the level at which dialog is encoded, the other for the overall dynamic range. The receiver uses the dialog indicator to scale the program levels so that dialog is reproduced at a constant level from program to program and channel to channel. The dynamic-range indicator will allow a program's range to be transposed to fit that of the receiving system (or to fit the viewer's preferences). If, for any given program, these values are not correct, the program's audio level will not be scaled correctly. Therefore, broadcasters are required to verify their accuracy. Imagine if every discount merchant in America learned that he could advertise at the level of a full-scale explosion! If abuses of DTV's extreme range prove to be widespread, new regulations will surely follow.

That's all the time and space we have for this month. Next month, we'll put the video and audio together and send it out over the airwaves. Be sure to tune in again next month; same digital time, same digital channel!

I hope that you have learned something about color video and will find this project useful. Fortunately, everything is neatly broken into simple blocks so that you can be assured of success. Have fun.

# With this Colorburst Reference, You Can

*If you can access a TV signal, you can have an accurate reference for calibrating your test equipment.*

THOMAS GOULD

**A**re you looking for a good calibration-reference source? Maybe you need to verify that your latest color-video project is "up to snuff." What can you use if you don't have a good frequency reference available?

That's a trick question—you *do* have a good frequency reference available, and it's no farther than the television set in your living room. If you can tap into a TV antenna or cable-box output, you've got a reference that's stable, accurate, and available 24 hours a day. Of course, you need to pick out the right *portion* of the video band. That's where this project, the *Colorburst-Calibration Reference*, comes in. When this unit is attached to a video-cassette recorder or television tuner, you gain access to a very accurate calibration reference for your frequency counter; you can then check any other signal for accuracy.

**Accurate Television.** Most modern VCRs and TV tuners give you access to the "baseband" television signal, which has a great reference signal as part of the NTSC television-signal specification. The signal that we are talking about is the *colorburst-reference* signal that is exactly  $3.579545 \text{ MHz} \pm 10 \text{ Hz}$ . That portion of the video signal is shown in Fig. 1. That level of accuracy is required by the FCC for any television-broadcast signal.

"So," I hear you ask, "if I can get baseband video, how can I utilize the colorburst since it only appears for 9 cycles out of every 63.5-

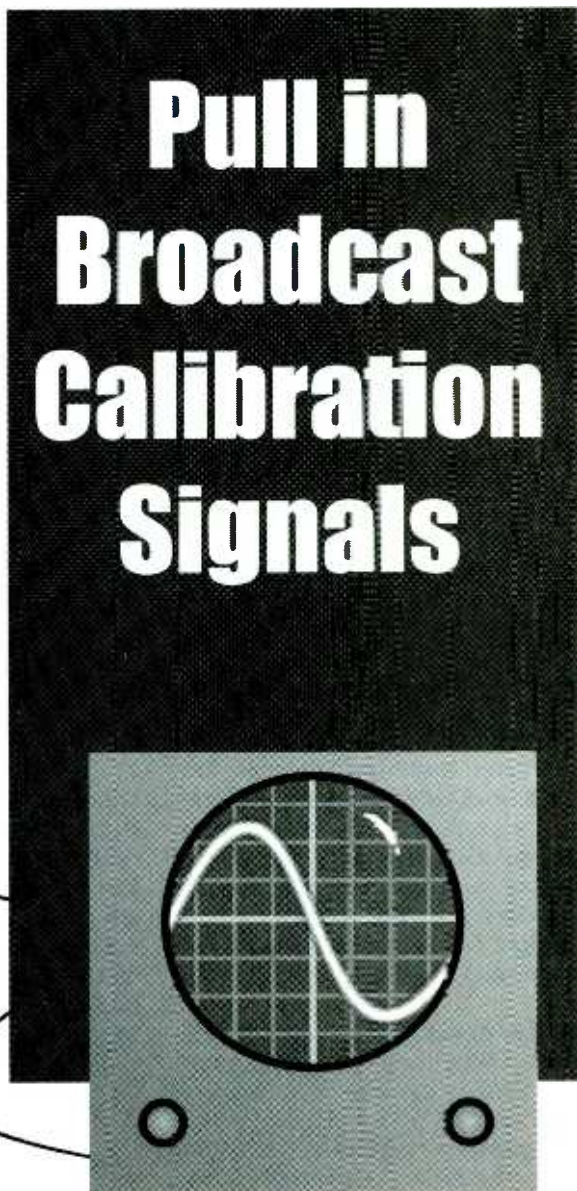
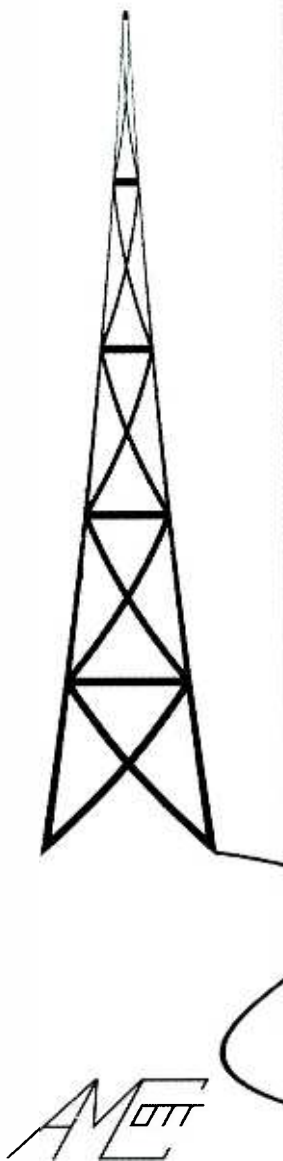

microsecond-long TV line?" That's a good question. Having a reference signal that winks in and out of existence for only a small percentage of time doesn't sound very helpful. However, think about how televisions work. They can hold onto the reference while they display the various colors for each line

of TV picture. After all, that's how color television works: the display portion of the video signal is a frequency that's related phase-wise to the colorburst reference. The degree to which the phase shifts determines the hue of the display. The TV has to hold onto the reference long enough to make an

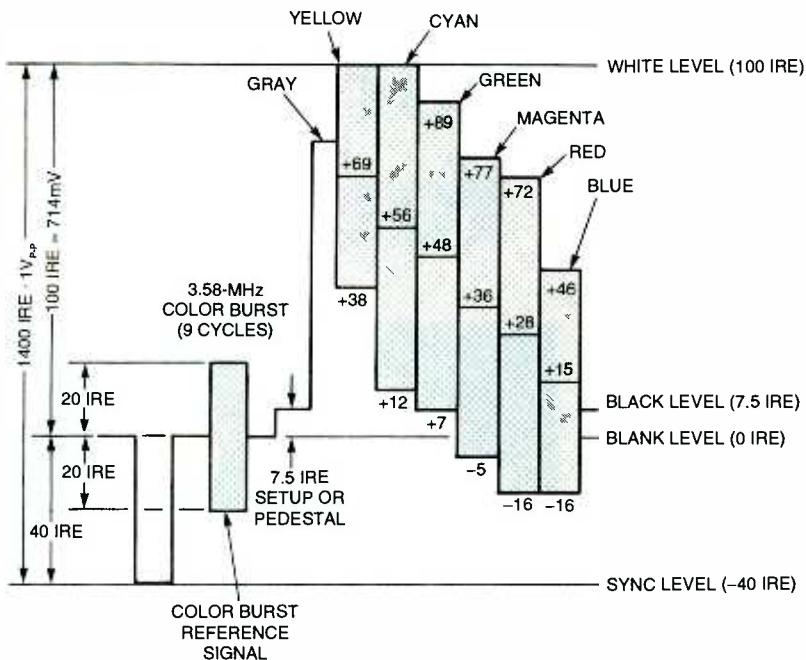

Fig. 1. The colorburst of an NTSC color-video signal is accurate and stable to  $\pm 10$  Hz. The problem is that it's only available for 7.5% of the time.

accurate comparison between the two signals.

The answer, therefore, is to use a circuit that, like a TV, creates a continuous signal that's locked to the colorburst.

The heart of the Colorburst-Calibration Reference, as shown in the Fig. 2 block diagram, is a phase-locked loop that locks onto the color burst and creates that continuous subcarrier signal. Because of the nature of how a phase-locked loop works, it is a simple matter to have the unit deliver a standard 3.58-MHz frequency or to multiply it to four times the subcarrier, or 14.318 Mhz.

**How It Works.** The Colorburst-Calibration Reference's design, according to Fig. 2, is broken into two sections: the TV-timing generator and the subcarrier phase-locked loop (PLL). The timing generator generates a gate signal that tells the PLL when to sample the colorburst signal. The PLL portion of the circuit actually samples the colorburst and creates the 4 times (4X) subcarrier output. It then divides that frequency by four to create the subcarrier-reference output at the original frequency.

Putting a switch on those outputs lets us choose either the 1X or

4X output from the subcarrier oscillator. A transistor buffer isolates the Colorburst-Calibration Reference from any outside equipment. That way, you can easily drive a low-impedance load.

Now that we understand the basics of how the unit operates, let's take a closer look at the circuit; follow along in Fig. 3.

The composite color-video-input signal is connected to J1 and can be looped through to J2 or terminated by JP2 into R8. The loop-through feature lets you tap into an existing setup like a home-theater without disturbing normal operation. If you're using a dedicated source, like an old VCR, you'll probably need the 75-ohm termination load.

The video is then AC coupled by C14 to IC3, an LM1881 sync-sepa-

erator chip. The composite video is also AC coupled through C13 to IC1, an MC44144 PLL that's used to lock on to the colorburst signal.

The main use for IC3 is to generate the colorburst gate signal. The sync separator strips the composite-sync signal and generates the burst-gate signal from the trailing edge of the composite-sync signal. That signal, appearing on pin 5 of IC3, is about 4.8 microseconds long with a negative-true logic; that is, it is normally high and drops low during the burst pulse.

Since we need a positive-going signal for the phase-locked-loop chip, IC2-a inverts the colorburst signal so that it's "going in the right direction."

Although they're not needed, R7 and C9 have been included so that IC3 can decode and separate out the vertical-sync signal as well. This feature, while not part of the Colorburst-Calibration Reference, makes the vertical sync available in case you need that signal for something else.

Now we get to dig into the heart of the Colorburst-Calibration Reference: IC1, the MC44144. This chip was originally designed to implement the color-sync function in a video system. The 4X-subcarrier phase-locked loop portion of the chip does exactly what we need: generate a continuous subcarrier frequency from the momentary colorburst input. When an NTSC- or PAL-format composite-video signal with a burst gate is applied, the IC will phase lock its internal voltage-controlled crystal oscillator (VCXO) to the colorburst reference. Both 4X and 1X subcarrier-frequency outputs are provided on pins 1 and 5 of IC1. The free-running frequency

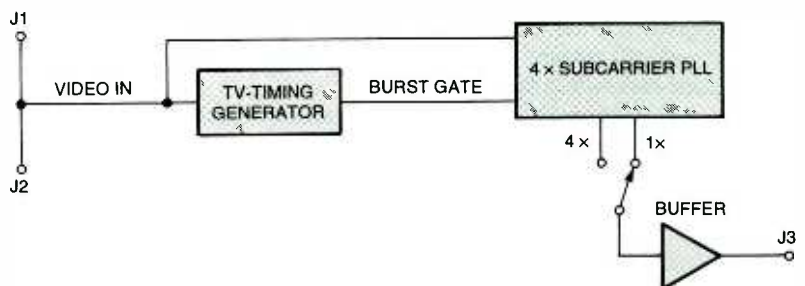

Fig. 2. To turn a colorburst reference into a continuous signal, a phase-locked loop is used to sustain the signal until the next time it is broadcast.

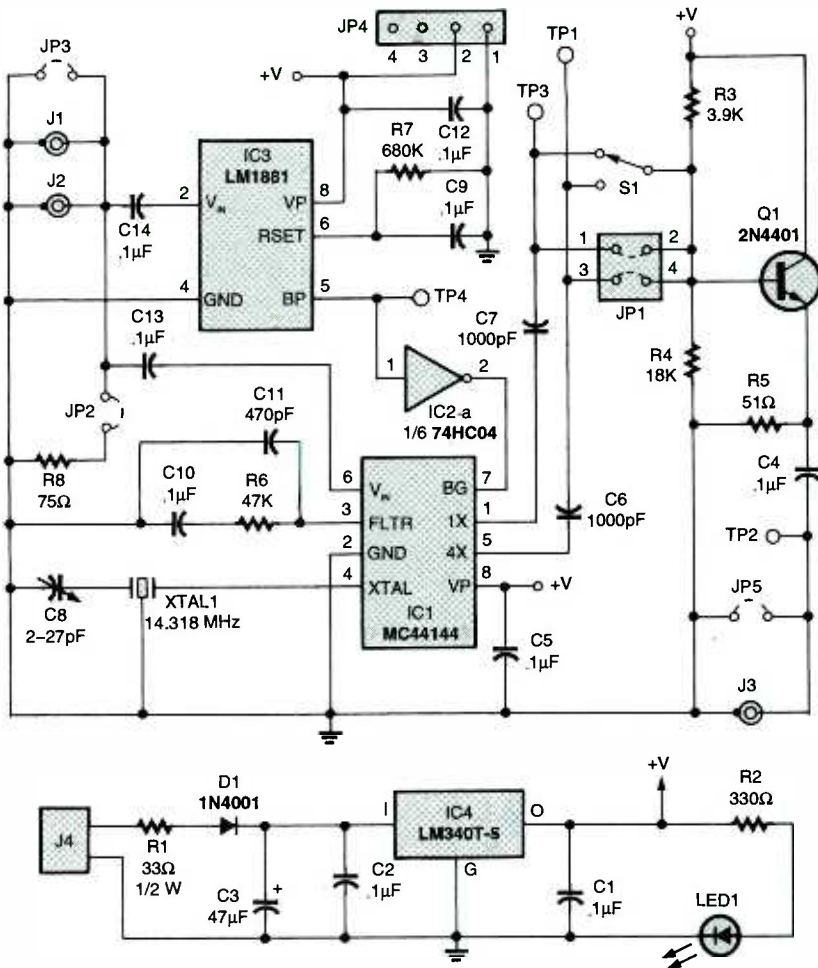

Fig. 3. The Colorburst-Calibration Reference is built around two integrated circuits: an LM1881 sync separator that indicates when the colorburst signal is present and an MC44144 phase-locked loop that holds that pulse, turning it into a continuous signal.

of the VCXO is set by XTAL1, which must be four times the desired lock-in frequency. In our case, the free-running frequency is 14.318 MHz. You would normally think that a crystal oscillator can't be adjusted, and you're right. However, varying the resonant capacitors associated with a crystal oscillator can "tweak" the frequency in either direction. In the case of IC1, the design allows for the PLL to "pull in" within a  $\pm 50$ -Hz window.

The burst-gate pulse from IC2-a tells the PLL when to sample and lock the subcarrier oscillator to the input video. You can see that the PLL is only locked for a short time during the video line: only 4.8 microseconds out of 63.5 microseconds, or about 7.5% of the time.

The phase-detector-loop filter (C11, C10, and R6) is designed to hold the colorburst frequency for the time ratio mentioned. It should

work for PAL timing as well, also; unfortunately, I have not verified that ability.

The 4X and 1X outputs from IC1 are coupled by C6 and C7 and can be selected by S1. The selected signal is buffered by Q1. The bias network of R3, R4, and R5, along with the output coupling of C4, gives the Colorburst-Calibration Reference the ability to drive a 50-ohm load, if necessary.

**Construction.** Although building the Colorburst-Calibration Reference is not critical, a PC board should be used. For added stability, a double-sided board with a full ground plane and plated-through holes is best. Foil patterns have been provided for making such a board; Fig. 4 shows the component side while Fig. 5 is the solder side. If you don't want to face the difficulties of fabricating a double-sided board your-



Once the completed Colorburst-Calibration Reference is installed in a case and closed up, it's ready to be a trusty, always-available assistant on your workbench

self, one can be purchased from the source given in the Parts List.

If you use a purchased board or one made from the foil patterns, use the parts-placement diagram in Fig. 6 as a component locator. Start by installing the small components, such as the resistors, and work up from there. Any semiconductors that are static sensitive should be installed last.

The power supply components are not necessary if you plan to supply your own 5-volt source at JP4; if not, you'll need to install IC4, C1, C2, R1, D1, and J4. Also, reference-select switch S1, power indicator LED1, and BNC connectors J1-J3 are not necessary if you use your own input and output connectors to JP3 and JP5. All of those connectors are included if you want to include the Colorburst-Calibration Reference as a part of a larger project.

If you prefer, you may use sockets for the integrated circuits. Do not install any "active" components—the ICs—at this time; we'll do that after we perform the initial power-supply "smoke" test. However, you should install IC4.

Once everything is installed, check your work for the usual manufacturing errors like missing components, polarized capacitors or diodes that are installed backwards, poor-quality or missing solder joints, and the like. If you set the board aside and come back to it

## PARTS LIST FOR THE COLORBURST-CALIBRATION REFERENCE

### SEMICONDUCTORS

IC1—MC44144P subcarrier reference oscillator, integrated circuit  
 IC2—74HC04 hex inverter, integrated circuit  
 IC3—LM1881N video-sync separator, integrated circuit  
 IC4—LM340T-5 5-volt fixed voltage regulator, integrated circuit  
 Q1—2N2222 silicon transistor, NPN  
 LED1—Light-emitting diode, green  
 D1—IN4001 silicon rectifier diode

### RESISTORS

(All resistors are 1/2-watt, 5% units unless otherwise noted.)

R1—33-ohm, 1/2-watt  
 R2—330-ohm  
 R3—3900-ohm  
 R4—18,000-ohm  
 R5—51-ohm

R6—47,000-ohm  
 R7—680,000-ohm  
 R8—75-ohm, 1%

### CAPACITORS

C1, C2, C4, C5, C9, C10, C12—C14—0.1- $\mu$ F, ceramic-disc  
 C3—47- $\mu$ F, 16-WVDC, tantalum electrolytic  
 C6, C7—1000 pF, ceramic-disc  
 C8—2.3–27-pF, adjustable  
 C11—470-pF, ceramic-disc

### ADDITIONAL PARTS AND MATERIALS

J1–J3—BNC connector, PC mount  
 J4—Coaxial power connector, PC mount  
 JP1—4-pin jumper, 2  $\times$  2  
 JP2, JP3—2-pin jumper  
 JP4—4-pin connector, PC mount  
 S1—Single-pole, double-throw toggle switch, PC mount

XTAL1—14.318-MHz crystal  
 9-volt DC, 200-mA wall-mounted transformer, IC sockets, case, wire, hardware, etc.

**Note:** The following items are available from: Gekco Labs, PO Box 642, Issaquah WA 98027-0642, 425-392-0638; [sales@gekco.com](mailto:sales@gekco.com); [www.gekco.com](http://www.gekco.com): Blank PC board, \$29; basic kit without connectors, power supply, etc., \$59; complete kit of all parts and PC board, without case, \$99; complete kit with case, \$129. Please include \$5 shipping/handling for US orders, \$10 for international. WA residents add appropriate sales tax. Visa, Mastercard and American Express accepted.

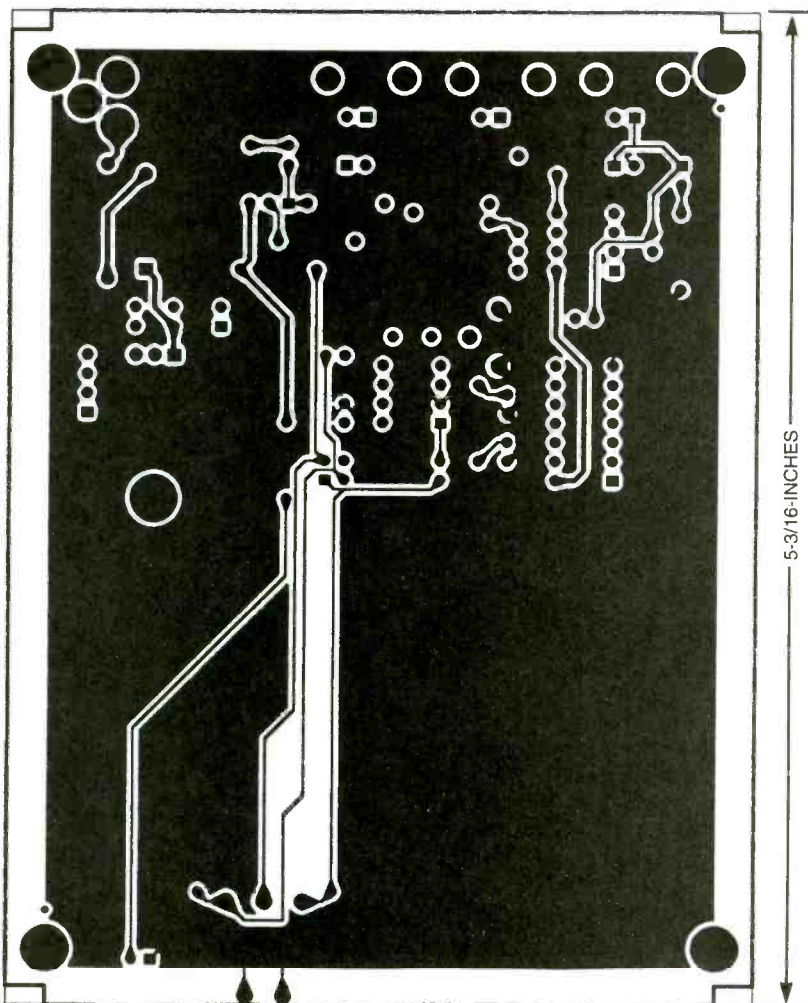

Fig. 4. Here's the foil pattern for the component side of the Colorburst-Calibration Reference. Note the large ground plane to control stray signals.

the next day, you'll be amazed at the number of errors and "stupid" mistakes that looked perfectly fine the night before. A well-rested mind is one of the best troubleshooting tools available.

**Testing The Power Supply.** Using an ohmmeter, verify that the resistance between pin 7 (negative lead) and pin 14 (positive lead) of IC2 measures greater than 2000 ohms. Connect a 9-volt DC power transformer to J4. You should see LED1 light...assuming that the transformer is plugged into the wall socket! With a voltmeter, check to see that there is 5 volts across the same two pins (7 and 14) on IC2. Again, pin 7 is ground and pin 14 is the positive voltage. If those tests pass muster, unplug the power transformer and install the rest of the ICs.

**Functional Testing.** A dual-channel oscilloscope is required for the best setup of the Colorburst-Calibration Reference. Connect a color-video-broadcast signal to J1. With a BNC cable, connect J2 to your oscilloscope's Channel 1. Use a BNC "T" connector and terminate it with a 75-ohm terminator. Set up the oscilloscope to view the colorburst signal, magnified so that the burst cycles are easily viewable.

(Continued on page 70)

## Superconductors, Part II

Last time, we discussed the fundamental properties of superconductivity. This month, we shall begin with the actual experiments.

Although we already touched on this subject, the handling of liquid nitrogen can be dangerous. For safety's sake, let's go over it one more time.

### Liquid Nitrogen

The safety recommendations that I'm going to mention here give a general outline that you should follow when handling liquid nitrogen for the superconductor experiments. These recommendations are not an exhaustive procedural manual on handling liquid nitrogen and should not be considered as a substitute for supervision of a person trained in relevant safety procedures. If a question arises, get help and advice from a person who is trained in these procedures.

First, let's recall why we're using liquid nitrogen. This substance is extremely cold, 77° Kelvin. That's equivalent to -320° Fahrenheit. Small quantities of liquid nitrogen are stored in Dewar flasks with loose-fitting lids that are certified as containers for liquid nitrogen. Dewar flasks have good insulation and can store liquid nitrogen for extended periods without the need for additional refrigeration.

When you first pour some liquid nitrogen into a Dewar flask at room temperature, it will boil furiously until the container—or more accurately, the lining of the container—drops down to a much cooler temperature. While the nitrogen is boiling furiously, some might splatter and splash out of the container. Therefore, it is important to keep the mouth of the container pointed away from people while this is happening.

I've included a sidebar with a list of general safety rules that you should follow when using or handling liquid nitrogen.



Fig. 1. Suspending a magnet above a chilled superconductor is one of the basic tests of superconductivity.

### First Experiment: The Meissner Effect

This is the classic superconductor experiment of levitating a rare-earth magnet above a superconductor. This experiment can be performed using the S1 superconductor kit; see the sidebar that lists the various kits that I offer for these experiments. The general arrangement of the experiment is shown in Fig. 1. I took a standard Styrofoam cup and trimmed the sides down to about 1/4 inch in height.

Before doing the experiment, take the rare-earth magnet and place it on top of the superconductor. Since the superconductor is not chilled with liquid nitrogen, it is not in a superconducting state, so the magnet simply rests on top of the superconductor without any apparent interaction.



Fig. 2. Related to the Meissner effect, a superconductor can be suspended below a magnet as long as it remains cold enough. Once it warms past its critical temperature, gravity takes over.

Place the superconductor in the center of the Styrofoam cup and fill the cup with liquid nitrogen—carefully! When you first pour the liquid nitrogen into the cup, it will boil furiously until the temperature of the superconductor and Styrofoam cup are reduced below the liquid's boiling point.

Bring the rare-earth magnet about 1/8 inch above the chilled superconductor. Release the magnet; it floats above the superconductor.

The magnetic field of the rare-earth magnet surrounds but does not penetrate the superconductor. The magnet generates a current in the superconductor that creates a counter-magnetic force, expelling the magnet's magnetic field.

The rare-earth magnet's magnetic field must be below the superconductor's critical magnetic field,  $HC_2$ . If the magnetic field were stronger than  $HC_2$ , it would penetrate the superconductor and extinguish the superconductivity.

### Second Experiment: Frictionless Magnetic Bearing

While the magnet is suspended above the superconductor, it can be set rotating by tapping it gently or gently blowing air on a corner of the magnet using a plastic-drinking straw. The rotating magnet will slow and eventually stop due to air resistance.

### Third Experiment: Superconductor Critical Temperature

The basic Meissner experiment may also be used to check the critical-transition temperature of the superconductor. To do so, one needs to attach a thermocouple capable of reading extremely low temperatures. A suitable superconductor-thermocouple assembly is included in the four-point probe kit; we'll talk about that in greater detail later.

Begin by placing a rare-earth magnet 55

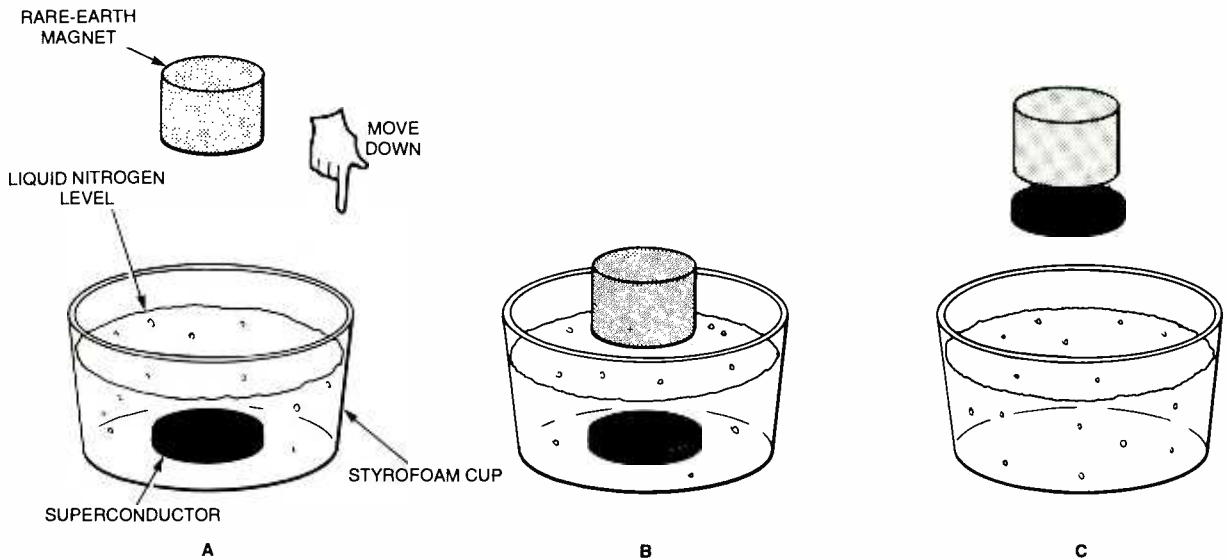

Fig. 3. To demonstrate the suspension effect, cool a superconductor (A). Bring a magnet down to a point just above the surface of the liquid nitrogen (B). When you lift the magnet, the superconductor will be suspended below it (C).

on top of the superconductor. Pour liquid nitrogen into the Styrofoam cup. Record the temperature reading from the thermocouple. Mark the temperature that the rare-earth magnet begins to float above the superconductor. That temperature is the superconductor's critical temperature.

#### Fourth Experiment: Suspension Effect

In 1988, Palmer Peters of NASA announced an unpredicted suspension effect of superconductors; see Fig. 2. Peters was experimenting with a ceramic superconductor "doped" (adding a small amount of an impurity) with silver oxide. When Peters lifted a magnet out of a dish filled with liquid nitrogen, he noticed that the small piece of superconductor that was in the dish was missing.

He found that piece of superconductor floating below the magnet.

To perform this experiment, one needs the S3 kit (again, see the sidebar). This kit contains a superconductor that has been doped with a small amount of silver metal.

The impurities in the superconductor permit a greater-than-normal amount of magnetic flux lines from a rare-earth magnet to permeate the superconductor inside the regions where the impurity (silver) exists in the superconductor's chemical matrix. The flux lines are pinned in these regions by the supercon-

ductor material surrounding the silver. Figure 3 shows a schematic of the Suspension Effect.

#### Fifth Experiment: Superconducting Energy-Storage Ring

The S6 energy-storage superconductor kit is simple to understand. The fundamental property of superconductors is its complete lack of resistance to electrical current. This property can be exploited by using a donut-shaped ring (a *toroid* is the proper term) of superconductor material to store electrical power. Once the current is induced in the toroid, its

#### LIQUID NITROGEN SAFETY TIPS

- Wear insulating gloves when handling liquid nitrogen.
- Wear safety glasses when using liquid nitrogen.
- Do not touch or allow liquid nitrogen to touch your body.
- Do not touch anything that has been immersed in liquid nitrogen until that item warms to room temperature. If you need to move an item, use plastic tweezers. I've included a pair in the superconductor kits.
- While nitrogen gas is non-toxic, it can asphyxiate by replacing the air in an enclosed space though displacement. Use liquid nitrogen in a well-ventilated area. For example, the engine compartment of the Space Shuttle is filled with pure nitrogen during launch to help

- lower the risk of explosion and fire. Several years ago, after an aborted launch attempt, some pad technicians died when they entered the Shuttle's engine compartment before the nitrogen atmosphere was ventilated; they died of asphyxiation in a matter of minutes after entering the oxygen-free compartment.
- Never store liquid nitrogen in a container with a tight-fitting lid. Pressure from the boiling liquid can build up and explode the container, sending shrapnel flying in all directions.
- Be careful not to spill, splash, or overfill liquid nitrogen. If you do, back away from it as fast as possible. Any spill on a bench will clean itself up in due course—just wait it out until it evaporates and the spill area warms back to room temperature.

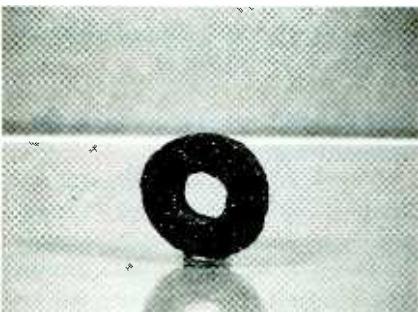

Fig. 4. A donut-shaped ring of superconductor material can circulate an electric current within it for over a thousand years as long as it remains cold enough. To start the current flow, simply pass a magnet through the central hole.



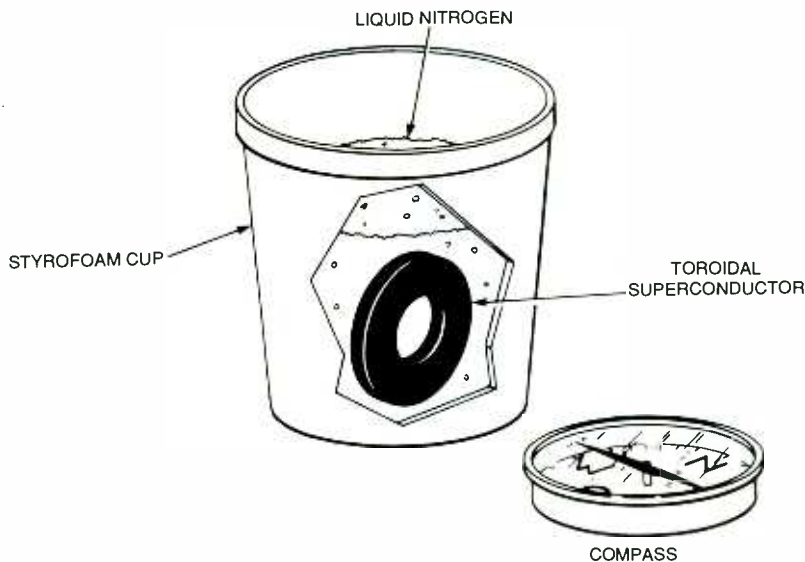

Fig. 5. A compass can show that a superconducting toroid is carrying an electric current. The magnetic field generated by the circulating current will deflect a compass needle.

lack of resistance allows the induced current to flow forever. These permanent currents in a superconductor are called persistent currents. Following standard electrical theory, the current also produces a magnetic field around the superconductor, creating a powerful electromagnet with its own power source.

The primary component in the S6

kit is a superconductor toroid as shown in Fig. 4. To perform the experiment, the toroid is completely immersed in liquid nitrogen (Fig. 5).

A current is induced in the toroid ring by passing a rare-earth magnet through the toroid's central hole. The toroid may be momentarily removed from the liquid nitrogen to perform this

### AVAILABLE SUPERCONDUCTOR KITS

#### S1 Superconductor Kit (\$33)

Demonstrates the Meissner Effect. The kit includes a one-inch-diameter  $\text{YBa}_2\text{Cu}_3\text{O}_7$  superconductor disc (90°K), a rare-earth magnet, non-magnetic tweezers, and a 36-page booklet.

#### S2 Superconductor Kit (\$42)

Demonstrates the Meissner Effect. The kit includes a one-inch-diameter  $\text{Bi}_2\text{Sr}_2\text{CaCu}_2\text{O}_9$  superconductor disc (110°K), a rare-earth magnet, non-magnetic tweezers, and a 36-page booklet.

#### S3 Superconductor Kit (\$63)

Demonstrates the Meissner Effect and Flux-Pinning Suspension. The kit includes a one-inch-diameter  $\text{YBa}_2\text{Cu}_3\text{O}_7$  superconductor disc (90°K), a flux-pinning-enhanced  $\text{YBa}_2\text{Cu}_3\text{O}_7$  superconductor, two rare-earth magnets, non-magnetic tweezers, and a 36-page booklet.

#### S5 Superconductor Kit (\$255)

Compares the Meissner Effect, Critical Temperature, Critical-Current Density, Critical-Magnetic Fields, Resistance versus Temperature, and the reverse AC Josephson effect. The Kit includes four-point probes containing  $\text{YBa}_2\text{Cu}_3\text{O}_7$  and

$\text{Bi}_2\text{Sr}_2\text{CaCu}_2\text{O}_9$  superconductors respectively, one-inch-diameter  $\text{YBa}_2\text{Cu}_3\text{O}_7$  and  $\text{Bi}_2\text{Sr}_2\text{CaCu}_2\text{O}_9$  superconductor discs, two rare-earth magnets, non-magnetic tweezers, and an experiment guide.

#### S6 Superconducting Energy-Storage Device (\$175)

Stores an electric current in a superconducting toroid. The  $\text{YBa}_2\text{Cu}_3\text{O}_7$  toroid-shaped superconductor stores a persistent electric current and magnetic field with an estimated decay lifetime of 1023 years. Superconductor storage rings are expected to find uses in space-based laser systems, electric utilities, and medical diagnostics. The kit includes a toroidal superconductor, two powerful rare-earth magnets, a superconductor disc, a detector needle, non-magnetic tweezers, and an experimenter's guide.

All of the above-mentioned kits are available from:

**Images Company**  
39 Seneca Loop  
Stater Island, NY 10314  
718-698-8305  
[www.imagesco.com](http://www.imagesco.com)

operation, then quickly placed back into the liquid nitrogen before it warms above its critical temperature.

The induced current can be detected by measuring the deflection of a compass needle held in close proximity to the superconducting toroid.

The S6 kit's experimenter's guide provides equations and procedures for estimating the current in the superconductor based on the deflection of the compass needle.

While in theory the current in the toroid should flow forever, flux creep and flux flow result in a small exponential decay of the stored electrical current. Current estimates put the decay at about 1023 years for the stored current to decrease to about 50% of its initial value. I don't think I have the spare time to try proving that theory right or wrong; do you?

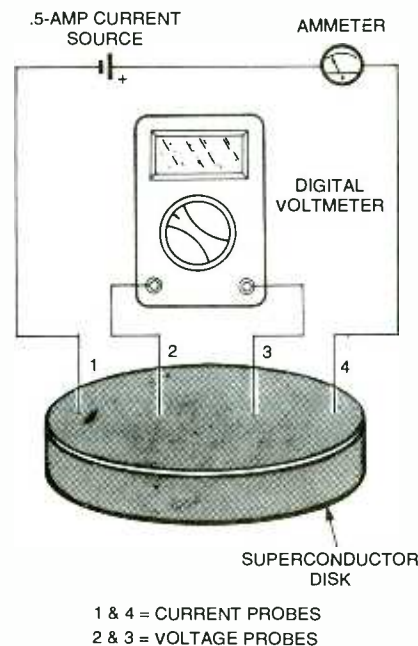

Fig. 6. A four-point probe demonstrates how the voltage drop across a superconductor drops to zero when cooled below its critical temperature.

#### Sixth Experiment: Four-Point Probe

The four-point probe is a versatile instrument that can make a number of useful measurements. We will look at one popular experiment using this device. Figure 6 is a schematic of a four-point probe; many times a thermocouple (not shown) is also included in the probe.

In this experiment, we will pass 0.5 amps through the current probes (the outer probes at the edges of the disc). We will measure the voltage drop across

(Continued on page 64)

## Building Robot Brains: A (Re) Visit With The BasicX-24 Microcontroller

**B**ack in the June, 2000 issue, we looked at the BasicX-24 microcontroller. I had intended the subject to span two columns. For whatever reason—Murphy, the Cosmic Convergence, the Men In Black, or what have you—the first part got waylaid somewhere along the line. The result is that the second part was printed but not the first part. At this point, I'm not sure which is cause for more concern: the fact that the first-part column never ran, or that no one apparently noticed!

Nevertheless, I now take pride in presenting the “lost” part of our BasicX tutorial, direct from the underground vaults of “secret knowledge!” If you read this column followed by the June installment, things should make a bit more sense.

### Little Tiny Brains

Microcontrollers are fast becoming a favorite method of endowing a robot with smarts. In fact, they're a robot-builder's dream come true. Microcontrollers are single-chip computers complete with their own input/output ports, and even memory. Typical cost of a microcontroller is from \$5 to \$15; for most, PC software is all that's needed for programming. Once programmed and disconnected from the PC, the chip operates on its own.

Microcontrollers are power misers, too: nearly all have simple power requirements (usually just 3.3 or 5 volts DC), and consume just a few milliamps for their own operation, even when running at speeds of five or 10 MHz.

Microcontrollers are available in two basic flavors: low-level programmable and embedded programmable. Those loose definitions relate to the program-

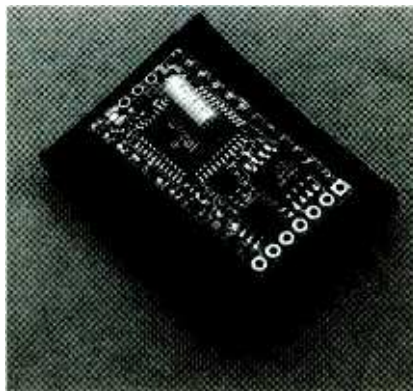

*Fig. 1. The BasicX-24 consists of surface-mount integrated circuits on a small circuit board. The BX-24 circuit board has the same dimensions as a standard 24-pin IC.*

ming of the controller. Both kinds of microcontroller are fully programmable, but one contains a kind of built-in operating system that allows the use of a higher-level language such as BASIC.

Let's talk about the low-level microcontrollers first. These types are programmed using assembly language or C, using your PC as a host-development system. Assembly language appears somewhat arcane to newcomers, but the language offers full control over the internal workings of the microcontroller. Unfortunately, there's no standard when it comes to assembly languages: the popular PIC microcontrollers from Microchip follow one language convention; microcontrollers from Intel, Atmel, Motorola, NEC, Texas Instruments, Philips, Hitachi, Holtek, and other companies may follow a different convention. The structure of the assembly language is intimately tied to the hardware design (memory access, storage registers, etc.) and resources (serial ports,

EEPROM, watchdog timers, etc.) of the microcontroller

Popular alternatives to these low-level-programmable microcontrollers are products that have a built-in programming interface, such as the Basic Stamp from Parallax or the OOPic from Savage Industries. These controllers support a high-level programming language—typically Basic—that's permanently embedded within the chip. Using your PC as a development platform, you write software for the microcontroller using a custom program editor. The software is compiled to a series of “tokens” and downloaded to the microcontroller. The tradeoff is that interpreting a token usually takes many clock cycles, slowing the microcontroller down in terms of how many tasks it can accomplish in a given amount of time. On the other hand, they're easy to program. By analogy, assembly language is a laborious description of how to handle, place, and work with bricks and mortar a single step at a time, while high-level languages simply say “build a brick wall.”

A relative newcomer to the field of embedded-programmable microcontrollers is the BasicX-24 by NetMedia, a company that previously devoted itself to home automation and small Web cameras. The BasicX-24 is actually a member of a family of microcontrollers from NetMedia, which also includes the less expensive (but network capable) BasicX-01. Since the BasicX-24 is perhaps the most versatile, I'll concentrate on just it for this column.

### Inside the BasicX-24 Microcontroller

A selling point of the BasicX-24 (hereinafter referred to as the “BX-24”) is that it is pin-for-pin compatible with

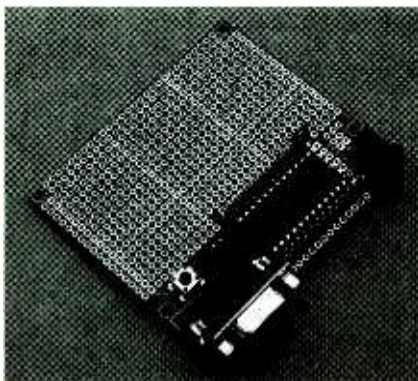

Fig. 2. The easiest way to experiment with the BX-24 is to use the carrier board included as part of the BX-24 developer's kit. The carrier board includes a DB-9 connector for hooking the system up to a PC for programming.

Parallax's Basic Stamp II. That is, the functions of all 24 pins of the BX-24 replicate the functions of the Basic Stamp II, including power and ground connections. It's important to note, however, that the BX-24 is not a Stamp "clone." The two microcontrollers don't share the same programming languages, so programs written for one will not work on the other. Moreover, the BX-24 has several additional features not found in the Basic Stamp II, such as built-in analog-to-digital conversion and 32K of EEPROM memory.

Figure 1 shows the BX-24 "chip," which, like the Basic Stamp, is actually several integrated circuits on a small circuit board. The pin layout of the BX-24 is identical to that of any standard-size 24-pin IC, so it will plug into a regular 24-pin socket. Additional plated-through holes on either end of the BX-24 board, making it just slightly longer than the Basic Stamp II, provide connections to additional input/output lines; I'll get to those in a bit.

Like the Basic Stamp II, the BX-24 directly supports 16 input/output (I/O) lines. For each I/O line or pin, you can change the data direction between input and output. When an I/O line is an output, you can individually control the value of the pin, either 0 (logic LOW) or 1 (logic HIGH). When an I/O line is an input, you can read a digital value of a TTL-compatible device connected to the BX-24. Eight of the 16 I/O lines can be used for analog connections. The BX-24 incorporates its own built-in 10-bit analog-to-digital converter (ADC). Under software control, you can indicate which of the eight input lines is an analog input.

Three of the plated-through holes of

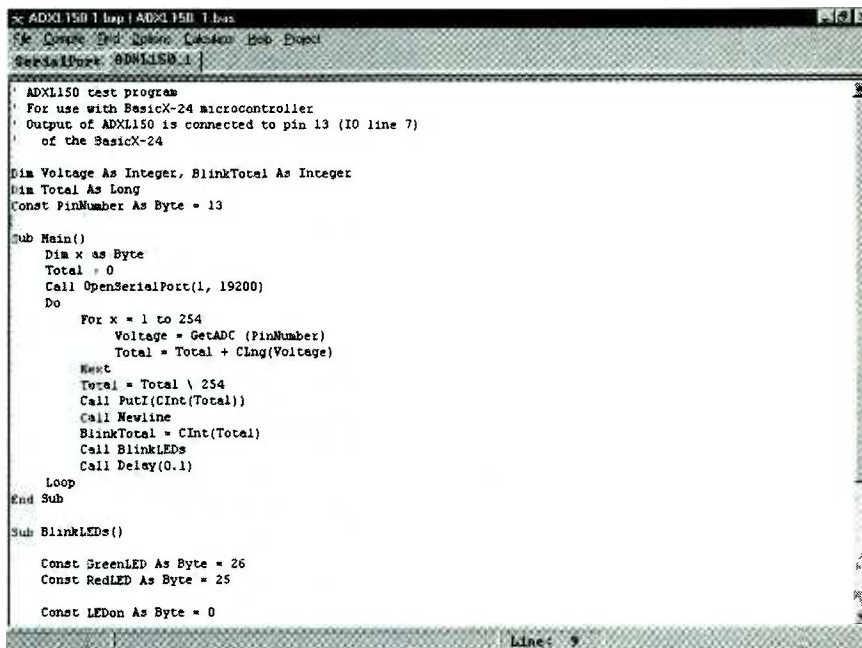

Fig. 3. Use the BasicX program editor to create, edit, compile, and (optionally) download compiled programs to a target BX-24. After downloading, you can then use the software as a debugging terminal, displaying messages sent back from the BX-24.

the BX-24 serve as optional I/O and are programmatically referred to as pins 25, 26, and 27, making a total of 19 input/output pins on the BX-24. The remaining plated-through holes provide a way to connect to the chip's serial peripheral interface, or SPI, lines. Connecting to those lines is not recommended unless you're familiar with SPI interfaces, especially as the BX-24's EEPROM is controlled by these same I/O lines.

A nice touch of the BX-24 is its two LEDs: one red and one green. The green LED is normally used to indicate power-on for the chip, but you can individually control both LEDs from your own programs. You might use the LEDs as status indicators, for example. The LEDs share two of the additional plated-through hole connectors on the BX-24.

The BX-24 board comes with its own five-volt voltage regulator, which provides enough operating current for all the components on the board, plus one or two LEDs or logic ICs. If you plan to use the BX-24 with a robot, you'll want to provide a separate power supply of adequate current rating to the robot's other components. You should not rely on the BX-24's on-board regulator for this task.

### Programming the BX-24

In order to program the BX-24, you need to purchase the BasicX-24 developer's kit, which contains one BX-24, a

programming cable, a power supply, a "carrier board" (see Fig. 2), and programming software on CD-ROM. Cost as of this writing is \$99 for the developer's kit, with additional BX-24s at \$39.95 each. You plug the BX-24 into the carrier board, which has a 24-pin socket and empty solder pads that you can use to add your own circuitry. The programming cable connects between the carrier board and a serial port on your PC. The power supply is the wall-mounted-transformer variety, providing about 12-16 volts DC.

The BX-24 uses a proprietary programming environment, which consists of an editor and a download console. The download console serves double-duty as a terminal for data sent from the microcontroller, handy for debugging your latest program. The program editor, shown in Fig. 3, supports the BasicX language, which is a subset of Microsoft Visual Basic. Don't expect all Visual Basic commands to be available in BasicX, however. BasicX supports the same general syntax as Visual Basic, and many of the same data types (bytes, integers, strings, and so forth).

If you're familiar with the Visual Basic environment, you should feel right at home with BasicX. The BasicX language supports the usual control structures, such as If/End If, While/Wend, For/Next, and Select/Case. Your BasicX programs can be subroutines, and you

## ON THE WEB

### BasicX Home Page

[www.basicx.com/](http://www.basicx.com/)

### NetMedia Home Page

[www.netmedia.com/](http://www.netmedia.com/)

can call those subroutines from anywhere in the program.

Depending on how you've used Visual Basic, however, you may discover that BasicX is far less forgiving of certain programming habits, like not dimensioning variables before they are used. BasicX uses a "strict" data-typing syntax that requires you to use the DIM statement—or one of its variations, such as CONST—to define each variable before it is used. With the DIM statement, you must also indicate the variable type, such as "Byte" or "String."

Modern versions of Visual Basic support a special type of variable called the *variant*. Variants can hold most any kind of data, allowing you to freely "mix and match" data types, such as adding an integer to a string (i.e., adding the number 1 to the name "Smith" to get "Smith1"). Apart from the dangers of introducing bugs by mixing data types, variants consume a lot of memory. They also tend to slow execution speed, as the type of variable must be determined each time it is accessed.

Visual Basic allows such variable features because memory is abundant on PC systems, and—at least with the latest machines—processor speed is fast. Conversely, memory in a microcontroller must be carefully rationed, lest it run out of it too fast. The BX-24 supports 400 bytes—that's *bytes*, not *megabytes* or even *kilobytes*—of RAM to store data. For a microcontroller, that's actually a copious amount of memory! By the way, if you're wondering, programs are stored separately in a 32K block of EEPROM, which is enough for some 8000 instructions. You'll be hard-pressed to create programs that large for your robot.

With BasicX, you must be constantly aware of each variable's data type. If you need to manipulate two variables that contain different types of data, you must remember to use the various data-conversion commands that BasicX supports. This is perhaps one of the most frustrating aspects of BasicX programming for newcomers.

A particularly nice feature of the

## BASIC-X SOFTWARE FEATURES

**Real-Time Clock.** The BX-24 contains its own real-time clock (RTC), accurate to several seconds per day. You must set the correct time whenever you power up the BX-24, but once set, you can use the RTC to measure events. For example, you can write a robot program that accurately marks the time it takes to travel from one side of a room to another. The RTC is also handy for data logging, allowing your robot to roam around the house or yard, and store data from its sensors. Coupled with the BX-24's ability to optionally store data in EEPROM, the data log will survive even if power is removed to the chip.

**GetADC and PutDAC.** These functions let you access the BX-24's eight-channel, 10-bit ADC. With the *GetADC* function, you can read a voltage level on any of eight I/O pins and correlate that voltage level with a binary number (from 0 to 1023). Conversely, you can use the *PutDAC* function to output a pulse train that will mimic a variable voltage.

**ShiftIn and ShiftOut.** With *ShiftIn*, you can receive a series of bits on a single I/O pin and convert them to a single byte in a variable. *ShiftOut* does the inverse, where you can convert a byte into a series of bits. Both functions allow you to specify an I/O pin for use as the data source, and another I/O pin for the clock. The BasicX software automatically triggers the clock pin for each bit received or sent. The *ShiftIn* and *ShiftOut* functions are particularly handy when using serially-based components, which allow you to interface with devices using only two I/O lines.

**OpenCom.** The BX-24 supports as many serial ports as you have available I/O pins. With *OpenCom*, you can establish serial communications with other BX-24 chips or any other device that supports serial-data transfer. One common use for *OpenCom* is to establish a link from the BX-24 chip back to the download window of your PC; this

window can serve as a terminal for debugging and other monitoring tasks.

**PulseIn and PulseOut.** The *PulseIn* function waits for the level at a given I/O pin to change state. One practical application of this feature is to watch for a critical button press to activate some function on your robot. *PulseOut* sends a pulse of a certain duration (in 1.085-microsecond units) out a given I/O pin. *PulseOut* is one of the most commonly used functions, used to blink LEDs, trigger sonar pings, and command servo motors to move to a new location. Note that both *PulseIn* and *PulseOut* turn off the task-switching feature of the BX-24 (several other BasicX functions behave in the same manner, because they literally "take over" the chip). Because these functions hog processor time, both can also cause errors in the real-time clock.

**InputCapture.** Somewhat akin to *PulseIn*, *InputCapture* watches for signal transition on a specific I/O pin of the BX-24. *InputCapture* can time the duration of these transitions, thereby giving you a "snapshot" of a digital pulse train, including how long each pulse lasted. One application of *InputCapture* is watching for and decoding the serial signals from an infrared remote control. The downside to *InputCapture* is that it suspends all other activity of the BX-24, effectively paralyzing it if a pulsetrain is never received.

**PlaySound.** The *PlaySound* function outputs a waveform that, when connected to an amplifier via a decoupling capacitor, allows you to play previously sampled sound that has been stored in the EEPROM. You can play back sounds at various sampling rates and control the number of times the sound repeats. The repeat function is a handy way to stretch a relatively short sound sample into a longer one—for example, the "chug-chug" of a machine motor or a series of blips.

BasicX editor is that it lets you build "projects" consisting of multiple files. For instance, you can build a library of commonly used programming functions that you may regularly use in your robotics work. When building a new program for the BX-24, you create a new project, then include any constituent files. This saves you from having to manually cut-and-paste commonly used code to make one big program file.

Advanced programmers will appreciate the ability to work with real arrays in the BX-24 environment. You can create arrays of any data type except strings or other arrays. You can then reference the elements of the array using an index

number. That feature makes it handy to manipulate such things as data streams, where you want to store a series of bytes in one compact package. A good example of this technique is used in one of the application notes that NetMedia provides for the BX-24 on their Web site. The note discusses how to use a BX-24 and a readily available infrared receiver/demodulator to capture infrared-control signals from an ordinary universal-remote control.

Before sending your programs to the BX-24, you must first compile them. This is done in the BasicX editor by choosing the "Compile" command from the Compile menu. Compiling can take

a while on slower machines, so be patient. Syntax errors are flagged and, if found, compiling stops. When you have successfully compiled the program, it's ready for downloading to the BX-24 chip. The BasicX editor or the download console can do that. After the program has been successfully compiled, it can be re-downloaded any number of times. It does not need recompiling before each download.

### Multi-Tasking with the BX-24

One of the more striking uses of subroutines is to create multi-tasking programs, a built-in feature of the BasicX operating system. In most instances, the multi-tasking is "pre-emptive," meaning that the BasicX operating system forces the activity of the central processing unit in the BX-24 microcontroller to "time slice" between each multi-tasked subroutine.

Each slice is given 1/512 of a second, more than enough to complete over a hundred instructions before moving on to the next subroutine (the BX-24 processes some 65,000 instructions per second, or about 127 instructions per time-slice). A few of the commands supported in the BasicX system suspend multitasking, as they are sensitive to timing. These include commands such as *InputCapture* (see the sidebar), which accurately measures the duration of signals received by the BX-24.

While multi-tasking is a powerful feature of the BX-24, it's not always easy to implement. For each subroutine that you wish to multi-task, you must manually calculate the amount of RAM necessary to hold data for that subroutine while the system switches. This calculation is necessary in order to allocate sufficient stack space to hold the data as the BX-24 services each task. If you underestimate the RAM requirements, your program won't work properly; if you over-estimate the requirements, you waste precious memory.

### BasicX Functions for Robotics

The BX-24 is a general-purpose microcontroller, gearing many of its built-in features toward any typical personal- or commercial-microcontroller application. Still, a number of features of the BasicX programming language, implemented as functions, lend themselves to use in robotics. To use a feature, you merely include it in your program, along with any necessary com-

mand parameters. I've detailed several of these features in the sidebar.

Note that several of these functions require you to use version 1.45 of the BasicX compiler. If you're already a BX-24 owner, you'll also need to make sure that your chip has the latest BasicX operating-system firmware embedded into it. Look (closely!) at the BX-24 board and locate the smaller EEPROM near the corner. It will have a colored dot on it. If it's red, your BX-24 contains the first release of the firmware, and you need to return the chip to NetMedia to be reprogrammed; check their site for details.

In addition to the built-in functions, you can access many of the internal hardware registers of the BX-24 chip. The BX-24 is based on the Atmel 8535 microcontroller; download the datasheet for the 8535 to learn more about the internals of this powerful chip. By controlling the hardware registers of the BX-24, you can program features that the BasicX language itself does not directly support. For example, by setting a few registers for TIMER1 (one of three timers in the BX-24), you can produce dual pulse-width-modulated (PWM) signals, useful for controlling the speed of DC motors. In a practical circuit, you will need to interface the two PWM outputs of the BX-24 to a suitable transistor or H-bridge circuit in order to provide enough drive current to run the motors.

Working directly with the hardware

### LISTING 1

```
Sub Main()
' BX-24 LED demonstration.
Const GreenLED As Byte = 26
Const RedLED As Byte = 25
Const LEDOn As Byte = 0
Const LEDOff As Byte = 1

Do
' Red pulse.
Call PutPin(RedLED, LEDOn)
Call Delay(0.07)
Call PutPin(RedLED, LEDOff)

Call Delay(0.07)

' Green pulse.
Call PutPin(GreenLED, LEDOn)
Call Delay(0.07)
Call PutPin(GreenLED, LEDOff)

Call Delay(0.07)
Loop
End Sub
```

registers of the BX-24 is not for the faint of heart, however. If you want to try this technique, first study the Atmel 8535 datasheet, as mentioned above, and learn about how the registers of the chip work. It's entirely possible to set the registers in a way that will crash the chip, rendering it inoperative. Of course, you can always reset the BX-24 and try again with a new program.

### A Sample BX-24 Program

The construction of a BX-24 program consists of at least one subroutine, called MAIN, and one or more BasicX commands. In the program example shown in Listing 1, the BX-24 flashes its red and green LEDs on and off several times each second.

Here's how the program works: The commands

```
Sub Main()
...
End Sub
```

form the main subroutine that is automatically executed when the BX-24 is first turned on or reset. You can have additional subroutines in the program, each with a different name, but as I said, you need the MAIN subroutine to get things started.

The next set of lines

```
Const GreenLED As Byte = 26
Const RedLED As Byte = 25
Const LEDOn As Byte = 0
Const LEDOff As Byte = 1
```

defines four variables using the CONST statement (similar to DIM). CONST stands for *constant* and represents a variable that will never be changed again in the program. In our example, the CONST statement defines three things:

- The name of the variable, such as GREENLED or LEDON.
- The type of variable (how many bits it requires). In all four instances, the variables are of type "Byte," each requiring eight bits.
- The value of each variable. For example, GREENLED is assigned the value of 26; LEDOFF is assigned the value of 1.

All four constants are used elsewhere in the program and serve as a convenient way to change values should it ever be necessary.

(Continued on page 68)

## VCR Control System Problems—Part 2

**V**CR control-system failures are responsible for a large number of VCR problems. We started looking at the problems and their solutions last month. The range of problems is so large that we were unable to cover them all. This month, we will pick up where we left off and look at some more control-system problems that can put your VCR out of commission.

### VCR Is Failing The Power-Up Sequence

This often means that the internal microcomputer found the mechanism in an unusual state and was unable to reset it. Some VCRs will actually move portions of the mechanism to make sure that everything is OK to accept a tape. Failure here might be the result of a slipping or broken belt, a belt that has popped off its pulleys, gummed-up lubrication, or some other mechanical fault. Age is also a factor—rubber parts tend to become smooth and lose their elastic properties over time. Does the VCR make any kind of whirring sounds before shutting down? This could mean that it is attempting to move something back into position. Is there a tape in the machine? How about a toy, a peanut-butter-and-jelly sandwich, or a little applesauce? It could be a sensor or other electronic problem, but check out the mechanical possibilities first.

After you are sure that the VCR has been cleaned and that the rubber parts are good, check the end-of-tape sensor. This device, as we have mentioned before, is a light or infrared LED in the middle of the mechanical assembly that detects the end of tape. When a tape is loaded, the tape will cover the sensor. The controller can tell if the tape is at the beginning, middle, or end because of the clear leader at the beginning and end of the tape; light hitting the sensor from the appropriate side is all that's needed.

The microcontroller will report a problem if the sensors detect no light (a "middle-of-the-tape" condition) when the carriage assembly is up (no tape loaded); both sides should be detected. In that case, the VCR will shut down. If this happens, these procedures can help you find and repair the problem.

If you have an incandescent light that's not lit, it is burned out. If you have the LED type, you can buy an IR tester from an electronic-parts supplier or construct one for yourself. Replacement LEDs are readily available.

The VCR might be in a "confused" state. Many VCRs have a belt that drives a loading motor. This motor drives the tape around the heads. If those guides are not fully retracted, the VCR shuts down. Check the belt and replace it if necessary.

Ensure that the tape guide assembly is fully retracted by physically turning the appropriate gears.

Some obstruction might be preventing part of the mechanism from resetting. Visually inspect for foreign objects or rough edges on something preventing full movement. Dried-up grease can also cause this.

A gear can slip a tooth and one part of the mechanism does not track another. This may happen if a tape was forcefully ejected after being eaten. You might find that a tooth has actually broken off.

If the problem occurred after you've disassembled part of the mechanism, confirm the timing relationships. Make sure that the belts are installed in the correct locations—and on the correct sides of any intermediate pulleys where belts link more than two pulleys.

Without a service manual, determining the correct relationships for all of the gears might be impossible. But if only one has slipped, you might be able to locate timing marks near the edges of the gears that should line up—usually

when the tape is unloaded. (Portions of the above suggestions are thanks to [michael@marconi.nsc.com](mailto:michael@marconi.nsc.com).)

### VCR Displays DEW Warning

Your VCR has worked fine for several years, but now you get the "DEW" warning in the display and no tape functions work. The DEW sensor is intended to prevent operation of the tape transport if the humidity is so high that moisture would build up and cause the videotape to stick to the rotating drum and damage the heads or get hopelessly tangled as a result.

First, perhaps the DEW warning is telling the truth. If you have just moved the VCR from a cold area to a warm one, let it sit for an hour or so and see if the DEW warning goes away. If you just fished it out of the toilet or scraped stewed peaches from the interior, well, DEW may be the least of your problems.

If there is no apparent reason for a DEW warning, the DEW sensor might be bad or have changed value. There may or may not be an adjustment for this. Before you go inside, try unplugging the VCR to clear any spontaneous fault condition.

The DEW sensor is a resistor that changes value when there is condensation. If the sensor is bad, you should be able to replace it with a resistor and keep the VCR happy. You should be able to determine the appropriate resistance by trial and error. If it is the type where the resistance decreases with moisture and the controller does not care if the resistance is too high, then you can just remove it. Either way, this is just a temporary "band-aid" fix; you have now lost the protection that the DEW sensor provides. Replacement is obviously best.

Don't overlook the possibility of a bad connection—it might be plugged in and just need to be reseated. One type that I have encountered looks like a ceramic board, maybe ¼- to ½-inch on a

side with a silver/gray printed-circuit pattern on it.

### VCR Shows "LOCKED" In The Display

You try to play a tape and the VCR displays the word "LOCKED," or perhaps just a flashing "L" or "PL" on the display. This might mean that the VCR has somehow been programmed to prevent use by unauthorized children. Even if your model does not have this feature, the same basic chassis is probably used for a range of models, so it could have gotten into a confused state.

Sometimes, just pressing the PLAY, POWER, VCR1, VCR2, or other much more obscure button on the remote control (it might be designed not to work from the front panel) for 10 to 20 seconds will clear this mode. Some remotes have a little "key" symbol. How logical! Press it.

Unplugging the VCR for a minute or two may work. Unplugging for long enough to drain the backup battery will probably work, but you may then need to reinitialize the clock, channel selection, and programming.

The best bet is to check your instruction manual...you *can* locate your instruction manual, right?

### VCRs With Alzheimer's Disease

Suppose your just-out-of-warranty VCR is now acting up for no apparent reason—making strange sounds, forgetting its programming, refusing to cooperate, etc. I don't know what kind of recourse you may have as an unsatisfied consumer, but I would try to get some resolution through your place of purchase. Such a VCR has all the symptoms of Alzheimer's disease—it should not be failing in these ways so early in life unless it is under penalty of hard labor in the damp, snake-infested dungeon of an English castle, or it has been the depository for peanut-butter-and-jelly sandwiches, applesauce, or marbles!

All the usual recommendations of cleaning and checking rubber parts and so forth apply to units that have seen significant use, are a few years old, or both. Something this new under normal use should not be causing this amount of grief. However, sometimes I wonder whether using a machine very little contributes to problems.

First, try your place of purchase—there may still be some degree of interest in maintaining customer satisfaction. If you have given up on the store, start by checking the rubber parts for dust and deterioration. With that kind of use,

dirt should not be a problem, but dust or smoke can accumulate. Check for adequate lubrication, but don't add any unless it is definitely needed and then only the smallest amount. VCRs do not need much oil or grease; too much will just compound your problems. Remember to check for foreign objects—especially if there are small kids about.

### VCR Has Gone "Whacko"

You might think that you are on the set of the latest sci-fi movie. The VCR displays are counting at random, pushing buttons produces unexpected results, motors might be spinning, or the VCR might be repeatedly loading and unloading a non-existent tape. It might be attempting to play a tape even without you pressing any buttons. While these could be symptoms of an actual problem, first try unplugging the VCR from the wall outlet—don't just turn it off—for a minute or so. If this does not help, try unplugging it for a couple of hours. This will usually drain the backup battery and reset many other functions of the VCR.

If one of those techniques results in the universe returning to normal, there might have been a power surge or lightning strike nearby that threw the microcontroller into a confused state. It may never happen again. However, power surges can be the result of heavy appliances like air conditioners on the same circuit. If this is the case, you should consider using a different circuit for

your electronic equipment.

If this behavior started when the VCR was just plugged in or following some other action requiring the mechanism to move or initialize, check for mechanical problems like a broken belt or one that has popped off its pulleys, or an obstruction like a rock or toy that is preventing the VCR from completing the required motions.

Once you have ruled out mechanical problems, it is likely that the VCR has a microcontroller, power-supply, or other electronic problem that may require professional service.

### VCR Forgets Settings

Normally, the AC line provides power to retain the clock, active channels, and programming settings. During a power failure, the clock and programming is usually powered using a "supercap" or battery (usually rechargeable). Channel settings for older style varactor-type tuners were often stored in some kind of non-volatile memory while active channels for quartz tuners generally use battery backup.

As I just mentioned, the clock and programming backup might be a supercap—a very high-value special electrolytic capacitor that's as large as one Farad (1,000,000  $\mu$ F) and rated at somewhere between 5 and 12 volts. Alternatively, it might use a rechargeable NiCd battery. In either case, these are easily replaceable with standard parts. A NiCd battery pack of similar ratings should be readily available. Supercaps are available from large electronics distributors.

NiCd batteries fail in two ways: loss of capacity or shorted cells. If memory is retained for a much shorter time than it used to, then the battery has probably lost most of its capacity. See if you can determine how many individual cells make up the battery pack. Take that number and multiply it by 1.2 volts. If you measure less than that with a DC voltmeter after the pack has been charging for awhile, there is likely a shorted cell. In either case, the best solution is a replacement, though the various common techniques for rejuvenating NiCd battery packs can be attempted. If you want to try one of those methods, remove the battery from the VCR first! The last thing you want is to fry the electronics with higher than normal voltages or shrapnel from an exploding battery!

The non-volatile memory could use a special chip like EEPROM that does not require power, a battery-backed SRAM, or

VACUUM-FLUORESCENT DISPLAY PINOUT	
Pin 1:	Filament 1A
Pin 2:	Filament 1B (Tied together)
Pin 5:	Grid 6
Pin 6:	Grid 5
Pin 7:	Grid 4
Pin 8:	Grid 3
Pin 9:	Grid 2
Pin 10:	Grid 1
Pin 11:	Grid 0
Pin 12:	Segment 8
Pin 34:	Segment 7
Pin 35:	Segment 6
Pin 36:	Segment 5
Pin 37:	Segment 4
Pin 38:	Segment 3
Pin 39:	Segment 2
Pin 40:	Segment 1
Pin 41:	Segment 0
Pin 44:	Filament 2A
Pin 45:	Filament 2B (Tied together)

could be internal to one of the VCR's microcontrollers. Channel memory might use a separate power source from the clock and programming. A Lithium battery would be a good choice from an engineering standpoint since it is undesirable for the channel settings to be forgotten, even if the VCR is unplugged for a month or more; it is such a pain to reinitialize them. Rechargeable batteries have too high a self-discharge rate.

### The Display Is Dim

Where the display works but is dim, there can be several causes. Some VCRs have a "night mode" that dims the display after, say, 10:00 PM. Check to be sure that you don't have the clock's AM/PM indicator set incorrectly. There is usually a way to disable this feature, depending on the model.

If the VCR has been used in a location where there are heavy smokers, whatever tar and nicotine that somehow avoided getting trapped in their lungs may have been deposited on the front and rear surfaces of the plastic display window and on the front of the display tube. Remove the front panel and use alcohol and a soft cloth to thoroughly clean all of these surfaces.

The VCR might have seen a long, active life. Like CRTs and other vacuum tubes, cathode emissions and phosphor brightness can degrade over time. There is nothing much that can be easily done to remedy this other than replacing the display. That, unfortunately, is usually an expensive and difficult procedure, even if you can get a replacement display for an old VCR.

The filament or anode voltage might be low or faulty due to a bad connection, a dried-up electrolytic capacitor, or other power-supply problem.

### The Display Is Dead, But Everything Else Works

This usually means that one or more of the voltages to the vacuum-fluorescent display (VFD) are missing or that the display controller is bad. If the front panel suffered physical damage, the display tube, circuit board, or other components could be damaged.

The VFD is usually designed to operate in a multiplexed mode to minimize the number of pins and drivers needed in the circuit at the expense of more complex logic, but that is all inside the system-controller chip, anyhow. Thus, there are "segments" that correspond to the portions of each character and individual symbols and grids that enable each character or group of symbols. Like a multiplexed LED display, the segments correspond to rows and the grids to columns. The filament, grid, and anodes operate in the same manner as in a vacuum tube or a CRT, for that matter. A typical VFD might have 9 segments and 7 grids for a total of 63 possible individually-controlled displayed items.

The filament requires 2 to 6 volts AC. Each of the segment lines is sequentially pulsed to about 30 volts or more while the appropriate set of grids are pulsed positive to enable the desired combination of displayed items.

As an example, I've included the pinout for a typical VFD in the sidebar. That pinout is from a Sharp VCR. All other pins

are either not present or not connected. While specific pinouts for each VFD device are likely to differ somewhat, the general arrangement appears to be similar—filaments on the ends, grids mostly on the low-numbered pins, a gap with no pins or unconnected pins, and the segments on the high-numbered pins.

Remove the front panel and, with the VCR plugged in, turn out the lights, and inspect the filament. Several very fine wires run the length of the display. They should be glowing a very faint red-orange. If you see nothing, the filament voltage is likely missing. Filament voltage might come directly from the power transformer (if a non-switching type power supply) or be one of the DC outputs of the supply.

Check around the VFD for the (approximately) 30 volts DC. If you have an oscilloscope, look for pulses on the pins of the VFD. If the 30-volt supply is missing, there will be nothing displayed. In some VCRs like those manufactured by Hitachi, a separate DC-DC converter module provides power for the display only.

Look for bad connections, open resistors, blown IC protectors or fuses, etc. Of course, if the VCR has an on-screen display, you will be no worse off than many newer models that have done away with the front panel VFD entirely!

Once again, we've run out of space. For such an inexpensive device, VCRs seem to be filled with possible problems. Until next time, feel free to check out my Web site at [www.repairfaq.org](http://www.repairfaq.org). I welcome e-mail comments and questions sent to the address at the top of this column. See you again next time. P

---

## AMAZING SCIENCE

*(continued from page 57)*

the superconductor material from probes 2 and 3 using a digital voltmeter with a resolution of 0.01 mV.

Before the superconductor is chilled, record the voltage-drop reading across the inner probes. Next, chill the superconductor with liquid nitrogen. When the material cools down past its critical temperature, it enters its superconductor state. Now the voltage reading across the inner probes should drop to zero volts.

If a thermocouple is part of the four-point probe, the temperate reading from the thermocouple at that electrical transition can also be recorded. This will be the critical-transition temperature of the

superconductor.

Note that with ceramic superconductors, the transition temperature is not a singular value, but usually varies over a five-degree range.

### Future Experiment: Gravity Shielding?

If you talked to scientists about anti-gravity a few years ago, they'd say that such a concept is pure science fiction. That may have changed about 10 years ago when Eugene Podkletnov, at Finland's Tampere University of Technology, noticed a gravity-shielding effect when experimenting with superconductors.

The experiment that Podkletnov conducted was to magnetically levitate a large (about 12 inches in diameter) YBa<sub>2</sub>Cu<sub>3</sub>O<sub>7</sub>

superconductor disc while rotating it at several thousand RPM. Any object held above that rotating superconducting disc supposedly lost anywhere from 0.5% to 2% of its mass (weight).

Pure fiction? The jury is still out. Nevertheless, NASA and a number of universities have been investigating this phenomenon for the last few years. NASA started the Delta-G experiment, led by scientist David Noever at the Marshall Space Flight Center, to verify Podkletnov's claims.

If you would like to see additional columns on superconductor experiments, or perhaps you're conducting your own gravity-modification experiments, write and let me know at the address given at the top of the column. P



## Testing, Testing... 1, 2, 3...

This time around, I'd like to share with you a number of basic testing circuits that are easy and inexpensive to build and, more importantly, useful in determining the condition and value of various electronic components we often use in our circuit experiments and projects. We'll look at a circuit that will help determine a Zener diode's operating voltage, a testing circuit that will help to identify the anode and cathode leads of a diode, and a transistor checker that will determine if a transistor is an NPN or PNP type. These are just our first three stops on the "circuit train," so hop on board and we'll see what's farther down the track.

### First Stop: Zener-Diode City

Zener diodes are available with many different voltage and power ratings. The 400-mW and the 500-mW series, with an operating voltage of 3.3 to 24 volts, are the ones most often used. Our zener diode checker (Fig. 1) will indicate the operating voltage of Zeners that are rated up to 25 volts; the circuit can easily be modified to check higher-voltage Zeners.

The Zener checker uses three standard 9-volt batteries connected in series to supply the circuit's operating voltage and three resistors to limit the test current. A four-position rotary switch selects the testing-voltage range, and a digital or analog voltmeter indicates the Zener's operating voltage.

Using the Zener checker goes like this: Set S1 to the "off" position and connect the Zener diode to the test terminals with the diode's anode (not the band, which is the cathode) to the "B" test terminal; the cathode goes to the "A" terminal. If a digital auto-ranging voltmeter is used, just set it to read DC voltage and continue on, but if an analog meter is used, set the meter's selector switch to its lowest voltage range; that

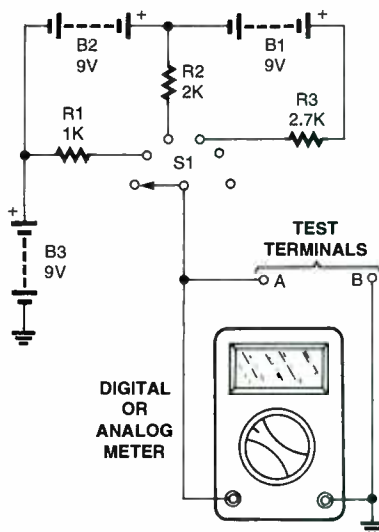

Fig. 1. To test a Zener diode, select the appropriate voltage with S1; the Zener voltage is measured with a voltmeter.

will keep the voltage readings in the upper 25% of the meter's voltage range. If possible, always go with the digital voltmeter because it is much simpler and definitely more accurate.

Rotate S1 to its first position. If the meter reading is less than 9 volts, that's the voltage rating of the Zener. If the reading is 8 volts or greater, rotate S1 to the second position and check the meter reading. Always go to the next higher switch position if the meter reading is near the actual test voltage for that switch position.

Higher-voltage Zeners may also be tested with the circuit by adding more 9-volt batteries in series. Also, a current-limiting resistor must be added, just like R1-R3, between each added battery and the selector switch. The circuit is set up for a maximum test current of about 10 milliamps in each switch position. That comes out to about 100 ohms per volt. Adding another 9-volt battery in series with the other three will raise the total voltage to 36 volts. We'll multiply 36 times

### PARTS LIST FOR THE ZENER-DIODE CHECKER (FIG. 1)

#### RESISTORS

(All resistors are 1/4-watt, 5% units.)

R1—1000-ohm

R2—2000-ohm

R3—2700-ohm

#### ADDITIONAL PARTS AND MATERIALS

B1-B3—9-volt battery

S1—Single-pole, six-position rotary switch

Digital or analog meter, test terminals, wire, hardware, etc.

100 to obtain the needed series-resistor value, which is 3600 ohms.

The nearest available 5% resistor value is either 3300 ohms or 3900 ohms, so I would go with the lower value, which will only raise the maximum short-circuit test current to about 10.9 milliamps.

### Next Stop: Diode-Tester Junction

Our next test item is the diode-lead-decoder circuit of Fig. 2. This device indicates which end of the diode is the anode and which end is the cathode. The tester will also indicate a shorted or open diode. This tester is AC powered with a 12-volt wall-mounted transformer. These plug-in transformers are plentiful and are available from many suppliers for only a few bucks. First, check out your closets and junk box before going out to buy one, because around here they seem to multiply like bunny rabbits. Any plug-in transformer with an AC-output voltage of 8 to 14 volts AC will do. The transformer's current rating can be as little as 50 milliamps.

Here's how the diode decoder operates: The transformer's output is fed to two half-wave rectifier circuits. Diode

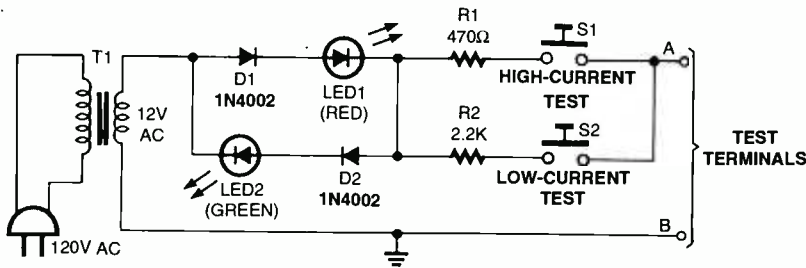

Fig. 2. This diode tester can check for both open and shorted diodes as well as tell you which ends of the diode are the anode and cathode. That feature is handy if you have a "bargain pack" of diodes that don't have bands painted on them. Choose the test current appropriate to the device that you're testing.

### PARTS LIST FOR THE DIODE TESTER (FIG. 2)

#### SEMICONDUCTORS

D1, D2—1N4002 1-amp silicon-rectifier diode  
 LED1—Light-emitting diode, red  
 LED2—Light-emitting diode, green

#### RESISTORS

(All resistors are 1/4-watt, 5% units.)  
 R1—470-ohm  
 R2—2200-ohm

#### ADDITIONAL PARTS AND MATERIALS

S1, S2—Single-pole, single-throw, normally-open pushbutton switch  
 T1—12-volt AC wall-mounted transformer (see text)  
 Test terminals, wire, hardware, etc.

D1 allows the transformer's positive-output voltage to pass to the test terminals; D2 does the same for the negative-output voltage. Each half-wave rectifier circuit has an LED that indicates when current is flowing through that half of the circuit. The red LED indicates a positive current flow, and the green LED indicates a negative current flow.

Resistors R1 and R2 limit the current flow through the diode under test. The maximum test current for S1 is about 34 milliamps, and for S2 it's about 7 milliamps. Most rectifier diodes can easily

handle 34 milliamps as can many signal diodes. To be on the safe side of Murphy's Law, check the smaller and signal diodes with S2 and the larger diodes with S1.

The simple magic of the diode-decoder is in the LEDs. Take a diode and connect it any way you like to the test terminals. Press one of the switches. If the red LED lights, the diode's anode is connected to the "A" terminal; if it's the green LED, the anode is on the "B" terminal.

Follow the current path of the circuit. To light the red LED, both it and the diode under test must point in the same direction. The green LED works the

### PARTS LIST FOR THE TRANSISTOR CHECKER (FIG. 3)

#### SEMICONDUCTORS

D1-D4—1N914 silicon diode  
 LED1—Light-emitting diode, red

#### RESISTORS

(All resistors are 1/4-watt, 5% units.)  
 R1—470-ohm  
 R2—22000-ohm

#### ADDITIONAL PARTS AND MATERIALS

B1, B2—9-volt battery  
 S1—Single-pole, double-throw, center-off toggle switch  
 Test socket or terminals, wire, hardware, etc.

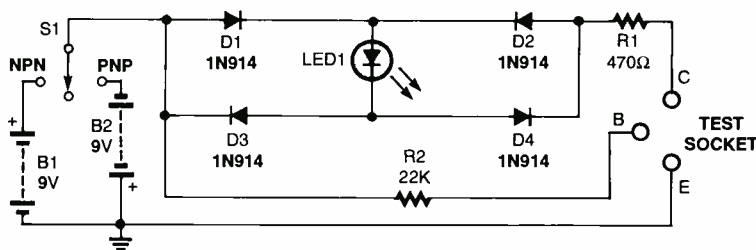

Fig. 3. This simple transistor tester will help you determine the transistor type (NPN or PNP) as well as the various terminal designations.

same way in its direction. A shorted diode will cause both LEDs to light and an open diode will keep them extinguished. A poor-quality diode with a high reverse leakage can cause both LEDs to light with one brighter than the other. In addition, checking a Zener diode can have the same results. Don't automatically toss a diode because it lights both LEDs. Check it out with our Zener checker and see if it turns out to be a good Zener and not a bad rectifier diode.

### Station Stop: Transistor Heaven

Our next handy-dandy tester circuit, as shown in Fig. 3, will let you know if you have an NPN- or a PNP-type transistor. It will also let you know if the transistor is shorted or open. With a little extra effort, it will help identify the emitter, base, and collector leads. The checker places the transistor under test in a basic common-emitter-amplifier circuit. The transistor's base and collector are connected through separate resistive paths to one battery polarity, and the emitter is connected to the opposite polarity. PNP transistors require a negative base and collector voltage to function while NPN devices need positive base and collector voltages to operate. The transistor's base current is limited to about 380 microamps, and the collector to about 10 milliamps.

With a good NPN transistor correctly configured in the test fixture (that is, with the emitter connected to the "E" terminal, the base to the "B" terminal, and the collector connected to the "C" terminal), the LED will only light when S1 is in the "NPN" position, which connects the test circuit to the positive supply. Switch S1 must be in the "PNP" position for the same to occur with PNP transistors. Diodes D1-D4 are connected in a bridge circuit so that the LED will always receive the correct polarity when current flows through R1 and the transistor's collector. Most of the time you can determine the transistor's lead arrangement by swapping the leads around and testing it in each position until the LED lights. Again, don't toss a transistor just because it fails the transistor-type test, as it could be some other type of semiconductor device.

### All Aboard For Resistance Measuring

Our next step (Fig. 4) is a circuit that will make reading low-value resistors much easier than using a generic VOM. You can also check the resistance of

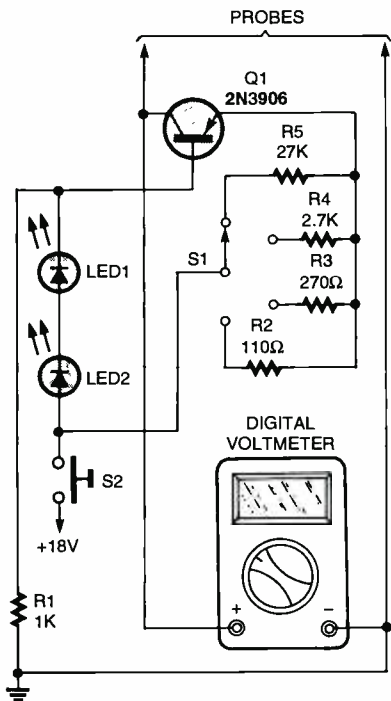

Fig. 4. If you need to take very low resistance measurements, this circuit will extend and enhance the capabilities of your ohmmeter.

motor windings, transformers, inductors, and other low-ohmage components. The typical ohmmeter is limited, by its very own test lead resistance, in making accurate resistance readings below one ohm. If you pass a known current through an unknown resistor and can accurately read the voltage drop across the resistor, you have all the information necessary to determine the resistance value. Just plug those values into

$$R = E/I$$

or the resistance equals the voltage divided by the current. A current flow of 10 milliamps and a voltage of 0.1 volt

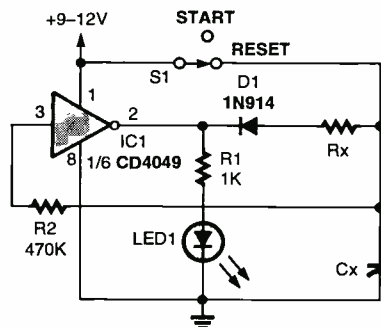

Fig. 5. With the appropriate choice of values for Rx and Cx, this timer can be set for hours or maybe even days!

### PARTS LIST FOR THE LOW-RESISTANCE MEASUREMENT ENHANCER (FIG. 4)

#### SEMICONDUCTORS

Q1—2N3906 silicon transistor, PNP  
LED1, LED2—Light-emitting diode, red

#### RESISTORS

(All resistors are 1/4-watt, 5% units.)

R1—1000-ohm

R2—10-ohm

R3—270-ohm

R4—2700-ohm

R5—27,000-ohm

#### ADDITIONAL PARTS AND MATERIALS

S1—Single-pole, four-throw rotary switch

S2—Single-pole, single-throw, normally-open pushbutton switch

Probes, digital voltmeter, wire, hardware, etc.

gives a resistance figure of 0.1/0.01, or 10 ohms. As long as the current is kept constant at 10 milliamps, the meter will indicate resistance values as 1 ohm per millivolt. A 100-ohm resistor would read 100 millivolts, and a 1-ohm resistor would read 1 millivolt. Unlike most analog ohmmeters, this circuit produces a linear readout. Just look at a typical analog ohmmeter scale and you'll see what I mean. To increase the circuit's accuracy and the millivolts-per-ohm output, the current level must be increased. Increasing the current level ten times—to 100 milliamps—will also increase the

### PARTS LIST FOR THE LONG-DURATION TIMER (FIG. 5)

#### SEMICONDUCTORS

IC1—CD4049 CMOS hex-inverting buffer, integrated circuit

LED1—Light-emitting diode, any color

D1—1N914 silicon diode

#### RESISTORS

(All resistors are 1/4-watt, 5% units.)

R1—1000-ohm

R2—470,000-ohm

Rx—See text

#### ADDITIONAL PARTS AND MATERIALS

Cx—See text

S1—Single-pole, double-throw switch

Wire, hardware, etc.

millivolts per ohm to 10.

A single transistor in the Fig. 4 circuit is connected as a simple constant-current generator. The current flow through the transistor's collector is determined by the current flow in the emitter. The emitter current is determined by the value of R2–R5. Two LEDs are used to produce a constant-reference voltage for the transistor's base circuit. That is necessary in keeping the current through the emitter constant. The collector current is almost the same as the emitter current minus the small base current.

Setting up the circuit to produce the best possible accuracy is easy. Connect an accurate current meter between Q1's collector and ground and set S1 to position "A." The value of R5 will be close to 27,000 ohms and the output current near 100 microamps. Close S2 to activate the circuit. If the current reading is too low, decrease the value of R5. Likewise, if the current is too high, increase the resistor's value. Decreasing the resistance value can be accomplished easily by paralleling high-value resistors across R5; add low-value resistors in series with R5 to increase the value. The current level for switch position "B" is 1 milliamp, position "C" is 10 milliamps, and position "D," 25 milliamps. The current level for position "D" can be increased to 100 milliamps by lowering the value of R2. At this higher current level, the transistor can be damaged or cooked if S2 is closed for more than a brief time. One solution would be to substitute a medium-power Darlington transistor for Q1 and recalibrate the circuit. You can learn a lot by experimenting, so give it a try!

### Change Here For Accurate Timers

I have one more circuit that I would like to share with you this visit although it is not a testing circuit. The circuit in Fig. 5 is a simple timer circuit that uses a single CMOS inverting buffer and a few assorted components to make a simple and interesting timer. In most simple timing circuits, a capacitor is set up in a charging circuit. When the voltage across the capacitor reaches some predetermined voltage, the timer "times out." There is nothing wrong with that method of marking time as long as the capacitor's internal leakage isn't too high. In timing circuits with very brief timing periods, this is usually not a problem but for extended timing peri-

ods, this internal-leakage factor is the single most important limit to accuracy.

If we just turn the process around and use a fully charged capacitor and discharge it at a near-constant rate, the internal leakage can be figured in as part of the discharge resistance. We all know that given enough time, all charged capacitors will eventually discharge. Even a very leaky capacitor will time out in a discharge circuit but might never make it to the necessary voltage level in a charging circuit to complete the timing cycle. Of course, a capacitor with high leakage should never be used in any charging/discharging timer circuit.

Here's how our simple discharge

timer operates. The circuit in Fig. 5 shows the timer in a ready or standby condition. The inverter's input is at the positive-supply level, and the output is at or near ground. Switching S1 to the "START" position allows the capacitor to begin its discharge cycle through Rx, D1, and the "on" resistance of the CD4049 inverter. When the voltage across the capacitor falls to about three volts, the output of the CD4049 switches from low to high, lighting the LED to indicate that the timing cycle is completed. Diode D1 keeps the positive output at pin 2 from slowly recharging the timing capacitor back up. The cycle may be repeated by temporarily switching S1 to

its "RESET" position and then back to "START" to start the timing cycle over.

Here are some values of capacitors and resistors to get you started in setting up your very own timer. A delay time of about 35 seconds can be expected with Rx=1 megohm, and Cx=47 µF, or with Rx=10 megohm and Cx=4.7 µF. Much longer time periods can be had by going to much higher values of capacitors. This is a good circuit to enjoy experimenting with to see just how long a time period can be obtained.

Last stop; everybody off, watch your step when leaving the column. I thank you for riding the Basic Circuitry Railroad today, and look forward to serving you again next month. **P**

## LETTERS

(continued from page 27)

### LP to CD Applause

I have devoured your "Computer Bits" columns on "Converting LPs to CDs" (**Poptronics**, March and April 2000), and I have a couple of questions. Is it necessary to use an intermediate amp to equalize and amplify the analog audio or could the audio be derived from the changer? I suspect that the amplifier is required.

Does the Adaptec program include a provision for input-level control? It isn't clear just how the hard drive output is introduced to the CD burner. I have been looking at HP's *CD-Writer Plus*

8250, which includes a burner and the Adaptec software and is locally priced at \$189.99. Except for the CD-Rs, will I have a complete package?

BOB REED

via e-mail

Yes, the pre-amp is necessary to both boost and equalize the output from the turntable. At least it was with my setup. The level of output from older magnetic phono cartridges is very low, and just jacking it into the line-in connector on your PC's sound card won't work. There's also an equalization curve that was applied in recording a vinyl record that needs to be accounted for. That was the reason for my running around.

However, lots of "DJ"-style setups

with a mixing board actually have line-out connectors that can be directly jumpered to a sound card's input.

As far as what's going on with the hard disk, the software (Adaptec or other) converts the input to the sound card into a .WAV file, which is stored on the hard disk. When you're done recording the LP, *Easy CD Creator* burns those files to the CD-R.

Assuming that you have a turntable that's amped enough to drive the sound card, the HP package you describe should do the trick. But before you run out to buy it, make sure that you can use the utility that came with your sound card to actually record a track or two from the turntable.

Have fun.

TED NEEDLEMAN **P**

## ROBOTICS WORKSHOP

(continued from page 61)

The statements

Do

...

Loop

set up an "infinite loop." That is, the loop repeats for as long as power is applied to the BX-24 or until the chip is reset. Without the "do-loop" statements, the commands in the program would execute just one. The loop provides a simple way to repeat the commands for an unlimited period of time.

Now we're ready to start doing some work. The statements

' Red pulse.

Call PutPin(RedLED, LEDon)

Call Delay(0.07)

Call PutPin(RedLED, LEDoff)

Call Delay(0.07)

use some of the BasicX functions. Each BasicX function, such as PUTPIN, is preceded by an optional CALL statement. This tells the BasicX operating system to perform the named function. The PUTPIN function, called twice, changes the state of a specified I/O line. Note the use of the variable constants. The syntax for PUTPIN is

PutPin (PinNumber; Value)

where PINNUMBER is the number of the

pin that you want to use (e.g. pin 25 for the red LED), and VALUE is either "1" for on (or logical HIGH) or "0" for off (or logical LOW).

The DELAY function causes the BX-24 to pause a brief while—in this case, 70 milliseconds. DELAY is called twice so that there is a period of time between the on/off flashing of each LED.

The process is repeated for the green LED.

Now that we've finally discussed the "basics" of the BX-24, the "second-part" column that discussed controlling servos and interfacing ultrasonic sensors should make a bit more sense. Next month, we'll be back on track with our usual fare. **P**

# ELECTRONIC TECHNOLOGY TODAY INC.

P.O. Box 240 • Massapequa Park, NY 11762

## INVENTORY BLOWOUT SALE

**30% OFF**



\* ALL CANADIAN CHECKS MUST CLEAR THROUGH AN AMERICAN BANK

BP07	100 Radio Hookups	\$3.00	BP304	Projects for Radio Amateurs and S.W.L.S	\$5.99
BP37	50 Projects for TR's and Triacs	\$3.99	BP317	Practical Electronic Timing	\$6.99
BP48	Electronic Projects for Beginners	\$2.99	BP320	Electronic Projects for Your PC	\$5.99
BP56	Electronic Security Devices	\$3.99	BP321	<b>SOLO OUT</b>	\$6.99
BP64	Semiconductor Technology Elements of Elect Book 3	\$5.99	BP322	Circuit Source Book 2	\$6.99
BP74	Electronic Music Projects	\$3.99	BP329	Electronic Music Learning Projects	\$6.99
BP76	Power Supply Projects	\$3.99	BP332	A Beginners Guide to TTL Digital ICS	\$6.99
BP78	Practical Computer Experiments	\$2.99	BP333	A Beginners Guide to CMOS Digital ICS	\$6.99
BP88	How to Use OP Amps	\$5.99	BP334	Magic Electronic Projects	\$6.99
BP93	<b>SOLO OUT</b>	\$2.99	BP355	A Guide to the World's Radio Stations	\$7.99
BP103	Multi-Circuit Board Projects	\$2.99	BP359	An Introduction to Light in Electronics	\$6.99
BP112	A Z-80 Workshop Manual	\$5.99	BP367	Electronic Projects for the Garden	\$6.99
BP114	The Art of Programming the 16K ZX81	\$3.99	BP370	The Superhet Radio Handbook	\$6.99
BP115	The Pre-Computer Book	\$2.99	BP371	Electronic Projects for Experimenters	\$6.99
BP124	Easy Add-On Projects for the Spectrum, ZX81 & ACE	\$3.99	BP374	Practical Fibre-Optic Projects	\$6.99
BP148	Computer Terminology Explained	\$2.99	BP378	45 Simple Electronic Terminal Block Projects	\$6.99
BP154	An Introduction to MSX Basic	\$3.99	BP379	30 Simple IC Terminal Block Projects	\$6.99
BP156	An Introduction to QL Machine Code	\$3.99	BP384	Practical Electronic Model Railways Projects	\$6.99
BP187	A Prac Ref Guide to Word Pro Amstrad PCW8256/PCW8512	\$7.99	BP391	Fault-Finding Electronic Projects	\$6.99
BP190	More Advanced Electronic Security Projects	\$3.99	BP392	Electronic Project Building for Beginners	\$6.99
BP194	Modern OPTO Device Projects	\$3.99	BP393	Practical Oscillator	\$6.99
BP232	A Concise Introduction to MS-DOS	\$3.99	BP394	An Introduction to PIC Microcontrollers	\$7.99
BP245	Digital Audio Projects	\$3.99	BP396	Electronic Hobbyists Data Book	\$7.99
BP248	Test Equipment Construction	\$3.99	BP401	Transistor Data Tables	\$7.99
BP256	An Intro to Loudspeakers and Enclosure Design	\$3.99	BP411	A Practical Intro to Surface Mount Devices	\$6.99
BP264	A Concise Advanced User's Guide to MS-DOS	\$3.99	BP413	Practical Remote Control Projects	\$7.99
BP267	How to Use Oscilloscopes and Other Test Equipment	\$5.99	PCP107	Digital Logic Gates and Flip-Flops	\$10.99
BP272	Interfacing PCS and Compatibles	\$5.99	PCP112	Digital Electronics Projects for Beginners	\$10.99
BP290	An Intro to Amateur Communications Satellites	\$5.99	PCP114	Advanced MIDI Users Guide	\$10.99
BP297	Loudspeakers for Musicians	\$6.99	ETT1	Wireless & Electrical Cyclopedia	\$4.99
BP299	Practical Electronic Filters	\$6.99			

PRICES DO NOT INCLUDE SHIPPING & HANDLING. ALL SALES ARE FINAL, NO RETURNS

ORDER FORM				
Book No.	Title	Price	No. of Copies	Cost

<b>SHIPPING COSTS</b>		<b>Total Amount \$</b>	
\$0.01 to \$5.00	..\$2.00	\$20.01 to \$30.00	..\$5.00
\$5.01 to \$10.00	..\$3.00	\$30.01 to \$40.00	..\$6.00
\$10.01 to \$20.00	..\$4.00	\$40.01 to \$50.00	..\$7.00
\$50.01 and above	.....\$8.50		
			<b>TOTAL COST \$</b>

Name \_\_\_\_\_  
 Address \_\_\_\_\_  
 City \_\_\_\_\_ State \_\_\_\_\_ Zip \_\_\_\_\_

If you wish to use a Credit Card:

MasterCard    Visa   Expire Date \_\_\_\_\_ / \_\_\_\_\_

Card No. \_\_\_\_\_  
 Signature \_\_\_\_\_

Allow 6-8 weeks for order to be fulfilled.

Please return this order form to:  
 ELECTRONIC TECHNOLOGY TODAY, INC.  
 P.O. Box 240  
 Massapequa Park, NY 11762-0240

Telephone Orders: If you wish to place your credit-card order by phone, call 516/592-6722. Automated order taking system functions 24 hours a day. Have your credit-card ready. Sorry, no orders accepted outside of U.S.A. and Canada, New York State Residents must add applicable sales tax. Offer expires 9/30/00.

ET11

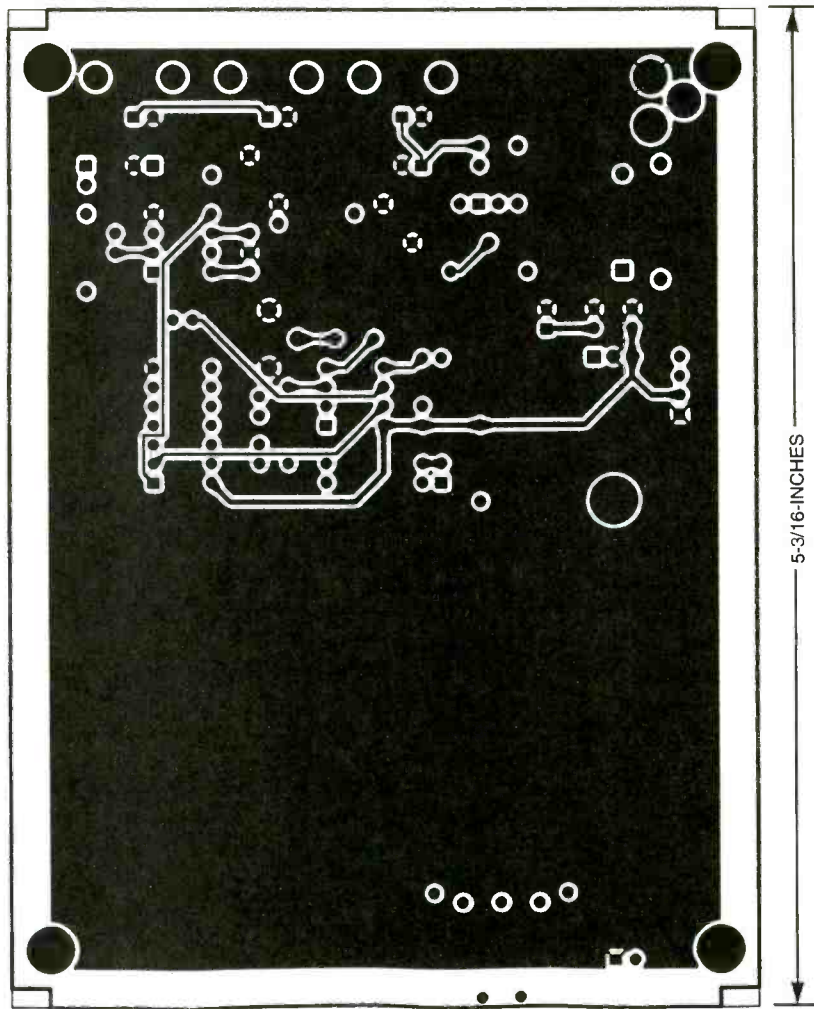

Fig. 5. Here's the foil pattern for the solder side of the Colorburst-Calibration Reference. If you make your own board, you'll have to make connections between both sides of the board.

## COLORBURST REFERENCE

(continued from page 54)

Plug in the power transformer to power up the unit. Connect the other oscilloscope channel probe to J3. Set S1 for the 1X subcarrier output.

As you adjust C8, note that there are two settings where the output on J3 loses lock with the incoming colorburst signal on J1. Center C8 between those two spots.

With the Colorburst-Calibration Reference adjusted, finish construction by installing the completed board in a suitable metal case. Congratulations—you now have a precision frequency source that is guaranteed accurate and won't ever go out of tune! P

### An Introduction to Light in Electronics

#### An Introduction to Light in Electronics

F. A. WILSON

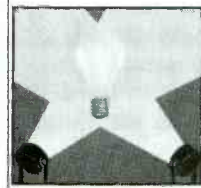

Taken for granted by us all perhaps, yet this book could not be read without it, light plays such an impressive role in daily life that we may be tempted to consider just how much we understand it. This book makes a good start into this fascinating and enlightening subject. It has been written with the general electronics enthusiast in mind.

To order Book #BP359 send \$6.99 plus \$3.00 for shipping in the U.S. and Canada only to Electronics Technology Today Inc., P.O. Box 240, Massapequa Park, NY 11762-0240. Payment in U.S. funds by U.S. bank check or International Money Order. Please allow 6-8 weeks for delivery. ET08

### Practical PIC Microcontroller Projects

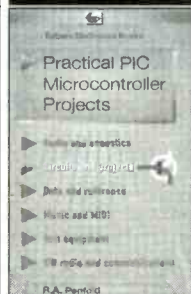

This book covers a wide range of PIC based projects, including such things as digitally controlled power supplies, transistor checkers, a simple capacitance meter, reaction tester, digital dice, digital locks, a stereo audio level meter, and MIDI pedals for use with electronic music systems. In most cases the circuits are very simple and they are easily constructed. Full component lists and software listings are provided. For more information about PICs we suggest you take a look at BP394 - An Introduction to PIC Microcontrollers.

To order Book #BP444 send \$7.99 plus \$3.00 for shipping in the U.S. and Canada only to Electronics Technology Today Inc., P.O. Box 240, Massapequa Park, NY 11762-0240. Payment in U.S. funds by U.S. bank check or International Money Order. Please allow 6-8 weeks for delivery. ET10

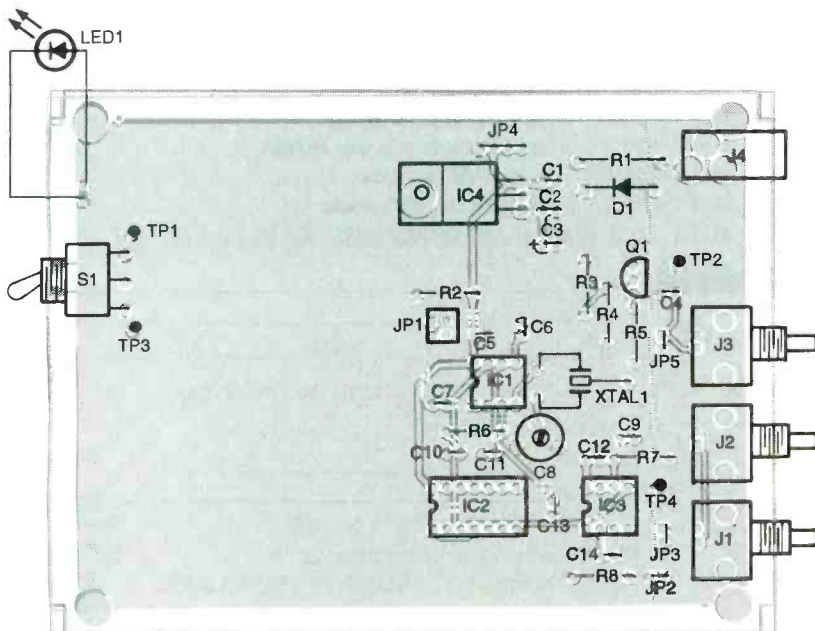

Fig. 6. The Colorburst-Calibration Reference is easily built on a printed-circuit board. Note that all parts are PC mounted; no additional wiring is necessary unless you need to use short lengths of wire-wrap wire as jumpers between both sides of the board.

# Poptronics®

# SHOPPER®

## The Leader in Micro Video Cameras

### Wireless Camera System



Color Camera/Transmitter  
GFC-5001 \$159.95

4-Channel A/V Receiver  
GFR-5002 \$119.95

**Features:**

- 2.4 Ghz Wireless CCD Camera with 4-channels selection switch.
- Operating frequency of ISM band 2.4 - 2.4835GHz on 4-channels.
- Patch Antennas
- Digital Image Filter to enhance picture clarity.
- Connects to any PC Video capture card, TV or VCR.
- Unequaled quality and reliability.
- 5-minutes to install.

**1-Camera/Receiver Package  
GFP-5005 \$249.95**

**Package Contents:**

- 1-Transmitting Camera & 1-Receiver
- 2-Patch antennas
- 2-Power supplies
- 1-RCA Cable
- 1-Mounting Bracket

### Flat Screen TFT-LCD Monitors



TFT-4 \$179.95

4" Screen. (Size: 6"(W) x 4.5"(H) x 2"(D))  
An excellent monitor for one camera monitoring or for setting up cameras during installation or maintenance.  
Several Sizes Available.



CM-500CBC \$129.95  
Aluminum cased Color camera with mounting bracket.

Dimensions: 1.5" Sq.



LP-850w \$169.95

Built-In Infrared Illuminator, Camera can See in the Dark without Additional Light Source!  
1.4"(Dia.) x 1.8"(L) w/o stand



Color weatherproof video camera.  
WP-300c \$229.95  
0.78"(Dia.) x 2.6"(L) w/o stand

### Wireless Transmitter & Receiver

**Transmits From:**

- Surveillance Camera
- Digital Video Disc
- Laser Disc Player
- Satellite Receiver
- Wireless Cable
- Stereo Audio
- VCR
- Cable TV
- CD Player
- Camcorder
- A/V Receiver

WR-2400 wireless Receiver \$129.95



Receiver



Transmitter

WT-2400 wireless Transmitter \$129.95



Back of Transmitter & Receiver are identical.

### Live Remote Video Server



NETVID-6x6M (Includes software)

3-Systems Available to choose from

View Up To Six Live Camera Locations on Your PC!

**NETVID-6x6M Server... Works 3-Ways!**

1. Over standard phone line or ISDN.
2. Internet using Internet Explorer or Netscape Navigator.
3. PC - LAN/Network.

PC remote software allows user to dial into NETVID-6x6M Server from any location!  
Includes: NETVID-6x6M server, Software & Modem. Cameras are Not included.

**Dial-Up Video Security for:**

- Security/Intrusion • Detect & Photograph Intruders
- Corporate management tool • Beach House, Cabin
- View your home while at work • Save to a Hard Drive

### Camera with Vari-Focal Lens

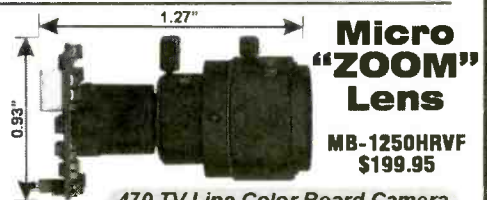

Micro "ZOOM" Lens  
MB-1250HRVF \$199.95

470 TV Line Color Board Camera with a 4-8mm Vari-focal lens.



•MB-1250HRVF \$199.95 High-Res Vari-Focal Color Camera

•MB-1250HRp \$149.95 High-Res Pinhole Color Camera

•MB-1250p \$99.95 Low-Res Pinhole Color Camera

### LIPSTICK CAMERAS

LP-850p \$119.95

LP-850i \$109.95

Length: 1.9" Diameter: .91"



Length: 1.37" Diameter: .87" B/W Model

B/W Model

**Polaris Industries**  
www.polarisusa.com  
800.752.3571

**Free Polaris Video Catalog**

Polaris Industries 470 Armour Dr. Atlanta GA 30324 • Tech Info: 404.872.0722 FAX: 404.872.1038

CIRCLE 300 ON FREE INFORMATION CARD

# spyoutlet.com

Countersurveillance - Electronic Devices

Purchase your video cameras from  
*one of the largest importers in the U.S.*

- NEW Waterproof Bullet Cameras • Spy Pinhole Cameras starting at \$79<sup>00</sup> • Wireless Video
  - Voice Changer • 3 Hour Micro Recorder • Shotgun Mic • Locksmithing • Bug & Phone Tap Detectors
  - Phone Call Register • UV Pens & Powder
  - Realtime Telephone Recording Systems: 12 Hour \$125<sup>00</sup>, 15 Hour \$149<sup>00</sup>
  - GPS Vehicle Tracking System (nationwide)
- And much more

[www.spyoutlet.com](http://www.spyoutlet.com)

Printed Catalog send \$5<sup>00</sup>

## SPY OUTLET

2468 Niagara Falls Blvd., Tonawanda NY 14150

(716) 695-8660 fax (716) 695-7380

# MOUSER

ELECTRONICS

A  COMPANY

Electronic components online

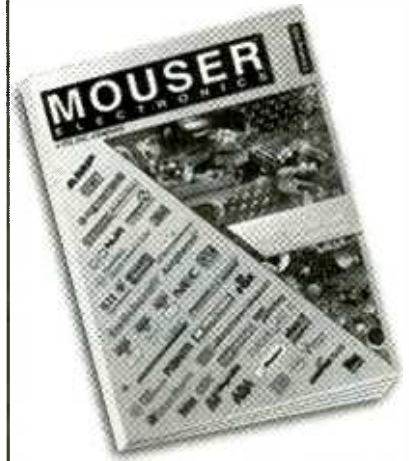

800-346-6873

[sales@mouser.com](mailto:sales@mouser.com)

[www.mouser.com](http://www.mouser.com)

CIRCLE 220 ON FREE INFORMATION CARD

## Learn to Hack!

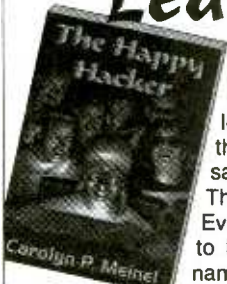

*The Happy Hacker* is nothing less than a step-by-step, easy to follow course on computer hacking. In it you'll learn all the ins and outs of hacking like the pros. You'll also learn how to hack safely, without getting busted or fired. This brand new 3rd edition has it all! Everything from breaking in to computers to hacking web sites, forging email - you name it!

**432 PAGE PAPERBACK, \$34.95 SHIPPING \$3**

The Hacker's Companion CD-ROM is chock full of hacking software and information. It includes everything from phones, cellular and satellite hacking to password crackers, war dialers, sniffers and exploit programs. Even a video of dutch hackers breaking into a classified US military computer. An excellent companion to the Happy Hacker, includes many of the programs discussed there. Brand new for the year 2000!



**PC CD-ROM, \$29.95, SHIPPING \$3**

Or call or write for **FREE CATALOG** of hard-to-get information about computer viruses, computer hacking, security and cryptography!! Check our web site [www.ameaglepubs.com](http://www.ameaglepubs.com) for lots more about these books and CD's!

**American Eagle Publications, Inc.**  
P. O. Box 1507, Dept E.  
Show Low, AZ 85902  
(800)719-4957

CIRCLE 315 ON FREE INFORMATION CARD

## Start A Career With High Wages, Excellent Benefits and Job Security!!

With UCANDO's extraordinary maintenance training programs you can quickly and easily enter a high paying field as a maintenance technician for a very small investment of time and money.



**RC-M ONLY \$165** RC-M is a 15 hour training course on relay ladder logic systems. Includes a 5-part video and workbook. **Great Value!**

**PLC-M ONLY \$198** PLC-M is a 32 hour training course on PLC systems. Includes (2) 4-part video's and workbook. This training is valuable.



**HYD-M ONLY \$209** HYD-M is a 32 hour course on Fluid Dynamics. Includes (2) 4-part video's and workbook. **This Module is a must.**

**SC-M ONLY \$215** SC-M is a 32 hour training course on AC & DC Servo Controllers. Includes (2) 4-part video's and workbook. **Learn everything you need about AC and DC servo Control Systems.**



**Electronic Training Videos:** Basic Electronics, Digital Electronics, TV Repair, LASER and Fiber Optic training videos available at very affordable prices starting at **Only \$39.95 each.**

For information or to place an order call:

**1-800-678-6113**

[www.ucando-corp.com](http://www.ucando-corp.com)

UCANDO VCR Educational Products Corp., Greenville, OH



Attention: PC TECHNICIANS

# Get A+ certified

and increase your income potential...



## Get the best interactive training bundle to help you pass your A+ Certification tests

Did you know that technicians with A+ Certification have starting salaries of \$30,000 plus per year? Take positive action to increase your earning power and get the kind of clout you need in the real world job market. Today many companies require A+ Certification before they will seriously consider you even for an interview.

WAVE's A+ Certification program is complete with all the materials you see above, including an extensive interactive CD — a full CompTIA Certification Program.

This special bundle edition also contains Micro-Scope™, the top-selling O/S-independent PC diagnostic package on the market, which has been fully updated for the millennium.

- 24-hour WAVE Online University. One year free tech support responses.
- Micro-Scope diagnostic software, recognized by technicians everywhere. Includes excellent FREE phone support. Our technicians can walk you through any technical situation, whether in your office or on-site.

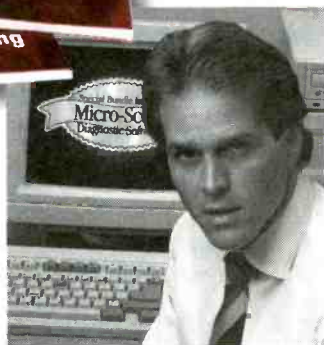

Micro 2000, Inc.  
1100 E. Broadway, Glendale, CA 91205  
(800)864-8008 • (818)547-0125 • Fax (818)547-0397  
www.micro2000.com • netsales@micro2000.com

# EARN MORE MONEY!

## Be an FCC LICENSED ELECTRONIC TECHNICIAN!



No costly school. No commuting to class. The Original Home-Study course prepares you for the "FCC Commercial Radiotelephone License." This valuable license is your professional "ticket" to thousands of exciting jobs in Communications, Radar, Radio-TV, Microwave, Maritime, Avionics and more...even start your own business! You don't need a college degree to qualify, but you do need an FCC License.

**No Need to Quit Your Job or Go To School**  
This proven course is easy, fast and low cost! GUARANTEED PASS-You get your FCC License or money refunded. Send for FREE facts now.

**Call 1-800-932-4268 Ext. 210**

Fax 1-415-332-1901

Email: [fcc@commandproductions.com](mailto:fcc@commandproductions.com)

Visit our Website: [www.LicenseTraining.com](http://www.LicenseTraining.com)

### COMMAND PRODUCTIONS

FCC LICENSE TRAINING - Dept. 210  
P.O. Box 2824 San Francisco, CA 94126-2824

Please rush FREE details immediately!

Name \_\_\_\_\_

Address \_\_\_\_\_

City \_\_\_\_\_

State \_\_\_\_\_ Zip \_\_\_\_\_

Mail This Coupon Today!

CIRCLE 231 ON FREE INFORMATION CARD

# PIC'n Books

LEARN ABOUT PIC MICROCONTROLLERS



See Table Of Contents: <http://www.sq-1.com>  
Secure Online Ordering Is Available

PIC is a trademark of Microchip Technology Inc.

**SQUARE 1 ELECTRONICS**

Voice (707) 279-8881 Fax (707) 279-8883

<http://www.sq-1.com>

## CONTROL

RELAYS • LIGHTS • MOTORS

## MEASURE

TEMPERATURE • PRESSURE • LIGHT LEVELS • HUMIDITY

## INPUT

SWITCH POSITIONS • THERMOSTATS • LIQUID LEVELS

MODEL 30 ..... \$79

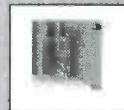

- PLUGS INTO PC BUS
- 24 LINES DIGITAL I/O
- 8 CHANNEL-8 BIT A/D/IN
- 12 BIT COUNTER
- UP TO 14K B/M/SEC

MODEL 45 ..... \$189



- RS-232 INTERFACE
- 8 DIGITAL I/O
- 8 ANALOG INPUTS
- 2 ANALOG OUTPUTS
- 2 COUNTERS-24 BIT

MODEL 100 ..... \$279



- 12 BIT 100 KHZ A/D
- 4 ANALOG OUTPUTS
- 3 TIMER COUNTERS
- 24 DIGITAL I/O

MODEL 150-02 .... \$179



- RS-232 INTERFACE
- TRMS, 20 AMPS
- 12 BIT A/D
- OPTO-ISOLATED
- COMPLETE DMM

MODEL 40 ..... \$109



- RS-232 INTERFACE
- 28 LINES DIGITAL I/O
- 8 ANALOG INPUTS
- PWM OUTPUT

MODEL 70 ..... \$239



- RS-232 INTERFACE
- 18 BIT A/D
- 5.5 DIGIT
- UP TO 60 B/M/SEC

## Prairie Digital, Inc.

PHONE 608-643-8599 • FAX 608-643-6754

420 SEVENTEENTH STREET • PRAIRIE DU SAC, WISCONSIN 53658

CIRCLE 219 ON FREE INFORMATION CARD



Check out our full line catalog @:

**www.mcmelectronics.com**

**1-800-543-4330**

**fax: 1-800-765-6960**

You Must Provide This Source Code To Receive Discount Pricing: ▼

**POP79**

Free Literature!



What You Want....  
Today!™

Prices effective August 15 through September 29, 2000.



### Soldering Station

Perfect for all types of board level and precision work. Digital LED display shows

temperature and setpoint.

Order # 21-1590 Reg. \$119.00

now only! **\$79.95**



### DMM with Logic Function

3 1/2 digit LCD display meter measures AC/DC voltage to 600V, AC/DC current to 10A, resistance to 2000Mohm, capacitance to 20µF, transistor h<sub>FE</sub> and provides diode and logic test. Includes holster and test leads.

Order # 72-4025 Reg. \$65.95

now only! **\$39.95**

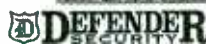

### Micro Board CCD Camera

Perfect for incorporation in to existing housing for CCTV, observation and general hobby use. Produces over 380 lines of resolution with a 92° viewing angle. Requires 12VDC, 330mA.

Order # 82-2990 Reg. \$64.95

now only! **\$49.95**



### 4" Color LCD Monitor Module

Open circuit board has no case or housing allowing easy incorporation into automotive seat backs, custom panels and enclosures. Use for automotive multimedia and navigation systems, surveillance and video equipment.

- 3.5mm A/V input
- Resolution: 383 (H) x 234 (V) • Requires: 12VDC, 500mA
- Dimensions: 3 1/2" x 5" x 1 1/2"

order #60-9855  
now only! **\$119.00**



### 450VA Isolation Transformer

Essential on any service bench. Features two direct and two isolated fused AC outlets. Handles 450VA continuous, 550VA intermittent.

Order # 72-6670 Reg. \$79.95

now only! **\$59.95**



### Sealed Lead Acid Battery

12 volt, 4.5 amp/hour battery is ideal for security and other power back-up applications. 0.25"

tabs accept standard quick-disconnects. Dimensions 3 1/2" x 2 3/4" x 4".

Order # 29-1335 Reg. \$26.95

now only! **\$14.95**



### Multiple Voltage 2 Amp Power Supply

Indispensable accessory for any hobby or tech bench. Rotary switch selects 3, 4 1/2, 6, 7 1/2, 9 or 12V output. Ideal for battery operated devices or your latest project.

Order # 28-2200 Reg. \$16.95

now only! **\$9.95**

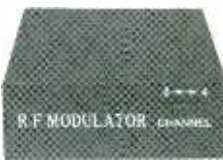

### RF Modulator

Outstanding price on this popular audio/video/surveillance accessory. Accepts standard A/V signal and places it on channel three or four. RCA type inputs, "F" type output. Requires 117VAC.

Order # 33-1480 Reg. \$19.95

now only! **\$10.95**



**MCM ELECTRONICS®**  
850 CONGRESS PARK DR.  
CENTERVILLE, OH 45458

A Premier Farnell Company

SOURCE CODE: POP79

CIRCLE 160 ON FREE INFORMATION CARD

# B<sup>2</sup> Spice A/D 2000

\$299

## Mixed-Mode Circuit Design

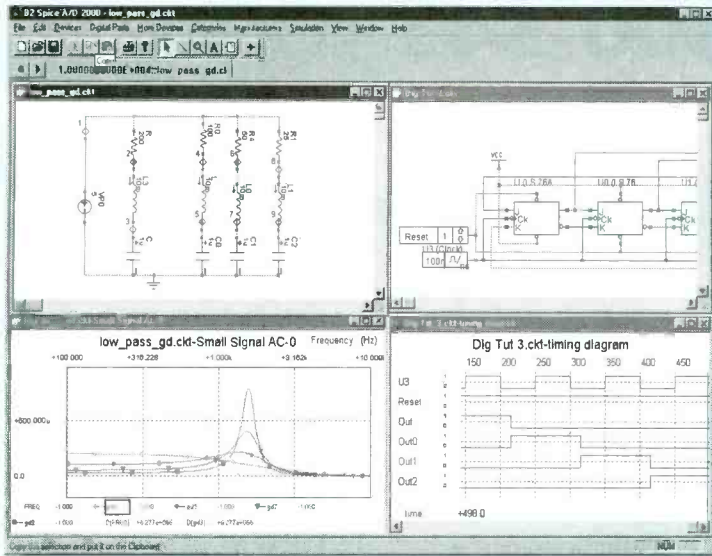

- ◆ Build complex circuits in minutes with our intuitive schematic editor.
- ◆ Turn any circuit into a functional part with just a few simple clicks.
- ◆ Interpret simulation results with customizable graphs.
- ◆ Find exactly the part you need from our database of 4500 parts.
- ◆ Run an interactive Digital Simulation and view signals in the Timing Diagram

## Competitive Analysis

Characteristics	B <sup>2</sup> Spice A/D 2000	EWB Multisim Personal
PRICE	\$299	\$399
DC Operating point	X	X
DC Parameter Sweep	X	X
Temperature Sweep	X	-
Transient	X	X
Fourier	X	X
Parameterized transient	X	-
AC Analysis (freq sweep)	X	X
Parameterized AC Sweep	X	-
Pole Zero	X	-
Transfer function	X	-
DC Sensitivity	X	X
Distortion	X	X
Noise	X	X
DC Op. Pt. Monte Carlo	X	-
DC Sweep Monte Carlo	X	-
AC Monte Carlo	X	-
Transient Monte Carlo	X	-
Interactive, free running digital logic simulation.	X	-

Visit our web site for a free trial.

\$99 Lite Version

Beige Bag Software • www.beigebag.com • 734.332.0487 • info@beigebag.com

CIRCLE 319 ON FREE INFORMATION CARD

www.poptronics.com

Accredited B.S. Degree in Computers or Electronics by studying at Home

Grantham College of Engineering offers 3 distance education programs:

- B.S.E.T. emphasis in Electronics
- B.S.E.T. emphasis in Computers
- B.S. in Computer Science

-Electronics Workbench Professional 5.0 included in our B.S.E.T. curriculums  
-Approved by more than 200 Companies, VA and Dantes, (tuition assistance avail.)

For your free catalog of our programs dial

1-888-919-8181 Ext. 15

http://www.grantham.edu

**GCE**

Your first step to help yourself better your future!



Grantham College of Engineering  
34641 Grantham College Road  
Slidell, LA 70460-6815

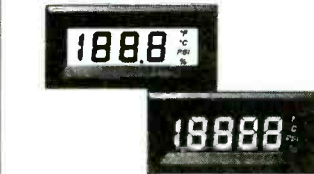

### Digital Panel Meters!!

- LCDs • LEDs • 3 1/2 digits • 4 1/2 digits
- loop powered • adjustable voltage input
- bezel mount • surface mount
- miniatures • big digits
- black • red
- amber • green
- negative backlighting
- positive backlighting
- RF resistant EMI resistant
- displayed engineering units • snap-in

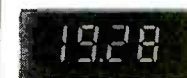

We also have Kroy tape and shrink tube labeling systems and supplies!



**KNS**  
Instruments

1-800-

356-4920

Visit our catalog on-line  
knsinstruments.com

Or call toll free: 800/356-4920  
Fax: 800/356-1250

603/627-5144 • Fax 603/624-4710  
PO Box 10158 • Bedford, NH 03110-0158



# Electronics made easy & affordable **velleman**

**NEW**

**PERSONAL SCOPE™**

**HP55**

The Velleman **PERSONAL SCOPE™** is a portable fully-functional *oscilloscope*. At the cost of a good multimeter it gives you the best possible *value for the money*. The **PERSONAL SCOPE™** provides you with the **high sensitivity** (down to 5mV/div) often missing in higher or similarly priced units. Together with the other scope functions it makes this the ideal tool for students, hobbyists and professionals.



AC MAINS (e.g. phase control)

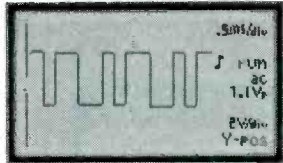

DIGITAL SIGNALS (e.g. pulse train)

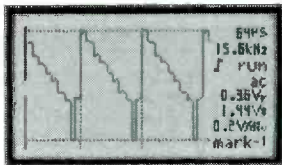

TV AND VIDEO (e.g. composite video signal)

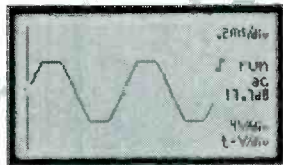

AUDIO SIGNALS (e.g. amplifier output clipping level)



**SPECIFICATIONS:**

- Maximum sample rate: 5MHz
- Input amplifier bandwidth: 1MHz (-3dB at 1V/div setting) 1Mohm // 20pF (standard probe)
- Vertical resolution: 8 bit (6 bit on LCD)
- LCD Graphics: 64 x 128 pixels
- dBm measurements: From -73dB to +40dB (up to 60dB with X10 probe) ±0.5dB
- True rms AC measurement: 0.1mV to 80V (400Vrms with X10 probe) 2.5% accuracy
- Time base: 20s to 2µs / div in 22 steps
- Input sensitivity range: 5mV to 20V/div in 12 steps (up to 200V/div with X10 probe)
- Supply voltage: 9VDC / min 300mA adapter
- Batteries (in option): Alkaline type AA (5 pcs required)  
NiCd/NiMH rechargeable
- Battery life: Up to 20 hours with Alkaline batteries
- Safety: Meets IEC1010-1 600V CATII, pollution degree 1
- Dimensions: 105 x 220 x 35mm (4.13"x7.95"x1.38")
- Weight: 395g (14oz.) (excl. batteries)



**OPTIONS:**

- Insulated measurement probe x1 / x10: PROBE605
- Adaptor for 110VAC: PS905USA

**\$199.95**

Probe not included



SERVICE & DEVELOPMENT



CAR DIAGNOSTICS



ALICE TROUBLE SHOOTING

# velleman

7415 Whitehall Street Suite 117  
 Fort Worth, TX 76118  
 (817) 284-7785 F : (817) 284-7712  
 www.velleman-kit.com email : velleman@earthlink.net

Questions ? Contact us for a list of US distributors or to get your **FREE** catalogue

CIRCLE 275 ON FREE INFORMATION CARD

# VISION ELECTRONICS



- No Rolls/Jitters/Flickers/Fading
- Works on all TV's, VCR's, Beta, & Cable
- Gold Video Connectors & Cables Included
- 1 Year Warranty
- Money Back Guarantee

**FREE CATALOG!**



## COPY RENTAL TAPES WITH OUR VIDEO STABILIZER

**1-800-562-2252**

2609 S. 156th Circle • Omaha, NE 68130  
[www.modernelectronics.com](http://www.modernelectronics.com)



### Build Your Own Intelligent Robot, We Make It Easy!

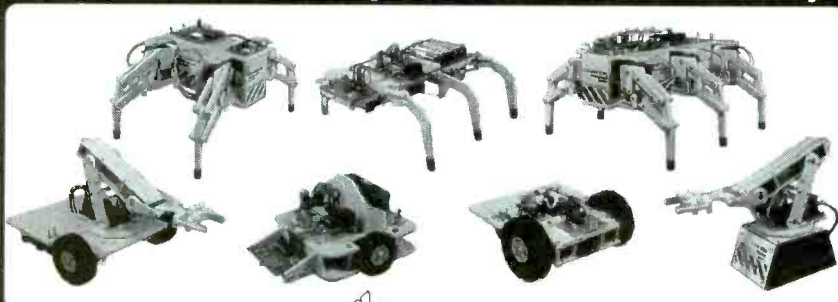

Lynxmotion, Inc.  
 104 Partridge Road  
 Pekin, IL 61554-1403  
[www.lynxmotion.com](http://www.lynxmotion.com)



**lynxmotion**

Visit our website or ask for our free catalog!

Tel: 309-382-1816  
 Fax: 309-382-1254  
[sales@lynxmotion.com](mailto:sales@lynxmotion.com)  
[tech@lynxmotion.com](mailto:tech@lynxmotion.com)

### HOT NEW PRODUCTS!!!

**Phone and Internet Voice Changer** - This device is new to the market and provides realistic sounding voices. It allows you to interface directly to your phone jack, or computer via patch cord and mic. Intro price \$129.95



**Phone Manager - Reverse Caller ID**. Now you can keep track of outgoing numbers. Records length, time and date of call. Keep track of the children, the wife, or the phone company. Easy hookup via phone jack. \$79.95



[www.electronickits.com](http://www.electronickits.com) - Over 200 Electronic Gadgets  
 Carl's Electronics Inc. [sales@electronickits.com](mailto:sales@electronickits.com)

## BE AN ELECTRONICS TECHNICIAN!

Home study. Learn to repair, service, and install TVs, VCRs, camcorders, stereos, sound and lighting systems, alarms, and more!

**FREE LITERATURE:**  
**800-223-4542**



Name \_\_\_\_\_  
 Age \_\_\_\_\_ Phone (\_\_\_\_) \_\_\_\_\_  
 Address \_\_\_\_\_

City/State \_\_\_\_\_ Zip \_\_\_\_\_  
**The School of Electronics, Dept. ELK341**  
 PCDL 430 Technology Pky., Norcross, GA 30092

## CABLE BOXES

- WE'LL BEAT ANY PRICE!
- 1 YR WARRANTY
- FREE CATALOG
- 30 DAY MONEY BACK GUARANTEE

[WWW.CATVBOXES.COM](http://WWW.CATVBOXES.COM)

**1-800-765-4912**

## World's Smallest 68HC11 Microcontroller Module!



- Applications:**
- telemetry
  - microbotics
  - smart toys
  - animatronics
  - model railroads
  - automate your home
  - many others!

## MicroStamp1™

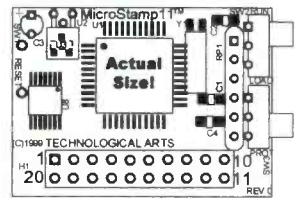

- tiny 1-inch x 1.4-inch 68HC11 module
- 5V regulator, 8MHz crystal
- choice of 8K or 32K EEPROM
- plugs into your breadboard like a DIP
- SCI, SPI, OCs, ICs, timers, & more
- all 14 I/O lines and 2 interrupts brought out to versatile 20-pin connector
- easy code-loading with Docking Module
- Starter Packages: \*  
 with 8K EEPROM (#MS11SP8K).....\$49  
 with 32K EEPROM (#MS11SP32K).....\$60
- additional modules from \$34 each

\* includes MicroStamp11, documentation, PC software, serial cable & Docking Module

## MicroCore-11™

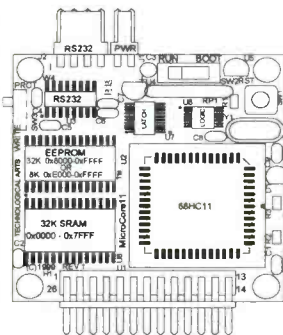

- tiny 2-inch x 2-inch 68HC11 module
  - 12 inputs/outputs plus 8 analog inputs
  - RS232, 5V regulator, 8MHz crystal
  - 32K SRAM plus 8K or 32K EEPROM
  - plugs into your breadboard like a DIP
  - simple program loading from any PC
  - motor driver & accessories available
  - ideal for MicroMouse robot competitions
- 8K Starter Package #MC11SP8K.....\$75  
 32K Starter Package #MC11SP32K.....\$89

## Technological Arts

Many other modules & accessories available.  
 Visit our website at:  
[www.technologicalarts.com](http://www.technologicalarts.com)  
[sales@technologicalarts.com](mailto:sales@technologicalarts.com)  
**Phone: (416) 963-8996**  
**Fax: (416) 963-9179**  
 Add \$5 shipping & handling within Canada & USA  
 Visa • MasterCard • Discover • Amex

# AMAZING DEVICES

## Laser Window Bounce Listening System

Powerful listening system, yet simple in operation.

You shine a LASER at a window and intercept the reflected beam with our ultra-sensitive filtered OPTICAL RECEIVER. Vibrations on the window from internal sounds and voices are now clearly heard. Range can be up to several hundred meters depending on the output power of the laser and optics used.



LWB9 Plans and all Data for 3 Laser Window Bounce Systems.....	\$20.00
LWB6K Kit of Complete 100' System with Visible Laser for Demo/Science Project .....	\$129.95
LLR30 Optical RECEIVER with voice filter.....	\$99.95
LLR3K Kit of Optical Receiver.....	\$69.95
LLR40 Higher performance with low noise preamp, basic optics and deluxe headsets.....	\$199.95
CWL10 10 mw ClassIIIB Invisible IR LASER for 500'.....	\$199.95
CWL1K Kit of LASER.....	\$149.95
LM650P5 5 mw ClassIIIA Visible Red Laser Module for up to 100'.....	\$19.95
LM650P10 10 mw ClassIIIB Visible Red Laser Module for up to 200'.....	\$69.95

See Our "Action" Web Site at  
[www.amazing1.com](http://www.amazing1.com)

Experiment with and Construct Lasers, Phasers, Hypnosis, Mind Control, TESLA COILS, Time Travel, Rail Guns, Magnetic Cannons, Coil and Sleeve Guns, Super High Gravity Pulses, Explode Wires and Water, Antigravity, Levitation, Mass Warping, Magnetic Can Crushing, Plasma Propulsion, High Energy Radio Frequency Guns (Herf), EMP, Lattice Snapping, Force Fields, Ion Ray Guns and all Types of Electrical Pyrotechnics, Plasma and Neon Displays, Sound Blasters, Ultrasonics, Super Hearing, Long Range Transmitters, Jammers, Personal and Property Protection, Surveillance Plus More!!

## Ultra Bright Green Laser visible over a mile!!

30 to 50x brighter than the red pointers. Shirt pocket sized pen. 55" x 6.3" Full 5mw. Operates for hours from two "AAA" batteries.  
Call for pricing as we will not be undersold!!!!!!!

## Gravity Motor

Electrical charge reactions produce the effect of "anti gravity. You build a model craft from simple parts and levitate it with our ion power source. Battery or 115vac operation. Great science or fascinating research project includes our gravity handbook.

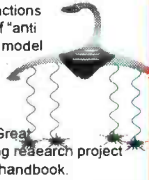

GRA3 Plans/Book.....	\$20.00
GRA3K Power Source Kit.....	\$99.95
GRA30 Assembled Above.....	\$149.95

## Tesla Coil

Produces 30" Sparks

Create a spectacular display of nature own lightning. Many amazing experiments possible. See in action on our web site!!



BTC4 Plans.....	\$20.00
BTC4K kit.....	\$799.95
BTC40 Ready to use.....	\$999.95
Smaller Version (8-10" Sparks)	
BTC3 Plans.....	\$15.00
BTC3K Kit.....	\$349.95
BTC30 Ready to Use.....	\$449.95

## Ion Ray Guns

Star Wars Technology Directs Energy

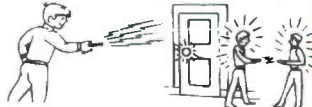

Star Wars Technology Demonstrates Weapons Potential, Force Fields, IonMotors, Antigravity etc. Projects electric shocks without contact!! Conduct many weird and bizarre experiments. Handheld battery operated and easy to operate.

IOG7/9 Plans.....	\$10.00
IOG7K Kit/Plans.....	\$99.95
IOG70 Assembled/Tested.....	\$149.95
Higher Powered Device	
IOG9K Kit/Plans.....	\$129.95
IOG90 Assembled/Tested.....	\$199.95

## 6 Easy FM Xmtr Projects!

- 1 Super Sensitive Ultra Clear 1 Mile+ Voice Transmitter.
- 2 1 Mile+ Telephone Transmitter.
- 3 Line Powered Phone Transmitter Never Needs Batteries!!
- 4 Tracking/Homing Beacon Beeping Transmitter
- 5 Video/Audio Rebroadcaster 1 Mi.
- 6 TV/FM Radio Disrupter. Neat Prank! Discretion Required

Includes Hints Using Wireless Devices  
COMBOX Parts Above 6 Projects.....\$49.95  
COMBOB Plans Above 6 Projects.....\$10.00

## TAKE CONTROL Using Electronic Hypnosis

Electronic circuitry induces hypnotic as well as ALPHA relaxed mind states. Place subjects under your control



HYP2 Plans.....	\$10.00
HYP2K Kit/Plans.....	\$49.95
HYP20 Ready to Use.....	\$69.95

MIND2 Plans for Mind Control.....	\$15.00
MIND2K Kit/Plans.....	\$49.95
MIND20 Ready to Use.....	\$79.95

## Pain Field Pistol

Caution! Do not aim at people!

Blast out rodents with high power ultrasonics. Handheld and battery operated with all controls.



Rental units available.	
PPP1 Plans.....	\$8.00
PPP1K Kit/Plans.....	\$49.95
PPP10 Ready to Use.....	\$79.95

## Amazing Gravitron

Remarkable true levitation without any tethering or external sources of energy. Winning science project. Includes self starter



GRV10 - Anti Gravity Top.....	\$39.95
GRV30 - Super Levitator.....	\$49.95

## Hover Board

28 pages of data related to the most revolutionary advance in transportation. Cutting edge R&D



HOVER Plans and Data.....	\$25.00
---------------------------	---------

## Semi-Cond Burning Lasers

10mw to 2 Watts of continuous output!! Use for directed beam of heat, illumination source for night vision, laser window bounce IR driver for ultra-bright green lasers.



CWL5K Kit/Plans minus diode.....	\$199.95
CWL50 Assembled minus diode.....	\$299.95
LD34 CW 3/4 W 980nm diode.....	\$249.95

## Nightstar Night Viewer

Sees in total darkness

- 35000x Light Gain
- Over 100 yds Recognition
- Built in IR Illuminator
- 20 degree Field of View
- 20 Hours Battery Life
- Spectral Response 810-840 nm.



NSTAR10 - Ready to Use.....	\$239.95
-----------------------------	----------

## Jacobs Ladder

Pyrotechnical traveling fiery plasma expands over 3' before evaporating into space. Solid state circuitry with adjustable arc control. 115/230 volt operation. Uses safe high frequency energy.



JACK1 Plans.....	\$8.00
JACK1K Supply, Mtg Blks, Ladders.....	\$149.95
JACK10 Ready to Use.....	\$249.95

## 3 Mi FM Voice Transmitter

Crystal clear performance. Many applications. Easy to assemble



FMV1K Parts and plans.....	\$39.95
----------------------------	---------

## Theramagnetic Pulsar

Complex Magnetic waves are claimed to produce many health benefits. Board level experimental device is sold for research purposes only.



THMAG10 Lab Assembled.....	\$24.95
----------------------------	---------

## Cybernetic Ear!

Provides that "extra edge" for many listening applications. Enhances 3 to 4x of normal.



CYBEREAR.....	\$19.95
---------------	---------

## Mini TESLA Coil

Lights up a 4' fluorescent tube-all without any contact!! Yet only 3" tall!



MTC1K Kit/Plans.....	\$19.95
MTC10 Assembled.....	\$34.95

## Telephone Line Grabber Room Listener Controller and Call Diverter

Listen to your premises. Break in to calls Control household appliances. Remote dial long distance calls-from anywhere!!



TELCON4 Plans.....	\$10.00
TELCON4K Kit/Plans.....	\$129.95
TELCON40 Ready to Us.....	\$169.95

## Attention! High Voltage Modules

Battery powered for hovercraft, plasma guns, anti gravity, force fields, pyrotech



MIMIMAX4 4KV.....	\$19.95
MIMIMAX3 3KV.....	\$17.95
MIMIMAX2 2KV.....	\$14.95

## Shock Force Field Vehicle Object Electrifier

Hand shock balls,wands. Mini circuit is easily hidden. Great payback for those wise guys. SHK1K Kit/plan.....\$19.95



## Mind&Brain Controllers

Incredible device Turbo charges memory, Boost mental powers, Controls stress, Speeds up healing processes and Uncover hidden potentials. High quality unit with many features.



BWPLUS-APOLLO Ready to use.....	\$189.95
BWII- EINSTEIN Lower cost unit.....	\$129.95

## Burning Cutting Lasers

Current and Future Weapons Systems

We Stock Parts!  
LC3 Plans Poor Mans CO<sub>2</sub> System.....\$15.00  
LC7 Plans Lab CO<sub>2</sub> System 30W+.....\$20.00  
LAGUN2 Plans Nd,Yag, Ruby 6Kw.....\$20.00  
All Three Plans for only.....\$25.00!!

## PLASMA FIRE SABER

Patented Moving Light Concept Defies all Logic as it Appears to Evaporate into Space!! Duplicate the STAR WARS effect

Replaceable Blades, Override Switch, Interactive Sound Module Available on Request

Specify Color:  
photon blue, starfire red  
phaser green, neon red

SAB15K - Kit 15" Display.....	\$29.95+\$5.00 s&h
SAB24K - Kit 24" Display.....	\$59.95+\$5.00 s&h
SAB36K - Kit 36" Display.....	\$129.95+\$15.00 s&h

## Network Service Tool Set

Popular installation and service tools for networks, modems and telephones. All hand tools are professional heavy duty type.

Use the compact tester on 10BASE-T (UTP & STP), thin Ethernet (BNC), 8-position Token Ring, AT&T 258A and EIA/TIA 568A/B. Automatically scans cables for continuity, wiring sequence and polarization. Tests STP cable ground. Testing installed cables is easy with Remote Terminator and gender changers (UTP and BNC). 9V battery included.

- Coax Stripping Tool, RG-58 & RG-59
- BNC Crimping Tool, RG-58 & RG-59
- Modular Cutting/Stripping/Crimping Tool (4, 6 & 8-Position)
- Multi-Network Cable Tester
- AC Receptacle Tester
- Cable Cutter

Order No. 55625 **\$197.00**



## PC Service Tool Set

Contains all tools needed to troubleshoot & service IBM-compatible PCs. Set includes:

- AMI Diagnostic Software
- POST Card
- Logic Probe
- Digital Multi-Meter
- AC Receptacle Tester
- Serial Adapter
- Serial & Parallel Loopback Connectors
- DIP IC Puller
- PLCC IC Puller
- Grounding Wrist Strap
- Key Top Puller

Order No. 55000 **\$198.00**

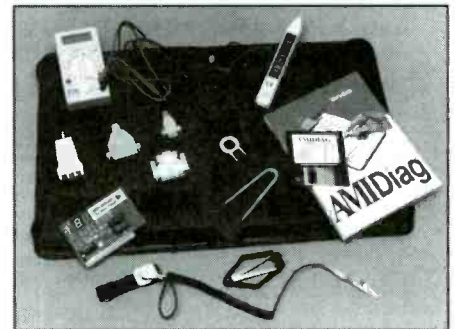

**CALL TODAY!**  
**800-854-7393**



## PC Diagnostic Tool Set

- AMI Diagnostic Software
- POST Card

Order No. 55555 **\$89.00**

## Network Installation Tool Set

- Network Tool Set 55625 without the Multi-Network Cable Tester.

Order No. 55600 **\$99.00**

Call for your **FREE** Catalog  
**Graymark®**

P.O. Box 2015 Tustin, CA 92781  
<http://www.labvolt.com>

CIRCLE 271 ON FREE INFORMATION CARD

OPEN  
SATURDAY  
9am-1pm

## Roger's Systems Specialist

24895 Avenue Rockefeller  
Valencia, California 91355

"We Have Great Connections"  
Computer • Communications  
Network • Audio • Video

OPEN  
Mon.-Fri.  
9am-5:30pm

www.rogerssystems.com

### RACKS

RACK-3B (3 foot, black)... \$110<sup>00</sup>  
RACK-7B (7 foot, black)... \$99<sup>00</sup>  
RACK-7A (7 foot, alum.)... \$121<sup>00</sup>



### HINGED BRACKETS

HB1 (1.75-inch)..... \$12<sup>00</sup>  
HB2 (3.5-inch)..... \$18<sup>00</sup>  
HB3 (5.25-inch)..... \$24<sup>00</sup>  
:: **BLOW OUT SPECIALS** ::  
HB4 (7-inch)..... \$5<sup>00</sup>  
HB8 (14-inch)..... \$5<sup>00</sup>



### 48 PORT PATCH PANEL



**\$69<sup>00</sup>**

# PP-48P-5

48 PORT CAT.5  
PATCH PANEL 568 A&B

### FREE MOUSE



PS/2 or USB  
with any \$20  
and up web order

### BELKIN

**\$14<sup>75</sup>**



# DS-401-1284

4 Computer to  
1 Printer AutoSwitch

Bi-Directional  
Printer Sharing  
IEEE 1284

Toll Free 800-366-0579 - Fax 661-295-8777

CIRCLE 308 ON FREE INFORMATION CARD



DVD Movies  
DVD Music

Weekly  
Specials

Home  
Theater

**BigBang**  
electronics

Auctions

# THE SIGN OF INTELLIGENT LIFE IN THE UNIVERSE ...

Big Bang offers top-quality name-brand electronic equipment and home theater components for lower prices than anywhere else in the galaxy. Make contact Toll Free: 1-888-314-2620 or [www.bigbangelectronics.com](http://www.bigbangelectronics.com).



## TACTILE SOUND

**DON'T JUST WATCH THE MOVIE - FEEL THE MOVIE.**

Tactile Sound is sound you feel. It's the exhilarating rumble of F-16 afterburners, the gentle pluck of a guitar...it's every action and special effect built in to the movie's soundtrack. Now you can experience your favorite movies with your entire body.



**Pioneer • Dennon • MB Quart • Philips • Pioneer • Dennon • MB Quart • Ph**



Rewritable CD Rom

Pronto Intelligent/Universal Remote controls unlimited number of components



PC Camera

MP3 Player records up to 80 hours of music

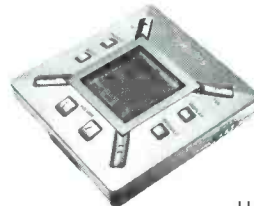

HandsFree Cell Phone Holder/Charger

# DIGITAL STORAGE OSCILLOSCOPES

WITH  
SPECTRUM  
ANALYZER,  
DVM, FREQ.  
COUNTER,  
AND DATA  
LOGGER.

from  
**\$189.**

**PORTABLE  
MODULES  
CONVERT PC'S  
INTO  
MULTIPURPOSE  
TEST AND  
MEASURING  
INSTRUMENTS.**

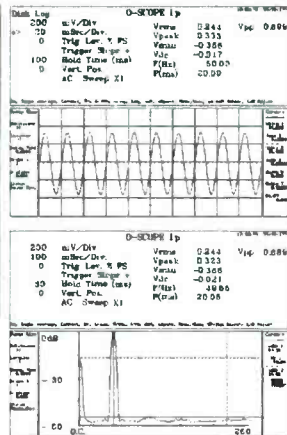

Why lug a scope around? Toss one of our modules into your laptop case or tool kit. For a multi-purpose test device, plug to a PC parallel port and use the PC screen. Continuous, delayed, or triggered sweeps can be frozen on the screen, printed out, or saved to disk. Frequency Spectrums DC to 25 MHz.

Allison now provides PICO TECHNOLOGY Ltd. portable test equipment, including high-speed scopes, and multi channel data loggers. Pico and O-Scope modules accept standard probes and work with 286 or faster PC's.

## FEATURES:

- PORTABLE UNITS TO 25 MHz
- USES PRINTER PORT
- USES STD. PROBES

## OPTIONS:

- PROBE SETS
- AUTOMOTIVE PROBES
- BATTERY PACKS
- SOFT & HARD CASES

O-Scopes Made in U.S.A. Picos Made in U.K.  
Same Day Shipping  
Includes Cable, Software & Manuals

O-Scope Ie (DC-50KHz, single trace) .....\$189.  
O-Scope II (DC-500KHz, dual trace) .....\$349.  
PICO (ADC 200/20) (DC-10MHz, dual trace) .....CALL  
PICO (ADC 200/50) (DC-25MHz, dual trace) .....CALL  
PICO pc based data loggers from \$99.

Shipping within U.S. UPS Ground \$7.50(Second day \$11.50)

SEND CREDIT CARD INFO., M.O., or CHECK, OR CALL

**1-800-980-9806**

**Allison Technology Corporation**

2006 FINNEY-VALLET, ROSENBERG, TX 77471  
PHONE: 281-239-8500 FAX: 281-239-8006

<http://www.atcweb.com>

# World Passing You By?

Are you interested in Microprocessors & Embedded Control Systems? If not you should be! Look around, just about everything these days has an embedded microprocessor in it. TVs, cars, radios, traffic lights & even toys have embedded computers controlling their actions. The Primer Trainer is the tool that can not only teach you how these devices operate but give you the opportunity to program these types of systems yourself. Examples & exercises in the Self Instruction manual take you from writing simple programs to controlling motors. Start out in Machine language,

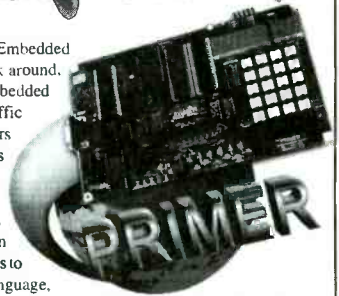

then move on to Assembler, & then continue on with optional C, Basic, or Forth Compilers. **So don't be left behind, this is information you need to know!**

## Examples Include:

- Measuring Temperature
- Using a Photocell to Detect Light Levels
- Making a Waveform Generator
- Constructing a Capacitance Meter
- Motor Speed Control Using Back EMF
- Interfacing and Controlling Stepper Motors
- Scanning Keypads and Writing to LCD/LED Displays
- Bus Interfacing an 8255 PPI
- Using the Primer as an EPROM Programmer
- DTMF Autodialer & Remote Controller (New!)

The PRIMER is only \$119.95 in kit form. The PRIMER Assembled & Tested is \$169.95. This trainer can be used stand alone via the keypad and display or connected to a PC with the optional upgrade (\$49.95). The Upgrade includes: an RS232 serial port & cable, 32K of battery backed RAM, & Assembler/Terminal software. Please add \$5.00 for shipping within the U.S. Picture shown with upgrade option and optional heavy-duty keypad (\$29.95) installed. Satisfaction guaranteed.

# EMAC, inc.

11 EMAC WAY, CARBONDALE, IL 62901  
618-529-4525 Fax 457-0110 BBS 529-5708  
World Wide Web: <http://www.emacinc.com>

1985 - 1998

OVER  
**12**  
YEARS  
OF SERVICE

# Fort777.com

The best in electronics anywhere in the galaxy

Here's a tiny sample of the things you'll find at  
[www.fort777.com](http://www.fort777.com)

## Resistors 1/4W

High quality metal-film.  
Only 9¢ for pack of 10.  
Also 0.6W to 10W available.

## Capacitors

Ceramic 0.1µF 16V.  
Only 25¢ for pack of 5.

## White LEDs T-1 and T-1½

Only \$2.99 each.  
Red, Green, Yellow, Blue  
and super bright available.

## Diodes & Rectifiers

1N4001 thru 7, 1N914,  
1N4148 all these types:  
Only 25¢ for pack of 10.

## Connectors

RCA Plug only 15¢ each.  
1/8" Plug mono 35¢ each.  
1/8" Plug stereo 59¢ each.  
1/4" Plug mono 49¢ each.  
BNC Crimp Plug 35¢ each.

## Computer Accessories

Fully shielded printer cable  
6 feet. Only \$1.99.

## Motorcycle Intercom

Talk to your passenger in  
comfort. Only \$19.99.

## Rechargeable Flashlight

Plugs directly to power. Auto  
on if power fails. Night light.  
Only \$11.99.

## Auto-tuning FM Radio

Super mini, weatherproof,  
twin earphones. Only \$7.99.

## Audio Patch Cables

Twin RCA-type 3ft 79¢.  
+ gold-plated contacts \$1.19.  
+ gold-plated plugs \$4.99.  
Many other types in stock.

## TV Flylead

Low-loss RG6 cable, gold-  
plated F male plugs screw-  
on or push-on 3ft \$1.49.

Contact us: [sales@fort777.com](mailto:sales@fort777.com)

Items shown here and on the website [www.fort777.com](http://www.fort777.com) are only available by mail from the website. The address below is for returns and servicing.

Fort777.com North American Service Agents, Frontier  
Engineering, 628 S. Sunset St., Longmont, CO 80501

# Power Tools for Electronic Design Automation

**More Features  
More Power  
Less Money**

Ivex Spice is the latest addition in affordable EDA solutions. Use Ivex Spice with WinDraft Schematics for fast, professional results with un-surpassed ease.

Ivex 650 pin versions have no feature limitations like other low cost products on the market. Fast expert technical support, free 24 hour Knowledge Base on the web, and professional full-featured tools have made Ivex the preferred choice for designers.

For larger designs use these Ivex Products:

WinDraft unlimited: \$495  
WinBoard unlimited: \$495  
Specetra autorouter  
SP2-1000: \$650  
Ivex View unlimited \$ 99

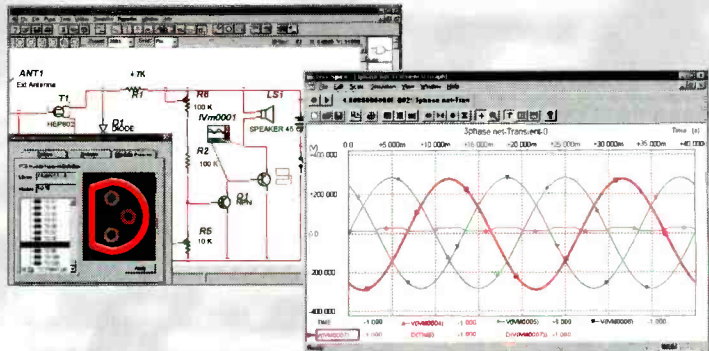

**WinDraft<sup>®</sup>**  
Schematics **\$250**  
650 pin version

Full Featured 32 bit application  
Powerful hierarchical designs  
Easy single click editing  
Graphical part editor  
Windows functionality  
Advanced Bill of Materials  
User Definable Electrical Rules Check  
Common netlist formats:  
(Accel, Protel, Pads, wirelist, Spice 3f5, & more.)  
Import Orcad/SDT files/parts  
Visual PCB footprint browser  
Over 12,000 parts included

**WinBoard<sup>®</sup>**  
PCB Layout **\$250**  
650 pin version

Multi layer designs (16)  
Surface mount designs  
Advanced Design Rule Check  
Electrical DRC check and Real-Time DRC  
Single click editing  
Graphical part & pad editor  
Hundreds of footprints  
Copper zone pour  
Output Gerber photo plot files

**Ivex Spice/Standard<sup>TM</sup>**  
Analog Simulation **\$99**

The Standard Edition includes:  
Multi channel display  
Over 3,000 models  
Uses Spice 3f5 netlist  
Use with WinDraft 3.05+

Seven Analysis types:  
Operating Point,  
DC Sweep, Transient Analysis,  
Fourier, AC Frequency Sweep,  
Small Signal Transfer,  
Sensitivity.

**Ivex Spice/Advanced<sup>TM</sup>**  
Analog Simulation **\$299**

The Advanced Edition has all the features of the Standard Edition, with these additional analysis types:

Transient Parameter Sweep,  
AC Parameter Sweep,  
Distortion Analysis,  
Pole-Zero Analysis, Noise  
Analysis and Monte Carlo.

Visit the Ivex web site for complete product information and download full function demos.

**www.ivex.com**

Tel: (503) 531-3555 e-mail: sales@ivex.com

**IVEX<sup>TM</sup>**  
DESIGN  
INTERNATIONAL

ADV5\_6

CIRCLE 309 ON FREE INFORMATION CARD

**CALL TOLL FREE**  
**(800) 292-7711**  
**Orders Only**  
 Se Habla Español

# C&S Sales

Look For Other  
 Monthly Specials  
 On Our Website  
 www.cs-sales.com

**Excellence in Service**

## D/A Trainer

Elenco Model XK-150

**\$89.95**



A low cost, full-function digital/analog trainer that meets the needs of electronic training programs. Rugged construction, can be used as fixed lab equipment or be portable. An economical zipper case is available.

## Soldering Stations

Weller Low Cost Soldering Iron Model WLC-100

**\$34.95**



- Variable power control produces 5-40 watts.
- Ideal for hobbyists, DIYers and students.
- Complete with 40W Iron.

Weller Soldering Station Model WES50

**\$119**

50 watts of controlled power - designed for continuous production soldering.



## Deluxe Electronic Soldering Station

Elenco SL-5 Series

Electronically controlled, ideal for professionals, students, and hobbyists. Available in kit form or assembled.

Works w/ any iron! Turn any soldering iron into a variable iron.

As Low As  
**\$29.95**

Ordering information:

- Model SL-4 - No Iron (Kit SL-4K) **\$29.95**
- Model SL-4-40 - Includes 40W UL Iron (Kit SL-4K-40) **\$35.95**
- Model SL-5-60 - Includes 60W UL Iron (Kit SL-5K-60) **\$36.95**

\*\*\* Limited Time Offer \*\*\*  
 FREE 3P-1A Solder Practice Kit w/ Kit Order!



Features:

- Cushion Grip Handle Soldering Iron (optional) with Grounded Tip for Soldering Static-Sensitive Devices. Easily Replacable. Uses Long-Life, Plated Conical Tip.
- Heavy Steel, Non-Slip Base.
- Iron Holder Funnel - Reversible, left or right side.
- Steel Tray for Sponge Pad.
- Sponge Pad.

## Generators & Counters

B&K 20MHz Sweep/Function Generator with Frequency Counter Model 4040

**\$445**

- 0.2Hz to 20MHz
- AM & FM modulation
- Burst Operation
- External Frequency counter to 30MHz
- Linear and Log sweep

21.5MHz Model 4070 **\$1295**  
 10MHz Model 4017 **\$319**  
 5MHz Model 4011 **\$249**



**BK PRECISION**

Four Functions in One Elenco Model MX-9300B

Features:

**\$450**

- One instrument with four test and measuring systems:
- 1.3GHz Frequency Counter
- 2MHz Sweep Function Generator
- Digital Multimeter
- Digital Triple Power Supply - 0-3V @ 2A, 5V @ 2A, 15V @ 1A



Elenco Handheld Universal Counter 1MHz - 2.8GHz Model F-2800

**\$99**



Features 10 digit display, 16 segment and RF signal strength bar-graph.  
 Includes antenna, NiCad battery, and AC adapter.  
 C-2800 Case with Belt Clip **\$14.95**

Elenco RF Generator with Counter (100kHz - 150kHz) Model SG-9500

**\$225**

Features internal AM mod. of 1kHz. RF output 100mV - 35MHz. Audio output 1kHz @ 1V RMS.



SG-9000 ..... **\$119.95**  
 (analog, w/o counter)

Elenco Sweep Function Generator w/ built-in frequency counter Model GF-8046

**\$195.95**

This sweep function generator with counter is an instrument capable of generating square, triangle, and sine waveforms, and TTL, CMOS pulse over a frequency range from 0.2Hz to 2MHz.



GF-8025 - Without Counter **\$139.95**

## Kit Corner

Quantity Discounts Available

over 100 kits available

Model RCC-7K

Radio Control Car Kit

**\$29.95**

- Fun & Easy to Assemble
- 7 Functions
- Radio Control Transmitter Included
- Also available as Model AK-870 (No Soldering) **\$24.95**



Model AK-700

Pulse/Tone Telephone Kit

**\$15.95**



Ideal School Project

Action Lab Kit

Model MX-902

- Safe, Solderless, Educational, and Fun!
- Easy-to-read, Illustrated, Lab-Style Manual Included.
- Requires 2 "AA" Batteries
- Build your own operating motor - It's easy, it's fun, it's Safe!
- For Ages 10 and up.

**\$24.95**

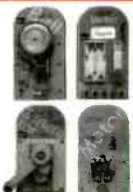

Model AM-780K

Two IC Radio Kit

**\$11.95**

Also available: Model AM/FM-108K AM/FM Radio Kit **\$29.95**

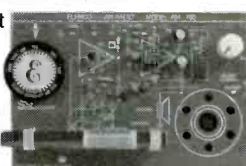

Model OWI-007

Robotic Arm (Wired Control)

Teaches the basic robotic sensing and locomotion principles while testing motor skills.

**\$55.95**



300-in-1

Experiment Kit

Model MX-908

- Everything you need to build 300 exciting electronic projects!
- Easy-to-read, Illustrated, Lab-Style Manual Included.
- Requires 6 "AA" Batteries
- For Ages 10 and up.

**\$54.95**



**Guaranteed Lowest Prices**

UPS SHIPPING: 48 STATES 5%  
 OTHERS CALL FOR DETAILS  
 IL Residents add 8.25% Sales Tax

**C&S SALES, INC.**

150 W. CARPENTER AVENUE  
 WHEELING, IL 60090  
 FAX: (847) 541-9904 (847) 541-0710

**15 DAY MONEY BACK GUARANTEE**  
**2 YEAR FACTORY WARRANTY**

PRICES SUBJECT TO CHANGE WITHOUT NOTICE

CIRCLE 290 ON FREE INFORMATION CARD

**SAME DAY SHIPPING**  
Secure on-line ordering

# C&S Sales

Excellence in Service

CALL OR WRITE FOR OUR FREE  
64 PAGE CATALOG!  
(800) 445-3201

## Elenco Oscilloscopes

Free Dust Cover and 2 Probes

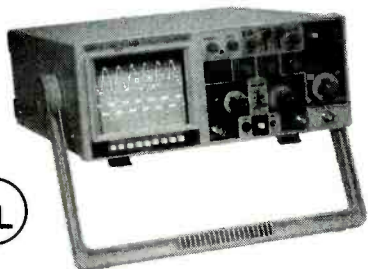

S-1325	25MHz	Dual Trace	\$325
S-1330	25MHz	Delayed Sweep	\$439
S-1340	40MHz	Dual Trace	\$475
S-1345	40MHz	Delayed Sweep	\$569
S-1360	60MHz	Delayed Sweep	\$725
S-1390	100MHz	Delayed Sweep	\$895

### DIGITAL SCOPE SUPER SPECIALS

DS-203	20MHz/10Ms/s Analog/Digital	\$695
DS-303	40MHz/20Ms/s Analog/Digital	\$850
DS-603	60MHz/20Ms/s Analog/Digital	\$950

**Quantity Discounts Available**

## Digital Multimeters

Fluke 87III



**\$319**

Features high performance AC/DC voltage and current measurement, frequency, duty cycle, resistance, conductance, and capacitance measurement.

Elenco LCR & DMM Model LCM-1950



**\$69**

- Large 1", 3 3/4 digit LCD
- Autoranging frequency to 4MHz
- Capacitance to 400µF
- Inductance to 40H
- Resistance to 4000MΩ
- Logic Test
- Diode & Transistor Test
- Audible Continuity Test

Elenco Model M-1740



**\$34.95**

- 11 Functions
- Freq. to 20MHz
- Cap. to 20µF
- AC/DC Voltage
- AC/DC Current
- Beeper
- Diode Test
- Transistor Test
- Meets UL-124 safety specs

**Model M-2760 - \$19.95 (9 functions)**

Dual-Display LCR Meter w/ Stat Functions B&K Model 878



**\$225**

Auto/manual range Many features with Q factor High Accuracy

Elenco LCR Meter Model LCR-1810



**\$99.95**

- Capacitance 1pF to 20µF
- Inductance 1µH to 20H
- Resistance 0.1Ω to 2000MΩ
- Temperature to 750°C
- DC Volts 0 - 20V
- Frequency up to 15MHz
- Diode/Audible Continuity Test
- Signal Output Function
- 3 1/2 Digit Display

Elenco DMM Kit Model M-1005K



**\$19.95**

- 18 Ranges
- 3 1/2 Digit LCD
- Transistor Test
- Diode Test
- Training Course

**M-1000B (Assembled) \$15.95**

## B&K Testers

Deluxe Multi-Network Cable Tester Model 231

**\$75**

- Tests 10BaseT, 100BaseTx, 10Base2, RJ45, RJ11, 356A, TIA-568A, TIA-568B, and Token Ring cables.
- Detects open, short, cross, and continuity.
- Tests Point-to-Point, rather than Pair-to-Pair
- Quick and easy-to-use.
- Tests cables on wall plate or patch panel up to 1,000 ft. away with the remote kit.
- Easy-to-read LED display.



Multi-Network Cable Tester Model 230

**\$69**

- Auto scans thin Ethernet (BNC), 10BaseT (UTP/STP), 100BaseTx, RJ45, 356A, TIA-568A, TIA-568B, and Token Ring cables in seconds.
- Detects miswiring, polarization, and continuity.
- Also tests the ground of shielded twisted pair cables.
- Tests cables before or after installation with the remote unit.
- LED display for clear indication of problems.



Remote Network Cable Tester Model 235

**\$195**

- Detects open, short, reversed, crossed, and split.
- Clear LED display for the fault status.
- Simple and easy-to-use.
- Test cable length: Minimum - 4 ft. (1.2m) Maximum - 492 ft. (150m).
- Identify up to 4 different cables at one end by provided remote identifiers.
- Tests: 10BaseT, 100BaseTx, 10Base2 (coax), RJ45, 356A, TIA-568A, TIA-568B, Token Ring, etc.



## CCTV Cameras

Cameras have 420 lines (360 color) of resolution, 0.08 Lux, 3.6mm/F2 90° field of view. Power requirement is 12VDC @ 100mA (order SC-1).

### MONOCHROME CAMERAS



SC-12 - 35mm Lens (1.25"x1.25") **\$69**

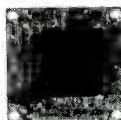

SC-15 - Pin Lens (1.25"x1.25") **\$69**

Add \$10 for lens • Add \$10 for audio

#### Accessories:

- SC-1 - 12V 100mA adapter **\$6.95**
- SC-2 - 50' cable with connectors **\$19.95**

### COLOR CAMERAS

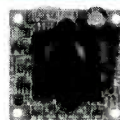

SC-20 Pin Lens  
SC-21 3.6mm Lens  
360 Lines 1.25" x 1.25"  
Infrared Sensitive, Audio Included  
**\$109**

Add \$10 for case  
Call for complete catalog.

## Power Supplies

Elenco Quad Power Supply Model XP-581

**\$79.95**



4 Fully Regulated DC Power Supplies In 1 Unit  
4 DC voltages: 3 fixed - +5V @ 3A, +12V @ 1A, -12V @ 1A  
1 Variable - 2.5 - 20V @ 2A

#### B&K High Current DC Power Supply

- Variable 3-14VDC
- Thermal Function
- Current Limiting

Model 1686 12A	\$169
Model 1688 28A	\$249



B&K 13.8V Fixed DC Power Supplies  
Model 1680 6A ..... \$42  
Model 1682 15A ..... \$75

Elenco Power Supply Kit Model XP-720K

**\$54.95**

- 1.5VDC - 15VDC @ 1A
- -1.5VDC - -15VDC
- 5VDC @ 3A
- 6.3VAC @ 1A & 12.6VAC center tapped @ 1A



XP-720 Fully Assembled  
**\$85**

Elenco DC Power Supply Model SPL-603 3A 0-30VDC

**\$79.95**

The SPL-603 is a solid-state DC power supply providing the exact output voltage no matter what current you use. Output fully protected from overload.



## Guaranteed Lowest Prices

UPS SHIPPING: 48 STATES 5%  
OTHERS CALL FOR DETAILS  
IL Residents add 8.25% Sales Tax

SEE US ON THE WEB

## C&S SALES, INC.

150 W. CARPENTER AVENUE  
WHEELING IL 60090

FAX: (847) 541-9904 (847) 541-0710

www.cs-sales.com

15 DAY MONEY BACK GUARANTEE  
2 YEAR FACTORY WARRANTY



PRICES SUBJECT TO CHANGE WITHOUT NOTICE

**WIRELESS MOBILE WORKSTATION is a Hackers Bonanza!  
Itronix T5000 mobile terminal with 2Meg. PCMCIA Mem card.**



This is a super device we would really like to know more about. Our people are working on it and this is what we know so far: This unit is built like a brick pizzeria. Case is polycarbonate & sealed from rain, dust & drops. It has a 75 key QWERTY keyboard which curiously seems to be mapped one key off. These units were just replaced by a fortune 500 company that was using them in the daily operations. They must require some external input for the correct keyboard mapping. Probably a security measure? The flip up cover holds a transreflective Samtron UG24D02 monochrome LCD display that we think is 640 x 240 pixels. Size: 7.3"W x 2.75"H and displays 16 shades of gray also has a white E/L backlight. Each has an internal Motorola Type RPM4051 Radio Packet Modem with built

in flip up antenna. we believe it operates on the ARDIS or similar network. There is also an RS-232 serial port / bar code wand port & a port for a hand held laser scanner. When powered via the external jack: 10VDC @ up to 800mA. Draws about 175ma after boot. Originally powered by a 7.2V, NICAD pack which has been removed. The battery compartment is external & could easily hold an alternate power source. We believe there is an internal modem as the unit sports an RJ-11 style connector as well tip and ring connections. The 80C552 processor boots MS DOS ROM Version 5.00 to an A: > prompt. The screen indicates an internal memory of 640K. A 2meg. PCMCIA memory card is also supplied. Operating temp from -4 to +140F. From there on your own. All units are tested for boot up otherwise sold as an experimenters package. **T5100.....\$49ea., or 3 for \$129**

**A VERY COOL COLOR CAMERA, "The ROVING EYE CAM" with Ultra Compact PAN and TILT, AUTO IRIS and AUTO FOCUS to boot!**



Another super quality color conference camera designed as part of a high end system from PictureTel. The unit consists of a camera head attached to a base PC board. The attachment is via a moveable mount. There are two tiny stepper drives which create the pan and tilt motion. The tilt stepper is mounted to the PC board. The pan stepper is unmounted and attaches to the side on your base or enclosure. We assume the camera is controllable via serial commands however we have no info on how to do it. Anyone who can tell us can have some free cameras. Specs: 400 lines @ 1lux, pwr required is 12VDC @ 500mA. size of head is: 5.5" diam. x 3.2"H. The attached PCB is 3W" x 4L" x 1.3"H. Oh, and did we mention it's auto focus and auto

iris too? Composite video output. We think it has 5 video also. Check our web site for further details as they become available. Order now, the price goes up when we get the serial commands. Removed and tested.

**SPECIAL MAY PRICE MINI-R2D2 CAM.....\$149ea. or 2 /\$289, or 5/\$499**

# RESOURCES UN-LTD.

VISA, MC, AMEX, DISCOVER, COD, ON-LINE  
ORDER: 800-410-4070 TECH: 603-648-2499  
FAX: 603-644-7815 E-MAIL sales@resunltd.com  
300 BEDFORD STREET, MANCHESTER, NH 03101

**NEW! LCD COLOR, TFT, ACTIVE MATRIX DISPLAY, Super 5.6" VIEWABLE AREA. Pro System w/Custom Case, 12V gel cell battery, A/V cables & charger.** Finally, exceptional quality & affordable LCD monitor. Perfect general purpose color/B&W monitor. NTSC. Fully compatible with all cameras, camcorders, VCR's etc. Use as a rear view system with any video camera with its built in, mirror image function. Completely enclosed unit. Adj. color, contrast, brightness & volume. Internal stereo speakers! Std. 1/4 x 20 Tripod socket & a tilt down stand for table top. Inputs: audio (L&R) & video on std. 1/8" mini jacks. External 12VDC@600mA on std. barrel connector. 5.6", TFT active matrix LCD, 76.8K Pixels, CCFL backlight, 270cd/m Lumin., 500mW audio out on std. 1/8" jack. 50mV min. std. line level audio in. Size: 6.4"W x 5.25"H x 2.2"D New, first quality. Pro accessory kit includes: Luggage quality, custom padded case with dual removable straps for shoulder and/or holding at waist level for, hands free viewing. Built into the case is a 12V Gel Cell, rechargeable battery & a complete set of A/V cables. Incl. AC pwr adapter & battery charger. **GM-TFT56,....\$299ea. PRO KIT, GM-ACCYFTT...\$45**



## SECURE ON-LINE ORDERING, WWW.RESUNLTD4U.COM

CIRCLE 246 ON FREE INFORMATION CARD

# suburban ELECTRONICS

- Large Selection of Batteries  
Replacement Batteries for  
Camcorders, Cell Phones, Laptops, etc.
- Semi-Conductors, Transistors  
& Integrated Circuits
- Soldering Equipment  
Soldering & Desoldering  
Stations
- Satellite Antenna Accessories  
Splitters, Diplexers & Amplifiers
- Electronic Tools, Tool Kits  
& Tool Cases
- Test Equipment  
Oscilloscopes,  
Power Supplies &  
Power Invertors

**To get a free catalog,  
visit us on the web at  
www.suburban-elect.com  
or call us at  
1-800-341-5353**

Temperature  
Controlled  
Soldering Station  
SEW-351 \$69.95



### OSCILLOSCOPE BLOW OUT

B&K #2190A 100 MHz \$899.00  
B&K #2160A 60 MHz \$599.00  
Goldstar #OS9020P 20 MHz \$299.00

### TEST EQUIPMENT

B&K #5390 True RMS Hand-held Digital Multi-meter \$149.00  
SRV-5 5-Amp Isolated Variable Transformer 0-130V \$99.95

Pro's Electronic  
Tool Kit  
Includes  
Tools & Case  
SEW-900 \$189.95



### Data Acquisition and Control

The ADR series of interfaces allow control of analog, digital and relay I/O via RS232 or RS485. Visit the web site for specs, applications and programs in VB, C, BASIC etc. (705) 671-2652

[www.ontrak.net](http://www.ontrak.net)

Ontrak Control Systems Inc.

### FCC License Preparation

#### RADIOTELEPHONE LICENSE

Electronics Tech, Avionics, Marine & Radar  
**Homestudy**--Fast-Easy & inexpensive.  
 Manuals-Audio-Video-podisks-Q&As  
**Guarantee Pass-see at [www.wptfcc.com](http://www.wptfcc.com)**  
 Details-800-800-7555.WPT Publications  
 4701 NE 47ST, Vancouver, WA, 98661

### Do You Repair Electronics?

Repair Databases for  
 TV, VCR, Monitor, UL  
 Audio, FCC, and more.

- Over 76,000 records
- Private user forums
- Live on-line chat rooms

**RepairWorld.com**

Electronics Corp. 1 Herald Sq. Fairborn, OH 45324 (937) 878-9878

ABC ELECTRONICS 315 7TH AVE N. MPLS. MN. 55401  
 (612)332-2378 FAX (612)332-8481 E-MAILSURP1@VISI.COM  
 WE BUY TEST EQUIPMENT AND COMPONENTS.  
 VISIT US ON THE WEB AT [WWW.ABCTEST.COM](http://WWW.ABCTEST.COM)

HP 51501A 100MHZ DIGITIZING SCOPE	\$1300.00	HP 4935A TRANS. IMPAIRMENT TEST SET	\$900.00
HP 51201D 300MHZ DIGITIZING SCOPE	\$1000.00	HP 5006A SIGNATURE ANALYZER	\$150.00
HP 54201A 300MHZ DIGITIZING SCOPE	\$1000.00	HP 8602B 1MHZ-1300MHZ RF PLUG	\$400.00
HP 54200A 300MHZ SCOPE/WAVEFORM ANALYZER	\$700.00	EIP 575 MICROWAVE COUNTER	\$1500.00
HP 3312A 13MHZ FUNCTION GENERATOR	\$250.00	FLUKE 95 50MHZ SCOPERMETER	\$550.00
HP 5379A 100MHZ U.T.I. COUNTER	\$100.00	LEICROY 7200 100MHZ O-SCOPE	\$1000.00
HP 3586C LEVEL METER	\$750.00	TEK 475 200MHZ O-SCOPE	\$500.00
HP 436A POWER METER W/O SENSOR & CABLE	\$500.00	TEK 465 100MHZ O-SCOPE	\$400.00
HP 8350B SWEEP OSCILLATOR MAINFRAME	\$2000.00	TEK 496P 1KHZ-1.8GHZ SPEC ANALYZER	\$3500.00
HP 3137A 3.5DIGIT SYSTEM VOLT METER	\$250.00	TEK 1240 LOGIC ANALYZER	\$750.00
HP 3155A DIGITAL MULTIMETER	\$250.00	TEK TDS320 100MHZ DIGITAL O-SCOPE	\$1400.00
HP 3156A DIGITAL MULTIMETER	\$400.00	TEK 11401A 500MHZ PROG O-SCOPE FRAME	\$750.00
HP 3336C SYNTHESIZER LEVEL GENERATOR	\$800.00	TEK 7854 400MHZ OSCILLOSCOPE FRAME	\$500.00
HP 3325A SYNTHESIZER FUNCTION GENERATOR	\$1000.00	TEK 7901 400MHZ OSCILLOSCOPE FRAME	\$2400.00
HP 5335A 200MHZ COUNTER	\$600.00	TEK 7A26 200MHZ VERTICAL PLUG	\$75.00
HP 8165A PROGRAMMABLE SIGNAL SOURCE	\$1100.00	TEK 7A21 100MHZ VERTICAL PLUG	\$150.00
HP 8558B 181 100K-1.600MHZ SPECTRUM ANALYZER	\$1000.00	TEK 7B80 400MHZ TIME BASE	\$75.00
HP 8559B 183 10MHZ-21GHZ SPECTRUM ANALYZER	\$3000.00	TEK T892A 500MHZ DUAL TIME BASE	\$125.00
HP 1100A 100MHZ OSCILLOSCOPE	\$240.00	TEK 7517 SAMPLING PLUG	\$250.00
HP 6034A 60VDC-10A POWER SUPPLY	\$750.00	TEK 7L14 10KHZ-1.8GHZ SPEC ANALYZER	\$1600.00
HP 6269H 40VDC-50A POWER SUPPLY	\$800.00	TEK AM503 CURRENT PROBE AMPLIFIER	\$250.00
HP 6653A 10VDC-12.5A POWER SUPPLY OPT 01	\$1200.00	WAVETEK 145 20MHZ PULSE/FUNCTION GEN	\$400.00
HP 6652A 20VDC-5A POWER SUPPLY	\$500.00	WAVETEK 182A 4MHZ FUNCTION GEN	\$150.00
HP 6613A 15VDC-13A POWER SUPPLY OPT 03	\$750.00	WAVETEK 955 7-8.12GHZ MICROSOURCE	\$1100.00

## MEMBRANE SWITCHES

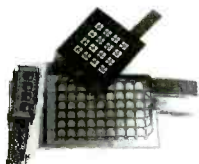

Stock Layouts!

Eliminate tooling costs...

\*\*From 2 to 128 keys\*\*

Optional Stainless Steel  
 Tactile "Clickdomes".

Industry \* Hobbyist  
 Production \* Prototyping

Popular tactile types are available as  
 complete kits, with bezel, connector  
 & overlay!

4 key DTK-4 kit \$14.67  
 12 key DTK-12 kit \$24.43  
 many more layouts...

**Sil-Walker**

(805) 491-0654  
 FAX (805) 491-2212  
 P.O. Box 3220  
 Camarillo, CA 93011-3220

[silwkr@vcnet.com](mailto:silwkr@vcnet.com)  
[www.vcnet.com/silwkr/](http://www.vcnet.com/silwkr/)

MASTERCARD/VISA

## TiePieScope HS801 PORTABLE MOST

# Reliability



50 MHz ARBITRARY WAVEFORM GENERATOR-  
 100 MHz STORAGE OSCILLOSCOPE-  
 50 MHz SPECTRUM ANALYZER-  
 6 DISPLAY MULTIMETER-  
 200 DAYS TRANSIENT RECORDER-

The HS801: the first 100 Mega samples per second measuring instrument that consists of a MOST (Multimeter, Oscilloscope, Spectrum analyzer and Transient recorder) and an AWG (Arbitrary Waveform Generator). This new MOST portable and compact measuring instrument can solve almost every measurement problem. With the integrated AWG you can generate every signal you want.

A user defined toolbar with which over 50 instrument settings quick and easy can be accessed is offered by the versatile software. An intelligent auto setup allows the inexperienced user to perform measurements immediately. Through the use of a setting file, the user has the possibility to save an instrument setup and recall it at a later moment. The setup time of the instrument is hereby reduced to a minimum.

Analyzing signals is done with an 8 bit resolution and a maximum sampling speed of 100 MHz. The input range is 0.1 Volt full scale to 80 Volt full scale. The record length is 32K/256K samples. The AWG has a 10 bit resolution and a sample speed of 25 MHz.

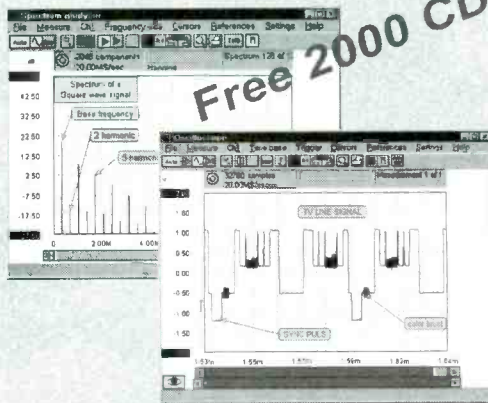

Convince yourself and download the demo software from our web page: [www.tiepie.nl](http://www.tiepie.nl). When you have questions and / or remarks, contact us via email: [support@tiepie.nl](mailto:support@tiepie.nl). The HS801 is delivered with a user manual, two probe's, Windows and DOS software.

US dealer:  
**Feedback Incorporated**: Tel 800-526-8783;  
 Fax 919-644-6470; [www.fbkc.com](http://www.fbkc.com)

Outside US:  
**TiePie engineering**, P.O. BOX 290, 8600 AG SNEEK,  
 The Netherlands.  
 Tel: +31 515 415 416 Fax: +31 515 418 819  
 Web: [www.tiepie.nl](http://www.tiepie.nl)

# Dalbani

Shop on line [www.dalbani.com](http://www.dalbani.com)

## General Instrument Universal Remote Control

Item # 82-1585

Controls TV's, VCR's Cable boxes & Stereos • Full menu & guide



Batteries Included

\$4.99

## Performance Keyboard IBM PC Compatible 104 keyboard

Item # 95-7760



DELL \$6.99

• Use Standard Mini 6-Pin DIN

## Fax Machine Six in one

Item # 85-2365

Fax, Phone, Printer, Copier, Scanner, PC Fax/Modem

\$119.99

SHARP  
Factory Serviced



## 12 Inch B & W Quad Screen Observation System

Item # 38-0525

\$269.99



Reg. \$399.00

## 120 Joules 6 Outlets Power Strip

Item # 40-2555

• 6 Outlets  
• UL Listed  
• one pair per package



\$3.99

## Panasonic DSS Beyond TV Reach

Allows you to view the same programming on a second TV in another Room

Item # 55-1845

Panasonic Model # TZ-A102RK



900 MHz

2nd Room Kit

\$49.99

For terms and conditions please refer to our catalog

To Get These Prices Please Mention Code  
**\$295**

All items are subject to availability  
All prices are subject to change without notice.

MAJOR CREDIT & C.O.D. ACCEPTED



Energizer  
Photo Batteries

## Cordless Phone Battery

Item # 29-2565

• Model# P5256  
• 500 MAH Lead Acid Battery



\$6.99

## Aluminum frame Tool Case

Item # 50-1890

• Black Color

\$24.99



## 21 Pieces Service Tool Kit

Item # 50-057

\$29.99



## Multimeters

Item # 50-3630

\$9.99

Quality Test Equipment



## Soldering Station

Item # 51-1505

Variable Power Control(5-40W)  
Interchangeable Tip & Heating Element

\$34.99



Weller

## Deluxe Video Dubbing and Enhancement System

Item # 55-1780

• Stereo / Mono Compatible



\$149.95

Energizer  
Photo Batteries

## Camcorder Battery

Item # 29-2570

• Model# CV3112C  
• 12V 200mAh Lead Acid Battery  
• Used with GE, Magnavox, Panasonic



\$17.99

## Wireless Digital Audio/Video Sender with 2.4GHz Transmitter



2.4GHz  
Up to 300ft

Item # 38-0885

Watch movies in another room from your Satellite Dish, VCR DVD, or Laser Disc Player without running cables

\$9.99

## Photo Inkjet Color Printer

Okijet® 2500

Item # 95-7580



\$95.99

Reg. \$189.00

## Digital Video Stabilizer

Item # 55-1265

\$16.99

• Eliminates brightening and darkening, blackout, color shifting, jitter, shaking, picture tearing and twisting, line effects and all other symptoms 9V battery (installed)



## 1350 Joules PC Network Surge Protection

Item # 40-2490

• 8 outlets & 2-device telephone protection using RJ45/RJ11 phone lines  
• 15Amp circuit breaker • 6ft power cord

CURTIS



\$16.99

## DC to AC Power Inverter

120V. AC  
Item # 40-1935

• AC output Voltage: 120V AC  
• DC Input Voltage: 10-15V  
• Low battery cutout: 10V DC  
• Frequency ± 1%: 60Hz 50Hz  
• No load current draw:  
Switch ON : < 0.6 A DC  
Switch OFF: < 0.2mA DC  
• Low battery alarm: audible, DC 10.7V

Common Features  
• Output power : 2500W • Over load: 2501-3000W

This Power Inverter Handles Temporary High Surge Loads to Start Electric Motors, Water Pumps, TVs and more.

240V. AC  
Item # 40-2315

• AC output Voltage: 240V AC  
• DC input Voltage: 24V(20-30V)  
• Low battery cutout: 20V DC  
• Output Frequency: 60Hz  
• No load current draw:  
Switch ON : < 0.5 A DC  
Switch OFF: < 0.2mA DC  
• Low battery alarm: audible, DC 21.5V



\$455.99 each

\$20.00 Minimum Order  
not including shipping & handling

ups  
2ND DAY AIR

CALL TOLL FREE  
**1-800-325-2264**

e-mail: [savings@dalbani.com](mailto:savings@dalbani.com)

In Canada Call 1-800-667-4362

3.95 shipping and \$2.25 handling  
Up to 5 lbs anywhere in the U.S.A.  
Excluding Alaska, Hawaii & Puerto Rico

SPECIAL SHIPPING RATE



Save up to 90% off list prices on thousands of goods and services!

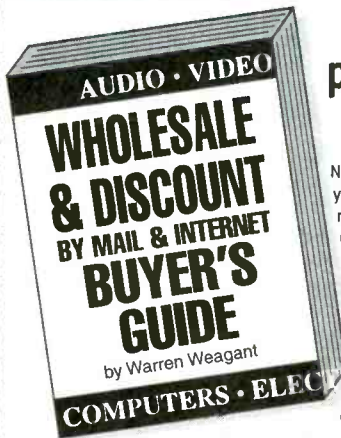

**Why pay retail prices when you don't have to?**

No matter what you're looking for, you can get it cheaper with this newly updated for 2000 Buyer's Guide: Audio and Video equipment and materials, Electronic products and surplus, Professional Recording and specialty items, Computers and components, Stereos, CDs, Software, wireless telephone and Communications Equipment and almost anything else you could want.

Here you'll find carefully researched and screened sources that represent the best businesses with the best bargain prices. Plus, you will find unusual companies selling hard-to-find items.

If you're looking for almost anything for yourself, your home or business—chances are you'll find a mail order or internet company listed that sells it at huge wholesale discounts. Company listings include complete address, phone, FAX, Email and Website addresses.

Only **\$19<sup>95</sup>** postpaid

## COMMAND PRODUCTIONS

Post Office Box 2824  
San Francisco, CA 94126  
Call toll free: 1-800-932-4268



# PCB LAYOUT

## Software For Windows - FREE

- 1 Download our board layout software
- 2 Design your 2 sided plated-through PCB
- 3 Send us your layout over the Internet
- 4 In 2-3 business days, UPS delivers your boards, often under \$100

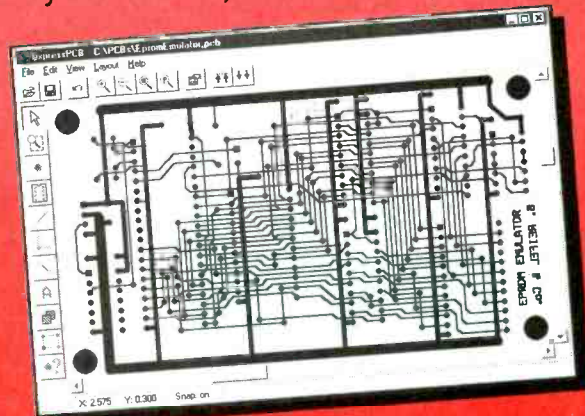

[www.expresspcb.com](http://www.expresspcb.com)

## NEW! All 1300 ACTUAL QUESTIONS! FCC Commercial General Radiotelephone Operator License (GROL) Plus Ship Radar

Only **\$18<sup>95</sup>** Plus \$4.00 shipping

Compete FCC Element I, 3 and 8 Question Pools.

## Become an FCC licensed ELECTRONIC TECHNICIAN

- 347-page Tests-Answers exam Guide covers everything you need to know to get your FCC Commercial Radiotelephone Operator License with Radar Endorsement.
- Newly revised multiple-choice exams cover all word-by-word questions covered on the actual FCC License exam.
- Revised 17th edition has complete information on every commercial radio license examination and how you can qualify...from the publisher specializing in FCC License training since 1969.
- Unconditional **Money Back Guarantee**.



**COMMAND PRODUCTIONS FCC LICENSE TRAINING**  
Post Office Box 2824 • San Francisco, CA. 94126  
Call Toll Free 1-800-932-4268

CIRCLE 232 ON FREE INFORMATION CARD

# RF Data Modules

### AM Transmitter



- Sub Miniature module
- SAW Controlled
- No adjustable components
- Low current - 2.5mA
- Supply 2.5-12Vdc
- 418MHz or 433MHz
- Range up to 300ft
- CMOS/TTL data input
- 7 x 11 x 4mm !
- AM-TX1-xxx .... \$12.60

### AM Receiver



- Compact Hybrid Module
- Very stable
- CMOS/TTL output
- Patented Laser Trimmed
- 5Vdc. 0.8mA (HRR6)
- 2kHz data rate
- Sensitivity -105dBm
- 38 x 12 x 2 mm
- AM-HRR6-xxx... \$16.33

### FM Transceiver



- Only 23 x 33 x 11mm
- Up to 40,000bps data rate
- Up to 450ft. range.
- 5V operation
- 418MHz or 433MHz FM
- 5V CMOS logic interface
- Fast 1mS enable
- Power saving feature
- Carrier Detect output
- BiM-xxx-F ..... \$87.36

### RS232 Transceiver



- 3wire RS232 interface
- 19.2Kbps half duplex
- 418MHz or 433MHz FM
- 7.5-15Vdc. 20mA
- TX/RX Status LED's
- Up to 400ft. range
- 1/4 wave ant. on board
- User data packetizing
- 58 x 40 x 15mm
- CYPHERNET .... \$139.30

### AM Transmitter

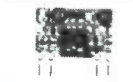

- Range up to 250ft.
- SAW controlled stability
- Wide supply range 2-14V
- CMOS/TTL input
- Low current. 4mA typ.
- Up to 4kHz data rate
- Small: 17 x 11mm
- AM-RT5-xxx .... \$12.10



**ABACOM**  
TECHNOLOGIES

Free Catalog

tel: (416)236 3858  
fax: (416)236 8866  
[www.abacom-tech.com](http://www.abacom-tech.com)  
MasterCard / VISA

## PIC MICROTOOLS

**PROGRAM PIC'S IN BASIC!**  
B2 compatible! Plus can be used within  
MPLAB IDE. Includes FREE Proto board!  
Pic n' Basic Pro Compiler \$129.00



**ALLPIC Plus Programmer**  
Program PIC - Scenix - Atmel  
Serial EEPROMS Includes 40  
Pin ZIF Complete \$99.00

**PIC & Scenix Prototyping Boards**  
New Special design makes it easier to  
prototype PIC & Scenix micros than  
any other prototyping boards!  
Starting at \$9.95



**New! Experimenter - Lab Board**  
Several models available! Built in  
Graphics LCD, Serpos, Bcton Matrix,  
EEPROM, Solderless Bread Boards.  
For Beginners to Professionals! All  
boards will work with PIC or Scenix  
Complete Kits Starting at \$49.95

Educational Discounts Available!  
VISA • MasterCard • American Express  
To Order Call 1-800-773-6698  
Send Money orders to: Worldwyde.Com,  
33523 Eight Mile Rd #A3-261, Livonia, MI 48152  
Visit us online <http://www.worldwyde.com>

## PIC PROJECTS Book & CD-ROM

Many PIC Projects for Beginners & Experts!  
Includes Software, Documentation, and PCB Layout

- LCDs
- X10 - Home Automation
- Keypads
- Serial Port Interface
- On-Screen Displays
- Robotics
- Data Logging
- Serial/Parallel
- And Many More!

Book &  
CD Only  
\$24.95

**PIC Programmer**  
Programs all PIC16C55x/6x/7x/8x/9x,  
PIC 16F8x, and PIC12C devices.  
Optional ZIF adapters for SOIC & PLCC.  
Includes all necessary software.  
Only \$39.95

Buy  
Both for  
\$59.95

We accept  
VISA • MasterCard • American Express  
To order, call Worldwyde @ 1-800-773-6698  
21365 Randall Street • Farmington Hills, MI 48336  
Visit us on the web at [www.worldwyde.com/pic](http://www.worldwyde.com/pic)

## Press-n-Peel Transfer Film PC Boards in Minutes

8.5" x 11" Shts.  
\* Or Photocopy  
\*\*Use standard  
household iron

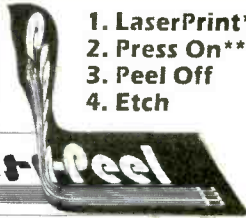

1. LaserPrint\*
2. Press On\*\*
3. Peel Off
4. Etch

Use Standard Copper Clad Board  
20 Shts \$30/ 40 Shts \$50/ 100 Shts \$100  
Visa/MC/PO/CK/MO \$4 S&H/Foreign Add \$7

**Techniks Inc.**  
P.O. Box 463, Ringoes NJ 08551  
ph. 908.788.8249 fax 908.788.8837  
[www.techniks.com](http://www.techniks.com)  
Visit Our E-Store On-Line!

## COVERT CATALOG2000

### BRAND NEW!

The Latest, Up-to-date, Hands-on  
Supplier and Source Guide for:

- Electronic surveillance equipment
- Covert video cameras and transmitters
- Counter measures gear
- Entry supplies
- Electronic tracking systems
- Computer surveillance and remote viewing

Equipment, exact addresses and ordering info  
from 15 countries!! 220 pages — \$39.95

11 3555 S El Camino Real, San Mateo, CA 94403  
Phone 650-513-5549 ■ fax 650-728-0525 or  
[www.intelligence.co](http://www.intelligence.co) (no ".dot.com")

## GLOBALTECH DISTRIBUTORS

The Ultimate Electronic Saving Store

Call Today!—1-(800)582-5116

	25pc.	100pc.	500pc.
PIC12C508	1.30	1.20	1.15
PIC16C54	1.40	1.35	1.30
PIC16C56	1.65	1.50	1.45
PIC16C621	2.00	1.95	1.85
PIC16C622	2.25	2.15	1.95
68HC705C8A	5.50	5.00	4.85
ATF89C52	4.00	3.50	3.15
82S131	1.50	1.30	1.15
Gall16V8b	1.00	.95	.75
4mhz Res.	.45	.40	.32
20mhz Crystal	.50	.45	.40
CATV Remote	4.25	3.75	3.25
Universal Remote Controls	4.50		

Order@globaltechdistributors.com



BEST MICROPROCESSOR STOCK DISTRIBUTOR WORLD WIDE.

## Underground Info!

Hacking • Cracking • Satellite • Cable • Phreaking • Micros  
GameBoy I/O • Smart Cards • Emulation • Hardware • Tools

Plus More! Visit us on the web!

**Books & CD's:**

Hackers Anarchy Cook Book 2000 .....	\$39.95
The Hack & Crack Bible Vol.2 .....	\$39.95
Hackers Gold CD Vol.1 .....	\$49.00
Secrets of Dish Network Vol.1 .....	\$49.95
DSS Secrets Vol.4 Book & CD .....	\$49.95
Cable Test Devices Source Code & Plans .....	\$79.00
PSX Secrets w/ MODCHIP Source Code .....	\$69.95
The Ultimate Phreaking Guide .....	\$39.95
Emulator Heaven CD .....	\$49.95
Game Boy I/O - Servos/Relays/Sensors .....	\$49.95

**Hardware:**

PIC, Scenix, Atmel Programmer Complete ...	\$99.00
ISO 7816 Smart Card Programmer .....	\$59.95
Smart Cards (from) .....	\$ 6.95
Prototyping Boards PIC & Scenix .....	\$ 9.95

VISA • MasterCard • American Express  
To Order Call 1-800-773-6698  
Send Money orders to: Worldwyde.Com,  
33523 Eight Mile Rd #A3-261, Livonia, MI 48152  
Visit us online <http://www.worldwyde.com>

## Video Scrambler

HIGH PERFORMANCE  
ENCODE/DECODE SYSTEM

CREATE OR RESTORE  
SCRAMBLED VIDEO  
AUTOMATICALLY

MAKES THE PERFECT  
PORTABLE ENCRYPTION  
SYSTEM!

OPERATES ON A STANDARD  
9 VOLT BATTERY

phone:  
(219) 233-3053  
fax:  
(219) 239-1566



MODEL VITR



R.C. Distributing • P.O. Box 552 • South Bend, IN 46624  
[www.reistributing.com](http://www.reistributing.com)

## 35¢ Switches

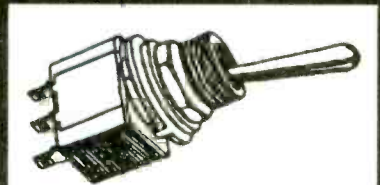

Premium quality. Rated 6A/125V. All  
hardware included. 1/4" panel hole.  
SPDT or DPDT, on-on or on-off-on.  
100pcs minimum. VISA or Master  
Card. Sorry, no COD. Order Toll-free.

Gateway Products Corporation

800-830-9195

## ANTENNA SCIENCE! WHY DO ANTENNAS RADIATE ELECTROMAGNETIC WAVES?

LEARN FOR YOURSELF FROM THIS  
ENLIGHTENING PAPER BY MAX RESEARCH  
GAIN AN UNDERSTANDING OF  
THE RADIATION MECHANISMS OF ANTENNAS.1  
WRITTEN IN A CLEAR STYLE FOR  
RADIO HOBBYISTS, INQUISITIVE AMATEURS  
AND EXPERIMENTERS.

\$4.95...ppd

ORDER FROM  
MAX RESEARCH  
P.O. BOX 1306

EAST NORTHPORT, NY, 11731



## Underground Info!

Hacking • Cracking • Satellite • Cable • Phreaking • Micros  
GameBoy I/O • Smart Cards • Emulation • Hardware • Tools

Plus More! Visit us on the web!

### Books & CD's:

Hackers Anarchy Cook Book 2000 .....	\$39.95
The Hack & Crack Bible Vol.2 .....	\$39.95
Hackers Gold CD Vol.1 .....	\$49.00
Secrets of Dish Network Vol.1 .....	\$49.95
DSS Secrets Vol.4 Book & CD .....	\$49.95
Cable Test Devices Source Code & Plans .....	\$79.00
PSX Secrets w/ MODCHIP Source Code .....	\$69.95
The Ultimate Phreaking Guide .....	\$39.95
Emulator Heaven CD .....	\$49.95
Game Boy I/O - Servos/Relays/Sensors .....	\$49.95

### Hardware:

PIC, Scenix, Atmel Programmer Complete ...	\$99.00
ISO 7816 Smart Card Programmer .....	\$59.95
Smart Cards (from) .....	\$ 6.95
Prototyping Boards PIC & Scenix .....	\$ 9.95

VISA • MasterCard • American Express  
To Order Call 1-800-773-6698

Send Money orders to: Worldwyde.Com,  
33523 Eight Mile Rd #A3-261, Livonia, MI, 48152  
Visit us online <http://www.worldwyde.com>

## LASER MODULE



Auto Power Control  
Collimated Laser  
Compact Size  
100,000 hr lifetime  
No Electronics Required

Visible Laser Modules(635-670 nm)  
TTL Modulated Laser Modules  
Line Generator Laser Modules  
Infrared Laser Modules(780-830 nm)

from  
**\$ 29 (US)**

## LASER POINTER



Focus Adjustable  
Elegant Design  
Solid Metal Body

Pen Style Laser Pointer (1500 ft visibility)  
Key Chain Laser Pointer (1500 ft visibility)  
Available in silver and, black finish.

**\$19.95 (US)**

World Star Tech.

Ask for free catalog

Tel:(416)204 6298 Fax:(416)596 7819

<http://www.worldstartech.com> e-mail: [info@worldstartech.com](mailto:info@worldstartech.com)

## CABLE SECRETS!!!

### Build your OWN cable box "test" devices!

Why pay \$100.00 or more for a "test" device that someone else made? Make your own! Includes complete source code and plans for the most commonly used cable boxes. *Unlock all of the channels on your box!*

Or start your own lucrative business!

Complete source code ..... \$79.95  
Code for individual boxes ..... \$29.95

## DSS SECRETS — Vol. 2

Step-by-step instructions on programming your own DSS access card. *Unlock all channels on your own card!* This is the most current information on the market! Includes software, plans, and hardware sources. Book & CD-ROM.

DSS Secrets Vol. 2..... \$49.95

VISA • MasterCard • American Express

To order, call Worldwyde • 1-800-773-6698

21365 Randall Street • Farmington Hills, MI 48336

Visit us on the web at [www.worldwyde.com](http://www.worldwyde.com)

## PIC Programmer Kits

Super Value!

**\$19.95**

+S&H \$4.95\*

• Program all 8, 18, 28 & 40 pin PICs in the

12C5xx (12C508),

14000 and 16Cxx (16F84) series (except 16C54-58). • All components, PCB and Instructions included. • Parallel port of PC is used with straight through (25 pin) cable (not supplied). • Kit uses shareware which is downloaded from the web and registered for \$20. • 40 pin ZIF socket recommended (available for \$11.95). • For more info and Atmel programmers visit [www.electronics123.com](http://www.electronics123.com)

Code: CPS99

CMOS Camera Module, Black & White, Size: 0.63"x0.63"x0.59". Low cost, low power and very small! Lens: f4.9, F2.8 FOV 56 deg x 42 deg. EIA 320Hx240V. Scan: 2:1 interface. 0.6" DIL Package. 5 pins. Pin 3 is 1V p-p composite video (75 ohm) to standard video monitor. Power Supply, 5V +/- 0.5V. Current 10mA. Needs regulated power supply. \*S&H to Canada is \$7.95

### Video Camera module

Code:BB004

**\$35.95**

+S&H \$4.95\*

Toll Free: 1-888-549-3749 (USA & Canada)

Tel: (330) 549-3726. Request a FREE catalog or visit us at: [www.electronics123.com](http://www.electronics123.com) for more products. Amazon Electronics, Box 21 Columbiana OH 44408

## 10Hr Phone Recorder \$69

Records both sides of conversation automatically

Telephone Scrambler \$159 ea. or 2 for \$149 ea.

Secure phone conversations with this high tech "tolling code" scrambler. Thousands of codes! Easy connection. Requires one at each end.

Voice Changer Phone \$99

Disguise your voice with this phone. 16 Pitches! Make your voice deeper or higher. Men can sound like a woman. Easy to use.

5 Hr. Phone Recorder Touch-tone decoder \$159

Records both sides of conversation including phone numbers dialed

Phone Information Recorder \$169

Records name and number of callers (requires Caller ID service)

PC Telephone Recorder \$119

Use your PC to record phone calls. Windows 95, Sound blaster compatible sound card 48k or higher PC required

Phone Tap detector \$159

Protect your phone against phone taps, eaves droppers and RF bugs.

Mini Bug Detector up to 2GHz \$119

Detects RF "Bugs", Video Transmitters and wireless microphones from 5MHz to 2 GHz. LED Bargraph and Audible alarm

VISA • MC • Money Orders • US & Canada Only

NO CHECKS • NO COD • Add \$6.95 S/H

[www.mscelectronics.com](http://www.mscelectronics.com)

MSC Electronics

PO BOX 461 Jessup, MD 20794

(301) 497-1600

FAX (301) 497-1925



## CONTROL IT

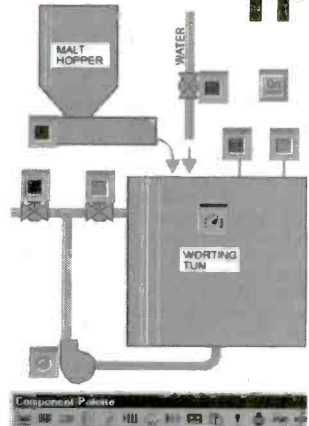

Intec Automation Inc.

[www.microcommander.com](http://www.microcommander.com)

## The Hack & Crack Bible on CD-ROM

Includes all Software, Documentation, Plans, and PCB Layouts!

Unlock the secrets of:

- DSS & Smart Cards — Programming & Schematics
- Cable Test Devices
- Sony Playstation — Mod Chip/CD Backups/Emulation
- Backup Sega & SNES Console Cartridges
- Sega & SNES Emulation on your PC or Mac
- WareZ— where to find them on the Internet
- Cellular Hack/Phreak/Mod
- And Much More!

**Only \$29.95**

PC & Mac Compatible CD-ROM

We accept

VISA • MasterCard • American Express

To order, call Worldwyde @ 1-800-773-6698

21365 Randall Street • Farmington Hills, MI 48336

Visit us on the web at [www.worldwyde.com/hack](http://www.worldwyde.com/hack)

## OWN A MACHINE SHOP!

### Do it yourself!

No more waiting to have parts or repairs done.

• Easy to use—Free training.

You'll be doing quality work right away.

• Affordable—Six models starting at \$995.

• Versatile—Work metal—and wood or plastic.

• CNC adaptable



Enjoy the freedom & cost savings of owning a benchtop machine shop.

**FREE Info Pak**

CALL TODAY! 1-800-345-6342 or write: **Smithy.**

Dept. PE001 PO Box 1517

Guaranteed to pay its own way Ann Arbor, MI 48106-1517

Visit us at [www.smithy.com](http://www.smithy.com)

## ELECTRONIC SECURITY DEVICES

A great book for project builders. It is quite common to associate the term "Security Devices" with burglar alarms of various types. However in fact it can refer to any piece of equipment that helps to protect people or property. The text is divided into three basic sections: Chapter 1 covers switch-activated burglar alarms and includes exit and entry delays. Chapter 2 discusses other types of burglar alarms and includes Infra-Red, Ultrasonic and Doppler-Shift Systems. Chapter 3 covers other types of security devices such as Smoke and Gas Detectors; Water, Temperature and Baby Alarms; Doorphones, etc. Most circuits are simple, and stripboard layouts are provided.



To order Book BP56 and send \$5.99 includes shipping and handling in the U.S. and Canada only to Electronics Technology Today Inc., P.O. Box 240, Massapequa Park, NY 11762-0240. Payment in U.S. funds by U.S. Bank check or International Money Order. Please allow 6-8 weeks for delivery. ET09 91



## Doppler Direction Finder

Track down jammers and hidden transmitters with ease! This is the famous WA2EBY DF'er featured in April 99 QST. Shows direct bearing to transmitter on compass style LED display, easy to hook up to any FM receiver. The transmitter - the object of your DF'ing - need not be FM, it can be AM, FM or CW. Easily connects to receiver's speaker jack and antenna, unit runs on 12 VDC. We even include 4 handy home-brew "mag mount" antennas and cable for quick set up and operation! Whips can be cut and optimized for any frequency from 130-1000 MHz. Track down that jammer, win that fox hunt, zero in on that downed Cessna - this is an easy to build, reliable kit that compares most favorably to commercial units costing upwards of \$1000.00! This is a neat kit!!

DDF-1, Doppler Direction Finder Kit ..... \$149.95

## Wireless RF Data Link Modules

RF link boards are perfect for any wireless control application; alarms, data transmission, electronic monitoring...you name it. Very stable SAW resonator transmitter, crystal controlled receiver - no frequency drift! Range up to 600 feet, license free 433 MHz band. Encoder/decoder units have 12 bit Holtek HT-12 series chips allowing multiple units all individually addressable, see web site for full details. Super small size - that's a quarter in the picture! Run on 3-12 VDC. Fully wired and tested, ready to go and easy to use!

RX-433 Data Receiver..... \$16.95 TX-433 Data Transmitter..... \$14.95  
RXD-433 Receiver/Decoder..... \$21.95 TXE-433 Transmitter/Encoder..... \$19.95

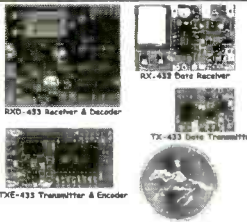

## World's Smallest TV Transmitters



We call them the 'Cubes'.... Perfect video transmission from a transmitter you can hide under a quarter and only as thick as a stack of four pennies - that's a nickel in the picture! Transmits color & B&W with fantastic quality - almost like a direct wired connection to any TV tuned to cable channel 59. Crystal controlled for no frequency drift with performance that equals models that cost hundreds more! Basic 20 mW crystal transmits up to 300' while the high power 100 mW unit goes up to 1/4 mile. Their very light weight and size make them ideal for balloon and rocket launches, R/C models, robots - you name it! Units run on 9 volts and hook-up to most any CCD camera or standard video source. In fact, all of our cameras have been tested to mate perfectly with our Cubes and work great. Fully assembled - just hook-up power and you're on the air! One customer even put one on his dog!

C-2000, Basic Video Transmitter..... \$89.95 C-2001, High Power Video Transmitter..... \$179.95

## CCD Video Cameras

Top quality Japanese Class 'A' CCD array, over 440 line line resolution, not the off-spec arrays that are found on many other cameras. Don't be fooled by the cheap CMOS single chip cameras which have 1/2 the resolution, 1/4 the light sensitivity and draw over twice the current! The black & white models are also super IR (Infra-Red) sensitive. Add our invisible to the eye, IR-1 illuminator kit to see in the dark! Color camera has Auto gain, white balance, Back Light Compensation and DSP! Available with Wide-angle (80°) or super slim Pin-hole style lens. Run on 9 VDC, standard 1 volt p-p video. Use our transmitters for wireless transmission to TV set, or add our IB-1 Interface board kit for super easy direct wire hook-up to any Video monitor, VCR or TV with A/V input. Fully assembled, with pre-wired connector.

CCDWA-2, B&W CCD Camera, wide-angle lens ..... \$69.95  
CCDPH-2, B&W CCD Camera, slim fit pin-hole lens... \$69.95  
CCDCC-1, Color CCD Camera, wide-angle lens ..... \$129.95  
IR-1, IR Illuminator Kit for B&W cameras ..... \$24.95  
IB-1, Interface Board Kit ..... \$14.95

## AM Radio Transmitter

Operates in standard AM broadcast band. Pro version, AM-25, is synthesized for stable, no-drift frequency and is settable for high power output where regulations allow, typical range of 1-2 miles. Entry-level AM-1 is tunable, runs FCC maximum 100 mW, range 1/4 mile. Both accept line-level inputs from tape decks, CD players or mike mixers, run on 12 volts DC. Pro AM-25 includes AC power adapter, matching case and bottom loaded wire antenna. Entry-level AM-1 has an available matching case and knob set that dresses up the unit. Great sound, easy to build - you can be on the air in an evening!

AM-25, Professional AM Transmitter Kit... \$129.95  
AM-1, Entry level AM Radio Transmitter Kit... \$29.95  
CAM, Matching Case Set for AM-1..... \$14.95

## Mini Radio Receivers

Imagine the fun of tuning into aircraft a hundred miles away, the local police/fire department, ham operators, or how about Radio Moscow or the BBC in London? Now imagine doing this on a little radio you built yourself - in just an evening! These popular little receivers are the nuts for catching all the action on the local ham, aircraft, standard FM broadcast radio, shortwave or WWV National Time Standard radio bands. Pick the receiver of your choice, each easy to build, sensitive receiver has plenty of crystal clear audio to drive any speaker or earphone. Easy one evening assembly, run on 9 volt battery, all have squelch except for shortwave and FM broadcast receiver which has subcarrier output for hook-up to our SCA adapter. The SCA-1 will tune in commercial-free music and other 'hidden' special services when connected to FM receiver. Add our snazzy matching case and knob set for that smart finished look!

AR-1, Airband 108-136 MHz Kit..... \$29.95 FR-6, 6 Meter FM Ham Band Kit ..... \$34.95  
HFRC-1, WWV 10 MHz (crystal controlled) Kit..... \$34.95 FR-10, 10 Meter FM Ham Band Kit ..... \$34.95  
FR-1, FM Broadcast Band 88-108 MHz Kit ..... \$24.95 FR-146, 2 Meter FM Ham Band Kit..... \$34.95  
SR-1, Shortwave 4-11 MHz Band Kit ..... \$29.95 FR-220, 220 MHz FM Ham Band Kit ..... \$34.95  
SCA-1 SCA Subcarrier Adapter kit for FM radio.... \$27.95 Matching Case Set (specify for which kit) ... \$14.95

## PIC-Pro Pic Chip Programmer

Easy to use programmer for the PIC16C84, 16F84, 16F83 microcontrollers by Microchip. All software - editor, assembler, run and program - as well as free updates available on Ramsey download site! This is the popular unit designed by Michael Covington and featured in Electronics Now, September 1998. Connects to your parallel port and includes the great looking matching case, knob set and AC power supply. Start programming those really neat microcontrollers now...order your PICPRO today!

PIC-1, PICPRO PIC Chip Programmer Kit ..... \$59.95

Order Toll-free: 800-446-2295

Sorry, no tech info, or order status at 800 number

For Technical Info, Order Status  
Call Factory direct: 716-924-4560

RAMSEY ELECTRONICS, INC.  
793 Canning Parkway Victor, NY 14564

See our complete catalog and order  
on-line with our secure server at:  
[www.ramseyelectronics.com](http://www.ramseyelectronics.com)

## 1 GHz RF Signal Generator



A super price on a full featured RF signal generator! Covers 100 KHz to 999.99999 MHz in 10 Hz steps. Tons of features; calibrated AM and FM modulation, 90 front panel memories, built-in RS-232 interface, +10 to -130 dBm output and more!

Fast and easy to use, its big bright vacuum florescent display can be read from anywhere on the bench and the handy 'smart-knob' has great analog feel and is intelligently enabled when entering or changing parameters in any field - a real time saver! All functions can be continuously varied without the need for a shift or second function key. In short, this is the generator you'll want on your bench, you won't find a harder working RF signal generator - and you'll save almost \$3,000 over competitive units!

RSG-1000B RF Signal Generator ..... \$1995.00

## Super Pro FM Stereo Transmitter

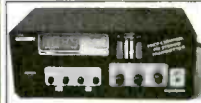

Professional synthesized FM Stereo station in easy to use, handsome cabinet. Most radio stations require a whole equipment rack to hold all the features we've packed into the FM-100. Set freq with Up/Down buttons, big LED display. Input low pass filter gives great sound (no more squeals or swishing from cheap CD inputs!) Limiters for max 'punch' in audio - without over mod, LED meters to easily set audio levels, built-in mixer with mike, line level inputs. Churches, drive-ins, schools, colleges find the FM-100 the answer to their transmitting needs, you will too. Great features, great price! Kit includes cabinet, whip antenna, 120 VAC supply. We also offer a high power export version of the FM-100 fully assembled with one watt of RF power, for miles of program coverage. The export version can only be shipped if accompanied by a signed statement that the unit will be exported.

FM-100, Pro FM Stereo Transmitter Kit ..... \$249.95  
FM-100WT, Fully Wired High Power FM-100..... \$399.95

## FM Stereo Radio Transmitters

No drift, microprocessor synthesized! Great audio quality, connect to CD player, tape deck or mike mixer and you're on-the-air. Strappable for high or low power! Runs on 12 VDC or 120 VAC. Kit includes snazzy case, whip antenna, 120 VAC power adapter - easy one evening assembly.

FM-25, Synthesized Stereo Transmitter Kit ..... \$129.95

Lower cost alternative to our high performance transmitters. Great value, easily tunable, fun to build. Manual goes into great detail about antennas, range and FCC rules. Handy for sending music thru house and yard, ideal for school projects too - you'll be amazed at the exceptional audio quality! Runs on 9V battery or 5 to 15 VDC. Add matching case and whip antenna set for nice 'pro' look.

FM-10A, Tunable FM Stereo Transmitter Kit..... \$34.95  
CFM, Matching Case and Antenna Set ..... \$14.95  
FMAC, 12 Volt DC Wall Plug Adapter ..... \$9.95

## RF Power Booster

Add muscle to your signal, boost power up to 1 watt over a freq range of 100 KHz to over 1000 MHz! Use as a lab amp for signal generators, plus many foreign users employ the LPA-1 to boost the power of their FM transmitters, providing radio service through an entire town. Runs on 12 VDC. For a neat finished look, add the nice matching case set. Outdoor unit attaches right at the antenna for best signal - receiving or transmitting, weatherproof, too!

LPA-1, Power Booster Amplifier Kit ..... \$39.95  
CLPA, Matching Case Set for LPA-1 Kit ..... \$14.95  
LPA-1WT, Fully Wired LPA-1 with Case ..... \$99.95  
FMBA-1, Outdoor Mast Mount Version of LPA-1 ..... \$59.95

## FM Station Antennas

For maximum performance, a good antenna is needed. Choose our very popular dipole kit or the Comet, a factory made 5/8 wave colinear model with 3.4 dB gain. Both work great with any FM receiver or transmitter.

TM-100, FM Antenna Kit ..... \$39.95  
FMA-200, Vertical Antenna ..... \$114.95



ORDERING INFO: Satisfaction Guaranteed. Examine for 10 days, if not pleased, return in original form for refund. Add \$6.95 for shipping, handling and insurance. Orders under \$20, add \$3.00. NY residents add 7% sales tax. Sorry, no CODs. Foreign orders, add 20% for surface mail or use credit card and specify shipping method.

# AVEN

## Delivering Performance With Value

e-mail: info@aventools.com • website: www.aventools.com

### MICROSCOPES

**System 703**  
Stereo Inspection Microscope  
Part #26.703

**Price \$270.00**

- Adjustable interpupillary distance between 2.5" (55mm) and 3/4" (75mm)
- Slide mount objectives for rapid magnification change
- Provides a long working distance of 6" at 10x magnification
- Built-in illuminator with articulating arm allows infinite positioning
- Weighted stand with 9" arm is fully adjustable
- Magnification 5x, 10x, and 20x
- 5 year limited warranty



**System 707**  
Deluxe Stereo Microscope  
Part #26.707

**Price \$266.00**

- Selectable 20x or 40x magnification
- Bottom transmitted and overhead illuminators
- Rotary turret mounted with posture click stop for easy power change
- Precision rack and pinion focus
- 45 degree inclined eye tubes
- Working distance 3.15" at 20x
- Incandescent (12v/10w) and Halogen (12v/10w) lights



### CABLETESTERS

**Multi-Network Cable Tester**  
Part #25.102

**Price \$94.50**

- Quickly tests by auto scanning
- Suitable for thin ethernet (BNC) /10 Base T, (UTP/STP) /356A /TIA 568A /TIA-568B /token ring
- Use attached remot terminator to test cable before or after the cables are installed. Also allows you to test the ground of shielded twisted pair cable.

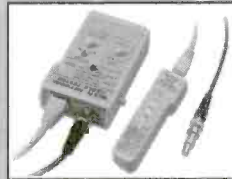

**Multi-Modular Cable Tester**  
Part #25.022

**Price \$76.82**

- Quickly test by auto scanning modular cables USOC4/USOC6/USOC8; terminating with RJ45, RJ12 and RJ11 modular plug
- Comes with remote terminator, allows you to test installed cables.



### TOOLKITS



**22 PC Aven Personal Computer Tool Kit**  
Part #15.014

**Price \$75.00**



**22 PC Aven Basic Electronic Tool Kit**  
Part #15.019

**Price \$59.60**



**73 PC Aven Master Electronic Tool Kit**  
Part #15.018

**Price \$234.69**

- Includes super drill set
- Aluminum Case



**47 PC Aven Premier Compact Technicians Kit**  
Part #15.004

**Price \$132.83**



**88 PC Premier Field Service Kit**  
Part #15.006

**Price \$244.90**

- Comprehensive assortment of tools for servicing electronics
- Double-sided case



**Professional Multimeter**  
Part #25.015

**Price \$35.75**



**20 PC Precision Screwdriver Set With Interchangeable Blades**  
Part #13.714

**Price \$16.64**

This useful set contains 19 assorted Slotted/Philip/Star/Hex/Ball point/Blades. Special quick release designed, make blade changes quick and easy



**Digital Soldering Station**  
Part #17.510

**Price \$132.65**

- Ceramic heater unit for quick start
- Temperature adjustment: 160-480 celcius
- Six different tip sizes available as options
- Perfect for most soldering applications including SMD
- ESD Safe



**Perfectly Balanced Fluorescent Lighting With A Precision 3 Diopter Magnifier Lens**  
Part #26.501

**Price \$77.90**

- 45 inch extension arm
- The shade with handle lets you bring the light where you want
- 3 diopter lens included
- Supplied with 22 watt circline tube
- Color: Ivory
- All metal construction

For your nearest distributor call: #1-800-624-8170  
Fax: #1-734-973-0097 • e-mail: info@aventools.com



Visa/Mastercard Accepted

CIRCLE 295 ON FREE INFORMATION CARD

**MODERN ELECTRONICS**

# CABLE TV DESCRAMBLERS



- ★ **FREE CATALOG!**
- ★ **BEST DEALER PRICING!**
- ★ **DISCOUNTED PRICING!**
- ★ **30 DAY FREE TRIAL!**
- ★ **100% MONEY BACK GUARANTEE**

**COPY RENTAL TAPES WITH OUR VIDEO STABILIZER**

**1-800-906-6664**

2609 S. 156th Circle • Omaha, NE 68130  
www.modernelectronics.com



## EZ-EP DEVICE PROGRAMMER - \$169.95

Check Web!! -- [www.m2l.com](http://www.m2l.com)

**Fast** - Programs 27C010 in 23 seconds

**Portable** - Connects to PC Parallel Port

**Versatile** - Programs 2716-080 plus EE and Flash (28F,29C) to 32 pins

**Inexpensive** - Best for less than \$200

- Correct implementation of manufacturer algorithms for fast, reliable programming.
- Easy to use menu based software has binary editor, read, verify, copy, etc. Free updates via bbs or web page.
- Full over current detection on all device power supplies protects against bad chips and reverse insertion.
- Broad support for additional devices using adapters listed below.

### Available Adapters

EP-PIC (16C5x.61.62x.71.84)	\$49.95
EP-PIC64 (62-5.72-4)	\$39.95
EP-PIC12 (12C50x)	\$39.95
EP-PIC17 (17C4x)	\$49.95
EP-51 (8751 C51)	\$39.95
EP-11E (68HC11 E/A)	\$59.95
EP-11D (68HC711D3)	\$39.95
EP-16 (16bit 40pin EPROMS)	\$49.95
EP-28 (286E02.3.4.6.7.8)	\$39.95
EP-SEE2 (93x.24x.25x.85x)	\$39.95
EP-750 (87C750.1.2)	\$59.95
EP-PEEL (CT22v10.18v8)	\$69.95
EP-105 (189C1051.2051)	\$39.95
EP-PLCC (PLCC EPROMS)	\$49.95
EP-SOIC (SOIC EPROMS)	\$49.95

Many Other Adapters Available

### M<sup>2</sup>L Electronics

970/259-0555 Fax: 970/259-0777  
250 CR 218, Durango, CO 81301  
CO orders add 7% sales tax  
<http://www.m2l.com>

**EZ-EP**  
**M<sup>2</sup>L ELECTRONICS**  
Los Angeles, California

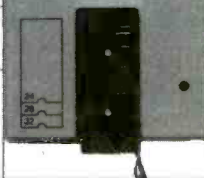

## Low Cost PICmicro Tools

New! PIC-XI  
Experimenter/  
Lab Board  
\$49.95 to \$199.95

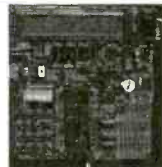

**EPIC Pocket PICmicro  
Programmer - \$59.95**

Program PICmicros in **BASIC!**  
PicBasic Compiler - \$99.95  
PicBasic Pro Compiler - \$249.95

PICProto Boards make  
prototyping with PICmicros  
easy - \$8.95 to \$19.95



*microEngineering Labs, Inc.*

Box 7532 Colorado Springs CO 80933  
(719) 520-5323 fax (719) 520-1867  
<http://www.melabs.com>

# BUGGED??

**EAVESDROPPING** is unbelievably widespread! Electronic Devices with amazing capabilities can be monitoring your telephone and room conversations **RIGHT NOW!** Are you sure you're safe? **FREE CATALOG** tells you fast! Includes Free Bonus details on fantastic opportunities now open in Counter-Surveillance field. Exciting, immensely interesting and **EXTREMELY** profitable (up to \$250 hr) full-part-time income. Call Now! **1-800-732-5000**

**SW** New-Old-Stock  
Tubes, Parts,  
Supplies,  
Speakers, Books,  
Transformers,  
Grill Cloth

6221 S. Maple Ave  
Tempe AZ, 85283  
ph. (480) 820 5411  
fax (480) 820 4643  
fax (800) 706 6789

**XICON JENSEN**

**GALEP-III**

**One size fits all!**

**\$333**

COMPLETE KIT

**CONITEC**

**Best for HIGH PERFORMANCE fieldwork**

**One Pocket Sized Tool Does It All**  
A universal multi-programmer combining performance, flexibility and room for expansion. Optimal for use in the field. Small enough to fit in your pocket, it will output to a wide array of devices.

**Fast, Versatile Field Programmer**  
Programs 8-bit and 16-bit EPROMs, EE-PROMs, Zero Power RAM's, Flash, Serial EPROMs / GAL, PALCE, ATF/87xxx, 89xxx, PIC12/16/17Cxx / All DIL devices without adapter / Lightning fast parallel data transfer (e.g. 27C512 read/compare 2 sec!)

**With Expanding Output Capability**  
Independent power supply with rechargeable battery / Uses PC printer port / Hex, JEDEC, and binary file formats / Hex & fuse-map buffer editor / Split & shuffle for 8-bit, 16-bit and 32-bit targets / Runs under Win3.1, 95, 98, NT / \*Remote Control\* by DDE scripts / Designed for the future with flexible pin driver technology / new devices added every month / Device list, demo software and lifetime free updates from our website.

**GALEP III / cable, batt. and recharger. \$333.00**  
PLCC adapt. / 8-bit EPROMs / 16-bit EPROMs / GALS ..... each \$149.00

**GALEP-III**  
Pocket Multiprogrammer

ONLINE ORDERS: [WWW.CONITEC.COM](http://WWW.CONITEC.COM)

CONITEC DATASYSTEMS - 1951 4th Avenue, Suite 301 San Diego, CA 92101 Tel: 619-702-4420

**3 Axis Motion Control System**  
Complete, ready to run

**\$ 295.00 + 12.00 S/H**

Build or adapt CNC mills, CNC routers, Robots, Etc. Includes: 3 Stepping motors (70 oz/in 200 steps/rev). External board (connects to parallel port of a PC). Power supply. Cables, Manual and the MAXNC drive software, with linear, circular and helical interpolation, acceleration deceleration, full contouring, 'G' code programming, screen plot, code generation from CAD (CAM), and more.

For more information, phone or write to:  
**MAXNC**  
6730 West Chicago  
Suites 2 & 3  
Chandler, AZ 85226  
Ph (480) 940-9414  
Fax (480) 940-2384

**CABLE TV BOXES**

**(WE'LL BEAT ANY PRICE!)**  
30 DAY TRIAL \* 1YR. WRNTY. \* FREE CATALOG  
QTY. DISCOUNTS \* DEALERS WELCOME!

**1-800-785-1145**

HABLAMOS ESPANOL

**PRIVATE CABLE SYSTEMS**

**Smart Battery Charger**

**FOR GEL-CELLS or LEAD ACID BATTERIES.**  
Features: Precision temperature tracking voltage reference & three mode charging sequence. Standard kit is for 12V @ 1/2 or 1 Amp, user selectable. Can be connected to the battery indefinitely, will not overcharge. Weighs 2 pounds and measures 4"W x 5 1/2"D x 2 1/2"H. Finished enclosure included in kit.

**Complete Kit Only ..... \$59.95**  
**Assembled & Tested ..... \$79.95**  
CA residents add 7.75% sales tax. S&H: \$6.50 (insured)  
Foreign orders add 20%. For more info or price list, send legal size SASE (\$5) to:

**A & A Engineering**  
2521 W. La Palma #K • Anaheim, CA 92801  
(714) 952-2114 • FAX: (714) 952-3280

Turn your PC into a 16-bit Storage Scope spectrum analyzer, and digital multimeter!

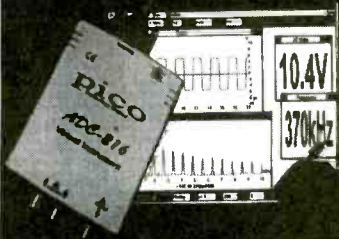

ADC216 turns your PC or laptop into a sophisticated storage scope AND spectrum analyzer AND multimeter. Display on large screen! Print in color! 100MS/s 8-bit, 1.2MS/s 12-bit or 333kS/s 16-bit versions. Great for test depts, schools. Input to Excel. LabView/NT drivers. Get very high precision without high cost!

**osziFOX**  
handheld 20MS/s Storage Scope

osziFOX is a sophisticated digital storage scope packed into a handy, slim penlike housing. Despite its small size, osziFOX can perform like a service scope with a 20MS/s sampling rate so signals in microprocessor or audio circuits can be measured easily. A built-in backlit LCD shows the waveforms but the recorded signals can also be sent to a PC via a serial interface. Runs from 9V battery or external source. Auto, internal and external triggers. AC/DC voltmeter function too. Only \$129!

also .....

RS232-422/485 converters, self-powered, opto-isolated I2C adapter boards for PC communication with I2C bus mini dataloggers for events, voltages, pressures, etc. Enviromon temperature and environment network logger thermocouple and thermistor adapters for PC ports. BASIC-programmable BASIC-TIGER controller modules PCI framegrabbers - switch between 2 inputs locked! lowcost A/D adapters turn your PC into a display scope



**Saelig Company**  
www.saelig.com saelig@aol.com  
716-425-3753 • 716-425-3835 (fax)

1-888-7SAELIG

**Poptronics SHOPPER**

**Home Automation**



**World's Largest Source for Home Automation!**

- Voice Control
- Gadgets & Motorized Devices
- Home Theater
- Phones & Intercoms
- X10 & Lighting Control
- Home Security & Surveillance
- Home Networking & Structured Wiring

and Much More...

**800-SMART-HOME**  
www.smarthome.com

**Free 144 pg. Color Catalog!**

Dealers/Resellers ask about our SmartHome PRO Dealer Program 800-949-6255

**SECURETEK**

DIRECT FROM MANUFACTURER  
"WE WILL BEAT ANY COMPETITORS PRICE"

WORLD SMALLEST  
WIRELESS VIDEO CAMERA  
(BLACK & WHITE OR COLOR)  
TRANSMITS VIDEO UP TO 1000FT.



CAMERA SHOWN  
ACTUAL SIZE

WE ALSO CARRY:

- COVERT VIDEO CAMERAS
- COUNTER-SURVEILLANCE PRODUCTS
- CUSTOM MADE VIDEO SYSTEMS
- IN HOUSE ENGINEERING DEPT.



RUNS ON 9V BATTERY  
FOR UP TO 12 HRS.

DISTRIBUTOR PROGRAM AVAILABLE

CALL FOR CATALOG:  
**SECURETEK**

7152 S.W. 47TH STREET  
MIAMI, FLORIDA 33137  
TEL. 305.667.4545  
FAX. 305.667.1744  
www.securetek.net

**KENWOOD**  
Analog Oscilloscopes

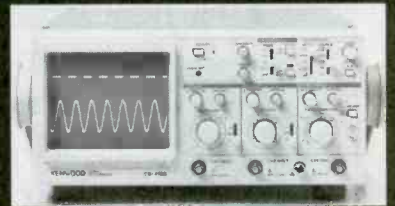

**PCS-4125 Features:**

- High Withstand Voltage to 400V
- Relay attenuator
- Wide bandwidth & fast sweep
- One touch X-Y switching
- VERT mode / FIX triggering

**Model**  
PCS-4125  
**Description**  
20MHz, 2ch  
**Price**  
\$399.00

**CALL FOR YOUR FREE CATALOG**  
**800-638-2020**

- Digital Multimeters
- Frequency Counters
- Power Supplies
- Function Generators
- Oscilloscopes
- Signal Generators

PRODUCTS INTERNATIONAL www.prodintl.com

9893 BREWER'S COURT LAUREL, MARYLAND 20723-1990  
PHONE: 800-638-2020 FAX: 800-545-0058  
INT'L PHONE: (240)568-3940 INT'L FAX: (240)568-3948  
E-MAIL: SALES@PRODINTL.COM WEB: WWW.PRODINTL.COM

September 2000, Poptronics

## Turn Your Multimedia PC into a Powerful Real-Time Audio Spectrum Analyzer

### Features

- 20 kHz real-time bandwidth
- Fast 32 bit executable
- Dual channel analysis
- High Resolution FFT
- Octave Analysis
- THD, THD+N, SNR measurements
- Signal Generation
- Triggering, Decimation
- Transfer Functions, Coherence
- Time Series, Spectrum Phase, and 3-D Surface plots
- Real-Time Recording and Post-Processing modes

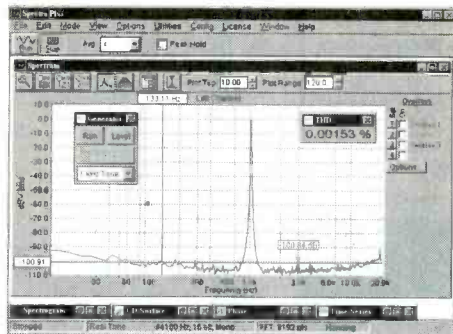

### Applications

- Distortion Analysis
- Frequency Response Testing
- Vibration Measurements
- Acoustic Research

### System Requirements

- 486 CPU or greater
- 8 MB RAM minimum
- Win. 95, NT, or Win. 3.1 + Win.32s
- Mouse and Math coprocessor
- 16 bit sound card

**Priced from \$299**

(U.S. sales only – not for export/resale)

**DOWNLOAD FREE 30 DAY TRIAL!**

[www.spectraplus.com](http://www.spectraplus.com)

**PHS** Pioneer Hill Software  
24460 Mason Rd.  
Poulsbo, WA 98370  
a subsidiary of Sound Technology, Inc.



**Spectra Plus**  
FFT Spectral Analysis System

Sales: (360) 697-3472

Fax: (360) 697-7717

e-mail: [pioneer@telebyte.com](mailto:pioneer@telebyte.com)

**MECI** 340 East First Street  
Dayton, Ohio 45402  
Your Electronics Value Company

## Tons of Electronics

Get your FREE catalog today and discover some of the best deals in electronics. We have thousands of items ranging from unique hard-to-find parts to standard production components. Call, write or fax today to start your subscription to one of the most unique catalogs in the industry, filled with super values on surplus electronic and hobbyist type items.



Check out our 10,000 item on-line catalog <http://www.meci.com>

**Order Toll Free** Why pay more?  
**1-800-344-4465** Call today!  
Fax Order Line  
1-800-344-6324

CIRCLE 250 ON FREE INFORMATION CARD

## Miniature Transmitters and Receivers

### 2 Button / 3 Channel Transmitter



**RF300T**  
1....\$22.95  
5....\$19.95 ea  
10...\$16.95 ea

**RF300XT**  
1....\$25.95  
5....\$22.95 ea  
10...\$19.95 ea

- 300' (XT), 150' (T) Range
- Frequency: 318 MHz
- 59,049 Settable Security Codes
- 12 Volt Battery and Keychain Included
- Current Draw: 4.8 ma
- Fully Assembled in Case
- Dimensions: 1.25" x 2.0" x .5"
- Push both buttons for the 3rd Channel
- Slide Button Cover Included

### 4 Button / 15 Channel Transmitter



**RF304XT**  
1....\$27.95  
5....\$24.95 ea  
10...\$21.95 ea

- 250' Range
- Frequency: 318 MHz
- 6,561 Settable Security Codes
- 12 Volt Battery and Keychain Included
- Current Draw: 4.6 ma
- Fully Assembled in Case
- Dimensions: 1.35" x 2.25" x .5"
- Push combination of buttons to achieve up to 15 channels

### 2-4 Data / 3-15 Channel Receivers



**RF300RL**  
**RF300RM**  
1....\$27.95  
5....\$24.95 ea  
10...\$22.95 ea

**RF304RL**  
**RF304RM**  
1....\$29.95  
5....\$26.95 ea  
10...\$23.95 ea

- Compatible with 300/4 Transmitters
- 11-24 volts DC Operating Voltage
- 13 ma. Current Draw
- Latching (L) or Momentary (M) Output
- Kits Available (subtract \$5.00 ea.)
- Dimensions: 1.25" x 3.75" x .5"
- 2 (300) / 4 (304) Output Data Lines
- Binary to Dec / Hex Converter can achieve up to 15 channels

- Alarm Systems
- Garage / Gate Openers
- Lighting Control

- Magic Props
- Medical Alert
- Monitoring Systems

- Industrial Controls
- Surveillance Control
- Motor Control

- Schematics Available
- Receiver Board Layout Available
- Custom Design Consulting Available

**Visitect Inc.**

(510) 651-1425 Fax: (510) 651-8454  
P.O. Box 14156, Fremont, CA 94539

Email: [Support@Visitect.Com](mailto:Support@Visitect.Com)  
Visa / Mastercard, COD

CIRCLE 314 ON FREE INFORMATION CARD

[www.americanradiohistory.com](http://www.americanradiohistory.com)



2539 W. 237th Street, Bldg. F, Torrance, CA 90505  
 Order desk only: USA: (800) 872-8878 CA: (800) 223-9977  
 L.A. & Technical Info: (310) 784-5488 Fax: (310) 784-7590  
<http://www.digisys.net/timeline>

# TIMELINE INC.

Over 14 years and 32,000 customers and still growing

Minimum Order: \$20.00. Minimum shipping and handling charge \$5.00. We accept cashiers checks, MC or VISA. No personal checks or COD's. CA residents add 8.25% sales tax. We are not responsible for typographical errors. All merchandise subject to prior sale. Phone orders welcome. Foreign orders require special handling. Prices subject to change without notice. 20% restocking fee for returned orders.

## LIQUID CRYSTAL DISPLAYS

### 240x64 dot LCD with built-in controller.

AND 4021ST-EO. Unit is EL back-lit. \$59.<sup>00</sup> or 2 for \$109.<sup>00</sup> or OPTREX DMF5005 (non back-lit) \$49.<sup>00</sup> or 2 for \$89.<sup>00</sup>

20 character x 8 line 7/16" x 2 1/4" The built-in controller allows you to do text and graphics.

### Alphanumeric—parallel interface

16x1	\$6.00	20x2	\$8.00	32x2	\$8.00
16x1 (ig char)	\$8.00	20x4	\$8.00	40x1	\$8.00
16x2	\$6.00	20x4 (ig char)	\$10.00	40x2	2 for \$20.00
16x2 (ig char)	\$10.00	24x2	\$8.00	40x4	\$20.00
16x4	\$12.00	32x4	\$10.00	4x2	\$5.00

5V power required • Built-in CMOS LCD driver & controller • Easy "microprocessor" interface • 98 ASCII character generator • Certain models are backlit, call for more info.

### Graphics and alphanumeric—serial interface

size	Mfr.	price	size	Mfr.	price
640x480 (backlit)	Epson	\$20.00	480x128	Hitachi	\$10.00
640x400 (backlit)	Panasonic	\$15.00	256x128	Epson	\$20.00
640x200	Toshiba	\$15.00	240x128 (backlit)	Optrex	\$20.00
480x128 (backlit)	ALPS	\$10.00	240x64	Epson	\$15.00
			160x128	Optrex	\$15.00

### 6" VGA LCD 640X480, Sanyo LMDK55-22 \$19.<sup>00</sup>

## MONITORS

### Non-Enclosed TTL

Comes with pinout. 12V at 1.4 Amp input • Horizontal frequency 15KHz. • Ability to do 40 and 80 column.

5 inch Amber \$19.00 • 7 inch Amber \$19.00  
 9 inch Amber or Green \$19.00

### 5" COLOR MONITOR \$29.<sup>00</sup>

- Flat Faceplate • 320 x 200 Dot Resolution • CGA & Hercules Compatible
- 12 VDC Operation • 15.75 KHz Horiz. Freq. • 60 Hz Vert. Sync. Freq.
- Open Frame Construction • Standard Interface Connector • Degaussing Coil included • Mfr. Samtron



### 9" COLOR SVGA MONITOR \$169.<sup>00</sup> Fully Enclosed - Tilt and swivel type.

## POS & BAR CODE

### MAGNETIC CARD READER \$19.<sup>00</sup>

Includes: • 20 character dot matrix display with full alpha-numeric capability • keypad with full alpha-numeric entry • separate 7.5 VDC/0.5 Amp power supply • standard telephone interface extension cord • lithium battery and flat cone speaker.

HP bar code wand (HBCS 2300) \$19.00

## HACKER CORNER

### Rockwell "Jupiter" GPS Receiver \$69.<sup>00</sup>

Miniature (2.75" x 1.5" x .25") 12 channel receiver engine. Supports NMEA 0183 and binary protocols. Supports DGPS input in both protocols. Compatible with active and passive antennas. "Keep-Alive" reduced power capability. Standard 2mm 2x10 interface connector. Complete manual and interface documentation available. Compatible with most laptop software using NMEA interface. Suitable for wide range of GPS applications including: Handheld GPS, Automotive / Marine / Aviation Applications, Amateur APRS and Packet.

### EMBEDDED 486 COMPUTER \$79.<sup>00</sup>

Complete enhanced Intel 486SX-33 based computer in ultra small (9-7/8" x 6-5/8" x 3-1/8") case. Ideal for embedded operations or as a second computer. Features include: • One 16 bit ISA slot • 3 serial ports plus dedicated printer port • Parallel optical coupled adapter port • Built in IBM PC/AT keyboard port • On board VGA video and port • Uses standard SIMM up to 32 MB • BIOS is PC/AT compatible

Unit has a backup Ni-Cd battery system in case of power failure (5 min. backup time) and lockable front cover to prevent floppy drive access. Mounting / interface provisions for standard 3.5" laptop floppy and 2.5 inch hard drives. Comes with very comprehensive manual.

### SONY Miniature Color LCD Display \$29.<sup>00</sup>

1.8cm (0.7 inch) unit LCX009AKB 827H x 228V \$29.<sup>00</sup>

### CELL SITE TRANSCEIVER \$29.<sup>00</sup> 2 for \$49.<sup>00</sup>

These transceivers were designed for operation in an AMPS (Advanced Mobile Phone Service) cell site. The 20 MHz bandwidth of the transceiver allows it to operate on all 666 channels allocated. The transmit channels are 870.030-889.980 MHz with the receive channels 45 MHz below those frequencies. A digital synthesizer is utilized to generate the selected frequency. Each unit contains two independent receivers to demodulate voice and data with a Receive Signal Strength Indicator (RSSI) circuit to select the one with the best signal strength. The transmitter provides a 1.5 watt modulated signal to drive an external power amplifier. Channel selection is accomplished with a 10 bit binary input via a connector on the back panel. Other interface requirements for operation are 26 VDC (unregulated) and an 18.990 MHz reference frequency for the digital synthesizer. The units contain independent boards for receivers, exciter, synthesizer, tunable front end, and interface assembly (which includes power supplies and voltage-controlled oscillator). Service manual, schematics and circuit descriptions included.

### 4 INCH LCD MONITOR \$49.<sup>00</sup>

Compact (4.4" x 3.8" x 1.4") TFT active matrix LCD color monitor including fluorescent backlight. Analog RGB and composite sync input with switchable horizontal / vertical viewing. Low power consumption and long life backlight make it ideal for security and door phone use. Single 8 VDC supply and good resolution allow mobile operations or use with laptops. Standard ribbon cable - Molex connector interface. Complete specifications included.

### NTSC COMPOSITE 4" LCD MONITOR \$69.<sup>00</sup>

CIRCLE 242 ON FREE INFORMATION CARD

**Call Today And SAVE!** **Unbeatable PRICES!**

# CABLE TV

**DESCRAMBLERS  
 CONVERTERS • FILTERS  
 VIDEO STABILIZERS**

**FREE** ➤ 30 Day Trial  
**FREE** ➤ Product Catalog  
**FREE** ➤ 1 Year Warranty

**100% MONEY BACK GUARANTEE**

Let us point you in the right direction ...

**Arrow Technologies**  
 Omaha, Nebraska

**TOLL FREE**  
**888-554-ARROW**  
 888-554-2776

## The Pocket Programmer Only \$129.95

**INTRONICS, INC.**  
 THE POCKET PROGRAMMER

The portable programmer that uses the printer port of your PC instead of a internal card. Easy to use software that programs Eprom, EEprom, Flash & Dallas Ram. 27(C) / 28(C) / 28F / 29F / 29C & 25XX series from 16K to 8 Megabit with a 32 pin socket. Adapters available for Pic, PLCC, 5-Gang, 874X, 875X MCU's, 40-Pin X 16 & Serial Eprom's, 82/74 Prom's and Eprom Emulator to 32K X 8.

**Same Name, Address & Phone # for 16 Years... Isn't it Amazing ?**

**Intronics, Inc.**  
 Box 13723 / 612 Newton St.  
 Edwardsville, KS 66113 Add \$5.00 COD  
 Tel. (913) 422-2094 Add \$4.00 Shipping  
 Fax (913) 441-1623 Visa / Master Charge

## Be Your Own Boss and Make Great Money!

### COMPUTER REPAIR

**FREE Opportunity Kit tells you how.**

The key to your success lies in providing a service that is in great demand. Computer Repair has that demand! No experience? You can get the skills with our exclusive FBI method. It really works and you can even earn as you learn.

Get the expert knowledge to earn \$100 or more for simple repairs. Free Opportunity Kit tells how quickly you can train for this exciting field and be your own boss in a profitable full-time or spare-time business of your own.

**Mail coupon or call toll free today!**  
**1-800-487-2100 Ext. A0130**  
 You FREE Kit will be rushed to you!

Foley-Belsaw Institute, 6301 Equitable Road  
 Kansas City MO 64120-1395

Check the business of your choice.

Computer Repair 321  Small Engine Repair 306  
 Locksmithing 307  Saw & Tool Sharpening 332

Name \_\_\_\_\_  
 Address \_\_\_\_\_  
 City \_\_\_\_\_  
 State \_\_\_\_\_ Zip \_\_\_\_\_

September 2000, Poptronics

**High Performance Auto Ranging DMM** New to our DMM line-up and possibly (probably) the best DMM value anywhere! Includes: Analog Bar Graph, Auto-Ranging! Data Hold! Temperature, Probe! Frequency Test! Continuity Test! AND MORE!

**Data Hold:** Freezes reading for easy checking  
**Auto Ranging:** For easy, precise range settings  
**Range Hold Control:** allows for manual selection of your test range  
**3-3/4 Digit LCD Display:** Reads up to 3260. Easy to read display.  
**Function Dial:** Easy to use to select measurement type or turn unit off.  
**4 Jack Plug-ins:** Safety design with different capacities for different functions:  
**Diode, Continuity Check Push-Button:** For toggling between diode check and continuity check.  
**Low Battery Indicator:** Advises you when it's time to change battery.  
**Extra Long 44" Test Leads:** Helps get to hard to reach places  
**Screw-On Alligator Clips:** Convert one or both probe tips to alligator clips  
**Fuse-Protected Circuitry**  
**Built-In Stand:** Makes one hand operation easier.  
**Shock Absorbing Rubber Carrying Case:** with convenient probe storage clips and hanging tab. Helps protect the DMM from damage if accidentally dropped.

Measures:  
 DC Volts: up to 1000V  
 AC Volts: up to 750V  
 AMPS: up to 20 Amps (AC & DC)  
 Resistance: up to 30M ohm  
 Continuity Check: with audible signal (signal sounds if resistance is less than 20 ohms. Display reads actual resistance).  
 Frequency: (1KHz to 300KHz) displays both digital and bar graph reading  
 Transistor hfe Test: Display shows approximate hfe value based on test condition of 10uA base current and Vce of approx. 3V.  
 Temperature Test: Measures from 0° to 1832° F. (probe supplied!)  
 Diode Test: Tests if diodes are shorted or open  
 Input Impedance: 10Mohm (Vdc/Vac); over 100Mohm on 300 mVdc range.

**NOW IN STOCK!** **ONLY \$29.95**

**#CSI9903**

**Specifications Accuracy**  
 Vdc: ±1.0% reading +5 digits  
 Vac: ±1.5% reading +8 digits  
 Vdc: ±1.2% reading +5 digits  
 Aac: ±1.5% reading +5 digits  
 Resistance: ±3.0% reading +5 digits  
 Frequency: ±1.0% reading +6 digits  
 Temperature: Requires two AAA batteries sold separately.

**Removable Hard Drive Rack**  
 For IDE/Ultra DMA Hard Drives  
 We Sold Over 14,000 in 1998!  
 This product can be used with any 3-1/2 IDE hard drive up to 1" high. It includes an electronic keylock for safe removal and insertion. Made of ABS 707 fireproof plastic. Use this product to protect sensitive hard drive data, take your hard drive between work and home or even set up different users with their own hard drives that they physically insert: every time they use a PC. Other models available from C.S.I. include RH1C series and RH20 series, which are interchangeable within the same interface design (IDE or SCSI). Other Models are Available. See www.web-tronics.com under "hard drive and accessories" for more details and pictures.

**ONLY \$14.95** any qty.

**#RH-10C-IDE**

**Removable Hard Drive Rack with Auto Door And Cooling Fan**

- Auto door on the outer frame
- ABS material of outer frame. High efficiency cooling fan
- Worldwide patent pending function handle
- CE Approved
- Coating iron bottom cover
- For IDE interface
- For 1" high 3.5" HDD
- Not compatible with our RH10 & RH20 series
- Compatible with our RH17-IDE model.

**ONLY \$18.95** any qty.

**#MR-27**  
 Details at www.web-tronics.com

**2GHz RF Field Strength Analyzer**

- Frequency Range: 100KHz to 2.060MHz
- Narrow Band FM (NFM), Wide Band FM (WFM), AM and Single Side Band (SSB) Modulated Signals May Be Measured
- PLL Tuning System for Precise Frequency Measurement and Tuning
- LED Backlight LCD (192x192 dots)
- Built-In Frequency Counter
- Hand-Held and Battery Operated
- All Functions are Menu Selected
- RS232C for PC Interface and Printer

**ONLY \$1589**

**#3201**

**CTRL - D to bookmark this site**

**www.web-tronics.com**

**Don't forget the dash**

**Circuit Specialists Inc.**

**In Business Since 1971**

- Easy to Navigate
- Includes a Search Engine That Really Works
- New Items Added Constantly

**LOWER PRICES**

**Mini CCDs (B/W & Color)**  
 Sensational NEW Design for Small Observation Cameras. Smaller and Better!

- Ultra Miniature Design
- Black & White Versions Only 25mm x 25mm
- Color Versions Only 32mm x 32mm
- Available in Standard Lens or Pinhole Lens
- All Include Pre-Wired Cable Harness for Video & Power
- 12V Regulated Power Supply Required (120mA typical power consumption)
- 0.1 LUX Rating (B/W), 1 LUX (color)
- CCD Area Image Sensor for Long Camera Life
- Back Light Compensation Circuit
- Built-In Electronic Auto Iris Lens

**VMCW-H11A** 32mmx32mmx30mm, Color CCD with standard lens, pre-wired cabling 12V DC Power \$139.00 / \$129.00 5 or more  
**VMCW-H12A** 32mmx32mmx19mm, Color CCD with pinhole lens, pre-wired cabling, 12V DC Power Input \$139.00 / \$129.00 5 or more  
**VMPS-718A** 25mmx25mmx30mm, B/W CCD with standard lens, pre-wired cabling, 12V DC Power Input \$59.00 / \$49.00 5 or more  
**VMPS-250A** 25mmx25mmx15mm, B/W CCD with pinhole lens, pre-wired cabling, 12V DC Power Input \$49.00 / \$49.00 5 or more  
**VCC-3232** 32mmx32mmx30mm, CMOS COLOR, std lens, see web for specs \$79.00 / \$72.00 5 or more

**LOWER PRICES**

**Detailed Specs on the Web**

**CCD B&W Board Cameras**

- ASIC CCD Area Image Sensor
- Extremely Low Power Consumption
- 0.5 Lux Min Illumination
- Built-In Electronic Auto Iris for Auto Light Compensation

**VM1030PA-B** 30mmx30mmx25mm, Pinhole lens, 12V \$39.00 any qty.  
**VM1030A** 30mmx30mmx26mm, Standard lens, 12V \$39.00 any qty.  
**VM1035A** 42mmx42mmx25mm, Standard lens, 12V with back light compensation \$49.00 any qty.  
**VMCB21** 44mmx38.5mmx28mm, with 6 infra-red LEDs, 12V \$49.00 any qty.  
**VM1036A** 32mmx32mmx25mm, Standard lens, 12V, reverse mirror image feature \$49.00 any qty.

**Detailed Specs on the Web**

**LOWER PRICES**

**Bullet CCD Cameras B&W and Color**

- Smart Rugged Metal Housing
- Extremely Low Power Consumption
- 12 Volt
- CCD Area Image Sensor for Long Camera Life
- Built-In Electronic Auto Iris for Auto Light Compensation
- No Blooming, No Burning
- 0.1 Min Lux Illumination (B&W), 1 Lux Min Lux Illumination (color)

**VMBLT1020** B&W, 21mm(D)x55mm(L) \$49.00 any qty.  
**VMBLT1020W** B&W Weatherproof, 21mm(D)x58.5mm(L) \$79.00 any qty.  
**VMBLTJC198W** COLOR! Weatherproof, 17mm(D)x88mm(L) \$139.00 any qty.

**Detailed Specs on the Web**

**LOWER PRICES**

**COLOR CCD Mini Board Cameras**

- Low Power Consumption
- 1 Lux Illumination
- Internal Synchronization
- 12Volts
- 400 TV Lines
- Built-In Electronic Auto Iris for Auto Light Compensation

**VM3010PA** 33mmx33mmx18mm, Pinhole lens \$99.00 any qty.  
**VM3011-A** 45mmx40mmx24mm, Standard lens, single board \$89.00 any qty.  
**VM3010-A** 33mmx33mmx32mm, Standard lens \$99.00 any qty.

**PRICE REDUCTION**

**Detailed Specs on the Web**

**2.4 GHz A/V Sender/Receiver System**

- Wireless FM transmission of video (color or B/W) and sound (stereo or mono) up to 150 meters (line of sight)
- Directional Antenna Design optimizes performance
- Use with remote cameras or any input (satellite TV, cable etc.) where wireless transmission is desired. View on a TV set.
- Performance through walls varies depending on construction methods etc.
- Each set includes a plug-in power supply for the transmitter & receiver.
- 7 segment LED displays channel (1-4) on receiver & transmitter.

**Now On Sale Order Now**

**CSIHTR2400** Includes One Transmitter & One Receiver with Power Supplies \$109.00  
**CSIHTR2400TX** Extra Transmitter/Each Receiver will Monitor up to 4 Transmitters \$89.00

See more detailed specifications at www.web-tronics.com in the CCD camera section.

**Hot Air SMD Rework Station WOW! ONLY \$489**  
 Similar Systems Cost 100s More!

**ONLY \$489**

**#SR-979**

For technicians, service/repair depots and assembly rework. We also stock a selection of nozzles for QFP, SOP & PLCC devices (see our website for selection details). Hot Air temperature variable from 100°C to 400°C (212°F to 754°F) power consumption: 275w max. Auto cooling feature cools system after shut off to extend service life of heating elements and handle. One year limited warranty from C.S.I. Comes with QFP Nozzle (0.68" x 0.68")

**O'Scope Offer ONLY \$299**  
**30MHz! ONLY \$299!**  
 Industries Best Price!  
 See web for specs

**#OSC-1030**

- Dual Channel
- Dual Trace
- Vert Trigger
- 1 Year C.S.I. Warranty!

Manufactured for CSI by a leading O.E.M. manufacturer. See our website for detailed specifications!

**3000 Series Digital R/O Bench Power Supply**  
 ← Low Cost Single Output → 3 Amp

**AS LOW AS \$89**

High stability digital read-out bench power supply featuring constant voltage and current outputs. Short-circuit protection and current limiting protection is provided. Highly accurate LED accuracy and stable line regulation make the 3000 series the perfect choice for lab and educational use.

Line Regulation: 2x10<sup>-4</sup> +1ma  
 LED Accuracy: Voltage ±1% +2 digits  
 Current ±1.5% +2 digits  
 Wave Line Noise: ≤1mvrms  
 Dimensions: 291mm x 158mm x 136mm (CSI3003)

**CSI3003: 0-30V/0-3amp Digital R/O Bench PS, 1x10<sup>-4</sup>+5mv Load Regulation \$99.00 5/\$89.00**

**Our Most Sophisticated DMM** We Sold Over 700 Last Year!

with RS-232 Interface & Software, 3-3/4 Digit, 4000 Count, Auto-Ranging with Analog Bargraph

- True RMS Mode
- 10MHz Frequency Counter
- Time Mode with Alarm, Clock, and Stop Watch
- Dual Display
- 10 Location Memory
- Min, Max, Avg and Relative Mode
- Decibel Measurement
- Cap and Ind. Measurement
- Temperature Mode (C/F)
- K Type Temperature Probe Included
- Pulse Signal for Logic & Audible Test
- Continuity/Diode Test
- Logic Test
- Auto Power OFF/"Keep ON" Mode
- Fused 20A Input with Warning Beeper
- Back Light
- Data Hold/Run Mode
- Safety Design UL1244 & VDE-0411
- Protective Holster
- Silicon Test Leads

**NOW ONLY \$129**  
 Reg. \$169

More Details on our Web Site

**PROTEK 506**

Poptronics, September 2000

# CREDIT CARD COMPUTER

**\$14.20** OEM (1000 pc.) price  
EVAL KIT (Qty 1) \$50

Includes:

- serial and parallel
- ISA/PC104 bus
- 256kbit nvmem
- BASIC and ASSY
- A to D converter
- Calendar/Clock

NEW, improved version with ...

## PLUG-N-GO™ !!!

COMPLETE! No cables or power supply to buy.

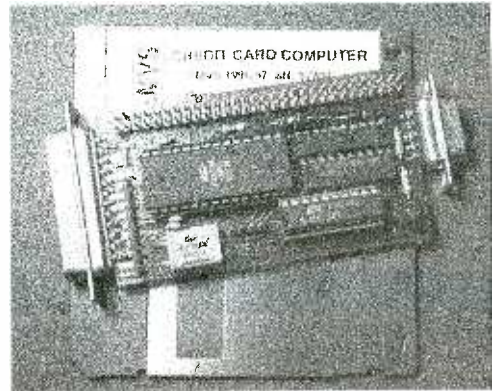

## \$95 UNIVERSAL PROGRAMMER



FLASH, EPROM, NVRAM, EEPROM to 8meg (27080). Adapters for micros, PLCC, etc.. Parallel port version for notebooks. FAST and EASY TO USE.

## PC SOLID STATE DISK



\$21 OEM (1k), EVAL \$75  
FLASH, NVRAM, ROM  
256K-16M DIP/PCMCIA

## LCD VGA \$27



OEM (1k), eval \$95  
640x480 controller  
use with PC or SBC

## PC WATCHDOG!

NO MORE HANGUPS..  
Reboots PC on hardware  
or software hangup..  
oem \$21, eval \$75



## ADC/DAC cards

8/12/16/18bit up to 32 channel for PC or SBC starting at \$14.20 oem

## \$27 MINI PC

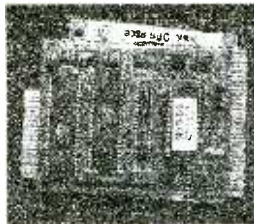

eval \$95, oem \$27 includes:  
DOS, 3 ser, 2 par, rtc, nvmem,  
built-in LED display, ISA bus,  
Keyboard and LCD interface  
COMPLETE!

Not a "core" or "engine". All  
utilities and tutorial included.  
Use Turbo C, Basic, MASM.  
386 version \$42 oem \$195 eval

## SINGLE CHIP COMPUTER!

**\$1.99** OEM (1K)  
EVAL KIT (1) \$7.00

- Zero External Components
- Built-in BASIC / Assembly
- RS232 Program Download
- 1K flash, 64ee, 3irq, 2timers
- 15 I/O bits, A/D comparator
- 20mips, faster than pic/8051
- 20 pin DIP part #MV1200



## NEW! 8K SUPER CHIP

Improved BTERP with 40 times the BASIC program capacity  
- 40 pin DIP part #MV8515 - 32 I/O, 12 irq, 3 timers, bus  
- 8K flash, 512 ee, 512 nvram - Watchdog with internal osc.  
**\$5.40 OEM (1k), Eval Kit \$19.00**

[WWW.STAR.NET/PEOPLE/~MVS](http://WWW.STAR.NET/PEOPLE/~MVS)

MVS Box 850  
Merr., NH 03054  
(508) 792 9507



5yr Limited Warranty  
Free Shipping  
Mon-Fri 10-6 EST

# New and Pre-Owned Test Equipment

## New Equipment Specials

### SIMCHECK IIse PLUS - Module Tester

- \* Tests SIMMs/168 pin DIMMs
  - \* Identifies Module properties
  - \* Stand alone/portable
  - \* Built-in Serial Interface
- Only \$1,995.00**

### AVCOM PSA-37D - Spectrum Analyzer

Satellite Downlink - Installation - Maintenance & Service

- Band 1: 10 - 1750 MHz
  - Line or Battery Powered
  - Band 2: 3.7 - 4.2 GHz
  - Built-in DC Block & Power for LNA/LNB's
  - Carrying Case Included
- Only \$2,395.00**

### Instek GOS-6103 - Analog Oscilloscope

- 100 MHz Bandwidth
  - Time Base Auto-range
  - 2 Channel, High Sensitivity
  - Includes Two Probes
  - Trigger Signal Output
  - 2 Year Warranty
  - Cursor Readout
- Only \$899.00**

### Leader LF 941 - CATV Signal Level Meter

- ✓ TV/CATV Coverage from 46 - 870 MHz
  - ✓ Video/Audio Carrier Measurements
- Only \$489.00**

### Fluke 87 IV - Digital Multimeter

- ✓ Basic DC Accuracy of 0.025% at 50,000 Count
  - ✓ True-RMS AC, AC+DC, dBm, & dBV
- Only \$319.00**

## Pre-Owned Oscilloscope Specials

B+K Precision	1466	10 MHz	\$185.00
Tektronix	465	100 MHz	\$599.00
Tektronix	465B	100 MHz	\$729.00
Tektronix	475	200 MHz	\$829.00
Tektronix	475A	250 MHz	\$999.00

- Professionally Refurbished
- Aligned & Calibrated to Original Specifications
- The Industry Standard of Oscilloscopes
- 1 Year Warranty - The Longest Available!!!
- See Website for Complete Specifications

See us on the Web!

[www.testequipmentdepot.com](http://www.testequipmentdepot.com)

**We Buy Surplus Test Equipment**

**Test Equipment Depot**

A FOTRONIC CORPORATION COMPANY

99 Washington St. Melrose, MA 02176

(781) 665-1400 • FAX (781) 665-0780

e-mail: [sales@testequipmentdepot.com](mailto:sales@testequipmentdepot.com)

(1-800-996-3837)

**TOLL FREE 1-800-99-METER**



CIRCLE 313 ON FREE INFORMATION CARD

## Do Thieves Want Your Computer?

This Year 1.2 Million Desktop Computers Will Be Stolen. Protect Your Computer with PC Doberman Security.

Thousands of PCs are equipped with security cards in North America and Europe. PC Doberman is the most comprehensive computer security available. Providing both anti-theft and access control in one package.

- Motion Detection
- Motion Sensitivity Control
- Unauthorized Access Alarm
- Time Lock Access Control
- Anti Password Hacking Alarm
- Minimum Password Length Feature
- Access Control and Disable Mechanism
- Warning or Continuous Motion Alarms at 85 dB
- A Log to keep track of when your PC is used.
- A Real Time Clock



This commercial ISA bus card is easy to install under Windows 3.1, 95 or 98 and DOS. A dozen Windows setup and dialog boxes let you configure the security to suit your needs.

PC Doberman protects your computer at **\$99.95**

Mention this add and save \$30.00 for only **\$69.95**

For a kit of all parts, PCB, Windows software and build instructions save \$40.00. A great deal at **\$59.95**

Shipping and handling charges of \$6.00 applies on all orders within continental United States and Canada. Elsewhere \$11.00.

Canadians add GST/HST. Ontario residents add PST. All funds in US dollars. Checks or Money Orders accepted.

**Microdev** 363 Dale Crescent, Waterloo, ON, Canada, N2J 3Y6, Tel: 519-746-6819 Fax: 519-746-7292

[sales@microdev.com](mailto:sales@microdev.com) <http://www.microdev.com>

## Future Horizons Advanced Technology

Po Box 125 Marquette, MI 49855 [www.futurehorizons.net](http://www.futurehorizons.net)

### Traffic Light Buster

This device will turn traffic lights green in many cities by the touch of a button.

Emergency vehicles use this to pass through traffic lights quickly. Can be dash mounted or handheld.

TLBU Plans-\$15.00

TLBZ Ready to Use-\$250.00

### Ambient Power Module

Low cost circuit provides up to 9 watts of electrical power from free-energy in the air. Can replace batteries in many devices.

PWRM Plans-\$20.00

PWRZ Ready to use-\$97.00

### Ionocraft

Proven electrical phenomenon produces anti gravity levitation of small craft. Solid State, no moving parts, easily scaled up. Larger craft can exceed lifting efficiency of modern helicopters. Uses HIDZ pwr supply.

IONO plans-\$20.00

HIDZ Power supply-\$225.00

### Lightsaber

Produces brilliant blade of glowing humming light 36" long by the flick of a switch. Virtually identical to those seen in the movies

but this one is REAL. Completely safe (available in red, green, blue)

LIGH Plans-\$20.00

LIGZ 24" Lightsaber-\$140.00

LIGZ-36 36" Lightsaber-\$160.00

### Cordless Phone Extender

Learn to extend your cordless phone range to 50 miles. Place calls all around town.

Great alternative to cell phones.

CPHE Plans-\$20.00

### Electronic Mind Control

Control minds with this simple technology.

Others will do anything you program them to. Get that raise you always wanted or reprogram your mind.

MIND Plans-\$15.00

MINZ Ready to use-\$124.00

Please add \$5.00 Shipping/Handling, Overseas \$11.00

(906)249-5197 24 hr order only line (906)249-1525 Fax  
Pay by Visa, MC, Amex, Disc, Chk, Mo, Cash Send \$3 for catalog

# New REWORK STATION from Xytronic

your price leader in quality Soldering and Desoldering Tools

**TWZ60**  
Hot Tweezers  
available for SMD  
chip removal



**\$99.95**

**Xytronic 988**  
**\$465.00**

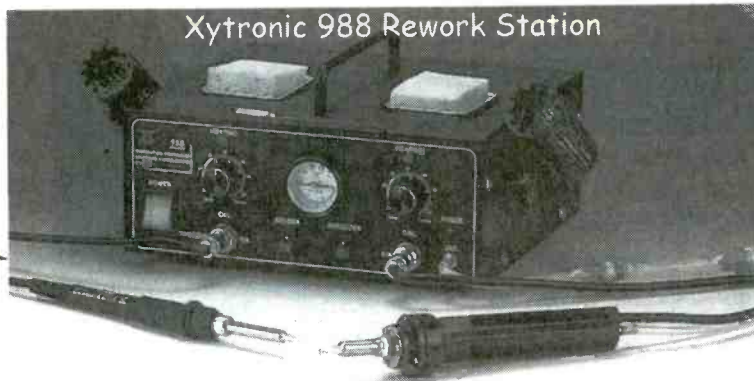

**HAP60**  
Hot Air Pencil  
Available for SMD  
chip removal



**\$79.95**

**Xytronic 988TP \$599.00**

Total Package includes Hot Tweezers and Hot air Pencil

For much more info go to  
[www.howardelectronics.com/xytronic/988.html](http://www.howardelectronics.com/xytronic/988.html)  
Free Trials Available On-Line

### Letter from a Very Satisfied Customer

When I first unpacked the solder station I was impressed with it's weight and feel. I fired it up and within a few seconds it was preheated and ready to go. I began to solder and loved the feel of the solder pencil. The heat is very adjustable and can be set to suit your needs. I have enjoyed soldering this last week. It's nice to not have the iron get so hot in your hand while soldering. Then it was finally time to desolder. The pump sounds smooth and has good power. At first I had a hard time working with it because of the pump staying on the extra few seconds, but after desoldering a few parts I got used to it. I just had to retrain my technique. Now when I use it I like that I can begin desoldering right away without unclogging it first. After I am done I use the cleaning stick and put it in the rest. So far it's always ready to go the next time I need it. I would attribute that to the pause mode. I have gone long periods of time between uses. I just push the button and within seconds it reheats to selected temperature and I am ready to go. After one week of use I am very impressed. It's a very good unit at a very good price! Thank You,  
Keith Sahs— J & M Electronics—Bellevue, NE

Order On-Line for 5% savings or call us Toll Free at 1-800-394-1984

Visa - M/C - Discover - A/E - COD - Terms to Qualifying Companies  
60 Day Money Back Total Satisfaction Guarantee

**HOWARD**  
**HEI** ELECTRONIC  
INSTRUMENTS INC  
Your Desoldering Specialists

6222 N. Oliver Kechi, KS 67067  
Toll Free U.S. and Canada  
**1-800-394-1984**

[www.howardelectronics.com](http://www.howardelectronics.com)  
sales@howardelectronics.com  
International (316) 744-1993  
or Fax (316) 744-1994

CIRCLE 237 ON FREE INFORMATION CARD



**CCTV OUTLET  
INTERNATIONAL DISTRIBUTORS**

**SECURITY CAMERAS  
WIRELESS  
TRANSMITTERS  
MONITORS  
OUTDOOR CAMERAS  
HIDDEN CAMERAS  
ALARMS & ACC.  
OUTDOOR HOUSINGS**



**WWW.CCTVCO.COM**

*over 50 brands to choose from  
buy on line or dial toll free  
1-800-323-8746*



**\$34.00**



**PC BOARDS**

**Low Cost, Precision-Made PC Boards  
From Your Gerber/NC Drill Files**

Put your CAD program to work for you!



- Milling
- Drilling
- Routing

www.pcbmilling.com FAX: (703) 818-0071

**CABLE TV BOXES**

30 Day Free Trial - 1 Year Warranty  
Quality Accounts - Dealers Welcome  
Installments Available  
www.allcableboxes.com



**888.242.0539**

**SERIAL LCDs**

Serial LCDs work great with BASIC Stamps® and other microcontrollers. One-wire interface • simple serial protocol • low cost • high quality • in stock



**BPI-216N**

- 2x16 text LCD
- 2400/9600 bps
- \$45 (non-backlit)

**SGX-120L**

- Mini graphics LCD
- 2400/9600 bps
- just \$99



Many other models available—see www.seetron.com!

Scott Edwards Electronics, Inc.  
www.seetron.com • 520-459-4802

**ELECTRONIC MILITARY SURPLUS**



**FAIR RADIO SALES**

WEBSITE: fairradio.com  
E-MAIL: fairradio@wcoil.com  
PHONE: 419-227-6573  
FAX: 419-227-1313  
1016 E. Eureka - Box 1105  
Lima, OH 45802  
VISA, MASTERCARD, DISCOVER  
Address Dept. ES

**30 FT MAST KIT**



AB-12-4/GRC MAST KIT, 12 aluminum alloy on steel sections form sturdy, lightweight 30 ft 1.7" dia mast. Kit includes 5 ea lower and upper sections, 1 ea lower and upper adapter sections, gin pole swivel base, 4 ea 36 and 42 ft guy ropes, 4 guy stakes, 2 guy rings plus 2.5 pound sledge hammer. Part of OE-254/ GRC antenna set; 30 lb sh. New, \$139.50 plus shpg. Nylon bag for above, \$39.50; See Web

SEND FOR OUR 2000 CATALOG!!

Radios - Test Equipment - Tubes - Antennas

**www.poptronics.com**



SUPPORTS DEVICES TO 32 MEG

**EPROM+**

A device programming system for design, repair and experimentation

- ◆ EXCEPTIONAL POWER FOR THE PRO
- ◆ EASY-TO-USE FOR THE NOVICE
- ◆ INCLUDES STEP-BY-STEP TUTORIAL

*Here's what you get:* A rugged, portable programming unit including the power pack and printer port cable both of which store inside the case. A real printed user and technical manual which includes schematic diagrams for the programming unit plus diagrams for all technology family adapters.\* Comprehensive, easy-to-use software which is specifically designed to run under DOS, Windows 3.1, 95 and 98 on any speed machine. The software has features which let you READ, PROGRAM, COPY and COMPARE plus much more. You have full access to your system's disk including LOADING and SAVING chip data plus automatic processing of INTEL HEX, MOTOROLA S-RECORD and BINARY files. For detailed work the system software provides a full screen buffer editor including a comprehensive bit and byte tool kit with more than 20 functions.

**Broad device support:** FIRST GENERATION EPROMS (2708, TMS2716\*, 25XX) SECOND GENERATION EPROMS (2716-28C080), 40 AND 42 PIN EPROMS\* (27C1024-27C160) FLASH EPROMS (28F29C, 29EE, 29F), EEPROMS (2816-28C010), NVRAMS (12XX, X2210/12) 8 PIN SERIAL EEPROMS\* (24, 25, 85, 93, 95, 80011A) PLUS ER1400/M586657\* AND ER5901 BIPOLAR PROMS\* (72S/82S), FPGA CONFIGURATORS (17CXXX) MICROCONTROLLERS\* (874X, 875X, 87C5XX, 87C75X, 89C5X) ATMEL MICROS\* (8-40) PIN 89C051, 89SXXX (AVR) 90SXXX PIC MICROS\* 8, 18, 28, 40 PIN (12CXXX-16CXXX, 16FX, 17C) MOTOROLA MICROS\* (68705P3/U3/R3, 68HC705, 68HC711)

**\$289**

\*REQUIRES SNAP-IN ADAPTER (ORDER FACTORY DIRECT OR BUILD YOURSELF) \$5.00 SHIPPING + \$5.00 C.O.D. 1 YEAR WARRANTY - 30 DAY MONEY BACK GUARANTEE VISA\*MASTERCARD\*AMEX

ANDROMEDA RESEARCH, P.O. BOX 222, MILFORD, OH 45150  
(513) 831-9708 FAX (513) 831-7562 website - www.arlabs.com

**Coil Design and Construction Manual**

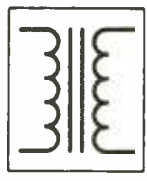

**YOU CAN WIND YOUR OWN COILS?**

There's no trick to it except knowing what you are doing. In a unique, 106-page book you can become expert in winding RF, IF, audio and power coils, chokes and transformers. Practically every type of coil is discussed and necessary calculations are given

with the mathematical data simplified for use by anyone. Get your copy today!

Mail coupon to:

**Electronics Technology Today, Inc.  
P.O. Box 240 • Massapequa Park, NY 11762-0240**

Please send me my copy of *Coil Design and Construction Manual* (BP160). I enclose a check or money order for \$8.99 to cover the book's cost and shipping-and-handling expenses. NY state residents must add local sales tax.

Name \_\_\_\_\_

Address \_\_\_\_\_

City \_\_\_\_\_ State \_\_\_\_\_ ZIP \_\_\_\_\_

All orders must be paid in U.S. funds only. Sorry, no orders accepted outside of USA and Canada. Please allow 6-8 weeks for delivery.

ET06

# ALL ELECTRONICS

C O R P O R A T I O N

QUALITY Parts  
FAST Shipping  
DISCOUNT Pricing

CALL, WRITE, FAX  
or E-MAIL For A  
Free 96 Page  
CATALOG.  
Outside the U.S.A.  
send \$3.00 postage.



## 150 Watt Power Supply

Power Switch Corporation

# PVI 150-39-PRV

Input:

100 - 240 Vac.

Outputs:

5 Volts @ 8 Amps

12 Volts @ 8 Amps

Maximum output

achieved with 20 CFM forced air cooling.

New, open-frame switching power supply.

7.13" x 4" x 1.9" high.

UL, CSA. CAT # PS-150 **\$8<sup>50</sup>** each

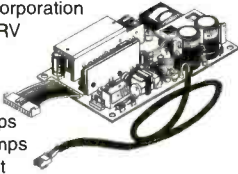

## 40 RPM 115 Vac Motor

Cramer Co # 105VA150-E

40 RPM, 115 Vac gear motor.

1.83" diameter x 1.18" body.

Mounting ears on 2.1" centers.

0.25" diameter x 1" long shaft.

Prepped with a 1.25" long pin

through the hole in the drive

shaft. Pin is removable.

4" long pigtail leads. UL, CSA.

CAT # ACM-108 **\$2<sup>50</sup>** each



## MINIATURE S.P.D.T. LEVER SWITCH

(ON) OFF (ON) Alps # SSCF2136LX

S.P.D.T., center-off miniature lever

switch. Spring-action lever returns

to center-off position. 0.49" x 0.43"

plastic body. Lever extends 0.375"

beyond body. Mounting flange

extends 0.24". Solder-loop terminals.

Large quantity available.

CAT # LSW-1 **4 for \$1<sup>00</sup>**

100 for \$20.00  
1250 for \$150.00 (12¢ each)



## 16 Character X 2 Line LCD with Backlight

Daewoo # 16216L-5-VSO

5 x 7 dot format.

2.56" x 0.54" viewing area.

3.15" x 1.41" module size.

LED backlight. Includes

hook-up/spec sheet.

CAT# LCD-53 **\$7<sup>50</sup>** each



## Infrared Receiver / Range Extender

Infrared receiver on a 16' cord terminated with a 3.5mm stereo mini-phone plug. Were packaged with audio/video equipment to extend the range of the IR controls. Black plastic, mouse-shaped device at end of cord is 1.9" x 1.4" x 0.9" and has double sided tape for attachment to equipment or wall. Contains a Sharp #GP1U59 IR receiver module which could be removed and reused for other applications.

CAT # IRD-8

10 for \$20.00

**\$2<sup>50</sup>** each



## Modular CD Racks

Organize your CDs or CD

ROMs with these high-

impact, black plastic

CD storage racks. Slots

for 12 jewel cases. Each

12 CD module can inter-

lock vertically and

horizontally with other

modules. Can be free-

standing or wall mounted.

CAT# CDR-3

10 for \$17.50

**\$2<sup>00</sup>** each

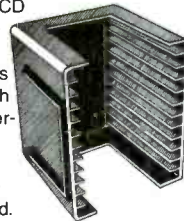

## Laser Level

Accurate and easy to use for short and long distance leveling. Center the bubble, and anything that intersects the beam is at exactly the same height. Use it to match heights in large rooms or across buildings. Set and align electrical and plumbing fixtures, cabinets and shelves. Rugged, black anodized aluminum housing with pocket clip. Locking push button switch to prevent unintended actuation.

Includes two AAA batteries.

CAT # LL-1

**\$16<sup>95</sup>** each



## 3 Outlet Lighter Cord w/ Battery Monitor

Three foot cord with LED lighted, fused, 10 Amp plug at one end and three outlet jacks at other end. Jack assembly has red, yellow and green LEDs to indicate battery condition. Can be mounted via mounting ears (4.7" centers) or double-sided tape (included). Mounting ears fold out of way if not in use.

CAT # CLP-44

**\$3<sup>75</sup>** each

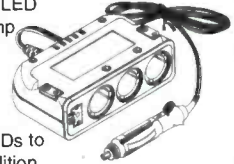

## Ionizer

Seawise Industrial Ltd.

Model # SW750. Input: 120 Vac

Output: 7.5 KV 60 Hz. The main

component in a household ion-

ization unit. 2.2" x 1" x 0.86" thick

with a mounting tab that extends

0.75" from the unit.

UL recognized.

CAT # SW-750 **\$4<sup>50</sup>** each

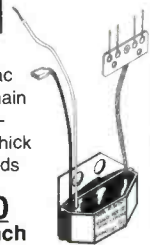

## Blue & White Ultrabrights

BLUE / water clear 1200 mcd

45 degree viewing angle.

**\$3<sup>75</sup>** each

CAT # LED-58

10 for \$30.00

WHITE / water clear 1100 mcd

**\$4<sup>00</sup>** each

CAT # LED-48

10 for \$35.00



## Motorized Potentiometer Dual 10K Linear Taper

Alps Electric # 726T-10KBX2

Dual 10K linear pot powered

by a small reversible 6 Vdc

gearhead motor. Pot and

motor assembly are 1" square x

1.7" long excluding shaft and

bushing. 6 mm flattened shaft is

0.5" long. 9mm threaded bushing. PC pins and

mounting tabs for pc board mounting.

**\$4<sup>00</sup>** each

CAT # MPOT-10K

10 for \$35.00

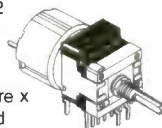

ORDER TOLL FREE

Shop ON-LINE

1-800-826-5432

www.allelectronics.com

MAIL ORDERS TO:

ALL ELECTRONICS CORP.

P.O. BOX 567 • VAN NUYS, CA 91408-0567

FAX (818) 781-2653 • INFO (818) 904-0524

E-MAIL [allcorp@allcorp.com](mailto:allcorp@allcorp.com)

NO MINIMUM ORDER • All Orders Can Be Charged to Visa, Mastercard, American Express or Discover • Checks and Money Orders Accepted by Mail • Orders Delivered in the State of California must include California State Sales Tax • NO C.O.D. • Shipping and Handling \$5.00 for the 48 Continental United States - ALL OTHERS including Alaska, Hawaii, P.R. and Canada Must Pay Full Shipping • Quantities Limited • Prices Subject to change without notice.

MANUFACTURERS - We Purchase EXCESS INVENTORIES... Call, Write, E-MAIL or Fax YOUR LIST.



**ROBOTS,  
ROBOTS,  
ROBOTS...**

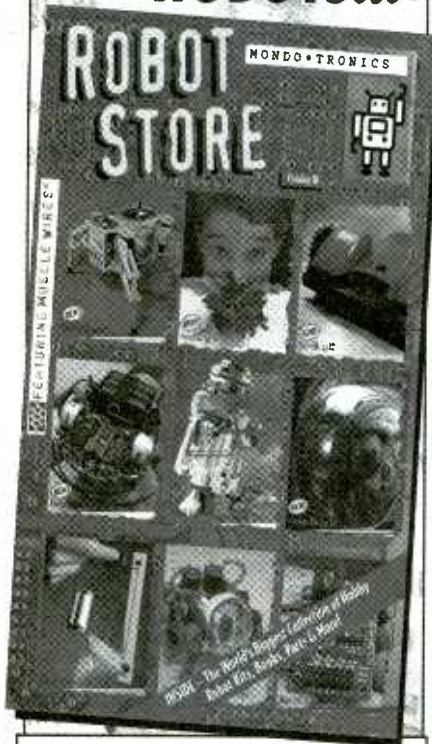

**Robot Kits, Programmable Robots,  
LEGO Robots, Living Robots,  
Home and Office Robots, Muscle  
Wires™, Electronics and More!**

**REQUEST OUR FREE  
48 PAGE CATALOG  
WITH OVER 400 ITEMS!**

**www.RobotStore.com  
800-374-5764**

**Mondo-tronics Inc.**

**PMB-N 4286 Redwood Hwy Dept. 166  
San Rafael, CA 94903  
ph 415-491-4600 fx 415-491-4696**

# CLASSIFIEDS

## BUSINESS OPPORTUNITIES

**\$400 WEEKLY ASSEMBLING** electronic circuit boards/products from home. For FREE information send SASE: Home Assembly-PT Box 216 New Britain, CT 06050-0216. **EASY WORK! EXCELLENT PAY!** Assemble Products At Home. Call Toll Free 1-800-467-5566 EXT. 1190

## CABLE TV

**CABLE TV Descramblers.** One-piece units. Scientific Atlanta, Jerrold, Pioneer, and others. Lowest Prices Around. **Precision Electronics** Houston, TX Anytime. 1-888-691-4610

**PAY TV AND SATELLITE DESCRAMBLING** 2001 \$18.95. Hacking Digital Satellite Systems IV \$29.95. Complete PayTV Series CD-ROM (Vol. 1-11) \$59.95. Scrambling News Online includes piracy \$59.95/yr. Everything above \$99.95. **SCRAMBLING NEWS.** 863-646-2564. [www.scramblingnews.com](http://www.scramblingnews.com)

**Descramblers, Converters, Activators, Rft's, Ftg's, Bullet Snoopers. All Options Explained, Best Prices, Services, 2 yr. Warranty, Free Catalog.** 1-800-854-1674 [www.resourceleader.com/aapc](http://www.resourceleader.com/aapc)

**NEW!** Jerrold and Pioneer wireless test units \$125 each, also 75DB notch filters \$19.95 each, quantity pricing available please call **KEN ERNY ELECTRONICS** 24-hour order and information hot line 516-389-3536.

**ROCK BOTTOM..DEALER..DISCOUNTS!** 125 CH. VISION MASTER PLUS.. "DECODE'S EVERYTHING PERMANENTLY" TEST CHIPS & ACTIVATORS 1-888-675-3687—201-386-1145

**ALL CABLE TV BOXES. WE'LL BEAT ANY PRICE. 30 DAY TRIAL 1 YEAR WARRANTY. FREE CATALOG! WWW.ONLINE CABLEBOXES.COM 1-888-211-7543**

**ABSOLUTE BEST PRICES ON CABLE TV BOXES! FREE 30 DAY TRIAL! 1 YEAR WARRANTY! FREE CATALOG. 1-888-242-0539**

## CB-SCANNERS

**CB Radio Modifications!** Frequencies, kits, high-performance accessories, books, plans, repairs, amps, 10-Meter conversions. The best since 1976! Catalog \$3. **CBCI**, Box 1898P, Monterey, CA 93942. [www.cbciintl.com](http://www.cbciintl.com)

## MISC. ELECTRONICS FOR SALE

**T & M ELECTRONICS.** Large variety of electronic parts since 1966. Visit our Web site at [www.tandmelectronics.com](http://www.tandmelectronics.com)

## PLANS-KITS-SCHEMATICS

**ELECTRONIC PROJECT KITS:** \$3.00 catalog. 49 McMichael St. Kingston, ON., K7M 1M8. [www.qkits.com](http://www.qkits.com) - **QUALITY KITS**

**AWESOME KITS:** Ion Propulsion Motor, Stepper Driver, Solar Robot, Scrolling Clock and more! Catalog \$1.00. **LNS Technologies**, PO Box 67243, Scotts Valley, CA 95067 [www.techkits.com](http://www.techkits.com)

**AM Tube Radio Kits.** TRF and Superhets. Visit our website at [www.ghostmoon.bigstep.com](http://www.ghostmoon.bigstep.com)

## SATELLITE EQUIPMENT

**FREE** Satellite TV Buyer's Guide. Best Products - Lowest Prices - Fastest Service! Dish Network, DirectTV, C/Ku-band, including 4DTV. Parts - Upgrades - Accessories! **SKYVISION** - 800-543-3025. International 218-739-5231. [www.skyvision.com](http://www.skyvision.com)

## TEST EQUIPMENT

**Browse** our Web site and check out the "Monthly Special". **TDL Technology, Inc.** [www.zianet.com/tld](http://www.zianet.com/tld)

**FIND** bad capacitors, diodes, transistors, in-circuit fast. Easy board level repair with the power off. **WILCO** (952) 937-9372. <http://www.wilcoedi.com>

## ROBOTICS

**Arobot Kit from Arrick Robotics** uses the BASIC Stamp II. Quality metal construction. Easy to assemble and very expandable \$235. <http://www.robotics.com/arobot>

## Get your copy of the CRYSTAL SET HANDBOOK



Go back to antiquity and build the radios that your grandfather built. Build the "Quaker Oats" type rig, wind coils that work and make it look like the 1920's! Only **\$10.95** plus \$4.00 for shipping and handling. **Clagg Inc.**, PO Box 12162, Hauppauge, NY 11788. USA Funds ONLY! USA and Canada—no foreign orders. Allow 6-8 weeks for delivery. MA01



## MULTIMEDIA on the PC!

What is Multimedia? What can it do for you? It can do lots of nice things! This 184-page book helps you create your own multimedia presentation. Multimedia applications by people like you can revolutionize educational and business applications as well bring more FUN, FUN, FUN into your leisure computer activities.

Mail coupon to:

**Electronics Technology Today, Inc.  
P.O. Box 240  
Massapequa Park, NY 11762-0240**

Please send me my copy of *Multimedia on the PC* (PCP120). I enclose a check or money order for **\$18.45** to cover the book's cost and shipping-and-handling expenses. NY state residents must add local sales tax.

Name \_\_\_\_\_

Address \_\_\_\_\_

City \_\_\_\_\_ State \_\_\_\_\_ ZIP \_\_\_\_\_

All orders must be paid in U.S. funds only. Sorry, no orders accepted outside of USA and Canada. Please allow 6-8 weeks for delivery.

MA02



# Gernsback Publications, Inc.

275-G Marcus Blvd. Hauppauge NY 11788

## POPTRONICS® CLASSIFIED ADVERTISING ORDER FORM

### Advertiser Information

Name \_\_\_\_\_

Company \_\_\_\_\_

Street Address \_\_\_\_\_

City/State/Zip \_\_\_\_\_

Telephone ( ) \_\_\_\_\_

Signature (required on all orders)  
\_\_\_\_\_

### Payment Information

Charge my:

Master Card  Visa  Discover

Account No. \_\_\_\_\_

Exp. Date \_\_\_\_\_

Full payment enclosed. Prepayment discounts offered for multiple insertions (except on credit card orders).

Payment for first insertion enclose; additional payments will be made prior to closing dates. Prepayment discounts not available.

### Do you want any special options? (where available)

Boldface Type\* Add 25% for entire ad  Screened Background – Add 30%

Special Heading – Add \$35.00

The first word of your ad and your name will be printed in boldface caps, at no additional charge. For individual boldface words, add .50¢ each.

### In what month(s) would you like your ad to run?

Entire year for publications selected above.

Jan.  Feb.  Mar.  Apr.  May.  June  July  Aug.  Sep.  Oct.  Nov.  Dec.

### Here's how to calculate the cost of your Regular or Expanded-Ad Classified:

Rate X Numbers of Words + Rate for Boldface + Rate for Screened Background = Cost per Insertion X Number of Months = Cost

Magazine	Rate	x	Number of Words (min. 15)	+ Boldface (add 25%)	+ Screened Background (add 30%)	=	Cost Per Insertion	x	Number of Months	=	Cost		
_____	_____	x	_____	_____	_____	+	_____	=	_____	x	_____	=	_____

#### Rates:

\$3.50 per word

Minimum 15 Words

### Here's how to calculate the total cost of your advertising:

#### Prepayment Discount:

(Full payment must accompany order, not applicable on credit card orders)

Prepay for  6 insertions in one magazine, 5%  12 insertions in one magazine, 10%

Subtotal \_\_\_\_\_  
Less Prepayment Discount \_\_\_\_\_  
**TOTAL COST \$** \_\_\_\_\_

Please use a separate piece of paper to write your copy, or for any special instructions you may have.

**HAVE A QUESTION? CALL: 1-631-592-6720 ext. 206**

**Fax signed orders with credit card information to : (631) 592-6723**

GP1895

## ADVERTISING INDEX

Poptronics does not assume any responsibility for errors that may appear in the index below.

Free Information Number	Page	Free Information Number	Page
- A & A Engineering	.94	- Lynxmotion	.78
- Abacom Technology	.89	- M <sup>2</sup> L Electronics	.94
- ABC Electronics	.87	160 MCM Electronics	.75
215 All Electronics	.103	250 Mendelsons	.96
- Allison Technology	.82	296 Merrimack Valley Systems	.99
- Amazon Electronics	.91	256 Micro 2000	.73
315 American Eagle Publications	.72	- Microdev	.100
- Andromeda Research	.102	- microEngineering Labs	.94
- Arrow Technologies	.97	- Modern Electronics	.94
295 AVEN Tools	.93	- Mondo-tronics	.104
- Big Bang Electronics	.81	220 Mouser Electronics	.72
319 Beige Bag Software	.76	- MSC Electronics	.91
283 Cadsoft, Inc.	.15	170 Newnes	.24
- Carl's Electronics	.78	- Pioneer Hill Software	.96
290 C&S Sales, Inc.	.84	300 Polaris Industries	.71
- CCTV Outlet	.102	219 Prairie Digital	.74
133 CircuitMaker	.CV2	- Print Products Int.	.95
233 Circuit Specialists	.98	- RC Distributing Co.	.90
- CLAGGK, Inc.	.16, 25	263 Ramsey Electronics	.92
- Cleveland Inst. of Electronics	.35	246 Resources Unlimited	.86
231 Command Productions	.74	308 Roger's Systems Specialist	.80
232 Command Productions	.89	- Saelig Co., LLC	.95
- Conitec Data Systems	.94	- Securetek	.95
316 Dalbani	.88	- Scott Edwards Electronics	.102
- EDE Spy Outlet	.72	- Sil Walker	.87
130 Electronic Workbench	.CV4	- Smarhome.com	.95
- Electronic Tech. Today	.69	- Smithy Company	.91
- EMAC Inc.	.82	- Square 1 Electronics	.74
- Engineering Express	.89	- Suburban Electronics	.86
- Fair Radio Sales	.102	- Techniks	.90
- Foley-Belsaw	.97	- Technological Arts	.78
- Fort777.com	.82	313 Test Equipment Depot	.100
- Future Horizons	.100	217 Tie Pie Engineering	.87
- Gateway Products	.90	242 Timeline	.97
- Globaltech Distributors	.90	- UCANDO Videos	.72
- Grantham College of Eng.	.76	275 Velleman	.77
271 Graymark Int.	.80	- Vision Electronics	.78
237 Howard Electronics	.101	314 Visitect, Inc.	.96
225 Information Unlimited	.79	150 Wavetek	.11
- Intec Automation	.91	- World Star Technologies	.91
- Intronics	.97	- World Wyde	.90, 91
309 IVEX Design	.83		
139 Jameco	.CV3		
- KNS Instruments	.76		

## ADVERTISING SALES OFFICES

**Gernsback Publications, Inc.**  
**275-G Marcus Blvd.**  
**Hauppauge, NY 11788**  
**Tel. 631-592-6720**  
**Fax: 631-592-6723**

**Larry Steckler**  
 Publisher (ext. 201)  
 e-mail: advertising@gernsback.com

**Adria Coren**  
 Vice President (ext. 208)

**Ken Coren**  
 Vice-President (ext. 267)

**Marie Falcon**  
 Advertising Director (ext. 206)

**Adria Coren**  
 Credit Manager (ext. 208)

### For Advertising ONLY EAST/SOUTHEAST

**Marie Falcon**  
 275-G Marcus Blvd.  
 Hauppauge, NY 11788  
 Tel. 631-592-6720 x206  
 Fax: 631-592-6723  
 e-mail: mfalcon@gernsback.com

### MIDWEST/Texas/Arkansas/ Oklahoma

**Ralph Bergen**  
 One Northfield Plaza, Suite 300  
 Northfield, IL 60093-1214  
 Tel. 847-559-0555  
 Fax: 847-559-0562  
 e-mail: bergenrj@aol.com

### PACIFIC COAST

**Megan Mitchell**  
 9072 Lawton Pine Avenue  
 Las Vegas, NV 89129-7044  
 Tel. 702-240-0184  
 Fax: 702-838-6924  
 e-mail: mmitchell@gernsback.com

**Subscription/  
 Customer Service/  
 Order Entry**  
 Tel. 800-827-0383  
 7:30 AM - 8:30 PM CST

# JAMECO<sup>®</sup>

ELECTRONICS

1-800-831-4242



August-October  
2000

An Integral Part of Your Production

[www.jameco.com/pop](http://www.jameco.com/pop)

Click on this URL to receive your special product pricing! Mention VIP # PT1

CIRCLE 139 ON FREE INFORMATION CARD

[www.americanradiohistory.com](http://www.americanradiohistory.com)

# The world's most popular electronics simulation software just got better!

## WHY settle for second best?

**\*FREE**

### Virtual Lab with Poptronics Circuits

Check out the circuits from recent issues, including this month's! Tweak the circuits and see the instruments respond instantly.

Download the Multisim demo with pre-built Poptronics circuits from [www.electronicworkbench.com/poptronics](http://www.electronicworkbench.com/poptronics)

### BEST PRODUCT! BEST PRICE!

Electronics Workbench is recognized around the globe for developing highly advanced, yet easy-to-use electronics software. Over 150,000 users tell us that they have completed projects using Electronics Workbench in less time than it takes to even install other programs.

And now we've just released Version 6.2! If you've never tried electronics simulation, this is your chance - you can now have your very own virtual lab! Work on your own or create circuits together with others across the country - live on the internet. Start with the **FREE** Electronics Workbench/Poptronics demo and then take advantage of this best price ever when you buy. Tried other products? You owe it to yourself to experience what only the market leader can offer - there is no comparison. And if you own earlier versions of Electronics Workbench, call us now for upgrade pricing starting at just **\$149!**

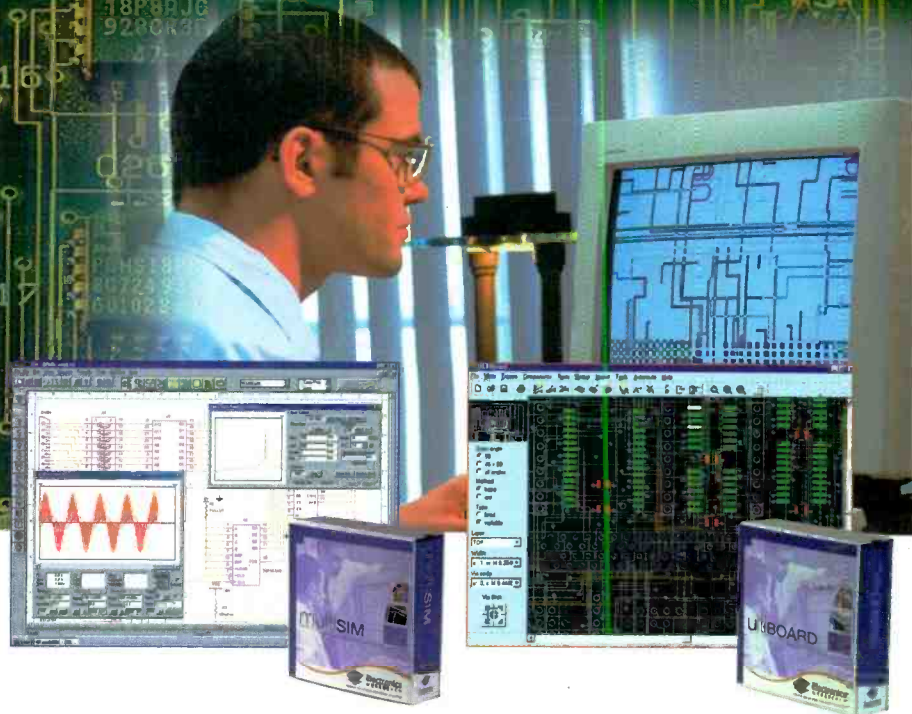

## multiSIM V6.2

Schematic Capture & Simulation

~~\$399~~ **\$299**

## ultiBOARD

Powerful PCB Layout

~~\$399~~ **\$299**

or get **BOTH** products for **\$498**

Limited Time Offer  
BEST price ever!

### Multisim Highlights

- ▶ Advanced schematic capture
- ▶ Intuitive auto & manual wiring (no toggle)
- ▶ Change circuits while simulating
- ▶ Mixed-mode SPICE analog/digital simulation
- ▶ Built-in symbol and component editor
- ▶ Parts organized into bins (no alpha lists)

**Don't settle for a program that has less than:**

- ▶ 6,000 parts in component database
- ▶ 9 virtual instruments & 8 powerful analyses
- ▶ Interactive design on the Internet
- ▶ OLE integration with Excel/MathCAD

### Ultiboard Highlights

- ▶ Powerful & easy-to-use PCB layout & editing
- ▶ Reroute while move (full rubberbanding)
- ▶ Built-in autorouter
- ▶ Real-time design rule check
- ▶ Automatic net highlighting (selective)
- ▶ Density histograms/placement vectors

**Don't settle for a program that has less than:**

- ▶ 3,000+ library of footprint shapes
- ▶ Capability for boards of any shape, up to 50"x50"
- ▶ 32 layers support
- ▶ 1 nanometer internal resolution

To order, or to find out why our products are the most popular in the industry, call **1-800-263-5552** or visit [www.electronicworkbench.com](http://www.electronicworkbench.com) (**FREE** demo available)



**Electronics**  
**WORKBENCH**

CIRCLE 130 ON FREE INFORMATION CARD

[www.americanradiohistory.com](http://www.americanradiohistory.com)