

Poptronics®

Formerly Popular Electronics® and **Electronics NOW**



Internet Appliance Development Board

Control "everything" in your home from remote locations

Appliances on the Information Highway

Is the electric company helping you save money or spying on you?

Linear ICs in Digital Applications

See what linear devices like op-amps can do in non-linear applications

Kirlian Photography

Making exposures using sheet film and cameras

Also Inside:

- VCR Play and Record Problems
- Experiments with Infrared LEDs
- The BasicX-24 Microcontroller
- Graphics on the Cheap
- Schemes Against Your Business

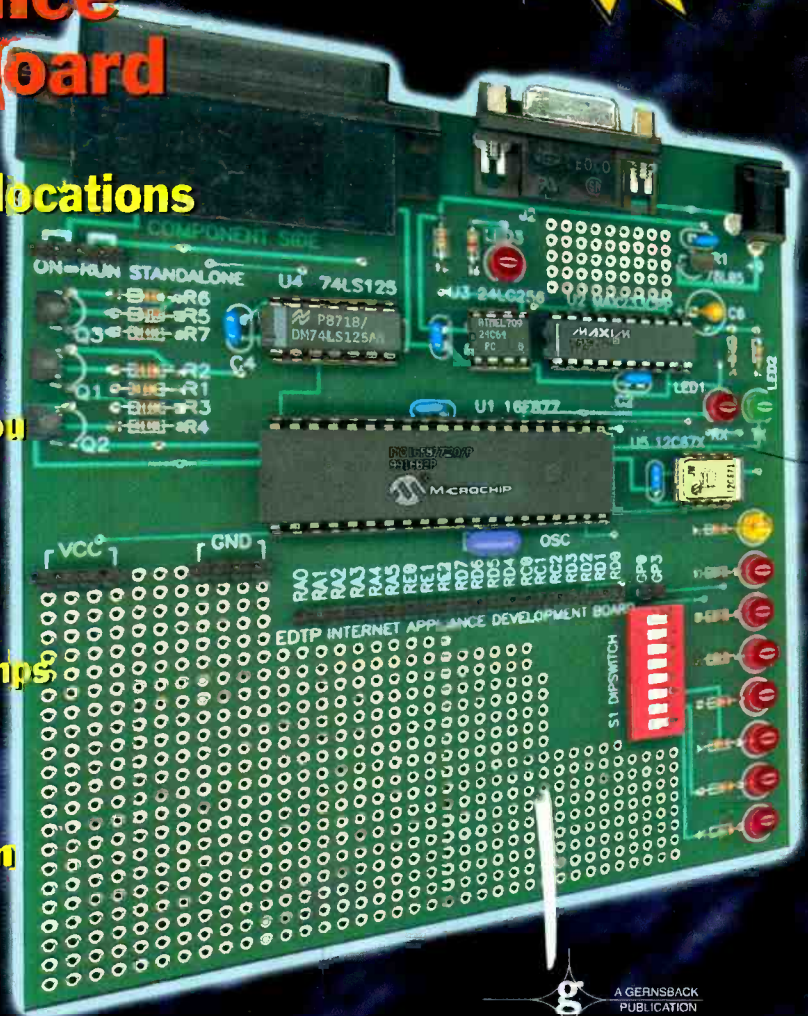

\$4.99 U.S.
\$5.99 CAN.

JAMECO[®]

Since 1974

ELECTRONIC COMPONENTS

COMPUTER PRODUCTS

1•800•831•4242



2000

www.jameco.com/pop

Click on this URL to receive
your free shipping and
special product pricing!

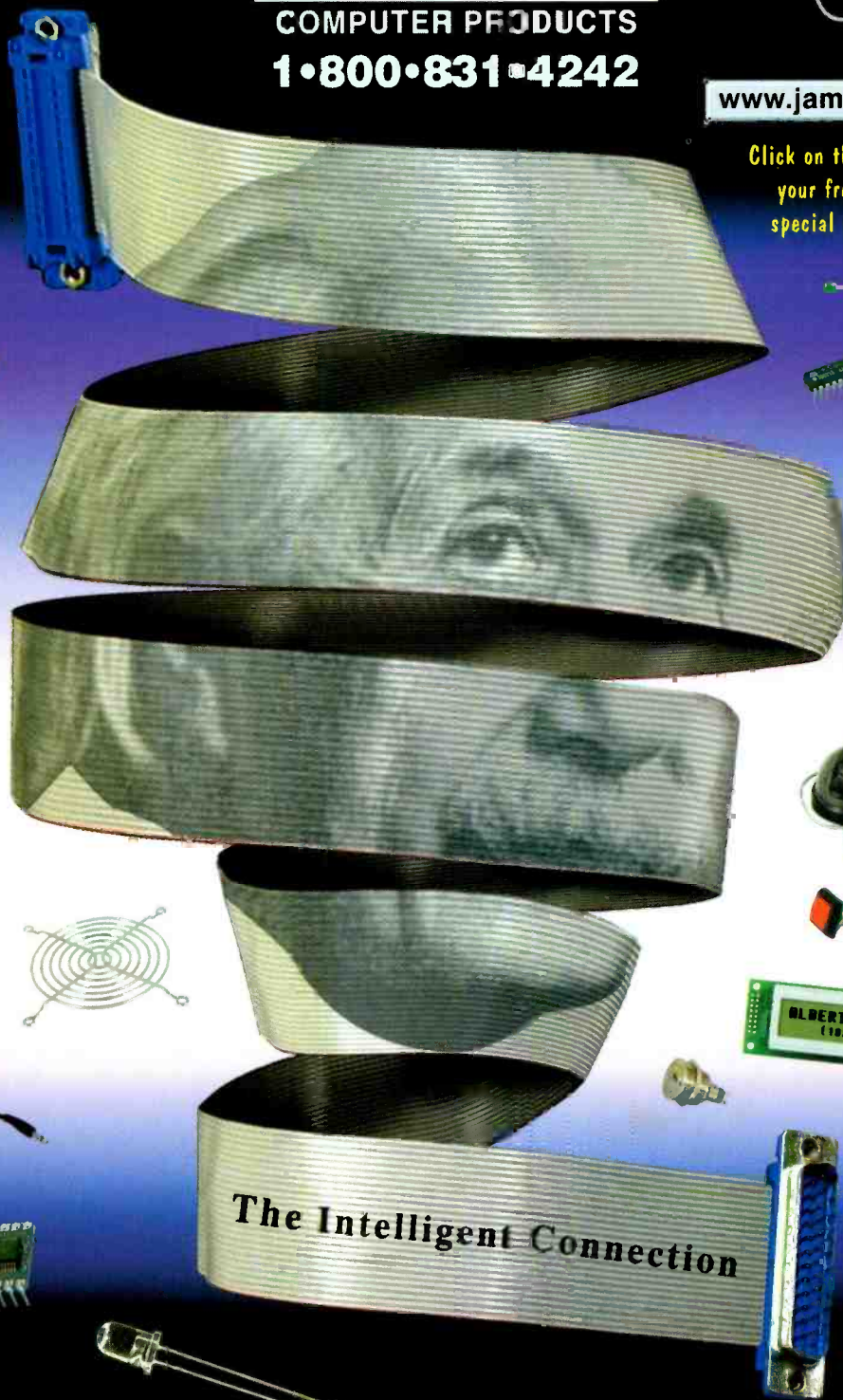

The Intelligent Connection

Free Shipping on Your First Order! Just Mention VIP# PT1

Call for details - Certain restrictions apply

CIRCLE 139 ON FREE INFORMATION CARD

Poptronics®

THE MAGAZINE FOR THE HANDS-ON ELECTRONICS ACTIVIST!

FEATURES

29 INTERNET APPLIANCE DEVELOPMENT BOARD

Take some "free" emWare and Microchip software and integrate it with inexpensive and tricky electronics to build your own development system for controlling appliances in your home from remote locations.

—Fred Eady



41 APPLIANCES ON THE INTERNET

Utilities can now "talk" to appliances through the information superhighway, allowing your utility company to measure demand, forecast load growth, and more. Learn how they do it.

—Bill Siuru

45 NON-LINEAR CONFIGURATIONS

Linear integrated circuits do not have to be limited to linear applications; there are a variety of non-linear services that these useful devices can perform.—Joseph J. Carr

51 HIGH-VOLTAGE GENERATION

How to turn low-voltage AC into very high DC voltages. All it takes are a few readily available components and some technical know-how.

—Bill Cody

PRODUCT REVIEWS

4 GIZMO®

Portable LCD Photo Album; Wireless Inter-tainment System; CD Recorder; e-Mail Traveler; Mobile Scanner; In-Dash MiniDisc Receiver; DVD Player; Human/Solar-Powered Radio; New Desktop Computers.

7 HANDS-ON REPORT

Night Owl Optics Explorer NOX3, a night-vision scope that combines starlight amplification with an infrared illuminator.

PR1 ProService Review—follows page 112. *Electronic Service Survival Solutions; Schemes Against Your Business; Define Your Market.*

DEPARTMENTS

9 COMPUTER BITS

Graphics on the cheap: How to get the graphics you need and how to process them to get the results you want.

13 PROTOTYPE

Spinning Gold into Electronics; Holographic Optical Data Storage; Clues to Astronomical Mysteries; Liquid-Crystal Display Panels.

20 AMAZING SCIENCE

Making exposures with our Kirlian photography equipment using sheet film and cameras.

23 SERVICE CLINIC

Solving the most common VCR play and record mechanical problems with some practical technical help from Sam Goldwasser.

57 Q&A

You've got questions? Michael Covington has the answers.

61 ROBOTICS WORKSHOP

More on the BasicX-24 microcontroller and using it with radio-control servos.

66 TECH MUSINGS

Using transfer functions; lithium polymer batteries; understanding non-linearity; algae hydrogen source; and more.

72 BASIC CIRCUITRY

Experiments with infrared LEDs, transistors, and phototransistors.

AND MORE

2	Editorial
12	New Literature
18	Letters
27	New Gear

77	Poptronics Shopper
	Inside The Back Cover:
	Advertising Index
	Free Information Card

Poptronics (ISSN 1526-3681) Published monthly by Gernsback Publications, Inc. 275-G Marcus Blvd., Hauppauge, NY 11788. Second-Class postage paid at Hauppauge, NY and at additional mailing offices. One-year, twelve issues, subscription rate U.S. and possessions \$24.99, Canada \$33.15 (includes G.S.T. Canadian Goods and Services Tax Registration No. R125166280), all other countries \$33.99. Subscription orders payable in U.S. funds only. International Postal Money Order or check drawn on a U.S. bank. U.S. single copy price \$4.99. Copyright 2000 by Gernsback Publications, Inc. All rights reserved. Hands-on Electronics and Gizmo trademarks are registered in U.S. and Canada by Gernsback Publications, Inc. Poptronics trademark is registered in U.S. and Canada by Poptronix, Inc. and is licensed to Gernsback Publications, Inc. Printed in U.S.A.

Postmaster: Please send address changes to Poptronics, Subscription Dept., P.O. Box 459, Mount Morris, IL 61054-7629

A stamped self-addressed envelope must accompany all submitted manuscripts and/or artwork or photographs if their return is desired should they be rejected. We disclaim any responsibility for the loss or damage of manuscripts and/or artwork or photographs while in our possession or otherwise.

As a service to readers, Poptronics publishes available plans or information relating to newsworthy products, techniques, and scientific and technological developments. Because of possible variances in the quality and condition of materials and workmanship used by readers, Poptronics disclaims any responsibility for the safe and proper functioning of reader-built projects based upon or from plans or information published in this magazine.

Larry Steckler, EHF, CET,
editor-in-chief and publisher

EDITORIAL DEPARTMENT

Joseph Suda, managing editor
Evelyn Rose, assistant editor
Nancy Serenita, editorial assistant
Michael A. Covington, N4TMI
contributing editor

Sam Goldwasser, contributing editor
John Iovine, contributing editor
Don Lancaster, contributing editor
Gordon McComb, contributing editor
Ted Needleman, contributing editor
Charles D. Rakes, contributing editor
Teri Scaduto, contributing editor

PRODUCTION DEPARTMENT

Ken Coren, production director
Kathy Campbell, production manager
Michele Musé, prepress specialist

ART DEPARTMENT

Russell C. Truelson, art director

CIRCULATION DEPARTMENT

Gina L. Gallo, circulation manager

REPRINT DEPARTMENT

Nancy Serenita, Reprint Bookstore

BUSINESS AND EDITORIAL OFFICES

Gernsback Publications, Inc.
275-G Marcus Blvd.
Hauppauge, NY 11788
631-293-3000

President: Larry Steckler
Vice-President: Adria Coren
Vice-President: Ken Coren

SUBSCRIPTION CUSTOMER SERVICE/ ORDER ENTRY

800-827-0383
7:30 AM - 8:30 PM EST

Advertising Sales Offices
listed on inside back cover

Cover by Michele Lyn Musé

VISIT US ON THE INTERNET AT:
www.gernsback.com/poptronics

Since some of the equipment and circuitry described in POPTRONICS may relate to or be covered by U.S. patents, POPTRONICS disclaims any liability for the infringement of such patents by the making, using, or selling of such equipment or circuitry, and suggests that anyone interested in such projects consult a patent attorney.

Long-Time Subscriber Makes Good

Where did it all begin? Well, it all started back on a little farm...oh, not that far back?

Actually, it all started back when I decided to get serious about electronics as a hobby. I had picked up a few "how-to" books and started studying data sheets, but I wanted to get a better grounding in the subject.

I wanted to subscribe to an electronics magazine.

The two contenders that I decided to choose from were **Popular Electronics** (back when it was published by Ziff-Davis) and **Radio-Electronics**. Although tempted to flip a coin, I decided on the former of the two. I was just about to send in my subscription card and payment when I heard that Ziff-Davis was changing the title to *Computers & Electronics*. Since I had no money for a computer (we're talking 1981 here, folks. An Apple II cost well over a thousand dollars—almost two months of my salary!), I sent my check to Gernsback Publications.

Flash forward 15 years: The career that I was building in the electronics manufacturing industry had dried up, and the job that I had taken to keep the bills paid wasn't doing as well as expected. Imagine my surprise when I looked in the help-wanted ads and saw, "Electronics magazine looking for technical editor. Electronics knowledge a must." I thought, "What's the worst that could happen?" as I typed up a cover letter, but the address kept sticking in my mind. Where had I seen it before?

Suddenly, it hit me. Grabbing a recent issue of **Electronics Now** I verified my suspicions. I was going to try working for the company whose magazine I had been reading for over a decade.

Obviously, I got the job.

Now that I've been given the chance to "step up to the batter's box," I'd like to remind everyone that first and foremost, I'm a reader just like you. Together, we can make sure that **Poptronics**, the magazine of the hobbyist, by the hobbyist, and for the hobbyist shall not perish from the newsstand!

So strap yourselves in and check that your seat backs and tray tables are in their upright and locked positions—we have quite a ride in store for you!

Now that I've taken care of the old business, let's move onto this month's controversial question. The other day, I was reading an interesting item in a trade journal for the Internet and computer industry. It seems that an interesting interpretation of copyright laws is occurring. You would expect that if you buy a book or magazine, you have the right to sell that item to someone else as long as you don't keep any copies, and that the same goes for software when the license says that it should be treated "like a book."

Apparently, a large software publisher stopped someone from selling their copy of the software on eBay citing copyright violations. It seems the person who bought the software found that it didn't do what they needed, didn't realize until too late that the publisher had a 30-day return policy, and just wanted to "make it go away." The software company felt that selling used software is "distributing copyrighted material without permission of the copyright owner."

Since I haven't verified for myself the facts in this story, I won't mention names, but the concept is a bit chilling. If I buy a piece of software that doesn't do it for me, am I stuck with both it and a bad feeling about the company that published it, or should I be allowed to unload it on someone else that might find it useful? What about magazines? Books? CDs? Paintings? Old computers with bundled software in them? Where will it stop—when we can only sell an old car back to the manufacturer if they feel like it?

Let us know how you feel about this.

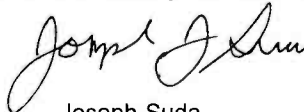

Joseph Suda
Managing Editor

New Models with Newly Added Features!!

TOUCH DISPLAY MODULE



CTD1047 COLOR

10.4-inch color TFT

NEW

CTD5741 COLOR

5.7-inch color STN

Model in photograph enclosed in case. (CTD5741J31)
CTD5741 is 100% compatible with μ TD4141.

NEW



μ TD4141

5.7-inch monochrome

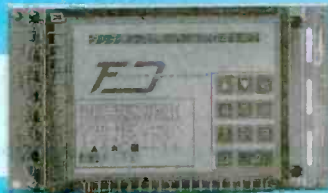

Development Support Tool

For Windows 98/95

\$170

NEW



New Features

Personalized Color Pallets

You can personalize the tone of the built-in 16-color pallet by setting RGB (brightness) level.

Copying

Areas of the screen can be selected and copied onto other screens.

Expanded Flash Memory

Image Manipulation

Images imported from digital cameras or other sources can be easily bitmapped and registered on screens or keycaps. (The demonstration fish was created with the Development Support Tool.)

Screen-to-Screen Group Move

Screen data can be selected, grouped and moved to other screens.

System Setup Example

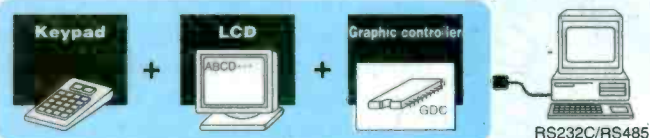

Specification	Model	μ TD4141	CTD5741	CTD1047
Display	LCD	5.7-inch, monochrome	5.7-inch, color STN	10.7-inch, color TFT
	Resolution	320 X 240	320 X 240	640 X 480
	Maximum digits	40 columns X 30 lines	40 columns X 30 lines	80 columns X 60 lines
	Effective display area (mm)	116 X 87	116 X 87	211 X 158
	Key matrix input	10 X 6	10 X 6	13 X 10 (640 X 480)
	Key size (mm)	12 X 14	12 X 14	15 X 15
	Power supply	5V DC 0.8A	5V DC 1A	5V DC 1.2A
	Dimensions (mm)	W189 X D112 X H32	W189 X D112 X H32	W272 X D205 X H43
	Standard price	\$635	\$845	\$1400

Escutcheons and cases available for all models.

*Standard prices shown in this table are changed without notice for rate of exchange.

- Via RS-232C communications, simple commands let you easily display characters, draw graphics or collect key-input information.
- The built-in display memory can hold 4 full screens, making paging and other screen operations more convenient. (Up to 54 screens can be added with the Expanded Flash Memory.)
- Expansion features can be easily used with the Development Support Tool optional software.

- A wide array of characters can be displayed including kanji, kana, alphabet, numerals and special patterns.
- Key-input can be selected between polling and interrupt.
- Equipped with buzzer ON/OFF and backlight ON/OFF commands.
- Characters can be displayed as large as 64 X 64 dot.
- Easy backlight replacement (for color LCD models).
- Portrait monitor and RS485 model are available as special specification.

URL = <http://www2.dango.no.jp/onomichi/inh/>

E-mail = inh@orange.ocn.ne.jp

INH International Hanbai Co., Ltd
22-30 Kanda-cho, Onomichi, Hiroshima, 722-0016, Japan

GIZMO®

Portable LCD Photo Album

Keep all your memories and important images with you at all times with an electronic *Wallet*, a compact portable digital image photo album from VideoChip Technologies. It measures 4 × 5 × 3/4 inches, fits easily into a pocket or purse, and holds up to 200 full-color images on a plug-in Compact Flash or SmartMedia card. The screen is a back-lit 4-inch 24-bit color LCD with 320 × 240 resolution.

To find a specific photo, multiple images are displayed in thumbnail form. The user scrolls through the images and chooses the desired one. Images can be shown in either portrait or landscape formats at the choice of the user. Two slide-show modes can be used to display the stored photos in sequence. The suggested retail price is \$349.95.

VideoChip Technologies Inc., 1010 El Camino Real, Suite 330, Menlo Park, CA 94025; 650-470-5130; www.videochip.com.



CIRCLE 50 ON FREE INFORMATION CARD

Wireless Inter-tainment System

It's called *Cybiko*—a portable entertainment and communications system that combines instant messaging, interactive gaming, e-mail and personal information manager capabilities in an all-in-one device. Priced between \$149 and \$179, *Cybiko* comes in a choice of four translucent colors, has a full QWERTY keyboard with a stylus to compose messages, LCD display, 1-MB memory (expandable to 16 MB), a high-frequency transmitter, and a vibration-alert device. The unit measures 4.8 × 2.8 inches and weighs less than 4 ounces.

Communication range is 150 to 300 feet depending upon the environment—and potentially much farther as multiple devices link and expand the range—creating their own virtual community. Users can set up their own *CyPage*, a personal profile. *Cybiko* will then alert users when a friend is within range or allow them to browse the virtual network to connect with everyone in the area. *CyLoader* allows users to synchronize the device to their PC and send and receive e-mail.

Cybiko, Inc., 1582 Lenox Ct., Bartlett, IL 60103; 630-540-1961; www.cybiko.com.



CIRCLE 51 ON FREE INFORMATION CARD

CD Recorder

Yamaha's first entry into the popular CD-recorder market is the *CDR-S1000* (\$599). The single-play recorder is said to provide excellent reproduction and duplication.

The *CDR-S1000* is equipped with coaxial digital and optical digital inputs and outputs. It also has a line-level analog input/output. The recorder's other features include analog and digital record-level controls, a headphone jack, headphone-level control, and automatic and manual track marking. With its 24-bit digital-to-analog converter and sampling rate converter, it can accommodate a variety of sampling rate standards. Recordings are finalized at 4X speed.

Yamaha Electronics Corporation, USA, 6660 Orangethorpe Ave., Buena Park, CA 90620; www.yamaha.com.



CIRCLE 52 ON FREE INFORMATION CARD

e-Mail Traveler



Combining the convenience of a personal digital assistant (PDA) device and a portable e-mail appliance, the *e-Mail Traveler* (\$149.99) from VTech is a stand-alone, pocket-sized device. It allows you to send and receive e-Mail without having to connect to a PC. With its built-in modem, the e-mail Traveler can be used anywhere. Information is entered using the included stylus pen and the 13-line × 25-character LCD touch-screen display. For use back home, the unit comes with a docking station with a full-sized keyboard and a printer port.

The e-Mail Traveler provides popular electronic-organizer functions, including an address book, a to-do list, a calendar, a memo pad, and games. It measures 5.5 × 3.4 × .86 inches, weighs about six ounces with batteries, and can store up to 400 e-mail messages.

VTech Industries, LLC, 101 East Palatine Road, Wheeling, IL 60090-6500; 888-GO-VTECH; www.vtechworld.com.

CIRCLE 53 ON FREE INFORMATION CARD

High-Tech Mobile Scanner

The *BC780XLT* (\$379.99) from Uniden America Corporation is a mountable radio scanner that is equipped with TrunkTracker III and SmartScanner technologies. TrunkTracker III allows the radio to track Motorola, EDACS, and LTR (Johnson) trunked radio systems. The scanner can detect when a transmission on any of those radio systems changes frequency and then automatically follows the transmission, allowing you to listen to entire conversations on a trunked radio system.

SmartScanner technology downloads local and national frequencies into the channels available in your zip code, through the use of an external modem or a PC. Using software downloaded from Uniden's Web site, the scanner can dial into a pre-programmed 900 number that identifies and automatically downloads the closest frequencies into channels. The *LC780XLT* offers 500 channels and an alphanumeric display.

Uniden America Corp., 4700 Amon Carter Blvd., Ft. Worth, TX 76155; 817-858-3300; www.uniden.com.



CIRCLE 54 ON FREE INFORMATION CARD



In-Dash MiniDisc Receiver

The *Dallas* (\$569.95) car stereo receiver from Blaupunkt features a MiniDisc (MD) deck mechanism hidden behind a protective, flip-down faceplate. The MD drive system has 10-second anti-shock memory to avoid music skips when traveling on bumpy roads. The *Dallas* displays the disc name, allows tracks to be programmed for

play sequence, and offers random and repeat functions.

The *Dallas* includes a DigiCeiver AM/FM digital tuner with RDS, a 4 × 40-watts power amplifier, high-voltage pre-amp and subwoofer outputs; and it also has controls for an outboard CD changer. It can be used with Blaupunkt's CDC A08 10-disc changer or the IDC-A09 in-dash five-disc changer.

The "true-digital" DigiCeiver is the only radio tuner that actually converts radio waves into digital data. That allows it to perform all radio and audio processing—such as Direct Software Control and digital signal processing (DSP)—in the digital domain and to provide exceptionally clear reception. DSP sound management features allow you to modify and fine-tune audio characteristics. The two-band digital parametric equalizer can be used to create a vehicle-equalization curve to correct for standing waves and cavity resonances. The *Dallas* also has preset curves for rock, jazz, disco, classical, and vocal genres. It offers bass and treble controls, along with a six-level loudness control and a three-level high-cut filter.

Blaupunkt, Robert Bosch Corp., 2800 South 25th Ave., Broadview, IL 60153; 800-950-BLAU; www.blaupunkt.com.

CIRCLE 55 ON FREE INFORMATION CARD

Feature-Rich DVD Player

The DVD-N2000 (\$499) from Samsung incorporates VM Labs' NUON video-processing technology for enhanced picture quality and increased functionality and interactivity. NUON technology is said to eliminate jitter and jumps during scan and slow modes.

The technology also enables features such as "infinite zoom," which allows up to 20X zoom during playback without distorting the picture. One interactive feature displays around the edge of the screen thumbnail images of adjacent angles. Highlight a thumbnail and view the movie from a different angle (if the software includes such scenes).

NUON adds a new dimension to CD playback with an on-screen spectrum-analyzer display that shows the changing musical content on screen as a visual display of musical energy. The Virtual Light Machine feature lets you choose from several vibrant design themes that NUON paints across the screen in real-time response to the rhythm of the music.

The DVD-N2000 can also play NUON educational and entertainment software that are currently being developed, including video games. Ports are available to accommodate planned NUON peripherals such as joysticks and driving wheels.

Samsung Electronics America, 105 Challenger Road, Ridgefield Park, NJ 07550-0511; 201-229-4000; www.samsungdigital.com.



CIRCLE 56 ON FREE INFORMATION CARD



Human-/Solar-Powered Radio

Freeplay Energy has added to its roster of human-powered devices the Model S360 (\$69.95), a portable radio small enough to take anywhere without having to worry about batteries or electricity. Measuring approximately 4 × 8 inches and weighing just over two pounds, the water-resistant S360 can be carried easily when hiking, boating, camping, or just around town. Winding the unit's handle for about 30 seconds will provide up to 45 minutes of play time. The radio's internal power storage system automatically saves all available spring and solar energy, giving 15 hours of play time when fully charged. It also accepts a charge

through an AC/DC adapter to provide hours of continuous music.

Freeplay Energy USA Inc., One Ramland Road, Orangeburg, NY 10962; 914-680-2233; www.freeplay.net.

CIRCLE 57 ON FREE INFORMATION CARD

New Desktop Computers

NetVista is IBM's new line of desktop computers, specifically designed and built for fast, high-bandwidth Internet access, easy setup, and simplified use. They feature high-resolution flat-panel screens, include USB (Universal Serial Bus), and offer the choices of 256-bit encryption and wireless LAN capability. The computers are 75% smaller than the typical home or office PC—just 16 × 16 × 10 inches, in a space-saving design. The CD/DVD-ROM and floppy drive tuck neatly away and a unique neck design allows the rapid access keyboard to fit under the monitor to free up desk space. Several different models and a variety of features make it easy for users to select those that they need most.

International Business Machines Corp., 1133 Westchester Ave., White Plains, NY 10604; www.pc.ibm.com/ww/netvista/index.html.

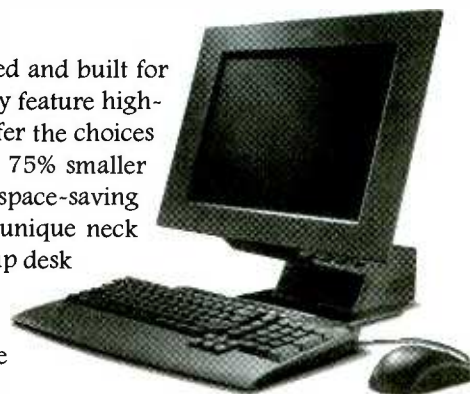

CIRCLE 58 ON FREE INFORMATION CARD





Night Owl Optics Explorer NOCX3 Starlight Amplification/Infrared Monocular

Stay up at night and watch how the other half lives!

Every so often, a product crosses the *Hands-On Report* desk that has the right combination of design, function, and usability, eliciting comments from other staff members like "Cool," "Neat," and, most importantly, "Oh, wow! Can I try it?" Such a product is the subject of this month's report, the *Explorer NOCX3* from Night Owl Optics.

While night-vision devices have traditionally been in the realm of the military and law enforcement, older-generation technology has dropped in price enough to become affordable to the average consumer. The *Explorer* is based on what is called "Generation I" technology. Light (either visible or infrared) is gathered by an objective lens and focused on the front surface of an electronic intensifier tube, or EIT. The front surface is a *photocathode screen*, where the photons strike elements that release electrons. The electrons are accelerated to the rear of the tube, illuminating a phosphorescent screen much like a television picture tube. An eyepiece lens focuses on the phosphorescent image for viewing.

Generation II technology uses a micro-channel plate for lower image distortion and higher light amplification. Generation III increases tube life by adding a gallium-arsenide layer as well as special protective coatings to the microchannel plate.

That's the good news. The bad news is that Generation II and III units can cost from \$1500 to a whopping \$10,000—not a price that the average consumer is willing to pay for a special-use toy.

Although the *Explorer's* technology is interesting, the factory location is sure to raise a few eyebrows. All of Night Owl Optics' products are made in a Russian factory that used to supply night-vision equip-



ment to the Soviet Army. With the collapse of the Soviet Union, the Commonwealth of Independent States are taking their first steps in providing their manufacturing abilities to the world market—the *Explorer* is just one example. Indeed, the bottom of the *Explorer's* case sports a sticker that proudly proclaims "RUSSIA" in 1/8-inch letters.

Before we descend to the depths of a debate on world politics, let's take a closer look at the unit itself. The *Explorer* feels like a slightly oversized tube that's surprisingly comfortable in the hand, much like the current generation of hand-held video recorders. The 2.3 x 3.3 x 7.2-inch monocular weighs in at a paltry 16 oz. The \$300 package includes a nylon-cloth-covered carrying case with reinforced sides, a lens cap with pinhole, an instruction manual in five languages (English, French, German, Italian, and Spanish), and an instructional video tape for those that believe that "manuals are for wimps."

The manual and tape are well done and informative. Both warn you of the pitfalls of owning and operating a night-vision device. As much fun as they are to work with, these units are not toys. Handling them roughly or removing the lens cap in bright light can cause problems. At best, the life of the EIT will be shortened; at worst, you'll break it. In either case, treating the unit

badly will void the one-year warranty, so handle the *Explorer* like a high-end camcorder or photographic camera.

But How Well Does It Work? The day after the *Explorer* arrived at the office, I arrived before the rest of the staff. With the office dark and quiet, I could put the *Explorer* to the test without disturbing anyone else.

The first step was to install the battery. You have to supply your own (the familiar "batteries not included" chant), but Night Owl Optics thoughtfully supplied one with the review unit. A 3-volt lithium battery powers the *Explorer*, although some other models use a pair of AA batteries. I confidently twisted open the battery door on the rear of the *Explorer*, grabbed the battery...and immediately noted that there were no indications as to the proper direction to insert the battery!

A quick glance through the manual revealed that while it was clear and concise on operation, care, and troubleshooting of the *Explorer*, there was not one single picture that showed which end of the battery to drop in first. Never in my career in high technology was I as embarrassed as I was at that moment. After all, how difficult could it be to stick in a battery?

A closer examination of the battery compartment revealed a spring at the bottom of the hole. The cover is a single metal casting with a rectangular protrusion that doubles as both cover latch and battery contact. That contact couldn't possibly touch the negative terminal of the CR123A battery because of the battery's design.

With a deep breath, I inserted the battery negative end first. Closing the cover and pressing one of the control switches lit up one of

the LED indicators on the back of the unit. If the Night Owl Optics people are reading this, it would be a good idea to engrave a great, big "+" on the inside of the battery cover! Now that the Explorer was working, it was time for some fun—er, initial tests.

Stepping into the office network room and closing the door left me in a place whose only illumination came from the plethora of LEDs on the computer equipment, power supplies, and network hubs. Pressing the "POWER" button and looking through the eyepiece was an experience that, to the first-time user, is nothing short of amazing. The view is like a black-and-white television with green phosphors. However, you shouldn't expect the scene to look like the latest Hollywood special effect with crisp, sharp detail. Remember, this is a Generation I device; slight distortions and an overall "grainy" look are normal; distortions are mostly located in the periphery of the viewable area.

The Explorer has a second switch marked "IR LED." As amazing as viewing scenes in low-light conditions is, turning on the built-in infrared flashlight is breathtaking. Whereas before I could easily identify the network server's keyboard, I could now easily read every legend printed on the keys. Of course, the IR illuminator is best used in a room or other enclosed area. With a range of about 75 yards, you won't light up distant objects in an open field as well as you might hope.

Environmental Limits. On the subject of open fields, another limitation of the Explorer is its ability to withstand weather exposure. Most of the Night Owl Optics line is "weatherproof," but that means that brief exposure to light rain or high humidity won't harm the unit. Indeed, the manual warns that if humidity condenses on the Explorer, don't use it for at least five hours.

As I write this, it's still early spring, and I'm looking forward to my friend putting his sailboat back in the water so we can try out the Explorer during some evening sailing. Rest assured that I will have a firm grip on the Explorer so that it

doesn't end up at the bottom of the bay. If you want to use a night-vision system for activities like night fishing, Night Owl Optics has a 100% waterproof version that floats if you drop it overboard.

Watch What You're Doing. After that first experience with the unit, I put it back in its carrying case and set it aside. The next day, I was showing it to one of the higher-ups and was again embarrassed when the Explorer wouldn't cooperate. Popping out the battery and checking it with a voltmeter showed that the fresh, new 3-volt battery only measured 0.52 volts!

Fortunately, CR123A batteries are no farther away than the closest RadioShack. In fact, they sell a pair of CR123As for about \$13. With a new battery in place, the Explorer came back to life.

When I put it away the second time, I carefully watched what I did to confirm my suspicions. Sure enough, it's easy to accidentally press one of the switches without realizing. No wonder I had a dead battery—the Explorer was dutifully flooding the inside of the carrying case with infrared light! The bottom line is to take a quick look at the LED indicators on the back of the Explorer before zipping up the bag, or you'll pay for your haste at \$6.50 per incident.

Further Tests. The world of infrared light is an incredible place to explore; seemingly simple things take on a new look when exposed to "invisible" light. At home, I was surprised by the amount of infrared light put out by a red LED power indicator in a set of cheap multimedia speakers. Although a friend's pair of sneakers didn't reflect very much infrared light, the shoelaces shone like neon lights. Even more startling is the fact that the human eye reflects infrared light like a mirror. With the Explorer, everyone can look like they're wearing the special contact lenses worn by actor Gary Lockwood in "Where No Man Has Gone Before," the second *Star Trek* television pilot filmed back in the mid 1960s!

When operating, the review unit makes a slight buzzing noise that

comes from its high-voltage power-supply circuit. Night Owl Optics assures us that's perfectly normal, which is logical for a unit that uses a 3-volt battery and needs thousands of volts to operate.

One issue that might confuse and disappoint people has to do with the infrared aspect of the Explorer's capabilities. Infrared light is the portion of spectrum that we can't see. As you go further down the electromagnetic spectrum, you come to the thermal portion. The Explorer can't do thermal imaging. Don't confuse infrared with heat—the frequencies are too far apart.

Extending the Play Value. The NOCX3 supports two accessories from Night Owl Optics. You can add a Lens Doubler to the standard 3.1X lens, boosting the magnification level to 5X. Additionally, a camera adapter is also available. If you have a 35mm or other photographic camera with a removable lens, simply replace the camera lens with a T-Mount adapter. Hook that adapter to the Explorer's camera adapter and you're ready to take pictures through the Explorer's "eye." Unfortunately, the camera adapter can't be used with camcorders. Both accessories retail for \$50.

The Explorer, incidentally, is just one in a series of night-vision systems in various price ranges and capabilities. Several types of monoculars are available with different levels of weight, magnification, and features. There are also two types of binoculars and even a full-featured hands-free head-mounted system—perfect for those that take their night-vision hobby *seriously!*

The Explorer is one of those high-tech toys that, while you can't think of a reason to own one, you want it anyway. Once you start experimenting with it, you'll find yourself exploring the world around you in ways you never imagined. You spend half your life in the dark—why do that at night as well?

For more information, contact Night Owl Optics, 307 Seventh Ave., New York, NY 10001; 212-229-0297; www.nightowloptics.com; or circle 80 on the Free Information Card. **P**

Graphics On The Cheap

Most of these columns have taken a similar approach. I like to talk about products you might find interesting, but in the context of solving a particular problem or accomplishing a specific project. For this column, I'm going to deviate a bit from that format and talk about several different products in a common context. Next time, it's back to the project-oriented approach.

If you've been reading this column for a while, you know that I'm pretty involved with graphics. In a sense, that's kind of ironic, as I have absolutely no artistic ability whatsoever. I tend to think visually, but in the process of putting what I see in my mind's eye down onto paper, something usually gets a bit jumbled. Back in the days when I was running a magazine, the Art Director and the rest of the staff used to look forward to our monthly art meetings, since I generally had an idea of what I wanted for each article's art. They would pass around my hand-drawn roughs as sort of an impromptu inkblot test. It's a good thing that I had a fairly thick skin, so comments on my hand-drawn sketches like "It looks like Samurai Butterflies with swords" and "No, it's a pair of pigs doing the Samba" didn't really bother me much.

They did hasten, however, my adoption of graphics software, especially large collections of clip art. These made it easy for me to quickly put together roughs that didn't look like the Ninja Turtles at a car wash. Art meetings, however, were never quite as much fun after that.

What I love about the technology that's evolved in the years since then is that it's become ever easier for me to get closer to what I can see in my mind's eye. I suppose that it's the difference between an artist and technician. A photographic artist, for example, composes in the camera. A technician, such as myself, shoots as many images as he can and composes in the



The inexpensive IXLA camera and Pablo graphic tablet are plugged into a Xircom PortStation.

darkroom or, more recently, on the computer using an image-editing application.

Not only has the technology become more accessible and easier to use, it's also become a lot more affordable. For example, many of the projects we've covered in previous columns have used a scanner at some point. You don't, however, need to spend a fortune to buy a scanner. In fact, I routinely notice scanners on sale for less than \$75 in the ads in the Sunday papers. Last week, while shopping at a nearby Costco/Priceco store, I walked past an Agfa SnapScan 1212U scanner that was selling for \$68.

WHAT YOU PAY FOR IS WHAT YOU GET

Starting to play with graphics doesn't mean that you need a huge budget. It really depends on exactly what you want to accomplish. For example, most of the photos I take for this column are snapped using a megapixel digital camera that I may have in my office for review. If you are interested in digital photography,

perhaps to enhance a Web site that you're building, you can get by with spending a lot less money on a digital camera. For this type of application, you don't need the 1600×1200 pixel resolution that a 2+ megapixel camera offers. A more modest 640×480 resolution will be fine in many cases.

That's where the *Photo Easy Deluxe*, from IXLA comes in. IXLA is an Australian company that has a major presence here in the US, and it has built a great reputation for its digital photography software over the last several years. *Photo Easy Deluxe* is basically a collection of the vendor's best image-oriented software, with a moderately good digital camera included in the package. What I find amazing about the package is that it's priced at about \$100. With a mail-in rebate offer, however, it was recently on special at CompUSA for \$50. That price was for the software *and* the camera!

The software in the package alone is easily worth the 50 bucks. It provides

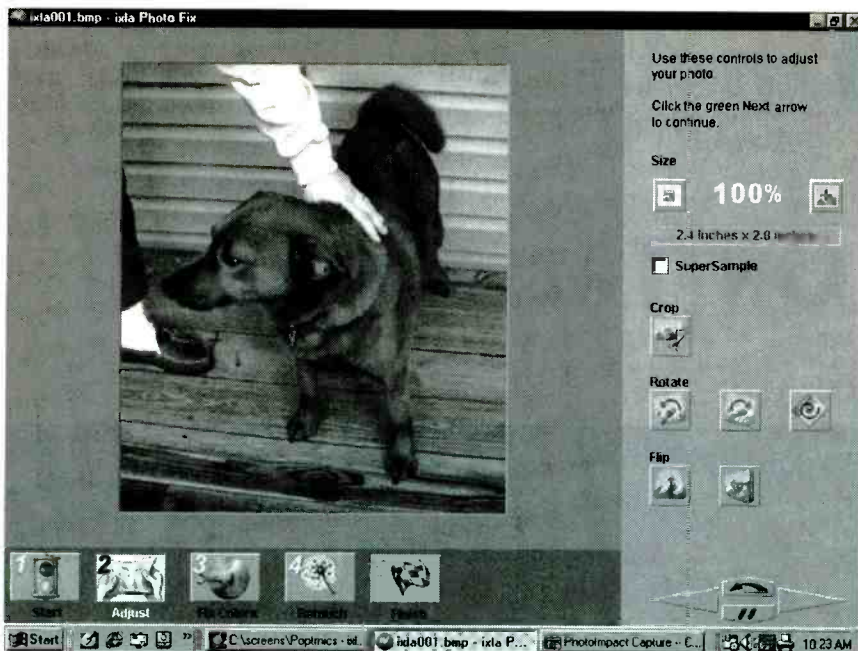

IXLA's utility software makes it easy to fix up and crop the photos taken with the camera.

good basic image editing and effects and includes a "fun" selection that lets you apply effects, like stretching someone's nose, to your photo. There's even a button on the excellent IXLA interface that lets you e-mail a photo to a friend. Other programs included make it easy to add fancy frames to your photos and create projects such as cards and "magazine" covers. You can use the camera included in the package or any other source of images, such as stock or clip art or a scanner.

The *Digital SuperPro 640* camera that's included in the package is pretty basic; but while it doesn't allow you to use removable media memory cards, the 2MB of RAM built into the camera lets it store up to 30 images. Unlike many of the other inexpensive cameras I've seen, the IXLA camera has a flash, so you can take photos indoors. It even includes a USB cable to make downloading a lot faster and easier than with those cameras that use a serial connection.

To be honest, a camera such as IXLA's and other similar 640 × 480 models is not going to let you make 5 × 7 prints. There's just not enough data in the image to blow it up that much. A package such as the *Photo Easy Deluxe*, however, is a terrific and affordable way to get your feet wet.

A LOT FOR THE MONEY

Costing a little bit more, *Pablo Internet Edition*, from KB Gear Interactive, is another terrific graphic device. Its list

price of \$99 goes down to \$79 with the \$20 mail-in rebate coupon.

Pablo is a large surface graphic drawing tablet. Unlike some of the tablets more oriented to the graphic artist or professional, *Pablo's* drawing pen is not wireless; it's attached by a small cable that plugs into a jack on the right side.

In just about every other way, however, *Pablo* holds its own very well against much more expensive tablets. It is pressure sensitive, providing up to 256 levels, with those drawing applications, including *CorelDRAW!*, that support this feature. The drawing surface measures a large 8



Here's a snap of Sparky, my trusty canine companion, taken with the IXLA camera.

× 6 inches. And there's a handy tracing flap for klutzes like me. Lift up the transparent plastic flap, slip in an image, and it's easy to trace an image. *SmartTrace*, which smooths out the jerkiness that's natural when you're trying to follow a line, makes the traced images look a lot better.

What really knocks me out about *Pablo*, however, is the software that comes bundled with it. For starters, there's a copy of *Adobe Photoshop 5 LE*, one of the most powerful (and widely used) image editing packages on the market. This edition has been whittled down a bit from the full package, but that only makes it easier for a novice to learn and use. The other packages, as you surmise from the "Internet Edition" tagline, are Web-oriented. Also from Adobe is a copy of *PageMill 3.0*, which makes it easy to create Web sites. A copy of *Totally Hip's WebPainter 3*, a utility for creating animations for a Web site, is the third package in the bundle.

VENDOR INFORMATION

IXLA USA Inc.
17 Jansen St.
Danbury, CT 06810
203-730-8805
www.ixla.com

CIRCLE 101 ON FREE INFORMATION CARD

KB Gear Interactive
1414 Washington Avenue S.
Eden Prairie, MN 55344
612-941-1905
www.kbgear.com

CIRCLE 102 ON FREE INFORMATION CARD

Xircom, Inc.
2300 Corporate Center Dr.
Thousand Oaks, CA 91320
805-376-9300
<http://portstation.Xircom.com>

CIRCLE 103 ON FREE INFORMATION CARD

Unlike a digital camera, a graphics tablet like *Pablo* isn't universally interesting. And, of course, the better you are at drawing and illustrating, the more it will merit your interest and consideration. If you can use it, though, it certainly meets my standard for a budget graphics value. As with the IXLA camera, *Pablo* can be connected via a serial port or simply be plugged into a USB port.

By the way, if you look closely at one of the photos that accompany this
(Continued on page 56)

ARE YOU A PROFESSIONAL OR JUST TINKERING?

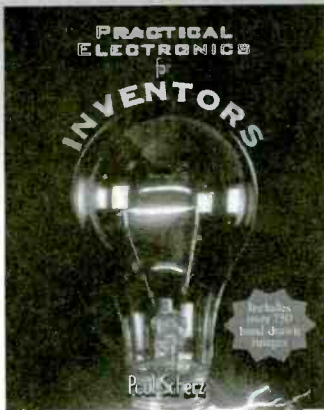

Practical Electronics for Inventors
Paul Scherz
0-07-058078-2 • \$39.95 • Pub. Date: 2000

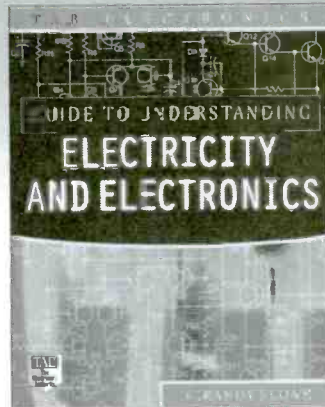

TAB Electronics Guide to Understanding Electricity & Electronics
Second Edition
G. Randy Slone
0-07-136057-3 • \$24.95 • Pub. Date: June 2000

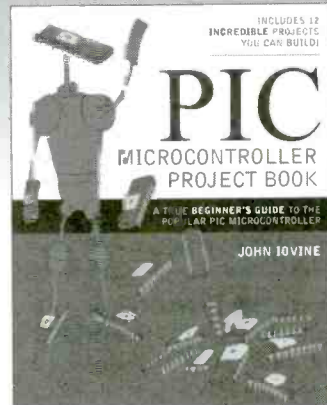

PIC Microcontroller Project Book
John Iovine
0-07-135479-4 • \$29.95 • Pub. Date: 2000



Programming and Customizing the HC11 Microcontroller
Thomas R. Fox
0-07-134406-3 • \$39.95 • Pub. Date: 2000

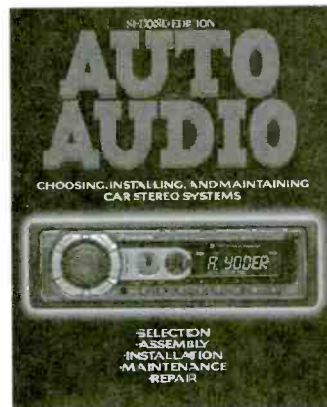

Auto Audio: Choosing, Installing, and Maintaining Car Stereo Systems
Second Edition
Andrew Yoder
0-07-134689-9 • \$29.95 • Pub. Date: 2000



Great Sound Stereo Speaker Manual with Projects
Second Edition
David B. Weems and G. R. Koonce
0-07-134874-3 • \$34.95 • Pub. Date: 2000

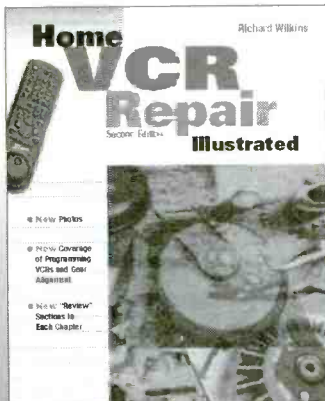

Home VCR Repair Illustrated
Second Edition
Richard Wilkins and Vicki Wilkins
0-07-070769-3 • \$29.95 • Pub. Date: 1999

CHOOSE FROM MCGRAW-HILL'S FINEST LINE-UP OF ELECTRONICS GUIDES

To preview content for each book featured in this ad along with our entire electronic hobbyist list, please visit:

<http://www.amazon.com/mcgraw-hill>

amazon.com



A Division of The McGraw-Hill Companies

NEW LITERATURE

Nikola Tesla: Guided Weapons & Computer Technology

edited by Leland L. Anderson
Twenty-First Century Books
P.O. Box 2001

Breckenridge, CO 80424

Tel: 970-453-9293

Web: www.tfcbooks.com

Nikola Tesla has often been called the greatest independent inventor. What set Tesla apart was the breadth and variety of his accomplishments. This work details the genesis of Tesla's AND logic-gate patents and describes the early efforts to design a practical remote-control guided weapon—his "telautomaton."

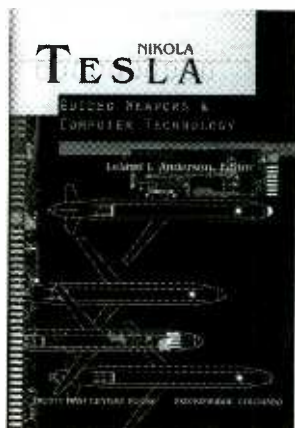

In the third book of the Tesla Presents Series, the author shows how the concept of the AND gate emerged from Tesla's work on remote-control devices. Reprinted are the two patents from 1903, demonstrating the methods and means of the invention.

Howard W. Sams Guide to Digital Cameras

by Michael Murie

Prompt Publications

Howard W. Sams & Company

2647 Waterfront Parkway, East Drive

Indianapolis, IN 46214-2041

Tel: 800-428-7267

Web: www.hwsams.com

\$39.95

How cameras work, software applications, managing and editing images, printing

and uploading to a Web page—this comprehensive volume covers all aspects of the digital camera world. The author also discusses webcams and digital conferencing and how to make your images "move."

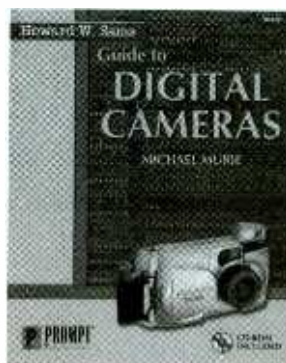

The included CD-ROM contains sample images and software, as well as a comprehensive table of the latest digital cameras, comparing features and specifications. Together, the book and CD-ROM answer readers' questions about digital cameras, enabling them to use the cameras to their fullest potential.

The Book of IRC

by Alex Charalabidis

No Starch Press

555 DeHaro St., Suite 250

San Francisco, CA 94107

Tel: 800-420-7240 or 415-863-9900

Web: www.nostarch.com

\$24.95

Informative and technical, this book includes detailed instruction on everything from the most basic Internet Relay Chat (IRC) issues to the most complicated IRC commands. IRC lets Internet users communicate directly, interactively, and in real time; but it can be difficult to master.

BooksNow

To order books in this magazine or any book in print. Please call anytime day or night: (800) BOOKS-NOW (266-5766) or (801) 261-1187 ask for ext. 1454 or visit on the web at <http://www.BooksNow.com/electronic-snow.htm>.

Free catalogs are not available.



Readers learn how to choose an IRC client, follow IRC etiquette, and find people on IRC. They will also learn how to create and manage an IRC channel; install, run, and operate an IRC server; and use bots and scripts to customize clients like mIRC and ircII.

The Unofficial Guide to LEGO MINDSTORMS Robots

by Jonathan B. Knudsen

O'Reilly & Associates, Inc.

101 Morris St.

Sebastopol, CA 95472

Tel: 800-998-9938 or 707-829-0515

Web: www.oreilly.com

\$24.95

In 1998, The LEGO Group introduced the MINDSTORMS Robotic Invention System, which makes it possible to affordably build and program robots for

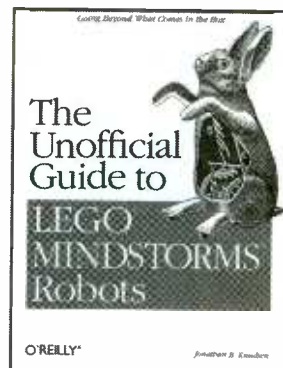

fun. This hands-on guide shows you how to use alternative programming environments like Not Quite C (NQC), pb-FORTH, and legOS to develop powerful

(Continued on page 26)

Prototype

Spinning Gold Into Electronics

Two University of Texas at Austin chemical engineers have achieved a scientific breakthrough in the production of far smaller silicon wires. Dr. Brian Korgel, 31, and Dr. Keith Johnston, 44, professors in the chemical engineering department, have produced silicon "nanowires" using tiny particles of gold suspended under pressure in a compressed fluid at a high temperature. Silicon wires that are this extremely small will be needed in the construction of the computers of the future and for optoelectronic devices, such as lasers, computer screens, and other flat panel displays.

Korgel and Johnston are members of the multi-disciplinary Texas Materials Institute that conducts research in metals, semiconductors, ceramics, polymers, and composites. Their research in nanotechnology was recently published in the journal *Science*. Nanotechnology refers to the manipulation of materials on an atomic or molecular scale to construct highly miniaturized mechanical devices. Nanoscience recently was declared a national research and budgetary priority by President Clinton.

The Limits of Miniaturization

There are one million nanometers in a millimeter. Current research is focusing on production of computer components that are 100 nanometers long. "We have made components that are four nanometers long, so we are 25 times smaller," Korgel said.

He explained that the electronics industry is reaching the limits of miniaturization and "five to 10 years from now, the way we make computer chips will not be able to be scaled down anymore." There has been a steady decrease in computer component size because, in

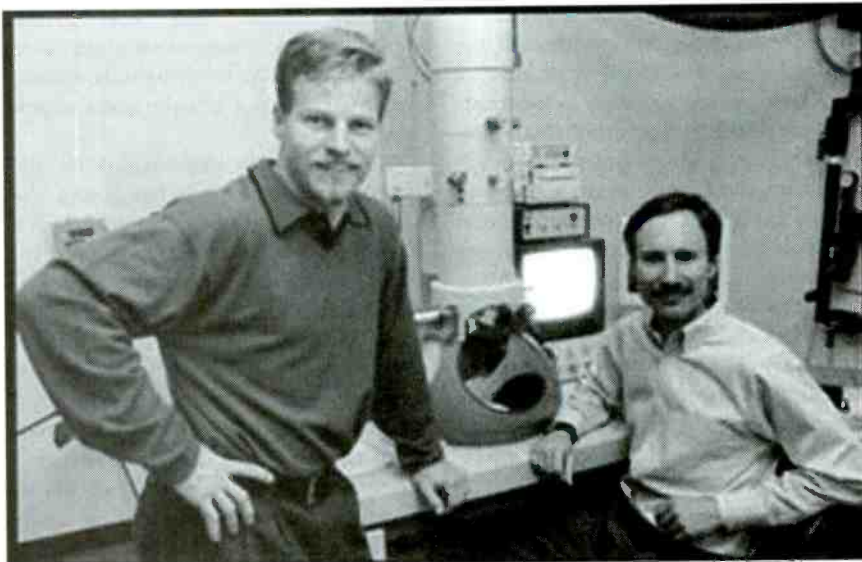

Dr. Brian Korgel (left) and Dr. Keith Johnston (right) are seen in their laboratory where they have produced silicon "nanowires" using tiny particles of gold suspended under pressure in a compressed fluid at a high temperature.

general, smaller means faster and more convenient.

"They have no idea how they are going to be making the next generation of devices 10 years from now. That's what we're working on," Korgel added.

Gold Quantum Dots

Korgel and Johnston are using methods that could lead to development of other new materials with exciting new properties. They produce their nanowires by heating silicon atoms connected to organic molecules until the silicon atoms come loose and form free silicon atoms. This is done in the presence of small clusters of gold atoms referred to as nanocrystals or quantum dots. The quantum dots in this research consist of 100 to 200 atoms of gold.

"The gold quantum dots are the seeds that start the growth of silicon nanowires," Johnston explained.

The silicon atoms don't remain free for long, either congregating together or dissolving within the gold quantum dots. "Fortunately for us, the silicon prefers to dissolve into the gold nanocrystals," said Korgel.

When the silicon dissolves inside the gold particles and the silicon concentration inside the gold becomes great enough, the gold ejects the silicon in the form of a wire. Molecules called "capping ligands" can be attached chemically to the gold quantum dots during their formation to keep them uniform in size. Being able to produce a uniform size is a crucial factor when the goal is the mass production of components.

"Ligands extend like hairs on the outside of the particles to keep from sticking together," Johnston said. "We're starting with uniform gold particles that produce silicon wires with basically the same size."

Supercritical Fluids

The researchers' new method of making nanowires is revolutionary in its use of supercritical fluids—fluids that are put under high pressure and high temperatures, in this case 5000 pounds per square inch and 500 degrees Celsius. "We have used supercritical fluids to control chemical reactions for the last 15 years, but never for the nanoscale materials," Johnston said.

Korgel added: "At that temperature we would expect the molecules to form a gas, but the pressure squeezes the molecules back into a fluid. Although the fluid is not a liquid in the sense that we think of liquids, it is, in fact, a supercritical fluid. These supercritical fluids have a variety of very interesting properties in their own right, and we are starting to exploit this unique medium to make new materials that cannot be made in any other way."

The properties, or behavior, of the nanowires are affected by quantum rules that only apply in the nanoworld. Learning to manipulate materials in the microscopic world could open the door to discoveries of what are, in effect, entirely new materials.

"When we make things as small as this, it affects the material properties so that silicon no longer really behaves like silicon," Korgel said. For example, silicon normally does not emit light. But in the nanoworld, silicon can emit light. Thus, it can be used in the construction of extremely high resolution light-emitting devices, such as computer monitors and TV screens.

"Instead of mining the Earth for a material with the appropriate material properties, we can just tune the size of the quantum dot to engineer materials with the desired properties," he added.

Future Possibilities

In the future, nanowires may be used as connectors for quantum dots according to Johnston. "As nanoparticles (quantum dots) are used as optoelectronic devices, nanowires will be a natural way to connect them. As quantum dot technology advances, nanowires will be very useful."

Changing the supercritical fluid's pressure affects how the layers of silicon in the nanowires are arranged, dramatically changing their optical properties

and, the researchers hope, changing the way electrons move along the wires. The goal is to channel electrons in one direction using nanowires.

Researchers now are testing what happens when prototype devices are created out of such small materials, by putting electrodes at both ends of the nanowires to "plug" them in and make little circuits.

"We are now trying to make a field-effect transistor, a type of electronic device, using these nanowires as a conduit for electrons," Korgel said. "It hasn't been done before, so we want to see if it will work. We're trying to take these new materials and actually make prototype devices."

The research was funded by the National Science Foundation and the U.S. Department of Energy as well as a DuPont Young Professor Award of \$75,000 to Korgel for a three-year period. Recently Korgel received a National Science Foundation Early Career Development (CAREER) Award of \$200,000 for four years. He was given these awards to study silicon nanostructures and electronic devices constructed from these material, as well as to improve education in chemical engineering materials and materials sciences.

Johnston and Korgel are also collaborating on nanoscale research in a new National Science Foundation Science and Technology Center in environmentally responsible solvents and engineering. **PT**

Holographic Optical Data Storage

Video cassettes have become a fixture in millions of American homes. In the not too distant future, video tapes will probably be replaced by Digital Video Discs (DVDs)—thin plastic platters the size of a CD-ROM. What will come next? Research currently being conducted at Southern Illinois University Carbondale may hold the key.

"Our aim is to make smaller, higher capacity storage devices that are rewritable," stated Mohammed Sayed, electrical engineering associate professor, who is researching holographic optical data storage. "Using a complex system of lasers and photosensitive materials, it is possible to store thousands

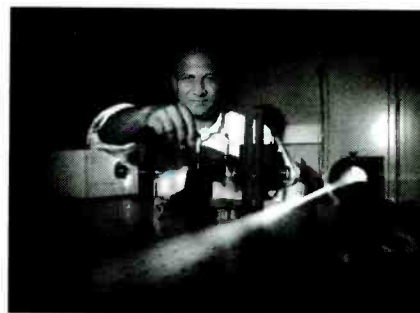

The high-powered laser in Professor Sayeh's lab is a water-cooled device about four feet long. It projects images through a series of lenses and mirrors laid out in a maze-like pattern that allows the laser beam to be repositioned as it sends pages of information to the crystal.

of pages on a small disk. The goal is to put the information contained on 20 DVDs on one disk the size of a quarter."

Sayeh uses high-powered lasers in an attempt to store up to 100 gigabytes of information on a substance known as lithium niobate, a crystal that possesses a combination of properties suitable for holographic memory storage. By contrast, a standard CD-ROM, which is an optical storage device, holds about 640 megabytes of data.

The high-powered laser in Sayeh's lab is a water-cooled device about four feet long. It projects images through a series of lenses and mirrors laid out in a maze-like pattern that allows the laser beam to be repositioned as it sends pages of information to the crystal. The images are reproduced in a similar manner by reversing the process. "Along with reducing the power needed to operate the laser, we also need to reduce its size," he explained. "If we can find better materials, it is possible that less power would be needed to record the data."

So far, Sayeh has been able to fit 50 percent of a typical movie on one disk. "Our biggest obstacle right now is getting the information written to the disk to 'stick,'" he said. Right now, reading the data after it is stored on the crystal partially erases the information, and writing new information to the crystal also may erase previously stored data. Sayeh believes it may take ten more years of research to overcome the problem.

Researchers need to clear those hurdles before holographic storage of digital data could be marketed to consumers. But some day the technology may be used in home-entertainment systems or for writable storage units in personal computers. **PT**

Clues to Astronomical Mysteries

In an inconspicuous, flat-roofed building, a machine that creates temperatures rivaling those of the sun is helping physicists examine up-close what happens to iron in black holes and neutron stars. Tests are being conducted by researchers from the Department of Energy's Livermore and Sandia National Laboratories on Sandia's Z machine—the most powerful X-ray generator on Earth. These tests should help astronomers who are trying to interpret images from the billion-dollar Chandra X-ray observatory now orbiting Earth. (Also benefiting will be the two billion-dollar X-ray orbiting observatories expected to be launched by Europe and Japan next year.)

The results will further our understanding of black holes and neutron stars, and of the evolution and eventual expiration of the universe, predicts Livermore physicist Mark Foord, one of the leaders of the joint Sandia-Livermore project. The methods developed here also can be used in weapons physics, says Sandia project collaborator and physicist Jim Bailey.

Iron is of interest to astronomers because it is among the most complicated of the elements that are widespread in the universe, and, therefore, among the hardest to understand. Several explanations are possible for the effects it creates on images taken by the Chandra-orbiting telescope.

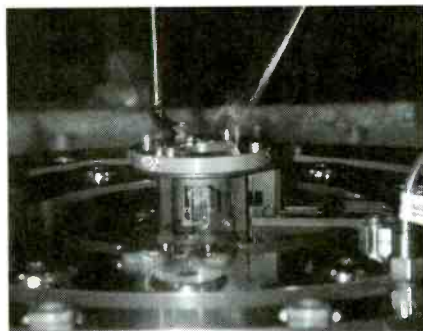

In front of a containment can at the center of Sandia's Z machine, a small window-like frame holds a shining foil containing a layer of mixed iron and sodium fluoride only 500 angstroms thick, sandwiched between micron-thick plastic substrates.

► Like Bees to Honey

Bees gathering nectar and pollen and taking it back to the hive may one day help protect the lives and limbs of people if a landmine-detection demonstration at Sandia National Laboratories is successful. Sandia chemists are working with entomologists at the University of Montana to see if foraging bees can reliably and inexpensively detect buried landmines, which could safely return hundreds of thousand of acres back to productive use. The work is funded by the Defense Advanced Research Project Agency's (DARPA) Controlled Biological Systems Program.

The project builds on three decades of explosives-detection work at Sandia and 25 years of biosystems research at the University of Montana, Missoula. Jerry Bromenshenk and his colleagues at the university have shown that as bees forage for nectar and pollen, they attract particles of dust, soil, and pollen to their fuzzy, statically charged bodies and bring samples back to the hive. All landmines leak small amounts of explosives into nearby soil or water.

Studies are being conducted to see if plants rooted in TNT-tainted soil will uptake the residues into their roots, stems, and flowers, and even incorporate them into their pollens. If plants that readily accumulated the TNT could be identified, a suspected minefield could be seeded with those plants (by air) to maximize the bees' chances of finding the mines. One goal of ongoing tests at Montana is to determine which explosives bees can smell and then train them to seek those chemicals.

PT



Sandia National Laboratories and the University of Montana are trying to determine whether foraging bees can detect buried landmines. In the foreground are two unused antitank mines.

The problem for astronomers, who can now watch titanic energies that are transforming elements on a scale never before seen, is that many fine points of the process can only be guessed at. Creating an actual neutron star or black hole on Earth so scientists could understand distant reactions is impossible since there would be no more Earth.

Because "neutron stars and black holes emanate X-rays similar in effect to those emanated by Z, we realized we have a chance to test astrophysical theoretical models that have never been tested experimentally," says Foord.

According to Bailey, "We're looking with spectroscopic eyes at the atomic physics of ionized iron so that these can be compared with theoretical calculations. Astrophysicists will have to consider what implications our figures have for their models." The results will be compared with astrophysical calculations embedded in computer codes of how neutron stars affect iron.

The experiments proceed by placing square centimeters of iron, a few hundred angstroms thick, close to the Z-pinch at the heart of Z. (A Z-pinch achieves its output by generating a powerful magnetic field that collides ions at an appreciable fraction of the speed of light.) This exposes the metal to temperatures of more than one million degrees for a few billionths of a second, ionizing it.

A Sandia instrument that takes seven images temporally and a Livermore instrument that takes one image in time and two images spatially will help determine the effects of the intense X-ray pulse from Z on iron samples in terms of spectrum, temperature, density, and ionization.

"It appears that we were successful at producing highly ionized iron and were able to obtain an accurate measurement of the radiation produced from the Z-pinch. We hope to do follow-up experiments and then return again in the summer to explore different regimes," Foord said.

PT

Liquid-Crystal-Display Panels

Philips Flat Display Systems (FDS), one of the world's largest suppliers of active-matrix liquid-crystal displays (AMLCDs), announced it has entered into a co-development agreement with Hana Microdisplay Technologies, Inc. (HMTI) to manufacture liquid-crystal-on-silicon (LCoS) panels. Under the agreement terms, Philips FDS and HMTI will collaborate on the manufacture of LCoS panels at HMTI's 18,000-square-foot advanced LCoS manufacturing facility in Ohio.

LCoS is a breakthrough projection display technology targeted for use in large-scale consumer and business applications, including desktop monitors, multimedia projectors, and large-screen TVs. Philips FDS and several other leading display manufacturers are looking at ways to commercialize this technology as it potentially offers tremendous advantages in terms of picture quality, resolution, and cost. LCoS as a technology, however, is still facing several challenges, before it gains acceptance as a mainstream display technology.

PT

Breaking the Bonds

While attempting to "photograph" the chemical reactions of an important enzyme of the nervous system, an international team of scientists found that the "flash" they were using—a high-intensity X-ray beam—was systematically destroying their target. The resulting "movie" of molecular images is the first-ever direct observation of how proteins break apart when exposed to high-energy X-rays.

"The observation was stunning," said collaborator Joel Sussman, a visiting biologist at the U.S. Department of Energy's Brookhaven National Laboratory, where some of this research took place. Stunning, because scientists previously believed radiation damage was nonspecific or random. But the Brookhaven work and studies with other enzymes elsewhere confirm that the X-rays selectively break particular chemical bonds.

"It looks like we are seeing 'weak points' in protein structures that are particularly sensitive to ionizing radiation,"

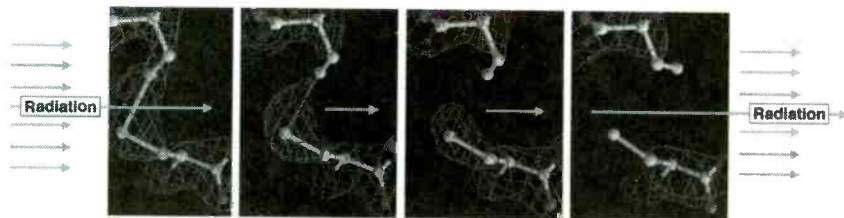

This series of photos shows how proteins break apart when exposed to high-energy X-rays. It appears that there are 'weak points' in protein structures that are particularly sensitive to ionizing radiation. Certain disulfide bonds and carboxyl acids seem particularly vulnerable. Understanding these weak links may lead to improved methods of preventing high-dose radiation damage.

says Sussman, now affiliated with the Weizmann Institute of Science in Israel. Certain disulfide bonds, which often bridge protein chains, and carboxyl acids, such as those found at an enzyme's "active site"—where reactions take place—seem particularly vulnerable. Understanding these weak links may lead to improved methods of preventing high-dose radiation damage.

Organisms are constantly exposed to radiation, mainly from natural sources, such as sunlight and cosmic rays, as well as man-made sources such as diagnostic X-rays. Knowing the specific damage caused by radiation is an important diagnostic tool for developing a method to protect against radiation damage. The Weizmann team and European collaborators, together with Brookhaven scientists, plan to examine the anti-radiation potential of various substances that might be used to offer general or emergency protection.

The findings of X-ray-induced damage will also have implications for the use of X-ray techniques to decipher molecular structures. In X-ray crystallography, scientists bombard crystalline samples of proteins with high-intensity X-rays and, by analyzing how the rays diffract or bend, they work backwards to decipher the protein's molecular structure. This common technique is an important research topic at Brookhaven's National Synchrotron Light Source (NSLS), where some of the research was carried out. (See *Proceedings of the National Academy of Science*, January 18, 2000.)

Scientists typically perform these experiments at very cold (cryogenic) temperatures to minimize the damage caused by X-rays. But the current research, conducted at cryogenic temperatures, shows that these techniques do not completely prevent the introduc-

tion of inadvertent changes into experimental samples. It is well known in science that the mere act of observation may change what you are trying to do observe. The current findings may lead to changes in procedure to minimize this effect.

The initial experiments were conducted at the European Synchrotron Radiation Facility (ESRF) in Grenoble, France, using acetylcholinesterase taken from the Torpedo fish. The work at Brookhaven used the same enzyme from humans and fruit flies. Additional experiments on a different enzyme, lysozyme, from hen egg white, were performed at the ESRF.

PT

MAY THE SOURCE BE WITH YOU

Don't let the dark forces of ignorance defeat you. Right in this galaxy you can tap into the source—the free Consumer Information Catalog. It lists free and low-cost federal publications on a variety of important topics.



So dispel the darkness and get the source. Call toll-free 1-888-8 PUEBLO for your free Catalog.

• Or set your coordinates for the Consumer Information Center Web site: www.pueblo.gsa.gov

CD ROM based resources for learning and designing



The internationally renowned series of CD ROMs from Matrix Multimedia has been designed to both improve your circuit design skills and to also provide you with sets of tools to actually help you design the circuits themselves.

Electronic Circuits and Components provides an introduction to the principles and application of the most common types of electronic components and how they are used to form complete circuits. Sections on the disc include: fundamental electronic theory, active components, passive components, analogue circuits and digital circuits.

The **Parts Gallery** has been designed to overcome the problem of component and symbol recognition. The CD will help students to recognize common electronic components and their corresponding symbols in circuit diagrams. Quizzes are included.

Digital Electronics details the principles and practice of digital electronics, including logic gates, combinational and sequential logic circuits, clocks, counters, shift registers, and displays. The CD ROM also provides an introduction to microprocessor based systems.

Analog Electronics is a complete learning resource for this most difficult subject. The CD ROM includes the usual wealth of virtual laboratories as well as an electronic circuit simulator with over 50 pre-designed analog circuits which gives you the ultimate learning tool. The CD provides comprehensive coverage of analog fundamentals, transistor circuit design, op-amps, filters, oscillators, and other analog systems.

Electronic Projects is just that: a series of ten projects for students to build with all support information. The CD is designed to provide a set of projects which will complement students' work on the other 3 CDs in the Electronics Education Series. Each project on the CD is supplied with schematic diagrams, circuit and PCB layout files, component lists and comprehensive circuit explanations.

PICtutor and **C for PICmicro** microcontrollers both contain complete sets of tutorials for programming the PICmicro series of microcontrollers in assembly language and C respectively. Both CD ROMs contain programs that allow you to convert your code into hex and then download it (via printer port) into a PIC16F84. The accompanying development board provides an unrivaled platform for learning about PIC microcontrollers and for further development work.

Digital Works is a highly interactive scalable digital logic simulator designed to allow electronics and computer science students to build complex digital logic circuits incorporating circuit macros, 4000 and 74 series logic.

CADPACK includes software for schematic capture, circuit simulation, and PCB design and is capable of producing industrial quality schematics and circuit board layouts. CADPACK includes unique circuit design and animation/simulation that will help your students understand the basic operation of many circuits.

Analog Filters is a complete course in filter design and synthesis and contains expert systems to assist in designing active and passive filters.



only
\$50
(student/home)

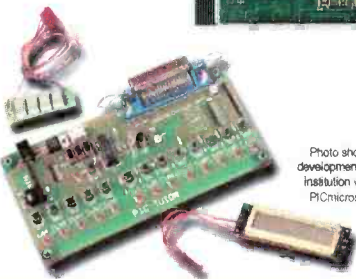

Photo shows PICmicro development kit supplied with instruction versions of C for PICmicros and PICtutor

Shareware/demo CD ROM with more than 20 programs \$4.99 refundable with any purchase.

Order Form

Please circle the products you would like to buy on the table below calculate the total cost, fill in the rest of the order form and send it to us. Please allow 6 weeks delivery.

	Student	Institution
Electronic Ccts. & Comps.	\$50	\$99
Digital Electronics	\$50	\$99
Analog Electronics	\$50	\$99
Electronic Projects	\$75	\$159
PICtutor	\$179	\$350
C for PICmicros	\$179	\$350
Digital Works	\$50	\$99
CADPACK	\$75	\$159
Analog Filters	\$75	\$159
Postage - USA	\$0	\$0
Postage - Canada	\$5	\$5

Name: _____

Phone your order to us on:

631 293 3000

Address: _____

or send your order to:



CLAGGK Inc.,
275-G Marcus Blvd.,
Hauppauge, NY 11788

Zip: _____ Phone: _____

Card Type: _____

Mastercard, Visa, or Discover only

Card number:

Expire date:

I have enclosed my check for \$: _____

Signature: _____

Please charge my credit card for \$: _____

CL02

Order online NOW from: www.gernsback.com/poptronics

Missing Figure

There seems to be a problem with the "Comm Links" column in the November 1999 issue of **Popular Electronics**. I followed the article down to the bottom of page 50 and then got lost. The article jumps to page 87, and something goes awry with the text. I've reread it several times and I think what happened is that the "L2" in the second paragraph on page 87 should be "L1" and "L1" in the next paragraph should be "L2."

In the last paragraph, a capacitor is mentioned out of nowhere. In addition, there is no mention as to where it should be connected.

I suspect that something got lost in the editing.

VINCENT S. W. DYMEK
Clifton, NJ

[You're right, but for the wrong reason. The text is fine; it's the figure that's wrong. The correct Fig. 4 is published below. (See Fig. 1.) What was published was a detail insert to illustrate the turns ratio for L1. We're sorry for the confusion that this caused.—Editor]

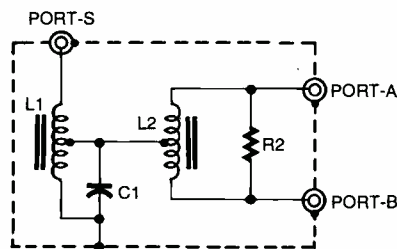

Fig. 1. This schematic should replace the Fig. 4 illustration that appeared on page 87 of the November 1999 issue of **Popular Electronics**.

Personal Sighting

While reading the article "Nikola Tesla: Scientific Savant" (**Popular Electronics**, November 1999), I especially noticed the section entitled "The Gernsback Connection," which states that Hugo Gernsback is recognized by most people as the "Father of Modern Science Fiction."

The article reminded me of a presen-

tation I witnessed during my freshman year (1948-49) at New York University, College of Engineering, which was then located in the Bronx. Since I was a commuting student, I was looking for a place to eat my brown bag lunch. A classmate suggested that we go to "some kind of presentation that was scheduled in Philosophy Hall at noon."

We entered the amphitheater late and found seats in the last row. The rows were arranged at a rather sharp angle, so that the elderly gentleman in the next row was just in front of my knees. I had no idea who he was until he was invited to the stage to receive an award for his contributions to the field of electronics. It was Hugo Gernsback. So the academic community also recognized his contributions.

To Mr. Gernsback's immediate right sat another elderly gentleman, who also received an award for his contributions to electronics. He was Lee DeForest, the father of the vacuum triode tube.

PAUL C. KRUEGER
Cape Coral, FL

New Uses for CD Cases

In regard to the article "Component Notebooks" by Peter Reintjes (**Electronics Now**, December 1999), I would like to add a comment. If you take out the insert of a CD case that holds the CD in place, there is a ¼-inch depth there that could be used to store items. Of course, there is an opening that will have to be filled or else the tab from the insert that goes there could be cut off and glued in. And if you have a notebook pocket for 5¼-inch floppies, then that could hold the converted CD case. When I lived in Indiana, I made a few trips to the Dayton Computerfest, and I acquired some notebooks that came with slip-in covers that were for paper that is 5½ to 6½ inches wide by 8½ inches high. Last summer when we moved here from Indiana I used the notebooks and cases to move some electronic parts that I put into ziplock baggies.

However, the idea by Mr. Reintjes is a valid one that I will use and improve on.

DONALD S. LAMBERT
Forsyth, IL

Further Input on Balanced-Line Converters

In the article "Test Equipment for Audio Technicians: Balanced-Line Converter" (**Electronics Now**, December 1999), the author mentioned that it is hard to find panel-mount versions of J3 and J4 (Panel-mount male XLR jacks). I believe that both RadioShack and MCM Electronics, another excellent supplier of electronics parts who is one of your advertisers, carry the panel-mount XLR connectors.

Thank you for publishing such a great magazine.

TERRY HARRIS
via e-mail

[Thanks for the suggestion. Sometimes you ignore the most convenient source because it's right under your nose.—Editor]

Interested readers of Gary McClellan's article "Balanced-Line Converter" may wish to refer to the January 1991 issue of **The Audio Amateur** (now **Audio Electronics**). Emo Barbely's article "Balanced Audio Amplifiers" is quite thorough.

Also, Analog Devices makes a dedicated Balanced Line Driver chip SSM-2142 and a -6dB Differential Line receiver chip specifically for this application. By the way, coupling capacitors would be desirable to prevent DC voltages from getting to the input of an amplifier.

CALVIN L. TAYLOR
Chehalis, WA

Illuminating Comments . . .

I believe there are some mistakes and errors of facts in the article "Freeze Motion with the Laser Scope" (**Electronics Now**, December 1999).

The statement "The basic unit of light is the candela, which is equal to one lumen per steradian (a unit of solid angle)" is misleading because the candela is actually defined as "the luminous intensity, in a given direction, of a source that emits monochromatic radiation of frequency 540×10^{12} hertz and that has

a radiant intensity in that direction of 1/683 watt per steradian." The lumen is a derived unit and defined as the flux in a steradian from a source of which the intensity is one candela.

Figure 1 is improperly drawn in some ways. The foot-candle is defined as the illumination produced when light from a point source of 1 candle falls normally on a surface at a distance of 1 foot. The flame from a candle is not just a point source. In addition, most of the light from the pictured light source does not fall normally on the flat surface. The diagram might better illustrate the concept by showing an area that is part of the surface of a sphere to overcome such difficulties.

In the next to last paragraph of the "Light" Talk section, the output of the laser is calculated incorrectly. One lumen is equivalent to 1.46 mW at 555nm. The photopic luminous efficiency at 670 nm is 0.032, so about 31.25 times the power at 555 nm is needed to produce one lumen rather than the 0.3 mW per lumen as stated. This suggests that a 5 mW laser would produce only about 0.11 lumens. However, there are a number of dubious assumptions being made when applying this calculation to a laser. These include the assumption that the laser and the LED have the same spectral spread function and that the human eye responds the same to coherent light as it does to incoherent light of approximately the same intensity.

The last paragraph of the "Light" Talk section contains the statement "Also, a wavelength of 620 nm appears to be about three times as bright to the eye as an equally intense 670 nm wavelength." The intensity ratio suggested cannot be computed using intensity measured in lumens because that is a photometric term that already accounts for the luminous efficiency of the human eye at different wavelengths.

The output of lasers and LEDs are normally not uniform over the area their luminous flux falls upon. This was not considered when comparing the output from the two devices falling on equal areas.

Intense light can cause a bleaching effect as the cones of the eye become saturated, and this affects the apparent brightness.

In spite of the apparent errors, I enjoyed the article and look forward to more from the same author. I am a long-time subscriber and think that overall the magazine is excellent.

PETER BAUM
Onset, MA

...and an Enlightened Reply

Thank you for your "illuminating" comments regarding my article. I'm happy that you enjoyed it.

As I stated in the article, my limited resources did not allow me to make an accurate mathematical comparison between the LED and laser diode. Your information appears to be accurate, but, of course, I have no way to verify it. However, you seem to be well-versed in the field, and I do appreciate your input.

I totally agree with your comments concerning Fig. 1, which illustrates the derivation of the foot-candle. Unfortunately, I didn't submit that drawing with the article. Using a spherical section would be correct.

However, the main purpose of my ill-conceived math was to show that the specified LED was indeed brighter to the human eye than a typical 5mW red (670 nm) laser diode. Once each beam was expanded (using negative lenses) to a similar angle (20°) of coverage, there was absolutely no doubt which was the brighter of the two devices.

One point I failed to mention in my article was the main reason for choosing the LED over the laser: the LED runs without damage at forward currents of fifty-times normal, while producing an almost fifty-times normal light output, at duty cycles as high as 10%. The laser spec-sheet I had on hand stated that the ABSOLUTE MAXIMUM POWER RATING of the 50 mW/670 nm laser diode is only 6 mW at a maximum duty cycle of 50%, with a maximum pulse duration of one microsecond.

Thus, I didn't even attempt to run the laser diode at a forward current of one ampere, at a 10% duty cycle, with a pulse duration of 500 microseconds. I couldn't see the point in risking an expensive device. However, the LED just coasted right along at these levels, far outshining the laser with its restrictions.
SKIP CAMPISI

Smartening the "Dummy Load"

I found the article "Precision Dummy Load" by Gary McClellan (*Electronics Now*, November 1999) quite interesting. As I do some work with musical instrument equipment and semi-pro and pro sound equipment, I have also found it necessary to make the most of my test equipment. Many items are not available, hard to find, and are usually much more expensive than the cost of the their parts.

The idea of using a fan to cool the dummy load is good. Since these fans are rather quiet, I think I'll add a pilot light to show when the fan is on. Also, if you don't already have a 12-volt fan, it is simpler to buy a 115-volt AC fan. They cost a little more, but that is offset by eliminating the power transformer and the bridge rectifier.

The resistors specified by the author are readily available at RadioShack. However, most RadioShack stores will not have 16 of them in stock and will have to order them. Also, high-power non-inductive dummy load resistors are stocked by at least two of your regular advertisers (Parts Express and MCM Electronics) at prices much lower than those given for Vishay/Dale resistors. Both suppliers stock both 4-ohm and 8-ohm resistors at three power ratings: 50-, 100- and 150-watts, and at 200 watts at Parts Express. The lowest cost per watt, at both suppliers, is for the 100-watt resistors.

Using four of the 100-watt resistors in a series-parallel connection will give a 400-watt dummy load at a cost for the resistors of just under \$50. This is twice the price of the 20-watt resistors, but there is a saving in insulated posts or tie points, and a considerable saving in construction time. The series-parallel connection, as mentioned by Mr. McClellan, does not become an open circuit if one resistor fails. Most high-power solid-state amplifiers produce their highest power into a 4-ohm load. Therefore, it might be desirable to build a dummy load using 4-ohm resistors.

The author did not mention that J3 and J4 should be mounted ¼-inches apart. The easiest way to do this is to use dual 5-way binding posts with integral banana jacks. These are available at most electronics parts suppliers (RadioShack stock number is 274-718). This connector is used for the speaker cables on high power pro sound amplifiers and speakers, and some musical instrument equipment. The connectors used on the speaker cables are spade lugs (for permanent installations) or dual banana plugs (for equipment on the road). The dual banana plugs are also widely available (RadioShack stock number is 274-717). The connector used on most lower-power sound equipment, and most musical instrument amplifiers and speakers, is a mono ¼-inch phone jack. One of these on the dummy load would allow the amplifier to be tested with the output cable normally used with it.

BILL STILES, CET
Hillsboro, MO

Kirlian Photography, Part Deux

Last month ended with descriptions of the various sheet films available. We will continue in this column by showing you, in detail, how to make exposures—in effect, how to take Kirlian photographs.

Making Exposures Using Sheet Film

What you are photographing determines whether the object involved should be grounded.

WARNING!: Whenever you photograph a living subject (person, animal or pet), under no circumstances should they be grounded or touch ground during exposure. Being in contact with a ground will lead to a nasty shock. Further, anyone with a heart condition or pacemaker should consult with their primary care physician before photographing or allowing them-selves to be photographed using this Kirlian device.

When photographing an inanimate object such as a coin, keys, leaf, etc., connect a ground to the object. Grounding the object produces a stronger corona discharge. You can use a natural ground by connecting a wire to an earth ground, such as a cold-water pipe or you can use a circuit ground by connecting a wire from the positive terminals of the discharge capacitor. That junction includes the opposite side of T1's secondary winding (see Fig. 2 of the *Amazing Science* column in the May 2000 issue of *Poptronics*).

Figure 1 shows the arrangement for making an exposure. In some cases you might place a flat sheet of glass (or plastic) on top of the object to lay flat on the film and discharge plate.

Whether you're working with black and white or color film, place the film emulsion side up on the discharge plate. Place the object you are photographing on top of the film. If the object is inani-

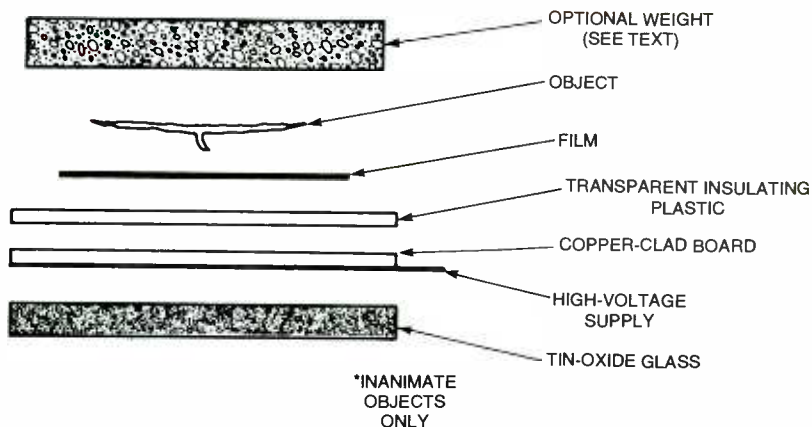

Fig. 1. Everything is set up for taking a Kirlian photo. In some instances, you might want to place a sheet of clear glass over the object being photographed.

mate, connect a ground wire to it. Flick switch S1 about 10–20 times. Each time the switch is flicked you should see a discharge between the object and the discharge plate. This is what is being recorded on the film. Proper exposure is determined by trial and error—making adjustments according to the previous result. More switch flicks for greater exposure, fewer to reduce the exposure.

To reduce the expense and speed the process, try using black-and-white sheet

film to determine the proper exposure and then switch to a color sheet film for the final shoot. Black-and-white ortho film offers the advantages of being able to be used with a red safe light and is easily developed.

If you would like to use a standard 35mm camera or video camera to record Kirlian pictures, you will need to construct a transparent electrode. The 35mm camera should be a single lens reflex (SLR) type with one or two close-up (macro) lenses. In addition, the camera must have a Bulb (B) setting among its shutter speed settings. The B setting keeps the shutter open for as long as the shutter release is held down.

Photographers usually use a cable release connected to the shutter to make B exposures. Most cable releases can be set to keep the shutter open after being pressed. The cable has a release mechanism the photographer hits to release the cable and allow the shutter to close after the exposure is completed.

Making a Transparent Electrode

A transparent electrode is easily crafted from a piece of glass or plastic that has a transparent conductive coating (typically tin oxide) on one side (see

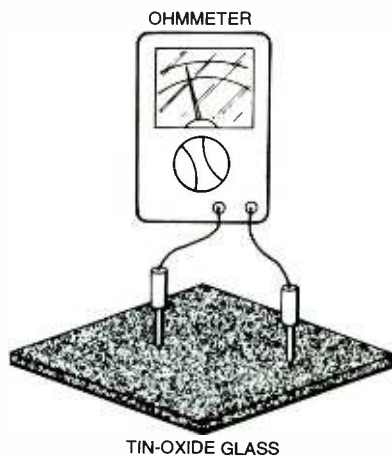

Fig. 2. When you find the conductive side of the glass, the ohmmeter will read a low resistance.

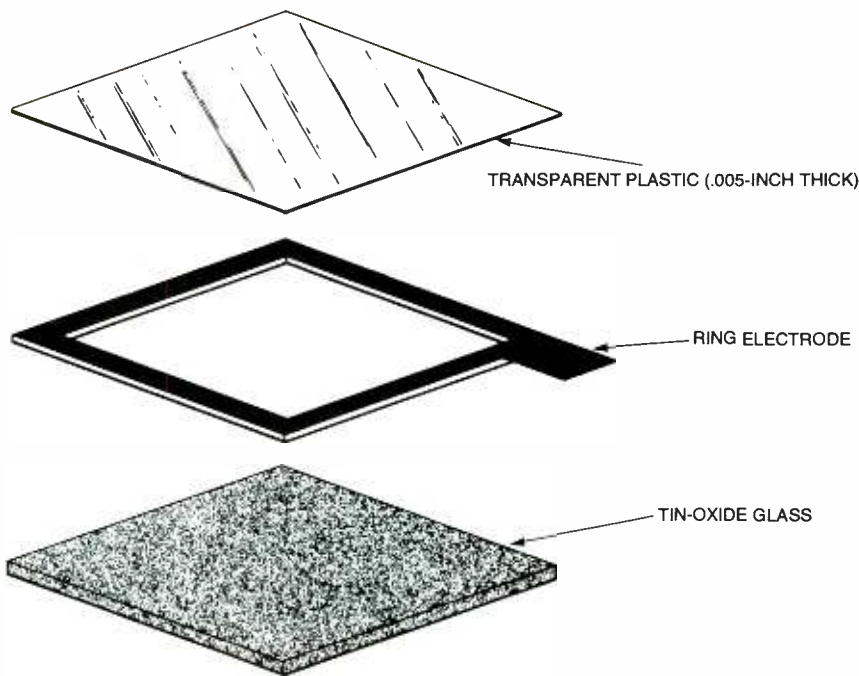

Fig. 3. The ring electrode is not hard to make. Just do it carefully.

the sidebar for details). The transparency of these electrodes needs to be 90-percent or better. The conductive tin-oxide coating is delicate. The high voltages involved in Kirlian photography can easily vaporize the coating. To keep this from happening you must be careful while making your electrode. First, if a good electrical connection is not made between the tin oxide coating and the HV conductor, the high voltage will spark between the high-voltage conductor and tin oxide coating, vaporizing the coating in the process. This renders the electrode useless. Second, a single-point connection doesn't work because this also initiates vaporization of the tin oxide coating starting from the single point connection and continuing vaporizing the tin oxide until the HV source can no longer spark (jump) across the distance. So soldering a wire directly to the tin oxide will not work.

The solution is to make a ring electrode that contacts the tin oxide on all of its sides (large surface area electrode). I use a conductive silver epoxy to secure the ring electrode to the tin oxide glass electrode.

To make a small 4- × 5-inch transparent electrode, purchase 4 × 5 inch tin-oxide glass. When you receive the glass, it will be difficult to tell visually which side of the glass has the conductive tin oxide coating. To determine the coating side you need an ohmmeter. Any inexpensive VOM (Volt-Ohmmeter) or DVM (Digital Voltmeter) will handle

this task. Set the VOM or DVM to OHMS on maximum resistance. Bring both probes in contact with one side of the transparent electrode material. The side with the conductive coating will deflect the meter as shown in Fig. 2.

Make the ring electrode from a thin conductive material. My ring electrode is made from single-sided copper clad board that is only .031 thick. You can easily cut this material with a scissors. You may substitute the ring electrode material I used with something comparable, like a thin copper (or steel, tin)

sheet (or thick aluminum foil, etc).

The outside dimension of the ring electrode is cut to the same size as the tin oxide glass, with a tab running off on one end as shown in Fig. 3. Next, cut away the inside of the ring electrode material, leaving a 1/2-inch border. This makes a rectangular ring electrode.

Before securing the ring electrode to the tin-oxide glass, clean the ring electrode thoroughly so you have a good surface for the silver epoxy. Mix the silver epoxy according to directions and apply it completely around the copper side of the board. Next, place the tin-oxide glass, conductive side facing the copper-clad side of the ring electrode, on top of the ring electrode. Place a book or flat object onto the assembly to hold it tight and together while the epoxy cures.

One peculiarity of the silver epoxy is that it needs a gentle heat treatment to become conductive and form a good bond. To do this, use an incandescent table lamp. Keep the lamp approximately 6- to 9-inches away from the assembly for about an hour. Test the completed assembly with an ohmmeter before proceeding. Touch the tab of the ring electrode with one probe and touch the tin oxide coating with the other. You should show good conductivity (low resistance).

Since the conductive coating of the tin-oxide glass is delicate, we need to protect it. Purchase a sheet of transparent plastic approximately 0.005 thick. Cut the plastic sheet to the size of the transparent electrode. Lay the plastic on top of the con-

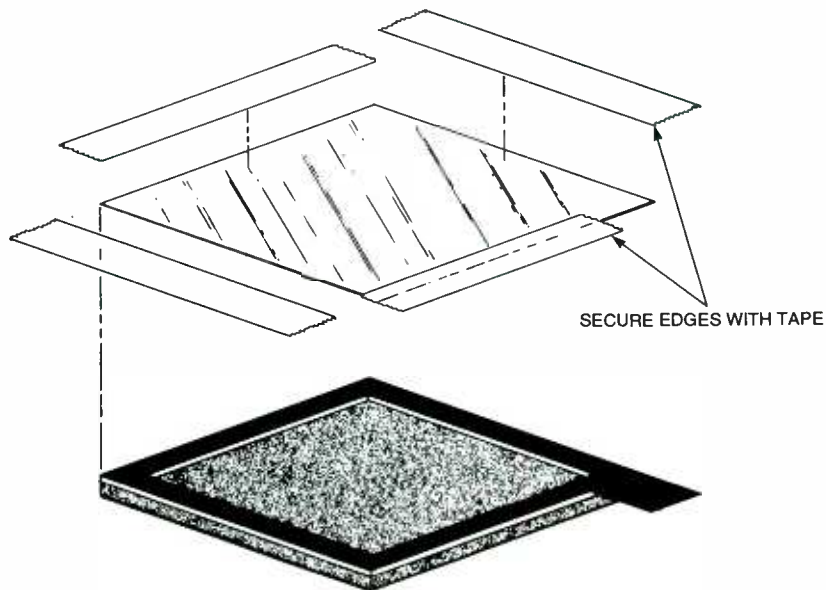

Fig. 4. Seal the transparent electrode in plastic to protect it.

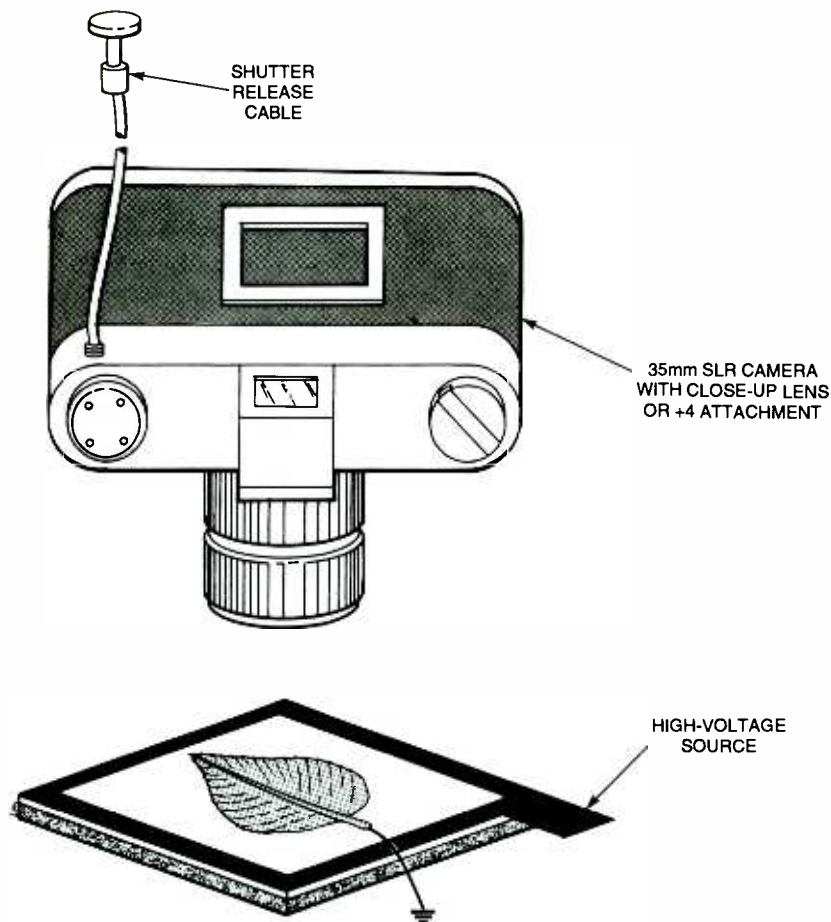

Fig. 5. Ground the subject—in this case a leaf—using a wire and an alligator clip. Position the camera directly over the subject.

ductive tin oxide coating. Place a book or flat object on the assembly to hold the plastic down flat, without any air bubbles. Run transparent tape along all of the edges of the transparent electrode to secure the plastic sheet, as in Fig. 4. The tape serves a dual purpose. First, it secures the plastic sheet to the transparent electrode. Second, it provides insulation along the edge of the electrode where it is needed. You may want to double tape the edges to provide an additional measure of insulation.

Using the Transparent Electrode

The transparent electrode may be used with a variety of Kirlian devices if it has an external high-voltage lead that you can use to connect the transparent electrode. We take the high voltage using an alligator clip wire connected to the wire or copper electrode of the Kirlian device at one end and connecting the other end to the tab of the transparent electrode.

Typically, the camera is located on the opposite side of the working surface. Because the electrode is transparent, you can shoot through the electrode as if it were an ordi-

nary pane of glass. As an example, here is the procedure to shoot a leaf. In this example, the leaf is at ground potential and the transparent electrode is at the high-voltage potential. Make the set up in a room that can be made relatively light tight. The leaf is placed on a black non-reflecting, nonconductive surface. This improves background contrast. The transparent electrode is placed over the leaf. The thin plastic sheet side on the electrode is placed on the leaf. The leaf is connected to ground by using an alligator clip wire as in Fig. 5.

The camera is positioned over the assembly. The view through the camera should only show the object under the transparent electrode. This is done with a close-up (macro) lens, with a 4+ adapter or a reversing ring. The camera must be manually focused onto the object. If an auto-focus camera is being used, set it to manual operation. Open the aperture (f-stop) of the camera as wide as possible (2.0 or 2.4). Set the shutter to B (bulb) to make long timed exposures. When it's set to B, the shutter remains open as long as pressure is kept on the release button. Using a shutter-release cable attached to the camera will make taking pic-

SOURCES OF SUPPLY

4- × 5-inch one-sided tin-oxide transparent glass, part number CGL4x5, is available for \$25.00 plus shipping from:

Images Company

39 Seneca Loop
Staten Island, NY 10314
718-698-8305
www.imagesco.com

Silver Epoxy Kit, catalog number 5168-2400, for \$19.18 plus shipping, is available from:

Mouser Electronics

12 Emery Ave.
Randolph, NJ 07869-1362
800-346-6873
www.mouser.com

tures much easier. You can use any type of color film in the camera. I strongly advise using the fastest film available, either ISO 1000 or ISO 1600.

Manually focus the camera on the object with the room lights on. After the camera is focused, turn off all the room lights. Use a flashlight with a deep red filter to navigate around the room. When you are by the camera, turn off the flashlight and open the shutter of the camera using the cable release. Now pulse the switch on the manual Kirlian Device. Hit the switch 50 to 100 times to build up a strong image onto the film. Next, release the shutter using the cable release. Turn on the room lights and set up your next picture.

One hint I'd like to pass along. Start each roll of film with a few conventional pictures. This allows the photo-lab to align the frames properly on the machine. Tell the photo-lab to print all frames; otherwise, they may interpret the glowing outlines and corona discharges as picture errors and not print them.

Making Kirlian Videos

The technique just described for still photos may also be used to film real-time Kirlian video. However, the manual Kirlian device is too weak to shoot video. If there is genuine interest in pursuing different aspects of Kirlian photography, we can return to this topic with a more powerful automatic device that would be suitable for video. Let me know if you are interested.

That wraps up this column. I look forward to bringing you more *Amazing Science* in the next issue of *Poptronics*. □

VCR Play and Record Mechanical Problems

This month we take the next step into VCR repair. We are going to cover basic functional problems. We assume for this section that the VCR behaves normally until you try to play a prerecorded tape or try to make a new recording.

Here is a quick list of the most common mechanical problems that you may run into. They aren't in any special order, but those toward the top of the list are the most likely to occur:

- Needs cleaning.
- Dirty or deteriorated rubber belts and/or idler tire.
- Idler clutch too weak or too strong because of wear.
- Selected parts need lubrication.
- Worn brake pad or engagement problems.
- Broken or misadjusted back-tension band.
- Dry or worn capstan motor bearing.
- Gear timing incorrect due to forcing of mechanism or gear damage.
- Other broken parts.

Now that we know the basic problem areas to check first, let's look at some specific complaints and their possible solutions.

VCR Refuses to Record

If efforts to record (directly or via the timer) are totally ignored or cause the cassette to be ejected, then the record protect tab on the cassette may be broken off or the record protect sense switch in the VCR may be dirty or defective. This switch sits just under the cassette slot (on front loaders). Locate it by referencing the tab position on the loaded cassette. It can easily be tested with an ohmmeter—if you can get to it.

To confirm, short out or disconnect

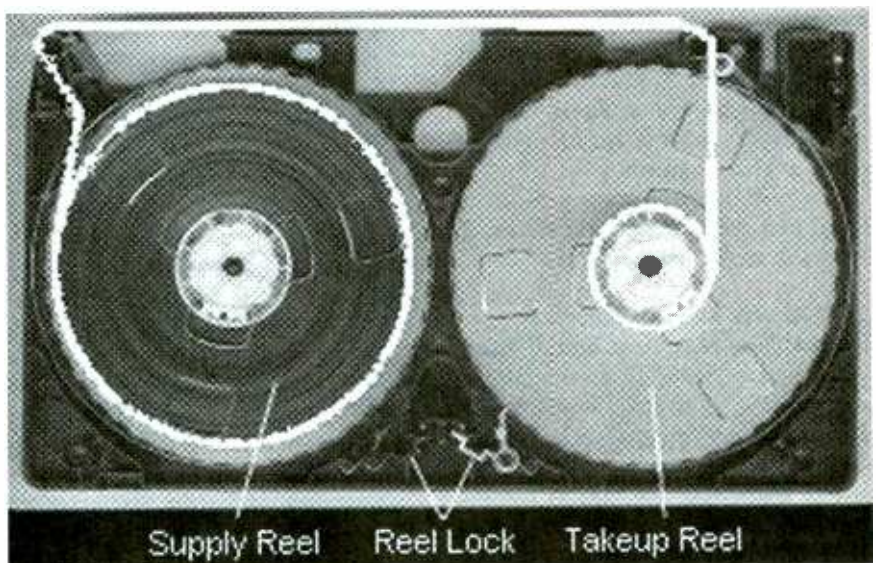

Fig. 1. As you can see from this inside view of a VHS cassette, there are very few parts that can break. When they do, however, you might lose the tape—as well as your machine.

(which you will need to do depends on the design of your VCR) the appropriate wires (maybe there is a connector—this could have bad contacts as well) and see if the VCR is more cooperative.

VCR Aborts Play or Record During Startup or Shortly Thereafter

This is a problem with the process called *tape loading*—pulling the tape loop out of the cassette and wrapping it around the spinning video drum, engaging the capstan and pinch roller and reel rotation. Check all the belts, both above and below the deck. Belts can appear to be firm; but if they do not return immediately to their relaxed length when you stretch them 25%, they will need to be replaced.

With the cover off, observe the behavior when you hit PLAY. (You may need to put a piece of cardboard over the cassette to block external light from

interfering with the start/end tape sensors). Assuming this is a basic VCR (no instant start features), you should see the following series of events occur:

- The video head drum begins to spin.
- The roller guides move smoothly on the tracks, the tape winds around the drum, and stops snugly pressed against the 'V-Stopper' at the end of the tracks.
- The pinch roller moves into position and presses the tape against the capstan.
- The tape begins to move and is wound up by the takeup reel.
- The picture and sound appear on the TV.

With a *rapid or quick start* (or it may be called something else) transport, the tape moves to a half-loaded position when the cassette is inserted. This is at an intermediate position partially pulled out of the cassette but not wrapped

around the drum. On VCRs with a real-time counter and/or index search capabilities, the tape will be in contact with the control head.

With an *instant start* transport, the tape will fully load around the spinning drum when the cassette is inserted, but the capstan will not engage and no tension will be applied to the tape until you press PLAY or REC. (After about 5 minutes, the drum will stop; and it may unload to the half loaded or unloaded position.)

Note that for VCRs with a real-time counter and/or index search capabilities, the tape must be in contact with the control head (but not the video heads) for all relevant modes. These VCRs (which include many modern units) must therefore pull the tape at least partly out of the cassette.

In all cases, the completion of the sequence results in approximately the same mechanical configuration during PLAY.

See the sidebar on this page for possible causes of VCR shutdown.

We will be discussing sensors in much more detail, including the mode switch, in an upcoming "Service Clinic".

VCR Aborts Play or Record at Random Times or Near End of Tape

In this case, the VCR starts to play or record but, say, an hour later, it shuts down for no good reason—at least not as a result of a command you thought you issued. Make sure the tape is not the problem—try another one. There may be spots on the tape where the oxide has come off resulting in pinhole (or larger) areas which are activating the end-sensors. Confirm that you are using the proper play or record modes—not OTR (One Time Record) or other timed play or record modes that will likely operate in increments of 15 minutes depending on how many times you press the button. In addition, on certain VCRs, if the program timer is enabled with a program setting that has its stop time occur while you are using the VCR—even if the record operation has been aborted by pressing the stop button—the VCR will shut down.

If play or record aborts at the same location on only certain tapes, there could be pinholes in the tape oxide coating allowing light to pass through and confuse the sensors. This happens mostly with T160 or old well-worn tapes. If you can locate the problem area, you can try indelible ink on the NON-oxide side of the tape but DO NOT use adhesive tape or glue. Otherwise, discard the tape

POSSIBLE CAUSES OF VCR SHUTDOWN

- **Everything occurs normally**, picture and sound appear for a few seconds, but then the VCR unloads the tape, ejects the cassette, goes into REW mode, stops, or shuts off. There are two common causes of this problem:

The takeup reel does not turn and tape spills into the machine. This is sensed by the microcontroller, which aborts RECORD or PLAY and attempts to save your valuable cassette. The most likely cause is an old or dirty idler tire. As a test, turn the idler tire inside-out. The fresh surface will now work well enough to confirm this diagnosis and will continue working long enough for your replacement idler tire to arrive.

The takeup reel is turning properly but one of the reel rotation sensors or its electronics is defective. As a test, check to see if the tape counter is changing at any time during the loading and abort process. Non-real-time tape counters usually get their pulses from this same sensor. (Real-time counters operate off of the A/C head control pulses and therefore would not be affected by a defective reel sensor). Some older VCRs used a belt-driven counter—the belt may have broken or fallen off. Most newer VCRs use an optical sensor which may simply be dirty.

- **The roller guides are getting hung up** and not fully loading the tape—either as a result of an obstruction or dried-up grease or a slipping tape-loading belt (often accompanied by a spine-tingling squeal). Parts may have broken or fallen off of the roller-guide assemblies, preventing them from fully engaging the *V-Stoppers*. A similar fault may prevent the capstan from fully engaging against the tape and pinch roller. A toy, candy, or a plastic bit of a cassette shell may be jamming something.
- **The mode switch sensor is dirty or defective** and confusing the poor microcomputer as to the position of the loading mechanism. In this case, the loading process may stop half way, pause, and then unload as in either of the preceding possibilities; or it may do almost anything.
- **Some other condition**, such as the end-of-tape sensor thinking that you are at the end of the tape, is aborting the tape-loading process. This might be indicated by a sudden reversal and shutdown rather than a pause (usually accompanied by the sound of a motor whirring) at some point attempting to complete part of the cycle. For problems with RECORD in particular, the record protect tab switch may be dirty or worn resulting in random aborts.
- **Electronic problems** like bad grounds or other bad connections are also possible. Some models (a number of JVC manufactured VCRs, for example) provide ground integrity via screws through the main circuit board. Should these loosen, erratic behavior may result. Tighten the screws.
- **A defective microcontroller** or other logic could also be at fault, but this is less likely than any of the preceding.

or live with its behavior. Finally, make sure you are not using any *insert editing* modes that require a previously laid down control track and would abort once blank tape was reached. Once all the obvious problems and cockpit errors have been eliminated, some mechanical problem may still be likely, even though the VCR does not abort immediately. A worn idler tire, worn or defective idler clutch, bad belt, or improperly adjusted back tension are all possibilities.

If the operation starts properly (as indicated by a changing picture on the TV in play or from a visual inspection with the cover off) but the tape counter does not change value and then the unit shuts down, a reel-rotation sensor problem is likely.

VCR Eats Tapes or Leaves Tape Loop Hanging Out After Eject

The most common cause of both these problems is a dirty/worn idler tire preventing the takeup reel from turning.

If dirty, worn, dried out, glazed, cracked, or otherwise deteriorated, it will slip and cause the takeup reel (in play mode) to stop turning at some point. Hopefully, the microcomputer senses this and tries to wind the tape back into the cassette. You guessed it; this requires the idler tire so you end up with a mess of tape inside the machine. When you go to eject, you may get the cassette with a tape loop hanging out. If you are careful, you may be able to extract the tape without crinkling it too

badly but don't just pull—it will break or be hopeless damaged. You will need to remove the top cover and carefully lift the tape loop out of the machine and wind it back into the cassette. If there is any significant crinkling or a partial break in the tape, discard the cassette. If it is priceless and irreplaceable, see the section a bit further on about recovering damaged or broken tapes. DO NOT try to use it or just return it to the video store without informing them of what happened—it is unfair to the next renter. A badly crinkled or partially broken tape can destroy expensive video heads.

Other causes include a stuck half loading arm (found in many Sony models and caused by a gummed up mechanism or lack of lubrication) or other mechanical problems.

Recovering Damaged or Broken Tapes

So you just pulled your favorite tape from the VCR, and there are two tape ends dangling from it. Or, perhaps, your VCR has just munched on that tape and a section is now seriously crinkled. Maybe you haven't been following the recommendations on preventive maintenance; maybe your VCR was just hungry. In any case, what to do? The recording is, of course, irreplaceable. Despite this, I recommend that you discard it. An imperfect splice or seriously crinkled section of tape can shatter your video heads—probably the most expensive single part in a VCR. If it is something you really treasure, then what I would do is the following. Note: If you have never seen the inside of a video cassette, try the following procedure on a couple you really don't care about first so that if you mess it up, there is no great loss. CAUTION: The tape itself is really really thin and easily crinkled. Be very gentle when handling it and avoid touching the oxide (dull side) if at all possible. Now, here's what to do:

- *Locate a garbage cassette and disassemble it.* Throw away the tape but save everything else including the reels. See Disassembling a VHS Cassette, below.
- *Construct two cassettes* from the combined collection of parts you now have. Cut out any sections of tape that got mangled. Cassette 1 has the first section of tape (before the break) and uses one empty reel from the garbage cassette for the supply reel. Rewind this

to the beginning. Cassette 2 has the second section of tape (after the break) and uses the other empty reel from the garbage cassette for the takeup reel. Use the little plastic plugs that came from the garbage tape reels or some adhesive tape to connect the tape to the reels.

- *If the break is at one end*, you can just reconnect the bulk of the tape to the reel and dispose of the original leader. Just don't rewind or fast-forward all the way to the end as the automatic end sensor will not work (for the particular end that has been repaired). What will happen is that instead of the sensor stopping REW or FF (as appropriate), the tape will run to the end and the VCR will then shut down when it discovers that the tape isn't moving. This can put additional stress on mechanical parts and/or rip the tape from the reel. Serious damage to the VCR isn't really that likely.
- *Copy to a good cassette.*
- *Dispose of the original(s)* or clearly mark "DO NOT USE" with a detailed explanation.

The idea is to never have a splice in a VHS cassette. (Even a seriously crinkled

tape such as might result from a tape-eating incident can damage the heads.) It is possible to splice safely, but, as noted, it can be quite costly if you don't get it quite right.

Disassembling a VHS Cassette

These instructions should show you how to get inside a cassette for the purpose of reattaching a leader that pulled off of one of the reels or to transfer its contents or a portion thereof to another shell or vice-versa.

- *Peel off the label on the side* or carefully slice down its centerline with a knife or razor blade. This is necessary to allow the cassette halves to be separated.
- *Place the cassette upside-down* and remove the five (5) Phillips head screws and set aside.
- *While holding the cassette together*, place it label side up on a clean surface.
- *Gently remove the top* (along with the hinged door) to reveal the interior. At this point, you should see something that looks like Fig. 1.

When you reassemble the cassette, be careful and do not crunch the tape under the hinged door—depress the unlock button on the side and lift it clear if needed.

TROUBLESHOOTING TESTS

- *If the capstan or its circuits are at fault*, the tape tension on the supply side of the capstan will be normal. This is relatively loose if gently pressed sideways or released by moving the back tension arm to the right. The picture will remain synced on the TV (though there may be noise bars that result from incorrect tracking).
- *Where a dry or worn capstan bearing is to blame*, there may be an associated mechanical groaning or grinding sound as well. Stop the VCR and immediately check to see if the capstan turns freely and smoothly. Cleaning and lubrication will help. Whether this is a permanent cure will depend on the severity of the damage.
- *A magnetic sensor that is mounted too close to the perimeter of the capstan motor rotor can also rub as the rotor expands.* As above, there will likely be noise—maybe a tick-tick sound with one tick per rotation of the capstan before it stops completely. Adjust the position of the sensor. It's hard to say from here how far away it can be; but, as a start, you should be able to slip a piece of letter paper between the sensor and the rotor without it rubbing at any position of the rotor.
- *If the capstan is belt driven* (most nowadays are direct drive DC motors), a worn or flabby belt could be the cause. If there is a belt, check and see if it is successfully turning the capstan and check to see if the capstan itself is hard to turn—which would point to a bearing problem. Inspect the belts and replace if necessary. In the meantime, clean the belts and pulleys which should result in some improvement and confirmation of the cause of the problem.
- *If, on the other hand*, it is a supply reel brake that hasn't released, excessive back-tension, or something binding; the tension will be very high, causing the head drum to slow down and stop in extreme cases. Sync will be lost as this happens. You will have to determine what is preventing the tape from being fed properly. There could be a broken part, a problem with the supply reel or some other bearing, or something else like a defective brake release solenoid or its driver.

Tape Slows or Stops (As Though in Pause or Slow Mode) While Playing

What this means is that the tape continues to show a picture, but it appears as if it's struggling to pull the tape through the machine—which is basically what is happening. Once the picture freezes, it will probably abort because of the lack of reel motion. With some VCRs, this may also result in periodic slowing or pausing. Many Sony models are particularly prone to this failure. Service parts suppliers like MCM Electronics often have bearing kits, so you don't have to replace the entire expensive capstan motor.

There can be a variety of causes for this behavior, but the most likely is related to a dry or worn capstan bearing or a defective capstan drive/servo circuit. The capstan rotation almost entirely determines tape movement during play and special effects modes. Only if for some reason the supply reel cannot rotate at all could the capstan attempt to pull the tape across the video head drum unsuccessfully.

If you can catch the VCR in the act, then there are several tests that can be performed easily to localize the cause. See the sidebar on the previous page for these tests.

Video Head Drum Stops or Slows During Play or Record

Check whether the back tension on the tape is applying so much pressure to the drum that it is slowing it down. Back tension should be just enough to keep the tape in good contact with the drum. If it is too tight, then the back tension you feel may be worn or adjusted too high. There is a lever just as the tape exits the cassette—push it to the right to reduce tension. Someone may have attempted to repair a broken back-tension band and reduced its length—I got a VCR for repair once where this was done.

If it is not the back tension, check free rotation of the drum when it stops—I bet it turns as freely as always. Could be a part in the motor driver that is faulty and failing when hot. However, the bearing could be worn or dry which would require disassembly and lubrication or replacement of the lower cylinder (assuming that this is where the drum bearings are located).

Wrapup

That's it for now. Next time we will go onto general control system prob-

lems like *my VCR totally ignores me!*. Until then, check out my Web site: www.repairfaq.org. I welcome comments (via e-mail only please) of all types and will reply promptly to requests for information. See you next time! **P**

NEW LITERATURE

(continued from page 12)

software for your robots. (In the "Robotics Workshop" column in our April issue, Gordon McComb discussed this subject, specifically using NQC to program LEGO MINDSTORMS.)

The book includes plans for five construction projects; and it gives mechanical tips, as well as strategies for making the robots move. Software tips are also provided, such as using subsumption architecture and ways to have one input read more than one sensor.

Newnes Windows 98 Pocket Book

by Ian Sinclair

Newnes, Butterworth-Heinemann

225 Wildwood Ave.

Woburn, MA 01801

Tel: 800-366-2665 or 781-904-2500

Web: www.bb.com

\$29.95

This handy guide offers an introduction to Windows 98, covering all aspects of the operating system, accessories, and utilities. The use of DOS from Windows is explained, along with the diagnostic and error-correcting tools of Windows 98 and methods of using them.

Ideal for a wide range of readers, the book provides simple how-to instructions and hints for those who want to get more out of their computers.

Electronic Troubleshooting, Second Edition

by Dan Tomal and Neil Widmer

McGraw-Hill

1221 Avenue of the Americas

New York, NY 10020

Tel: 800-2MCGRAW

Web: www.books.mcgraw-hill.com

\$34.95

A comprehensive introduction to electronics and an indispensable hands-on repair guide, this book covers the practical side of electronics from basic problem solving through repair of sophisti-

cated medical instruments. Thorough and grounded in fundamentals, it has been updated to cover the latest troubleshooting methods, electrical and electronic devices, and the field of digital technology.

The text provides explanations of all testing equipment, valuable tricks of the trade, and useful problem-solving techniques. Numerous illustrations, tables, charts, and graphs help readers understand the material.

The Forrest Mims Circuit Scrapbook, Vol. I

by Forrest M. Mims, III

LLH Technology Publishing

3578 Old Rail Road

Eagle Rock, VA 24085

Tel: 800-247-6553 or 540-567-2000

Web: www.LLH-Publishing.com

This collection of the author's classic circuits from *Popular Electronics* is a book that readers will refer to often as they experiment with electronics. Using commonly available components, Mims explains how to build and experiment

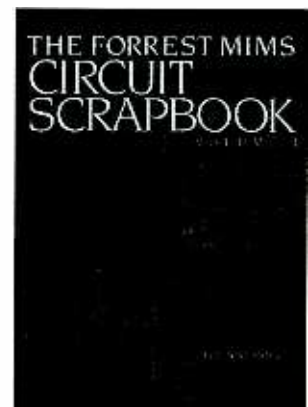

with circuits, including analog computers, color organs, and frequency/voltage and voltage/frequency converters. In addition, there are interval timers, LED oscilloscopes, and light wave communicators, among others.

Each circuit is accompanied by a hand-drawn schematic, detailed theory of operation, and construction hints. **P**

BooksNow

To order books in this magazine or any book in print. Please call anytime day or night: (800) BOOKS-NOW (266-5766) or (801) 261-1187 ask for ext. 1454 or visit on the web at <http://www.BooksNow.com/electronic-snow.htm>.

Free catalogs are *not* available.

USE THE FREE INFORMATION CARD FOR FAST RESPONSE

Speech Recognition Kit

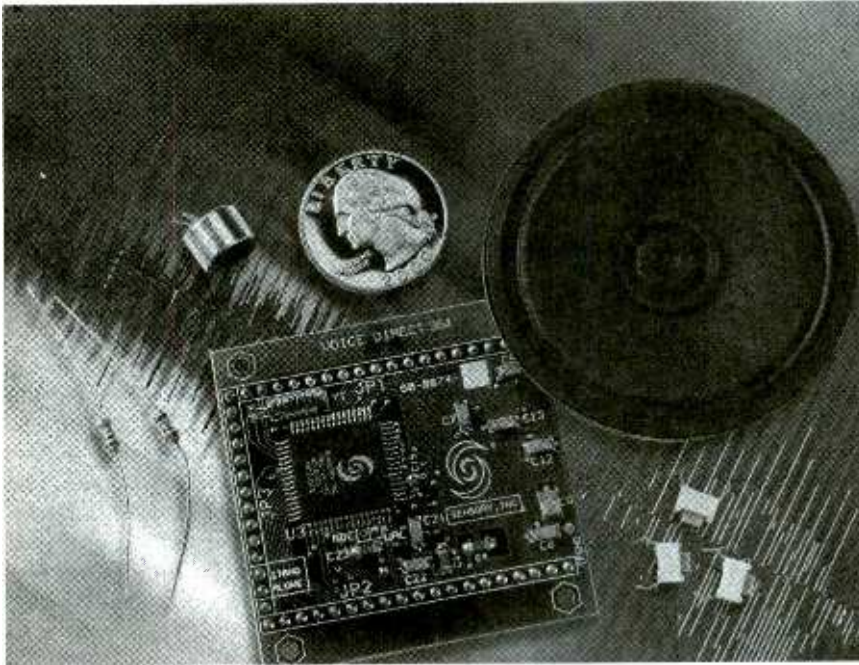

CIRCLE 60 ON FREE INFORMATION CARD

DESIGNED TO EASILY ENABLE hands-free speech-recognition, the *Voice-Direct 364 Speech Recognition Kit* voice activates all types of ordinary consumer electronics, like set-top boxes, microwaves, cars, remote controls, garage-door openers, alarm clocks, telephones, lights, Internet appliances, and others.

VoiceDirect 364 features continuous listening technology that allows a device to be switched on or off with just the sound of one key word or short phrase. It then employs speaker-dependent (user-trained) speech-recognition technology to recognize up to 60 words or phrases (15 as a stand-alone module) lasting up to 2.5 seconds each. Prompts are available in English or German, although the technology works in any language. It can also be configured to use three continuous listening key words or phrases, each with up to five speaker-dependent sub-commands.

It is designed for consumer telephony products and cost-sensitive consumer electronic applications and is software compatible with the original Voice-

Direct kit. The latest generation offers improved recognition accuracy and noise immunity and faster response times. The VoiceDirect 364 works in an easy-to-use standalone pin-configurable mode, but also supports slave mode operation for increased programmability and features.

The VoiceDirect Kit comes complete with the assembled module, a microphone element, speaker, (4) micro-switches, passive component selection to configure the module, and a quick setup guide. All that's needed for setup is a soldering iron, solder, a 4.5 to 5.25V/100mA power source, multimeter, hookup wire, 0.1-inch headers, and a 3- by 3-inch prototyping board.

The VoiceDirect 364 Speech Recognition Kit retails for \$49.95 and is available through several leading distributors, such as Jameco Electronics and JDR Microdevices.

SENSORY, INC.

521 East Weddell Drive
Sunnyvale, CA 94089-2164
Tel: 408-774-9000
Web: www.SensoryInc.com

Stand-Alone Cable Tester

LIGHTWEIGHT AND PORTABLE, the *Model 204 PC Cable Tester* is a battery/AC-powered cable tester that can be used for testing just about any cable or harness in under a second. Its flexibility makes it ideal for use by PC and cable manufacturers, system integrators, airlines, and repair facilities.

The Model 204 can be used for testing most popular PC data and network cables, such as printer; monitor; modem; mouse extension; game BNC coax; and RJ45, 1394, and USB cables. It displays opens, shorts, crosswires, miswire, continuity of wires, and pin configuration. In seconds, the unit provides a bright LED display of a complete pin out of any cable attached to one of its cable hubs.



CIRCLE 61 ON FREE INFORMATION CARD

Weighing only 1.75 pounds and measuring 9½ by 1½ by 6 inches, the Model 204 PC Cable Tester is priced at \$169.

B&K PRECISION CORP.

1031 Segovia Circle
Placentia, CA 92870-7137
Tel: 714-237-9220
Web: www.bkprecision.com

Test Accessory Kit

IDEALLY SUITED FOR TEST ENVIRONMENTS in plant maintenance; and for electrical, HVAC, automobile, and field repair; the *Test Companion Kit* features different combinations of DMM test accessories for use with Keithley's most popular meters. The shoulder pack carrying case that can be easily attached to a tool belt is designed so the test accessories can be stored with the meter in multiple zippered and Velcro-enclosed compartments.

The carrying case contains a wide range of accessories, including two sets



CIRCLE 62 ON FREE INFORMATION CARD

of Kelvin Test Tweezers, the Minigrabber, Micrograbber, and SMD Grabber test clip leads, a modular electronic probe set, medium alligator clip, flexible test lead set with straight banana plugs, spade lug adapter set, and slide-on extended and IC tip sets.

The Test Companion Kit for Keithley Meters is priced at \$134.

POMONA ELECTRONICS

1500 E., Ninth St.

Pomona, CA 91766

Tel: 909-469-2900

Web: www.pomonaelectronics.com

Portable Flat-Antenna System

LOW-PROFILE AND LIGHTWEIGHT (5 lbs.), the SatCom PASSPort Mini Plus is a one-piece flat-panel satellite antenna system designed for portability. It features an integrated LNB (Low Noise Block) for Direct Broadcast Satellite (DBS)-TV viewing. The antenna requires no assembly; users plug, aim, play, and enjoy satellite TV programming anywhere.

The portable SatCom PASSPort Mini Plus package includes the compact (12 by 16 inches) SatCom PASSPort Mini Plus antenna, the Digital Satellite Seeker, a carrying case, a compass, and all necessary components for connection and mounting. The Digital Satellite Seeker is a pocket-sized meter that assists with satellite antenna setup to ensure that proper aim is established



CIRCLE 63 ON FREE INFORMATION CARD

quickly. Users simply observe an LCD display that measures satellite signal strength.

The portable SatCom PASSPort Mini Plus package (model MP-1001-PKG) has a suggested retail price of \$349.99.

SATCOM ELECTRONICS, INC.

13400-B Danielson St.

Poway, CA 92064

Tel: 858-486-6600

Web: www.satcomweb.com

Digital Tachometer Counter

THE DIGITAL TACHOMETER COUNTER, Model 461501, provides RPM (rev/min) and RPS (rev/sec) photo tachometer measurements, plus a counter mode for counting units on a production line. An optional contact tachometer adapter allows for linear surface measurements in RPM, m/s, ft/min, and yard/min. The non-contact tachometer measurements range from 10 to 99,999 RPM, with 0.1% basic accuracy; while contact measurements range from 10 to 29,999



CIRCLE 64 ON FREE INFORMATION CARD

RPM, with 0.04% basic accuracy.

Measurements and counts are displayed on a dual 5-digit LCD. Other features include Max/Min/Average functions, Hold, and Auto Off. The built-in RS-232 interface, Windows 95/98 compatible software, and the serial cable allow for data acquisition and display from a PC.

The Model 461501, which measures 6.5 by 2.5 by 1.5 inches, comes complete with four AA batteries, reflective tape, software, serial cable and case; and it has a suggested list price of \$249.

EXTECH INSTRUMENTS CORP.

285 Bear Hill Road

Waltham, MA 02451

Tel: 781-890-7440

Web: www.extech.com

Current Level Indicator

AN EASY AND LOW-COST WAY TO monitor electrical current flow, the CR2530 Current Level Indicator contains a toroidal-wound current transformer attached to a high efficiency LED. The custom-set indicator, capable of operating in 50- or 60-Hz systems, glows when the current flowing is above the set point and turns off when the current is below the set point.

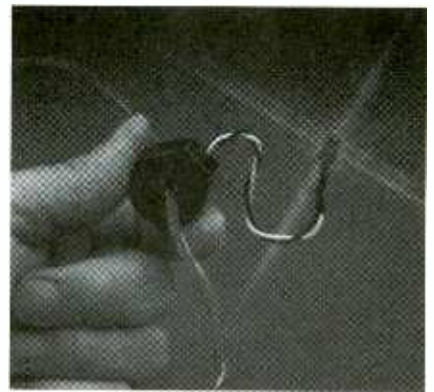

CIRCLE 65 ON FREE INFORMATION CARD

The Current Level Indicator easily slips over current-carrying wires or cables and requires no splices or electrical connections. The indicator will accept up to one size #8 AWG wire through its center opening.

The CR250 has a retail price of \$20.90.

CR MAGNETICS, INC.

544 Axminster Drive

Fenton, MO 63026

Tel: 314-343-8518

Web: www.crmagnetics.com

(Continued on page PS-7)

BUILD THIS INTERNET APPLIANCE DEVELOPMENT BOARD

Learn how you can take some "free" emWare and Microchip software and integrate it with some inexpensive and tricky electronics to form the basis for your own personal Internet Appliance.

FRED EADY

Web browsers and the Internet are an everyday way of life for most of us. Have you ever thought about what kind of power lies within your seemingly simple Web browser? Visualize this: How would you like to turn off a light in your garage, or flip a switch to activate one of your homemade gadgets, directly from your favorite Web browser? Would being able to remotely monitor things like temperature, humidity or even the light level in an area of your home, using your Web browser interest you? Ever wonder if someone entered your room or a sensitive storage bin without your permission? Wouldn't it be nice to check for that illegal entry from your laptop in a hotel room or from the office? Well, how about an inexpensive and simple project that does all of the above and more? I see you nodding "YES!" but you're asking "How inexpensive?" Is FREE close enough for you? The software for this Web browser remote control is free for the downloading. In the text that follows, I will show you how to take "free" emWare and Microchip software and integrate it with some inexpensive and tricky electronics to form the basis for a personal Internet appliance.

The Internet Appliance Development Board. Thanks to the folks at emWare, the technology to remotely monitor and control electronic devices over the Internet is available without charge to the public. If you're thinking that you have to have direct access to the Internet to use emWare, that's not

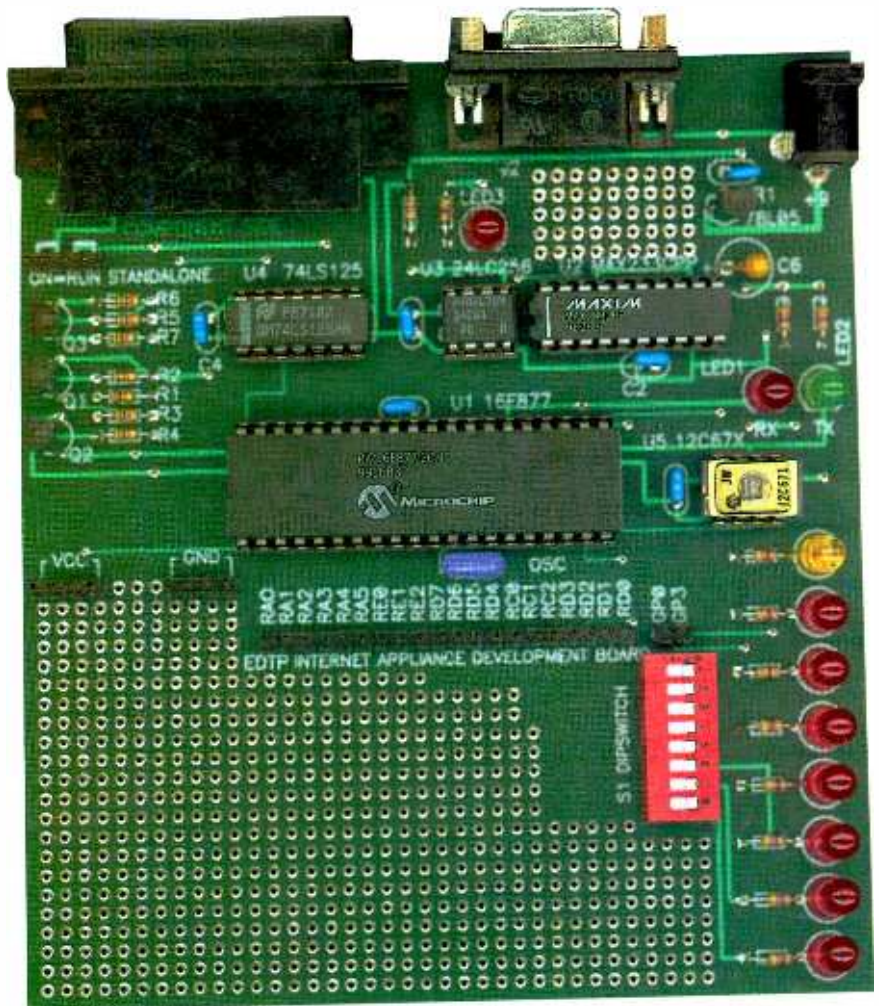

necessarily true. While some are truly "on the Internet," most of us simply use the Internet. By "use the Internet," I mean that we can access various sites and resources on the Internet with Web browsers, mail clients, and other specialty software through an Internet Service Provider. If you are "on the Internet," you actually have an IP address

that stands in conjunction with a server that supplies those downloadable resources to users. The emWare software is designed for use by those that are on the Internet, but can be adapted to work for those that simply use the Internet. How is that done? Simple: In addition to being a very powerful Web-based control and moni-

emWare EMIT™ Architecture

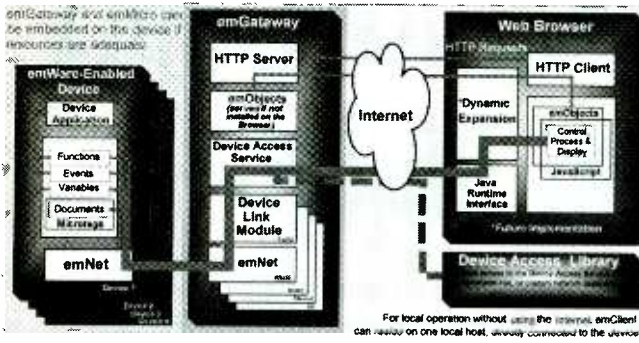

Fig. 1. How the emWare and EMIT technology works. You can see how your Web browser interfaces with the rest of the system.

teering application, emWare can be accessed using a standard serial connection over a Windows 98 dialup session or a simple Ethernet LAN. That means that we, the users, can effectively make our own little "Internet."

All we need is Windows 95 or

velopment Board and take advantage of the remote control and monitoring capabilities of the emWare package.

What is emWare and EMIT Technology? EMIT is short for Embedded Micro Internetworking Technology.

Windows 98, the emWare software, Microchip's MBLAB package, an electronic device to control or monitor, and a PC with a parallel port and a couple of standard serial ports. In this article, I'm going to show you how to build your own Internet Appliance De-

While you are reading this text, I suggest you do the following:

- Download the FREE emWare, EMIT SDK, and Visual Café Trial packages from www.emWare.com
- Download the latest release of the MPLAB package from www.microchip.com
- Download the Internet Appliance Development Board software package and examples from www.edtp.com or ftp.gernsback.com/pub/pop/iapdb.zip
- Download the latest version of Netscape Navigator

The code and documentation you get from emWare and Microchip will be very detailed. So, I won't get too deeply into that here for space considerations. The idea is to convey how to interface the emWare code and your user-written PIC code with the IAPDB (Internet Appliance Development Board) and thus make it possible for you to construct a working Internet Appliance.

EMIT consists of a number of different modules. For the IAPDB, we are only concerned with emMicro, emNet, emManager, emGateway and emPackage. Let's start by looking at the server, which in our case is based on the new PIC16F877. emNet, a component of emMicro, resides at the server level on the PIC16F877 and within emGateway. The purpose of emNet is to link the PIC-based server and its resources to a larger networked host (your PC in our case) running emGateway. emNet enables a small network (PIC server to emGateway) to interface to a "large network" (emGateway to the world). Of course, the PIC application that toggles the PIC's I/O pins resides in the PIC16F877 server program flash along with emMicro. Once loaded and running on the PIC16F877, the device application can employ functions, events, and variables to perform various user-defined tasks. For instance, coupling the device application and the PIC's A/D converter allows monitoring of anything that outputs a variable voltage. By combining the emMicro-enhanced device application with the PIC's digital

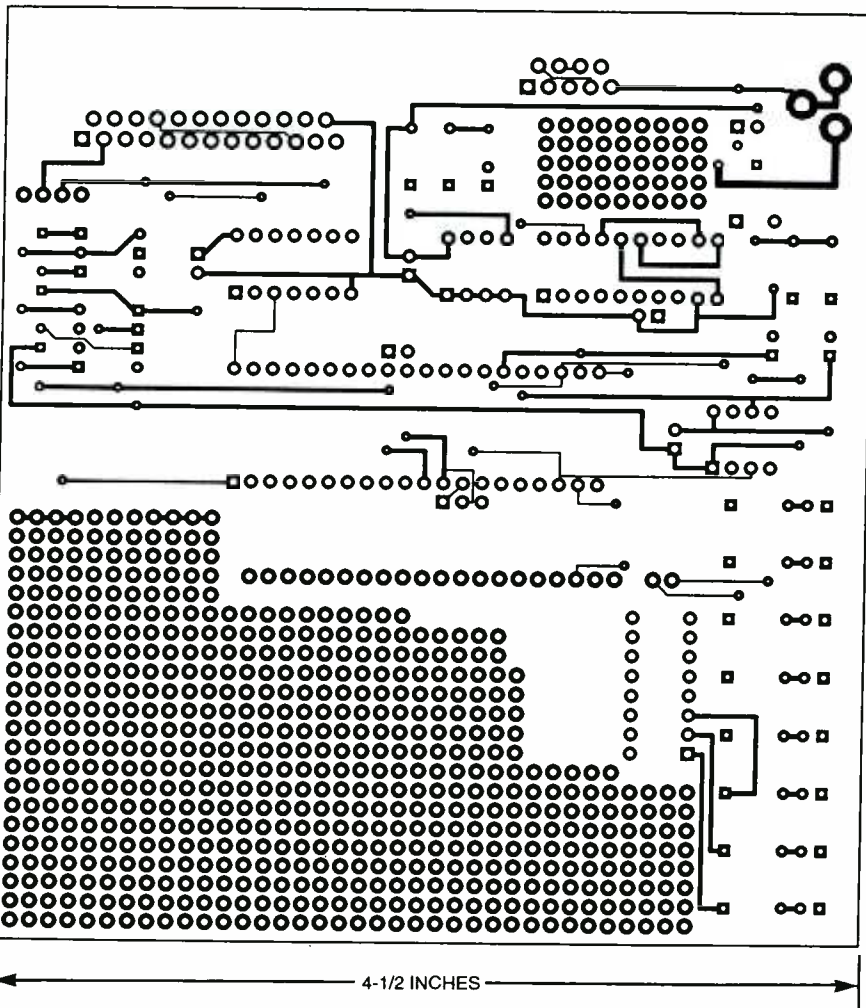

I/O resources, you can control and monitor any device that can be interfaced to the PIC.

Although the emMicro application is very small, it can also serve standard HTML objects. Compressing some of the served HTML components into *Microtags* makes this possible. These Microtags are passed between emMicro and emGateway and are expanded by other EMIT processes to expose their content on the Web browser. In other words, Microtags are expandable abbreviations of the actual data. That lets servers with limited memory resources handle large amounts of data. Using Microtags also reduces the amount of traffic between client and server.

Several emMicro-based servers can be connected to one gateway machine. With the IAPDB, that connection is made serially; the gateway must have a unique serial port for each server device. It is also possible to use RS-485 "multidrop" technology to connect to emGateway. RS-485 uses an addressing scheme to allow multiple server devices on a single RS-485-capable port. On the hardware side, a MAX233 does the RS-232 duties while the MAX487 does the same for RS-485.

A Data Link Module, or DLM, manages each physical connection between the server and the gateway. The DLMs are initiated by the DAS (Device Access Service), which does most all of the heavy-duty communication chores. The emGateway also contains an HTTP server to transfer emObjects between the server and gateway to the HTTP Client. These emObjects are the custom controls that make emWare GUIs unique. Examples of emObjects are meters, switches, and 7-segment displays that can be manipulated by the server application or JavaScript on the client.

To sum up, emMicro and the user-written application reside on the server (PIC16F877). The emGateway resides on a networked host PC running Windows 95 or Windows 98. It can also run on Windows NT, but the PIC16F877 IAPDB host programmer code isn't designed to run on NT.

Although the IAPDB host pro-

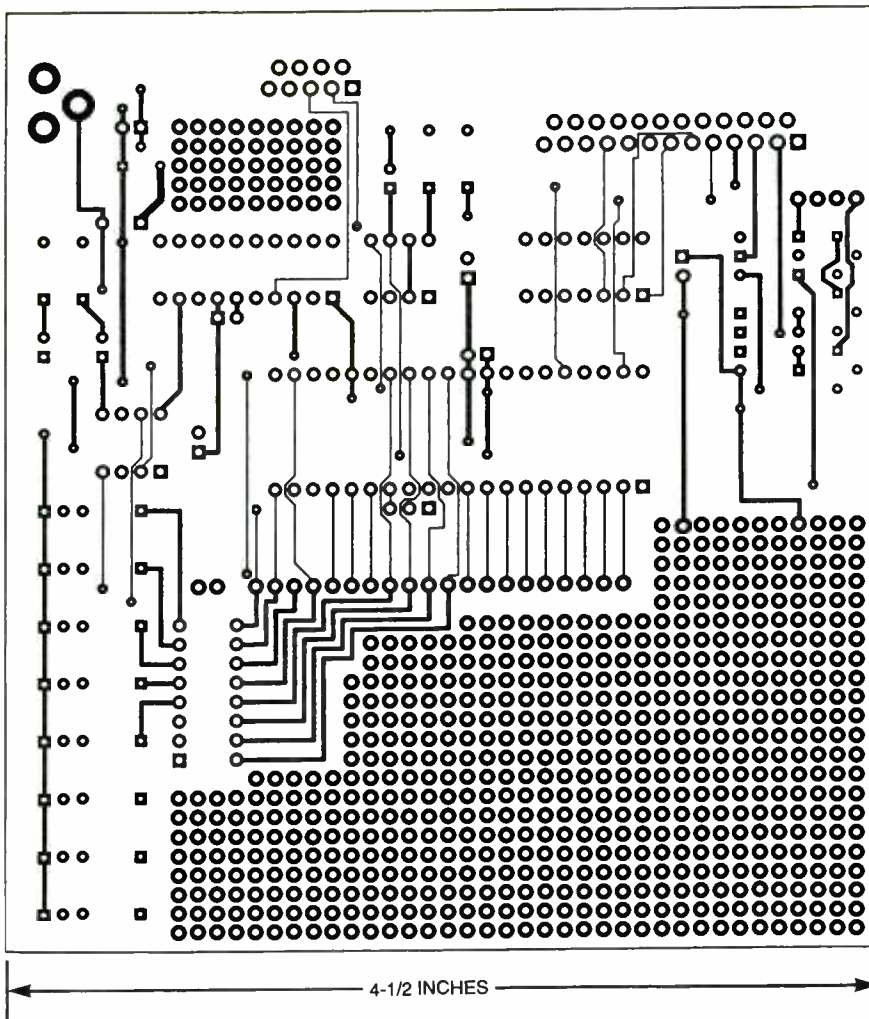

Fig. 4. Here's the foil pattern for the solder side. Note that large amount of space for prototyping additional circuitry.

gram won't use NT, you can use NT in the development mix. Here's how I did it. I connected my IAPDB's serial port to an NT machine running emGateway, Visual Café, and Netscape Navigator. The IAPDB's parallel interface connected to the parallel port of a Windows 98 machine running the IAPDB host program and MPLAB. My machines are all connected to an Ethernet LAN, but that's not required. This arrangement lets me develop my PIC code on the Windows 98 machine and download it to the IAPDB using the IAPDB host program. Since I didn't interfere with the Netscape browser on the NT machine, my code changes on the 98 machine were reflected immediately on the NT Netscape browser. On the other hand, if I wanted to make a change in the GUI, I simply used Visual Café on the NT

machine to do so without interrupting the host IAPDB program or the IAPDB on the 98 machine. The Ethernet LAN setup allows me to transfer files between machines without the frustration of diskettes.

Let's talk about emGateway. Its job is to pass information between the server and the client. If the PIC server does not contain the emObjects it needs to serve, emGateway can be configured to "serve" them to the client instead. The emObjects are the variables and GUI objects that display the information at the Web-browser level. For a standard serial connection between the server and a gateway, the gateway must have a serial port for every device connected to it. As you read on, it will become apparent as to how all of this fits together. If you feel that you need to get deeper right now, you

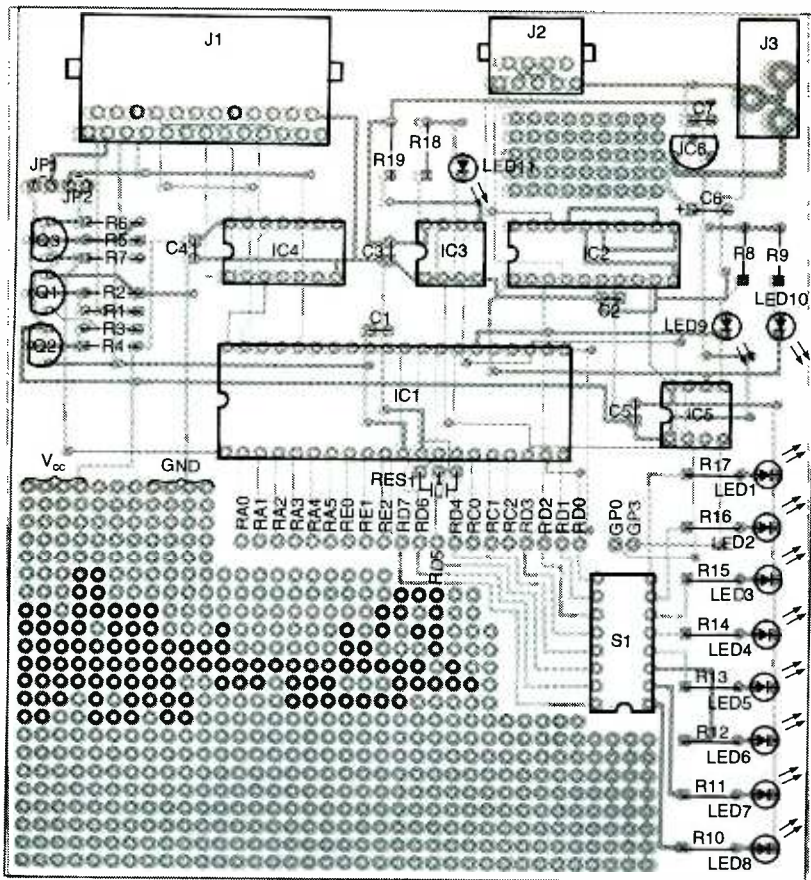

Fig. 5. When building the IAPDB, use sockets for the ICs. Don't forget to make connections on both sides of the board.

can read the details in the EMIT User's Manual. A logical view of what I have described so far can be seen in Fig. 1.

IAPDB Theory of Operation. Now that you understand the concepts behind *emWare* and EMIT, you can

see that the IAPDB is a very tiny Web server that doubles as a PIC16F877 programmer. Look at the IAPDB schematic shown in Fig. 2 on page 38. Most of the EMIT server code resides in IC1, the PIC16F877. IC3 is a Microchip I2C serial EEPROM that lets you store HTML, plain text, or just about any other type of file. In essence, IC3 is a tiny file system. Think of it as a tiny disk drive with no motor.

For instance, if you wanted to include a how-to-use-this-appliance README.TXT file with your design, you would simply create the file and copy it to the file area in IC3 using *emGateway*. The end user would then be able to click on the file in *emGateway*, and it would be displayed in a Web browser window. The split file system can also be used to store variables and constants that can be retrieved with the user's PIC program. The beauty of this file system is that the 24LCXXX series of EEPROMs are nonvolatile. When you put something in the EEPROM, even if your

appliance loses power, the data is there until you erase it or change it. If you think you have to write supporting code to make this happen, you are wrong. The *emMicro* module has built-in code to handle all of the 24LCXXX parts. You simply choose your part from the list in the *emWare*-supplied skeleton code.

Although the PIC16F877 will be acting as a server, most of the PIC16F877's I/O is available to you. On the IAPDB, three pins (RB7, RB6, and RB3) are reserved for programming IC1. Once you've created your custom appliance, you can use these lines as standard I/O. Pin 40 of IC1 (RB7) is the program data I/O line. It is accessed through pin 6 of J1, which is connected to the PC parallel port. The PIC can send program data back to the host PC through pin 10 of J1. To isolate those two functions, IC4-a keeps data from pin 6 of J1 from interfering, as long as pin 7 of J1 is not grounded. To program the PIC, a clock signal is also needed; pin 5 of J1 supplies that signal to pin 39 (RB6) of IC1.

One very important difference in programming the flash-based PIC16F877 with respect to the EPROM-based PICs is that the 13-volt DC programming voltage is optional. As you can see, high-voltage programming is not employed here. A logic level applied to pin 36 (RB3) of IC1 from the PC's parallel port controls program mode. By using the 5-volt programming mode, I was able to eliminate parts and software overhead needed for high-voltage programming. The PIC16F877 on the IAPDB can be programmed without moving jumpers or removing it from its socket.

Another advantage of low-voltage programming is the simplified power-control circuitry, represented by transistors Q1-Q3 and resistors R1-R7. Pin 2 of J1 controls Q1, which in turn activates or deactivates pass transistor Q2, applying regulated VDD from IC6 to IC1. The signal on pin 3 of J1 controls the state of IC1's master reset line through Q3. The reset pin is used in programming and as an IAPDB host program RUN/STOP/RESET line after IC1 is programmed.

Regulator IC6, along with C6 and C7, provides a regulated 5-volt

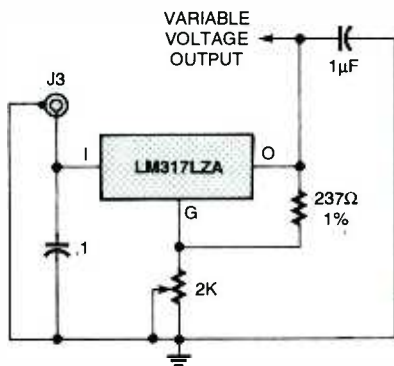

OPTIONAL VARIABLE VOLTAGE REGULATOR

Fig. 6. If you want to use a variable-voltage power supply with the IAPDB, this circuit will do the trick. Having a variable voltage makes calibrating and using IC1's A/D converter a snap. Note that there's additional breadboarding space on the PC board near the power supply components.

Distance Education ...

Nearly 70 years of experience with over 150,000 graduates worldwide. At CIE you get a proven, patented, learning method to achieve your career and educational goals.

Choose from a Bachelor or Associate Degree/10 Career Courses or over 30 Micro Courses.

Toll-Free Faculty Assistance and 24 hour priority grading. At CIE you're just a phone call away for one-on-one assistance.

Enroll on-line. Visit CIE's web site at www.cie-wc.edu and take a look at all of our educational offerings and services. You can even take a first lesson.

Visit CIE's Bookstore's web site at www.ciebookstore.com and review our Micro Course offerings and Supplemental Training programs, plus thousands of books, software, tools, test equipment, study guides and videos.

It truly is your one stop training resource center.

We wrote the book on it ...Since 1934



If you're looking to earn a degree, complete a career course, or upgrade your current skills, CIE's independent study programs may be the right answer for you.

Find out more about CIE by logging on to www.cie-wc.edu. In addition to the online enrollment form you'll find everything you need to know about CIE like detailed course descriptions, VA and DANTES benefits, a sample lesson, tuition prices, financial assistance, and it's all just a click away at www.cie-wc.edu.

Call For A Free Catalog

1-800-243-6446



A school of thousands. A class of one. Since 1934.

Enroll On-line www.cie-wc.edu Shop On Line www.ciebookstore.com

YES! I am interested
Please send me a catalog. PT11

Name: _____

Address: _____

City: _____ State: _____ Zip: _____

Phone: _____

1776 E. 17th St. • Cleveland, OH 44114

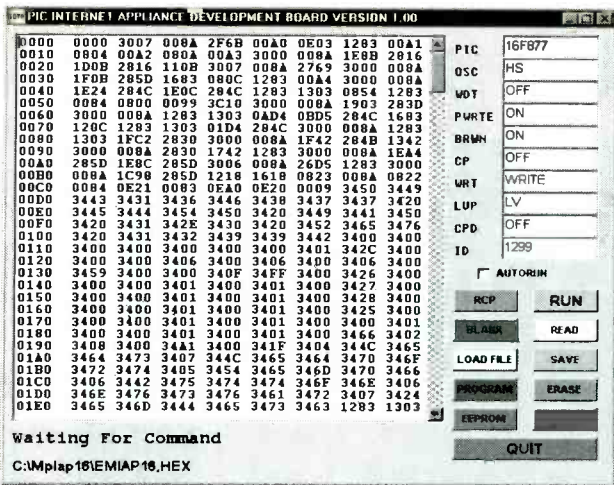

Fig. 7. Here, the IAPDB host program is ready to download the PIC software into IC1.

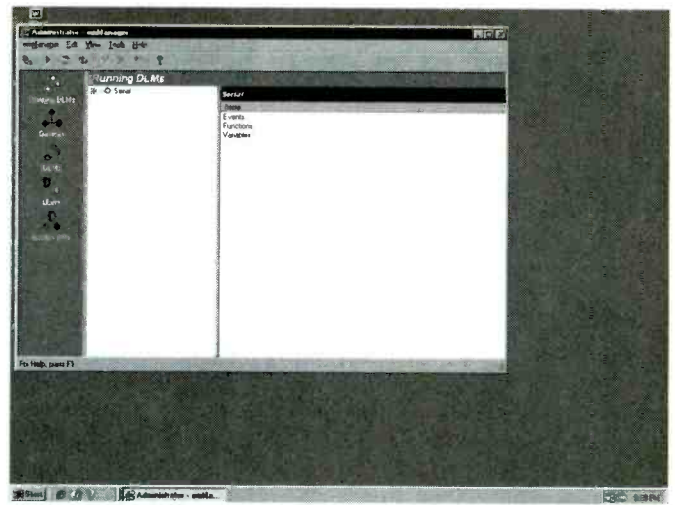

Fig. 9. Once connected, you can start accessing the IAPDB's functions.

source for the circuit. A 9-volt power source is connected to J3; it can be a wall transformer or a standard 9-volt battery. Once IC1 is programmed, IC4 can be removed. A shorting block across JP1 allows Vcc voltage flow to IC1. Another shorting block across JP2 grounds pin 36 of IC1, inhibiting programming. Normally, the host IAPDB program controls those jumper points. The IAPDB can operate for quite a while from a standard 9-volt battery when it is in this configuration.

As you already know, the IAPDB interfaces to an emWare software module called emGateway. That module runs on the PC; the IAPDB accesses it through a serial connection provided by IC2, a MAX233. Using the MAX233 eliminates the need for a negative voltage supply to meet the RS-232 standard. Note also that the

MAX233 needs no external components to generate the negative voltage. Connector J2 is wired like an external modem so you can connect the IAPDB to a PC serial port with a standard ribbon cable outfitted with the appropriate 9-pin connectors. If we didn't do that, you'd need a "null-modem" cable that crosses the appropriate signals such as the transmit and receive lines. The PIC16F877's internal serial interface connects to IC2 through pins 25 and 26. Just as it does for the serial EEPROM, IC3, the emMicro code provided by emWare automatically handles the operation of the IC1's USART.

Parallel connector J1 connects the IAPDB to a Windows-based host program that reads, writes, erases, and controls the programming aspects of IC1. Another way to look at it is that the IAPDB is a PIC16F877

programmer that doubles as an emWare development system. We'll look at that in greater detail when IC1 is programmed.

An array of eight LEDs is attached to IC1's port "D" through S1. Those LEDs are not committed to any particular function; their use is entirely up to you and the program that you write for your particular application. In addition, LED9 and LED10 monitor both receive and transmit lines, giving a visual indication of emNet serial activity. Activity between IC3 and IC1 is monitored by LED11. Those LEDs are useful when troubleshooting your homegrown code as they indicate when the IAPDB is communicating with emGateway and when it is accessing IC3.

The EMIT/emWare client/server theory that applies to IC1 also applies to IC5. The IAPDB does not

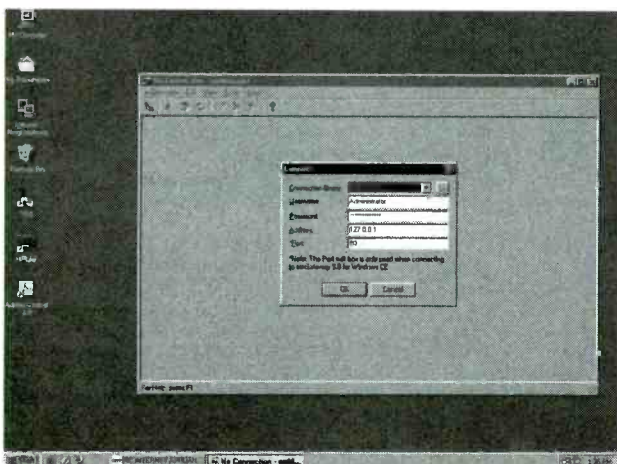

Fig. 8. To connect to the IAPDB, you have to tell emManager where to look.

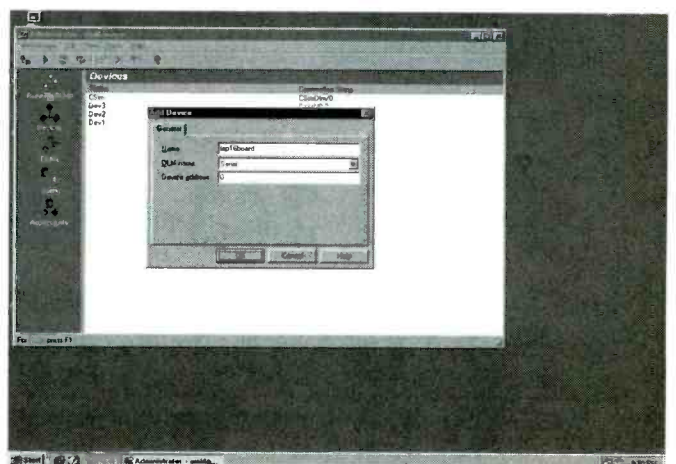

Fig. 10. When you're ready to work with the IAPDB, you need to give it a name.

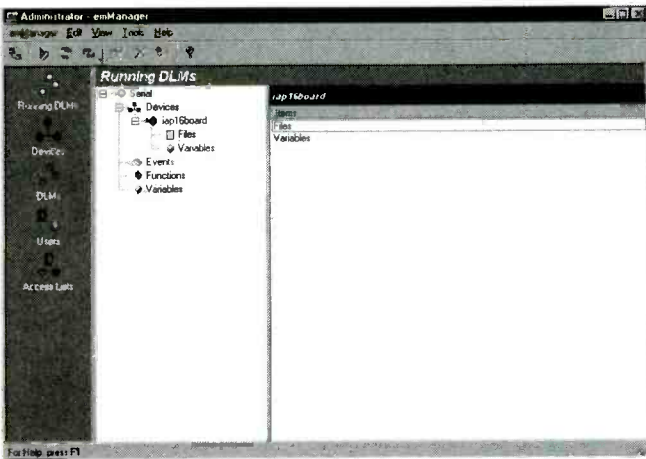

Fig. 11. A fully expanded Running DLMs Window without the File or Variable details.

have PIC12CXXX programming capability. You can use any suitable programmer, such as the *PIC Replicator* that was described in last month's issue of **Poptronics**.

Assembling the IAPDB. The IAPDB can be assembled using point-to-point or wirewrap techniques on a piece of perfboard. As an alternative, you can etch and drill a PC board for a more professional appearance. Foil patterns have been included here for a double-sided board; see Figs. 3 and 4. If you do not wish to etch a double-sided board—not an easy task—one is available as part of a complete kit from the source given in the Parts List.

If you do use an etched board from the Parts List source or the foil patterns, use the parts-placement diagram in Fig. 5 as a guide to component location. Using sockets for the ICs is recommended; this is, after all, a development project.

Since the "D" in IAPDB stands for development, the IAPDB includes a generous amount of breadboarding space. Another reason for using sockets is that the IAPDB is a double-sided board; solder connections need to be made on both sides of the board. If you can't plate the holes on a self-made board, you can use one of the standard alternatives such as eyelets, short lengths of 30-gauge wire-wrap wire, or soldering the component leads on both sides of the board where necessary.

Do not install any ICs at this time. Once all of the other components are installed, apply 9 volts to J3 and check the output voltage of IC6. Make sure that 5 volts is present across C2, C3, C4 and C5. If there is a problem, recheck your work. When you're satisfied with the voltage measurements, install the ICs.

If you plan to use the analog/

digital-conversion feature of IC1, you may want to add a variable voltage source to the IAPDB. A suggested circuit that uses an LM317 is shown in Fig. 6. Note that there is a prototyping area next to IC6 for this purpose. The advantage of an adjustable supply lets you set a precise voltage (usually 5.12 volts) for IC1's A/D reference voltage. An example application that I'll touch on later involves connecting an LM34DZ Fahrenheit temperature sensor to IC1. With that hardware and appropriate software, you'll be able to read and display the measured temperature with a Web browser. Consult the data sheets for the LM34DZ and IC1 as well as Fig. 2 for information on interfacing that (and other sensors) to IC1's A/D inputs.

Now that our hardware is built, it's time to start working with the software end of the IAPDB.

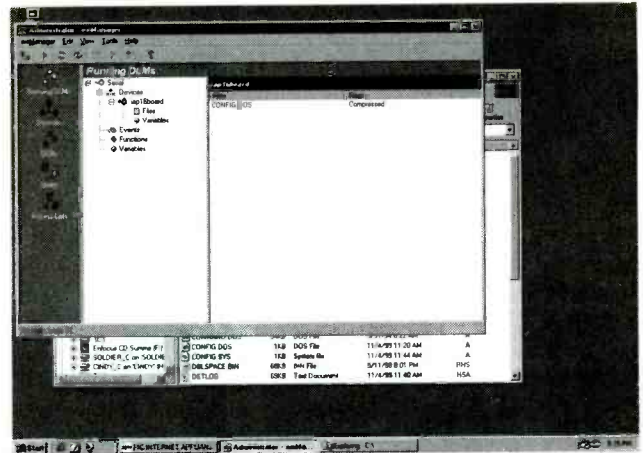

Fig. 13. Once a file is successfully copied, it shows up immediately.

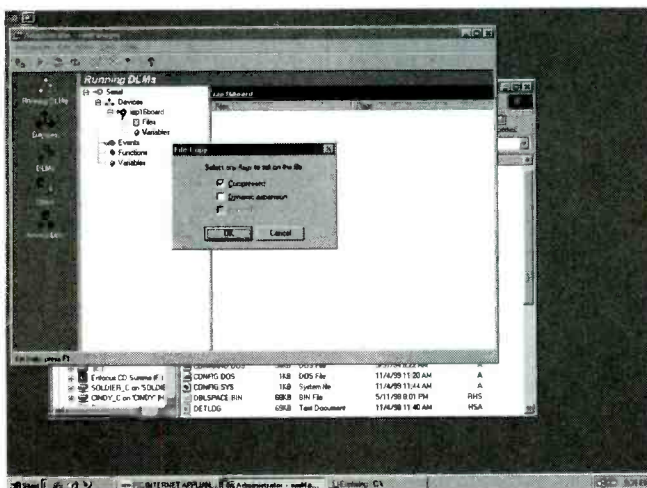

Fig. 12. Copying any type of data to IC3 is as simple as "drag 'n' drop!"

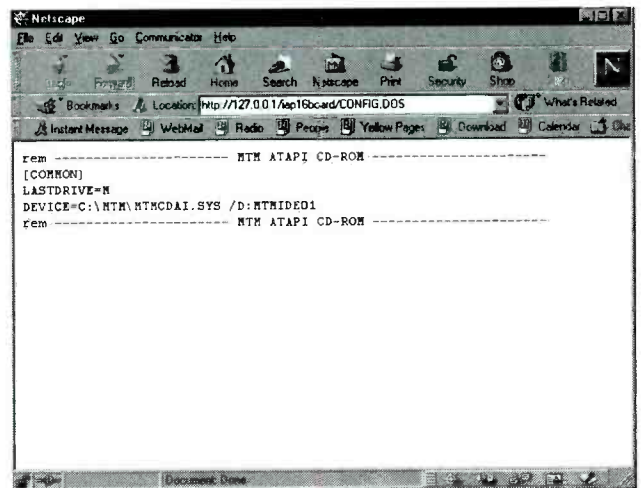

Fig. 14. Reading the copied file is a snap for any Web browser.

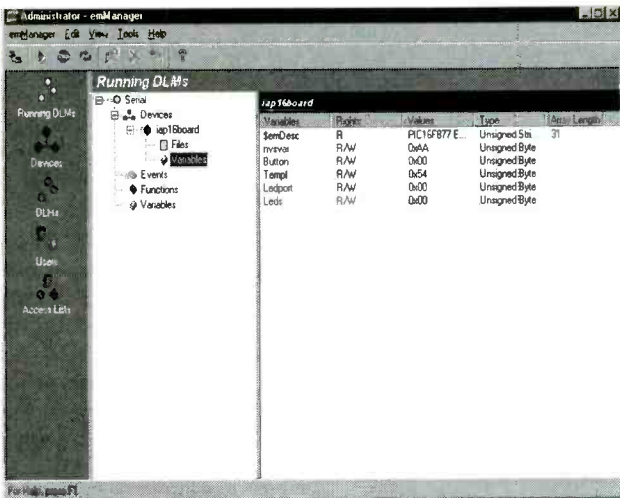

Fig. 15. Variables used by the PIC program can be examined and modified "behind the PIC's back."

Loading and Testing the IAPDB Software. Microchip's MPLAB is a breeze to install; just click on "setup," choose a directory, and you're off. The IAP host program is just as easy as MPLAB to install; again, click on "setup" and off it goes.

The files that you downloaded include some ready-to-run PIC and Visual Café code that you can use to test your new IAPDB. Prepare the Java code by placing the IAPL6.JAR, IAPL6.CLASS, and IAPL6.HTM files in the \emWare\emGateway\Html directory. The Java code assumes that COM1 is used to connect to the IAPDB. You can change that to another COM port later; for now, use COM1 so that you do not have to change any code. The IAPDB

host program auto-finds the parallel port, so unless you have nonstandard hardware, you should be OK.

Connect your host PC's parallel port to J1 and your PC's COM1 serial port to J2. Make sure that JP1 and JP2 are not installed. Apply power to the IAPDB and start the IAPDB PC host program. A window similar to the one shown in Fig. 7 should appear. Click on "LOAD FILE" and choose EMIAP16.HEX. The IAPDB host application should open that file and show a hexadecimal "dump" of the program in the hex view window. Be sure to have EMIAP16.COD in the same directory as the EMIAP16.HEX file as the IAPDB host program uses the .cod file as well.

Click on "PROGRAM;" you should see programming activity messages in the program's status area. When programming is done, the "Program Verify Status" window will appear. If all entries in that window indicate OK, click on "RUN." That will start IC1 running the program that you just downloaded into it. Note that the "RUN" button will change to a "STOP" button.

Now let's start emManager; you'll find a red emWare logo in your Windows Start menu. From the emManager pulldown menu item, select "Open Connection." You should get a dialog box similar to Fig. 8. Set the "Connection Library," "Username," and "Password" entries to "Administrator." The "Address" is

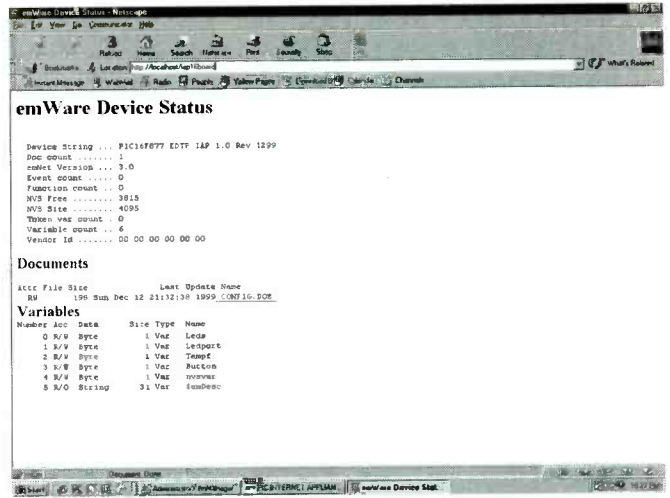

Fig. 17. When you point your browser at the IAPDB, you can read all sorts of status information from it. Imagine if you connected an IAPDB to a soft-drink dispensing machine; you could read status of how many bottles of which flavors are available without having to walk down to the machine.

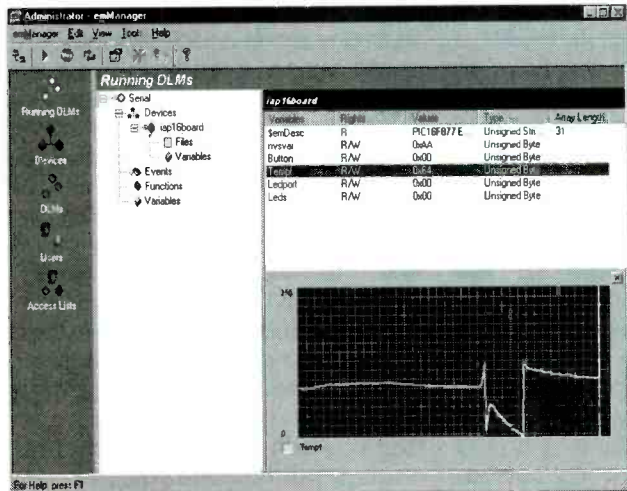

Fig. 16. If a variable changes, you can examine and graph the results in real time. Here are the results of hitting a temperature sensor with a hot-air gun.

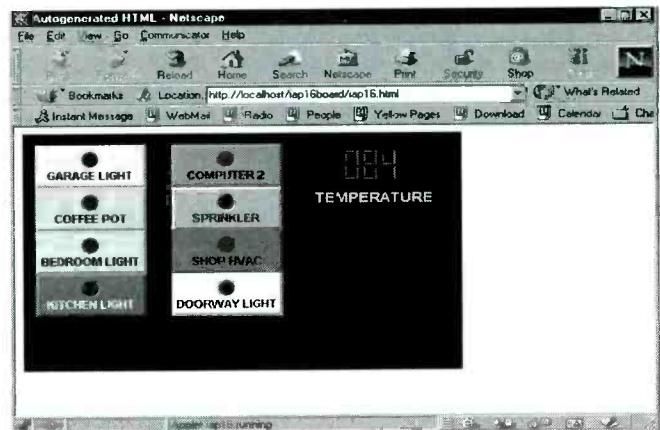

Fig. 18. Accessing the embedded HTML code in the IAPDB demonstration software shows how you can read information (temperature) as well as issue commands. If you replace the LEDs on the IAPDB with transistors or solid-state relays, you could control the displayed devices by clicking on them. With the IAPDB connected to the Internet on a permanent basis, you could do that from anywhere in the world!

PARTS LIST FOR THE INTERNET APPLIANCE DEVELOPMENT BOARD

SEMICONDUCTORS

- IC1—PIC16F877 microcontroller, integrated circuit
- IC2—MAX233CPI Dual RS-232 transmitter/receiver, integrated circuit
- IC3—24LC256 Electrically-erasable read-only memory, 32k by 8-bit, serial interface, integrated circuit
- IC4—74LS125 Quad tri-state buffer, integrated circuit
- IC5—PIC12C67X microcontroller, integrated circuit
- IC6—LM7805ACZA 5-volt fixed voltage regulator, integrated circuit
- Q1, Q3—PN2222A silicon transistor, NPN
- Q2—2N2907 silicon transistor, PNP

RESISTORS

(All resistors are 1/8 watt, 5% units unless otherwise noted.)

- R1—R7, R19—10,000-ohm
- R8—R18—470-ohm

CAPACITORS

- C1—C5, C7—0.1- μ F, ceramic-disc
- C6—10- μ F, 25-WVDC, tantalum electrolytic

ADDITIONAL PARTS AND MATERIALS

- J1—DB-25 female connector, PC-mount
- J2—DB-9 female connector, PC-mount
- J3—Co-axial power-supply connector
- JP1, JP2—Two-Pin jumper block
- LED1—LED11—Light-emitting diode, any color
- S1—8-position DIP switch
- RES1—Ceramic resonator, 10-MHz
- 0.1-inch header pins, IC sockets, 9-volt DC power source, wire, hardware, etc.

Note: The following is available from EDTP, PO Box 541222, Merritt Island, FL 32954; 800-499-3387; www.edtp.com: Kit of all parts including 9-volt power supply, \$80 US. Check, MasterCard, Visa, and AMEX are accepted via telephone or Web. Please add \$7.50 for shipping and handling. FL residents must add appropriate sales tax.

the HOSTS file, use Windows' FIND utility to locate it and a text editor such as Notepad to examine it. The HOSTS file entries allow you to associate host names with IP addresses. On my PC, the name local host is assigned to 127.0.0.1. The Port entry should be set to 80. Once you have the proper entries for your system, click on "OK."

You are now inside emManager at the "Running DLMs" window similar to the one shown in Fig. 9. If by chance a DLM is running, stop it. On the far left of the window, choose "DLMs." Look for the serial entry in the DLM window; it should have a connection string defined as EMNET.RS232+COM1. Double-click on the "Serial" entry. This will return you to the "Running DLMs" window. A Serial entry should now be present under the "Running DLMs" caption. On the IAPDB, LED9 and LED10 should be flashing slowly, indicating that the IAPDB and emGateway are communicating.

Now choose "Devices" from the far left menu of the window. Look for SDKBOARD in the Name column. Note that its Connection String is "Serial/O." Delete this entry using the context menu by right-clicking on it. Now move your cursor to a clear area in the window and right click again. Choose "Add" and then "Device." In the Add Device window, make the Name "iap16board." Use the pulldown to select "Serial" for the DLM entry. Enter 0 (zero) in the Device Address field. See Fig. 10. Click on OK and the device "iap16board" should appear under the Name column with a Connection String of Serial/O. The iap16board device is the IAPDB.

Double click on the iap16board device that you just made. There should be a flurry of activity on LED9 and LED10, plus some activity on LED11 as well. The emManager software should return to the "Running DLMs" window and the Serial DLM should have a plus sign in a box to its left—much like a Windows-style file manager. Clicking on this box will display a subtree like a directory structure with a "Devices" entry. Open the Devices item in the same way and your iap16board should appear as a subitem. Figure 11 shows a fully

expanded tree.

Before we move on, let's format the split file system in IC3. With the iap16board entry highlighted, select "Tools" from the pulldown menus and then select "Format Device." Choose a cluster size of 2KB and click OK in the Format window. A "format complete" window will appear when the operation is complete. While formatting, there should be lots of activity on LED11.

After formatting, expand the iap16board entry again until you see the "Files" and "Variables" subitems. Double click on "Files." Start Windows Explorer, select a small text file, right click on it, and drag it into the "Files and Flags" area of the iap16board window. The File Copy window shown in Fig. 12 will appear with the "Compressed" option checked. Click OK, and you should see more activity on LED11 as the file is copied into the split file system in IC3. When the copy is finished, the name of the file that you selected will appear in the Files column and the Flags entry will read "Compressed." As you can see in Fig. 13, I copied CONFIG.DOS from my PC's root directory to IC3. If you double click on the just copied file in the Files window, your Web browser (Netscape in my case) will start and display the file's text content within the browser window. You can see in Fig. 14 how the browser resolves the IP address of IC3 in order to read and display its contents. According to the HOSTS that I mentioned before, IP address 127.0.0.1 points to the IAPDB rather than any server on the Internet. You could also view this file by entering <http://localhost/iap16board/CONFIG.DOS>. The http server address is followed by the device, iap16board, and the file name.

Close the browser and click on "Variables" in the iap16board subtree. The variables that you see listed in Fig. 15 are the actual names of the variables used in the PIC program. These variables are identified and classified using the emPackage utility. This window is very powerful in that you can actually monitor and change the variable values in real time. For example, highlight and right click on the BUTTON variable.

(Continued on page 44)

your PC's designated local host address. Most local host addresses are preset to 127.0.0.1. That address can be found in the HOSTS configuration file. If you're unfamiliar with

Appliances On The Information Superhighway

BILL SIURU

Utilities can now “talk” to appliances through the information superhighway, allowing utilities to measure demand, determine rate structures, forecast load growth, and model future system requirements to better meet the needs of their customers.

An employee at the local utility views a computer screen and finds a faulty sump pump. She notifies the customer and a flooded basement is averted. Another operator notices a furnace running in the middle of the summer—the problem is an air conditioner blowing cold air directly on the thermostat. Those actions are made possible by the non-intrusive appliance load-monitoring system, or NIALMS.

NIALMS allow utilities to learn where, when, and how much electrical power consumers use. It can be done without entering homes to install monitoring devices on individual appliances. The NIALMS Field Recorder, illustrated in Fig. 1, is placed between the meter box and meter. The recorder is plugged in without any wiring and with only a short power interruption. That feature makes the NIALMS ideal for temporary troubleshooting.

The recorder samples power-line data at 2 kHz with watt and VAR (volt-ampere-reactive) values computed at a rate of three-times-per-

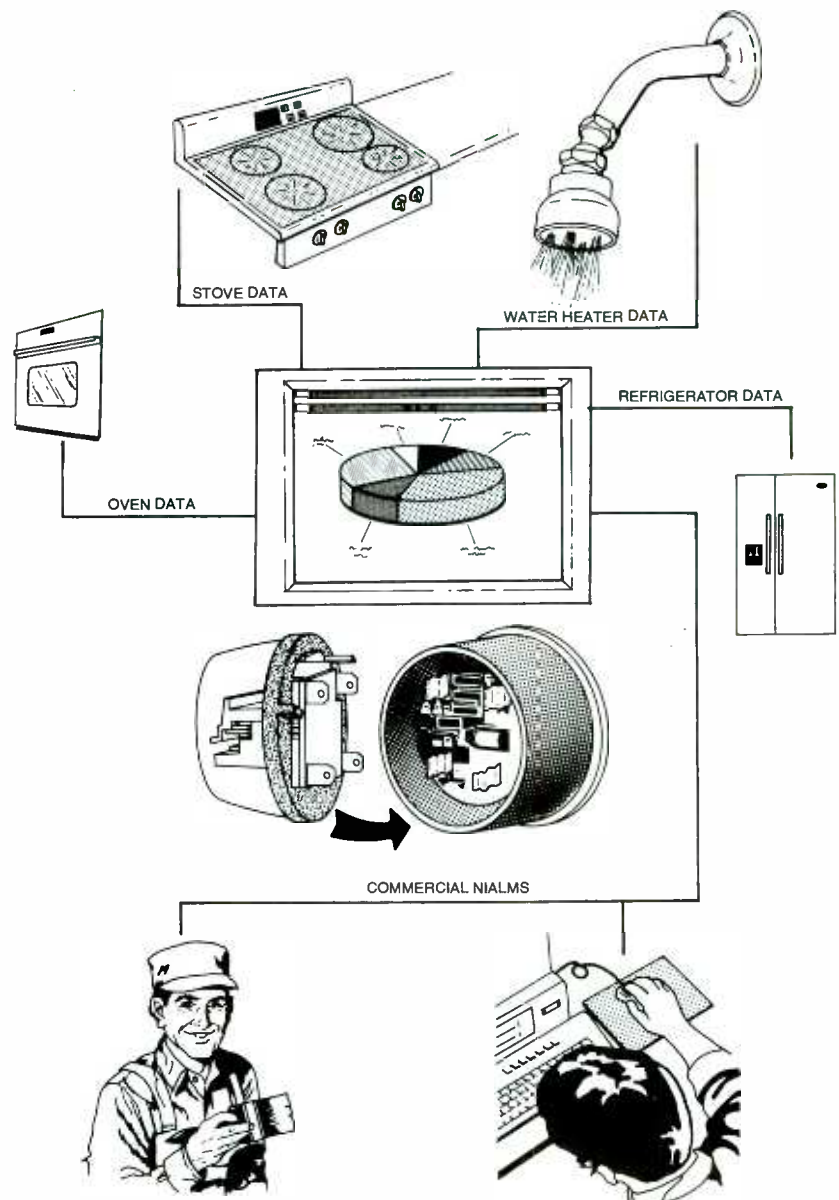

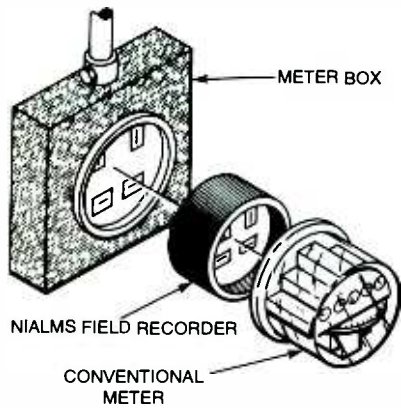

Fig. 1. The NIALMS Field Recorder is installed on the home's utility meter in between the meter box and the meter, as shown here.

second. Data is stored in memory for subsequent automatic retrieval by the utility's master-station computer, as shown in Fig. 2, via a built-in modem and telephone line. The

NIALMS algorithm looks for edge transitions—that is, stepwise changes that are above a programmed threshold—to determine exactly when a particular appliance goes on and off. Then it records, calculates, and stores the date and time of each on/off event along with the voltage, current, and real and reactive power (watt, VAR). The recorder also computes and stores the watt-hours and VAR-hours for each recording interval.

Next, see Fig. 3, the edge transitions (i.e., the on/off events) are plotted on a watt-versus-VAR graph. Transitions from individual appliances tend to form clusters that can be compared against appliance signatures stored in a software library. A positive identification is made and the specific appliance is tagged when a cluster matches a stored signature. Results can be

FOR MORE INFORMATION

Telog Instruments, Inc.
 830 Canning Parkway
 Victor, NY 14564
 Tel: 716-742-3000
 Fax: 716-742-3006

Electric Power Research Institute
 3412 Hillview Ave.
 PO Box 10412
 Palo Alto, CA 94303
 Tel: 650-855-2000
 www.epri.com

displayed at several analysis stations on a variety of whole-house and individual appliance graphics, including 2-D load profiles, 3-D time-of-use by appliance plots, and energy consumption by appliance pie charts, as shown in Fig. 4. Tabular formats are also available.

NIALMS can identify faulty appli-

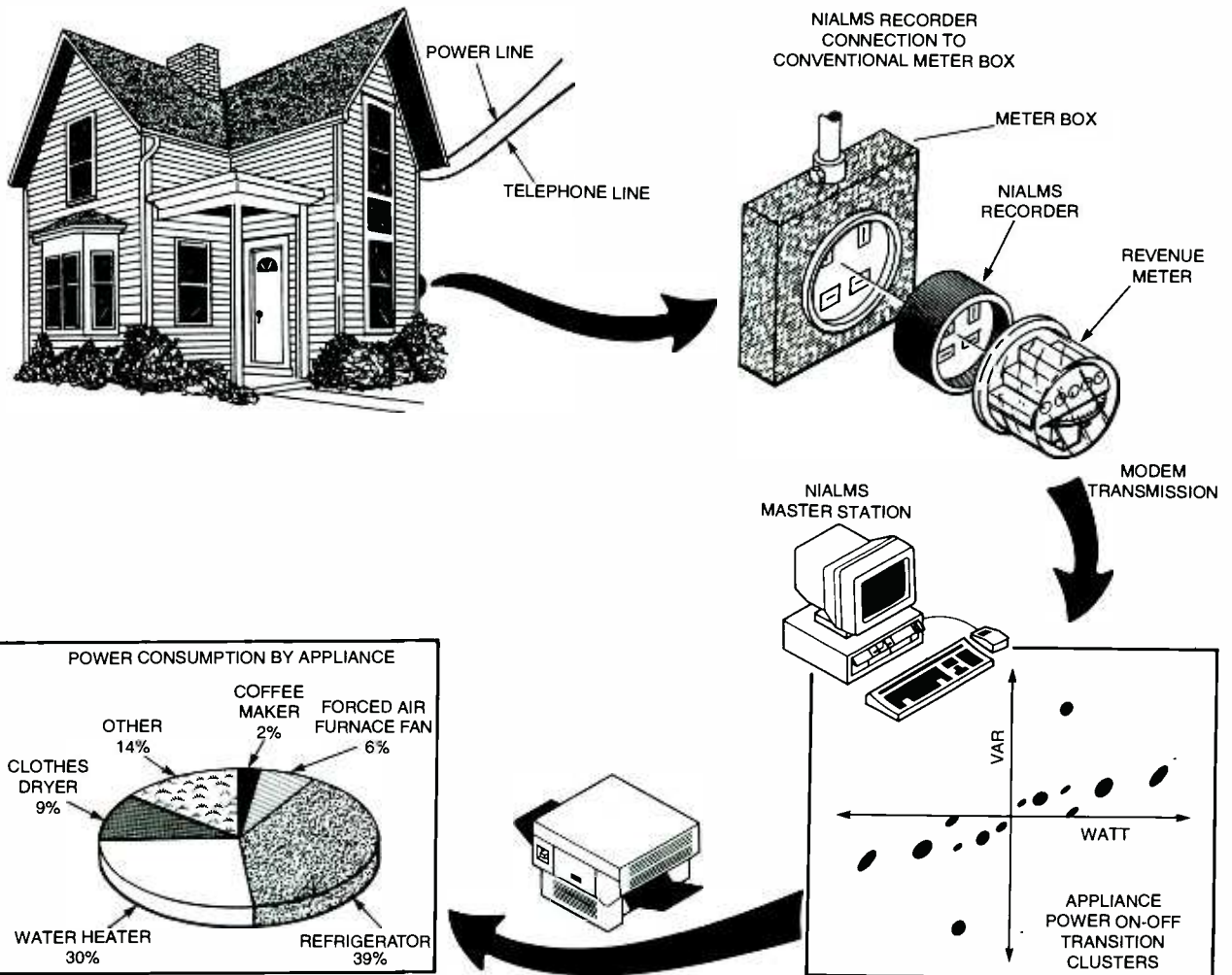

42 Fig. 2. Information flows from the NIALMS recorder to a final graphic product.

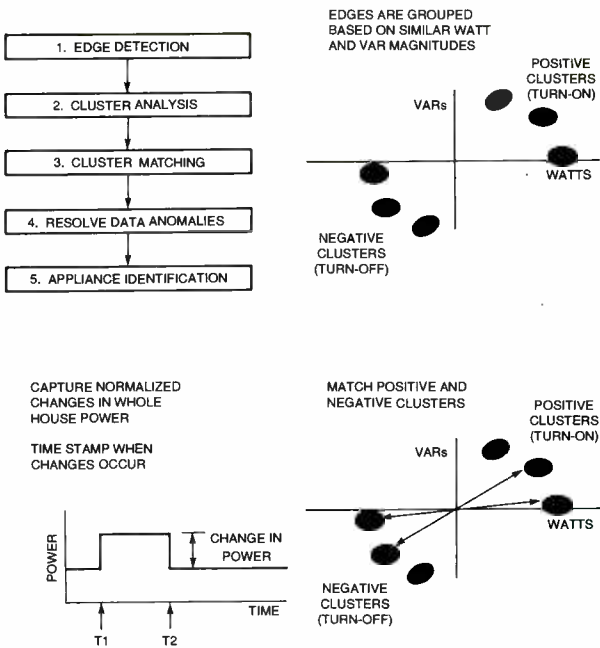

Fig. 3. By analyzing the raw data captured by the recorder, NIALMS can recognize individual appliances by their usage pattern.

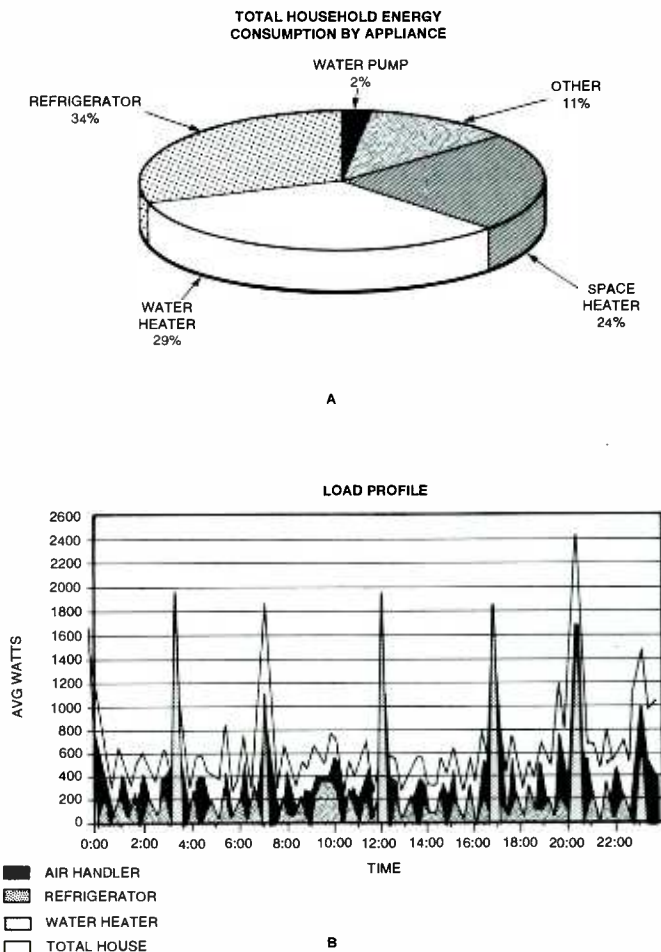

Fig. 4. Samples of graphics available from NIALMS: A Pie chart showing energy consumption by individual appliances in a home (A) and the graph in B shows usage by an individual appliance and when it was used.

ances, abnormal energy usage, and, in the future, serve as an "early-warning system" for appliances about to fail. Utilities can use NIALMS to measure demand, determine rate structures, forecast load growth, and model future system needs. Cost-of-service and energy-consumption information can help customers make decisions on the use, maintenance, and replacement of appliances. Time-of-use billing, timely resolution of billing disputes, and minimized power disruptions enhance customer relations. In the future, NIALMS could be used, for example, to monitor elderly people who live alone or identify unauthorized tenants by monitoring changes in electricity usage patterns.

NIALMS, commercially available from Telog Instruments, Inc., was developed under the sponsorship of the Electric Power Research Institute (EPRI). Over a decade ago, the EPRI picked up on the pattern recognition techniques discovered by researchers at Massachusetts Institute of Technology (MIT) as a means to identify individual appliances. The Empire State Electric Energy Research Corp., New York State Energy and Development Authority, Consolidated Edison of New York City, and Rochester NY Gas & Electric contributed to the development. MIT is still working on improvements.

During testing, NIALMS recorders were installed by seven utilities in from five to eight different homes. At each site, four to eight appliances were monitored to give a total of about 140 individual appliances, including:

- Window, central, and evaporative air conditioners
- Heat pumps
- Resistance and thermal-storage heating systems
- Refrigerators and freezers
- Water heaters
- Clothes washers and dryers
- Well, pool, and sewage pumps
- Dishwashers
- Televisions and computers
- Waterbed heaters
- Central vacuums
- Ranges, ovens, microwaves, and mini-ovens
- Whirlpools

The accuracy of NIALMS was determined by parallel, conventional metering of the appliances monitored. In six months of testing, NIALMS had an accuracy of 90–95% for most appliances. Simple on/off appliances like water pumps and water heaters had the highest accuracy. Accuracy was lower for more complex appliances like heat pumps and dryers with multiple components like compressors, heater

elements, and lights that go on and off at different times. Refrigerators, which are complex devices, are easily identified by the defrost cycle. The algorithms can be modified and the accuracy improved as more real-world data is collected.

One problem during testing was noise and the somewhat quirky behavior of telephone communications. Hand-held data-transfer units, cellular communications, radio-frequency transmissions, hybrid coax/fiber cable, or even a portable computer could be used in the future.

The recorder modules located at each meter cost around \$1200—still too expensive to install at every residence, but ideal for sampling and troubleshooting. NIALMS requires a 486 or higher IBM-compatible PC with Windows NT (Version 3.5), 16MB of RAM, a 500MB hard drive, VGA or SVGA monitor, SCSI CD ROM, and a 2400-baud modem. A high-powered PC and software that can accommodate about 300 recorders costs about \$15,000.

The next step is to extend the NIALMS technology to commercial and industrial customers. A commercial non-intrusive load and monitoring system (C-NILMS) will initially handle more complex three-phase items under 100 kW with enhanced algorithms and more advanced software. P

INTERNET APPLIANCE

(continued from page 40)

Choose "Modify" and enter 0x01. If the switch between pins 1 and 9 of S1 is closed, LED1 should light. You can't turn the LED off because under normal conditions, the PIC program reads the button variable and acts accordingly. By modifying the value this way, we are using a "back door;" the PIC program doesn't know that we changed anything.

If you've connected an LM34DZ to the IAPDB, you should also see a hexadecimal representation of the temperature in the `TEMPF` variable. Highlight the `TEMPF` variable and right click on it. Select `Subscribe to Variable` in the menu, and you will get a graph that tracks the value of `TEMPF`. Hold the LM34DZ between your fingers to increase its tempera-

ture. Note that the graph follows the variable value. In Fig. 16, I first heated the LM34DZ with my fingers. The big spike is from hitting the sensor with a heat gun and allowing it to cool off and recover. Pretty slick, huh? Highlight and right click on `TEMPF` and choose "Unsubscribe to Variable" to remove the graphical display.

Highlight and right click on the `NVSVAR` variable. That variable is a *nonvolatile storage variable* that I reserved in the serial EEPROM. You can reserve as many bytes as you want as long as there is room within IC3. Formatting IC3 will not remove the reserved variables. They can be accessed and modified by the PIC program. Just like the other variables, we can set it from em-Manager. The difference is that once a value is entered, it is there until it is either erased or changed even following the absence of power to the IAPDB. Choose "Modify" and enter 0xAA in the Set Variable window. Click OK and 0xAA will appear under the Values column of the `NVSVAR` variable; Fig. 16 shows that result. Remove power from the IAPDB and everything should go "blank" in the em-Gateway window. Apply power to the IAPDB. You should have LED9 and LED10 activity on the IAPDB. Double click on the `iap16board` in the Devices subtree. Lots of LED activity should occur. Select Variables in the `iap16board` subtree. Notice that the `NVSVAR` variable has the same value it had before you removed power. The `BUTTON` variable that held 0x01 has been cleared and LED1 is off. That should demonstrate the function of volatile vs. non-volatile storage.

If everything is working as it should, you're ready to bring up the browser and take the IAPDB out for a ride. Start your browser. My examples use Netscape; you'll have to adjust the following instructions accordingly for the browser that you use. Click on "OK" if your browser complains that it "Can't find home." In the Netscape Location panel, enter `http://localhost/iap16board`. You should get an emWare Device Status screen similar to Fig. 17—all of which should be familiar to you. The Device String is a line of text in the PIC code to identify this

application. This string corresponds with the `SEMDESC` variable. Note that all of the program variables that we saw in emGateway are listed here. Under Documents, you should see the text file that you copied to IC3. If you click on it here, the text contents will be displayed just like it was in the emGateway window; is this cool or what!

We're almost to the end of the rainbow. Enter this URL in the Location panel: `http://localhost/iap16board/iap16.html`. After lots of LED activity on the IAPDB, and—poof!—you should have Fig. 18 in your Web browser. Hold the LM34DZ to see the temperature readout change. Click on one button to see the associated IAPDB LED illuminate or extinguish. You have created your first Internet Appliance!

This is the moment that it all comes together. Now that you know how to navigate in the EMIT world, dig a little deeper into the documentation and study the examples and tutorials. I will be posting code updates on my Web site (`www.edtp.com`). The emWare tutorial demos are the best that I've ever seen. They take you step by step through the PIC code development process. A working code skeleton is presented and the developer is walked through making additions and changes.

Once you've mastered the Visual Café environment and understand the basics of EMIT, send a note to `evalupgrade@emWare.com` to get a proper EMIT license. Unfortunately, the Visual Café trial version expires after 30 days of use, and you must purchase a full copy from Symantec. If you have other ways to produce your Java code, go for it. The emWare documentation explains how to use Microsoft tools to obtain the same results.

As you can see, making a personal Internet Appliance is within your reach. The things that you can create with these tools are only limited by your imagination and desires. Let the editors at **Poptronics** know what you are doing with your Internet Appliance. They can publish the information or post it on the Web site for others to use. It will be interesting to see where this project takes the readers. P

NON-LINEAR CONFIGURATIONS FOR LINEAR ICs

Linear integrated circuits are not limited to linear applications—there are a variety of non-linear services that these useful devices perform.

JOSEPH J. CARR

The linear integrated circuit, the operational amplifier (better known as an op-amp) in particular, is an extremely flexible electronic device. Anyone with a passing interest in electronics is probably familiar with the varied linear applications for linear ICs, but there are numerous non-linear applications for which the op-amp and other such devices are very well suited.

In this article, we'll explore various non-linear circuits. Of particular interest are circuits in which PN-junction diodes are used. But before we get into the "nuts-and-volts" of the subject, however, it might be prudent to do a quick review of the PN-junction diode.

PN-Junction Diode Review. The PN diode is the oldest form of solid-state electronic component. Solid-state diodes are available in two configurations—PN junction and point contact—and although they're considerably different from one another, it has become common practice (even if erroneous) to consider them as one and the same. Figures 1A and 1B show the differences. Both forms feature P- and N-type semiconductor material locked in close contact with each other.

In the point-contact PN diode (see Fig. 1A), the main body of the semiconductor material consists of one type of material (in this instance,

P-type), with the alternate type (N-type) diffused into the bulk material. A large metallic electrode connects the P-type end to an external electrode. The N-type material is connected to its electrode through a *cat's whisker*—a contact that is reminiscent of the "ancient" crystals used in early radio receivers. The PN-junction diode (see Fig. 1B), on the other hand, consists of a bulk semiconductor that has N-type impurities at one end and P-type impurities at the other end. Metallic end electrodes connect the semiconductor material to the outside world. While the PN-junction diode is the most popular, point-contact types are still used in some applications. Germanium diodes

tend to be point-contact units, as do the older microwave diodes, while modern silicon signal and switching diodes tend to be PN-junction types.

Bowing to modern usage—even if a little sloppy—when we refer to "PN-junction diodes," assume that both types are meant.

Figure 1C illustrates the current versus voltage (I-vs.-V) transfer characteristic of the "ideal" PN-junction diode. When the anode of a diode is made positive with respect to its cathode, the diode is forward biased, and as such conducts current in the forward direction. Alternately, when the diode's anode is made negative with respect to its cathode, the diode is reverse biased; therefore, no current flows.

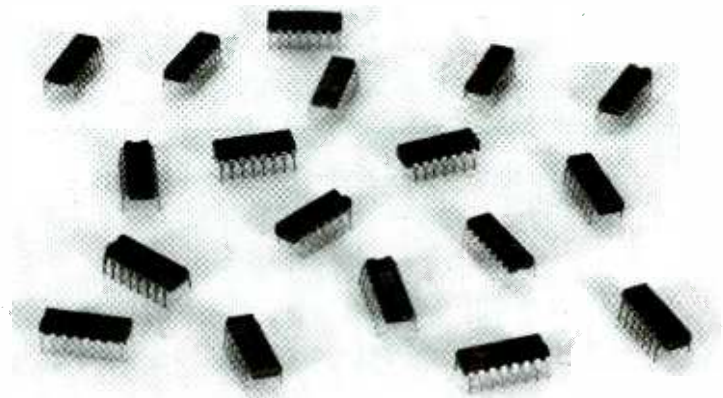

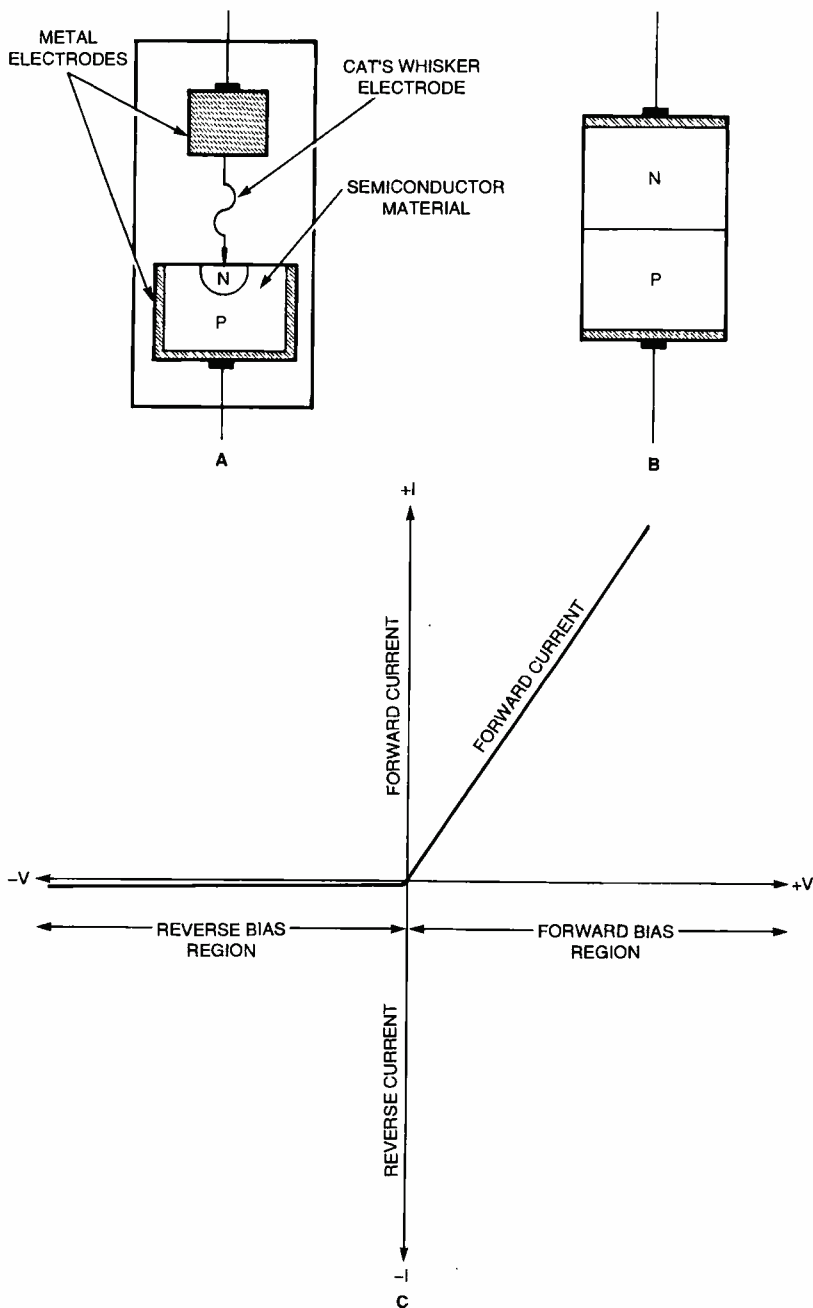

Fig. 1. Solid-state diodes are available in two different configurations; point-contact (A) and junction (B) types. The current-vs.-voltage characteristic of the "ideal" PN-junction diode is illustrated in C. Note that there is no reverse-current flow through an ideal diode when reverse biased.

Practical diodes don't live up to the ideal in a couple of important respects. Figure 2 shows the transfer characteristics for a practical junction diode. For the ideal diode, current flow in the reverse direction is always zero; while, in a real diode, a minute leakage current (I_L) flows backward across the junction. A manifestation of that current can be seen by measuring the forward and reverse resistances of a PN-junction diode. The forward resis-

tance is very low, while the reverse resistance is very high . . . but not "infinite," as one might expect from an open circuit.

Another departure from the ideal in the reverse-bias region is the *avalanche point* (V_Z)—the point at which reverse bias is great enough to cause a sharp increase in current flow. That condition is called *avalanche breakdown*. When carefully regulated, the breakdown potential is both sharply defined

and reasonably stable except for a slight temperature dependence. A device designed in that manner is called a Zener diode and is used as a voltage regulator.

There is also an anomaly in the forward-bias region. In the ideal case, there is an ohmic relationship between current flow and the applied forward voltage. Similarly, there is a linear relationship between the applied forward voltage (V_F) and the output voltage (V_O). In real diodes, however, there is a significant departure from the ideal transfer characteristic. Between zero and some critical junction voltage (V_G), the characteristic curves are non-linear. The actual voltage is a function of the type of semiconductor material used and the junction temperature. In general, V_G for germanium diodes is 0.2 to 0.3 volts and is 0.6 to 0.7 volts for silicon diodes. In the 0-to- V_G region, the diode's forward resistance is a variable function of V_F and temperature; the I-vs.- V_F characteristic is logarithmic. Above V_G , the I-vs.- V_F characteristic curve becomes more nearly linear.

Precise-Diode Circuits. A *precise-diode*, also called *ideal-rectifier*, circuit combines an active device, such as an op-amp, with a pair of solid-state PN-junction diodes to "servo-out" (i.e., to compensate for or eliminate) the errors introduced to the circuit by a non-ideal diode using a feedback network. Such an arrangement provides a couple of advantages. The circuit can rectify very small AC signals between zero volts and V_G , with rectification more nearly linear than with the diode alone, even in the diode's ohmic range.

Figure 3 shows a schematic diagram of a basic inverting half-wave precise rectifier. A basic assumption about that circuit is that load impedance (R_L) is purely resistive, and therefore contains no energy production or storage elements. The circuit is essentially an inverting, voltage-follower amplifier coupled with two PN-junction diodes (D1 and D2). Half-wave rectification occurs because the circuits offer two different gains, which depend on the polarity of the input signal.

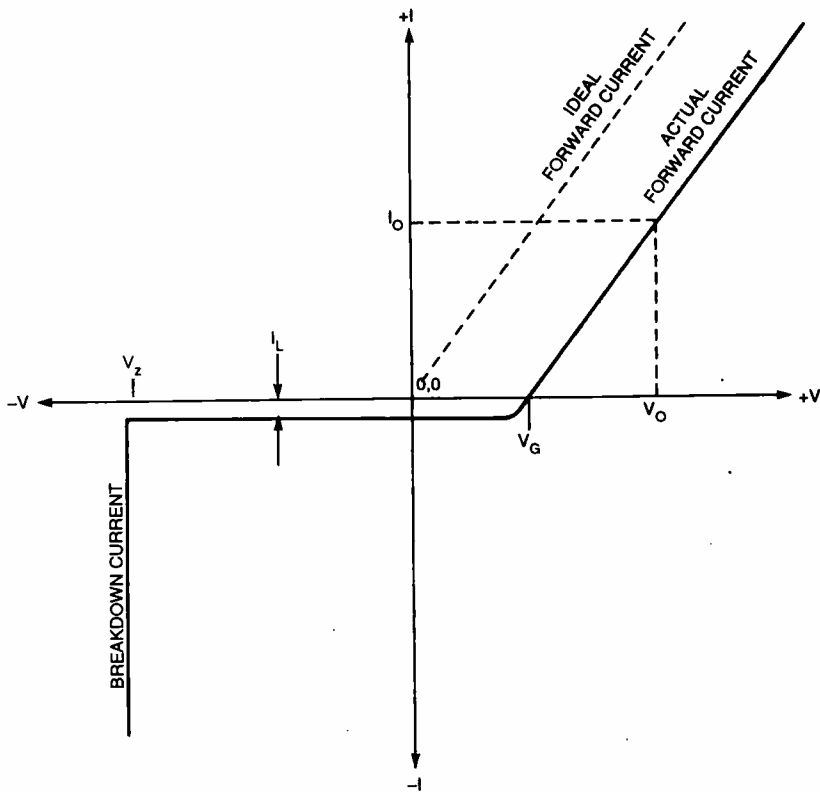

Fig. 2. The transfer characteristic of a practical (non-ideal) solid-state diode is shown here. Unlike the ideal diode, there is a minute leakage current (I_L) flowing backwards across the junction in a practical diode.

When V_{IN} is positive, the gain (V_O/V_{IN}) is zero, but when V_{IN} is negative, the voltage gain is R_F/R_{IN} .

Consider the operation of the circuit with a positive V_{IN} . The non-inverting input (+) is grounded, and so it is held at zero volts. In accordance with the properties of the ideal op-amp, the inverting input (-) is also assumed to be grounded ($V_A = 0$). Because of that concept—called *virtual ground*—the differential voltage, V_D , is zero.

When $V_{IN} > 0$ (i.e., when it is positive), $I_1 = +V_{IN}/R_{IN}$. In order to maintain the equality, $I_1 + I_3 = 0$. Because of Kirchoff's Current Law ($I_1 + I_2 = 0$), the op-amp's output voltage (V_B) swings negative, but is limited by the D1 junction voltage to V_G (about 0.6 to 0.7 volts). With $V_B < 0$, even by only 0.6 to 0.7 volts, diode D2 is reverse biased and therefore cannot conduct. Currents I_2 , I_4 , and I_5 are zero. Thus, for a positive V_{IN} , the output voltage (V_O) is zero.

Now consider its operation when $V_{IN} < 0$. Under that input condition, the op-amp's output voltage (V_B) swings positive, making D1 reverse biased and D2 forward biased. In

order to preserve Kirchoff's Current Law ($I_1 + I_2 = 0$), current I_2 must be of equal magnitude but of opposite polarity relative to I_1 . Because $V_{IN}/R_{IN} = 2V_O/R_F$, the voltage gain

($A_V = V_O/V_{IN}$) reduces to $2R_F/R_{IN}$, as is appropriate for an inverting amplifier. Thus, the gain for negative input voltages ($V_{IN} < 0$) is $2R_F/R_{IN}$, while for positive input voltages ($V_{IN} > 0$), it is zero. From that difference comes half-wave rectification.

The voltage drop across diode D2 is about 10.6 to 10.7 volts and is "servoed out" by the fact that D2 is in the negative feedback loop of A1. Voltage V_B is correspondingly higher than V_O in order to null the effects of V_{GD2} .

The precise rectifier is capable of half-wave rectifying very low-level input signals. The minimum signal allowed is given by:

$$V_{IN} > V_G/A_{VO1} \quad (1)$$

where V_{IN} is the input signal voltage, V_G is the diode junction potential (0.6 to 0.7 volts), and A_{VO1} is the open-loop gain of the amplifier.

In Eq. 1, the term A_{VO1} refers to the open-loop gain, which for DC and low-frequency AC signals is extremely high. But at some of the frequencies at which precise diodes operate, the input frequency is a substantial fraction of the gain-bandwidth product, so A_{VO1} is less than it might otherwise be. For example, if the gain-bandwidth product is 1.2 MHz, the gain at 100

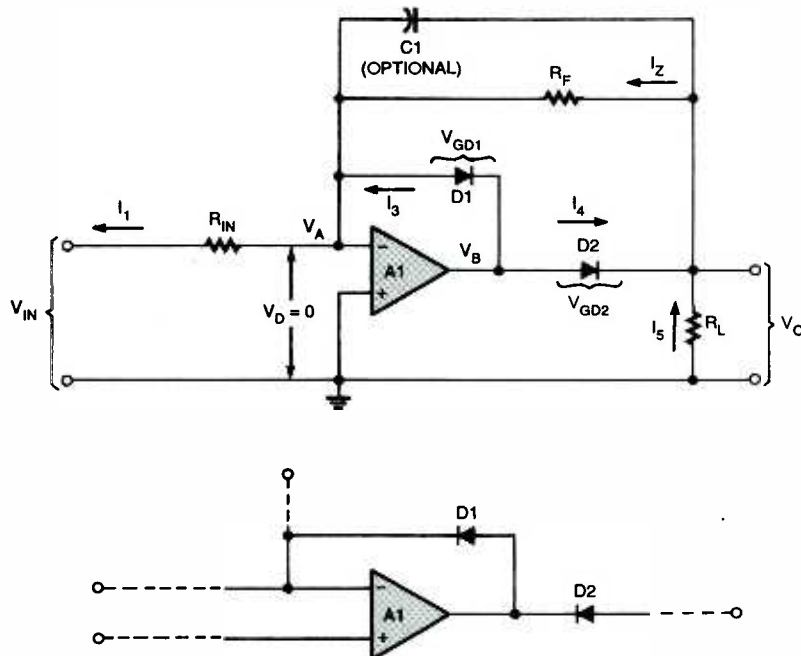
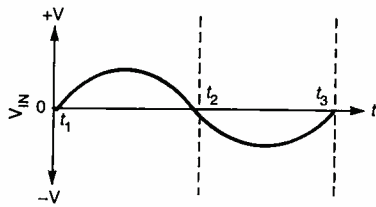
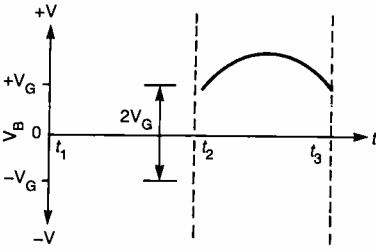

Fig. 3. Shown here is a schematic diagram of a basic inverting half-wave precise rectifier, which is comprised of an inverting, voltage-follower coupled with a pair of PN-junction diodes (D1 and D2).



A



B

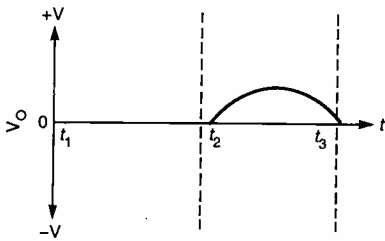

C

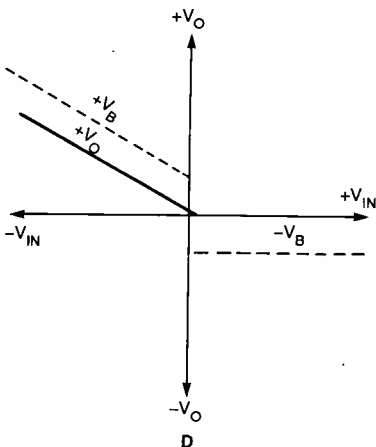

D

Fig. 4. These waveforms help to illustrate the operation of the precise rectifier. The illustration in A shows the input waveform, B shows the waveform at the output of the op-amp, C shows the circuit's output waveform, and D shows the same situation graphically.

Hz is 12,000. But at 1000 Hz (a typical frequency for a precise rectifier), the gain is only 1200.

The waveforms shown in Fig. 4 help to illustrate the operation of the precise rectifier. If a sine wave (see Fig. 4A) is applied to a precise rectifier, from time t_1 to t_2 (during the positive excursion), V_O is zero, while V_B rests at $-V_G$ (about -0.6 to

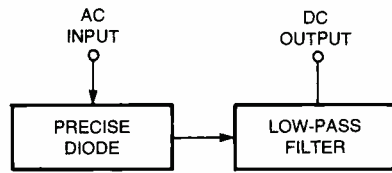

Fig. 5. Shown here is the block diagram of a circuit that's designed to create a DC level that is proportional to the average voltage (or rms value) of the output waveform by time-averaging the pulsating DC.

-0.7 volts). Between t_2 and t_3 , the input is negative, so V_O is a positive voltage with a half-wave sine shape (Fig. 4C). Note the behavior of V_B , the op-amp output (Fig. 4B). From t_1 to t_2 , the output rests at $-V_G$, but at t_2 it snaps positive. The half-wave sine shape rests on top of the $+V_G$ offset caused by V_{GD2} .

Figure 4D graphically illustrates the same situation.

The circuit in Fig. 3 is designed to rectify and invert the negative peaks of the input signal. In order to accommodate the positive peaks, the polarity of the diodes (D1 and D2) need only be reversed.

The output of a precise diode (ideal rectifier) is a pulsating DC waveform. If you need to create a DC level that is proportional to the average voltage (or rms value) of the output waveform, it is possible to time-average the pulsating DC. The block diagram of a circuit that's designed for that purpose is shown in Fig. 5. In that illustration, the precise diode is followed by either a low-pass filter (as shown) or an electronic integrator (basically the

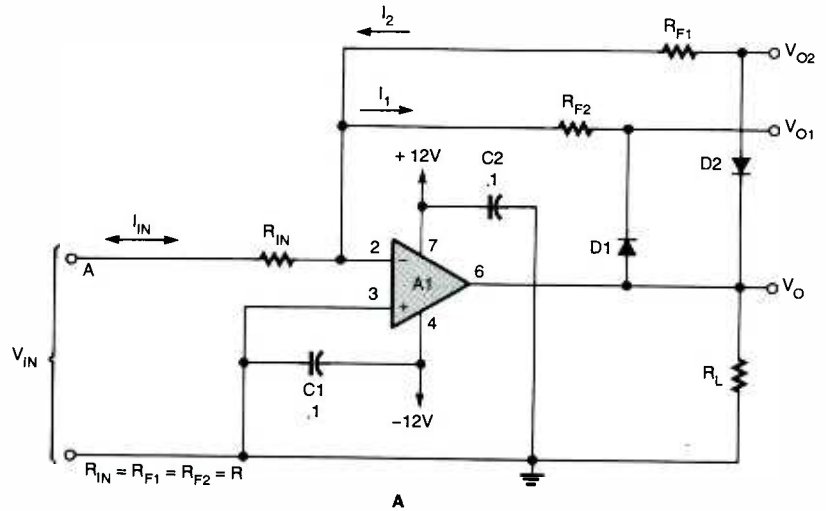

A

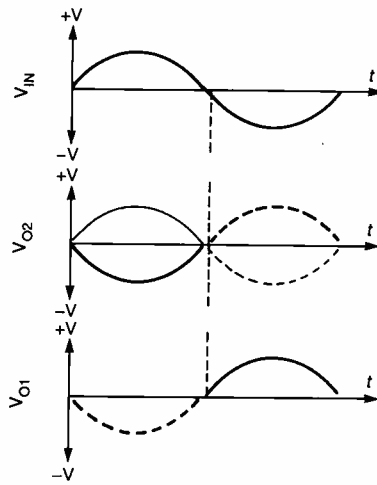

B

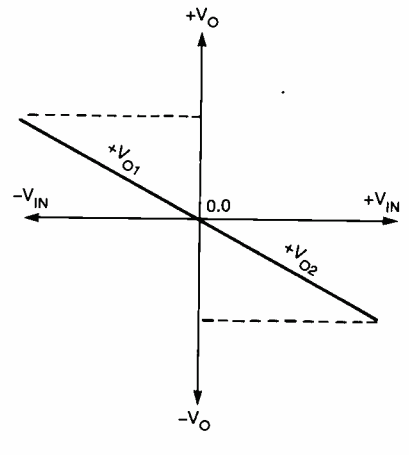

C

Fig. 6. The polarity discriminator shown in A—a circuit built around the inverting voltage-follower—indicates whether the input voltage is zero, positive, or negative. The circuit's input and two output waveforms are shown in B, and the circuit's transfer characteristics are shown in C.

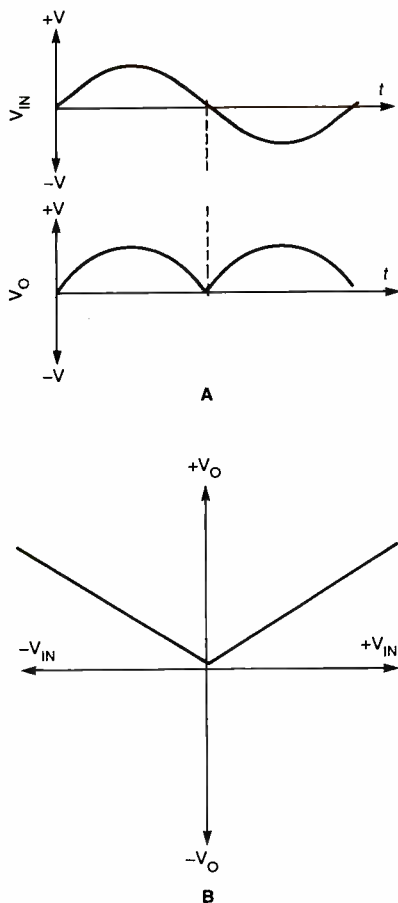

Fig. 7. The fullwave rectifier uses both halves of the input sinewave. Shown in A is the input sinewave and the pulsating DC output of a fullwave rectifier. The characteristic function for the fullwave rectifier is shown in B.

same thing) that has a low enough time constant to produce a time-averaged output. The time constant should start at five times the period of the applied waveform.

Polarity Discriminators. A polarity discriminator is a circuit that produces outputs that indicate whether the input voltage is zero, positive, or negative. Applications for such circuits include alarms, controls, and instrumentation. Figure 6A shows a typical polarity-discriminator circuit. Again the circuit is rooted in the inverting voltage follower; but in this case, the op-amp is coupled with a pair of negative-feedback networks. Each feedback network contains a diode, but because the diodes are connected with opposing polarities, the polarity of the output voltage determines which diode conducts and which is reverse biased.

Consider what happens when

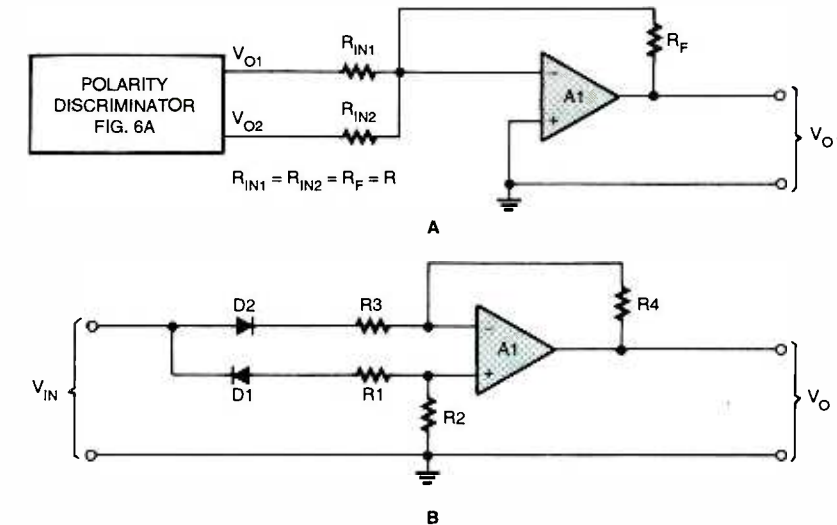

Fig. 8. There are several methods for creating a precise fullwave rectifier. The circuit in A is based on the polarity discriminator circuit of Fig. 6. The approach illustrated in B uses a pair of oppositely polarized diodes connected to the inputs of a DC differential amplifier.

V_{IN} is positive. (Refer to Fig. 6A.) With a positive V_{IN} , current (I_{IN})—with a magnitude of $+V_{IN}/R_{IN}$ —flows away from the summing junction toward the source. That causes the output of the op-amp to swing negative, reverse biasing D1 and forward biasing D2. Current I_1 is zero and I_2 equals V_{O2}/R_F . Output voltage V_{O2} is negative, with a value of $V_{O2} = V_O - 0.6$ volts; output voltage V_{O1} is zero.

Now consider the opposite case; i.e., where V_{IN} is negative. The current flows away from the source toward the summing junction. The output of the op-amp swings positive, causing diode D1 to become forward biased, while D2 is reverse biased. Current I_2 is now zero, while I_1 is V_{O1}/R_F . In this case, V_{O1} is positive, while V_O is zero. The waveforms shown in Fig. 6B and the transfer characteristics shown in Fig. 6C help to illustrate the operation of the circuit in Fig. 6A.

Fullwave Precise Rectifier. The fullwave rectifier uses both halves of the input sinewave. Recall that the halfwave rectifier removes half of the sinewave; the fullwave rectifier preserves it. Figure 7 shows the relationships between the various signals in a fullwave-rectifier circuit. Figure 7A shows the input sinewave (upper trace) and the resulting pulsating DC output (lower trace) of a fullwave rectifier. Note that the negative half of the input sinewave is flipped over so as to produce a positive-going out-

put. The characteristic function for the fullwave rectifier is shown in Fig. 7B. Because the output voltage is always positive, regardless of the polarity of the input signal, the fullwave rectifier can be called an *absolute-value* circuit. The output voltage will be either:

$$V_O = K/V_{IN} \quad (2)$$

or

$$V_O = -K/V_{IN} \quad (3)$$

depending on the orientation of the diodes within the circuit. While the fullwave rectifier has major applications in DC power supplies, it is the absolute-value characteristic that makes it important for instrumentation and related applications.

Several methods can be used to create a precise fullwave rectifier, several of which are shown in Fig. 8. The circuit in Fig. 8A incorporates the polarity discriminator circuit outlined in Fig. 6. In the Fig. 8A circuit, the two outputs of the polarity discriminator (V_{O1} and V_{O2}) are applied to the inputs of a DC differential amplifier.

Another approach is shown in Fig. 8B, wherein a pair of oppositely connected diodes are applied to the inputs of a simple DC differential amplifier. That approach is not as well regarded because the diodes in the input stage are not connected in the feedback loop, so their voltage drops are not "servoed-out."

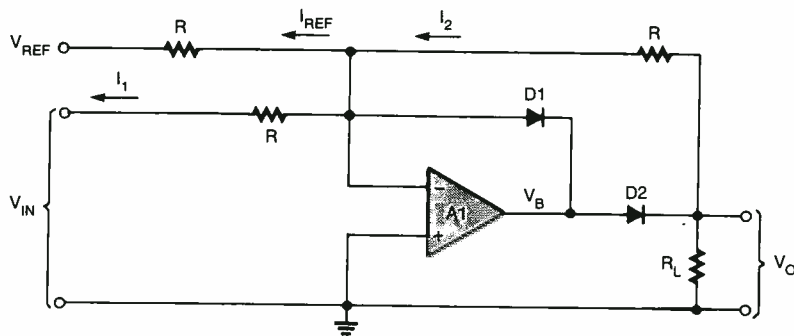

$$V_{IN} + V_{REF} = V_O \quad (10)$$

Thus, the output voltage is still proportional to the input voltage, but is offset by V_{REF} . The transfer characteristics for the circuit are shown in Fig. 10. In Fig. 10A, the value of V_{REF} is negative, while in Fig. 10B the value of V_{REF} is positive. In both cases, the transfer curve is offset by V_{REF} .

Consider the operation of the circuit in Fig. 9 under two conditions: $V_{IN} > 0$ and $V_{IN} < 0$. First assume that $V_{REF} = 0$. For the positive input ($V_{IN} > 0$), the output of the op-amp (A1) swings negative (the circuit is an inverter), causing diode D2 to be reverse biased and D1 to be forward biased. The output voltage, V_O , is zero in that case. The output voltage remains zero for all values of $V_{IN} > 0$.

Conclusion. Although we normally think of op-amp circuits in terms of linear electronics, we've shown that there are indeed many non-linear applications of the ubiquitous op-amp. P

BUY BONDS

Coil Design and Construction Manual

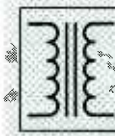

YOU CAN WIND YOUR OWN COILS?

There's no trick to it except knowing what you are doing. In a unique, 106-page book you can become expert in winding RF, IF,

audio and power coils, chokes and transformers. Practically every type of coil is discussed and necessary calculations are given with the mathematical data simplified for use by anyone. Get your copy today!

Mail coupon to:

Electronics Technology Today, Inc.
P.O. Box 240
Massapequa Park, NY 11762-0240

Please send me my copy of *Coil Design and Construction Manual* (BP160). I enclose a check or money order for \$8.99 to cover the book's cost and shipping-and-handling expenses. NY state residents must add local sales tax.

Name

Address

City State ZIP

All orders must be paid in U.S. funds only. Sorry, no orders accepted outside of USA and Canada. Please allow 6-8 weeks for delivery. **ET07**

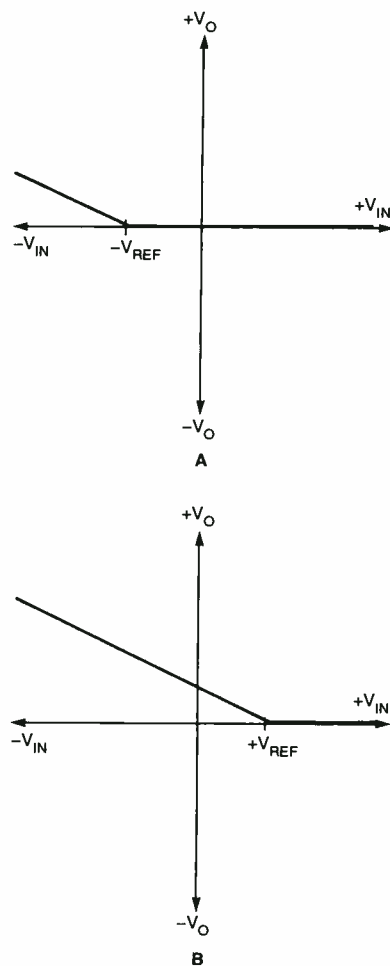

Fig. 10. The transfer characteristics for the circuit in Fig. 9 are shown here. In A, V_{REF} is negative, while V_{REF} is positive in B. In both cases, the transfer curve is offset by the reference signal.

Another possibility is to connect two precise diode circuits, each with opposite polarity, in parallel.

Zero-Bound and Dead-Band Circuits. Another non-linear application for the op-amp is the zero-bound circuit. In a zero-bound circuit, the

output voltage is limited in such a way as to be more or less than zero for certain input-voltage levels and zero for all others. The term does not mean that V_{IN} values are in any way constrained, but rather that there are constraints on the allowable output voltages. The output of a zero-bound circuit can be used to determine when the input signal exceeds a certain threshold and by how much.

Figure 9 shows a zero-bound amplifier circuit. That circuit is based on the half-wave precise rectifier outlined in Fig. 3. It functions in exactly the same way and includes an additional input (V_{REF}), which generates I_{REF} . The effect of I_{REF} is to offset the trip point at which the input voltage takes effect.

To understand the circuit, we can use an analysis based on the properties of the ideal op-amp. From Kirchoff's Current Law and the fact that op-amp inputs neither sink nor source current, we know that the following relationship is true:

$$I_1 + I_{REF} = 0 \quad (4)$$

or

$$I_1 + I_{REF} = I_2 \quad (5)$$

We also know that:

$$I_1 = V_{REF}/R \quad (6)$$

$$I_{REF} = V_{REF}/R \quad (7)$$

$$I_2 = V_O/R \quad (8)$$

Thus,

$$V_{IN}/R + V_{REF}/R = -(V_O/R) \quad (9)$$

and after multiplying both sides by R:

HIGH-VOLTAGE GENERATION

A few readily available components and some technical know-how is all that's required to produce very high DC voltages from a relatively low AC voltage source.

BILL CODY

Although the trend in modern electronics is toward lower-power circuitry, there is simply no getting around the fact that many of the latest electronic gadgets still require a "spritz" or two of high voltage to make them function properly. Unfortunately, many high-voltage circuits depend on relatively expensive and bulky step-up transformers to generate the "juice" that they require. That's because those circuits also have fairly hefty current requirements, as well as a "thirst" for good regulation. Other circuits, in which extensive regulation and "vast" amounts of current are not

Warning!! This article deals with and involves subject matter and the use of materials and substances that may be hazardous to health and life. Do not attempt to implement or use the information contained herein, unless you are experienced and skilled with respect to such subject matter, materials, and substances. Neither the publisher nor the author make any representation as for the completeness or accuracy of the information contained herein, and disclaim any liability for damages or injuries, whether caused by or arising from the lack of completeness, inaccuracies of the information, misrepresentations of the directions, misapplication of the information, or otherwise.

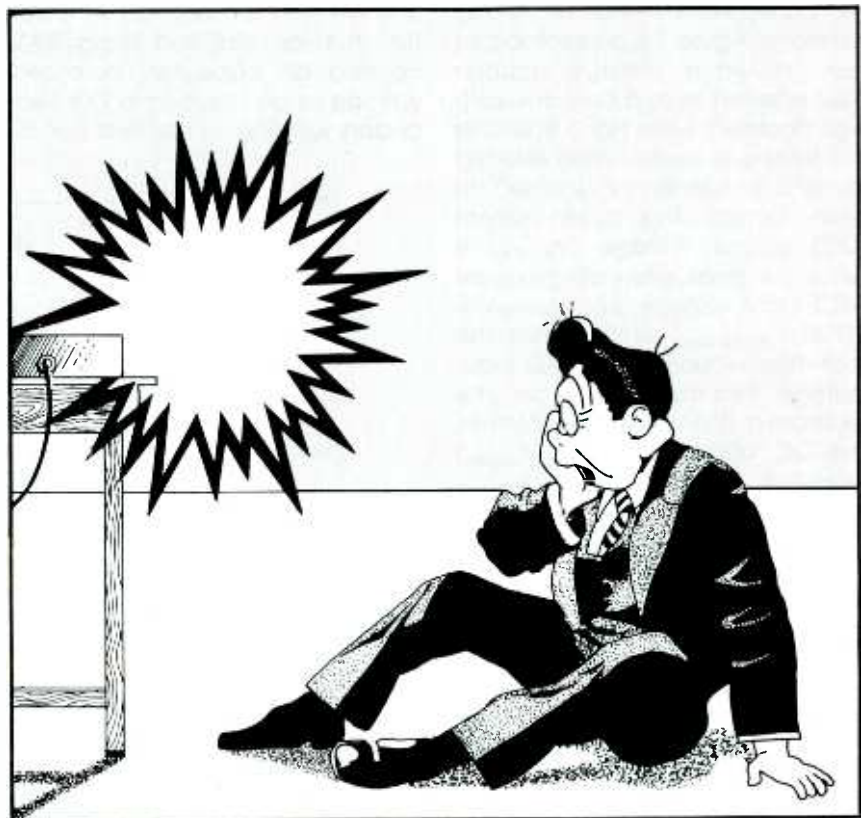

required, rely heavily on high-voltage-generating configurations that can be built around relatively inexpensive and readily available components.

In order to obtain the high voltages needed for the less demanding circuit configurations, a voltage-doubler is often used. Voltage doublers, which are sometimes

used in radio-frequency-actuated circuits to obtain the control voltage, allow you to generate higher voltages than would otherwise be possible with conventional power supplies. Voltage doublers are not generally used when a high degree of regulation is required or when the current drain is high.

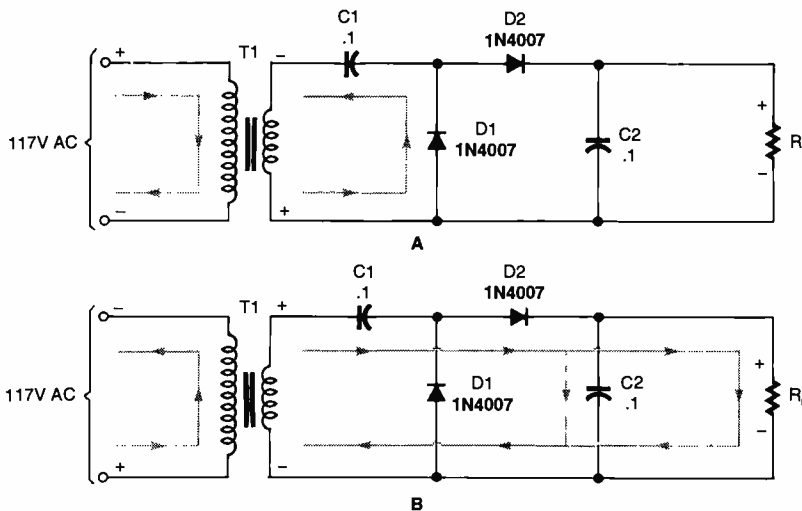

Fig. 1. Shown here is an example of a half-wave voltage doubler, which produces a DC output voltage ($V_{DC(OUT)}$) that's twice the peak of the AC input voltage.

Voltage-Doubler Circuits. As in conventional power-supply circuits, there are two basic voltage-doubler configurations—half-wave and full-wave. Figure 1 is an example of the half-wave voltage doubler (also referred to as a cascade voltage doubler), while Fig. 3 illustrates the full-wave version (also referred to as a conventional doubler). In both circuits, the direct-current (DC) output voltage ($V_{DC(OUT)}$) is twice the peak alternating-current (AC) input voltage; i.e., $V_{DC(OUT)} = 2(1.41)V_{AC(RMS\ INPUT)}$, or 2.8 times the root-mean-square of the AC input voltage. That means if the circuit is fed from a 12.6-volt AC transformer, the DC output voltage ($V_{DC(OUT)}$) would be:

$$V_{DC(OUT)} = 2(1.41)V_{AC(RMS\ INPUT)}$$

$$V_{DC(OUT)} = 2 \times 1.41 \times 12.6$$

$$V_{DC(OUT)} = 35.532$$

The conventional doubler (Fig. 3) provides superior voltage regulation and less output ripple, but the cascade circuit (Fig. 1) can be used without a transformer. In addition, two or more cascade circuits can be connected in series to form voltage multiplier circuits with various multiplication factors.

Half-Wave Doubler. Refer to the half-wave voltage-doubler circuit shown in Fig. 1A, and assume that C1 and C2 are both initially dis-

charged. During the first half-cycle of the AC input, the upper input terminal of T1's primary winding is positive with respect to the lower terminal (as illustrated in Fig. 1A), causing an oppositely polarized voltage to be induced in T1's secondary winding. Under that condi-

tion, D1 begins to conduct, causing C1 to charge. At the same time, diode D2 is reverse biased, preventing its conduction, so C2 discharges through R_L . The analysis is similar in the second half-cycle, except (as illustrated in Fig. 1B) that D2 conducts and C2 charges, while D1 is cut off and C1 discharges into R_L .

The circuit is really a transformer-less voltage amplifier. While T1 can provide isolation, as well as increase the AC voltage initially going into the doubler, the amplification due to the doubling action would occur without it. When the polarity reverses, both the input voltage and the charge across C1 behave like two batteries connected in series, with their voltages combining to produce a DC output of about 36 volts peak. One problem, though, is that a half-wave doubler **cannot** be used with a current-hungry load.

One way of increasing the circuit's current capacity is to use a full-wave voltage doubler.

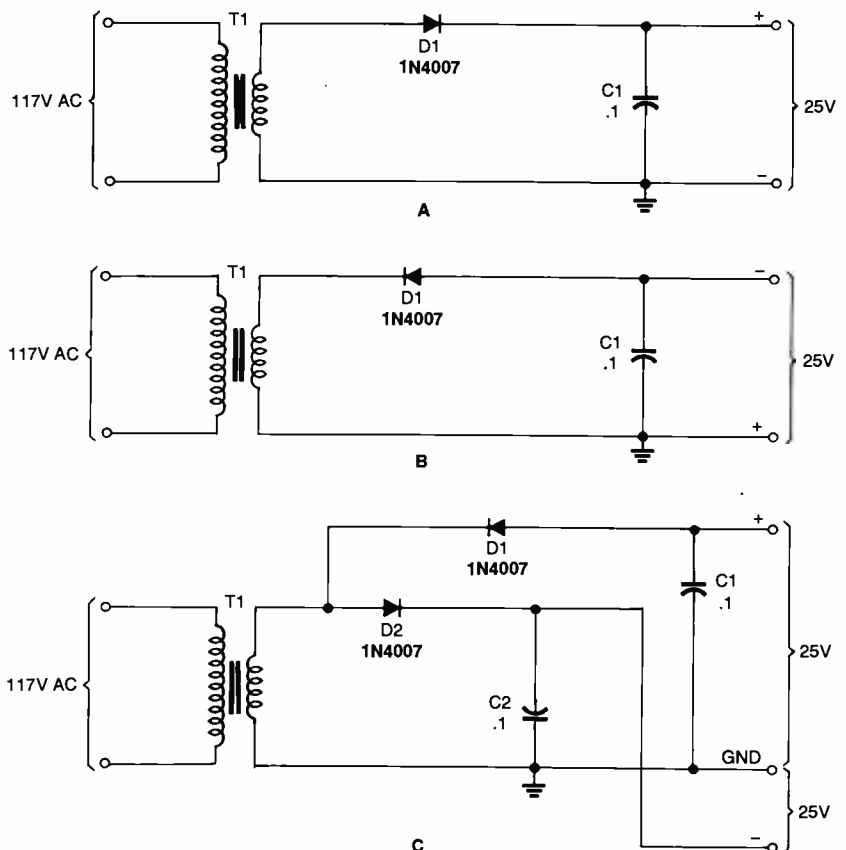

Fig. 2. The half-wave rectifier circuits shown in A and B can be combined, as shown in C, to form a full-wave voltage doubler.

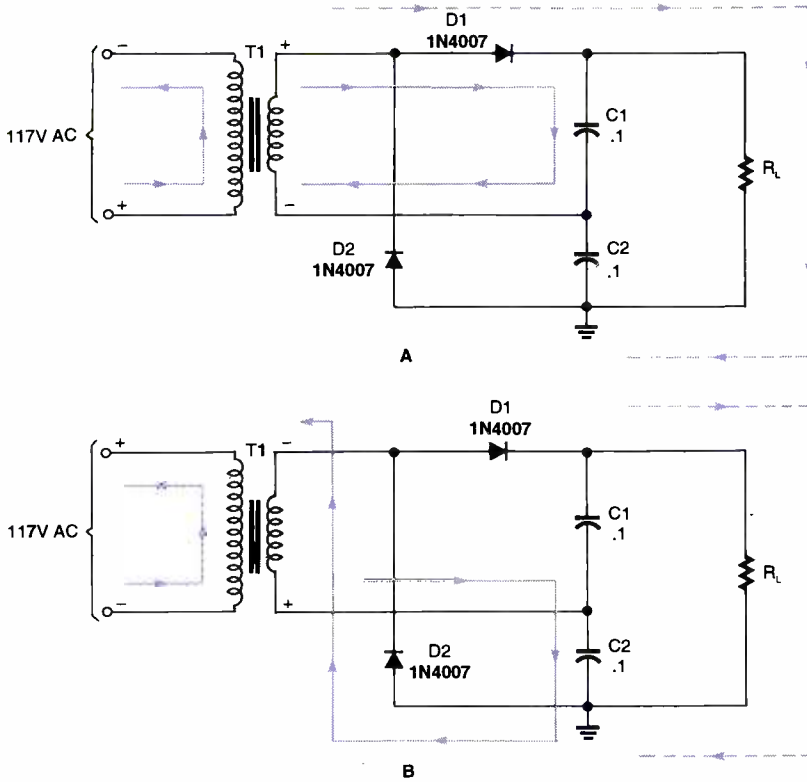

Fig. 3. For the sake of greater clarity, the full-wave voltage doubler illustrated in Fig. 2C can be redrawn as shown here. The full-wave voltage-doubler circuit has better regulation, is easier to filter, and produces nearly double the peak AC voltage of the half-wave version.

Full-Wave Doubler. A full-wave voltage doubler, unlike the half-wave version, is designed to take advantage of both positive and negative half-cycles of the input AC voltage. Figure 2A shows a half-wave rectifier with a positive output, Fig. 2B shows the same circuit redrawn with a negative output. Those half-wave rectifier circuits can be combined (as shown in Fig. 2C) to form a full-wave voltage doubler.

For the sake of greater clarity, the full-wave voltage doubler illustrated in Fig. 2C is shown redrawn in Fig. 3. The full-wave voltage-doubler circuit has better regulation than the half-wave version, is easier to filter, and produces nearly double the peak AC voltage (approximately 36 volts for the previous example) across R_L . During the first half-cycle (see Fig. 3A), D2 is reverse biased and therefore cut off, while D1 is forward biased into conduction, so that the voltage across C1 (V_{C1}) is approximately 17.766 volts DC. On the next half-cycle (see Fig. 3B), the polarization of the applied voltage is reversed, forward biasing D2 into conduction, while reverse biasing D1 into cutoff. The load resistor (R_L) is wired in parallel with the C1/C2 series combination effectively creating a doubled level of about 36 volts DC.

Unlike the half-wave voltage doubler, the full-wave version has two capacitors across R_L rather than one. Whereas C1 shown in Fig. 1 is cut off and unsupplied for half of every cycle, C1 and C2 in Fig. 3 are supplied on alternate half

cycles. When the capacitor corresponding to the diode that's cut off discharges, it can only do so through the capacitor being supplied, slightly decreasing both its current and the maximum voltage it has reached.

Voltage-Multiplication Circuits.

There are many variations of the voltage-doubler scheme. Figure 4 illustrates a voltage-multiplication configuration based on the circuit in Fig. 3 that can be used to generate a DC output voltage three times that of the AC input to the circuit. That circuit, a voltage tripler, operates in essentially the same manner as the doubler circuit of Fig. 3. Like the circuit's operation, the formula for calculating the output voltage of the tripler circuit is very similar to that for the doubler: $V_{DC(OUT)} = 3(1.41)V_{AC(RMS INPUT)}$.

Another circuit—a voltage quadrupler—based on the voltage-doubler of Fig. 3 is shown in Fig. 5. Like the tripler, the voltage quadrupler operates in much the same manner as the voltage doubler. By now a pattern should be beginning to emerge; i.e., $V_{DC(OUT)} = 4(1.41)V_{AC(RMS INPUT)}$. Note the correlation between each circuit's voltage-multiplication factor and the number of diodes and capacitors in each circuit. For example, the voltage doublers in Figs. 1 and 3 use two diodes and two capacitors to provide a $\times 2$ multiplication factor, while the voltage tripler (Fig. 4) and quadrupler (Fig. 5) use three and

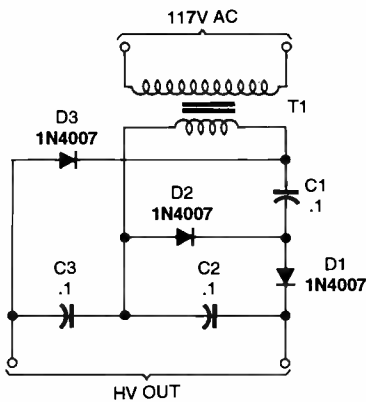

Fig. 4. Here is a voltage-multiplication configuration based on the circuit in Fig. 3 that can be used to generate a DC output voltage three times that of the AC input to the circuit.

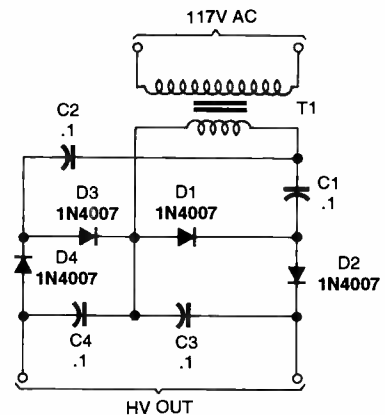

Fig. 5. Like the voltage tripler, this circuit (a voltage quadrupler) is based on the voltage-doubler of Fig. 3 and operates in much the same manner.

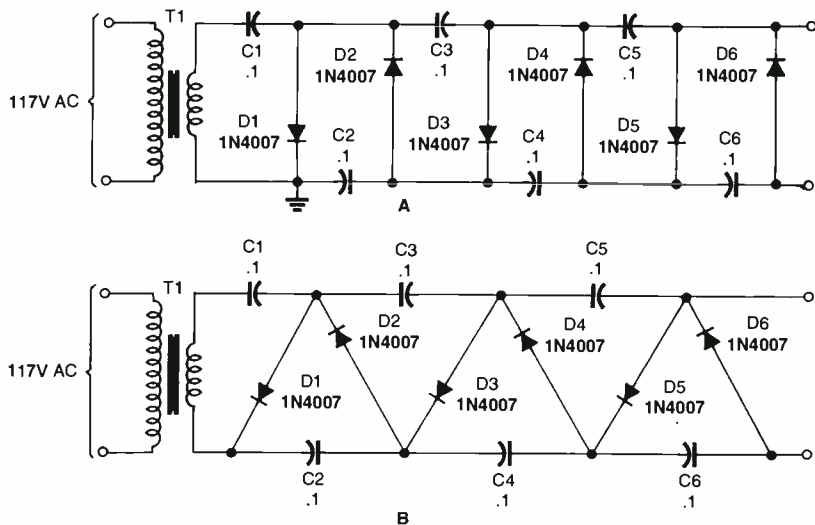

Fig. 6. Note that the circuit in A is electrically identical to the one in B. The usefulness of these circuits can be enhanced by adding voltage taps at each of the diode junctions (D1/D2, D2/D3, D3/D4, D4/D5, and D5/D6) to provide for multiplication factors of $\times 1$, $\times 2$, $\times 3$, $\times 4$, and $\times 5$.

four diode/capacitors pairs (respectively), to achieve multiplication factors of $\times 3$ and $\times 4$.

Figures 6-8 show a few additional voltage-multiplication circuits. The voltage multipliers shown in Fig. 6 are the most straightforward. Note that the circuit in Fig. 6A is electrically identical to the one in Fig. 6B,

so keep that in mind if you should come across either format. The usefulness of the Fig. 6 circuits can be enhanced by adding voltage taps at each of the diode junctions. For example, referring to Fig. 6B, voltage taps can be added at the D1/D2, D2/D3, D3/D4, D4/D5, and D5/D6 junctions, for multiplication factors of $\times 1$, $\times 2$, $\times 3$, $\times 4$, and $\times 5$. Plus, another tap can be connected to the anode of D6 for a multiplication factor of $\times 6$, or $V_{DC(OUT)} = 6(1.41)V_{AC(RMS INPUT)}$. Thus the circuit is able to provide six levels of DC voltage. Additional stages can be added to the circuit to generate multiplication factors of $\times 10$ or more. Note, however, that as the voltage multiplication factor increases, the available current that can be drawn from the circuit decreases by a similar factor. For example, feeding a 12.6-volt, 1-amp AC source through a voltage doubler yields a DC output of approximately 36 volts at about 0.5-amps.

Figure 7 shows an enhanced version of the Fig. 6 circuit—known as either a Cockcroft-Walton or Greinacher cascaded voltage doubler—that offers better stabilization for moderate-current applications.

A sewing needle can be used as an emitter for the voltage doubler shown in Fig. 8 to generate "corona wind," which sounds like a hissing noise. The circuit is capable of delivering 3.75 kV (kilovolts) DC when powered from 117-volt AC

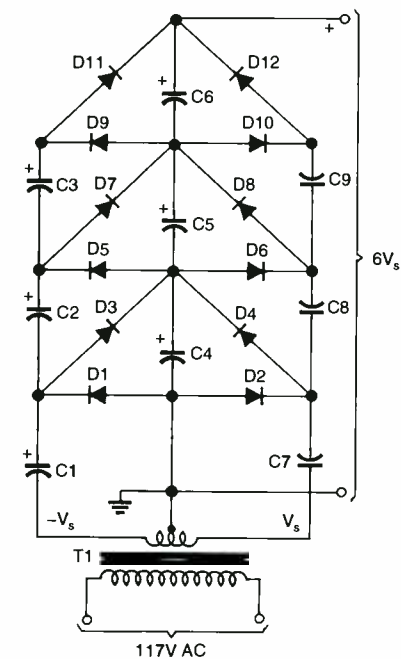

D1-D12—1N4007
C1-C9—.068- μ F, 400WVDC

Fig. 7. Based on the Fig. 6 configuration, this circuit—known as either a Cockcroft-Walton or Greinacher cascaded voltage doubler—offers better stabilization than previous circuits for moderate-current applications.

PARTS LIST FOR THE HIGH-VOLTAGE DC GENERATOR

SEMICONDUCTORS

- IC1—4584 CMOS hex inverting Schmitt trigger, integrated circuit
- Q1—TIP31A NPN silicon power transistor
- BR1—6-amp, 50-PIV full-wave bridge rectifier
- D1-D21—1N4007 1-amp, 1000-PIV, silicon rectifier diode
- LED1—Jumbo green light-emitting diode

RESISTORS

(All resistors are $\frac{1}{4}$ -watt, 5% units, unless otherwise noted.)

- R1—1500-ohm
- R2—300-ohm
- R3—220-ohm
- R4—1-megohm
- R5—10,000-ohm potentiometer

CAPACITORS

- C1—0.022- μ F, 50-WVDC, metallized-film
- C2, C13—220- μ F, 16-WVDC, electrolytic
- C3-C12—0.001- μ F, 2000-WVDC, ceramic-disc
- C14—4700- μ F, 35-WVDC, electrolytic

ADDITIONAL PARTS AND MATERIALS

- NE1—NE-2 neon lamp
- T1—Ferrite core step-up transformer (see source below)
- T2—12-volt, 2-amp step-down power transformer
- PL1—117-volt AC plug with line cord
- Perfboard materials, enclosure, heat sink, IC socket, banana jack, hook-up wire, solder, hardware, etc.

Note: Transformer T1 (part # HVM-COR-B2) is available from Allegro Electronic Systems, Dept. HVM, 3 Mine Mountain Road, Cornwall Bridge, CT 06754

source, or 7.5 kV DC when fed from 240 volts AC.

The output of a cascaded voltage doubler should be terminated with no less than 200 megohms, and only then be allowed to extend beyond a protective plastic case, for safety. Voltages as high as 5 megavolts DC have been generated using cascaded voltage doublers, especially when operating in a pressurized atmosphere. The biggest advantage to using voltage doublers is that they use inexpensive

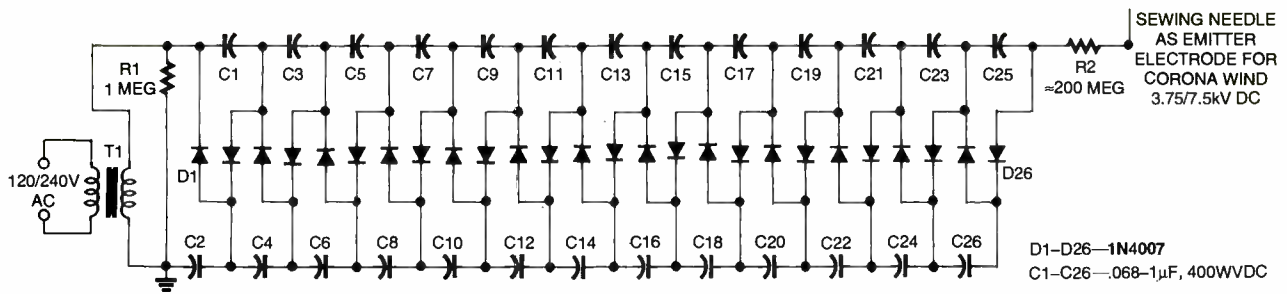

Fig. 8. This circuit, which is capable of delivering 3.75 kV (kilovolts) DC when powered from 117-volt AC source or 7.5 kV DC when fed from 240 volts AC, can be used to generate "corona wind," which sounds like a hissing noise.

low-voltage parts. Otherwise, if all the parts had to be of the high-voltage variety, you would have to use expensive and rather large capacitors.

High-Voltage DC Generator. A schematic diagram of a high-voltage DC generator is shown in Fig. 9. The circuit is built around a single hex inverting Schmitt trigger (IC1), a couple of transformers (T1 and T2), a transistor (Q1), 21 diodes, and several support components.

At the heart of the circuit is the hex Schmitt trigger. One gate of the hex Schmitt trigger (IC1-a) is config-

ured as a square-wave pulse generator. The output of IC1-a (a pulsating DC voltage) at pin 2 is fed to the inputs of IC1-b to IC1-f, which are connected in parallel to increase the available drive current. The pulsating output of the paralleled gates is fed to the base of Q1 through R2, causing Q1 to toggle on and off in accordance with the oscillations of IC1-a. The collector of Q1 is connected in series with the primary winding of T1. The other end of T1 is connected directly to the positive terminal of the power supply. That produces a

driving wave in the primary winding of T1 that is similar to a square wave.

The on/off action of Q1, caused by the pulsating signal applied to it, creates a rising and collapsing field in the primary winding of T1 (a small ferrite-core, step-up transformer). That causes a pulsating signal, of opposite polarity, to be induced in T1's secondary winding.

The pulsating DC output at the secondary winding of T1 (ranging from 800 to 1000 volts) is applied to a 10-stage voltage-multiplier circuit, consisting of D1 through D20,

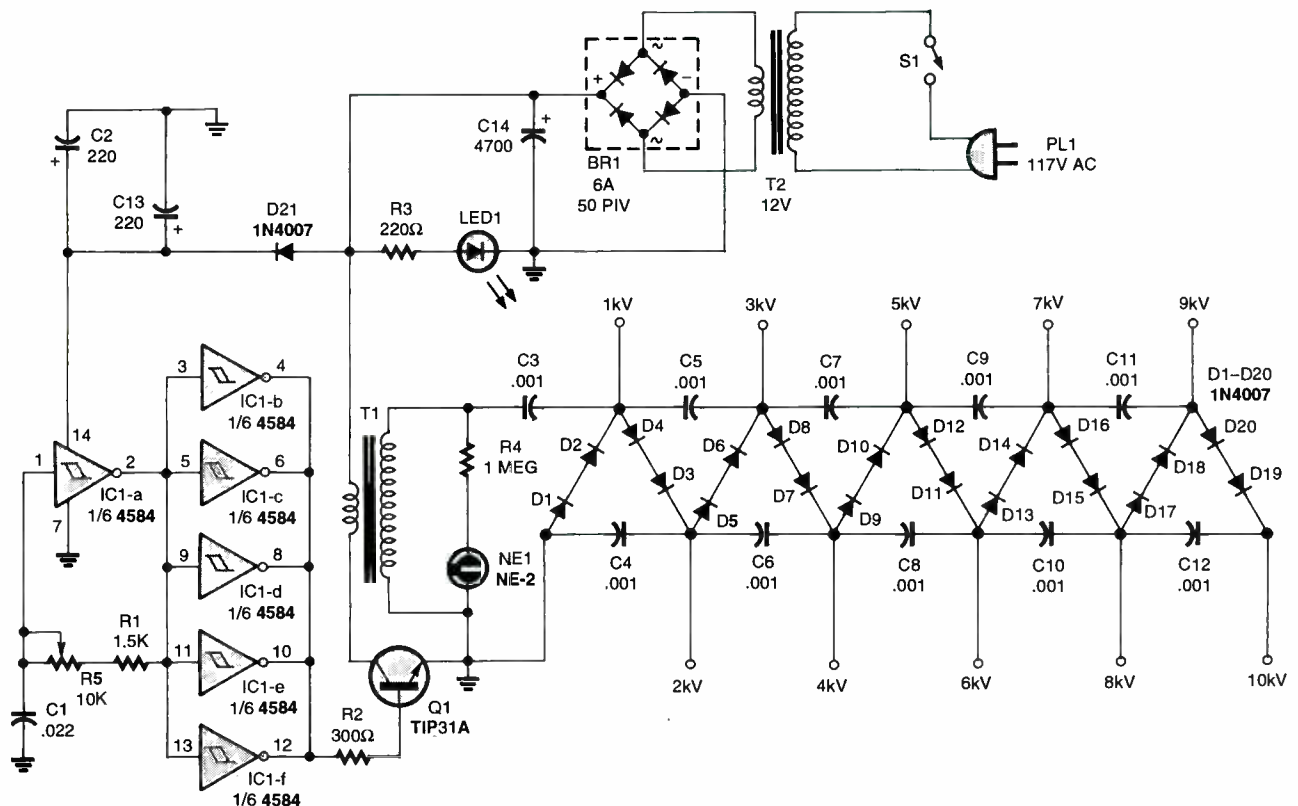

Fig. 9. Generate up to 10 kilovolts with this advanced design.

and C3 through C12. The multiplier circuit increases the voltage 10 times, producing an output of up to 10,000-volts DC— $V_{DC(OUT)} = 10(1.41)V_{AC(RMS\ INPUT)}$. The multiplier accomplishes its task by charging the capacitors (C3–C12) through the diodes (D1–D20); the output is a series addition of all the capacitors in the multiplier.

In order for the circuit to operate efficiently, the frequency of the squarewave, and therefore the signal applied to the multiplier, must be considered. The output frequency of the oscillator (IC1-a) is set via the combined values of R1, R5, and C1 (which with the values specified is approximately 15 kHz). Potentiometer R5 is used to fine tune the output frequency of the oscillator. The higher the frequency of the oscillator, the lower the capacitive reactance in the multiplier.

Light-emitting diode LED1 serves as an input-power indicator, while NE1 indicates an output at the secondary of T1. A good way to get the maximum output of the multiplier is to connect an oscilloscope to its high-voltage output via a high-voltage probe and adjust potentiometer R5 for the maximum output. If you don't have the appropriate test gear, you can place the output wire of the multiplier about a half-inch away from a ground wire and draw a spark, while adjusting R5 for a maximum spark output.

Caution: The output of the multiplier can cause a strong electric shock. In addition, be aware that even after the multiplier has been turned off, there is still a charge stored in the capacitors, which, depending on the state of discharge, can be dangerous if contacted. That charge can be bled off by shorting the output of the circuit to ground. (In fact, it's a good idea to get in the habit of discharging all electronic circuits before handling or working on them.)

Also, IC1 is a CMOS device and, as such, is static sensitive. It can handle a maximum input of 15 volts DC. Do not go beyond the 15-volt DC limit or the IC will "vaporize." Diode D21 is used to prevent reverse polarization of the input voltage source.

As far as the voltage multiplier

goes, the diodes and the capacitors must be rated for at least twice the anticipated input voltage. So, if we have a 1000-volt input, all of the diodes and the capacitors must be, respectively, rated for at least 2000-PIV and 2000-WVDC (working volts DC) each. Because diodes with that voltage rating can be hard to find and expensive (if you can find them), pairs of series-connected 1-amp, 1000-PIV diodes were used to form 2000-PIV units. **P**

COMPUTER BITS

(continued from page 10)

month's column, you'll notice that the camera and graphics tablet are plugged into a box, rather than the PC. With the proliferation of USB devices in my house, I quickly realized that I was continuously plugging and unplugging devices from the same PC. With the eMachines system pictured, that's actually pretty easy, since it has a handy USB connector on the front panel. So does the Compaq *Presario 5868* that's my other main test bed. Still, both of these systems only offer two USB ports. At any one time, I may have four or more USB devices that I'm switching between.

A good investment, with so many USB peripherals available, is a USB hub. This provides four or more USB ports, and if it is a powered hub, with an AC supply, each port can provide the maximum 500 mA that the USB standard provides. Unpowered hubs provide only 500 mA in total, so if one or more of the USB devices connected to the hub draws its power from the USB port, you can quickly exhaust the hub's capacity.

Rather than a hub, I use a device from Xircom called a *PortStation*. This modular device consists of a pair of end caps, one of which has an input for an AC power supply. In between the end caps, you can insert any combination of modules Xircom offers.

The particular *PortStation* pictured is simply a 7-port USB hub. It plugs into one of my PC's USB ports and offers connectors for up to seven USB devices, plenty for my needs. I also have another *PortStation* that serves as a universal port replicator when I'm using a laptop. That *PortStation* offers serial, parallel, and even 10Base-T Ethernet connectors. *PortStations* aren't cheap; the 7-port USB one, for instance, sells for about \$130.

Nevertheless, I've always had great luck with Xircom products, and I don't hesitate to recommend them.

As always, feel free to e-mail me (needleman@aol.com) with your comments or questions. **P**

Practical PIC Microcontroller Projects



This book covers a wide range of PIC based projects, including such things as digitally controlled power supplies, transistor checkers, a simple capacitance meter, reaction tester, digital dice, digital locks, a stereo audio level meter, and MIDI pedals for use with electronic music systems. In most cases the circuits are very simple and they are easily constructed. Full component lists and software listings are provided. For more information about PICs we suggest you take a look at BP394 -- An Introduction to PIC Microcontrollers.

To order Book #BP444 send \$7.99 plus \$3.00 for shipping in the U.S. and Canada only to Electronics Technology Today Inc., P.O. Box 240, Massapequa Park, NY 11762-0240. Payment in U.S. funds by U.S. bank check or International Money Order. Please allow 6-8 weeks for delivery. ET10

POPTRONIX®

Online Edition

We're on the web

FREE

We are starting up,
but you can watch us grow!

Projects for beginners
to experts!
New Product information!
Bookstore—discover
what's new!

<http://www.poptronix.com>

WE'RE WITH YOU EVERY DAY
24 HOURS A DAY! DROP IN!
WE'D LOVE TO HAVE YOU VISIT!

Ersatz Fox And Hound

Q I would like to request that you publish a wire tracer circuit. I have a broken phone wire buried in a wall. I need to trace the length of the wire (50 feet) behind drywall with 2 × 4 studs, to find where it is broken—D. S., Orlando, FL

A The “Fox” and “Hound,” made by Triplett Corporation (www.triplett.com), are a transmitter and receiver for tracing telephone lines through walls. You connect the transmitter to the wire, and the receiver helps you trace the wire from several inches away. Triplett doesn't say much about how they work, but the Fox and Hound apparently use inductive coupling of a low-frequency signal, maybe around 50 to 100 kHz.

Connect the transmitter to the wire to be traced, tune the signal in, and set VR1 to give the weakest signal that does the job. At maximum intensity, you can probably pick it up several feet away; lower settings will enable you to locate wires to within an inch or two. Note that you are using the AM loop antenna inside the radio, not the FM whip, which should be fully retracted.

As shown, the circuit transmits on 1000 kHz and is controlled by a 1-MHz microprocessor crystal. Figure 2 shows how to use an LC oscillator to get other frequencies or to save having to order a crystal. Although built with a CMOS gate, this is simply a Colpitts oscillator. Note that the two capacitors are effectively in series, so only half of their capacitance is present in the tuned circuit.

Line-In-Use Indicator Problems

Q Your “Telephone Hold and Line-In-Use Project” on page 21 of the February 2000 issue appears to violate federal regulations. Specifically, 47 CFR 68.312 specifies that the DC resistance of a telephone that is not in use shall be greater than 5 megohms, but the circuit shown will result in a resistance of about 75K (R1 in parallel with R3).—D. B., by e-mail

A Alas, you're right. The circuit draws too much current from the telephone line when it's not in use (“on the hook,”) and the telephone company's test equipment is likely to detect it as a defect in the line. An older standard allowed the resistance to be as low as 1 megohm, but the circuit that we published doesn't even meet that criterion.

Although I haven't tried it, you could probably correct the problem by changing Q1 and Q2 to type 2N7000 field-effect transistors, changing R1 and R3 to 10 megohms each (try 2.2 megohms if behavior is finicky), and changing R2 to 2.2 megohms.

When working with such large resistors, the circuit board must be clean and dry; coating it with an insulating material after assembly is desirable, because it is easy to get 50 or even 20 megohms of leakage through invisible contaminants adhering to the parts.

As others have pointed out, the article was also in error in saying that the red telephone wire is usually positive. On telephones, red is usually negative. A full-wave-bridge rectifier between the circuit and the phone line will guarantee correct polarity even if the line is miswired.

Really Isolated?

Q Further to the February 2000 Q&A, you can't test an isolation transformer with just a common ohmmeter. What you need is an insulation tester or a Sencore “Z-meter,” which can be set to use a test voltage of 999.9 volts. Using this instrument, I have tested a Sola 20-13-60 (small) and a 23-22-125, and both tested OK for isolation.—D. H., Buffalo, NY

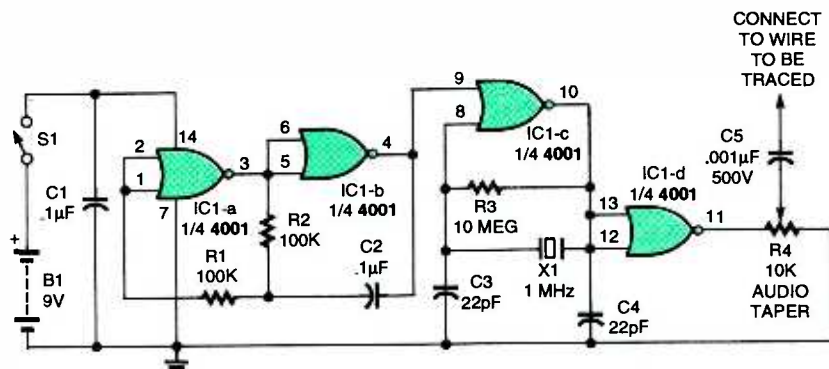

Fig. 1. A simple carrier-wave transmitter injects an RF signal into a wire; an AM radio can pick up the signal as a low-pitched “growl.”

Figure 1 shows a cheaper transmitter that uses an AM transistor radio as the detector. It uses a type 4001 (CD4001B) integrated circuit to generate a pulsing signal at 1 MHz (1000 kHz), which is heard as a growling sound in the radio.

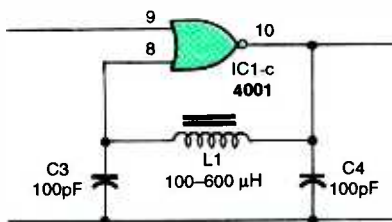

Fig. 2. If you don't want to use a crystal for the frequency that you want, put an inductor in place of the crystal and shunt resistor.

Now for the bad news. As you may have discovered, this type of device probably will not detect a small break in a phone line. Radio waves that can go several inches through wood and plaster can also jump across a tiny gap in the metal. Nonetheless, with care, you may be able to find the break by looking for a place where the signal strength drops dramatically.

Another approach would be to use a much lower-frequency signal, such as 5 kHz from an audio-signal generator, and pick it up inductively with a microphone-level audio amplifier. Try using a coil from a relay as the detector, in place of a microphone. Low-frequency signals are harder to pick up but also less able to jump across breaks in the wiring.

A You're right, if the quality of the isolation is in question. All we were trying to do was distinguish an isolation transformer from an autotransformer. We're glad to know that those Sola transformers do pass the test at 999.9 volts.

Troubleshooting Windows Failures

Q My 300-MHz Windows 98 computer has been giving me occasional page faults and general protection faults, about once per week. When the fault message comes up, I click on "details" and get locations that look like hexadecimal addresses. Is there a book that will tell me how to decipher these messages?—L. R., Huntington Beach, CA

A The messages mean that a running program is trying to address memory locations that do not exist or are assigned to other programs. Many people blame Microsoft Windows for detecting these errors, but, actually, Windows is very often just notifying you of a bug in an application program or a device driver. Indeed, Microsoft has had to make numerous small changes in Windows to work around mistakes in popular application programs.

Unless you have an inside track to the authors of Windows and all the other software on the machine, you'll probably never be able to interpret the numbers precisely. But that's not as bad as it sounds. There are plenty of things you can check. Here are a few of the most important.

(1) Is the problem associated with a particular piece of software or hardware? If the error message contains a file name, look at the file (find it, right-click on it, and choose "Properties"). It may be a device driver for which a newer version is available.

(2) Do a Disk Cleanup (under "Programs," "Accessories," "System Tools") and discard any temporary Internet files that may be on your hard disk. Then run ScanDisk to make sure the disk drive is in good order.

(3) Use Windows System File Checker to look for corrupted system files. Click "Start," "Run," and type *sfc.exe*.

(4) Perform a Windows Update and make sure you are running the current version of the operating system. This is something you should do every month or two anyhow.

HOW TO GET INFORMATION ABOUT ELECTRONICS

On the Internet: See our Web site at www.gemsback.com/poptronics for information and files relating to **Poptronics** and our former magazines (**Electronics Now** and **Popular Electronics**) and links to other useful sites.

To discuss electronics with your fellow enthusiasts, visit the newsgroups sci.electronics.repair, sci.electronics.components, sci.electronics.design, and rec.radio.amateur.homebrew. "For sale" messages are permitted only in rec.radio.swap and misc.industry.electronics.marketplace.

Many electronic component manufacturers have Web pages; see the directory at <http://www.hitex.com/chipdir/>, or try addresses such as <http://www.ti.com> and <http://www.motorola.com> (substituting any company's name or abbreviation as appropriate). Many IC data sheets can be viewed online: www.questlink.com features IC data sheets and gives you the ability to buy many of the ICs in small quantities using a credit card. You can also get detailed IC information from www.icmaster.com, which is now free of charge although it formerly required a subscription. Extensive information about how to repair consumer electronic devices and computers can be found at www.repairfaq.org

Books: Several good introductory electronics books are available at RadioShack, including one on building power supplies.

An excellent general electronics textbook is *The Art of Electronics*, by Paul Horowitz and Winfield Hill, available from the publisher (Cambridge University Press, 800-872-7423) or on special order through any bookstore. Its 1125 pages are full of information on how to build working circuits, with a minimum of mathematics.

Also indispensable is *The ARRL Handbook for Radio Amateurs*, comprising over 1000 pages of theory, radio circuits, and ready-to-build projects, available from the American Radio Relay League, Newington, CT 06111, and from ham-radio equipment dealers.

Copies of past articles: Copies of past articles in **Electronics Now**, **Popular**

Electronics (post 1995 only) and **Poptronics** are available from our Claggk, Inc., Reprint Department, P.O. Box 12162, Hauppauge, NY 11788; Tel: 631-293-3751.

Electronics Now and many other magazines are indexed in the *Reader's Guide to Periodical Literature*, available at your public library. Copies of articles in other magazines can be obtained through your public library's interlibrary loan service; expect to pay about 30 cents a page.

Service manuals: Manuals for radios, TVs, VCRs, audio equipment, and some computers are available from Howard W. Sams & Co., Indianapolis, IN 46214; (800-428-7267). The free Sams catalog also lists addresses of manufacturers and parts dealers. Even if an item isn't listed in the catalog, it pays to call Sams; they may have a schematic on file which they can copy for you.

Manuals for older test equipment and ham radio gear are available from HI Manuals, PO Box 802, Council Bluffs, IA 51502, and Manuals Plus, PO Box 549, Tooele, UT 84074.

Replacement semiconductors: Replacement transistors, ICs, and other semiconductors, marketed by Philips ECG, NTE, and Thomson (SK), are available through most parts dealers (including RadioShack on special order). The ECG, NTE, and SK lines contain a few hundred parts that substitute for many thousands of others; a directory (supplied as a large book and on diskette) tells you which one to use. NTE numbers usually match ECG; SK numbers are different.

Remember that the "2S" in a Japanese type number is usually omitted; a transistor marked D945 is actually a 2SD945.

Hamfests (swap meets) and local organizations: These can be located by writing to the American Radio Relay League, Newington, CT 06111; (<http://www.arrl.org>). A hamfest is an excellent place to pick up used test equipment, older parts, and other items at bargain prices, as well as to meet your fellow electronics enthusiasts—both amateur and professional.

(5) Go to the Microsoft Knowledge Base (<http://support.micr osoft.com>) and search for the particular error message that you're getting. If it points to anything specific, you'll probably find it there. Also search for it on <http://www.dejanews.com>, but remember that the discussions there are not authoritative.

(6) Look for hardware problems. Unplug everything inside the computer and plug it back in to ensure a good connection. (Take anti-static precautions, of course.) Make sure your memory SIMMs or DIMMs are

the right kind and are well matched. Test power supply voltages (5.0 and 12.0 V, accessible at a disk-drive connector). Make sure a cooling fan has not failed and that external cables are not loose.

(7) Look for DLL conflicts. Use "Find" to locate every file on the machine whose name ends in DLL. If you find two with the same name, rename the older one so that its name no longer ends in DLL, and copy the newer one into C:\WINDOWS\SYSTEM. That way, only the newest version of each DLL will be accessible.

(8) Under "My Computer," "Properties," disable virtual memory, reboot, and re-enable it on a different disk drive. This will get rid of any corrupt data in your swap file.

(9) If all else fails, re-install Windows (which you can do over an existing installation without destroying your data).

Testing Capacitors In-Circuit

Q I would like to know how to test small-value surface-mount capacitors in-circuit. Would a digital multimeter that has capacitance-measuring capability work by doing comparison measurements with a good board?—*J. R., Lemon Grove, CA*

A Comparison measurements with a good board are always helpful, but measuring the actual value of a capacitor that is connected to other components is always difficult and sometimes impossible.

The normal way to measure capacitance is to apply an AC voltage and measure the current that flows, thereby finding the capacitive reactance. Any other conductive path across the capacitor will throw this measurement off.

A couple of tricks are possible. If the test voltage is less than about 0.1 volt, transistors and diodes will act like open circuits, keeping some of the unwanted paths out of the picture. By applying AC at more than one frequency, you could distinguish capacitive reactance from other effects. Even then, though, perfect in-circuit measurements are not always feasible; for example, if you have two capacitors connected in parallel, all you can measure is the total capacitance of the two.

Howard Electronic Instruments (www.beinc.com) markets a "Capacitor Wizard" for in-circuit testing of the effective series resistance (ESR) of capacitors, not the capacitance. (Bad capacitors generally short out or develop high ESR rather than just changing capacitance.) The instrument is designed for capacitors of 1 microfarad and larger, the ones that are the most failure-prone, and uses an 0.005-volt, 100-kHz test signal.

Hungry For Hungary

Q I got a shortwave radio for Christmas and would like to know the frequencies

and broadcasting times of international shortwave broadcasts, especially those from Hungary.—*R. A. S., El Cajon, CA*

A For a complete guide to international shortwave broadcasts, consult the *World Radio-TV Handbook* or *Passport to World-Band Radio*. These are annual handbooks that can be special-ordered through almost any bookstore. If you have trouble finding them, write to Radio Bookstore, PO Box 209, Rindge, NH 03461-0209; Tel: 800-457-7373; Web: www.radio-ware.com.

Or look on the Web at <http://www.angelfire.com/wi/worldbandradio/> for a guide to English-language broadcasts beamed at North America.

According to their listings, you can find Radio Budapest on 9835 kHz between 0200 and 0230 UTC, and again between 0330 and 0400 UTC, daily. (That's 6:00-6:30 p.m. and 7:30-8:00 p.m. Pacific Standard Time.) This may change in the summer.

Bear in mind that Hungary is not a shortwave radio powerhouse; the signal will probably not be very strong and will vary from day to day. It's much easier to hear England, France, Russia, and the Voice of America. Also, for several reasons California does not receive as many signals from Europe as the East Coast. Nonetheless, shortwave listening can be a fascinating hobby as long as you recognize that its unreliability is part of the fun. Sometimes even the most reliable signals won't come in; at other times, you'll hear small local or regional stations in far-off parts of the world.

Dim Paper?

Q Is my eyesight dimming or is *Poptronics* using paper that is less white, thereby making it harder for old eyes to read?

If I recall, the old pulp magazines of the 1930s, where you could actually see slivers of wood in the paper, were easier to read. But then, to be fair, my eyes were a lot younger then—H. S., Longmont, CO

A It must be your eyes, because although our paper is not as glossy as it used to be, it's still lighter than the pulp paper of the 1930s (at least as far as I know; I wasn't actually reading magazines then!).

The new paper is not perfectly white, but it also isn't shiny, so you're not likely to be bothered by glare. Many people

find it easier to read the print on this paper than on glossy magazine paper, which, after all, is designed primarily for printing pictures.

(To get real technical, we used to use a coated glossy paper. Then we went to a glossy uncoated paper, known in the trade as SCB. Now we use SCB, another uncoated paper. We used to use pulp paper in our Shopper section, but have abandoned that and now publish on all SCB, except for the cover, of course.—Editor)

Need Philips Scope Manual

Q I am looking for a service manual and an operator's manual for a Philips model PM3305 oscilloscope. Can someone help?—*Aldo Martinez, 21420 SW 102 Avenue, Miami, FL 33189*

A Did you perhaps mean PM3350, a 100-MHz oscilloscope that was fairly popular in Europe? In any case, we assume you've tried Philips (www.philips.com, a set of Web pages I found almost unusable; all of them were very slow, and some came up blank). Since Philips operates worldwide and has changed its structure several times, the right division may be hard to find. We're publishing your name and address in the hope that a reader can help.

Writing To Q&A

As always, we welcome your questions. The most interesting ones are answered in print. Please be sure to:

- (1) include plenty of background information (we'll shorten your letter for publication);
- (2) give your full name and address on your letter (not just the envelope);
- (3) type your letter if possible, or write very neatly; and
- (4) if you are asking about a circuit, include a complete diagram.

Questions can be sent to Q&A, *Poptronics* Magazine, 275 G Marcus Blvd., Hauppauge, NY 11788, or e-mailed to q&a@gernsback.com, but please do not expect an immediate reply in these pages (because of our backlog) and please don't send graphics files larger than 100K. Due to the volume of mail, we regret that we cannot give personal replies.

ELECTRONIC TECHNOLOGY TODAY INC.

P.O. Box 240 • Massapequa Park, NY 11762

INVENTORY BLOWOUT SALE



* ALL CANADIAN CHECKS MUST CLEAR THROUGH AN AMERICAN BANK

BP07 ... 100 Radio Hookups	\$3.00	BP304 ... Projects for Radio Amateurs and S.W.L.S	\$5.99
BP37 ... 50 Projects for Radio Amateurs and Triacs	\$3.99	BP317 ... Practical Electronic Timing	\$6.99
BP48 ... Electronic Projects for Beginners	\$2.99	BP320 ... Electronic Projects for Your PC	\$5.99
BP56 ... Electronic Security Devices	\$3.99	BP321 ... SOLD OUT	\$6.99
BP64 ... Semiconductor Technology Elements of Elect Book 3	\$5.99	BP322 ... Circuit Source Book 2	\$6.99
BP74 ... Electronic Music Projects	\$3.99	BP329 ... Electronic Music Learning Projects	\$6.99
BP76 ... Power Supply Projects	\$3.99	BP332 ... A Beginners Guide to TTL Digital ICS	\$6.99
BP78 ... Practical Computer Experiments	\$2.99	BP333 ... A Beginners Guide to CMOS Digital ICS	\$6.99
BP88 ... How to Use OP Amps	\$5.99	BP334 ... Magic Electronic Projects	\$6.99
BP93 ... SOLD OUT	\$2.99	BP355 ... A Guide to the World's Radio Stations	\$7.99
BP103 ... Multi-Circuit Board Projects	\$2.99	BP359 ... An Introduction to Light in Electronics	\$6.99
BP112 ... A Z-80 Workshop Manual	\$5.99	BP367 ... Electronic Projects for the Garden	\$6.99
BP114 ... The Art of Programming the 16K ZX81	\$3.99	BP370 ... The Superhet Radio Handbook	\$6.99
BP115 ... The Pre-Computer Book	\$2.99	BP371 ... Electronic Projects for Experimenters	\$6.99
BP124 ... Easy Add-On Projects for the Spectrum, ZX81 & ACE	\$3.99	BP374 ... Practical Fibre-Optic Projects	\$6.99
BP148 ... Computer Terminology Explained	\$2.99	BP378 ... 45 Simple Electronic Terminal Block Projects	\$6.99
BP154 ... An Introduction to MSX Basic	\$3.99	BP379 ... 30 Simple IC Terminal Block Projects	\$6.99
BP156 ... An Introduction to QL Machine Code	\$3.99	BP384 ... Practical Electronic Model Railways Projects	\$6.99
BP187 ... A Prac Ref Guide to Word Pro Amstrad PCW8256/PCW8512	\$7.99	BP391 ... Fault-Finding Electronic Projects	\$6.99
BP190 ... More Advanced Electronic Security Projects	\$3.99	BP392 ... Electronic Project Building for Beginners	\$6.99
BP194 ... Modern OPTO Device Projects	\$3.99	BP393 ... Practical Oscillator	\$6.99
BP232 ... A Concise Introduction to MS-DOS	\$3.99	BP394 ... An Introduction to PIC Microcontrollers	\$7.99
BP245 ... Digital Audio Projects	\$3.99	BP396 ... Electronic Hobbyists Data Book	\$7.99
BP248 ... Test Equipment Construction	\$3.99	BP401 ... Transistor Data Tables	\$7.99
BP256 ... An Intro to Loudspeakers and Enclosure Design	\$3.99	BP411 ... A Practical Intro to Surface Mount Devices	\$6.99
BP264 ... A Concise Advanced User's Guide to MS-DOS	\$3.99	BP413 ... Practical Remote Control Projects	\$7.99
BP267 ... How to Use Oscilloscopes and Other Test Equipment	\$5.99	PCP107 ... Digital Logic Gates and Flip-Flops	\$10.99
BP272 ... Interfacing PCS and Compatibles	\$5.99	PCP112 ... Digital Electronics Projects for Beginners	\$10.99
BP290 ... An Intro to Amateur Communications Satellites	\$5.99	PCP114 ... Advanced MIDI Users Guide	\$10.99
BP297 ... Loudspeakers for Musicians	\$6.99	ETT1 ... Wireless & Electrical Cyclopedia	\$4.99
BP299 ... Practical Electronic Filters	\$6.99		

PRICES DO NOT INCLUDE SHIPPING & HANDLING. ALL SALES ARE FINAL, NO RETURNS

ORDER FORM

Book No.	Title	Price	No. of Copies	Cost

Name _____
 Address _____
 City _____ State _____ Zip _____

If you wish to use a Credit Card:

MasterCard Visa Expire Date _____ / _____
 Card No. _____
 Signature _____

Allow 6-8 weeks for order to be fulfilled.

Please return this order form to:
ELECTRONIC TECHNOLOGY TODAY, INC.
 P.O. Box 240
 Massapequa Park, NY 11762-0240



SHIPPING COSTS		Total Amount \$
\$0.01 to \$5.00	\$2.00	- 30% off
\$5.01 to \$10.00	\$3.00	Subtotal
\$10.01 to \$20.00	\$4.00	Add shipping cost (see table)
\$20.01 and above	\$5.00	Local NY State Sales Tax
	\$8.50	TOTAL COST \$

Telephone Orders: If you wish to place your credit-card order by phone, call 516/293-0467. Automated order taking system functions 24 hours a day. Have your credit-card ready. Sorry, no orders accepted outside of U.S.A. and Canada, New York State Residents must add applicable sales tax. Offer expires 6/31/00.

More on the BasicX-24 Microcontroller

Last month, we began our look at the BasicX-24 microcontroller from NetMedia (<http://www.basicx.com/>). This month, we'll continue our discussion of this new chip and look at how we can put it to use in various robotic applications, including controlling servomotors and building a joystick teaching pendant.

Controlling RC Servos

Radio-control servos can be readily controlled with the BasicX-24 (BX-24) using a few simple statements. While there is no built-in "servo command" as there is with the OOPic microcontroller (see *Poptronics* February and March, 2000), the procedure is nevertheless very easy to do in the BX-24. Here's a basic program that places a servo connected to pin 20 of the BX-24 to its approximate mid-point position (I say "approximate" because the mechanics of RC servos can be different between makes, models, and even individual units):

```
Sub Main
Do
Call PulseOut(20, 1.5E-3, 1)
Call Delay(0.02)
Loop
End Sub
```

The program runs continuously because it is within a "Do" loop. The PULSEOUT statement sends a short 1.5-millisecond (ms) HIGH pulse to pin 20. The Delay statement causes the BX-24 to wait 20 milliseconds, before the loop is repeated all over again. With a delay of 20 milliseconds, the loop will repeat 50 times a second (50×20 milliseconds = 1000 milliseconds, or one second).

Note the optional use of scientific notation for the second parameter of PULSEOUT. Using the value 0.0015 would yield the same result. You should be aware that the BX-24 supports two versions of the PULSEOUT statement: a float version and an integer version. The float version is used with floating-point

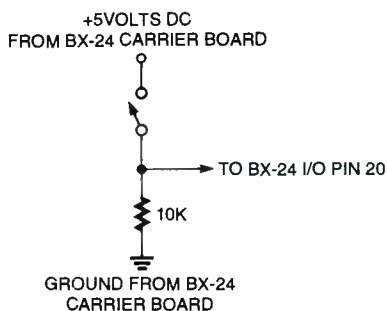

Fig. 1. Wire the switch so that it connects to the V+ (pin 21, not pin 24) of the BX-24.

numbers; that is, numbers that have a decimal point. The integer version is used with integers; that is, whole numbers only.

The BX-24 compiler automatically determines which version to use based on the data format of the second parameter of the PULSEOUT statement. If you use:

```
Call PulseOut(20, 20, 1)
```

```
Const ServoPin As Byte = 20
```

it tells the BX-24 that you want to send a pulse of 20 "units." Since each unit is 1.085 microseconds long; 20 units would produce a very short pulse of only 21.7 microseconds. To continue working in more convenient milliseconds, be sure to use the decimal point:

```
Call PulseOut(20, 0.020, 1)
```

This creates a pulse of 20 milliseconds in length.

Listing 1 shows a more elaborate servo-control program and is based on an application note provided on the BasicX Web site. This program allows you to specify the position of the servo shaft as a value from 0 to 100, making it easier for you to use.

The five lines at the beginning of the program set up all the variables that are used. The line:

Listing 1

```
Const ServoPin As Byte = 20
Const RefreshPeriod As Single = 0.02
Const NSteps As Integer = 100
Dim SetPosition As Byte
Dim Position As Single, PulseWidth As Single

Sub Main ()
' Moves a servo by sending a single pulse.
' Insert position as a value from 0 to 100
SetPosition = 50 ' move to mid-point

Position = CSng(SetPosition) / CSng(NSteps)
Do
' Translate position to pulse width, from 1.0 to 2.0 ms
PulseWidth = 0.001 + (0.001 * Position)

' Generate a high-going pulse on the servo pin
Call PulseOut(ServoPin, PulseWidth, 1)
Call Delay(RefreshPeriod)
Loop
End Sub
```

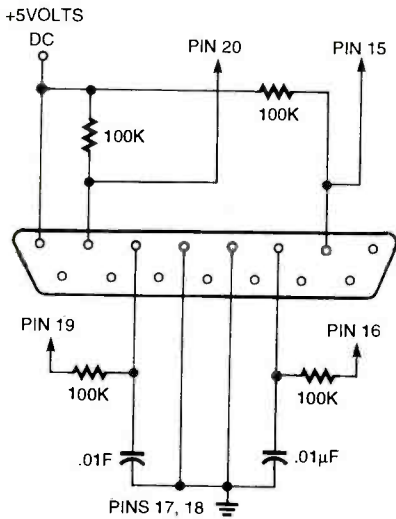

Fig. 2. Connecting an IBM PC-style joystick to the BasicX-24 microcontroller.

creates a byte-sized constant, and also defines the value of the constant as pin 20. Because it is a constant, the value assigned to `SERVOPIN` cannot be changed elsewhere in the program. Similarly, the lines:

```
Const RefreshPeriod As Single = 0.02
Const NSteps As Integer = 100
```

create the constants `REFRESHPERIOD` and `NSTEPS`. `REFRESHPERIOD` is a single-precision floating point number, meaning it can accept numbers to the right of the decimal point. `NSTEPS` is an integer and can accept values from -32768 to +32767.

The main body of the program begins with `Sub Main`. The statement:

```
SetPosition = 50
```

sets the desired position of the servo relative to the total number of steps defined in `NSTEPS` (in the case of our

Listing 2

```
Sub Main()
Const InputPin As Byte = 20
Const LED As Byte = 26
Dim State as Byte
Sub Main()
Do
' Read I/O pin 20
State = GetPin(InputPin)
' Copy it to the LED
Call PutPin(LED, State)
Loop
End Sub
```

Listing 3

```
Private S1 As Byte
Private S2 As Byte
Private JoystickX As Integer
Private JoystickY As Integer
Private Steps As Integer
Private TempByte As Byte
Private Motors As Byte
Private MotorsStr As String * 10
Private TempStr As String * 20
Private RecordFlag As Boolean
Private PlayFlag As Boolean

Private Const GreenLED As Byte = 26
Private Const RedLED As Byte = 25
Private Const LEDOn As Byte = 0
Private Const LEDOff As Byte = 1
```

```
Private Const MotLD As Byte = 9
Private Const MotLC As Byte = 10
Private Const MotRD As Byte = 11
Private Const MotRC As Byte = 12
```

```
Private Const Min As Integer = 450
Private Const Mid As Integer = 850
Private Const Max As Integer = 1200
```

```
Private Const CmdDelay As Integer = 256
Private Const MaxSteps As Integer = 60
```

```
Dim RecordArray (1 to MaxSteps) As Integer
```

```
'DLDR
'D=0, forward
'D=1, reverse
'L=0, left motor off
'L=1, left motor on
'R=0, right motor off
'R=1, Right motor on
```

```
Sub Main()
```

```
Dim Count As Integer
Call PutPin (17, BxOutputLow) ' take low
Call PutPin (18, BxOutputLow) ' take low
Call OpenSerialPort(1, 19200)
RecordFlag = False
PlayFlag = False
```

```
Call PutPin (GreenLED, LedOff)
Call Sleep (1.5)
Do
```

```
JoystickX = GetPotValue (19) ' X stick
JoystickY = GetPotValue (16) ' Y stick
Select Case JoyStickY
Case Min to (Mid-51) 'Forward
Select Case JoystickX
Case Min to (Mid-51)
MotorsStr = "bx00000100"
Motors = bx00000100
Case (Mid-50) to (Mid+50)
```

(Listing 3 continued on page 63)

(Listing 3 continued from page 62)

```

        MotorsStr = "bx00000101"
        Motors = bx00000101
    Case Mid+51 to Max
        MotorsStr = "bx00000001"
        Motors = bx00000001
    End Select
Case (Mid-50) to (Mid+50) ' Center
    Select Case JoystickX
        Case Min to (Mid-51)
            MotorsStr = "bx00001101"
            Motors = bx00001101
        Case (Mid-50) to (Mid+50)
            MotorsStr = "bx00000000"
            Motors = bx00000000
        Case Mid+51 to Max
            MotorsStr = "bx00000111"
            Motors = bx00000111
    End Select
Case Mid+51 to Max ' Reverse
    Select Case JoystickX
        Case Min to (Mid-51)
            MotorsStr = "bx00001100"
            Motors = bx00001100
        Case (Mid-50) to (Mid+50)
            MotorsStr = "bx00001111"
            Motors = bx00001111
        Case Mid+51 to Max
            MotorsStr = "bx00000011"
            Motors = bx00000011
    End Select
End Select
Call SetMotors (Motors)
Call PutStr (MotorsStr)
Call Newline
S1 = GetPin (20)
S2 = GetPin (15)
If S1 = 0 Then ' button 2, red led, pin 20
    RecordFlag = Not RecordFlag
    Call SetRedLed (RecordFlag)
    If RecordFlag = True Then
        Steps = 1
        TempStr = "****Recording On****"
        Call PutStr (TempStr)
        Call Newline
    End If
    If RecordFlag = False Then
        TempStr = "****Recording Off****"
        Call PutStr (TempStr)
        Call Newline
    End If
End If
If S2 = 0 Then ' button 1, green led, pin 15
    PlayFlag = Not PlayFlag
    Call SetGreenLed (PlayFlag)
    If PlayFlag = True Then
        TempStr = "****Playback On****"
        Call PutStr (TempStr)
        Call Newline
    End If
End If

```

(Listing 3 continued on page 64)

example, 100). Therefore, a SETPOSITION value of 50 will move the servo to its approximate midpoint.

The line:

$$\text{Position} = \text{CSng}(\text{SetPosition}) / \text{CSng}(\text{NSteps})$$

produces a value from 0.0 to 1.0, depending on the number you used for SETPOSITION. With a value of 50, the POSITION variable will contain 0.5. The POSITION variable is then used within the Do loop that follows. Within this loop are the statements:

```

PulseWidth = 0.001 + (0.001 * Position)
Call PulseOut(ServoPin, PulseWidth, 1)
Call Delay(RefreshPeriod)

```

The first statement sets the pulse width, which is between 1.0 and 2.0 milliseconds. The PULSEOUT statement sends the pulse through the indicated servo pin (the third parameter, 1, specifies that the pulse is positive-going, or HIGH). Finally, the DELAY statement delays the BX-24 for the REFRESHPERIOD, in this case 20 milliseconds (0.02 seconds).

Reading Button Inputs and Controlling Outputs

A common robotics application is reading an input, such as a button, and controlling an output, such as an LED, motor, or other real-world device. The program in Listing 2 demonstrates some simple code that reads the value of a momentary pushbutton switch connected to I/O pin 20. The switch is connected in the circuit shown in Fig. 1, so that when the switch is open, the BX-24 will register a 0 (LOW), and when it's closed, the BX-24 will register a 1 (HIGH).

The instantaneous value of the switch is indicated in the LED. The LED will be off when the switch is open, and on when it is closed.

Now let's see how the program works. The lines:

```

Const InputPin As Byte = 20
Const LED As Byte = 26
Dim State as Byte

```

set the constant INPUTPIN as I/O pin 20, and the constant LED as I/O pin 26 (recall from last month that one of the BX-24's on-board LEDs—the green one, by the way—is connected to I/O pin 26). Finally, the variable STATE is

defined, as type Byte:

```
Do
  ' Read I/O pin 20
  State = GetPin(InputPin)
  ' Copy it to the LED
  Call PutPin(LED, State)
Loop
```

The Do loop repeats the program repeatedly. The GETPIN statement gets the current value of pin 20, which will be either LOW (0) or HIGH (1). The companion PUTPIN statement merely copies the state of the input pin to the LED. If the switch is open, the LED is off; if it's closed, the LED is on.

Build a Joystick "Teaching Pendant"

No doubt you've been to Disneyland or other theme parks that uses robotic or *Animatronic* performers. These on-stage automatons are operated via a sophisticated computer system that plays back the audio portion of the program and controls every movement or every robot on the stage. Walt Disney was one of the early pioneers of this art and science, calling it audio-animatronics; a system his Walt Disney Enterprises group developed that used audio tones on recorded tape as the control medium.

Animatronic shows are most commonly acted out by a human director who operates a joystick or other control in real time. As the sound portion of the program is played, the director moves the joystick to operate the various animatronic devices on stage. The movements of the joystick are recorded for later playback. This same concept is used in many kinds of manufacturing robots, whose actions are programmed not from a keyboard, but from a "teaching pendant," a controller that records the actions of a human operator.

Using an ordinary joystick, you can create your own teaching pendant for your robot (or animatron, if that's to your liking). For this next project, I'll use a common garden variety IBM PC-style analog joystick, though you can apply the same techniques to any kind of joystick, analog or digital. IBM PC-style joysticks are inexpensive (mine cost \$5) and available everywhere. The joystick teaching pendant controls the motors of a two-wheel robot. Up to 30 seconds of commands can be recorded and played back. You can also use the joystick teach-

(Listing 3 continued from page 63)

```
    If RecordFlag = True Then
      If Steps <= MaxSteps Then
        RecordArray(Steps) = CInt(Motors)
        Call PutI (RecordArray(Steps))
        Call Newline
        Steps = Steps + 1
      End If
    End If
  End If
  If PlayFlag = True Then
    RecordFlag = False
    Call SetRedLed (RecordFlag)
    For Count = 1 to (Steps - 1)
      Call PutI (RecordArray(Count))
      TempByte = CByte(RecordArray (Count))
      Call SetMotors (TempByte)
      Call Newline
      Call Sleep (CmdDelay)
      If GetPin (15) = 0 Then
        PlayFlag = False
        Call PutPin (GreenLED, LedOff)
        Exit For
      End If
    Next
    PlayFlag = False
    Call PutPin (GreenLED, LedOff)
  End If
  Call Sleep (CmdDelay)
Loop
End Sub

Private Sub SetMotors (Motors As Byte)
Select Case Motors
  Case 0
    ' all stop
    Call PutPin (MotLD, 0)
    Call PutPin (MotLC, 0)
    Call PutPin (MotRD, 0)
    Call PutPin (MotRC, 0)
  Case 5
    ' forward
    Call PutPin (MotLD, 0)
    Call PutPin (MotLC, 1)
    Call PutPin (MotRD, 0)
    Call PutPin (MotRC, 1)
  Case 15
    ' reverse
    Call PutPin (MotLD, 1)
    Call PutPin (MotLC, 1)
    Call PutPin (MotRD, 1)
    Call PutPin (MotRC, 1)
  Case 1
    ' right
    Call PutPin (MotLD, 0)
    Call PutPin (MotLC, 0)
    Call PutPin (MotRD, 0)
    Call PutPin (MotRC, 1)
  Case 7
    ' hard right
    Call PutPin (MotLD, 0)
    Call PutPin (MotLC, 1)
    Call PutPin (MotRD, 1)
    Call PutPin (MotRC, 1)
  Case 4
    ' left
    Call PutPin (MotLD, 0)
    Call PutPin (MotLC, 1)
```

(Listing 3 continued on page 65)

(Listing 3 continued from page 64)

```

        Call PutPin (MotRD, 0)
        Call PutPin (MotRC, 0)
    Case 13                                ' hard left
        Call PutPin (MotLD, 1)
        Call PutPin (MotLC, 1)
        Call PutPin (MotRD, 0)
        Call PutPin (MotRC, 1)
    Case 12                                ' left reverse
        Call PutPin (MotLD, 1)
        Call PutPin (MotLC, 1)
        Call PutPin (MotRD, 0)
        Call PutPin (MotRC, 0)
    Case 3                                  ' right reverse
        Call PutPin (MotLD, 0)
        Call PutPin (MotLC, 0)
        Call PutPin (MotRD, 1)
        Call PutPin (MotRC, 1)
End Select
End Sub

Private Sub SetRedLed (Flag As Boolean)
If Flag = True Then
    Call PutPin (RedLED, LedOn)
Else
    Call PutPin (RedLED, LedOff)
    RecordFlag = False
End If
End Sub

Private Sub SetGreenLed (Flag As Boolean)
If Flag = True Then
    Call PutPin (GreenLED, LedOn)
Else
    Call PutPin (GreenLED, LedOff)
    PlayFlag = False
End If
End Sub

Private Function GetPotValue(ByVal PinNumber As Byte) As Integer
    Const CapacitorDischargeTime As Integer = 4
    Call PutPin(PinNumber, bxOutputLow)
    Call Sleep(CapacitorDischargeTime)
    GetPotValue = Rctime(PinNumber, 0)    ' Timeout returns 0.
End Function

```

ing pendant in “free” (no record or play-back) mode, controlling the robot by manually pushing the stick.

For the control electronics, we’ll connect the joystick to a BasicX-24, by way of a simple interface. The joystick interface is shown in Fig. 2. The output of the BasicX-24 can drive the motors of your robot, when connected through an H-bridge motor driver or other suitable circuit, such as relays, transistors, or power MOSFETs. The program assumes that pins 9 through 12 are used to control the two motors of a typical robot as shown in Table 1.

IBM PC-style joysticks contain ana-

log potentiometers. The resistive value of these pots changes as you move the joystick around. We actually won’t be using the analog nature of the joystick for this project, but you can add this feature in your own if you wish. For example, instead of controlling the power and direction of the motors, you could rig the joystick so that the more you push on the stick, the faster the motor goes.

Listing 3 provides the BX-24 code for the joystick teaching pendant. **Note:** This program requires the use of the SERIALPORT.BAS file, which is included with the BX-24 developer’s kit (and is available for download at the BasicX

TABLE 1

Function	BX-24 Pin
Left motor direction	9
Left motor on/off control	10
Right motor direction	11
Right motor on/off control	12

site). When creating the project file for the joystick teaching pendant, be sure to include SERIALPORT.BAS as well.

Using the Joystick Teaching Pendant

Test the program by pushing the joystick. For purposes of verification and testing, the Joystick2.Bas program uses the BasicX debug window to display the binary value of the four motor control bits (only the last four bits are used). For example, when you push the joystick forward, the text *bx0000101* is shown in the debug window. The last four bits are *0101*:

```

0—LeftMotDir
1—LeftMotCtrl
0—RightMotDir
1—RightMotCtrl

```

A value of 0 for LEFTMOTDIR/RIGHTMOTDIR means the motor is going forward (conversely, a value of 1 means the motor is going in reverse). A value of LEFTMOTCTRL/RIGHTMOTCTRL means that the motor is activated. Reading the 0101 bits, both motors are operating and are going forward. Note that the program samples the position of the joystick once every half second.

Recording and Playing Back Steps

Briefly depress button 1 (usually the “fire” button). The Red LED on the BX-24 chip will light up as a visual indicator that recording is on. In addition, a “Recording On” message is displayed in the debug window. The joystick is now in record mode, and the joystick positions are being stored in memory. Recording is simple in the Joystick2.Bas program: each half second the joystick position is stored in an element of a 60-element array. Since there are 60 elements, and a new “snapshot” of the joystick controls is made every half second, this means there is a maximum of 30 seconds of recording.

You can revise the program to add

(Continued on page 76)

Algae Hydrogen Source, Applying Taylor Series, Surplus & Auction Update, Lithium Polymer Batteries, and Understanding Nonlinearity

Many of the formulas that you'll find in electronics books are oversimplifications of the vastly fancier math behind what is really coming down. These simple formulas can get you in trouble should you try to use them without understanding their limits. We have already seen in previous columns how power measurement is *never* the average volts times average amps and how voltmeter-ammeter methods often lie like a rug. They either severely *underreport* when low duty cycles or strange waveforms are involved or misleadingly *overreport* when AC reactance lead or lag phase angles are present. Check out MUSE112.PDF and MUSE113.PDF in particular for more power measurement secrets. Another advanced concept that can cause you considerable grief is...

Understanding Nonlinearity

A *linear system* is one where if you double your input, you'll double your output. In addition, separate inputs will give separate *superpositioned* outputs, which do not interact with each other in any way. Linear systems are often assumed in most electronics math.

Sadly, real-world linear systems *do not exist*. Instead, there are *always* behavior deviations of one type or another, introducing mild to severe *nonlinearity*. Often, the inevitable nonlinearities are small enough that you can ignore them.

Other times they may not be.

Electronic rules all change in the presence of strong nonlinearity. For instance, if you take a resistor and apply a sane voltage, you should measure some current by Ohm's law. Double the voltage and your current also should double.

Now, select any silicon diode and briefly apply 0.4 volts in its forward direction. Measure the current. When you double this voltage, you will get a current that is *thousands of times* higher than before. Why? Because a diode is a classic nonlinear device. Similarly, if you apply one volt DC to a water electrolysis cell, you will measure a relatively weak current. Double it and the current increases by hundreds or thousands of times—just like a diode.

Yes, Ohm's Law is still valid. However, the resistance now *depends* upon the voltage or current you apply, rather than being some constant, which is a basic definition of nonlinearity. Let

us look at two useful tools for dealing with nonlinearities. The first of these involves...

Using Transfer Functions

A *transfer function* or a *response curve* can show the output to input ratio of nearly any "history free" physical system, linear or not. In electronics, transfer functions can relate the voltage in to voltage out, current in to voltage out, voltage in to current out, or current in to current out, depending on the device. Transfer functions can often be calculated or measured. They can be based upon observed numbers, upon theoretical math functions, on plotted graphs, or be any combination of the three. The automatic generation of suitable graphs is sometimes called *curve tracing*.

Let's look at a subtle example that seems to be causing untold grief both on the Web and in the patent office. Figure 1 shows us the very low frequency transfer function of a cell used for hydrogen electrolysis. If you remain under the threshold of 1.28 volts, only the solution conductivity will contribute to the current drawn. Above that threshold, more and more current is drawn by the electrolysis gas production itself.

Curiously, the electrons you'll get back are *not* the ones that you sent out. The outgoing electrons convert hydrogen ions into hydrogen atoms, while the incoming electrons convert oxygen ions

NEED HELP?

Phone or write all your US Tech Musings questions to:

Don Lancaster
Synergetics
Box 809-EN
Thatcher AZ, 85552
Tel: 520-428-4073

US email: don@tinaja.com
Web page: <http://www.tinaja.com>

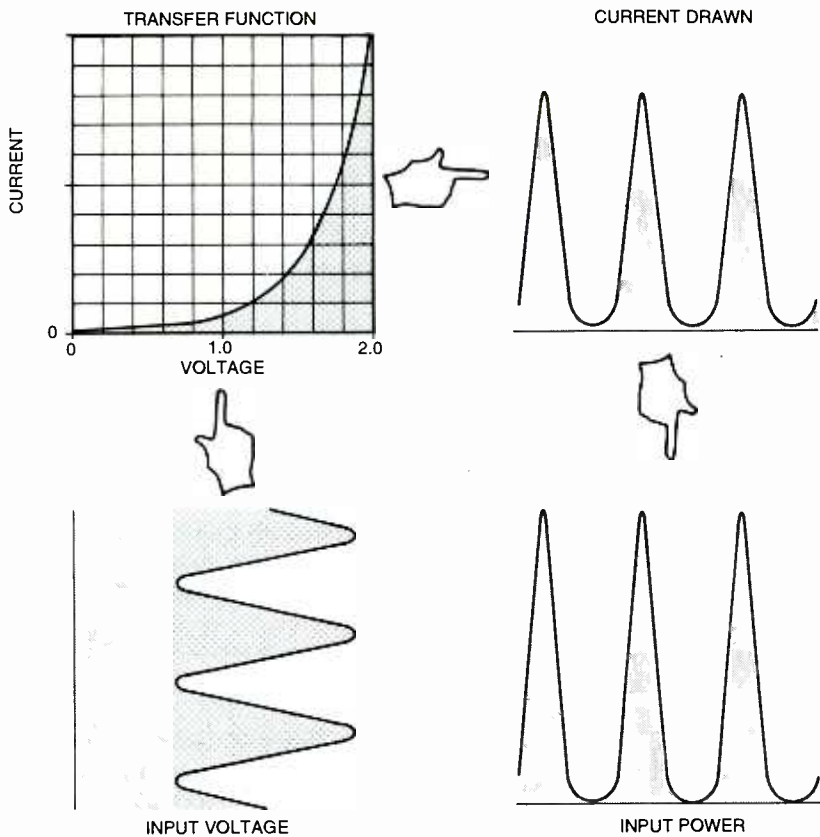

Fig. 1. A transfer function can relate the output to the input of any history-free physical system. In this low frequency hydrogen cell, extreme nonlinearity redistributes the spectral energy.

to oxygen atoms. At the terminals, any electron looks like any other electron. Since any overvoltage above the threshold sharply increases both the current and the gases liberated, the transfer function is somewhat similar to a diode or Zener and thus ends up remarkably nonlinear.

Suppose you apply a DC-biased, low-frequency AC to this cell. What will the current look like? Mathematically, you can multiply the instantaneous voltage times the transfer function to get the output current. Graphically, you can simply “bounce off” the curve, sending the voltage in on the x axis and reading the current you get out the y axis.

We see that we input a nice, clean voltage-offset sinewave, but we get a very nonlinear series of quite narrow current pulses out. When you analyze these pulses by using Fourier Series (details in MUSE90.PDF), you’ll see a strong DC term, lots of useless high harmonics, and *very little remaining fundamental sinewave energy!* Note that the narrow current pulses have rms values that are very much *higher* than their average value. Note also that the useful portions of your power pulses will be even narrower.

This is the usual source of wildly understated power measurements. There is at least one patent that claims that some audio or ultrasonic sinewaves might “resonate” a water molecule. For a dozen solid technical reasons, I personally feel that this is totally bogus. For starters, the nonlinear cell *immediately changes* most any sinewave voltage input to a strong DC term, which does a normal electrolysis, plus a bunch of useless harmonics that most likely contribute only to cell heating. The cell capacitance effects should even further significantly reduce both the fundamental and harmonics.

Now yes, a *mechanical* sonic wave might be able to shake some bubbles loose or maybe sonoluminesce, or do something similar, possibly for some modest efficiency gain, but these are completely different and acceptable “real-science” effects.

If you really wanted to prove there was a highly unlikely process such as electrically-driven audio-frequency water resonance, you would have to use input *current* waveforms instead. Why? *Because the cell’s nonlinearity trashes input voltage waveforms!*

% POSTSCRIPT MATH FUNCTION UTILITIES

```
%
=====
=====
% Copyright c 2000 by Don Lancaster
  and Synergetics, Box 809, Thatcher,
  AZ 85552
% (520) 428-4073 don@tinaja.com
  http://www.tinaja.com
% Consulting services available per
  http://www.tinaja.com/info01.html
% All commercial rights and all electronic
  media rights fully reserved.
% Personal use permitted provided head-
  er and entire file remains intact.
% Linking welcome. Reposting expressly
  forbidden.
% These PostScript-as-language routines
  show you how to generate two useful
% math functions, namely a swept
  sinewave and a classic narrow pulse.
% To use this program, move the modules
  into your code, reposition as needed
% and then distill the file. Or send the file
  to GhostScript.
```

```
sinxx {gsave translate -1000 240 div -
  1000 sin -1000 div 300 mul -1000 10
  div cos mul
moveto -1000 3 1000 { dup 0 eq {pop
  0.0001} if /val exch def val 240 div val
  sin val div
  300 mul val 10 div cos mul lineto} for
  line1 stroke grestore} def
/chirpscale 1 8 div def /chirpscale 2 def
/sweeprate 0.3 def
/chirp {gsave translate newpath 1 setline
  join -7C chirpscale mul -70 dup mul cos
  chirpscale mul moveto -70.4 .1 70.4 {
  /val exch def val chirpscale mul val
  dup mul cos
  chirpscale mul lineto} for line1 stroke
  grestore} def
%%%% demos - remove before use
%%%%
100 100 translate % position on page
0.1 dup scale % select size
16 21.2 chirp % create swept waveform
16 7.2 sinxx % create sin/x pulse
showpage % and show the page
%% EOF
```

Taylor Series

There is a useful math tool known as the *Taylor Series* that can be handy in dealing with major or minor nonlinearities.

Suppose, as in Fig. 2, you have a “bent” waveshape. Near a value of interest, you could use that value as a *zero-order approximation*. Mathematically, we can say:

$$f(x) = a_0$$

or that it is the same everywhere, which is about as useful as a stopped clock that is right twice a day. But, hey, it’s a start.

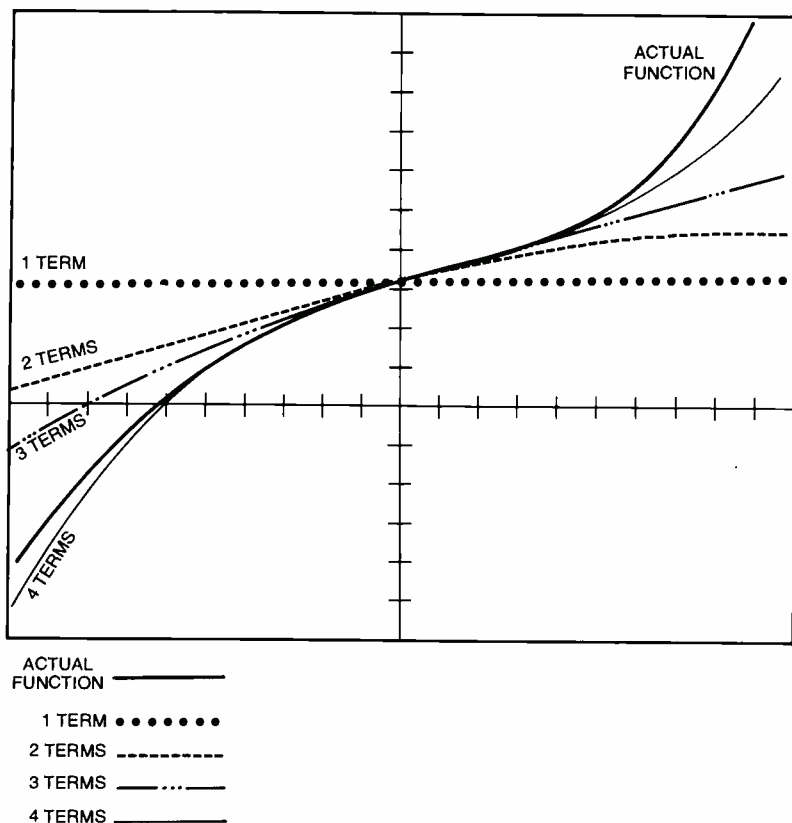

Fig. 2. Taylor Series deals with nonlinearity by breaking a curve down into separate terms.

Chances are your waveshape will have some non-horizontal slope at a point of interest. Thus, for our *first order approximation*, we'll draw a straight line through that slope at our a_0 point:

$$f(x) = a_0 + a_1x$$

This is a classic linear system with offset. You can think of a_0 as the *DC offset*, and a_1 as the *gain*. Negative gain values mean that there is a polarity or phase inversion. Gain values that range between +1 and -1 might be interpreted as *loss* or *attenuation*. This linear approximation will end up exact at one point and pretty good nearby. To try and correct the errors that are further out, we add a *second order* term to our series:

$$f(x) = a_0 + a_1x + a_2x^2$$

In other words, we try to add in a little piece of a parabola to our fitting process. This square term is the first nonlinear one. And it often will do nasty or ugly things. For instance, a square term will *multiply* an input by itself. Worse yet, it might multiply all of the inputs together. Either of these leads to harmonics, distortion, spurs, and other new frequencies that were not present in

the input. Proof of this can be found on the *trigonometric identities* page of any trig book. *Add* two sinewaves and they'll remain the same. But if you *multiply* any two sinewaves together, you'll get lots of *sum* and *difference* frequencies. Square a sinewave and you get double frequency and other more exotic terms.

The second order Taylor term may end up "good enough" for analyzing amplifier distortion or correcting the response of a thermocouple or other real world sensor. If a second order approximation is not good enough, you can add a new cubic term, a quartic, and so on. In general, *even* terms will do the *same* thing on either side of the zero point, while *odd* terms will do the *opposite*. Odd terms thus add *asymmetry*. It turns out that *higher order* terms should be more effective *away* from your zero reference, while the *lower order* terms can have more results *near* your zero reference. Normally, the *higher order* Taylor terms will be quite small and may not be needed at all.

At any rate, you use as much of a "full" Taylor Series as you need:

$$f(x) = a_0 + a_1x + a_2x^2 + a_3x^3 + \dots + a_nx^n$$

Taylor Series let you approximate many real-world responses. You can find your first n Taylor series terms from your data plot. Evaluate the plot at $n+1$ points. Then you solve $n+1$ equations in $n+1$ unknowns. This gives you a_0 through a_n . We saw an example in MUSE142.PDF

Note that the Taylor terms form a *linear* system. Thus, you can largely deal with each individual Taylor term on its own. Note also that the Taylor Series and the transfer functions can be combined.

Lithium Polymer Batteries

The "next big thing" in rechargeable batteries may use *lithium polymer* technology. Figure 3 shows us a new example from *UltraLife*. These can offer energy densities of 125 watt-hours per kilogram and 250 watt-hours per liter. A typical three-volt and one-ampere-hour cell might measure two inches by three inches by a tenth of an inch thick.

Their cycle life now exceeds 300 charge/discharge cycles. There is no "memory effect" common to heavier NiCD batteries. Prices do remain a tad high, but are certain to drop as the learning curve falls and volume production continues to ramp up. Because most batteries involve the movement of only one electron per atom, the lightest elements (such as lithium) would seem to be the best choice to maximize the watt-hours-per-kilogram density. An important problem has been getting violently reactive lithium to behave well enough to be safe for consumer products.

Extreme caution is needed when you charge a lithium battery. Special chips that monitor voltage, current, and temperature are a must. Initial charging of a nearly empty cell *must* be very gentle. One good choice for single cell charging



Fig. 3. New lithium polymer rechargeable batteries can give you one ampere-hour of storage in a credit-card sized package.

NAMES AND NUMBERS

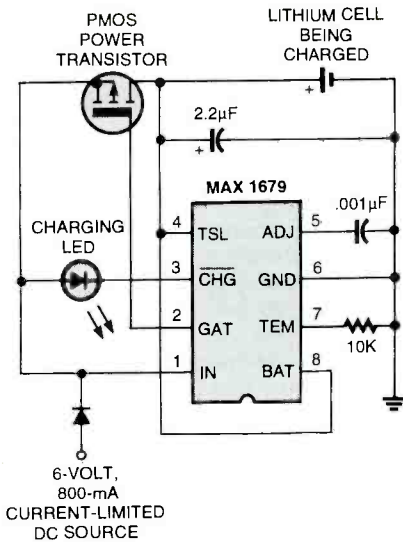

Fig. 4. Special charging circuits are needed to safely charge lithium cells. This example uses a new Maxim chip.

is the Maxim MAX1679 of Fig. 4.

Be certain to read the Maxim data sheet very carefully, for there are a few subtle "gotchas," not the least of which is that the input DC current must be current limited *externally* to the maximum fast-charging rate! Typically, you'll handle this with a 6-volt, 600-milliampere wall transformer. The optional LED has four modes: On for fast charge, weak blinking for full-charge maintenance, strong blinking for a fault, or off for no battery present or lack of input power. Evaluation kits are obtainable by way of www.maxim-ic.com. There's also some fancier versions, such as the multi-cell MAX1645.

Some Battery Books

One free resource is the *Battery Power Products & Technology* trade journal; you can locate it online at www.infowebcom.com. Useful alternate energy battery info appears in *Home Power Magazine* and their recently released *Solar CD IV*. Some more scholarly publications include *Advanced Battery Technology*, *Battery and EV Technology*, and *CA Selects: Batteries & Fuel Cells*. Many other related links are found at www.tinaja.com/b2gas01.html.

I've gathered some of the better and newer battery books together for you as this month's resource sidebar.

Plotting Real Functions

As much as possible, I try to use the "real" math in most of my figures and illustrations. For instance, the bat communications plot in last month's Fig. 4

Adobe Systems

PO Box 7900
Mountain View, CA 94039
800-833-6687
www.adobe.com

Advanced Battery Technology

913 Tressler Street
Boalsburg, PA 16827
814-466-6559
www.sevmtncsci.com

Auction Advisory

Box 61104
Phoenix, AZ 85082
602-994-4512
www.auctionadvisory.com

Battery & EV Technology

25 Van Zant Street #13
Norwalk, CT 06855
203-853-4266
buscom2@aol.com

Battery Power Online

7355 E. Orchard Road, Ste. 100
Englewood, CO 80111
800-803-9488
www.infowebcom.com/battery

CA Selects: Batteries

PO Box 3012
Columbus, OH 43210
800-848-6538
www.cas.org

e.bill

2424 American Lane
Madison, WI 53704
608-241-8777
www.ebillmag.com

Home Power

PO Box 520
Ashland, OR 97520
916-475-3179
www.homepower.com

Industrial Laser Solutions

PO Box 21288
Tulsa, OK 74121
800-752-9764
www.industrial-lasers.com

LBS

PO Box 1413
Des Moines, IA 50305
800-247-5323
www.lbsbind.com

Levy Latham

6263 N. Scottsdale Rd., Ste. 371
Scottsdale, AZ 85250
480-367-1100
www.levylatham.com

Lindsay Publications

PO Box 538
Bradley, IL 60915
815-935-5353
www.lindsaybks.com

Maxim

120 San Gabriel Dr
Sunnyvale, CA 94086
800-998-8800
www.maxim-ic.com

Science/AAAS

1333 H St. N.W.
Washington, DC 20005
202-326-6400
www.sciencemag.org

Spread Spectrum Scene

PO Box 2199
El Granada, CA 94018
800-524-9285
www.sss-mag.com

Synergetics

Box 809
Thatcher, AZ 85552
520-428-4073
www.tinaja.com

Test Equipment Connection

525 Technology Park
Lake Mary, FL 32746
800-615-8378
www.4testequipment.com

Ultralife Batteries, Inc.

2000 Technology Parkway
Newark, NY 14513
315-332-7100
www.ulbi.com

was generated from a swept sinewave and a sin x/x pulse. PostScript-as-a-language, of course, makes this trivial. As our PostScript utility example for this month, I've excerpted and modified slightly the Fig. 4 code needed to generate these two useful math functions. As usual, you first enter your PostScript code into a word processor or editor, modifying it to suit your needs. Then, be certain to save your file as an ordinary ASCII text file; do *not* use your word

processor's custom format. You then send this file to a Postscript interpreter such as Acrobat Distiller, *GhostScript*, or a PostScript-speaking laser printer. More PostScript-as-a-language is in www.tinaja.com/post01.html and in www.tinaja.com/acrob01.html. Ready to run code for this month's example can be found in the file MUSE147.PSL.

By the way, the nonlinear function that I happened to actually use in Fig. 1 is the partial Taylor Series:

new from
DON LANCASTER

ACTIVE FILTER COOKBOOK

The sixteenth (!) printing of Don's bible on analog op-amp lowpass, bandpass, and highpass active filters. De-mystified instant designs. **\$28.50**

RESEARCH INFOPACKS

Don's instant cash-and-carry flat rate consulting service. Ask any reasonable technical question for a detailed analysis and complete report. See www.tinaja.com/info01 for specifics. **\$79.00**

CMOS AND TTL COOKBOOKS

Millions of copies in print worldwide. THE two books for digital integrated circuit fundamentals. About as hands-on as you can get. **\$28.50** each.

INCREDIBLE SECRET MONEY MACHINE II

Updated 2nd edition of Don's classic on setting up your own technical or craft venture. **\$18.50**

LANCASTER CLASSICS LIBRARY

Don's best early stuff at a bargain price. Includes the CMOS Cookbook, The TTL Cookbook, Active Filter Cookbook, PostScript video, Case Against Patents, Incredible Secret Money Machine II, and Hardware Hacker II reprints. **\$119.50**

LOTS OF OTHER GOODIES

Tech Musings V or VI	\$24.50
Ask the Guru I or II or III	\$24.50
Hardware Hacker II, III or IV	\$24.50
Micro Cookbook I	\$19.50
PostScript Beginner Stuff	\$29.50
PostScript Show and Tell	\$29.50
PostScript Video & secrets	\$29.50
PostScript Reference II	\$34.50
PostScript Tutorial/Cookbook	\$22.50
PostScript by Example	\$32.50
Understanding PS Programming	\$29.50
PostScript: A Visual Approach	\$22.50
PostScript Program Design	\$24.50
Thinking in PostScript	\$22.50
LaserWriter Reference	\$19.50
Type 1 Font Format	\$16.50
Acrobat Reference	\$24.50
Whole works (all PostScript)	\$380.00
Technical Insider Secrets	FREE

BOOK-ON-DEMAND PUB KIT

Ongoing details on Book-on-demand publishing, a new method of producing books only when and as ordered. Reprints, sources, samples. **\$39.50**

THE CASE AGAINST PATENTS

For most individuals, patents are virtually certain to result in a net loss of sanity, energy, time, and money. This reprint set shows you Don's tested and proven real-world alternatives. **28.50**

BLATANT OPPORTUNIST I

The reprints from all Don's Midnight Engineering columns. Includes a broad range of real world, proven coverage on small scale technical startup ventures. Stuff you can use right now. **\$24.50**

RESOURCE BIN I

A complete collection of all Don's Nuts & Volts columns to date, including a new index and his master names and numbers list. **\$24.50**

FREE SAMPLES

Check Don's Guru's Lair at <http://www.tinaja.com> for interactive catalogs and online samples of Don's unique products. Searchable reprints and reference resources, too. Tech help, hot links to cool sites, consultants. email: don@tinaja.com
FREE US VOICE HELPLINE VISA/MC

SYNERGETICS
Box 809-EN
Thatcher, AZ 85552
(520) 428-4073

$$y = 0.15x + 2.00x^6$$

over an x range of 0 to 1. This seems to give a good low-frequency approximation to the real world response of a typical cell. However, it almost certainly does *not* reflect the true underlying physics, which should consist of an IR ion conduction term and a nonlinear 1.28-volt-thresholded gas-generation term. As I mentioned a time or two before, the definitive SPICE model for a H_2 electrolysis cell still seems to remain conspicuously absent, and it is sorely needed.

Surplus Auction Update

The feds are now in the process of privatizing many of their military surplus sales. That change seems to be driven by administrative costs that are much *higher* than their typical sale income of 0.7 cents on the dollar. The fed-run sales that remain can still be reached by clicking on the DRMS buttons on my home page.

A commercial outfit by the name of *Levy-Latham* has now taken over many of these military surplus sales. Reach them at www.levylatham.com or by clicking the LEVYLAT button on my home page. They currently offer sealed-bid plus live auctions, private treaty sales, pack-ship info, eBay auctions, and online sales. Your best source for live auction info remains Auction Advisory found at www.auctionadvisory.com. You can also click on the AUC-TADV button on my home page. These people are now nationwide, having some 75,000 live auctions published to date. I've found that I get the best results in obscure, remote, and lousy weather auctions, especially when I'm the only bidder at a site where the tech goodies are only a non-obvious and very minor part of what is being sold. Community college auctions seem particularly productive for me.

Because auctions are typically an extremely inefficient market, lowball bidding on twenty times what I could possibly use and taking a five percent success rate makes a lot of sense to me, as does heavy dumpster triage. (AC linecords with a 386 computer attached are *much* cheaper than the linecords by themselves!) One little known insider-bidding secret: You can often cut your next bid increment in half simply by waving your hand horizontally across your chest palm down. The closest approach to a used test equipment "blue book" seems to be the free catalog from

SOME BATTERY TECHNOLOGY BOOKS

- Battery Reference Book* (Thomas Crompton)
- Battery Technology Handbook* (H.A. Kiehne)
- Electric Hybrid Vehicles ... Battery Technology* (SAE)
- Electric Vehicle Battery Systems* (Sandeep Dhameja)
- Electrochemical Cell Design* (Ralph White)
- Electrochemical Power Sources* (M. Barak)
- Electrochemical Supercapacitors* (B. E. Conway)
- Electrochemistry of Novel Materials* (Jacek Lipkowski)
- Fuel Cell Systems* (Leo Blomen)
- Handbook of Batteries* (David Linden)
- Handbook of Battery Materials* (Jurgen Besenhard)
- Hydrogen & Metal Hydride Batteries* (P. D. Bennett)
- Lithium-Ion Batteries* (Masataka Wakihara)
- Lithium Polymer Batteries* (J. Broadhead)
- Modern Batteries: Intro to Electrochemical...* (C. Vincent)
- New Materials for Batteries and Fuel Cells* (D. Doughty)
- Practical Photovoltaics* (Richard J. Komp)
- River's Guide to Solar Battery Charging* (Noel Kirkby)

For more book details, see www.tinaja.com/amlink01.html

Test Equipment Connection that you should pick up at www.4testequipment.com. Divide their list prices by five to get a typical eBay price, by eight to get a fair hamfest price, and by thirty to get a sane bid on a military surplus skidded lot. Note that Hewlett Packard and Tektronix overwhelmingly dominate the used test equipment market. With a very few Wavetek, Fluke, or ancient GR exceptions, anything else is likely to end up high risk. See www.tinaja.com/resbn01.html I have test equipment bargains up at www.tinaja.com/barg01.html or by clicking on the AUCTION button on my Web site at www.tinaja.com.

New Tech Lit

The first really new thermoelectric material in three decades is described in *Science* for February 11, 2000 on pages 945+ and 924+. Although still incomplete and not more efficient than previous abysmal TE offerings, this just may be able to significantly extend thermoelectrics to amazingly low cryogenic temperatures, as well as reawakening a stagnant field of research.

A sneaky ploy to trick algae into generating hydrogen appeared in the January 2000 issue of *Plant Physiology*, authored by Melis, Zhang, and a few others on pages 127-136. The free abstract is at www.plantphysiol.org. Be sure to try and obtain one of the free Microchip Technology "over one billion sold" PR promo kits. Without my giving away the punch line, let's just say that their mailing tube uses an amazingly advanced technology. [In our recent office move, we used that technology to good effect when rehanging Hugo Gernsback's portrait in the front lobby!—Editor.] Our featured trade journals for this month are Randy Roberts' *Spread Spectrum Scene*, *Industrial Laser Solutions*, and the new *e.bill* covering Internet online payments. The latest in "old-new" books from *Lindsay Publications* are a 1944 publication titled *High Frequency Induction Heating* and their *Lead Acid Batteries* text. Reach them from their banner on my Web site. For your own banner, see www.tinaja.com/advt01.html or my BANNYEAR.PDF tutorial. Freebie samples of laser-printable hardback book-cover materials are offered by LBS. They also publish a *Cover to Cover* newsletter. More on

Book-on-demand publishing help is in www.tinaja.com/bod01.html. Several useful consulting Web sites are at www.freeagent.com, guru.com, www.expertcentral.com and my own www.tinaja.com/consul01.html and www.tinaja.com/info01.html.

Contacts and publications on underground cave radio communication can be gotten at www.sat.dumdee.ac.uk/~arb/creg. For all the fundamentals of digital integrated circuits, check into my *CMOS Cookbook* and *TTL Cookbook*, either by themselves or as part of the bargain-priced *Lancaster Classics Library* as you'll find in my nearby *Synergetics* ad. Be sure to look into my low-cost consulting services that you'll find at www.tinaja.com/info01.html, surplus bargains at www.tinaja.com/barg01.html, and banner advertising opportunities at www.tinaja.com/advt01.html. As usual, most of the mentioned references appear in our *Names & Numbers* or *Battery Books* sidebars. These are available hotlinked in the on-line version of this column, MUSE148.PDF. Be sure to check here first before you e-mail me at don@tinaja.com or calling the US tech helpline shown in the box.

Let's hear from you.

ELECTRONIC GAMES

BP69—A number of interesting electronic game projects using IC's are presented. Includes 19 different projects ranging from a simple coin flipper, to a competitive reaction game, to electronic roulette, a combination lock game, a game timer and more. To order BP69 send \$4.99 clearance (includes s&h) in the US and Canada to **Electronic Technology Today Inc., P.O. Box 240, Massapequa Park, NY 11762-0240**. US funds only. Use US bank check or International Money Order. Allow 6-8 weeks for delivery. MA07



Wireless & Electrical Cyclopedia

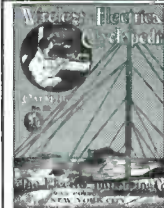

ETT1—Wireless & Electrical Cyclopedia \$4.99. Step back to the 1920's with this reprinted catalog from the Electro Importing Company. Antiquity displayed on every page with items priced as low as 3 cents. Product descriptions include: Radio components, kits, motors and dynamos, Leyden jars, hot-wire meters, carbon mikes and more. The perfect gift for a radio antique collector. To order ETT1, send \$4.99 (includes s&h) in the US and Canada to **Electronic Technology Today Inc., P.O. Box 240, Massapequa Park, NY 11762-0240**. US funds only. Use US bank check or International Money Order. Allow 6-8 weeks for delivery. MA11

RF Data Modules

AM Transmitter



- Sub Miniature module
- SAW Controlled
- No adjustable components
- Low current - 2.5mA
- Supply 2.5-12Vdc
- 418MHz or 433MHz
- Range up to 300ft
- CMOS TTL data input
- 7 x 11 x 4mm !

AM-TX1-xxx \$12.60

AM Receiver

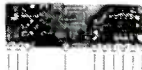

- Compact Hybrid Module
- Very stable
- CMOS/TTL output
- Patented Laser Trimmed
- 5Vdc, 0.8mA (HRR6)
- 2kHz data rate
- Sensitivity -105dBm
- 38 x 12 x 2 mm

AM-HRR6-xxxx... \$16.33

FM Transceiver



- Only 23 x 33 x 11mm
- Up to 40,000bps data rate
- Up to 450ft. range.
- 5V operation
- 418MHz or 433MHz FM
- 5V CMOS logic interface
- Fast 1mS enable
- Power saving feature
- Carrier Detect output
- BiM-xxx-F \$87.36

BiM-xxx-F \$87.36

RS232 Transceiver



- 3wire RS232 interface
- 19.2Kbps half duplex
- 418MHz or 433MHz FM
- 7.5-15Vdc, 20mA
- TX/RX Status LED's
- Up to 400ft. range
- 1/4 wave ant. on board
- User data packetizing
- 58 x 40 x 15mm

CYPHERNET \$139.30

AM Transmitter



- Range up to 250ft.
- SAW controlled stability
- Wide supply range 2-14V
- CMOS/TTL input
- Low current, 4mA typ.
- Up to 4kHz data rate
- Small, 17 x 11mm
- AN-RT5-xxx \$12.10

AN-RT5-xxx \$12.10



ABACOM
TECHNOLOGIES



tel: (416)236 3858
fax: (416)236 8866
www.abacom-tech.com
MasterCard / VISA

DIRECT FROM MANUFACTURER

WE WILL BEAT ANY COMPETITORS PRICE

WORLD SMALLEST
WIRELESS VIDEO CAMERA
(BLACK & WHITE OR COLOR)
TRANSMITS VIDEO UP TO 1000FT.

WE ALSO CARRY:

- COVERT VIDEO CAMERAS
- COUNTER-SURVEILLANCE PRODUCTS
- CUSTOM MADE VIDEO SYSTEMS
- IN HOUSE ENGINEERING DEPT.

DISTRIBUTOR PROGRAM AVAILABLE

RUNS ON 9V BATTERY FOR UP TO 12 HRS.

CALL FOR CATALOG:
SECURETEK
7175 S.W. 47TH STREET
MIAMI, FLORIDA 33155
SUITE 205
TEL. 305.667.4545
FAX. 305.667.1744
www.securetek.net

June 2000, Poptronics

Experiments With Infrared LEDs, Transistors, and Phototransistors

Welcome back. This time we are going to toss a few infrared (IR) LEDs, transistors, phototransistors, and CMOS ICs into the old circuit pot, stir it up, and see what fun and useful items turn up. Infrared LEDs and infrared-sensitive phototransistors are not only fun to experiment with but are inexpensive as well. To locate the best variety and prices try searching the ads in the *Poptronics Shopper* section of this magazine and your local parts stores. Excellent IR devices can be found for about a buck each from many suppliers and for even less on the surplus market. When it comes to purchasing the CMOS 4000-series of ICs, it's really a buyer's market. The going price, at most mail-order houses, is usually much less than a buck each in single quantities and still less on the surplus market.

Simple Electronic Switch

In our first circuit (see Fig. 1), we have an electronic switch that uses two pairs of infrared LEDs and phototransistors and a single CMOS IC. The IR devices are used in our switching circuit to eliminate the troublesome metal contacts found in all mechanically-operated contact switches. In almost every case, the first failure in an electronic piece of equipment is a mechanical component; a properly designed solid-state circuit seldom if ever fails. The only mechanical device in this circuit is the opaque switch handle that is used to block the IR light source.

The 4066 CMOS quad bilateral switch doubles the switch outputs of each IR emitter/detector pair. But before going any further, here's a brief look at the characteristics of the versatile 4066 IC. The IC contains four separate single-pole electronic switches. Each

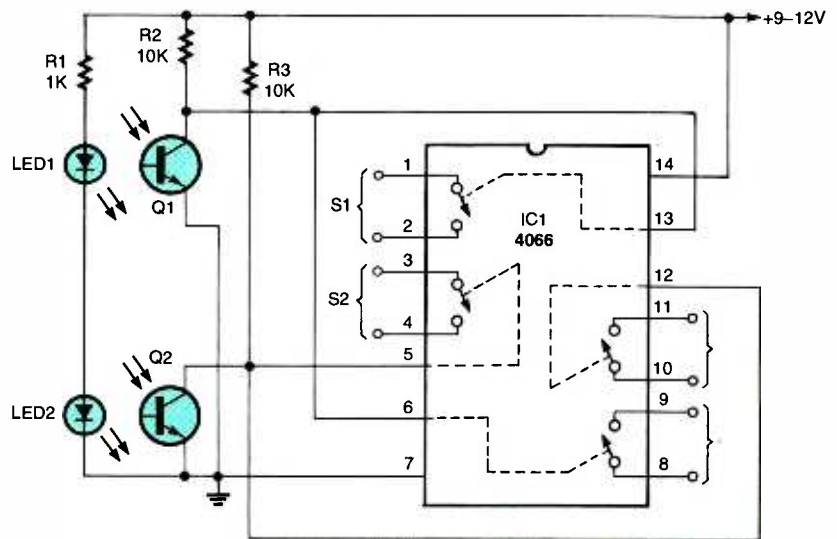

LED1-LED2 = RADIOSHACK 276-143
Q1, Q2 = RADIOSHACK 276-145

Fig. 1. This simple electronic switch is built around two pairs of infrared LEDs and phototransistors. The CMOS analog switches isolate the phototransistors from whatever load you want to drive.

one may be used separately, or all four can be combined into various switch combinations. Each switch has its own

input control pin. Connect the control pin to ground, and the switch is an open circuit. Connect the same pin to the circuit's positive supply, and the switch closes. The switch in the off position is like a very-high-impedance circuit and in the on position offers a closed resistance of slightly less than 100 ohms. There is no difference between the two switch contact terminals. The 4066 will operate at a maximum speed of 10-MHz with a 12-volt power source. And just about any number of 4066 ICs can be driven by the same input to multiply the number of output switches.

Now back to our circuit in Fig. 1. When neither IR light source is blocked, transistors Q1 and Q2 are biased on with a collector voltage near zero. All of the 4066's control inputs are at ground potential and the four switches are open.

PARTS LIST FOR THE SIMPLE ELECTRONIC SWITCH (FIG. 1)

SEMICONDUCTORS

IC1—4066B CMOS quad analog switch, integrated circuit
Q1, Q2—IR phototransistor
LED1, LED2—Light-emitting diode, infrared

RESISTORS

(All resistors are 1/4-watt, 5% units.)
R1—1000-ohm
R2, R3—10,000-ohm

PARTS LIST FOR THE MECHANICAL INFRARED SWITCH (FIG. 2)

Block of wood, plastic or similar material to construct switch block, circuit-board material or similar opaque material for the switch handle (see text)

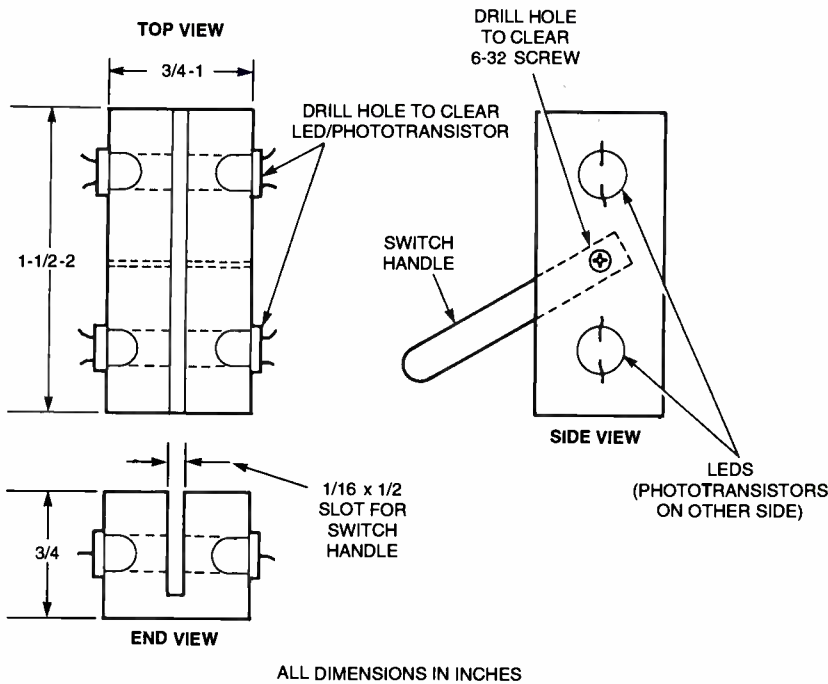

Fig. 2. You can use infrared LED/phototransistor pairs in an optical switch. Throwing the handle to either extreme blocks one of the pairs. An advantage of this arrangement is that you can sense if the handle is only thrown half way.

Placing an opaque object between any of the IR emitter/detector pairs will cause that transistor's collector voltage to rise to the positive supply, turning on the two switches it controls.

Mechanical Details

A 3/4- to 1-inch-square block of wood, opaque plastic, or any similar material that is 1 1/2- to 2-inches long may be used

to build a two-pole IR electronic switch. The actual dimensions are not critical, so we can be inventive. The drawing in Fig. 2 is a guide to making your own mechanical version of an electronic knife switch. You can use any scheme that allows an opaque object to block and unblock the IR light source. The basic idea is to have the phototransistor and LED face each other with a separa-

tion of no more than about 1/2-inch. The actual range of separation can be several inches if the application dictates, but you have to make sure that no ambient light reaches the phototransistor when it is blocked from receiving the LED's IR light source. Even though the phototransistors are designed to be IR sensitive, most will respond to other light sources. One way to overcome the ambient light problem is to have the blocking device located as close to the phototransistor as possible, thereby blocking all light sources that are exposed to the detector.

Simple Optical Electronic Lock

Our next IR light circuit is in Fig. 3. It is an electronic lock that requires a simple programmed key to open and close the lock. Three pairs of IR LEDs and phototransistors are arranged very much like what was done in the previous circuit. The key can be made out of circuit board material, cardboard, or some other opaque material with a single 1/4-inch hole (see drawing of key in Fig. 3). It is used to unlock the electronic locking circuitry.

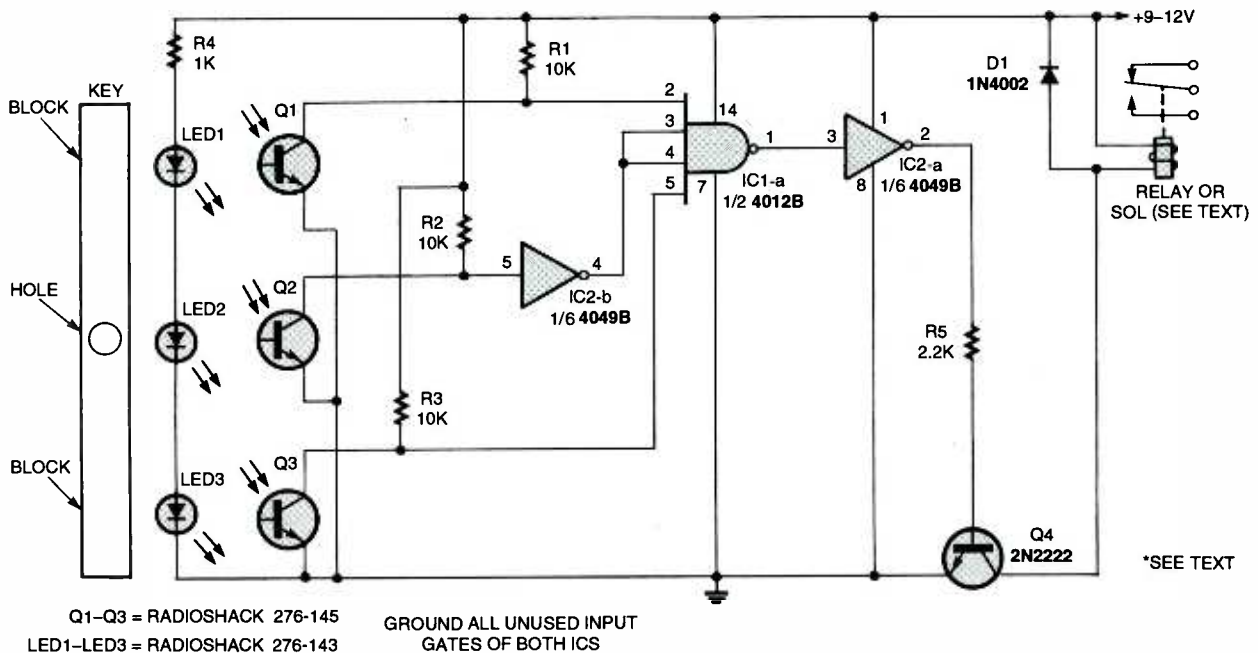

Fig. 3. A simple programmed key operates this basic electronic lock.

PARTS LIST FOR THE SIMPLE ELECTRONIC LOCK (FIG. 3)

SEMICONDUCTORS

IC1—4012B CMOS dual four-input NAND gate, integrated circuit
 IC2—4049B CMOS hex inverter, integrated circuit
 Q1—Q3—IR phototransistor
 Q4—2N2222 NPN transistor
 LED1—LED3—Light-emitting diode, infrared

RESISTORS

(All resistors are 1/4 watt, 5% units.)
 R1—R3—10,000-ohm
 R4—1000-ohm
 R5—2200-ohm

ADDITIONAL PARTS AND MATERIALS

Relay or solenoid, material for key, mounting block for IR devices, etc.

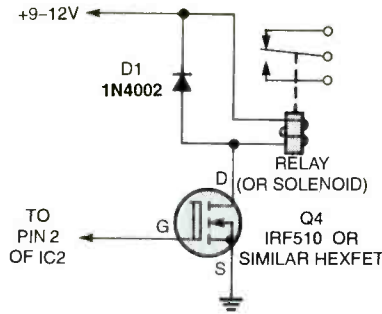

Fig. 4. For heavy-duty requirements over 100 mA, a hexFET driver is needed to handle the higher current load.

Two CMOS ICs are used to handle the lock's simple logic circuitry. IC1 is a 4012 dual 4-input NAND gate. All four inputs of the NAND gate must be high to produce a low output. If one or more of the inputs are low, the output will be high. Our circuit only uses one of the four input NAND gates. The unused NAND gates must have all inputs tied to

PARTS LIST FOR THE ELECTRONIC LOCK DRIVER (FIG. 4)

Q4—IRF510 hexFET field-effect transistor
 D1—1N4002 silicon diode
 Relay or solenoid

circuit ground. This is necessary to keep the unused gates from interaction with the operating gate. When using CMOS logic ICs, all unused inputs should be tied to either battery positive or battery negative. IC2 is a 4049 hex-inverting buffer that simply inverts the input signal.

When the key is not in place, all phototransistors are flooded with an IR source and are turned on producing a near zero voltage at their collectors. The inputs at pins 2 and 5 of IC1 are low and if any input of a NAND gate is low, the output will always be high. The low out-

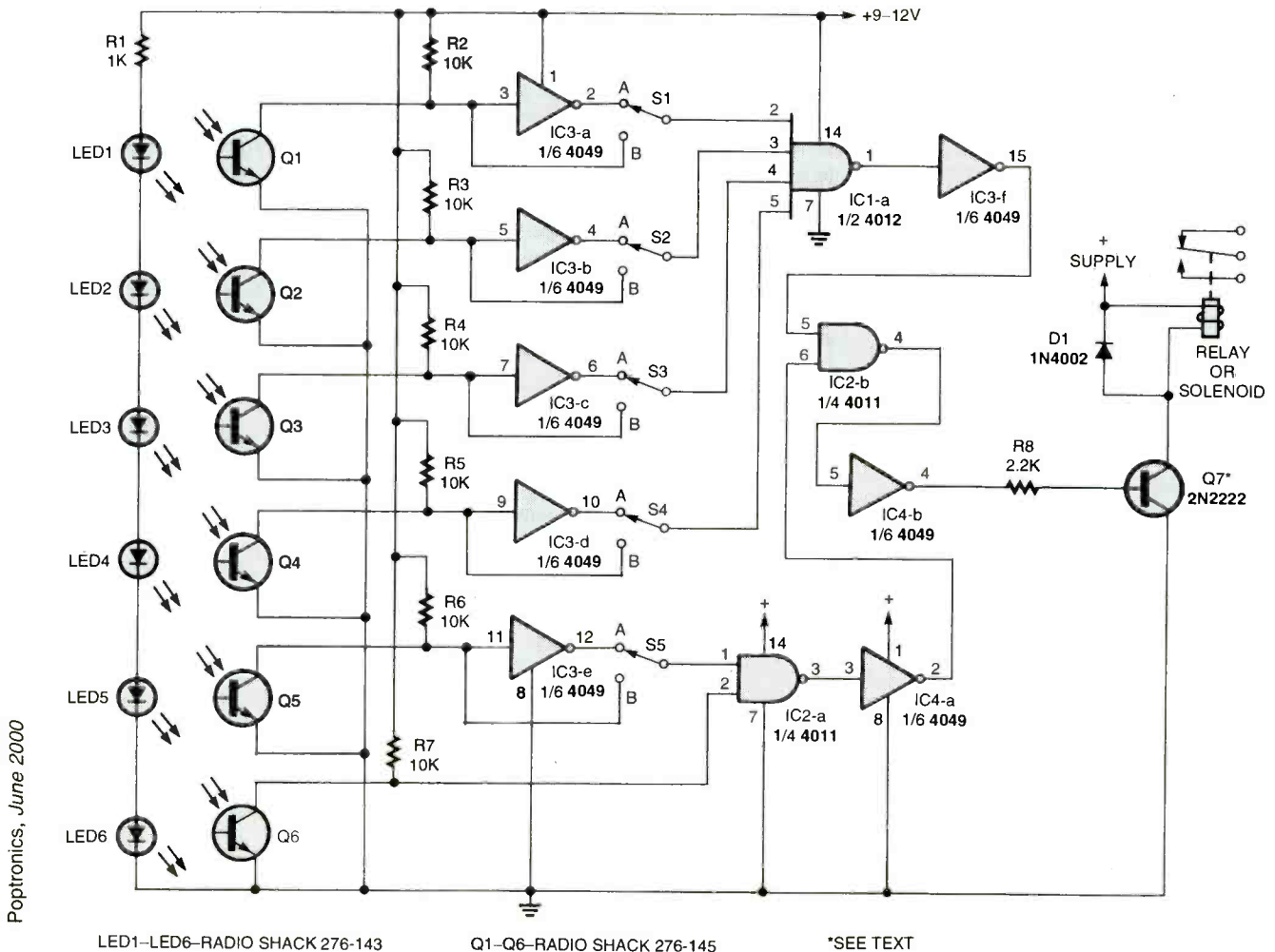

LED1—LED6—RADIO SHACK 276-143

Q1—Q6—RADIO SHACK 276-145

*SEE TEXT

PARTS LIST FOR THE COMPLEX ELECTRONIC LOCK (FIG. 5)

SEMICONDUCTORS

LED1-LED6—Light-emitting diode, infrared

Q1-Q5—IR phototransistor

Q7—2N2222 NPN transistor

IC1—4012B CMOS dual four-input NAND gate, integrated circuit

IC2—4011B CMOS quad two-input NAND gate, integrated circuit

IC3, IC4—4049B hex inverter, integrated circuit

RESISTORS

(All resistors are 1/4-watt, 5% units.)

R1—1000-ohm

R2, R7—10,000-ohm

R8—2200-ohm

ADDITIONAL PARTS AND MATERIALS

S1-S5—Single-pole, double-throw toggle switch

Relay or solenoid, IC sockets, material for key and IR devices, etc.

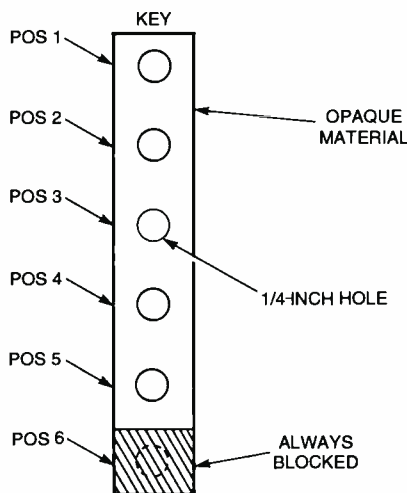
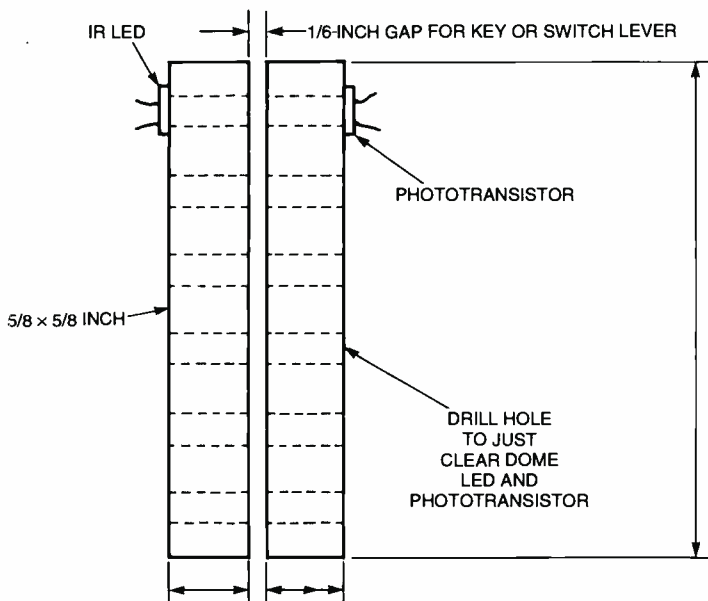

Fig. 6. One way you can arrange the IR LEDs and phototransistors is to create a slot for the key. As you swipe an opaque card with holes cut in it to match the required pattern of blocked and unblocked pairs, the circuit activates when the patterns match.

put at the collector of Q2 is inverted by IC2 to a high, which ties to inputs 3 and 4 of IC1. The high output of IC1 is inverted by IC2 to a low at the base of Q4. This turns Q4 off, and the relay or solenoid is not activated.

Inserting a key with a hole in the middle position blocks the IR light source from Q1 and Q3, but allows Q2 to continue receiving its IR signal. The collectors of Q1 and Q3 go high to produce a high at input pins 2 and 5 of IC1. Now all inputs of IC1 are high, and its output is low. IC2 inverts the low output, supplying a positive input to the base of Q4, turning it on, and activating the relay or solenoid to unlock whatever is attached.

The circuit shown in Fig. 3 will operate a relay or solenoid that requires no more than 100-mA, but if a heavy-duty solenoid or relay is required, you can use the hexFET driver circuit shown in Fig. 4. An IRF510 hexFET can handle up to 3 to 5 amps in the driver circuit.

More Complex Lock Circuit

Our next design (see Fig. 5) is an expanded version of the electronic lock circuit. This one offers greater security by increasing the number of IR pairs to six. This expanded circuit requires two

4049 hex inverters, a 4012 four-input NAND gate, and a 4011 quad two-input NAND gate to take care of the added logic functions. Five pass/block selector switches are added to give greater versatility in programming the circuit for various key configurations.

The drawing in Fig. 6 shows one way of arranging the IR LEDs and phototransistors on an opaque block of wood, plastic, or similar material. Now the key can be inserted into the slot to operate the lock circuit. This is by no means the only arrangement that will work. The IR devices could be arranged so that a credit card shaped key could be used to activate the lock. Design your own unique arrangement. It will make it much more difficult for someone to operate or

PARTS LIST FOR THE SLOTTED-CARD SENSOR FIG. 6

Wood, or similar opaque material for IR devices and key.

bypass your electronic lock. The key can be made out of any opaque material that will slide down the slot between the IR devices. Set your imagination free.

The lock circuit is designed to read the output of the first five IR pairs only when the last IR source is blocked (LED6 and Q6). This arrangement insures that the key must be fully inserted into the lock before the circuit reads the input code. Switches S1 through S5 are used to select either a blocked or

unblocked logic output that is fed to the gate inputs of IC1 and IC2-a. The circuit can only unlock when all six inputs of IC1 and IC2-a are high. If the position on the key is programmed to block an IR source, the corresponding selector switch must be placed in the "B" position to allow the high at that collector to be fed to the input of the NAND gate. If the position on the key is programmed to pass the IR source, the corresponding selector switch must be placed in the "A" position. The 4049 inverter changes the low to a high and sends it on to the input of the NAND gate. A key may be programmed with up to twenty-five different combinations of blocked and unblocked positions. Therefore, twenty-five different keys may be made and used with the circuit by setting the five selector switches to their proper positions for any given key.

Without a key in place, all six phototransistors are flooded with IR light and are turned on with their collectors at near ground level. If all of the selector switches are placed in the "B" position and a key without any holes (set up to block all positions) is slid into position, the circuit will unlock.

With all selector switches set in the "A" position and a key with holes in all of the first five positions (the last position must always be blocked) moved into position, the circuit also will unlock. Here's how the logic must function for the circuit to unlock and operate the relay or solenoid. When all of the inputs of IC1 and IC2 are high, their outputs are both low. Inverters IC3-f and IC4-a invert the lows to highs. This brings both inputs of IC2-b high, which produces a low output. This low is inverted by IC4-b to a high that turns Q7 on, operating the relay or solenoid.

As in the previous circuit, output driver Q7 may be replaced with the higher powered IRF510 hexFET driver circuit. The electronic lock circuit can be expanded to as many positions as desired by adding IR LED/phototransistor pairs and the necessary logic circuitry.

Here's hoping that at least one of the basic circuits we looked at this visit will be helpful to you in a present or future project. In any case, be sure to be here next month, same time, same station. Good circuitry!

Great consumer information is a shoe-in with our free Catalog. Call toll-free 1 (888) 8-PUEBLO or go to www.pueblo.gsa.gov.

ROBOTICS WORKSHOP

(continued from page 65)

longer programming time, but take note that the BX-24 has 400 bytes of memory; the more elements, the more memory is consumed. As written, Joystick2.Bas consumes about 190 bytes of RAM, so there is room for expansion if you so wish.

When you are done recording the steps you want, *briefly* depress button 1 again. The joystick will be taken out of record mode. You can play back your previously stored steps by *briefly* depressing button 2. While playing a previously stored set of steps, any joystick motions are ignored. If necessary, you can abort play mode at any time by depressing button 2 again. When playback is complete, the program goes back into "free run" mode.

Possible Enhancements

You can add a number of enhancements. One is to increase the number of steps per second. This is done by decreasing the value:

$$\text{mdDelay As Integer} = 256$$

The value 256 is approximately one half of a second, so 128 would be a quarter second, 64 would be an eighth of a second, and so forth. Be aware that the smaller the number, the more steps that are recorded per second, so the faster the 60-element array will fill.

This concludes our look at the BasicX-24 microcontroller. Next month, we'll cover some "back to basics" topics, including motor control and sensor-interfacing techniques. P

ELECTRONIC SECURITY DEVICES

A great book for project builders. It is quite common to associate the term "Security Devices" with burglar alarms of various types. However in fact it can refer to any piece of equipment that helps to protect people or property. The text is divided into three basic sections: Chapter 1 covers switch-activated burglar alarms and includes exit and entry delays. Chapter 2 discusses other types of burglar alarms and includes Infra-Red, Ultrasonic and Doppler-Shift Systems. Chapter 3 covers other types of security devices such as Smoke and Gas Detectors; Water, Temperature and Baby Alarms; Doorphones, etc. Most circuits are simple, and stripboard layouts are provided.



To order Book BP56 and send \$5.99 includes shipping and handling in the U.S. and Canada only to **Electronics Technology Today Inc.**, P.O. Box 240, Massapequa Park, NY 11762-0240. Payment in U.S. funds by U.S. Bank check or International Money Order. Please allow 6-8 weeks for delivery. ET09

VCR Cross Reference

NOW Find the right Part for your VCR

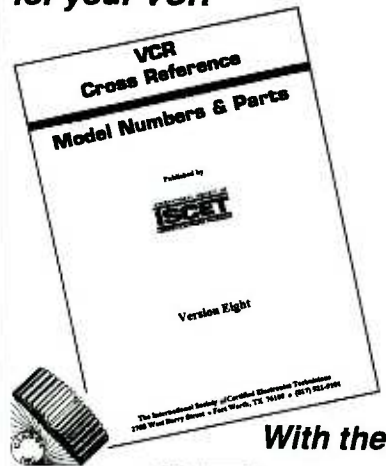

With the

ISCET VCR

CROSS REFERENCE

This 172-page reference contains both model and part-number cross-references updated as of Feb, 1997.

VCR's are made in a few factories from which hundreds of different brand names and model numbers identify cosmetically-changed identical and near-identical manufactured units. Interchangeable parts are very common. An exact replacement part may be available only a few minutes away from you even though the manufacturer supplier is out-of-stock. You may be able to cannibalize scrap units at no cost!

The ISCET VCR Cross Reference is pre-punched for standard loose-leaf binding. . . \$29.95 includes shipping in the United States for each Reference.

Clagg Inc.
VCR CROSS REFERENCE OFFER
P.O. BOX 12162
HAUPPAUGE, NY 11778

Name _____
Business _____
Address _____
City _____
State _____ Zip _____
Phone _____

Enclose \$29.95 for the Eighth Edition of the ISCET VCR Cross Reference including shipping for each Reference in the United States. All other countries add \$5.00 (surface mail).

The total amount of my order is \$ _____.

Check enclosed—do not send cash.

or please charge my credit card.

Visa MasterCard Exp. Date ____/____/____

Card No. _____

Signature _____

New York State residents must add applicable local sales tax to total. US funds only. Use US bank check or International Money Order. CB02

Poptronics®

SHOPPER[®]

Polaris Video Cameras for all environments

Wireless Camera System

GW-2400S - \$449.95
Includes: 2.4 Ghz Color Wireless Camera, 4-Channel Receiver with Built-In Monitor

GC-2400 \$269.95 (monitor/receiver)

GC-2400 \$229.95 (camera)

Get Cell Batteries for wireless equipment

Flat Screen TFT-LCD Monitors

TFT-4 \$179.95
4" Screen. (Size: 6"(W) x 4.5"(H) x 2"(D))
An excellent monitor for one camera monitoring or for setting up cameras during installation or maintenance. Several Sizes Available.

Camera with Vari-Focal Lens

Micro "ZOOM" Lens
MB-1250HRVF \$199.95

470 TV Line Color Board Camera with a 4-8mm Vari-focal lens.

- MB-1250HRVF \$199.95 High-Res Vari-Focal Color Camera
- MB-1250HRp \$149.95 High-Res Pinhole Color Camera
- MB-1250p \$99.95 Low-Res Pinhole Color Camera

Live Remote Video Server

NETVID-6x6M \$1595.95
(Includes software)

View Up To Six Live Camera Locations on Your PC!

NETVID-6x6M Server... Works 3-Ways!

1. Over standard phone line or ISDN.
2. Internet using Internet Explorer or Netscape Navigator.
3. PC - LAN/Network.

PC remote software allows user to dial into NETVID-6x6M Server from any location!
Includes: NETVID-6x6M server, Software & Modem.

Dial-Up Video Security for:

- Security/Intrusion • Detect & Photograph Intruders
- Corporate management tool • Beach House, Cabin
- View your home while at work • Save to a Hard Drive

CM-500c \$129.95
Aluminum cased Color camera with mounting bracket.

Dimensions: 1.5" Sq

LP-850w \$169.95
Built-In Infrared Illuminator, Camera can See in the Dark without Additional Light Source!
1.4"(Dia.) x 1.8"(L) w/o stand

Color weatherproof video camera. WP-3000c \$229.95
1"(Dia.) x 2.6"(L) w/o stand

B/W & Color C-Mount Cameras

The CM-220 & CM-220c are truly outstanding performance cameras with 380 Line Resolution with C-Mount option. Color CMOS Camera: CM-220C \$139.95

B/W CMOS Camera: CM-220 \$69.95
(Comes with a 3.6mm lens, Shown)

VFL-50 an excellent Lens for this camera!

B/W CMOS Camera: CM-220C \$69.95
(Comes with a 3.6mm lens B/W model comes with stand)

LIPSTICK CAMERAS

LP-850p \$119.95
Length: 1.37" Diameter: .87" B/W Model

LP-850i \$109.95
Length: 1.9" Diameter: .91" B/W Model

Polaris Industries
<http://www.polarisusa.com>
800.752.3571

Free Polaris Video Catalog

Polaris Industries 470 Armour Dr. Atlanta GA 30324 • Tech Info: 404.872.0722 FAX: 404.872.1038

RAMSEY

Doppler Direction Finder

Track down jammers and hidden transmitters with ease! This is the famous WA2EBY DF'er featured in April 99 QST. Shows direct bearing to transmitter on compass style LED display, easy to hook up to any FM receiver. The transmitter - the object of your DF'ing - need not be FM, it can be AM, FM or CW. Easily connects to receiver's speaker jack and antenna, unit runs on 12 VDC. We even include 4 handy home-brew "mag mount" antennas and cable for quick set up and operation! Whips can be cut and optimized for any frequency from 130-1000 MHz. Track down that jammer, win that fox hunt, zero in on that downed Cessna - this is an easy to build, reliable kit that compares most favorably to commercial units costing upwards of \$1000.00! This is a neat kit!!

DDF-1, Doppler Direction Finder Kit \$149.95

Wireless RF Data Link Modules

RF link boards are perfect for any wireless control application; alarms, data transmission, electronic monitoring...you name it. Very stable SAW resonator transmitter, crystal controlled receiver - no frequency drift! Range up to 400 feet, license free 433 MHz band. Encoder/decoder units have 12 bit Holtek HT-12 series chips allowing multiple units all individually addressable, see web site for full details. Super small size - that's a quarter in the picture! Run on 3-12 VDC. Fully wired and tested, ready to go and easy to use!

RX-433 Data Receiver..... \$16.95 TX-433 Data Transmitter..... \$14.95
RXD-433 Receiver/Decoder..... \$21.95 TXE-433 Transmitter/Encoder..... \$19.95



World's Smallest TV Transmitters



We call them the 'Cubes'.... Perfect video transmission from a transmitter you can hide under a quarter and only as thick as a stack of four pennies - that's a nickel in the picture! Transmits color or B&W with fantastic quality - almost like a direct wired connection to any TV tuned to cable channel 59. Crystal controlled for no frequency drift with performance that equals models that cost hundreds more! Basic 20 mW model transmits up to 300' while the high power 100 mW unit goes up to 1/4 mile. Their very light weight and size make them ideal for balloon and rocket launches, R/C models, robots - you name it! Units run on 9 volts and hook-up to most any CCD camera or standard video source. In fact, all of our cameras have been tested to mate perfectly with our Cubes and work great. Fully assembled - just hook-up power and you're on the air! One customer even put one on his dog!

C-2000, Basic Video Transmitter..... \$89.95

C-2001, High Power Video Transmitter..... \$179.95

CCD Video Cameras



Top quality Japanese Class 'A' CCD array, over 440 line line resolution, not the off-spec arrays that are found on many other cameras. Don't be fooled by the cheap CMOS single chip cameras which have 1/2 the resolution, 1/4 the light sensitivity and draw over twice the current! The black & white models are also super IR (Infra-Red) sensitive. Add our invisible to the eye, IR-1 illuminator kit to see in the dark! Color camera has Auto gain, white balance, Back Light Compensation and DSP! Available with Wide-angle (80°) or super slim Pin-hole style lens. Run on 9 VDC, standard 1 volt p-p video. Use our transmitters for wireless transmission to TV set, or add our IB-1 interface board kit for super easy direct wire hook-up to any video monitor, VCR or TV with AV input. Fully assembled, with pre-wired connector.

CCDWA-2, B&W CCD Camera, wide-angle lens \$69.95
CCDPH-2, B&W CCD Camera, slim fit pin-hole lens \$69.95
CCDCC-1, Color CCD Camera, wide-angle lens \$129.95
IR-1, IR Illuminator Kit for B&W cameras \$24.95
IB-1, Interface Board Kit \$14.95

AM Radio Transmitter



Operates in standard AM broadcast band. Pro version, AM-25, is synthesized for stable, no-drift frequency and is settable for high power output where regulations allow, typical range of 1-2 miles. Entry-level AM-1 is tunable, runs FCC maximum 100 mW, range 1/4 mile. Both accept line-level inputs from tape decks, CD players or mike mixers, run on 12 volts DC. Pro AM-25 includes AC power adapter, matching case and bottom loaded wire antenna. Entry-level AM-1 has an available matching case and knob set that dresses up the unit. Great sound, easy to build - you can be on the air in an evening!

AM-25, Professional AM Transmitter Kit. \$129.95
AM-1, Entry level AM Radio Transmitter Kit... \$29.95
CAM, Matching Case Set for AM-1..... \$14.95

Mini Radio Receivers



Imagine the fun of tuning into aircraft a hundred miles away, the local police/fire department, ham operators, or how about Radio Moscow or the BBC in London? Now imagine doing this on a little radio you built yourself - in just an evening! These popular little receivers are the nuts for catching all the action on the local ham, aircraft, standard FM broadcast radio, shortwave or WWW National Time Standard radio bands. Pick the receiver of your choice, each easy to build, sensitive receiver has plenty of crystal clear audio to drive any speaker or earphone. Easy one evening assembly, run on 9 volt battery, all have squelch except for shortwave and FM broadcast receiver which has subcarrier output for hook-up to our SCA adapter. The SCA-1 will tune in commercial-free music and other 'hidden' special services when connected to FM receiver. Add our snazzy matching case and knob set for that smart finished look!

AR-1, Airband 108-136 MHz Kit \$29.95 FR-6, 6 Meter FM Ham Band Kit \$34.95
HFRC-1, WWV 10 MHz (crystal controlled) Kit \$34.95 FR-10, 10 Meter FM Ham Band Kit \$34.95
FR-1, FM Broadcast Band 88-108 MHz Kit \$24.95 FR-146, 2 Meter FM Ham Band Kit \$34.95
SR-1, Shortwave 4-11 MHz Band Kit \$29.95 FR-220, 220 MHz FM Ham Band Kit \$34.95
SCA-1 SCA Subcarrier Adapter kit for FM radio..... \$27.95 Matching Case Set (specify for which kit) \$14.95

PIC-Pro Pic Chip Programmer



Easy to use programmer for the PIC16C84, 16F84, 16F83 microcontrollers by Microchip. All software - editor, assembler, run and program - as well as free updates available on Ramsey download site! This is the popular unit designed by Michael Covington and featured in Electronics Now, September 1998. Connects to your parallel port and includes the great looking matching case, knob set and AC power supply. Start programming those really neat microcontrollers now...order your PICPRO today!

PIC-1, PICPRO PIC Chip Programmer Kit \$59.95

Order Toll-free: 800-446-2295

Sorry, no tech info, or order status at 800 number

For Technical Info, Order Status

Call Factory direct: 716-924-4560

1 GHz RF Signal Generator



A super price on a full featured RF signal generator! Covers 100 KHz to 999.99999 MHz in 10 Hz steps. Tons of features; calibrated AM and FM modulation, 90 front panel memories, built-in RS-232 interface, +10 to -130 dBm output and more! Fast and easy to use, its

big bright vacuum florescent display can be read from anywhere on the bench and the handy 'smart-knob' has great analog feel and is intelligently enabled when entering or changing parameters in any field - a real time saver! All functions can be continuously varied without the need for a shift or second function key. In short, this is the generator you'll want on your bench, you won't find a harder working RF signal generator - and you'll save almost \$3,000 over competitive units!

RSG-1000B RF Signal Generator \$1995.00

Super Pro FM Stereo Transmitter



Professional synthesized FM Stereo station in easy to use, handsome cabinet. Most radio stations require a whole equipment rack to hold all the features we've packed into the FM-100. Set freq with Up/Down buttons, big LED display. Input low pass filter gives great sound (no more squeals or swishing from cheap CD inputs!) Limiters for max 'punch' in audio - without over mod, LED meters to easily set audio levels, built-in mixer with mike, line level inputs. Churches, drive-ins, schools, colleges find the FM-100 the answer to their transmitting needs, you will too. Great features, great price! Kit includes cabinet, whip antenna, 120 VAC supply. We also offer a high power export version of the FM-100 fully assembled with one watt of RF power, for miles of program coverage. The export version can only be shipped if accompanied by a signed statement that the unit will be exported.

FM-100, Pro FM Stereo Transmitter Kit \$249.95

FM-100WT, Fully Wired High Power FM-100 \$399.95

FM Stereo Radio Transmitters



No drift, microprocessor synthesized! Great audio quality, connect to CD player, tape deck or mike mixer and you're on-the-air. Strappable for high or low power! Runs on 12 VDC or 120 VAC. Kit includes snazzy case, whip antenna, 120 VAC power adapter - easy one evening assembly.

FM-25, Synthesized Stereo Transmitter Kit \$129.95

Lower cost alternative to our high performance transmitters. Great value, easily tunable, fun to build. Manual goes into great detail about antennas, range and FCC rules. Handy for sending music thru house and yard, ideal for school projects too - you'll be amazed at the exceptional audio quality! Runs on 9V battery or 5 to 15 VDC. Add matching case and whip antenna set for nice 'pro' look.

FM-10A, Tunable FM Stereo Transmitter Kit \$34.95

CFM, Matching Case and Antenna Set \$14.95

FMAC, 12 Volt DC Wall Plug Adapter \$9.95

RF Power Booster



Add muscle to your signal. boost power up to 1 watt over a freq range of 100 KHz to over 1000 MHz! Use as a lab amp for signal generators, plus many foreign users employ the LPA-1 to boost the power of their FM transmitters, providing radio service through an entire town. Runs on 12 VDC. For a neat finished look, add the nice matching case set. Outdoor unit attaches right at the antenna for best signal - receiving or transmitting, weatherproof, too!

LPA-1, Power Booster Amplifier Kit \$39.95

CLPA, Matching Case Set for LPA-1 Kit \$14.95

LPA-1WT, Fully Wired LPA-1 with Case \$99.95

FMBA-1, Outdoor Mast Mount Version of LPA-1 \$59.95

FM Station Antennas



For maximum performance, a good antenna is needed. Choose our very popular dipole kit or the Comet, a factory made 5/8 wave colinear model with 3.4 dB gain. Both work great with any FM receiver or transmitter.

TM-100, FM Antenna Kit \$39.95

FMA-200, Vertical Antenna \$114.95

RAMSEY ELECTRONICS, INC.

793 Canning Parkway Victor, NY 14564

See our complete catalog and order on-line with our secure server at:

www.ramseyelectronics.com



ORDERING INFO: Satisfaction Guaranteed. Examine for 10 days, if not pleased, return in original form for refund. Add \$6.95 for shipping, handling and insurance. Orders under \$20, add \$3.00. NY residents add 7% sales tax. Sorry, no CODs. Foreign orders, add 20% for surface mail or use credit card and specify shipping method.

CIRCLE 263 ON FREE INFORMATION CARD

AVEN

Delivering Performance With Value

e-mail: info@aventools.com • website: www.aventools.com

MICROSCOPES

System 703
Stereo Inspection Microscope
Part #26.703

Price \$270.00

- Adjustable interpupillary distance between 2.5" (55mm) and 3.4" (75mm)
- Slide mount objectives for rapid magnification change
- Provides a long working distance of 6" at 10x magnification
- Built-in illuminator with articulating arm allows infinite positioning
- Weighted stand with 9" arm is fully adjustable
- Magnification 5x, 10x, and 20x
- 5 year limited warranty



System 707
Deluxe Stereo Microscope
Part #26.707

Price \$266.00

- Selectable 20x or 40x magnification
- Bottom transmitted and overhead illuminators
- Rotary turret mounted with posture click stop for easy power change
- Precision rack and pinion focus
- 45 degree inclined eye tubes
- Working distance 3.15" at 20x
- Incandescent (12w/10w) and Halogen (12w/10w) lights



CABLETESTERS

Multi-Network Cable Tester
Part #25.102

Price \$94.50

- Quickly tests by auto scanning
- Suitable for thin ethernet (BNC) /10 Base T, (UTP/STP) /356A /TIA 568A /TIA-568B /token ring
- Use attached remot terminator to test cable before or after the cables are installed. Also allows you to test the ground of shielded twisted pair cable.



Multi-Modular Cable Tester
Part #25.022

Price \$76.82

- Quickly test by auto scanning modular cables USOC4/USOC6/USOC8: terminating with RJ45, RJ12 and RJ11 modular plug
- Comes with remote terminator, allows you to test installed cables.



TOOLKITS

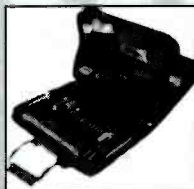

22 PC Aven Personal Computer Tool Kit
Part #15.014

Price \$75.00



22 PC Aven Basic Electronic Tool Kit
Part #15.019

Price \$59.60

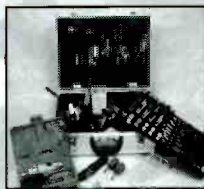

73 PC Aven Master Electronic Tool Kit
Part #15.018

Price \$234.69

- Includes super drill set
- Aluminum Case



47 PC Aven Premier Compact Technicians Kit
Part #15.004

Price \$132.83



88 PC Premier Field Service Kit
Part #15.006

Price \$244.90

- Comprehensive assortment of tools for servicing electronics
- Double-sided case



Professional Multimeter
Part #25.015

Price \$35.75



20 PC Precision Screwdriver Set With Interchangeable Blades
Part #13.714

Price \$16.64

- This useful set contains 19 assorted Slotted/Philip/Star/Hex/Ball point/Blades. Special quick release designed, make blade changes quick and easy



Digital Soldering Station
Part #17.510

Price \$132.65

- Ceramic heater unit for quick start
- Temperature adjustment: 160-480 celcius
- Six different tip sizes available as options
- Perfect for most soldering applications including SMD
- ESD Safe



Perfectly Balanced Fluorescent Lighting With A Precision 3 Diopter Magnifier Lens
Part #26.501

Price \$77.90

- 45 inch extension arm
- The shade with handle lets you bring the light where you want
- 3 diopter lens included
- Supplied with 22 watt circline tube
- Color: Ivory
- All metal construction

For your nearest distributor call: #1-800-624-8170
Fax: #1-734-973-0097 • e-mail: info@aventools.com



Visa/Mastercard Accepted

CIRCLE 295 ON FREE INFORMATION CARD

www.americanradiohistory.com

Start a Great Career! Study at Home

BE AN FCC LICENSED ELECTRONIC TECHNICIAN



- No costly school
- No commuting to class

The original Home-Study course prepares you for the "FCC Commercial Radio-telephone license." This valuable license is your professional "ticket" to thousands of exciting jobs:

- Communications
- Radar
- Maritime
- Microwave
- Radio-TV
- Avionics & more

**You can even start your own business
No Need to Quit Your Job or Go to School
This proven course is easy, fast and low cost!**

GUARANTEED PASS
You get your FCC License or money refunded

Call Now for FREE Info:
(800) 932-4268 ext. 412
FAX: 415.332.1901

email: fcc@commandproductions.com
Visit our website: www.LicenseTraining.com

COMMAND PRODUCTIONS

FCC LICENSE TRAINING - Dept. 412
P.O. Box 2824 San Francisco, CA 94126-2824

Yes! Please rush FREE details immediately on how I can study at home for my FCC License.

Name _____

Address _____

City _____

State _____ Zip _____

Mail This Coupon Today!

CIRCLE 232 ON FREE INFORMATION CARD

Future Horizons Advanced Technology

Po Box 125 Marquette, MI 49855 www.futurehorizons.net

Traffic Light Buster

This device will turn traffic lights green in many cities by the touch of a button.

Emergency vehicles use this to pass through traffic lights quickly. Can be dash mounted or handheld.

TLBU Plans-\$15.00
TLBZ Ready to Use-\$250.00

Ambient Power Module

Low cost circuit provides up to 9 watts of electrical power

from free-energy in the air. Can replace batteries in many devices.

PWRM Plans-\$20.00
PWRZ Ready to use-\$97.00

Ionocraft

Proven electrical phenomenon produces anti gravity levitation of small craft.

Solid State, no moving parts, easily scaled up. Larger craft can exceed lifting efficiency of modern helicopters. Uses HIDZ pwr supply.

IONO plans-\$20.00
HIDZ Power supply-\$225.00

Lightsaber

Produces brilliant blade of glowing humming light 36" long by the flick of a switch. Virtually identical to those seen in the movies

but this one is REAL. Completely safe.(available in red,green,blue)

LIGH Plans-\$20.00
LIGZ 24" Lightsaber-\$140.00
LIGZ-36 36" Lightsaber-\$160.00

Cordless Phone Extender

Learn to extend your cordless phone range to 50 miles. Place calls all around town.

Great alternative to cell phones.
CPHE Plans-\$20.00

Electronic Mind Control

Control minds with this simple technology.

Others will do anything you program them to. Get that raise you always wanted or reprogram your mind.

MIND Plans-\$15.00
MINZ Ready to use-\$124.00

Please add \$5.00 Shipping/Handling, Overseas \$11.00

(906)249-5197 24 hr order only line (906)249-1525 Fax
Pay by Visa,MC,Amex,Disc,Chk,Mo,Cash Send \$3 for catalog

World Passing You By?

Are you interested in Microprocessors & Embedded Control Systems? If not you should be! Look around. just about everything these days has an embedded microprocessor in it. TVs, cars, radios, traffic lights & even toys have embedded computers controlling their actions. The Primer Trainer is the tool that can not only teach you how these devices operate but give you the opportunity to program these types of systems yourself. Examples & exercises in the Self Instruction manual take you from writing simple programs to controlling motors. Start out in Machine language, then move on to Assembler, & then continue on with optional C, Basic, or Forth Compilers. So don't be left behind; this is information you need to know!

Examples Include:

- Measuring Temperature
- Using a Photocell to Detect Light Levels
- Making a Waveform Generator
- Constructing a Capacitance Meter
- Motor Speed Control Using Back EMF
- Interfacing and Controlling Stepper Motors
- Scanning Keypads and Writing to LCD/LED Displays
- Bus Interfacing an 8255 PPI
- Using the Primer as an EPROM Programmer
- DTMF Autodialer & Remote Controller (New!)

The PRIMER is only \$119.95 in kit form. The PRIMER Assembled & Tested is \$169.95. This trainer can be used stand alone via the keypad and display or connected to a PC with the optional upgrade (\$49.95). The Upgrade includes: an RS232 serial port & cable, 32K of battery backed RAM, & Assembler/Terminal software. Please add \$5.00 for shipping within the U.S. Picture shown with upgrade option and optional heavy-duty keypad (\$29.95) installed. Satisfaction guaranteed.

EMAC, inc.

11 EMAC WAY, CARBONDALE, IL 62901
618-529-4525 Fax 457-0110 BBS 529-5708

World Wide Web: <http://www.emacinc.com>

1985 - 1998

OVER
12
YEARS
OF SERVICE

AMAZING DEVICES

Laser Window Bounce Listening System

Powerful listening system, yet simple in operation. You shine a LASER at a window and intercept the reflected beam with our ultra-sensitive filtered OPTICAL RECEIVER. Vibrations on the window from internal sounds and voices are now clearly heard. Range can be up to several hundred meters depending on the output power of the laser and optics used.



LWB9 Plans and all Data for 3 Laser Window Bounce Systems.....\$20.00

LWB6K Kit of Complete 100' System with Visible Laser for Demo/Science Project.....\$129.95

LLR30 Optical RECEIVER with voice filter.....\$99.95 LLR3K Kit of Optical Receiver.....\$69.95

LLR40 Higher performance with low noise preamp, basic optics and deluxe headsets.....\$199.95

CWL10 10 mw ClassIIB Invisible IR LASER for 500'.....\$149.95 CWL1K Kit of LASER.....\$99.95

LM650P5 5 mw ClassIIIA Visible Red Laser Module for up to 100'.....\$19.95

LM650P10 10 mw ClassIIB Visible Red Laser Module for up to 200'.....\$69.95

See Our "Action" Web Site at www.amazing1.com

Experiment with and Construct Lasers, Phasers, Hypnosis, Mind Control, TESLA COILS, Time Travel, Rail Guns, Magnetic Cannons, Coil and Sleeve Guns, Super High Gravity Pulses, Explode Wires and Water, Antigravity, Levitation, Mass Warping, Magnetic Can Crushing, Plasma Propulsion, High Energy Radio Frequency Guns (Herf), EMP, Lattice Snapping, Force Fields, Ion Ray Guns and all Types of Electrical Pyrotechnics, Plasma and Neon Displays, Sound Blasters, Ultrasonics, Super Hearing, Long Range Transmitters, Jammers, Personal and Property Protection, Surveillance Plus More!!!

Ultra Bright Green Laser visible over a mile!!



30 to 50x brighter than the red pointers. Shirt pocket sized pen .55" x 6.3" Full 5mw. Operates for hours from two "AAA" batteries. Call for pricing as we will not be undersold!!!!!!!

Gravity Motor

Electrical charge reactions produce the effect of "anti gravity". You build a model craft from simple parts and levitate it with our ion power source. Battery or 115vac operation. Great science or fascinating research project includes our gravity handbook.

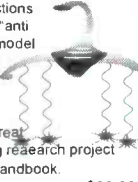

GRA3 Plans/Book.....\$20.00

GRA3K Power Source Kit.....\$99.95

GRA30 Assembled Above.....\$149.95

Tesla Coil

Produces 30" Sparks

Create a spectacular display of nature own lightning. Many amazing experiments possible. See in action on our web site!!



BTC4 Plans.....\$20.00

BTC4K Kit.....\$799.95

BTC40 Ready to use.....\$999.95

Smaller Version (8-10" Sparks)

BTC3 Plans.....\$15.00 BTC3K Kit.....\$349.95

BTC30 Ready to Use.....\$449.95

Ion Ray Guns

Star Wars Technology Directs Energy

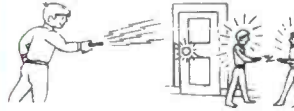

Star Wars Technology Demonstrates Weapons Potential, Force Fields, IonMotors, Antigravity etc. Projects electric shocks without contact!! Conduct many weird and bizarre experiments. Handheld battery operated and easy to operate.

IOG7/9 Plans.....\$10.00

IOG7K Kit/Plans.....\$99.95

IOG70 Assembled/Tested.....\$149.95

Higher Powered Device

IOG9K Kit/Plans.....\$129.95

IOG90 Assembled/Tested.....\$199.95

TAKE CONTROL Using Electronic Hypnosis



Electronic circuitry induces hypnotic as well as ALPHA relaxed mind states. Place subjects under your control

HYP2 Plans.....\$10.00

HYP2K Kit/Plans.....\$49.95

HYP20 Ready to Use.....\$69.95

MIND2 Plans for Mind Control.....\$15.00

MIND2K Kit/Plans.....\$49.95

MIND20 Ready to Use.....\$79.95

Pain Field Pistol

Caution! Do not aim at people!

Blast out rodents with high power ultrasonics. Handheld and battery operated with all controls. Rental units available.



PPP1 Plans.....\$8.00

PPP1K Kit/Plans.....\$49.95

PPP10 Ready to Use.....\$79.95

Theramagnetic Pulsers

Complex Magnetic waves are claimed to produce many health benefits. Board level experimental device is sold for research purposes only.



THMAG10 Lab Assembled.....\$24.95

Amazing Gravitron

Remarkable true levitation without any lithering or external sources of energy. Winning science project. Includes self starter



GRV10 - Anti Gravity Top.....\$39.95

GRV30 - Super Levitator.....\$49.95

Cybernetic Ear!

Provides that "extra edge" for many listening applications. Enhances 3 to 4x of normal.



CYBEREAR.....\$19.95

Hover Board

28 pages of data related to the most revolutionary advance in transportation. Cutting edge R&D

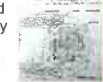

HOVER Plans and Data.....\$25.00

Mini TESLA Coil

Lights up a 4' fluorescent tube-all without any contact!! Yet only 3" tall!



MTC1K Kit/Plans.....\$19.95

MTC10 Assembled.....\$34.95

Transistorized TESLA Coil

Amazing and bizarre effects turn a normal light bulb into a spectacular plasma display!! With adjustable frequency control. Safe 12vdc input



TCL5 Plans.....\$8.00 TCL5K Kit/Plans.....\$59.95

TCL50 Assembled and Tested.....\$99.95

Telephone Line Grabber

Room Listener Controller and Call Diverter Listen to your premises. Break in to calls Control household appliances. Remote dial long distance calls-from anywhere!!

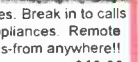

TELCON4 Plans.....\$10.00

TELCON4K Kit/Plans.....\$99.95

TELCON40 Ready to Us.....\$149.95

Attention! High Voltage Modules

Battery powered for hovercraft, plasma guns, anti gravity, force fields, pyrotech



MIMIMAX4 4KV.....\$19.95

MINIMAX3 3KV.....\$17.95

MINIMAX2 2KV.....\$14.95

Nightstar Night Viewer

Sees in total darkness

- 35000x Light Gain
- Over 100 yds Recognition
- Built in IR Illuminator
- 20 degree Field of View
- 20 Hours Battery Life
- Spectral Response 810-840 nm.



NSTAR10 - Ready to Use.....\$239.95

Jacobs Ladder

Pyrotechnical traveling fiery plasma expands over 3" before evaporating into space. Solid state circuitry with adjustable arc control. 115/230 volt operation. Uses safe high frequency energy.



JACK1 Plans.....\$8.00

JACK1K Supply, Mtg Blks, Ladders.....\$149.95

JACK10 Ready to Use.....\$249.95

3 Mi FM Voice Transmitter

Crystal clear performance. Many applications. Easy to assemble



FMV1K Kit and Plans.....\$39.95

6 FM Xmtr Kits!

- 1 Super Sensitive Ultra Clear 1 Mile+ Voice Transmitter.
- 2 1 Mile+ Telephone Transmitter.
- 3 Line Powered Phone Transmitter Never Needs Batteries!!
- 4 Tracking/Homing Beacon Beeping Transmitter
- 5 Video/Audio Rebroadcaster 1 Mi.
- 6 TV/FM Radio Disrupter. Neat Prank! Discretion Required

Includes Hints Using Wireless Devices

COMBOX Above 6 Kits/Plans.....\$59.95

COMBOP Above 6 Plans Only.....\$10.00

Shock Force Field Vehicle Object Electrifier

Hand shock balls,wands. Mini circuit is easily hidden. Great payback for those wise guys.

SHK1K Kit/plan.....\$19.95

Mind&Brain Controllers

Incredible device Turbo charges memory. Boost mental powers, Controls stress, Speeds up healing processes and Uncover hidden potentials. High quality unit with many features.



BWPLUS-APOLLO Ready to use..\$179.95

BWII- EINSTEIN Lower cost unit...\$129.95

Burning Cutting Lasers

Current and Future Weapons Systems

We Stock Parts!

LC3 Plans Poor Mans CO₂ System.....\$15.00

LC7 Plans Lab CO₂ System 30W+.....\$20.00

LAGUN2 Plans Nd,Yag, Ruby 6Kw.....\$20.00

All Three Plans for only.....\$25.00!!

PLASMA FIRE SABER

Patented Moving Light Concept Defies all Logic as it Appears to Evaporate into Space!!

Replaceable Blades, Override Switch Interactive Sound Module Available on Request



Available colors: "C" photon blue, starfire red

phaser green, neon red

PFS15K "C" Kit of 15" Active Length.....\$24.95

SAB34K "C" Kit of 24" Active Length.....\$39.95

*SAB46K "C" Kit of 36" Active Length.....\$99.95

*Please add \$10.00 for special handling

Information Unlimited PO Box 716 Amherst N.H. U.S.A. 03031
1 800 221 1705 Orders/Catalogs Only! Fax 1 603 672 5406 Information 1 603 673 4730 Free Catalog on Request
Pay by MC,VISA,Cash, Check, MO, COD. Add \$5.00 S&H plus \$5.00 if COD. Overseas Contact for Proforma

CIRCLE 225 ON FREE INFORMATION CARD

MOUSER[®] ELECTRONICS

- Heat Sinks
- Semiconductors
- Crystals
- Optoelectronics
- LEDs
- Lamps
- Wire
- Cable
- Connectors
- Sockets
- Jacks
- Plugs
- Cable Assemblies
- Resistors
- Potentiometers
- Capacitors
- Fans
- Power Supplies
- Inductors
- Transformers
- Switches
- Relays
- Speakers
- Batteries
- Fuses
- Panel Meters
- Cabinets
- Knobs
- Hardware
- Equipment
- Tools
- Kits

(800) 346-6873

sales@mouser.com

Fax: 817-483-6899

www.mouser.com

CIRCLE 220 ON FREE INFORMATION CARD

Train At Home To Become A Telecommunications Technician



This is the hi-tech electronics career you've been searching for! Study the ins and outs of fax machines, modems, fiber optics, cellular networks, and more. And learn it all from your own home!

Work for telephone companies, hospitals, or electronics repair shops. And earn as much as \$34,000 a year! Endorsed by the National Association of Radio and Telecommunications Engineers (NARTE), this great Harcourt Learning Direct program features a voucher for the NARTE Class IV Technician Certification exam.

Mail Coupon For FREE Facts Or Call Toll Free Today!

1-800-572-1685 ext. 1347

Call anytime, 24 hours a day, 7 days a week.

www.harcourt-learning.com



Harcourt
Learning Direct
Dept. AJZS60S

925 Oak Street, Scranton, PA 18515-0700

YES! Send me FREE FACTS on how I can train at home to be a Telecommunications Technician. I understand there is no obligation.

Name _____ Age _____
Street _____ Apt. # _____
City/State _____ Zip _____
Phone () _____

AG03
387

COPY RENTAL TAPES WITH OUR VIDEO STABILIZERS

BEFORE

AFTER



FREE
CABLE TV
CATALOG!

The clearest picture possible
playing back movies.
GUARANTEED
to eliminate copy protection.

- No Rolls/Jitters/Flickers/Fading
- Works on all TV's VCR's Beta & Cable
- Gold Video Connectors & Cables Included
- 1 Year Warranty
- Money Back Guarantee



VISION ELECTRONICS

1-800-562-2252

2609 S. 156TH CIRCLE • OMAHA, NE 68130
http://www.modernalectronics.com

New-Old-Stock,
Tubes, Parts,
Supplies,
Speakers, Books,
Transformers,
Grill Cloth

6221 S. Maple Ave
Tempe AZ, 85283
ph. (480) 820 5411
fax (480) 820 4643
fax (800) 706 6789

AMERICAN ELECTRONIC SUPPLY

www.americanradiohistory.com

www.tubesandmore.com

www.vintage-tube.com

XICON JENSEN

NetSurf^{PRO} wireless keyboard™

100 feet range

Power indicator



Integrated Touchpad

104-key functionality

\$99
only

- 900MHz Wireless RF Technology
- No Line of Sight Requirement
- Encrypted Data Transmission
- Long Battery Life

Ultima Associates, Inc. 4564th Northport Loop East Fremont, CA 94538
Tel: 510-423-8832 • Fax: 510-423-8849 • Email: Sales@RFDevices.com • URL: www.RFDevices.com

ROBOTS, ROBOTS, ROBOTS...

MONDO-TRONICS

ROBOT STORE

FEATURING MUSCLE WIRES™

The World's Biggest Collection of Hobby Robot Kits, Books & Parts & More!

Robot Kits, Programmable Robots,
LEGO Robots, Living Robots,
Home and Office Robots, Muscle
Wires™, Electronics and More!

REQUEST OUR FREE
48 PAGE CATALOG
WITH OVER 400 ITEMS!

www.RobotStore.com
800-374-5764

Mondo-tronics Inc.

PMB-M 4286 Redwood Hwy Dept. 166
San Rafael, CA 94903
ph 415-491-4600 fx 415-491-4696

MEMBRANE SWITCHES

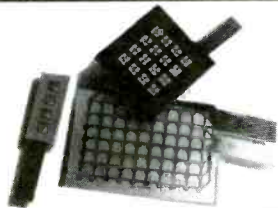

Stock Layouts!

Eliminates tooling cost...

****From 2 to 128 keys****

Industrial/Commercial/Prototyping

Popular types are available as complete kits, with bezel, connector & overlay!

4 key DSK-4 kit \$9.60
12 key DSK-12 kit \$13.87
many more layouts...

Optional Stainless Steel "Clickdomes".

Sil-Walker

(805) 491-0654

FAX (805) 491-2212

P.O. Box 3220

Camarillo, CA 93011-3220

silwkr@vcnet.com

www.vcnet.com/silwkr/

MASTERCARD/VISA

LISTEN UP!



only \$169.95

MFR introductory price before store release
30-Day Money Back Guarantee

Hear what you've been missing!

"I could not believe my ears!" - Audio Magazine

- New award-winning technology creates incredible Theater Sound for your EXISTING 2 or 5-speaker system
- Easy hook-up to your stereo receiver or amplifier
- Transforms your TV, VCR, CD, Satellite or Video games into pure cinema sound

THEATER 2000™
by Spectrum Research

www.TheaterSound.com or toll free (877) 857-3484

ABC ELECTRONICS 315 7TH AVE N. MPLS. MN. 55401
(612)332-2378 FAX (612)332-8481 E-MAILSURP1@VISI.COM
WE BUY TEST EQUIPMENT AND COMPONENTS.

VISIT US ON THE WEB AT WWW.ABCTEST.COM

HP 54501A 100MHZ DIGITIZING SCOPE	\$1300.00	HP 4935A TRANS. IMPAIRMENT TEST SET	\$900.00
HP 54201D 300MHZ DIGITIZING SCOPE	\$1000.00	HP 5006A SIGNATURE ANALYZER	\$150.00
HP 54201A 300MHZ DIGITIZING SCOPE	\$1000.00	HP 86602B 1MHZ-1300MHZ RF PLUG	\$400.00
HP 54200A 30MHZ SCOPE WAVEFORM ANALYZER	\$700.00	RIP 575 MIC ROWAVE COUNTER	\$1500.00
HP 3312A 13MHZ FUNCTION GENERATOR	\$250.00	FLUKE 95 50MHZ SCOPEMETER	\$550.00
HP 5370A 100MHZ UTILITY COUNTER	\$400.00	LRCROY 7200 100MHZ O-SCOPE	\$1000.00
HP 3580c LEVEL METER	\$750.00	TEK 475 200MHZ O-SCOPE	\$500.00
HP 436A POWER METER W/O SENSOR & CABLE	\$500.00	TEK 465 100MHZ O-SCOPE	\$400.00
HP 8350B SWEEP OSCILLATOR MAINFRAME	\$2000.00	TEK 496P 1KHZ-1.8GHZ SPEC ANALYZER	\$3500.00
HP 3437A 3.5 DIGIT SYSTEM VOLT METER	\$250.00	TEK 1240 LOGIC ANALYZER	\$750.00
HP 3455A DIGITAL MULTIMETER	\$250.00	TEK TDS320 100MHZ DIGITAL O-SCOPE	\$1400.00
HP 3456A DIGITAL MULTIMETER	\$400.00	TEK 1140A 500MHZ PROG-O-SCOPE FRAME	\$750.00
HP 3336c SYNTHESIZER LEVEL GENERATOR	\$800.00	TEK 785 400MHZ OSCIL LOSCOPE FRAME	\$500.00
HP 3325A SYNTHESIZER FUNCTION GENERATOR	\$1000.00	TEK 790 400MHZ OSC PLOSCOPE FRAME	\$240.00
HP 5345A 200MHZ COUNTER	\$600.00	TEK 7A26 200MHZ VERTICAL PLUG	\$75.00
HP 8165A PROGRAMMABLE SIGNAL SOURCE	\$1100.00	TEK TA21 100MHZ VERTICAL PLUG	\$150.00
HP 8558B 181 100K-1500MHZ SPECTRUM ANALYZER	\$1000.00	TEK 7880 400MHZ TIME BASE	\$75.00
HP 8550B 183 10MHZ-21GHZ SPECTRUM ANALYZER	\$3000.00	TTK TB92A 500MHZ DUAL TIME BASE	\$125.00
HP 1110A 100MHZ OSCILLATOR	\$250.00	TEK 512 SAMPLING PLUG	\$250.00
HP 6034A 60VDC-10A POWER SUPPLY	\$750.00	TTK TL14 10KHZ-1.8GHZ SPEC ANALYZER	\$1000.00
HP 6029B 10VDC-50A POWER SUPPLY	\$800.00	TEK AMS03 CURRENT PROBE AMPLIFIER	\$250.00
HP 6553A 10VDC-12.5A POWER SUPPLY OPT.01	\$1200.00	WAVETEK 145 20MHZ PULSE/FUNCTION GEN	\$400.00
HP 6632A 20VDC-5A POWER SUPPLY	\$500.00	WAVETEK 182A 4MHZ FUNCTION GEN	\$150.00
HP 6643A 15VDC-13A POWER SUPPLY OPT.03	\$750.00	WAVETEK 955 7.5-12.1GHZ MICROSOURCE	\$1100.00

SINGERS! REMOVE VOCALS

Unlimited, Low Cost, Instantly Available Background Music from Original Standard Recordings! Does Everything Karaoke does... Better and gives you the Thompson Vocal Eliminator! Free Brochure & Demo Tape. LT Sound Dept PE, 7988 LT Parkway, Lithonia, GA 30058 Internet: http://www.LTSound.com 24 Hour Demo/Info Request Line (770)482-2485 Ext 49 When You Want Something Better Than Karaoke!

FCC License Preparation

RADIOTELEPHONE LICENSE
Electronics Tech, Avionics, Marine & Radar
Homestudy--Fast-Easy & Inexpensive.
Manuels-Audio-Video-pedisks-Q&As
Guarantee Pass-see at www.wptfcc.com
Details-800-800-7555.WPT Publications
4701 NE 47ST, Vancouver, WA. 98661

CABLE BOXES BEST PRICES

Ship Anywhere In U.S.A.

1-800-637-4615

www.xxbox.com

EZ-EP DEVICE PROGRAMMER - \$169.95

Check Web!! -- www.m2l.com

Fast - Programs 27C010 in 23 seconds

Portable - Connects to PC Parallel Port

Versatile - Programs 2716-080 plus EE and Flash (28F, 29C) to 32 pins

Inexpensive - Best for less than \$200

- Correct implementation of manufacturer algorithms for fast, reliable programming.
- Easy to use menu based software has binary editor, read, verify, copy, etc. Free updates via bbs or web page.
- Full over current detection on all device power supplies protects against bad chips and reverse insertion.
- Broad support for additional devices using adapters listed below.

Available Adapters

EP-PIC (16C5x, 61, 62x, 71, 84)	\$49.95
EP-PIC64 (62-5, 72-4)	\$39.95
EP-PIC121 (12C50x)	\$39.95
EP-PIC17 (17C4x)	\$49.95
EP-51 (8751 C51)	\$39.95
EP-11E (68HC11 E/A)	\$59.95
EP-11D (68HC711D3)	\$39.95
EP-16 (16bit 40pin EPROMS)	\$49.95
EP-Z8(Z86E02 3, 4, 6, 7, 8)	\$39.95
EP-SEE2 (93x, 24x, 25x, 85x)	\$39.95
EP-750 (87C750, 1, 2)	\$59.95
EP-PEEL (ICT22v10, 18v8)	\$59.95
EP-1051 (89C1051, 2051)	\$39.95
EP-PLCC (PLCC EPROMS)	\$49.95
EP-SOIC (SOIC EPROMS)	\$49.95

Many Other Adapters Available

M²L Electronics

970/259-0555 Fax: 970/259-0777
250 CR 218 Durango CO 81301
CO orders add 7% sales tax.
<http://www.m2l.com>

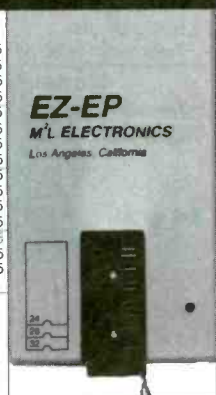

CALL TOLL FREE
(800) 292-7711
Orders Only
 Se Habla Español

C&S Sales

Look For Other
 Monthly Specials
 On Our Website

Excellence in Service

www.cs-sales.com

Power Supplies

Elenco Quad Power Supply
 Model XP-581

\$79.95



4 Fully Regulated DC Power Supplies In One Unit

4 DC voltages: 3 fixed - +5V @ 3A, +12V @ 1A, -12V @ 1A
 1 Variable - 2.5 - 20V @ 2A

Elenco Power Supply Kit
 Model XP-720K

\$54.95

- 1.5VDC - 15VDC @ 1A
- -1.5VDC - -15VDC
- 5VDC @ 3A
- 6.3VAC @ 1A & 12.6VAC center tapped @1A



XP-720 Fully Assembled **\$85**

B&K High Current DC Power Supply

- Variable 3-14VDC
- Thermal Function
- Current Limiting

Model 1686 12A **\$169**
 Model 1688 28A **\$249**



B&K 13.8V Fixed DC Power Supplies
 Model 1680 8A **\$42**
 Model 1682 15A **\$75**

Elenco DC Power Supply
 Model SPL-603 3A 0-30VDC

The SPL-603 is a solid-state DC power supply providing the exact output voltage no matter what current you use. Output fully protected from overload.



\$79.95

Soldering Equipment

Elenco Hot Air SMD Rework Station
 Model SR-979

\$450



The workstation is engineered to meet the needs of today's electronic industry. Wide range of adjustments of air volume and temperature (212°F to 754°F) permits soldering of most surface mount devices. Comes with an A1138 nozzle QFP 28 x 28mm (1.1 x 1.1").

Weller Low Cost Soldering Iron
 Model WLC-100

\$36.95



- Variable power control produces 5-40 watts.
- Ideal for hobbyists, DIYers and students.
- Complete with 40W iron.

Weller Soldering Station
 Model WES50

\$119



50 watts of controlled power - designed for continuous production soldering.

Weller Marksman® 23W Soldering Iron
 Model SP23

\$9.95



Generators & Counters

Elenco Sweep Function Generator
 w/ built-in frequency counter Model GF-8036

\$225



This sweep function generator with counter is an instrument capable of generating square, triangle, and sine waveforms, and TTL, CMOS pulse over a frequency range from 0.2Hz to 2MHz.

10 Function 1.3GHz Universal Counter
 Elenco Model F-1300

\$225

- Frequency .05Hz - 1.3GHz 3 Ranges
- Period - Can read 60Hz to 60,000,000 F=1/T
- Totalize - Counts to 199,999,999
- RPM - 3 to 209,999.4 RPM
- Duty Cycle
- Max/Min/AVG with Time
- Stop-watch set .2 sec. to 100 hrs.
- Math Functions
- Timer - 2 sec. to 99 days
- Pulse Width - 0.1ms to 65656.6ms



Multifunction Counter
 B&K Model 1875

\$189

10Hz - 2.5GHz



Ultra sensitive synchronous detector bargraph and RF strength. 3 Channels

Elenco Handheld Universal Counter
 1MHz - 2.8GHz Model F-2800

\$99



Features 10 digit display, 16 segment and RF signal strength bargraph.

Elenco RF Generator with Counter
 (100kHz - 150kHz) Model SG-9500

\$225

Features internal AM mod. of 1kHz. RF output 100MV - 35MHz. Audio output 1kHz @ 1V RMS.



SG-9000 **\$119.95** (analog, w/o counter)

B&K 20MHz Sweep/Function Generator with Frequency Counter
 Model 4040

\$445

- 0.2Hz to 20MHz
- AM & FM modulation
- Burst Operation
- External Frequency counter to 30MHz
- Linear and Log sweep

21.5MHz Model 4070 **\$1295**
 10MHz Model 4017 **\$319**
 5MHz Model 4011 **\$249**



BK PRECISION

Measures Frequency, Period, Data Hold, Relative, Memory (min., max., average). High Sensitivity, Microprocessor Controlled.

Includes antenna, NiCad battery, and AC adapter.

Kit Corner

over 100 kits available

Quantity Discounts Available

Model RCC-7K
 Radio Control Car Kit

\$29.95

- Fun & Easy to Assemble
- 7 Functions
- Radio Control Transmitter Included



Model AK-700
 Pulse/Tone Telephone Kit

\$15.95

• Ideal School Project



Model AM-780K
 Two IC Radio Kit

\$11.95



Model OWI-007
 Robotic Arm (Wired Control)

Teaches the basic robotic sensing and locomotion principles while testing motor skills.

\$55.95



Oscilloscopes

Free Dust Cover and 2 Probes



S-1325	25MHz	Dual Trace	\$325
S-1330	25MHz	Delayed Sweep	\$439
S-1340	40MHz	Dual Trace	\$475
S-1345	40MHz	Delayed Sweep	\$569
S-1360	60MHz	Delayed Sweep	\$749
S-1390	100MHz	Delayed Sweep	\$995

DIGITAL SCOPE SUPER SPECIALS

DS-203	20MHz/10Ms/s Analog/Digital	\$695
DS-303	40MHz/20Ms/s Analog/Digital	\$995
DS-603	60MHz/20Ms/s Analog/Digital	\$1295

Guaranteed Lowest Prices

UPS SHIPPING: 48 STATES 5%
 OTHERS CALL FOR DETAILS
 IL Residents add 8.25% Sales Tax

C&S SALES, INC.

15 DAY MONEY BACK GUARANTEE
 2 YEAR FACTORY WARRANTY

150 W. CARPENTER AVENUE
 WHEELING, IL 60090
 FAX: (847) 541-9904 (847) 541-0710



PRICES SUBJECT TO CHANGE WITHOUT NOTICE

CIRCLE 290 ON FREE INFORMATION CARD

SAME DAY SHIPPING
Secure on-line ordering

C&S Sales

Excellence in Service

CALL OR WRITE FOR OUR FREE

64 PAGE CATALOG!
(800) 445-3201

Digital Multimeters

Elenco LCR & DMM Model LCM-1950



12 Functions
Freq. to 4MHz
Inductance
Capacitance
and Much More

\$69

Elenco Model M-1740 **\$39.95**



11 Functions:
• Freq. to 20MHz
• Cap. to 20µF
• AC/DC Voltage
• AC/DC Current
• Beeper
• Diode Test
• Transistor Test
• Meets UL-1244 safety specs.
Model M-2760 - \$24.95 (9 functions)

Fluke 79III **\$195**



• Capacitance ranges from 99.99nF to 9999µF.
• Built-in frequency counter of voltage input from 1Hz to over 20kHz.
• Lo-Ohms range, a 40Ω range with Fluke's proprietary Zero Calibration, offers 0.01 resolution with increased noise rejection.

Fluke 87III **\$319**



Features high performance AC/DC voltage and current measurement, frequency, duty cycle, resistance, conductance, and capacitance measurement.

Elenco LCR Meter Model LCR-1810 **\$99.95**



• Capacitance 1pF to 20µF
• Inductance 1µH to 20H
• Resistance 0Ω to 2000MΩ
• Temperature to 750°C
• DC Volts 0 - 20V
• Frequency up to 15MHz
• Diode/Audible Continuity Test
• Signal Output Function
• 3 1/2 Digit Display

Elenco Digital Multimeter Kit Model M-1005K **\$19.95**



• 18 Ranges
• 3 1/2 Digit LCD
• Transistor Test
• Diode Test
• Training Course
M-1000B (Assembled) \$15.95

Dual-Display LCR Meter w/ Stat Functions B&K Model 878 **\$225.95**



Auto/manual range
Many features with Q factor
High Accuracy

B&K Video Monitor Tester Model 1275 **\$169**



Great handheld unit to test PC and Mac monitors. The model 1275 is ideal for the field or the service bench. Small, portable and very effective, the 1275 generates crosshatch, dots, color bars and raster patterns in green, blue, red, black and white.

PC Repair

CCTV Cameras

Introduction to PC Repair Self-Study Course™ **\$179**



COURSE CONTENTS.

Introduction to Computers
IBM PC's and Clones
PC Assembly/Disassembly
Introduction to MS-DOS

Introduction to Windows 3.1
Introduction to Windows 95
Introduction to Networks
Introduction to the Internet

Provides you with the easiest and most effective way to learn the fundamentals necessary for a profitable and successful career as a PC Repair Technician. Ideal for individuals new to the I.T. profession and as instruction prior to studying for A+ certification.

Cameras have 420 lines (360 color) of resolution, 0.08 Lux, 3.6mm/F2 90° field of view. Power requirement is 12VDC @ 100mA (order SC-1).

MONOCHROME CAMERAS

COLOR CAMERAS



SC-12 - 35mm Lens (1.25"x1.25") *69
SC-15 - Pin Lens (1.25"x1.25") *69

Add \$10 for lens • Add \$10 for audio

Accessories:

SC-1 - 12V 100mA adapter *6.99
SC-2 - 50' cable with connectors *19.99

SC-20 Pin Lens
SC-21 3.6mm Lens
360 Lines 1.25" x 1.25"
Infrared Sensitive, Audio Included

\$109

Add \$10 for case
Call for complete catalog.

A+ Certification Self-Study Course™ **\$379**



DOS/WIN Exam

DOS 6.2
Windows 3.1 Installation and Configuration
Windows 3.1 Application Support
Windows 3.1 Devices and Drivers
Windows 3.1 Networking and Troubleshooting
Windows 95 Installation and Deployment
Windows 95 Basic Configuration
Windows 95 Troubleshooting and Optimization

Includes all the technical material, knowledge and interactive exercises needed to pass the A+ exams and excel in the competitive PC repair marketplace.

11 pc. Computer Service Tool Kit Model TK-1100 **\$12.95**

Includes:

- 3/16" Nut Driver
- 1/4" Nut Driver
- 3-Prong Parts Retriever
- Reversible Bit Screwdriver T10 & T-15
- Reversible Bit Screwdrivers 3/16", 1/4", #1 & #2 Phillips
- Tweezer
- IC Inserter 14-16 pin
- IC Extractor
- 1/8" Flat Screwdriver
- #0 Phillips Screwdriver



Available in Yellow, Blue & Black

No License Required

Talk up to 2 miles!

TEKK Radios

Pro-Sport FRS Two-Way Radio Model PRO-SPORT+ **\$69.00 each or 2 for \$125.00**

- 1/2 Watt Output, 14 Channels.
- TX & RX LED/LCD Indicators.
- Large LCD Display.
- 38 Privacy (CTCSS) Tones.
- Removeable Antenna.
- Water Resistant.
- 500mW Output.
- Palm Sized.



Guaranteed Lowest Prices

C&S SALES, INC.

15 DAY MONEY BACK GUARANTEE
2 YEAR FACTORY WARRANTY

UPS SHIPPING: 48 STATES 5%
OTHERS CALL FOR DETAILS
IL Residents add 8.25% Sales Tax
SEE US ON THE WEB

150 W. CARPENTER AVENUE
WHEELING, IL 60090
FAX: (847) 541-9904 (847) 541-0710
www.cs-sales.com



PRICES SUBJECT TO CHANGE WITHOUT NOTICE

CIRCLE 290 ON FREE INFORMATION CARD

DIGITAL STORAGE OSCILLOSCOPES

WITH
SPECTRUM
ANALYZER,
DVM, FREQ.
COUNTER,
AND DATA
LOGGER.

from
\$189.

**PORTABLE
MODULES
CONVERT PC'S
INTO
MULTIPURPOSE
TEST AND
MEASURING
INSTRUMENTS.**

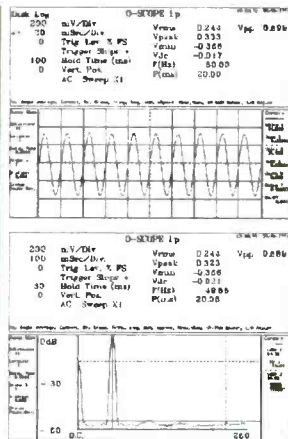

Why lug a scope around? Toss one of our modules into your laptop case or tool kit. For a multi-purpose test device, plug to a PC parallel port and use the PC screen. Continuous, delayed, or triggered sweeps can be frozen on the screen, printed out, or saved to disk. Frequency Spectrums DC to 25 MHz.

Allison now provides PICO TECHNOLOGY Ltd. portable test equipment, including high-speed scopes, and multi channel data loggers. Pico and O-Scope modules accept standard probes and work with 286 or faster PC's.

FEATURES:

- PORTABLE UNITS TO 25 MHz
- USES PRINTER PORT
- USES STD. PROBES

OPTIONS:

- PROBE SETS
- AUTOMOTIVE PROBES
- BATTERY PACKS
- SOFT & HARD CASES

O-Scopes Made in U.S.A. Picos Made in U.K.
Same Day Shipping
Includes Cable, Software & Manuals

O-Scope Ip (DC-50KHz, single trace)\$189.
O-Scope II (DC-500KHz, dual trace)\$349.
PICO (ADC 200/20) (DC-10MHz, dual trace)CALL
PICO (ADC 200/50) (DC-25MHz, dual trace)CALL
PICO pc based data loggers from \$99.

Shipping within U.S. UPS Ground \$7.50(Second day \$11.50)

SEND CREDIT CARD INFO., M.O., or CHECK, OR CALL

1-800-980-9806

Allison Technology Corporation

2006 FINNEY-VALLET, ROSENBERG, TX 77471
PHONE: 281-239-8500 FAX: 281-239-8006

<http://www.atcweb.com>

Learn to Hack!

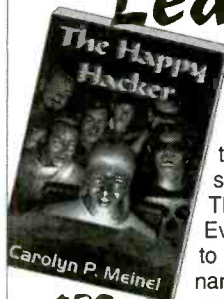

The Happy Hacker is nothing less than a step-by-step, easy to follow course on computer hacking. In it you'll learn all the ins and outs of hacking like the pros. You'll also learn how to hack safely, without getting busted or fired. This brand new 3rd edition has it all! Everything from breaking in to computers to hacking web sites, forging email - you name it!

432 PAGE PAPERBACK, \$34.95 SHIPPING \$3

The Hacker's Companion CD-ROM is chock full of hacking software and information. It includes everything from phones, cellular and satellite hacking to password crackers, war dialers, sniffers and exploit programs. Even a video of dutch hackers breaking into a classified US military computer. An excellent companion to the Happy Hacker, includes many of the programs discussed there. Brand new for the year 2000!

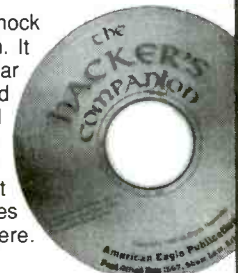

PC CD-ROM, \$29.95, SHIPPING \$3

Or call or write for **FREE CATALOG** of hard-to-get information about *computer viruses, computer hacking, security and cryptography!* Check our web site www.ameaglepubs.com for lots more about these books and CD's!

American Eagle Publications, Inc.
P. O. Box 1507, Dept E.
Show Low, AZ 85902
(800)719-4957

CIRCLE 315 ON FREE INFORMATION CARD

Start A Career With High Wages, Excellent Benefits and Job Security!!

With UCANDO's extraordinary maintenance training programs you can quickly and easily enter a high paying field as a maintenance technician for a very small investment of time and money.



RC-M ONLY \$165 RC-M is a 15 hour training course on relay ladder logic systems. Includes a 5-part video and workbook. **Great Value!**

PLC-M ONLY \$198 PLC-M is a 32 hour training course on PLC systems. Includes (2) 4-part video's and workbook. **This training is valuable.**

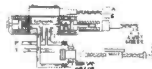

HYD-M ONLY \$209 HYD-M is a 32 hour course on Fluid Dynamics. Includes (2) 4-part video's and workbook. **This Module is a must.**

SC-M ONLY \$215 SC-M is a 32 hour training course on AC & DC Servo Controllers. Includes (2) 4-part video's and workbook. **Learn everything you need about AC and DC servo Control Systems.**

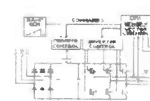

Electronic Training Videos: Basic Electronics, Digital Electronics, TV Repair, LASER and Fiber Optic training videos available at very affordable prices starting at **Only \$39.95 each.**

For information or to place an order call:

1-800-678-6113

www.ucando-corp.com

UCANDO VCR Educational Products Corp., Greenville, OH

CEBEK

ELECTRONIC CIRCUITS

TO RECEIVE SALE PRICING,
You Must Provide This

source code: **POP76A**

PRE-ASSEMBLED CIRCUIT MODULES

Prices effective May 23 through October 27, 2000.

FM Transmitters

- Accepts mic level input
- Transmits from 88-108MHz
- Requires single 9-15VDC supply

Description	Order #	Mfr. #	Reg.	Sale
FM transmitter				
28-4850	FM-1		\$14.95	\$10.90
High power FM transmitter				
28-4851	FM-2		24.95	22.39
Pre-amplifier with compression				
28-6230	PM-9		12.50	10.20

Digital Message Recorder

- Records any audio signal
- Retains information with power removed
- Includes an electret microphone
- TR-4 and TR-6 have on-board 5W amplifiers

Description	Order #	Mfr. #	Reg.	Sale
16 second				
28-4855	TR-1		\$34.95	\$28.99
16 second with repeat				
28-7854	TR-3		39.95	35.90
16 second with repeat				
28-7856	TR-4		52.50	47.20
60 second with repeat				
28-6245	TR-6		87.95	79.00

CHECK

OUT our

full line catalog at:

1-800-543-4330

www.mcmelectronics.com

Free Literature!

Fax: 1-800-765-6960



MCM ELECTRONICS
650 CONGRESS PARK DR.
CENTREVILLE, OH 43089



Perfect for hobbies, repair, prototype, OEM and equipment modification
Low cost, high quality boards are fully assembled and 100% tested at the factory
Each includes full specifications and application information
These and over 100 additional modules stocked exclusively at MCM Electronics
Complete Information at www.cebek.com

Timer Modules

- Operates from a single 12VDC supply
- Provides precise time delay for a variety of uses
- SPDT, 5A relay output

Description	Order #	Mfr. #	Reg.	Sale
Single event 1-180 second				
28-4735	I-1		\$17.95	\$12.45
Single event 2-45 minute				
28-4736	I-2		17.95	12.45
Single event 30-240 minute				
28-4737	I-3		18.49	13.85
Repeat cycle 0.3-60 second				
28-4740	I-10		18.49	13.85
Repeat cycle 1-30 minute				
28-4741	I-11		19.95	17.75
Repeat cycle 20-150 minute				
28-4742	I-12		18.95	15.85

Counters

- Up/down count •LED display
- Contact closure count and reset input
- Requires single 12VDC supply

Order #	Mfr. #	Description	Reg.	Sale
28-5150	CD-3	Three digit	\$39.95	\$35.50
28-5155	CD-5	Three Digit w/relay output	64.95	58.00
28-4785	CD-9	Two digit	14.95	11.55

Audio Amplifiers

- Perfect for repair and equipment modification
- Operates from a single 12VDC supply
- Accepts line level input

Description	Order #	Mfr. #	Reg.	Sale
0.5W single channel				
28-5165	E-13		\$7.49	\$5.60
1W single channel				
28-4795	E-1		7.49	5.60
1W two channel				
28-5170	ES-1		14.95	11.25
5W single channel				
28-4796	E-2		13.95	10.99
5W two channel				
28-4800	ES-2		24.95	20.65
15W single channel				
28-4797	E-4		19.95	17.20
15W two channel				
28-4801	ES-4		39.95	35.50

DC Power Supplies

- Includes AC transformer
- Provides tight voltage regulation
- Short circuit protected

Order #	Mfr. #	Output	Reg.	Sale
28-4772	FE-2	12VDC, 300mA	\$14.95	\$11.85
28-4775	FE-4	12VDC, 1A	19.95	16.70
28-4776	FE-7	24VDC, 1A	24.95	20.65
28-4777	FE-11	12VDC, 2A	34.95	29.95
28-4778	FE-13	12VDC, 5A	49.95	44.50

Audio Pre-Amplifiers

- Use with Cebek or any amplifier with line level input
- Operates from a single 6-18VDC supply
- Gain adjusted via board-mounted potentiometer

Description	Order #	Mfr. #	Reg.	Sale
Microphone preamp, Hi-Z				
28-7962	PM-1		\$8.39	\$6.90
Microphone preamp, Low-Z				
28-4805	PM-2		8.95	6.50
Preamp for general use				
28-7960	PM-4		8.59	7.09
Electric guitar preamp				
28-4815	PM-7		8.95	6.49
Voice activation "VOX" relay				
28-4825	PM-11		17.95	13.15

Programmable LCD Displays

- Provides one or two line x 16 character display
- Fully programmable with easy menu programming
- Stores up to 14 alpha numeric messages
- EC-3 and EC-4 are backlit

Order #	Mfr. #	Description	Reg.	Sale
28-6135	EC-1	Single line	\$89.95	\$79.95
28-6140	EC-2	Two line	99.95	89.95
28-4765	EC-3	Single line	115.00	103.50
28-4766	EC-4	Two line	140.00	126.00

mcm Electronics
What you want... Today!™

SOURCE CODE: POP76A

A Premier Farnell Company

CIRCLE 160 ON FREE INFORMATION CARD

www.americanradiohistory.com

PRINTED CIRCUIT BOARDS

QUALITY PRODUCT

FAST DELIVERY

COMPETITIVE PRICING

We will beat any competitor's prices!!!

- * UL approved
- * Single & Double sided
- * Multilayers to 8 layer
- * SMOBC, LPI mask
- * Reverse Engineering
- * Through hole or SMT
- * Nickel & Gold Plating
- * Routing or scoring
- * Electrical Testing
- * Artwork or CAD data
- * Fast quotes

10 pcs (3 days) 1 or 2 layers **\$249**

10 pcs (5 days) 4 layers **\$695**

(up to 30 sq. in. ea.) includes tooling, artwork, LPI mask & legend. Send files via e-mail before 9:00am. Receive boards next day.

PROTOTYPE THROUGH PRODUCTION

PULSAR, INC

Direct Manufacturer

9901 W. Pacific Ave., Franklin Park, IL 60131
 Phone 847.233.0012 • Fax 847.233.0013 • Modem 847.233.0014
 yogii@flash.net • flash.net/~yogii
 We are not brokers

CABLE BOXES

• WE'LL BEAT ANY PRICE!

• 1 YR WARRANTY

• FREE CATALOG

• 30 DAY MONEY BACK GUARANTEE

WWW.CATVBOXES.COM

1-800-765-4912

SURVEILLANCE HIDDEN CAMERAS

DIRECT FROM MANUFACTURER—BEST PRICE IN THE MARKET
 Ultra miniature hidden camera, in dome, smoke or motion detector w/ mic. B/W or Color. Wide view angle. Low light sensitivity + super sharp images, plus video and audio output. From \$150.00. Also 1/4" B/W Board Camera w/mic, starts at \$79.00 USD. Wireless hidden camera, start at only \$249.00 USD. Plus \$5.95 for S/W. Wholesale Welcome. Cash, Check, Money Order or Visa/MC.

HOLIDAY INTERNATIONAL CORPORATION
 PH: (800) 255-0895 or (626) 575-8178
 9660 Fleair Drive #218, El Monte, CA 91731
<http://www.holidaycamzinyproducts.com>

Poptronics SHOPPER

BUGGED??

EAVESDROPPING is unbelievably widespread! Electronic Devices with amazing capabilities can be monitoring your telephone and room conversations **RIGHT NOW!** Are you sure you're safe? **FREE CATALOG** tells you fast! Includes Free Bonus details on fantastic opportunities now open in Counter-Surveillance field. Exciting, immensely interesting and **EXTREMELY** profitable (up to \$250 hr) full/part-time income. Call Now! **1-800-732-5000**

VIDEO SYNC GENERATOR



Restores Horizontal and Vertical Sync Lines from Distorted Video



Lost Sync



Restored Sync with VSG

For Free Information Package and Pricing



Call (219) 233-3053
www.south-bend.net/red



R.C. Distributing, PO Box 552 South Bend, IN 46624

PC BOARDS

Low Cost, Precision-Made PC Boards From Your Gerber/NC Drill Files

Put your CAD program to work for you!



- Milling
- Drilling
- Routing

www.pcbmilling.com FAX: (703) 818-0071

New Science & Robotic Kits For The Millennium

Awards include:



BEAMSTER



Beginner Soldering

OWI-209K \$19.95

Multifunctional; 90° Halogen light head or fluorescent lamp.

TURBO 2000



Beginner

OWI-6567 \$19.95

Air, motor drive or solar propelled (sold separately) speedster.

SUMOROBOT



Beginner

OWI-9647 \$49.95

Retreats or attacks. Sensor system & infrared beam to detect opponents

KNIGHT INVADER



Beginner

OWI-6577 \$19.95

Air, motor drive or solar propelled (sold separately) with principles of electricity.

AM RADIO



Beginner Soldering

OWI-215K \$24.95

Principles of radio wave technology. Tuner & volume control. Easy assembly.



ROBOTIKITS™ DIRECT

17141 Kingsview Ave. Suite B, Carson, CA 90746 USA
 Phone: (310) 515-6800 • Toll Free: (877) 515-6651
 Fax: (310) 515-0927
 E-mail: robotikitsdirect@pacbell.net • Web: www.robotikitsdirect.com



Order M - F 8a.m. - 4p.m. PST

ELECTRONIX EXPRESS

Visit Our Website At
<http://www.elexp.com>

WELLER SOLDERING STATION - MODEL WLC 100

- Variable power control (5 to 40 watts)
- Replaceable heating element
- Quality light-weight pencil iron

\$36⁹⁵



RSR TELECOMMUNICATIONS TRAINER

HANDS-ON TELEPHONY, LAN, CATV EXPERIENCE
WITH ONE SELF-CONTAINED UNIT

- T-Comm Trainer (TCM-100) \$199.95
- Lab Manual / Work Book 26.95
- Component and Supplies Kit 37.95
- Tool Kit 119.95

Only
\$199⁹⁵



MODEL TCM-100

LOWEST PRICE 20MHZ

INSTEK[®] OSCILLOSCOPE

MODEL GOS-620
Dual Channel - 20MHZ
(INCLUDES PROBES)

\$299⁰⁰



INSTEK[®] FUNCTION GEN. WITH INT/EXT FREQ. COUNTER

3 MHz, Digital Display
MODEL 8216

\$199⁰⁰



ALLIGATOR LEADS

SET OF 10



SWITCHES

Mini Toggle SPDT 50¢ ea.



SOLDERING IRON 3-WIRE

HIGH PERFORMANCE
#060501

\$5²⁵

SOLDERLESS BREADBOARD

830 tie points, MB102PLT
model features 3 binding posts
and aluminum backplate.

Part No.	1-9	10+
MB102	5.95	5.00
MB102PLT	8.95	8.00



MOTION DETECTOR

\$2 ea. - 10 For \$15



LM555 10 Min.	22¢ ea.
LM741 10 Min.	27¢ ea.
74LS00 10 Min.	18¢ ea.
7805 Regulator 10 Min.	30¢ ea.
2N3904 10 Min.	6¢ ea.
PN2222 10 Min.	6¢ ea.
Red LED T 1 3/4 10 Min.	6¢ ea.
Green LED T 1 3/4 10 Min.	7¢ ea.
Yellow LED T 1 3/4 10 Min.	8¢ ea.
Photo Cell 10 Min.	65¢ ea.
100K Pot, 1" Shaft PC ML 10 Min.	15¢ ea.

PRESS-N-PEEL



PC Board Transfer Film

- PNP Blue 5 Sheet \$9.90
- PNP Wet 5 Sheet 9.90
- PNP Blue 20 Sheet .. 28.95
- PNP Wet 20 Sheet ... 28.95

RESISTOR KIT

1/4 W 5%
film. 5 pieces
each of 73
values. 365
pieces total.

\$3⁹⁵

PAD-234 DIGITAL/ANALOG TRAINER

Complete portable workstation. Variable and fixed power supplies, function generator, digital I/O, rugged design, high impact case.



Assembled **\$150⁰⁰** Kit **\$110⁰⁰**

HIGH QUALITY TOOLS

With Cushion Grips and Return Spring

- Needle Nose Pliers **\$2⁹⁵**
- Wire Stripper **\$1⁵⁰**
- Diagonal Cutter **\$2⁹⁵**

DC POWER SUPPLIES

MODEL HY3003 - DIGITAL DISPLAY
Variable output, 0-30 VDC, 0-3 Amp **\$89⁰⁰**

MODEL HY3003-3 - TRIPLE OUTPUT
Two 0-30 VDC, 0-3 Amp
variable outputs plus 5V 3A
fixed. Digital Display. **\$215⁰⁰**



FREE CATALOG

MORE
Low-Priced
Items In Our
FREE

256-Page Catalog



TERMS: Min. \$20 + shipping. School Purchase Orders, VISA/MC, Money Order, Prepaid. NO PERSONAL CHECKS, NO COD. NJ Residents Add 6% Sales Tax.

In NJ: 732-381-8020
FAX: 732-381-1006

365 Blair Road • Avenel, NJ 07001-2293

800-972-2225

<http://www.elexp.com>

email: electron@elexp.com

CIRCLE 205 ON FREE INFORMATION CARD

(800)366-0579

(661)295-5577

fax(661)295-8777

Roger's Systems Specialist

24895 Avenue Rockefeller
Valencia, California 91355

"We Have Great Connections"
Computer • Communications
Network • Audio • Video

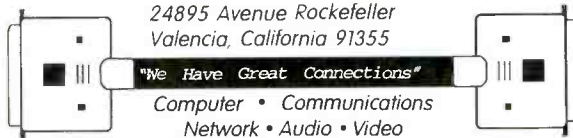

- > ADAPTORS
- > HUBS
- > SWITCH BOXES
- > PATCH PANELS
- > SCSI CABLES
- > MOTHERBOARDS
- > CPU'S

Case fan system exhaust
4pin
\$12⁰⁰
cat.no. TM-1AN-SLOT



Includes:

- > One MiniView KVM switch
- > 2 Sets of Premium Grade KVM Cables
- > One PS/2 to AT keyboard adapter
- > One PS/2 to Serial mouse adapter
- > One User Guide

Features:

- > Keyboard & mouse emulation for error
- > Free PC booting
- > No external power required
- > Works virtually with any operating system
- > Fully hot pluggable

\$99⁰⁰

DS-102-KMMP5

Acer
\$5⁰⁰
cat.no. TM-290-PS

EXTENSIONS, male to female

CC-VGA-4C	6FT	\$6 ⁰⁰
CC-VGA-5C	10FT	\$9 ⁰⁰
CC-VGA-25CX	25FT	\$16 ⁰⁰
CC-VGA-50CX	50FT	\$25 ⁰⁰
CC-VGA-100CX	100FT	\$44 ⁰⁰

SWITCH BOX, male to male

CC-VGA-3C	6FT	\$6 ⁰⁰
CC-VGA-9C	10FT	\$8 ⁰⁰
CC-VGA-11C	25FT	\$16 ⁰⁰
CC-VGA50MM	50FT	\$25 ⁰⁰
CC-VGA100CX	100FT	\$44 ⁰⁰



Triple
Shielded
Plug-n-Play

Category 5 Patch Cable

TE-038-1.5	3ft. Straight Patch	\$1 ⁷⁵
TE-068-1.5	7ft. Straight Patch	\$2 ⁰⁰
TE-128-1.5	14ft. Straight Patch	\$4 ⁰⁰
TE-258-1.5	25ft. Straight Patch	\$5 ⁰⁰
TE-358-1.5	35ft. Straight Patch	\$7 ⁰⁰
TE-508-1.5	50ft. Straight Patch	\$8 ⁰⁰
TE-758-1.5	75ft. Straight Patch	\$17 ⁰⁰
TE-108-1.5	100ft. Straight Patch	\$16 ⁰⁰

SVGA COAXIAL CABLES

CIRCLE 308 ON FREE INFORMATION CARD

www.americanradiohistory.com

New MILLENNIUM SALE on Our Best Soldering & Desoldering Tools

DEN-ON SC7000Z Desoldering Tool
Guaranteed to be the **BEST** Transportable Desoldering Tool you will ever own. **Base Station Performance** in a Portable Tool. Very High and Quick Vacuum. Quick cleaning filter.

10% off of our
 Nationally Advertised
 Low Price of \$395
 For a Limited Time
\$355.50



Inspect your SMD work with the **Stereo Zoom Microscope** from Scienscope. Add different eyepieces and auxiliary lens to get various Magnifications, field of views, and large working distances. Several microscopes listed on our Web site as low as \$495.

GL-CO-PK4
 Regular Price \$1364.00
Millennium Price
\$1245.60



DEN-ON SS-8200 Temperature Controlled Soldering Pencil is a hit with everybody who ventures to try it. It is small, lightweight, easy to use, temperature controlled, and has a burn proof cord and long lasting tips. It also has a **200W Ceramic Element** that keeps it at a constant temperature.

Special Millennium Price
\$95.00



The **Best Hot Air Tool** available is the **HG3002LCD** by Steinel. Temperature controlled from 120°F to 1100°F. Variable speed motor, Hot and Cool switch. LCD Readout for Accurate Nozzle Temperature control.
 Regular price \$182.00
Now \$163.80



EDSYN's 951SX Industrial Grade Temperature Controlled Soldering Station is by far their most popular Soldering Station. Sold nationally for as much as \$164.95.

Our Special Price
\$99.00



EDSYN's ZD906 includes a **Desoldering Tool**, a **Soldering Pencil** and a **Hot Air Pencil**. Shop air is required. Very small footprint required on your bench. Check out the Specs on our Web Site. 18 Month Warranty. Save 10% from our already low price of \$1169.00
New Millennium Price
\$1061.10



Very **REDUCED** Price on the **EDSYN ZD500DX**. Save **\$200.00** on one of the Best Industrial Grade Desoldering Stations available. Completely made in the USA by skilled USA workers. 18 Month Warranty. Very Inexpensive to Operate.

Was \$749.95
Now \$549.95



Contract Manufacturers
 This Spot Type Hot Air Rework Station was made for you. Check out the specs. on our web site. **Free Trials Available**. Advertised Nationally for \$5000.

DEN-ON SD-3000 Millennium PRICE
\$4250.00



New Product from EDSYN 971HA SMT Hot Air Station
 Precise adjustment for heat and air flow. Air automatically shuts off when pencil is placed in holder. Excellent for SMD work up to 80 pins. Easily converts to Powerful Solder Station w/large selection of tips.

Our Regular Price \$599.00
Now \$539.10



Capacitor Wizard ESR Meter
 Will be on sale for a **Limited Time Only**
 Advertised elsewhere
 In this magazine for \$179.95
Must Mention this Ad
Now \$159.95



Scienscope Video Inspection System
 Ideal for inspection, training, and/or documentation. Magnification to 540x & working distances to 13 inches. Specs are on web site. **Mention this ad for 10% Off regular Price of \$2520.00**
CC-97-VS2 includes single lens Adapter, CCD camera, 3x extender, digital CCD Camera, 14" monitor, fiber optic illuminator, Fiber optic ring light, and large boom stand.



PDR/Xytronic 710 SolderLight
 IR Component Heating w/IR Hand tool
 IR PCB Preheating W/Bottom Heater
 All types SMD's and BGA's
 See Web Site for Specs.
Millennium Madness
\$2395.00



www.howardelectronics.com

Visa - M/C - Discover - A/E - COD - Terms to Qualifying Companies
30 Day Money Back Total Satisfaction Guarantee

HOWARD ELECTRONIC INSTRUMENTS INC
 Your Desoldering Specialists

6222 N. Oliver Kechi, KS 67067
 Toll Free U.S. and Canada
1-800-394-1984

www.howardelectronics.com
 sales@howardelectronics.com
 International (316) 744-1993
 or Fax (316) 744-1994

CIRCLE 237 ON FREE INFORMATION CARD

A Trained Computer Repairman Charges \$100 An Hour and More... You Can Get That Training!

Foley-Belsaw's Totally New Computer Repair Course gives you the skills to start earning top pay **FAST!!!!!!**

You get these Foley-Belsaw Exclusives! At no extra cost!

- A+ Certification Test Preparation Tutor™
- Foley-Belsaw CD-ROM Learning Assistant™
- Business Start-up Resource



SPECIAL BONUS

Inquire now and your course will come with a complete video archive library of early printer and computer repair techniques... at no additional cost.



No Experience Necessary!

Get "hands-on" training in the exciting field of computer repair.

Train At Home!

There's not a more complete—or affordable—PC Repair course that will have you trained and job ready in such a short time.

Fully illustrated, easy to understand course gives you everything you need to succeed.

The key to your success lies in providing a service that is in great demand. Even if you have no experience, you can become an expert in a few short months. Foley-Belsaw's computer repair course is broken into small, easy to manage lessons. Each lesson is designed with your success in mind. After you complete the course, you'll have the expert knowledge to earn up to \$100 an hour, or more!

Latest technologies and insider knowledge available only to Foley-Belsaw students!

Get the hands-on experience you need in Computer Repair. Foley-Belsaw's CD-Rom Learning Assistant™ guides you through each lesson and is always right at your fingertips. The Test Preparation Tutor™ makes preparing for your A+ Certification as easy as turning on your computer. Foley-Belsaw's inside knowledge gives you the practical experience to become a computer repair professional. Get started today!

Take the first step to top pay. Call for a FREE Opportunity Kit today! 1-800-487-2100 Ext #A0092

or complete this coupon and mail to Foley-Belsaw Institute, 6301 Equitable Road, Kansas City, MO 64120-1395

Yes! Send me one of the following Free Opportunity Kits:

- Computer Repair, Maintenance, Upgrade, 321 NEW!
- Personal Computer Specialist, 325
- Professional Computer Programming, 323
- Professional Saw and Tool Sharpening, 332
- VCR/DVD Service and Repair, 320 NEW!
- Small Engine Service and Repair, 306
- TV/Satellite Dish Service and Repair, 322
- Professional Gunsmithing, 340
- Home Inspection, 342 NEW!
- Networking Specialist, 324
- Locksmithing, 307
- Woodworking, 319
- Upholstery, 308
- AC/Refrigeration, 343
- Electrician, 326

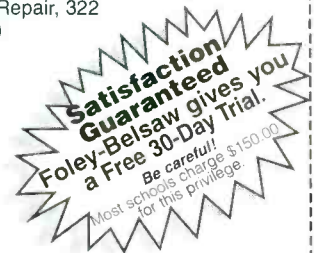

World leader in training since 1926, provides at-home, "hands-on" training in high-demand fields.

Name _____
 Street _____
 City _____ State _____ Zip _____
 Phone () _____ A0092

CIRCLE 318 ON FREE INFORMATION CARD

Electronics made easy & affordable **velleman**

NEW

PERSONALSCOPE™

HPS5

The Velleman **PERSONAL SCOPE™** is a portable fully-functional **oscilloscope**. At the cost of a good multimeter it gives you the best possible **value for the money**. The **PERSONAL SCOPE™** provides you with the **high sensitivity** (down to 5mV/div) often missing in higher or similarly priced units. Together with the other scope functions it makes this the ideal tool for students, hobbyists and professionals.

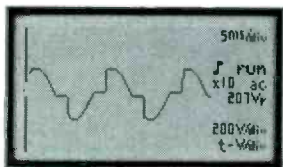

AC MAINS (e.g. phase control)



DIGITAL SIGNALS (e.g. pulse train)

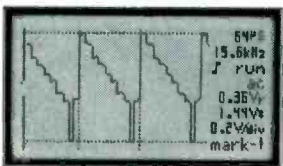

TV AND VIDEO (e.g. composite video signal)

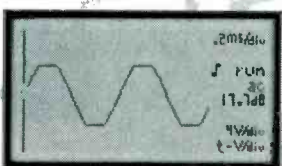

AUDIO SIGNALS (e.g. amplifier output clipping level)



SPECIFICATIONS:

- Maximum sample-rate: 5MHz
- Input amplifier bandwidth: 1MHz (-3dB at 1V/div setting) 1Mohm //20pF (standard probe)
- Vertical resolution: 8 bit (6 bit on LCD)
- LCD Graphics: 64 x 128 pixels
- dBm measurements: From -73dB tot +40dB (up to 60dB with X10 probe) ±0.5dB
- True rms AC measurement: 0.1mV to 80V (400Vrms with X10 probe) 2.5% accuracy
- Time base: 20s to 2µs / div in 22 steps
- Input sensitivity range: 5mV to 20V/div in 12 steps (up to 200V/div with X10 probe)
- Supply voltage: 9VDC / min 300mA adapter
- Batteries (in option): Alkaline type AA (5 pcs required) NiCd/NiMH rechargeable
- Battery life: Up to 20 hours with Alkaline batteries
- Safety: Meets IEC1010-1 600V CATII, pollution degree 1
- Dimensions: 105 x 220 x 35mm (4.13"x7.95"x1.38")
- Weight: 395g (14oz.) (excl. batteries)

\$199.95

Probe not included

OPTIONS:

- Insulated measurement probe x1 / x10: PROBE60S
- Adaptor for 110VAC: PS905USA



SERVICE & DEVELOPMENT



CAR DIAGNOSTICS



AUDIO TROUBLE SHOOTING

velleman

7415 Whitehall Street Suite 117
 Fort Worth, TX 76118
 (817) 284-7785 F : (817) 284-7712
www.velleman-kit.com email : velleman@earthlink.net

Questions ? Contact us for a list of US distributors or to get your **FREE** catalogue

CIRCLE 275 ON FREE INFORMATION CARD

EARN MORE MONEY!

Be an FCC LICENSED ELECTRONIC TECHNICIAN!

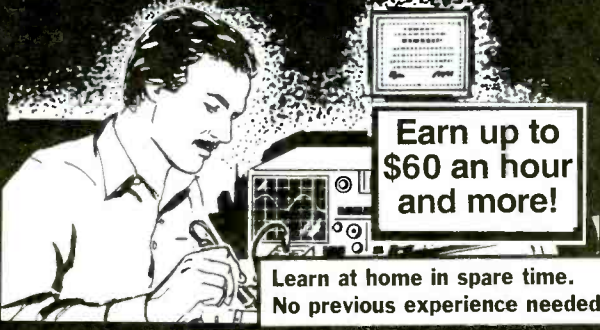

No costly school. No commuting to class. The Original Home-Study course prepares you for the FCC Commercial Radiotelephone License. This valuable license is your professional ticket to thousands of exciting jobs in Communications, Radar, Radio-TV, Microwave, Maritime, Avionics and more even start your own business! You don't need a college degree to qualify, but you do need an FCC License.

No Need to Quit Your Job or Go To School
This proven course is easy, fast and low cost!
GUARANTEED PASS—You get your FCC License or money refunded. **Send for FREE facts now.**

Call 1-800-932-4268 Ext. 210

Fax 1-415-332-1901

Email: fcc@commandproductions.com

Visit our Website: www.LicenseTraining.com

COMMAND PRODUCTIONS

FCC LICENSE TRAINING - Dept. 210
P.O. Box 2824 San Francisco, CA 94126-2824

Please rush **FREE** details immediately!

Name _____

Address _____

City _____

State _____ Zip _____

Mail This Coupon Today!

CIRCLE 231 ON FREE INFORMATION CARD

Electronic CAD Software



Only \$99.95 each (msrp)

- Ivex Spice simulation-standard
- Ivex Gerber View
- WinDraft Schematics-P350
- WinBoard PCB Layout-P350

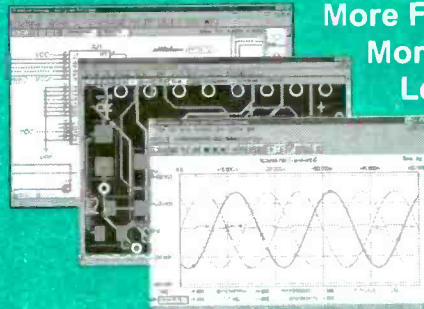

**More Features
More Power
Less Money**

Ivex Spice is available now!
Find a store near you at the NTE web site, product selection "CAD software"

www.nteinc.com

800-631-1250

Call Today



KENWOOD

Analog Oscilloscopes



CS-4125/4135 Features:

- High Withstand Voltage to 400V
- Wide bandwidth & fast sweep
- VERT mode / FIX triggering
- One touch X-Y switching
- Relay attenuator

CS-5355/75 & CS-5370

Features:

- 2% accuracy
- Delay sweep for expanded waveforms
- Reliable relay attenuator
- 3 signals synchronized on V mode

800.638.2020

www.prodintl.com



Model	Description	Sale
PC3-4125	20 MHz, 2 ch	\$399.00
PC3-4135	40 MHz, 2 ch	\$599.00
PC3-5355	50 MHz, 3 ch, delayed sweep	\$799.00
PC3-5375	100 MHz, 3 ch, delayed sweep	\$1,049.00
PC3-5370	100 MHz, 3 ch, delayed sweep with readout & cursors	\$1,299.00

CALL FOR YOUR FREE CATALOG!

- digital multimeters
- function generators
- frequency counters
- oscilloscopes
- power supplies
- signal generators

June 2000, Poptronics

PCB LAYOUT

Software For Windows - FREE

- 1 Download our board layout software
- 2 Design your 2 sided plated-through PCB
- 3 Send us your layout over the Internet
- 4 In 2-3 business days, UPS delivers your boards, often under \$100

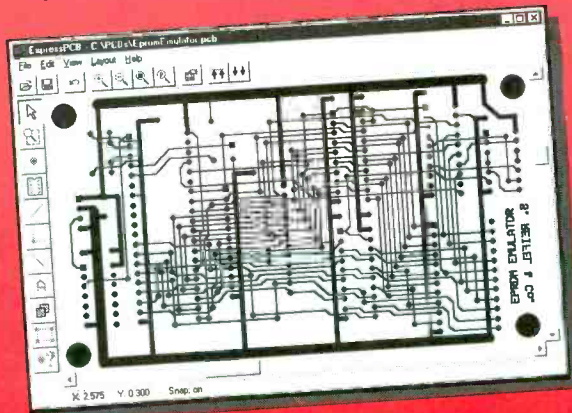

www.expresspcb.com

DATA ACQUISITION & CONTROL

AFFORDABLE PLUG-IN BOARDS FOR PC's ISA BUS

ANA100 Analog I/O \$ 99



- 8 Channel 8-Bit
- 0 to 5 Volt Input
- 14 TTL I/O lines
- Analog Output
- 400KHz Sampling

DIG100 Digital I/O \$ 39



- 82C55 PPI
- 24 or 48 TTL I/O Lines option
- Selectable Base Address

ANA150 Analog/Counter... \$ 89



- 8 Channel 8-Bit
- 0 to 5 Volt Input
- 3 16-Bit Counters
- 400KHz Sampling

DIG200 Counter I/O \$ 79



- 3 16-Bit Counters
- 8 TTL Input lines
- 8 TTL Output lines
- Selectable Clock Frequency input

ANA200 Analog I/O \$ 79



- 1 Channel 12-Bit
- 0 to 5 Volt input optional bi-polar
- 100KHz / 300KHz Sampling rate
- 24 TTL I/O lines

ANA201 Analog \$ 119



- 8 Channel 12-Bit
- x1, x5, x10, x50 Programmable Channel gain
- 100KHz Sampling rate

On-Line Product Catalog at Our Web Site

<http://www.Bsof.com>

E-Mail: Sales@Bsof.com

BSOFT Software, Inc.

444 COLTON ROAD * COLUMBUS, OH 43207
PHONE 614-491-0832 * FAX 614-497-9971

CIRCLE 310 ON FREE INFORMATION CARD

SONY, ROBOTIC, COLOR CAMERA.
Over 450Lines, 8X zoom, PAL & Y/C OUT,
WINDOWS 95/98 Control Software.

NOTE: This is the PAL (European version)
Serial Control of Pan, Tilt, Zoom,
Auto Iris and Auto Focus as well!



Like having your own R2D2. Intended for use in fortune 500 board rooms. The video performance superior to almost anything we have seen. Camera and lens is an integral assembly. Excellent Condition. I/O is on 8 pin mini-DIN & Std.

SVHS jack. Size: 8"Dx6.5"H. Serial port (COM 2) software is provided. Std. rs232 serial cable not supplied. The unit does self test on power up and the video is active. Reg price over \$4K.

VERY Limited QTY, SONYPAL.....\$249ea.

NEW, "COLOR STEALTH CAM", MICRO SIZE, & AUDIO!



That's right! COLOR! In the same size package too! Sleek aluminum housing fits like a glove! Removeable mtg. bracket & a 1.3M cable with BNC vid., RCA aud., (internal mic) & DC pwr. jack for, no sweat hook up. Why fool around with an open P.C. board? Now you can have the "COLOR STEALTH CAM"

- 1/3" • 350 Lines
- Auto Shutter
- 270k pixels
- Focus:10mm to inf.
- 1-ounce!
- 0.7 Lux • AGC
- Pwr. 6-12V @30mA
- Std. 7 mm, 56° FOV
- NTSC video
- 31mm sq. x 28mm d.

GM-4000S-STDw/audio, NOW...\$89ea.

**SECURE ON-LINE ORDERING,
UNIQUE ITEMS
WWW.RESUNLTD4U.COM**



VISA, MC, AMEX, DISCOVER, COD, ON-LINE
CRDR: 800-810-4777 TECH: 603-648-2499
FAX: 603-444-7825 E-MAIL sales@resunltd.com
300 BEDFORD STREET, MANCHESTER, NH 03101

MINIMOTOR SA, SWISS GEARMOTOR, Sooooo TINY



State of the art "ironless" type, mini motor. Model: 1219E-012G-400. Includes: 104:1 Planetary gearbox. Size: 12mm d x 44mm L (shown actual size) 2mm d x 6mm L, flatted shaft, solder terminals.

@VIN In RPM
6V 5mA 68
12V 5mA 145

**LIMITED QUANTITY
TYPE A: \$22ea. or 5 for \$99**

**GEAR MOTOR, METAL CONSTRUCTION,
HIGH TORQUE,**

BUEHLER PRODUCTS, type 127K01880

These are brand new, very rugged gearmotors. They offer a 5mm diameter x 9mm long, flatted output shaft, located off-center (approximately 10mm from the edge of the 35mm diameter gearbox.) Overall size: 35mm d x 73 mm L (including the shaft) with 2" red and black leads. The motors are rated at 17VDC nominal and provide the following speeds:



@VIN I NOLOAD RPM
12V 60mA 360
15V 62mA 457
17V 64mA 523

**BUEHLER #127K
\$12ea. or 3 for \$29**

**NEW, LINEAR SLIDE,
GOES to EXTREME LENGTHS,**



**Techno-Isel, series one,
Very high quality, German made.**

This is the slide you have been looking for! Did we say it was LONG? How does 4 feet sound? Actually 49 and 1/4" to be precise and we know you are. Very sturdy, based on a heavy duty 1.5" wide, extruded aluminum and 1/2 diam. steel, dual rail. The slide carriage incorporates superior quality, recirculating ball bearings. Size of carriage is 3" x 3" with a solid 1/2" thick aluminum mounting plate. Limited quantity. The dual rails are new or have been carefully removed from precision optical equipment. The slider carriages are all brand new & unused. Each rail includes one slide carriage. Extras are available.

**LONG-ISEL-48.....\$149ea. or \$279 for pair.
CAR-1, carriage only.....\$69ea. or 2 for \$129**

CIRCLE 246 ON FREE INFORMATION CARD

High Performance Auto Ranging DMM New to our DMM line-up and possibly (probably) the best DMM value anywhere!

- Includes: Analog Bar Graph, Auto-Ranging, Data Hold, Temperature Probe, Frequency Test, Continuity Test AND MORE!
- Data Hold:** Freezes reading for easy checking
- Auto Ranging:** For easy, precise range settings
- Range Hold Control:** allows for manual selection of your test range
- 3-3/4 Digit LCD Display:** Reads up to 3260. Easy to read display.
- Function Dial:** Easy to use to select measurement type or turn unit off.
- 4 Jack Plug-ins:** Safety design with different capacities for different functions
- Diode, Continuity Check Push-Button:** For toggling between diode check and continuity check.
- Low Battery Indicator:** Advises you when it's time to change battery.
- Extra Long 44" Test Leads:** Helps get to hard to reach places
- Screw-On Alligator Clips:** Convert one or both probe tips to alligator clips
- Fuse-Protected Circuitry**
- Shock-In Stand:** Makes one hand operation easier.
- Built-In Absorbing Rubber Carrying Case:** with convenient probe storage clips and hanging tab. Helps protect the DMM from damage if accidentally dropped.

Measures:
 DC Volts: up to 1000V
 AC Volts: up to 750V
 AMPS: up to 20 Amps (AC & DC)
 Resistance: up to 30M Ohm
 Continuity Check: with audible signal (signal sounds if resistance is less than 20 ohms. Display reads actual resistance).
 Frequency: (1KHz to 300KHz) displays both digital and bar graph reading.
 Transistor hfe Test: Display shows approximate life value based on test condition of 10uA base current and Vce of approx. 3V.
 Temperature Test: Measures from 0° to 1832° F (probe supplied)
 Diode Test: Tests if diodes are shorted or open
 Input Impedance: 10Mohm (Vdc/Vac) over 100Mohm on 300 mVdc range

NOW IN STOCK!



ONLY \$29.95

#CSI9903

Specifications Accuracy
 Vdc: ±1.0% reading +5 digits
 Vac: ±1.5% reading +8 digits
 Adc: ±1.2% reading +5 digits
 Aac: ±1.5% reading +5 digits
 Resistance: ±1.5% reading +5 digits
 Frequency: ±3.0% reading +5 digits
 Temperature: ±1.0% reading +5 digits
 Requires two AAA batteries sold separately.

Removable Hard Drive Rack

For IDE/Ultra DMA Hard Drives
We Sold Over 14,000 in 1998!
 This product can be used with any 3-1/2" IDE hard drive up to 1" high! It includes an electronic keylock for safe removal and insertion. Made of ABS 707 fireproof plastic. Use this product to protect sensitive hard drive data, take your hard drive between work and home or even set up different users with their own hard drives that they physically insert every time they use a PC. Other models available from C.S.I. include RH10 series and RH20 series, which are interchangeable within the same interface design (IDE or SCSI). Other Models are Available. See www.web-tronics.com under "hard drive and accessories" for more details and pictures.



ONLY \$14.95 any qty.

#RH-10C-IDE

Removable Hard Drive Rack with Auto Door and Cooling Fan

- Auto door on the outer frame
- ABS material of outer frame. High efficiency cooling fan
- Worldwide patent pulling function handle
- CE Approved
- Coating iron bottom cover
- For IDE interface
- For 1" high 3.5" HDD
- Not compatible with our RH10 & RH20 series. Compatible with our RH17-IDE model.



ONLY \$18.95 any qty.

#MR-27

Details at www.web-tronics.com

2GHz RF Field Strength Analyzer

- Frequency Range: 100KHz to 2,060MHz
- Narrow Band FM (NFM), Wide Band FM (WFM), AM and Single Side Band (SSB) Modulated Signals May Be Measured
- PLL Tuning System for Precise Frequency Measurement and Tuning
- LED Backlight LCD (1192x192 dots)
- Built-In Frequency Counter
- Hand-Held and Battery Operated
- All Functions are Menu Selected
- RS232C for PC Interface and Printer

ONLY \$1589



#3201

CTRL - D to bookmark this site



- Easy to Navigate
- Includes a Search Engine That Really Works
- New Items Added Constantly

In Business Since 1971

Circuit Specialists Inc.

CCD B&W Board Cameras

- ASIC CCD Area Image Sensor
- Extremely Low Power Consumption
- 0.5 Lux Min Illumination
- Built-In Electronic Auto Iris for Auto Light Compensation
- VM1030PA-B 30mmx30mmx25mm, Pinhole lens, 12V \$39.00 any qty.
- VM1030A 30mmx30mmx26mm, Standard lens, 12V \$39.00 any qty.
- VM1035A 42mmx42mmx25mm, Standard lens, 12V with back light compensation \$49.00 any qty.
- VMCB21 44mmx38.5mmx28mm, with 6 infra-red LEDs, 12V \$49.00 any qty.
- VM1036A 32mmx32mmx25mm, Standard lens, 12V, reverse mirror image feature \$49.00 any qty.

Detailed Specs on the Web

LOWER PRICES

Bullet CCD Cameras B&W and Color

- Smart Rugged Metal Housing
- Extremely Low Power Consumption
- 12 Volt
- CCD Area Image Sensor for Long Camera Life
- Built-In Electronic Auto Iris for Auto Light Compensation
- No Blooming, No Burning
- 0.1 Min Lux Illumination (B&W), 1 Lux Min Lux Illumination (color)
- VMBLT1020 B&W, 21mm(D)x55mm(L) \$49.00 any qty.
- VMBLT1020W B&W Weatherproof, 21mm(D)x58.5mm(L) \$79.00 any qty.
- VMBLTJC19BW COLOR! Weatherproof, 17mm(D)x88mm(L) \$139.00 any qty.

Detailed Specs on the Web

LOWER PRICES

COLOR CCD Mini Board Cameras

- Low Power Consumption
- 1 Lux Illumination
- Internal Synchronization
- 12Volts
- 400 TV Lines
- Built-In Electronic Auto Iris for Auto Light Compensation
- VM3010PA 33mmx33mmx18mm, Pinhole lens \$99.00 any qty.
- VM3011-A 45mmx40mmx24mm, Standard lens, single board \$89.00 any qty.
- VM3010-A 33mmx33mmx32mm, Standard lens \$99.00 any qty.

Detailed Specs on the Web

PRICE REDUCTION

2.4 GHz A/V Sender/Receiver System

- Wireless FM transmission of video (color or B/W) and sound (stereo or mono) up to 150 meters (line of sight)
- Directional Antenna Design optimizes performance
- Use with remote cameras or any input (satellite TV, cable etc.) where wireless transmission is desired. View on a TV set.
- Performance through walls varies depending on construction methods etc.
- Each set includes a plug-in power supply for the transmitter & receiver.
- 7 segment LED displays channel (1-4) on receiver & transmitter.

IN STOCK! Order Now!

CSIHTR2400 Includes One Transmitter & One Receiver with Power Supplies \$139.00
CSIHTR2400TX Extra Transmitter/Each Receiver will Monitor up to 4 Transmitters \$89.00
 See more detailed specifications at www.web-tronics.com in the CCD camera section.

Our Most Sophisticated DMM We Sold Over 700 Last Year!

- with RS-232 Interface & Software, 3-3/4 Digit, 4000 Count, Auto-Ranging with Analog Bargraph
- K Type Temperature Probe Included
- Pulse Signal for Logic & Audible Test
- Continuity/Diode Test
- Logic Test
- Auto Power OFF/"Keep ON" Mode
- Fused 20A Input with Warning Beeper
- Back Light
- Data Hold/Run Mode
- Safety Design UL1244 & VDE-0411
- Protective Holster
- Silicon Test Leads

NOW ONLY \$129 Reg. \$169

More Details on our Web Site

PROTEK 506

Mini CCDs (B/W & Color)

- Sensational NEW Design for Small Observation Cameras. Smaller and Better!
- Ultra Miniature Design
- Black & White Versions Only 25mm x 25mm
- Color Versions Only 32mm x 32mm
- Available in Standard Lens or Pinhole Lens
- All Include Pre-Wired Cable Harness for Video & Power
- 12V Regulated Power Supply Required (120mA typical power consumption)
- 0.1 LUX Rating (B/W), 1 LUX (color)
- CCD Area Image Sensor for Long Camera Life
- Back Light Compensation Circuit
- Built-In Electronic Auto Iris Lens

LOWER PRICES

Detailed Specs on the Web

- VMCW-H11A 32mmx32mmx30mm, Color CCD with standard lens, pre-wired cabling 12V DC Power \$139.00 / \$129.00 5 or more
- VMCW-H12A 32mmx32mmx19mm, Color CCD with pinhole lens, pre-wired cabling, 12V DC Power Input \$139.00 / \$129.00 5 or more
- VMP5-718A 25mmx25mmx30mm, B/W CCD with standard lens, pre-wired cabling, 12V DC Power Input \$59.00 / \$49.00 5 or more
- VMP5-250A 25mmx25mmx15mm, B/W CCD with pinhole lens, pre-wired cabling, 12V DC Power Input \$59.00 / \$49.00 5 or more

Hot Air SMD Rework Station WOW! ONLY \$489

Similar Systems Cost 100s More!
ONLY \$489



#SR-979

For technicians, service/repair depots and assembly rework. We also stock a selection of nozzles for QFP, SOP & PLCC devices (see our website for selection details). Hot Air temperature variable from 100°C to 400°C (212°F to 754°F) power consumption: 275w max. Auto cooling feature cools system after shut off to extend service life of heating elements and handle. One year limited warranty from C.S.I.
 Comes with QFP Nozzle (0.68" x 0.68")

O'Scope Offer ONLY \$289

30MHz! ONLY \$289! Take Advantage of this low introductory price!



- Dual Channel
 - Dual Trace
 - Vert Trigger
 - 1 Year C.S.I. Warranty!
- Manufactured for CSI by a leading O.E.M. manufacturer. See our website for detailed specifications!**

#OSC-1030

3000 Series Digital R/O Bench Power Supplies

Low Cost Single Output 3 Amp & 10 Amp Versions
AS LOW AS \$89

High stability digital read-out bench power supplies featuring constant voltage and current outputs. Short-circuit protection and current limiting protection is provided. Highly accurate LED accuracy and stable line regulation make the 3000 series the perfect choice for lab and educational use.



Line Regulation: 2x10⁻⁴ +1ma
 LED Accuracy: Voltage ±1% +2 digits
 Current ±1.5% +2 digits
 Wave Line Noise: ≤1mVrms
 Dimensions: 291mm x 158mm x 136mm (CSI3003 & CSI3010)

CSI3003: 0-30v/0-3amp
 Digital R/O Bench PS,
 1x10⁻⁴+5mv Load Regulation
\$99.00 5/\$89.00

CSI3010: 0-30v/0-10amp
 Digital R/O Bench PS,
 1x10⁻⁴+30mv Load Regulation
\$159.00 5/\$149.00

PIC'n Books

LEARN ABOUT PIC MICROCONTROLLERS

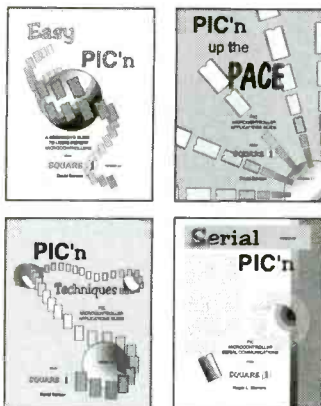

See Table Of Contents: <http://www.sq-1.com>
Secure Online Ordering Is Available

PIC is a trademark of Microchip Technology Inc.

SQUARE 1 ELECTRONICS

Voice (707) 279-8881 Fax (707) 279-8883

<http://www.sq-1.com>

SERIAL LCDs

Serial LCDs work great with BASIC Stamps® and other microcontrollers. One-wire interface • simple serial protocol • low cost • high quality • in stock

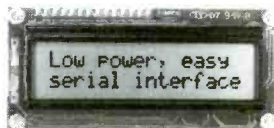

BPI-216N

- 2x16 text LCD
- 2400/9600 bps
- \$45 (non-backlit)

- **SGX-120L**
- Mini graphics LCD
- 2400/9600 bps
- just \$99



Many other models available—see www.seetron.com/

Scott Edwards Electronics, Inc.
www.seetron.com • 520-459-4802



EPROM+

A device programming system for design, repair and experimentation

- ◆ EXCEPTIONAL POWER FOR THE PRO
- ◆ EASY-TO-USE FOR THE NOVICE
- ◆ INCLUDES STEP-BY-STEP TUTORIAL

Here's what you get: A rugged, portable programming unit including the power pack and printer port cable both of which store inside the case. A real printed user and technical manual which includes schematic diagrams for the programming unit plus diagrams for all technology family adapters.* Comprehensive, easy-to-use software which is specifically designed to run under DOS, Windows 3.1, 95 and 98 on any speed machine. The software has features which let you READ, PROGRAM, COPY and COMPARE plus much more. You have full access to your system's disk including LOADING and SAVING chip data plus automatic processing of INTEL HEX, MOTOROLA S-RECORD and BINARY files. For detailed work the system software provides a full screen buffer editor including a comprehensive bit and byte tool kit with more than 20 functions.

Broad device support: FIRST GENERATION EPROMS (2708, TMS2716*, 25XX) SECOND GENERATION EPROMS (2716-28C08), 40 AND 42 PIN EPROMS* (27C1024-27C160) FLASH EPROMS (28F, 29C, 29EE, 29F), EEPROMS (2816-28C010), NVRAMS (12XX, X2210/12) 8 PIN SERIAL EEPROMS* (24, 25, 85, 93, 95, 80011A) PLUS ER1400/M58657* AND ER5901 BIPOLAR PROMS* (72S/82S), FPGA CONFIGURATORS (17CXXX) MICROCONTROLLERS* (874X, 875X, 87C5XX, 87C75X, 89C5X) ATMEL MICROS* (8-40) PIN 89C0501, 89SXXX (AVR) 90SXXXX PIC MICROS* 8, 18, 28, 40 PIN (12CXXX-16CXXX, 16FXX, 17C) MOTOROLA MICROS* (68705P3/U3/R3, 68HC705, 68HC711)

\$289

*REQUIRES SNAP-IN ADAPTER (ORDER FACTORY DIRECT OR BUILD YOURSELF) \$5.00 SHIPPING • \$5.00 C.O.D.
1 YEAR WARRANTY - 30 DAY MONEY BACK GUARANTEE VISA* MASTERCARD* AMEX

ANDROMEDA RESEARCH, P.O. BOX 222, MILFORD, OH 45150
(513) 831-9708 FAX (513) 831-7562 website - www.arlabs.com

CONTROL MEASURE INPUT

RELAYS • LIGHTS • MOTORS
TEMPERATURE • PRESSURE • LIGHT LEVELS • HUMIDITY
SWITCH-POSITIONS • THERMOSTATS • LIQUID LEVELS

MODEL 30 \$79



- PLUG & INTO PC BUS
- 24 LINES DIGITAL I/O
- 8 CHANNEL
- 8 BIT A/D/IN
- 12 BIT COUNTER
- UP TO 14K SMP/SEC

MODEL 45 \$189



- RS-232 INTERFACE
- 8 DIGITAL I/O
- 8 ANALOG INPUTS
- 2 ANALOG OUTPUTS
- 2 COUNTERS-24 BIT

MODEL 100 \$279



- 12 BIT 100 KHZ A/D
- 4 ANALOG OUTPUTS
- 3 TIMER COUNTERS
- 24 DIGITAL I/O

MODEL 150-02 \$179



- RS-232 INTERFACE
- TRMS, 28 AMPS
- 12 BIT A/D
- OPTO-ISOLATED
- COMPLETE DMN

MODEL 40 \$109



- RS-232 INTERFACE
- 28 LINES DIGITAL I/O
- 8 ANALOG INPUTS
- PWM OUTPUT

MODEL 70 \$239



- RS-232 INTERFACE
- 18 BIT A/D
- 5.5 DIGIT
- UP TO 60 SMP/SEC

Prairie Digital, Inc.

PHONE 608-643-8599 • FAX 608-643-6754

920 S. FIFTEENTH STREET • PRAIRIE DU SAC, WISCONSIN 53578

LASERS

AT GREAT PRICES

Complete Ruby Laser Assembly less than \$300

He-Ne Lasers, complete, for less than \$50

American 60X Argon Lasers from \$595

Laser Diode Modules from under \$40

X-Y Scanners from \$79

FREE CATALOG

- Helium-Neon
- Argon Lasers
- Diode Lasers
- Holography
- Books
- Ruby Lasers
- Scanners
- Lightshow Equipment
- Pointers
- Optics

Email: mlp@nlenx.com <http://www.midwest-laser.com>



Midwest Laser Products

P.O. Box 262, Frankfort, IL 60423

Phone: (815) 464-0085 FAX: (815) 464-0767

30 Day Satisfaction Guarantee.

VISA / MC Accepted

VISUALSPICE

High Performance web savvy 32-bit mixed signal Analog, Digital Circuit Design and Simulation

www.islandlogix.com
1-888-847-0080 or 847-688-9621

Prices start at \$99

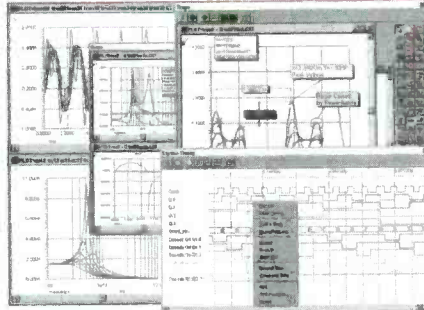
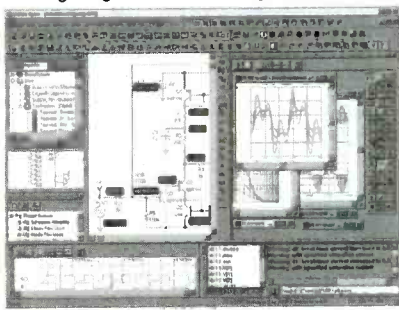

- ✓ Signal Cross Probing
- ✓ Editable PCB FootPrint Fields
- ✓ Combinational Breakpoints
- ✓ Advanced Sequential Breakpoints
- ✓ Voltage threshold breakpoints
- ✓ Edge and level sensitive breakpoints
- ✓ Customizable Tool Bars
- ✓ AutoZooming
- ✓ Expandable Symbol Library
- ✓ Expandable Model Library
- ✓ Mathematical Interpreter + Scripting
- ✓ Power meter with complex V and I
- ✓ Watt Meter
- ✓ Digital Word Pattern generator
- ✓ Import models from different manufacturers
- ✓ Stackable Waveform Display Output
- ✓ Waveform Tracking Cursors
- ✓ Automatic measurements using cursors

Also available:

* Basic and Advanced PCB Layout loaded with features!!!!

* Basic AutoRouter

* Advanced Spectra Autorouter from Cadence Design Systems

* Student and University Discounts

* FREE LIFETIME TECH SUPPORT

* IMPROVED CUSTOMER SERVICE

* FASTER SHIPPING

* DEALERS WANTED!!!!

- ✓ Voltages + Currents on Schematic
- ✓ Auto Save
- ✓ Docking Windows
- ✓ Hierarchical Project Browser

- ✓ Full Featured Schematic Capture
- ✓ Device Symbol + Model Editor
- ✓ Create Your Own Parts + Libraries
- ✓ Device librarian
- ✓ Auto Save
- ✓ Searchable Device + Model Browser
- ✓ Over 7000 devices/models
- ✓ BSIM SOI Support
- ✓ BSIM3 Deep SubMicron
- ✓ BSIM4 (NEW!!!)
- ✓ Named Off Page Connectors
- ✓ Interface with PCB Layout programs
- ✓ Virtual Instruments
- ✓ 64 channel Real-Time Oscilloscope
- ✓ Multimeter + Function Generator
- ✓ Named Busses and wires
- ✓ 20 Different Analysis
- ✓ AC,DC,TRAN,MC/WC, Pole/Zero
- ✓ OP, Transfer Function, Noise, THD
- ✓ Fourier, Power Plots, Impedance plots
- ✓ Distortion + Bode Plotter
- ✓ Nested Parameter Sweep
- ✓ Temperature Sweep
- ✓ Polynomial Source Converter
- ✓ Logic analyzer with break points
- ✓ Model Import Wizard
- ✓ Import and Simulate External Netlist
- ✓ Device Parts Search/Browser
- ✓ Bill Of Materials
- ✓ Multiple WorkSpaces
- ✓ Signal Generator Preview
- ✓ Automatic Graphics Legends
- ✓ Graphical Annotation on Graphs
- ✓ Signal Post Processor
- ✓ PCB Netlist Generation

New and Pre-Owned Test Equipment

New Equipment Specials

SIMCHECK[®] Hse PLUS – Module Tester

- * Tests SIMMs/168 pin DIMMs
- * Identifies Module properties
- * Stand alone/portable
- * Built-in Serial Interface

Only \$1,995.00

AVCOM PSA-37D – Spectrum Analyzer

Satellite Downlink – Installation – Maintenance & Service

- Band 1: 10 – 1750 MHz
- Line or Battery Powered
- Band 2: 3.7 – 4.2 GHz
- Built-in DC Block & Power for LNA/LNB's
- Carrying Case Included

Only \$2,395.00

Instek GOS-6103 – Analog Oscilloscope

- 100 MHz Bandwidth
- Time Base Auto-range
- 2 Channel, High Sensitivity
- Includes Two Probes
- Trigger Signal Output
- 2 Year Warranty
- Cursor Readout

Only \$899.00

Leader LF 941 – CATV Signal Level Meter

- ✓ TV/CATV Coverage from 46 - 870 MHz
- ✓ Video/Audio Carrier Measurements

Only \$489.00

Fluke 87 IV – Digital Multimeter

- ✓ Basic DC Accuracy of 0.025% at 50,000 Count
- ✓ True-RMS AC, AC+DC, dBm, & dBV

Only \$319.00

Pre-Owned Oscilloscope Specials

B+K Precision	1466	10 MHz	\$185.00
Tektronix	465	100 MHz	\$599.00
Tektronix	465B	100 MHz	\$729.00
Tektronix	475	200 MHz	\$829.00
Tektronix	475A	250 MHz	\$999.00

- Professionally Refurbished
- Aligned & Calibrated to Original Specifications
- The Industry Standard of Oscilloscopes
- 1 Year Warranty - The Longest Available!!!
- See Website for Complete Specifications

See us on the Web!
www.testequipmentdepot.com

We Buy Surplus Test Equipment

Test Equipment Depot

A FOTRONIC CORPORATION COMPANY

99 Washington St. Melrose, MA 02176

(781) 665-1400 • FAX (781) 665-0780

e-mail: sales@testequipmentdepot.com

(1-800-996-3837)

TOLL FREE 1-800-99-METER



CIRCLE 313 ON FREE INFORMATION CARD

CABLE SECRETS!!!

Build your OWN cable box "test" devices!

Why pay \$100.00 or more for a "test" device that someone else made? Make your own! Includes complete source code and plans for the most commonly used cable boxes. *Unlock all of the channels on your box!*

Or start your own lucrative business!

Complete source code \$79.95
Code for individual boxes \$29.95

DSS SECRETS—Vol. 2

Step-by-step instructions on programming your own DSS access card. *Unlock all channels on your own card!* This is the most current information on the market! Includes software, plans, and hardware sources. Book & CD-ROM.

DSS Secrets Vol. 2..... \$49.95

VISA • MasterCard • American Express

To order, call Worldwyde @ 1-800-773-6698

21365 Randall Street • Farmington Hills, MI 48336

Visit us on the web at www.worldwyde.com

ARCOL

The Power in Resistors

- Standard and non-standard values
- 10W ~ 1000W
- Low inductance
- Full technical support
- Short delivery time
- Special terminations available



www.j-tron.com



J-TRON INC.

(888) 595-8766

OWN A MACHINE SHOP!

Do it yourself!

No more waiting to have parts or repairs done.

- Easy to use—Free training.
- You'll be doing quality work right away.
- Affordable—Six models starting at \$995.
- Versatile—Work metal—and wood or plastic.
- CNC adaptable



"I can fix most anything. Now I don't know how I lived without it. It paid for itself in no time."

Enjoy the freedom & cost savings of owning a benchtop machine shop.

FREE
Info Pak

CALL TODAY!

or write: **Smithy.**

1-800-345-6342 Dept. PE001 PO Box 1517
Guaranteed to pay its own way Ann Arbor, MI 48106-1517

Visit us at www.smithy.com

Press-n-Peel Transfer Film

PC Boards in Minutes

8.5" x 11" Shts.
* Or Photocopy
**Use standard household iron

1. LaserPrint*
2. Press On**
3. Peel Off
4. Etch



Use Standard Copper Clad Board
20 Shts \$30/ 40 Shts \$50/ 100 Shts \$100
Visa/MC/PO/CK/MO \$4 S&H/Foreign Add \$7

Techniks Inc.

P.O. Box 463, Ringoes NJ 08551

ph. 908.788.8249 fax 908.788.8837

www.techniks.com

Visit Our E-Store On-Line!

10Hr Phone Recorder \$69

Records both sides of conversation automatically

Telephone Scrambler \$159 ea. or 2 for \$149 ea.

Secure phone conversations with this high tech "rolling code" scrambler. Thousands of codes. Easy connection. Requires one at each end.

Voice Changer Phone \$99

Disguise your voice with this phone. 16 Pitches. Make your voice deeper or higher. Men can sound like a woman. Easy to use.

5 Hr. Phone Recorder Touch-tone decoder \$159

Records both sides of conversation including phone numbers dialed

Phone Information Recorder \$169

Records both sides of conversation along with the number dialed

Records name and number of callers (requires Caller ID service)

PC Telephone Recorder \$119

Use your PC to record phone calls. Windows 95, Sound blaster compatible sound card 48k or higher PC required

Phone Tap detector \$159

Protect your phone against phone taps, eaves droppers and RF bugs.

Mini Bug Detector up to 2Ghz \$119

Detects RF "bugs". Video Transmitters and wireless microphones from 5Mhz to 2 GHz. LED Bargraph and Audible alarm

VISA • MC • Money Orders • US & Canada Only

NO CHECKS • NO COD • Add \$6.95 S/H

www.mscelectronics.com

MSC Electronics

PO BOX 461 Jessup, MD 20794

(301) 497-1600

FAX (301) 497-1925



LASER MODULE



Auto Power Control

Collimated Laser

Compact Size

100,000 hr lifetime

No Electronics Required

Visible Laser Modules (635-670 nm)

TTL Modulated Laser Modules

Line Generator Laser Modules

Infrared Laser Modules (780-830 nm)

from

\$ 29 (US)

LASER POINTER



Focus Adjustable

Elegant Design

Solid Metal Body

Pen Style Laser Pointer (1500 ft visibility)

Key Chain Laser Pointer (1500 ft visibility)

Available in silver and black finish.

\$19.95 (US)

World Star Tech.

Ask for free catalog

tel: (416) 204 6298 Fax: (416) 596 7619

<http://www.worldstaretech.com> e-mail: info@worldstaretech.com

CONTROL IT

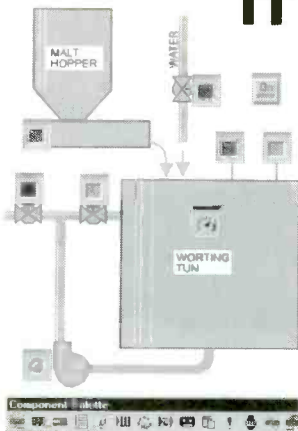

Intec Automation Inc.

www.microcommander.com

GLOBALTECH DISTRIBUTORS

The Ultimate Electronic Saving Store

Call Today!—1-(800)582-5116

	25pc.	100pc.	500pc.
PIC12C508	1.30	1.20	1.15
PIC16C54	1.40	1.35	1.30
PIC16C56	1.65	1.50	1.45
PIC16C621	2.00	1.95	1.85
PIC16C622	2.25	2.15	1.95
68HC705C8A	5.50	5.00	4.85
ATF89C52	4.00	3.50	3.15
82S131	1.50	1.30	1.15
Gall16V8b	1.00	.95	.75
4mhz Res.	.45	.40	.32
20mhz Crystal	.50	.45	.40
CATV Remote	4.25	3.75	3.25
Universal Remote Controls-----			4.50

Order@globaltechdistributors.com



BEST MICROPROCESSOR STOCK DISTRIBUTOR WORLD WIDE.

PIC PROJECTS

Book & CD-ROM

Many PIC Projects for Beginners & Experts!
Includes Software, Documentation, and PCB Layout

- LCDs
- X10 — Home Automation
- Keypads
- Serial Port Interface
- On-Screen Displays
- Robotics
- Data Logging
- Serial-Parallel
- And Many More!

Book & CD Only
\$24.95

PIC Programmer

Programs all PIC16C55x/6x/7x/8x/9x, PIC16F8x, and PIC12C devices. Optional ZIF adapters for SOIC & PLCC. Includes all necessary software.

Only \$39.95

Buy Both for **\$59.95**

We accept

VISA • MasterCard • American Express

To order, call Worldwyde @ 1-800-773-6698

21365 Randall Street • Farmington Hills, MI 48336

Visit us on the web at www.worldwyde.com/pic

CONTROL YOUR WORLD

Modular, Open Source Automation

Digital Input
From \$40

Controllers
From \$75

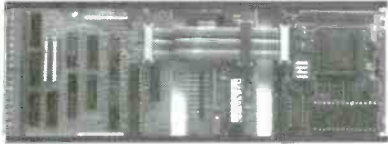

X-10 Control
From \$47

Event control software included
Build Custom controllers for -

- ** Home Automation
- ** Machine Automation
- ** Security
- ** Robotics

Low Cost Microcontroller boards, kits & applications

ZORIN

<http://ZORINco.com>
or call (206) 282-6061

The Hack & Crack Bible on CD-ROM

Includes all Software, Documentation,
Plans, and PCB Layouts!

Unlock the secrets of:

- DSS & Smart Cards
– Programming & Schematics
- Cable Test Devices
- Sony Playstation
– Mod Chip/CD Backups/Emulation
- Backup Sega & SNES Console Cartridges
- Sega & SNES Emulation on your PC or Mac
- Wareg – where to find them on the Internet
- Cellular Hack/Phreak/Mod
- And Much More!

Only
\$29⁹⁵

PC & Mac Compatible CD-ROM

We accept

VISA • MasterCard • American Express

To order, call Worldwyde @ 1-800-773-6698
21365 Randall Street • Farmington Hills, MI 48336
Visit us on the web at www.worldwyde.com/hack

35¢ Switches



Premium quality. Rated 6A/125V. All hardware included. 1/4" panel hole. SPDT or DPDT, on-on or on-off-on. 100pcs minimum. VISA or Master Card. Sorry, no COD. Order Toll-free.

Gateway Products Corporation
Email: GtwyPrds@aol.com

800-830-9195

PIC Programmer Kits

Super Value!

Code:
CPS96

\$19.95
+S&H \$4.95*

• Program all 8, 18, 28 & 40 pin PICs in the 12C5xx (12C508), 14000 and 16Cxx (16F84) series (except 16C54-58). • All components, PCB and Instructions included. • Parallel port of PC is used with straight through (25 pin) cable (not supplied). • Kit uses shareware which is downloaded from the web and registered for \$20. • 40 pin ZIF socket recommended (available for \$11.95). • For more info and Atmel programmers visit www.electronics123.com

Video Camera module

Code:BB004

CMOS Camera Module, Black & White, Size: 0.63"x0.63"x0.59"H. Low cost, low power and very small! Lens: f4.9, F2.8 FOV 56 deg x 42 deg. EIA 320Hx240V. Scan: 2:1 interface, 0.6" DIL Package, 5 pins. Pin 3 is 1V p-p composite video (75 ohm) to standard video monitor. Power Supply, 5V +/- 0.5V. Current 10mA. Needs regulated power supply. *S&H to Canada is \$7.⁹⁵

\$35.95
+S&H \$4.95*

Toll Free: 1-888-549-3749 (USA & Canada)
Tel: (330) 549-3726. Request a FREE catalog or visit us at: www.electronics123.com for more products. Amazon Electronics, Box 21 Columbiana OH 44408

www.jm-micro.com

PIC In-Circuit Emulator

for the PIC16Cxx from \$295

PIC Programmer \$155

80C552 (8051) Development Training System \$235

68HC11 SBC \$120

ROMY-16 EPROM Emulator from \$195

Universal Microprocessor Simulator/Debugger (including Assembler, and Disassembler)

\$100 each CPU

J&M Microtek, Inc.

83 Seaman Rd, W Orange, NJ 07052
Tel: (973) 325-1892 Fax: (973) 736-4567

COVERT CATALOG 2000

BRAND NEW!

The Latest, Up-to-date, Hands-on Supplier and Source Guide for:

- Electronic surveillance equipment
- Covert video cameras and transmitters
- Counter measures gear
- Entry supplies
- Electronic tracking systems
- Computer surveillance and remote viewing

Equipment, exact addresses and ordering info from 15 countries!! 220 pages — \$39.95

11355 S El Camino Real, San Mateo, CA 94403
Phone 650-513-5549 ■ fax 650-728-0525 or www.intelligence.to (no ".dot.com")

Call Today And **SAVE!** **Unbeatable PRICES!**

CABLE TV

DESCRAMBLERS
CONVERTERS • FILTERS
VIDEO STABILIZERS

- FREE ➤ 30 Day Trial
FREE ➤ Product Catalog
FREE ➤ 1 Year Warranty

100% MONEY BACK GUARANTEE

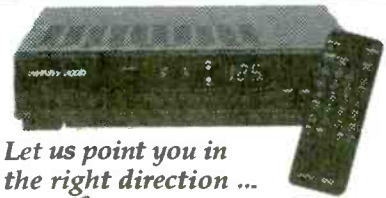

Let us point you in the right direction ...

Arrow Technologies
Omaha, Nebraska

TOLL FREE
888-554-ARROW

888-554-2776

MECI 340 East First Street
Dayton, Ohio 45402
Your Electronics Value Company

Tons of Electronics

Get your FREE catalog today and discover some of the best deals in electronics. We have thousands of items ranging from unique hard-to-find parts to standard production components. Call, write or fax today to start your subscription to one of the most unique catalogs in the industry, filled with super values on surplus electronic and hobbyist type items.



Checkout our 10,000 item on-line catalog <http://www.meci.com>

Order Toll Free **1-800-344-4465** Why pay more? Call today!
Fax Order Line 1-800-344-6324

CIRCLE 250 ON FREE INFORMATION CARD

**POWER HOUSE 650NET
HEAVY DUTY BACK-UP
POWER SUPPLY**

Brand new latest and most powerful uninterruptible power supply features: save and restore software, phone modem protection and full network backup protection. These heavy duty units can provide up to an incredible 40 minutes of run time for computer and monitor. Rated 650V, this is the unit you need for serious network workstation & home office use. These are factory fresh, brand new retail boxed units by SL Waber and they are complete with full factory warranties. These retail for up to \$300.00 however if you hurry you can get yours for our blowout price! Weighs 21 lbs. Size 15 1/2" (L) x 6 1/2" (H) x 4 1/4" (W)

**BLOWOUT
PRICE**



G1817 \$149.00

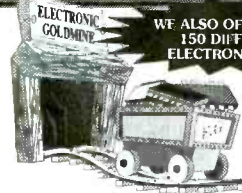

WE ALSO OFFER OVER
150 DIFFERENT
ELECTRONIC KITS.

**ELECTRONIC
GOLDMINE**

PO Box 5408
Scottsdale, AZ 85261

<http://www.goldmine-elec.com>

NOTE: All items subject to prior sale; All prices expire 5-31-00

For Phone Orders Call: **800-445-0697**
or Fax Your Orders to: **(480) 661-8259**
For a Free Catalog Call: **800-445-0697**
e-mail: goldmine-elec@goldmine-elec.com
Foreign catalog request: send \$5.00

Minimum Order: \$10 (plus min. \$5 Shipping and Handling). We accept MasterCard, Visa and personal checks, however, we cannot accept personal checks on orders outside the U.S. Minimum Foreign Order Amount: \$50 (plus a minimum \$10 S&H)

**CALL, E-MAIL, WRITE OR FAX US FOR YOUR FREE COPY OF OUR NEW
104 PAGE CATALOG CONTAINING ALMOST 5,000 PRODUCTS!**

**UPSTART
UNINTERRUPTIBLE POWER SUPPLY**

High quality UPS by Waber features up to 10 minutes of backup for your computer when the power fails plus includes save and restore software. This model features a slim line design to allow you to place your monitor or computer right on top of unit. Exclusive Electronic Bookmark™ Software saves any job... In a power outage, automatically saves work & shuts down... Then reboots and restores data when power returns... Unattended. Also stops surges, and spikes from damaging computers and peripherals. This unit even has modem protection. These are factory new perfect units with complete warranties. High quality retail boxed unit with software, warranty and simple to understand instructions. Weighs 16 lbs. Size 13 (L) x 2 1/2" (H) x 13 1/2" (W). Buy yours today at a fraction of the retail price.



G1816 \$69.95

**HANDY WALL POWER SUPPLY +5VDC,
+12VDC, -12VDC**

Handy power supply plugs into any standard 120VAC wall outlet and provides the following +5VDC @ .8AMP, +12VDC @ .1AMP, and -12VDC @ .1AMP. Brand new. Has built in 3 prong outlet plug on wall unit and flexible cable with 5 pin Din plug on other end.



E1004 ~~\$4.95~~ SALE! \$1.95 ea.

**"AS IS" INVENTORY MANAGEMENT
HANDHELD BARCODE WAND AND
COMPUTER**

These are handheld data collection computers with barcode wands. They were used by people to take inventory of products in stores. The data was scanned in from the barcode wand and qty, etc was entered. After collecting the data, a built in modem with a "plug in" acoustic speaker cup was used with standard phones to download the data to the mainframe computer. These were made by Telxon and are well used. We are selling them "as is" only and we don't have any info or data on them. We do know that each unit has a barcode wand, and a removable acoustic cup. The units are made to operate from 4 AA batteries but the batteries and battery holder are probably missing. We make no claim as to the condition of these as the cases are scratched and slightly dinged up. Sorry no returns.



E1005 ~~\$9.95~~ SALE! \$2.99 ea.

★ FREE ★

**SHOP & GARDEN TOOLS, SMALL
APPLIANCES GREENPLUG®**

This type of GreenPlug® is for use on: drills, saws, compressors, shop vacuum, sanders, routers, lawn mowers, hedge trimmers, leaf blowers, weed cutter/edger, snow blowers, mixers/blenders, food processors, vacuum cleaners, lamps/fans, garbage disposals that operate on 120VAC 60HZ at up to 7amps (cont. res) 7FLA, 22.5 LRA. New with instructions.



E2100 \$4.50 ea.

(Free with a \$10.00 purchase-Mention Code: Green) Limit one free gift per order

SPY MIKE

This is the tiniest electret condenser microphone we have ever seen. It is only 6 mm in diameter x 3 mm thick. Has dust screen and 2 tiny pins for PC board mounting. Operates on 1.5V up to 3VDC.



G1841 2/\$1.00 • 100/\$45.00

**HIGH QUALITY IBM
JOYSTICK**

Very nicely made joystick made for IBM PC Jr. Can be used for hundreds of custom applications. Smooth action type with black lever, flexible cable, red and black "fire" buttons. Also has "mode" change for X and Y on bottom. Size about 4" sq. Brand new in box.



E1011 ~~\$3.49~~ Sale! 99¢ ea.

**SURGE PROTECTED 6 OUTLET MULTIPLE
OUTLET STRIP**

This high quality strip has surge suppressor capability built in. Great for computers or other sensitive electronic products. Rated 15amp 125VAC and has a clamping response time of 1 nanosecond. Brand new retail carded with 2 year warranty. Computer grey color.



G1823 \$7.95

**• THE ELECTRONIC GOLDMINE: PO BOX 5408 SCOTTSDALE AZ 85261 •
TOLL FREE ORDER LINE: 800-445-0697 • FAX: (480) 661-8259 • ALL OTHER CALLS: (480) 451-7454**

Power Tools for Electronic Design Automation

**More Features
More Power
Less Money**

Ivex Spice is the latest addition in affordable EDA solutions. Use Ivex Spice with WinDraft Schematics for fast, professional results with un-surpassed ease.

Ivex 650 pin versions have no feature limitations like other low cost products on the market. Fast expert technical support, free 24 hour Knowledge Base on the web, and professional full-featured tools have made Ivex the preferred choice for designers.

For larger designs use these Ivex Products:

WinDraft unlimited: \$495
 WinBoard unlimited: \$495
 Specetra autorouter
 SP2-1000: \$650
 Ivex View unlimited \$ 99

Visit the Ivex web site for complete product information and download full function demos.

www.ivex.com

Tel: (503) 531-3555 e-mail: sales@ivex.com

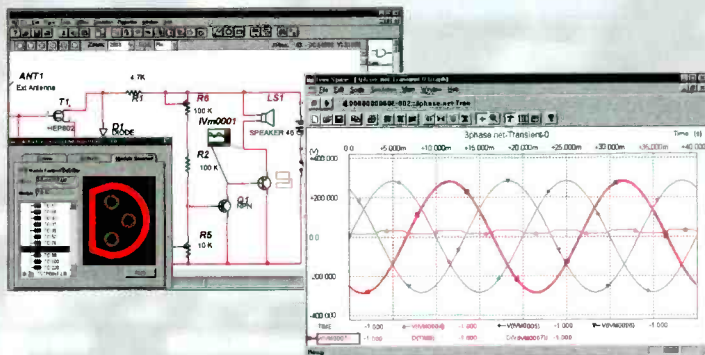

WinDraft[®]
 Schematics **\$250**
 650 pin version

Full Featured 32 bit application
 Powerful hierarchical designs
 Easy single click editing
 Graphical part editor
 Windows functionality
 Advanced Bill of Materials
 User Definable Electrical Rules Check
 Common netlist formats:
 (Accel, Protel, Pads, wirelist, Spice 3f5, & more.)
 Import Orcad/SDT files/parts
 Visual PCB footprint browser
 Over 12,000 parts included

WinBoard[®]
 PCB Layout **\$250**
 650 pin version

Multi layer designs (16)
 Surface mount designs
 Advanced Design Rule Check
 Electrical DRC check and Real-Time DRC
 Single click editing
 Graphical part & pad editor
 Hundreds of footprints
 Copper zone pour
 Output Gerber photo plot files

Ivex Spice/StandardTM
 Analog Simulation **\$99**

The Standard Edition includes:
 Multi channel display
 Over 3,000 models
 Uses Spice 3f5 netlist
 Use with WinDraft 3.05+

Seven Analysis types:
 Operating Point,
 DC Sweep, Transient Analysis,
 Fourier, AC Frequency Sweep,
 Small Signal Transfer,
 Sensitivity.

Ivex Spice/AdvancedTM
 Analog Simulation **\$299**

The Advanced Edition has all the features of the Standard Edition, with these additional analysis types:

Transient Parameter Sweep,
 AC Parameter Sweep,
 Distortion Analysis,
 Pole-Zero Analysis, Noise Analysis and Monte Carlo.



ADV5_6

CMM

Monitor/TV Test Equipment

Checker Pro



There is the Computer monitor tester you have been asking for. Sweep rates to 15-64 kHz, MGA, CGA, VGA, lots of MACs, even video (mono), GRAY SCALE, quick push button operation, "Energy Star" testing, and more. AC or Battery.

PRICE: \$499.95

Checker 12e



Now you can repair and test Computer monitors with ease. With sweep rates up to 64Khz., eight step gray scale, white screen, single color mode. Mac II, EGA, CGA support. you can run almost ANY PC monitor. And it is EASY to use. Color front panel displays show just what you should see. Don't let its' small size fool you. It is the most powerful handheld available, and it supports ALL basic VGA modes (some don't). It is suitable for bench or field operations. Battery or AC operation.

PRICE: \$295

Checker TV Pro & TV Jr.



The TV Pro is just the tool for your repair bench. It provides Video, S-Video, and RF outputs. It also has the most important pattern, GRAY SCALE! You can't set up a color TV without it. All with NTSC standards and COMPLEX sync. The RF output also includes an audio tone and STEREO signaling. With colorbars, gray scale, crosshatch with dots you can set and test quickly.

Checker TV Pro...PRICE: \$499.95

The TV Jr is a small NTSC video generator with colorbars crosshatch with dots, white red blue green, and black screens. Small enough to fit in your pocket, powerful enough to drive the largest projection TV!

Checker TV Jr...PRICE: \$129.00

Computer & Monitor Maintenance, Inc.
 1-800-466-4411
<http://www.computermonitor.com>

PROGRAMMERS OVER 50 MODELS

ADVANTECH EETOOLS NEEDHAMS DATA VO ICE TECHNOLOGY HILO SYSTEM GENERAL CHROMA MODULAR CIRCUIT TECHNOLOGY XELTEK

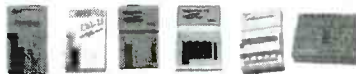

PROMAX EMP-20 MEGAMAX MEGAMAX4 SIMM/SIP TESTER EMUPA

CALL ADVANTECH LABTOOL 599 EETOOLS SIMMAX
 629 ICE TECH MICROLV 795 CHROMA SIMM/SIP
 650 EETOOLS ALLMAX + 359 MOD-MCT-EMUPA/R
 409 EETOOLS MEGAMAX 279 MOD-MCT-EMUP/R
 509 EETOOLS MEGAMAX4 49 EPROM 1G TO 512K
 369 XELTEK SUPERPRO II 69 EPROM 1G TO 1MEG
 409 XELTEK SUPERPRO II P 99 EPROM 4G TO 1MEG
 249 XELTEK SUPERPRO L 199 EPROM 16G TO 1 MEG
 165 XELTEK ROMMASTER II 89 EPROM 1G TO 8MEG
 479 MOD-MCT-EMUPA 129 EPROM 4G TO 8MEG
 739 STAG ORBIT-32 250 EPROM 8G TO 8MEG



LABTOOL48 MICROMASTER SUPERPRO ALLMAX PLUS ROMMASTER2

General Device Instruments
 Sales 916-393-1655 Fax 916-393-4949 BBS 983-1234
 Web www.generaldevice.com E-Mail icdevice@best.com

Low Cost PICmicro Tools

**New! PIC-X1
 Experimenter/
 Lab Board**
 \$49.95 to \$199.95



**EPIC Pocket PICmicro
 Programmer - \$59.95**

Program PICmicros in BASIC!
PicBasic Compiler - \$99.95
PicBasic Pro Compiler - \$249.95

PICProto Boards make
 prototyping with PICmicros
 easy - \$8.95 to \$19.95



microEngineering Labs, Inc.
 Box 7532 Colorado Springs CO 80933
 (719) 520-5323 fax (719) 520-1867
<http://www.melabs.com>

**Visit our
 Web Site at:
www.poptronics.com**

**3 Axis Motion Control System
 Complete, ready to run**
\$ 295.00 + 12.00 S/H
 Build or adapt CNC mills, CNC routers, Robots, Etc.
 Includes: 3 Stepping motors (70 oz/in 200 steps/rev).
 External board (connects to parallel port of a PC). Power
 supply, Cables, Manual and the MAXNC drive software,
 with linear, circular and helical interpolation, acceleration
 deceleration, full contouring, 'G' code programming,
 screen plot, code generation from CAD (CAM), and more.
 For more information,
 phone or write to:
MAXNC
 6730 West Chicago
 Suites 2 & 3
 Chandler, AZ 85226
 Ph (480) 940-9414
 Fax (480) 940-2384



Accredited B.S. Degree in Computers or Electronics

by studying at Home
Grantham College of Engineering
 offers 3 distance education programs:

- B.S.E.T. emphasis in Electronics
 - B.S.E.T. emphasis in Computers
 - B.S. in Computer Science
- Electronics Workbench Professional 5.0
 included in our B.S.E.T. curriculums
 -Approved by more than 200 Companies,
 VA and Dantes, (tuition assistance avail.)

For your free catalog of our programs dial
1-888-919-8181 Ext. 15
<http://www.grantham.edu>

GCE

Your first step
 to help yourself
 better your future!



Grantham College of Engineering
 34641 Grantham College Road
 Slidell, LA 70460-6815



A public service of this magazine

TrailBlazer™ wireless joystick



**\$49.95
 ONLY**

- Omni-directional wireless joystick
- 20 feet Operating range
- Integrated wireless mouse controls

U.A. ULTIMA ASSOCIATES
 45645 Northport Loop East, Fremont, CA 94538, USA
 Tel: (510) 623 8832, Fax: (510) 623 8849
 Email: sales@rddevices.com
 Website: www.rddevices.com

CREDIT CARD COMPUTER

\$14.20 OEM (1000 pc.) price
 EVAL KIT (Qty 1) \$50

Includes:

- serial and parallel
- 256kbit nvmem
- A to D converter
- ISA/PC104 bus
- BASIC and ASSY
- Calendar/Clock

NEW, improved version with ...
PLUG-N-GO™ !!!
 COMPLETE! No cables or power supply to buy.

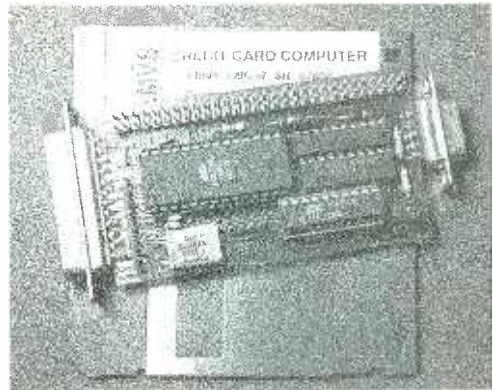

\$95 UNIVERSAL PROGRAMMER



FLASH, EPROM, NVRAM, EEPROM to 8meg (27080). Adapters for micros, PLCC, etc.. Parallel port version for notebooks. FAST and EASY TO USE.

PC SOLID STATE DISK



\$21 OEM (1k), EVAL \$75
 FLASH, NVRAM, ROM
 256K-16M DIP/PCMCIA

LCD VGA \$27



OEM (1k), eval \$95
 640x480 controller
 use with PC or SBC

PC WATCHDOG!

NO MORE HANGUPS..
 Reboots PC on hardware
 or software hangup..
 oem \$21, eval \$75



ADC/DAC cards

8/12/16/18bit up to 32 channel for PC or SBC starting at \$14.20 oem

\$27 MINI PC

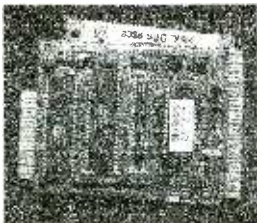

eval \$95, oem \$27 includes:
 DOS, 3 ser, 2 par, rtc, nvmem,
 built-in LED display, ISA bus,
 Keyboard and LCD interface
COMPLETE!
 Not a "core" or "engine". All
 utilities and tutorial included.
 Use Turbo C, Basic, MASM.
 386 version \$42 oem \$195 eval

SINGLE CHIP COMPUTER!

\$1.99 OEM (1K)
 EVAL KIT (1) \$7.00

- Zero External Components
- Built-in BASIC / Assembly
- RS232 Program Download
- 1K flash, 64ee, 3irq, 2timers
- 15 I/O bits, A/D comparator
- 20mips, faster than pic/8051
- 20 pin DIP part #MV1200



NEW! 8K SUPER CHIP

Improved BTERP with 40 times the BASIC program capacity
 - 40 pin DIP part #MV8515 - 32 I/O, 12 irq, 3 timers, bus
 - 8K flash, 512 ee, 512 nvram - Watchdog with internal osc.
\$5.40 OEM (1k), Eval Kit \$19.00

WWW.STAR.NET/PEOPLE/~MVS

MVS Box 850
 Merr., NH 03054
 (508) 792 9507



5yr Limited Warranty
 Free Shipping
 Mon-Fri 10-6 EST

PLUG IN AND MEASURE

NEW



500mVolt - 400Volt
0 - 20MHz
8 bit

STORAGE OSCILLOSCOPE
SPECTRUM ANALYZER
VOLTMETER
TRANSIENT RECORDER

TiePie introduces the **HANDYPROBE model HP 2**
A powerful 8 bit, 20MHz virtual measuring instrument for the PC

Convince yourself and download the demo software from our web page: <http://www.tiepie.nl>
When you have questions and / or remarks, contact us via e-mail: support@tiepie.nl. The
HANDYPROBE HP2 is delivered with a user manual, Windows and DOS software.
The price of the HANDYPROBE HP2 starts at USD 199 excl. VAT.

US dealers:

Conway Engineering Inc.: Tel 510-568-4028; Fax 510-568-1397; www.conway-engineering.com
Feedback Incorporated: Tel 800-526-8783; Fax 919-644-6470; www.fbk.com

Outside US:

TiePie engineering, P.O. BOX 290, 8600 AG SNEEK, The Netherlands.
Tel: +31 515 415 416 Fax: +31 515 418 819 Web: www.tiepie.nl

CIRCLE 217 ON FREE INFORMATION CARD

Poptronics SHOPPER

Wireless Remote Control



- 8 ch. keychain size RF/IR transmitter.
- 8 ch. receiver can learn up to 4 transmitters.
- Encoder and decoder ICs available.
- Easily prototype your wireless concepts.

Visit our web site for on-line catalog:

www.rfmicrolink.com

www.irmicrolink.com

Copyright © International Electronics Corp.

Phone: (865) 546-9863

Fax: (865) 546-8324

Visa/MasterCard/Discover

©1994 EDF

Thanks to you, all sorts
of everyday products are
being made from the paper,
plastic, metal and glass that
you've been recycling.

But to keep recycling
working to help protect the
environment, you need to
buy those products.

BUY RECYCLED.



AND SAVE.

So look for products made
from recycled materials, and
buy them. It would mean the
world to all of us.

For a free brochure, write
Buy Recycled, Environmental
Defense Fund, 257 Park Ave.
South, New York, NY 10010,
or call 1-800-CALL-EDF.

ENVIRONMENTAL
DEFENSE
FUND EDF

A Public Service of
This Publication

EPA

Prices effective May 23 through July 7, 2000.

MCM Electronics MCM

What you want.... Today!™

You Must Provide This Source Code To Receive Discount Pricing: **POP76**



MCM GOLDLINE®
4" Color LCD Monitor Module

Open circuit board has no case or housing allowing easy incorporation into automotive seat backs, custom panels and enclosures. Use for automotive multimedia and navigation systems, surveillance and video equipment.

- 3.5mm A/V input
- Resolution: 383 (H) x 234 (V)
- Requires: 12VDC, 500mA
- Dimensions: 3½" x 5" x 1½"

ORDER # 60-9855

\$119.00



Electrolytic Capacitor Assortment

- Contains 75 assorted radial and axial lead capacitors
- Values range from 0.1~470µF
- Voltages vary from 6.3~50V

ORDER # 102-030
\$6.95



TENMA® 450VA Isolation Transformer

- Provides safety and equipment protection on the service bench
- Two direct and two isolated outputs
- Direct and isolated outlets are independently fused
- 550VA intermittent duty

ORDER # 72-6670
\$79.95

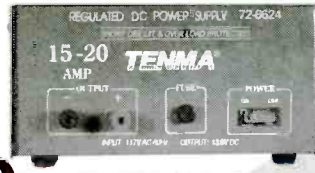

TENMA® 13.8VDC 15 Amp Power Supply

- Perfect for servicing or operating high current autosound products
- Provides 15A output, 20A surge
- Front panel fuse is easily accessible

Order # 72-6E24 Reg. \$84.95

NOW ONLY \$69.95

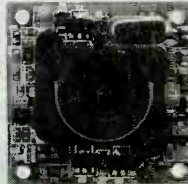

Micro Board CCD Camera

- Compact open-t-card black and white camera
- Measures 1½" x 1" x 1"½"
- CCD image device
- 380 lines of resolution
- NTSC composite video output
- 12VDC, 330mA

ORDER # 82-2990
\$49.95



PRO-LUXE "Behind-the-Head" Stereo Headphones

- 30mm diaphragms
- Straight 4' cord
- 3.5mm nickel plated plug
- 3.5mm to ¼" adaptor
- Frequency response 20Hz~20KHz
- SPL 115 dB at 1KHz
- Impedance 32ohm

ORDER # 35-1070
\$9.99

CHECK OUT OUR

full line catalog at:

1-800-543-4330

www.mcmelectronics.com

fax: 1-800-765-6960

Free Literature!

TENMA® Soldering Station



- Perfect for all types of board level and precision work
- LED bargraph display accurately shows temperature and setpoint
- Temperature range: 300°~790°

ORDER # 21-147
\$59.95



PC Mount 12 Volt Relays

- High current for autosound, security and other applications
- PC board mount, pins may be directly soldered
- Contact rating: 15A/16VDC
- Coil resistance: 180ohm
- Current consumption: 67mA
- Dimensions: ¾" (H) x ¾" (W) x ¼" (D)

Order #	Contact Type	(1-9)	(10-24)	(25-up)
26-531	SPST	\$0.89	\$0.75	\$0.60
26-532	SPDT	0.89	0.75	0.60

SOURCE CODE: POP76

A Premier Farnell Company



MCM ELECTRONICS®
 650 CONGRESS PARK DR.
 CENTERVILLE, OH 45459



CIRCLE 160 ON FREE INFORMATION CARD

spyoutlet.com

Countersurveillance - Electronic Devices

Purchase your video cameras from *one of the largest importers in the U.S.*

- NEW Waterproof Bullet Cameras • Spy Pinhole Cameras starting at \$79⁰⁰ • Wireless Video
 - Voice Changer • 3 Hour Micro Recorder • Shotgun Mic • Locksmithing • Bug & Phone Tap Detectors
 - Phone Call Register • UV Pens & Powder
 - Realtime Telephone Recording Systems: 12 Hour \$125⁰⁰, 15 Hour \$149⁰⁰
 - GPS Vehicle Tracking System (nationwide)
- And much more

www.spyoutlet.com
Printed Catalog send \$5⁰⁰

SPY OUTLET

2468 Niagara Falls Blvd., Tonawanda NY 14150
(716) 695-8660 fax (716) 695-7380

The Pocket Programmer Only \$129.95

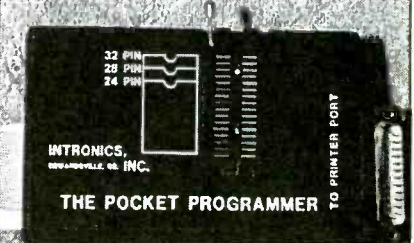

The portable programmer that uses the printer port of your PC instead of an internal card. Easy to use software that programs Eprom, EEprom, Flash & Dallas Ram. 27(C) / 28(C) / 28F / 29F / 29C & 25XX series from 16K to 8 Megabit with a 32 pin socket. Adapters available for Pic, PLCC, 5-Gang, 874X, 875X MCU's, 40-Pin X 16 & Serial Eprom's, 82/74 Prom's and Eprom Emulator to 32K X 8.

Same Name, Address & Phone # for 16 Years... Isn't it Amazing ?

Intronics, Inc.

Box 13723 / 612 Newton St.
Edwardsville, KS 66113 Add \$5.00 COD
Tel. (913) 422-2094 Add \$4.00 Shipping
Fax (913) 441-1623 Visa / Master Charge



KNS

Instruments



1-800-

356-4920

Digital Panel Meters!!

- LCDs • LEDs • 3 1/2 digits • 4 1/2 digits
- loop powered • adjustable voltage input
- bezel mount • surface mount
- miniatures • big digits
- black • red
- amber • green
- negative backlighting
- positive backlighting
- RF resistant EMI resistant
- displayed engineering units • snap-in



We also have Kroy tape and shrink tube labeling systems and supplies!



Visit our catalog on-line
knsinstruments.com

Or call toll free: 800/356-4920
Fax: 800/356-1250



603/627-5144 • Fax 603/624-4710
PO Box 10158 • Bedford, NH 0311C-0158

BEST DEALER PRICING!

CABLE DIRECT

CONVERTERS • FILTERS
DESCRAMBLERS

IMPROVE YOUR IMAGE WITH
VIDEO STABILIZERS

FREE
CABLE TV
CATALOG!

100%
MONEY BACK
GUARANTEE!



Now you can tune-in your favorite
cable TV programming
and SAVE \$100'S -
EVEN \$1000'S on premium
CABLE TV EQUIPMENT.

30 DAY
FREE
TRIAL!



MODERN ELECTRONICS

1-800-906-6664

2609 S. 156TH CIRCLE • OMAHA, NE 68130
http://www.modernelectronics.com

B² Spice A/D 2000

\$299

Mixed-Mode Circuit Design

Competitive Analysis

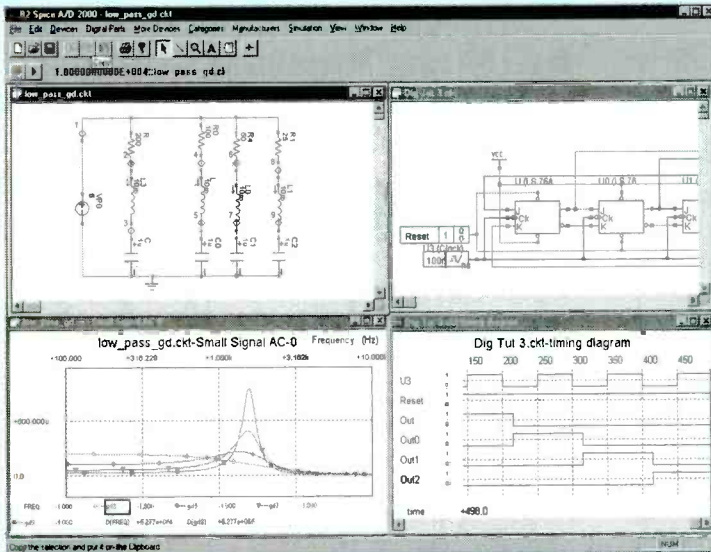

Characteristics	B ² Spice A/D 2000	EWB Multisim Personal
PRICE	\$299	\$399
DC Operating point	X	X
DC Parameter Sweep	X	X
Temperature Sweep	X	-
Transient	X	X
Fourier	X	X
Parameterized transient	X	-
AC Analysis (freq sweep)	X	X
Parameterized AC Sweep	X	-
Pole Zero	X	-
Transfer function	X	-
DC Sensitivity	X	X
Distortion	X	X
Noise	X	X
DC Op. Pt. Monte Carlo	X	-
DC Sweep Monte Carlo	X	-
AC Monte Carlo	X	-
Transient Monte Carlo	X	-
Interactive, free running digital logic simulation.	X	-

- ◆ Build complex circuits in minutes with our intuitive schematic editor.
- ◆ Turn any circuit into a functional part with just a few simple clicks.
- ◆ Interpret simulation results with customizable graphs.
- ◆ Find exactly the part you need from our database of 4500 parts.
- ◆ Run an interactive Digital Simulation and view signals in the Timing Diagram

Visit our web site for a free trial.

\$99 Lite Version

Beige Bag Software • www.beigebag.com • 734.332.0487 • info@beigebag.com

CIRCLE 319 ON FREE INFORMATION CARD

2539 W. 237th Street, Bldg. F, Torrance, CA 90505
 Order desk only: USA: (800) 872-8878 CA: (800) 223-9977
 LA. & Technical Info: (310) 784-5488 Fax: (310) 784-7590
<http://www.digisys.net/timeline>

TIMELINE INC.

Over 14 years and 32,000 customers and still growing

Minimum Order: \$20.00. Minimum shipping and handling charge \$5.00. We accept cashiers checks, MC or VISA. No personal checks or COD's. CA residents add 8.25% sales tax. We are not responsible for typographical errors. All merchandise subject to prior sale. Phone orders welcome. Foreign orders require special handling. Prices subject to change without notice. 20% restocking fee for returned orders.

LIQUID CRYSTAL DISPLAYS

240x64 dot LCD with built-in controller.

AND 4021ST-EO. Unit is EL back-lit. \$59.⁰⁰ or 2 for \$109.⁰⁰ or OPTREX. DMF5005 (non back-lit) \$49.⁰⁰ or 2 for \$89.⁰⁰

20 character x 8 line 7xL x 2xH The built-in controller allows you to do text and graphics.

Alphanumeric—parallel interface

16x1	\$6.00	20x2	\$8.00	32x2	\$8.00
16x1 (lg char.)	\$8.00	20x4	\$8.00	40x1	\$8.00
16x2	\$6.00	20x4 (lg char.)	\$10.00	40x2	2 for \$20.00
16x2 (lg char.)	\$10.00	24x2	\$8.00	40x4	\$20.00
16x4	\$12.00	32x4	\$10.00	4x2	\$5.00

5V power required • Built-in C-MOS LCD driver & controller • Easy microprocessor interface • 98 ASCII character generator • Certain models are backlit, call for more info.

Graphics and alphanumeric—serial interface

size	Mfr.	price	size	Mfr.	price
640x480 (backlit)	Epson	\$20.00	480x128	Hitachi	\$10.00
640x400 (backlit)	Panasonic	\$15.00	256x128	Epson	\$20.00
640x200	Toshiba	\$15.00	240x128 (backlit)	Optrex	\$20.00
480x128 (backlit)	ALPS	\$10.00	240x64	Epson	\$15.00
			160x128	Optrex	\$15.00

6" VGA LCD 640X480, Sanyo LMDK55-22 \$19⁰⁰

MONITORS

Non-Enclosed TTL

Comes with pinout. 12V at 1.4 Amp input • Horizontal frequency 15KHz. • Ability to do 40 and 80 column.
5 inch Amber \$19.00 • 7 inch Amber \$19.00
9 inch Amber or Green \$19.00

5" COLOR MONITOR \$29.⁰⁰

- Flat Faceplate • 320 x 200 Dot Resolution • CGA & Hercules Compatible
- 12 VDC Operation • 15.75 KHz Horiz. Freq. • 60 Hz Vert. Sync. Freq.
- Open Frame Construction • Standard Interface Connector • Degaussing Coil included • Mfr. Samtron

2 for \$49⁰⁰

9" COLOR SVGA MONITOR \$169.⁰⁰ Fully Enclosed - Tilt and swivel type.

POS & BAR CODE

MAGNETIC CARD READER \$19.⁰⁰

Includes: • 20 character dot matrix display with full alpha-numeric capability • keypad with full alpha-numeric entry • separate 7.5 VDC/0.5 Amp power supply • standard telephone interface extension cord • lithium battery and flat-coin speaker.

HP bar code wand (HRCS 2300) \$19.00

HACKER CORNER

Rockwell "Jupiter" GPS Receiver \$69⁰⁰

Miniature (2.75" x 1.5" x .25") 12 channel receiver engine. Supports NMEA 0183 and binary protocols. Supports DGPS input in both protocols. Compatible with active and passive antennas. "Keep-Alive" reduced power capability. Standard 2mm 2x10 interface connector. Complete manual and interface documentation available. Compatible with most laptop software using NMEA interface. Suitable for wide range of GPS applications including: Handheld GPS, Automotive / Marine / Aviation Applications, Amateur APRS and Packet.

EMBEDDED 486 COMPUTER \$79.⁰⁰

Complete enhanced Intel 486SX-33 based computer in ultra small (9.78" x 6.58" x 3.18") case. Ideal for embedded operations or as a second computer. Features include: • One 16 bit ISA slot • 3 serial ports plus dedicated printer port • Parallel optical coupled adapter port • Built in IBM PC/AT keyboard port • On board VGA video and port • Uses standard SIMM up to 32 MB • BIOS is PC/AT compatible

Unit has a backup Ni-Cd battery system in case of power failure (5 min. backup time) and lockable front cover to prevent floppy drive access. Mounting / interface provisions for standard 3.5" laptop floppy and 2.5 inch hard drives. Comes with very comprehensive manual.

SONY Miniature Color LCD Display \$29⁰⁰

1.8cm (0.7 inch) unit LCX009AKB 827H x 228V \$29⁰⁰

CELL SITE TRANSCEIVER \$29⁰⁰ 2 for \$49⁰⁰

These transceivers were designed for operation in an AMPS (Advanced Mobile Phone Service) cell site. The 20 MHz bandwidth of the transceiver allows it to operate on all 666 channels allocated. The transmit channels are 870.030-889.980 MHz with the receive channels 45 MHz below those frequencies. A digital synthesizer is utilized to generate the selected frequency. Each unit contains two independent receivers to demodulate voice and data with a Receive Signal Strength Indicator (RSSI) circuit to select the one with the best signal strength. The transmitter provides a 1.5 watt modulated signal to drive an external power amplifier. Channel selection is accomplished with a 10 bit binary input via a connector on the back panel. Other interface requirements for operation are 26 VDC (unregulated) and an 18.990 MHz reference frequency for the digital synthesizer. The units contain independent boards for receivers, exciter, synthesizer, tunable front end, and interface assembly (which includes power supplies and voltage-controlled oscillator). Service manual, schematics and circuit descriptions included.

4 INCH LCD MONITOR \$49.⁰⁰

Compact (4.4" x 3.8" x 1.4") TFT active matrix LCD color monitor including fluorescent backlight. Analog RGB and composite sync input with switchable horizontal / vertical viewing. Low power consumption and long life backlight make it ideal for security and door phone use. Single 8 VDC supply and good resolution allow mobile operations or use with laptops. Standard ribbon cable - Molex connector interface. Complete specifications included.

NTSC COMPOSITE 4" LCD MONITOR \$69⁰⁰

CIRCLE 242 ON FREE INFORMATION CARD

Any waveform you want!



New Features:

- ✓ 21.5 MHz
- ✓ .01 Hz steps
- ✓ multi-unit phaselock

Telulex Inc. model SG-100A

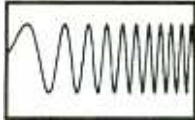

DC to 21.5 MHz linear and log sweeps



Int/Ext AM, SSB, Dualtone Gen.

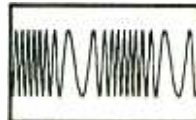

Int/Ext FM, PM, BPSK, Burst



Ramps, Triangles, Exponentials



Pulse Generator



Noise

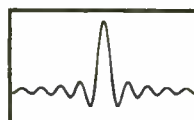

Arbitrary Waveforms

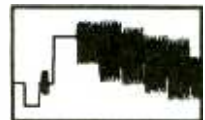

Unlimited Possibilities!

● Synthesized Signal Generator

Clean sinewaves DC-21.5 MHz, .001% accuracy! .01 Hz steps. DC Offset. RS232 remote control.

● Arbitrary Waveform Generator

40 Megasamples/Second. 32,768 points. 12 bit DAC

● Function Generator

Ramps, Triangles, Exponentials & more to 2 MHz!

● Pulse Generator

Digital waveforms with adjustable duty cycle

Telulex Inc.

2455 Old Middlefield Way S Tel (650) 938-0240 <http://www.Telulex.com>

Mountain View, CA 94043 Fax (650) 938-0241 Email: sales@Telulex.com

CIRCLE 311 ON FREE INFORMATION CARD

Turn Your Multimedia PC into a Powerful Real-Time Audio Spectrum Analyzer

Features

- 20 kHz real-time bandwidth
- Fast 32 bit executable
- Dual channel analysis
- High Resolution FFT
- Octave Analysis
- THD, THD+N, SNR measurements
- Signal Generation
- Triggering, Decimation
- Transfer Functions, Coherence
- Time Series, Spectrum Phase, and 3-D Surface plots
- Real-Time Recording and Post-Processing modes

Applications

- Distortion Analysis
- Frequency Response Testing
- Vibration Measurements
- Acoustic Research

System Requirements

- 486 CPU or greater
- 8 MB RAM minimum
- Win. 95, NT, or Win. 3.1 + Win.32s
- Mouse and Math coprocessor
- 16 bit sound card

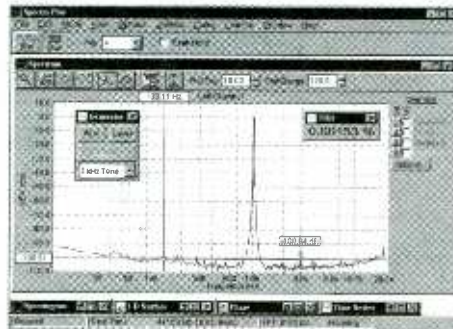

Priced from \$299

(U.S. sales only - not for export/resale)

DOWNLOAD FREE 30 DAY TRIAL!

www.spectraplus.com

PHS Pioneer Hill Software
24460 Mason Rd.
Poulsbo, WA 98370
a subsidiary of Sound Technology, Inc.

Sales: (360) 697-3472



Spectra Plus
FFT Spectral Analysis System

Fax: (360) 697-7717

e-mail: pioneer@telebyte.com

Data Acquisition and Control

The ADR series of interfaces allow control of analog, digital and relay I/O via RS232 or RS485. Visit the web site for specs, applications and programs in VB, C, BASIC etc. (705) 671-2652

www.ontrak.net

Ontrak Control Systems Inc.

Visit our Web Site at:

www.poptronics.com

Mobile Robotics

- Sonar
- Vision Systems
- Micro Controllers
- Motor Drivers
- Neural Networks

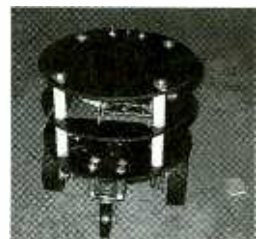

Zagros Robotics
PO Box 460342
St. Louis, MO 63146-7342
(314) 768-1328
<http://www.zagrosrobotics.com>
info@zagrosrobotics.com

PARTS EXPRESS

ELECTRONICS & MORE

6-1/2" Two Way System

This is our most popular in-wall. You won't believe how good these really sound. Big enough to produce great home theatre sound and still fit everyone's budget. Put a pair in every room of your house.

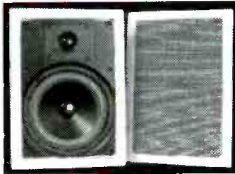

Great for front or rear speakers in your surround system. The 6-1/2" polypropylene woofer and 1" textile dome tweeter were specially designed with home theatre in mind. The crossover network utilizes a mylar capacitor for crisp clean highs. 3 piece design make installation in new or existing walls a snap. **Specifications:** ◆6-1/2" polypropylene cone woofer with poly foam surround ◆1" textile dome tweeter/midrange ◆8 ohm impedance ◆3 component L/C crossover network ◆Frequency response: 50-20,000 Hz ◆Power handling capability: 30 watts RMS/85 watts max ◆Sensitivity: 89 dB 1W/1m ◆Overall dimensions: 8-1/2" W x 12" L x 3-1/2" D ◆Hole size: 7-1/4" x 10-3/4" ◆Fits into standard 2" x 4" wall ◆Net weight: 12 lbs. per pair.

#300-036 \$89.90 (1-3 PRS) \$79.50 (4 PRS-UP)

Satellite Speaker Stands

These quality speaker stands are perfect for mini or rear surround speakers. The heavy die cast base provides stability. Textured black satin finish blends in well with any decor. The height is adjustable from 26-1/2" to 47-1/2" and the speaker wire can be run inside the pole for a better appearance. The top base is adjustable from 4-1/8" to 7-1/2" to accommodate most mini speakers. Includes foam pads to prevent marring of speaker cabinet. Sold in pairs. Net weight: 12 lbs.



#240-762 \$39.80 (1-3 PRS) \$35.50 (4 PRS-UP)

5 Function Remote

◆Operates five devices (TV, VCR, Cable, Satellite, A/V Receiver) ◆Lighted component keys which indicate what device is currently being used ◆Preprogrammed, 621 codes that work over 6,400 models ◆New ergonomic design features a contoured case, index finger grooves, and keys grouped in clusters for easy operation ◆Satellite cursor control is tailored for use with a Home Theatre system, keypad design allows movement through menus with ease ◆Retains codes when replacing batteries ◆New flat back design for easy operation ◆Money back guarantee ensures customer satisfaction ◆Toll free customer service number provides the customer with friendly, knowledgeable assistance ◆Requires 2 AAA batteries (#140-150 not included)



#180-806 \$29.95 (1-3) \$26.35 (4-UP)

3M 3/4" Temflex™ 1700 Vinyl Electrical Tape

General purpose 7 mil electrical tape. UL listed and CSA approved. 3/4" x 60' rolls.



#350-052 75c (1-9) 59c (10-UP)

Gold Plated A/V Cables

A super quality, "siamesed" type cable. Two RCA cables for stereo (audio) signal from VCR to receiver/stereo TV and one low noise coaxial type cable for video.



Part #	Length	Price (1-9)	Price (10-UP)
180-120	3 ft.	\$4.25	\$3.95
180-118	6 ft.	4.90	4.50
180-121	12 ft.	8.95	7.95
180-124	20 ft.	12.75	11.50

If you haven't received a copy of our current 260 page catalog ... have one added to your order or give us a call and we will send one out to you immediately.



6-1/2" Round Coaxial System

Designed for the home and office, these 6-1/2" round in-walls are ideal for ceiling installations, or for use as rear channel surround speakers. Adding music to the kitchen, den, bath, or patio has never been easier! System features a weather resistant 6-1/2" treated paper cone with poly foam surround, coaxially mounted 1/2" polymer dome tweeter, and built-in crossover with a mylar capacitor in the tweeter lead. Retrofit design allows installation in both new and existing construction in just minutes. System includes removable steel mesh grills, built-in mounting bracket, hardware, and installation instructions. **Specifications:** ◆Impedance: 8 ohms ◆Frequency response: 60-20,000 Hz ◆Power handling capability: 30 watts RMS/45 watts max. ◆Sensitivity: 89 dB 1W/1m ◆Dimensions: 9" round x 2-7/8" deep. ◆Net weight: 5 lbs. per pair.



#300-408 \$69.95 (1-3 PRS) \$62.75 (4 PRS-UP)

3 Amp Power Supply

This fully regulated power supply is perfect for powering CBs, car radios, and other 12 VDC devices that draw up to 3 amps. Heavy duty steel housing with front mounted switch and binding posts. Short circuit and overload protection! **Specifications:** ◆Output Voltage: 13.8 VDC (fixed) ◆Output Current: 3A (cont), 5 amps (surge) ◆Ripple Voltage: Less than 3mV at rated output ◆Input Voltage: 120 VAC, 60Hz ◆Dimensions: 5-1/2" x 3-1/2" x 6-1/2" ◆Weight: 5 lbs.



#120-530 \$19.95 (1-3) \$18.50 (4-UP)

DMM and LCR Meter

In addition to functions found in regular DMM's, this meter can also measure inductance in 5 ranges (4mH, 40mH, 400mH, 4H, 40H), capacitance in 5 ranges (4nF, 40nF, 400nF, 4uF, 400uF), frequency in 4 ranges (4KHz, 40KHz, 400KHz, 4MHz), TTL logic test, diode test and transistor hFE test. 5 AC/DC ranges up to 1000V (AC750V), 3 AC/DC current ranges up to 20A and 7 resistance ranges up to 4000 M ohms. Includes test leads, battery, spare fuse, and manual. Net weight: 1 lb.



#390-513 \$85.90 EACH

2.5W Mini Audio Amplifier

This amp contains both pre-amplifier and power amplifier on a super small board measuring only 1-5/8"x1-1/4". Maximum output power is 2.5W into 4 ohms with 12VDC input power. No adjustments required. Short circuit protected.



#320-215 \$9.95 EACH

Weller WLC100 Soldering Station

The Weller WLC100 solder station is ideal for the professional, serious hobbyist, or kit builder who demands higher performance than usual of a standard iron, but without the high cost of an industrial unit. Power is adjustable from 5 to 40 watts. Includes 40 watt pencil iron. UL approved. Net weight: 1-3/4 lbs. Replacement sponge #372-119.



#372-120 \$39.95 EACH

"44" Solder

Kester "44" rosin core solder is designed for electronic and electrical work. It uses a fast acting, instant wetting, non-corrosive, and non-conductive flux for faster soldering and a strong, long lasting bond.



Part #	Alloy Lead/Tin	Spool	Dia.	Price (1-3)	Price (4-UP)
370-080	60/40	1 lb.	.031"	\$8.50	\$7.95
370-090	60/40	4 lb.	.050"	8.50	7.95
370-098	60/40	4 lb.	.031"	33.90	31.80
370-088	60/40	1/2 lb.	.020"	6.95	5.75
370-072	63/37	1 lb.	.020"	14.90	13.50
370-086	63/37	1/2 lb.	.031"	9.95	8.50
370-074	63/37	1 lb.	.031"	12.50	11.50
370-087	36/37	1/2 lb.	.031"	7.95	6.75



Pro Wick

Pro Wick's advanced fine braid design provides wicking action that is second to none.



Part #	TS #	Size	Length	Price (1-9)	Price (10-UP)
341-415	1802-5	.06"	5'	\$1.40	\$1.25
341-416	1803-5	.08"	5'	1.45	1.30
341-417	1804-5	.10"	5'	1.60	1.45
341-424	1802-10	.06"	10'	2.75	2.50
341-425	1803-10	.08"	10'	2.80	2.55
341-426	1804-10	.10"	10'	2.95	2.70
341-440	1802-25F	.06"	25'	6.80	6.30
341-441	1803-25F	.08"	25'	6.85	6.35
341-442	1804-25F	.10"	25'	7.60	7.00
341-418	1802-100	.06"	100'	21.90	20.50
341-419	1803-100	.08"	100'	21.90	20.50
341-423	1804-100	.10"	100'	23.90	22.50

725 Pleasant Valley Dr., Springboro, OH 45066-1158
Phone: 513-743-3000 ◆ Fax: 513-743-1677
E-mail: sales@parts-express.com

KEY CODE: POM I

LARGEST SELECTION OF SPEAKER DRIVERS IN THE COUNTRY!

VISIT OUR WEB SITE AT
www.parts-express.com

OR CALL TOLL FREE
1-800-338-0531

CIRCLE 257 ON FREE INFORMATION CARD

ALL ELECTRONICS

C O R P O R A T I O N

QUALITY Parts
FAST Shipping
DISCOUNT Pricing

CALL, WRITE, FAX
or E-MAIL For A
Free 96 Page
CATALOG.
Outside the U.S.A.
send \$3.00 postage.



Digital On-Timer

Digital timer from Mr. Coffee™. Small modular design, no brand name or logo. Ideal for use in any product that needs to be turned on automatically at a specific time. Operates on 120 Vac. Switch loads up to 10 amps.

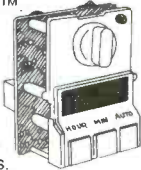

Can be switched manually. White plastic face. 2.48" X 1.77", with four digit LED clock. Overall size: 2.48" X 2.17" X 1.88" deep behind face. 02.5" qc terminals. Easy to connect and operate. Includes instruction sheet.

CAT# MCT-3 **\$5.00** each

Modular CD Racks

Organize your CDs or CD ROMs with these high-impact, black plastic CD storage racks. Slots for 12 jewel cases. Each 12 CD module can interlock vertically and horizontally with other modules. Can be free-standing or wall mounted.

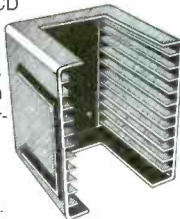

\$2.00 each

CAT# CDR-3
10 for \$17.50

Thermoelectric Cooler



These incredible miniature solid state heat pumps raise or lower temperature in a small area almost instantly. Utilizing the Peltier effect these modules perform the same cooling or heating functions as freon based refrigerators but they do it with no moving parts, and are very reliable. Current applied to the device will produce heat on one side and cold on the other side, up to 68° C difference between the two sides. Operate on 3-12 Vdc. Requires a heat sink to prevent overheating. 1.57" (40mm) square X 0.16".

\$13.95 each

CAT # PJT-3
5 for \$62.50

"Ear Bud" Stereo Earphones

Miniature "in-ear" earphones for use with most portable CD, radio and tape players. 3.5 mm stereo phone plug. 32 ohm impedance.



Large Quantity Available
CAT # HP-6

85¢ each

10 for \$7.50
100 for \$50.00

22 UF 450 Vdc



0.63" diameter X 1.6" long axial electrolytic capacitor.
CAT# 22/450VA

\$1.25 each

10 for \$10.00
100 for \$80.00

Powerful 12 Vdc Motor

Bosch. Powerful new 12 Vdc motor with replaceable brushes. Purchased from a company making electric bicycles, they were used two per bicycle, powered with a 24 Volt battery pack. May have originally been fan motors for Ford automobiles. 4" diameter x 2.75".



0.31" (5/16") diameter shaft is 1.2" long. No load Rating: 2200 RPM @ 12 Vdc @ 2.8 Amps. Weight: 3.25 lbs. 0.25" quick-connect terminals.

\$9.50 each

CAT # DCM-142

16 Character X 2 Line LCD with Backlight

Daewoo # 16216L-5-VSO 5 x 7 dot format. 2.56" x 0.54" viewing area. 3.15" x 1.41" module size. LED backlight. Includes hook-up/spec sheet.



CAT# LCD-53

\$7.50 each

Heatsink

4.53" X 2.3" X 1.44". High-capacity black anodized aluminum heatsink. 4.2" x 2" mounting centers. Weight: 0.54 lbs.

CAT # HS-65

\$3.75 each

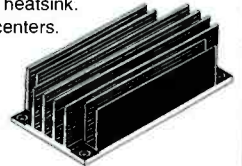

Ionizer

Seawise Industrial Ltd. Model # SW750

Input: 120 Vac

Output: 7.5 KV 60 Hz.

The main component in a household ionization unit. 2.2" x 1" x 0.86" thick with a mounting tab that extends 0.75" from the unit. UL recognized.

CAT # SW-750

\$4.50 each

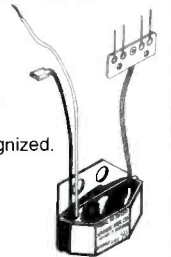

Blue & White Ultrabrights

BLUE / water clear 1200 mcd 45 degree viewing angle.

\$3.75 each

CAT # LED-58
10 for \$30.00

WHITE / water clear 1100 mcd

\$4.00 each

CAT # LED-48
10 for \$35.00

Motorized Potentiometer Dual 10K Linear Taper

Alps Electric # 726T-10KBX2 Dual 10K linear pot powered by a small reversible 6 Vdc gearhead motor. Pot and motor assembly are 1" square x 1.7" long excluding shaft and bushing. 6 mm flatted shaft is 0.5" long. 9mm threaded bushing. PC pins and mounting tabs for pc board mounting.

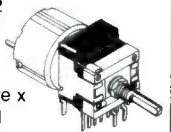

\$4.00 each

CAT # MPOT-10K
10 for \$35.00

ORDER TOLL FREE

Shop ON-LINE

1-800-826-5432

www.allelectronics.com

MAIL ORDERS TO:

ALL ELECTRONICS CORP.

P.O. BOX 567 • VAN NUYS, CA 91408-0567

FAX (818) 781-2653 • INFO (818) 904-0524

E-MAIL allcorp@allcorp.com

NO MINIMUM ORDER • All Orders Can Be Charged to Visa, Mastercard, American Express or Discover • Checks and Money Orders Accepted by Mail • Orders Delivered in the State of California must include California State Sales Tax • NO C.O.D. • Shipping and Handling \$5.00 for the 48 Continental United States • ALL OTHERS including Alaska, Hawaii, P.R. and Canada Must Pay Full Shipping • Quantities Limited • Prices Subject to change without notice.

MANUFACTURERS - We Purchase EXCESS INVENTORIES... Call, Write, E-MAIL or Fax YOUR LIST.



CIRCLE 215 ON FREE INFORMATION CARD

www.americanradiohistory.com

World's Smallest 68HC11 Microcontroller Module!



- Applications:**
- telemetry
 - microrobotics
 - smart toys
 - animatronics
 - model railroads
 - automate your home
 - many others!

MicroStamp1™

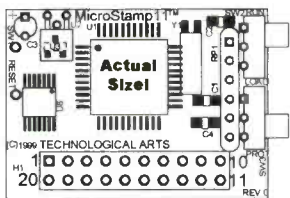

- tiny 1-inch x 1.4-inch 68HC11 module
- 5V regulator, 8MHz crystal
- choice of 8K or 32K EEPROM
- plugs into your breadboard like a DIP
- SCI, SPI, OCs, ICs, timers, & more
- all 14 I/O lines and 2 interrupts brought out to versatile 20-pin connector
- easy code-loading with Docking Module
- Starter Packages: *
 - with 8K EEPROM (#MS11SP8K).....\$49
 - with 32K EEPROM (#MS11SP32K).....\$60
- additional modules from \$34 each

* includes MicroStamp11, documentation, PC software, serial cable & Docking Module

MicroCore-11™

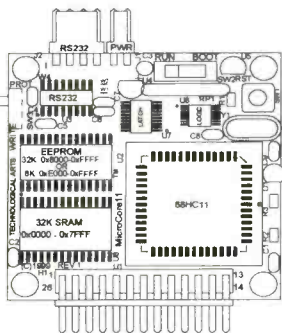

- tiny 2-inch x 2-inch 68HC11 module
- 12 inputs/outputs plus 8 analog inputs
- RS232, 5V regulator, 8MHz crystal
- 32K SRAM plus 8K or 32K EEPROM
- plugs into your breadboard like a DIP
- simple program loading from any PC
- motor driver & accessories available
- ideal for MicroMouse robot competitions
- 8K Starter Package #MC11SP8K.....\$75
- 32K Starter Package #MC11SP32K.....\$89

Technological Arts

Many other modules & accessories available. Visit our website at:

www.technologicalarts.com

Phone: (416) 963-8996

Fax: (416) 963-9179

Add \$5 shipping & handling within Canada & USA
Visa • MasterCard • Discover • Amex

Build Your Own Intelligent Robot, We Make It Easy!

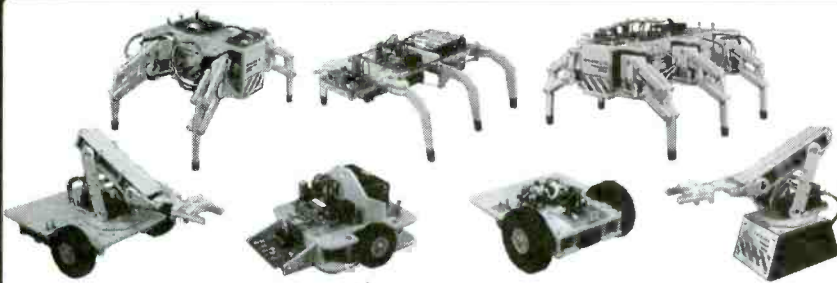

Lynxmotion, Inc.
104 Partridge Road
Pekin, IL 61554-1403
www.lynxmotion.com



Visit our website or ask for our free catalog!

Tel: 309-382-1816
Fax: 309-382-1254
sales@lynxmotion.com
tech@lynxmotion.com

CCTV OUTLET INTERNATIONAL DISTRIBUTORS

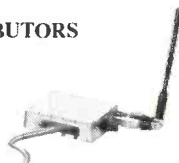

- SECURITY CAMERAS
WIRELESS TRANSMITTERS
MONITORS
OUTDOOR CAMERAS
HIDDEN CAMERAS
ALARMS & ACC.
OUTDOOR HOUSINGS

WWW.CCTVCO.COM

\$34.00

over 50 brands to choose from
buy on line or dial toll free

1-800-323-8746



Best for HIGH PERFORMANCE fieldwork

One Pocket Sized Tool Does It All

A universal multi-programmer combining performance, flexibility and room for expansion. Optimal for use in the field. Small enough to fit in your pocket, it will output to a wide array of devices.

Fast, Versatile Field Programmer

Programs 8-bit and 16-bit EPROMs, EEPROMs, Zero Power RAM's, Flash, Serial EPROMs / GAL, PALCE, ATF/87xxx, 89xxx, PIC12/16/17Cxx / All DIL devices without adapter / Lightning fast parallel data transfer (e.g. 27C512 read/compare 2 sec!)

With Expanding Output Capability

Independent power supply with rechargeable battery / Uses PC printer port / Hex, JEDEC, and binary file formats / Hex & fuse-map buffer editor / Split & shuffle for 8-bit, 16-bit and 32-bit targets / Runs under Win3.1, 95, 98, NT / "Remote Control" by DDE scripts / Designed for the future with flexible pin driver technology / new devices added every month / Device list, demo software and lifetime free updates from our website.

GALEP III / cable, batt. and recharger. \$333.00
PLCC adapt. / 8-bit EPROMs / 16-bit EPROMs / GALS each \$149.00

ONLINE ORDERS: WWW.CONTEC.COM



One size fits all!
\$333
COMPLETE KIT

GALEP-III Pocket Multiprogrammer

CONTEC DATASYSTEMS • 1951 4th Avenue, Suite 301 • San Diego, CA 92101 • Tel: 619 702 4420

CABLE TV BOXES



(WE'LL BEAT ANY PRICE!)
30 DAY TRIAL* 1YR. WRNTY. *FREE CATALOG
QTY. DISCOUNTS * DEALERS WELCOME!

1-800-785-1145

HABLAMOS ESPANOL



PRIVATE CABLE SYSTEMS

BE AN ELECTRONICS TECHNICIAN!

Home study. Learn to repair, service, and install TVs, VCRs, camcorders, stereos, sound and lighting systems, alarms, and more!

FREE LITERATURE:
800-223-4542



Name _____

Age _____ Phone (____) _____

Address _____

City/State _____ Zip _____

The School of Electronics, Dept. ELG341
PCDI, 430 Technology Pky., Norcross, GA 30092

PRO PLANET CABLE TV CONVERTERS & EQUIPMENT



FOR ALL MAKES
AND MODELS

LOWEST PRICES

DEALER QUANTITY
DISCOUNT

30 DAY MONEY BACK

1 YEAR WARRANTY



www.cable4you.com

1-800-888-5585

Do You Repair Electronics?

Repair Databases for
TV, VCR, Monitor, UL
Audio, FCC, and more.

- Over 76,000 records
- Private user forums
- Live on-line chat rooms

RepairWorld.com

Electronics Corp | 11000 Sq. Feet | 001 407-324-6970 472-9076

An Introduction to Light in Electronics

An Introduction to
Light in
Electronics

F.A. WILSON



Taken for granted by us all perhaps, yet this book could not be read without it, light plays such an impressive role in daily life that we may be tempted to consider just how much we understand it. This book makes a good start into this fascinating and enlightening subject. It has been written with the general electronics enthusiast in mind.

To order Book #BP359 send \$6.99 plus \$3.00 for shipping in the U.S. and Canada only to Electronics Technology Today Inc., P.O. Box 240, Massapequa Park, NY 11762-0240. Payment in U.S. funds by U.S. bank check or International Money Order. Please allow 6-8 weeks for delivery.

ET08

CLASSIFIEDS

AUDIO-VIDEOS-LASERS

Esoteric Audio! "Master Pieces", "Tech Reports", Unique Plans, Modules. www.DaviSound.com, Box 521, Newberry, SC 29108-0521.

BUSINESS OPPORTUNITIES

HAVE AN IDEA? National company helps submit ideas, inventions to industry. Trade show. Patent Services. 1-888-439-IDEA.

FREE MONEY! NEVER REPAY. GUARANTEED. BUSINESS START, EXPANSION, PERSONAL NEEDS, DEBT CONSOLIDATION. FREE PACKAGE 1-888-290-5605.

START your own technical venture! Don Lancaster's newly updated **INCREDIBLE SECRET MONEY MACHINE III** tells how. We now have autographed copies of the Guru's underground classic for \$24.50. **Synergetics Press**, Box 809-C, Thatcher AZ, 85552. (520) 428-4073. www.tinaja.com VISA/MC.

\$400 WEEKLY ASSEMBLING electronic circuit boards/products from home: For **FREE** information send SASE: Home Assembly-PT Box 216 New Britain, CT 06050-0216.

CABLE TV

CABLE TV Descramblers. One-piece units. Scientific Atlanta, Jerrold, Pioneer, and others. **Lowest Prices Around. Precision Electronics** Houston, TX Anytime. 1-888-691-4610

PAY TV AND SATELLITE DESCRAMBLING 2000 EDITION. \$16.95. Hacking Digital Scrambling Systems III (NEW) \$29.95. Scrambling News Online \$40.00. Pay TV Series CD (Vol. 1-10) \$59.95. Everything listed here \$99.95. Free catalog. **SCRAMBLING NEWS.** 863-646-2564. www.scramblingnews.com

Descrambler Blowout-Wholesale Prices-Universal Box. Works for most Scientific Atlanta, Jerrold, Pioneer, Zenith Models. 412-833-0773

Descramblers, Converters, Activators, Rft's, Ftg's, Bullet Snoopers. All Options Explained, Best Prices, Services, 2 yr. Warranty, Free Catalog. 1-800-854-1674 www.resourceleader.com/aapc

NEW! Jerrold and Pioneer wireless test units \$125 each, also 75DB notch filters \$19.95 each, quantity pricing available please call **KEN ERNY ELECTRONICS** 24-hour order and information hot line 516-389-3536.

ALL CABLE TV BOXES. WE'LL BEAT ANY PRICE. 30 DAY TRIAL 1 YEAR WARRANTY. FREE CATALOG! WWW.CATVBOXES.COM 1-800-765-4912.

CABLE DESCRAMBLER SUPERSALE! Original, Universal and Add-on equipment. Guaranteed to beat any price. Models available for all areas in the U.S. 30 day trial, One year warranty. Great discount prices! 877-203-6854

CB-SCANNERS

CB Radio Modifications! Frequencies, kits, high-performance accessories, books, plans, repairs, amps, 10-Meter conversions. The best since 1976! Catalog \$3. **CBCI**, Box 1898P, Monterey, CA 93942. www.cbciintl.com

EDUCATION

THE CASE AGAINST PATENTS Thoroughly tested and proven alternatives that work in the real world. \$28.50. **Synergetics Press**, Box 809-C, Thatcher, AZ 85552. (520) 428-4073. www.tinaja.com VISA/MC.

MISC. ELECTRONICS FOR SALE

T & M ELECTRONICS. Large variety of electronic parts since 1966. Visit our Web site at www.tandmelectronics.com

ATMEL MICROCONTROLLER board with integrated programmer. <http://www.telusplanet.net/public/brianps/>

PLANS-KITS-SCHEMATICS

ELECTRONIC PROJECT KITS: \$3.00 catalog. 49 McMichael St. Kingston, ON., K7M 1M8. www.qkits.com - **QUALITY KITS**

AWESOME KITS: Ion Propulsion Motor, Stepper Driver, Solar Robot, Scrolling Clock and more! Catalog \$1.00. **LNS Technologies**, PO Box 67243, Scotts Valley, CA 95067 www.techkits.com

SATELLITE EQUIPMENT

FREE Satellite TV Buyer's Guide. Best Products - Lowest Prices - Fastest Service! Dish Network, DirectTV, C/Ku-band, including 4DTV. Parts - Upgrades - Accessories! **SKYVISION** - 800-543-3025. International 218-739-5231. www.skyvision.com

TEST EQUIPMENT

Browse our Web site and check out the "Monthly Special". **TDL Technology, Inc.** WWW.ZIANET.COM/TDL

DIGITAL MULTIMETERS. Used \$10.00 up. New Fluke23 \$115.00. Big selection. Free catalog. **GEOMA.** (608) 462-4222.

ROBOTICS

Arobot Kit from **Arrick Robotics** uses the BASIC Stamp II. Quality metal construction. Easy to assemble and very expandable. \$235. <http://www.robotics.com/arobot>

Get your copy of the CRYSTAL SET HANDBOOK



Go back to antiquity and build the radios that your grandfather built. Build the "Quaker Oats" type rig, wind coils that work and make it look like the 1920's! Only \$10.95 plus \$4.00 for shipping and handling. **Claggg Inc., P.O. Box 4099, Farmingdale, NY 11735. USA Funds ONLY!** USA and Canada - no foreign orders. Allow 6-8 weeks for delivery. MA01

ProService

June, 2000

Review

NESDA,
Happy 50th!

An official journal of NESDA (National Electronics Service Dealers Association), and IS CET (International Society of Certified Electronics Technicians).

VOL. XXVI, NO. 6

PURPOSE

ProService Review, included in each issue of *Poptronics*, is produced by NESDA, the National Electronics Service Dealers Assn., 2708 W. Berry St., Ft. Worth, TX 76109. It is intended for the enlightenment, education and entertainment of the members of NESDA, IS CET, and other ethical professionals engaged in or connected with the appliance, computer, and electronics service industries.

With the exception of official announcements, the statements and opinions expressed herein are those of the authors and not necessarily those of the associations.

Unless otherwise clearly indicated, neither NESDA nor IS CET endorses any company, product or service appearing in any article in this publication.

BUSINESS/EDITORIAL OFFICES

2708 W. Berry St., Ft. Worth, TX 76109-2397

817-921-9061; Fax 817.921.3741
www.nesda.com

Executive Director: Clyde W. Nabors
Clyde.Nabors@nesda.com

Editor-in-Chief: Wallace S. Harrison
Email: Wallace.H@nesda.com

Associate Editor/Production: M. Merrill
Email: Mary.Margaret@nesda.com

COPYRIGHT

Copyright © 2000 by NESDA, Inc., all rights reserved. No part of this publication may be reproduced or transmitted in any form or by any means without written permission from NESDA.

Contents

Calendar of Events	2
NESDA	3
NESDAnet	5
IS CET VCR Cross Reference	6
Nat. Professional Svc. Convention	8

ARTICLES

NESDA and Manufacturers Seek Service Survival Solutions <i>by Wallace Harrison</i>	1
Schemes Against Your Business <i>by the Better Business Bureau</i> ..	4
Define Your Market <i>by Kathy Kobliski</i>	5

NESDA and Manufacturers Seek Service Survival Solutions

In today's business climate, few servicers can afford to subsidize product sales through no-profit warranty work. NESDA advised manufacturers that they must pay more now, if they expect independents to service their consumers' products in the future. Manufacturers were receptive, but ...

by Wallace Harrison

On January 8, 2000, NESDA leaders met again with key service personnel of major product manufacturers at a manufacturer/servicer "summit meeting." This was part of NESDA's ongoing effort to strengthen a wobbly and numerically declining product service industry. NESDA invited leaders from other national associations, and a replacement-parts distributor, to share in the dialog.

The meeting was held at the Tropicana Hotel in Las Vegas, during the International Consumer Electronics Show. Leading the NESDA contingent were Wayne Markman, President, and Vic Gerry, Chair of the Industry Relations Committee. Following is a complete roster of participating manufacturer representatives (MR), distributor personnel (DP), and service dealers (SD), plus title and company or association affiliation.

ATTENDANCE ROSTER

Manufacturers: **HITACHI:** Walt Herin, Dir., Nat'l. Service; Kazuaki Nemoto, Sr. Engineer, Svc.; and Michael Snead, Tech. Svcs. Mgr.; **MITSUBISHI:** David Velasquez, Warr. Mgr.; Glen Yamashita, Cust. Rel. Mgr.; and Chuck Painter, Tech. Support. Mgr.; **PHILIPS:** Jose Garcia, V.P., Tech. & Field Svcs.; Wayne Nichols, Mgr. Field Ops.; and Gary Fenton, S.W. Region Tech. Mgr.; **PIONEER:** Larry Tinkler, V.P. Nat'l, Svc.; **SONY:** Thomas Ryan, V.P. Tech. Svcs.; Steve Camulli, Dir. Field Ops., East; Wayne Mooneyhan, Dir. Field Ops., West; **THOMSON:** Steve Zell, Dir. Cons. & Prod. Svcs. & Mktg.; and Charlie Jost, Mgr. Svc. Adm. & Mktg.; and

ZENITH: Mark Thorson, Interim Dir. of Svc.; Thomas Hagensick, V.P., Cust. Care, Network Systems; Gene Pilgrim, Dir. Warr. Ops.; and Dave Phipps, Dir., Int'l. Parts Ops.

Distributors: Tritronics: Kimberly Wagner CSM, V.P.

Servicers: **NESDA:** Wayne Markman, Pres., Markman TV, Hamden CT; Mike Webber CSM, V.P., Rucker's Radio/TV, Ft. Worth TX; Vic Gerry, Chair, Ind. Rel. Com., Page TV, Bethpage NY; Leo Cloutier CSM, Past Pres., Electronic Service Center, Los Angeles CA; George Weiss CSM, Past Pres., Bell TV, Chicago IL; Pat Narcisco, Tech-Tron TV, Brooklyn NY; and Bill Warren CET/CSM, Warren Electronic Services, Knoxville TN; **NASD:** Randy Whitehead CSM, NASD Pres., Wood Technologies Inc., Long Beach CA; and **PSA:** John Eubanks CET, PSA Dir., Quality TV, Jacksonville FL.

Bill Warren served as meeting recorder, and his minutes provided much of the material contained in this report. Other contributors were Wayne Markman and Kim Wagner.

SETTING THE AGENDA

NESDA President Markman announced the dual purposes of the meeting: (1) to discuss the state of today's service industry, and (2) solicit input to improve the value of the annual National Professional Service Convention.

He paraphrased the written preamble to the meeting agenda, as follows:

"Most manufacturers need a healthy independent service network to honor your commitments to the consumers of

(continued on PS-2)

Calendar of Events

CEA Technical Workshop: DVD Servicing

June 7-8, 2000
Arlington, VA
Contact: Sharon Means 703-907-7599
www.ce.org

Digital Hollywood - Tools, Technology, R&D

June 7-10, 2000
San Jose CA
CEA (VA): 703-907-7600;
www.ce.org

CEO Summit

June 21-23, 2000
San Diego, CA

COMDEX Canada 2000

July 12-14, 2000
Metro Toronto Convention Centre
Toronto, Ontario CANADA
Steve Prahalis 416-283-3334, ext. 1581, or
in U.S. 781-433-1581;
steve_prahalis@zd.com
www.zdevents.com/exhibitors

NESDA's 50th/ISCET's 30th Annual National Professional Service Con- vention & Professional Service Trade Show

August 6-12, 2000
John Ascuaga's Nugget Hotel
Sparks (Reno) NV
Clyde Nabors (TX): 817-921-9061, ext. 10
clydenesda@aol.com; www.nesda.com

CEA Technical Workshop:

Monitor/TV Servicing
August 14-16, 2000
Arlington, VA
Contact: Sharon Means 703-907-7599
www.ce.org

Nebraska Electronic Service Association's Fall Convention

September 8-10, 2000
Holiday Inn@ Grand Island Exit (Hwy. 80)
Jon Ludwig (NE) 402-464-9181 or
Myron Sahs (NE) 402-291-0559

CEA Technical Workshop: PCs/Peer-to-Peer Networking

October 11-13, 2000
Arlington, VA
Contact: Sharon Means 703-907-7599
www.ce.org

AFSM International's 30th World Conference & Exposition

October 15-17, 2000
The Opryland Hotel Convention Center
Opryland USA, Nashville, TN
Contact: Ginny Goodman 914-275-7887;
Fax 914.275.0794; ggoodman@afsmi.org
www.afsmi.org

CEA Fall Conference

October 15-18, 2000
San Francisco, CA
703-907-7600; www.ce.org

CEA Technical Workshop: DVD Servicing

November 15-16, 2000
Arlington, VA
Contact: Sharon Means 703-907-7599
www.ce.org

2001 International CES - Your Source for Workstyle and Lifestyle Technology

January 7-10, 2001
Las Vegas, NV
www.cesweb.org

(Service Summit, continued)

your products. At NPSC '99, many of you shared some valuable insights with our members, on how they might better survive today's business climate. You stressed the need for servicers to become computerized, to get on-line, and to have their service center certified for quality service. You said that the future of service is in digital, HDTV, and systems. We agree with much of what you said.

"However, many servicers have spent the necessary funds to become fully computerized, and have gone on-line. Many have also made the substantial investment to certify their service center. Yet, with the eroding profit structure for consumer electronics products, and the shrinking dealer network, it's difficult for them to amortize their investments. And it will be some time before HDTV, and the other promises of large-screen video become a profit factor in the service community. We have concerns that many good servicers won't be around when you need them in the 'more profitable' future."

DISAPPEARING SERVICE CENTERS

Some of the following discussion substantiated that the numbers of dealers is indeed rapidly declining. And it was noted that the business closings and bankruptcies included many large and formerly profitable service centers. Kim Wagner of Tritronics said that, for the first time, her company was having to write-off debts for some previously large companies that have closed. Jose Garcia of Philips confirmed that his company was losing 50 to 60 servicers per month. George Weiss, editor of the ESDA (IL) Newsletter informed the group that there has always been a certain amount of returned mail due to business closings or deceased members and subscribers. Lately, however, the number of returned copies has reached "alarming" proportions.

OUTSIDE PRESSURES

Since the failed businesses include both large and small service centers, as well as well-run and previously profitable organizations, the blame can't be placed solely on poor management. It is common knowledge that increased product reliability has drastically reduced the numbers of failed out-of-warranty units. It is also common knowledge that the low price of new consumer products, versus the artificially high price of replacement parts has further and more dramatically limited the number of failed out-of-war-

ranty units offered for repair. At the same time, the escalating costs of doing business, and the low, below-profit repair rates offered for in-warranty service, severely restricts the potential for service company profits.

The questions that these revelations lead to formed the topics of the fact-seeking agenda. The first item up for discussion was: "What can the remaining servicers do NOW to remain profitable in light of the eroding prices on many products, and the vanishing dealer network?"

PROFIT SOURCES

Mr. Garcia suggested that servicers within market segments might merge their companies, or form cooperatives to combine income sources while achieving reductions in overhead expenses. Some other MRs suggested soliciting service business from large retailers, even those that do their own service. A consensus of opinion by the MRs was that only dealers who provide in-home service would survive. But some also felt that the need for highly skilled technicians will diminish, since most products will feature one or more field-replaceable boards.

The SDs were skeptical of the latter thought. Based on previous experiences, they question the manufacturers' ability to consistently supply high-quality, bug-free replacement modules. They feel that competent technicians will continue to be needed to restore the product's optimum performance. Moreover, they question the implied savings in doing field service. That's because an in-home technician — even a less technically qualified one — must have a higher degree of rare people-skills.

WARRANTY PAY VS. ACTUAL COSTS

The next most-discussed agenda item covered the topic of whether warranty or service contract labor rates should be based on a service center's costs of doing business.

Pat Narcisco detailed many inherent costs, and pointed out how manufacturers' current rates fail to address them. Several SDs addressed the difficulty independents have in attracting competent technicians. This is due to both the sub-profit rates paid by warrantors, and out-of-warranty rates being limited by the low cost of new, replacement products.

One MR opined that servicers' business costs are too high, and that the profitability of the offered rates depend on the ASCs reducing their overhead, and

profit expectations. Another MR said that NESDA should work with the manufacturers to establish the extent of servicers' needs. Another said that it's unrealistic to expect that big rate increases will "just happen." He stated, and other MRs concurred, that they need valid information on service business costs to take to their cost-conscious superiors when asking for a budget increase.

However, it was pointed out by some MRs that an individual dealer's statement of business costs would not be sufficient by itself. Since business costs vary by region, and even between metropolitan and suburban areas, they need a composite, or average of figures from the different areas. Gene Pilgrim of Zenith revealed that he has started to develop a multi-tiered warranty rate structure, and would be glad to work with NESDA on such a project. When the question was asked as to whether the owner's salary and desired return-on-investment should be included, some MRs said no. They felt this would skew the results.

Many of the MRs seemed to agree that it would help them help their servicers if NESDA could develop such regional averages for product service business costs. They cautioned, however, that it could not be done simply by NESDA. The form, and/or the resultant figures must be authenticated by a nationally recognized accounting firm.

President Markman, and IRC Chair Gerry accepted the charge for NESDA to get this done.

WARRANTY SPECIALIZATION

Wayne Markman noted that many servicers who have been long-time authorized service centers (ASC) are facing difficult choices. Though they might be relatively satisfied with the warranty arrangements on one or more type of product, they can't justify the financial arrangements on some other products. His question to the MRs was whether ASCs could decline to service certain products without jeopardizing their ASC status for the original categories?

With but one exception, the MRs were unanimous in saying the servicers could be selective in product choices. One, Mr. Ryan of Sony, said that the decisions would be made case-by-case.

GOOD COMMUNICATIONS

In closing, President Markman expressed the gratitude of NESDA, and of the independent product service industry, for the participation of these execu-

tives, and the support of their respective companies. They came at NESDA's request, and they participated with unusual candor. Their attendance involved some cost in time, money, and risk. Many of these people are aware of the crisis facing independent service. They know how it can affect their future ability to provide quality service to the consumers of their products.

The meeting was relatively informal, and discussion was random and candid. Even without tangible results at this time, the demonstrated concern and intelligent

contributions of all the participants is encouraging. NESDA is proud to be the catalyst for meaningful dialog between manufacturers and interdependent servicers. With the support of caring MRs, we will continue our harmonious search for mutually beneficial solutions to common problems.

ONGOING DIALOG

The next Service Industry Summit Meeting is tentatively scheduled to be held at NPSC 2000 in Reno during the first week in August. §

NESDA.com

Your Gateway to Repair

Welcome to
NESDA.com

The On-line Home of the
National Electronics Service Dealers Association
*representing 50 years of servicing the
independent consumer product servicer*

Consumer Resources NESDA World Service Network Servicer Resources

Click here Click here Click here

If you're a consumer, search for a NESDA Servicer in your area by zip code using our FREE Servicer Locator. NESDA stands for ethical, high-quality repair and customer satisfaction by caring, highly trained, professional repair dealers.

If you're a servicer, you'll find links to major manufacturers, a FREE tech tips service download, and information on how to figure your "cost of doing business" in NESDA's "Members Only" section. Or, sign up for technical training and management seminars at the 2000 National Professional Service Convention in Reno. You can't lose!

For more information — *lots of information* — visit **www.nesda.com**. We're here to help.

National Electronics Service
NESDA
Dealers Association, Inc.

Making a Difference for You.

2708 W. Berry St., Ft. Worth TX 76109
817-921-9061; Email: info@nesda.com; www.nesda.com

Schemes Against Your Business

“They” are always out there, lurking in the shadows waiting for you to slip up. Before the vultures start circling, make sure your business doesn’t fall prey to one of these common scams.

from the *Better Business Bureau*

Every year, businesses lose millions of dollars to con artists through a host of different tricks and scams. As the workload for the average American employee increases, so does the likelihood of business scheme success.

A recent workplace survey revealed that, in today’s bustling business world, 9 out of 10 employees responsible for paying company bills have other major responsibilities in addition to handling accounts payable. Therefore, it’s understandable how busy employees can be easy prey for business schemes if they aren’t careful.

The best protection against business schemes is knowledge and vigilance.

During the holiday season or summer months, employees who are responsible for paying company invoices sometimes take time off. As a result, con artists may step up their efforts to try to cheat a company during those periods.

Even when persons with financial accountability are present, such as accountants, bookkeepers, etc., nearly 4 out of every 10 companies do not require any second line of oversight; i.e., no other employee is required to provide a second look at or approval of invoices before bills are paid.

Business scheme crooks and shysters owe their success to companies that have careless bookkeeping practices, inattentive or ill-equipped employees, and faulty corporate communications that blind each division of a company to the important responsibilities of another division. By educating your employees to identify common business scams, you can help them to defend your business against swindlers.

To protect your organization, learn to recognize the most common business scams.

ADVANCE FEE LOAN BROKERS

Businesses in need of commercial loans to expand or even stay afloat may be vulnerable to pitches by loan broker

sharks. In a typical advance fee loan scheme, a business will answer an advertisement regarding the availability of money to lend. During a subsequent phone conversation with the loan broker, the client is assured that he qualifies for a loan but is asked to submit an advance fee for the finding of this risk capital or loan. The advance fee is characterized as payment to the broker to prepare a business plan and present it to prospective investors. However, the disreputable “broker” all too often makes no effort to find funds as promised. The business never receives the promised loan, and loses all advance fees paid to the broker.

THE GIFT HORSE

This scam tries to create mistrust within an organization. It starts when the caller tricks an employee into accepting a gift—a free promotional item—with a passing reference to merchandise or services. Overpriced, unordered merchandise is received, followed by an invoice with the employee’s name. If the business questions whether it must pay the invoice, the employee comes under suspicion. The scheme works if the company believes that the employee blundered into ordering something that must now be paid for.

PHONY INVOICES

Schemers know that a business sometimes makes mistakes or can be careless in its accounting, so they prey on these weaknesses. Lifting names from mailing lists, business registers, the Yellow Pages or published advertisements, swindlers send “pro-forma” invoices for directory listings or advertising in various publications, journals or directories.

The invoice may seem genuine to the company’s accounting department, and may even include the name of a company executive as the “authorizing agent.” However, the invoice may be a solicitation in disguise and in very fine print contain the following disclaimer: “This is a solicitation. You are under no obligation to pay unless you accept this offer.” Al-

though the law states that it is illegal to send such a solicitation without the disclaimer being conspicuous and in large print, there are those who flout the regulations and send disguised solicitations. These phony invoicers are often persistent and may send a company two or more advertising invoices in the hope that the “bill” will be paid twice.

OFFICE SUPPLY & PAPER PIRATES

This scheme covers a wide range of office goods such as photocopying paper, copying supplies or ballpoint pens. The supplier makes a pitch by telephone, fax, or e-mail or a salesperson may just show up on the premises. Usually, the supplier tries to target an employee who is unfamiliar with purchasing procedures. A common approach is for the salesperson to claim “liquidation of stock” or “going out of business.” The merchandise, if delivered at all, is often of inferior quality, greatly overpriced, or may come in twice the amount ordered.

THE BRUSH OFF

When a business or organization complains that it didn’t order merchandise or services or that prices are too high, a scam seller reacts in predictable ways:

- **Bullying:** If you express any uncertainty about whether the supplies or services were ever ordered, the seller argues: “They were ordered. We have a recording of Mr. Jones. If you don’t pay, we can take you to court.”

- **Negotiating:** The seller agrees to accept a lower price. The goods and services are so grossly overpriced that almost anything the seller gets is profit. If you complain about price, the seller may say, “You were charged what? They must not have given you the discount for . . .” The seller then tries to negotiate “a better deal.” Sometimes, the seller appeals for sympathy: “We really need the business. I’ll let you have it for . . .”

- **Paying for returned merchandise:** The seller claims you can return merchandise if you pay a “restocking fee.” In fact, the fee is often more than the goods are worth. Similarly, the seller may try to get you to pay shipping charges to return the items.

THE VANITY PITCH

“Dear Business Executive” begins the letter. “We would like to include you in our next edition of ‘Who’s Who in the (fill in the blank).’” All too frequently, such pitches for “Who’s Who” type pub-

lications, biographies of successful people, or nominations for awards or special memberships have a catch to them. The executive who is flattered into providing the details of his or her career may be stuck with a subscription fee, a charge for the listing, or an inflated price for buying a publication that does not receive the widespread distribution implied in the initial offer.

PROTECT YOUR BUSINESS

Here are some ways you can protect your business from paying for unsolicited or unordered goods and services:

1. Know your rights. If you receive supplies or bills for services you didn't order, don't pay, and don't return the unordered merchandise as a gift. By law, it's illegal for a seller to send you bills or dunning notices for unordered merchandise, or ask you to return it—even if the seller offers to pay for shipping.
2. Assign designated buyers and document your purchases. For each order, the designated employee should issue a purchase order—electronic or written—to the supplier with an authorized signature and a purchase order number. The order form should instruct the supplier to note the purchase order number on the invoice and bill of lading. The buyer should send a copy of purchase orders to the accounts

payable department. Keep blank order forms secure.

3. Check your documentation before paying bills. When merchandise arrives, an employee should verify that it matches the shipper's bill of lading and your purchase order. Pay close attention to brand and quantity. Refuse merchandise that doesn't match internal documentation.
4. Train your staff. Train everyone how to respond to unsolicited phone, fax or email offers for office supplies and services. Advise employees who are not authorized to order supplies and services to refer all such sales pitches to the employee who is authorized to make these purchases. The authorized employee should then properly document any purchase orders.

QUICK CHECK LIST

Before accepting any business proposition, you should do the following:

- **Get everything in writing.** Require that all in-person, Internet or telephone sales pitches, advertising and charity appeals, or requests for your personal information be made in writing;
- **Refuse to make commitments with the unknown.** Train employees to refuse to make deals with un-known sellers, especially over the phone, without first verifying the reliability and complaint history of the seller's business with your

local Better Business Bureau and other consumer protection agencies.

- **Institute strict accounting controls.** The handling of invoices, etc. should be centralized and authorization closely checked.
- **Comparison Shop.** Compare product prices, quality, and company service with other suppliers when offered a deal from an unknown salesperson or company.
- **Keep a list of regularly used publications or vendors.** Protect your business against schemers who try to take your money by claiming that your company previously used a publication or service.

BOGUS YELLOW PAGE BILLS

Each year, businesses fall prey to phony mail invoices bearing the familiar "walking fingers" and the name "Yellow Pages."

Unscrupulous promoters are soliciting advertising in alternative or nonexistent business directories from unsuspecting businesses. Although these directories are portrayed as legitimate Yellow Pages publications, they are not distributed to the general public; and worse yet, they might not even be published at all.

The Yellow Pages Publishers Association estimates that over \$500 million is collected annually by con artists.

(continued on PS-6)

What is it?

NESDAnet is a group of astute repair service professionals working together to improve their service businesses.

Who can join?

Any independent servicer who is also a Member of NESDA or wants to join NESDA is welcome.

How does it work?

Electronic messages (E-mail) are sent via the Internet. NESDAnet then forwards the message to other users.

What is needed to participate?

Membership in NESDA, a computer, a modem, and a subscription to any E-mail account.

What is the cost?

\$60 per year (does not include NESDA membership, E-mail subscription, or phone-line charges.)

NESDAnet

the Professional Servicers' E-Mail Network

- ✓ Read Service Industry News
- ✓ Get Business Advice from Professional Service Dealers
- ✓ Locate Hard-to-find Parts
- ✓ Solve Tough Repair Problems
- ✓ Expose Unfair Business Practices
- ✓ Receive Association News
- ✓ Discuss Service Industry Standards
- ✓ Share Unpublished Warranty Policies
- ✓ Participate in Roundtable Discussions
- ✓ Send a Message to the Manufacturers

With **NESDAnet** you'll never be "the Only One" again.

National Electronics Service Dealers Assn.

2708 W. Berry St., Ft. Worth, TX 76109 • 817-921-9061 • Fax 817.921.3741 • www.nesda.com

The solicitation to buy ad space in a bogus Yellow Pages directory may look like an invoice and bear the "walking fingers" logo and the Yellow Pages name. Neither the name nor logo is protected by federal copyright or trademark registration. Consequently, con artists can fool businesses into believing that they are dealing with a local, affiliate telephone directory.

The United States Postal Service requires that all solicitations, that are not invoices, conspicuously carry the following notice: **"THIS IS NOT A BILL. THIS IS A SOLICITATION. YOU ARE UNDER NO OBLIGATION TO PAY THE AMOUNT STATED ABOVE UNLESS YOU ACCEPT THIS OFFER."**

HOW TO PROTECT YOURSELF

Before buying advertising space through a mail solicitation or paying a "Yellow Pages" invoice, do the following:

1. Check out the company and its publication. Call your local Yellow Pages publisher to discover if it is affiliated with the soliciting company.
2. Ask the publisher for a copy of a previous directory edition. If one is provided, contact a sampling of previously listed businesses to find out if the directory was helpful to them.
3. Ask the publisher to provide all information in writing. This includes: where the directory is distributed; the way it is distributed (does each local telephone customer receive it?); how often it is published; and total distribution or circulation figures.
4. Check out the company and its publication. Call your local Better Business Bureau and other state and local consumer protection agencies to determine if any complaints have been filed against the publisher.

To learn more about schemes against business issues, contact the following:

- **Your Local Better Business Bureau:** www.bbb.org/bureaus
- **Federal Trade Commission** at 202-382-4357; www.ftc.gov
- **U.S. Postal Inspection Service** at www.usps.gov/websites/depart/inspect
- **U.S. Small Business Administration** at 1-800-U-ASK-SBA; www.sba.gov
- **Yellow Pages Publishers Assn.** at 303-333-9772; www.yppa.org

**If you find any of the web sites listed above to be inactive, please contact the respective organization. Also, be aware that the above phone numbers may be subject to change without notice.* §

Define Your Market

When you decide to spend money advertising, do you know who you will be advertising to? Get better results by targeting the right market.

by Kathy J. Kobliski

Most entrepreneurs have had experience as employees of similar businesses and already have a grasp of who their customers should be. It is a good idea, even if you think you know who your customers are, to keep track of them on paper — not only during your first weeks and months, but throughout your business life. Your customer base can change with the addition of services or new merchandise to your inventory, a shift in the community caused by the opening or closing of a university, an industry, a military base, or just the natural aging of people in the community. Throughout this article, I refer to the following groups:

18-34, 18-49, 25-54, 50+
Female, Male, Adults

These are basic demographic age ranges and gender groups used by media to divide the population into manageable segments.

At one time 18-34 was rarely used; a wider range of 18-49 covered the bigger group. However, there is a huge difference in the musical taste of an 18-year-old and a 49-year-old — the opposite ends of that spectrum — so the 18-34 group was created to break down the larger segment. It allows us to see where the younger portion of that group tunes in and where the older population settles in to listen. The same principle applies to the overlapping of the other groups. As you read along, keep in mind that they do, and are supposed to, overlap. For instance:

The group 18-34 seems like it could be synonymous with 18-49. But 18-34 represents the younger segment of the two groups, ending a full 15 years short of the larger group. Therefore, a business catering to teens or people in their twenties, would choose to advertise to the 18-34 group rather than choosing the 18-49 group simply because it doesn't want to waste money reaching people too old for its product.

The 18-49 group fits totally within the 25-54 range. But you will reach the younger portion of that population segment (ending around age 35) by using 18-49 and the

older group (35-54) in the 25-54.

The same goes for the 25-54 segment and the 50+ group. The 50+ group represents persons age 50 and up: senior citizens, grandparents, and retired people. While you may reach *some* of these people using 25-54, you would mainly be reaching people too young for your product or service if your major target group is 50+.

While television stations use slightly different age groups, they will fall into the same ranges as the ones listed above. Your television account executives will know exactly which programming best suits your business based on the information you provide.

This chapter provides guidelines for making the correct demographic age and gender choices for your business. Use those guidelines until you get a feel for the process, and keep in mind the "overlap" factor of the groups as you read.

In the advertising and media-buying class I teach, I offer myself as an example of how complex choosing a primary and secondary (even tertiary) demographic group can be. I am a 52-year-old female. Businesses catering to 50+-year-old females, like those selling cars, clothing, grocery stores, weight-loss clinics and products, vitamins, etc., would know they could send their message to me on the stations and programs catering to the 50+ Female demographic group. Easy, right? Well . . .

- I am also a wife and I buy men's clothes. My husband's hobbies include hunting and railroad modeling.
- I am the mother of 3 sons. The oldest works in a bank and is also a hunter. Along with men's clothing, I need to know where to purchase hunting items for birthday and holiday gifts. He was married 2 years ago and that involved me in some of the wedding preparations: balloons, invitations to the rehearsal dinner, flowers, the rehearsal dinner itself, tuxedos, hotel accommodations for our out-of-town guests.
- I love to shop for my 27-year-old daughter-in-law, a teacher by trade, whose hobby is photography.
- Last year my husband and I became grandparents and I began purchasing

The Professional's Choice!

SATELLITE RECEIVERS

- DBS and C-Band most makes and models
- World's Largest Inventory of TV Tuners & Mainboards

CALL 1-800-844-7871 To RECEIVE OUR LATEST CATALOG

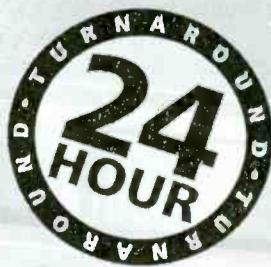

TV Mainboards

We stock Zenith, RCA & Philips!
We service Hitachi, Mitsubishi, Sony and many others

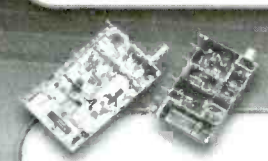

Television Tuners

We stock over 40 major brands and will save you up to 60%. Orders are shipped the same day they are ordered with free overnight delivery.

PTS Electronics

Bloomington, Indiana Corporate Headquarters - 5233 South Highway 37 ■ Bloomington, IN 47401 ■ 800-844-7871 ■ Fax: 800-844-3291
Arvada, Colorado - 800-331-3219 ■ Fax: 303-422-5268 ■ **E-mail: pts@ptscorp.com** ■ **www.ptscorp.com**

CIRCLE 150 ON FREE INFORMATION CARD

NEW GEAR

(continued from page 28)

Desoldering Braid Dispenser

A HAND-HELD TOOL, THE XURON Wickgun Desoldering Braid Dispenser eliminates the handling of braid and getting burned fingers when desoldering. Technicians can dispense, position, and cut off braid with one hand using a thumbwheel and trigger while holding their soldering iron in the other.

Featuring replaceable cassettes, the Desoldering Braid Dispenser speeds up desoldering and cuts braid waste. The cassettes are preloaded with 15 feet of pure copper braid impregnated with

water clear flux and are offered in four different braid sizes.

The Xuron Wickgun Desoldering Braid Dispenser is priced at \$39.95.

Xuron Corp.

62 Industrial Park Road
Saco, ME 04072-1865
Tel: 207-283-1401
Web: www.xuron.com

Memory Card Reader

QUATECH'S PCD-U USB SMART-Media and Flash Card Reader/Writer provides an easy way to move large blocks of data via a USB port. The PCD-U has two card slots, each designed for a different type of media. The small bottom slot is designed for SmartMedia cards—tiny storage disks, available in 2 to 32 MB versions. The larger upper slot can accommodate a single Type I or Type II PCMCIA ATA Flash card or CompactFlash card.

The PCD-U provides both Read and Write access. High-speed transfer speeds of up to 1.5 MB/sec can be expected. Easy to install, the reader is bus powered, so no external power supply is needed.

The PCD-U USB SmartMedia and Flash Card Reader/Writer has a list



CIRCLE 67 ON FREE INFORMATION CARD



CIRCLE 66 ON FREE INFORMATION CARD

price of \$99.

QUATECH, INC.

662 Wolf Ledges Parkway
Akron, OH 44311
Tel: 800-553-1170 or 330-434-3154
Web: www.quatech.com

P

Are You A Service Center?
Then you need 'nControl!
Software for service professionals
Time clock, automatic tech production, point & click billing
Electronic billing, credit card terminal built-in, service tips, manuals, etc.
Download Free Trial! **ServiceSolutions.com**
(888) PBS-6288
Windows 95/98/NT/2000

baby clothes, baby furniture, and many other baby items.

- Son #2 is a police officer who is interested in physical fitness. Again, I need to know about men's clothing, but for a younger demographic than the clothes I buy for my husband. He plays the guitar and likes to go to concerts, things I consider when buying for him.
- Son #3 is 14-years-old. I shop for clothes, movie passes, computer games and programs, video games, school supplies, orthodontist services, and a whole different set of products and services than I deal with for his father and older brothers.

Would you think of advertising to the 50+ Female group for the following items:

- Guitars and accessories
- Baby furniture and baby clothes
- Wedding products and services
- Hunting gear, including guns, ammunition, camouflage outerwear, etc.
- Video games
- Clothes and shoes for 25-27-year-old women

While I may not be your primary audience, I surely am a strong secondary. You must think very hard about the people you want to reach. Your conclusions will not only guide your decisions on where to consistently place your advertising dollars, but will allow you to take advantage of affordable promotions or advertising packages proposed to you by reps of stations or programs you don't normally consider.

Delivering your message to the right people is the whole story of advertising. The first critical step of determining who the right people are is the one you are about to take. You may find after some thought, that the answer might not be as obvious as you believed.

A car dealer reading this book may go to the next page and circle all of the age choices in Group A because everyone who can drive is a potential customer. Then again, he or she may consider one demographic group for brand-new luxury models, another for the more economical models and still another for used cars as the secondary market. Other types of businesses will have a very narrow selection for a primary choice and another very specific group circled for the secondary market.

When you feel you have identified your primary and secondary customers, circle the correct choices from Groups A and B. You may need to circle more than one age choice from Group A. From

Group B, you will circle only one option. Does your business lend itself primarily to males, females, or both (in which case you will circle Adults). You will now use this information to identify radio and television stations and publications targeting the groups you have selected. These choices are the basis for all of your media planning and media buying. This is the information from which all advertising decisions are made, so give careful thought to your selections.

Describe your customers by circling the appropriate choices from Groups A and B. You may need to circle more than one choice from Group A. To simplify the demographic choices you need to make and compensate for the overlapping, use the following guidelines until you develop a feel for the process:

- If you estimate your customers to be 12-24 years of age, circle the 18-34 group.
- If you estimate your customers to be 25-35 years of age, then circle the 18-49 group.
- If you estimate your customers to be 36-50 years of age, circle 25-54.
- If you estimate them to be over 50 years of age, circle the 50+ group.

Primary Market

Group A-Age	Group B-Gender
18-34	Male
18-49	Female
25-54	Adults (Male & Female)
50+	

Secondary Market

Group A-Age	Group B-Gender
18-34	Male
18-49	Female
25-54	Adults (Male & Female)
50+	

A *Customer Information Worksheet* will track changes in your customer base and provide facts you need to make proper advertising decisions. At least twice a year for a 3- or 4-week period, keep these worksheets by your register on a clipboard. Ask for each purchaser's zip code, fill in the gender section and estimate the age. Analyzing this information will provide, along with the demographic facts for selecting radio and television stations, the zip code data you need to help you with direct mail and outdoor advertising. It will allow you to evaluate changes in your customer base and respond accordingly.

After each sheet is completed, total the columns and list in order the top 5 zip codes, the number of males and females, and the number of people falling into each age group at the bottom of the page. As you begin analyzing your *Customer Information Worksheet*, the results

will either validate your original assessment of who your customers are or give you a clearer picture of them. If, over time, the numbers in the columns change, you will be ready to react not only with your service or product lines, but with your advertising decisions.

A small budget doesn't allow much experimentation, and common sense dictates that you target your primary audience first, then the secondary group. Start by reaching the people closest to your location and then work your way out. Various forms of advertising let you be geographically specific as well as demographically specific, such as direct mail, some forms of print, outdoor advertising, and even cable TV.

Tip: Does your business require you to enter customers' homes for estimates, cleaning, or installations? Be aware of what station the radio is tuned to or what program is on the television when you are there. Keep a list.

Kathy J. Kobliski is author of Advertising Without an Agency, a Comprehensive Guide to Advertising for Small Business, available from The Oasis Press (\$19.95). To order your copy or a catalogue, call 800-228-2275. §

VCR ^{ISCET} Cross Reference

VCR Cross Reference 8.0
VCR Model Number and Parts Cross Reference. 110 pages. A complete guide to IC and Module replacements and substitutions for over 35,000 parts and models. Three-hole punched; shrink wrapped.
\$19.95 shipping \$4.00

VCR Cross Reference on Disc
Ver. 8.0. One 3-1/2" disc. For IBM PC AT/XT or compatibles. Model search by manufacturer or description. Contains all the new models and parts listed in the book. New faster search engines.
\$39.95 shipping \$4.00

VCR Cross Reference Disc & Manual
Ver. 8.0. Save a bundle when ordering both.
\$50.95 shipping \$4.00

Allow 4-5 weeks delivery when using personal checks or VISA and MasterCard. Money orders and cashiers checks processed immediately. Payment: Check; Visa; MC

Amount _____ Card Exp _____
Card No _____
Name _____
Business _____
Address _____
City _____
State _____ Zip _____
Phone _____

Member: ISCET; NESDA; Non-member
*Texas residents multiply dollar value x 8 1/4% for taxes.
Foreign shipments please add international postage.*

Order from ISCET
2708 W. Berry St., Ft. Worth TX 76109

National Professional Service Convention 2000

and Professional Service Trade Show

John Ascuaga's Nugget Hotel — Sparks (Reno) NV

Register for the Full Convention, Any Three Consecutive Days, or Daily

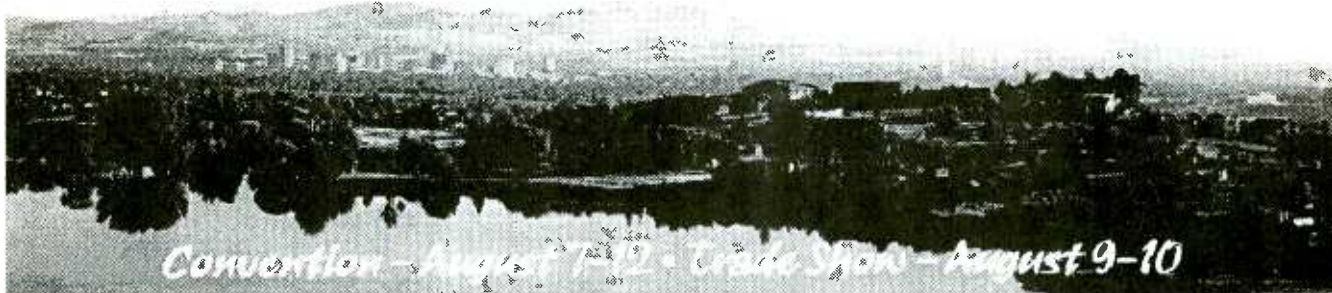

Complete this form, detach and mail to: NPSC 2000, 2708 W. Berry Street, Fort Worth, TX 76109; 817-921-9061; Fax 817.921.3741; www.nesda.com

Full convention registration includes all programmed meals, banquets, door prize drawings, trade show, dealer/manufacture meetings, seminars and workshops. Activities may be scheduled for optional participation at an extra cost. There is no convention youth program. However, children 17 and under are free.

NOTE: Special Registration Rates are valid ONLY on registrations completed, fully paid and received before the deadlines listed. "Three-Day Special" registration is available for any three consecutive days. Children age 17 and under are free. Convention fee schedule per person (ages 18, up):

Name _____
Firm Name _____
Address _____
City _____ State _____
Zip _____ Phone _____

If registered and fully paid by ...	Full Convention Registration	3-day Special	Daily	Totals:
May 15, 2000	\$200	\$160	\$80	\$ _____
Aug. 3, 2000	\$220	\$180	\$85	\$ _____
At the door	\$250	\$200	\$90	\$ _____

Member of (please check the appropriate boxes below):

- NESDA; IS CET; PSA; NARDA/NASD; Non-Member;
 Instructor; Speaker; Distributor; Manufacturer; Sales Rep;
 Press; Dealer; Technician; Other _____

If registering for a 3-day special, check which 3 days you are registering:
 Mon.-Wed. Tues.-Thurs. Wed.-Fri. Thurs.-Sat.

Below, please print legibly your name, and the names of all other registrants (including nicknames) as they are to appear on the registration badges:

Check box if first NPSC

Youth Ages

Full Name (The one name you want in large letters)	Badge Name	Youth Ages
<input type="checkbox"/> _____	_____	_____
<input type="checkbox"/> _____	_____	_____
<input type="checkbox"/> _____	_____	_____
<input type="checkbox"/> _____	_____	_____
<input type="checkbox"/> _____	_____	_____

Numbers of Participants/Length of Registration

# Adults Full: _____	# Adults 3-Day: _____	# Adults Daily: _____	Total No. of Days: _____
# Children Full: _____	# Children 3-Day: _____	# Children Daily: _____	Total No. of Days: _____

Make your check payable to NESDA

Visa MasterCard No. _____ Exp. _____ Signature: _____

Special Room Rates: Deluxe room rates at John Ascuaga's Nugget Hotel are \$89 single or double; \$10 per person over 2 in the same room, max. 4. Children 18 years and under stay free with parents. Rates do not include room tax. Rooms are subject to availability. You may call the Nugget directly to make your reservations at 800-648-1177 (tell them you're reserving under the National Professional Service Convention). *Due to a city-wide celebration the week prior to NPSC 2000, our room-block does not begin until Sunday, August 6th. Hotel reservations beginning prior to August 6th are on your own. To guarantee a room at John Ascuaga's Nugget Hotel, reservations MUST be made by June 30.*

REFUND POLICY: Register in advance. If find that you have to cancel — any time prior to convention — all money prepaid will be refunded except for a 10% processing fee per registered person.

ADVERTISING INDEX

Poptronics does not assume any responsibility for errors that may appear in the index below.

Free Information Number	Page	Free Information Number	Page
- Abacom Technology	71	- Lynxmotion	111
- ABC Electronics	83	- M ² L Electronics	83
215 All Electronics	110	142 McGraw-Hill	11
- Allison Technology	86	160 MCM Electronics	87, 105
- Amazon Electronics	99	250 Mendelsons	99
315 American Eagle Publications	86	296 Merrimack Valley Systems	103
- Andromeda Research	96	- microEngineering Labs	102
- Arrow Technologies	99	- Midwest Laser	96
295 AVEN Tools	79	- Modern Electronics	106
319 Beige Bag Software	107	- Mondo-tronics	82
310 Bsoft Software, Inc.	94	220 Mouser Electronics	82
290 C&S Sales, Inc.	84	- MSC Electronics	98
- CCTV Outlet	111	- NESDA	PS-9
233 Circuit Specialists	95	- NTE Electronics, Inc.	93
- CLAGGK, Inc.	CV3, 17, 76	257 Parts Express	109
- Cleveland Inst. of Electronics	35	- Pioneer Hill Software	108
231 Command Productions	93	300 Polaris Industries	77
232 Command Productions	80	219 Prairie Digital	96
- Computer Monitor Maintenance	102	- Print Products Int.	93
- Conitec Data Systems	111	- Pro Planet	112
- EDE Spy Outlet	106	150 PTS Electronics Corp.	PS-7
312 Electronic Goldmine	100	- Pulsar, Inc.	88
130 Electronic Workbench	CV4	263 Ramsey Electronics	78
- Electronic Tech. Today	60	246 Resources Unlimited	94
205 Electronix Express	89	- RobotiKits Direct	88
- EMAC Inc.	80	308 Roger's Systems Specialist	89
- Engineering Express	94	- Securetek	71
318 Foley-Belsaw	91	- Scott Edwards Electronics	96
- Future Horizons	80	- Sil Walker	83
- Gateway Products	99	- Smithy Company	98
- General Device Instruments	102	- Spectrum Research	83
- Globaltech Distributors	98	- Square 1 Electronics	96
- Grantham College of Eng.	102	- Techniks	98
237 Howard Electronics	90	- Technological Arts	111
- ICS	82	311 Telulex	108
225 Information Unlimited	81	313 Test Equipment Depot	97
- Intec Automation	98	217 Tie Pie Engineering	104
- Intelligence I ² Inc.	99	242 Timeline	107
- International Electronics Corp.	104	- UCANDO Videos	86
- International Hanbai, Co., Ltd.	3	- Ultima Associates	82, 102
- Intronics	106	275 Velleman	92
- Island Logix	97	- Vision Electronics	82
309 IVEX Design	101	- World Star Technologies	98
- J&M Microtek	99	- World Wyde	98, 99
- J-Tron	98	- XX Box	83
139 Jameco	CV2	- Zagros Robotics	108
- KNS Instruments	106	- Zorin	99

ADVERTISING SALES OFFICES

Gernsback Publications, Inc.
275-G Marcus Blvd.
Hauppauge, NY 11788
Tel. 631-293-3000
Fax: 631-293-3115

Larry Steckler

Publisher (ext. 201)
 e-mail: advertising@gernsback.com

Adria Coren

Vice President (ext. 208)

Ken Coren

Vice-President (ext. 267)

Marie Falcon

Advertising Director (ext. 206)

Adria Coren

Credit Manager (ext. 208)

For Advertising ONLY EAST/SOUTHEAST

Megan Mitchell

9072 Lawton Pine Avenue
 Las Vegas, NV 89129-7044
 Tel. 702-240-0184
 Fax: 702-838-6924
 e-mail: mmitchell@gernsback.com

MIDWEST/Texas/Arkansas/ Oklahoma

Ralph Bergen

One Northfield Plaza, Suite 300
 Northfield, IL 60093-1214
 Tel. 847-559-0555
 Fax: 847-559-0562
 e-mail: bergenrj@aol.com

PACIFIC COAST

Megan Mitchell

9072 Lawton Pine Avenue
 Las Vegas, NV 89129-7044
 Tel. 702-240-0184
 Fax: 702-838-6924
 e-mail: mmitchell@gernsback.com

Poptronics Shopper

Megan Mitchell

National Representative
 9072 Lawton Pine Avenue
 Las Vegas, NV 89129-7044
 Tel. 702-240-0184
 Fax: 702-838-6924
 email: mmitchell@gernsback.com

Subscription/ Customer Service/ Order Entry

Tel. 800-827-0383
 7:30 AM - 8:30 PM CST

The world's most popular simulator just got better.

MULTISIM SCHEMATIC CAPTURE AND SIMULATION

**NEW
VERSION 6**

Flexible Symbol Editor **NEW**

To add or modify symbols for any component.

Power Meter **NEW**

Works just like with a real Wattmeter.

1000 New Components **NEW**

New families include Electromechanical, Connector, Wideband Opamp, and Tiny Logic.

Editable Footprint Field **NEW**

Add or change default footprint values directly from the schematic.

New Analyses **NEW**

AC sensitivity and DC sensitivity help determine the stability of your design.

Multiple Instruments **NEW**

Now you can have more than one copy of an instrument on the screen at once.

Enhanced Wiring **NEW**

Improved connections to pins and more intelligent autowiring.

Analysis Wizards **NEW**

Guide you through an analysis, making it easier than ever to take advantage of these powerful functions.

Virtual Instruments

Includes oscilloscope, function generator, multimeter, bode plotter, word generator, and logic analyzer.

9 Powerful Analyses

To analyze circuits in ways just not possible with real instruments. Includes DC, & AC operating point, transient, fourier, noise, DC sweep and Ac & DC sensitivity.

5,000 Components

Wide selection of commonly used components, all complete with simulation, symbol and footprint information.

Full-Featured Schematic Capture

Industry's easiest-to-use design entry is ideal for generating high-quality schematics.

Changes on the Fly

The world's only simulator that lets you tweak your circuit during simulation for instant feedback.

Analog and Digital SPICE Simulation

Fast, accurate SPICE simulation with no limit on circuit size.

Custom Model Support

Edit existing models to create new parts, or import components as SPICE models from vendors.

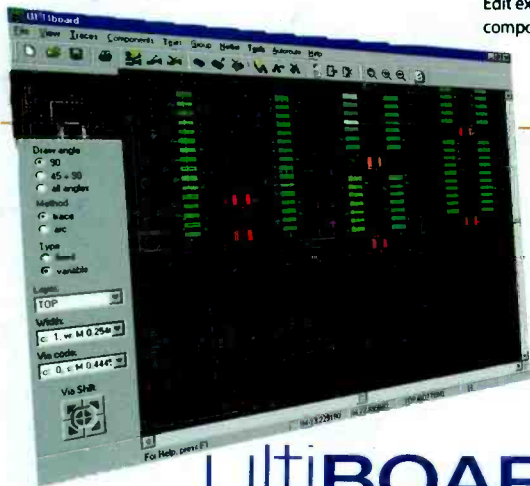
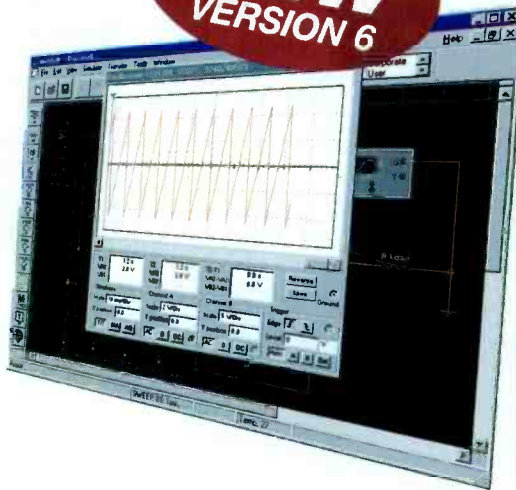

multisim **\$399**

Call for upgrade pricing

ULTIBOARD POWERFUL PCB LAYOUT

Fast Autorouting Multi-layer autorouter with configurable options for customized performance.

Real-Time DRC Automatic Design Rule Check prevents costly errors by monitoring the size and clearance of pads, vias and traces.

Ideal for all Boards Built-in board editor to create any shape board up to 50" X 50" in size, with as many as 32 layers.

Multiple Output Formats Outputs to the formats you need including Gerber, DXF, plotters, printers, and more.

Tight Integration with Multisim Supports forward and back annotation with Multisim, so that the programs share important design information.

Flexible Editing Full support of power and ground planes, with or without thermal relief. 'Reroute while move' to move copper without losing connectivity.

ultiBOARD **\$399**

TO ORDER

For a **FREE** demo visit www.electronicworkbench.com

SAVE
\$100.00

Call **1-800-263-5552**

Save \$100 when you order the Personal Design Solution
(Includes Multisim and Ultiboard).



**Electronics
WORKBENCH**

DESIGN SOLUTIONS FOR EVERY DESKTOP

CIRCLE 130 ON FREE INFORMATION CARD