

FREE INTERNET ACCESS FOR ALL

JULY 1999

Popular Electronics®

PLUS!
New Robotics
Column

Join The Search For Extraterrestrial Intelligence

Learn how to set up your own listening station and hunt for signals from space

Experimenting with Small FM Transmitters

From simple communications to covert listening devices, there are circuits here for everyone

Gizmo®

- Using "Big" Satellite Dishes Today
- Shopping Online with iPhone
- Transmitting Video in a Home
- And much more

Also Inside:

- Speeding Up Analog Modems
- Voltage-Reversal Circuits
- Isolating Causes of EMI
- Benchmarking PCs

\$4.99 U.S.
\$5.99 CAN.



 A GERNSBACK
PUBLICATION

#BXBDCCH CAR-RT

[REDACTED]

[REDACTED]

[REDACTED]

High-end features. Low-end price.

\$299
CircuitMaker 6:
Schematic design
and simulation
software

The features
of **high-end
schematic design
and simulation
software** at a
fraction of
the cost.

10
MICRO CODE
SERVING ENGINEERS FOR
YEARS
30-DAY GUARANTEE

\$299
TraxMaker 3:
Printed circuit
board layout
software

The features
of **high-end
printed circuit
board layout
software** at a
fraction of
the cost.

CircuitMaker Version 6 and TraxMaker Version 3 give you the features of professional, high-end software at a fraction of the cost. Plus, with exceptional ease-of-use you'll spend less time learning to use the software and more time designing. Both applications are compatible with your existing software, and feature outstanding technical support. Call now for your free functional demo.

CircuitMaker 6 is a powerful schematic design and simulation program featuring:

- Professional schematic features including printout borders, title block and barred pin names
- Symbol editor and Macro feature for custom devices
- Fast, accurate SPICE3f5/XSPICE-based simulation
- Complete array of analysis types, including Fourier, AC, DC, Parameter sweep, Transient and more
- Virtual instruments including a digital oscilloscope, multimeter, Bode plotter, curve tracer and more
- Extensive library of over 4,000 models
- Tight integration with TraxMaker® for quick PCB layout
- Output PCB netlists in Protel®, Tango® and TraxMaker® formats for use in a variety of PCB layout programs
- Windows 3.1, 95 and NT

TraxMaker 3 is a powerful printed circuit board layout program featuring:

- Over 2,000 component footprints in a fully-documented, indexed library. Documentation shows footprints actual size
- Built-in autorouter and Design Rules Check
- Supports up to 6 signal layers plus power and ground planes, silk screen overlays and solder and paste masks
- Board sizes up to 32" x 32", with no pin limitations
- Intelligent manual routing with unrout capabilities
- Import any PCB netlist in CircuitMaker®, Protel® or Tango® format
- Output RS274X Gerber files, Excellon N/C drill files and Bill of Materials
- Print to any Windows-compatible printer or plotter
- Windows 3.1, 95 and NT

MICRO CODE ENGINEERING INC For free demo software, or to order, call **1-800-419-4242**
927 West Center Street • Orem, UT 84057 • Phone (801) 226-4470 • Fax (801) 226-6532 • www.microcode.com

©1998 MicroCode Engineering, Inc. All rights reserved. CircuitMaker, TraxMaker, SimCode and MicroCode are registered trademarks of MicroCode Engineering, Inc. All other brand and product names are trademarks or registered trademarks of their respective companies.
CIRCLE 174 ON FREE INFORMATION CARD

Popular Electronics®

THE MAGAZINE FOR THE ELECTRONICS ACTIVIST!

FEATURES AND CONSTRUCTION

JOIN THE SEARCH FOR EXTRATERRESTRIAL INTELLIGENCE.....	<i>Dr. H. Paul Shuch</i>	29
<i>Find out how to set up your own listening station and hunt for signals from space</i>		
EXPERIMENTING WITH SMALL FM TRANSMITTERS.....	<i>Newton C. Braga</i>	37
<i>From simple communicators to covert listening devices, there are circuits here for everyone</i>		
SOUND PARTNER.....	<i>Newton C. Braga</i>	43
<i>Build it and connect a second set of headphones to a portable device, without audio-signal loss</i>		

PRODUCT REVIEWS

GIZMO®.....		18
<i>Using "big" satellite dishes today, shopping online with iPhone, transmitting video in a home, and more</i>		
HANDS-ON REPORT.....		26
<i>Micro 2000 Basic PC Learning Course</i>		
PRODUCT TEST REPORT.....		27
<i>RCA Video Source Selector</i>		

COLUMNS

NET WATCH.....	<i>Konstantinos Karagiannis</i>	3
<i>Free Internet Access</i>		
COMPUTER BITS.....	<i>Ted Needleman</i>	6
<i>Benchmarking Your PC</i>		
MULTIMEDIA WATCH.....	<i>Marc Spiwak</i>	9
<i>A USB Modem, Travel Accessories, and Lots More</i>		
PEAK COMPUTING.....	<i>Andrew T. Angelopoulos</i>	12
<i>Getting the Most from Analog Modems</i>		
ROBOTICS WORKSHOP.....	<i>Gordon McComb</i>	64
<i>Using Stepper Motors</i>		
CIRCUIT CIRCUS.....	<i>Charles D. Rakes</i>	67
<i>Voltage-Reversal Circuits, Plus</i>		
SCANNER SCENE.....	<i>Marc Saxon</i>	71
<i>Space Calls</i>		
COMM LINKS.....	<i>Joseph J. Carr</i>	72
<i>Unusual Cases of EMI</i>		

DEPARTMENTS

EDITORIAL.....	2
LETTERS.....	16
ELECTRONICS LIBRARY.....	17
POPULAR ELECTRONICS MARKET CENTER.....	45
NEW PRODUCTS.....	75
ADVERTISING INDEX.....	80
FREE INFORMATION CARD.....	80A

Popular Electronics (ISSN 1042-170-X) Published monthly by Gernsback Publications, Inc. 500 Bi-County Boulevard, Farmingdale, NY 11735. Second-Class postage paid at Farmingdale, NY and at additional mailing offices. One-year, twelve issues, subscription rate U.S. and possessions \$24.99. Canada \$33.15 (includes G.S.T. Canadian Goods and Services Tax Registration No. R125166280), all other countries \$33.99. Subscription orders payable in U.S. funds only. International Postal Money Order or check drawn on a U.S. bank. U.S. single copy price \$4.99. Copyright 1999 by Gernsback Publications, Inc. All rights reserved. Hands-on Electronics and Gizmo trademarks are registered in U.S. and Canada by Gernsback Publications, Inc. Popular Electronics trademark is registered in U.S. and Canada by Electronics Technology Today, Inc. and is licensed to Gernsback Publications, Inc. Printed in U.S.A. Postmaster: Please send address changes to Popular Electronics, Subscription Dept., P.O. Box 338, Mount Morris, IL 61054-9932.

A stamped self-addressed envelope must accompany all submitted manuscripts and/or artwork or photographs if their return is desired should they be rejected. We disclaim any responsibility for the loss or damage of manuscripts and/or artwork or photographs while in our possession or otherwise.

As a service to readers, Popular Electronics publishes available plans or information relating to newsworthy products, techniques, and scientific and technological developments. Because of possible variances in the quality and condition of materials and workmanship used by readers, Popular Electronics disclaims any responsibility for the safe and proper functioning of reader-built projects based upon or from plans or information published in this magazine.

Larry Steckler, EHF, CET
editor-in-chief and publisher

EDITORIAL DEPARTMENT

Konstantinos Karagiannis, editor

Robert Young, technical editor

Evelyn Rose, assistant editor

Teri Scaduto, assistant editor

Janine Abitabile, editorial assistant

Andrew T. Angelopoulos,
contributing editor

Joseph J. Carr, K4IPV, contributing editor

Gordon McComb, contributing editor

Ted Needleman, contributing editor

Charles D. Rakes, contributing editor

Marc Saxon, contributing editor

Marc Spiwak, contributing editor

PRODUCTION DEPARTMENT

Ruby M. Yee, production director

Ken Coren, desktop production director

Kathy Campbell, production assistant

Michele Musé, production assistant

ART DEPARTMENT

Andre Duzant, art director

Russell C. Truelson, illustrator

CIRCULATION DEPARTMENT

Gina L. Gallo, circulation manager

Christina M. Estrada, circulation assistant

REPRINT DEPARTMENT

Janine Abitabile, Reprint Bookstore

BUSINESS AND EDITORIAL OFFICES

Gernsback Publications, Inc.

500 Bi-County Blvd

Farmingdale, NY 11735

516-293-3000

Fax: 516-293-3115

President: Larry Steckler

Vice-President: Adria Coren

Vice-President: Ken Coren

**SUBSCRIPTION
CUSTOMER SERVICE/
ORDER ENTRY**

800-827-0383

7:30 AM - 8:30 PM EST

**Advertising Sales Offices
listed on page 80**

Composition by Ma es Graphics

Cover by Loewy Design

VISIT US ON THE INTERNET AT:

www.gernsback.com

Since some of the equipment and circuitry described in POPULAR ELECTRONICS may relate to or be covered by U.S. patents, POPULAR ELECTRONICS disclaims any liability for the infringement of such patents by the making, using, or selling of such equipment or circuitry, and suggests that anyone interested in such projects consult a patent attorney.

EDITORIAL

Making Contact

It's rare that an amateur in a technical hobby can make more of a contribution to science than a professional can—nuclear physics and aerodynamics, for instance, do not exactly lend themselves to home-based experimentation. However, astronomy and certain other sky-watching sciences are disciplines where amateurs make regular, important discoveries. Using optical instruments (telescopes and binoculars), sky explorers in backyards are often the ones to find new comets approaching our solar system. Perhaps more notably, amateurs using radio-astronomy techniques worldwide are getting ready to make the biggest discovery of all time.

Will you be one of them?

As it turns out, the government can't handle the task of searching for intelligent life in our galaxy. Funding even a few large radio telescopes, which can each only focus on a small part of the sky, costs a truly astronomical amount. And because of the partial coverage offered by using only a few of these so-called pro devices, it's highly likely that the "big boys" would miss the call from an ET when it came.

Enter the amateurs. By combining the sky-blanketing power of thousands of home-brewed listening stations, we have the best chance of catching an intelligent signal from outer space. SETI League is an organization coordinating just such an effort, and this month we're proud to present an article describing how you can enlist in the ongoing search. The story, written by SETI League's Executive Director, begins on page 29.

For those who want to experiment with more terrestrial contact, our feature on small FM transmitters is sure to fascinate. It's a collection of easy-to-build circuits spanning the gamut from standard communicators to electronic bugs—turn to page 37 to check it out.

Also, in keeping with our current phase of change and growth, we're proud to present our new *Robotics Workshop* column. Written by a well-recognized author and experimenter in the field, Gordon McComb, the *Workshop* will cover all facets of experimenting with automatons, androids, and artificial intelligence. We've received your letters asking for more robotics coverage and are happy to be able to bring it to you monthly. The column begins on page 64.

The excitement of change continues next month when we kick off another new surprise—a column dedicated to the most cutting-edge, exciting experiments possible with electronics. Look for it whether you need to find a prize-winning science-fair project for the kids or simply want to push our hobby to its limits.

See you next month.



Konstantinos Karagiannis
Editor

FREE INTERNET ACCESS

Sick of paying 20 bucks or so a month to surf the Web? Tired of your local provider and its lack of nationwide access numbers? Whether you want to save money or be able to keep in touch with a portable PC, free, nationwide Internet access may interest you ... possibly fascinate you!

No, we're not talking about those free-e-mail-only accounts. Regular readers of this column might recall that a few months ago we covered them. This month, we're looking at a provider that will hopefully start a trend. In addition to free e-mail service, you get full Internet access. That includes the Web, videoconferencing, you name it.

Well, okay, there is one facet of Net access that's not available through the provider: Usenet newsgroups. However, we'll take a look at how you can still get free Usenet access. See we weren't kidding when we named this month's column.

What's the catch with free Net access? There's always a catch with anything free, right? Don't worry, it's a minor one. Read on to find out how they do it.

NETZERO ARRIVES

Internet access can't be free. Someone has to pay the people who keep a network running, buy and maintain the equipment it's made up of, and handle the fees involved in having the network access the Internet backbone. Normally, these costs are covered through an ISP's monthly fees; twenty dollars times thousands (or hundreds of thousands) of members equals more than enough monthly income to keep a provider running. Of course, there is another way for ISPs to generate the revenue they need ... advertising.

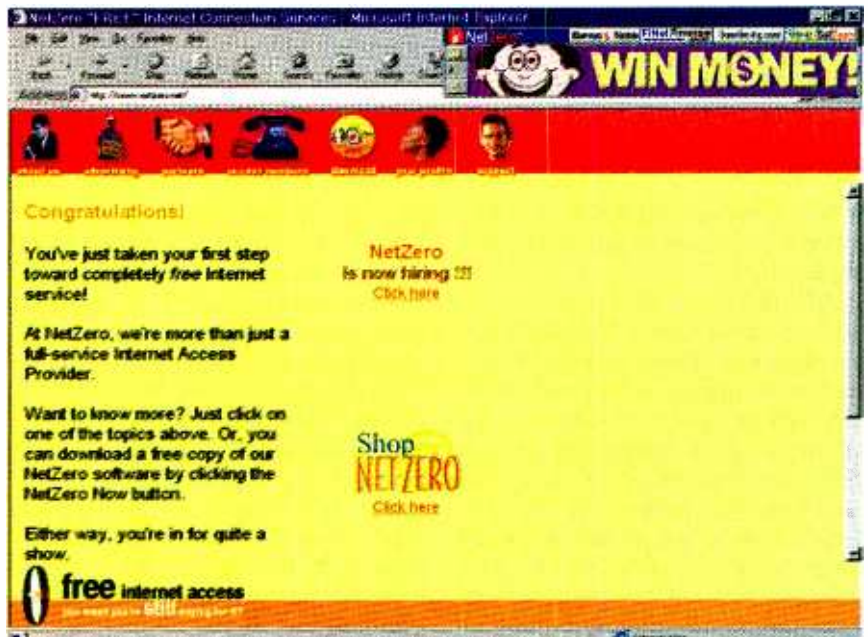

NetZero might just be the company that changes the Internet forever. If you can live with the ad window (shown in the upper right), you can use the Web and e-mail for free.

Enter NetZero, a provider taking just such an approach. By having its members complete profiles that record their interests and demographic data, NetZero can provide advertising that's targeted and of interest to the consumer. This is actually a good thing for all parties. If I had to look at ads for hours, I'd rather they not be for women's clothing or country music, for instance. The advertisers therefore pay to reach only people who are inter-

ested in their products, and NetZero gets to offer a free service. Everyone wins this way.

Those turned off to targeted ads might want to keep the following in mind: broadcast TV and radio are free for precisely the same reason. If you listen to a particular type of station, you fit into a certain demographic. Though they might be off in guessing your age (though not as far off as you'd think), chances are advertisers are getting a few of your interests right, and definitely your geographical location.

If you join NetZero your profile is automatically refined depending on your online behavior; however, don't worry about "Big Brother's watching" paranoia. NetZero doesn't sell any lists

HOT SITES

DejaNews
www.dejanews.com

NetZero
www.netzero.net

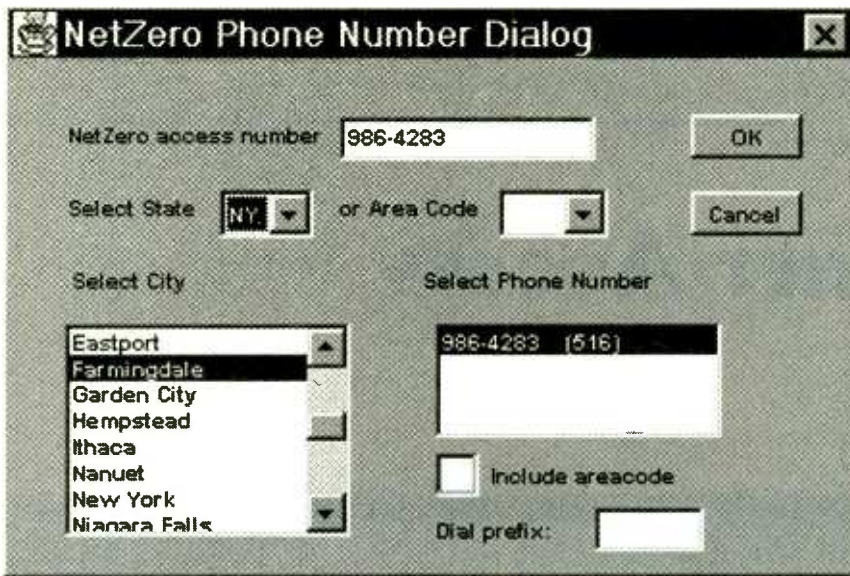

A dialog box lets you choose your local dialup number. You may be surprised by the terrific selection spanning 48 states.

or give away any personal info. Your profile is only used to deliver targeted ads to you.

Whenever you dial into one of NetZero's local access numbers (there are numerous areas and cities covered in 48 states), your e-mail client and Web browser will always turn up "under" a small advertising window called the AdVantage Window. You can't hide the window and you can't close it while online (in fact, any other programs you open, like a word processor, will not cover it)—the ads that rotate in the window are there to stay until you close your connection. You can position AdVantage in the least annoying spot onscreen (the upper right corner usually works for me).

This popup ad window measures about 1 by 3 inches on an 800 × 600 display. The 30-second ads that AdVantage displays are not only targeted, but intelligent in relation to what site you're visiting. Visit a music site, for instance, and an offer from an online music shop may appear.

In exchange for your viewing of these popup ads, you get free, unlimited access to the Web, and an e-mail address. As mentioned earlier, you'll need to find your own Usenet newsgroup access (more on how to do this later).

Before we move on to how you can take advantage of this free service, one more point deserves attention.

4 Free Net access with advertising may

in some ways benefit users. While traditional ISPs make more money when subscribers pay a monthly fee but don't use the service much (*i.e.*, their bandwidth is thereby available for more customers to join), ad-based services like NetZero actually make more money when users are connected. Therefore, count on NetZero to keep strengthening its infrastructure and bandwidth. If you get a busy signal, they're missing out on a moneymaking opportunity. We wouldn't be surprised if free Net access results in better connectivity in future years than what you get with traditional ISPs.

GETTING STARTED

If you're already online, getting a NetZero account is a cinch. Just visit the company's site and download its dialer software package. Those of you who want NetZero to be your first provider, and don't have a friend with online access, can call 888-NETZERO to get a CD with the software plus Microsoft Internet Explorer and Netscape Communicator. Note that downloading is a better option as the CD-ROM has a \$6.95 shipping and handling fee and takes four to six weeks to get to you.

When you run the software, it presents you with a dialog box that lets you enter your state or area code and choose the dialup number closest to you. We found one right in the town that our office is located in.

Then you choose a username and

password—your e-mail account is automatically created as `yourusername@netzero.net`. To access e-mail, you'll have to configure an e-mail client (Outlook, Eudora, whatever) using your account info. NetZero's Web site has support information that should help you if you have trouble with the process.

After you have an account, you need to fill in your personal details including address and phone number, and proceed to fill out the questionnaire. The latter asks you your general interests and basic vitals (marital status, income range, *etc.*). It's surprisingly *not* intrusive. As mentioned, NetZero's software relies more on sites you visit than on data you enter.

Once you're done, you're ready to go. Each time you want to log on you simply click on the NetZero dialer icon, enter your username and password (or set the dialer to remember them for you), and surf for free.

FREE NEWSGROUPS

Usenet newsgroups are wonderful forums where people share information and even post multimedia files. The latter are referred to as *binaries* and make it possible to share with anyone just about any type of file. People post CD-quality music (in .MP3 format), video clips, and even games. As for the text-based newsgroups, you can learn about fixes to computer problems, post questions to like-minded individuals about a hobby, learn about upcoming events, and perform countless other bulletin-board applications.

To get free newsgroup access you have two choices: visit a Web-based Usenet news service or find a free news server. Each has its pros and cons.

We've covered the best Web-based news service in the past, so we'll only briefly recap on it here. DejaNews lets you not only read and post to most of the newsgroups, but even search for posts that might have been made years ago. If your use of newsgroups is to get specific info (*e.g.* how to get a pesky peripheral to work with an old computer program), you'll love DejaNews. It uses your Web browser so there's no newsreader-software interface to learn, and you can get data faster than if you had a regular Usenet account.

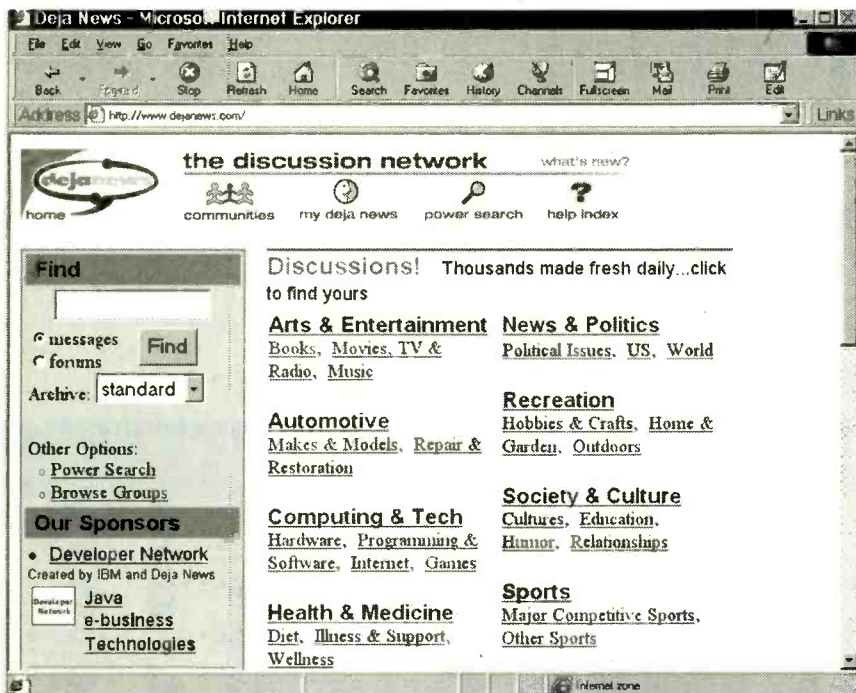

While it may not offer access to binaries, DejaNews grants free, searchable access to most text-based Usenet newsgroups.

Now, for those of you who love illegally posted and in copyright violation, by the way), you'll want to get

access to a free server. Doing so is an exploratory adventure. You have to find a list on the Web of servers that are free, then hope the server hasn't gone out of free service. We won't be listing any server lists here simply because they go out of date so fast. Check with a good search engine for "free Usenet servers" or a similar query. Finding a server is difficult, but when you succeed you might have free access to binary groups. Of course, these files will probably disappear hours after being posted to help keep server space down. As great as free access to Net services is, sometimes you really do get what you pay for. This is definitely the case with free news servers.

And that about does it. We hope NetZero will help some of you take that first step online, or make it possible to cut one more monthly bill for those of you already connected. As usual, send us any questions or comments via snail-mail to **Net Watch**, **Popular Electronics**, 500 Bi-County Blvd., Farmingdale, NY 11735, or e-mail to netwatch@gernsback.com. ■

SENCORE "LITE"

High Quality Test Equipment At Affordable Prices



OSCILLOSCOPE

- 150 MHz CRT readout
- CRT readout of frequency, time, voltage
- 10 on-screen memory settings
- Dual channel
- Built-in component analyzer

\$1,799

• 3-year limited warranty

CALL TODAY
1-800-SENCORE
 or e-mail
sales@sencore.com



PS402 \$529



PS400 \$269 PS401 \$299

DM500 METER

- AC/DC voltage and current
- Resistance to 30 MΩ
- Beep Guard™ Input Protection
- Continuity/Diode Test
- Shockproof
- 1-year limited warranty



\$99

DM501 METER

- True RMS
- AC/DC voltage and current
- Resistance to 30 MΩ
- Data hold
- Water resistant
- Beep Guard™
- Current to 20A (limited)
- 1-year limited warranty



\$199

POWER SUPPLIES

- Low ripple
- Constant current and voltage
- Master slave operation
- 1-year limited warranty

SENCORE
 3200 Sencore Drive Sioux Falls, SD 57107
 1-800-SENCORE • www.sencore.com

CIRCLE 40 ON FREE INFORMATION CARD

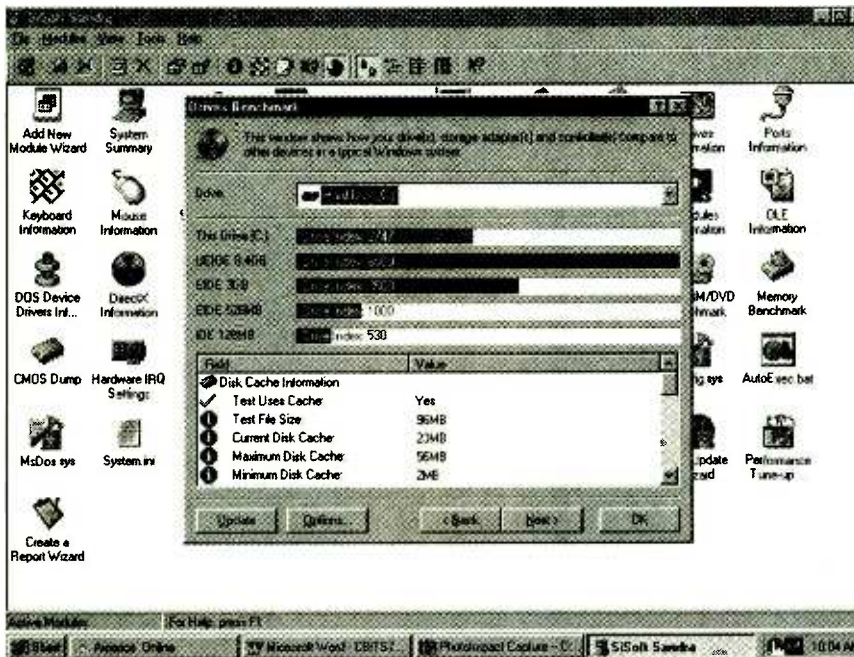

Another benchmark offered in the SANDRA utility is a hard-disk performance test.

ing is to pick a standard of measurement that is both definable and remains constant over the long run.

YOU LOOK TALLER (WIDER?)

One problem I frequently have with computer benchmarks is that they aren't always relevant to what you want to know. Computer benchmarks break down into two broad categories: application benchmarks and synthetic benchmarks. Application benchmarks actually run one or more applications, such as word-processing or graphics programs, perform a set of specified tasks on predefined files, and measure the time it takes to complete these tasks.

If the suite of tasks is relevant to the type of tasks you also perform, then an application benchmark will tell you the real difference in performance between two systems, or the differential produced by an upgrade. There aren't a lot of application benchmarks available to the casual user. The most commonly used application suite is the *SysMark* benchmark, produced in several versions by the non-profit group Bapco. This is not a free or shareware benchmark, though the Windows 3.x version is available for a \$10 handling fee. The version for use on a Windows 95/98 or NT system costs a hundred bucks, and few can cost-justify the purchase of the *SysMark* benchmark

suite. The company's Web site is still an interesting spot to visit.

It's not hard to create your own application benchmark suite. Just look at the applications you use most often. You can use a macro utility, such as the *Windows Recorder* included with Windows 3.x or a commercial version, such as CE Software's *QuicKeys* (you can download a 30-day trial copy at the Web site) to automate the keystrokes needed to run a typical application session. Time the process with a stopwatch (or better yet, by reading and printing the system clock as the first and last operations of the process). This will give you an application benchmark that can even be used on different PCs, just as long as you move all of the relevant files from system to system.

Synthetic benchmarks attempt to emulate an application benchmark by using a mix of instructions that mimic the applications' processes. The majority of benchmarks in use are synthetic, simply because they usually provide a more consistent result, and the benchmark vendor doesn't have to worry about licensing "real" applications to use. The problem with many synthetic benchmarks is that you really don't have a clue as to what they actually measure. For example, Symantec's popular *Norton Utilities* includes a System Information (SI) utility that's frequently used as a bench-

mark. But a single SI score, while convenient, doesn't tell you all that much. The same holds true for popular benchmarks of the past, such as Dhrystones or Whetstones. Both of these are processor performance benchmarks (Whetstones test floating-point performance), but by themselves, they give you only a limited basis of comparison.

So rule number two in benchmarking is to use benchmarks that measure the system attributes that you are interested in and to understand what the benchmarking process is telling you. After all, knowing someone's belt size isn't going to tell you if they will fit in a five-foot-long cot.

PUTTING IT TO THE TEST

Now that we've covered some background, let's take a look at some of the many benchmarks you can download for your own use. Not all of them may be germane to your needs or interests, but many of you will find them all useful.

If you don't download any other program, download *SANDRA*. Despite the funny name, which is an acronym (System ANalyzer, Diagnostic and Reporting Assistant), *SANDRA* is probably the most useful of the bunch. It's not primarily a benchmarking application, though it does contain benchmarks. Rather, *SANDRA* provides in-depth information on the hardware and even operating system processes of your PC. You can find out at what speed the AGP port in your system is operating, check BIOS information, and even determine what type of RAM

WHERE TO FIND IT

QuicKeys for Windows
CE Software, Inc.
www.quickeys.com

SysMark Benchmarks
Bapco
www.bapco.com

Michael's Disk Benchmark
www.softseek.com

SANDRA
SiSoft
www.sissoftware.demon.co.uk/sandra/

3Dmark99 MAX
FutureMark
www.3dmark.com

chips are in each of the system's sockets. The Standard version of *SANDRA* is free for the downloading, as long as you don't make commercial use of it. The Professional version, which adds information about SCSI ports and devices, and network cards, costs a reasonable \$29.

Additionally, *SANDRA* contains a variety of benchmarks. The CPU benchmarks are simply calculations of Dhrystone and Whetstone capabilities, measurements originally developed for mainframe and minicomputers. But they are useful for comparing two systems with different CPUs, different processor speeds, or new CPU

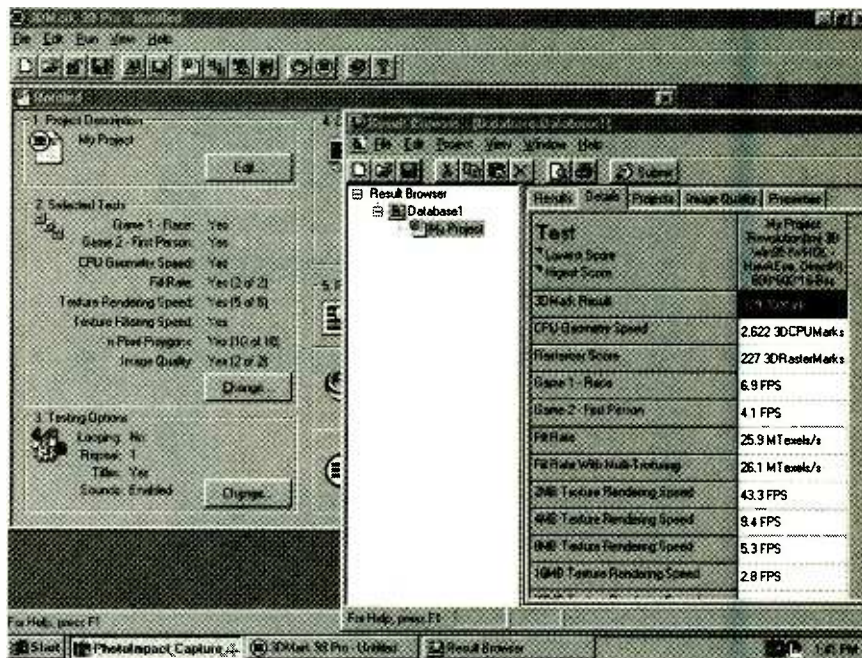

3Dmark99 is one of the most comprehensive video benchmarks available for testing 3D video-card performance.

Accredited B.S. Degree in Computers or Electronics

by studying at Home

Grantham College of Engineering

offers 3 distance education programs:

- B.S.E.T. emphasis in Electronics
- B.S.E.T. emphasis in Computers
- B.S. in Computer Science

NEW! Electronics Workbench Professional 5.0 included in our B.S.E.T. curriculums - Approved by more than 200 Companies, VA and Dantes, (tuition assistance avail.)

For your free catalog of our programs dial

1-800-955-2527

<http://www.grantham.edu>

GCE

Your first step
to help yourself
better your future!



Grantham College of Engineering
34641 Grantham College Road
Slidell, LA 70460-6815

LynX-10

HOME AUTOMATION KIT

- Software Included
- Use Existing Wiring
- Simple Inexpensive

1-800-928-5299 www.marrickltd.com

BUY BONDS

upgrades. Also included are simple benchmarks for measuring the performance of hard drives, CD-ROMs, DVD-ROMs, and memory. Again, these are rather simple tests, and they yield a single number result.

A somewhat more detailed hard-disk benchmark is available from Michael's Disk Benchmark. This application allows you to set the size of the test file to be written and the file type (all zeros, random data, or use a pre-defined test file), and it reports results both with the disk cached and non-cached for sequential and random reads and writes. This isn't the ultimate in hard-disk performance testing, but it does provide a bit more basis for comparison than does *SANDRA*'s hard-disk benchmark. Between these two applications, you can get a good sense of how the components of the PCs under test are behaving.

There's one more program I recommend that you download for your test suite. This is a comprehensive test suite that measures 3D video system performance using the latest DirectX video drivers. Called *3Dmark99*, the "Lite" version is a free download from FutureMark, its vendor. A Pro version, which adds several tests and lets you vary the number of times each component of the suite is run, is also available if you are seriously into benchmarking video cards.

3Dmark99 is a terrific example of what a benchmarking suite should be, with comprehensive tests that include rendering at different texture map sizes, frame rates calculated on two game demos, and even the automatic capturing of screen images generated by the demos, so that they can be compared with reference images supplied with the software. A new version of the suite, which should be available when this appears, will add support for the AMD K6-2 and K6-III's 3DNow! instructions as well as the Pentium III's Katmai instruction extensions. And, best of all, *3Dmark99* includes a terrific "Results Browser," which makes it easy to view the results of multiple test runs side by side. It is a very large program, and does take a long time to download, but it's definitely worth the effort.

I hope this column has gotten you interested in the benchmarking process. Performance metrics are a fascinating area, and while benchmark results often get bandied about, they're much more fun when you can actually perform them and use the information on your own. As always, please feel free to either e-mail me with your comments at tneedleman@aol.com, or send snail-mail to *Computer Bits*, *Popular Electronics*, 500 Bi-County Blvd., Farmingdale, NY 11735.

MULTIMEDIA WATCH

MARC SPIWAK
TECHNICAL EDITOR
COMPUTER RESELLER NEWS

A USB Modem, TRAVEL ACCESSORIES, AND LOTS MORE

I recently came across a wonderful little modem called the *Leopard Pocket USB* from Shark Multimedia. This tiny little external modem takes advantage of Windows 98's support of the Universal Serial Bus, or USB. The Leopard really is small—it measures only 3.5 by 1.5 by .75 inch (HWD)—about the size of a candy bar—and it's molded in see-through teal-blue plastic. One of the best things about the Leopard is that it eliminates cables; well, one at least.

A typical external modem has one cable for power, one that connects to the phone line, and another that connects the modem to the serial port of a PC. The Leopard Pocket USB has just one cable for the phone line and a USB cable that provides power for the modem and a data path to and from the PC.

Like any USB peripheral, you can connect the Leopard Pocket USB modem into a USB port on a notebook or desktop computer while it is turned on, and plug and play takes it from there. If you've wanted to upgrade to a V.90 modem for your desktop computer, and still have a clunker of a PC card modem for your notebook computer, this is one way to upgrade for both. The catch is that both your desktop and notebook computers must have USB ports and Windows 98 or Windows 95 with added USB support. The Leopard draws less than 40 mA, so it's not a big drain on notebook computers.

The Leopard Pocket USB modem comes with software that turns your computer into a call center with password-protected voice-mail boxes with separate greetings. Of course, it sup-

ports faxes up to 14.4 Kbps as well. It costs \$79.95 and comes with a short



The Leopard Pocket USB modem is about the size of a candy bar, and offers V.90 connectivity in a see-through package.

USB cable. If you've been thinking about getting a new modem, and your PC supports USB, then consider Shark's tiny little Leopard.

CASE LOGIC ACCESSORIES

Back in January, I raved about a rugged notebook bag from Tenba. I liked the size and ruggedness of that bag, and also the Velcro straps that secure it to a luggage cart. When I travel on business trips I usually have more stuff to carry than will fit in a typical notebook bag, especially on the trip home. Perhaps somebody at Case Logic read my column and decided to make a bigger bag as well.

Case Logic makes some really nice notebook bags, but they're usually not big enough for me. The new *Galileo NCL-60*, Case Logic's top-of-the-line notebook bag, has a roomier computer compartment than most bags, measuring 15.5 by 11.5 by 3 inches, and it has useful, roomy compartments on both sides as well. Of course, it has

the usual inside eyeglass pockets, folder pockets, zippered pockets, Velcro pockets, penholders, key-chain clip, and more. The bag comes with a zippered organizer pouch that can be stuck with Velcro anywhere inside the bag and a set of Velcro cable ties.

The Galileo notebook bag has a padded leather-wrapped carry handle and comes with a detachable padded shoulder strap. This bag also has a strap sewn on one side that slides over the extendable handle on most wheeled suitcases. I could not get the strap to fit over the handle on my luggage cart, which is admittedly much wider than the handles on my wheeled suitcases. The Galileo NCL-60 costs \$149.99.

Case Logic also makes smaller, lower priced bags for notebook computers, and specialized cases for handheld computers such as Palm Pilots, removable media drives such as Jaz and Zip, digital cameras, regular cameras, camcorders, and so on. I love Case Logic's CDX-72/36 audio CD/CD-ROM holder. This rugged nylon CD case comes in many wild colors. And not only does it hold up to 72 discs, it has card pockets and a zippered mesh pocket inside, and a zippered pocket outside. This will become my emergency software kit for the next Comdex show, where I'll also keep critical business cards, phone numbers, small tools, and other odds and ends. This handy case costs \$24.99. Smaller and larger ones are available.

I've been using one of Case Logic's gel-filled mouse pads for a few years now. It's basically a regular foam-rubber mouse pad with a gel-filled pad

that sticks to it with Velcro. The company also make a similar, longer pad to place in front of keyboards, but it's hard to keep it in place, especially with kids in the house—it makes a great squishy toy to swing around. But Case Logic came up with a new gel-filled keyboard pad that has a rigid plastic base and grippy rubber feet, so it stays put—and it sure is comfortable on the wrists.

Case Logic also designed a similar mouse pad with a gel-filled wrist rest and textured plastic playing field. This is great if you're tired of those curled fabric edges on regular mouse pads. The mouse pad has a molded-in slot to press your mouse cable into so that the mouse doesn't wander away from you all the time. These gel-filled accessories cost less than \$20 each.



Case Logic's top-of-the-line Galileo NCL-60 notebook bag is roomier than most bags, with compartments on both sides of the computer compartment.

PARALLEL-PORT CD REWRITERS

I have two new CD-RW drives this month, both of which connect to the parallel port of a PC. The parallel port and the drivers for it have grown up over the years, and now throughput is up to the point where you can do stuff with them that would have been unthinkable years back. Though SCSI is always my first choice for CD-R and CD-RW, sometimes it's just not convenient to use SCSI. All systems have parallel ports, however.

The CRW-726 from EXP Memory Products can write to CD-R blanks and write and rewrite to CD-RW discs at 2X speed (300 KBps), and read all discs at 6X, all through the parallel port. The CRW-726 CD-RW drive comes with Adaptec's *Easy CD Creator* and *DirectCD* software, and it supports

Micro Solutions makes some of the fastest parallel-port peripherals I've ever seen, and the new *Backpack CD-Rewriter* will write at up to 4X (600 KBps) through a parallel port. You can fill up a disc in about 20 minutes, and the drive reads at 6X speed. The Backpack CD-Rewriter works with desktop and notebook computers, as long as it's a Pentium class or better. Backpack is MPC-2 compliant when connected to an EPP port. This is an easy way to hook up a fast CD-RW drive, and drivers are included for Windows 95, 98, and NT 4.0. A passthrough port lets you print without disconnecting the Backpack. The Backpack CD-Rewriter measures 2.25 by 7 by 11.5 inches and weighs 4 pounds 2 ounces. The Backpack CD-Rewriter comes with Adaptec *DirectCD* and *Easy CD Creator* software and retails for \$399.

NEW HP PRINTER-SCANNERS

Hewlett-Packard is always updating its line of printers and scanners, and now you can get HP's well-known quality in a newly designed laser printer that can be purchased with the option of a built-in scanner. I'm talking about the HP *LaserJet 1100* printer and *LaserJet 1100A* combination printer/scanner. Both produce high quality documents at 8 pages per minute with true laser-quality, 600-dpi resolution, and 2MB standard memory. Memory

can be upgraded up to 18MB. You can print on different types and sizes of paper and other media, including Letter, Legal, and A4 paper to transparencies, envelopes, labels, and more.

The HP LaserJet 1100A enhances the basic printer with copying and scanning capabilities. Optical scan resolution is 300 dpi, which is software-enhanced to 600 dpi. You can make laser copies without the PC turned on, and enlargements, reductions, and multiple copies in conjunction with the PC. All the software you need to transform printed documents into editable text is included with the 1100A. A parallel cable is also included. The LaserJet 1100A is 14.5 by 15.8 by 14.9 inches, and the 1100 is a bit smaller. The LaserJet 1100 costs \$399 and the LaserJet 1100A costs \$499.

I still use an HP LaserJet IIIP that I got in 1990, so I can attest to Hewlett-Packard reliability. I've never had any problems with my IIIP, though on the page-count meter my printer is still a baby—it has printed only 4000 pages. Hell, I haven't even replaced the original toner cartridge, though I do think its end is near.

Due to my job, I can use almost any printer I want, because new ones are always coming in for review. But I can't bring myself to retire the IIIP before it dies a natural death. I'll even buy a genuine HP toner cartridge for it when this one finally does quit. Even though a new HP cartridge probably costs more than the printer is worth now, I'll still give it a new one. I've had the IIIP for nearly a decade, so it's the least I can do.

GIGABYTE GA-630 GRAPHICS ACCELERATOR

If you're looking for a powerful 3D graphics card that's not too expensive, then consider Gigabyte's new GA-630. This graphics accelerator is based on the Voodoo Banshee accelerator chip, which is well-known for fast 3D action in the gaming industry. The card also does 2D acceleration, so you don't need to use it along with a 2D card like some 3D accelerators require. You can get a GA-630 with 16MB of mem-



The CRW-726 can write to CD-R and CD-RW discs at 2X and read discs at 6X, all through the parallel port.

WHERE TO GET IT

Activision

3100 Ocean Park Boulevard
Santa Monica, CA 90405
310-255-2000
www.activision.com

**CIRCLE 60 ON FREE
INFORMATION CARD**

Case Logic, Inc.

6303 Dry Creek Parkway
Longmont, CO 80503
800-925-8111
www.casellogic.com

**CIRCLE 61 ON FREE
INFORMATION CARD**

Electronic Arts

209 Redwood Shores Parkway
Redwood City, CA 94065
650-628-1500
www.ea.com

**CIRCLE 62 ON FREE
INFORMATION CARD**

EXP Computer, Inc.

12-C Mauchly
Irvine, CA 92618
800-EXP-6922
www.expnet.com

**CIRCLE 63 ON FREE
INFORMATION CARD**

Gigabyte Technology, Inc.

17088 Green Drive
City of Industry, CA 91745
www.giga-byte.com

**CIRCLE 64 ON FREE
INFORMATION CARD**

Hasbro Interactive

50 Dunham Road
Beverly, MA 01915
978-921-3700
www.hasbro.com

**CIRCLE 65 ON FREE
INFORMATION CARD**

Hewlett Packard Company

3000 Hanover Street
Palo Alto, CA 94304
800-752-0900
www.hp.com

**CIRCLE 66 ON FREE
INFORMATION CARD**

Humongous Entertainment

13110 NE 177th Place
Suite B101
Woodinville, WA 98072
800-499-8386
www.humongous.com

**CIRCLE 67 ON FREE
INFORMATION CARD**

MicroSolutions

132 W. Lincoln Highway
DeKalb, IL 60115
800-890-7227
www.micro-solutions.com

**CIRCLE 68 ON FREE
INFORMATION CARD**

Shark Multimedia

3040 Oakmead Village Drive
Santa Clara, CA 95051
800-800-3321
www.sharkmm.com

**CIRCLE 69 ON FREE
INFORMATION CARD**

ory for little more than \$100. It really is a terrific bargain. You'll find Gigabyte's Voodoo Banshee based accelerator card in most major computer outlets.

NEW SOFTWARE

Fans of the old Atari game, *Centipede*, will be pleased to learn that Hasbro Interactive has newly released it for the PC, now with two modes of play. The arcade mode is what fans will remember, where you zap the bugs before they get to the bottom of the screen. Of course it has been enhanced with 3D graphics. In the new adventure mode, you fight the bugs face to face in 3D worlds generated onscreen. *Centipede* has a suggested retail price of \$39.95.

Also from Hasbro Interactive comes *Glover*, a glove-shaped hero that saves the day in this game. Seven magic crystals have transformed

themselves into rubber balls and Glover must find them. Balls are used to help solve puzzles and advance through 30 levels. Balls have to be thrown to hit switches and dribbled up stairs in this game filled with action and mystery. Another Hasbro title is *Top Gun: Hornet's Nest*. You're Maverick, the Navy's top gun, piloting an F/A-18 taking on enemies at full afterburner. Intense 3D flying through 30 missions in 3 theaters provides endless hours of air-combat. Easy-to-use controls, weapons, and radar add to the realism. These games cost \$39.95 each.

The HeadGames Extreme Series from Activision brings you one of the most realistic tennis simulators you'll find anywhere, *Extreme Tennis*. This game features tennis playing in the US, England, Australia, or France, with 16 star players from around the world.

There are five match options, and four court surfaces: hardcourt, grass, clay, and synthetic. The graphics make the game, and there's even a virtual pro shop you can visit. *Extreme Tennis* costs \$24.95.

More sports simulation comes from Electronic Arts, in the form of *X Games Pro Boarder*, a snowboarding festival for the PC. Snowboard enthusiasts don't have to leave the comfort of their home to experience the action and the flavor of snowboarding. It costs \$44.95, which is less than a lot of lift tickets. Electronic Arts' *Future Cop: L.A.P.D.* is loaded with shoot-em-up action with futuristic weapons and settings. You must help rid the city of the criminal gangs that have taken over the place. *Future Cop* costs \$19.95. *Moto Racer 2* is a new offering where you can race street or dirt bikes in various settings. You can even set up your own custom track. *Moto Racer 2* costs \$49.95.

My son loves a new game from Humongous Entertainment that features a familiar character: Putt-Putt. In *Putt-Putt Enters the Race*, kids go back to Cartown to enter the Cartown 500 Auto Race. Kids help Putt-Putt find stuff that will turn him into a racing car. I can tell when a game is entertaining and easy to play, because my four-year-old son can run the easy-to-play ones all by himself, and he's busy for hours if it's entertaining. Sometimes he plays *Putt Putt* for hours on end. *Putt-Putt Enters the Race* is \$29.99 well-spent on any child. ■

An Introduction to Light in Electronics

An Introduction to Light in Electronics

F A 92.50*



Taken for granted by us all perhaps, yet this book could not be read without it, light plays such an impressive role in daily life that we may be tempted to consider just how much we understand it. This book makes a good start into this fascinating and enlightening subject. It has been written with the general electronics enthusiast in mind.

To order Book #BP359 send \$6.99 plus \$3.00 for shipping in the U.S. and Canada only to Electronics Technology Today Inc., P.O. Box 240, Massapequa Park, NY 11762-0240. Payment in U.S. funds by U.S. bank check or International Money Order. Please allow 6-8 weeks for delivery.

ET08

GETTING THE MOST FROM ANALOG MODEMS

The Internet is growing up. Web pages are getting more complex and larger multimedia streams are flooding cyberspace. People with standard modem connections are beginning to feel as though they are sucking data through a clogged straw—their 56-Kbps connections simply feel more sluggish than they should.

Under ideal circumstances, 56 Kbps ought to be just enough bandwidth (though, I am aware you can never have enough) for Web surfing. A simple calculation leads us to believe that 56,000 bits of data per second translates into a download rate of 6222 bytes (6.07K) of real data per second (9 bits per byte in this case: 8 bits of data and one stop bit). Not bad, right? Well, then....

WHY THE WAIT?

Speed is affected by almost everything, including the weather. Snow, cold, and rain keep people indoors, which means more people are online, which means that many more people dial into your ISP's telephone line and use its bandwidth and computer time just when you wanted to use it.

When a computer makes a connection with a Web site the data transmitted between the two actually makes several detours, or hops, along the way. Data can be a mouse click, a keystroke, or a large file. It's passed from one computer to the next, then retransmitted to another, and so on, until it reaches its target, for example, a Web page. The response (a new Web page or file download) takes an equally convoluted route back to your PC. While seemingly silly, this *Dynamic Routing* is what makes the Internet so special (think of the

appearance of a spider web when thinking of the Web's dynamics). If part of the system goes down, data simply takes another route there.

Also, data bottlenecks can occur at each of these detours when demand strains processing time and bandwidth to their limits. Perhaps a hot new download at the site you are visiting, the weather, or something unexpected in between is to blame.

With all these possible Net slowdowns, the last thing anyone should have to worry about is something as local as their PC.

MOVING THE DATA

Data throughput is often compared to a volume of liquid through a pipe, but data doesn't actually travel through

the Internet like water through a garden hose. Data is actually broken up into pieces for transmission, and not always sent so continuously as to emulate fluid.

Each piece of data is put in a virtual envelope called the MTU, or Maximum Transmission Unit. In addition to the data, the MTU also contains addressee and addresser information. Like envelopes, MTUs come in sizes. The "paper" or data inside is called the MSS, or Maximum Segment Size. It has to be smaller than the MTU to be carried by it.

The life expectancy of the message is referred to as TTL, or Time To Live. Each hop, each redirection of your data, is a tick mark against its existence. This way, hopelessly

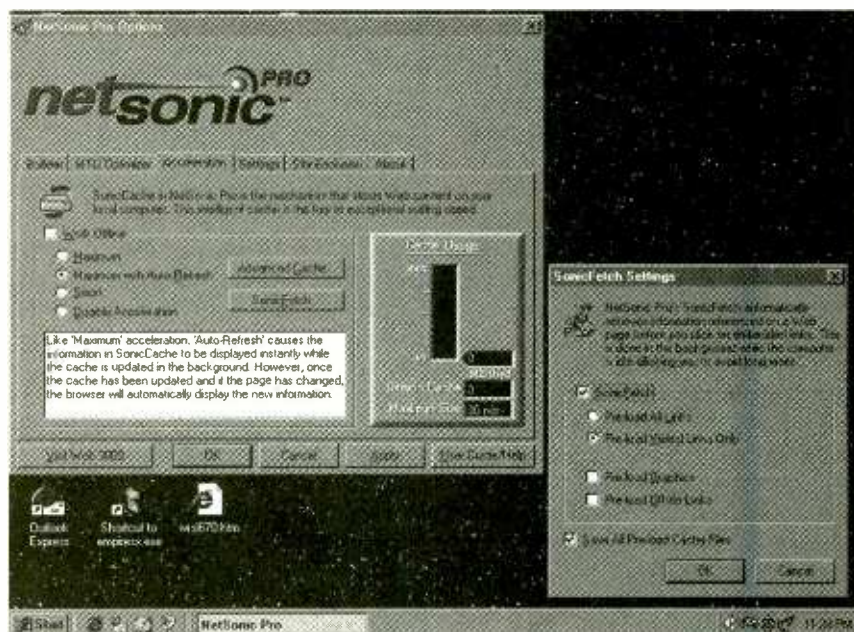

NetSonic Pro caches visited Web pages more efficiently than your browser, making sites spring onto your screen. You can even set it to store pages for offline viewing.

lost data is prevented from taking up space and cluttering the Internet. Unfortunately, as the Net increases in size, so do the number of hops that data might take.

Then there's the mailbox, the RWIN or Receive Window. If it is too small, transmission rates drop. The mailbox must be "emptied" before more is delivered. Error correction is responsible for asking for missing or damaged mail.

A typical MTU setting is usually 1500, which is great for high-speed connections, like an office LAN or ISDN line. However, it's a lousy setting for regular modems, analogous to mailing a dollar in dimes in ten shoeboxes. Sticking to this analogy, still more trouble arises with analog connections.

Consider the RWIN—typically it has space for fewer "shoeboxes" than "envelopes" and must be emptied more frequently. And then, there is the added difficulty that the Internet likes smaller packages, like an MTU of 576, and busts up our ten shoeboxes into 20 or so smaller packages that have to be put back together in just the right way to get you your dollar. If a couple of packages get lost along the way, you have to wait even longer for your dollar. If the dimes had been mailed in the right-sized envelopes to begin with, and to the right sized mailbox, only ten packages would need to be put back together.

A large part of your PC's transmission and receive efficiency depends on these aforementioned settings in Windows 95 and 98. The problem with Win95 is that some of the settings are nearly impossible to find and require very detailed knowledge to change. For example, the MTU setting is buried in the Windows 95 Registry. One mis-step here and you may end up having to reinstall Windows. In Windows 98, the settings can be accessed through the Control Panel in the Network applet. It's hidden in the advanced section of your Dial-Up Adapter properties. Control is limited to four MTU options: Automatic (Windows' best guess), Large (1500), Medium (1000), and Small (576). RWIN settings are automated. The only way, it seems, to deal easily with Windows' settings involves third-party software. We looked at a couple of programs that handle them, as well as products that

boost speed in other ways (more on these in a moment).

POWER TO THE PEOPLE

Before we get to products that tweak transmissions, make sure your modem's as good as it can be. If you have anything less than a 56-Kbps modem or connection, by all means upgrade. You'll love yourself for it. There were some compatibility issues when there were two competing 56K standards (K56Flex vs. x2), but the emergence of the V.90 standard has pretty much put this argument to rest.

Even after you get a 56-Kbps modem (or if you already have one), a lot of usable bandwidth is being wasted. To help take care of that, we looked at four different products that claimed to improve efficiency with Windows 95/98. They were all easy to install and operated using surprisingly simple and clever technologies. How well they work with your system depends on your setup and surfing style.

The cost of these helpers ranges from free to \$49.95. It is almost impossible to gauge improvement concrete-

Get our Freeware version
and you will know
why more and more PC-boards
are designed with EAGLE.



EAGLE 3.5

Schematic Capture • Board Layout
Autorouter

for Windows[®] 95/NT

Windows 95 and Windows NT are registered trademarks of Microsoft Corporation.

EAGLE Professional offers the full EAGLE power. 99 schematic sheets, pc-boards up to 64 x 64 inches, 16 signal layers. With EAGLE Standard you can use 4 signal layers and place components on an area of 6.4 x 4 inches. EAGLE Light is limited to 1 schematic sheet (of any size) and to 2-layer boards. Components can be placed on an area of 4 x 3.2 inches. All other features are equivalent to EAGLE Professional and Standard.

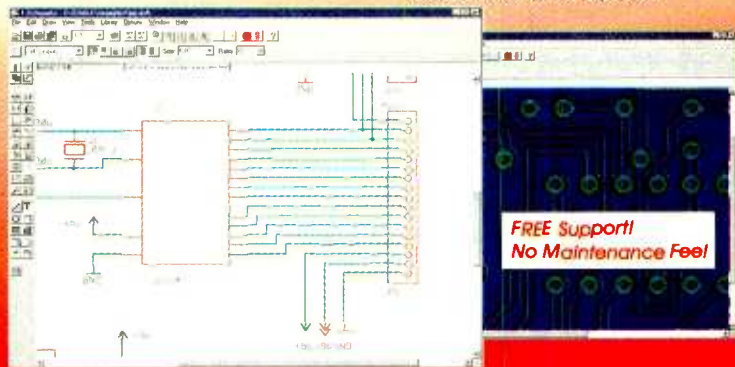

FREE Support!
No Maintenance Fee!

EAGLE 3.5 Light is Freeware!

EAGLE Light is now available free for non-profit and evaluation use! Download it from our Internet Site or order our free CD. Registered users (49 \$ for the complete package) get the commercial license, the reference manual, and free online support.

<http://www.CadSoftUSA.com>

800-858-8355

CadSoft Computer, Inc., 801 S. Federal Highway, Delray Beach, FL 33483
Hotline (561) 274-8355, Fax (561) 274-8218, E-Mail: info@cadsoftusa.com

Prices	Light	Standard	Professional
Layout		199\$	399\$
Layout + Schematic		398\$	798\$
Layout + Autorouter		398\$	798\$
Layout + Schematic + Autorouter	49\$	597\$	1197\$

Pay the difference for Upgrades

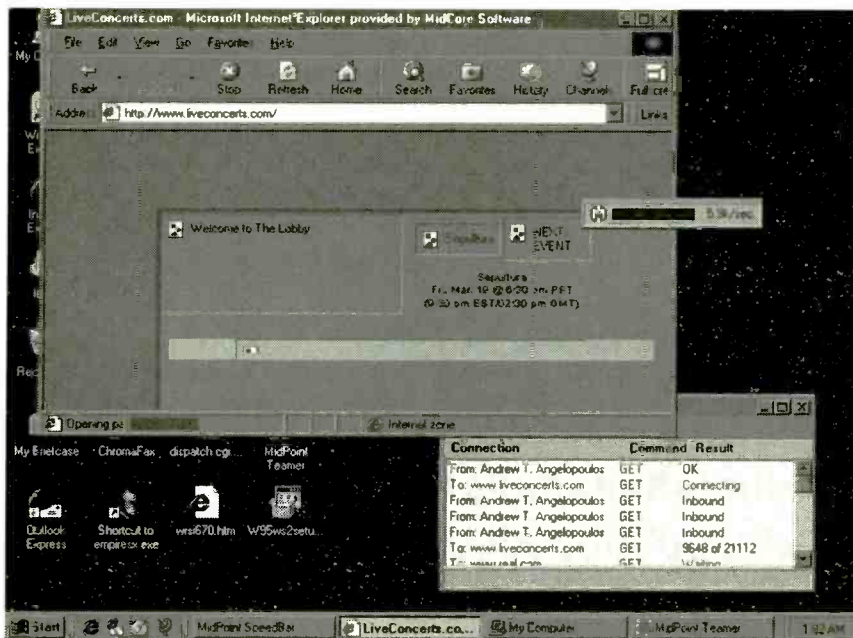

MidPoint Teamer, shown here aiding a download, automatically adjusts your Windows MTU/MSS/RWIN settings and lets you use two modems in one PC, providing faster Net connections. With one modem, the connection shown here reached 5.9K/sec, where 3.5K/sec used to be the norm.

ly, since conditions vary on the Net, but we noticed significant improvement with all.

MODEM SHARK

Very neat and very sweet. This little gadget from CyberBay Digital looks like a telephone wall jack with a short tail. The gadget requires no software—it plugs right into your modem and your phone line goes into

it. Modem Shark filters your phone line from RF frequencies and AC hum. After all, phone companies guarantee only voice-quality lines, not data. The more line noise, the more error-correcting, and the more dropped connections (my personal greatest time waster).

To test the Shark, I connected it to a system that violates every sugges-

tion for a clean phone line (part of the reason for all the dropped connections I just mentioned). The system's connected with an overly long (100-foot) extension to a wall jack with a splitter to accommodate PC, fax, and answering machine. While I didn't really notice an increase in throughput, the prematurely dropped connections virtually disappeared.

The Modem Shark's price of \$24.95 includes postage.

NETSONIC PRO

This great Web3000, Inc. program is part Web accelerator and part Windows system tinkerer. If you are a heavy Web-page surfer, you'll love NetSonic Pro. Like other Web accelerators, it caches visited Web pages more efficiently than your browser and, in fact, replaces its cache. The more you browse, and the more often you return to the same pages, the better off you are. They get painted across your screen so quickly you're actually aware the pages couldn't possibly be coming through your modem.

This one also "fetches." In other words, when you visit a page it can be set to start downloading the data from the links (text, graphics, or both) found on that page. You can also limit it to local links or expand the fetch to include all off-site links. When you finally click over to a link, most of the data may already be there. NetSonic Pro conveniently supports offline viewing of visited pages, including an option to save unviewed, but already fetched, pages for offline use.

NetSonic Pro is great for people who primarily surf. While the full version is \$39.95, you can first try out a free, toned-down version available from Web3000's Web site.

MIDPOINT TEAMER

Without a doubt, MidPoint Teamer is a Cadillac. This MidCore Software program is best used by fast surfers, those who click links before a page is done or heavy down/uploaders. It automatically adjusts your Windows MTU/MSS/RWIN settings (without any real control on the part of the user), but offers a host of other technologies, including the option to use two modems in one PC (depending on your provider, you might need two accounts) for home or LAN use.

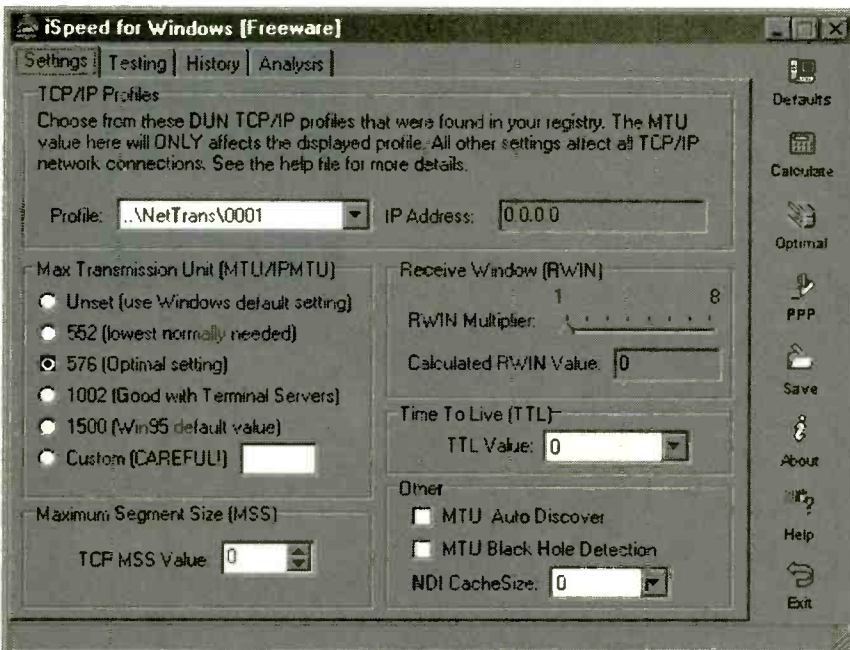

With iSpeed, a freeware program, you can take total control of your computer's MTU/MSS/TTL/RWIN settings. With a little tweaking you should be able to get more optimized Net access.

WHERE TO GET IT

The CyberBay Digital Group
3 Jill Road
Suite 100
Clovis, NM 88101
888-647-0031
www.cyberbay.com

High Mountain Software
P.O. Box 591
Pine, CO 80470-0591
www.hms.com

MidCore Software, Inc.
900 Straits Turnpike
Middlebury, CT 06762
800-673-6274
www.midcore.com

Web3000, Inc.
7525 166th Avenue NE
Suite D-230
Redmond, WA 98052
415-836-3000
www.web3000.com

Another really neat feature is its FailSafe Downloads. If the server you are downloading from supports the Transfer Restart protocol, lost connections are nothing to sweat. Teamer stores the part of the file it has already downloaded, restores the connection, and picks up from where it left off. It works with call waiting, too. Fantastic for the individual or small office and worth the \$49.95 cost.

ISPEED

This little freeware application from High Mountain Software paradoxically does the most and the least while costing nothing at all. No bells or whistles with iSpeed, but it does offer the most control of MTU/MSS/TTL/RWIN settings, allowing individual tweaking of each. There are optimization guidelines in the help file and an auto-configure option, but it is left to users to investigate their connections and determine which settings best work with their machines. To help ease this task, you can save different configurations and use a chart to compare their performance. Advanced users will love the control it gives them. Novice users can get their feet wet and still feel confident that they can undo mistakes and improve performance.

And hey, iSpeed is a free download. You've got nothing to lose by giving it a try.

Electronics CD ROMs

Want to improve your design skills?

Then you should consider our range of CD ROMs by best-selling author Mike Tooley.

Electronic Circuits and Components provides a sound introduction to the principles and applications of the most common types of electronic components and how they are used to form complete circuits. Sections on the disc include: fundamental electronic theory, active components, passive components, analog circuits and digital circuits. Includes circuits and assignments for Electronics Workbench.

The Parts Gallery has been designed to overcome the problem of component and symbol recognition. The CD ROM will help students recognize common electronic components and their corresponding symbols in circuit diagrams. Quizzes are included. The Parts Gallery is free with Electronic Circuits and Components.

Digital Electronics details the principles and practice of digital electronics, including logic gates, combinational and sequential logic circuits, clocks, counters, shift registers, and displays. The CD ROM also provides an introduction to microprocessor-based systems. Includes circuits and assignments for Electronics Workbench.

Analog Electronics is a complete learning resource for this most difficult subject. The CD ROM includes the usual wealth of virtual laboratories as well as an electronic circuit simulator with over 50 pre-designed analog circuits, which gives you the ultimate learning tool. The CD ROM provides comprehensive coverage of analog fundamentals, transistor circuit design, op-amps, filters, oscillators, and other analog systems.

"...hammers home the concepts in a way that no textbook ever could." Electronics Australia

Interested in programming PIC micros?

We have the perfect solution:

Our PICtutor CD ROM can teach you how to write assembly language programs for the PIC series of microcontrollers. The CD ROM's 39 tutorial sections will guide you from basic PIC architecture, commands, and programming techniques up to advanced concepts such as watchdog timers, interrupts, sleep modes, and EEPROM data memory use. Over 80 exercises and challenges are provided to test your understanding, and the unique Virtual PIC allows you to write and test programs on-screen.

The complementary development kit includes a reprogrammable PIC16C84, which you can program via your printer port. The institution version (designed for use in schools, colleges and industry) includes a quad 7-segment LED display and alphanumeric LCD display. The development kit provides an excellent platform for both learning PIC programming and for further project/development work. Assembler and send (via printer port) software is included on the CD ROM.

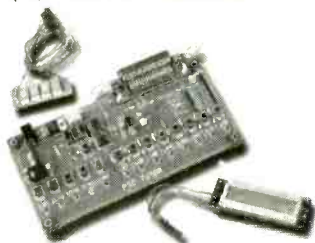

development board (institution version)

Prices and Versions

Institution versions are suitable for use in schools, colleges and industry. Student versions are for student/home use.

	student version	institution version
Electronic Circuits & Components	\$56	\$159
Digital Electronics	\$75	\$189
Analog Electronics	\$75	\$189
PICtutor (CD and development board)	\$179	\$350

Shipping costs to Canada an additional \$5. Overseas orders please contact CLAGGK Inc. for shipping costs.

see <http://www.MatrixMultimedia.co.uk> for full specs and demos

Please circle the products you would like to buy on the table above right, calculate the total cost, fill in the form below and send it to us. Please allow 4 - 6 weeks for delivery.

Name: _____

Address: _____

Zip: _____ Telephone: _____

I have enclosed my check for \$: _____

Signature: _____

Please charge my credit card for \$: _____

Number: _____

Note that the delivery address and the address at which the card is registered must be the same

<input type="checkbox"/>	<input type="checkbox"/>	<input type="checkbox"/>	<input type="checkbox"/>	<input type="checkbox"/>	<input type="checkbox"/>	<input type="checkbox"/>	<input type="checkbox"/>
--------------------------	--------------------------	--------------------------	--------------------------	--------------------------	--------------------------	--------------------------	--------------------------

Card type: _____

Expire date: _____

Mastercard, Visa, or Discover only

CL02

Order Form



Claggk Inc., PO Box 4099, Farmingdale, NY 11735-0792
Tel: 516-293-3751 email claggk@poptronix.com

produced by
matrix
multimedia

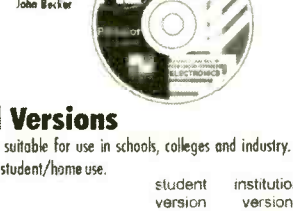
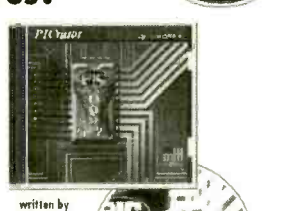
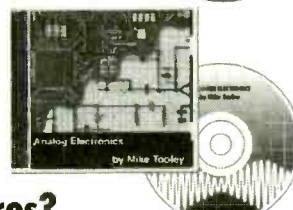
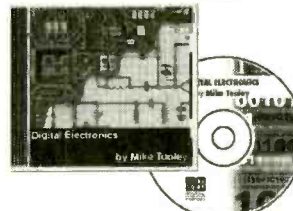
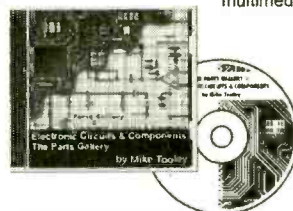

LETTERS

CHANGE OF ADDRESS

It has come to our attention that the wrong address was picked up for Optiquest (*New Products*, June 1999). The correct address is 381 Briar Canyon Road.

—Editor

ELECTROLYTIC METER CORRECTIONS

There is an error in the schematic in my article: "Electrolytic Meter" (*Popular Electronics*, May 1999). The wire attached between R16 and R17 should be connected to the base of Q10 (PN2907) instead of the emitter of Q10. Resistors R16 and R17 form a voltage divider between +5V and ground, giving +4.5V to the base of Q10. This voltage is used by Q10 to clamp the output on the emitter to +5.5V.

On page 43, paragraph 3, the text states that R11 is a 10k potentiometer; it is actually 20k. It is correct in the Parts List. Also, I listed R1 incorrectly in the Parts List as ¼ watt; R1 should be ½ watt.

Eugene W. Vahle, Jr.
Quincy, IL

SEMICONDUCTOR TESTER UPDATES

I noticed that a few errors crept into my article: "Semiconductor Tester" (*Popular Electronics*, May 1999). In Fig. 1, the resistors are missing from current-range switch S7. The value for R39 is incorrect in Fig. 2; it should be 4.99K, not 41.99K. On page 33, paragraph 4, diode D18 should actually read D17.

Table 1 has the step polarity for the JFETs reversed. N-channel requires - polarity and P-channel requires + polarity. Lastly, in the Parts List, the value for R39 should be 4990 ohms, not 4199 ohms (to match the correction I just made to Fig. 2).

Your staff did an excellent job with all the complicated artwork. I'm amazed how small they can make the schematics and still have them come out legible.

Charles Hansen
Tinton Falls, NJ

HAVES & NEEDS

I'm in need of a high-voltage multiplier block for an HP Model 1706A oscilloscope and a schematic for a Ramsey Model 2200 oscilloscope.

Thanks for your help.
Stan Bogovich
c/o Audio Video King
820 N. Beach St.
Daytona Beach, FL 32114

I am looking for a low-cost circuit that would be able to step up 12 volts

KEEP IN TOUCH

We appreciate letters from our readers. Comments, suggestions, questions, bouquets, or brickbats ... we want to hear from you and find out what you like and what you dislike. If there are projects you want to see or articles you want to submit—we want to hear from you. And now there are more ways than ever to contact us at **Popular Electronics**.

You can write via snail mail to:

Letters
Popular Electronics
500 Bi-County Blvd.
Farmingdale, NY 11735

Please note the above address is the snail-mail way to get the quickest response. Some readers send letters to our subscription address, and although the mail is forwarded to our editorial offices, it does increase the time it takes to answer or publish your letters.

Send e-mail to:

peeditor@gernsback.com

Of course e-mail is fast. Check the end of your favorite columns, too. Many of them list individual e-mail addresses for their respective authors.

And don't forget to visit our Web site: www.gernsback.com

DC to 120 volts AC 60 Hz at about 10–15 amps.

I have a friend who is in the battery business, and we have many used 12-volt sealed lead-acid batteries that we would like to use as a 120-volt AC source during power outages. The amperage draw on the batteries is no problem for us.

Also could anyone figure out how many amps (from the batteries) I would need to run 10 amps (AC) for two hours?

Please send me any designs or tips. Thanks for your help.

Josh Sponenberg
3553 First Street
Bloomsburg, PA 17815-3303
e-mail: dolphin@sunlink.net

I have been a reader of **Popular Electronics** since its beginning, and I congratulate you for a great and helpful magazine.

I am in need of plans to adapt a single-trace Heathkit scope for use in displaying the firing patterns of 4-, 6-, and 8-cylinder auto ignitions. I know this has to be some type of inductive pickup, but I am not certain how to go about constructing one.

Any help would be greatly appreciated.

Marcel E. Faust
2731 E. 35th Street Terrace
Kansas City, MO 64128

Help! I desperately need a schematic, assembly manual, or even model number, for the Allied Radio (of Chicago) "Knight-Kit" 20-watt, "hi-fidelity," "ultra-linear" amplifier sold in their catalog, circa 1957–60, or a copy of the catalog in which it was featured. I would even happily pay for a copy of the page in that catalog that shows that amplifier.

Is there a source for the "Knight-Kit" literature or for the Allied Radio catalogs?

Thanks for any help.
F. Nelson Farnsley
7320 W. Cinnabar
Peoria, AZ 85345

ELECTRONICS LIBRARY

AVR RISC MICROCONTROLLER HANDBOOK

by Dr. Claus Kuhnel

This comprehensive guide to designing with Atmel's new controller family, which offers high speed and low power consumption at a low cost, is the only book currently available on the subject. It is a practical handbook for advanced hobbyists or design professionals.

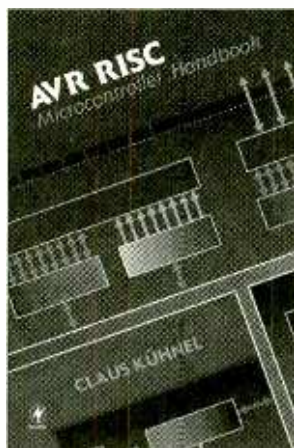

The text is divided into three sections: hardware covers all internal peripherals, software covers programming and the instruction set, and tools explains using Atmel's Assembler and Simulator (available on the Web) as well as IAR's C compiler.

AVR RISC Microcontroller Handbook costs \$34.95 and is published by Newnes, Butterworth Heinemann, 225 Wildwood Avenue, Woburn, MA 01801; Tel. 781-904-2500 or 800-366-2665; Fax: 800-446-6250 or 781-904-2620; Web: www.bh.com/newnes.

CIRCLE 90 ON FREE INFORMATION CARD

SILICON SKY: HOW ONE SMALL START-UP WENT OVER THE TOP TO BEAT THE BIG BOYS INTO SATELLITE HEAVEN

by Gary Dorsey

For more than a decade, some of the world's most powerful defense compa-

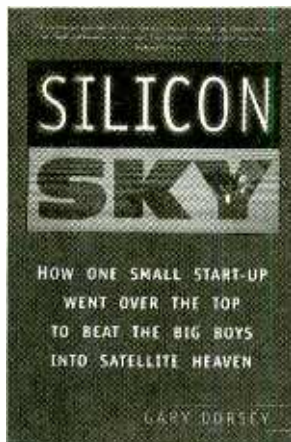

nies have raced to launch the first low-earth-orbit commercial satellites. The prize? An explosive global market for personal communications worth billions of dollars.

This is the story of David Thompson, who started out with a crazy idea: to build his own rockets, satellites, and a multi-million-dollar corporation. It reads like a fast-paced novel, but it's a true story that traces the advent not just of a single company but an emerging technological industry.

Silicon Sky costs \$26 and is published by Perseus Books, 1 Jacob Way, Reading, MA 01867; Tel. 781-944-3700; Fax: 781-944-8243.

CIRCLE 91 ON FREE INFORMATION CARD

FIBER OPTICS AND THE TELECOMMUNICATIONS EXPLOSION

by Norma Thorsen

In this book, fiber optics is explained in language that everyone can understand. Readers learn how fiber optics works and how fiber networks are constructed. The author also discusses how fiber technology and the

BooksNow

To order books in this magazine or any book in print. Please call anytime day or night: (800) BOOKS-NOW (266-5766) or (801) 261-1187 ask for ext. 1456 or visit on the web at <http://www.BooksNow.com/popularelectronics.htm>.

Free catalogs are *not* available.

Telecommunications Act of 1996 changed the telecommunications industry.

In addition, the book examines all the applications that fiber makes pos-

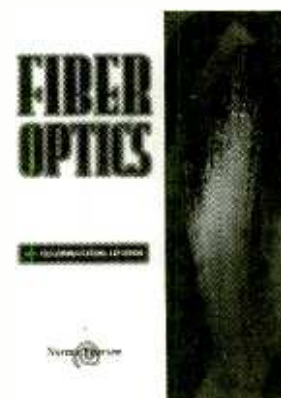

sible—including video-on-demand, telemedicine, videoconferencing, telecommuting, remote education, CAD/CAM, robotic surgery, home security, "smart houses," multiplayer games, virtual reality, and more.

Fiber Optics and the Telecommunications Explosion costs \$49.99 and is published by Prentice-Hall, One Lake Street, Upper Saddle River, NJ 07458; Tel. 800-811-0912; Web: www.phptr.com.

CIRCLE 92 ON FREE INFORMATION CARD

BEYOND VAN ECK TEMPEST

by John J. Williams

The author describes in detail how to eavesdrop on computer and TV CRT video signals using an ordinary TV and a specially designed sync circuit, with ranges up to 1 km. Among the topics covered are electromagnetic interference, video-signal components, receivers, and Van Eck displays.

Beyond Van Eck Tempest costs \$29 and is published by Consumertronics, P.O. Box 23097, Albuquerque, NM 87192; Tel. 505-237-2073; Fax: 505-292-4078; Web: www.tsc-global.com.

CIRCLE 93 ON FREE INFORMATION CARD

(Continued on page 78)

GIZMO®

Internet Screen Phone

InfoGear Technology's *iPhone* (\$299) is an integrated telephone and Internet-access device. In addition to the standard phone handset, keypad, and speakerphone, it features a touch-screen interface, a pull-out keyboard, and built-in software that allows you to send and receive e-mail, find information on the Internet, and conduct e-commerce transactions.

The Version 1.3 software upgrade, now available free to all registered *iPhone* users, offers expanded e-mail support for four users or accounts, enlarged font size for easier reading, and "persistent cookies" for faster customized interaction with personalized Web sites.

(Cookies are the technical mechanisms that enable a server to "remember" a user

and his preferences.) Having a persistent (i.e., permanent) cookie means that when you log into a frequently visited site, such as Amazon.com, the *iPhone* browser will remember your information and password, so that you won't have to re-enter it.

"Smart" Digital Camera

The Olympus *D-340R* is a point-and-shoot digital camera with an entry-level price of \$499 but with

features and picture quality for which you'd expect to pay more. The camera has a maximum resolution of 1280 × 960 and offers an uncompressed TIFF recording mode for maximum-quality images. It also offers an all-glass lens system and a 1.3-megapixel CCD, a burst mode of 10 shots in 1/2-second intervals for sequence shooting, a four-mode intelligent flash system, and 2X digital telephoto mode. Video output allows images to be viewed on a standard TV set or transferred to videotape. The camera comes with a video cable and a serial cable for connection to a Mac or PC.

The filmless camera stores photos on SmartMedia cards, and stored images can be directly transferred to a PC or Mac using an optional "FlashPath" floppy-disk adapter. SmartMedia cards are available in 2, 4, 8, and 16MB versions. Storage capacity ranges from nine shots with 1280 × 960 resolution on a 2MB card (or one uncompressed TIFF image) to 240 images with 640 × 480 resolution on a 16MB card.

Mobile "Home" Theater

You've already got your home rigged up with a state-of-the-art home theater—now, what about your car? One of the fastest growing categories of automotive options is mobile theater, represented here by the Audiovox *Prestige PAV-1* (\$1100). The double-DIN head

unit includes an AM/FM radio with full-logic cassette player, CD-changer controller, and a five-inch color TFT LCD screen for video viewing. The *PAV-1* features a motorized tilt front panel, and comes with a credit-card style remote control.

Two A/V line inputs and one output are provided. The car stereo outputs 25 watts each into 4 channels and offers electronic bass, treble, volume, balance, and fader controls.

Family Communicator

How can you keep in touch with family members at Disney World when your wife takes the little ones to "It's a Small World" and you bring the older kids down the Matterhorn slide? When you split up at the mall and everyone's heading to a favorite shop, food court, or arcade? When you're taking a bike trip and not everyone pedals at the same speed?

The Family Radio Service (FRS) offers a simple, inexpensive way to communicate with each other via two-way radios. FRS radios operate at an ultra-high FM frequency and require no tests or licenses. The first FRS units to carry the GE brand are the bright-blue model *GE 3-5873* and the light orange model *GE 3-5877* (\$69.99 each) from Thomson Consumer Electronics. The small, colorful two-way radios, which operate on three AA batteries, provide clear



reception for up to two miles. They have 14-channel electronic tuning and feature a two-way page function that can be set to communicate with other GE radios or with competing brands of FRS.

Flat TV

Samsung is adding *Pure Flat Progressive Scan* sets to its Tantus line of high-end televisions. Shown here is the 27-inch *TSJ2799* (\$1699), said to deliver 900 lines of resolution without the distortion of a standard CRT set. The *Pure Flat TV* features a progressive-scan system that doubles the scanning lines to produce a picture with impressive depth, vivid colors, and no flicker. A PC VGA input is included, allowing the set to be used as a computer display as well as a video monitor.

The *Pure Flat* set boasts "Dynamic Multiple Focus," which focuses the image evenly from corner to corner, and not just in the center of the screen. Two-tuner picture-in-picture allows you to watch two broadcast shows simultaneously. A built-in four-speaker sound system with 12.5 watts of audio output per channel and Dolby Surround Pro Logic rounds out the home-theater system with high-quality sound.

Monitor Magnifier

What can you do to combat the eyestrain associated with long hours spent in front of a computer? Bausch & Lomb's *PC Magni-Viewer* (\$295) is one solution. The device magnifies

onscreen information 175%, offers multiple adjustments for customized viewing, and allows PC users to position themselves in an ergonomically correct work posture.

The magnification system features a 19.5 × 15-inch rotating base that sits under any 13-, 15-, or 17-inch monitor; an adjustable swivel-arm that extends over the top of the monitor; and an adjustable 6 × 8-inch acrylic optical lens. The image viewed through the device looks as if it is 30 to 60 inches away from the user (depending on placement). That reduces the need for near focusing, which is harder on the eyes than repetitive focusing from farther away.

Besides easing eyestrain, the *Magni-Viewer* allows writers to fit more words on a page, layout artists to view full pages and still read the text, finance professionals to add more columns and rows to a spread-sheet, and engineers to enlarge schematics or block diagrams.

Serving Up A Big Dish-Full

Are you one of those people who—on principle or for lack of local service—never went the cable-TV route? Did you install, way back when, one of those great big satellite dishes that used to provide virtually unlimited free programming, unparalleled picture quality, and the thrill of hunting down those entertaining wild feeds?

It was great while it lasted, wasn't it?

Then came scrambling and sub-

scription services, and you could no longer laugh quite so loudly at your friends who were paying for cable. Next came digital satellite television, and you began to wonder just who had the best deal in town, as

your favorite C-band channels began switching to digital transmissions, and those small dishes began cropping up all over town.

Well, perhaps you can get the last laugh after all.



General Instrument's *4DTV* digital satellite receiver (\$1200) brings your full-size, C-/Ku-band dish into the digital age.

It allows big-dish owners to watch four different types of satellite signals: "in-the-clear" analog signals (the free stuff), VideoCipher-encoded analog subscription channels (with an add-on VideoCipher descrambler), free digital channels, and encrypted subscription digital broadcasts.

With *4DTV*, it's almost like the good ol' days, just more expensive. You won't get HBO or MSG for free—but neither do cable or DIRECTV subscribers. *4DTV* allows you much more flexibility in program purchases than either cable or small-dish satellite providers. You're not obligated to accept a bundle of stations if you want to receive a premium movie or sports channel; you can order just what you want a la carte—and you can shop around for the best price. So, although your initial cash outlay is large (the *4DTV* receiver's street price is about \$900), you get more for your programming money.

And you'll still be able to get those wild feeds—even more of them than before, in fact. Your friends with small dishes never get to eavesdrop on sportscasters' conversations during commercial breaks, or watch *The X Files*, commercial free, on Sunday morning (14 hours before its network air time). You get the same first-



generation studio-quality analog and digital signals that professional broadcasters receive.

Programming might not be unlimited, but it sure seemed that way to us. We couldn't count the number of channels we received during the review period (when GI activated virtually all channels for us), but we estimate it to be well over 500 video channels and more than 150 stereo audio channels (though not all were available 24 hours a day). Even after all the subscription

channels had been deactivated, there was still plenty to watch—the beauty of big-dish satellite TV.

The sheer quantity of available programming demands a comprehensive onscreen guide, and 4DTV supplies one that is also easy to use. The interactive program guide contains information about a week's worth of programming. Updated data is downloaded each night, while the 4DTV's power is turned off.

You can scroll through the entire guide, calling up information about any program that interests you. Of course, you won't have much time left for actually watching anything if you try to tackle the entire guide. Instead, you can customize the guide by creating favorite-channel lists. You can also opt to see listings by category, such as movies, sports, music, news, education, pay-per-view, etc. You can press a button to display the program title, rating, satellite and channel name and number, start and finish time, and current time. A Mini-Guide appears as a small box, allowing you to watch a show while you access program information.

One of the problems that's long plagued satellite viewers is that providers often move programs to different satellites or transponders. You'll go to tune in a favorite show at its usual place and time, and it's simply disappeared. 4DTV solves that problem by automatically tracking your favorite programs to their new locations.

nience features, including parental control with password protection, instant pay-per-view by ordering movies at the touch of a button, and program timers that you can set to automatically tune to a certain channel at any time. The included remote control can be programmed to operate your TV and VCR as well as the satellite receiver. The remote uses both infrared and UHF technologies, allowing it to operate the 4DTV receiver from anywhere in the house.



The satellite receiver is equipped with high-speed data ports for inter-

facing it to a computer or peripheral device. A high-speed "multimedia access port" is capable, theoretically, of outputting high-definition television information when available. Unfortunately—particularly with the vast number of digitally transmitted movies and digital music channels available—no digital audio output is provided on the 4DTV receiver. Dolby Digital audio-encoded material can be played as stereo or decoded by a Dolby Pro Logic processor for four-channel surround sound.

4DTV is a couch potato's dream come true. There is simply so much to watch that you can spend your entire life (or at least whole weekends) glued to the tube, just flipping through channels and from satellite to satellite. And having someone else keep track of satellite and channel changes is much easier than doing it yourself.

If you're the type of person who loves "video DXing" you'll be in heaven, even though the 4DTV takes a little too long to hook onto channels and its reception characteristics—such as audio and video bandwidth—can't be manipulated as much as we'd like. Nevertheless, we had plenty of fun tracking down news feeds, including some great footage from Mardi Gras. And you can't really claim to be Monica-ed out until you've watched the countless news feeds we have!

For those family members who prefer to watch particular shows at specific times, we'd recommend setting up Favorite Channels on the programming guide. That will let them easily access the programs they want to see, without subjecting them to the wild feeds and weird shows that make big-dish satellite TV so appealing to true believers.

4DTV is a one-of-a-kind product that provides the best of both worlds—subscription and free stuff—in digital and analog transmissions. It puts your big satellite dish way ahead of the mini-dish pack, and provides you the best picture quality and program choices available today and into the future. But if you're not bitten by the video bug, and you just want a system that will let your kid watch Nickelodeon and you watch CNN, then you might as well stick with cable or get a little dish—you just don't appreciate the finer points of TV!

A/V: Here, There, And Everywhere

There we were, two hours into our annual Super Bowl party. As usual, we'd set a projector and 10-foot screen up in our living room (which is much too small for such equipment unless it's Super Bowl or World Series time). The lights were dimmed, the surround-sound system tweaked, and we'd found a brilliantly clear satellite feed. Just in case anyone had to leave the room for some hot food or cold beer, we also had the game on in the kitchen and the "family" (play) room.

We'd finally made it through all the pre-game blabber and settled in for some serious football, when the under-7 set (who, unfortunately, outnumbered the adults) decided they were finished playing with every toy in our house (including all the new ones from Santa) and needed to watch a video. They couldn't all fit in the kitchen to watch the 13-inch TV/VCR, and the playroom was temporarily VCR-less. There was no way we were going to relinquish our big-screen game to *The Land Before Time VI*, but a dozen bored kids were

becoming a major distraction.

How lucky for us that we'd just gotten Terk's *Leapfrog HomeNetwork* (\$179.95) in for review. Leapfrog uses existing phone lines and jacks to transmit audio and video signals from sources in one room to TVs or PCs in another.

It isn't fair to test review units "under fire," but we must admit that Leapfrog rose to the occasion. It took just a few minutes (in football time) to get the device connected to the living room VCR and send the signal to

the playroom TV. Voila! We had contented kids and happy football fans for the duration of the movie.

The next day, we took a closer look. Leapfrog consists of two small ($6 \times 6 \times 2\text{-}\frac{1}{2}$ -inch) units—a transmitter and a receiver—that look almost identical. While both units have 15-VDC-power, phone-in, and line-out ports, the transmitter adds an IR input for remote control signals and the receiver has an IR window. Both units have stereo-left and -right jacks and composite-video inputs; the transmitter has a second set of loop-through outputs as well.

Also included in the package are three A/V cables for connecting the Leapfrog to your gear, two 15-VDC power adapters, two phone wires for connecting the transmitter and receiver to phone jacks, and an IR emitter. Hookup is really pretty simple. The transmitter is connected to the source—say, a satellite receiver or VCR. It's also connected to a phone line (a pass-through phone jack is provided on the rear panel). The receiver is connected to a remote TV (through its A/V inputs) and plugged into a phone line (a pass-through connector is also provided on the receiver). Our hookup was simplified by the fact that we've installed phone jacks everywhere we have A/V equipment (and more), including in our office in a detached garage about

50 feet behind the house.

Leapfrog HomeNetwork transmits analog signals through the twisted-pair telephone wiring that's already in place in every home. It claims an effective range of more than 500 feet, which should be sufficient for all but the largest mansions.



are susceptible to interference from other RF sources, and AC power lines are plagued by noise and interference from outside sources as well as "spikes" caused by the generation of alternating current.

Telephone wiring, on the other hand, is engineered for optimum transfer of low-voltage signals. You might think of phone lines as being too "slow" for video transmissions. But it's not the lines themselves that limit the speed of our modems, it's the switching equipment at the phone company that's the problem. In addition, HomeNetwork uses differential amplifier circuitry, which means that only those signals (carried by two signal conductors) that are different from one another are amplified. Because noise signals are identical in both wires of a twisted pair, they are blocked from the system and remain unamplified.

It sounds good on paper, but we were a bit skeptical about Leapfrog's real-life capabilities. Our phone lines are anything but quiet, and we worried that the noise would affect the HomeNetwork's performance.

We worried needlessly. Our first test came the day following our Super Bowl bash, leaving the Leapfrog setup the same as the night before. Once again, the source material was a kid's movie, played through our living room VCR and transmitted to the

Terk opted to design a system that uses phone wiring to avoid the problems inherent in transmission systems that use RF or AC power lines. RF broadcast-based systems

family-room TV. There was no noticeable difference in picture quality between the transmitted signal and the image displayed on the living-room TV.

This time, we also put Leapfrog's remote-remote control capability to the test. The device allows you to control the source device from the remote location. The original remote control can be aimed at the IR window on the Leapfrog receiver, and its commands will be transmitted through the phone lines and back to the source component. We were able to fast-forward conveniently through the opening commercials from the family room.

HomeNetwork's patented technology allows users to maintain full control of source components throughout the home by adding multiple receivers to the system. The system can be operated remotely from anywhere in the house, allowing you to pause a movie without having to leave the room in which you're watching it, for instance.

Next, we tried using it to transmit satellite signals to other rooms in the house. The results were slightly less impressive. There was some video degradation visible—but certainly not enough to ruin our son's enjoyment of viewing *Rugrats* in the comfort of "his" family room (which doubles as the playroom)—or our enjoyment of a DVD film in the living room while he was otherwise occupied.

The signal was not quite up to our digital standards. However, the Leapfrog's purpose is not to provide a signal to a home-theater, but to transmit a signal from that (digital or other) source to other rooms in the house. And that it does very well. Terk's Leapfrog HomeNetwork is probably the cheapest and easiest way to achieve whole-house A/V.

Phone For Two

Like many families whose house is not only home but a home business, we are constantly seeking a way to keep our family and business phone calls and messages straight. We have

two phone lines, of course, and our “communications central” is a conveniently located shelf in the dining area. We started with a two-line corded phone and two digital answering machines. As any at-home worker knows, a cordless phone is mandatory for those times when a business call catches you switching the laundry from washer to dryer. We eventually ended up adding two cordless phones, and the requisite phone books, note pads, and writing implements, until we ended up where we are now—with a conveniently located mess.

Casio offers a communications clutter-buster in the form of its *PhoneMate TC-945* (\$179), a two-line, 900-MHz cordless phone with a built-in, two-line digital answering machine. It offers several features designed to keep your family and your business (or your calls and your kids’ calls) separate but equal, including separate message playback for each line, and simultaneous answering of both lines. The TC-945 also offers Casio’s patent-pending Modem Monitor connection protection to prevent broken Internet connections.

The TC-945 takes up about the same space as a standard phone/answering combination, measuring about 8 × 10 × 2 inches. A telescoping antenna swings up from the right side of the base. The handset is equipped with a “rubber duckie” antenna and several convenience features, including hold, redial, and intercom/page buttons; a flash button; a button for switching channels (the phone offers 30); a conference-call button; and a volume control.

The handset also provides easy access to the unit’s dual answering machine. There’s a red LED that flashes to let you know there are messages. And the first six numeric keys double as answering-machine controls that allow you to play, save, erase, file, and file messages; retrieve

filed messages; and even record conversations to the answering machine.

The digital answering machine can hold a total of 24 minutes of outgoing and incoming messages on both lines, in as many as 59 separate messages. A backup battery protects stored messages and greetings. Digital recording technology offers convenience features not possible with tape-based recorders, including the ability to play back new messages only, selectively save and erase messages, and instantly repeat or skip over a message during playback.

The TC-945’s dual-line answering machine adapts those digital features to two-line recording and playback. For instance, if a call comes in on one line while the answering machine is recording a message on the other line, the TC-945 will broadcast a message to the second caller. “Hello. Thank you for calling. Your call will be answered shortly,” is repeated every ten seconds until the machine is clear to record the second caller’s message. You can use the same greeting for both lines—or separate ones for each. The TC-945 stores messages by line—which means that you can play back messages from one line or opt to play back only the new messages on one line—and provides a separate LCD message counter for each line. The answering machine also provides an audible time/day stamp for all messages, variable-speed playback, and voice assistance to help you get through the initial setup.

If you receive a long message—be it complex shipping instructions, directions to an out-of-town meeting, or just a bunch of friends sending birthday greetings—you can store it in a separate location using the proprietary Message File feature. A press of the message file button on the base or handset during playback automatically files that message away for safekeeping, future reference, or just to

keep the digital memory clear for more messages. Messages stored in the Message File can be retrieved, played, or deleted using either the handset or the base unit.

All answering-machine functions, including Message File features, can be accessed remotely. The phone is “short burst/cellular compatible,” which means that you can use any phone, including a cell phone, to remotely access messages stored on the TC-945’s answering machine.

The base unit offers several features not found on the handset, including an LCD screen. When the TC-945 is idle, the screen displays message counters for both lines and a clock. When the phone or answering machine is in use, various other icons appear to let you know there’s a conference call in progress, for instance, or the message number during playback. The base unit also serves as a speakerphone on each line—a necessity for those times when a call comes in and the handset is in another room. The ringer can be programmed to sound different on each line, making it easy to distinguish between the two. Finally, the base has a 10-station auto-dialer for speed dialing, and the capacity to store 10 additional auto-dial numbers.

The *PhoneMate TC-945* features “Modem Monitor” technology, which prevents the telephone from interrupting an online session or fax transmission and safeguards data during file transfers. Dubbed “Connection Protection,” the technology can distinguish between voice calls and a data stream by looking for the periods of silence that occur during normal speech, but not during modem or fax transmissions. If Modem Monitor recognizes that a voice call is in progress, normal phone operation is allowed. If it senses a modem or fax call, it protects the connection by preventing the telephone from seizing the line. The feature works only with *PhoneMate* phones, however, so if someone picks up a non-*PhoneMate* extension, the online session will not be protected.

We inadvertently tested that feature several times the first day the

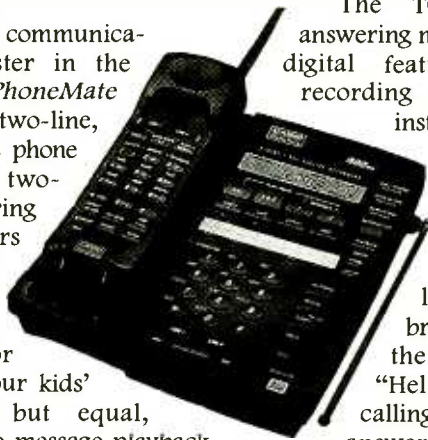

phone was installed (before we'd become accustomed to glancing at its line-in-use indicators before trying to make a call). Each time we tried to use line one, we were prevented from interrupting an ongoing Internet session. Annoying as it was from our end, the Net surfer was blissfully unaware of our attempts to use that line.

Another thing that took a few days to get used to was the TC-945's half-second or so delay in accessing the line we'd selected. Whether picking up an incoming call or trying to place a call, that tiny pause caused problems. We had to train ourselves to wait for a dial tone instead of dialing immediately, as with our other phones. It was even harder not to say "hello" immediately upon answering the phone; instead, we had to wait to hear the connection made before speaking.

The answering machine offered exceptional clarity, especially when compared with the two first-generation digital units that it replaced, which offered great convenience at the expense of fidelity. Now, however, it seems that technology has caught up with real life. Early cordless phones were plagued by interference; early digital answering machines were low on fidelity. The TC-945 seems to have those problems beat.

But in our opinion, the best thing about the PhoneMate TC-945 is its clutter-busting capability. Our kitchen telephony equipment has been reduced to the TC-945 and our old-standby corded two-line phone (for use when the battery in the handset is dead or it is in another room and we'd rather not use the speakerphone). The other cordless units have been tucked out of sight in bedrooms, while the two stand-alone answering machines are now relegated to the basement.

Big Brother Is Listening

Now that he's almost four years

old, our son's movie tastes have begun to mature. His favorites are still primarily animated tales (*The Land Before Time*, *The Lion King*), but he's begun to venture into PG territory, with films like *The Borrowers* and *Angels in the Outfield*. And we've been prepping him for the big-screen release of the latest *Star Wars* saga, *Episode I*, by renting the original three films.

While it's nice to be able to enjoy movies together as a family (as opposed to leaving the room when he watched *Thomas the Tank Engine* for the umpteenth time), PG movies, by definition, require parental guidance. There are many films that



we don't feel are appropriate at all for small children. We've vetoed *Jurassic Park* and *Godzilla*, for instance, due to their violent content.

But there are plenty of films out there that, while not particularly gory, sexy, or gross, include foul language. Those that are aimed at teenage and older audiences are particularly profanity-prone, but many classic family films also include some words or phrases that parents might find offensive or simply not appropriate for young ears. It comes as no surprise that *Ransom* contains 143 offensive words, and *Men in Black*, 66. But *E.T.* (13)? *Mrs. Doubtfire* (21)? *Home Alone* (12)?

In fact, the average PG-rated movie today contains more than 15 obscenities, and words that were once heard only in R-rated films are now commonplace in PG films and even in prime-time television shows. In those late 70s and early 80s *Star Wars* movies, somehow the rebels and even Darth Vader managed to wage war and wreak havoc upon each other without uttering a single profanity. Good luck finding a modern action film that doesn't punctuate every punch with a curse!

Technology offers parents a couple of solutions. First, there are blocking devices, which stop programming

that parents have deemed inappropriate from being viewed at all. But what if it's a movie or program that (to paraphrase the Supreme Court), "has some redeeming social value." Do you ban it on the basis of a few offensive words?

Another option is Principle Solutions' TVGuardian "Foul Language Filter" (\$199.95), a set-top add-on that removes profanities without otherwise disrupting the program's content.

TVGuardian is an innovative device that makes use of the closed-caption signal that's included in most movies and broadcast with most primetime shows. TVGuardian compares the words in the captions with those in its "internal dictionary of offensive words and phrases." When one is detected, the audio is muted to remove that offensive word or phrase from the dialog.

Of course, not everyone has the same opinion as to just which words are considered offensive or obscene. That's why TVGuardian offers several different modes. In "tolerant" mode, words such as "butt-head" get by. That wouldn't cut it in "strict" mode, however. The strict setting also analyzes the context around words such as God or Jesus to determine if they are being "taken in vain" or otherwise misused. At the other extreme, you have the option of bypassing the filter altogether.

Three different captioning settings are also available. You can opt to have the caption appear only when a word is muted; a profanity-free version of the phrase will be shown. Hearing-impaired viewers can watch continuous filtered captioning during the entire program. Or the captioning can be turned off entirely.

TVGuardian connects between your TV and source (VCR, cable box, satellite receiver). The different modes are selected via slide switches inside the unit, and the back of the box can be locked shut to prevent the kids from tampering with the settings.

If you want to preview a movie before watching it with the kids, you might want to keep the filter setting switched to "off": You'll hear the

soundtrack as recorded, but a count of the words that TVGuardian would filter is displayed. Bad language has become so commonplace, that sometimes you won't even notice it, until you check the count!

In our initial test, we turned TVGuardian to its strict setting with the captioning on. Then we cheated. We used the H.H. Scott Cinema-Surround system (reviewed here last month) so that we could bypass the TV sound and the TVGuardian's mute effect. We could hear the original soundtrack, intact, while reading in the closed captioning the replacement words used by TVGuardian. (Make sure your kids don't think of this!)

We popped in *Men in Black*, and boy did it keep TVGuardian busy. The first line, and most of the rest of the dialog in the first two minutes, was filtered. “__damn bugs” was changed in the caption to simply “bugs” and two commonly used expletive phrases both were changed to “oh, crap.” “Who the hell are you?” became “Who are you?” and “swear to God” was replaced by “swear to __”. (This was in strict mode). When we switched to tolerant mode, that was the only instance in which a phrase that was filtered in strict mode was left intact—at least in the first part of *MIB*.

Next, we switched to TV sound to hear how the dialog sounded when words were being muted. To our surprise, TVGuardian was muting every sentence that contained a curse. (Will Smith was practically silenced!)

A call to Principle Solutions verified that our unit was, indeed, functioning properly. Entire sentences are often deleted from the soundtrack, which is why the company included the option to have the closed captioning pop up whenever something is muted—that way you can keep track of the dialog without being exposed to offensive language.

TVGuardian works differently depending upon the dialog and even on the film itself. If the movie contains “standalone” curses (such as might be uttered when you bang your thumb with a hammer or your

MANUFACTURERS

Audiovox Corporation
150 Marcus Blvd.
Hauppauge, NY 11788
516-231-7750
www.audiovox.com

CIRCLE 100 ON FREE INFORMATION CARD

Bausch & Lomb
One Bausch & Lomb Place
Rochester, NY 14604-2701
800-553-5340
www.bauschvision.com

CIRCLE 101 ON FREE INFORMATION CARD

Casio Phonemate Inc.
20665 Manhattan Place
Torrance, CA 90501
310-618-9910
www.casiophonemate.com

CIRCLE 102 ON FREE INFORMATION CARD

General Instrument Corporation of Delaware
Satellite Data Networks Group
5744 Pacific Center Blvd.
San Diego, CA 92121
www.4dtv.com

CIRCLE 103 ON FREE INFORMATION CARD

InfoGear Technology Corporation
2055 Woodside Road, Suite 200
Redwood City, CA 94061
650-568-2909
www.infogear.com

CIRCLE 104 ON FREE INFORMATION CARD

Olympus America Inc.
Two Corporate Center Drive
Melville, NY 11747-3157
800-347-4027
www.olympus.com/digital

CIRCLE 105 ON FREE INFORMATION CARD

Principle Solutions
P.O. Box 670
Rogers, AR 72756
888-799-4TVG
www.tvguardian.com

CIRCLE 106 ON FREE INFORMATION CARD

Samsung Electronics America, Inc.
105 Challenger Road
Ridgefield Park, NJ 07660-0511
201-229-4000
www.sosimple.com

CIRCLE 107 ON FREE INFORMATION CARD

Terk Technologies Corporation
63 Mail Drive
Commack, NY 11725
516-543-1900
www.terk.com

CIRCLE 108 ON FREE INFORMATION CARD

Thomson Consumer Electronics
10330 North Meridian Street
Indianapolis, IN 46290-0124
317-587-4450
www.rca-electronics.com

CIRCLE 109 ON FREE INFORMATION CARD

buddy's plane is downed by alien missile), they will be deleted without affecting the next sentence. That's often the case with action films (like *Independence Day*). In *Good Will Hunting*, however, every scene featuring the title character and his neighborhood friends was almost entirely muted, because they couldn't seem to speak a sentence without a few curses sprinkled in.

Occasionally, TVGuardian makes some amusing changes. We had left the TVGuardian in tolerant mode, and forgot all about it until later that evening when the title characters in *Dharma and Greg* were arguing over who would get to drive a sports car. She asked why he should drive; he

responded, “I don't suppose ‘because I'm a guy’ would cut it.” Dharma snapped back “Not unless you drive with your penis!” (Hey, if they can say it in the presidential hearings ... which, as a live broadcast, could not be filtered with TVGuardian.) The captioning read, “Not unless you drive with your jerk!”

(Ironically, our little boy didn't notice that anything untoward had

Gizmo is published by Gernsback Publications, Inc., 500 Bi-County Blvd., Farmingdale, NY 11735. Senior Writers: Christopher Scott and Teri Scaduto. Copyright 1999 by Gernsback Publications, Inc. Gizmo is a registered trademark. All rights reserved.

been said until we began discussing the change made by TVGuardian. Then he began giggling, highly amused that grownups on TV would be talking about “peepees.”)

Such quirks can be amusing. Even so, we found TVGuardian to be extremely intrusive during *MIB* and *Good Will Hunting*, and somewhat annoying during *Independence Day*. Maybe we’re super-liberal, but we found ourselves wishing they’d included a third filter level that might leave in words like hell and damn so that at least a few conversations could remain intact!

Personally, we prefer to do our viewing uncensored. Our tastes in video lead us away from action-packed, expletive-filled films anyway, and our son is still young enough that most of the films that need a language filter are unsuitable for other reasons as well.

But if your kids are old enough to handle the content of a film, yet you prefer not to have them hear filthy language in your home (can’t do anything about it outside!), the TVGuardian could be a good solution for your family.

GIZMO NEWS

Meet The Linux “Gnome”

Although Linux is a powerful, stable, and free operating system, it hasn’t gained widespread acceptance with corporate and technical users of server computers and workstations. That’s because its user interface, like that of other Unix-family operating systems, depends on complex commands rather than the point-and-click simplicity associated with the graphical Windows and Macintosh systems.

But a new software program, dubbed Gnome for GNU Network Object Model Environment, will make it easy for non-programmers to use Linux and the software that runs on it. Gnome adds a graphical user interface between the operating sys-

tem and the user. It uses a set of “themes” that resemble various operating systems such as Windows and Macintosh. It also adds several new and sophisticated technical features to the Linux environment.

Gnome’s creators and the backers of the free software movement see the software as a direct challenge to Microsoft’s dominance via the Windows desktop. Aimed at ordinary PC users as well as corporate systems engineers, Gnome includes a word processor, database, presentation manager, and spreadsheet, as well as a Web browser and e-mail. Gnome’s designers are trying to convince commercial software companies to adapt their Windows-based programs to use the Gnome interface.

Two Hewlett-Packards

Hewlett-Packard Company is reorganizing to form two independent companies, one focused on test and measurement devices and the other on computing and imaging. “We are taking this action to sharpen the strategic focus of our businesses, improve their agility, and increase their responsiveness to customers and partners,” said HP president and CEO Lewis E. Platt. “This will offer exciting opportunities for our employees and will enhance the two new companies’ growth and earnings potential.”

Each company will be a distinct entity, with its own central research-and-development team and its own board of directors. The new measurement company will include HP’s test-and-measurement, components, chemical-analysis, and medical businesses. Edward W. (Ned) Barnholt, currently HP executive vice president and general manager of the Measurement Organization, has been named chief executive officer of the newly formed measurement company. It will focus on high-growth opportunities, such as communications and life sciences.

The new computing and imaging company, which will continue to operate under the Hewlett-Packard

name, will include all of HP’s enterprise computing systems, software and services, personal computer, printing, and imaging solutions businesses, as well as the recently formed Internet Business Unit (IBU). The company will be active in the mass proliferation of electronic services over the Internet. Platt stated, “HP will provide the fundamental innovations and solutions that make it easier for companies to build and deploy e-services, including enabling technologies that allow these services to interact with and leverage each other.”

Next-Generation PlayStation

Not to be outdone by Sega’s Dreamcast gaming console, due to be released this fall, Sony has unveiled specs for its next-generation PlayStation. The new unit includes a CD/DVD-ROM drive, a whopping 128-bit 300-MHz CPU with 32MB RAM, an enhanced graphics synthesizer, MPEG-2 image decompression, “3D” digital sound processing and enhancement, a PC-Card slot, and something called “Emotion Synthesis” that, according to Sony, “not only enhances the appearance of objects and characters, it allows them to think, act, and behave as they would in the real world with real-time processing.”

For instance, a character’s hair and clothing might be affected by a digital wind that’s calculated and processed in real time. The concept requires a computer system that, in Sony’s words, “approaches the performance of large-scale super-computers used for scientific simulation.”

In a first for the video-game industry, the system will be backward compatible with the more than 3000 titles currently available for today’s PlayStation, thanks to the inclusion of an I/O processor that uses a 32-bit core identical to that of the current system. The next-generation PlayStation will debut in Japan by spring of 2000, followed by a fall roll-out in the U.S.



Micro 2000 Basic PC Learning Course

Learn how to repair, diagnose, and even build your own PC with this course in a box.

If you're new to the world of PCs and would like to expand your awareness of what's really going on inside those beige boxes, Micro 2000 has come up with a great hands-on learning tool. Unjustifiably named the *Basic PC Learning Course*, it's anything but a mere primer. The Course will leave you not only well aware of numerous facets of computer operation, but supplied with some tools to help you maintain computers for years to come.

Clear Instruction. While the Learning Course is not a certified program, it does a decent job of covering all the basics of PC repair, diagnosis, and building. The included manual has step-by-step lessons that cover basics such as how memory works and how a system's components interact. After you feel confident in what makes up a PC, you can move on to learning troubleshooting basics and upgrading projects.

Those with PCs that are a year or more old (up to Pentium II) will benefit greatly from the upgrading instructions included in the manual. Not only do older computers have more to gain from upgrades, but the static nature of a printed course limits its contents to slightly older systems (unfortunately, computers change too fast for books to keep up with). Of course, you wouldn't need to upgrade a brand new Pentium III anyway, would you?

Still, the computer architecture detailed here is handled completely, making the Course a great way to "catch up" with all but the newest facets of the computer industry.

As this magazine makes evident on a monthly basis, you learn best by doing. This is probably why the Course comes with a couple of



videocassette tutorials that guide you through hands-on applications. We'll deal with the diagnostic video in a moment, but for now let's focus on the hour-long *PC Assembly & Configuration*.

The cost savings of building your own PC aren't what they used to be; in fact, without a bulk discount you'd pay more to build a PC than to buy one, in most instances. Still, building and setting up a PC is a terrific way to fully master computer-hardware concepts. The *PC Assembly & Configuration* video guides you through the process of assembling a Socket 7 system with two hard-disk, a CD-ROM, a tape-backup, and two floppy-disk drives. You'll also see the installation of a video card, modem, sound card, and power supply. Then you get to watch the steps required to get the creation up and running.

Diagnostics Worth Keeping. When you build a PC or buy one, it's a good idea to know how to keep it operating smoothly. To help you achieve this end, Micro 2000 has included a couple of wonderful diagnostic items—things you'll be using long after you've mastered the concepts in the Learning Course.

We're talking about *Micro-Scope*, a diagnostic program, and its accompanying tutorial video-

cassette. The packaging of *Micro-Scope* makes the software a tool you're likely to bring with you when an offsite PC is on the fritz. The program comes in a zipper case, complete with diagnostic manual and three loopback plugs, which help the software test a system's parallel and 9- and 25-pin serial ports.

Micro-Scope is a boot disk, letting you check out a system that won't otherwise start up (unless the problem's related to the power supply or a fried motherboard). Contained within the program are easy-to-master, yet effective, applications. You can log all hardware in a system, as well as the software configuration—useful if you have to call a service center, or if you're not sure what you're dealing with. It's then possible to run individual diagnostics covering every possible error or problem we could think of.

An interesting feature of *Micro-Scope* is that you can run it on a system with any type of IBM-compatible processor (Intel, Cyrix, AMD, etc.). Further, because the program speaks directly to a PC and has its own "operating system" built in, it doesn't matter which OS your machine uses, whether DOS, Windows (any version), OS/2, Novell, Unix, whatever.

The videotape tutorial is even more in-depth than the tape describing PC assembly. Just under two hours, the video will help you fully master the features of *Micro-Scope*. Indeed, the tape's a perfect ingredient for those who like to toss away instruction manuals.

The Basic PC Learning Course retails for \$249. Contact Micro 2000, Inc., 1100 East Broadway, Suite 301, Glendale, CA 91205; Tel. 800-864-8008; visit the company's Web site at www.micro2000.com; or circle 50 on the Free Information Card. ■

Product Test Report

RCA Video Source Selector

STEPHEN A. BOOTH

It's always gratifying to discover a product that serves a particular need, more so when that product performs up to its claims—and better still when it sells for a reasonable price. Based on these criteria, Thomson Consumer Electronics' RCA brand has hit the bull's-eye with its *VH920 Video Source Selector*, a set-top black box that feeds multiple S-Video sources to the single S-Video input now found on many TVs.

For the record, S-Video connections (sometimes called "S-VHS" and seldom, though more technically correct, referred to as "Y/C") should provide a visibly better image than the standard composite video connection (and RF hookups). Whereas the luminance ("Y" for B/W brightness) and chroma ("C" for color) are multiplexed in composite-video connections, each is sent separately to the TV (or another compatible component) through an S-Video connector.

Net result? On a worthy TV (and any boob-tube with an S-Video connector ought to be), certain artifacts of composite NTSC transmission are eliminated. The most visible of these is the so-called "dot crawl" along the edges of video images. Eliminating the vertically percolating dots tends to make the picture appear sharper. In and of itself, S-Video doesn't yield greater sharpness in terms of more lines of horizontal resolution—that's inherent to the source-format (e.g., DVD and digital satellite at a nominal 480 lines, S-VHS at about 420). But splitting the luminance and color components does make the available lines of resolution look cleaner.

What makes the VH920 a "welcome" product? The answer is simple arithmetic.

MORE INPUT

More and more video sources today offer S-Video output, yet a typical mid-line TV (say, 27-inch size and up) has but a single S-Video input. Even higher-priced TVs (direct-view

tube or rear/front projection) typically have two S-Video inputs at best. Meanwhile, among the source units that offer S-Video output there are DVD players, satellite TV receivers, camcorders, and increasingly cheaper S-VHS videocassette recorders (now down to as little as \$299 MSRP). And it's likely that even some conventional VHS decks will offer S-Video output soon.

THX, the Lucasfilm Ltd. subsidiary that polices quality control for the picture and soundtrack of movies and videos, has recently proposed a spec for improved VHS



playback.

Among other things, getting a THX logo on a VCR would require manufacturers to incorporate an S-Video output even on conventional VCRs. This stands to reason: VCRs record video as separate Y/C components. Rather than multiplex (and muddy them!) as composite output, THX is challenging electronics companies to offer consumers the better option of S-Video output—even at the VHS format's 240 lines.

There aren't, to date, enough S-Video source units to occupy all the seven available ports in RCA's VH920 (unless you've got multiple VCRs). Six connections are on the back panel, and source selection is done either through corresponding lighted buttons on the front or by remote control (more on this later). There's also a convenience connection on the front panel, for temporary hookups, such as a camcorder.

Besides S-Video, the switcher provides a composite video input for each device and left- and right-channel RCA photo jacks for audio. The composite-

video inputs enable you to run through the switcher non-S sources, such as laserdisc players, videogame consoles, conventional VCRs, and camcorders. Consequently, the switcher provides both an S- and composite-video output to the TV monitor (along with the audio outs).

Although sources can be selected manually through buttons on the VH920, that would be wasteful of the wireless remote controls for the source units. One of the dandiest features of the VH920 is its ability to learn the infrared codes from virtually any remote control. This enables you to power up the switcher and select the input when you activate the desired source.

The VH920 is preprogrammed for the remote controls of Thomson brand (GE, ProScan, RCA) sources. For other brands, the "teaching" process is a straightforward matter of engaging the "Learn" and source buttons on the switcher, then aiming the appropriate remote at the switcher's IR receiver and pressing the zapper's power-on button. You'd do this in turn for the remote control of each source connected to the switcher. The VH920 accepts IR remote commands only, not RF or ultrasonic. Also, although each source button is labeled (e.g., DVD, VCR, AUX), it doesn't matter what sources you connect to the inputs.

LAB RESULTS

Although using a switching device is certainly convenient, you wouldn't want to sacrifice picture or sound quality. We were happy to see that the VH920 generally doesn't compromise video or audio fidelity from the source. The only exception might be academic, as you'll see in the numbers generated by the Advanced Product Evaluation Laboratory, the independent testing facility in Bethel, CT that performs the measurements for *Product Test Report* in this magazine.

In APEL's experience, there's sometimes signal loss when sources are routed through passive (unampli-

fied) switchers—but also the possibility of distortion in active switchers that amplify the source signal. The VH920 is an active switcher, but its amp is whistle-clean.

APEL's measurements for S- and composite-video signal-to-noise ratio far exceed the S/N ratio of any video source available today (DVD players we've tested weigh in at about 51 dB, compared with better than 70 dB for the VH920). Similarly, video frequency response is flawless. It doesn't begin to drop off until 11 MHz, beyond the

range of even DVD.

Besides video, DVD provides a performance benchmark for the audio capabilities of the VH920. It's here where we've spotted a potential shortcoming, but one with a ready remedy.

As Table 1 indicates, frequency response is virtually flat through the audible range, and although total harmonic distortion is higher than the 0.01% typical of DVD, it's still inaudible. Where the VH920 falls short of DVD's audio capability is in signal-to-noise ratio (65.1 dB) and channel sep-

aration (63 dB at 1 kHz).

In both cases, these measurements are far superior to the output of any other video sound source, as well as the sound reproduction quality from the audio section of virtually any TV. But they fall short compared with the 84 dB and above channel separation of DVD players we've tested, and their 94 dB and better signal-to-noise ratios.

This shouldn't be much of a concern, for two reasons. People who want to exploit all the multi-channel soundtrack quality of DVD will probably route the audio directly to a Dolby Digital or Dolby Pro Logic surround-sound amplifier—not to a TV. And for those who do connect the DVD player's audio output to a TV, the VH920 won't be the limiting factor.

The TV's audio section itself is very unlikely to have an S/N ratio as good as the VH920 (we can think of only one that APEL has tested, where the TV's S/N ratio was 69 dB). Meanwhile, no TV will have as good channel separation as what the VH920 will feed it—the best APEL has tested doesn't reach 30 dB.

Two other things that make the comparative channel separation of the VH920 and DVD a moot point have to do with psychoacoustics and the operation of Dolby Surround.

Some experts argue that human hearing doesn't need more than about 15 dB of separation to detect the directionality of sounds. Be that as it may, the circuits that "steer" sounds to the proper channels in Dolby Surround decoders are believed to need 25 dB of separation from the source unit to distribute the matrixed audio correctly. (We say "believed" because Dolby Laboratories does not divulge its specification publicly.) So, regardless of the inherent Channel Separation of DVD, the VH920 provides enough for the ears and the equipment to do their job. At a typical street price below \$100, this black box will let all of your video components perform to the limits of their capabilities—not just the one connected to the TV's single S-video input.

For more information on the RCA VH920 Video Source Selector, contact RCA/Thomson Consumer Electronics, 10330 North Meridian St., Indianapolis, IN 46290; Tel. 800-336-1900; Web: www.rca.com; or circle 120 on the Free Information Card. ■

TABLE 1—PERFORMANCE MEASUREMENTS

The following test results were furnished by the Advanced Product Evaluation Laboratory, an independent testing facility located in Bethel, CT. All electrical measurements were performed using both S-Video (Y/C) and composite-input signals, and analog stereo.

Brand: RCA
Model: VH920 Video Source Selector
Price: \$129 (MSRP)

S-VIDEO MEASUREMENTS

Video Frequency Response:

Frequency (MHz)	Video Output (dB)
00.50	0.00
11.00	-0.6

Video Signal-to-Noise Ratio (Luminance, 10 kHz to 4.2 MHz):

Level (IRE)	Video Output (dB)
100	70.5
50	72.5
10	71.5

COMPOSITE VIDEO MEASUREMENTS

Video Frequency Response:

Frequency (MHz)	Video Output (dB)
00.50	0.00
11.00	-0.6

Video Signal-to-Noise Ratio (Luminance, 10 kHz to 4.2 MHz):

Level (IRE)	Video Output (dB)
100	70.0
50	72.0
10	71.0

Video Signal-to-Noise Ratio (Chroma, 100 Hz to 500 kHz):

Modulation	Video Output (dB)
AM	77.0
PM	60.0

AUDIO MEASUREMENTS (Input Level: 500 mV)

Frequency Response: 20 Hz to 20 kHz, -3.0 dB to +1.0 dB

Signal-to-Noise Ratio ("A" Weighted): 65.1 dB

Total Harmonic Distortion plus Noise (@1 kHz, versus output voltage level):

Output	THD+N
100 mV	0.30%
1.0 V	0.34%

Channel Separation (left channel): 63.0 dB @ 1 kHz
63.9 dB @ 20 kHz

ADDITIONAL DATA

Power Consumption: 3.5 watts
Dimensions (HWD, inches): 2 1/4 x 11 7/16 x 7 1/4
Weight: 2 1/2 pounds

Join The Search For

Extra-Terrestrial Intelligence

Remember SETI, the electromagnetic search for extra-terrestrial intelligence? For more than three decades, beginning in 1960, this quasi-government research project sought clear, unambiguous evidence of other technologically advanced civilizations in the cosmos. SETI existed under the auspices of the *National Radio Astronomy Observatory (NRAO)*, *National Atmospheric and Ionospheric Center (NAIC)*, *National Science Foundation (NSF)*, *National Aeronautics and Space Administration (NASA)*, other various alphabet-soup organizations, and several universities. Three dozen different SETI programs once scanned the skies with the world's greatest radio telescopes, sifting through "buckets of bits" with massive computers, trying to separate the "cosmic wheat" from the "galactic chaff." When each search came up dry, tax dollars funded the next with still more sensitive receivers, yet more massive antennas, even grander computers. SETI, so the conventional wisdom held, required the kinds of facilities that only governments could afford.

Then in 1993, Congress pulled the plug, pushing SETI away from the public trough. SETI science was just too expensive. SETI, it began to

appear, required the kinds of facilities that *not even governments could afford*. By terminating gov-

ernment-funded SETI, Congress reduced the federal deficit by . . . 0.0006 percent!

night sky are other suns: "Are we alone?" Today the search continues, privatized by laymen from all walks of life who cannot let that question go unanswered. Around the world, dozens of amateur SETI observatories are springing up, built by radio hams, microwave experimenters, and computer hobbyists who hope to make up in strength of numbers what they lack in government funding. Today's "SETIzens" embrace a new wisdom: that as technology advances, SETI begins to require the kinds of facilities that *ordinary citizens can afford*.

Ham radio operators call SETI the ultimate DX. In this article, we'll explore the privatization of SETI, what it takes in nuts and bolts and ones and zeroes to seek out our cosmic companions, and how you can join the search.

Where Do We Look?

Today's amateur SETI efforts scan the skies in the range of radio frequencies known as the *microwave window*, where photons (the fastest spaceship known to man) can travel relatively unimpeded through the interstellar medium. Most searches concentrate on the 1.3- to 1.7-GHz band, exactly where the pros started out. That's a spectral region for which much inexpensive equipment

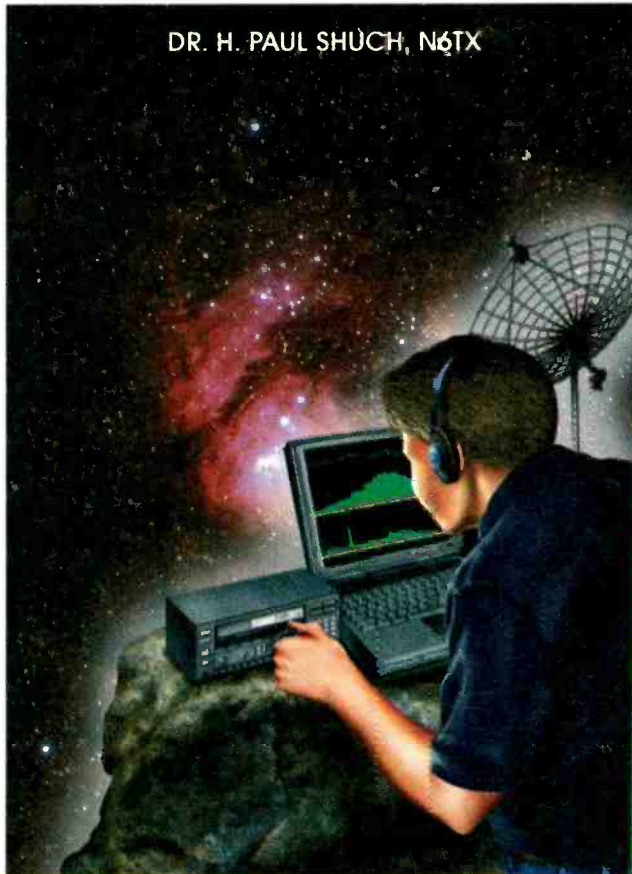

DR. H. PAUL SHUCH, N6TX

But SETI is a science that refuses to die. Driven by humankind's insatiable curiosity, it seeks to answer the fundamental question that has haunted humankind since first we realized that the points of light in the

as the *microwave window*, where photons (the fastest spaceship known to man) can travel relatively unimpeded through the interstellar medium. Most searches concentrate on the 1.3- to 1.7-GHz band, exactly where the pros started out. That's a spectral region for which much inexpensive equipment

Is Earth the only planet in the universe that's capable of sustaining intelligent life? You can help to answer that question for yourself by joining the legion of dedicated enthusiasts who are already scanning the heavens for signs of intelligent life—it can be an exciting as well as fulfilling pastime.

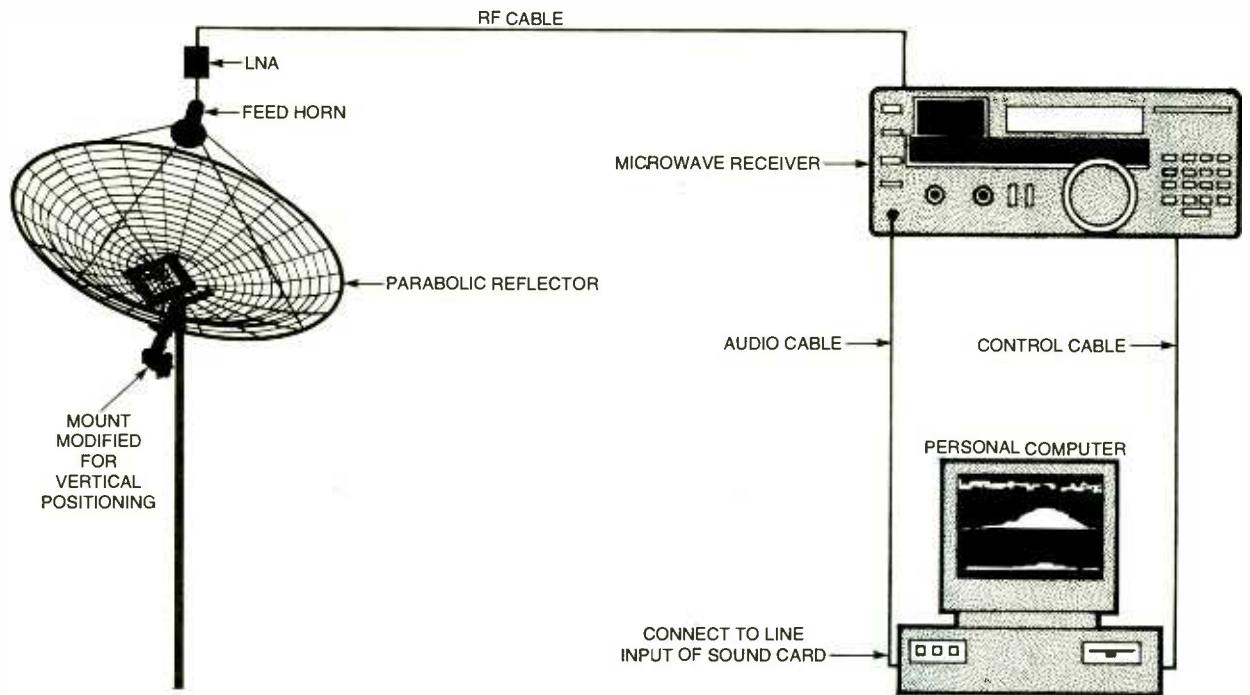

Fig. 1. While no two amateur SETI stations are ever exactly alike, they all have much in common—all contain some sort of antenna, an amplifier, a receiver (downconverter), and a computer.

already exists and much amateur-radio activity takes place on planet Earth. Though other interesting frequency bands show considerable promise, they generally require equipment that is either too costly or too complex for today's amateurs.

But that is changing even as we speak. The rule is that, since we don't know exactly from where ET might be transmitting, there are no *wrong* frequencies for SETI. So we build the best equipment today's technology allows and search where we can. If we get incredibly lucky, we'll find the definitive proof we seek. If not, we'll continue searching, knowing that tomorrow's technology will tune wider, hear farther, dig deeper, and greatly improve the odds. Amateurs are not discouraged by the primitive nature of their stations, because today's private SETI observatory is fully as sensitive as the best NASA had to offer just twenty years ago. And with NASA out of the game, the gap is narrowing!

Strength in Numbers. The giant radio telescopes from the era of NASA SETI were incredibly sensitive.

They dug deep into the noise by zeroing in on an incredibly small portion of the sky and surveying it for hours on end. But the immensity of the antennas, while making the telescope tremendously powerful, also imparted an important limitation. The typical research-grade radio telescope only sees about one millionth of the sky at a time. Even if it were tuned to exactly the right frequency, at exactly the instant when *the call* came in, there would still be a 99.9999% chance it would be pointed the wrong way, and miss the signal completely.

One solution to that dilemma is to build a million such research-grade instruments and point them in all possible directions. But at a cost of about \$100 million apiece, we've just exceeded the *gross* planetary product. Isn't there a cheaper way?

The SETI League believes there is. Small radio telescopes of the type that amateurs have been building for years are perhaps 200 times less sensitive than NASA's finest. That means they'll be somewhat deaf, detecting only the very strongest

extra-terrestrial signals. It also dictates that each unit cut across a swath of sky that's about 200 times wider than what its professional counterpart can handle. So, it would only take about 5000 small SETI telescopes, properly aimed and coordinated, to accomplish something NASA never even contemplated—to see in all directions at once, so that no direction in the sky could evade our gaze.

Better still, the cost of the typical amateur SETI station is today on the order of \$2000 US dollars. That means the entire global network described above can be built for a total cost of about a tenth of that of a *single* research-grade radio telescope. And that's individual hobbyists' money, not tax dollars, at work. SETI's detractors call it a waste of time and money. And I agree. This is, after all, a hobby for most of us, and isn't "wasting time and money" the very definition of a hobby?

The dream of real-time all-sky monitoring is still a long way off, but it is the vision of The SETI League to be implemented by its *Project Argus* search. Argus was the mythical Greek guard-beast who had a

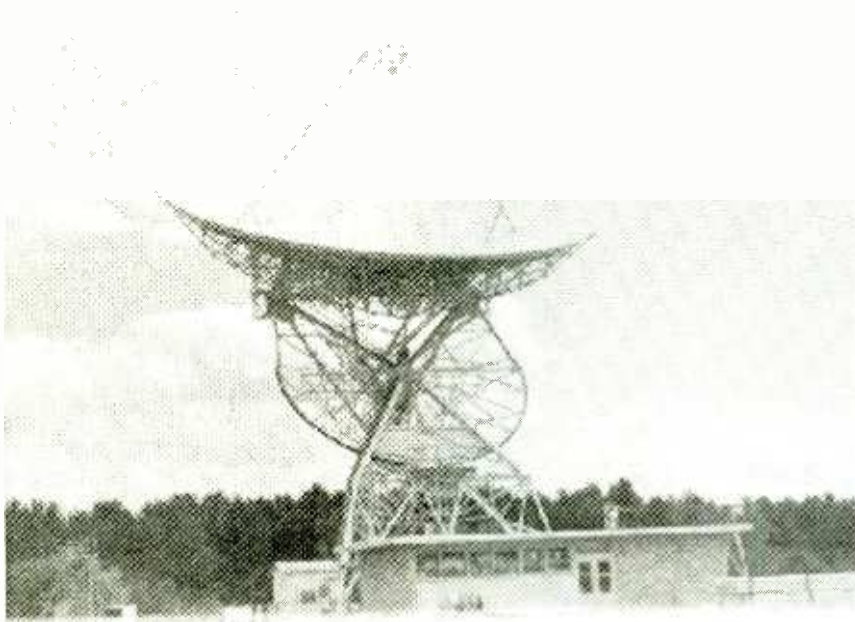

Three dozen different SETI programs once scanned the skies with the world's greatest radio telescopes, sifting through "buckets of bits" with massive computers, trying to separate the "cosmic wheat" from the "galactic chaff."

hundred eyes and could see in all directions at once. Mythology tells us that when Argus died, the gods put his eyes on the tail of the peacock. Though that's a lovely story, we of The SETI League know better. When Argus died, the gods put his eyes in the backyards of 5000 ama-

teur-radio astronomers, all over the world. With their help, we'll someday see in all directions at once.

The Typical Station. While no two amateur SETI stations are ever exactly alike, they all have much in common. For example, all use some

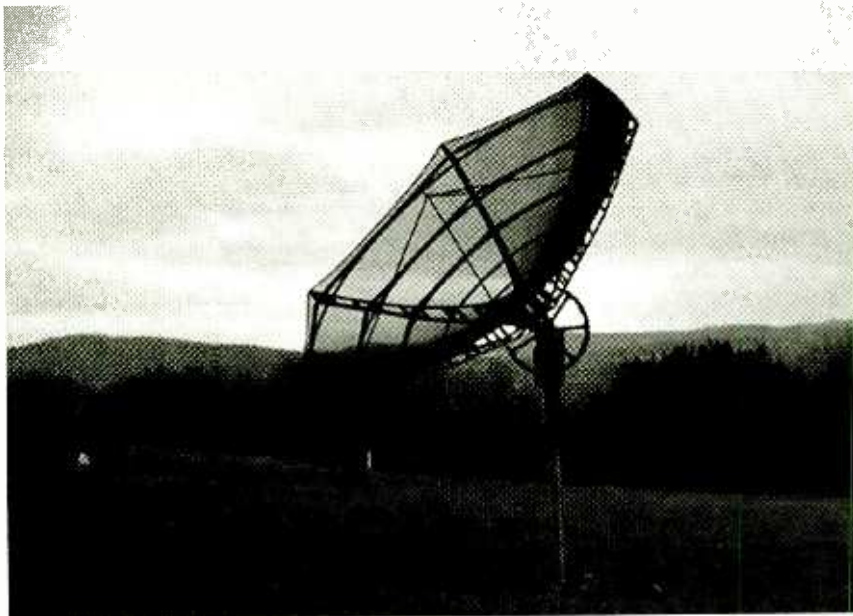

Though many other antenna types have been used successfully, by far the favored antenna for amateur SETI use is the parabolic reflector (or dish). For reception in the 1.3 to 1.7 GHz L-band region, which is highly favored for amateur SETI activity, optimum dish size is about three to five meters in diameter.

kind of antenna to scoop up weak photons from space, an amplifier to boost weak signals, a receiver to shift them down (downconvert) to audio signals, and a computer to sift through the audio noise in search of patterns that could not have been naturally occurring phenomena. Figure 1 shows a typical block diagram of just such a station.

The sections below provide a general overview of the main elements of a typical amateur SETI station. Further details are available in the appropriate chapter in *The SETI League Technical Manual* online at www.setileague.org or in hard-copy from The SETI League, Inc., PO Box 555, Little Ferry, NJ 07643 USA. While it's unlikely that the average experimenter can build a successful station from either this article or the tech manual alone, The SETI League's worldwide network of volunteer regional coordinators stands ready to assist any member in getting his or her station on the air.

The Antenna. Though many other antenna types have been used successfully, by far the favored antenna for amateur SETI use is the parabolic reflector (or dish). The chief advantage of the parabolic reflector is that it operates over an extremely wide range of frequencies, limited at the low end by its diameter (which must be a respectable multiple of the longest wavelength being received to provide reasonable gain), and at the high end by its surface accuracy (which must not deviate from the parabolic shape by more than a small fraction of the shortest wavelength being received to maintain reasonable efficiency). Typical satellite TV dishes generally provide reasonable performance over the 1- to 10-GHz portion of the microwave window.

For reception in the 1.3- to 1.7-GHz L-band region, which is highly favored for amateur SETI activity, optimum dish size is about three to five meters in diameter. In countries such as the US and Canada, where C-band satellite television distribution has been widely used for two decades, suitable dishes are abundantly available at low to no cost. In other parts of the world, they're

harder to come by. Enterprising SETI League members have acquired surplus commercial telecommunications dishes or even built their own from scratch.

The size of the dish and the operating wavelength together determine antenna gain. As a first order approximation, the voltage gain (as a ratio) is equal to the circumference of the reflector, measured in wavelengths. Consider, for example, a three-meter dish that has a circumference of $3 \times \pi$ (i.e., 3×3.1416) or about 9.4 meters. At the 21-cm resonant wavelength of neutral hydrogen atoms (which corresponds to the popular SETI frequency of 1420 MHz), the voltage gain of the dish would approach $(940/21) = 45$.

Since the power ratio equals the voltage ratio squared, the power gain of such an antenna would be about 2000; i.e., a gain of +33 dBi. However, since the efficiency of amateur SETI antennas is generally about 50%, the actual gain realized is more like +30 dBi.

Dish size also determines beamwidth, thereby dictating the degree of aiming precision required when targeting specific stars. As an approximation, half-power beamwidth in radians equals wavelength divided by antenna diameter. Thus, for our example of a three-meter dish operated at 21 cm, the beamwidth is approximately $(21/300) = 0.07$ radians or 70 milli-radians, which is about four degrees.

If you choose to use a surplus antenna, dish condition is an important factor. The main consideration for the dish is surface accuracy. In order to perform up to expectations, the dish surface cannot deviate from the parabolic by more than a tenth of a wavelength. At 1420 MHz, that's about 2 cm of allowable surface error. If the dish surface is dimpled, dented, or distorted beyond 2 cm, avoid that dish! Look for something that approximates a smooth parabolic curve. If panels are missing or bent, performance is sure to suffer.

Next, look at the mounting hardware. If it's rusted, expect trouble in getting the dish apart and even more trouble reassembling it.

Weight is sometimes a consideration, as is wind loading. If weight or wind concerns you, a more realistic approach might be to use a mesh dish instead of a solid one.

Many of the accessories that come along with a satellite TV dish are of limited use for SETI; therefore,



The most common feedhorn for amateur SETI use is a metal pipe, closed off at the end farthest from the dish, forming a shorted cylindrical waveguide. The chief drawback of the cylindrical waveguide feedhorn is its large physical size, which actually blocks a part of the dish surface from the "view" of incoming signals, thereby reducing the effective gain of the parabolic antenna.

you should not pay extra for them. C-band or Ku-band feedhorns and preamps are only useful if you're going to search in C-band or Ku-band (some of our members do; most prefer to scan the popular L-band region). TVRO systems are great sources of microwave components, but unless ET uses exactly the same TV transmission standards as we *Earthlings*, they're not particularly useful as SETI receivers. And a motorized mount that tracks the Clarke geosynchronous orbital belt is not particularly useful for drift-scan, meridian transit-mount radio telescopes, except if modified per the instructions in the following "Antenna Mount" section of this article.

In the final analysis, your financial situation is likely to be your chief limitation, so go with what you can afford. Any old dish receives better than no dish at all!

(Additional information on various SETI antenna options, along with vendor recommendations, may be found in the "Antennas and Feedhorns" chapter of *The SETI League Technical Manual*.)

The Antenna Mount. The beauty of mounting a parabolic antenna for SETI use is that you just can't go wrong. Since we are interested in monitoring the sky for artificial signals from beyond, the antenna merely need be pointed up—there are stars (with potentially habitable planets) to be found in all directions. So mounting an antenna for SETI use is considerably simpler than, for example, using the same antenna for satellite TV, where it must be precisely aimed at the satellite's location.

Because there are no wrong directions for SETI, many SETI antennas are simply set on the ground, "bird-bath" style, looking straight up. But a disciplined sky survey, such as The SETI League's *Project Argus* effort, requires coordinated sky coverage, and that, in turn, necessitates a limited steering ability for at least some of the antennas in the network.

Where steering of the antennas is desired, we need to consider two degrees of freedom: azimuth (the compass heading to which the antenna points) and elevation (the angle that the antenna's beam makes with respect to the horizon). In terms of celestial coordinates, the azimuth of a radio telescope (along with a station's latitude and longitude, and the date and time) determines the *right ascension* (RA) of its target, while elevation (again, along with latitude/longitude, time, and date) determines *declination* (Dec). Conversion between terrestrial and celestial coordinates is handled by a spreadsheet found on The SETI League's Web site.

Since we live on a rotating sphere, the earth itself makes a most cost-effective RA rotor, as long as you are patient enough to let the proper portion of the sky eventually rotate into view. But since (thankfully!) the earth doesn't rotate north-to-south, the only way to achieve Dec control is to physically rotate the antenna along a north-south line.

Times Are Tough...



Today's headlines scream of the lack of qualified individuals to fill new and existing high-tech job openings. If you feel the robust economy is passing you by, there is something you can do about it. **Become CIE Qualified.** Since 1934, The Cleveland Institute of Electronics has been providing its students with the necessary technical and academic credentials employers are seeking. In fact, CIE was started in 1934 to fill a similar void in the radio/television industry.

Since then, CIE boasts of over 150,000 worldwide graduates who have benefited from a patented, independent-study program that lets the student complete a Career Course, Associate Degree program, or through our affiliate school

World College, a Bachelor Degree program.

If you are currently "under-employed" and want to increase your level of income, the most proven method is an education. With CIE's independent-study program you study when and where you wish with no time constraints on how quickly you can proceed. And though it is an independent-study program you have the full support of the faculty and staff at CIE's Cleveland Campus.

To discover all the Benefits, Career Courses and Degree Programs available from CIE send for your Free Course Catalog Today!

The Cleveland Institute of Electronics has been approved for the training of eligible veterans and active duty military service members, under the G.I. Bill. Military tuition assistance (Up-Front and Basic) is also available under the DANTES Distance Learning Program.

...For Employers



F R E E C A T A L O G



Cleveland Institute of Electronics
 1776 E. 17th Street
 Cleveland, Ohio 44114-3679
 Visit Our Web-Site: www.cie-wc.edu

*A School of Thousands.
 A Class of One. Since 1934.*

YES! Please send me a catalog. AH139

Name: _____

Address: _____

City: _____ State: _____ Zip: _____

Phone Number: _____

Check Box for a Bulletin on Military Education Benefits:

VA Benefits DANTES Benefits

July 1999, Popular Electronics

That can be accomplished by aligning a satellite-TV antenna's position rotor as a vertical (elevation) rotor, as described in an article on The SETI League's Web site.

(Additional information on mounting SETI antennas can be found in the "Antennas and Feedhorns" chapter of *The SETI League Technical Manual*.)

The Feedhorn. When radio waves strike a dish antenna, the parabolic shape of its reflector directs all the energy to a single point—called its focus or focal point—out in front of the dish. The purpose of the feedhorn, which is mounted at the focus facing the reflector, is to scoop up all that energy and route it to the low-noise amplifier (LNA) and receiver for processing.

The most common feedhorn for amateur SETI use is a metal pipe, closed off at the end farthest from the dish, forming a shorted cylindrical waveguide. The horn contains a small metallic probe (connected to the center pin of a coaxial connector) that is used to collect the energy and channel it to the LNA. The horn might be surrounded by a metal ring, which serves to improve the efficiency of energy collection from the dish surface or to block interference from entering the feed from beyond the periphery of the dish (as described in yet another SETI League Web site article).

The chief drawback of the cylindrical waveguide feedhorn is that its large physical size actually blocks a part of the dish surface from the "view" of incoming signals, thereby reducing the effective size (hence, the gain) of the parabolic antenna. That signal loss due to blockage is most severe for small dishes, but is almost negligible at the popular 1.3- to 1.7-GHz SETI frequencies when the dish diameter exceeds about four meters.

An alternative to the cylindrical waveguide feedhorn is the helical feed, which consists of about three turns of heavy-gauge wire wound into a corkscrew shape with a circumference of one wavelength at the operating frequency, and a spacing between turns of a quarter



High-end microwave scanning receivers (typified by the Icom models R-7000, R-7100, and R-8500, as well as the AOR 3000, 5000, and 7000) are multi-mode receivers capable of receiving AM, FM, CW, SSB, and sometimes video and digital modes.

wavelength. A helix feed doesn't block the aperture of the dish to the extent that the waveguide horn does, but it is more prone to interference from signals off to the side of the antenna. Both helix and waveguide feedhorn designs have been used successfully by SETI League members.

(Additional information on various SETI antenna feeds, along with vendor links, can be found in the "Antennas and Feedhorns" chapter of *The SETI League Technical Manual*.)

The Low-Noise Amplifier. The LNA, which is also sometimes called a preamplifier or preamp, is used to turn an impossibly weak signal into a merely ridiculously weak one. The critical parameters to consider in selecting an LNA are its frequency response, gain, and noise temperature.

Frequency response determines that portion of the electromagnetic spectrum over which a particular LNA will boost the received signal with minimum distortion or added noise. The LNA should be selected to have a frequency range consistent with your particular SETI station requirements. For example, C-band satellite-TV LNAs cover the portion of the spectrum ranging from 3.7 to 4.2 GHz; ergo, they are not suitable for use in SETI stations designed to monitor the 1.4-GHz hydrogen line.

Incorporated into some LNAs are filtering circuits that reduce the overall range of frequencies amplified; the filtering circuits can also help to reduce out-of-band interference.

Gain, which is measured in decibels (dB), indicates how much the

LNA boosts the incoming signal. Although in many things "if a little is good, a lot is better," that's not the case for preamplifier gain. In fact, excessive LNA gain can actually reduce the sensitivity of a SETI receiver.

The rule of thumb is that the gain of the LNA should equal the sum of the microwave receiver's noise figure (in dB) plus the RF cable insertion loss (also in dB), plus an additional ten dB. For the average SETI station with a short coaxial cable between the LNA and the receiver, 20 dB of preamp gain is usually about right. If a very long or unusually lossy RF cable is used, a 30-dB gain LNA might be more appropriate.

Noise temperature is a measure of how much additional noise the LNA adds to your SETI system. Since any actual signal has to compete with a variety of natural and artificial noise sources, the lower the noise temperature, the better. The LNAs commonly used for amateur SETI typically have between 35 Kelvin and 100 Kelvin of internal noise. Noise is sometimes expressed not in Kelvins, but as *noise figure* (in dB) or *noise factor* (a unitless power ratio). (The SETI League provides a Microsoft Excel spreadsheet for conversion between these various noise units.) The noise temperature of an LNA can sometimes be reduced by thermally cooling it. (An additional spreadsheet allows you to calculate the improvement achieved by lowering an LNA's ambient temperature.)

Many commercial LNAs are provided with a choice of coaxial input and output connectors. Most SETI League members prefer to standardize on the coax connector known as Type N, since that's the connector used on most feedhorns and microwave receivers. To minimize losses, the LNA should be mounted directly on the output connector of the antenna feedhorn, with the appropriate coaxial adapter (probably an N-type male-to-male barrel adapter).

An additional consideration is how to get the appropriate operating potential to the LNA. Most LNAs operate from a DC power supply,

typically in the +12-volt DC range. Some designs require that the operating voltage be applied via the center-conductor of the RF cable, and some LNA vendors give you a choice between internal and separate DC feed. DC feed via the transmission line requires that the microwave receiver be designed to provide the voltage or that an accessory called a *DC Inserter* or *Bias Tee* be connected in the signal path ahead of the receiver and tied in to an appropriate power source. Although that's the scheme commonly used to power antenna-mounted circuitry in commercial satellite-TV receivers, most SETI experimenters see direct DC feed through the coax as more of a problem than a cure. It's generally preferred that a separate DC cable be run outside to the LNA; the DC potential is then applied to the LNA from inside the SETI station. (**Caution:** It is extremely important that the polarity of voltage applied to the cable be double-checked, as reversing the positive and negative power-supply leads can damage the LNA.)

Although most commercial (and many home-built) LNAs are housed in metal enclosures to provide shielding against radio-frequency interference (RFI), few reside in weather-proof enclosures. To prevent damage from exposure to the elements, I like to put my LNAs in plastic Tupperware sandwich boxes. It is necessary to drill or punch holes in the plastic for the input coax adapter, output cable, and power wiring. Be sure to seal the openings with room-temperature vulcanizing (RTV) silicon rubber (which can be purchased from most any hardware store).

(Information on various commercial LNAs available in kit form or fully assembled, along with vendor links, can be found in the "Preamplifiers and Filters" chapter of *The SETI League Technical Manual*. For the experienced microwave experimenter, schematics, component-selection criteria, and do-it-yourself information are also provided.)

The RF Cable. The most common SETI station configuration places the



The first generation of computer-controlled receivers, which were prone to RFI generated by the computer itself, were built on ISA cards, and plugged directly into one of the vacant slots on the motherboard of a personal computer.

microwave receiver, signal-analysis computer, and related accessories inside the house, with the antenna and LNA mounted outside some distance away. An RF cable—usually coaxial (i.e., "coax" cable), preferably those with low loss at radio (specifically microwave) frequencies is—used to link the two halves of a SETI station.

The stuff used for cable TV is cheap (pennies per meter), but pretty lossy in the 1.4- to 1.7-GHz region of the spectrum typically used for amateur SETI. The kind used for, say, CB radio antennas is a little better, but a bit more costly. If you have a local RadioShack or similar store, you can probably find what they call low-loss coax. Low-loss coax is larger (perhaps 1 cm diameter) than the CB or TV type, costs maybe a dollar or more per meter, and may go under such part numbers as Belden 9913, RG-8 Polyfoam, etc. It may take special connectors—called Type N—which require some experience to properly install.

For any type of coax, the longer the run, the lossier. So try to keep your antennas near the radio room. If that's not practical, there are several things that can be done: Use more gain in the preamp (to boost the weak signal before it suffers cable loss), mount the whole receiver or just the downconverter outside on the dish (pumping a lower frequency through the cable is more efficient), or use specialized cables such as hardline or Andrew Heliac (which can cost upwards of tens of dollars per meter).

The Microwave Receiver. The microwave receiver takes a small, selected portion of the radio spectrum and converts it to audio for

signal analysis. Selection of the appropriate receiver leaves more to the discretion of the experimenter than any other portion of the amateur SETI system. Four distinct options present themselves. In descending order of cost, they are:

1. High-end microwave scanning receivers—typified by the Icom models R-7000, R-7100, and R-8500, as well as the AOR 3000, 5000, and 7000—are multi-mode receivers capable of receiving AM, FM, CW, SSB, and sometimes video and digital modes. Various IF bandwidths are usually available, and these receivers are normally programmable to scan a selected range of frequencies. They typically tune from a few hundred kHz all the way up to about 2 GHz, which actually exceeds our SETI needs. Prices are likely to start around \$2000 US, making the receivers as expensive as all other portions of an amateur SETI station combined.

2. Modified radio-telescope receivers. One of the very few vendors of commercial radio-astronomy receivers for the amateur market is Radio Astronomy Supplies of Roswell, GA, USA. Their microwave receivers, which are designed specifically for continuum radio astronomy (that is, searching for natural astrophysical phenomena) can sometimes be modified for SETI use. Such modifications generally require considerable electronics expertise, but offer the ultimate in performance. As this is being written, Radio Astronomy Supplies reports being hard at work developing a dedicated SETI receiver, named *Seeker 2000*, which is slated to sell in the \$1200 (US) range.

3. Computer-controlled receivers. The first generation were built on ISA cards and plugged directly into one of the vacant slots on the motherboard of a personal computer. The units were prone to RFI generated by the computer itself. Later units, like the Icom PRC1000 and WinRadio 1500e, are separate boxes that plug into a computer via a serial, parallel, or USB port. They have many of the features offered by high-end microwave scanning receivers, but

since they rely on a companion computer for digital control, they typically cost half as much.

4. Downconverter/receiver combinations are available to down-shift selected portions of the microwave spectrum for reception via a shortwave or VHF ham-radio receiver. Popular units are available from Down East Microwave in the US, and VHF Communications in Europe. Downconverters are appealing for those who already own a high-performance communications receiver, which unfortunately doesn't tune to the SETI frequency of interest. Downconverters cost about half as much as the computer-controlled receivers, but require the user to couple them to an existing receiver.

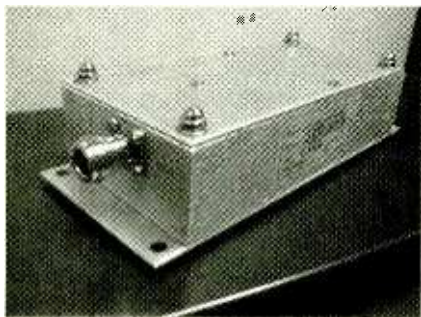

Downconverter/receiver combinations are available to down-shift selected portions of the microwave spectrum for reception via a shortwave or VHF ham-radio receiver.

Whichever receiver scheme is selected, present practice suggests operating it in single sideband mode (either upper sideband or lower sideband) and leaving it fixed-tuned, rather than scanning it across the spectrum. The reason for avoiding frequency scanning is that the Earth is turning the antenna continually, so that the spatial dimension of the observation is always changing. Only by holding frequency constant for at least one rotational period of the Earth (i.e., one day) can we avoid the problem of "too many variables."

The bandwidth of the receiver's audio stages will typically be the limiting factor, as far as instantaneous frequency span is concerned. Many SSB receivers cover as little as 3 kHz of spectrum at a time, which is an inefficient way to search for ETI.

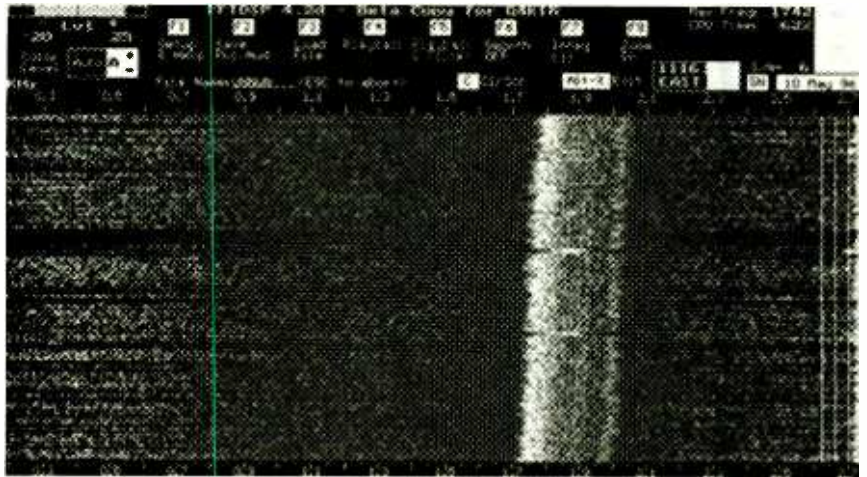

To accomplish their objective—to reach farther and farther out into space in the hopes of contacting intelligent life forms—SETI stations use digital signal processing. Shown here is an example of the first candidate signal received by The SETI League in May of 1996, which turned out to be interference from a classified military satellite.

Advanced SETI experimenters sometimes modify their receivers for up to 22 kHz of instantaneous IF and audio bandwidth, while custom-built receivers can cover from several hundred kHz to a few MHz of the spectrum at a time.

(Information on various commercial and kit receivers, recommended modifications, and vendor contact information can be found in the "Receivers and Converters" chapter of *The SETI League Technical Manual*.)

The Computer. Even the simplest of today's personal computers is thousands of times more powerful than the ones NASA used to put men on the moon. Of course, the objective of SETI is not to reach the moon, but rather to reach much farther out into space for intelligently generated signals. To do so, a technique known as digital signal processing (DSP) is used.

The first step in the DSP process is to feed the receiver's audio output into the computer in a form (i.e., binary data) that the computer can recognize. An analog-to-digital converter (ADC) is required to accomplish that task; the ADC of choice for amateur SETI is the PC sound card. Just about any *SoundBlaster*-compatible audio card will work with The SETI League's signal analysis software. The cards sample an audio waveform 44,000 times per second. One of the rules of information theory is

that to digitize a signal, it must be sampled no less than twice for every cycle at its highest frequency. With 44-ksp/s (kilo-samples per second) sound cards, it's possible to digitize and analyze audio components out of our receiver up to 22 kHz in frequency—a rather narrow bandwidth that even a 486 computer can analyze in real time with excellent resolution. The typical DSP program chops the received audio band into 2048 individual channels, each about 10 Hz wide, analyzing and displaying all those channels simultaneously, in real time. Thus, the computer turns the SETI station into a 2048-channel receiver.

The required software, developed by SETI League members, typically runs under the Microsoft DOS or Windows operating systems. It is shareware, offered at low or no cost to all participating SETI League members via the software pages of The SETI League Web site. Its job is to identify signals that exhibit the hallmarks of artificiality—characteristics that distinguish intelligently generated signals from natural phenomena—and then to help determine whether those characteristics might have come from some terrestrial source. Our civilization pollutes its own radio environment, so we need to sift through any detected signals rather thoroughly in order to rule out man-made interference from our own transmitters, aircraft, spacecraft,

(Continued on page 79)

EXPERIMENTING With SMALL FM TRANSMITTERS

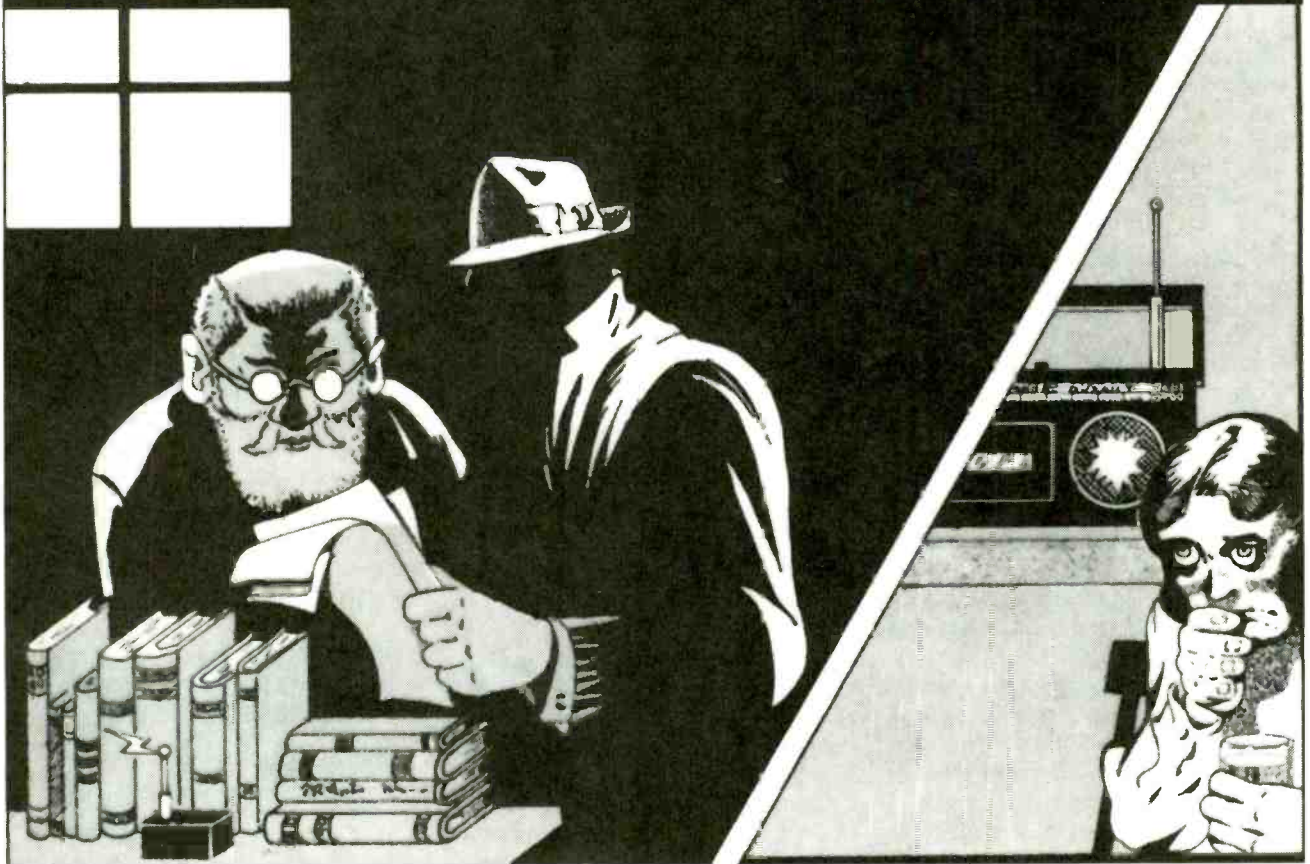

Build one or more of these elementary FM transmitters and learn how simple it is to convey intelligence from one point to another.

NEWTON C. BRAGA

There are those who would say that the wireless communications hobby has gone the way of the dinosaur—and perhaps they're right ... from a particular point of view, that is. No one would dispute that the ranks of ham radio enthusiasts and DXers have been on the decline for some time now. Even so, there are still plenty of communications enthusiasts out there searching for simple low-power FM transmitters. This article, in catering to that all but forgotten segment of the electronics hobby, presents a number of RF transmission circuits with which the hobbyist can experiment. All of the circuits—which are composed of readily available components, powered from sources ranging from 3 to 9 volts, and capable of covering dis-

tances up to half a mile—are tolerant of modifications, such as increasing the power or altering the frequency band or the modulation signal used.

One-Transistor FM Transmitter. Our first transmitter circuit (see Fig. 1), which is built around a single transistor, is probably the simplest of

its kind. The signal transmitted by that circuit can be picked up by any FM receiver within 150 feet or less of the transmitter. The circuit, which offers excellent performance, is ideally suited to wireless microphone applications. As the Fig. 1 circuit lacks an audio amplifier stage, it's necessary to speak directly into MIC1.

Inductor L1 is a hand-wound, air-core coil comprised of 4 turns of 18 to 22 AWG enameled wire wound on a 1-cm form. The number of turns comprising L1 can be varied in order to produce a circuit that can output signals in the high VHF band (2 or 3 turns) or the low band between 50 and 80 MHz (5 to 7 turns). Operating in the low VHF band, the signal from the transmit-

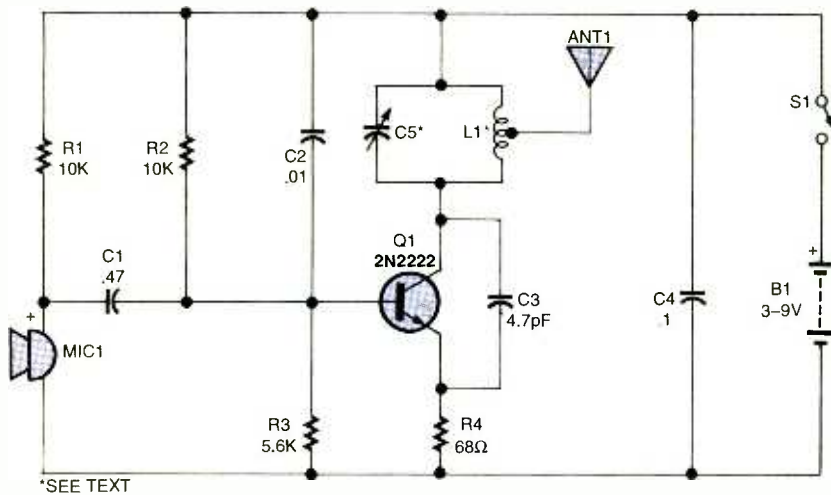

PARTS LIST FOR THE ONE-TRANSISTOR FM TRANSMITTER (Fig. 1)

RESISTORS

(All resistors are 1/4-watt, 5% units.)
 R1, R2—10,000-ohm
 R3—5600-ohm
 R4—68-ohm

CAPACITORS

C1—47-μF ceramic-disc or metal-film
 C2—0.01-μF ceramic-disc
 C3—4.7-pF ceramic-disc
 C4—0.1-μF, ceramic-disc
 C5—Trimmer capacitor, see text

ADDITIONAL PARTS AND MATERIALS

Q1—2N2222, BF494, etc., or equivalent, general-purpose NPN silicon transistor
 L1—See text
 ANT1—See text
 MIC1—Electret microphone
 S1—SPST toggle or slide switch
 B1—3- to 6-volt power source

Fig. 1. The output of this One-Transistor FM Transmitter circuit, which can be picked up by any FM receiver within 150 feet or less of the transmitter, offers excellent performance and is ideally suited to wireless microphone applications.

ter can be picked up on any VHF TV channel between 2 and 6.

Capacitor C6 can be any trimmer with a value ranging from 20 to 40 pF. The transmitter, as shown, can be powered from a 3- to 6-volt source. However, if greater output power is desired, the circuit can be driven from a 9-volt battery—in that case, the value of R4 must be increased to 120 ohms. The antenna is little more than a 4- to 15-inch length of bare wire, connected to the second turn of L1. The wire antenna can be replaced by a telescoping antenna.

To use the circuit, simply tune your receiver to a free point on the FM band. Adjust C5 until you hear

the signal from your FM transmitter. Speak near the microphone to test the sound reproduction. If carrying the transmitter to a position far from the receiver causes the signal to disappear, you've probably tuned a spurious signal or harmonic frequency. In that case, readjust the circuit and try again.

Two-Transistor FM Transmitter.

Our next transmitter, see Fig. 2, is nearly identical to the previous circuit, except that an extra transistor has been added to the mix and a couple of resistor/capacitor values have been altered to accommodate the new circuit configuration. The inclusion of a single transistor in

the microphone circuit increases the circuit's sensitivity to signals that are picked up by the microphone.

Low-volume conversations, bird songs, and natural sounds can be

PARTS LIST FOR THE TWO-TRANSISTOR FM TRANSMITTER (Fig. 2)

SEMICONDUCTORS

Q1—2N2907 general-purpose PNP silicon transistor
 Q2—2N2222 general-purpose NPN silicon transistor

RESISTORS

(All resistors are 1/4-watt, 5% units.)
 R1, R4—10,000-ohm
 R2—220,000-ohm
 R3—22,000-ohm
 R5—5600-ohm
 R6—68-ohm

CAPACITORS

C1—10-μF, 16-WVDC, electrolytic
 C2—1-μF, metal-film or electrolytic
 C3—0.01-μF, ceramic-disc
 C4—4.7-pF, ceramic-disc
 C5—0.1-μF, ceramic-disc
 C6—Trimmer capacitor, see text

ADDITIONAL PARTS AND MATERIALS

L1—See text
 ANT1—See text
 MIC1—Electret microphone
 S1—SPST toggle or slide switch
 B1—3- to 9-volt power source, see text

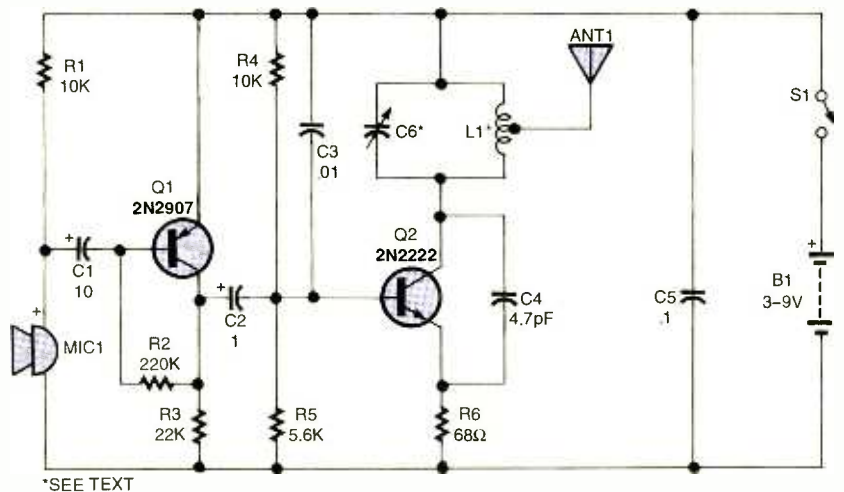
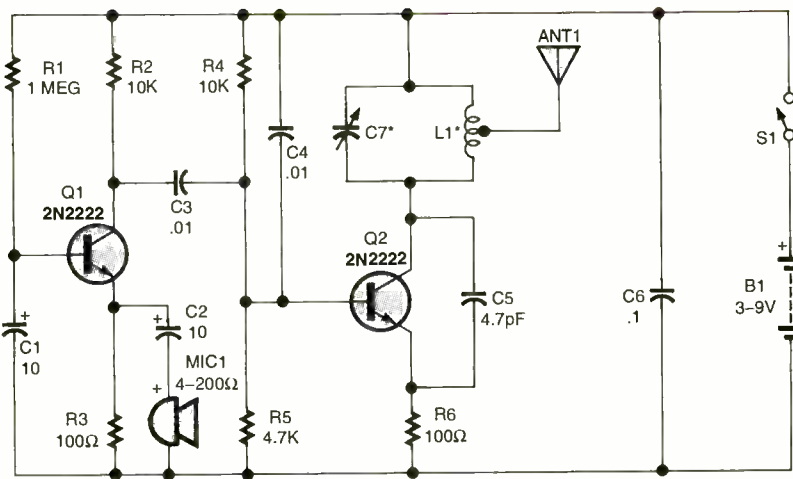

Fig. 2. The Two-Transistor FM Transmitter is nearly identical to the previous circuit, except that an extra transistor has been added to the mix and a couple of resistor/capacitor values have been altered to accommodate the new circuit configuration.



PARTS LIST FOR THE LOW-IMPEDANCE TRANSMITTER (Fig. 3)

RESISTORS

(All resistors are 1/4-watt, 5% units.)

- R1—1-megohm
- R2, R4—10,000-ohm
- R3, R6—100-ohm
- R5—4700-ohm

CAPACITORS

- C1, C2—10- μ F, 12-WVDC, electrolytic
- C3—0.01- μ F, ceramic-disc or metal-film
- C4—0.01- μ F, ceramic-disc
- C5—4.7-pF, ceramic-disc
- C6—0.1- μ F, ceramic-disc
- C7—Trimmer capacitor, see text

ADDITIONAL PARTS AND MATERIALS

- Q1, Q2—2N2222 general-purpose NPN silicon transistor
- L1—See text
- ANT1—See text
- MIC1—1- to 2-inch loudspeaker or low-impedance transducer, see text
- S1—SPST toggle or slide switch
- B1—3- to 9-volt source, see text

Fig. 3. The Low-Impedance Transmitter, using a telephone receiver pick-up coil (which does not load down the phone line), can be used to intercept telephone conversations without being discovered.

picked up and transmitted to a common FM receiver placed as far as 150 feet from the transmitter. The microphone itself can be placed at the focal point of a parabolic reflector, making it ideally suited to picking up very weak sounds emanating from a single direction. Such a circuit might find application in surveillance operations.

Inductor L1 and antenna ANT1 in the Fig. 2 circuit are identical to the coil and antenna used in the Fig. 1

circuit, and like the Fig. 1 circuit this one can be powered from 3- to 6-volt sources with no modifications to the circuit. In order to operate the Fig. 2 circuit from a 9-volt source, the value of R1 must be changed to 120 ohms. That modification allows the output of this circuit to be picked up at distances of up to 600 feet when operating in an open field. The transmission range diminishes considerably when the transmitter is operated

from within a closed solid structure, such as a brick or metal edifice. Tuning for this circuit is accomplished as it was for the previous transmitter.

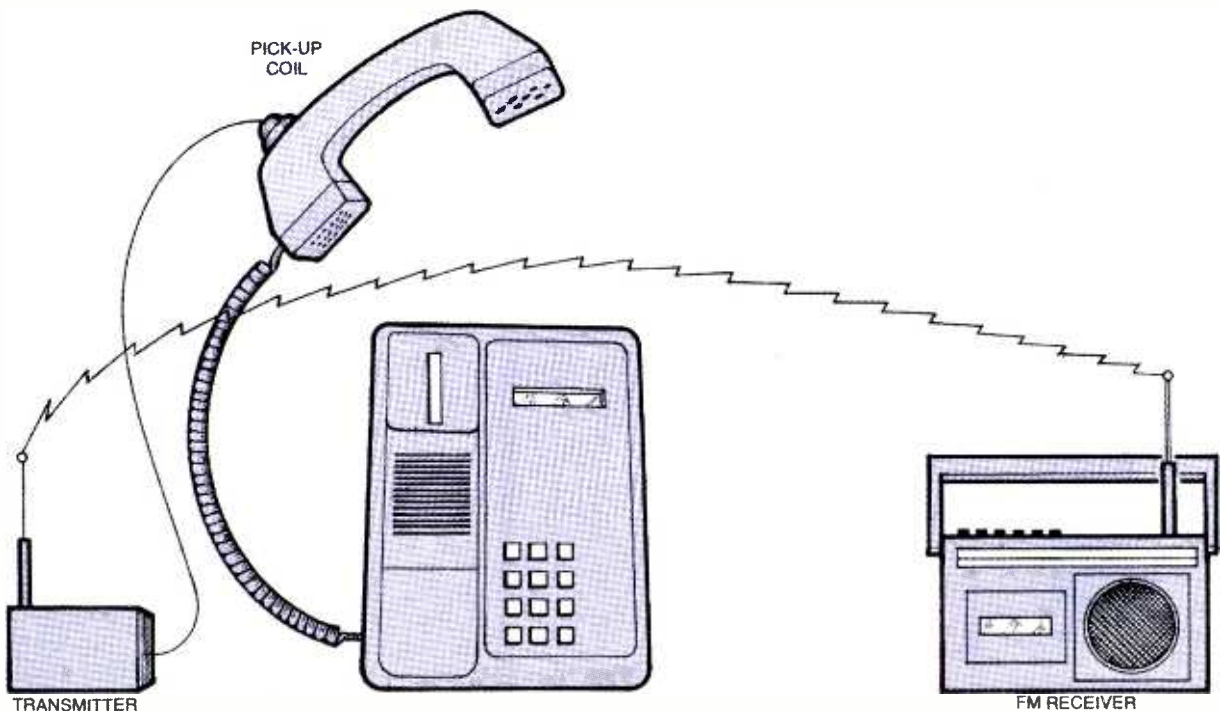

Fig. 4. Using a telephone pick-up coil and the Low-Impedance Transmitter, as depicted here, phone conversations can be heard at a remote location through any FM receiver.

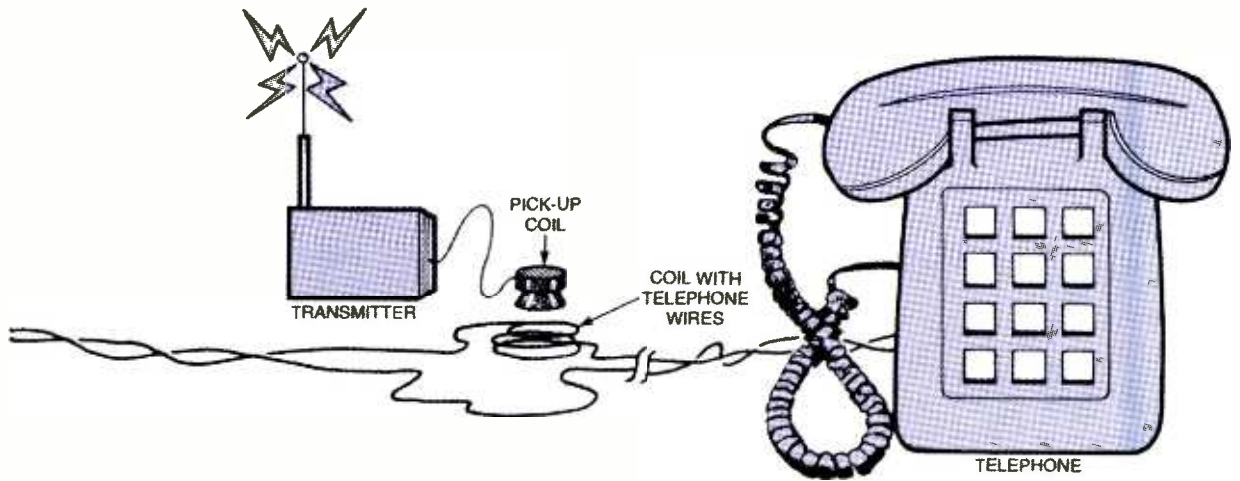

Fig. 5. The telephone pick-up coil/transmitter combination is sensitive enough that it can be used to inductively snare conversation from a coiled section of telephone line.

To use the Fig. 2 circuit in spying applications, place the transmitter far from metal objects, such that the microphone has an unobstructed "view" of the area that is being monitored.

Low-Impedance Transmitter. The third circuit (see Fig. 3) is designed to use a low-impedance transducer as the pick-up device. The transmission range for this circuit is the same as for the two previous transmitters, but offers some advantages over the prior circuits. One of the advantages is that a small low-impedance speaker can be used as a microphone. In addition, with a telephone pick-up coil attached to

the telephone receiver (as shown in Fig. 4), the conversation can be fed to a receiver placed several feet away. The pick-up coil can also be coupled to the telephone line in the manner illustrated in Fig. 5, allowing you to intercept telephone conversations without being discovered. Since there is no direct connection to the telephone line with that arrangement, the transmitter won't have a loading effect on the phone line.

When coupling the circuit to the telephone line in the manner outlined here, the telephone feed (the wire cable that connects to the telephone base) must also be coiled, as illustrated in Fig. 5. While the pick-up

coil can be purchased from almost any electronic parts dealer, a homebrew unit can be manufactured by winding 1000 to 5000 turns of 30 or 31 AWG enameled wire on a small ferrite rod. Inductor L1 in this circuit is the same as described in the previous circuits. And like the other transmitter circuits, this one can be powered from a 3- to 9-volt source, with the 9-volt power source requiring that R6

PARTS LIST FOR THE TONE TRANSMITTER (Fig. 6)

SEMICONDUCTORS

- IC1—555 oscillator/timer, integrated circuit
- Q1—2N2222 general-purpose NPN silicon transistor

RESISTORS

- (All resistors are 1/4-watt, 5% units.)
- R1—47,000-ohm
- R2, R3—10,000-ohm
- R4—5600-ohm
- R5—68-ohm

CAPACITORS

- C1—0.022- to 0.1- μ F, ceramic-disc or metal-film
- C2, C3—0.01- μ F, ceramic-disc or metal-film
- C4—0.0047- μ F ceramic-disc
- C5—4.7-pF, ceramic-disc
- C6—0.1- μ F, ceramic-disc
- C7—Trimmer capacitor, see text

ADDITIONAL PARTS AND MATERIALS

- L1—See text
- ANT1—See text

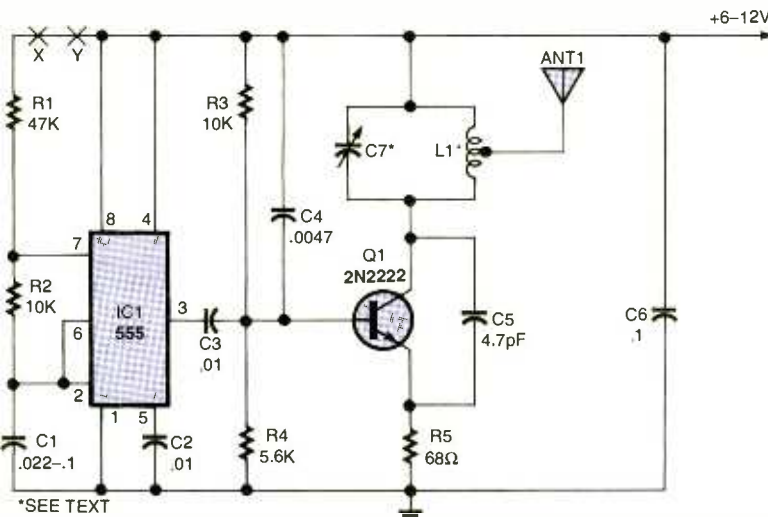

Fig. 6. The Tone Transmitter can be used as part of a wireless alarm, Morse-code practice circuit, or as part of a wireless annunciator (using an appropriate sensor).

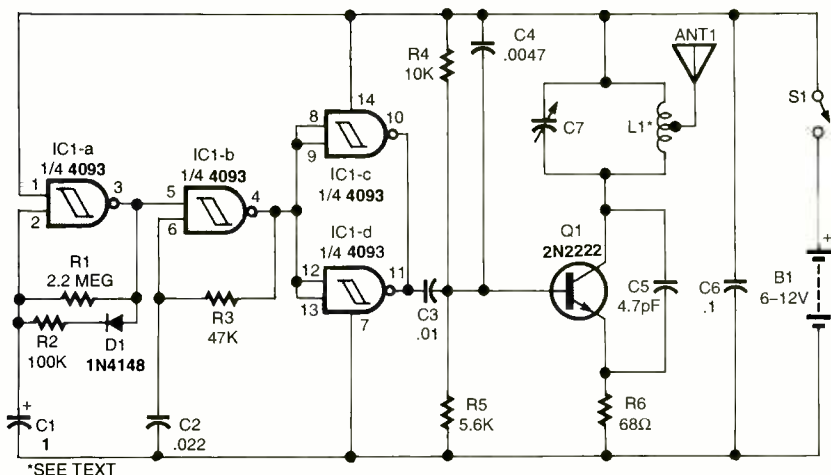

Fig. 7. The Beep Transmitter outputs intermittent beeps that can be picked up by any FM receiver within its coverage range.

be replaced by a 120-ohm resistor. Also like the previous circuits, this one is tuned via a variable capacitor (C7).

If the received signal saturates the transmitter, causing it to output distortion-rich audio, it may be necessary to alter the value of R3, which can range from 22 ohms to 220 ohms.

Tone Transmitter. The Tone Transmitter circuit shown in Fig. 6 can be used as part of a wireless alarm, Morse-code practice circuit, or as part of a wireless annunciator (using an appropriate sensor). Wired to a trap, the circuit can be used to alert you when the trap is sprung. For example, to use the circuit as a remote temperature or light sensor, replace R1 with a light-dependent resistor (LDR), or a negative-temperature coefficient (NTC) thermistor. Regardless of the type of sensor selected, it should have the nominal resistance of between 10k and 100k. In such an arrangement, the frequency of the output signal depends on the amount of light striking the LDR or the temperature sensed by the thermistor. The sensor can be connected in the circuit at points X and Y.

The output frequency of the transmitter can be determined by connecting a frequency-counter to the output of an FM receiver. The circuit generates an FM signal that's modulated by an audio tone whose frequency is determined by R1, R2, and C1. Inductor L1 is the same used in the other transmitters,

with circuit tuning accomplished in the same manner.

The Tone Transmitter has a range of between 150 and 600 feet in an open field when the circuit is powered from 4 AA-cells. The circuit's output power can be increased (in order to provide greater transmission coverage) by powering the circuit from 9- or 12-volt DC supply. To reconfigure the circuit for 9-volt operation, replace R5, a 68-ohm resistor, with a 120-ohm unit. If 12-volt operation is desired, replace Q1, a 2N2222 general-purpose NPN transistor, with a 2N2218. Those alterations allow the circuit to transmit over distances of up to a mile in an open field.

Caution: The FCC forbids operation of high-powered versions of a circuit like this one within city limits, where the signals can cause interference in emergency or other communications, FM receivers, and VHF TV.

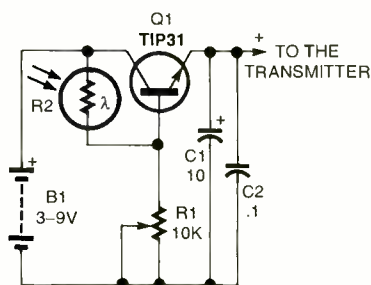

Fig. 8. This simple Light-Activation Circuit can be added to any of the transmitters, except those powered from 12-volt sources, allowing the transmitters to turn on whenever the light level detected by R2 dips below the threshold set by potentiometer R1.

PARTS LIST FOR THE BEEP TRANSMITTER (Fig. 7)

SEMICONDUCTORS

IC1—4093 CMOS quad 2-input NAND Schmitt trigger, integrated circuit
Q1—2N2222 general-purpose NPN silicon transistor
D1—1N4148 general-purpose, small-signal, silicon diode

RESISTORS

(All resistors are 1/4-watt, 5% units.)
R1—2.2-megohm
R2—100,000-ohm
R3—47,000-ohm
R4—10,000-ohm
R5—5600-ohm
R6—68-ohm

CAPACITORS

C1—1-μF, 16-WVDC, electrolytic
C2—0.022-μF, ceramic-disc or metal-film
C3—0.01-μF, ceramic-disc or metal-film
C4—0.0047-μF, ceramic-disc
C5—4.7-pF, ceramic-disc
C6—0.1-μF, ceramic-disc
C7—Trimmer capacitor, see text

ADDITIONAL PARTS AND MATERIALS

L1—See text
S1—SPST toggle or slide switch
B1—6- to 12-volt power source, see text

Beep Transmitter. The circuit shown in Fig. 7 transmits intermittent beeps to a remote FM receiver. The pitch of the transmitted tones and the interval between beeps can be altered according to the application. Resistor R3, which can range between 10k and 100k, determines the pitch of the tone, while the beep interval is determined by R1,

PARTS LIST FOR THE LIGHT-ACTIVATION CIRCUIT (Fig. 8)

RESISTORS

R1—10,000-ohm trimmer potentiometer
R2—Light-dependent resistor

CAPACITORS

C1—10-μF, 16-WVDC, electrolytic
C2—0.1-μF, ceramic-disc capacitor

ADDITIONAL PARTS AND MATERIALS

Q1—TIP31 NPN silicon power transistor
B1—3- to 9-volt power source (see text)

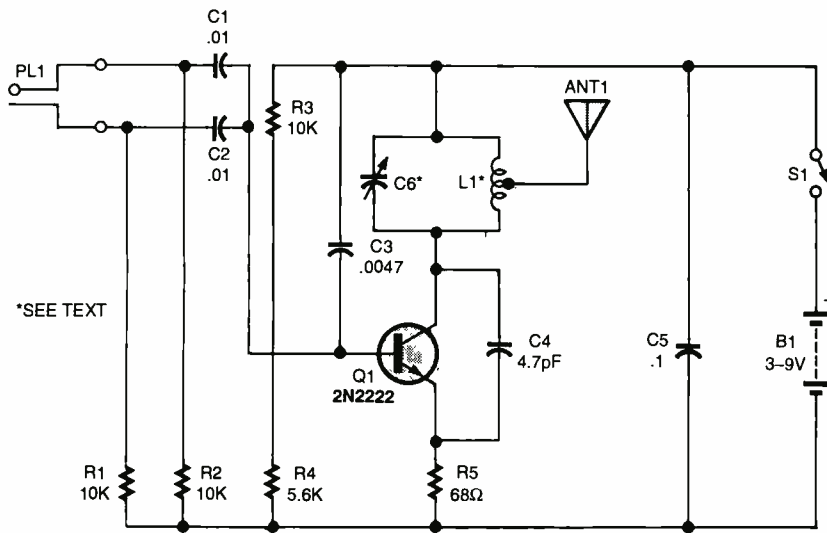

Fig. 9. This CD-Player/Multimedia Transmitter allows audio signals from a PC or CD player to be sent to your FM sound system for reproduction through the system's loudspeakers without the need for interconnecting wires.

whose value can range between 100k and 10 megohms.

The Beep Transmitter can be used in a game named "Fox Hunt." The transmitter is the fox and the hunters are those using FM receivers to locate the fox by the transmitted signal.

To increase the transmitter's coverage area, make the same modifications described for the Fig. 4 circuit. The circuit, when operated from a 12-volt supply, should be used *only* in an open field, far from radio receivers, so as not to interfere with their reception.

Light-Activation Circuit. The simple circuit shown in Fig. 8 can be added to any of the transmitter circuits, except those powered from 12-volt supplies, allowing the transmitters to turn on whenever light level detected by R2 (an LDR) dips

below the threshold set by potentiometer R1.

CD-Player/Multimedia Transmitter.

The circuit shown in Fig. 9 allows audio signals from a PC or CD player to be sent to your FM sound system for reproduction through the system's loudspeakers without the need for interconnecting wires. The circuit is monophonic, so the left and right channel audio signals are mixed in the transmitter circuit before being output to the antenna (ANT1) as shown in Fig. 9. As there is no multiplexing of the signals, the receiver can't reconstitute the left and right stereo channels.

The circuit can be powered from a 3- to 9-volt power supply. For 3- to 6-volt operation, no changes are necessary, but for 9-volt operation, the value of R4 must be increased to 120 ohms.

PARTS LIST FOR THE CD-PLAYER/MULTIMEDIA TRANSMITTER (Fig. 9)

RESISTORS

(All resistors are 1/4-watt, 5% units.)
 R1-R3—10,000-ohm
 R4—5600-ohm
 R5—68-ohm

CAPACITORS

C1, C2—0.01-μF, ceramic-disc or metal-film
 C3—0.0047-μF, ceramic-disc
 C4—4.7-pF, ceramic-disc
 C5—0.1-μF, ceramic-disc
 C6—Trimmer capacitor, see text

ADDITIONAL PARTS AND MATERIALS

Q1—2N2222 general-purpose NPN silicon transistor
 L1—See text
 ANT1—See text
 PL1—Stereo plug
 S1—SPST toggle or slide switch
 B1—3- to 9-volt power source, see text

Field-Strength Meter. Our final circuit, see Fig. 10, is a useful little circuit that can be used to indicate the strength of the signals output by any of the transmitters that we looked at here.

PARTS LIST FOR THE FIELD-STRENGTH METER (Fig. 10)

SEMICONDUCTORS

Q1—2N2222 general-purpose NPN silicon transistor
 D1—1N34 or 1N60 or similar germanium diode

RESISTORS

(All fixed resistors are 1/4-watt, 5% units.)
 R1—1-megohm
 R2—22,000-ohm
 R3—100,000-ohm, trimmer potentiometer

ADDITIONAL PARTS AND MATERIALS

C1—0.01-μF, ceramic-disc capacitor
 L1—470-μH coil
 ANT1—See text
 M1—0-200-μA meter
 S1—SPST toggle or slide switch
 B1—3- to 6-volt power source (see text)

Potentiometer R3 (a 100k unit) is used to adjust the sensitivity of the circuit, by biasing the transistor near the point of conduction. The antenna (ANT1) is nothing more than a 5- to 20-inch length of wire.

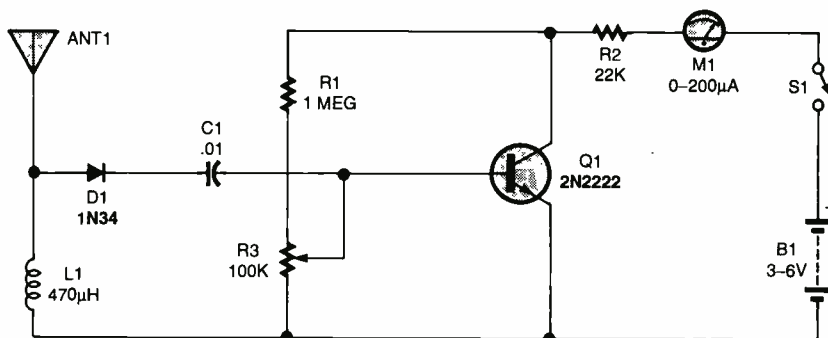

Fig. 10. The Field-Strength Meter can be used to indicate the strength of the signals output by any of our transmitters.

SOUND PARTNER



This simple circuit allows you to connect a second set of headphones to your portable personal-sound system without concern that doing so could destroy the unit's output drivers.

NEWTON C. BRAGA

In these times, it's not unusual to see people listening to personal radios, cassettes, or even CD players through a set of headphones while walking, or while riding on buses or trains. Those devices are just fine for the individual. But what about those times when you find yourself traveling with a companion with whom you'd like to share a particularly memorable cut from a tape or CD, or a song on the radio? Of course, you could plug a dual-headphone adapter into your audio device, allowing you to con-

nect two headphones.

At first glance taking that route might seem the ideal solution, but there is an unforeseen downside. Such adapters simply (as shown in Fig. 1A) tie the two sets of headphones in parallel. That reduces by half the total impedance seen by the output driver of your personal sound system and places unnecessary strain on the sound system's output circuits. And that, in turn, could lead to overheating and other problems that could possibly cause irreversible damage. Even if connecting the adapter and a second headphone doesn't completely destroy the unit's output driver, the loading effect is sure to severely distort the output audio to a point where it's almost unintelligible. Alternatively, if the two headphones are series connected to the personal sound system (as

shown in Fig. 1B), the increased (doubled) impedance produces power losses and could possibly severely distort the output signal.

Enter the *Sound Partner*—a small low-power audio amplifier designed to provide sufficient output current to drive a second set of headphones without distorting the output audio or loading the unit's output driver. The *Sound Partner*, based on National Semiconductor's LM386 low-power audio amplifier and powered from 4 AA-cell batteries (i.e., a 6-volt source), can output up to 100 mW.

A Little Background. The *Sound Partner*, as shown in Fig. 2, is extremely easy to use. You simply connect it to the headphone jack of your personal sound system and then connect two headphones to the *Sound Partner*. Note from Fig. 2

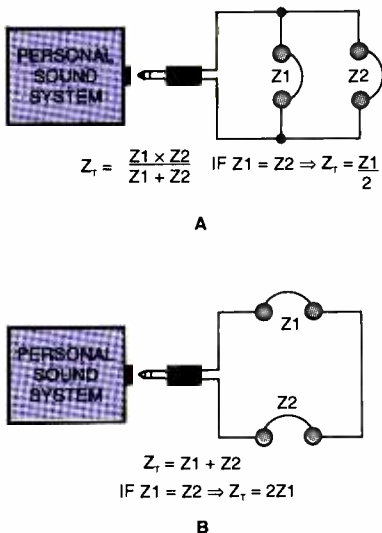

Fig. 1. Dual-headphone adapters (as shown in A) simply tie the two sets of headphones in parallel. If the two headphones are series connected to the personal sound system (as shown in B), the increased impedance produces power losses and possibly distortion.

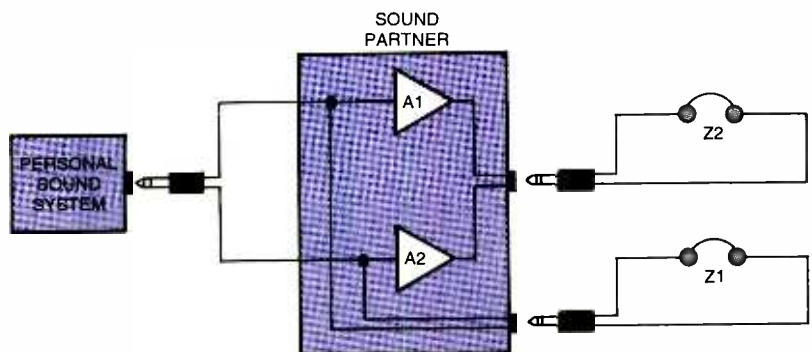

Fig. 2. The *Sound Partner* is configured such that audio from a personal sound system is fed to the headphones connected to J1 without modification, while the same two-channel audio is fed to a pair of amplifiers, which provide two-channel audio to a second set of headphones.

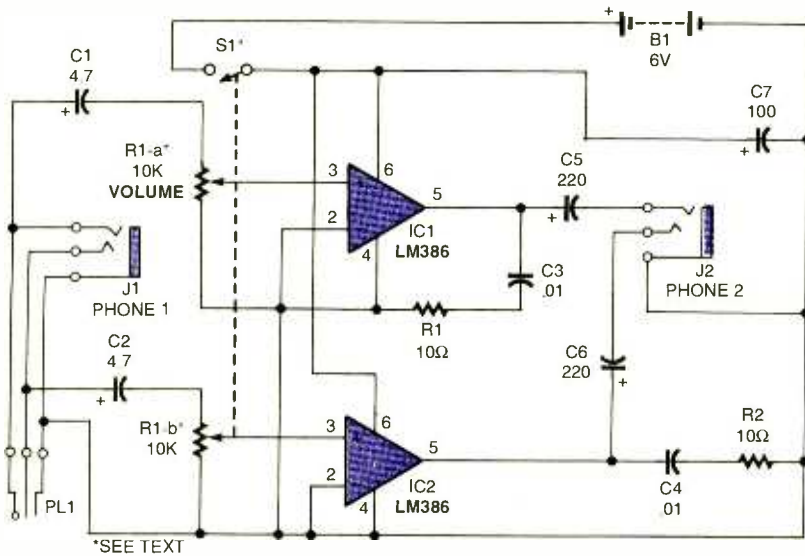

Fig. 3. The Sound Partner, which is built around a pair of LM386 low-power audio amplifiers (IC1 and IC2), can be used with headphones with impedances ranging from 16 to 100 ohms.

that audio from the personal sound system is fed to the input of the Sound Partner, where the signal is split into distinct and separate left and right channel signals that divide along two paths. In the first path (going to the first set of headphones), the unaffected signal is applied to J1. In the second path, the left and right channel audio is applied to a pair of low-power amplifiers. Because the two amplifiers have a very high impedance, the Sound Partner offers no loading to the personal sound system.

How It Works. A schematic diagram of the Sound Partner is shown in Fig. 3. The circuit, built around a pair of low-cost LM386 low-power audio amplifiers (IC1 and IC2), can be used with common headphones with impedances ranging from 16 to 100 ohms.

The audio from the portable sound system is routed through PL1 (a stereo phone plug) to the Sound Partner, where the stereo signal is broken down into its left and right channel components. The stereo (the left and right channel) audio is AC coupled through a pair of 4.7- μ F capacitors (C1 and C2) to volume control R1 (a 10k dual-ganged audio-taper potentiometer with a piggy-backed SPDT switch, S1). Capacitors C1 and C2 are used to prevent any DC from reaching the circuit. After signal level adjustment, the left- and right-channel

signals are fed to a pair of LM386 amplifiers, where the signal is ramped up to a level sufficient to drive a set of stereo headphones. The amplified outputs of IC1 and IC2 are routed through C5 and C6, respectively, to jack J2 and applied to the connected headphones.

Power for the Sound Partner is provided by a 6-volt power source, B1 (comprised of 4 AA-cell batteries). The source voltage is filtered by C7, a 100- μ F electrolytic capacitor, to establish a relatively ripple-free power source for the Sound Partner.

Construction. There is nothing critical about the construction of the Sound Partner, so the circuit can be put together using any assembly method with which you are comfortable. The author's prototype of the circuit was assembled on a

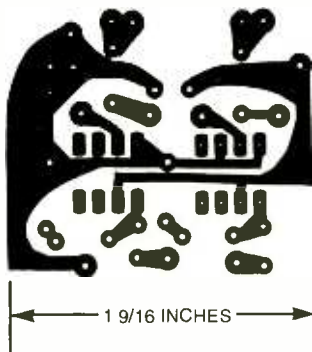

Fig. 4. The author's prototype of the circuit was assembled on a printed-circuit board, measuring 1 $\frac{9}{16}$ by 1 $\frac{7}{16}$ inches. A full-size template of the author's board is shown here.

printed-circuit board, measuring 1 $\frac{7}{16}$ by 1 $\frac{9}{16}$ inches. A full-size template of the author's printed-circuit layout is shown in Fig. 4.

Once you've obtained all of the components listed in the Parts List, construction can begin. If you intend to build the circuit on perf-board, using point-to-point wiring techniques, assemble the circuit using the schematic diagram (Fig. 3) as a guide. If you take a non-printed-circuit approach to assembling the circuit, be sure to pay strict attention to the electrical orientation of the polarized components. For those who prefer the printed-circuit approach, assemble the Sound Partner's printed-circuit board guided by the parts-placement diagram shown in Fig. 5. Note that with the exception of the input and output jacks, the batteries and battery holder, and the volume control (R1), all of the components mount to the printed-circuit board. The off-board components can be wired to the rest of the circuit using 22- or 24-gauge stranded wire.

Note: If desired, separate components can be used in place of R1-a, R1-b, and S1. Once completed, the circuit can be housed in any plastic or other non-metallic enclosure, with the printed-circuit board fixed in position using a few (2 or 3) machine screws with nuts and washers. If the board is housed in a metallic enclosure, it is wise to mount the board on quarter-inch spacers to prevent shorting.

Prior to mounting the circuit board and off-board assembly into its enclosure, carefully drill holes at convenient locations in the enclosure wall(s) to accommodate the off-board components—S1, J1, J2, PL1, B1 (along with its 4 AA-cell battery holder), and R1 (the volume control). Be careful when drilling holes in a plastic enclosure: Too much pressure can cause the plastic to crack.

Testing. Once the circuit has been completely assembled, check your work for the usual construction errors—solder bridges, misoriented or mispositioned (e.g., improperly located) components, etc. When you are satisfied that the circuit contains no construction errors, it is

(Continued on page 79)

Market Center™

Paperback Books

GREAT BOOKS AT BUDGET PRICES

100 RADIO HOOKUPS
—#7—\$3.00

First published in May, 1923 this popular booklet went into reprint editions nine times. It is packed with circuits, theory, antenna installation and tips on consumer radio receivers that were popular in the early 1920's. Antique radio buffs and those inquisitive about the early days of radio will find this booklet an exciting, invaluable and excellent reference into the minds of early-day radio listeners. Sorry, we cannot honor the original 25-cent cover price.

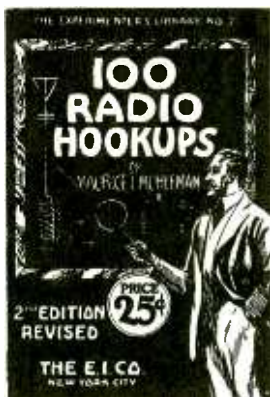

GUIDE TO THE WORLD'S RADIO STATIONS
—BP355—\$7.99

An easy-to-read guide for the casual listener and top notch QSL getter! The Guide is an essential reference work designed to steer the listener around the ever more complex radio bands. Listings cover world-wide shortwave stations with a special emphasis on international broadcasts in English. Medium and long-wave listings are also included for the US, Canada, European, Middle and Near East, and North Africa regions

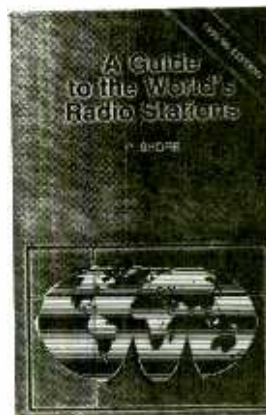

THE INTERNET AND WORLD WIDE WEB EXPLAINED —BP403—
\$7.99

Strip away the hype and mystery of the WWW and you'll be cruising on the information Superhighway! Understand the jargon used: ftp, protocols, TCP, hypertext, http, URL, home pages, threads, HTML, domains, FAQs, etc. Discover that e-mail is easy, fast and free! Learn how to guard against hackers and viruses. Develop friendships and "buddies" in Singapore, India, Cape Town, Peru—just about anywhere!



WIRELESS & ELECTRICAL CYCLOPEDIA
—ETT1—\$4.99

A slice of history. This early electronics catalog was issued in 1918. It consists of 176 pages that document the early history of electricity, radio and electronics. It was the "bible" of the electrical experimenter of the period. Take a look at history and see how far we have come. And by the way, don't try to order any of the radio parts and receivers shown, it's very unlikely that it will be available.

ELECTRONIC TECHNOLOGY TODAY INC.
P.O. BOX 240, Massapequa, NY 11762-0240

Name _____
Address _____
City _____ State _____ Zip _____

SHIPPING CHARGES IN USA AND CANADA

\$0.01 to \$5.00\$2.00
\$5.01 to \$10.00\$3.00
\$10.01 to 20.00\$4.00
\$20.01 to 30.00\$5.00
\$30.01 to 40.00\$6.00
\$40.01 to 50.00\$7.00
\$50.01 and above\$8.50

SORRY No orders accepted outside of USA & Canada

Number of books ordered

Total price of merchandise \$ _____
Shipping (see chart) \$ _____
Subtotal \$ _____
Sales Tax (NYS only) \$ _____
Total Enclosed \$ _____

All payments must be in U.S. funds!

ET01

Turn Your Multimedia PC into a Powerful Real-Time Audio Spectrum Analyzer

Features

- 20 kHz real-time bandwidth
- Fast 32 bit executable
- Dual channel analysis
- High Resolution FFT
- Octave Analysis
- THD, THD+N, SNR measurements
- Signal Generation
- Triggering, Decimation
- Transfer Functions, Coherence
- Time Series, Spectrum Phase, and 3-D Surface plots
- Real-Time Recording and Post-Processing modes

Applications

- Distortion Analysis
- Frequency Response Testing
- Vibration Measurements
- Acoustic Research

System Requirements

- 486 CPU or greater
- 8 MB RAM minimum
- Win. 95, NT, or Win. 3.1 + Win.32s
- Mouse and Math coprocessor
- 16 bit sound card

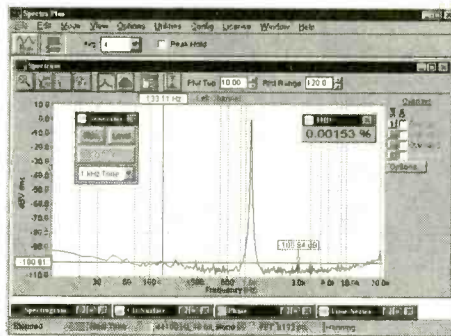

Priced from \$299

(U.S. sales only – not for export/resale)

DOWNLOAD FREE 30 DAY TRIAL!

www.spectraplus.com

PHS Pioneer Hill Software
24460 Mason Rd.
Poulsbo, WA 98370
a subsidiary of Sound Technology, Inc.



Spectra Plus
FFT Spectral Analysis System

Sales: (360) 697-3472

Fax: (360) 697-7717

e-mail: pioneer@telebyte.com

Call Today And **SAVE!** **Unbeatable PRICES!**

CABLE TV

**DESCRAMBLERS
CONVERTERS • FILTERS
VIDEO STABILIZERS**

FREE ➤ 30 Day Trial
FREE ➤ Product Catalog
FREE ➤ 1 Year Warranty

100% MONEY BACK GUARANTEE



Let us point you in the right direction ...

Arrow
Technologies
Omaha, Nebraska

**TOLL FREE
888-554-ARROW**

888-554-2776

ATTENTION DEALERS: WHOLESALE ONLY!



**BEST PRICES!
FAST SERVICE
SAME DAY SHIPPING**

EXCLUSIVE:

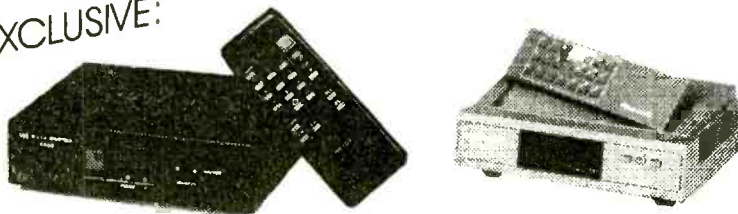

2 PIECE SETUPS: \$85⁰⁰

10 lot • 1 Year Warranty

**Latest Technology • Universal Combo's - Ask For Details
CALL US LAST! LOWEST PRICES GUARANTEED!**

**TOLL FREE:
800-375-3682**



**FAX:
516-246-5634**

ELECTRONIC COMPONENTS



Visit our web site!
www.mouser.com

Subscribe, download, or
view catalog online!

- Over 87,000 Products
- More than 145 Suppliers
- Same Day Shipping
- No Minimum Order

800-992-9943

817-483-6828 Fax: 817-483-6899
catalog@mouser.com

958 North Main St., Mansfield, TX 76063

CIRCLE 165 ON FREE INFORMATION CARD

Any waveform you want!



New Features:

- ✓ 21.5 MHz
- ✓ .01 Hz steps
- ✓ multi-unit phaselock

Telulex Inc. model SG-100A

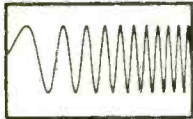

DC to 21.5 MHz linear and log sweeps



Int/Ext AM, SSB, Dualtone Gen.

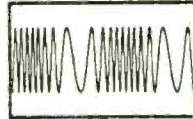

Int/Ext FM, PM, BPSK, Burst

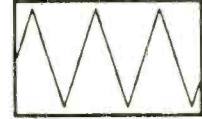

Ramps, Triangles, Exponentials

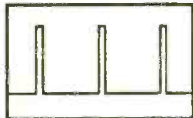

Pulse Generator



Noise

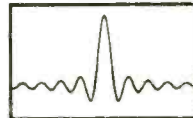

Arbitrary Waveforms



Unlimited Possibilities!

- **Synthesized Signal Generator**
Clean sinewaves DC-21.5 MHz, .001% accuracy!
.01 Hz steps. DC Offset. RS232 remote control.
- **Arbitrary Waveform Generator**
40 Megasamples/Second. 32,768 points. 12 bit DAC
- **Function Generator**
Ramps, Triangles, Exponentials & more to 2 MHz!
- **Pulse Generator**
Digital waveforms with adjustable duty cycle

Telulex Inc.

2455 Old Middlefield Way S Tel (650) 938-0240 <http://www.Telulex.com>

Mountain View, CA 94043 Fax (650) 938-0241 Email: sales@Telulex.com

CIRCLE 137 ON FREE INFORMATION CARD



The 5300 Series, one of the world's finest digital multimeters. The best of the ASYC II Series, it has the best accuracy, a built-in counter, and displays AC voltage as resistive power or dB (impedance selectable), saving you the time of making the calculation. A careful examination of the performance features and user-conscious design will tell you that you hold a superior DMM in your hand, designed with measurement capability needed by users who demand the best.

MFG	MODEL	ACC'Y	LIST	SPECIAL PRICE
B&K	5360/MX53B	0.1%	\$229.00	\$129.00
B&K	5380/MX55	0.025%	\$309.00	\$139.00
B&K	5390/MX56B	0.025%	\$325.00	\$149.00

(resistive power on model #5390/MX56B)

- meters made in France by Metrix for B&K, feature 50,000 count capability, bargraph, true RMS, mains disturbance indication, good transient protection, a wide temperature range, conform to IEC 1010 class 2 safety compliance and feature a 3 year warranty

PRINTTM
Products International

8931 Brookville Rd * Silver Spring, MD, 20910

800-638-2020 * Fx 800-545-0058 * www.prodintl.com * sales@prodintl.com

Call, fax or email today for complete specs, a free B&K Precision catalog, and a copy of our 84 page test and measurement instrument catalog

CIRCLE 153 ON FREE INFORMATION CARD

EARN MORE MONEY!

Be an FCC LICENSED ELECTRONIC TECHNICIAN!



No costly school. No commuting to class. The Original Home-Study course prepares you for the "FCC Commercial Radiotelephone License." This valuable license is your professional "ticket" to thousands of exciting jobs in Communications, Radio-TV, Microwave, Maritime, Radar, Avionics and more... even start your own business! You don't need a college degree to qualify, but you do need an FCC License.

No Need to Quit Your Job or Go To School
This proven course is easy, fast and low cost! **GUARANTEED PASS**—You get your FCC License or money refunded. **Send for FREE facts now. MAIL COUPON TODAY!**

Or, Call 1-800-932-4268 Ext. 240

COMMAND PRODUCTIONS
FCC LICENSE TRAINING, Dept. 240
P.O. Box 2824, San Francisco, CA 94126
Please rush FREE details immediately!

NAME _____
ADDRESS _____
CITY _____ STATE _____ ZIP _____

Development Boards, Microcontrollers, Kits,
Control and Measurement

Development, Prototype and Testing

- JCM Vulcan Logic Trainer: Design and test digital circuits in minutes with this trainer and a breadboard. \$32
- JCM Advanced dig daughterboard \$39
- JCM Analog Trainer: Use on its own, or to complement to the logic trainer. test analog circuits in minutes. \$45
- UTI PIC-Micro Trainer: This system gives you the flexibility to test and experiment with micro based designs, includes a 64K-bit non-volatile E² mem. and RS-232 and RS-485 drivers. \$129
- UTI Control Trainer: Real world interface for the trainer series. with inputs and outputs for measurement and control. analog cond. relays. buffered dig I/O. and more. \$69
- JCM Cybug1 kit, a great little robot kit for the hobbyist \$32
- Prototyping breadboard to fit the above

Serial Control and Measurement

- UTI-XX-232,485 Series: measure Inputs and trigger events over serial. uses simple ASCII protocol \$99-\$299
- UTI-05-XXX: 0-5VDC 4 channel 8 bit A/D
- UTI-DI-XXX: 0-30VDC 4 channel digital Input. adjustable trigger level
- UTI-OC-XXX: 8 channel open collector outputs. opt 5V pull-up. drive relays or solenoids
- UTI-RE-XXX: 4 SPDT relays w/ 2A contacts
- UTI-PM-XXX: 2 channel PWM output with two buffered digital outputs. good for motor control apps. opt H-bridge version
- UTI-WM-XXX: ambient temperature and relative humidity. 8 bit resolution
- More available....
- UTI- 232-485: Speak to an RS-485 device with your PC. extend 500' to other serial devices, or chain several UTI-XX-485 devices. \$129

Microcontroller Boards and Interfaces

- These boards include voltage regulation, 64K-bit serial E², RS-232 and RS-485 drivers. interface with screw terminals and/or stackable expansion headers.
- UTI-P76F: A flash PIC micro dev board \$169
 - UTI-11A1: A 68HC11 based 5BC \$189
- Some interfaces available: \$49-\$99
- 4 and 8 channel analog zero and span cct
 - 8 SPDT relays with 2A contacts
 - 2A dual H-bridge for motors and solenoids
 - Audio capture. 2-4 min of audio
 - Micro modem rates @ 2400 - 28.8
 - LCD. 2 line x 16 char. and 4 line x 20 char
 - Ambient temperature and relative humidity
- UTI-I2CM-XXX-X: Non-volatile I²C memory boards (up to \$12K per board!) \$39

Other Exciting Products

- UTI-WC1: Serial CCD Camera. Board level. takes serial commands through RS-232 at up to 115K Baud. returns CCD data in various res. Great for pics and experimenting. PC 5W incl. \$249
- UTI-SCL: WinCam.Live. Serial port based webcam system for your PC. \$499
- UTI-SCP: SecureCam Pro. Remote access surveillance camera. event trigger. motion detection. outdoor encl. available \$599
- UTI-ACC: Capture and play 2-4 min of audio. line level input. dry contact trigger \$129
- UTI-MP-XXX: serial RS232 radios. 900MHz narrow band RF. ch selectable. 1000' range outdoor. combine with our control and measurement products for a telemetry system. \$519

* All prices in US\$

**Shipping and handling not included

We also provide affordable electronic design, consulting, assembly, and product development.



UTI
Unbound
Technologies Inc.
1-877-UNBOUND
(1-877-862-6863)

#25-1725 30 Ave NE Calgary, Alberta, CANADA T2E 7P6
Tel: 403-291-0054 Fax: 403-291-0017
Payment by Cash, Chk, MO, COD
Call us to receive details via fax, mail or email.

Learn MICROCONTROLLERS EMBEDDED SYSTEMS and PROGRAMMING...

...with the AES learning system/ embedded control system. Extensive manuals guide you through your development project. All programming and hardware details explained. Complete schematics. Learn to program the LCD, keypad digital, analog, and serial I/O. for your applications.



THREE MODELS AVAILABLE. Choose from an Intel 8051, Intel 8088, or Motorola 68HC11 based system. All models come with:

- 32K Byte ROM, 32K Byte RAM • 2 by 16 Liquid Crystal Display • 4 by 5 Keypad • Digital, Analog, and Serial I/O • Interrupts, timers, chip-selects • 26 pin expansion connector • Built-in Logic Probe • Power Supply (can also be battery operated) • Powerful ROM MONITOR to help you program • Connects to your PC for programming or data logging (cable included) • Assembly, BASIC, and C programming (varies with model) • Program disks with Cross Assembler and many, well documented, program examples • User's Manuals: cover all details (over 500 pages) • Completely assembled and ready to use • Source code for all drivers and MONITOR • Optional Text Book

Everything you need. From \$279.
Money Back Guarantee

Call for Free Info Pack, or see
WEB at <http://www.aesmicro.com>
714-550-8094, FAX 714-550-9941



Call 1-800-730-3232

AES 575 ANTON BLVD., SUITE 300, COSTA MESA, CA 92626, USA

Dalbani

www.dalbani.com

Computer Cases

Lexon®
\$45⁹⁹

Nickel Chassis
with built in
250 power
supplies
7 ATX Slots
7 AT Slots

FCC Approved

Item # 95-4025



Amplifiers

\$19⁹⁹

120 Watt
Separate
Bass/Treble Switch

Item # 89-3470



Soldering Station

\$34⁹⁵

Variable Power
Control (5-40W)
Interchangeable Tip
& Heating Element

Item # 51-1505



Weller

RCA

Video Tapes

\$1²⁵

Min. 10
pieces

6 Hours
Hi-Fi Sound

Item # 50-1005



F-Quick Cable

\$2⁷⁵

Gold Plated
3ft.,
75Ω

Item # 17-7395



MAGNAVOX

Remote Control

\$5⁹⁵

Min. 5 pieces
Controls
3 Units
TV, VCR,
Cable Box

Item # 82-1380



SONY

PlayStation

\$24⁹⁵

Minimum
3 pieces

Laser Pickup

Original Sony# KSM-440ACM

Item # 46-4720



GEMINI II

Power Strip

\$3⁹⁵

25 Joules
6 Outlets

Item # 40-1755



Multimeters

\$7⁹⁵

6 Functions
19 Ranges
9V Battery
Included

Item #
50-2895



Clearance

\$24⁹⁵

Aluminum frame
Tool Case

Item # 50-1890 Black



CALL TOLL FREE

e-mail: savings@dalbani.com

1-800-325-2264

SPECIAL SHIPPING RATE

\$20.00
Minimum Order
not including shipping & handling

UPS
2ND DAY AIR.

3⁹⁵ plus shipping
and handling

Up to 5 lbs anywhere in the U.S.A.
Excluding Alaska, Hawaii & Puerto Rico.

CIRCLE 164 ON FREE INFORMATION CARD

www.americanradiohistory.com

CALL TOLL FREE
(800) 292-7711
Orders Only
 Se Habla Español

C&S Sales

Excellence in Service

**Look For Other
 Monthly Specials
 On Our Website**
www.cs-sales.com

Power Supplies

Elenco Quad Power Supply Model XP-581

\$79.95



4 Fully Regulated DC Power Supplies In One Unit

4 DC voltages: 3 fixed - +5V @ 3A, +12V @ 1A, -12V @ 1A
 1 Variable - 2.5 - 20V @ 2A

Elenco Power Supply Kit Model XP-720K

\$54.95

- 1.5VDC - 15VDC @ 1A
- -1.5VDC - -15VDC
- 5VDC @ 3A
- 6.3VAC @ 1A & 12.6VAC center tapped @ 1A



XP-720 Fully Assembled **\$85**

Elenco DC Power Supply

Model SPL-603
 3A 0-30VDC

\$79.95



The SPL-603 is a solid-state DC power supply providing the exact output voltage no matter what current you use. It contains one fully regulated power supply. The variable voltage is capable of delivering 0-30V at up to 3A. The output is precisely held to the desired output voltage by a special regulating circuit. Output fully protected from overload.

Miscellaneous

Elenco Model EP-50

Electronic Playground
 and Learning Center
 Contains Over 50
 Experiments

\$19.95

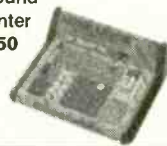

Elenco Model XK-150

Digital/Analog
 Trainer

\$89.95

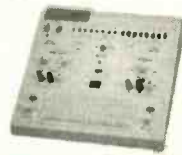

Ideal for Schools

Elenco Model MX-9300 Four Functions In One



\$450

Features:

- One instrument with four test and measuring systems:
- 1.3GHz Frequency Counter
- 2MHz Sweep Function Generator
- Digital Multimeter
- Digital Triple Power Supply - 0-30V @ 3A, 15V @ 1A, 5V @ 2A

Generators & Counters

Elenco Sweep Function Generator w/ built-in frequency counter Model GF-8036



\$225

This sweep function generator with counter is an instrument capable of generating square, triangle, and sine waveforms, and TTL, CMOS pulse over a frequency range from 0.2Hz to 2MHz.

10 Function 1.3GHz Universal Counter Elenco Model F-1300

- Frequency .05Hz - 1.3GHz 3 Ranges
- Period - Can read 60Hz to 60,000,000 F=1/T
- Totals - Counts to 199,999,999
- RPM - 3 to 2099994 RPM
- Duty Cycle
- Max/Min/AVG with Time
- Stop-watch set 2 sec. to 100 hrs.
- Math Functions
- Timer - 2 sec. to 99 days
- Pulse Width - 0.1ms to 66666.6ms

\$225

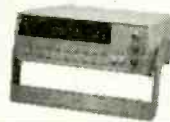

Multifunction Counter B&K Model 1875



\$189

Ultra sensitive
 synchronous
 detector bar-
 graph and RF
 strength.
 3 Channels

Elenco Handheld Universal Counter 10Hz - 2.8GHz Model F-2800



\$99

Features 10 digit display, 16 segment and RF signal strength bar-graph.
 Includes antenna, NiCad battery, and AC adapter.

Elenco RF Generator with Counter (100kHz - 150kHz) Model SG-9500



Features internal AM mod. of 1kHz, RF output 100MV - 35MHz. Audio output 1kHz @ 1V RMS.

\$225

SG-9000 \$119.95
 (analog, w/o counter)

B&K 20MHz Sweep/Function Generator with Frequency Counter Model 4040

- 0.2Hz to 20MHz
- AM & FM modulation
- Burst Operation
- External Frequency counter to 30MHz
- Linear and Log sweep

\$399



BK PRECISION

10MHz Model 4017 **\$309**
 5MHz Model 4011 **\$249**

Measures Frequency, Period, Data Hold, Relative, Memory (min., max., average). High Sensitivity, Microprocessor Controlled.

Kit Corner

over 100 kits available

Model AK-870

Radio Control Car Kit

\$24.95

- Solderless
- 7 Functions
- Radio Control Transmitter Included



Model AK-700

Pulse/Tone
 Telephone Kit

Ideal
 School
 Project



\$15.95

Model AM/FM-108K

AM/FM
 Transistor
 Radio Kit
 w/ Stand

\$29.95

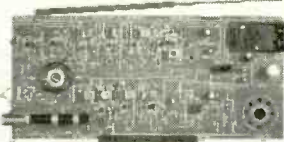

Elenco Digital / Analog Trainer

Model XK-700

Elenco's newest advanced Digital / Analog Trainer is specially designed for school projects. It is built on a single PC board for maximum reliability. It includes 5 built-in power supplies, a function generator w/ continuously sine, triangular and square waveforms, 1,560 tie point breadboard area. Tools and meter shown optional. (Mounted in a professional tool case made of reinforced metal).



XK-700
 Assembled & Tested
\$189.95

XK-700K - KH
\$159.95

Made in USA

Guaranteed Lowest Prices

UPS SHIPPING: 48 STATES 5%
 OTHERS CALL FOR DETAILS
 IL Residents add 8.25% Sales Tax

C&S SALES, INC.

150 W. CARPENTER AVENUE
 WHEELING, IL 60090
 FAX: (847) 541-9904 (847) 541-0710

15 DAY MONEY BACK GUARANTEE
2 YEAR FACTORY WARRANTY

PRICES SUBJECT TO CHANGE WITHOUT NOTICE

SAME DAY SHIPPING

C&S Sales

Excellence in Service

CALL OR WRITE FOR OUR FREE

**64 PAGE CATALOG!
(800) 445-3201**

Digital Multimeters

Elenco LCR & DMM Model LCM-1950



12 Functions
Freq. to 4MHz
Inductance
Capacitance
and Much More

\$69

Elenco Model M-1740



\$39.95

11 Functions:
• Freq. to 20MHz
• Cap. to 20µF
• AC/DC Voltage
• AC/DC Current
• Beeper
• Diode Test
• Transistor Test
• Meets UL-1244 safety specs.
Model M-2760 - \$24.95 (9 functions)

Fluke 79III



\$185

• Capacitance ranges from 99.99nF to 9999µF.
• Built-in frequency counter of voltage input from 1Hz to over 20kHz.
• Lo-Ohms range, a 40Ω range with Fluke's proprietary Zero Calibration, offers 0.01 resolution with increased noise rejection.
Series II (limited qty.)
\$179

Fluke 87III



\$299

Features high performance AC/DC voltage and current measurement, frequency, duty cycle, resistance, conductance, and capacitance measurement.
Series II (limited qty.)
\$289

Elenco Model LCR-1810



\$99.95

• Capacitance .1pF to 20µF
• Inductance 1µH to 20H
• Resistance 01Ω to 2000MΩ
• Temperature to 750°C
• DC Volts 0 - 20V
• Frequency up to 15MHz
• Diode/Audible Continuity Test
• Signal Output Function
• 3 1/2 Digit Display

Elenco Model M-1005K



\$14.95

Digital Multimeter Kit
• 18 Ranges
• 3 1/2 Digit LCD
• Transistor Test
• Diode Test

M-1000B (Assembled) **\$14.95**

Dual-Display LCR Meter w/ Stat Functions B&K Model 878



\$219.95

Auto/manual range
Many features with Q factor
High Accuracy

B&K Model 5390



\$295

• 50,000 Count
• 0.025% DCV
• True RMS, AC or AC+DC
• 0.07% ohms
• 100kHz AC Response
• Autoranging, Bargraph with Zoom.
• Capacitance to 50,000µF
• Frequency, Duty Cycle, Pulse Width
• dB across 1Ω to 10kΩ
• Disturbance Indicator

Oscilloscopes

Free Dust Cover and 2 Probes



S-1325	25MHz	Dual Trace	\$325
S-1330	25MHz	Delayed Sweep	\$439
S-1340	40MHz	Dual Trace	\$475
S-1345	40MHz	Delayed Sweep	\$569
S-1360	60MHz	Delayed Sweep	\$749
S-1390	100MHz	Delayed Sweep	\$995

DIGITAL SCOPE SUPER SPECIALS

DS-203	20MHz/10Ms/s	Analog/Digital	\$695
DS-303	40MHz/20Ms/s	Analog/Digital	\$995
DS-603	60MHz/20Ms/s	Analog/Digital	\$1295

TEKK Radios

Pro-Sport FRS Two-Way Radio Model PRO-SPORT+

Both Models Available in Yellow, Blue & Black

Talk up to 2 miles!

Model PRO-SPORT

- 1/2 Watt Output, 14 Channels.
- TX LED Indicator.
- Removable Belt Clip.
- Highly Water Resistant.
- Economy Type
- No License Required!

\$68.00 each or 2 for \$109.95



No License Required

Model PRO-SPORT +

- 1/2 Watt Output, 14 Channels.
- TX & RX LED/LCD Indicators.
- Large LCD Display.
- 38 Privacy (CTCSS) Tones.
- Plus All Features of Pro-Sport Model.

\$79.00 each or 2 for \$149.95



Elenco Technician Tool Kit

Model TK-1500 **\$49.95**

28 tools plus a DMM (M-1000B) contained in a large flexible tool case with a handle ideal for everyone on the go.

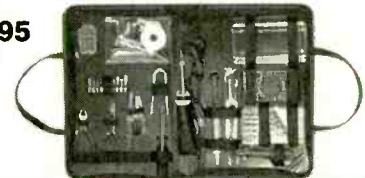

Guaranteed Lowest Prices

UPS SHIPPING: 48 STATES 5%
OTHERS CALL FOR DETAILS
IL Residents add 8.25% Sales Tax

SEE US ON THE WEB

C&S SALES, INC.

150 W. CARPENTER AVENUE
WHEELING, IL 60090

TEL: (847) 541-9904 (847) 541-0710

FAX: (847) 541-9904 (847) 541-0710
www.cs-sales.com



15 DAY MONEY BACK GUARANTEE
2 YEAR FACTORY WARRANTY

PRICES SUBJECT TO CHANGE WITHOUT NOTICE

CIRCLE 32 ON FREE INFORMATION CARD

LEADER

For Professionals Who Know The Difference

- Oscilloscopes
- Video Sync/Test Generators
- Waveform Monitors/Vectorscopes
- EFP/ENG Instruments
- RF Signal Level Meters
- Audio Generators & Meters
- Frequency Counters
- Meters & Bridges
- Power Supplies
- Function Generators
- RF Generators



Test Instruments, Equipment, Tools & Supplies For Electronic Production, Maintenance & Service
8931 Brookville Road, Silver Spring, MD, 20910 * 800-638-2020 * Fax 800-545-0058

CIRCLE 143 ON FREE INFORMATION CARD

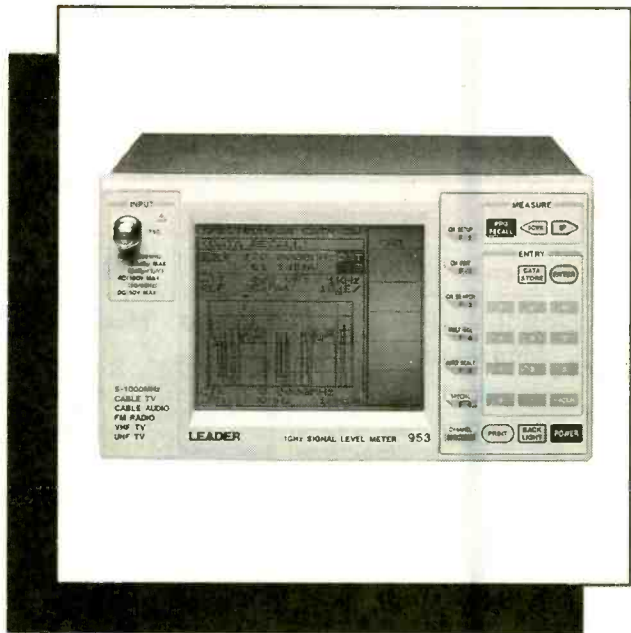

Call, fax or email for your free test and measurement instrument catalog today!
800-638-2020 * Fax 800-545-0058
www.prodintl.com

CONTROL MEASURE INPUT

RELAYS • LIGHTS • MOTORS
TEMPERATURE • PRESSURE • LIGHT LEVELS • HUMIDITY
SWITCH POSITIONS • THERMOSTATS • LIQUID LEVELS

MODEL 30 \$79



- PLUGS INTO PC BUS
- 24 LINES DIGITAL I/O
- 8 CHANNEL-8 BIT A/D / IN
- 12 BIT COUNTER
- UP TO 14K SMP/SEC

MODEL 45 \$189



- RS-232 INTERFACE
- 8 DIGITAL I/O
- 8 ANALOG INPUTS
- 2 ANALOG OUTPUTS
- 2 COUNTERS-24 BIT

MODEL 100 \$279



- 12 BIT 100 KHZ A/D
- 4 ANALOG OUTPUTS
- 3 TIMER COUNTERS
- 24 DIGITAL I/O

MODEL 150-02 \$179



- RS-232 INTERFACE
- TRMS, 20 AMPS
- 12 BIT A/D
- OPTO-ISOLATED
- COMPLETE DMM

MODEL 40 \$109

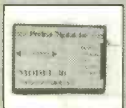

- RS-232 INTERFACE
- 28 LINES DIGITAL I/O
- 8 ANALOG INPUTS
- PWM OUTPUT

MODEL 70 \$239



- RS-232 INTERFACE
- 16 BIT A/D
- 5.5 DIGIT
- UP TO 60 SMP/SEC

Prairie Digital, Inc.

PHONE 608-643-8599 • FAX 608-643-6754

200 SEVENTEENTH STREET • PRAIRIE DU SAC, WISCONSIN 53978

CIRCLE 150 ON FREE INFORMATION CARD

DATA ACQUISITION & CONTROL

AFFORDABLE PLUG-IN BOARDS FOR PC's ISA BUS

ANA100 Analog I/O \$ 99



- 8 Channel 8-Bit
- 0 to 5 Volt Input
- 14 TTL I/O lines
- Analog Output
- 400KHz Sampling

DIG100 Digital I/O \$ 39



- 82C55 PPI
- 24 or 48 TTL I/O Lines option
- Selectable Base Address

ANA150 Analog/Counter... \$ 89



- 8 Channel 8-Bit
- 0 to 5 Volt Input
- 3 16-Bit Counters
- 400KHz Sampling

DIG200 Counter I/O \$ 79



- 3 16-Bit Counters
- 8 TTL Input lines
- 8 TTL Output lines
- Selectable Clock Frequency input

ANA200 Analog I/O \$ 79



- 1 Channel 12-Bit
- 0 to 5 Volt Input
- optional bi-polar
- 100KHz / 300KHz Sampling rate
- 24 TTL I/O lines

ANA201 Analog \$ 119



- 8 Channel 12-Bit
- x1, x5, x10, x50 Programmable Channel gain
- 100KHz Sampling rate

On-Line Product Catalog at Our Web Site
<http://www.Bsof.com>
E-Mail: Sales@Bsof.com

BSOFT Software, Inc.

444 COLTON ROAD * COLUMBUS, OH 43207
PHONE 614-491-0832 * FAX 614-497-9971

Top Secret! FORBIDDEN KNOWLEDGE

The Hack & Crack Bible
Book & CD-ROM
Everything you've always wanted to know about hacking, but everyone was afraid to publish. Only \$29.95!

Secrets of DSS
Book & CD-ROM
Hundreds of channels, and you can't get them all...until now! Learn the secrets of DSS! Only \$29.95!

PIC Projects
Book & CD-ROM
The perfect PIC primer, complete with detailed instructions, full explanation, schematics, programming software & source code. Only \$29.95!

Home Automation
Book & CD-ROM
Control every appliance in your home from one central location...or even remotely! The local control module doesn't even require a computer! Only \$29.95!

Virtual Reality
Book & CD-ROM
Ever want to just reach inside your computer and grab something? Learn how to construct and use your own VR interface devices! Do it like the pros! Only \$29.95!

Secrets of Free Cable
Book & CD-ROM
From test chips and boxes to line traps for stopping the "magic bullet" - everything you need to know to enhance your cable viewing experience! Only \$29.95!

- Free Energy \$19.95
- Anti-Gravity \$19.95
- Home-Brew Lasers \$24.95
- PlayStation Secrets \$29.95
- The Moon: NASA's Secrets! ... \$19.95
- Testa/High Voltage \$29.95
- Secrets of UFOs \$19.95
- True Origins of Man \$29.95
- Earth-Mars Connection \$19.95

We accept the following:   

1-800-773-6698
or visit us on the web @ <http://www.worldwyde.com>

Since 1971 **www.WEB-TRONICS.com** You'll "Bookmark" This Site!

Circuit Specialists Inc.

B/W Board Camera with Infra-Red
ONLY \$59
Part #VMCB-21
And that's not all!

Full-Sized, Full Featured DMM
ONLY \$19
Part #9300G
Even includes the rubber boot

Hard Drive Slide Rack for 3.5" IDE Drives
ONLY \$14.95
Part #RH-10C-IDE
Allows for easy removal of hard drives. Includes key-lock!

Color Board Cameras with Audio Function
ONLY \$144
Part #VM3010-A
We also have great deals on bullet (B/W & color) cameras, pinhole cameras (B/W & color), some with audio. Get specs, details & prices from our web site.

Electronic Soldering Station with Ceramic Heating Element, 3-Conductor Grounded Power Cord, 250-480°C (470-900°F) Fast Heating
ONLY \$39
Part #SR-976
Extra tip selection on our web site.

Get all of the specifications and details on these items and thousands of other electronic components, test equipment, PCB supplies, computer parts, and much much more at www.web-tronics.com

Secure on-line ordering, or by FAX, toll free, or snail mail. Please check our web site for the latest prices.

Circuit Specialists, Inc.
800-528-1417/(602)464-2485
FAX (602)464-5824

ALFA ELECTRONICS

HIGH QUALITY TEST EQUIPMENT

Visit www.alfaelectronics.com for complete info
Call 1-800-526-2532 for Order and Free Catalog

DMM	TOP/COUNTER	FLUKE	SPECIALTY
<p>DMM-895 (\$179.00): true rms, AC/DC (V,A), Ω, bar graph, freq, capac, dBm, logic, diode</p> <p>DMM-231 (\$99.95): 4 1/2 digit, true rms, high resol (10μV, 10nA, 10mΩ), hFE, diode, contin.</p> <p>DMM-20 (\$74.95): AC/DC (V, A), Freq, cont., Capac, Induct., Ω, hFE, diode, duty cycle</p> <p>DMM-122 (\$59.95): DC/AC(V,A), Ω, hFE, diode, capacitance, freq, logic, continuity</p> <p>DMM-123 (\$44.95): DMM + capacitance, DC/AC(V,A), Ω, hFE, diode, continuity</p> <p>DMM-10 (\$19.95): 3 1/2 digit, DC/AC V, Ω, hFE, diode, signal output(+3V,-0.5Vsq, 50% duty)</p>	<p>CAP-150 (\$49.95): 3 1/2 digit, 0.1pF-20mF, 9 Ranges, 0.1pF resolution, zero adjustment.</p> <p>LCR-24 (\$119.95): 0.1μH-200H, 0.1pF-2000μF, 0.01Ω-20MΩ, diode test. <i>New Model.</i></p> <p>LCR-131D (\$219.95): autorange, 0.1μH-10kH, 0.1pF-10mF, 1mΩ-10MΩ, Q Factor, serial/parallel, 120Hz/1kHz testing mode.</p> <p>FC-1200 (\$129.95): 1.25GHz Handheld, 8 digits display, 10ppm accuracy, sensitivity 5mV (130-350MHz), 30mV (440MHz)</p>	<p>12B \$ 94.95</p> <p>70-III \$ 99.00</p> <p>73-III \$125.00</p> <p>75-III \$155.00</p> <p>77-III \$173.00</p> <p>79-III \$195.00</p> <p>87-III \$325.00</p> <p>92B-III \$1,445</p> <p>96B-III \$1,695</p> <p>99B-III \$2,095</p> <p>105B \$2,495</p> <p>123-III \$1,130</p> <p>863E \$555</p> <p>867B \$740</p>	<p>• AC Current Probe \$34.95</p> <p>• DC/AC Current Probe \$79.95</p> <p>• Mini AC Clamp \$59.95</p> <p>• AC Clamp w/temp \$89.95</p> <p>• DC/AC Clamp \$109.95</p> <p>• Thermometer \$69.95-\$89.95</p> <p>• IR Thermometer \$189.95</p> <p>• Sound Level Meter \$169.95</p> <p>• Tachometer \$169.95-\$219.95</p> <p>• EMF Tester \$69.95</p> <p>• Pressure Meter \$299.95</p> <p>• Watt Meter \$129.95</p> <p>• High Voltage Probe \$59.95</p> <p>• pH Meter \$79.95</p> <p>• Light Meter \$79.95-\$89.95</p> <p>RF Generator • SG-4160 (\$124.95) 100kHz-150MHz sinewaves in 8 ranges</p> <p>• SG-4162AD (\$229.95) with 6 digit counter</p> <p>Audio Generator • AG-2601 (\$124.95) 10Hz-1MHz, 0.8Vpp sine, 0-10Vpp squarewave</p> <p>• AG-2603AD (\$229.95) with 6 digit counter</p> <p>Function Generator • FG-2100A (\$154.95) 0.2Hz-2MHz, 5mV-20Vpp</p> <p>• FG-2103 (\$329.95) Sweep 0.5Hz-5MHz</p>
Single Output DC Power Supplies			
<p>• Constant current, constant voltage mode</p> <p>• Short Circuit and overload protected</p> <p><i>Analog Meters Display</i> <i>Digital Volt, Analog Current</i></p> <p>PS-303 (\$159.00) 30V/3A PS-8200 (\$179.95) 30V/3A</p> <p>PS-305 (\$219.95) 30V/5A PS-8201 (\$239.95) 30V/5A</p> <p>PS-8112 (\$399.95) 60V/5A <i>Digital Volt & Current Display</i></p> <p>PS-1610 (\$289.00) 16V/10A PS-8300 (\$199.95) 30V/3A</p> <p>PS-8107 (\$399.95) 30V/10A PS-8301 (\$259.95) 30V/5A</p>			
Triple Output			
<p>• Independence or Tracking operation</p> <p>• Parallel to double current output (PS-8102 & PS-8103 only)</p> <p><i>Triple Output (Analog displays)</i></p> <p>PS-8102 (\$399.95) 30V/3A/30V/3A</p> <p>PS-8103 (\$489.95) 30V/5A/30V/5A</p> <p><i>Digital Displays</i></p> <p>PS-8202 (\$499.95) 30V/3A/30V/3A</p> <p>PS-8203 (\$549.95) 30V/5A/30V/5A</p>			
AUDIO/RF/FUNCT. GEN.			
<p>RF Generator • SG-4160 (\$124.95) 100kHz-150MHz sinewaves in 8 ranges</p> <p>• SG-4162AD (\$229.95) with 6 digit counter</p> <p>Audio Generator • AG-2601 (\$124.95) 10Hz-1MHz, 0.8Vpp sine, 0-10Vpp squarewave</p> <p>• AG-2603AD (\$229.95) with 6 digit counter</p> <p>Function Generator • FG-2100A (\$154.95) 0.2Hz-2MHz, 5mV-20Vpp</p> <p>• FG-2103 (\$329.95) Sweep 0.5Hz-5MHz</p>			
GW/INSTEK			
20 MHz Scope	Cursor Readout	Triple Output	Single Output
<p>• OS-620 \$324.95</p> <p>• Most economical scope</p> <p>• Dual CH/X-Y operation</p> <p>• 1mV/div sensitivity</p> <p>• Z-axis input, CH1 output</p> <p>• TV syn, ALT trigger</p> <p>• 2 probes (X1, X10)</p>	<p>• OS-626G \$599.95</p> <p>• <i>Readout & Cursor meas</i></p> <p>• Dual CH / Delay sweep</p> <p>• Built-in delay line</p> <p>• ALT trigger, Hold-Off</p> <p>• Z-axis input, CH1 output</p> <p>• 2 probes (X1, X10)</p>	<p>• 2 variable out 0-30V, 0-3A</p> <p>• One fixed 5V, 3A output</p> <p>• Auto track, serial, parallel</p> <p>• Const. volt, current mode</p> <p>• 4 analog or 2 digital display</p> <p>PC-3030 (\$499.95)</p> <p>PC-3030D (\$549.95) digital</p>	<p>• Const voltage, current mod</p> <p>• Voltage regulation <0.01%</p> <p>• Current regulation <0.2%</p> <p>PS-1830 (\$198.95) 18V/3A</p> <p>PS-1850 (\$214.95) 18V/5A</p> <p>PS-1830D (\$214.95) 18V/3A</p> <p>PS-1850D (\$244.95) 18V/5A</p>
DC POWER SUPPLIES			
<p>• Auto serial/parall (PPT ser)</p> <p>• Auto track (PPT series), IEEE-488.2 and SCPI compatible command set</p> <p>PPS-1860G (\$1,149.95) 18V/6A</p> <p>PPS-3635G (\$1,149.95) 36V/5A</p> <p>PPT-1830G (\$1,499.95) 18V/3A</p> <p>PPT-3615G (\$1,499.95) 36V/1.5A</p>	<p>FG-8020G (\$209.95)</p> <p>• 0.02Hz-2MHz w/counter</p> <p>FG-8020G (\$209.95)</p> <p>• 0.02Hz-2MHz w/counter</p> <p>FG-8050 (\$449.95) Sweep</p> <p>PPT-1830G (\$1,499.95) 18V/3A</p> <p>PPT-3615G (\$1,499.95) 36V/1.5A</p> <p>• INT/EXT AM/FM mod</p>	<p>DM-8034 (\$179.95) 3 1/2 dgt</p> <p>• AC/DC (V,A), Ω, diode</p> <p>DM-8040 (\$339.95) 3 1/2 dgt</p> <p>• ACV to 50kHz, true rms</p> <p>DM-8055G (\$889.95) 5 1/2 dgt</p> <p>• 0.006% accuracy, GPIB</p> <p>• dBm, auto, REL, min/max</p>	
FUNCTION GENERATOR			
BENCHTOP DMM			
<p>ALFA ELECTRONICS TEL: (800)526-2532 / (609) 897-1135 Call / Write / Fax / Email for FREE CATALOG</p> <p>P.O. BOX 8089 FAX: 609-897-0206 Visa, MC, AMEX, COD, PO Accepted. OEM Welcome.</p> <p>PRINCETON, NJ 08543-8089 E-mail: sales@alfaelectronics.com 1 Year Warranty (2 Years for GW/Instek)</p>			

July 1999, Popular Electronics

PLASMA BALLISTIC GUN

SHOOTS A HIGH VELOCITY PROJECTILE
 Uses New Technology to Generate High Propellant Pressure Without Chemical Reactions
 Velocities Up To 3000 m/sec with 50mg Projectile!!
 Easily Scaled Up or Down
 Easy to Build-Kit and Parts Available
 Approximately .16 Caliber Bore
PPR01 Plans, Parts Lists and Sources.....\$20.00



Includes Our HEP Series Plans Used for RAILGUNS, COIL GUNS, EMP LEVITATION, ANTIGRAVITY, MASS WARPING, LATTICE SNAPPING etc

BURNING LASER RAY GUN

BLASTS THRU THE HARDEST OF METALS!
 All Parts Available
 A FUTURISTIC CONCEPT!!
LAGUN2 Plans.....\$20.00



BURNING CO2 BENCH LASER

HOTTER THAN MOST TORCHES!
 Easy to Assemble
LC7 Plans.....\$20.00



TAKE CONTROL!! ELECTRONIC HYPNOSIS & MIND MACHINES

Electronic Circuitry Induces Hypnotic as Well as ALPHA Relaxed States of the Mind. Place Subjects "Under" Your Control. Enhances Hidden PSYCHIC Ability in Many People!
MIND Plans.....\$15.00
MIND2K Kit and Plans.....\$49.95
MIND20 Assembled.....\$89.95

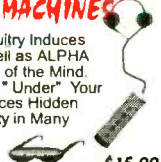

JACOBS LADDER

Observe a pyrotechnical display of "traveling" fiery plasma. Starts off as 1/2" arc and expands to over 3" before evaporating into space. This is an excellent attention getting display as well as a winning science project!! With arc control.



JACK1 Plans.....\$8.00
JACK1K Kit Minus Case.....\$129.95
JACK10 Ready to Use.....\$249.95
12KVGEN20 Pwr Supply Only.....\$99.95
12KVGEN2K Kit of Pwr Supply.....\$79.95

3Mi FM VOICE TRANSMITTER

Safety Product Allows Listening to Children or Invalids in Hazardous Areas, Pools, Ponds etc. Great Security Intrusion Alert! Uses FM Table Top Radio. Become the local neighborhood D.J.
FMV1K Kit/Plans.....\$39.95



ALL NEW CYBERNETIC EAR!

Enhances Normal Hearing 3 to 4 Times. Provides That Extra "Edge" for Hunters Trackers Nature Enthusiasts
 Adjustable Volume Control
 Fits Into Either Ear
 Built In Long Lasting Batteries
CYBEREAR Ready to Use.....\$19.95



MICRO TESLA COIL

Lights up a 4 ft Fluorescent Tube Without Contact!! Yet Only 3" Tall!
 Super Magic Trick
 Low Cost Science Project
 12 VDC/115 VAC Operation
MTC1K Kit/Plans.....\$19.95
MTC10 Ready to Use.....\$34.95



PHASOR PAIN FIELD PISTOL

Blast out rats and rodents with high power Shock Waves Handheld and Battery Operated
PPPI Plans.....\$8.00
PPPIK Kit/Plans.....\$49.50
PPPI10 Ready to Use.....\$79.50



HOVERBOARD PLANS

Kit Soon to be Available
 28 Pages of "how to" build a magnetic force field capable of containing a column of ionized air up to several psi! Includes theory on how to build a HOVERBOARD prototype capable of lifting 200 lbs.
HOVER Plans and Data.....\$25.00



TELEPHONE TAPING SYSTEM EXTENDED X4 PLAY

Tapes Both Sides of Phone Conversation - Check Laws!
TAP30X Ready to Use.....\$84.95
BEEP10 Beeper Alert.....\$29.95



TRANSISTORIZED TESLA COIL

Turns a Light Bulb into a Spectacular Plasma Display
 Transmits Wireless Energy. Brush and Corona Discharge. Noiseless Operation. Pyrotechnic Effect. 12 VDC/5 Amps or Battery 115 VAC Optional Converter. Adjustable Frequency Control For Effect.
 Shown With Oil Fill Options
TCL5 Plans.....\$8.00
TCL5K Kit/Plans.....\$59.95
TCL50 Ready to Use.....\$109.95
12DC/7 12VDC@7Amps.....\$39.95



1 800 221 1705 ORDERS ONLY! FAX 1 603 672 5406 INFO 9-5pm 1 603 673 4730 FREE CATALOG ON REQUEST
 Pay by MC, VISA, Cash, Chk, MO, COD. Please Add \$5.00 S&H plus \$5.00 if COD. Overseas Please Contact for PROFORMA

Electronic Training Videos

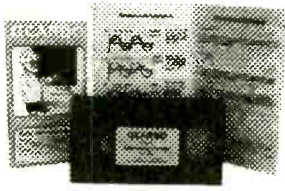

Learn electronics quickly and easily with UCANDO's computer-animated training videos. Students can learn at their own pace and professionals will find the UCANDO videos to be a valuable source of reference material. If these videos aren't the best learning tools you've ever seen, return them within 30 days for a complete refund. These videos are being used by Tech-Schools, CET's, Military Branches, Ham Operators, Industries, and more, across the United States and around the world. Order today and see how UCANDO is ...
"Changing The Way The World Learns Electronics."

VCR Maintenance & Repair ... \$29.95 All others ... \$44.95 each
 • Intro to VCR Repair • Direct Current • Alternating Current • Semiconductors • Power Supplies • Amplifiers • Oscillators • Digital 1 • Digital 2 • Digital 3 • Digital 4 • Digital 5 • Digital 6 • AM Radio • FM Radio Part 1 • FM Radio Part 2 • TV Part 1 "Intro to TV" • TV Part 2 "The Front End" • TV Part 3 "Audio" • Fiber Optics • Laser Technology •

SAVE!!! 6 videos for only \$240 or 12 videos for only \$450



1-800-678-6113

or mail check or money order to:
 UCANDO Videos
 P.O. Box 928
 Greenville, OH 45331



FREE Shipping ... FREE Catalog

CAD FILES TO CASH PILES

IMAGINE THE POSSIBILITIES!

STARTING AT \$895.00



NOW YOU CAN
 TURN YOUR
DREAMS
 INTO
REALITY!

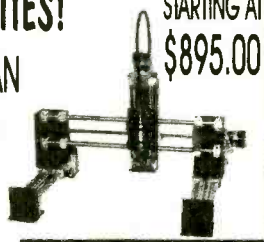

3 AXIS UNITS FROM
 12" X 12" TO 60" X 60"
 MACHINING AREAS

THE ROBOPRO X50 CNC ROBOTIC MACHINING SYSTEM

YOUR WISH IS ITS COMMAND!

FREE 3D

ROUTE, MILL, DRILL, CARVE, ENGRAVE, PAINT, ETC. ...
 IN WOOD, PLASTIC, VINYL, PC BOARD, & LIGHT METALS



U.S. CYBERLAB, INC., 14786 SLATE GAP ROAD
 WEST FORK, AR 72774 (501) 839-8293

Visit us at www.uscyberlab.com

"I earned \$1,000 on just 12 VCR repairs in one week"

A true statement by Paul B.* of San Pedro, California

How to cash in on skyrocketing field of VCR repair!

You too can earn up to \$85 an hour, pocket \$200 a day, double your income...in the high-profit field of VCR repair...part-time or full time. There are over 77 million VCR's currently in use in America today - a lot of business out there just waiting for you!

Here is a once-in-a-lifetime opportunity to go into a booming business of your own, make really big money starting right away, be your own boss and enjoy financial freedom and security.

It's easy to learn VCR cleaning, maintenance and repair at home in just a few short weeks through Foley-Belsaw's unique method which emphasizes the mechanics involved in 90% of all repairs, without dwelling on all the unnecessary basic electronics. This exclusive practical hands-on course was developed and proven over a long period of time in an actual VCR repair shop. It combines simple step-by-step lessons with easy-to-follow video cassette guidance. No special experience or electronics background is necessary. Just average mechanical aptitude and the ability to follow simple A-B-C repair procedures that are clearly outlined for you. And when you complete the course you will receive the School's official diploma attesting to your expertise.

Send coupon today for FREE Fact Kit. No obligation.

Don't miss out on this opportunity to give your income a tremendous boost. Send in the coupon NOW. Get all the facts and study them in the privacy of your own home. There's absolutely no obligation and no salesmen will call on you. So don't delay. Mail the coupon today!

"I started 3 months ago, now earn over \$900 a week."
D.K., New York, NY

"Took in over \$3,200 in the past 10 days!"
H.H., Denver, CO

"Doubled my income within 6 weeks."
R.B., Bakersfield, CA



MAIL TODAY FOR FREE INFORMATION PACKAGE

**Foley-Belsaw Institute,
6301 Equitable Road
Kansas City, MO 64120-1395**



CHECK ONE BOX ONLY FOR FREE INFORMATION KIT!

- YES**, without obligation send me information on how I can learn at home to become a VCR technician. 62942
- | | |
|--|--|
| <input type="checkbox"/> Computer Repair 64851 | <input type="checkbox"/> TV/Satellite Dish 31713 |
| <input type="checkbox"/> Computer Programmer 35650 | <input type="checkbox"/> Electrician 95521 |
| <input type="checkbox"/> Networking Specialist 39465 | <input type="checkbox"/> Computer Specialist 38478 |

Name _____

Address _____

City _____ State _____ Zip _____

*Last name withheld by request.

Direct from Manufacturer
We will beat any competitor's price

World's Smallest Wireless Video Camera!

- Transmits video up to 1000 ft.
- Runs on 9V battery for 12 hrs.
- Can be built into just about anything (beeper, clock, etc.)

World's smallest plug & play system about 1" x 1"

We also carry:

- Color micro video cameras
- B&W micro video cameras
- Hidden cameras
- Custom video systems
- Countersurveillance & More



Looking for Distributors

Call for a free catalog (305) 667-4545
SECURETEK Fax (305) 667-1744
7175 SW 47 St. #205 • Miami, FL 33155

PIC Programmer Kits

Our PIC Programmer kits of parts attach to the parallel port of a PC and contain the following: PCB, parts and instructions. Uses a straight through (25 pin) cable (not supplied). S&H: USA \$4.95, Canada \$7.95 Other \$11.95

P16PRO PIC Programmer
• Program all 8, 18, 28 & 40 pin PICs in the 12C5xx, 14000 and 16Cxx series (except 16C54-58). • This kit uses the P16PRO shareware which is downloaded from the web and registered for \$20. • Visit www.electronics123.com for the complete list of PICs that can be programmed. • Can program 64 pin PICs with adapter (not supplied). • New PICs can be added. **PICALL PIC Programmer:** As above but can also program 16C54-58. Price includes PICALL software. (need Internet for latest upgrade) Price \$79.95 Order Code: CPS117

PIC 16C/FB4 Programmer: Software supplied on disk is for 16F84 • **16F84-4MHz PIC included!** • **EEPROM** • Separate erase command • Test command to check programmer & cable • Vpp (programming voltage) is under software control • Microchip data sheets on disk • Software can read, verify & load (Win95/3.x/Dos)

Code: CPS81 **For the beginner!**

Toll Free 1-888-549-3749 (USA & Canada)
Tel (330)-549-3726. Request a FREE catalog or visit us at: www.electronics123.com for more products. Amazon Electronics, Box 21 Columbiana OH 44408

32K 68HC11 - PLUG 'N PLAY!

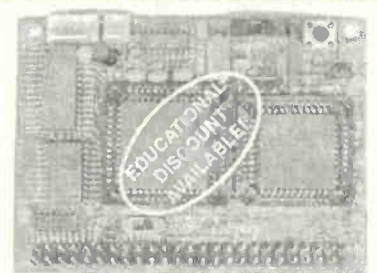

Adapt11C24DX is a compact (2.8" x 2.1") 68HC11 module that "plugs right in" to virtually any solderless breadboard. Build your own application circuit in minutes! Adapt11C24DX has all essential 68HC11 support circuitry, including 32K EEPROM for your code, lots of digital & analog input/output lines, RS232 interface and a 5-Volt regulator. Program it in C, BASIC, or assembler. Easy on-circuit re-programming via your PC's serial port makes it a valuable re-usable educational & hobby tool. Starter Package #AD11C24DX-SP..... only \$139 includes serial cable, demo program, utility software & handbook. Other configurations available for \$74.95. See website, or call.

TECHNOLOGICAL ARTS

Phone: (416) 963-8996 • Fax: (416) 963-9179
www.technological-arts.com

PCB LAYOUT
Software For Windows - FREE

- 1 Download our board layout software
- 2 Design your 2 sided plated-through PCB
- 3 Send us your layout over the Internet
- 4 In 2-3 business days, UPS delivers your boards, often under \$100

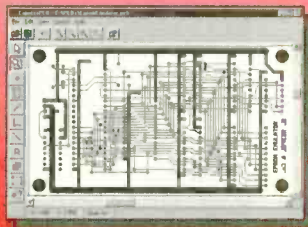

www.expresspcb.com

VIDEO SYNC GENERATOR



Restores Horizontal and Vertical Sync Lines from Distorted Video



For Free Information Package and Pricing

Call (219) 233-3053
www.south-bend.net/rcd

R.C. Distributing, P.O. Box 552, South Bend, IN 46624

Do You Repair Electronics?

- | | |
|---|---------------------------|
| Repair Databases for TV, VCR, Monitor, UL Audio, FCC, and more. | • Over 76,000 records |
| | • Private user forums |
| | • Live on-line chat rooms |

RepairWorld.com

Electronic Corp. 1 Herald Sq. Fairborn, OH 45324 (937) 878-9878

BUGGED??

EAVESDROPPING is unbelievably widespread! Electronic Devices with amazing capabilities can be monitoring your telephone and room conversations RIGHT NOW! Are you sure you're safe? **FREE CATALOG** tells you fast! Includes Free Bonus details on fantastic opportunities, now open in Counter-Surveillance field. Exciting, immensely interesting and EXTREMELY profitable (up to \$250/hr) full/part-time come. Call Now! **1-800-732-5000**

CABLE EQUIPMENT
LOW, LOW WHOLESALE PRICES!
1-800-521-0512

New 1-piece Jerrold-5 units \$109/ea; 10 u. \$99/ea; 20 u. \$89/ea.
New RFT-M -5 units \$109/ea; 10 u. \$99/ea; 20 u. \$89/ea.
Basic Converter -5 units \$75/ea; 10 u. \$65/ea; 20 u. \$55/ea.

WHOLESALE ELECTRONICS
Check out our website: www.whe.net

!!! BROADCAST EQUIPMENT !!!

We manufacture & carry Stereo FM Transmitters, RF Amplifiers, Low Pass Filters, Antennas, DJ Mixing Boards & Consoles, Mics, Compressor/Limiters, Digital Reverbs, Automation Software, RF Test Equipment, RF Parts, including 8GY133's, and much more! Call For Free Catalog.

Progressive Concepts
BOX 586 STREAMWOOD, IL 60107
(830) 738-9822 FAX: (830) 738-0353

Weeder Technologies



Visit our **ON-LINE CATALOG**



Pro-Kit

PO Box 2426, Ft. Walton Beach, FL 32549

www.weedtech.com

Voice/Fax 850-863-5723

Stackable RS-232 Kits

Digital I/O - 12 I/O pins individually configurable for Input or output. DIP switch addressable; stack up to 16 modules on same port for 192 I/O points. Turn on/off relays. Sense switch transitions, button presses, 4x4 matrix decoding using auto-debounce and repeat. **\$32**

Analog Input - 8 Input pins. 12-bit plus sign self-calibrating ADC. Returns results in 1mV steps from 0 to 4095. Software programmable alarm trip-points for each input. DIP switch addressable; stack up to 16 modules on same port for 128 single-ended or 64 differential inputs. **\$49**

Home Automation (X-10) - Connects between a TW523 and your serial port. Receive and transmit all X-10 commands with your home-brewed programs. Full collision detection with auto re-transmission. **\$39**

Caller ID - Decodes the caller ID data and sends it to your serial port in a pre-formatted ascii character string. Example: *12/31 08:45 850-863-5723 Weeder, Terry <CR>. Keep a log of all incoming calls. Block out unwanted callers to your BBS or other modem applications. **\$35**

Touch-Tone Input - Decodes DTMF tones used to dial telephones and sends them to your serial port. Keep a log of all outgoing calls. Use with the Caller ID kit for a complete in/out logging system. Send commands to the Home Automation or Digital I/O kits using a remote telephone. **\$34**

Telephone Call Restrictors

Two modes of operation; either prevent receiving or placing telephone calls (or call prefixes) which have been entered into memory, or prevent those calls (or call prefixes) which have "not" been entered.

Block out selected outgoing calls. Bypass at any time using your password. **\$35**

Block out selected incoming calls. Calls identified using Caller ID data. **\$46**

Phone Line Transponder

7 individual output pins are controlled with buttons 1-7 on your touch-tone phone. Automatically answers telephone and waits for commands. Monitor room noises with built in mic. "Dial-Out" pin instructs unit to pick up phone and dial user entered number(s). Password protected. **\$49**

IR Remote Control Receiver

Learns and responds to the data patterns emitted by standard Infrared remote controls used by TVs, VCRs, Stereos, etc. Lets you control all your electronic projects with your TV remote. 7 Individual output pins can be assigned to any button on your remote, and can be configured for either "toggle" or "momentary" action. **\$32**

DTMF Decoder/Logger

Keep track of all numbers dialed or entered from any phone on your line. Decodes all touch-tones and displays them on a 18 character LCD. Holds the last 240 digits in a non-volatile memory which can be scrolled through. Connect directly to radio receiver's speaker terminals for off-air decoding of repeater codes, or numbers dialed on a radio program. **\$55**

❖ **ATTENTION** ❖
CABLE VIEWERS

CABLE VIEWERS ... get back to your

BASIC Cable Needs

Call 1-800-577-8775

For information regarding all of your **BASIC** cable needs.

**5 GOOD REASONS
TO BUY OUR FAR SUPERIOR PRODUCT**

- ❖ **PRICE**
- ❖ **EFFICIENT SALES AND SERVICE**
- ❖ **WE SPECIALIZE IN 5, 10 LOT PRICING**
- ❖ **ALL FUNCTIONS (COMPATIBLE WITH ALL MAJOR BRANDS)**
- ❖ **ANY SIZE ORDER FILLED WITH SAME DAY SHIPPING**



We handle **NEW** equipment **ONLY** -
Don't trust last years

OBSOLETE and UNSOLD stock!

COMPETITIVE PRICING - DEALERS WELCOME

**BASIC
ELECTRICAL
SUPPLY &
WAREHOUSING
CORPORATION**

It is not the intent of B.E.S.W. to defraud any pay television operator and we will not assist any company or individual in doing the same.
*Refer to sales personnel for specifications.

P.O. Box 8180 • Bartlett, IL 60103-8180 • 847-584-2099

OSCILLOSCOPES
from \$169 !!!

ATC O-Scope uses printer port to turn PC-AT into Digital Storage Oscilloscope, Spectrum Analyzer, Freq. Counter, Logger, DVM. DC-500KHz

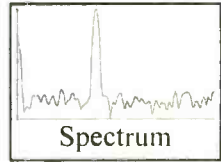
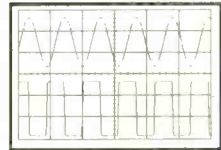

- Print, log to disk, or export data
- Accepts standard scope probes
- Uses standard printer port
- Small and portable
- Works with laptops
- Same day shipping
- Made in U.S.A.
- Single channel units from \$169
- Dual channel units from \$349

Options:

- Probe sets
- Automotive probes
- Battery packs

Order yours today.

800 980 9806

MC/Visa/Amex

Allison Technology Corporation

2006 Finney-Vallet, Rosenberg, TX 77471

PH: 281 239 8500, FAX: 281 239 8006

<http://www.atcweb.com>

**COPY
RENTAL
TAPES**
WITH OUR
VIDEO STABILIZERS

BEFORE

AFTER



**FREE
CABLE TV
CATALOG!**

The clearest picture possible
playing back movies.
GUARANTEED
to eliminate copy protection.

- No Rolls/Jitters/Flickers/Fading
- Works on all TV's, VCR's Beta & Cable
- Gold Video Connectors & Cables Included
- 1 Year Warranty
- Money Back Guarantee



**VISION
ELECTRONICS**
1-800-562-2252

2609 S. 156TH CIRCLE • OMAHA, NE 68130
<http://www.modernelectronics.com>

MECI
Your Electronics Value Company

340 East First Street
Dayton, Ohio 45402

**Tons of
Electronics**

Get your **FREE** catalog today and discover some of the best deals in electronics. We have thousands of items ranging from unique hard-to-find parts to standard production components. Call, write or fax today to start your subscription to one of the most unique catalogs in the industry, filled with super values on surplus electronic and hobbyist type items.



Checkout our 10,000 item on-line catalog <http://www.meci.com>

Order Toll Free Why pay more?
1-800-344-4465 Call today!
Fax Order Line
1-800-344-6324

**Start an exciting career as a
Telecommunications
Technician**

Train at home in your spare time for an exciting new career! Earn as much as \$35,000 a year and more working with fiber optics, radar and cellular networks.



This ICS program is endorsed by the National Association of Radio and Telecommunications Engineers (NARTE) and features a voucher for the NARTE Class IV Technician Certification exam.

Mail Coupon below for FREE facts or call toll free

1-800-595-5505 ext. 3105

Call Anytime — 24 hours a day, 7 days a week.

<http://www.icsearn.com> AG01

YES! Please send me free information on how I can train at home for a career as a Telecommunications Technician. There's no obligation.

Name _____ Age _____
Street _____ Apt. # _____
City/State _____ Zip _____
Phone () _____

**International
Correspondence Schools**

A Subsidiary of Harcourt Brace & Company
Dept. AEM069S, 925 Oak Street, Scranton, PA 18515

CIRCLE 139 ON FREE INFORMATION CARD

CABLE TV EQUIPMENT

Converters, Test Cubes & Chips
Video Stabilizers

1 Year Warranty
30 Day Money
Back
Guarantee

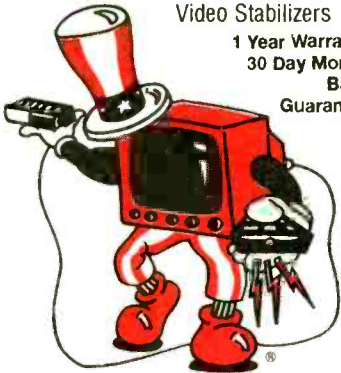

**"ABSOLUTE LOWEST
WHOLESALE &
RETAIL PRICES"
CABLE U.S.A.
1-888-388-CUBE**

PicC C Compiler \$59

for Microchip's PIC microcontrollers
Supports PIC16C55x, 16C6x, 16C62x, 16C8x, 16C92x PIC families

SnXC C Compiler \$59

Supports Sencix sx18ac and sx28ac microcontrollers

Both compilers based on ANSI C standard. Arrays, unions, structures, pointers, strings, function calls, if, for, switch, while, interrupt vectors, in-line assembler code, 8 & 16 bit variables, etc. Outputs Intel Hex format and assembly code. Code optimizer included. Excellent development tools!

DebugIDE Debugger \$79

C source level debugger for PicC and SnXC compilers. Integrated Development Environment Step, Run, Stop, Reset. Variable monitoring and modification. Oscillator/cable kit (\$39)

732-873-1519 fax: 732-873-1582 e: griebrc@aol.com
Grich RC Inc. 120 Cedar Grove Ln, Ste 340, Somerset NJ USA 08873
URL: <http://members.aol.com/piccompile>

SURVEILLANCE

The Latest High Tech Professional Electronic Devices

Our latest catalog offers a HUGE selection of surveillance, countersurveillance - privacy devices: **spy pinhole camera \$99⁰⁰**, hidden video, **"realtime" 15-Hour telephone recorder \$149⁰⁰**, 12 hour VOX recorder, phone call register, bug detectors, phone tap detectors, voice disguisers, locksmithing tools, wireless video, vehicle tracking via the internet and much more. Wholesale/retail.

We will not be undersold.

Catalog \$5.00 or
www.spyoutlet.com

SPY OUTLET

PO Box 337, Buffalo NY 14226
(716) 691-3476/(716) 695-8660

Hexapod Walker Kit \$150.00 Plus S&H



You can build this Hexapod Robot

This easy to build robot really walks using an alternating tripod gait. It can walk forward, reverse, and turn on a dime, left or right. With a payload of more than 12 oz., this robot is a real workhorse. The robot is programmed using simple BASIC instructions. It makes an excellent foundation for many simple and advanced robot experiments. The kit includes all the hardware, structural components, Hitec servos, First Step Micro kit, software, and an illustrated assembly manual. The Lynxmotion Hexapod Walker is a lot of fun to build and even more fun to operate.

Shown with the IRPD, no contact obstacle detector.

We have many more cool robots, check out our web page or ask for our free catalog!

Lynxmotion, Inc.
104 Partridge Road
Pekin, IL 61554-1403
www.lynxmotion.com



Tel: 309-382-1816
Fax: 309-382-1254
sales@lynxmotion.com
tech@lynxmotion.com



One tree can make
3,000,000 matches.



One match can burn
3,000,000 trees.

Website www.j-tron.com

Visit us online and
enter our contest
for a test meter.
Call J-Tron today!

- Components
 - Kits
 - Motors
- 888-595-8766**

SINGERS! REMOVE VOCALS

(Unlimited, Low Cost, Instantly Available Background Music from Original Standard Recordings! Does Everything Karaoke does... Better and gives you the Thompson Vocal Elimination Free Brochure & Demo Tape... LT Sound Dept PE 7988 LT Parkway, Lithonia, GA 30058 Internet: <http://www.LTSound.com> 24 Hour Demo/Info Request Line (770)482-2485 - Ext 49 When You Want Something Better Than Karaoke!

MAY THE SOURCE BE WITH YOU

Don't let the dark forces of ignorance defeat you. Tap into the source of free or low-cost government publications--the free CONSUMER INFORMATION CATALOG.

Call toll-free 1-888-8 PUEBLO.

Or set your coordinates for our web site:

www.pueblo.gsa.gov

METERS! METERS! METERS!

Digital Panel Meters!!
LCDs • LEDs • 3 1/2 digits
• 4 1/2 digits • loop powered • adjustable voltage input • bezel mount • surface mount • miniatures • big digits • black • red • amber • green • negative backlighting • positive backlighting • RF resistant • EMI resistant • displayed engineering units • snap-in •

For the best selection...
800-356-4920
Visit our catalog on the web
www.knsinstruments.com

KINS Instruments
PO Box 10158
Bedford, NH 03110-0158
Fax 800-356-1250

We also have Kroy tape and shrink tube labeling systems and supplies!

BEST DEALER PRICING!

CABLE DIRECT
CONVERTERS • FILTERS
DESCRAMBLERS

IMPROVE YOUR IMAGE WITH
VIDEO STABILIZERS

FREE
CABLE TV
CATALOG!

100%
MONEY BACK
GUARANTEE!



Now you can tune-in your favorite cable TV programming and **SAVE \$100'S - EVEN \$1000'S** on premium CABLE TV EQUIPMENT.



MODERN ELECTRONICS
1-800-906-6664

2609 S. 156TH CIRCLE • OMAHA, NE 68130
<http://www.modernelectronics.com>

SUPPORTS DEVICES TO 32 MEG

EPROM+

A device programming system for design, repair and experimentation

- ♦ EXCEPTIONAL POWER FOR THE PRO
- ♦ EASY-TO-USE FOR THE NOVICE
- ♦ INCLUDES STEP-BY-STEP TUTORIAL

Here's what you get: A rugged, portable programming unit including the power pack and printer port cable both of which store inside the case. A real printed user and technical manual which includes schematic diagrams for the programming unit plus diagrams for all technology family adapters.* Comprehensive, easy-to-use software which is specifically designed to run under DOS, Windows 3.1, 95 and 98 on any speed machine. It includes features which let you READ, PROGRAM, COPY and COMPARE plus much more. You have full access to your system's disk including LOADING and SAVING chip data plus automatic processing of INTEL HEX, MOTOROLA S-RECORD and BINARY files. For detailed work the system software provides a full screen buffer editor including a comprehensive bit and byte tool kit with more than 20 functions.

Broad device support: FIRST GENERATION EPROMS (2708, P1S2716*, 25XX) SECOND GENERATION EPROMS (2716-28C080), 40 AND 42 PIN EPROMS* (27C1024-27C1600) FLASH EPROMS (281, 29C, 29FE, 29F), EEPROMS (2816-28C010), NVRAMS (12XX, X2210/12) 8 PIN SERIAL EPROMS* (24, 25, 85, 93, 95, 80011A) PL1 S ER1400/M58657* AND ER5901 BIPOLAR PROMS* (72S, 82S), FPGA CONFIGURATORS (17CXXX) MICROCONTROLLERS* (874X, 875X, 87C5XX, 87C75X, 89C5X) ATMEL MICROS* (8-40) PIN 89C051, 89SXXX (AVR) 90SXXX PIC MICROS* 8, 18, 28, 40 PIN (12CXX-16CXX, 16LXX, 17C) MOTOROLA MICROS* (68705P3113, R3, 681C705, 681C711)

*SOME SERIAL ADAPTERS ARE ALSO AVAILABLE FOR YOUR SYSTEM

\$289

55.00 SHIPPING • 55.00 C.O.D.
1 YEAR WARRANTY • 30 DAY MONEY BACK GUARANTEE VISA-MASTERCARD-AMEX

ANDROMEDA RESEARCH, P.O. BOX 222, MILFORD, OH 45150
(513) 831-9708 FAX (513) 831-7562 website - www.arlabs.com

Home Automation

- World's Largest Selection!
- Best Customer Service
- Top Technical Support

Take a step into the future - discover the latest in innovative home technology, from remote controls to high-tech toys to voice-activated systems. We will show you the *smart* (and easy!) way to automate your home.

Lowest Prices Guaranteed!

Call **800-SMART-HOME**
800-762-7846

or visit us on the web @ **smarthome.com**
to order your **FREE** catalog today!

Order 24 Hours • 7 Days

HOME AUTOMATION SYSTEMS, INC.

Dealers/Resellers ask about our SmartHome PRO Dealer Program 800-949-6235

The Pocket Programmer

\$129.95

The portable programmer that uses the printer port of your PC instead of an internal card.

Easy to use software that programs E(E)prom, Flash & Dallas Ram. 27(C)/28(C)(F)/29(C)(F)/25 series from 16K to 8 Megabit with a 32 pin socket. Adapters available for MCU's 874X, 875X, Pic, 40-Pin X 16 & Serial Eprom's, PLCC, 5-Gang and Eprom Emulator to 32K X 8.

Same Name, Address & Phone # for 13 Years.... Isn't it Amazing ?

Intronics, Inc.
Box 13723 / 612 Newton St.
Edwardsville, KS 66113 Add \$4.75 CDD
Tel. (913) 422-2094 Add \$4.00 Shipping
Fax (913) 441-1623 Visa / Master Charge

CABLE TV BOXES

(WE'LL BEAT ANY PRICE!)
30 DAY TRIAL* 1YR. WRNTY. *FREE CATALOG
QTY. DISCOUNTS *DEALERS WELCOME!

1-800-538-2225

HABLAMOS ESPANOL

VISA M/C C.O.D.

<http://www.tvcableboxes.com>
GLOBAL ELECTRONICS INC.

Quality Microwave TV Systems

WIRELESS CABLE • ITFS • MMDS
ATV • INTERNATIONAL • S-BAND
Amplifiers • Antennas • Books • Components
Filters • Systems • Video Products

- 3F Frequency 1990 - 2700 MHz
- Cable Ready - VHF - UHF Outputs
- BASE For "FREE" Catalog or Send \$1

PHILLIPS-TECH ELECTRONICS
PC Box 8533 • Scottsdale, AZ 85252
ORDER LINE 800-880-MMDS
CATALOG/INFO 602-947-7700
FAX LINE 602-947-7799
Visa • M/C • Amx • Disc • CDD's • Qty Pricing

SURVEILLANCE HIDDEN CAMERAS

DIRECT FROM MANUFACTURER - BEST PRICE IN THE MARKET

Using miniature hidden cameras. In doors, smoke or motion detector w/ mic. B/W or Color. Wide view angle. Low light sensitivity & super sharp images, plus video and audio output. From \$159.00. Also 1/3" B/W board cameras w/mic. only \$99.00 USD. Wireless hidden camera, start of only \$249.00 USD. Plus \$3.95 for S/H. Wholesale/Patent Welcome. CDD, Check, Money Order or M/C.

BEST BY MAIL
FBI: (800) 333-8995 or (626) 575-8178
9660 Flair Drive #218, El Monte, CA 91731
<http://www.bestby-mail-zamazingproducts.com/>

BEST BY MAIL

Rates: Write National, Box 5, Sarasota, FL 34230

STOP HAIR LOSS! Treat three major causes of hair loss. Clinically tested. Pharmaceutically prepared. FREE information: Kessler Pharmaceutical, PO Box 76, Tallmadge, Ohio 44278.

WIN AT HORSE RACING. INCREDIBLE! Free audio tape. WB, Box 1540, Minden, NV 89423.

STOP PAYING FULL PRICE for hotels, restaurants, airlines, etc. 50% Discount Card. Send \$24.95. P.O. Box 415, Salinas, PR 00751.

LOSING YOUR HAIR?! Send for easy solution. 1-888-456-6593 24hr Msg. www.hairloss1ps.com

HEALTH PROBLEMS. Wealth needed. Please put Arthur in your will. Arthur F. Bothwell, P.O. Box 31, Wildwood, NJ 08260. Thank you. God bless you. Jesus Christ loves you.

FCC License Preparation

Electronics Tech., Avionics, Marine & Radar
HOMESTUDY—Fast, Easy & Inexpensive
Manuals, Audio, Video, PC disks, latest Q&As
Free 1-800-800-7555 "Guaranteed Pass"
See at <http://www.worldaccessnet.com>
BusinessShowcase/wpt. 4701 NE 47th St.
Vancouver, WA 98661 - WPT Publications

Max '99' \$459.90

Used world wide for research!

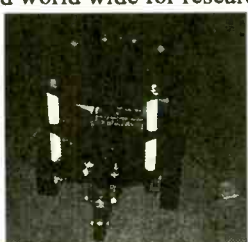

- * Three 12 inch diameter decks
- * 30 lbs payload capacity
- * HC11 microprocessor w/ 32k ram
- * Basic, Forth and 'C' programming lang.

Zagros Robotics
PO Box 460342
St. Louis, MO 63146-7342
(314) 768-1328
<http://www.zagrosrobotics.com>
info@zagrosrobotics.com

ATTENTION CABLE VIEWERS

Own Your Own Unit Today
Cable TV Converters & Descramblers
All Makes / All Models

Call 1-800-577-8775
Technical Info: 847-584-2099

LEARN ELECTRONICS REPAIR

Home study. Learn to repair, service, and install stereos, TVs, VCRs, camcorders, sound/lighting systems. Free literature: send or call now.

CALL 800-223-4542
The School of Electronics
430 Technology, Dept. ELH341
PCDI, Norcross, GA 30092

Cable T.V. Converters & Equipment

Lower Prices
Dealer Discounts
30-Day Money back
1-year warranty
MC, Visa, AE, COD

Pro Planet

No Florida Sales

www.cable4you.com
1-(800) 888-5585

USE POPULAR ELECTRONICS

READ BY BUYERS OF ELECTRONIC EQUIPMENT ACCESSORIES AND PARTS

INSTRUCTIONS FOR PLACING YOUR AD!

HOW TO WRITE YOUR AD

TYPE or **PRINT** your classified ad copy **CLEARLY** (not in all capitals) using the form below. If you wish to place more than one ad, use a separate sheet for each additional one (a photo copy of this form will work as well). Place a category number in the space at the top of the order form (special categories are available). If you do not specify a category, we will place your ad under miscellaneous or whatever section we deem most appropriate.

We cannot bill for classified ads. **PAYMENT IN FULL MUST ACCOMPANY YOUR ORDER.** We do permit repeat ads or multiple ads in the same issue, but, in all cases, full payment must accompany your order.

WHAT WE DO

The first word and company name of each ad are set in bold caps at no extra charge. No special positioning, centering, dots, extra space, etc. can be accommodated.

RATES

Our classified ad rate is \$1.75 per word. Minimum charge is \$26.25 per ad per insertion (15 words). Any words that you want set in bold are each .40 extra. Indicate bold words by underlining. Words normally written in all caps and accepted abbreviations are not charged anything additional. State abbreviations must be post office 2-letter abbreviations. A phone number is one word.

If you use a Box number you must include your permanent address and phone number for our files. **ADS SUBMITTED WITHOUT THIS INFORMATION WILL NOT BE ACCEPTED.**

For firms or individuals offering Commercial products or Services. **Minimum 15 Words.** 5% discount for same ad in 6 issues within one year; 10% discount for same ad in 12 issues. **Sorry, no discounts on credit-card orders. Boldface (not available as all caps), add .40 per word additional. Entire ad in boldface, add 20%. Tint screen behind entire ad, add 25%. Tint screen plus all boldface ad, add 45%. Expanded type ad, add \$2.25 per word.**

General Information: A copy of your ad must be in our hands by the 13th of the fourth month preceding the date of issue (i.e. Sept issue copy must be received by May 13th). When normal closing date falls on Saturday, Sunday or Holiday, issue closes on preceding work day. Send for the classified brochure.

DEADLINES

Ads not received by our closing date will run in the next issue. For example, ads received by November 13 will appear in the March issue that is on sale January 17. **POPULAR ELECTRONICS** is published monthly. No cancellations permitted after the closing date. No copy changes can be made after we have typeset your ad. **NO REFUNDS, advertising credit only. No phone orders.**

CONTENT

All classified advertising in **POPULAR ELECTRONICS** is limited to electronics items only. All ads are subject to the publishers approval. **WE RESERVE THE RIGHT TO REJECT OR EDIT ALL ADS.**

AD RATES: \$1.75 per word, Minimum \$26.25

Send you ad payments to:

POPULAR ELECTRONICS 500 Bi-County Blvd, Farmingdale, NY 11735-3931

CATEGORIES

100 - Antique Electronics	270 - Computer Equipment Wanted	450 - Ham Gear Wanted	630 - Repairs-Services
130 - Audio-Video Lasers	300 - Computer Hardware	480 - Miscellaneous Electronics For Sale	660 - Satellite Equipment
160 - Business Opportunities	330 - Computer Software	510 - Miscellaneous Electronics Wanted	690 - Security
190 - Cable TV	360 - Education	540 - Music & Accessories	710 - Telephone
210 - CB-Scanners	390 - FAX	570 - Plans-Kits-Schematics	720 - Test Equipment

CLASSIFIED AD COPY ORDER FORM

Place this ad in Category # _____

Special Category \$20.00 Additional _____

1 - \$26.25	2 - \$26.25	3 - \$26.25	4 - \$26.25	29 - \$50.75	30 - \$52.50	31 - \$54.25	32 - \$56.00
5 - \$26.25	6 - \$26.25	7 - \$26.25	8 - \$26.25	33 - \$57.75	34 - \$59.50	35 - \$61.25	36 - \$63.00
9 - \$26.25	10 - \$26.25	11 - \$26.25	12 - \$26.25	37 - \$64.75	38 - \$66.50	39 - \$68.25	40 - \$70.00
13 - \$26.25	14 - \$26.25	15 - \$26.25	16 - \$28.00	Total words _____ \$1.75 per word = \$ _____			
17 - \$29.75	18 - \$31.50	19 - \$33.25	20 - \$35.00	Bold Face _____ \$0.40 per word = \$ _____			
21 - \$36.75	22 - \$38.50	23 - \$40.25	24 - \$42.00	Special Heading _____ \$20.00 = \$ _____			
25 - \$43.75	26 - \$45.50	27 - \$47.25	28 - \$49.00	Other _____ = \$ _____			

Total classified ad payment \$ _____ enclosed

TOTAL COST OF AD \$ _____

Check Mastercard Visa Discover

Card # _____ Expiration Date ____/____/____

Signature _____

Name _____ Phone _____

Address _____ City State Zip _____

Kenwood CS-4125 Sale!!!

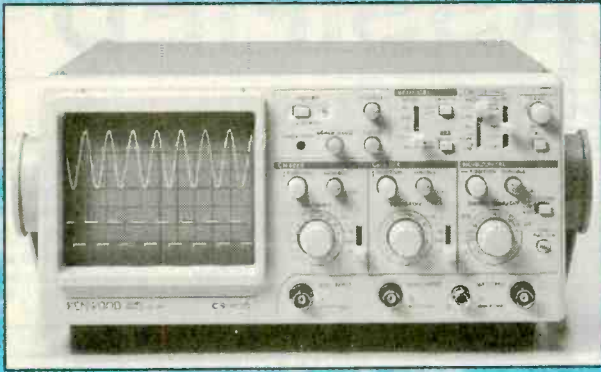

Free **KENWOOD** t-shirt
with purchase of
CS-4125 oscilloscope!!!

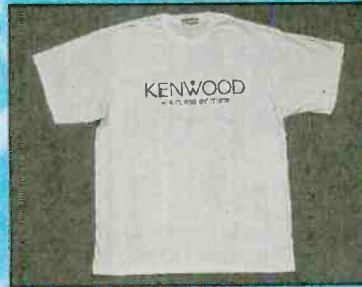

KENWOOD

MODEL CS-4125
20 MHz, 2 Channel, includes probes
Suggested Price \$595.00
SUPER SPECIAL \$389.00!!!

SPARE SCOPE PROBE SPECIAL:

Kenwood PC-35 - 10:1, DC to 50 MHz	Regular \$62.00	SALE \$29.95
Kenwood PC-41 - 10:1/1:1, DC to 50 MHz	Regular \$62.00	SALE \$29.95

PRINT™
Products International

Call today for your free 84 page test & measurement instrument catalog!

8931 Brookville Rd * Silver Spring, MD, 20910 * 800-638-2020 * Fx 800-545-0058
www.prodintl.com

CIRCLE 142 ON FREE INFORMATION CARD

New and Pre-Owned Test Equipment

Goldstar



Model OS-5100 → **\$899.00**

Full 100 MHz Bandwidth!

- Dual-Channel, High Sensitivity
- TV Synchronization Trigger
- Calibrated Delayed Sweep
- Includes Two Probes, 2 Year Warranty

Spectrum Analyzer
Avcom PSA-37D

Satellite Downlink
Installation
Maintenance & Service

- Band 1 10 - 1750 MHz
 - Band 2 3.7 - 4.2 GHz
 - Built-in DC Block & Power for LNA/LNB's
 - Line or Battery Powered
- Only \$2,475.00!

We Buy Surplus
Test Equipment

Leader CATV Signal Level Meter Model LF 941

- ✓ TV/CATV Coverage from 46 - 870 MHz
- ✓ Video/Audio Carrier Measurements \$695.00!

Just Released! → "Series III" Multimeters
Fluke Model 87III \$319.00 !!!

**SIMCHECK® II PLUS
Module Tester**

- * Tests SIMMs/168 p DIMMs
 - * Stand alone/portable
 - * Identifies Module properties
 - * Advanced Setup Capabilities
- Only \$2750.00!

(1-800-996-3837)

Pre-Owned Oscilloscope Specials

Tektronix 2213	60 MHz	\$549.00
Tektronix 2215	60 MHz	\$649.00
Tektronix 465	100 MHz	\$599.00
Tektronix 465B	100 MHz	\$729.00
Tektronix 475	200 MHz	\$829.00
Tektronix 475A	250 MHz	\$999.00

- Professionally Refurbished
- Aligned & Calibrated to Original Specifications
- The Industry Standard of Oscilloscopes
- **1 Year Warranty - The Longest Available!!!**

See us on the Web!
www.fotronic.com

Test Equipment Depot

A FOTRONIC CORPORATION COMPANY
99 Washington St. Melrose, MA 02176
(781) 665-1400 • FAX (781) 665-0780

email: sales@fotronic.com



TOLL FREE 1-800-99-METER

ALL ELECTRONICS

C O R P O R A T I O N

Precision Stepper Motor

Miniba Co., "Astrosyn"
Miniangle Stepper
IBM P/N 1039265
Bipolar, 150 step per
revolution motor. 1.9 volt,
0.75 amps per phase.

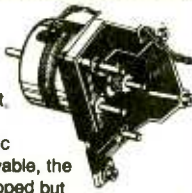

Mounted on a hard plastic
bracket and easily removable, the
motor appears to be prepped but
unused. The 0.25" diameter shaft is 1.125" long
and has a brass gear press-fit on about mid way.
The shaft also extends 0.375" from the rear of
the motor. Motor body is 2.21"
diameter x 1.55". Mounting
bracket is 2.25" square.

\$5.50
each

Four 7" leads.
CAT # SMT-35

10 for \$45.00

20 Character X 4 Line LCD

Optrex # DMC 20434-CEM
(PWB 20434-CEM)
5 x 8 dot format.



3" x 1" viewing area.
3.88" x 2.38" module.
Removed from new
equipment. May have felt padding on metal
bezel. 14 pin single row header is pre-attached.
Spec/hook-up sheet included. Large quantity
available. CAT # LCD-46

\$7.00
each

10 for \$60.00

30 Minute Timer Board

Timer circuit board will operate
120 or 240 Vac devices.

Originally designed to
run a vibrating
motor in a
massage chair, the
circuit automatically shuts-off
a motor, lamp or other device
after approximately 30 minutes. Shut-off time
can be varied by replacing one of the
resistors on the board with a pot or resistor of dif-
ferent value. Hook-up instructions included
with the board explain how to make this modifi-
cation. 1.9" x 2.5".

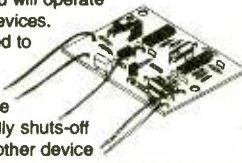

\$3.50
each

CAT # TMR-5

ORDER TOLL FREE

1-800-826-5432

CHARGE ORDERS to Visa, Mastercard,
American Express or Discover.

TERMS: NO MINIMUM ORDER. Shipping and handling for the
48 continental U.S.A. \$5.00 per order. All others including AK,
HI, PR or Canada must pay full shipping. All orders delivered
in CALIFORNIA must include local state sales tax. Quantities
limited. NO COD. Prices subject
to change without notice.

CALL, WRITE
FAX or E-MAIL
for our FREE

96 Page
CATALOG
Outside the U.S.A.
send \$3.00 postage.

MAIL ORDERS TO:
ALL ELECTRONICS
CORPORATION

P.O. Box 567
Van Nuys, CA 91408

FAX (818)781-2653

e-mail allcorp@allcorp.com
internet - http://www.allcorp.com/

CLASSIFIED

AUDIO-VIDEO-LASERS

Unique Video Products Pattern Generators with
character identification, composite, s-video, RGB,
distribution amplifiers, kits also available. Free cat-
alog, GEKCO Labs, PO Box 642 Issaquah, WA
98027-0642, 425-888-5756, www.gekco.com

BUSINESS OPPORTUNITIES

Inventions/new products. ISC, America's lead-
ing invention firm, helps submit to companies.
Patent Services. 1-800-288-IDEA.

\$400 Weekly Assembling electronic circuit
boards/products form home. For free information
send SASE: Home Assembly-PE, Box 216, New
Britain, CT 06050-0216

EASY WORK! EXCELLENT PAY! Assemble
Products At Home. Call Toll Free 1-800-467-5566
Ext. 5730

CABLE TV

Cable TV Descramblers. One piece units.
Scientific Atlanta, Jerrold, Pioneer, and others.
Lowest Prices Around. Precision Electronics,
Houston, TX, anytime 1-888-691-4610.

CABLE Descrambling, New secret manual. Build
your own Descramblers for Cable and Subscription
TV. Instructions, schematics for SSAVI, Gated
Sync, Sinewave, \$12.95. \$2 postage. CA-
BLETRONICS, Box 30502PE, Bethesda, MD
20824.

ALL CABLE TV BOXES. WE'LL BEAT ANY
PRICE. 30 DAY TRIAL 1 YEAR WARRANTY. 1-
800-538-CABLE(2225).

CABLE BOXES ALL MODELS, ALL CHAN-
NELS, lowest prices in the United States. Open
seven days a week, till midnite, Pacific time. Call
(877) 789-7337 Toll-Free.

CABLE DESCRAMBLERS, including activators
for all Jerrold Dp5- CFT 22x's and SP's. Lowest
single or lot prices. Also, RFT-Dams Zenith,
Scientific Atlanta, and Pioneer. Se habla en es-
panol. Call 888-684-9277.

CABLE DESCRAMBLERS, UNIVERSAL
WHOLESALE AND VOLUME PRICING. FULL
TECHNICAL SUPPORT. 1-888-922-0671.

Descramblers, Converters, Activators, Rft's,
Fig's, Bullet Snoopers, All Options Explained,
Best Prices, Services, 2yr. Warranty, Free
Catalog 1-800-854-1674 www.resource-
leader.com/aapc

PROGRAMMERS

ADVANTECH EETOOLS NEEDHAMS DATA I/O ICE TECHNOLOGY HILO
SYSTEM GENERAL CHROMA MODULAR CIRCUIT TECHNOLOGY XELTEK



PROMAX	EMP-20	MEGAMAX	MEGAMAX4	SIMM/SP	TESTER	EMUPA
CALL ADVANTECH LAB700L	629 ICE TECH MICROLV	599 EETOOLS SIMMAX	795 CHROMA SIMM/SP	359 MOD-MCT-EMUPA/R	279 MOD-MCT-EMUP/R	
650 EETOOLS ALLMAX +	409 EETOOLS MEGAMAX	509 EETOOLS MEGAMAX4	369 XELTEK SUPERPRO II	409 XELTEK SUPERPRO II P	249 XELTEK SUPERPRO L	165 XELTEK ROMMASTER II
479 MOD-MCT-EMUPA	739 STAG ORBIT-32	89 EPROM 1G TO 1MEG	99 EPROM 4G TO 1MEG	199 EPROM 16G TO 1 MEG	89 EPROM 1G TO 8MEG	129 EPROM 4G TO 8MEG
		250 EPROM 8G TO 8MEG				



LAB700L48 MICROMASTER SUPERPRO ALLMAX PLUS ROMMASTER2

General Device Instruments

Sales 916-393-1655 Fax 916-393-4949 BBS 983-1234
Web www.generaldevice.com E-Mail icdevice@best.com

Have A Beeping or Chirping Sound with
Scrambled Video on Channels. We can help.
Professional quality positive notch filters. \$16.00ea.
Discounts on 5 or more. 100 @ 7.00. Fast
Courteous Service. All credit cards. Call the Filter
Company, 1-800-684-0527 or www.gofilters.com.

DESCRAMBLERS Scientific, Atlanta 8580 with
remote. Original factory one piece unit. Like new.
99 channels. Guaranteed \$190.00 BETHEL EN-
TERPRISES 412-833-0773.

MISC. ELECTRONICS FOR SALE

RF Transistors & Tubes MRF454, SD1446,
2SC2879, 2SC1969, 2SC2166, 3-500ZG,
4CX250B, 572B, 3CX3000A7, Westgate 800-213-
4563.

PLANS-KITS-SCHEMATICS

"HEATHKIT COMPANY is selling photocopies of
most Heathkit manuals. Only authorized source
for copyright manuals. Phone: 616-925-5899, 8-
4 ET."

AWESOME KITS: Voice Changers, Levitators,
Lasers, Solar Robots and more! Catalog \$1.00.
LNS Technologies, PO Box 67243, Scotts Valley,
CA95067. www.ncal.verio.com/~Lnstech

ELECTRONIC PROJECT KITS: \$3.00 catalog.
49 McMichael St. Kingston, ON., K7M 1M8.
www.qkits.com - QUALITY KITS

REPAIRS - SERVICES

CIRCUIT Diagnostic Initiatives provides schemat-
ic evaluation, trouble-shooting assistance and re-
pair services for technicians, kit builders, students.
Reasonable rates. 336-495-7032 8-4ET.

SATELLITE EQUIPMENT

FREE CATALOG-Satellite TV/GPS-DIY Technical
Books, Installation Videos, Computer Analysis
Software. www.baylln.com 800-483-2423.

DSS Test card. Authorizes all channels for infor-
mation, plus free bonus. Call toll free 1-888-416-
7296.

FREE Satellite TV Buyer's Guide. Best Products -
Lowest Prices - Fastest Service! Dish Network,
Direct TV, C/Ku-band, including 4DTV,
Parts-Upgrades-Accessories! SKYVISION
800-543-3025. International 218-739-5231.
www.skyvision.com

DSS Hacking: How to construct and program
smart cards, with pic 16C84, PCB layout.
Complete DSS system schematics. \$16.95
Software \$25 CABLETRONICS, Box 30502PE,
Bethesda, MD 20824.

TEST EQUIPMENT

Large assortment of used test equipment for sale.
Request catalog or visit our website. STEVEN-
SON EQUIPMENT COMPANY 609-888-2846
Fax: 609-888-2847 http://www.stevensonlabs.com

CB-SCANNERS

CB Radio Modifications! Frequencies, kits, high-
performance accessories, books, plans, repairs,
amps, 10-Meter conversions. The best since 1976!
Catalog \$3.00. CBCI, Box 1898PE, Monterey, CA
93942. www.cbciintl.com

COMPUTER SOFTWARE

Mother of all CD-ROMS! Everything you need to
start your home business! Free Details: PARA-
DIGM-CD, 1516 E. Fountain Mesa, AZ. 85203

RETAILERS THAT SELL OUR MAGAZINE EVERY MONTH

Arizona

Circuit Specialists, Inc.
220 S. Country Club Dr.
Bldg 2
Mesa, AZ 85210

Elliott Elec. Supply
1251 S. Tyndell Ave.
Tucson, AZ 85713

California

California Electronics
221 N. Johnson Ave.
El Cajon, CA 90202

Ford Electronics
8431 Commonwealth Ave
Buena Park, CA 90621

All Electronics
14928 Oxnard Street
Van Nuys, CA 91411

Electronics Warehouse
2691 Main Street
Riverside, CA 92501

Orvac Electronics
1645 E. Orangethorpe Ave.
Fullerton, CA 92631

Sav-On Electronics
13225 Harbor Blvd.
Garden Grove, CA 92643

JK Electronics
6395 Westminster Blvd.
Westminster, CA 92683

Kandarian Electronics
1101 19th Street
Bakersfield, CA 93301

Minute Man Electronics
37111 Post St., Suite 1
Fremont, CA 94536

HCS Electronics
6819 S. Redwood Drive
Cotati, CA 94931

Halted Specialties Co.
3500 Ryder Street
Santa Clara, CA 95051

Metro Electronics
1831 J Street
Sacramento, CA 95814

HSC Electronics
4837 Amber Lane
Sacramento, CA 95841

Colorado

Centennial Elec. Inc.
2324 E. Bijon
Colorado Springs, CO
80909

Connecticut

Cables & Connectors
2198 Berlin Turnpike
Newington, CT 06111

Electronic Service Prod.
437 Washington Avenue
North Haven, CT 06473

Illinois

Tri State Elex
200 W. Northwest Hwy.
Mt. Prospect, IL 60056

Indiana

Black Cat
566 S. Main Street
North Webster, IN 46555

Maryland

Mark Elec. Supply Inc.
5015 Herzel Place
Beltsville, MD 20705

Michigan

Purchase Radio Supply
327 East Hoover Avenue
Ann Arbor, MI 48104

The Elec. Connection
37387 Ford Road
Westland, MI 48185

Minnesota

Acme Electronics
224 Washington Avenue N.
Minneapolis, MN 55401

New Jersey

Lashen Electronics Inc.
21 Broadway
Denville, NJ 07834

New York

LNL Distributing Corp.
235 Robbins Lane
Syosset, NY 11791

Unicorn Electronics
Valley Plaza
Johnson City, NY 13790

Ohio

Philcap Electronic Suppliers
275 E. Market Street
Akron, OH 44308

Oregon

Norvac Electronics
7940 SW Nimbus Avenue
Beaverton, OR 97005

Texas

Tanner Electronics
1301 W Beltline
Carrollton, TX 75006

Mouser Electronics
958 N. Main Street
Mansfield, TX 76063

Electronic Parts Outlet
3753 B Fondren
Houston, TX 77063

Computers Electronics Etc.
110 E. Medical Center Blvd.
Webster, TX 77598

If you'd like to sell our magazine in your
store, please circle 180 on free information card
or Contact

Christina Estrada at (516) 293-3000 ext 223

Robotics Workshop

Using Stepper Motors

GORDON MCCOMB

Welcome to the new **Popular Electronics** robotics column! Each month we'll bring you exciting tips, techniques, and news on hobby robotics. For this column, we'll talk about using stepper motors in your robot creations.

Dismantle most any computer printer or floppy disk drive and you'll encounter a stepper motor. Instead of being powered by a continuous flow of current—as with an AC or DC motor—a stepper motor is driven by pulses of current. Each pulse drives the shaft a fraction of a rotation. The more pulses that are fed to the motor, the more the shaft turns. Stepper motors are inherently digital devices, a fact that comes in handy when you want to control your robot by computer.

Stepper motors aren't as easy to use as standard DC motors because they require specialized control circuitry. Still, they are common finds in surplus stores and catalogs, and their price (under \$10 or \$12, on average) makes them affordable for most any robotics project.

INSIDE A STEPPER

There are several designs of stepper motors. Perhaps the most popular and commonly available stepper motor is the four-phase unipolar stepper. A four-phase stepper motor is actually two motors sandwiched together. Each motor is composed of two windings. Wires connect to each of the four windings of the motor pair, so there are as many as eight wires coming from the motor. However in actual practice the commons from the windings are often ganged together, reducing the wire count to five or six.

In operation, the common wires are attached to one side of the power supply (either positive or negative). Each winding is then energized in turn by providing a pulse of current from the power supply. The motor shaft turns a fraction of a revolution each time a winding is energized. For the shaft to turn properly, at minimum the windings

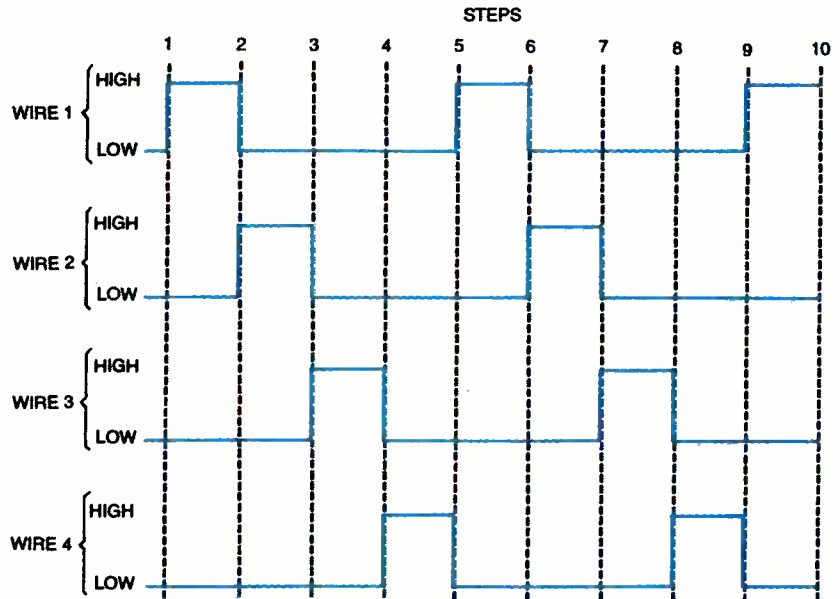

Fig. 1. Shown here is the basic wave-step activation sequence of a four-phase stepper motor.

must be energized in wave-step sequence. For example, energize wires 1, 2, 3, and 4 in sequence, as shown in Fig. 1, and the motor turns clockwise. Reverse the sequence, and the motor turns in the opposite direction. The wave-step sequence is the basic actuation technique of four-

phase stepper motors. An alternative approach actuates two windings at once in an on-on/off-off sequence, as shown in Fig. 2. The enhanced actuation sequence increases the driving power of the motor and provides greater shaft-rotation precision.

Another form of stepper motor is

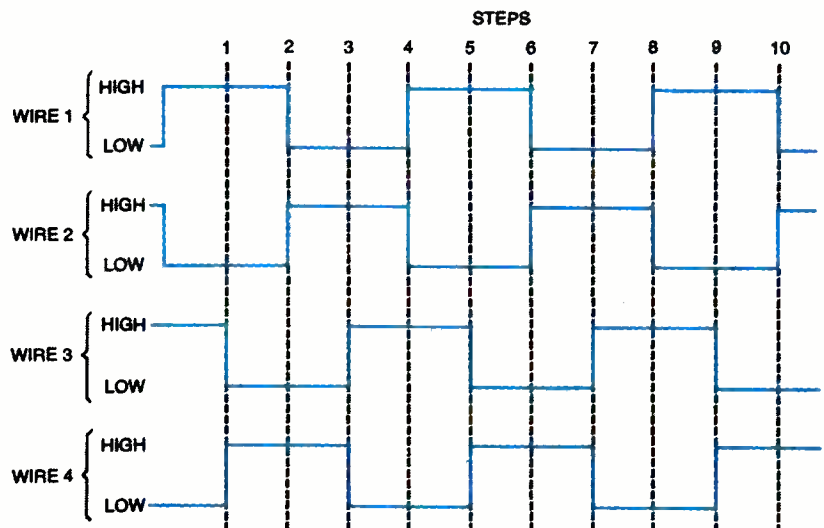

Fig. 2. An alternate to wave-step actuation of four-phase steppers is the enhanced on-on/off-off actuation sequence shown here.

the bipolar variety. It has four wires and is operated by reversing the polarity of the power supply for each of the four steps. Bipolar steppers are not quite as common as four-phase unipolar motors, and their drive circuitry is more complex. For the rest of this column, I'll concentrate just on the four-phase unipolar motor.

STEPPER DESIGN

A four-phase stepper requires a sequence of four pulses applied to its various windings for proper rotation. By their nature, all stepper motors are at least two-phase. Most are four-phase—some are six-phase. Usually, but not always, the more phases in a motor, the more accurate it is.

Stepper motors vary in the amount that the shaft turns each time a winding is energized. The amount or rotation, called the *step angle*, can vary from as small as 0.9 degrees (1.8 degrees is more common) to 90 degrees. The step angle determines the number of steps per revolution. A stepper with a 1.8-degree step angle, for example, must be pulsed 200 times for the shaft to turn one complete revolution.

Obviously, the smaller the step angle, the more accurate the motor is. But stepper motors have an upper limit to the number of pulses they can accept per second, a limit that determines the maximum speed of the shaft. Heavy-duty steppers usually have a maximum *pulse rate* (or *step rate*) of 200 or 300 steps per second, so they have an effective top speed of no more than 60 to 180 rpm. Bear in mind that stepper motors cannot be motivated to run at their top speeds immediately from a dead stop. Applying too many pulses from a dead stop may cause the motor to freeze up. To achieve top speeds, the motor must be gradually accelerated over a period of several milliseconds.

Stepper motors cannot deliver as much *running torque* as standard DC motors of the same size and weight. A typical 12-volt, medium-size stepper motor may have a running torque of only 12 or 25 oz-in (an ounce-inch is the force a motor applies when a one-ounce weight is suspended one inch from the center of the shaft). The same 12-volt, medium-size standard DC motor may have a running torque three or four times more. It is important

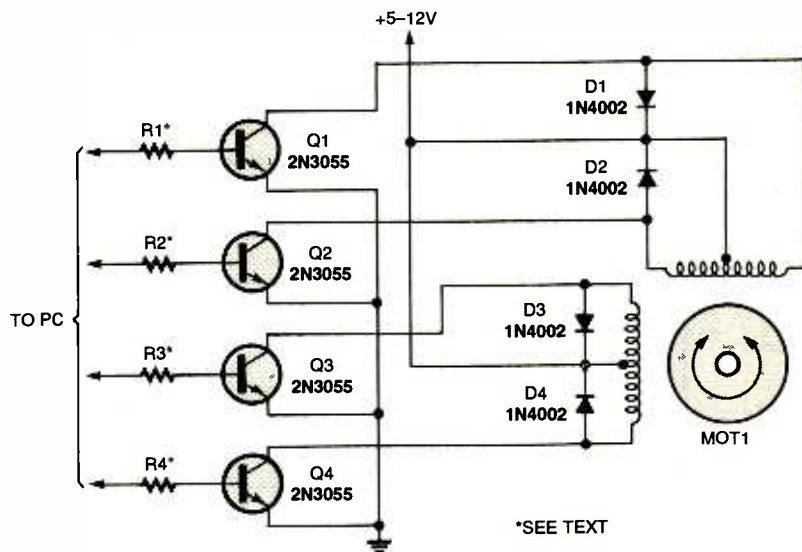

Fig. 3. Add four transistors with bias resistors and protection diodes to provide a power output stage for any TTL- or CMOS-level stepper-motor interface.

to note that stepper motors are at their best when turning slowly. With a typical stepper motor, the slower the motor revolves, the higher the torque—the reverse is usually true of continuous DC motors.

Actuation of one of the windings in a stepper motor advances the shaft. Continue to apply current to the winding and the motor won't turn any more. In fact, the shaft will be locked, as if you've applied brakes. The amount of braking power of a stepper motor is expressed as *holding torque*. Small stepper motors have a holding torque of a few oz-in. Larger, heavier-duty models have holding torque exceeding 400 oz-in.

Like DC motors, stepper motors vary in their voltage and current rat-

ings. Steppers for 5-, 6-, and 12-volt operation are not uncommon. But unlike DC motors, using a higher voltage than specified doesn't result in faster operation, but more running and holding torque. It is inadvisable to operate a stepper motor at voltages higher than its specified rating.

The current rating of a stepper is expressed in amps (or milliamps, if it's a small motor) per phase. The power supply driving the motor needs to deliver no less than twice the per-phase specification (preferably more), because with the traditional unipolar drive circuit, two phases are activated at any one time.

PC CONTROL

Though stepper motors are often

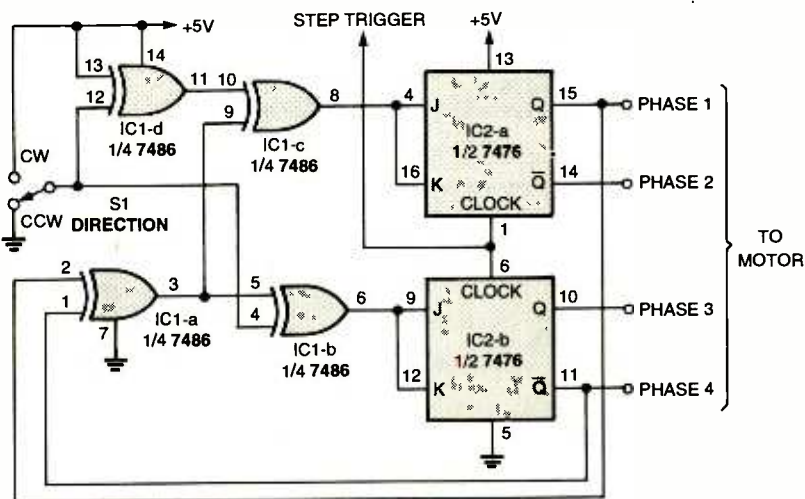

Fig. 4. A stepper-motor translator circuit can be easily built using a pair of TTL ICs.

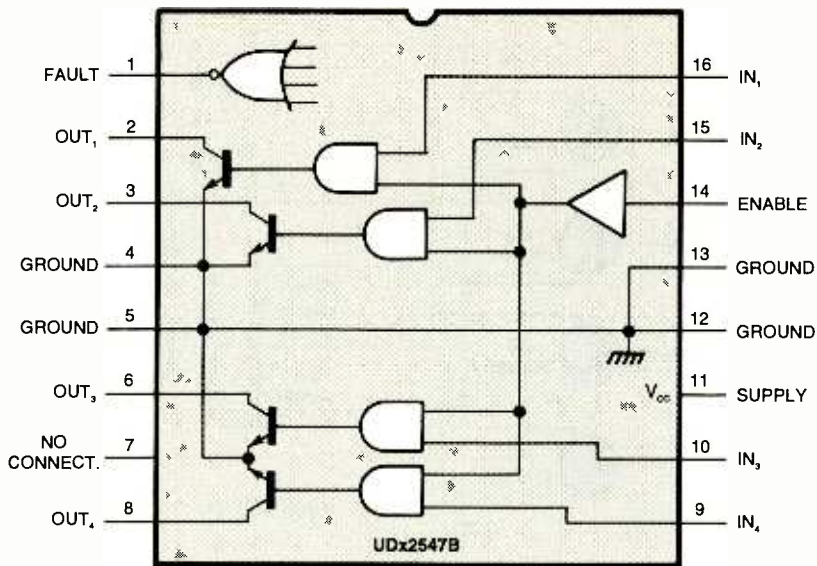

Fig. 5. The UDx2547B family of quad-power drivers can be used to drive unipolar stepper motors of up to 600 mA per phase.

associated with the personal computing age, they've been around for decades. In years past, stepper motors were typically actuated by a mechanical switch, a solenoid-driven device that pulsed each of the windings of the motor in the proper sequence. Now, stepper motors are invariably controlled by electronic means. Basic actuation can be accomplished via computer control (say, a parallel printer port) by pulsing each of

the four windings in turn. The computer can't directly power the motor, so transistors must be added to each winding. Figure 3 shows a very basic wiring diagram using common 2N3055 NPN power transistors (Q1-Q4) and is suitable for driving stepper motors with up to about 1-1.5 amps per phase. Resistors R1 through R4 are 270- to 1000-ohm units; D1 through D4 are 1N4002 units (the diodes prevent back EMF generated by the motor windings

from destroying the transistors).

The phasing sequence is provided by software running on the computer (this is a subject for a future column). The software generates the necessary stepping pattern following a four-bit binary sequence: 1010, 0110, 0101, 1001. To reverse motor MOT1, you merely reverse the binary sequence.

USING AN IC

Direct connection to data-output pins on a PC isn't the only means to control a stepper motor. Another approach is to use an integrated stepper motor controller (or "translator") IC. The Philips SAA1027 has been a popular choice for years, but it appears rather difficult to find these days. Fortunately, a number of other chip makers, including Ericsson and Allegro Microsystems (see the "Stepper Motor Web Resources" box), provide ICs expressly for use with the common four-phase stepper. As an example, the UCN5804LB from Allegro can control a stepper motor of up to 1.5 amps per phase.

Common to all stepper-motor controller chips is a "trigger" and a "direction" pin. Setting the direction pin high or low controls the direction of the motor—either clockwise or counter-clockwise. Applying a pulse or continuous square wave to the trigger pin advances the stepper motor shaft. For a free-running motor, a 555 timer IC can be used to supply the train of pulses to trigger the stepping.

USING DISCRETE COMPONENTS

Discrete gates and clock ICs are yet another method to control stepper motors. You can assemble a stepper motor translator circuit using just two IC packages, either TTL or CMOS chips. A simple TTL version is shown in Fig. 4. Four exclusive OR gates from a single 7486 IC (IC1) provide the steering logic. You set the direction by pulling pin 12 high or low. The stepping actuation is controlled by a 7476 (IC2), which contains two JK flip-flops. The outputs of the flip-flops control the phasing of the motor. Stepping is accomplished by triggering the clock inputs of both flip-flops.

The 7476 does not provide sufficient current for powering a stepper motor directly. You must use power

•(Continued on page 70)

STEPPER MOTOR WEB RESOURCES

CONTROL ICs

www.allegromicro.com/
Allegro Microsystems

www.ericsson.se/microe/industri.html,
Ericsson Industrial ICs

www.ericsson.se/microe/apn_ind.html
Ericsson Stepper motor application notes

eu.st.com/stonline/index.htm
STMicroelectronics home page; controller ICs, etc.

www.eio.com/
Surplus stepper motors

STEPPER MOTORS, CONTROL BOARDS

www.robotics.com/
Arrick Robotics

www.newmicros.com/txs7040.html
Integrated stepper motor controller board

GENERAL STEPPER RESOURCES

www.cs.uiowa.edu/~jones/step/
Tutorial on stepper motor control

www.unet.com/ph/mas/projects/scotch/saa1027.htm
SAA-1027 IC overview.

www.eio.com/jasstep.htm
Working with stepper motors

www.eio.com/stepindx.htm
Introduction to stepper motors

www.eio.com/public/stepper/subject.html
Stepper motor discussion board

members.tripod.com/~schematics/stepper2.htm
Stepper motor control circuit (using 555 and 74194)

Circuit Circus

Voltage-Reversal Circuits, Plus

CHARLES D. RAKES

Last month, when we met, we were deep into a number of voltage-reversal circuits and ran out of time and space before completing all that I wanted to cover. As promised, we are continuing that discussion with a few new voltage-reversal circuits and a number of add-on circuits. If you missed our last meeting and can not locate a copy of the material covered, all is not lost because most of the add-on circuits we are going to look at this time can be used with our new reversal circuits as well as the reversal circuits covered last month.

VARIABLE-OUTPUT ADD-ON CIRCUIT

Our first add-on circuit, see Fig. 1, can be used to turn any of the PNP-input, voltage-reversal circuits that appeared in Figs. 2, 6, and 7 of last month's column into a variable-output circuit. The basic circuit illustrated in Fig. 1A can also be modified to function with any of last month's NPN-input

circuits (as we'll see shortly), but first, let's get a clear understanding of how our first circuit for this month operates.

The circuit in Fig. 1A is comprised of half a 4011 CMOS quad 2-input NAND gate (IC1), a couple of diodes (D1 and D2), a transistor (Q1), and a few support components. In that circuit, two gates from the 4011, IC1-a and IC1-b, are configured as a free running oscillator that operates at about 40 Hz. Potentiometer R1 adjusts the oscillator's output pulse width over a range of almost 98% or from less than 1 millisecond to about 25 milliseconds. The oscillator's output frequency remains almost constant during pulse-width changes, providing a smooth and wide range of output control for the voltage-reversal circuit.

Transistor Q1, a 2N3906 PNP unit, functions as a buffer amplifier, affording some degree of isolation between the output of IC1-b and the input circuitry of the PNP-reversal circuit.

Figure 1B illustrates the variable-

PARTS LIST FOR THE VARIABLE-OUTPUT ADD-ON, CIRCUIT (FIG. 1)

SEMICONDUCTORS

IC1—4011 CMOS quad two-input NAND gate, integrated circuit
Q1—2N3906 general-purpose silicon PNP transistor
D1, D2—1N914 general-purpose, small-signal silicon diode

RESISTORS

(All fixed resistors are 1/4-watt, 5% units.)

R1—500,000-ohm potentiometer
R2—2200-ohm

ADDITIONAL PARTS AND MATERIALS

C1—0.1- μ F, ceramic-disc capacitor
Printed-circuit or perfboard materials, wire, solder, hardware, etc.

output pulse generated by the Fig. 1A circuit. When the negative portion of the waveform is very small, the average output voltage of the reversal circuit is also very small. But, as the negative pulse increases in width, output power also increases. Since the reversal circuits are primarily used to run small DC motors, the variable pulse width generator does a smooth job in controlling the motor's speed. The direction of rotation is selected by which transistor input is being driven.

MODIFIED VARIABLE-OUTPUT ADD-ON CIRCUIT

The driver circuit shown in Fig. 2 is essentially identical to the one shown in Fig. 1, except that the Fig. 2 circuit has a third gate added to the mix. The Fig. 2 circuit is designed to operate NPN-input reversal circuits, including the Fig. 4 circuit in last month's column, as well as the circuits in Figs. 5 and 6 this month.

Like the previous circuit, this one revolves around an oscillator comprised of two gates (IC1-a and IC1-b, half of a 4011 CMOS quad two-input NAND gate). The output of the oscillator

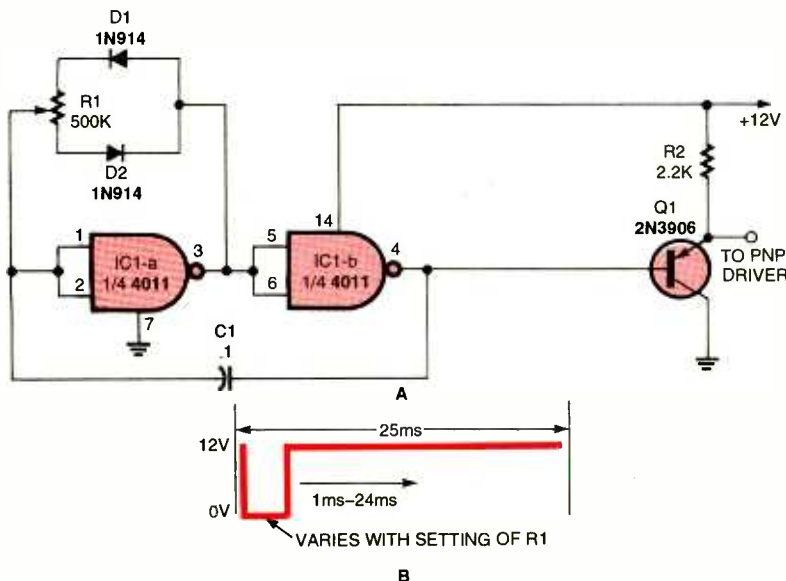

Fig. 1. The variable-output add-on circuit illustrated in A—which is comprised of half a 4011 CMOS quad 2-input NAND gate (IC1-a and IC1-b are configured as a free running oscillator that operates at about 40 Hz), a couple of diodes (D1 and D2), a transistor (Q1), and a few support components—is designed to be used with any of the PNP-input, voltage-reversal circuits that appeared in last month's column. The graph in B illustrates the waveform generated by the circuit in A.

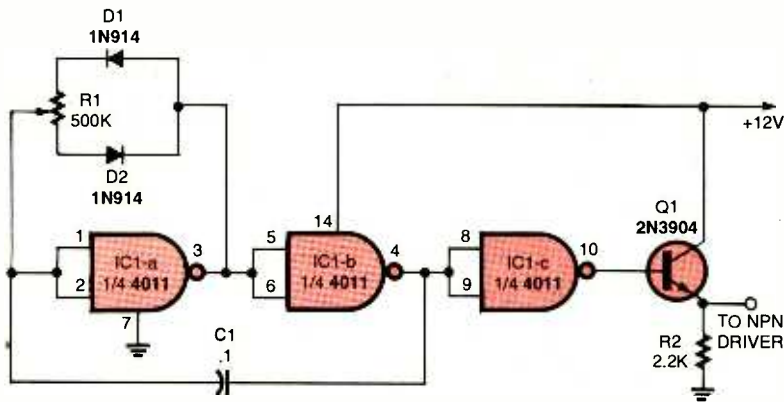

Fig. 2. The basic circuit illustrated in Fig. 1A can be modified—as illustrated here—so as to function with any of last month's NPN-input circuits. Note that this circuit and the previous one are identical except that a third gate has been added to the circuit and R2 has been switched from the collector lead of Q1 to its emitter terminal.

at pin 4 is fed to a third gate (IC1-c), which is configured as an inverter. The inverter flips the polarity of the input signal and applies the resulting signal to the base of Q1, a 2N3904 NPN transistor configured as an emitter follower. Transistor Q1 is used to amplify the output signal. The circuit's output can be switched from one NPN input to the other to reverse the output voltage or the motor's direction of rotation.

Up to this point all of the voltage-reversal circuits we've worked with have been strictly DC output circuits, but our next circuit, which generates an AC output waveform, can be used to alter the operation of the voltage-reversal circuits.

AC-DRIVER

Our next add-on circuit, see Fig. 3, connects to both inputs of any of last month's or this month's NPN-input voltage-reversal circuits, turning it into an AC output generator circuit. That allows you to experiment with a vari-

able-frequency drive that can be used to control the speed of low-voltage AC motors; or, with the aid of a step-up transformer, the circuit can be used to drive a standard low-power 117-volt AC motor.

In the Fig. 3 circuit, half of a 4011 CMOS quad two-input NAND gate (IC1-a and IC1-b) is configured as a variable-frequency square-wave oscillator, with an adjustable output frequency that ranges from about 20 Hz to over 1000 Hz. The oscillator's output at pin 4 of IC1-b is fed to the clock input of IC2, half of a CMOS 4013 dual D-type flip-flop. The outputs of the flip-flop at pins 1 and 2 are always 180 degrees out of phase; *i.e.*, when one output is high or near 12 volts, the other output is low or at ground potential. The 4013—which in this application functions as a simple divide-by-two counter—produces a symmetrical output waveform that toggles at half the input frequency. The two outputs of IC2 at pins 1 and 2 are, respectively,

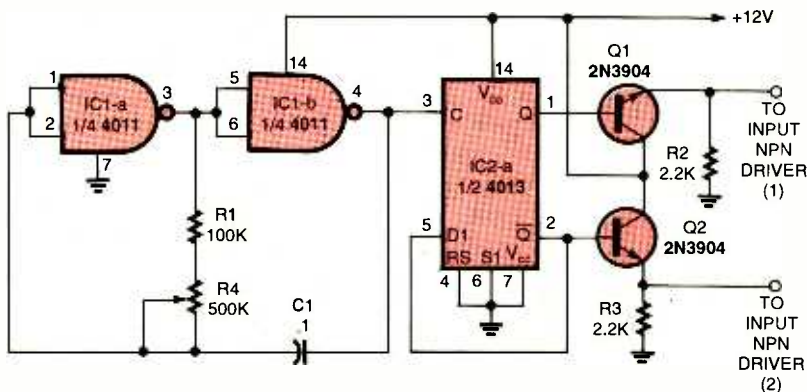

Fig. 3. The complementary outputs of this AC-driver circuit can be connected to the two inputs of any of the NPN-input voltage-reversal circuits.

PARTS LIST FOR THE MODIFIED VARIABLE-OUTPUT ADD-ON CIRCUIT (FIG. 2)

SEMICONDUCTORS

IC1—4011 CMOS quad two-input NAND gate, integrated circuit
Q1—2N3904 general-purpose silicon NPN transistor
D1, D2—1N914 general-purpose, small-signal silicon diode

RESISTORS

(All fixed resistors are 1/4-watt, 5% units.)
R1—500,000-ohm potentiometer
R2—2200-ohm

ADDITIONAL PARTS AND MATERIALS

C1—0.1- μ F, ceramic-disc capacitor
Printed-circuit or perboard materials, wire, solder, hardware, etc.

routed to a pair of 2N3904 general-purpose NPN transistors, Q1 and Q2. Those transistors, configured as emitter followers, are used to supply drive current to the base terminals of the NPN transistors in the voltage-reversal circuits. To see how the AC Driver works, we'll jump ahead to this month's first voltage-reversal circuit to see how it operates, and then connect the two circuits together.

HexFET VOLTAGE-REVERSAL CIRCUIT

Figure 4 shows this month's first voltage-reversal circuit: Note that instead of bipolar junction transistors (BJTs) or conventional FETs, the Fig. 4

PARTS LIST FOR THE AC DRIVER (FIG. 3)

SEMICONDUCTORS

IC1—4011 CMOS quad two-input NAND gate, integrated circuit
IC2—4013 CMOS dual D-type flip-flop, integrated circuit
Q1, Q2—2N3904 general-purpose NPN silicon transistor

RESISTORS

(All fixed resistors are 1/4-watt, 5% units.)
R1—100,000-ohm
R2, R3—2200-ohm
R4—500,000-ohm potentiometer

ADDITIONAL PARTS AND MATERIALS

C1—0.1- μ F, ceramic-disc capacitor
Printed-circuit or perboard materials, wire, solder, hardware, etc.

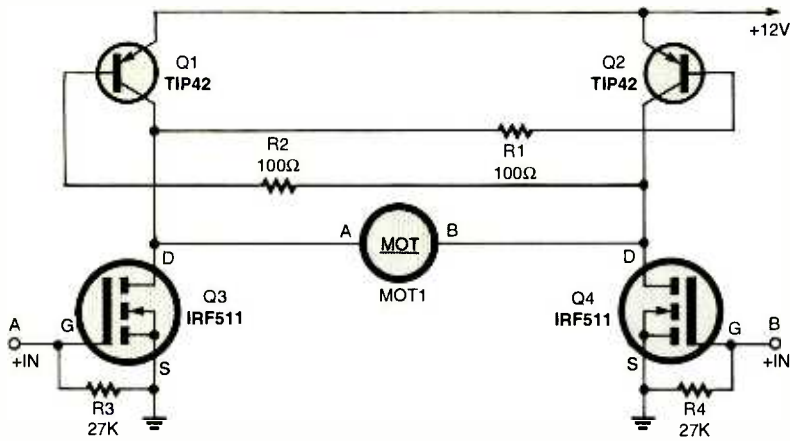

Fig. 4. This circuit differs from previous ones in that it combines a pair of PNP bipolar-junction transistors (Q1 and Q2) with a couple of N-channel HexFETs.

circuit uses a combination of PNP BJTs and N-channel HexFETs. The HexFETs are used as power-controlling components in this application. The two PNP power transistors, Q1 and Q2, are biased in a crisscross fashion as was done in our other voltage-reversal circuits (see last month's column). The two IRF511 N-channel HexFETs replace the two MJE3055 power transistors used in last month's Fig. 7 voltage-reversal circuit. In addition, the Fig. 4 circuit is set up for a positive instead of a negative input, as was used in last month's Fig. 7 circuit.

The following is a brief description of the Fig. 4 circuit and is presented especially for those who were unable to join us last month. As shown, the gate of each HexFET, Q3 and Q4, is tied to ground through its respective 27k resistor, R3 or R4, biasing each

HexFET off, allowing no current to flow from source-to-drain. When +12-volts is applied to input A, Q3 turns on, pulling its drain low. Turning Q3 on pulls the base of Q2 low, causing it to turn on, forcing its collector voltage to rise toward the positive supply voltage. The motor's A terminal is now tied low, while its B terminal is tied high, causing the motor to rotate in one direction.

When the positive bias previously applied to Q3 is removed and instead applied to the base of Q4, Q4 turns on feeding a forward-bias voltage to the base of Q1. That causes Q1 to turn on, feeding +12-volts to the motor's A terminal. At the same time, Q4 provides a path to ground through Q4 for MOT1. Under those conditions, the motor rotation reverses.

Now let's see what happens when the Fig. 3 and Fig. 4 circuits unite to

PARTS LIST FOR THE HexFET VOLTAGE-REVERSAL CIRCUIT (FIG. 4)

SEMICONDUCTORS

Q1, Q2—TIP42 silicon PNP power transistor
Q3, Q4—IRF511 N-channel power HexFET

RESISTORS

R1, R2—100-ohm, 1/2-watt, 5%
R3, R4—27,000-ohm, 1/4-watt, 5%

ADDITIONAL PARTS AND MATERIALS

MOT1—12-volt DC motor
Printed-circuit or perboard materials, wire, solder, hardware, etc.

form a single motor-controller. The two outputs from the AC Driver (Fig. 3) connect to the A and B inputs of the reversal circuit in Fig. 4. Since the two outputs of the AC driver are always 180-degrees out of phase, only one of the HexFETs in Fig. 4 can be turned on at any given time. Each time the inputs flip-flop, the output polarity reverses, producing an alternating effect, making the voltage applied to the motor an AC source.

As an experiment, connect the secondary of a 12-volt, 1- to 3-amp transformer to the voltage-reversal output circuit in Fig. 4, and connect a very low-power 117-volt AC motor to the transformer's primary winding. Set the AC Driver to generate a 120-Hz output so that frequency of the signal applied to the transformer is 60 Hz. If the motor takes off, try varying the oscilla-

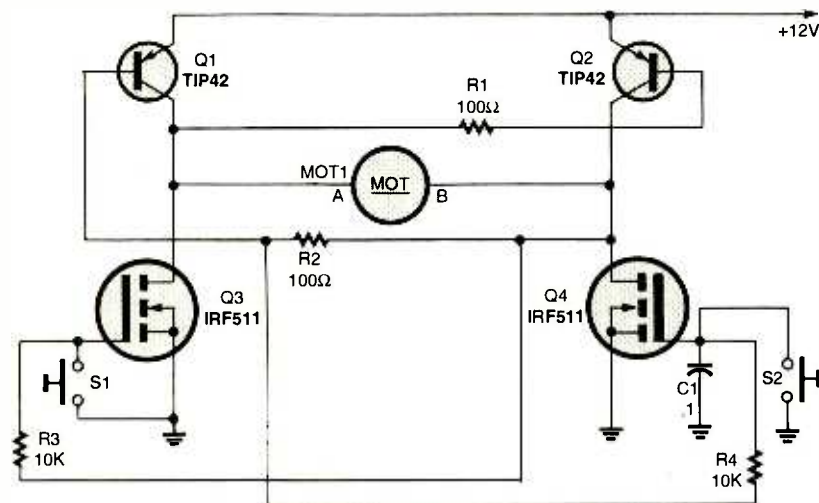

Fig. 5. This latching HexFET voltage-reversal circuit is little more than a slightly altered rendition of the Fig. 4 circuit.

PARTS LIST FOR THE LATCHING HexFET VOLTAGE-REVERSAL CIRCUIT (FIG. 5)

SEMICONDUCTORS

Q1, Q2—TIP42 PNP silicon power transistor
Q3, Q4—IRF511 N-channel power HexFET

RESISTORS

R1, R2—100-ohm, 1/2-watt, 5%
R3, R4—10,000-ohm, 1/4-watt, 5%

ADDITIONAL PARTS AND MATERIALS

C1—0.1-μF, ceramic-disc capacitor
S1, S2—Normally open pushbutton switch
MOT1—12-volt DC motor
Printed-circuit or perboard materials, wire, solder, hardware, etc.

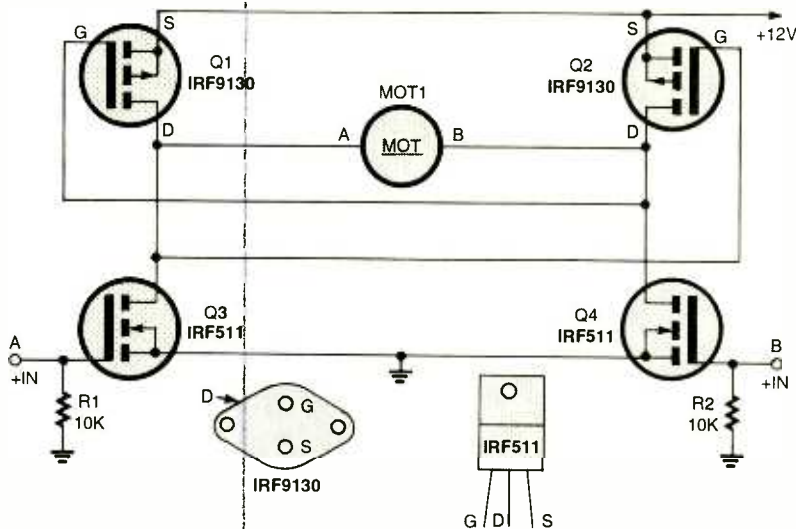

Fig. 6. This circuit, built around a pair of IRF9130 P-channel (Q1 and Q2) and a couple of IRF511 N-channel (Q3 and Q4) HexFETs, operates like the previous circuit.

tor frequency. The motor should increase in speed as the frequency increases and decrease as the frequency drops (I've not tried this so proceed with caution!). Adding a fuse in series with the power source feeding the circuit might be a wise move.

LATCHING HexFET VOLTAGE-REVERSAL CIRCUIT

Our next entry, see Fig. 5, is a slightly altered rendition of the Fig. 4 circuit, making the resulting configuration a latching HexFET voltage-reversal circuit. In the Fig. 5 circuit, the gates of the two HexFETs (Q3 and Q4) are cross-coupled to each other's drain through a 10k resistor. A normally open pushbutton switch is connected from each HexFET's gate to ground. A 0.1-μF capacitor (C1) is connected from the gate of Q4 to ground. When power is first applied to the circuit, the input to Q3 goes high for a very brief period. During that period, the input to Q4 remains low because C1 has not had time to charge. That turns Q3 and Q2 on, supplying a positive voltage to output terminal B and ground to terminal A. The circuit is now latched in that condition. Pressing S1 turns Q3 off allowing Q4 and Q1 to turn on, reversing output-voltage polarity. Pressing S2 causes the polarity of the output voltage to revert to its initial or startup condition.

ALL-HEXFET VOLTAGE-REVERSAL CIRCUIT

Our last entry this time around,

PARTS LIST FOR THE ALL-HEXFET VOLTAGE-REVERSAL CIRCUIT (FIG. 6)

SEMICONDUCTORS

- Q1, Q2—IRF9130 or similar P-channel power HexFET
- Q3, Q4—IRF511 or similar N-channel power HexFET

ADDITIONAL PARTS AND MATERIALS

- R1, R2—10,000-ohm, 1/4-watt resistor
- MOT1—12-volt DC motor
- Printed-circuit or perfboard materials, wire, solder, hardware, etc.

refer to Fig. 6, is an all-HexFET voltage-reversal circuit. The circuit is comprised of a pair of IRF9130 P-channel HexFETs (Q1 and Q2) and a couple of IRF511 N-channel HexFETs (Q3 and Q4), which probably don't constitute the best-matched complementary pairs. However, they were available and I found that they worked very well together.

The All HexFET Voltage-Reversal Circuit operates just like the previous circuit, but requires no base drive current as did the transistor version. The cross-coupled gates require only a voltage input not a current input. If a high-power voltage-reversal circuit is required, the all-HexFET approach would be the best choice to follow. It would be wise to search out and use a matched complementary pair of HexFETs with a suitable voltage and current ratings for the application at hand.

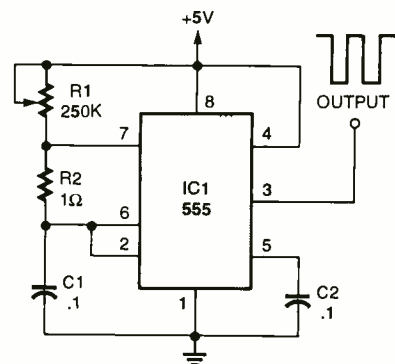

Fig. 6. A 555 timer IC can be configured to provide a train of pulses to operate a stepper motor in free-run mode—R1 controls the speed.

transistors (see Fig. 3), Darlington arrays, or MOSFETs to increase the current capacity of the circuit. Darlington arrays make short work of connecting stepper motors to CMOS- and TTL-level components. For example, the ULN2003 Darlington array from Allegro Microsystems supports outputs of up to 500 milliamps per phase. The ULN2003 contains seven Darlington transistors with TTL-compatible inputs. Self-contained power driver ICs, such as the UDx2547B ICs also from Allegro, will drive all four inputs of a four-phase unipolar motor. Each phase can draw up to 600 milliamps without additional external circuitry. Figure 5 shows a pinout diagram of the UDx2547B.

Finally, you need a square-wave generator to provide the trigger pulses that drive the stepper motor. You can use the 555 timer wired as an astable multivibrator (see Fig. 6), if you merely want a free-running stepper motor demonstrator. If you're connecting your robot to a computer, such as through a parallel port, connect a pin from the PC to the trigger input of the stepper motor translator IC or circuit. Connect another pin from the PC to the direction input of the translator IC or circuit. You'll have to write control software using C, QBASIC, Visual Basic, or another programming language to activate the proper pins on the parallel port. Note that filter capacitors C1 and C2 are important, as the 555 puts out a lot of noise into the power supply, and this noise could regularly disturb the counting logic in the translator circuit or IC.

Next month: Robots and vision.

SCANNER SCENE

Space Calls

MARC SAXON

Optoelectronics has introduced an interesting and versatile receiver they call the OptoCom. Physically, it's a compact box that connects to any laptop or desktop computer. With the OptoCom's special software installed, you end up with a well-endowed computer-controlled triple-conversion receiver that's a 25–520- and 760–1300-MHz high-speed scanner. (Cellular frequencies are blocked, per federal requirements.)

OptoCom will provide you with the only scanner having the ability to follow both the Motorola and also the LTR trunked systems on any frequency. So you could, for example, monitor 400-MHz, 500-MHz, 800-MHz, and 900-MHz trunked systems. You can set up multiple trunked systems as well as conventional frequencies for scanning simultaneously.

This receiver can decode CTCSS, DCS, LTR, DTMF, and Motorola talk group IDs. It scans at up to 65 channels/second. Pipeline tuning scans 60–100 channels/second. A store-scan feature allows downloading up to 28 different frequencies into OptoCom's internal memory. This permits scanning when away from the computer, such as while mobile.

NFM sensitivity is 0.5 μV from 25–1000 MHz, 3 μV above 1000 MHz. WFM sensitivity is 3 μV from 25–1000 MHz, 10 μV above. AM sensitivity is 2 μV from 25–1000 MHz, 5 μV above. NFM selectivity is –6 db at ± 10 kHz and –50 db at ± 20 kHz.

The OptoCom has a built-in speaker, plus jacks for tape out, headphones, and an external speaker. There's a built-in telescoping antenna. It operates from 120 VAC and 13.8 VDC. The unit comes with the software and CI-5 interface. The cost is \$549.

For more information, contact Optoelectronics, 5821 NE 14th Avenue, Ft. Lauderdale, FL 33334;

Tel. 954-771-2050; Web: www.optoelectronics.com.

FOR THE BIRDS?

There has been increased hobby interest in extraterrestrial signals, what with the multinational space station finally under construction. This seems like a good time to run down some relevant frequencies within tuning range of scanners.

The Russian MIR has been noted in NFM mode on 121.75, 130.165, and



Connect the Optoelectronics OptoCom to any laptop or desktop computer and you'll have a terrific computer-controlled triple-conversion receiver that scans 25–520 and 760–1300 MHz.

143.625 MHz. Our Space Shuttle astronauts use 259.7, 270.0, and 296.8 MHz, AM mode, for voice communications while working outside the vehicle. The Space Shuttle has been reported with a data channel on 416.50 MHz.

The 137.00–138.00-MHz band has long been used for various satellite downlink transmissions, so it's worth searching here in NFM mode 5-kHz increments. A few of the frequencies reported of late include: 137.30, 137.40, 137.44, 137.46, 137.50, 137.62, 137.665, 137.685, 137.71, 137.745, 137.77, 137.80 and 137.85 MHz. These are beacons and data transmissions. You may discover a number of others.

Between 243.845–269.95 MHz (mostly NFM mode, but some WFM) there are numerous voice and data downlinks of U.S. military satellites. Sometimes the voices are scrambled, but not always. Once in a while you

hear Russian, French, or Italian being spoken (occasionally even using AM mode). Search in 12.5- or 25-kHz steps.

The 399.90–404.00-MHz band is authorized for numerous satellite downlink uses. Search in 12.5- or 25-kHz steps, NFM mode.

The Navstar GPS satellites transmit navigation signals on 1227.6 and 1575.42 MHz. These are primarily intended for military purposes, such as guiding smart missiles to zero in for pinpoint accuracy hits on designated targets. Military GPS receivers can also receive nuclear explosion alerts that the system transmits on 1381.05 MHz. There are several Russian navigational satellites on frequencies in the 149.90–150.03 MHz band, NFM mode.

For best results when using a hobby-grade scanner to search for any satellite signals, you'll need an outside antenna. A signal preamplifier (such as the GRE SuperAmplifier) is a definite help.

JEEPERS BEEPERS

When someone says beeper, the first thing that comes to mind is a radio pager. But remember the bumper beeper. That's a tiny electronic surveillance device surreptitiously attached to a suspect's vehicle by a federal or local enforcement agency. The unit transmits a signal to aid tailing and locating a suspect's vehicle. These devices most often transmit in the VHF low band using a 1/2-watt unmodulated carrier. They will transmit for 10 days and then automatically shut off.

Fact is, using electronics to locate and track vehicles is as much of an art as it is a science. While the humble bumper beeper remains in active use, it has inspired several high-tech spin-offs.

Popular police and federal-agency bumper-beeper frequencies can be

(Continued on page 74)

Comm Links

Unusual Cases of EMI

JOSEPH J. CARR

Welcome to the new incarnation of our *Ham Radio* column. In addition to the types of topics we've addressed in the past, we'll be covering even more aspects of the electronics behind communications.

This month our focus will be on one of the undesirable things that comes along with radio communications—electromagnetic interference (EMI)—as well as the necessity for electronic products (communications and otherwise) that possess electromagnetic compatibility (EMC). It's not always so easy. The problems of EMI/EMC afflict all communications: commercial, governmental, citizen's band, and amateur radio. It's one of the things these services have in common.

Over the years I've serviced a lot of different problems of EMI/EMC, including residential, business, industrial and mobile. Some of them are pretty funny.

SOME REMINISCING

During a much earlier period of my life I worked installing CB and land-mobile two-way radios, as well as ordinary automobile radios. One of the main jobs for an installer of mobile electronic gear is to locate and suppress interference sources. And vehicles abound in such sources! The ignition and the charging system are prime culprits, but also causing problems are things like the gas-gauge sending unit, power windows, and almost anything else electrical. Today, we have a number of digital processors and computers on board as well as the traditional noise sources.

Even if your field of interest is limited to eliminating mobile ignition-system noise, the task can be daunting. I've seen cases where an ungrounded hood caused massive noise problems. And the fiberglass hoods found on some cars are absolutely evil if the bonding comes loose! In other cases,

noise all across the band.

The master technician, a rough and ready fellow named Moodie, came down to the garage, determined to "... show that Carr kid how it's done." He inspected my work and could find no fault. He tried a few things himself, and after two hours was still unsuccessful.

At that point, weary from lack of success (not to mention a two-hour chewing out by Moodie), I leaned my elbow against the chrome roof-line of the Crown Vicky. The noise stopped!

Why? One of the features that distinguished the '56 Crown Vicky from less costly models was a 9-foot long curved chrome decoration strip around the front of the roof line, continuing on to the two sides of the vehicle. Get

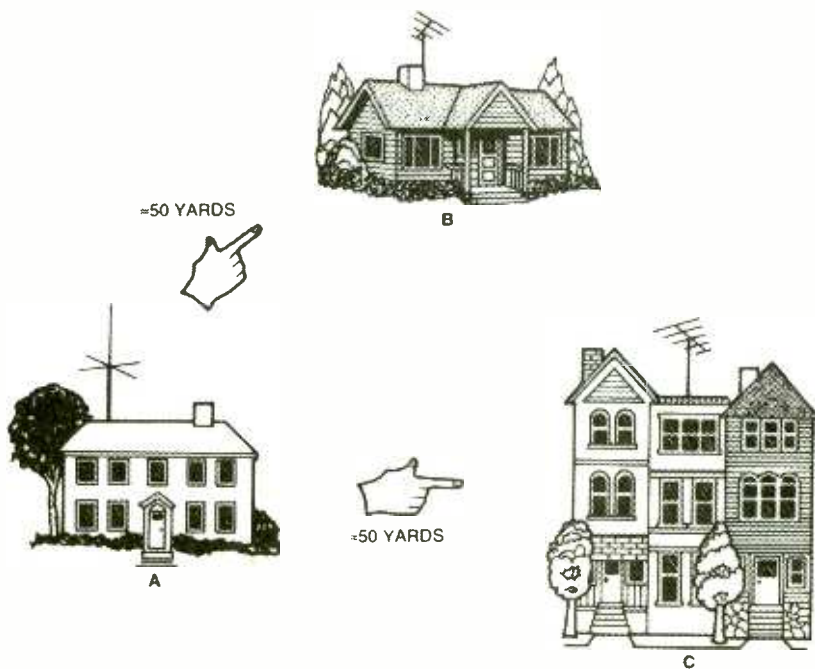

Fig. 1. This diagram shows the layout of one of the first EMI trouble spots I looked into. House "A" was the site of the CB equipment involved, while "B" and "C" were sites of interference.

noise is induced on the DC power lines that pass through the firewall from the engine compartment to the passenger compartment, where it is re-radiated and picked up by the electronic equipment. In some cases, an ungrounded engine exhaust pipe will re-radiate noise as effectively as an antenna.

All of those things are routinely found. But some are not so routine. Once (if you will permit me a nostalgic regression), I was working installing CB sets at the dawn of the CB era (late 1950s and early 1960s). The vehicle was a then recent-model 1956 Ford Crown Victoria sedan. I tried everything in the technician's bag of tricks, and the CB kept clicking with ignition

the point? Nine-feet is quarter wavelength at the 11-meter (27 MHz) citizen's band, so even minute amounts of radiation would find a resonant situation and re-radiate right into the antenna! Cleaning and resetting the clips and screws that held the chrome strip fast solved the problem.

During that same period I worked part-time for an AM/FM broadcaster. It played mostly country music in the past, but had just started carrying what passed for "folk music" in those days. FM broadcasting was relatively new, and only then were large numbers of FM broadcast receivers being installed on hi-fi sets. In previous times, FM receivers were add-ons to AM

designs, so they tended to be low-fi. Listeners didn't notice the 60-Hz hum that permeated the signal because their receivers' audio rolled off considerably above 60 Hz (the -3 dB point was usually about 200-300 Hz). But when Dick Cerri's *Music Americana* went on the air, a lot of listeners called in and complained. The audience for that show had a lot of hi-fi owners whose equipment worked really well at 60 Hz. That hum was a huge component of the signal.

The problem with that system was that someone managed to install a new studio and never even considered using a common ground. One night, the chief engineer showed up with a roll of copper roofing flashing (7-inches wide, 1-lb/ft²), a foot-square ¼-inch copper plate, some tinned copper braid, and a drill. We placed the copper plate underneath the disk jockey's desk, and ran bonding braid from all pieces of equipment to that plate. The copper flashing was routed down the back of the desk, under the fake wall, to the transmitter. The flashing was bolted to a grounding surface on the footers of the transmitter. Unfortunately, there were no connectors and I broke three bits on some of the hardest steel I've seen trying to fasten that darn copper flashing.

When the chief engineer measured the hum before and after we had achieved at least 50 dB of suppression. It might've been more, but that was the limit of our test equipment at the time.

Some years later I was at Old Dominion College in Norfolk, Virginia, and working part-time to pay my way. Another rough and ready fellow was named Dexter. He was a fellow ham-radio operator (which is how I met him), but he was also a broadcast engineer for one of the larger independent AM broadcast stations in the area. In his free time, ol' Dexter would find new FM broadcast stations, get the license, rent it and his station in his garage to budding new broadcasters, and sit back and collect the money. The broadcaster would stay in Dexter's garage until they could build their own transmitter and get it FCC approved. I was rather amused when

someone showed me a copy of a book by televangelist Pat Robertson that showed the Christian Broadcasting Network's first FM station—it was a clear picture of Dexter's garage.

One day I was riding with another ham operator on the way over to Dexter's house. We were listening to

enough to the antenna to be overloaded. For all these years I haven't been able to figure out why tying off the coax that way stopped the oscillation. If you have any good theories, please contact me (see the end of this column).

DON'T COMPLAIN TOO LOUDLY

My final example is one that I handled for a customer of a radio shop. A local ham operator was accused of causing television interference. His neighbors could hear his voice on their sets. In our area, the local FCC Field Engineering Office relied on volunteers to solve TVI problems for commercial, amateur-radio, and CB stations, and I was one of the volunteers. Consider Fig. 1, which represents the layout of the area. The interfering

signal was located in a duplex house ("A" in the diagram), and it had a vertical antenna.

Although the guy was a ham operator, he was using a citizen's band set. I checked the output of the transmitter and it was right at four watts (where it legally should be). I then inserted a pretty heavy-duty low-pass filter with a 33-MHz cut-off frequency and a very sharp roll-off slope. The output of the CB set went down only a very small amount equal to the insertion loss of the filter. That's a good sign that there was no harmonic radiation. Other tests showed that there were no spurious emissions of any sort. Yet the interference persisted even with the filter in-line. Grounding was ruled out.

Refer to Fig. 1 again. The buildings were separated by not more than fifty yards or so. Again, the CB rig was at "A." The complainants were at "B" (a single family home), and "C" (a townhouse block). The loudest and most profane of the complainers was the president of the townhouse homeowner's association.

My first attempt was to solder a high-pass TVI filter directly to the antenna terminals of the tuner inside the TV set at "B" (I was also a qualified consumer electronics Certified Electronics Technician). The problem persisted. The interference didn't even abate. That's not supposed to happen, by the way. Putting a low-pass filter on

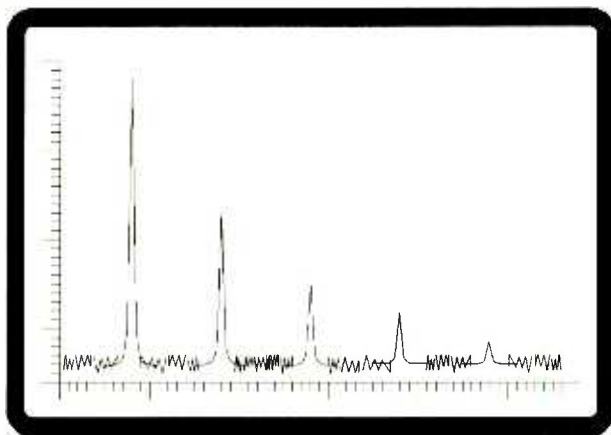

Fig. 2. Spectrum analyzers are essentially swept receivers that display output on a cathode-ray oscilloscope. The amplitude-vs.-frequency plot shown here is an example of such output.

another station, but were soon pretty certain that the interference we were hearing was coming from Dexter's transmitter. It was all up and down the FM band! Every half megahertz or so, there was Dexter's FM signal. The signal itself was really broad on its own frequency. When we got over to the house we ran inside and told ol' Dexter what we heard. He said that the shoestring had slipped again.

Huh? The *what* slipped?

We followed Dexter out to the garage and watched him open the rear door of the transmitter. Oddly, the thing didn't go off the air (the door AC interlocks were all shorted—don't try that at home, kids). The deviation meter was slashing back and forth, rather than oscillating about a fixed (legal) point. The 1000-watt final amplifier was in one deck of the 19-inch rack, and the exciter/modulator were in another deck. The coaxial cable between them had a black piece of shoelace dangling free. Dexter pushed the coax over to the side of the cabinet and refastened the knot that secured it. Sure enough, the deviation meter settled down as a result of this action.

A quick check on my buddy's car radio showed the problem was cured, even though the car radio was close

the HF transmitter and a high-pass filter directly on the TV tuner front-end is supposed to nip the problem in the bud. Right? After all, the *ARRL Handbook* said so.

Not if the interfering signal is on-channel!

So how could that be? The emission from the transmitter at "A" was at 27 MHz or so, and the interference was to VHF television channels, some of which weren't harmonically related to the transmitter frequency. I borrowed a Stoddard Field Strength Meter and went to work looking for the source of the problem. Sure enough, a signal was present on one of the non-harmonically related TV channels, and it got stronger and stronger as I got closer to the townhouse block ("C").

The problem turned out to be quite simple. The townhouse block had one television antenna in the center of the cluster (antennas were frowned on, and cable hadn't been installed in that neighborhood), so they used a Master Antenna TV (MATV) system. A single high gain antenna served the entire block. To give it enough signal, there was a 60-dB wideband amplifier at the antenna "head end." My more physically fit buddy climbed into the attic of the townhouse cluster and turned off the amplifier, while the CBer at "A" was transmitting. Simultaneously, the interference at "B" also disappeared!

We later pieced together what happened. The front-end RF amplifier transistor (a PNP germanium unit) was leaky (weren't most of 'em in those days?), and it was easily saturated. When the CB signal was picked up on the twin-lead transmission line (they didn't even use coax from the antenna to the amplifier!), it was rectified by the RF amplifier transistor. This created a large number of harmonics. To make matters more interesting, there were also a large number of TV and FM signals applied to the amplifier as well. These mixed together to produce a mish-mash of intermodulation products that were re-radiated back out the TV antenna. Unfortunately, for many of the frequencies the antenna was not only resonant (making the re-radiation very effective), it produced gain. The overall result was interference to both "B" and "C" sites.

I proved that the amplifier was causing the problem (and have since learned that it was not a rare case), but

the president of the homeowners association still complained that it must've been the CBer's four-watt setup that wrecked the amplifier. You can't win with some people.

One lesson learned: Keep your blaming, rebuking mouth zipped until you know for sure where the fault lies. After all, the cause of a problem might be in your own house.

The years I was doing EMI troubleshooting were a bit different than today. In those days, we would look for spurious emissions (parasitics) and harmonics from a transmitter with a communications receiver, field strength meter, or a tunable wavemeter. Today, we would probably use a spectrum analyzer. These instruments are essentially swept receivers with the output displayed on a cathode-ray oscilloscope as an amplitude-vs.-frequency plot (see Fig. 2 for an example of this).

If the spectrum analyzer is used, then it becomes really easy to check the output of a transmitter to see if the harmonics are legal. If the rules call for a harmonic to be -40 dBc (decibels below the carrier), then it becomes immediately apparent on the spectrum analyzer if the spec is not being met. You can also see if any other signals are present and do a site analysis to determine the possible signal combinations.

Spectrum analyzers can be quite expensive. It's possible to pay \$40,000 for one. But today you can also buy commercially built spectrum analyzers for less than \$2000. Some of these work by using your oscilloscope as the display, while others have a built-in oscilloscope.

If you are the type of person who doesn't find the building of complex electronic projects from scratch a daunting experience, then you might want to try building the Poor Man's Spectrum Analyzer kit produced by Murray Barlowe of Science Workshop (P.O. Box 310N, Bethpage, NY 11714-0310; Tel. 516-731-7628; Fax: 516-796-1693; e-mail mbarlowe@hoflink.com; Web: www.science-workshop.com). I've built two of them, one in the 1980s and one more recently. No, it will not replace a \$40,000 instrument, but it will give a good account of itself alongside some of the lesser instruments. Some people have built rather sophisticated ver-

sions of the Poor Man's Spectrum Analyzer using clever additions of their own.

As always, I can be reached by snail mail at P.O. Box 1099, Falls Church, VA 22041; or by e-mail at carjj@aol.com. ■

SCANNER SCENE

(continued from page 71)

monitored on any scanner, though most are shared with other radio services. Try these in either AM or NFM mode: 30.86-31.06 MHz (channels in 40-kHz steps), 31.12 MHz, 31.18-31.98 MHz (40-kHz steps), and 33.015, 33.06, 40.12, 40.17, 40.22, and 40.27 MHz. There are other frequencies available, but the foregoing appear to be the ones most often used. The US Secret Service is reported to use UHF frequencies 408.50 and 408.975 MHz.

Note that the well-known Lojack stolen-vehicle recovery system operates on 173.075 MHz. When a Lojack-equipped vehicle is reported stolen, a 300-watt base station transmitter sends out a signal to activate the 2.5-watt tracking transmitter hidden in the stolen vehicle. In many cities, police cars specially equipped with direction finders can use this signal to quickly track and locate the stolen vehicle, regardless of whether it's parked or in motion.

A system called Teletrac is used by many owners of vehicle fleets, such as trucks. The Teletrac base frequently transmits a signal that polls all of the vehicles in a fleet. This causes them to respond automatically with signals advising their specific locations, as determined by on-board GPS receivers. The Teletrac operator then notifies the fleet owner of the location of each vehicle. Brief messages can also be exchanged in this network. The frequency pairs used include 906.875/927.875 and 908.00/925.015 MHz. Teletrac is used in the Chicago, Detroit, Buffalo, and New York City metro areas, and possibly elsewhere as well.

Keep us posted! Let's hear from you with frequencies, column ideas, and questions. Our direct e-mail address is sigintt@aol.com. Our snail mail address is *Scanner Scene*, **Popular Electronics**, 500 Bi-County Blvd., Farmingdale, NY 11735. ■

New Products

HEAVY-DUTY MULTIMETER

Designed to withstand constant use in the field, the *HD110B Multimeter* is resistant to damage from water, dust, chemicals, voltage transients, and spikes. Special features of the HD110B include an oversized character display and an ergonomic shape. It is ideal for electricians, electrical contractors, industrial plant personnel, and HVAC/R installers and service people.

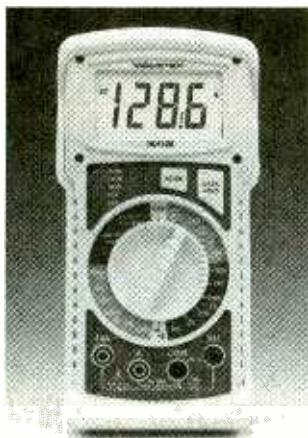

Functions include a 1500 VDC/1000 VAC voltage range; measurement of current to 10A and resistance to 20 megohms; and continuity, diode test, and data hold. A unique Safety Tester feature quickly checks for live circuits and indicates the presence of common power-supply voltages with a series of LEDs. Other features are high-voltage alerts, thirty-minute auto-off to preserve battery life, anti-skid rubber holster, and tilt-stand.

The HD110B Multimeter costs \$149. For more information, contact Wavetek Wandel & Goltermann, Inc., 9045 Balboa Avenue, San Diego, CA 92123; Tel. 619-279-2200; Fax: 619-450-0325; Web: www.wavetek.com.

CIRCLE 70 ON FREE INFORMATION CARD

CONNECTIVITY TESTER

A small handheld connectivity tester, the *CT100* enables technicians to accurately locate all the interconnected points on a PCB within seconds,

simply by wiping a conductive brush over the surface of the board and listening for a tone. This design significantly reduces fault-finding time on virtually any type of PCB, especially boards with bus structures or surface-mount components where locating shorts and opens often is time consuming and frustrating.

To locate all points directly connected to a particular circuit node, the user attaches the CT100's clip to that node and sweeps all soldered connections on the board with the unit's conductive brush. An audible tone indicates a connection, and the edge of the brush or a single-point test probe can home in on its exact location. The CT100 has a maximum output of 150mV and comes complete with test probes, circuit marker, carrying case, and user manual.



The CT100 costs approximately \$151 (US). For more information, contact Circuit Trace, P.O. Box 70, Retford DN22 0SY, United Kingdom; Web: www.toneohm.com.

CIRCLE 71 ON FREE INFORMATION CARD

RADAR DETECTOR

The *ESD-7850*, a 7-band detector, alerts drivers to the presence of speed-monitoring systems—X, K, Ka, and Laser. The Safety Alert Traffic Warning band provides early warning of potential driving hazards, including nearby emergency vehicles, stationary road hazards, and oncoming trains. Strobe Alert technology warns of vehicles with transmitters that activate traffic lights at intersections in high-speed

emergency situations.

All seven bands provide audio and visual alerts on a high-visibility LED display. The detector is equipped with Cobra's LaserEye 360-degree laser



detection, which supplies multi-directional protection, and has a VG-2 band invisible to radar "detector detectors."

The ESD-7850 has a suggested retail price of \$239.95. For more information, contact Cobra Electronics Corp., 6500 W. Cortland St., Chicago, IL 50707; Tel. 773-889-8870; Fax: 773-794-1930; Web: www.cobraelec.com.

CIRCLE 72 ON FREE INFORMATION CARD

BATTERY CHARGER

The *Power Advantage 30 Battery Charger* is designed to increase the delivery of DC power to a solar electrical system's batteries from photovoltaic (PV) panels. The charger finds the maximum power point of the solar pan-

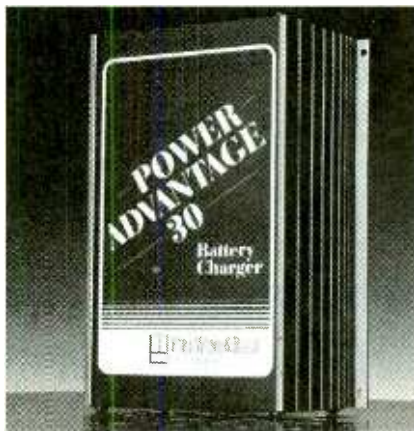

els and constantly re-adjusts for changes in sunlight, temperature, and battery voltage.

In addition to delivering 30 amps of

output current to deep-cycle lead acid batteries—typically used in solar systems—the Power Advantage features a powerful processor that monitors energy production, energy consumption, battery use, battery temperature, and illumination of the solar cells. The charger's processor communicates to Power Advantage's Virtual Control Panel software, which quickly monitors the system and shows voltage, current, and power of the PV panels. Data can easily be downloaded via modem to popular spreadsheet programs for monitoring and historical analysis.

The Power Advantage 30 Battery Charger has a list price of \$699. For more information, contact Fire-Wind&Rain Technologies LLC, 3920 E. Huntington Dr., Flagstaff, AZ 86004; Tel. 520-526-1133; Web: www.firewindrain.com.

CIRCLE 73 ON FREE INFORMATION CARD

COMPUTER MONITOR PATTERN GENERATOR

Compact (1.5 × 3.8 × 5.7 inches) and lightweight, the *Model 1275 Hand-Held Computer Monitor Pattern Generator* is ideal for use by service technicians in field and bench applications. The Model 1275 provides basic test and alignment patterns necessary

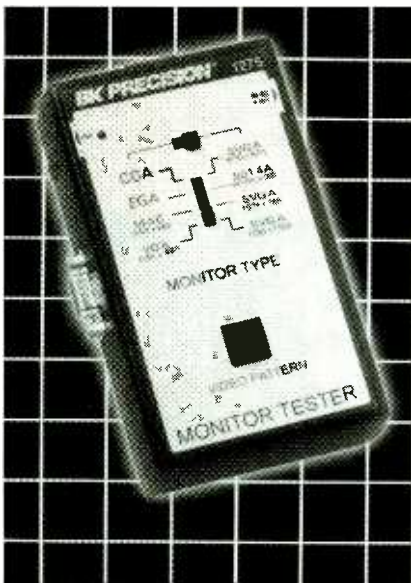

for internal or external monitor adjustment, using crosshatch or dot pattern, color bars, and Raster patterns in red, green, blue, black, and white.

The device can be used to test
76 CGA, EGA, VGA, SVGA, and Mac

monitors with a wide range of resolutions. It works with both interlaced and progressive monitors. The pattern generator features convenient front-panel controls and indicators, including the POWER ON/OFF switch, LED power indicator, left- or right-column switch, monitor-type selector switch, step-through Video Pattern Switch, and AC Adapter Power Jack.

The Model 1275 Hand-Held Computer Monitor Pattern Generator costs \$189. For more information, contact B&K Precision Corp., 1031 Segovia Circle, Placentia, CA 92870-7137; Tel. 714-237-9220; Fax: 714-237-9214; Web: www.bkprecision.com.

CIRCLE 74 ON FREE INFORMATION CARD

TWO-WAY RADIO

The *GRMS-21X*, a long-range two-way radio, produces one-watt RF output power and provides two-channel operation in the UHF (462-MHz) frequency range. It offers automatic squelch and a dual-color LED for identifying transmit "TX" and busy conditions. The compact radio is perfect for stuffing into a backpack, gear bag, or glove compartment.

The radio comes packaged with antenna and belt clip, as well as a desktop charger with power supply and two battery packs, and a rechargeable NiCd battery. Optional accessories include an ear bud speak-



er with in-line Push-to-Talk and microphone, a lapel speaker/microphone with ear jack, and a ¼-wave UHF magnetic mount mobile antenna.

The GRMS-21X costs \$199.95. For more information, contact Maxon America, Inc., 10828 NW Air World Drive, Kansas City, MO 64153; Tel. 816-891-6320; Fax: 816-891-8815; Web: www.maxonusa.com.

CIRCLE 75 ON FREE INFORMATION CARD

COMPUTER/CONTROLLER BOARD

The *SBC-1 Single Board Computer/Controller* board and developer package was designed to make prototyping and final assembly quick and easy for the system designer. The SBC-1 features 8K of EEPROM and 8K of RAM; a powerful ROM-based monitor and



developer interface, including commands that allow the SBC-1 to be operated as a "slave" to any RS-232 device; 50 digital I/O signals when used in its maximum I/O configuration; and a 50-pin I/O port to connect I/O "brick" modules and racks where each one of 24 I/O signals can be selected as an input or output. There is one 0- to 5-volt, 8-bit, analog-to-digital-converter input, two RS-232 physical ports with DB-9 connectors, and a real-time clock that can be set or read from the monitor or TinyBASIC.

The SBC-1 comes complete with circuit board, a serial-port cable for connection to an IBM-compatible PC, a wall-block power supply, host computer software and programming examples, and a manual.

The complete SBC-1 package is \$179 in single quantities. For more information, contact Industrologic Inc., 3201 Highgate Lane, St. Charles, MO 63301; Tel. 314-707-8818; Web: www.industrologic.com.

CIRCLE 76 ON FREE INFORMATION CARD

LINEAR POWER SUPPLY

The *HWD Constant Voltage/Current Linear Power Supplies* are designed for the lab bench or for a variety of system applications. The HWD Series provides full-rated voltage or current at any setting, without the need for any detailing.



The availability of RS-495 and RS-232 programming options makes the HWD series a versatile system test instrument. Digital voltmeter and ammeter provide accurate readings of the output voltage and current without the need of external DVMS. Features include digital meters, remote programming and sensing, and series parallel operation. The half-rack size unit has 10-turn voltage control, 10-turn current control, and an RS-485/RS-232 control option.

Models include maximum voltages of 6, 10, 20, 40, 60, 100, 200, and 400 VDC, and they range in price from \$950 to \$1200. For more information, contact Mid-Eastern Industries, 100 School St., Bergenfield, NJ 07621; Tel. 201-385-0500; Fax: 201-385-0702; Web: www.mideastind.com.

CIRCLE 77 ON FREE INFORMATION CARD

SOLDERING STATION

The *Antex Model 660-TC Temperature Controlled Soldering Station* can be mounted on a wall or bench and features an ergonomically designed 50-watt iron that remains cool to the touch

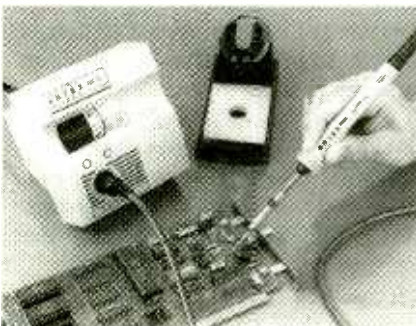

because the heating element is located directly under the tip. Providing tip-to-ground continuity for soldering sensitive electronic devices, this station has a thumbwheel for adjusting the tip temperature from 65° to 450°C (150° to 840°F).

Available with a wide selection of slide-on tips that fit the iron for specific types of soldering, the Antex Model 660-TC has LEDs to indicate "power-on" and "power-to-iron." A separate stand stores four extra tips and has a sponge to collect excess dross.

The Antex Model 660-TC Temperature Controlled Soldering Station has a list price of \$264.88. For more information, contact M.M. Newman Corp., 24 Tioga Way, P.O. Box 615, Marblehead, MA 01945; Tel. 800-777-6309 or 781-631-7100; Fax: 781-631-8887; Web: www.mmnewman.com.

CIRCLE 78 ON FREE INFORMATION CARD

GPS NAVIGATION UNIT

With a database of more than 20,000 cities world-wide, the *GPS 315* handheld receiver can guide travelers from



place to place or simply help relate their position and location to the nearest city. Connecting it to a PC enables users to download additional information on attractions. Users can also access information from an optional companion CD-ROM containing hundreds of thousands of points of interest around the world. The unit has the ability to transfer saved locations, landmarks, and routes to a PC for storage and editing. It can be used with most PC software mapping systems that are available.

The GPS 315 contains a user-friendly menu interface that's easy to learn. Its powerful 12-parallel-channel receiver coupled with a sensitive quadrifilar antenna ensures superior tracking performance anywhere you may end up.

The GPS 315 has an estimated street price of \$149.99. For more information, contact Magellan Corp., 960 Overland Court, San Dimas, CA 91773; Tel. 800-611-7955 or 909-394-5000; Fax: 909-394-7050; Web: www.magellangps.com.

CIRCLE 79 ON FREE INFORMATION CARD

CABLE VERIFIER SERIES

Ranging from a LAN and Telco cable tester to a LAN multi-cable checker



and traffic detector, the *Cable Verifier (CV) Series* testers are among the smallest in the market and easily fit into shirt pockets, tool belts, and tool kits.

Testing is as easy as plugging the connectors into a particular tester and viewing the status of the front-mounted LED array. The CV Series is ideal for locating and fixing problems in existing Datacom, Telecom, and Video cabling systems.

For LAN cable applications, there are nine CV models. Other models help wiring installers and service technicians in the Telco industry verify proper wiring. There is also a tester that provides quick and easy verification of 75-ohm CATV cabling or any coax cables that terminate in "F"-type connectors.

The Cable Verifier Series range in price from \$79 to \$799. For more information, contact Wavetek Wandel & Goltermann, Inc., 9045 Balboa Ave., San Diego, CA 92123; Tel. 619-279-2200; Fax: 619-450-0325; Web: www.wavetek.com.

CIRCLE 80 ON FREE INFORMATION CARD

ELECTRONICS LIBRARY

(continued from page 17)

MOBILE ROBOTS: INSPIRATION TO IMPLEMENTATION, 2nd EDITION

by Joseph L. Jones, Bruce A. Seiger, and Anita M. Flynn

Robotics has made quantum leaps since the first edition of this book was published. This book helps readers keep pace with the ever-growing and rapidly expanding field of robotics. Using photographs, illustrations, and informative text, this edition provides step-by-step instruction in the process

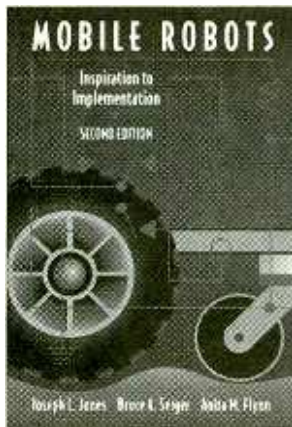

of building two robots—the TuteBot and the Rug Warrior.

Additional material includes a number of projects for the Rug Warrior, examples of robot projects and products by commercial and research groups, and heuristics and advice about robot design. The appendices have been revised and updated, and an appendix on robot contests has been added, as has information on programs and activities for robot enthusiasts.

Mobile Robots: Inspiration To Implementation, 2nd Edition costs \$32 and is published by A. K. Peters, Ltd., 63 South Avenue, Natick, MA 01760; Tel: 508-655-9933; Fax: 505-655-5847.

CIRCLE 94 ON FREE INFORMATION CARD

PATENT, COPYRIGHT & TRADEMARK

by Stephen Elias

This book provides clear, plain-English definitions of intellectual property terminology, including definitions of new

intellectual property terms spawned by the Internet. Whether you're completely new to the topic and want a basic overview, are about to enter into an

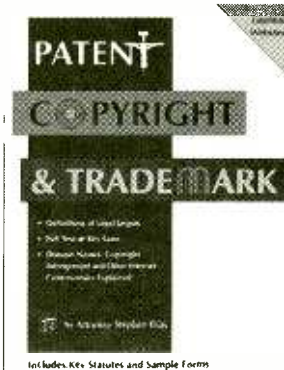

agreement and want to understand all the terms before you sign, or need the answer to a specific question, this book is an essential guide. The book contains clear and concise overviews of patent, copyright, trademark, and trade secret laws.

Readers can find the information they need quickly and easily—all entries are organized by topic and extensively cross-referenced. Key statutes and sample forms are included along with intellectual property resources and Web sites.

Patent, Copyright and Trademark, 3rd Edition costs \$24.99 and is published by Nolo Press, 950 Parker Street, Berkeley, CA 94710; Tel: 800-992-6656 or 510-549-1976; Fax: 510-548-5902; Web: www.nolo.com.

CIRCLE 95 ON FREE INFORMATION CARD

CIRCUIT TROUBLESHOOTING HANDBOOK

by John D. Lenk

This problem-solving guide helps readers coax peak performance from and resolve faults in a wide variety of circuits. It provides a complete description of the operation of important circuits and shows how each circuit's characteristics may figure in its failure or poor performance.

BooksNow To order books in this magazine or, any book in print. Please call anytime day or night: (800) BOOKS-NOW (266-5766) or (801) 261-1187 ask for ext. 1456 or visit on the web at <http://www.BooksNow.com/popularelectronics.htm>. Free catalogs are *not* available.

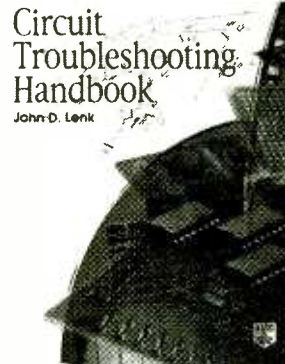

Among the circuits covered are Op-Amps, Audio Amps, Linear Supply, Switching Supply, Data Converter, Voltage-Frequency Converter, and Oscillator/Generator.

Without abstract theory or complicated math, this handbook gives clear explanations and hands-on troubleshooting procedures that point quickly toward the source of any circuit malfunction—whether it's the capacitor, transistor, resistor, IC, or any other component. Emphasis is placed on testing and the circuit's responses to the tests.

Circuit Troubleshooting Handbook costs \$39.95 and is published by McGraw-Hill, 1221 Avenue of the Americas, New York, NY 10020; Tel: 800-2MCGRAW; Web: www.ee.mcgraw-hill.com.

CIRCLE 96 ON FREE INFORMATION CARD

MAKING YOUR OWN PRINTED CIRCUIT BOARDS, 2nd EDITION

from JV Enterprises

Designed for the home hobbyist or small-business owner, this book describes a process that results in perfect single- and double-sided printed circuit boards with feature resolutions of 10 mils and less. The second edition adds over 50 pages of new material, as well as 30 illustrations and additional tables.

New chapters cover schematic capture; placement and routing, including information on the layout of analog, digital, and RF circuits; and an updated resource list.

Making Your Own Printed Circuit Boards, 2nd Edition costs \$14.95 plus \$3 S&H and is published by JV Enterprises, P.O. Box 370, Hubbardston, MA 01452; Tel: 978-928-5655; Web: <http://home.att.net/~jventerprises>.

CIRCLE 97 ON FREE INFORMATION CARD

JOIN THE SEARCH

(continued from page 36)

and orbiting relay stations.

In addition to analyzing signals, some SETI League computers also control the station. Remember the computer-controlled microwave receivers discussed above? They can often be tuned by software, driven from the PC's serial, parallel, or universal-serial-bus (USB) port. Antennas can similarly be computer-aimed, if they're equipped with software-driven azimuth and elevation rotors. Some SETI computers make lights flash and bells ring whenever they detect something interesting. And the most advanced of the computers used by SETI League members also dial into the Internet when an interesting candidate signal is received, automatically alerting other participants that their assistance in signal verification is required.

(More SETI computer information may be found in the "Software" chapter of *The SETI League Technical Manual*.)

Putting It All Together. When I built my first amateur dish more than twenty years ago, I was going it alone. That was frustrating, because I had to learn from my own mistakes. Today there's assistance. The non-profit, membership-supported SETI League exists to help you become one of the 5000 active *Argus* observers. Though only 1000-members strong at present, The SETI League is still a young organization, just three years into its search. The group's volunteer regional coordinators in over 50 countries on six continents have already helped more than five dozen members to put stations on the air. The SETI League's extensive Web site and various books and articles are already attracting hundreds of like-minded enthusiasts into the SETI community. To come on line with The SETI League, e-mail them your postal address (join@setileague.org), call their membership hotline (800-TAU-SETI), or write for a free brochure. Together, amateur SETI volunteers may well end humanity's isolation in the universe. ■

SOUND PARTNER

(continued from page 44)

time to test the project. **Note:** No calibration adjustments are needed. Simply plug PL1 into the headphone output of the personal sound system and connect two 16-

Adjust the audio level for headphone 1 (J1) using the volume control of the personal-sound system. After that, adjust volume of headphone 2 by adjusting R1. **Caution:** Never use the Sound Partner without a headphone connected to J1. Doing so could damage your

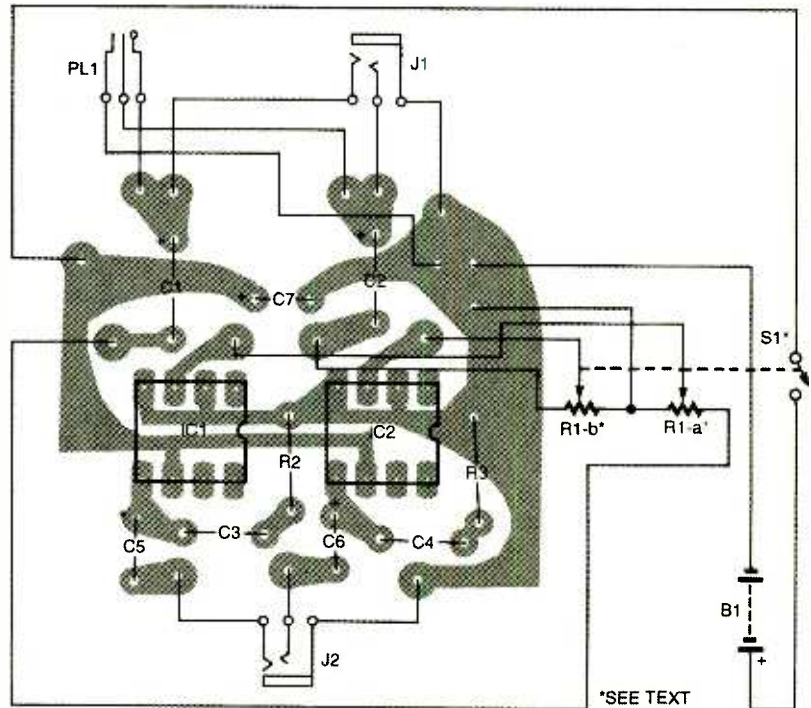

Fig. 5. Assemble the Sound Partner's printed-circuit board guided by this parts-placement diagram. Note that with the exception of the input and output jacks, the battery with its holder, and the volume control (R1), all of the components mount to the printed-circuit board.

to 100-ohm stereo headphones to the Sound Partner outputs (J1 and J2). Set power switch S1 (ganged to R1) to the off position, install the batteries in their holder, and the Sound Partner is ready for use.

personal sound system.

When all is working properly, there is nothing left to do but seal the project into its enclosure, plug it into your personal sound system, and share that must-hear tune. ■

PARTS LIST FOR THE SOUND PARTNER

RESISTORS

(All fixed resistors are 1/4-watt, 10% units.)

R1—10,000-ohm dual-gang audio taper potentiometer with SPST switch (see text)

R2, R3—10-ohm

CAPACITORS

C1, C2—4.7- μ F, 16-WVDC, miniature electrolytic

C3, C4—0.01- μ F, ceramic-disc or metal-film

C5, C6—220- μ F, 16-WVDC, miniature electrolytic

C7—100- μ F, 16-WVDC, miniature electrolytic

ADDITIONAL PARTS AND MATERIALS

IC1, IC2—LM386 low-power audio-amplifier, integrated circuit

B1—6-volt battery, see text

J1, J2—1/4-inch stereo phone jack (see text)

PL1—1/4-inch stereo phone plug (see text)

S1—SPST (ganged to R1)

Printed-circuit materials, 8- to 100-ohm headphones, plastic knob, enclosure, battery holder, IC sockets, wires, solder, hardware, etc.

ADVERTISING INDEX

Popular Electronics does not assume any responsibility for errors that may appear in the index below.

Free Information Number	Page	Free Information Number	Page
— AES	48	26 Interactive Image Technologies CV4	
— Alfa Electronics.....	53	— Intronics, Inc.....	59
— All Electronics.....	62	— James Electronic Services.....	46
— Allison Technology.....	57	— KNS Instruments.....	58
— Amazon Electronics.....	56	— Lynxmotion	58
— Andromeda Research.....	59	161 MCM Electronics.....	CV3
— Arrow Electronics.....	46	139 Mendelson's.....	57
— Basic Electrical Supply	57	174 MicroCode Engineering.....	CV2
— Bsoft	52	— Modern Electronics	58
32 C&S Sales, Inc.	50	165 Mouser	46
— Cable USA.....	58	— Pioneer Hill Software.....	46
173 Cadsoft, Inc.	13	150 Prairie Digital Inc.	52
— Circuit Specialists.....	53	143 Print	52
— CLAGGK, Inc.....	15	142 Print	61
— Cleveland Inst. of Electronics.....	33	153 Print Products Int'l.....	47
— Command Productions	48	— ProPlanet.....	59
164 Dalbani	49	— Securetek	56
— EDE Spy Outlet	58	40 Sencore, Inc.....	5
— Electronic Tech. Today.....	45	— Technological Arts.....	56
— Engineering Express.....	56	137 Telulex.....	47
— Foley-Belsaw	55	— Test Equipment Depot.....	61
— General Device Instruments.....	62	— UCANDO Videos.....	54
— Global Electronics	59	— Unbound	48
— Grantham College of Eng.....	8	— US Cyberlab	54
— Grich RC Inc.	58	— Vision Electronics	57
— Home Automation Systems.....	59	— Weeder Technologies.....	56
— ICS Computer Training.....	57	— World Wyde	53
— Information Unlimited.....	54	— Zagros Robotics	59

ADVERTISING SALES OFFICES

Gernsback Publications, Inc.
500 Bi-County Blvd.
Farmingdale, NY 11735-3931
Tel. 516-293-3000
Fax: 516-293-3115

Larry Steckler, EHF/CET
 President (ext. 201)
 e-mail: advertising@gernsback

Adria Coren
 Vice-President (ext. 208)

Ken Coren
 Vice-President (ext. 267)

Christina Estrada
 Assistant to the President (ext. 209)

For Advertising ONLY
Tel. 516-293-3000
Fax: 516-293-3115

Larry Steckler
 Publisher

Marie Falcon
 Advertising Director (ext. 206)

Adria Coren
 Credit Manager (ext. 208)

**Subscription/
 Customer Service/
 Order Entry**
 Tel. 800-827-0383
 7:30 AM - 8:30 PM CST

ADVERTISING SALES OFFICES EAST/SOUTHEAST

Megan Mitchell
 9072 Lawton Pine Avenue
 Las Vegas, NV 89129-7044
 Tel. 702-240-0184
 Fax: 702-838-6924
 e-mail: mmitchell@gernsback.com

MIDWEST/Texas/Arkansas/ Oklahoma, Colorado, Arizona

Ralph Bergen
 One Northfield Plaza, Suite 300
 Northfield, IL 60093-1214
 Tel. 847-559-0555
 Fax: 847-559-0562
 e-mail: bergenrj@aol.com

PACIFIC COAST/Mountain States

Anita Bartman
 Hutch Looney & Assoc., Inc.
 6310 San Vicente Blvd.
 Suite 360
 Los Angeles, CA 90048-5426
 Tel. 323-931-3444 (ext. 227)
 Fax: 323-931-7309
 e-mail: anita@hlooney.com

MCM ELECTRONICS®

The Source For All Of Your Electronics Needs

When ordering, please provide this code: ► SOURCE CODE: POP66

Prices effective May 18, 1999 through July 30, 1999

For over 20 years, MCM has been the leading supplier to the electronics service industry. Huge inventory, rapid delivery and competitive prices have made MCM the choice for:

- Hobbyists
- Educators
- Service Technicians
- Installers

Discover the MCM difference, call today for your free catalog.

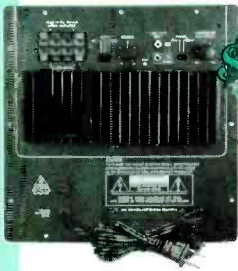

ONLY \$99.95

Order #50-6265

100W Subwoofer Amplifier Module

Ideal for anyone interested in making their own powerful subwoofer. Internally, this amplifier isolates, then sums the left and right inputs to give a single mono channel with 100W RMS output @ 4ohm, 85W RMS @ 8ohm. •Speaker level inputs •Satellite outputs •Line level inputs •Auto turn-on •12dB continuously variable 60Hz~160Hz crossover •Adjustable level control •0°/180° phase selector •Fully sealed rear housing •Requires 8 1/2" square opening •Call for quantity pricing



ONLY \$14.95

Order #29-1335



Sealed Lead Acid Battery

12 volt, 4.5 Amp/hour battery is ideal for security and other power backup applications. 0.25" tabs accept standard quick-disconnects. Dimensions 3 1/2" x 2 1/2" x 4". Regular price \$26.95



Order #82-835

DEFENDER CCD Camera

1/2" format black and white CCD camera features built-in iris and operates in subdued light to 0.3 lux. Includes 12VDC, 150mA adaptor. NTSC composite video output via BNC connector. Lens not included. Regular price \$129.00

Lenses

Order #	Description	Viewing Angle	Mount	(ea.)
82-870	4mm	101°	CS	\$59.95
82-875	8mm	40°	C	59.95
82-880	16mm	21°	C	59.95



ONLY \$39.95

Order #72-4025

TENMA® DMM W/Logic Function

3 1/2 digit DMM measures AC/DC voltage from 200mV-600V, resistance to 2000Mohm, capacitance to 20µF, transistor hFE gain and audible continuity test. Requires 9V battery (#290-080) not included. Dimensions: 2 1/2" (W) x 5 1/2" (H) x 1 1/2" (D). Regular price \$65.95.



ONLY \$9.95

Order #28-2200

Multi-Voltage Power Supply

Fully regulated supply provides up to two amps, at the following selectable voltages: •3 •4 •6V •7V •9V •12V. Regular price \$16.95.



Pre-Assembled Circuit Modules

Ideal for repairing old equipment, prototype work or your latest project. These well constructed PC boards are fully assembled, tested and ready to use. Supplied with application instructions and technical specifications. All operate from a single 12VDC source. Call your MCM Sales Representative for more information on over 120 available modules.

Order #	Description	Reg.	Sale
28-4795	1W audio amplifier	\$7.49	\$5.99
28-4796	5W audio amplifier	13.95	11.15
28-4800	5W x 2 stereo amplifier	24.95	19.96
28-4801	15W x 2 stereo amplifier	39.95	31.96
28-4851	88-108MHz FM transmitter	24.95	19.96
28-4785	2 digit LED counter	14.95	11.96
28-5115	Flip-flop relay	14.95	11.96
28-4825	VOX relay	17.95	14.36
28-4815	Electric guitar preamplifier	8.95	7.16



ONLY \$19.95

Order #32-4425

Remote Control A/B Switch

Remote controlled RF switch allows selection from two sources for output to TV or VCR, via infrared remote. Frequency range: 5MHz-8900MHz. "F" type in/out connections. Remote requires two "AA" batteries not included (#290-070). Regular price \$25.75

Introductory price \$61.50

Order #60-9490

15VDC, 350mA Solar "Power Supply"

Intended to maintain car batteries when vehicle is parked for extended periods of time, this solar panel generates 350mA @ 15VDC in full sunlight. Completely weatherproof design is UV/shock/hail resistant. Dimensions: 12" (L) x 12" (W) x 1" (D). Regular price \$74.95.



FREE Catalog!

1-800-543-4330

www.mcmelectronics.com

Hours: M-F 7 a.m.-9 p.m., Sat. 9 a.m.-6 p.m., EST.

Same Day Shipping!

In stock orders received by 5:00 p.m. (YOUR TIME), are shipped the same day.



MCM ELECTRONICS®

650 CONGRESS PARK DR.
CENTERVILLE, OH 45459
A PREMIER FARNELL Company

SOURCE CODE: POP66

THE WORLD'S MOST POPULAR
DESIGN TOOL CHOSEN BY OVER
100,000 USERS!

Electronics Workbench[®] *Personal Edition*

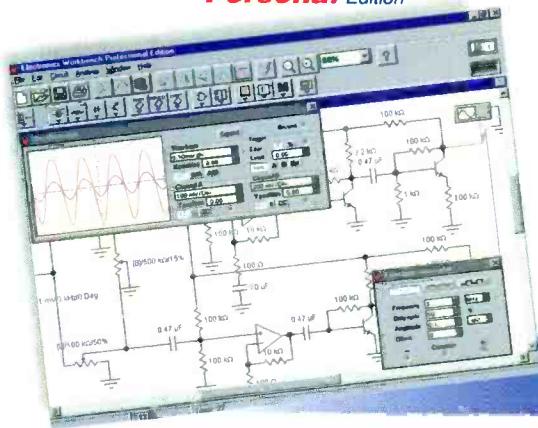

TRIPLE MIXED ANALOG/DIGITAL
FULLY INTERACTIVE SIMULATION
PRO SCHEMATIC EDITOR
6 VIRTUAL INSTRUMENTS
ON-SCREEN GRAPHS
OVER 4,000 MODELS
8 POWERFUL ANALYSES
FREE TECHNICAL SUPPORT

\$299

Full-featured schematic capture and SPICE circuit simulation!

The world's most popular circuit design tool that sets the standard for powerful, insightful SPICE simulation. Create professional looking schematics and then with the flick of a switch, display simulated waveforms live on a suite of virtual instruments. Includes 15 powerful analyses and a library of over 4,000 robust component models.

Electronics Workbench[®] *Layout* *Personal Edition*

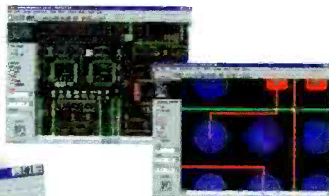
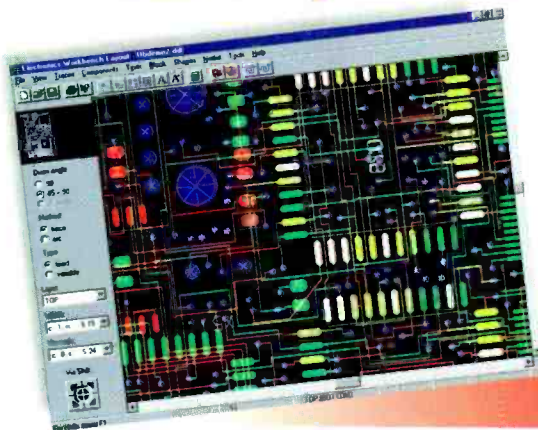

AUTOROUTING
REROUTE WHILE MOVE
32 ROUTING LAYERS
50" X 50" BOARD SIZE
OVER 3,500 LIBRARY SHAPES
EXTENSIVE OUTPUT
REAL TIME DESIGN RULE CHECK
DENSITY HISTOGRAMS
FREE TECHNICAL SUPPORT

\$299



Power-packed PCB layout with autorouting and real-time DRC!

EWB Layout is a powerful board layout package for producing high-quality, multi-layer printed circuit boards. Offering tight integration with our schematic capture program, EWB Layout is the best way to quickly produce well-designed boards.

CALL FOR INFORMATION
AND PRICING ON OUR
PROFESSIONAL EDITION.

800.263.5552

For a free demo, visit our website at www.electronicworkbench.com

BUY BOTH AND SAVE! ~~\$598~~ \$548

30-DAY MONEY-BACK GUARANTEE

Fax: 416-977-1818

E-mail: ewb@interactiv.com



CIRCLE 26 ON FREE INFORMATION CARD