

TEST GEAR YOU CAN BUILD

MAY 1999

Popular Electronics®

PLUS!
New PC Upgrading Column

Semiconductor Tester

Avoid troubleshooting hassles—check out transistors and diodes before you use them in circuits

PC Monitor Checker

Find out if MGA, EGA, VGA, and even composite-video displays are working

Electrolytic Meter

Use it to identify large-value capacitors with accuracy

Gizmo®

Cutting-Edge CES Technology—
Interactive and Digital TV
Better-Than-CD Audio
Home Networking, and much more



Also Inside:

- Portable MP3 Music
- Help for Net Newbies
- Scanning on Airplanes
- Building an HF Receiver

\$4.99 U.S.
\$5.99 CAN.



High-end features. Low-end price.

\$299

CircuitMaker 6:
Schematic design
and simulation
software

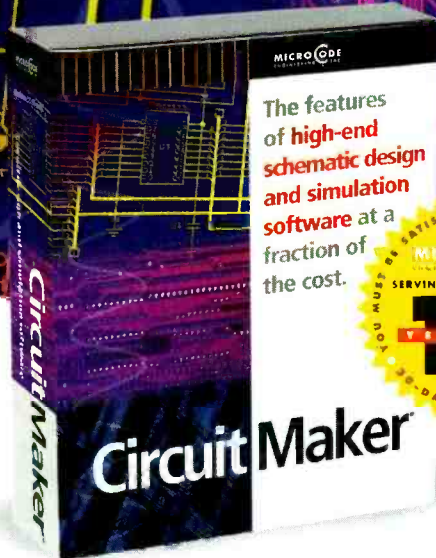

The features
of **high-end
schematic design
and simulation
software** at a
fraction of
the cost.



The features
of **high-end
printed circuit
board layout
software** at a
fraction of
the cost.

\$299

TraxMaker 3:
Printed circuit
board layout
software

CircuitMaker Version 6 and TraxMaker Version 3 give you the features of professional, high-end software at a fraction of the cost. Plus, with exceptional ease-of-use you'll spend less time learning to use the software and more time designing. Both applications are compatible with your existing software, and feature outstanding technical support. Call now for your free functional demo.

CircuitMaker 6 is a powerful schematic design and simulation program featuring:

- Professional schematic features including printout borders, title block and barred pin names
- Symbol editor and Macro feature for custom devices
- Fast, accurate SPICE3f5/XSPICE-based simulation
- Complete array of analysis types, including Fourier, AC, DC, Parameter sweep, Transient and more
- Virtual instruments including a digital oscilloscope, multimeter, Bode plotter, curve tracer and more
- Extensive library of over 4,000 models
- Tight integration with TraxMaker[®] for quick PCB layout
- Output PCB netlists in Protel[®], Tango[®] and TraxMaker[®] formats for use in a variety of PCB layout programs
- Windows 3.1, 95 and NT

TraxMaker 3 is a powerful printed circuit board layout program featuring:

- Over 2,000 component footprints in a fully-documented, indexed library. Documentation shows footprints actual size
- Built-in autorouter and Design Rules Check
- Supports up to 6 signal layers plus power and ground planes, silk screen overlays and solder and paste masks
- Board sizes up to 32" x 32", with no pin limitations
- Intelligent manual routing with unroute capabilities
- Import any PCB netlist in CircuitMaker[®], Protel[®] or Tango[®] format
- Output RS274X Gerber files, Excellon N/C drill files and Bill of Materials
- Print to any Windows-compatible printer or plotter
- Windows 3.1, 95 and NT

MICRO CODE ENGINEERING INC For free demo software, or to order, call **1-800-419-4242**
927 West Center Street • Orem, UT 84057 • Phone (801) 226-4470 • Fax (801) 226-6532 • www.microcode.com

©1998 MicroCode Engineering, Inc. All rights reserved. CircuitMaker, TraxMaker, SimCode and MicroCode are registered trademarks of MicroCode Engineering, Inc. All other brand and product names are trademarks or registered trademarks of their respective companies.
CIRCLE 174 ON FREE INFORMATION CARD

Popular Electronics®

THE MAGAZINE FOR THE ELECTRONICS ACTIVIST!

CONSTRUCTION ARTICLES

SEMICONDUCTOR TESTER	Charles Hansen	31
<i>Use it with an oscilloscope to determine if transistors and diodes are working properly</i>		
ELECTROLYTIC METER	Eugene Vahle	42
<i>Identify those large-value capacitors in your junkbox with this accurate device</i>		
PC MONITOR CHECKER	Chet Roher	47
<i>This video source can test MGA, EGA, VGA, and composite-video displays</i>		

PRODUCT REVIEWS

HANDS-ON REPORT		13
<i>CLAGGK PICTutor CD-ROM/Trainer Board</i>		
GIZMO		20
<i>The cutting-edge from CES—interactive and digital TV, better-than-CD audio, home networking, and more</i>		

COLUMNS

PEAK COMPUTING	Andrew T. Angelopoulos	3
<i>Time for a New Video Card?</i>		
MULTIMEDIA WATCH	Marc Spiwak	5
<i>Portable MP3 Music, Canon Peripherals, and More</i>		
NET WATCH	Konstantinos Karagiannis	8
<i>Help for Newbies and the Experienced</i>		
SCANNER SCENE	Marc Saxon	15
<i>InFlight Listening</i>		
HAM RADIO	Joseph J. Carr	53
<i>Building a Top-Notch HF Receiver</i>		
DX LISTENING	Don Jensen	55
<i>X Marks the Spot</i>		
CIRCUIT CIRCUS	Charles D. Rakes	57
<i>More Half-Effect Circuits</i>		
THINK TANK	Alex Bie	61
<i>Lights on with Photodiodes</i>		
ANTIQUE RADIO	Marc Ellis	65
<i>Those Magnificent Philco Cathedrals</i>		

DEPARTMENTS

EDITORIAL	2
LETTERS	10
NEW PRODUCTS	12
ELECTRONICS LIBRARY	28
POPULAR ELECTRONICS MARKET CENTER	71
ADVERTISING INDEX	90
FREE INFORMATION CARD	90A

Popular Electronics (ISSN 1042-170-X) Published monthly by Gernsback Publications, Inc. 500 Bi-County Boulevard, Farmingdale, NY 11735. Second-Class postage paid at Farmingdale, NY and at additional mailing offices. One-year, twelve issues, subscription rate U.S. and possessions \$24.99, Canada \$33.15 (includes G.S.T. Canadian Goods and Services Tax Registration No. R125166280), all other countries \$33.99. Subscription orders payable in U.S. funds only. International Postal Money Order or check drawn on a U.S. bank. U.S. single copy price \$4.99. Copyright 1999 by Gernsback Publications, Inc. All rights reserved. Hands-on Electronics and Gizmo trademarks are registered in U.S. and Canada by Gernsback Publications, Inc. Popular Electronics trademark is registered in U.S. and Canada by Electronics Technology Today, Inc. and is licensed to Gernsback Publications, Inc. Printed in U.S.A. Postmaster: Please send address changes to Popular Electronics, Subscription Dept., P.O. Box 338, Mount Morris, IL 61054-9932

A stamped self-addressed envelope must accompany all submitted manuscripts and/or artwork or photographs if their return is desired should they be rejected. We disclaim any responsibility for the loss or damage of manuscripts and/or artwork or photographs while in our possession or otherwise.

As a service to readers, Popular Electronics publishes available plans or information relating to newsworthy products, techniques, and scientific and technological developments. Because of possible variances in the quality and condition of materials and workmanship used by readers, Popular Electronics disclaims any responsibility for the safe and proper functioning of reader-built projects based upon or from plans or information published in this magazine.

Larry Steckler, EHF, CET,
editor-in-chief and publisher

EDITORIAL DEPARTMENT

Konstantinos Karagiannis, editor
Robert Young, technical editor
Evelyn Rose, assistant editor
Teri Scaduto, assistant editor
Janine Abitabile, editorial assistant
Andrew T. Angelopoulos,
contributing editor
Alex Bie, contributing editor
Joseph J. Carr, K4IPV, contributing editor
Marc Ellis, contributing editor
Don Jensen, contributing editor
Charles D. Rakes, contributing editor
Marc Saxon, contributing editor
Marc Spiwak, contributing editor

PRODUCTION DEPARTMENT

Ruby M. Yee, production director
Ken Coren, desktop production director
Kathy Campbell, production assistant

ART DEPARTMENT

Andre Duzant, art director
Russell C. Truelson, illustrator

CIRCULATION DEPARTMENT

Theresa Lombardo, circulation manager
Gina L. Gallo, circulation assistant

REPRINT DEPARTMENT

Christina M. Estrada, Reprint Bookstore

BUSINESS AND EDITORIAL OFFICES

Gernsback Publications, Inc.
500 Bi-County Blvd.
Farmingdale, NY 11735
516-293-3000
Fax: 516-293-3115

President: **Larry Steckler**
Vice-President: **Adria Coren**
Vice-President: **Ken Coren**

SUBSCRIPTION CUSTOMER SERVICE/ ORDER ENTRY

800-827-0383
7:30 AM - 8:30 PM EST

Advertising Sales Offices listed on page 90

Composition by Mates Graphics

Cover by Loewy Design

VISIT US ON THE INTERNET AT:
www.gernsback.com

Since some of the equipment and circuitry described in POPULAR ELECTRONICS may relate to or be covered by U.S. patents, POPULAR ELECTRONICS disclaims any liability for the infringement of such patents by the making, using, or selling of such equipment or circuitry, and suggests that anyone interested in such projects consult a patent attorney.

EDITORIAL

Really Doing it Yourself

Sweeping changes are happening here at **Popular Electronics**. As part of our new direction—to include more hands-on and cutting-edge material—we are introducing a new column and devoting this month's issue to building test gear.

First, about the new column, *Peak Computing*. While there are plenty of computer magazines out there dealing with what PC to buy and so on, there's very little practical material available on how to keep the computer you have in peak shape. In our new column, you'll learn in clear, step-by-step language how to upgrade, fine-tune, and enhance your system. While computers are undoubtedly a part of electronics, shopping for a new system every month shouldn't be—check out *Peak Computing* on the very next page. It and all computer-oriented columns will now sport a new look.

Our collection of construction features this month focuses on test gear that will help you troubleshoot and identify components, as well as check if a certain important device is working. While these are somewhat advanced projects, and require patience to build, we felt many of our readers could use home-built, yet sophisticated test devices ... hence this special issue.

Our Semiconductor Tester lets you determine if transistors and diodes you're about to use in a project are up to the task. Learn how to build this oscilloscope add-on by turning to page 31.

If you've got a bunch of large-value capacitors sitting around and want to verify if any are just right for your next circuit, use the Electrolytic Meter. Find out how to build the accurate device on page 42.

Is your video monitor acting up? Whether it's an MGA, EGA, VGA, or even composite-video unit, your CRT can be given a great exam with our PC Monitor Checker. The story begins on page 47.

Next month, and in the issues following, we'll be balancing complexity levels by running some simpler gadgets. Coming soon are circuits that let you take control of your home, experiment with high voltage, and even reach out to the stars! Despite the amount of mail we might get on that last statement, you'll just have to wait and see what it means....

Until next time, we hope you enjoy the new direction of our old friend.



Konstantinos Karagiannis
Editor

TIME FOR A NEW VIDEO CARD?

Is your computer system beginning to feel a little sad? Do you find yourself turning off clouds, terrain, textures, and everything else in your favorite game to keep the frame rate up? Even when your system meets or exceeds the minimum and recommended requirements? Are you tired of looking at low-resolution presentations and multimedia effects because it's the only way to get 16-bit color?

All these problems might not be your processor or memory. It might just mean that a new video card could solve your problem.

Whether you have a 90-MHz Pentium with MMX or a 450-MHz Pentium II powerhouse, adding a new video card for optimal system performance is not as hard, or as expensive, as it sounds. It's quite easy—all you need are a small Philips- and a flat-head screwdriver—and cost effective, with new video cards costing \$100–\$200.

TYPES OF CARDS

There are two types of video-card interfaces available: the Accelerated Graphics Port (AGP) and Peripheral Component Interface (PCI). Most, but not all, Pentium II and AMD K6-2 systems use AGP, a dedicated video pathway, for their video needs. All other Pentium-class machines get a PCI port.

There are important differences here. AGP and PCI cards are *not* interchangeable. AGP connectors, introduced a little over a year ago, are video dedicated. PCI slots share the PCI infrastructure with modems, sound cards, and almost anything else

you have installed, thereby sharing PC resources in a less than desirable fashion. Think of the plumbing in your



Attention, gamers! Diamond Multimedia's Monster Fusion card has all the power you need, fueled by 3Dfx's Voodoo Banshee chip. In both PCI and 1X AGP models, the 128-bit card supports Direct3D, Glide, and MiniGL; has 16MB of SDRAM on board; and handles refresh rates as high as 200 Hz.

home; the more faucets turned on in a house the less water each gets.

At their most basic, AGP cards are plenty faster than PCI cards. While PCI limits video to 133 MB/sec of data transfer, AGP 1X doubles that number to 266 MB/sec. Faster versions of AGP are also available, with 2X providing 533 MB/sec speed, and 4X a whopping 1.07 GB/sec! This kind of video data will blow a hole in the bottom of the aforementioned sink.

Of course, you can only take advantage of AGP if your system's motherboard supports the bus. The good news is that either type of system—AGP or PCI—can benefit from an upgrade. Regardless of what the standards imply about computer slots, the cards that go into them are not equal. Compared to the card that came with your system, a new card will certainly handle data more effectively, come with more mem-

ory (which is directly related to color depth and resolution—more memory means more of both), and integrate the latest standards (important for gaming, especially).

In deciding on a video card you have to be realistic about your needs and system. A 90-MHz Pentium will not run a game that requires a faster CPU (check a title's box), even with the best video card. However, word-processed documents, browser pages, and multimedia presentations will draw faster and look great with 16- or 24-bit color and the resolution set to a sharp 1024 × 768 or better.

Modern video cards offer combined 2D/3D solutions. Game cards offer superior 3D, running Direct3D, Glide, or MiniGL programming languages (essentially, these make games that support them look sharper and run smoother). Business video cards are strong 2D performers, offer a comfortable amount of memory for high resolutions and color depth, and have decent 3D performance for multimedia needs. Both categories work well for users who use their machines for both work and play.

SOME CARDS TO START WITH

On the gamer's front, Diamond Multimedia's new *Monster Fusion* card comes in both PCI and 1X AGP models. It is based on 3Dfx's Voodoo Banshee chip and supports Direct3D, Glide, and MiniGL. It offers 128-bit performance, 16MB of SDRAM, and a 250-MHz DAC, and will support monitor refresh rates as high as 200 Hz. The

Accredited B.S. Degree in Computers or Electronics

by studying at Home

Grantham College of Engineering
offers 3 distance education programs:

- B.S.E.T. emphasis in Electronics
- B.S.E.T. emphasis in Computers
- B.S. in Computer Science

NEW! -Electronics Workbench Professional 5.0
included in our B.S.E.T. curriculums
-Approved by more than 200 Companies,
VA and Dantes, (tuition assistance avail.)

For your free catalog of our programs dial
1-800-955-2527

<http://www.grantham.edu>

GCE

Your first step
to help yourself
better your future!



Grantham College of Engineering
34641 Grantham College Road
Slidell, LA 70460-6815

ANTIQUE RADIO CLASSIFIED Free Sample!

Antique Radio's
Largest Circulation Monthly
Articles, Ads & Classifieds.

6-Month Trial: \$19.95. 1-Yr: \$39.49 (\$57.95-1st Class).
A.R.C., P.O. Box 802-L22, Carlisle, MA 01741
Phone: (978) 371-0512 VISA/MC Fax: (978) 371-7129

LynX-10

HOME AUTOMATION KIT

- Software Included
- Use Existing Wiring
- Simple Inexpensive

1-800-928-5299 www.marrickltd.com

EARN BSEE DEGREE EFFECTIVE HOME STUDY PROGRAM



Highly Effective BSEE Degree Program for
Experienced Electronic Technicians. Our New
Advanced Placement Program grants Credit for
previous Schooling & Professional Experience.
Advance Rapidly! Established over 80 Years!

FREE DESCRIPTIVE LITERATURE!

COOK'S INSTITUTE OF ELECTRICAL ENGINEERING
PO BOX 20345, JACKSON, MS 39209 601-371-1351

Trees Make a World of Difference™

Find out how trees can make a world of difference
for you, and your neighborhood. For your free
brochure write: Trees For America, The National
Arbor Day Foundation, Nebraska City, NE 68410.

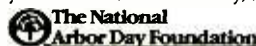

VIDEO CARD MANUFACTURERS

ATI Technologies Ltd.
33 Commerce Valley Drive East
Thornhill, Ontario
L3T 7N6 Canada
Tel. 905-882-2600
Web: www.atitech.com

Matrox Graphics, Inc.
1055 St. Regis Blvd.
Dorval, Quebec
H9P 2T4 Canada
Tel. 800-361-1408
Web: www.matrox.com

Diamond Multimedia Systems, Inc.
2880 Junction Avenue
San Jose, CA 95134
Tel. 800-468-5846
Web: www.diamondmm.com

Number Nine Visual Technology
Domestic Sales
18 Hartwell Avenue
Lexington, MA 02421
Tel. 800-GET-NINE
Web: www.nine.com

Hercules Computer Technology, Inc.
3839 Spinaker Court
Fremont, CA 94538
Tel. 800-532-0600
Web: www.hercules.com

Real3D
12506 Lake Underhill Road, MP-811
Orlando, FL 32825
Tel. 800-393-7730
Web: www.real3d.com

AGP version comes with DVD MPEG-2
decoding ability. This card runs so fast
and hot that it comes with its own cool-
ing fan. It looks like it will be a solid
card. The PCI version requires a 90-
MHz Pentium. And at \$149.95 for each
model, not too expensive either.

One of Number Nine Visual
Technology's best, the *Revolution IV 2X*
AGP card also offers 128-bit perfor-
mance and comes with either 16MB or
32MB of SDRAM. While this card is
good for lunchtime combat, it's geared
more towards the serious business
user. It supports Direct3D, OpenGL
(under Windows NT only), and 3D
Studio Max. It has a 250-MHz DAC and
will support refresh rates as high as 150
Hz. The 16MB model sells for \$169 and
the 32MB model for \$219.

There is a third option for those who
feel that their current system is ade-
quate or could use a low-cost tweak:
add-on cards, like Diamond
Multimedia's *Monster 3D* and *Monster*
3D II. They work with existing video
cards; you connect a cable from your
video card to the Monster and from the
Monster to your monitor. The cards
install just like other video or computer
cards.

The *Monster 3D* is based on 3Dfx's
Voodoo chip and supports Direct3D,
Glide, and MiniGL. It has 4MB of EDO
DRAM—2MB dedicated to a frame
buffer and 2MB dedicated textures. It
lists for just \$99 and will work with any
existing 2D (or 2D/3D card) card,
adding excellent 3D features.

The *Monster 3D II* is an improvement
on the *Monster 3D* and is based on

3Dfx's Voodoo2 chip. The 12MB (4MB
frame/8MB texture) version goes for
\$169 and the 8MB (4MB frame/4MB
texture) version for \$149. The primary
card of this add-on must be a 2D/3D
video card. The *Monster 3D* and
Monster 3D II both require at least a 90-
MHz Pentium with MMX and an open
PCI slot.

So far we've been talking about
replacing video cards. What if you have
a system with integrated PCI or AGP
video? You should check to make sure
that you can install a new video card.
Integrated PCI systems may not have a
free PCI slot. Integrated AGP systems
may or may not even have an AGP slot
for a new card. There are three ways to
find out: check your manual, check with
your manufacturer (Web or phone), or
peek inside. Of course, non-integrated
video is not a problem. Pop out the old
card and pop the new one in its place.

A LITTLE RECON

Peeking inside your PC is a good
idea if you want to check on your com-
puter's video-card status; after all, you'll
have to open the case to install your
new video card. First, unplug the system
from the outlet and any external con-
nections. Then discharge yourself of
static by touching something metal and
grounded. An accidental discharge
inside the system can destroy it.

Remove the chassis cover of your
system. If you see a PC card located
where you connect your monitor,
you've found your video card.

If your video is integrated, then you'll

(continued on page 16)

PORTABLE MP3 Music, CANON PERIPHERALS, AND MORE

Did you know that right now you can download hi-fi digital audio from the Internet? I'm not talking about .WAV files—at CD-quality settings, they're tremendous. No, there's a much more compact file format out there—MP3—and there are tons of audio files available in this form, which is a standard that took shape on its own, with no help from any standards organizations. MPEG is an industry-standard method for compressing video, and the same technique that compresses the audio that accompanies the video is used on just audio in the case of MP3 or Layer-3 audio.

There are good things about MP3 audio and bad things about it, depending on who you are and how you look at it. A typical CD audio track is generally about 50 megabytes worth of data, where whole albums can consume 650 megabytes or more. Distributing songs and entire albums of this nature over the Internet is impractical to say the least.

MPEG Layer-3 audio compression works by removing signals that are recorded in a track but are canceled out by one another when played so that you don't hear them anyway. Files end up being compressed by about 10:1, so that 50-megabyte song is now only 5 megabytes. Five megabytes, or entire albums totaling 65 megabytes, are easy to download if you have a fast connection—a cable modem or T1 line does nicely.

Now that we have a practical way of distributing audio over the Internet, there is a need for MP3 encoders, players, search engines for media, and so on. And wouldn't you know it? All those needs have been met. Do a search on the web for MP3-related material and you'll turn up a wealth of sites that hand out the stuff for free.

WinAmp is a shareware player I've used quite a bit (download a copy at www.winamp.com).

Download an MP3 file, download a player, and hi-fi audio plays on your computer. Depending on how well the original file was made—who did it, what equipment was used, the compression level applied, *etc.*—and how good your multimedia system is, .MP3 files can



Diamond Multimedia's Rio PMP300 is a handheld music player for compressed MP3 audio files. MP3s can be obtained via the Internet or can be made using software included with Rio.

sound as good as CD audio. But the files are apparently stuck in your computer—or are they? No, they are not!

Other shareware will convert .MP3 files to .WAV files. And then Adaptec's sophisticated *Easy CD Creator* software can convert those .WAV files to CD audio files for burning an audio

CD. It's all very automated. I've made a few CDs in this manner, and most of them sound terrific in my car stereo. So audio made its way to the Internet, to my computer, to my CD recorder, to my car. Because it's digital, sound quality does not deteriorate.

WHO WANTS MP3 AND WHO DOESN'T

Lots of individuals are in favor of MP3, aside from the millions of Internet users looking for free audio. There are plenty of music artists that will never be big enough to have their CDs on store shelves. But their work can now be distributed with little overhead over the Internet. Even the major recording labels can distribute samples and entire products via MP3 and the Internet over secured ordering connections. But the record companies also have a lot to lose, because any knucklehead armed with a shareware MP3 encoder and some music CDs can post digital audio illegally.

There are lots of battles going on right now over how MP3 should be used or if it should even be used at all. But I see no way of stopping it, because it started on its own. Everyone, including the industry, will have to learn to live with MP3. But it's actually the Internet that we're all getting used to. It's a new world now, one where I can create my own custom CDs using free material off the web and \$1 blank discs, without leaving my comfy chair.

DIAMOND RIO

One company that is at the head of the curve when it comes to MP3 audio is Diamond Multimedia. Diamond's *Rio PMP300* portable MP3 player is an ultra-small, ultra-cool device. It's a handheld headphone-equipped music player

that downloads MP3 files from a PC and lets you play them in any order.

Diamond Multimedia's Rio PMP300 portable music player is indeed the Walkman-like gadget of the 21st century. This unique device plays MPEG Layer-3 audio files from its internal memory through a headphone jack. MP3s can be obtained via the Internet or can be made using MusicMatch's *Jukebox* software, included with Rio.

Rio contains no moving parts, so it's immune to skipping caused by jostling the device. It includes 32 megabytes of internal memory, which is enough to store about a half hour's worth of CD-quality MP3s. Rio also has a slot for accepting a SmartMedia memory card, which can add more storage to the device. You can buy these cards with as much as 64 megabytes of memory.

Rio comes with all the software you need to use it. The included software, which runs on Windows 95/98 only, lets you transfer MP3s from your PC, through a parallel interface, directly into the Rio's memory. The Rio is quite small and fits easily into a shirt pocket. It weighs a mere 2.4 ounces. The device is powered by a single AA battery, which is good for about 12 hours of continuous playback. It retails for \$199.

CANON PERIPHERALS FIT SMALL OFFICES

I recently received some really neat peripherals from Canon Computer Systems. One of them is an all-in-one printer/scanner/copier that prints in color. Canon's *MultiPass C5500* is a multifunction unit that's perfect for the small or home office with limited space. Plus you can add color to all of your work. Pop-in cartridges make this device easy to use for anyone, plus it comes with all the software you need. What's best is that it can operate as a color copier without a PC.

Canon's Bubble Jet technology delivers photo-realistic color printing. An optional *Photo Kit*, with special ink, offers true photo-quality printing. The C5500 lets you receive crisp plain-paper faxes and scan everything from photos to text in color or black and white. It even includes Canon's *Desktop Manager 3.0* software, which helps you keep track of all incoming

and outgoing documents. *Canon Creative Pro* helps you create and print stationery, brochures, labels, and more.

The *MultiPass C5500* does plain paper faxing at up to 6 seconds per



Canon's PowerShot A5 digital camera fits in a shirt pocket and has a maximum resolution of 1024 × 768. It comes with a rechargeable NiMH battery pack.

page, and it can store up to 42 pages of incoming messages while the machine is printing, copying, or scanning. It prints photo-realistic output at 720 × 360 dots per inch (dpi). Print speed is rated at 6.5 pages per minute in monochrome or 2.5 pages per minute in color. Optional photo inks allow true photo-quality printing.

General copying in black and white is done at 360 × 360 dpi, and it can scan at 400 dpi when software-enhanced with 256 levels of grayscale. It does color scanning at 600-dpi, software enhanced, in 24-bit color. The TWAIN-compliant scanner measures 15.8 by 14.2 by 7.8 inches (WDH) and weighs 13.2 pounds. It costs \$449.

Canon is also manufacturing some of the world's most affordable and compact flatbed scanners. The *Canoscan FB 320P* is easy to use—just plug it into an outlet and your PC's parallel port, and it's ready to scan at 300 dpi in grayscale and color. The output can be interpolated to 1200 × 1200 dpi. The FB 320P comes with all the software you need to scan and enhance images. Adobe *PhotoDeluxe* lets you enhance and manipulate images and *TextBridge Plus* OCR software lets you import scanned text. The FB 320P weighs only 4 pounds and measures 10.1 by 14.7 by 2.5 inches (WDH). It costs only \$79.

The *Canoscan FB 620P* has the same small size and weight as the FB 320P and comes with the same soft-

ware, but it scans at 600 dpi, which can be interpolated to 2400 dpi. It, too, connects to the parallel port. The higher resolution unit costs \$99.

I've also been playing with a rather unique kind of photo printer from Canon. It's similar to Olympus' *P-300* photo printer that connects directly to Olympus cameras and prints beautiful color prints without needing a computer. Though I've raved about the Olympus *P-300*, it can't print from video sources. But Canon's *CD-200* digital printer can.

The *CD-200* accepts digital images from a CompactFlash card and makes 4 × 6-inch glossy photo prints with an image area of 3.2 × 4.2 inches, without connecting to a PC. It has a video output to view on a TV images for printing. A

CompactFlash card is a memory module commonly used in digital cameras. You can pop a CompactFlash card out of a camera and into the *CD-200*. Prints are ready in 95 seconds.

Not only does the *CD-200* print from CompactFlash cards, it is also Windows and Macintosh compatible with its Centronics and RS-422 connectors. But what's really cool is that the *CD-200* also has a video input so you can capture and print still images from TV programs, camcorders, and other video sources. The *CD-200* is a dye-sublimation printer with a resolution of up to 288 dots-per-inch. Its image quality can rival that of 35mm prints, depending on the source images. The *CD-200* costs \$499, and refills containing a print ribbon and 50 sheets of glossy photo paper cost \$30.

Canon's *PowerShot A5* is the perfect digital camera to use with the *CD-200* printer. Naturally the *A5* uses CompactFlash memory cards. The camera has a sleek alloy body and it's small enough to fit in a shirt pocket. It has a maximum resolution of 1024 × 768 in 24-bit color. The camera is 4 by 2.7 by 1.3 inches (WDH) and weighs only 8.1 ounces. An 8MB CompactFlash card comes with the camera. The camera has its own 2-inch color LCD monitor for composing images and reviewing stored images—it also has an optical viewfinder to save battery power. The camera comes with a rechargeable NiMH battery pack and

an AC adapter, all for \$699.

While on the subject of digital cameras and memory, I might as well mention Lexar Media. Lexar is busy manufacturing CompactFlash cards that fit cameras such as the Canon A5, and SmartMedia cards, which are even more compact cards used in Olympus cameras. The SmartMedia also fits in Diamond's Rio player. CompactFlash and SmartMedia memory comes in various capacities to suit your needs, up to 64MB.

NEW SOFTWARE

New from Psygnosis comes *O.D.T.*, meaning you have to escape ... Or Die Trying. *O.D.T.* takes place in the World of Tonantzin where an epidemic is consuming the city. The only hope is to use the magic powers of the green pearl. Captain Lamat and his crew of four people man the ship, the Nautiflyius, which crashes in the forbidden zone. The group must fend off endless attacks from hideous monster-like enemies in the dark and unfamiliar terrain. *O.D.T.* costs \$44.99.

Lucas Arts' *Grim Fandango* drags you into the Land of Dead. Manny Calavera is a travel agent for souls on their journey to eternal rest. But a con-

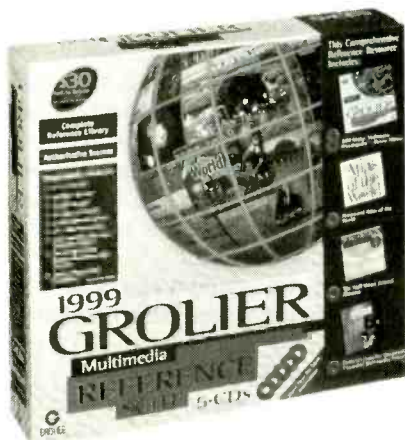

The 1999 Grolier Multimedia Reference Suite includes four titles on five CDs.

spiracy that threatens everything must be solved. This adventure pays homage to Mexican folklore with a dead cast of 55 characters, hundreds of puzzles, 90 exotic locations, and lots of fun. Characters come to life as skeletons depicted in a folk-art style. This title costs about \$40.

I recently came across an interesting CD-ROM title from Synthonics that's
(continued on page 14)

Electronics CD ROMs

Want to improve your design skills?

produced by
matrix
multimedia

Then you should consider our range of CD ROMs by best-selling author **Mike Tooley**.

Electronic Circuits and Components provides a sound introduction to the principles and applications of the most common types of electronic components and how they are used to form complete circuits. Sections on the disc include: fundamental electronic theory, active components, passive components, analog circuits and digital circuits. Includes circuit's and assignments for **Electronics Workbench**.

The Parts Gallery has been designed to overcome the problem of component and symbol recognition. The CD ROM will help students recognize common electronic components and their corresponding symbols in circuit diagrams. Quizzes are included. The Parts Gallery is free with **Electronic Circuits and Components**.

Digital Electronics details the principles and practice of digital electronics, including logic gates, combinational and sequential logic circuits, clocks, counters, shift registers, and displays. The CD ROM also provides an introduction to microprocessor-based systems. Includes circuit's and assignments for **Electronics Workbench**.

Analog Electronics is a complete learning resource for this most difficult subject. The CD ROM includes the usual wealth of virtual laboratories as well as an electronic circuit simulator with over 50 pre-designed analog circuits, which gives you the ultimate learning tool. The CD ROM provides comprehensive coverage of analog fundamentals, transistor circuit design, op-amps, filters, oscillators, and other analog systems.

"...hammers home the concepts in a way that no textbook ever could."
Electronics Australia

Interested in programming PIC micros?

We have the perfect solution:

Our **PICtutor** CD ROM can teach you how to write assembly language programs for the PIC series of microcontrollers. The CD ROM's 39 tutorial sections will guide you from basic PIC architecture, commands, and programming techniques up to advanced concepts such as watchdog timers, interrupts, sleep modes, and EEPROM data memory use. Over 80 exercises and challenges are provided to test your understanding, and the unique **Virtual PIC** allows you to write and test programs on-screen.

The complementary development kit includes a reprogrammable PIC16C84, which you can program via your printer port. The institution version (designed for use in schools, colleges and industry) includes a quad 7-segment LED display and alphanumeric LCD display. The development kit provides an excellent platform for both learning PIC programming and for further project/development work. Assembler and send (via printer port) software is included on the CD ROM.

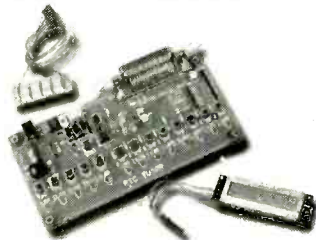

development board (institution version)

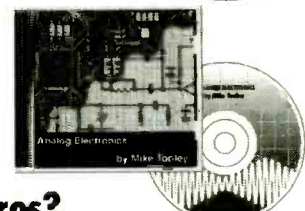
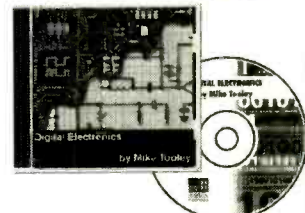

Prices and Versions

Institution versions are suitable for use in schools, colleges and industry. Student versions are for student/home use.

	student version	institution version
Electronic Circuits & Components	\$56	\$159
Digital Electronics	\$75	\$189
Analog Electronics	\$75	\$189
PICtutor (CD and development board)	\$179	\$350

Shipping costs to Canada an additional \$5. Overseas orders please contact CLAGGK Inc. for shipping costs.

see <http://www.MatrixMultimedia.co.uk> for full specs and demos

Please circle the products you would like to buy on the table above right, calculate the total cost, fill in the form below and send it to us. Please allow 4 - 6 weeks for delivery.

Name: _____

Address: _____

Zip: _____

Telephone: _____

I have enclosed my check for \$: _____

Please charge my credit card for \$: _____

Note that the delivery address and the address at which the card is registered must be the same

Card type: _____

Mastercard, Visa, or Discover only

Signature: _____

Number: _____

Expire date: _____

CL02

Order Form

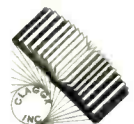

Claggk Inc., PO Box 4099, Farmingdale, NY 11735-0792
Tel: 516-293-3751 email claggk@poptronix.com

Help For Newbies AND THE EXPERIENCED

Whether you're new to the world of the Internet or have been searching its terabytes of data for years, you've probably figured out that you have to learn to make the most of your time online. It really is a "big" place, and it's far too easy to lose track of the hours you spend pointing and clicking your way through it.

While many of the sites we've covered may save some of our readers time (e.g. one-stop online shops), this month we're going to shift our focus to address two types of users: beginners who need to learn more about the Net and experienced users who want to get quality information faster.

First we'll deal with three sites that can make the Internet a more user-friendly place. Visiting these spots will help beginners get the most out of the Net in the least amount of time. Our second feature this month is a new type of search site that grants you access to real, human experts instead of just a crawler engine. No more completely irrelevant hits ... finally!

FOR NEWBIES ONLY

New Net users or "newbies" are sometimes intimidated by the scope of what they have to explore online. In addition to feeling as if they click and click and don't get anywhere, many newbies have the extra frustration of encountering enough acronyms to make them think they're reading Top Secret government project files. Getting online isn't enough for most people—sometimes guidance is nice.

That's what the following sites provide.

First we checked out NetWelcome, a really simple site with some useful information and plenty of links. Reading the page only takes a minute

some of the basics.

The next site we accessed also keeps visitors from getting overloaded. Newbie dot Org presents less information on each screen (NetWelcome is one long page), but overall it lets you click from useful fact to fact. Each link contains clear and concise data.

Newbie dot Org contains three main classes: Newbie 101, Newbie 201, and Newbie 301. The first of these deals with basics like settings that you need to know about your account and preparations you need to get your browser ready to surf and print what you find. Newbie 201 explores plugins, newsgroups, e-mail, and searching. The last, Newbie 301, teaches the basics of creating Web pages and writing HTML. You'll also learn how to recover from crashes

and shop safely online.

Finally, we visited a site called New Users. It's mainly composed of text like the other sites, but New Users is probably the most complete of all of them (i.e. be prepared to spend a little more time reading through the pages here). One of the best features is the Where to Start booklet, which includes dozens of tips and even an Acronym Dictionary. Do you know what *IITYWTMWWYBMAD* stands for? Visit the site and find out. Incidentally, it's the longest acronym listed at the site (most have three letters).

Another great feature of New Users is a listing of Internet Service Providers. This list could come in handy if you're browsing for the first time on a friend's machine and want to set up your own account at home.



NetWelcome was designed to take newbies by the hand and show them the basics of the Internet. The site features links to dozens of useful, free documents.

or two and gets beginners on the right track. What we found most helpful, though, is that each brief section (Netiquette, Browsing the Web, Getting in Touch, and Talk the Talk) either has links to software you can download for tasks such as browsing, e-mail, and newsgroup use or links to more detailed documents describing

HOT SITES

Mining Company
www.miningco.com

NetWelcome
www.netwelcome.com

Newbie dot Org
www.newbie.org

New Users
www.newusers.com

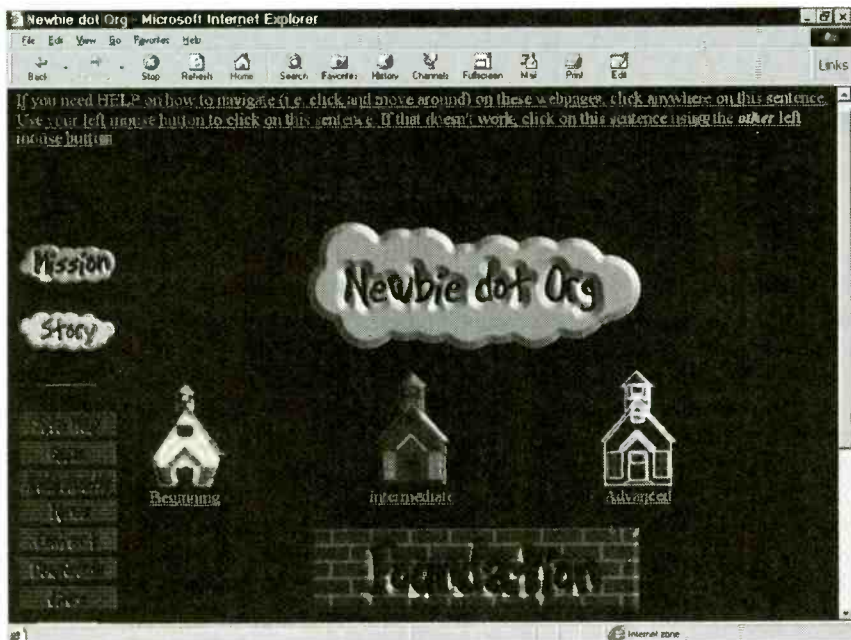

Visiting *Newbie dot Org* can expand a beginner's knowledge of the Net in minutes. Concise and accurate, it's a great starting point.

TRUSTING THE EXPERTS

One of the first sites you should point your browser to after you're done reading this magazine is the Mining Company's terrific offering. Whether you've just started using the Net or have been punching in search queries for eons, you'll appreciate the one factor about Mining Co. that separates it from all those other search sites on the Web.

Rather than rely on software engines, Mining Co. has 500 expert guides who "mine" the Net to find valuable information about thousands of topics.

Ever use a search engine and get back some results that don't make sense? We typed in a search for a semiconductor once and got back info on a sale for silverware! Or perhaps you've simply gotten back a list of



Rather than using a crawler program to gather data, Mining Co. relies on experts in various fields to set up links to sites that they feel are of interest and that are actually still up and running—no more dead links!

dead links? Say goodbye to all these problems if you use Mining Co.

The site can be used in one of two main ways. First, you can type in a search query and let the system check its database for appropriate subject matches. We typed in "Star Wars" and got a list of great, *still functional*, Web sites, as well as a listing of categories at Mining Co. where more or relevant information about the saga might be lurking (for example, the Games section has info on SW titles). Why did we search for *Star Wars*? Come on, with the new *Episode 1* movie coming out on May 21, do you really need to ask?

The other way to search, which eventually takes you to the same types of screens, is by clicking on subjects and browsing them. Examples of these include Arts/Entertainment, which has selections on books, music, and humor; and Computing/Science, which helps you with online info, software, physics, and a variety of techie subjects. Each of the main subject groupings has so many subcategories that you'll be hard pressed to find something missing.

Whichever search method you use, you eventually end up at a subcategory of interest. At the top of the screen will be a picture and e-mail address of the Mining Co. guide in charge of gathering site links related to the subject. Above the top of the main window will be a frame bar that shows, from left to right, the hierarchical structure of the subcategory (e.g. Computing/Science / Science / Archaeology). If you click on one of the recommended sites on the page, you never really leave Mining Co. The bar will stay at the top, allowing you to go to another part of the hierarchy (e.g. you can click "Science" from our last example) even though your screen's main window shows the site to which you "moved."

Newbies who didn't visit one of our earlier mentioned sites might want to check out Mining Co.'s excellent Net Basics link (right on the main page). It's got handy tips on Netiquette, basic HTML and Web publishing, connectivity, computing basics, and more.

As usual, you can send questions or comments via snail-mail to *Net Watch*, Popular Electronics, 500 Bi-County Blvd., Farmingdale, NY 11735, or e-mail to netwatch@gernsback.com.

LETTERS

NOT EASILY DISMISSED

Regarding the *Computer Bits* column: "Mass Storage for the Millennium" (**Popular Electronics**, March 1999), I must take issue with Mr. Holtzman's critique of the Imation LS-120 SuperDisk Drive. To wit: Mr. Holtzman didn't do his homework regarding these drives, as he only reviewed the parallel-port version of the LS-120 SuperDisk drive. To be thorough in his research, he needed to work with the internal ATAPI version, which is far superior to the parallel-port version in speed and throughput performance.

I personally have an internal ATAPI LS-120 drive, distributed through Digital Research Technologies (www.dr-tech.com). I can say this drive has a raw throughput and access speed comparable to a Maxtor 7120AT hard drive (which I had installed in a 286 machine). True, the LS-120 drive has an initial delay when starting up, but once it's spinning, you'd swear you were dealing with a hard drive, rather than a "SuperFloppy." As for the drive making a racket while operating, the internal ATAPI drive is no more noisy than a regular floppy. In fact, the start-up noise when a disk is inserted tells me that it's properly read the type of disk and is ready to use.

However, in all fairness, I do have three criticisms of the LS-120 drive:

First, it's occasionally finicky, sometimes failing to properly read an inserted disk. However, simply ejecting the disk and reinstalling it usually takes care of that problem. In rare situations, I need to reboot my machine to clear the fault.

Second, the drive can be a pain to install. Which motherboard, chipset, and BIOS vintage you have has a big impact on the ease of installation, as does the version of Windows. Thankfully, Mitsubishi's Web site—www.mitsubishi.com—has lots of information on the LS-120 drive, since they manufacture the drive mechanism. Ultimately, a little time and patience result in a fairly dependable drive installation.

Finally, because the LS-120 can also read and write standard 3.5-inch floppies, we're back to the dilemma that occurred with writing/formatting 5.25-inch, 360K floppies in 1.2MB, 5.25-inch drives: potential data-read errors. Thankfully, the LS-120 documentation specifically cautions against formatting 720K or 1.44MB floppies in the LS-120. In fact, the manual strongly advises using pre-formatted disks to ensure readability of LS-120-written standard floppies in standard drives.

I hope this letter clears up any misinformation and misconceptions regarding the LS-120 SuperDisk drive. While it's true the Iomega Zip drive

KEEP IN TOUCH

We appreciate letters from our readers. Comments, suggestions, questions, bouquets, or brickbats ... we want to hear from you and find out what you like and what you dislike. If there are projects you want to see or articles you want to submit—we want to hear from you. And now there are more ways than ever to contact us at **Popular Electronics**.

You can write via snail mail to:

Letters
Popular Electronics
500 Bi-County Blvd.
Farmingdale, NY 11735

Please note the above address is the snail-mail way to get the quickest response. Some readers send letters to our subscription address, and although the mail is forwarded to our editorial offices, it does increase the time it takes to answer or publish your letters.

Send e-mail to:

peeditor@gernsback.com

Of course e-mail is *fast*.

Check the end of your favorite columns, too. Many of them list individual e-mail addresses for their respective authors.

And don't forget to visit our Web site: www.gernsback.com.

came first and has a larger installed base than the LS-120, the latter is not a drive to be "easily dismissed." Because it has the ability to read/write standard floppies (unlike the Zip drive), it's best suited to be "the only floppy drive needed" in computers today.

K.S.

Auburn, WA

MASS STORAGE APPROVAL

Thanks for publishing Jeff Holtzman's *Computer Bits* column. His March column on mass storage was especially timely for those of us preparing to buy a CD-RW drive. I'll miss Jeff's columns and hope to see occasional contributions from him in future issues.

Incidentally, in his final column, Jeff observed that HP claims the life of its new CD-RW disks is about 30 years and that of its CD-R disks is about 100 years. While these are impressive numbers for this technology, consider the competition. Read/write manuscripts on acid-free paper and parchment have lasted thousands of years. Read-only manuscripts on clay tablets have lasted much longer. The situation is reminiscent of photography, a field in which 100-year-old black-and-white prints look as good today as when they were printed. But today's color prints can fade after several years. Maybe a **PE** reader will someday invent a form of mass storage that will begin to match the storage life of these much older media.

F.M.M. III
via e-mail

OUT OF BUSINESS

It has come to our attention that Checkpoint Laser Tools, whose Sound Alignment System was covered in *Gizmo* in the March 1999 issue, is no longer in business.

—Editor

ADVICE WANTED

How come I never see any articles about CD recorders? I'm about to pur-

(continued on page 64)

Buyers' Budget Books Better Buys

BP294-A Concise Introduction to Microsoft Works \$6.99. In the shortest and most effective way, you can use the word processor to advantage to type, edit, print and save documents. It goes on to explain how Works can be used to build up simple spreadsheet examples, edit them, save them, print them and retrieve them. It informs you how to create simple macros, and enables you to simplify long repetitive tasks and to customize the program to your own needs.

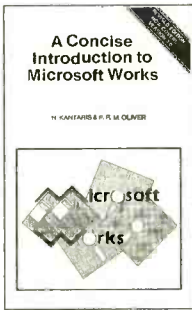

BP349-Practical Opto-Electronic Projects \$6.99. If you shun opto-electronic projects for lack of knowledge, this is the book for you. A bit of introductory theory comes first and then a number of practical projects which utilize a range of opto devices, from a filament bulb to modern infrared sensors and emitters.

BP350-Electronic Board Games \$6.99. Twenty novel electronic board games that you can build from the plans in this book. Whether you are interested in motor racing, searching for buried treasure on a barren island or for gold in Fort Knox, spinning the wheel of fortune, or doing a musical quiz—there is something for you to build and enjoy!

BP378-45-Simple Electronic Terminal Block Projects \$6.99. Contains 45 easy-to-build electronic projects that can be built by an absolute beginner. Projects are assembled on terminal blocks using only a screwdriver and other simple hand tools. No soldering is required.

BP432-Simple Sensor Terminal Block Projects \$6.99. This book is the next logical step from 45 Simple Electronic Terminal Block Projects (BP378), by the same author. The former describes an easy method of constructing transistor circuits without the need for soldering. It is an *open sesame* to the practical world of electronics for youngsters or beginners.

BP367-Electronic Projects for the Garden \$6.99. Electronics enters the Garden! New exciting book points out how gardeners can build simple gadgets to promote success where the elements work against you. Some of the projects are: over/under temperature monitoring, dusk/dawn switching, automatic plant watering, warming cables, etc.

BP368-Practical Electronics Musical Effect Units \$6.99. There is a constant hullabaloo for musical effects projects by the hobbyist community. This book provides practical circuits for several projects that range in complexity and are sure to work. All the circuits are easy to build and use readily-available parts.

BP385-Easy PC Interfacing \$6.99. The built-in ports in your PC provide an easy and hassle-free way of interfacing your circuits. This book provides useful PC add-on circuits including the following: Digital input/output ports; analog-to-digital and digital-to-analog converters; voltage and current measurement circuits; resistance and capacitance meters, temperature measurement interface, biofeedback monitor, and many other useful interfaces.

BP396-Electronic Hobbyists Data Book \$7.99. This book provides a wide range of data. If, for example, you require details of a modern five-band resistor code or an old color code for a ceramic capacitor, the formula for parallel resistance, or basic data on an NE5534AN operational amplifier, it is contained within these pages. The subjects covered are numerous and widespread to cover all hobbyist interests.

BP343-A Concise Introduction to Microsoft Works for Windows \$7.99. The book explains and details: How the Works for Windows package fits into the general Microsoft Windows environment; how to use the word processor to advantage; how to use Microsoft Draw to create and edit graphics and place them in your documents; how to build up simple spreadsheet examples; and how single, and multiple charts, or graphs, of different types can be generated. And there's much more!

BP282-Understanding PC Specifications \$5.99. This book explains PC specifications in detail, and the subjects covered include the following: Differences between types of PC (XT, AT, 80386, 80486, Pentium etc.); math co-processors; input devices (keyboards, mice, and digitizers); memory, including both expanded (EMS) and extended RAM; RAM disks and disk caches; floppy disk drive formats and compatibility; hard disk drives; and display adapters (CGA, Hercules, super VGA, etc.).

BP298-Concise Intro to the Macintosh System and Finder \$5.99. Although the Mac's WIMP user interface is designed to be easy to use, much of it only becomes clear when it is explained in simple terms. The book explains: The System and Finder, what they are and what they do; how to use the System and Finder to manipulate disks, files and folders; configuring and printing files from the Finder; getting the most from the system utility programs; and running MultiFinder.

BP88-How To Use OP Amps \$5.99. The Operational Amplifier is the most adaptable circuit module available to the circuit designer. It is possible to purchase a low-cost integrated circuit with several hundred components, very-high gain and predictable performance. This book has been written as a designer's guide for most Operational Amplifiers, serving both as a source book of circuits and a reference book for design calculations.

BP316-Practical Electric Design Data \$7.99. A builder's bargain book—a comprehensive ready-reference manual for electronic enthusiasts with over 150 practical circuits. It covers the main kinds of components (from pig-tail leads to surface mount), pin-outs, specs and type selection. Basic units are defined and most used formulae explained. Five additional sections are devoted to circuit design, covering analog, digital, display, radio and power supply circuits.

BP346-Programming in Visual Basic for Windows \$7.99. This book is a guide to programming. The reader is not expected to have any familiarity with the language as both the environment and statements are introduced and explained with the help of simple programs. The user is encouraged to build these, save them, and keep improving them as more complex language statements and commands are encountered.

BP345-Getting Started in Practical Electronics \$6.99. If you are looking into launching an exciting hobby activity, this text provides basic essentials for the builder and 30 easy-to-build fun projects with which every experimenter should toy. Printed-circuit designs are included to give your project the professional touch.

BP451-Troubleshooting Your PC Printer \$8.99. Explains the different printer types, their suitability for different tasks, the costs of running them, how to connect them and get the driver software running and, of course, what is most likely to go wrong and what you can do for yourself. Most important of all, it warns you of what you should quite definitely NOT try to do for yourself.

PCP112-Digital Electronics Projects \$10.99. Contains 12 digital electronics projects suitable for the beginner to build with the minimum of equipment — from instrumentation to home security, and a few "fun" projects too. With one exception, all projects are battery powered, and therefore, are completely safe for the beginner or young constructor.

PCP107-Digital Logic Gates and Flip-Flops \$10.99. Intended for enthusiasts, students and technicians, this book seeks to establish a firm foundation in digital electronics. It is for the user who wants to design and troubleshoot digital circuitry with full understanding of the principles. No background other than a basic knowledge of electronics is assumed.

BP76-Power Supply Projects \$3.99. Presents a number of power-supply designs including simplified unbiased types, fixed voltage-regulated types and variable voltage stabilized designs. All are low-voltage types intended for use with semiconductor circuits. Apart from presenting a variety of designs that will satisfy most applications, the data in this book should help the reader to design his own power supplies. An essential addition to the experimenters electronics library.

ELECTRONIC TECHNOLOGY TODAY INC.
P.O. BOX 240, Massapequa, NY 11762-0240

Name _____
Address _____
City _____ State _____ Zip _____

SHIPPING CHARGES IN USA AND CANADA

\$0.01 to \$5.00.....	\$2.00
\$5.01 to \$10.00.....	\$3.00
\$10.01 to \$20.00.....	\$4.00
\$20.01 to \$30.00.....	\$5.00
\$30.01 to \$40.00.....	\$6.00
\$40.01 to \$50.00.....	\$7.00
\$50.01 and above.....	\$8.50

SORRY No orders accepted outside of USA & Canada

Total price of books	\$ _____	No. of Books Ordered <input type="text"/>
Shipping (see chart)	\$ _____	
Subtotal	\$ _____	
Sales Tax (NYS only)	\$ _____	
Amount Enclosed	\$ _____	

All payments must be in U.S. funds!

NW1

Allow 6-8 weeks for delivery

NEW PRODUCTS

AC AMMETER

The miniature *AD15 DMM* can take measurements in even the tightest spaces. Its size (2.1 by 6.1 by 0.8 inches) and its digital display make it ideal for the electrical contractor and the handyman to use anywhere for light commercial and residential applications.



Features of the AD15 include two measuring ranges (20A and 200A), a data hold function for taking measurements in difficult-to-read places, and a slip-proof grip on the side. The ammeter comes with batteries and a wrist strap.

The AD15 DMM has a suggested retail price of \$49.95. For more information, contact Wavetek Corp., 9045 Balboa Ave., San Diego, CA 92123; Tel. 619-279-2200; Fax: 619-565-9558; Web: www.wavetek.com.

CIRCLE 80 ON FREE INFORMATION CARD

LIGHTNING PROTECTION

The *Model 22-64 Lightning Sponge* is designed for use on 64-Kbps communications circuits. This device accommodates lightning strikes and safely diverts them to a low-impedance path to earth ground before they can damage any network equipment and computers.

It uses three stages to limit high-voltage transients—gas tubes and two stages of semiconductor avalanche diodes. The Model 22-64 includes four circuits whose data rate does not exceed 64 Kbps.



The Model 22-64 sells for \$72 in single quantity, and \$57.60 each in quantities of 100. For more information, contact Telebyte Technology, Corp., 270 Pulaski Road, Greenlawn, NY 11740; Tel. 800-835-3298; Fax: 516-385-8848; Web: www.telebyteusa.com.

CIRCLE 81 ON FREE INFORMATION CARD

GRAPHICAL PROGRAMMING SOFTWARE

Students can use the *LabVIEW Student Edition* to design their own experiments, acquire data, perform analysis, test hypotheses, and perform simulations. Included with the student edition is *Learning with LabVIEW*, writ-



ten by Dr. Robert Bishop.

The software contains many examples, exercises, and solutions that are presented in the book. There are also tools for displaying data over the Internet and for performing interactive data visualization and numerical analysis.

The LabVIEW Student Edition has a suggested retail price of \$60. For more information, contact National Instruments, 11500 N. Mopac Expressway, Austin, TX 78759-3504; Tel. 800-258-7022 or 512-794-0100; Fax: 512-794-8411; Web: www.natinst.com.

CIRCLE 82 ON FREE INFORMATION CARD

BENCHTOP SIGNAL GENERATOR

Designed for test, simulation, and characterization of telephony, and for COTS and DT testing, this function and arbitrary waveform generator, the *BNC Model 625A SmartARB* allows users to sweep through ranges without



skipped points. It provides function, arbitrary waveform, and pulse-generation capabilities.

Modes include not only the standard sine, square, ramp, triangle, and random waveform, but also AM, FM, PM, SSB, FSK, BPSK signal modulation, DTMF detect, voltage and power measurement, and data and word generation. All operating parameters are presented on a single display. Values can be entered via the numeric keypad or rapidly changed with a rotary knob. Modes are clearly labeled on and selected by the keypad in a single operation.

(continued on page 68)



CLAGGK PICtutor CD-ROM/Trainer Board

Learn how to get the most out of Programmable Integrated Circuits with this comprehensive bundle.

It is without a doubt that many of our readers have computers. True, more people are into computers as a hobby than electronics, but there are lots of computer owners who want to learn more about electronics. A great place to start doing so on a PC is with various CD-ROM titles.

One of the most fascinating, but little-understood components used in electronics today is the PIC, or Programmable Integrated Circuit. PICs are found in all types of circuitry, and understanding how they operate and how they are programmed is an important part of being a good technician or engineer heading into the 21st century.

The *PICtutor* CD-ROM is an interactive computer-based multimedia laboratory/textbook that teaches the basics behind PICs in electronics—the theory, circuits, parts, and so on. The CD-ROM is bundled with a circuit board that contains a working PIC, and the board connects to a PC for programming.

Quite a Bundle. *PICtutor* is useful for students, technicians, engineers, teachers, and so on. Not much of a PC is required, so finding an adequate system on which to run the disc shouldn't be a problem. System requirements include an IBM-compatible 486/25-MHz PC, Windows 3.1 or 95 (or 98), a mouse, CD-ROM drive, VGA graphics with 256 colors, 8MB of RAM, and about 10MB of hard disk space. You do not need a sound card.

The software is easy to install. Menus and sub-menus take the user through different sections of the disc. Each section includes dia-

grams, text, drawings, and so on. The PIC trainer board works off a

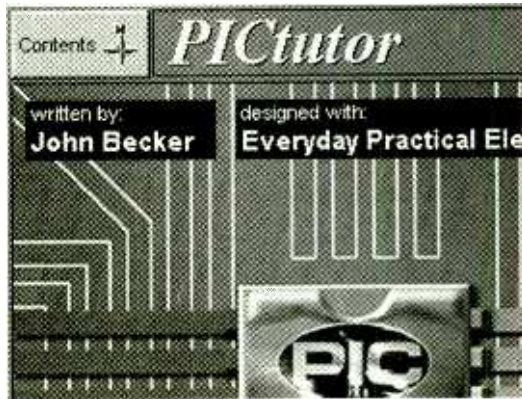

Part of the PICtutor package is the comprehensive CD-ROM with an easy-to-master interface.

DC power supply and connects to the parallel port of a PC. Together, the software and trainer board help the user gain a good understanding of how PICs operate. While playing with a CD-ROM and trainer board is no substitute for a college degree or hands-on experience in the field, the package is a good resource for anyone involved in electronics.

The *PICtutor* CD-ROM is intended to teach users of all levels how to write machine code programs for PIC microcontrollers. The CD-ROM contains 39 tutorial sections that guide the user through PIC architecture, commands, and programming. Included are advanced programming techniques with discussion, and examples of watchdog timers, interrupts, sleep modes, and more.

The CD-ROM includes over 80 exercises with tests for the user. An onscreen "virtual PIC" lets you write and test programs without ever leaving your PC. Over 30 working example programs are included,

along with a shareware assembler.

The PIC trainer board is designed for use with or without the CD-ROM. This fully populated board contains a programmable PIC16C84 microcontroller plus associated switches, LEDs, and various support circuitry. The trainer board helps teach users how to program PIC microcontrollers and is also useful in developing one's own PIC projects.

To connect the PIC board to a PC parallel port, you use a standard Centronics printer cable. An assembler and download software are included. The board can be upgraded to drive a quad 7-segment display and intelligent alphanumeric display. The board requires a 12- to 14-volt DC power supply. A battery holder for eight AA cells is provided with the development board.

You use a word processor or text editor when editing or creating .ASM files for assembly through *TASM*, the shareware assembler included with the CD-ROM/trainer board bundle. The *PICtutor* CD-ROM contains the PIC programming software and *TASM* documentation, plus all the demonstration files used in the tutorials. All the demo files are supplied as ASCII text files with a .ASM extension and as assembled object code files with a .OBJ extension—these demos are suitable for direct downloading to the PIC on the trainer board. The demo files were also written using the *TASM* programming software.

During the tutorials you are asked to modify some of the .ASM files and to write your own command sets. If you make an error in your typed command line, a message will appear. Other messages appear depending on the nature

of the error.

The CD-ROM/trainer board bundle is a valuable learning aid for PIC theory and use. You should consider investing in this bundle if you have a general interest in learning more about PIC usage, or even if you are already using PICs in your own circuit designs.

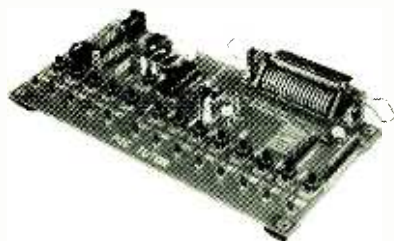

Here's the trainer board that lets you actually get some hands-on experience with PICs.

Testing out your own circuit theories on the trainer, before implementing a working circuit, can save you a lot of time at the prototyping bench. Besides, it's just a matter of time before you have to spend some time troubleshooting a PIC-bearing circuit. And the more you understand about PICs now, the better off you'll be with your future PIC encounter.

The *PICtutor* CD-ROM/PIC trainer circuit board bundle is available for \$179. Contact CLAGGK, Inc., PO Box 4099, Farmingdale, NY 11735; Tel. 516-293-3751; or circle 50 on the Free Information Card. ■

MULTIMEDIA WATCH

(continued from page 7)

perfect for science and history buffs. The *Smithsonian Museum Collection* is an overview of all 16 Smithsonian museums and the National Zoo. It contains 670 images of historic artifacts featured in Smithsonian museums. The CD-ROM is a virtual museum in itself, containing accurate 3D digital replicas of many artifacts. Artifacts are presented such that you can examine them in ways not possible in museums. This title costs \$24.95.

A new book from Jamsa Press is a good reference piece for beginners and novices alike when it comes to using Windows 98. *1001 Windows 98 Tips* by Kris Jamsa is loaded with

Activision

3100 Ocean Park Boulevard
Santa Monica, CA 90405
Tel. 310-255-2000

Web: www.activision.com

**CIRCLE 60 ON FREE
INFORMATION CARD**

Canon Computer Systems, Inc.

2995 Redhill Avenue
Costa Mesa, CA 92626
Tel. 800-385-2155

Web: www.ccsi.canon.com

**CIRCLE 61 ON FREE
INFORMATION CARD**

Diamond Multimedia Systems, Inc.

2880 Junction Avenue
San Jose, CA 95134
Tel. 408-325-7000

Web: www.diamondmm.com

**CIRCLE 62 ON FREE
INFORMATION CARD**

Grolier Interactive, Inc.

90 Sherman Turnpike
Danbury, CT 06816
Tel. 800-480-7633

Web: www.grolier.com

**CIRCLE 63 ON FREE
INFORMATION CARD**

Jamsa Press

3301 Allen Parkway
Houston, TX 77019
Tel. 713-525-4673

Web: www.jamsa.com

**CIRCLE 64 ON FREE
INFORMATION CARD**

pointers to help speed up productivity. Learn about the Start menu, Taskbar, the World Wide Web, and more. Discover undocumented features and put them to good use. *1001 Windows 98 Tips* costs \$39.95.

Grolier Interactive is always at it, updating its wonderful CD-ROM reference material. The latest product is the *1999 Grolier Multimedia Reference Suite*, a set of discs that puts almost any bit of information in the world at your fingertips. The suite's made up of 1999 Grolier Multimedia Encyclopedia Deluxe Edition, Hammond Atlas of the World, Bartlett's Familiar Quotations Expanded Multimedia Edition Version 2, and the Wall Street Journal Almanac. This valuable set of CD-ROMs costs only \$89.99.

Cyber Strike 2 from 989 Studios is a shoot-em-up game loaded with battling robots and spaceships. It takes place in a futuristic world of 3D graphics filled with explosive action. There are 50 single-player missions and net-

WHERE TO GET IT

Lexar Media, Inc.

47421 Bayside Parkway
Fremont, CA 94538
Tel. 510-413-1200

Web: www.lexarmedia.com

**CIRCLE 65 ON FREE
INFORMATION CARD**

MetaCreations

6303 Carpenteria Avenue
Carpenteria, CA 93013
Tel. 805-566-6200

Web: www.metacreations.com

**CIRCLE 66 ON FREE
INFORMATION CARD**

989 Studios

989 E. Hillsdale Boulevard
Foster City, CA 94404
Tel. 650-655-8000

Web: www.989studios.com

**CIRCLE 67 ON FREE
INFORMATION CARD**

Psygnosis

989 East Hillside Blvd.
Foster City, CA 94404
Tel. 800-438-7794

Web: www.psygnosis.com

**CIRCLE 68 ON FREE
INFORMATION CARD**

Synthonics

31324 Via Colinas 3106
Westlake Village, CA 91362
Tel. 800-582-6642

Web: www.synthonics.com

**CIRCLE 69 ON FREE
INFORMATION CARD**

work battles with up to 32 players. Check out *Cyber Strike 2* if the mood to strike out at cyborg enemies should strike you. It costs around \$20.

MetaCreations' *Dance Studio* makes for good family fun by letting you create your own custom, cartoon-like music videos on a PC. You pick one of several different male or female characters, a dance style, an environment, and a favorite music CD, .WAV file, or MIDI file—*Dance Studio* does the rest. It makes the chosen character dance around to your favorite music. The product is geared more toward kids than adults. It costs \$49.95.

Activision's interactive game, *Sin*, lets players explore the chaotic 21st century where crime runs rampant and vices are plentiful. *Sin* is a violent title that is powered by id software's *Quake II* engine, so smooth action is guaranteed. You're searching for the source and distribution channels of a highly addictive drug called U4. But ridding the streets of U4 will be dangerous—that's a sure bet. *Sin* costs \$49.95. ■

SCANNER SCENE

InFlight Listening

MARC SAXON

A few months ago I flew on a commercial airliner. But when I took out my scanner and earphone, the flight attendant politely advised me that it was against the airline's regulations for passengers to use scanners. When I asked why, I was given some double talk about how scanners cause interference to the aircraft's so-called delicate navigational instruments. Fact is, I later came to learn from a pilot, that many airlines simply don't want passengers listening to the aircraft's captain (pilot) communicating on their operational frequencies (in the 128.85- to 132.0- and 136.625- to 136.975-MHz bands).

In the past, readers had mentioned problems like this to me, but it's the first time I had ever attempted using my scanner on an airline.

The airline company operational frequencies are where, among other things, captains report writeups, that is, things they've discovered that are wrong with their plane. These include things like flashing warning lights, panel gauges that provide incorrect readings, malfunctioning radars, non-working headphones, cracked windshields, and worse. Or maybe the drinking water tastes bad, the lavatories are long overdue for service, several seats won't recline, there's a strange foul odor in the aircraft, or they need security personnel to show up at the gate in order to deal with a rowdy passenger. Whatever the problems might be, many airlines prefer their passengers don't hear such revelations about the aircraft in which they are flying. Hence, their ban on scanners.

BE HAPPY, GET SNEAKY!

A couple of weeks ago, I flew again, but this time I was smart. I was able to eavesdrop on everything, and with the full blessings of the airline. I had picked up a small, harmless-looking, tunable AM/FM pocket radio that just happened to also include the entire VHF aeronautical band. First, I showed it to the flight attendant and asked if there would be any problem if

I listened to FM music through an earphone. No problem at all, she said, happy to accommodate me. I spent the entire trip monitoring the plane's captain yakking on the company frequency. Not that it overjoyed me to learn he was getting an incorrect reading showing the aircraft's flaps were partially down and that he had complained about it previously.



RadioShack's Jetstream is a small, tunable AM/FM pocket radio that just happens to also include the entire VHF aeronautical band.

The little pocket receiver I used was a RadioShack *Jetstream* (catalog # 12-615), which cost less than \$25! It did a great job.

However, I find it much more reassuring and enjoyable to monitor these exciting frequencies from my base station. Because of VHF's line-of-sight characteristics, high altitude airliners can be monitored while they're more than several hundred miles distant. At any given moment, numerous airliners are within air/ground monitoring range. After allowing my scanner to search these bands, I was able to compile a

listing of the most active frequencies in my area. Then I programmed each into my scanner's memory. Never a dull moment.

SCANNER DX

Most scanner enthusiasts don't think of themselves as DX chasers, but it's rather an exciting aspect of the hobby. When conditions are right, the NOAA's 162-MHz weather channels occasionally provide some unusual ground/ground DX. Rare temperature inversions (when the high altitude air is warmer than the air below) are most often what's responsible for DX in the VHF high-frequency band. You might hear NOAA and other VHF stations from hundreds of miles away.

Ionospheric skip is responsible for DX on HF and the scanner lowband. This type of DX peaks in an 11-year cycle, and we are now emerging from one of the DX valleys and heading towards the next peak. You'll probably find low-band (30–50 MHz) stations from extreme distances can be heard at various times.

One interesting frequency to monitor is 28.20 MHz, between 0000–0300 UTC (2000–2300 EDT). That's where and when specific amateur radio CW beacons from all around the world are coordinated to take 10-minute turns transmitting. During its assigned slot, each station sends its call letters followed by a series of dashes, at the same time reducing its power from 100 watts to less than 1 watt in distinctive steps.

The stations in the order of their 10-minute transmissions: CS3B/Madeira; LU4AA/Argentina; OA4B/Peru; YV5B/Venezuela; 4U1UN/New York; VE8AT/NWT (Northwest Territories, Canada); W6WX/California; KH6WO/Hawaii; ZL6B/New Zealand; VK6RBP/Australia; JA2IGY/Japan; 4S7B/Sri Lanka; 5Z4B/Kenya; 4X6TU/Israel; OH2B/Finland. Note there are no transmissions presently operational between 0150–0210 UTC, which are the two slots reserved for Russia and

China.

Assuming you have a standard scanner, monitor the frequency in AM mode. Of course, if you have a more formidable piece of equipment, then place it in CW mode.

FORBIDDEN FRUIT

Ron C., of Idaho, wonders whether full-coverage 800-MHz scanners are sold in nations beyond the borders of the United States. That is, whether manufacturers block certain 800-MHz frequencies from all of their equipment, worldwide, or only from those sets made for sale in the U.S.

My impression is that our nation is a pioneer in the area of federal restrictions requiring blocked frequencies in its citizens' consumer-grade receivers. Freedom of speech seems somehow diminished without the guarantee of freedom to listen. Other nations still have full-frequency scanners available, however.

While snooping around on the Web, I came across a communications dealer outside of the U.S. who states he ships "around the world." The dealer carried a full line of handheld scanners, all of which have full unblocked coverage of the 800-MHz band. I have no idea what the service or warranty ramifications might be with regard to obtaining equipment from any of the dealers in Europe and Canada selling unblocked scanners. It occurred to me that it would be one way of someone obtaining a full-frequency scanner. But, inasmuch as Americans aren't allowed to import such equipment here, I wonder if any of these companies would ship the stuff. Not that anyone here would order it. Just thinking out loud.

You might want to look over a few Web sites of dealers outside of the U.S. that carry full-frequency scanners, anyway. Check out: www.interlog.com/~ahr/scan.htm, www.durhamradio.com, and www.waters-and-stanton.co.uk. Searching will probably reveal many other similar dealers.

Let us hear from you! Please share with us your thoughts, ideas, frequencies, and column ideas. Our direct e-mail address is Sigintt@aol.com. By snail mail, we can be reached at **Scanner Scene, Popular Electronics**, 500 Bi-County Blvd. Farmingdale, NY 11735. ■

PEAK COMPUTING

(continued from page 4)

have to look around a bit inside. You'll notice several slots towards the back of the case, where the serial, video, and input connectors are. There are three possible types of slots: ISA, PCI, and AGP. The ISA slots are distinguished by their length and are the longest slots in your system. PCI slots are about half as long. These two kinds of slots rest side-by-side, evenly spaced in a row, and are on the edge of your motherboard closest to the case's rear panel. An AGP slot, if available, is as short as a PCI slot but is offset from the PCI and ISA slots.

If you *know* that you have integrated graphics and don't see an AGP slot, you can still use the add-on-card option mentioned earlier. Even the best PCI video card is no match for integrated AGP video. Another option is to check with your PC manufacturer to see if it's possible to install additional video memory to boost video performance. Then hop in the car and buy your new video card.

INSTALLING THE CARD

Read the instructions that came with your card before you begin your installation. Certain cards have special considerations (for example, jumpers that need to be set).

Handle your new card by its edges. Don't touch any of the circuits or connectors to keep from accidentally damaging it. If you haven't done so already, remove your PC's case and identify your old card or a free slot (if you had integrated video). In either instance, you'll notice that the card or the case's slot cover is held in place with a small screw. Remove the screw and then firmly, but gingerly, remove the old video card or cover and put it aside. Hold your new card by the edges and line it up with the slot into which you wish to insert it. Slide the end opposite the VGA monitor connector in first, slightly, and work your way towards the other end of the card. Then press down firmly till it softly clicks into place. If the video card shakes or the motherboard bends you are pressing too hard. Pull it out and try again. There is a small tab on the video card's external faceplate that must rest inside a catch on your case. Make sure that it slips in.

Once the card's inserted, you can replace the screw, tighten it, and put the whole kit-and-caboodle back together again.

When everything has been reattached, it's time to power up. Turn on your monitor, CPU, and wait. The Plug-and-Play feature of Windows 95 and 98 identifies the card and prompts you for the driver disk or CD-ROM. Follow the prompts and



Is it possible to get a video boost on a budget? Rather than replacing your system's card altogether, consider getting a 3D add-on card that "takes over" whenever your PC needs to process game graphics.

then install any additional software that came with your card. The procedure doesn't change for integrated video. There is nothing to "turn off," as it were.

There are instances where you may have to do more. If your video doesn't work, remove and re-seat the video card. Also, sometimes Windows accepts your card but doesn't ask for the manufacturer's driver disk. Instead, it installs the standard Windows display drivers. Generally, clicking on the Setup icon on the driver CD-ROM or disk will take care of this. If not, go to your Control Panel, click on Display, then Settings, then Advanced Properties. There, under the Adapter tab, click on Change. Insert the manufacturer's disk and then choose the Have Disk option. You're done. Enjoy the new video. ■

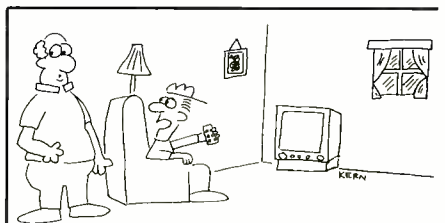

"Hey, Dad, the batteries are dead in the remote. How do I turn on the TV?"

With NRI training in Computer Programming, you

Build a top-paying career with up-to-the-minute programming skills

New!
Pentium® II
400 PC



By 2008, computer-related employment will jump by an estimated 60% nationwide for trained programmers — with as many as 400,000 NEW jobs opening up!

Now, with NRI training, you can get the in-demand skills you need to build a top-paying career — or business of your own — in this high-growth, high-opportunity field!



“Those with up-to-the-minute skills can almost name their price.”

— *The Washington Post* —

In as little as a year, you can become the highly skilled computer programmer today's companies seek — and see your NRI training literally pay off! In fact, according to *The Washington Post*, annual starting salaries range from \$32,000 all the way up to \$47,000 in some cities for those with expertise in the top programming languages!

Master today's hottest languages!

NRI's step-by-step lessons and hands-on programming projects help you first master the design concepts used every day by successful PC programmers. You quickly move on to learn how to design, code, run, debug, and document programs in one of three of today's hottest languages — Visual Basic, C++, or Java — plus you learn to generate fully functioning Windows 98 programs. And you do it all using the powerful Pentium® II 400 computer system included in your course.

And our new Online Connection lets you send e-mail to your instructor, attend virtual discussion groups, download supplemental information, and more!



Train with a Pentium® II 400 processor-based multimedia PC, featuring...

- MMX™ technology ■ 64 meg RAM ■ 5 gigabyte hard drive ■ Super VGA color monitor
- 32X CD-ROM drive with sound card ■ 56K baud fax/modem ■ Windows 98
- Netscape Navigator™ Web browser ■ And more!

With NRI's new PC Options Plan, you can keep up with late-breaking advances in technology by upgrading your computer system at special student rates. You'll get all the details shortly before your computer is scheduled for shipment. It's NRI's state-of-the-art guarantee!

Learn to tap the power of the Internet

Now your course includes bonus training in PC Communications and the Internet. Using the Netscape Navigator™ Web browser we provide, you can effortlessly move from one site to another as you explore the vast resources of the Internet and World Wide Web.

Send today for your FREE catalog

If the coupon is missing, write to us at the NRI School of Programming, 4401 Connecticut Ave., NW, Washington, DC 20008. Or...

**CALL 1-800-321-4634,
Ext. 3664**

SEND TODAY FOR FREE NRI CATALOG!

NRI Schools 4401 Connecticut Avenue, NW
Washington, DC 20008

www.nrischools.com

✓ Check one FREE career catalog only

- COMPUTER PROGRAMMING**
- Networking With Windows NT
- PC Servicing
- Multimedia Programming
- Bookkeeping and Accounting
- Industrial Electronics
- Mastering Microsoft Office

Name _____ (please print) _____ Age _____

Address _____

City/State/Zip _____

A Division of The McGraw-Hill Companies  Accredited Member, Distance Education and Training Council 5413-0599

GIZMO®

The View From Vegas

The 1999 International Consumer Electronics Show, held in January in Las Vegas, has come and gone, leaving in its wake a host of new industry buzzwords, emerging technologies, and some exciting new products (much of it last year's vaporware, finally available to consumers). In this month's *Gizmo*, we'll fill you in on all of that. But first, we'll take a look at some products that took home Innovations awards from the Design & Engineering Honors Program of the Consumer Electronics Manufacturer's Association (CEMA; Web: www.cemacity.org).

Audio On Demand

The RCA CA-1000 from Thomson Consumer Electronics will deliver to consumers Command Audio's personalized audio-on-demand service, which lets the user choose his own programming from hundreds of local and national programs that are selected from both print and broadcast media. Along with continuously updated local traffic, weather, news, sports, business, and finance reports, Command Audio will feature programs on topics such as home improvement and investing. Program sources include National Public Radio, ABC news, *Time* magazine, *People* magazine, and *Sports Illustrated*. Well-known radio per-



sonalities such as Dr. Laura, Art Bell, Jim Rome, and Bob Edwards, and television's Ted Koppel and Jim Lehrer will be broadcast.

The service is aimed primarily at commuters whose favorite radio programs don't always coincide with their drive times. The Command Audio service lets commuters quickly check the latest traffic and weather updates, and then spend the rest of the trip listening to things that truly interest them.

The pocket-sized CA-1000 receives wireless program transmissions from Command Audio. No computer or Internet connection is required to receive, select, or play back audio. Selections play wirelessly through the car radio; other listening options include headphones or the unit's built-in speaker. The user can skip from program to program,

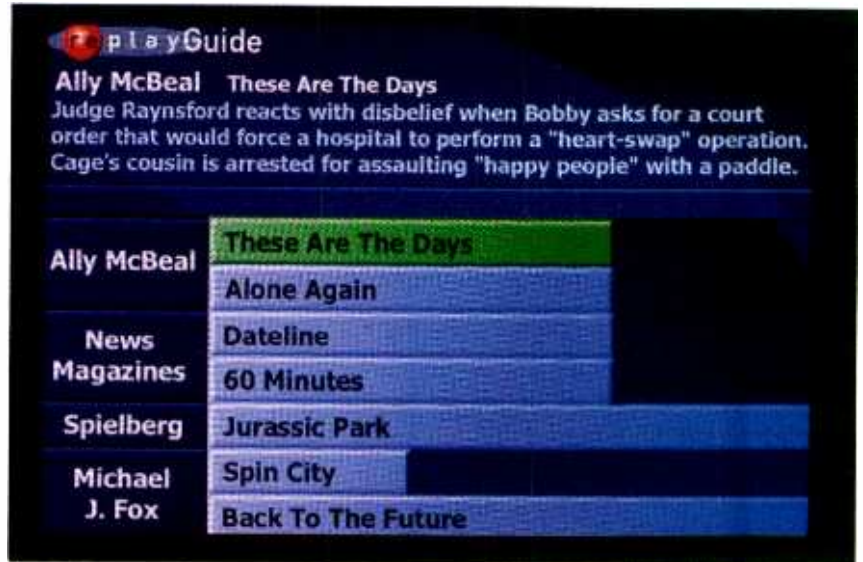

pause, scan by subject, or save shows for later listening. An "eyes free" interface makes it easy to use even when driving.

Available later this year, the CA-1000 will have a suggested retail price of \$199. The subscription-based audio-on-demand service will cost \$15 a month.

Video On Demand

Replay Networks, Inc. introduces a similar on-demand concept for video, allowing you to arrange TV programming around your schedule, instead of the other way around. With *ReplayTV*, however, you're not limited to someone else's programming choices. The *ReplayTV* device is a set-top box that finds your favorite programs and stores them digitally for playback when you want it. The onscreen program guide and free Replay Network Service allow you to

Gizmo® is published by Gernsback Publications, Inc., 500 Bi-County Blvd., Farmingdale, NY 11735. Senior Writers: Christopher Scott and Teri Scaduto. Copyright 1999 by Gernsback Publications, Inc. *Gizmo*® is a registered trademark. All rights reserved.

create personalized channels using a remote control. You might want to designate an all-*Jeopardy* channel, for instance, or one that stores every episode of every generation of *Star Trek* that airs.

ReplayTV, which picked up the Best of Show award in the video category, allows one-touch recording, storing shows digitally on a hard drive. That means there are no tapes to rewind, and recorded shows are easy to find and access. Using random-access storage, the device can record and play two different sections of a show simultaneously, allowing you to pause, rewind, and fast-forward live TV shows when your viewing is interrupted by a phone call, for instance. Finally, the ReplayTV is a learning device. Tell it to search for and record shows based on certain criteria—perhaps your favorite actor's name or "home-improvement shows"—and the device will create a Replay Channel in which those shows are stored. Tell it to record *ER* every week, and each episode will go into the ER Replay Channel. The continuously updated program guide, which covers broadcast, cable, and/or satellite stations, is loaded each night via the telephone line. Up to six hours of programming can be stored in the base model. A future expansion module, which will connect to an IEEE-1394 port, will provide yet more storage.

Product roll-out begins in the first quarter of 1999 in selected markets. The base ReplayTV box costs \$699; there is no subscription fee.

Parental Guidance Simplified

Providing a less sophisticated method of controlling your family's video viewing, Principle Solutions' TVGuardian Foul Language Filter is a set-top box that removes curses and other offensive words and phrases from television shows and videotapes. It works by carefully monitoring the closed captioning, checking each word against an internal dictionary. When it encounters an offensive word, TVGuardian mutes the audio and replaces the closed-caption with a

more socially acceptable word. Unlike the V-chip, TVGuardian doesn't block out portions of the film. You and your kids can watch the entire program, without being exposed to any offensive language.

The device offers three modes. In Tolerant Mode, curses and harsh phrases are removed. The Strict mode also eliminates mild expletives and references to God and Jesus Christ (taking the Lord's name in vain). The off mode allows programming to be heard in its original form.

The TV Guardian, a three-award Innovations winner, costs \$149.95.

TV/PC Network

Audio-on-demand, video-on-demand, ... do we sense a trend here? Philips Electronics and ShareWave snagged a Best of Show award for yet another in the take-control-of-your-electronics-through-new-electronics category with *Ambi*, a digital wireless PC peripheral that transmits PC functions, from software applications to Internet access, to any television set. By allowing different applications to be run at both locations simultane-

ously, it effectively doubles the functionality of the PC.

Designed for one-computer/many-user households, Ambi uses "advanced concurrent technology to create multiple desktops." Translation: You can prepare a report or spreadsheet while your kids play their favorite PC games (or vice versa). Both applications reside on a single PC. Ambi also allows multiple users to share printers and scanners and permits double Internet access over one phone line with one ISP account.

Ambi uses a high-speed (4-Mbps) radio combined with wavelet compression technology to transmit multimedia data (text, audio, video, and graphics) at an effective rate of 120 Mbps, delivering full-motion video across the wireless communication channel. Display-enhancers ensure



that images look as good ten feet from a TV screen as they do two feet from a computer monitor.

Ambi will come with PC antenna, TV terminal, PCI card, and infrared keyboard. It should be available by the time you read this in key markets, priced between \$500 and \$700.

Digital Home-Control Network

Not content to take digital control of just your AVC (audio/video/computer) products? Want to master the rest of your domain?

Axlon Electronics' *PalmPal*—another Best of Show winner—is an integrated home system based on a 900-MHz digital wireless platform. Dubbed DWKTS for Digital Wireless Key Telephone System, the *PalmPal* system allows three telephone lines to be shared by up to 16 wireless handsets and a wired door phone. Each handset has its own extension and voice mail, and an LCD screen that displays Caller ID, time, speed dial, and message information. Each phone also



has five programmable smart keys that can be used to dim the lights, activate a security system, or mute the stereo.

PalmPal can be used within the home or from remote locations. Answer the front door from the backyard. On your way home from work, turn on the air conditioner, lights, and your favorite CD. The system monitors sensor devices and phone-line status, directs messages to appropriate users where and when they need the information, and can react to certain situations—warning of an intruder, for instance.

Pricing depends upon configuration. *PalmPal* is distributed by Phast Corporation.

DTV Set-Top Converter

Thomson made news at CES—and took home a Best of Show Innovations award—for breaking the DTV price barrier with its \$649 *RCA DTC100* digital set-top box. The multi-platform digital receiver/decoder connects to any television to provide enhanced picture performance from analog NTSC broadcasts.

Moreover, it performs double duty by serving as a DirecTV satellite



receiver (when used with a three-foot elliptical dish), as well as picking up terrestrial broadcasts (when used with a standard off-air antenna). It also contains a built-in Dolby Digital decoder.

The *RCA DTC100* can handle all 18 Advanced Television Systems Committee (ATSC) digital formats, automatically converting the signals into significantly improved analog pictures and sound on today's TV sets. When connected to a high-resolution monitor, it can deliver the increased resolution of HDTV programming. The built-in onscreen programming guide lists available programs, lets you create customized favorite-channel listings, and provides one-touch VCR recording and one-touch tuning.

Rabbit Ears Redux

An offshoot of the DSS explosion is the renewed popularity of outdoor television antennas, needed to pick up the local broadcasts that satellite providers are not allowed to transmit in most areas. *Terk Technologies'*

TV42 amplified outdoor antenna, winner of the Best of Show award in the accessories category, is designed to clip right on to the DSS dish. It is

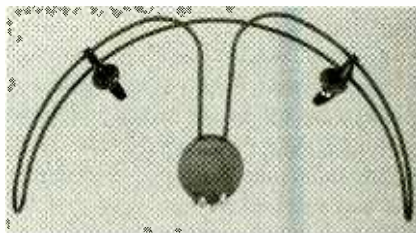

quick and easy to install, requires no extra wiring or special tools, and is completely unobtrusive. Patented clips hold the antenna to the back of the dish, neatly out of sight.

The *TV42*, designed for use with dual-LNB satellite dishes, has a built-in diplexer to combine local-antenna and satellite signals, eliminating the need for extra wiring from the dish to the home. Its highly tuned, efficient receiving element is said to provide superior reception of local programming, and a built-in amplifier ensures against signal loss in the cabling running from the dish mount to the TV, a common problem with long wire runs.

The *TV42* will be available early this year at a suggested retail price of \$79.95.

Portable Two-Way Voice Mail

The Best of Show award winner in the mobile-office category was *Maxon America's Responder*, which “combines the reply capability of e-mail with the tone and inflection of voice.”

Responder is a pager-sized two-way voice mail system that receives and stores voice messages sent over the cellular network. You can play messages at your convenience and reply to a message by pressing a button and speaking into the handset. *Responder* can be called from any phone and can send a reply to any phone, and users are guaranteed to get every message.

You can create and send voice messages to other *Responder* users or



groups of users, directly from the handset. As many as 25 voice messages and/or memos can be stored in the Responder. The device is also capable of placing a live telephone call to an emergency service number or to a limited list of key personal numbers.

Responder will be available later this year. Prices not available.

Dual-Deck CD Recorder

CD-recording decks have given consumers the ability to dub their own discs. Philips won a Best of Show



Award for the *CDR765 Audio CD-Recorder*, the first dual-deck CD recorder, which combines the ease of use and versatility of a dual cassette

deck with the digital sound and convenience of the CD format.

The CDR765 lets you transfer complete CDs and individual songs from the play deck to the record deck at double the standard playback speed, halving the time needed to create a new CD. With no need to connect a stand-alone CD player to serve as the source, the recording process is streamlined and simplified.

The CDR765 carries a suggested retail price of \$649 and is currently available. (By the way, Philips announced at CES that it was significantly dropping its prices on CD-R and CD-RW blank media, reducing 74-minute CD-R discs from \$5.99 to \$3.99 and halving the industry-average \$29.99 price for CD-RW discs.)

CES 1999 Show Roundup

“Consumer electronics” is a broad heading that encompasses dozens of diverse categories, hundreds of established and emerging technologies, and thousands of different products ranging from pocket calculators to HDTV sets. Likewise, the Consumer Electronics Show is actually several shows rolled up into one.

At the Las Vegas Convention Center, and at several off-premise sites, exhibits are generally grouped by product category: Mobile Electronics, Home Office, High-End Audio, Home Theater, Antennas, Telephony, and the like. The main floor of the center is home to the major manufacturers, each displaying its whole line of products. CES also hosted several “Technology Pavilions”: Habitech Institute ‘99, which showcased integrated home systems; the CEMA DTV Center; the Antenna Pavilion; and the 1394 Pavilion, demonstrating IEEE-1394 standard interconnectivity.

Of course, the primary purpose of a trade show such as CES is to sell products to retailers, which means presenting those products in exciting (generally noisy and flashy) ways on the show floor. But for retailers to suc-

cessfully sell complex pieces of electronic equipment to the public, they first must have an understanding of what that product does, how it works, and what it offers to the consumer. So the secondary goal of CES is to educate retailers (and the press) about new technologies. Complementing the manufacturer exhibits and technology pavilions were a series of educational seminars to help attendees make sense of some of the new products, terminology, and technologies being presented—and that’s exactly what we’ll try to do here.

Our Digital Destiny

Despite the size and diversity of the show, there was one common thread running throughout: digital technology. In and of itself, that doesn’t sound too exciting. After all, most of us use CD players and computers on a daily basis, and millions of us are watching digital video from digital satellite TV systems or on DVD.

But that overwhelming level of acceptance of things digital is big news, perhaps not in and of itself, but for what it heralds. Combine it with the arrival of digital television—which we’ll all be accepting within the next decade!—and the foundation is laid for the integration of digital technologies within the home. You can call it convergence, or home integration, or interconnectivity, or home networking. The name isn’t as important as the concept that, in the not-too-distant future, all of your electronics gear will be able to communicate, coordinate, and cooperate. Imagine, soon one remote control will be able to operate everything from your home theater to your home-security system.

And at the center of that digital conglomerate will be your big, new digital television set. The user-interface—remote control and on-screen menus—is comforting in its familiarity. The peripherals—DVD, DVD-Audio, CD recorders—surely will change and evolve, but all of them will be digital, and capable of being controlled by a single, integrated home network via menus displayed

on a DTV.

Here (in excerpts from his opening keynote address) is how Sony Chairman and CEO, Howard Stringer, envisions it: "Your digital television will become the centerpiece, at the nerve center of the home of the future ... a home which will be as connected as any office might be today. Whether wired or wireless, your home network will be the platform for dozens of consumer devices co-existing within the home ... set-top boxes, smart phones, a whole new class of devices designed for what Sony calls the coming era of intimate computing. These devices will have to be simpler to use ... devices intelligent enough to recognize one another, to anticipate user choices, and to perform as expected without cumbersome commands and menus.



Philips displayed at CES its 64-inch, rear-projection HDTV set, currently available in major markets at a suggested retail price of \$9990.

"The digital home must offer needed relief to a people weary and oppressed by vexatious VCRs and unruly remote controls. Every product and distribution system should be responsive ... to the most technophobic of customers."

Of course, such grandiose digital dreams are just that, unless the vari-

ous industry players (manufacturers, broadcasters, content providers, and the FCC, to name a few) can learn to



Zenith displayed its Model IQADTV1W Digital HDTV receiver/decoder set-top box.

communicate, coordinate, and cooperate as well as they expect their home networks to do! We'd love to report that everyone is in agreement on formats and standards. But, hey! We're talking consumer electronics here. When was the last time you can remember everyone being in complete agreement on anything?

Let's take a look at some of the emerging technologies, while we try to wade through the morass of conflicting formats and confusing jargon that will be thrown your way in the coming months and years of digital transition.

DTV Debuts

You probably don't have one, you might not even have seen one (we have), but digital televisions are here. We gave you a pretty thorough run-down of the who, what, when, where, and why of DTV in February's *Gizmo News*. Of course, things have changed since that column was penned last fall, particularly in light of announcements and new product introductions at CES.

A quick recap: DTV is a collection of 18 different formats of varying resolutions (all of which offer improved picture quality and sound when compared with NTSC), ranging from Standard Definition TV (SDTV), which delivers DVD-quality 300,000 pixels per frame, to High Definition TV (HDTV), with 2-million pixels per frame. Digital broadcasts began last November on a very limited (in terms of times and markets) basis.

At CES, there were almost two dozen separate exhibits featuring over-the-air HDTV broadcasts. The show came close on the heels of the November 1998 DTV launch, but preliminary sales figures were announced during a DTV "SuperSession" seminar. By early January, the industry had sold more than 13,000 DTV sets to dealers. Are those sets moving out of the showrooms and into some living rooms? Perhaps not as quickly as manufacturers (and retailers) would like to see.

Quipped Sony's Howard Stringer, "With the commencement of digital TV sales in your stores—at least sales in theory if not so much in actual



Thomson's first entry in the direct-view HDTV market is this 38-inch ("the world's largest direct-view HDTV color TV picture tube") ProScan set, expected to be available by year's end.

practice—the transition from analog to digital took a significant leap forward. Now that the holiday sales results are in, one might be inclined to view this occasion as one very small step for the consumer electronics business and one giant leap for digital hype."

That's not to say sales are non-existent. In fact, one of the SuperSession panelists, Tom Campbell of Dow Stereo/Video, noted that the chain had already sold 100 DTV sets—and that's

MANUFACTURERS**Ampro Corp.**

175-G New Boston Street
Woburn, MA 01801-6822
Tel. 781-932-4800

Web: www.amprocorp.com

**CIRCLE 100 ON FREE
INFORMATION CARD**

Axlon Electronics Corp.

5F-5, No. 77, Sec. 1, Hsin Tai Wu Rd.
Hsi-Chih, Taipei 221 Taiwan

Web: www.axlon.com

**CIRCLE 101 ON FREE
INFORMATION CARD**

Command Audio Corp.

101 Redwood Shores Parkway
Redwood City, CA 94065
Tel. 650-631-6140

Web: www.commandaudio.com

**CIRCLE 102 ON FREE
INFORMATION CARD**

Denon Electronics

222 New Road
Parsippany, NJ 07054
Tel. 973-396-0810

Web: www.denon.com

**CIRCLE 103 ON FREE
INFORMATION CARD**

DIRECTV, Inc.

2230 East Imperial Hwy.
El Segundo, CA 90245
Tel. 310-726-4656

Web: www.directv.com

**CIRCLE 104 ON FREE
INFORMATION CARD**

Echostar Communications Corp.

5701 Santa Fe Drive
Littleton, CO 80120
Tel. 303-723-1000

Web: www.dishnetwork.com

**CIRCLE 105 ON FREE
INFORMATION CARD**

**Hitachi Home Electronics
(America), Inc.**

1855 Dornoch Court
San Diego, CA 92173
Tel. 619-661-0227

Web: www.hitachi.com

**CIRCLE 106 ON FREE
INFORMATION CARD**

JVC Company Of America

1700 Valley Road
Wayne, NJ 07470
Tel. 973-315-5000

Web: www.jvc.com

**CIRCLE 107 ON FREE
INFORMATION CARD**

Kenwood U.S.A. Corporation

2201 E. Dominguez Street
P.O. Box 22745
Long Beach, CA 90801
Tel. 310-639-9000

Web: www.kenwoodusa.com

**CIRCLE 108 ON FREE
INFORMATION CARD**

Maxon America, Inc.

10828 NW Air World Drive
Kansas City, MO 64153-1238
Tel. 816-891-6320

Web: www.maxonusa.com

**CIRCLE 109 ON FREE
INFORMATION CARD**

Microsoft Corporation

One Microsoft Way
Redmond, WA 98052
Tel. 425-882-8080

Web: www.microsoft.com

**CIRCLE 110 ON FREE
INFORMATION CARD**

OpenTV, Inc.

401 E. Middlefield Road
Mountain View, CA 94043
Tel. 650-429-5500

Web: www.opentv.com

**CIRCLE 111 ON FREE
INFORMATION CARD**

Phast Corporation

79 W. 4800 S. Building 14
Salt Lake City, UT 84107
Tel. 800-979-9637

Web: www.phast.com

**CIRCLE 112 ON FREE
INFORMATION CARD**

Philips Consumer Electronics Co.

64 Perimeter Center East
Atlanta, GA 30346-6401
Tel. 770-821-2400

Web: www.philips.com

**CIRCLE 113 ON FREE
INFORMATION CARD**

Pioneer Electronics

2265 E. 220th Street
Long Beach, CA 90810
Tel. 310-952-2218

Web: www.pioneer-usa.com

**CIRCLE 114 ON FREE
INFORMATION CARD**

Principle Solutions

3708 Lehman Court
Rogers, AR 72758
Tel. 501-936-8443

Web: www.tvguardian.com

**CIRCLE 115 ON FREE
INFORMATION CARD**

Replay Networks, Inc.

1003 Elwell Court
Palo Alto, CA 94303
Tel. 650-968-9912

Web: www.replay.com

**CIRCLE 116 ON FREE
INFORMATION CARD**

Sanyo Fisher Company

21605 Plummer Street
Chatsworth, CA 91311-4131
Tel. 818-998-7322

Web: www.audvidfisher.com

**CIRCLE 117 ON FREE
INFORMATION CARD**

Sharewave, Inc.

5175 Hillsdale Circle
El Dorado Hills, CA 95762
Tel. 916-939-9400

Web: www.sharewave.com

**CIRCLE 118 ON FREE
INFORMATION CARD**

Sony Electronics, Inc.

One Sony Drive
Park Ridge, NJ 07656
Tel. 201-930-1000

Web: www.sony.com

**CIRCLE 119 ON FREE
INFORMATION CARD**

Terk Technologies Corp.

63 Mall Drive
Commack, NY 11725
Tel. 516-543-1900

Web: www.terk.com

**CIRCLE 120 ON FREE
INFORMATION CARD**

Thomson Consumer Electronics

10330 North Meridian Street
INH-310
Indianapolis, IN 46290
Tel. 317-587-3000

Web: www.rec-electronics.com

**CIRCLE 121 ON FREE
INFORMATION CARD**

TiVo, Inc.

894 Ross Drive
Sunnyvale, CA 94089
Tel. 708-747-5080

Web: www.tivo.com

**CIRCLE 122 ON FREE
INFORMATION CARD**

Zenith Electronics Corp.

Commercial Products
1000 Milwaukee Ave.
Glenview, IL 60025
Tel. 847-391-7000

Web: www.zenith.com

**CIRCLE 123 ON FREE
INFORMATION CARD**

in an area in which DTV broadcasts have not yet begun. The buyers (including a young Navy couple who took out a second mortgage to cover the cost of a set) are hooked when they see how the sets improve the quality of NTSC reception and want to be prepared for when digital broadcasts commence.

Optimism of manufacturers, broadcasters, and retailers—as well as those early adopters—was bolstered by HBO's announced plans to begin DTV broadcasts this spring. DIRECTV announced that it will join with New Line Cinema to distribute HDTV pay-per-view movies in May. Initial titles include *American History X*, *Living Out Loud*, and *Pleasantville*. EchoStar said it plans to deliver HDTV programming via its Dish Network, but offered no specifics.

The cable industry, on the other hand, is still dragging its collective heels over the switch to DTV. And content providers, concerned about digital piracy, are waiting for a digital copyright protection scheme to be adopted before they are willing to wholeheartedly embrace digital TV.

Copy protection is an area in which battle lines have been drawn between opposing camps. The two major proposals (outlined in last month's *Gizmo News*) are 5C, backed by Sony, Hitachi, Intel, Matsushita, and Toshiba; and Extended Conditional Access (XCA), favored by Thomson and Zenith. At the Consumer Electronics Show, however, Thomson surprised everyone with a demonstration of a Divx-ready HDTV DVD player, in which the Divx encryption system provided copy protection.

So, what if you decide you absolutely must be the first one on your block to own a DTV? The good news is there are plenty of choices out there, and you won't necessarily have to take out a second mortgage. (But you'd better stop throwing out those "You're pre-approved" credit-card offers that come in the mail each day!) By far the cheapest DTV solution is Thomson's \$649 set-top converter box. It won't let you see HDTV on your analog set, but DTV should significantly enhance the picture.

Nine other manufacturers are offering set-top boxes, in prices ranging from \$1500 to \$5000.

Add to those an HD-ready television, and you can view anything right up to HDTV. At least a dozen manufacturers are selling such sets, and most offer more than one model. Prices range from \$2799 for a 36-inch direct-view set from Hitachi, up to a whopping \$69,995 for a front-projection unit from Ampro.



JVC is showing its XV-D701BK (\$599.95) DVD player, complete with Dolby Digital decoder and 5.1-channel analog output, as well as the XV-DX1BK (\$699.95), which adds a Divx decoder/modem.

Or you can go for an integrated set. There are less than a dozen models currently available, and almost all are rear-projection units, with prices ranging from \$7000 to \$10,000. Sony has the only direct-view HDTV set to date, the \$8999 34-inch FD Trinitron Wega. Sanyo plans to market a 32-inch direct-view integrated set by the end of this year, and Thomson's 38-inch ProScan direct-view set will arrive in "late 1999." Almost all of the integrated sets offer NTSC line doubling and a built-in Dolby Digital decoder.

DVD Branches Out

DVD had an impressive first year, with over a million units sold, and it's predicted that sales figure will double this year. That's despite the conflict between DVD and Divx; both types of deck are selling well.

Two new DVD technologies are poised for market introduction—once some issues are resolved, that is. First (watch out, VHS!) there's DVD/RW: recordable digital video discs. Then there's DVD-Audio, or DVD-A.

Pioneer demonstrated a prototype DVD/RW unit that it planned to have on the market six months after copy-protection issues are ironed out by the DVD Forum, which the company

hopes will be by the end of the year. The working prototype provides up to 1.5 hours of recording on a 4.7GB disc at full DVD resolution. The actual product is expected to have a full two hours recording time. DVD/RW discs won't be playable on today's DVD decks, but future decks should be compatible with DVD-Video, DVD/RW, CD-RW, and DVD-Audio discs.

DVD-A offers artists and producers a variety of linear PCM (pulse code

modulation) modes and allows them to select the number of channels, quantizations, and sampling frequencies. Whereas most of the storage space on a DVD-Video disc is used for video, DVD-Audio discs are devoted almost entirely to multi-channel sound. It's expected, however, that many record labels will release high-resolution (96-kHz, 24-bit) two-channel discs for the audiophile market. The discs have enough storage space for liner notes, still images, and even full-motion video.

Several companies, including Pioneer, JVC, and Kenwood, showed prototype DVD-A players, some of which also can play DVD-video discs. Meridian demonstrated a DVD-Video player that can be upgraded to include DVD-A.

The DVD Forum's audio group hoped to announce final specifications at the show, but said instead that the final version 1.0 DVD-Audio format is expected to be finished early this spring. Once again, copy-protection issues are holding things back.

Pulling It All Together

DTV, HDTV, SDTV, DVD, Divx, DVD-A, CD, CD-R, DVD/RW—not to mention digital camcorders and still cameras, PCs and handheld "dig-

ital assistants,” computer peripherals, and whatever other digital devices the future holds in store—will all be interfaced in home networks ... someday. The vision is broad and ambitious. The goal is to simplify and enhance the lives of consumers by providing one standard network that will easily control a plethora of digital devices. Once again, the industry is striving to come up with a universal standard—this time, one that will allow any consumer electronics product, from any manufacturer, to interconnect with those from other manufacturers.

The CES seminar “Home Networks: Ready to Come Home?” made it woefully clear that the answer is “No!” Representatives from Microsoft, Intel, Compaq, Sony, and Pioneer did their best (within the limited time frame of a two-hour seminar) to outline the various options and state their company’s positions. Although they did not manage to convey a clear sense of the state of the home network, some trends did emerge.

The computer manufacturers agree that, in the words of Microsoft’s public networks product group manager, Joseph Mouhanna, “The Swiss Army knife of networks does not exist.” He sees a slow path toward consumer acceptance, the need for compelling applications to be created, and the co-existence of two or more networks within each home.

Sony and Pioneer are both backing the IEEE-1394 interface as the basis for any future home networks. The interface allows products to send and receive streams of digital audio, video, and control data at speeds up to 400 Mbps. Both companies also see Cable Lab’s Open Cable digital interface with copy protection as being an integral component. Pioneer New Media Technologies’ senior VP of sales and marketing for optical products, Paul Dempsey, envisions a digital media receiver as command central for the home network.

Out on the show floor, virtually every major company was displaying its idea of home networking, with its own catchy moniker. Sony’s is the “VAIO World.” Philips is touting

“Personal TV,” Pioneer calls it “Digital Networked Entertainment.” You get the picture—but not yet!

Interactive TV

Actually, there are a few current (or soon-to-become-available) products that foreshadow the interconnected future of home entertainment. Their scope is not broad enough to place them in the “networked” category. Instead, we’d have to call them convergence products, even though that concept has met with consumer resistance.

Not surprisingly, the folks who brought you digital satellite TV are now ready to offer other digital services via your TV.

EchoStar’s Dish Network is taking two approaches to interactive television. First, the company announced a joint venture with Microsoft’s WebTV network in which some Dish Network set-top boxes will house a WebTV-Plus



TiVo is the ingredient that brings Philips’ Personal TV to life.

terminal. WebTV-Plus offers an interactive onscreen programming guide (which will replace EchoStar’s own guide), giving viewers access to online banking, shopping, game-playing, and e-mail via their television sets. Viewers will be able to surf the web while watching TV in a small window inset. The WebStar set-top box, expected to cost between \$300 and \$400, will also offer Video Pause, a feature that allows viewers to store live programming to a hard drive (when the phone rings during a favorite show, for instance), and then resume watching at their convenience. (Philips, by the way, is also offering WebTV-Plus, in a set-top box that’s currently available for \$199.) EchoStar also will offer a Dish Network PCI receiver card that will

allow PC users to access Dish TV programming on their computers.

Second, EchoStar is partnering with OpenTV to offer interactive television in its new generation of satellite receivers. The OpenTV platform will provide e-mail, electronic banking, e-commerce, and data-enhanced TV programming. OpenTV will be included as a standard feature on



Wink interactive services, to be available through DirecTV, will offer in-depth additional program information to TV viewers.

basic-level Dish Network units, with WebStar considered the next step up in interactivity.

Meanwhile, DIRECTV plans to offer Wink analog interactive services in its set-top boxes later this year. Wink-enhanced broadcasting will provide DIRECTV subscribers with access to in-depth information on programming (and commercials) and with the ability to participate in polls, conduct e-commerce, and get in on special DIRECTV promotions.

DIRECTV also announced its alliance with Philips, which will offer DirecTV satellite receivers that incorporate TiVo’s personalized “push” service. An integral part of Philip’s first Personal TV product, TiVo offers an intelligent program guide with the ability to “learn” a viewer’s preferences so that it can automatically locate and record to a hard drive those programs it determines the viewer would like.

The first Philips-brand, TiVo-equipped DIRECTV unit should be available later this year. Plans are in the works for a second-generation unit, expected to be available in the first half of next year, which will include an ATSC receiver, “adding the benefits of digital television picture quality and programming.”

ELECTRONICS LIBRARY

LASER: LIGHT OF A MILLION USES

by Jeff Hecht and Dick Teresi

In clear, jargon-free language, the authors explain what lasers are, how they work, and their rapidly increasing uses—from checkout counter scanners to CDs to fiber-optical systems. In medicine, lasers have revolutionized surgery. The military is using them in the production of sophisticated weapons, while new uses for lasers are being found in many other areas, from holography to manufacturing, entertainment, and more.

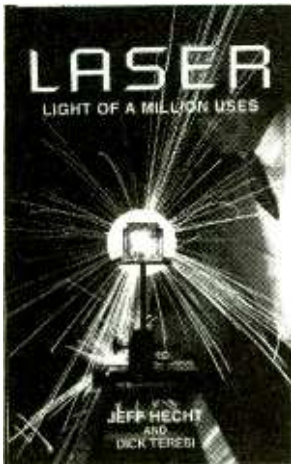

This authoritative, user-friendly volume satisfies the curiosity of anyone interested in this field. It includes a new preface on the latest laser technology, a discussion of the future of lasers, and an appendix on laser safety, as well as 44 illustrations.

Laser: Light of A Million Uses costs \$8.95 and is published by Dover Publications, Inc., 31 E. 2nd St., Mineola, NY 11501; Tel. 516-294-7000; Fax: 516-742-5049.

CIRCLE 90 ON FREE INFORMATION CARD

FUN PROJECTS FOR THE EXPERIMENTER

by Newton C. Braga

As electronics continues to become more involved in chemistry, biology, and physics, the need to understand its basic principles grows. Aimed at

students, hobbyists, and experimenters, this collection contains fifty fun and easy-to-build projects that give the electronics enthusiast practical experience in the application of electronics theory.



With this book, hobbyists can learn to build everything from LED flashers and electronic fishing lures to wireless beepers and signal tracers. These are primarily stand-alone, low-cost projects, with few components, intended for one night of work. The components for each project are listed, and schematics are provided. Hints and questions about the circuits are included to stimulate ideas about possible modifications and alternative uses.

Fun Projects for the Experimenter costs \$24.95 and is published by Prompt Publications, Howard W. Sams & Company, 2647 Waterfront Parkway, East Drive, Suite 300, Indianapolis, IN 46314-2041; Tel. 800-428-7267; Web: www.hwsams.com.

CIRCLE 91 ON FREE INFORMATION CARD

BEBOP BYTES BACK: AN UNCONVENTIONAL GUIDE TO COMPUTERS

by Clive "Max" Maxfield and Alvin Brown

Providing an in-depth introduction to the way computers work, the book describes the design of a simple microcomputer, starting with the AND gate; continues through the design of the arithmetic/logic unit (ALU); adds the CPU; and discusses the external components required for a complete system.

Accompanying the book is a CD-ROM containing the fully functional, Internet-ready Beboputer Virtual Computer. It is a simple microprocessor-based computer with an easily understood instruction set, but implemented as a virtual machine in software.

The book also documents a series of step-by-step interactive labs to be performed on the Beboputer, from running a simple 9-byte program to designing an assembly language.

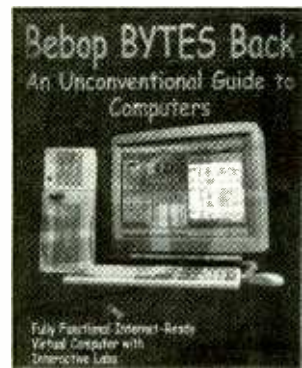

Bebop Bytes Back costs \$49.95 and is published by Doone Publications, 7950 Hwy. 72W, #G106, Madison, AL 35758; Tel. 800-311-3753 or 205-837-0580; Fax: 205-837-0580; Web: www.doone.com.

CIRCLE 92 ON FREE INFORMATION CARD

TROUBLESHOOTING, MAINTAINING & REPAIRING PERSONAL COMPUTERS

by Stephen Bigelow

This hands-on reference for technicians provides efficient, cost-effective troubleshooting and repair techniques. There are nearly 400 problems completely explained, as well as hundreds of POST and diagnostic codes to help identify and cure even the most difficult

BooksNow To order books in this magazine or, any book in print. Please call anytime day or night: (800) BOOKS-NOW (266-5766) or (801) 261-1187 ask for ext. 1456 or visit on the web at <http://www.BooksNow.com/popular-electronics.htm>. Free catalogs are *not* available.

problems. Supplementing the written material is one of the largest available collections of ready-to-use diagnostic freeware, shareware, and utilities on the included disc.

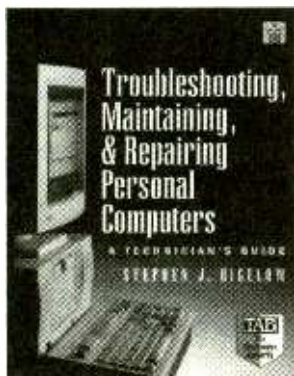

Three handy sections help readers get fast answers. Section I is a technician's primer; Section II discusses system data and troubleshooting, offering an extensive array of documented service procedures; and Section III is filled with real-world advice and procedures for maintenance and support. The nine appendices offer resource and reference information, useful forms, a sample certification test, and more.

Troubleshooting, Maintaining, & Repairing Personal Computers costs \$44.95 and is published by McGraw-Hill, 1221 Avenue of the Americas, New York, NY 10020; Tel. 800-2MCGRAW; Web: www.ee.mcgraw-hill.com.

CIRCLE 93 ON FREE INFORMATION CARD

THE ARRL HANDBOOK FOR RADIO AMATEURS: 1999 EDITION

edited by R. Dean Straw, N6BV

Over the past 75 years, this handbook has been an essential resource for projects for all levels of building experience and an invaluable source of reference material. The 76th edition of the handbook continues this tradition, providing a thorough foundation of electronics and communications theory for hams, students, engineers, and technicians.

The new projects in this edition include a 13.8 V/40 A switching power supply, a legal limit Svetlana 4CX1600B amplifier, and a voice keyer, as well as an enhancement to the high-power antenna tuner introduced last time. In response to read-

er's comments, this volume includes PC templates for the weekend projects. The larger more complex templates are on the ARRL Web site. In addition, the software for the book can be downloaded from the Web site or from its *Hiram* BBS, or it can be ordered for a nominal cost.

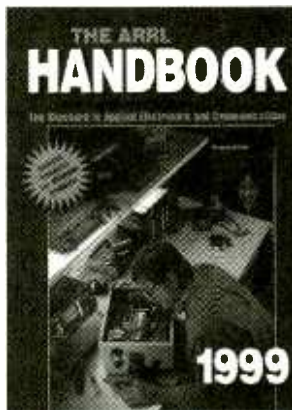

The ARRL Handbook for Radio Amateurs: 1999 Edition costs \$32 and is published by American Radio Relay League, 225 Main Street, Newington, CT 06111-1494; Tel. 800-243-7767; Fax: 860-594-0303; Web, www.arrl.org.

CIRCLE 94 ON FREE INFORMATION CARD

1999 CATALOG

from Antique Electronic Supply

Offering all types of tube gear, including vacuum tubes, transformers, capacitors, parts, supplies, and literature, this 72-page catalog contains



many new products. Among them are ferrite rods, inductor coils, gift items, a line of Hammond classic 300 series power transformers, and many other products.

Another new product line is high

quality, beautifully made, and reasonably priced telegraph keys. Imported from Spain, they have gold-plated brass keys on an olive wood base, and teakwood handles and knobs. Three types of keys are available: straight key, iambic paddle, and a dual straight key and iambic paddle.

The 1999 Catalog is free upon request from Antique Electronic Supply, 6221 South Maple Avenue, Tempe, AZ 85283; Tel. 602-820-5411; Fax: 800-706-6789 or 602-820-4643; Web: www.tubesandmore.com.

CIRCLE 95 ON FREE INFORMATION CARD

RIDE THE AIRWAVES WITH ALPHA AND ZULU

by John Abbott, K6YB

In cartoon format, this manual leads the novice step-by-step through the basics required to pass the novice and no-code technician amateur-radio license exams. Each lesson is accompanied with a short quiz on the material covered.

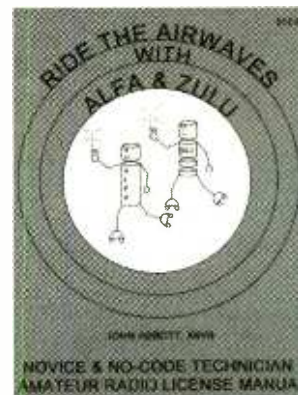

From getting on the air to everything a beginner needs to know about antennas to an introduction to Morse Code—all are covered in a clear and easy style. The second section continues in the same manner for the material students need to know for the more advanced technician exam.

BooksNow To order books in this magazine or, any book in print. Please call anytime day or night: (800) **BOOKS-NOW (266-5766)** or (801) 261-1187 ask for ext. 1456 or visit on the web at <http://www.BooksNow.com/popular-electronics.htm>.

Free catalogs are *not* available.

Books that Bridge Theory & Practice

Many electronics enthusiasts discovered that the bridge from classroom theory books to hands-on project building is difficult to span at times without a handy pocket guide. Even the equipment manual to operate a gadget often makes things murkier rather than clearer. A compact text authored by a seasoned expert with hands-on knowledge and a knack of writing in an easy-to-understand style is many times more valuable than the price of ponderous theory and equipment manuals or the parts for a project that could be damaged. Here's a sampler of some titles you may want to own!

ELECTRONIC HOBBYIST DATA BOOK—The info you need to transport you from the schematic diagram to project parts. Pin-outs, color codes, truth tables, parts parameters, etc. **Order BP396— \$10.99 Includes S & H**

PRACTICAL INTRODUCTION TO SURFACE MOUNT DEVICES—A technology that spun off the automated assembly line into the grasp of experimenters and project builders. **Order BP411— \$9.99 Includes S & H**

THE INTERNET AND THE WORLD WIDE WEB—The most difficult part of the Internet is its mystery. Erase the mystery and you'll become the super surfer with a little help from this book. **Order BP403— \$10.99 Includes S & H**

PRACTICAL OSCILLATOR CIRCUITS—If your budding project requires an oscillator, you can design it and build it from the many types described here in a hobbyist-friendly style. **Order BP393— \$9.99 Includes S & H**

EASY PC INTERFACING—Hot shot Pentium computers to the lowly XT slow poke can interconnect to the outside world to sense and/or control events governed by simple writeable software and simple home-brew projects. **Order BP385— \$9.99 Includes S & H**

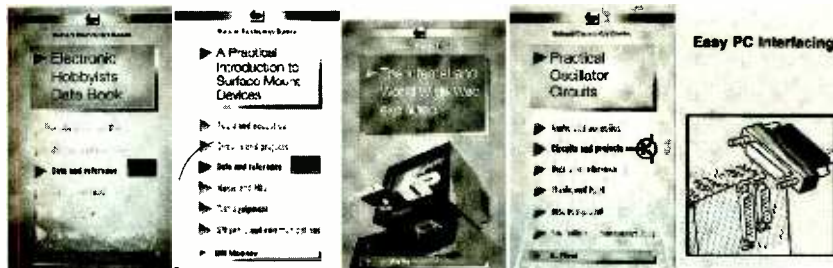

BP396

BP411

BP403

BP393

BP385

Electronics Technology Today Inc. Number of books ordered
P.O. Box 240
Massapequa, NY 11762-0240 Amount enclosed \$

Please send me the following book(s) that I checked:

- BP396— Electronic Hobbyist Data Book— \$10.99
- BP411— Practical Introduction to Surface Mount Devices— \$9.99
- BP403— The Internet and the World Wide Web— \$10.99
- BP393— Practical Oscillator Circuits— \$9.99
- BP385— Easy PC Interfacing— \$9.99

All above prices include shipping and handling.

ET05

Name/Company _____

Address _____ Apt. _____

City _____ State _____ ZIP _____

Sorry, no orders accepted outside the USA and Canada. All payments must be in US funds! NY state residents must include local sales tax. Allow 6-8 weeks for delivery.

BooksNow To order books in this magazine or, any book in print. Please call anytime day or night: (800) **BOOKS-NOW** (266-5766) or (801) 261-1187 ask for ext. 1456 or visit on the web at <http://www.BooksNow.com/popular-electronics.htm>.
 Free catalogs are *not* available.

Ride the Airwaves with Alpha and Zulu costs \$14.95 and is published by Abtronix, P.O. Box 220066, Newhall, CA 91322-0066; Tel. 805-222-7384; Fax: 805-222-7384; Web: <http://home.earthlink.net/~abtronix>.

CIRCLE 96 ON FREE INFORMATION CARD

BUYING A USED SHORTWAVE RECEIVER: FOURTH EDITION
 by Fred Ostermann

This book provides all the information you need to intelligently select the right used SW receiver at the right price. Features to consider are coverage, specifications, ratings, price when new, size, and weight.

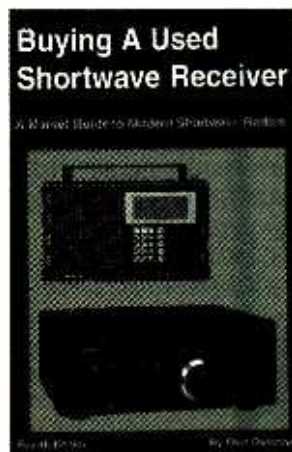

The 100 most sought-after receivers, portable and tabletop models from the last twenty years, are discussed. Among the selected models covered in the book are Allied, AOR, Drake, Grundig, Icom, Kenwood, Panasonic, Sony, and Ten-Tec units.

Buying A Used Shortwave Receiver costs \$5.95 and is published by Universal Radio Research, 6830 Americana Parkway, Reynoldsburg, OH 43068-4113; Tel. 800-431-3939 or 614-866-4627; Fax: 624-866-2339; Web: www.universal-radio.com.

CIRCLE 97 ON FREE INFORMATION CARD

SEMICONDUCTOR TESTER

No one will dispute that the development of semiconductor components has simplified the manufacture of electronic equipment. But in spite of all the good the "new breed" of components has wrought, it has also spawned a new set of problems. Chief among the difficulties associated with semiconductors is testing them for adherence to manufacturer's specs.

On the manufacturing level, testing is accomplished through specialized equipment. But, what's a hobbyist to do when confronted with a possible semiconductor malfunction? In many cases, the hobbyist is left to devise unconventional testing schemes that may or may not reveal pertinent information about the operability of the component.

In this article, we'll show you how to build the *Semiconductor Tester*—an instrument that allows you to measure both the static and dynamic characteristics of semiconductor transistors under simulated operating conditions. The tester is a curve tracer adapter that incorporates a collector supply and base-step generator, which together produce voltage and current signals that are applied to the device-under-test (DUT). The effects of the signals on the DUT produces a family of characteristic responses (curves) that can then be displayed on an oscilloscope and compared to manufacturer's specifications.

The tester can be used to measure and display a number of bipolar-transistor parameters simultaneously—for example, it can be used

to plot the I_C vs. V_{CE} characteristics of a transistor, determine saturation voltage, calculate gain (h_{FE}), and look at the spacing and slope of h_{FE} curves. The Semiconductor Tester is not limited to bipo-

tracer adapter, collector-supply and step-generator circuits produce signals that are applied to the oscilloscope through J1 and J2. The collector-supply output is also applied to the collector of the DUT via J3, while the step generator feeds current to the DUT's base through J4. Base current is stepped up in equal increments, starting from zero and increasing to its maximum, then returning to zero once the selected number of steps is completed. Step increments are controlled via S2.

Collector current flows through an emitter resistor, producing a voltage drop that serves as the vertical (Y-axis) signal (J1). The range of collector current is controlled by S7.

Circuit Description. A complete schematic diagram of the Semiconductor Tester is shown in Fig. 2. The circuit is comprised of six integrated circuits, four transistors, 17 diodes, a fullwave bridge rectifier, an LED, two transformers, and a goodly amount of support components.

The Semiconductor Tester contains two supply circuits: one supplying operational power to the adapter and the other (the collector supply circuit) providing the required collector and emitter signals. The collector-supply circuit is comprised of T2 (a 12.6-volt, 1.2-amp step-

down transformer), BR1 (an 8-amp, 250-volt, fullwave bridge rectifier), and S4 (a single-pole double-throw switch), which allows the user to determine the voltage (6.3 or 12.6 volts) applied to BR1 for rectification. The resulting DC output of BR1 is applied to S6-b and S6-c. Those

CHARLES HANSEN

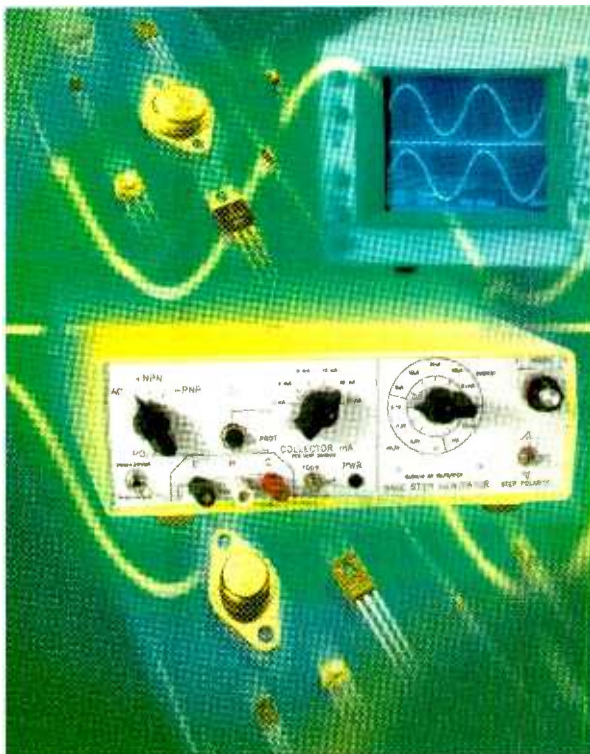

Build this curve-tracer adapter and eliminate one of the most frustrating dilemmas that electronics hobbyists face in assembling homebrew and published electronics circuits.

lar transistors—it can also be used to test JFETs, MOSFETs, SDs, rectifiers, and Zener diodes.

The Big Picture. Figure 1 is a functional block diagram of the tester, with a bipolar NPN transistor connected as the DUT. In this curve

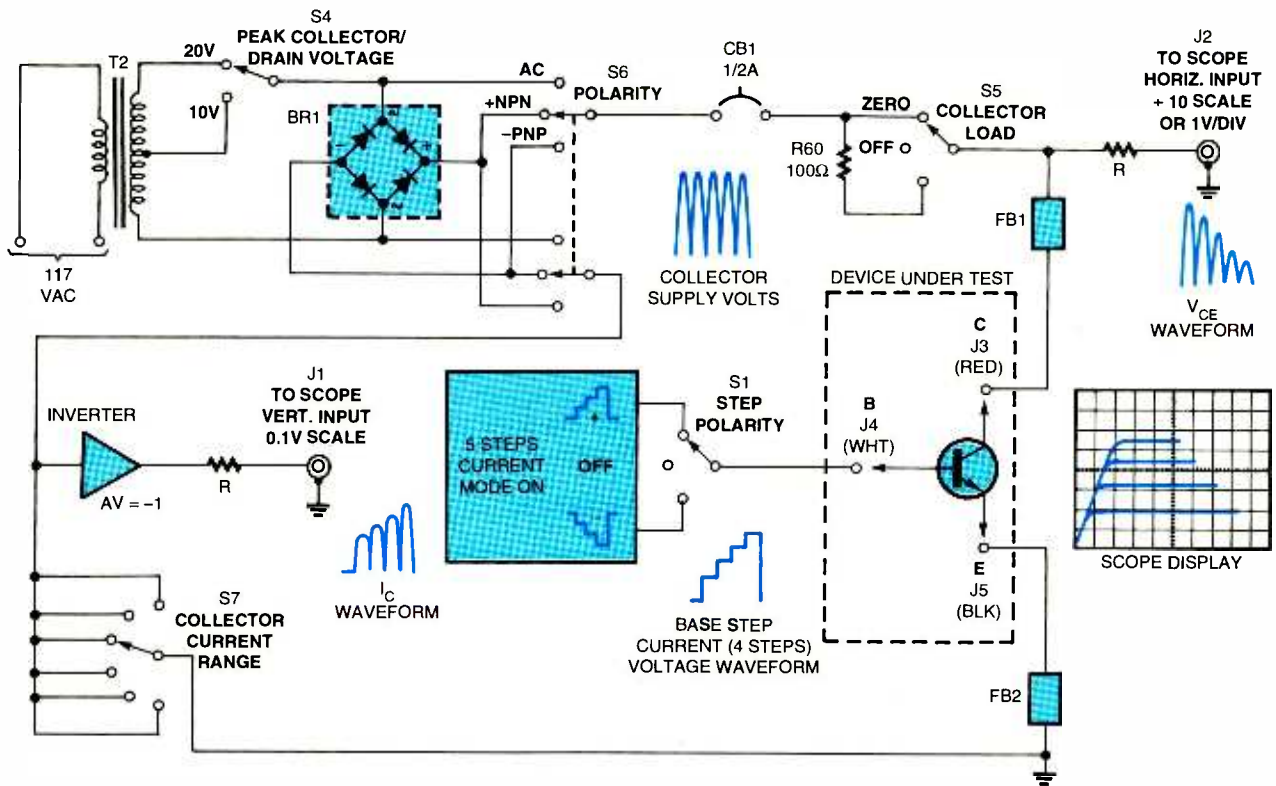

Fig. 1. As illustrated by this functional block diagram, the Semiconductor Tester is comprised of several sub-assemblies that coalesce to produce scope displays that reveal the "health status" of several two- or three-terminal semiconductor devices.

two sections of S6 (a 4P3T switch) permit the user to select any one of three sweep outputs (+NPN, -PNP, or AC), while a third section of S6 (S6-a) is used to ground J4 when the circuit is set for the AC mode.

The maximum amount of collector current applied to the DUT is controlled through S7, which places one of six resistors (R41-R46) in series with the emitter of the DUT. Placing S7 in the 50-mA position produces a maximum collector current of 0.63 amps, which should be adequate for testing most small-signal and medium-power bipolar transistors (up to TO-220 or TO-66 packages).

Note that a circuit breaker (CB1) is connected in series with the output of the collector-supply circuit in order to protect it from overload conditions.

The signal delivered to the DUT through J3 is also applied to J2 through R47, whose presence in the signal line sets the output impedance to approximately 600 ohms. A ferrite bead, FB1, connected in the lead to J3, prevents the DUT from

breaking into oscillation.

Switch S5 lets the user reduce the peak collector/emitter voltage applied to the DUT to less than that selected via S4 by placing R60 (a 100-ohm resistor) in series with the collector sweep signal. Placing S5 in the off position disrupts collector-signal flow to the DUT (via J3) when inserting or removing a transistor.

Both the collector and base currents are returned to a common ground at J5. A ferrite bead, FB2, connected in the lead to J5 helps prevent DUT oscillation.

Since the polarity of the voltage across R41-R46 is negative with respect to ground, IC4-b inverts the signal that's applied to J1, producing a family of correctly oriented curves when viewed on an oscilloscope. Resistors R37 and R38 set the gain of IC4-b, while R39 ensures that the input bias current at pins 5 and 6 are equal for best accuracy. Resistor R40 sets the output impedance at J1 to approximately 600 ohms.

Voltage Step Generator. The step generator portion of the circuit is

comprised of four major sub-assemblies: a clock, a counter, a step-level converter, and a step amplifier. The step generator is designed to supply discrete current (or voltage) levels to the base (or equivalent terminal) of the DUT for each cycle of the collector-supply sweep. The discrete levels are generated in ascending steps with a fixed, 1-volt separation.

A signal plucked from the secondary winding of T1 and fed to a clock circuit comprised of D1/D2 and Q1/Q2 determines the rate of change in the step-generator's output. The AC voltage diverted from the secondary of T1 is fullwave rectified by D1 and D2 and applied to the base of Q1 via R1. That causes Q1 to saturate (turn full on) during each AC half-cycle, producing a 120-Hz clock frequency. The output of Q1 is applied across R2 (which supplies a negative bias voltage that ensures that Q1 turns off at zero crossing) to the base of Q2. Transistor Q2 inverts the Q1 output, producing a clock signal that is applied to IC1—a 4017 decade

counter/divider that is used as a step-level converter—causing its ten decoded outputs (Q0-Q9) to sequentially go high. (Note: The Q0 output of IC1 is not used and represents the zero-level base step.)

The outputs (Q1-Q9) of IC1 are fed through individual resistor/diode pairs (comprised of R5-R13 and D3-D11) and S8, producing a voltage across R14 that increases in 1-volt steps.

Potentiometer R14 is used to calibrate the step voltage, while diodes D3-D11 block reverse-current flow to the outputs of IC1 when they are low. When set to the HOLD 1v position, S8 provides a fixed 1-volt reference to aid in checking the base-step generator's output stage during initial tests.

The summed output-voltage steps of IC1 are buffered by IC2-a (half of an LF412 dual op-amp), which is configured as a unity-gain voltage follower. The output of IC2-a is monitored by IC4-a (which is configured as a comparator). When the output of IC4-a at pin 3 reaches the level set by R18, IC4-a pin 1 goes high, resetting IC1 to zero, and the step count begins over again. Diode D18 prevents the -12-volt DC output of IC4-a from damaging IC1. Resistors R16 and R17 provide offsets so a single step is produced at the minimum setting of R18 and nine steps are produced at maximum rotation.

The negative-going voltage steps are generated by inverting op-amp IC2-b. Base-step polarity is determined through S1, which lets the user select between the output of IC2-a and the output of IC2-b. Switch S1 can also be used to remove the step signal from J4 when inserting or removing a transistor. Resistors R23 and R24 set the gain of IC2-b, while R22 ensures that the input bias current at pins 5 and 6 are equal for best accuracy.

The step signal from S1 drives two circuits. The first is a voltage divider, which provides the gate voltage steps necessary to test FETs. Resistors R32-R35 form a resistive divider network, which provides 0.1-, 0.2-, 0.5-, and 1-volt stepped outputs that can be selected through the first four positions of S2. The larger steps are required for

power MOSFETs.

The counter can be reset after 1 to 9 steps have been produced, with the number of steps determined by the setting of R18.

Voltage-To-Current Converter. In order to generate the base-current steps required to test bipolar transistors, a voltage-to-current converter is required. One way of accomplishing that is by placing a series resistor at the output of the voltage-step generator in order to produce current steps. The downside to that approach is that an off-

set voltage is required for the first step because it takes from 0.5 to 1.0 volts to forward-bias the base-emitter junction. The base-emitter voltage increases exponentially and is not the same at all collector currents. The base-emitter voltage increases even more in the saturation region, while also varying with temperature, so the series resistor method is not a good solution for accurate measurements.

Fortunately, there is an alternative—a bilateral current source built around an op-amp-based, voltage-to-current converter. The op-

Get our Freeware version
and you will know
why more and more PC-boards
are designed with EAGLE.



EAGLE 3.5

Schematic Capture • Board Layout
Autorouter

for Windows 95/NT

Windows 95 and Windows NT are registered trademarks of Microsoft Corporation.

EAGLE Professional offers the full EAGLE power: 99 schematic sheets, pc-boards up to 64 x 64 inches, 16 signal layers
With **EAGLE Standard** you can use 4 signal layers and place components on an area of 6.4 x 4 inches.
EAGLE Light is limited to 1 schematic sheet (of any size) and to 2-layer boards. Components can be placed on an area of 4 x 3.2 inches. All other features are equivalent to EAGLE Professional and Standard.

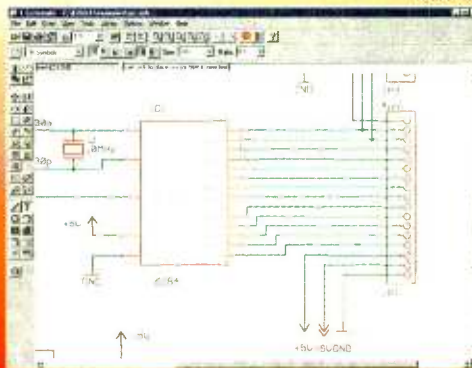

FREE Support!
No Maintenance Fee!

EAGLE 3.5 Light is Freeware!

EAGLE Light is now available free for non-profit and evaluation use! Download it from our Internet Site or order our free CD. Registered users (49 \$ for the complete package) get the commercial license, the reference manual, and free hotline support.

<http://www.CadSoftUSA.com>

800-858-8355

CadSoft Computer, Inc., 801 S. Federal Highway, Delray Beach, FL 33483
Hotline (561) 274-8355, Fax (561) 274-8218, E-Mail: info@cadsoftusa.com

Prices	Light	Standard	Professional
Layout		199\$	399\$
Layout + Schematic		398\$	796\$
Layout + Autorouter		398\$	796\$
Layout + Schematic + Autorouter	49\$	597\$	1197\$

Pay the difference for Upgrades

CIRCLE 173 ON FREE INFORMATION CARD

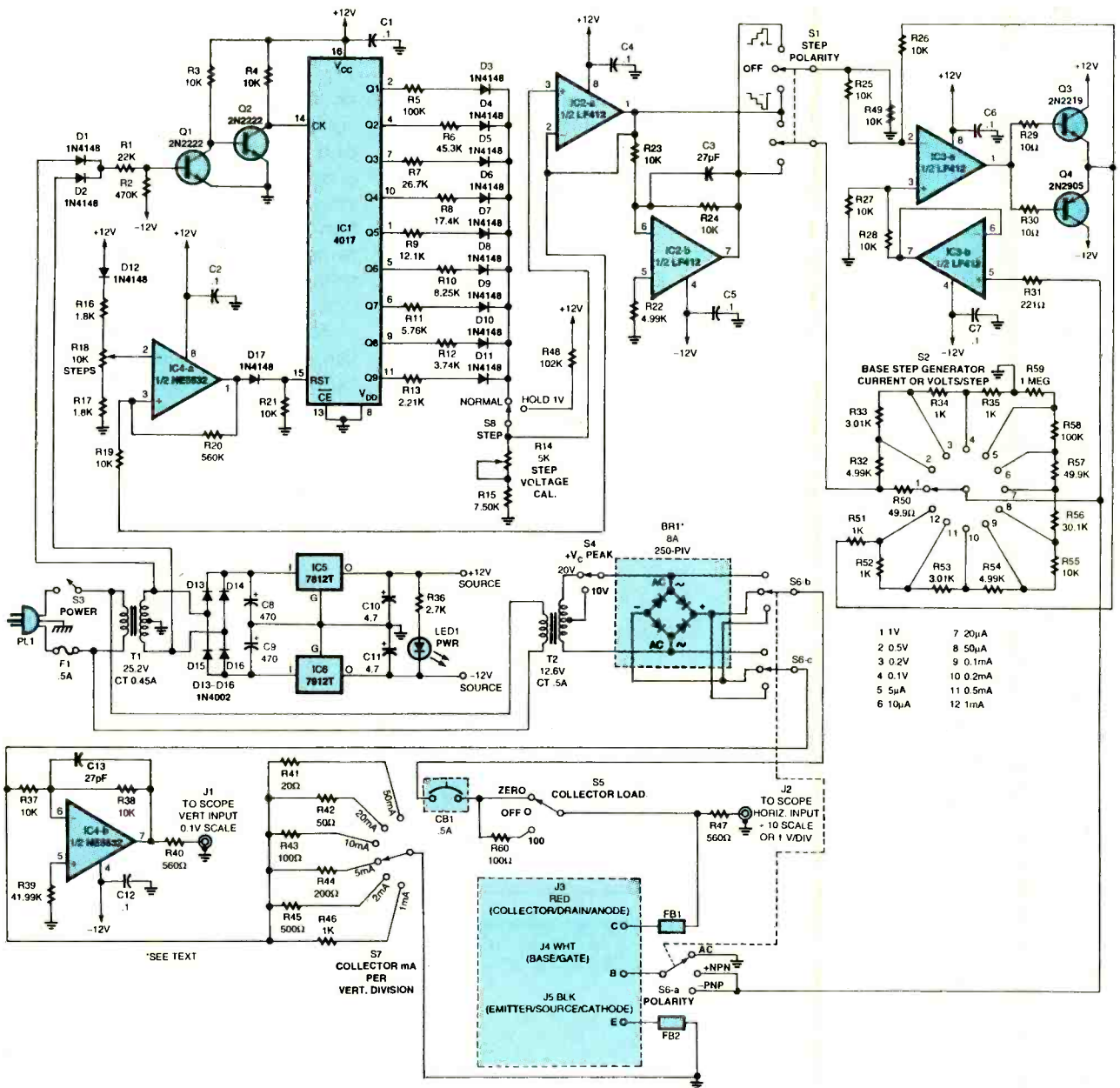

Fig. 2. The Semiconductor Tester is comprised of six integrated circuits, four transistors, 17 diodes, a fullwave bridge rectifier, an LED, two transformers, and a goodly amount of support components.

amp-based converter supplies a current that is proportional to the input voltage and, more importantly, drives a load referenced to any voltage within the output-swing capability of the op-amp. The voltage-to-current converter consists of dual low-offset, low-drift JFET op-amp IC3 along with a current amplifier that is composed of Q3 and Q4.

The base voltage steps are applied to IC3-a pin 2 via R25. Resistor R49 provides a ground reference when S1 is in the OFF position

to park the current output at zero. Negative feedback is taken from the emitters of Q3 and Q4 through R26.

Positive feedback is provided through R27 and R28 via IC3-b. The positive feedback increases the output impedance to a very high value, which is the characteristic of a true constant-current source. The input signal is amplified by IC3-a, which, if you make all of the feedback resistors exactly equal (R25 = R26 = R27 = R28), produces an output current of:

$$I_{OUT} = -V_{IN}/R_{SELECTED}$$

Note that the voltage-to-current converter produces an inverted output. Thus, S1 selects negative voltage steps to produce positive current steps and vice-versa. Since the voltage-step generator produces one volt steps, the current steps can easily be selected by changing a single resistor, $R_{SELECTED}$. Thus, the output current is determined by the value of the resistor (R51-R58) selected via S2. The current can be varied from 5 μ A/step

Times Are Tough...



Today's headlines scream of the lack of qualified individuals to fill new and existing high-tech job openings. If you feel the robust economy is passing you by, there is something you can do about it. **Become CIE Qualified.** Since 1934, The Cleveland Institute of Electronics has been providing its students with the necessary technical and academic credentials employers are seeking. In fact, CIE was started in 1934 to fill a similar void in the radio/television industry.

Since then, CIE boasts of over 150,000 worldwide graduates who have benefited from a patented, independent-study program that lets the student complete a Career Course, Associate Degree program, or through our affiliate school

World College, a Bachelor Degree program.

If you are currently "under-employed" and want to increase your level of income, the most proven method is an education. With CIE's independent-study program you study when and where you wish with no time constraints on how quickly you can proceed. And though it is an independent-study program you have the full support of the faculty and staff at CIE's Cleveland Campus.

To discover all the Benefits, Career Courses and Degree Programs available from CIE send for your Free Course Catalog Today!

The Cleveland Institute of Electronics has been approved for the training of eligible veterans and active duty military service members, under the G.I. Bill. Military tuition assistance (Up-Front and Basic) is also available under the DANTES Distance Learning Program.

...For Employers



BUSINESS NEWS
**Employers Searching For
Qualified Candidates**

F R E E C A T A L O G



Cleveland Institute of Electronics
1776 E. 17th Street
Cleveland, Ohio 44114-3679
Visit Our Web-Site: www.cie-wc.edu

*A School of Thousands.
A Class of One. Since 1934.*

YES! Please send me a catalog. AH137

Name: _____

Address: _____

City: _____ State: _____ Zip: _____

Phone Number: _____

Check Box for a Bulletin on Military Education Benefits:

VA Benefits DANTES Benefits

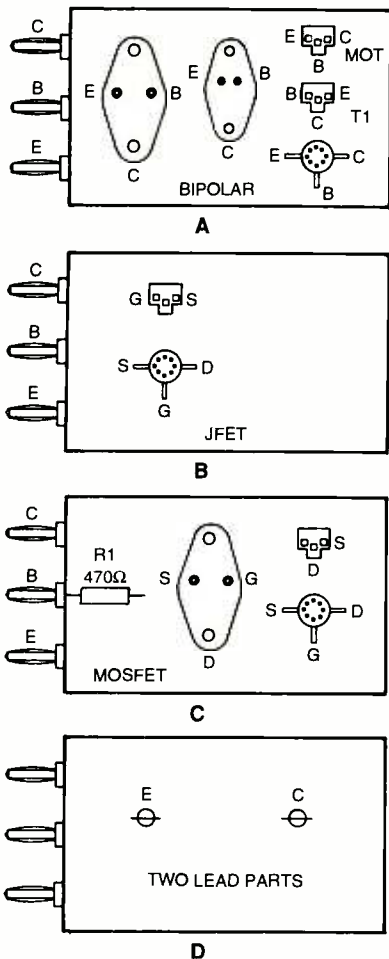

Fig. 3. The author's unit includes several test fixtures that are designed to plug directly into J3-J5 of the Semiconductor Tester—each containing several three-terminal sockets to accommodate various standard transistor-pin arrangements. The one in A is intended for testing bipolar transistors; the one in B is for JFETs; a fixture for testing MOSFETs is shown in C; and the final one shown in D is designed for two-terminal devices, such as rectifier and Zener diodes.

to 1 mA/step. Resistor R59 provides a ground return for the voltage-to-current converter when S2 is in one of the voltage-step modes.

The voltage-to-current converter delivers the current set by the selected resistance, independent of any load resistance at J4, even if the other side of the load is not sitting at ground potential, such as when a base-emitter junction is interposed between J4 and J5. Under that condition, positive feedback through R27 and R28 tends to reduce accuracy. To prevent that occurrence, IC3-b is configured as a unity-gain buffer with an extremely high input

resistance to drive positive feedback network R27 and R28. Since $R25 = R26 = R27 = R28$, the output current is independent of the feedback voltage. The output resistance of the circuit is given by:

$$R_{\text{SELECTED}} \times (R/\Delta R)$$

where R is any one of the feedback resistors (R25, R26, R27, or R28) and ΔR is the change in the resistor value due to component tolerances. Because of that, the feedback resistors should be selected to be equal in value. In order to facilitate matching, 10k 1% metal film resistors are used, even where less precision is required. That allows a larger selection of resistors (14) from which to match R25 through R28.

The circuit must be driven from a source resistance that is low by comparison to R25, since that resistance also unbalances the circuit, while affecting gain and output current. The low output resistance of IC2-a and IC2-b meets that requirement.

The output of IC3-a is applied to the base of Q3 and Q4 through R29 and R30, increasing the output drive current to the level required for the higher base-step current levels.

Once the collector supply and the step generator outputs have been applied to the DUT, measurements of the voltages and currents seen at the collector (or equivalent) terminal of the device must be displayed on the vertical and

horizontal axes of an externally connected oscilloscope.

Collector current is measured on the vertical X-axis of the oscilloscope. It is measured across one of the resistors (R41-R46) between ground and the current return to the collector supply by measuring the voltage developed across this resistor. Switch S7 selects the current sensing resistor, which varies the deflection factor of the scope display between 1 mA/DIV and 50 mA/DIV. The resulting voltage is inverted by IC4-b and applied to J1 through R40.

Collector-emitter voltage is sensed at J3 and sent via J2 to the horizontal Y-axis of the scope. Resistor R47 provides an output impedance of about 600 ohms.

Power for the Semiconductor Tester is provided by a conventional dual-voltage (\pm) supply circuit, comprised of T1 (a 25.2-volt center tapped transformer), and D13-D16 (four 1N4002 1-amp, 100-PIV diodes that form a fullwave bridge rectifier). The resulting DC voltages are applied to IC5 and IC6 to produce positive and negative DC voltages, respectively. The outputs of the regulators are filtered by C8 through C11. An LED (LED1) connected across the power supply output serves as a power-on indicator.

Components IC2 and IC3 were selected for precision and low input offset voltage in order to ensure the accuracy of the base-step voltage and current; and they should not

TABLE 1—TEST CONNECTIONS

	DEVICE	COLLECTOR POLARITY	STEP POLARITY
BIPOLAR	NPN	+NPN	+
	PNP	-PNP	-
JFET	N-Channel	+NPN	+
	P-Channel	-PNP	-
MOSFET	N-Channel	+NPN	+
	P-Channel	-PNP	-

Scope Connections:

1. Horizontal input to main trigger or amp in
2. Time/division to amplifier (was 10 ms)
3. Main trigger source to ext. $\div 10$ (was int.)

Deflection Factors:

- Ext. $\times 1 = 0.1\text{V/Div}$
- Ext. $\times 10 = 10\text{ mV/Div}$
- Ext. $\div 10 = 1\text{V/Div}$

4. Vertical = 1V/Div
5. NPN = dot lower left, PNP = dot upper right

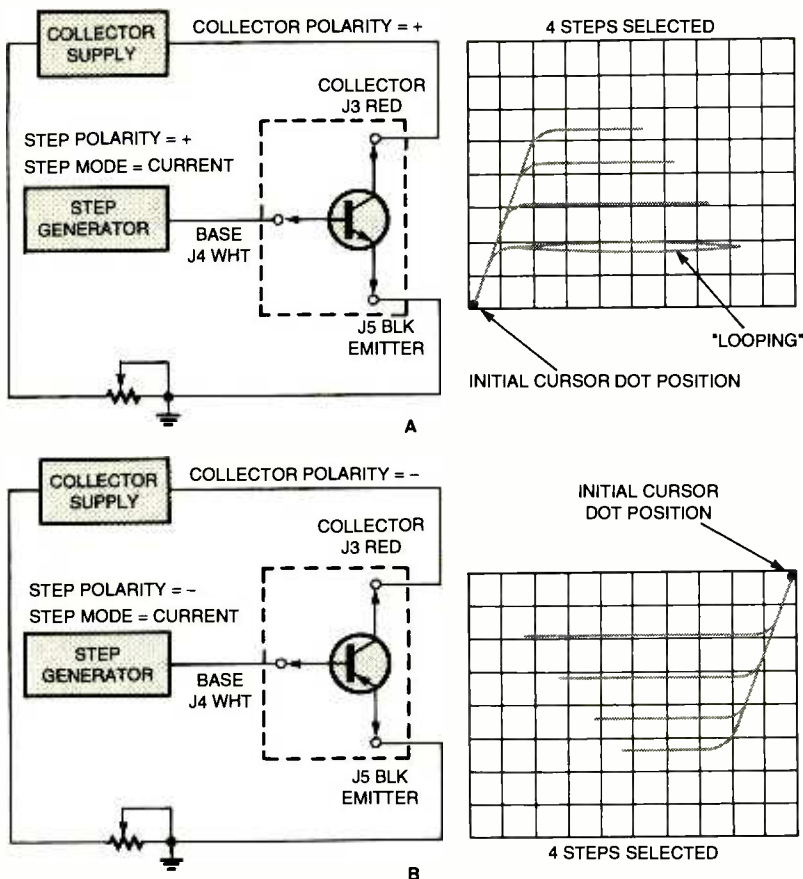

Fig. 4. Shown here is the correct way to connect bipolar transistors to the test fixture. The illustration in A shows how a bipolar NPN transistor is connected to the fixture; the DUT's characteristic curves are also shown. The illustration in B shows the PNP terminal connections and characteristic curves.

be replaced with less accurate FET op-amps, such as the TL072 or LF353. Precision op-amps such as the AD712JN or LT1057CN8 are acceptable substitutes. The NE5532 op-amp (IC4) was selected for its ability to drive the standard test equipment 600-ohm output impedance. Most other op-amps are only rated for 1k or higher loads.

Construction. The Semiconductor Tester was assembled on a fairly large section of Vector board, with point-to-point wiring techniques then brought into play to complete inter-component connections. Because no printed-circuit pattern is provided for this project, the circuit must be assembled according to the Fig. 2 schematic diagram. Be careful when assembling the circuit—this type of construction is more prone to errors than the printed-circuit method.

In keeping with good circuit-board assembly practice, install the

least sensitive passive components (resistors, capacitors, inductive devices, etc.) first, followed by the semiconductors.

Sockets should be provided for all DIP components. Install all of the semiconductors except IC1-IC4. When that's complete, double check the orientation of all polarized components—that includes all electrolytic capacitors and semiconductors (diodes, transistors, IC, etc.).

Note: Many of the resistors associated with switches are not mounted to the board, but are instead mounted directly to the switch terminals. For example, R32-R35 and R50-R59 are mounted to S2; R60 is mounted to S5; R43-R46 are mounted to S7. All the components associated with the collector supply are mounted on the front panel. Resistors R41 and R42 are mounted to 5-lug terminal strips that were cut down to 3 lugs. Flat-head screws were used to mount the 3-lug strips

and BR1 to the front panel.

A tapped turret-terminal caps the mounting screw for BR1 and serves as a grounding point for the collector supply circuitry, power supply, and base-step generator. That ground point is then wired directly to emitter jack J5. Another turret terminal is used for R47 near J2 on the rear panel. LED1 has its own integral lens holder.

Since the base-step generator processes very low voltages and currents that are sensitive to noise, the wiring associated with S2, S6, and J4 is twisted (2-3 turns per inch) with another wire, forming a pseudo shield. The pseudo shield should then be grounded at one end only. Other than that, the circuit and wiring layout is not critical.

The outputs of power transformers can be connected to the circuit board through 0.062-inch Molex crimp-terminal plugs and receptacles. That allows easy removal of the board for servicing should the unit require it somewhere down the road.

Once the board (minus the off-board components) has been assembled, put the board to the side for a moment and prepare the enclosure that will house the unit. Make sure when selecting an enclosure that it has sufficient room inside for the board and all of the off-board-mounted components (including the panel-mounted parts).

Drill holes in the front panel of the enclosure for the switches (S1, S2, and S4-S8), jacks (J3-J5), LED1 (the power "on" indicator), and potentiometer (R18). Follow that by drilling holes in the rear panel for the fuse holder, S3, J1, J2, and a hole through which to feed the unit's line-cord to the transformers. Next drill mounting holes in the bottom of the enclosure for the transformers.

Once the holes have all been drilled in the front and rear panels of the enclosure, dry-transfer lettering can be used to label the unit's panel-mounted control and jack positions as to their functions. The method used by the author for labeling the unit involved making a full-size copy of the front panel layout on transparent, adhesive-backed plastic appliqué film

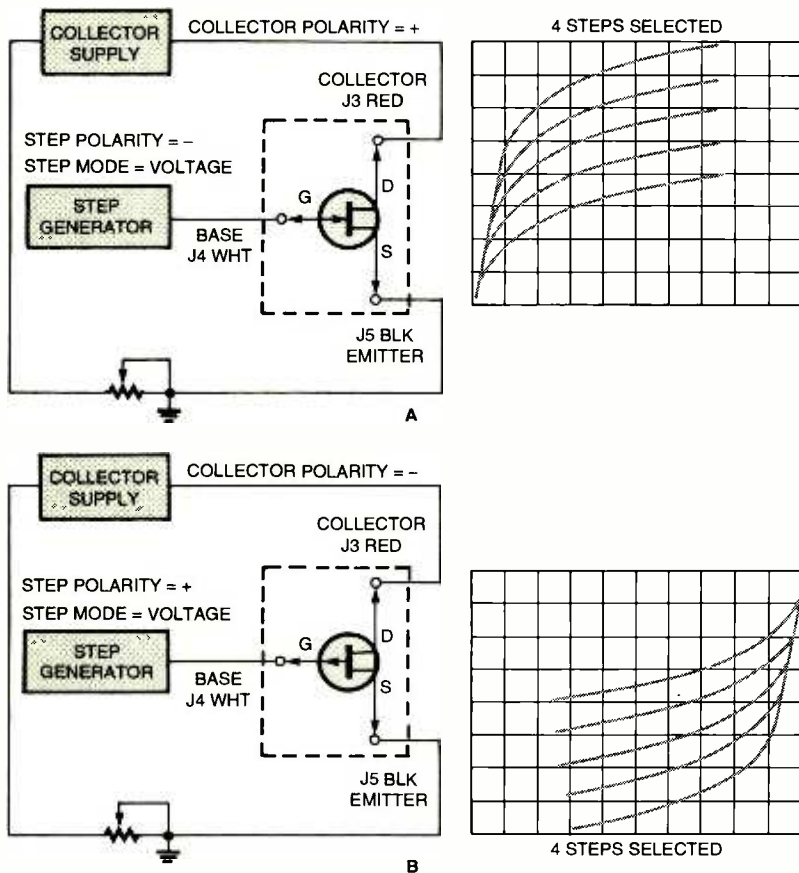

Fig. 5. The test setup and characteristic curves for an N-channel JFET is shown in A, while the test setup and characteristic curves for P-channel JFETs is shown in B.

(which is available from drafting and art supply houses).

Initial Checkout. At this point, attach the Molex connector to T1, plug in the unit, and check for the presence of +12 and -12 volts at the supply terminals of the sockets for the four ICs not yet installed. If all is well, power down the unit—allowing sufficient time for the power-supply capacitors to discharge—and install the four ICs. Again apply power to the circuit and check that the clock and counter (IC1) are working properly. Place S2 in the 1-volt position and, with a scope connected to J4 and J5, view the voltage step pattern. You should be able to vary the number of steps in 1-volt increments from 1 to 9 by adjusting R18.

Next, connect a 1000-ohm, 1% metal-film resistor from J4 to J5. This time set S2 to the 1-mA position and again observe the scope display; you should be able to vary the number of steps in 1-volt incre-

ments from 1 to 9. If the step generator is not working properly, you can use S8 to hold a single 1-volt step for troubleshooting.

Next, plug in the Molex connector for collector-supply transformer T2. View the waveform of the collector supply from J3 to J5. Select each polarity and verify that the 10- and 20-volt peak taps of T2 work properly.

Test Fixtures. The author's unit includes a test fixture that's designed to plug directly into J3-J5 of the tester. The test fixture—which contains three-terminal sockets to accommodate various standard pin arrangements (TO-3, TO-66, TO-220, TO-5, etc.)—provides a simple method of connecting the device under test to the Semiconductor Tester.

Figure 3A shows a fixture designed to facilitate the testing of bipolar transistors. Note that the fixture includes sockets to accommodate TO-3 and TO-66 transistor

packages, as well as a pair of TO-220 sockets, which are configured to accommodate both "E-B-C" and "B-C-E" pin arrangements. The fixture in Fig. 3B is designed for the testing of JFETs. Note that the drain of a JFET corresponds to the collector terminal, the gate corresponds to the base, and the source corresponds to the emitter of a bipolar transistor. A MOSFET test fixture is shown in Fig. 3C. Note that the correlation between the terminals of bipolar transistors and JFETs is identical to that between bipolar and MOSFETs. Notice that the MOSFET fixture contains a 470-ohm gate resistor, which is required to prevent DUT oscillation during tests. A two-pin fixture like the one shown in Fig. 3D (which includes alligator clip leads) can be added to your collection of fixtures and used to test signal and Zener diodes. In that case, the anode and cathode of the DUT correspond to the collector and emitter, respectively, of the bipolar transistor. When assembling any of the fixtures, be sure that the banana plugs are situated so that the fixture does not interfere with any of the front panel controls.

For comparison testing, you can develop a dual-socket test fixture with a DPDT center-off switch to

PARTS LIST FOR TEST FIXTURES

- TO-3 socket (Mouser 534-4601)
- TO-66 socket (Mouser 534-4611)
- TO-220 socket (Digi-Key WM2550-ND)
- TO-5 socket (Mouser 151-TO-5320G)
- R1—470-ohm ¼-watt, 5% carbon film resistor (MOSFET fixture only)
- Panel-mount banana plugs (Digi-Key J148-ND), 4.375 × 2.437 × 1.25 inch enclosure (Radio Shack 270-221), wire solder, hardware, etc.

alternately test two like devices. In such an arrangement, the unswitched emitter terminals can be connected together.

Jacks J3-J5 also accept lead wires, spade lugs or banana plugs (spaced at a standard 3/4-inch) so that almost any device can be connected to the Semiconductor Tester without requiring a specific test fixture.

Operation. The BNC connectors, J1 and J2, (which are mounted to the

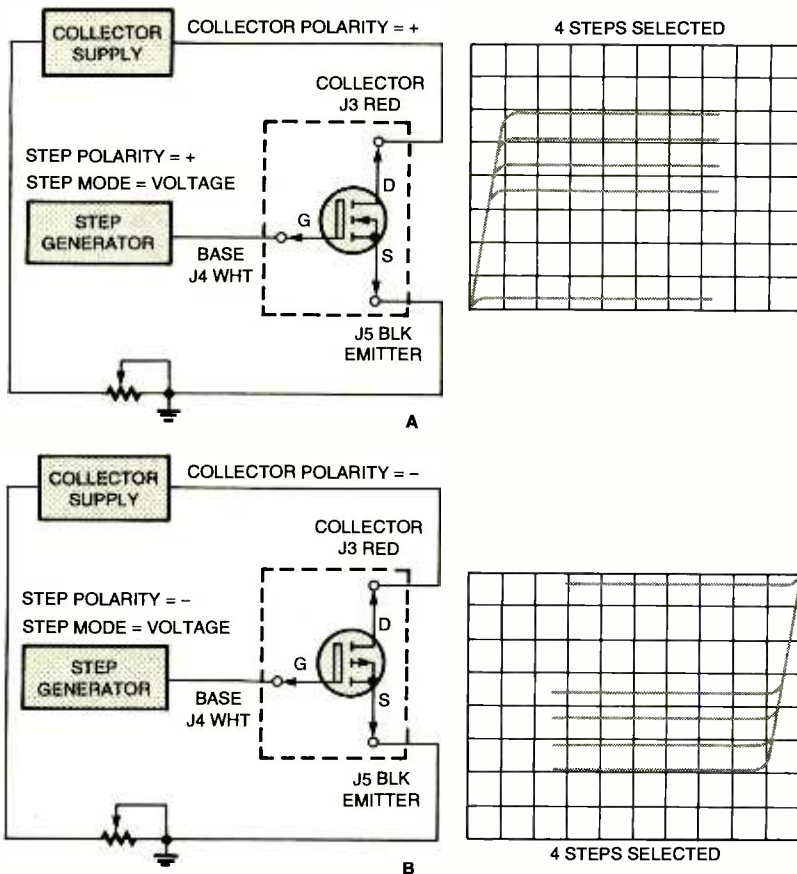

Fig. 6. Here we have the test setup and characteristic curves for MOSFETs: The drawing in A is for N-channel MOSFETs, while the one in B is for P-channel units.

rear panel of the unit) are used to connect the tester to your oscilloscope. Both the X and Y channels must be DC-coupled, but don't need a wide bandwidth on any of the channels. The scope's vertical input should be set to the 0.1 volt/DIV scale to provide proper collector current readings as indicated by the scale of S7. The scope's horizontal input should be set to the 1 volt/DIV scale to provide proper collector-emitter voltage readings.

If using a single channel scope, turn the time-base switch to the X or external position. A two-channel scope with an XY time-base switch position can use one channel as the X channel and the other channel as the Y channel.

Table 1 gives the scope connections and polarities for bipolar and field-effect devices; that table can be modified as required (to match your scope) and attached to the top of the tester as a reference, as was done in the prototype.

The step polarity and the collector voltage polarity switches should be set for the DUT. **CAUTION:** A number of the Semiconductor Tester's controls, if set too high, could cause damage to the DUT. The adapter's base-current capability is high enough to drive most power transistors to maximum collector current. When the tester is set to the high collector-supply-voltage range and the 50-mA/DIV range at the same time, the connected transistor can heat up rapidly. If you accidentally reverse-bias the base-emitter junction of a transistor, it may permanently increase the device's noise figure. Therefore, be sure to always double-check the pinout of all devices and make sure that the correct collector-voltage polarity and base-step polarity is applied to the DUT.

Let's make the first test with a small signal NPN transistor (2N2222, 2N3904, etc.). Set the front panel controls as follows: S6 to the +NPN mode, S4 to 10 volts peak, S7 to 1

mA/DIV, S5 to off, S2 to 5 μ A, R18 for 2 or 3 steps, S1 to off, move the cursor dot to the bottom left-hand corner of the display grid, connect the NPN transistor to the E-B-C terminals using the correct device pinout, set S5 to zero, and set S1 to + steps.

Connect a bipolar transistor to the test fixture as shown in Fig. 4. Figure 4A shows how an NPN transistor is connected to the fixture along with the DUT's characteristic curves, while Fig. 4B illustrates PNP terminal connections and characteristic curves. The scope display should show two or three curves similar to those shown in Fig. 4. Note that the curves in Fig. 4A are the exact opposite of those in Fig. 4B.

Move the bottom curve to the bottom left-hand corner of the display grid. That establishes the zero reference from which all the other voltage and current measurements are taken. The vertical-collector-current deflection depends on the transistor gain. It may be necessary to increase the base current (via S2) to get the traces shown in Fig. 4. You can also vary sensitivity via S7 for tests at collector currents other than 10 mA/div.

To calculate gain, select one of the horizontal curves, let's say from the third base current step. In Fig. 4A, that lies on vertical grid 3.1, which represents 3.1 mA (1 mA/vertical division). We know the third base step is 10 μ A (5 μ A/step, with the first step equal to zero). Therefore the gain is:

$$h_{FE} = I_C / I_B, \text{ or } 3.1 \text{ mA} / 10 \mu\text{A} = 310$$

You can also find saturation voltage, the vertical region of each characteristic curve.

Device Test Setups. When testing a device with unknown characteristics, set S2 to 5 μ A/step for bipolar transistors or 0.1 V/step for FETs. Set S4 to 10 V and S7 to 10 mA/div. Set R18 for 2 or 3 steps. That limits the dissipation to a safe level for any device.

Some of the characteristic curves displayed may consist of loops (as shown on the second step in Fig. 4A) rather than well-defined lines. That effect is known as looping and is noticeable at very low or very high

current levels. Looping is a phase shift caused by device capacitance and stray capacitance within the adapter, which allow collector current to bypass the DUT itself. It may also be caused by heating of the DUT. While lab-grade curve tracers use elaborate capacitance-cancellation circuitry, that is beyond the scope of this article. The best approximation of the actual characteristics curve when looping is present is an imaginary straight line drawn down the middle of the loop.

Refer to the test setup and char-

acteristic curves for a PNP transistor shown in Fig. 4B. Note that for P polarity devices, the initial cursor dot position is in the upper right corner of the scope grid, and the collector voltage and the step polarity are reversed. The deflection now will run from right to left, and from top to bottom, with the curves displayed "upside down."

Similarly, Fig. 5 shows JFET drain current vs. drain-to-source voltage for various steps of gate voltage. To calculate transconductance (gm), select one of the horizontal curves.

Since $g_m = I_D/V_{GS}$, that parameter can be found for any step of gate voltage.

Figure 5A shows test setup and characteristic curves for an N-channel JFET. For JFETs, the drain is connected to J3 and the source is connected to J5. The JFET gate (connected to J4) is driven from the volts/step portion of S2. JFETs are different from bipolar transistors in that they conduct maximum current with zero gate voltage, so the step polarity must be opposite that of the collector supply polarity. The

PARTS LIST FOR THE SEMICONDUCTOR TESTER

SEMICONDUCTORS

- IC1—CD4017 decade counter/divider, integrated circuit (Jameco 12749)
 IC2, IC3—LF412CN dual, low-off-set, FET-input, op-amp integrated circuit (Newark LF412CN)
 IC4—NE5532 dual, low-noise, op-amp, integrated circuit (Jameco 27385)
 IC5—7812T fixed, positive 12-volt regulator integrated circuit (Jameco 51334)
 IC6—7912T fixed, negative 12-volt regulator, integrated circuit (Jameco 51481)
 Q1, Q2—2N2222A general-purpose NPN silicon transistor (Jameco 38236)
 Q3—2N2219A general-purpose PNP silicon transistor (Jameco 38228)
 Q4—2N2905A general-purpose NPN silicon transistor (Jameco 38279)
 BR1—8A, 250-PIV fullwave bridge rectifier (RadioShack 276-1181)
 D1—D12, D17—1N4148 general-purpose, small-signal, silicon diode (Jameco 36038)
 D13—D16—1N4002 1-amp, 100-PIV, silicon rectifier diode (Jameco 76961)
 LED1—Red light-emitting diode with holder (RadioShack 276-011)

RESISTORS

(All fixed resistors are 1/4 watt, 1% metal-film, units, unless otherwise noted.)

- R1—22,000-ohm, 1/4-watt, 5%, carbon-film
 R2—470,000-ohm, 1/4-watt, 5%, carbon-film
 R3, R4, R19, R21, R23, R24, R37, R38, R49, R55—10,000-ohm
 R5, R58—100,000-ohm
 R6—45,300-ohm
 R7—26,700-ohm
 R8—17,400-ohm
 R9—12,100-ohm
 R10—8250-ohm
 R11—5760-ohm
 R12—3740-ohm

- R13—2210-ohm
 R14—5000-ohm 15-turn, cermet, trimmer potentiometer, (Mouser 323-4290W-5K)
 R15—7500-ohm
 R16, R17—1800-ohm, 1/4-watt, 5%, carbon-film
 R18—10,000-ohm linear, conductive-plastic, potentiometer (Digi-Key RV4N103-ND)
 R20—560,000-ohm, 1/4-watt, 5%, carbon-film
 R22, R32, R54—4990-ohm
 R25—R28—10,000-ohm (see text)
 R29, R30—10-ohm, 1/4-watt, 5%, carbon-film
 R31—221-ohm
 R33, R53—3010-ohm
 R34, R35, R52—1000-ohm
 R36—2700-ohm, 1/2-watt, 5%, carbon-film
 R39—4199-ohm
 R40, R47—560-ohm, 1/4-watt, 5%, carbon-film
 R41—20-ohm, 10-watt, 1%, wire-wound (RS-10, Newark 13F136-20)
 R42—50-ohm, 5-watt, 1%, wire-wound (RS-5, Newark 13F143-50)
 R43, R60—100-ohm, 5-watt, 1%, wire-wound (RS-5, Newark 13F143-100)
 R44—200-ohm, 3-watt, 1%, wire-wound (RS-2B, Newark 13F142-200)
 R45—500-ohm, 3-watt, 1%, wire-wound (RS-2B, Newark 13F142-500)
 R46, R51—1000-ohm, 1/2-watt, 1%, metal-film (Mouser 29MF500-1K)
 R48—102,000-ohm
 R50—49.9-ohm
 R56—30,100-ohm
 R57—49,900-ohm
 R59—1-megohm

CAPACITORS

- C1, C2, C4-C7, C12—0.1- μ F, ceramic-disc (Mouser 140-CD50Q9-104Z)
 C3, C13—27-pF, NPO, ceramic-disc (Mouser 141-100N5-027J)
 C8, C9—470- μ F, 50-WVDC, aluminum

- electrolytic (Mouser 140-XAL50V470)
 C10, C11—4.7- μ F, 35-WVDC, aluminum electrolytic (Mouser 140-XRL35V4.7)

ADDITIONAL PARTS AND MATERIALS

- T1—25.2-volt, center-tapped 0.45-amp transformer (RadioShack 273-1366)
 T2—12.6-volt, 1.2-amp, center-tapped transformer (RadioShack 273-1505)
 CB1—1/2-amp circuit breaker (All Electronics CB-05)
 F1—1/2-amp fuse
 FB1, FB2—Ferrite bead (All Electronics TOR-3)
 S1, S5—DPDT center-off mini toggle switch (Jameco 21952)
 S2—SP12T shorting-type, rotary switch (Mouser 10WW112)
 S3—DPST, 3-amp, 250-volt AC slide switch (Digi-Key CKC5105-ND)
 S4—DPDT miniature toggle switch (Jameco 21979)
 S6—4P3T non-shorting, rotary switch (Mouser 10YX043)
 S7—2P6T non-shorting, rotary switch (Mouser 10YX026)
 S8—SPDT miniature PCB slide switch (Jameco 109170)
 J1, J2—BNC receptacle UG-1094A (Mouser 532-31-221-RFX1)
 J3—Red banana jack (Newark 39F1546)
 J4—White banana jack (Newark 39F1545)
 J5—Black banana jack (Newark 39F1547)
 P1, P2—Molex connectors, optional, see text
 Experimenter's circuit board, enclosure, T-49 wire-wrap pins, wire-wrap IC sockets, 5-lug terminal strips, fuse holder, hardware, spacers, solder, hookup wire, rubber feet, power cord, grommet, etc.

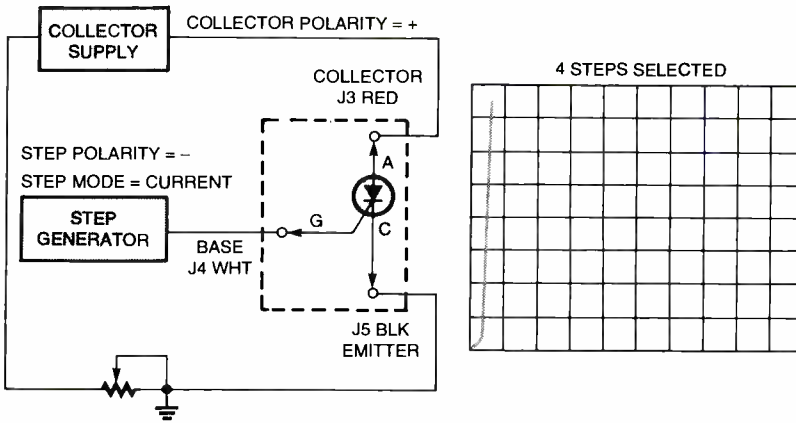

Fig. 7. The test setup and characteristic curves for an SCR are shown here.

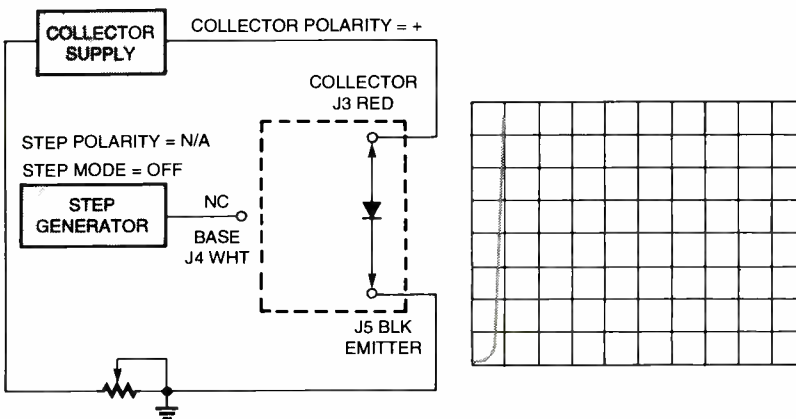

Fig. 8. The test setup and curve for a diode is shown here.

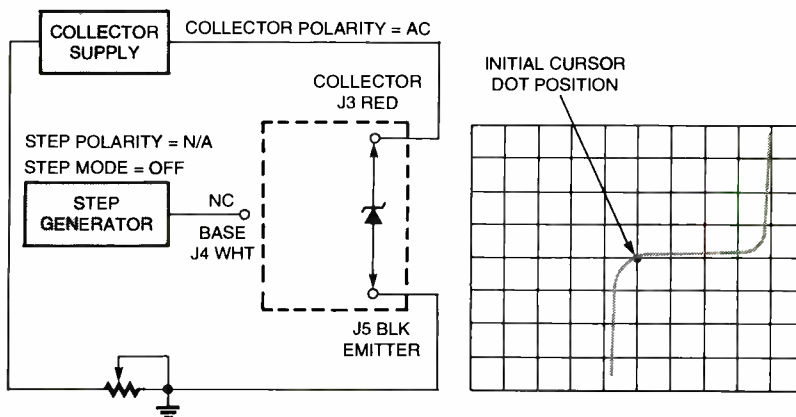

Fig. 9. Shown here is the test setup and curve for a Zener diode.

first step curve is on top; additional steps reduce drain-to-source current, producing additional curves below the first one. Figure 5B shows a test setup and characteristic curves for a P-channel JFET.

Figure 6A shows test setup and characteristic curves of an N-channel MOSFET. JFETs and MOSFETs have a tendency to oscillate on any

curve tracer, producing "fuzz" in the scope display. To guard against oscillation, the tester and MOSFET test fixture have built-in resistors in series with the gate, and the tester has ferrite beads at the collector and emitter jacks. Figure 6B shows a test setup and characteristic curves of a P-channel MOSFET.

Figure 7 shows the test setup and

characteristic curves for an SCR. Note the similarity to the diode curve (Fig. 8) once forward conduction is achieved.

Figure 9 shows the test setup and curve for a Zener diode. Note that the initial position of the cursor dot is in the center of the scope grid. If more vertical resolution is required, the cursor dot can be positioned in the lower left corner and positive collector polarity can be used to view only the reverse breakdown voltage portion of the curve. ■

ELECTRONIC GAMES

BP69—A number of interesting electronic game projects using IC's are presented. Includes 19 different projects ranging from a simple coin flipper, to a competitive reaction game, to electronic roulette, a combination lock game, a game timer and more. To order BP69 send **\$4.99 clearance (includes s&h)** in the US and Canada to **Electronic Technology Today Inc., P.O. Box 240, Massapequa Park, NY 11762-0240.** US funds only. Use US bank check or International Money Order. Allow 6-8 weeks for delivery. MA07



POPTRONIX®

Online Edition

We're on the web

FREE

We are starting up,
but you can watch us grow!

Projects for beginners
to experts!

New Product information!

Bookstore—discover
what's new!

<http://www.poptronix.com>

WE'RE WITH YOU EVERY DAY
24 HOURS A DAY! DROP IN!
WE'D LOVE TO HAVE YOU VISIT!

ELECTROLYTIC METER

EUGENE W. VAHLE JR.

Build a troubleshooting aid that can go a long way to determining the condition of the electrolytic capacitors commonly found in the power-supply circuits of computers, TVs, and other electronics equipment.



If you do any type of electronics testing, troubleshooting, or repair, you're probably well aware of how useful a decent capacitance meter can be. In most cases, the capacitance function of your DVM—which can normally handle capacitances of up to about 470 μF —will do. But what do you do when you need to check out the large capacitors that are found in TVs, VCRs, and computers?

Needing to measure capacitances of up to about 300,000 μF at voltages as low as 5.5 volts, the author developed the *Electrolytic Meter*.

Features. Many capacitor testers rely on frequency to measure capacitance, but the Electrolytic Meter is based on the RC time-constant method. That allows the unknown capacitor to be linearly charged from 0-4.4 volts. The graph in Fig. 1 illustrates the difference between series-resistor charging and the constant-current charging ($t = R \times C$, where R is the value of the selected range resistor, and C is the value of the unknown capacitor).

An important feature of the Electrolytic Meter—which has an accuracy of better than 5% (± 1 of the least significant digit)—is its ability to discharge capacitors before and after the testing with the flip of a switch to prevent the destruction of the meter. Most electrolytic capacitors have large tolerances, ranging from -20% to +80%, meaning that a capacitor specified at 1000 μF might have an actual capacitance of as little as 800 μF (-20%) to as much as 1800 μF

(+80%). Other capacitors have a lower tolerance ($\pm 10\%$). For capacitors with series resistance (such as those used in memory backups), the formulas provided can be used to find the actual capacitance and series resistance.

The display portion of the circuit is comprised of four 7-segment common-cathode display modules (of your choice), allowing the Electrolytic Meter to count and display any value up to 9999. That allows large capacitors to be tested on lower ranges.

About The Circuit. A schematic diagram of the Electrolytic Meter is shown in Fig. 2. The circuit is comprised of four integrated circuits—IC1, a 7805 positive 5-volt, 1-amp, fixed, voltage regulator; IC2, a 74C925 4-digit counter/multiplexed 7-segment display driver; IC3, a 7555 CMOS oscillator/timer; and IC4, a 79L05 negative 5-volt, 100-mA, fixed-voltage, low-power regulator—ten transistors (Q1-Q10), a fullwave-bridge rectifier (BR1), two light-emitting diodes (LED1 and LED2), four common-cathode seven-segment LED displays (DISP1-DISP4), and several support components.

The Power Supply. The Electrolytic Meter is powered from the 117-volt AC line. The AC voltage is applied to T1, a 12.6-volt, 1.2-amp step-down transformer, whose output is rectified by BR1 (a 1-amp, 50-PIV fullwave bridge rectifier) and filtered by C1 (a 470- μF capacitor), producing a voltage of between 16 and 19 volts DC. That voltage is applied along two circuit paths.

In one path, the output of BR1 is applied to IC1 (a 7805 positive 5-volt regulator), which produces a relatively ripple-free 5-volt output. In the other path, the output of BR1 is fed to a second regulator (that's set up, as explained later, in an unconventional configuration), a range-select network, and transistor Q10, which together form a constant-current source circuit.

Reference Voltage. The reference voltage (+4.5 volts) is provided by a voltage-divider network that's comprised of R16 and R17. The reference voltage is used to clamp the voltage across the test capacitor at 5 volts through Q10. The reference voltage—in conjunction with a two-transistor comparator comprised of Q5 and Q6—is also used to halt the count when the voltage across the test capacitor reaches 4 volts.

Two-Transistor Comparator. When S2 is in the discharge position, +5 volts is fed through R15 to the base of Q6, turning it off, which, in turn, sends Q5 into cutoff. With Q6 turned off, pin 5 of IC2 is pulled low through R14, latching the count into IC2 and transmitting the latched data to the display. At the same time, with Q5 cutoff, pin 12 of IC2 goes high, resetting IC2's internal counter to 0000 (resetting the counter has no effect on the latched data).

When S2 is set to the TEST position, the base of Q6 is pulled low (through the unknown capacitor, which initially acts as a short), turning it on. That forces pin 5 of IC2 high, turning the latch off. At the

same time, a low is applied to pin 12 of IC2, resetting the counter.

At that point, the charge on the unknown capacitor begins to rise. When the charge reaches about 4 volts, Q6 turns off again, latching the final count to the display and resetting the counter again. In the meantime, the charge on the unknown capacitor continues to increase until it reaches a level that's sufficient to forward-bias Q10, clamping the voltage to about 5 volts. Note: Capacitor C9 is included in the circuit to keep the two-transistor comparator (Q5/Q6) from false triggering, while C5 injects a delay between latching and resetting operations. When S2 is returned to the DISCHARGE position, the unknown capacitor discharges through R18.

DC Amp. As the unknown capacitor discharges, the voltage developed across R18 is amplified by Q7 and Q8. While that's happening, LED2 (DISCHARGE) lights to indicate the condition of the circuit. When the voltage across R18 drops to 0.4 volt, LED2 extinguishes, indicating that the unknown capacitor has been safely discharged. Note: If you plan to test a capacitor more than once, be sure to allow enough time between doing so for it to completely discharge.

Clock/Display-Driver. The counter/display driver (IC2) requires a clocking signal, which is generated by a 7555 CMOS oscillator/timer (IC3). The reason that the CMOS version of the 555 was chosen was because it has a cleaner output than the standard 555. The clock is configured to produce an output frequency of 105 Hz. A 10k potentiometer, R11 (FREQ. ADJUST) is included in the clock circuit, allowing the output of IC3 to be fine tuned.

The 105-Hz clock output of IC3 is fed to pin 11 of IC2. When IC2's reset terminal is pulled low, the value latched into the counter is output to DISP1-DISP4 (four common-cathode 7-segment LED display modules with right-hand decimal points). The decimal points are controlled through a section of S3 (the RANGE switch). When S3 is in the $\times 1$ position, DISP4's decimal point

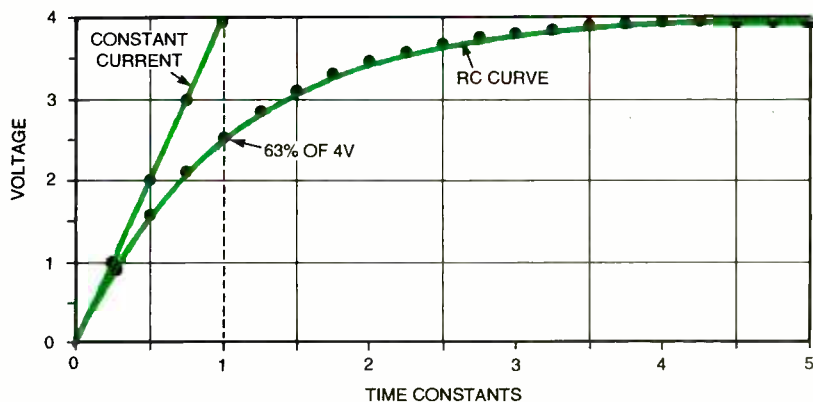

Fig. 1. This graph illustrates the difference between series-resistor charging and constant-current charging.

turns on. When S3 is in the $\times 1$ position, DISP3's decimal point lights. The other two positions of S3 do not need a decimal point.

The digit drivers of IC2 (pins 6, 7, 9, and 10) scan the display modules, sequentially activating them through driver transistors (Q1-Q4) at a rate determined by IC2's internal clock. While that's going on, IC2's segment-driver outputs (pins 1-4 and 13-15) activate the appropriate segments of DISP1-DISP4.

Resistors R2-R8 (43-ohm units), which are connected in series with IC2's segment-driver outputs, serve as current-limiting resistors.

Constant-Current Source. You've no doubt noticed the unusual configuration of IC4 (a 79L05 negative 5-volt regulator). In that configuration, the IC4's input is grounded, while the common (ground) terminal is tied to the positive supply rail. Because under that condition, ground is negative with respect to the positive supply rail, IC4 outputs a regulated -5 volt signal. That voltage is dropped across the base-emitter junction of Q9 and the range resistor selected by S3. Subtracting the average 0.6 volt dropped across the base-emitter junction of Q9, the voltage drop across the selected range resistor is approximately 4.4 volts.

Current through the selected range resistor equals 4.4 volts divided by the range resistor value— $44 \mu\text{A}$ for the $\times 0.1$ range, $440 \mu\text{A}$ for the $\times 1$ range, 4.4 mA for the $\times 10$ range, and 44 mA for the $\times 100$ range. **Note:** When the Electrolytic Meter is operated on the 44-mA

range, Q9 starts to warm up, slowly increasing the voltage across the range resistor until it stabilizes. Therefore, you have to wait a couple of minutes before testing an unknown capacitor on that range.

Capacitor C10 is included in the circuit to filter the output of IC4, while R22 places a slight load on IC4's output. That's done because on the $44\text{-}\mu\text{A}$ range, the current needed for Q9 is very small (in the order of $0.4 \mu\text{A}$). Capacitor C11 is included in the circuit to help prevent false triggering of the comparator. Resistor R27 controls the current to the decimal point selected through S3.

Construction. There is nothing very critical about the assembly of the Electrolytic Meter circuit, which was assembled in four sections—the display board, the power supply, the main board (which contains the comparator, the DC amp, the voltage reference, and the constant-current-source), and the counter/display driver board (which includes the clock circuitry)—on individual perfboards with inter-component and inter-board connections accomplished through 30-gauge (awg. 30) wire-wrap wire (for the most part) and point-to-point wiring techniques. A heavier gauge wire (awg. 22) was used for the power-supply connections. Since the readout is the least complicated of all of the subassemblies, let's begin construction of the meter by starting with the display board.

The Display Board. The size of the board depends on which displays

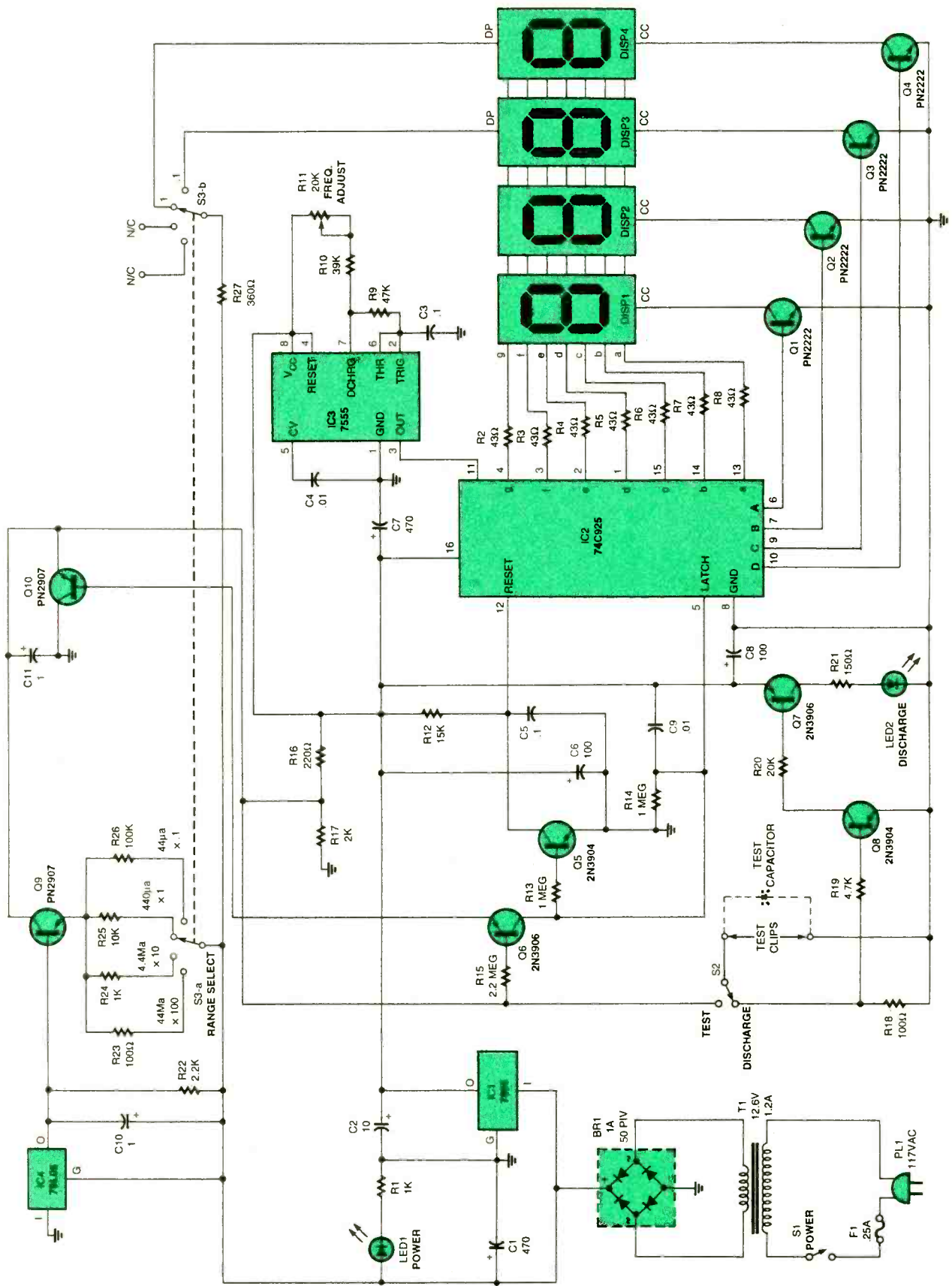

Fig. 2. The Electrolytic Meter is comprised of four integrated circuits (IC1-IC4), ten transistors (Q1-Q10), a fullwave-bridge rectifier (BR1), two light-emitting diodes (LED1 and LED2), four common-cathode seven-segment LED displays (DISP1-DISP4), and several support components.

TABLE 1—USING THE ELECTROLYTIC METER

ACTUAL READINGS		WITHIN 10% OF EACH OTHER?	CAPACITOR CONDITION
HIGH RANGE	LOW RANGE		
Low	Low	Yes	Has low capacitance; use high-range reading for correct capacitance.
Low	High	Yes	Slightly low capacitance; use high range reading for correct capacitance.
High	Low	Yes	Not possible unless the checker is not functioning properly.
High	High	Yes	Has some leakage but capacitor is usually OK. Use high-range reading.
Low	Low	No	Has some series resistance. Use low range reading for correct capacitance.
Low	High	No	May have both leakage and series resistance. Measure leakage with ohmmeter. If OK, use lower range reading.
High	High	No	Has some leakage; use ohmmeter to test. Use high-range reading for capacitance.
If tester continues counting non-stop on either range.			Capacitor has serious leakage or internal short.

APPROXIMATION FORMULAS

ESR = Equivalent series resistance HR = Capacitance measured on x10 range LR = Capacitance measured on x100 range $ESR = HR - LR/0.011 \times HR$	EPR = Equivalent parallel resistance HR = Capacitance measured on x1 range LR = Capacitance measured on x10 range $EPR = 6321.2 \times HR/(HR - LR)$
--	---

Actual capacitance if series resistance is present (e.g., memory backup capacitors)

HR = capacitance measured on x10 range
LR = capacitance measured on x100 range

$$C = (11 \times HR) - LR/10$$

are used. That's because no particular display modules are specified. Any common-cathode 7-segment modules with right-hand decimal points will do. The perfboard selected for the display should be large enough so that mounting holes can be drilled in the corners of the board without interfering with the display modules. Irregardless of the display modules selected, you'll need a pinout diagram of the modules for this operation.

Place and solder the four 7-segment display modules to the board (horizontally), and then wire like-segment (all "a" segments, all "b" segments, etc.) terminals together in a bus configuration. Upon completion of that task, attach lengths of hook-up wire to each of the seven strings of segment terminals and label them "a," "b," "c," etc. Next connect four lengths of hook-up wire to the common-cathode (CC) terminals, and label them 1-4. The leftmost module (DISP1) connects to the "A" driver output of IC2; DISP2 connects to "B," and so on. Attach lengths of hook-up wire to the decimal-point terminals of DISP3 and DISP4. When done, you should have seven wires for the seven segments, four common wires (one for each display), and two wires for the two decimal points (total of thirteen wires). Once that's done, check your work for the usual construction errors.

If all is well, place the board to the side for the time being, and move on to the next phase of construction—the power-supply board.

Power Supply. All of the components for the power supply (except T1 and IC4) were mounted to a small section of perfboard. The transformer was mounted to the inside-left rear corner of the enclosure with the power-supply board mounted to the right of the transformer.

Place and solder BR1, C1, R1, and C2 to the component side of the board. Mount IC1 to the bottom of the enclosure using appropriate non-conductive spacers and heatsink compound. Mount the power LED1 and S1 to the front panel of the enclosure. Solder everything together using the schematic as a guide. Since this is

the power supply, it's wise to use heavier gauge wire (awg. 22) in this section of the circuit. The fuse will be added later.

Main Board. Mount all the parts for the comparator, DC amp, +4.5-volt reference, and the constant-current source to the perfboard. The main board was mounted to the right side of the enclosure. Mount S3, S2, and LED2 to the front panel of the enclosure, and then solder the range resistors (R23-R26) and R27 directly to S3. Solder everything together according to the schematic. Next, connect lengths of wire to the B+, regulated +5-volt, and ground points on the power supply board. In addition, connect two wires to S3 (B+ and center tap of range resistors). Three wires must go to the clock/display driver board (latch, reset and ground.). Two wires go to LED2. Three wires go to S2 and two wires go to the test clips outside the enclosure for testing capacitors (total of fifteen wires). Attach B+ (on S3) to the

range resistors and R27.

Clock/ Display Driver. The other PC board in the Parts List is for the CMOS clock and display driver (IC2 and IC3). This board should be mounted in front by the display. You should now mount the display board to the front of the enclosure (I cut the rectangular hole with a Dremel drill and cutoff wheel). The black display cover was an old cover I found in the junkbox. It made the project a little more professional, but isn't needed if you don't have one. Solder the parts of the clock and display driver to the board. Be sure C7 (470 μF) is close to IC2. Solder a couple of fuse clips to the left of the board for F1. One fuse clip is connected to S1 and the other to 117 volts AC. Keep the fuse and its solder joints well away from the other parts and connections on the board! You can use a panel-mount fuse holder instead, if you wish.

Solder everything together according to the schematic diagram. You'll need +5 volts and

PARTS LIST FOR THE ELECTROLYTIC METER

SEMICONDUCTORS

- IC1—7805 positive 5-volt, 1-amp, fixed, voltage regulator, integrated circuit
IC2—74C925 4-digit counter/multiplexed 7-segment display driver, integrated circuit
IC3—7555 CMOC oscillator/timer, integrated circuit
IC4—79L05 negative 5-volt, 100-mA, low-power, fixed, voltage, regulator, integrated circuit
Q1-Q4—PN2222 general-purpose NPN transistor
Q5, Q8—2N3904 general-purpose NPN transistor
Q6, Q7—2N3906 general-purpose PNP transistor
Q9, Q10—PN2907 general-purpose PNP transistor
BR1—1-amp, 50-PIV, fullwave bridge rectifier
DISP1-DISP4—Common-cathode, seven-segment LED display with right-hand decimal point (RHDP)
LED1—Green light-emitting diode T1-3/4
LED2—Red light-emitting diode T1-3/4

RESISTORS

(All resistors are 1/4-watt, 5% units, unless otherwise noted.)

- R1—1000-ohm
R2-R8—43-ohm
R9—47,000-ohm
R10—39,000-ohm
R11—20,000-ohm, PC-mount potentiometer
R12—15,000-ohm
R13, R14—1-megohm

- R15—2.2-megohm
R16—220-ohm
R17—2000-ohm
R18—100-ohm, 1/2-watt, 5%
R19—4700-ohm
R20—20,000-ohm
R21—150-ohm
R22—2200-ohm
R23—100-ohm, 1/2-watt, 1%
R24—1000-ohm, 1/4-watt, 1%
R25—10,000-ohm, 1/4-watt, 1%
R26—100,000-ohm, 1/4-watt, 1%
R27—360-ohm, 1/2-watt, 5%

CAPACITORS

- C1—470- μ F, 35-WVDC, electrolytic
C2—10- μ F, 10-WVDC, electrolytic
C3—0.1- μ F, metal-film
C4, C9—0.01- μ F, ceramic-disc
C5—0.1- μ F, ceramic-disc
C6, C8—100- μ F, 10-WVDC, electrolytic
C7—470- μ F, 10-WVDC, electrolytic
C10, C11—1- μ F, 16-WVDC, electrolytic

ADDITIONAL PARTS AND MATERIALS

- T1—12.6-volt, 1.2-amp transformer
PL1—117-volt AC line cord with molded plug
F1—0.25-amp slow-blow fuse
S1—SPST toggle switch
S2—SPDT momentary switch
S3—3P4T rotary switch
Perfboard materials, 8- (W) \times 6- (D) \times 2- (H) inch metal enclosure, heatsink and heatsink insulators, heatsink compound, test clips, LED holders, power cord, fuse-holder, knob, IC sockets, strain relief, wire, solder, hardware, etc.

ground from the power supply. Connect the three wires from the comparator board. Attach the thirteen wires from the display (four go to Q1-Q4, and seven go to R2-R8). Connect the other two wires from the display decimal points to their appropriate places on S3. Note: S3 is a 3P4T switch. You only need two of the three poles. (It's hard to find 2P4T switches.) The extra pole was used to tie the range resistors together.

Calibration. First, test the B+ and +5-volt supplies for the correct voltages. Check ripple, if you can, on the B+ line. It should be no greater than 5 volts peak-peak (= 1.78 volts rms). If the ripple voltage exceeds 5 volts peak-peak, replace C1 with

1000- μ F capacitor. Next, check the current of each range by connecting a DMM (set as an ammeter) across the two test clips. Don't worry, doing so won't hurt anything. The approximate currents should be: $\times 1$ range = 44 μ A, $\times 1$ range = 440 μ A, $\times 10$ range = 4.4 mA, $\times 100$ range = 44 mA. Note: The current will rise on the $\times 100$ range from about 43 mA to 44 mA until it stabilizes. To improve accuracy, each of the range resistors can be replaced by parallel combinations of resistors in order to generate more precise test currents.

If you have a known good electrolytic (say, 10,000 μ F or more), connect it across the test clips. Test the capacitor (on the $\times 10$ range). Adjust R11 as required until the display

shows the correct capacitance. Keep testing and adjusting until the display matches the value of the known capacitor. If you don't have a known capacitor, then get several capacitors of the same value (say 10,000 μ F or more). Test each one to find the one that you think is the correct value. Set R11 as described for the known capacitor, using the value of the one you chose. Note: Overall accuracy is better on the $\times 10$ range.

Using the Meter. When testing unknown capacitors, it is not unusual to get readings that differ from the unit's specified value. When that happens, Table 1 can help you to figure out the reason for various readings. Normally, a quick check is all that is needed to find a bad capacitor. There will be times when the meter won't stop counting. As illustrated by Table 1, that may be an indication that the capacitor has excessive leakage or an internal short.

When using the $\times 100$ range (44 mA), you should let the meter warm up for a couple of minutes to allow the circuit to stabilize. That's because Q9's base-emitter junction voltage tends to vary as Q9 warms up. Although that does not pose a major problem, it can decrease accuracy until the circuit stabilizes. Also, remember the last digit may be off by ± 1 .

Computer-grade capacitors are designed to have a low equivalent series resistance (ESR) while memory backup capacitors have a fairly high ESR. When testing a capacitor that has a high ESR, use the formulas in Table 1 to find the correct capacitance and ESR. The formulas are not perfect, but they'll get you close enough. Power supplies hate capacitors with high ESR! When making a power supply, it's better to use a couple of capacitors in parallel than to have a single capacitor with too much ESR. The voltage drop across the unit's internal series resistance develops as current—not a good condition for capacitors used in power-supply applications.

The meter can be allowed to roll over (count to 9999 and continue)
(continued on page 52)

PC MONITOR CHECKER

You stare at the blank display and it stares right back, as you wonder: "Is the display broken or is it the video card?" If it's simply the video card, there might be a couple of hours of work involved in getting the system up and running again. Simply buy another circuit card, install it, and away you go. On the other hand, if the monitor is sick, you might be looking at a lot more than just a few hours of down time—not to mention, lightening your wallet by at least a couple hundred dollars.

If you are like me, then you do your own repairs regardless of how much hair pulling it might entail. In order to keep your sanity (and reduce your hair loss), you need effective diagnostic tools. A decent video source for testing the display is a good first step in the right direction.

The *PC Monitor Checker* presented in this article doesn't generate numerous NTSC color signal patterns, nor does it possess the special functions found on commercial-grade video testers; however, it also doesn't cost upwards of \$300 dollars as do most of the off-the-shelf units. The *PC Monitor Checker* is designed to test EGA, VGA, and Hercules MGA (monochrome) displays, as well as composite-video monitors. With the addition of an RF modulator, it can also be used to test the video portions of a television set—ranging from the tuner through the deflection circuit. On top of that, the *PC Monitor Checker* is inexpensive to build (between \$25 and \$35); it's battery operated, and can be assembled in about ten hours.

Circuit Description. A complete schematic diagram of the *PC Monitor Checker* is shown in Fig. 1.

C.C. ROHER

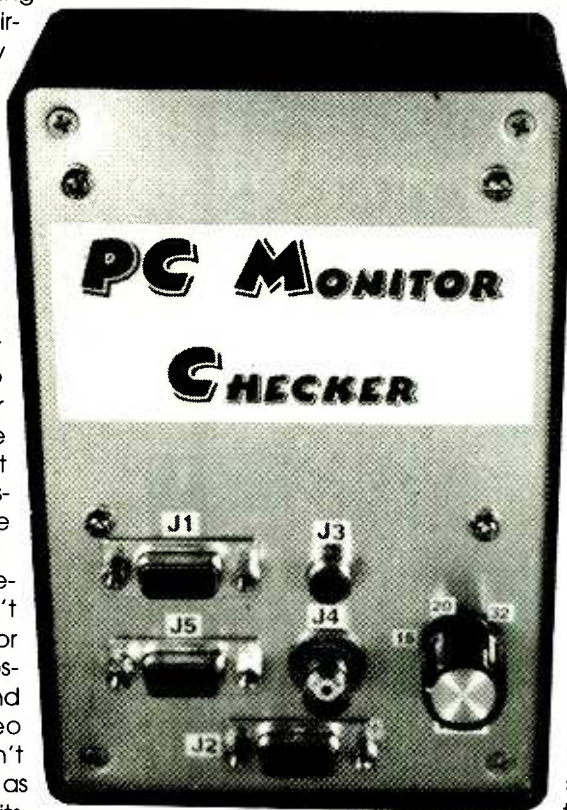

Whether you're an avid do-it-yourselfer or a professional computer repair technician, this evaluation circuit is sure to come in handy when trying to ascertain why your PC monitor—be it EGA, VGA, composite video, or Hercules MGA video displays—has suddenly gone dark.

The *Checker* is comprised of three primary sections: an oscillator (OSC1) with decoders for horizontal- and vertical-sync frequency generation, a sync-retrace section, and an output section. Power is derived from a 9-volt battery (B1), which is connected to a 5-volt regulator (IC12) through power switch S1. The maximum current drain from the fully loaded unit is between 30 and 40 mA, so the battery should last 2 to 3 hours. Most of the current drawn is used by IC7, an LM556 dual oscillator/timer. The dual oscillator/timer can be replaced by a CMOS unit, such as the 75561PD, thereby significantly reducing current consumption.

Oscillator/Sync Frequencies.

The circuit uses a crystal oscillator (OSC1) to generate a 2-MHz squarewave signal. The output of OSC1 is fed to IC1 (a 4013 dual D-type flip-flop). The 4013 divides the oscillator frequency to produce 1-MHz and 500-kHz squarewave signals, which are used to generate three horizontal-sync frequencies and a 60-Hz vertical-sync pulse. The 1-MHz signal is further divided and decoded by IC8 and IC11, and used to develop the various video pulses.

Horizontal and Vertical Sync.

The sync section is divided into two sub-assemblies: one of which develops the horizontal-sweep frequencies, while the other produces the vertical sync. Most common monitors use horizontal sweep frequencies in the 15-kHz to 32-kHz range. The 60-Hz AC line frequency is most often used for the vertical sync.

The 1-MHz squarewave output 47

PARTS LIST FOR THE PC MONITOR CHECKER

SEMICONDUCTORS

- IC1—CD4013 CMOS dual D-type flip-flop, integrated circuit
 IC2—CD4024 CMOS 7-stage ripple-carry binary counter/divider, integrated circuit
 IC3—CD4011 CMOS quad 2-input NAND gate, integrated circuit
 IC4, IC9—CD4012 CMOS dual 4-input NAND gate, integrated circuit
 IC5, IC10—CD4069 CMOS hex inverter, integrated circuit
 IC6—CD4020 CMOS 14-stage ripple-carry binary counter/divider, integrated circuit
 IC7—LM556 dual oscillator/timer, integrated circuit
 IC8, IC11—CD4017 CMOS decade counter/divider, integrated circuit
 IC12—LM7805 5-volt, 1-amp, fixed voltage regulator, integrated circuit
 Q1—Q5—2N2222A, 2N3904, or similar general-purpose NPN silicon transistor
 D1—1N914, 1N4148, or similar general-purpose, small-signal, switching diode

RESISTORS

(All fixed resistors are 1/4 watt, 5% units.)

- R1—1000-ohm, 10–15-turn potentiometer
 R2, R8, R10, R12, R17—10,000-ohm
 R3—100,000-ohm
 R4—15,000-ohm
 R5—22,000-ohm
 R6, R9, R11, R13, R18—4700-ohm
 R7, R14, R15, R16—82-ohm
 R19—100-ohm
 R20, R21—330-ohm

CAPACITORS

- C1—10- μ F, 16-WVDC, tantalum
 C2, C3—0.1- μ F, ceramic-disc
 C4, C6—0.02- μ F, ceramic-disc
 C5, C7—0.002- μ F, ceramic-disc

ADDITIONAL PARTS AND MATERIALS

- OSC1—2.000-MHz crystal oscillator
 S1—SPST miniature toggle
 S2—SP3T non-shorting, miniature rotary switch,
 J1, J5—9-pin, D-type connector
 J2—15-pin, D-type connector
 J3—RCA phone jack
 J4—BNC jack
 B1—9-volt transistor-radio battery
 Perfboard materials, 6 1/4- (L) \times 3 3/4 (W) \times 1 5/16 (D) inch enclosure (RadioShack 270-627), wire-wrap IC sockets, 0.8-inch threaded spacers, push-in flea terminals, headers, 9-volt battery holder and connector, wire, solder, hardware, etc.

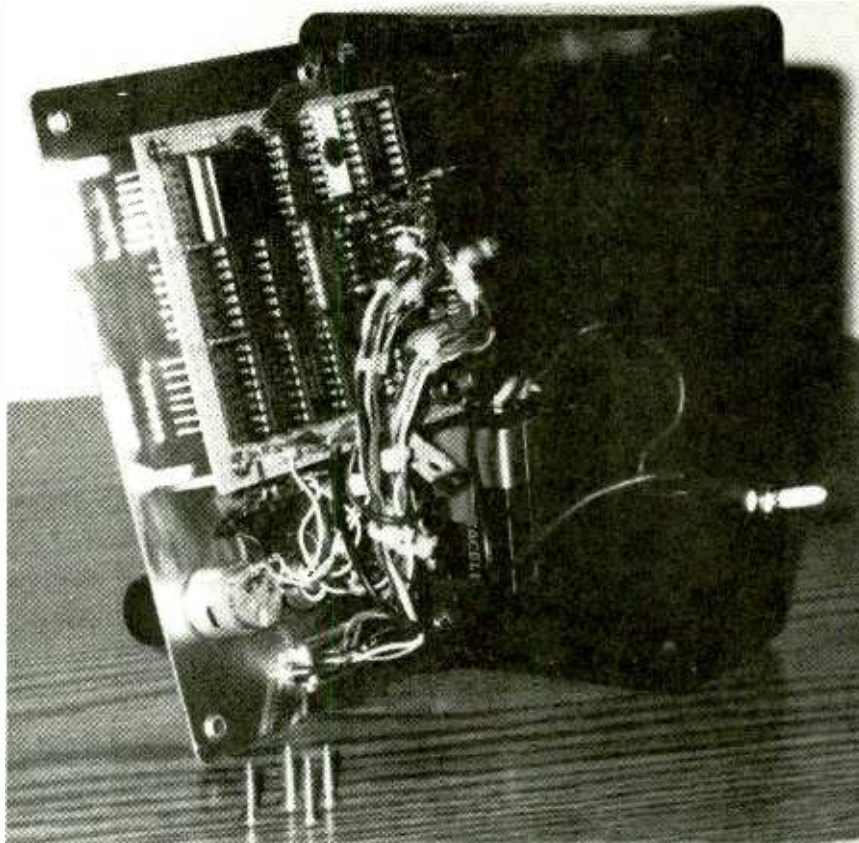

As shown in this internal shot, the author used perforated construction board and point-to-point and wire-wrapping assembly techniques in the PC Monitor Checker.

of IC1 is fed to IC2 (a 4024 CMOS 7-stage ripple-carry binary counter). The output of IC2 is applied to IC3-a, IC4-a, and IC9-b, where the signal is decoded to provide three selectable (via S2) signals: 15 kHz, 20 kHz, and 32 kHz. The selected output is fed back through IC5-c (1/6 of a 4069 hex inverter) to the reset input of IC2 at pin 2, causing it to generate a fast negative-going pulse that is applied to IC7-a (1/2 of the LM556 oscillator/timer) and used to generate the horizontal retrace signals. Given OSC1's frequency and the fact that the counter and decoders do integer division only, it should be obvious that precise frequencies are generated by the circuit. For example, the 15-kHz sweep frequency is really 15,150 Hz. That's not a problem. Adjusting the horizontal sweep on older monitors produces a good lock. In VGA monitors, the sweep is automatically/internally adjusted, within certain limits.

The horizontal retrace signal is another story: Every monitor that was tested or researched

appeared to have different retrace time periods that range from 5 to 20 microseconds, with most hovering at the greater time period. The retrace time determines how much picture is displayed horizontally. Potentiometer R1 can be adjusted to produce retrace widths of about 10 to 25 microseconds.

The 500-kHz output of IC1 at pin 13 is fed to IC6 (a 4020 14-stage ripple-carry binary counter) at pin 10. The binary counter then produces several output signals that are applied to IC4-b (half of a 4012 dual four-input NAND gate). That NAND gate decodes the signals, producing a positive pulse through IC5-d that is fed back to the reset input of IC6 at pin 11. At the same time, a fast negative-going pulse output by IC5-f is fed to pin 8 of IC7-b, causing it to generate a 220- μ s wide, fixed vertical-retrace pulse. Like the horizontal-retrace pulse, the vertical-retrace pulse widths seem to be unique for every monitor researched or tested and ranged from 75 μ s to 1 ms. In some of the monitors tested (MGA and

composite types), a dark horizontal space appeared at the top and bottom portions of the screen. With the newer VGA types, however, the vertical size of the picture is adjustable and the spaces could be eliminated.

Monitor Outputs. The checker produces several different "species" of monitor video: MGA, EGA, VGA, and composite. Many of the older model monitors and a very, very few of the newer models use the composite format. The composite format consists of a serial signal composed of video, vertical sync, and horizontal sync. The video signal "rides" on top of the peak sync-signal level in between the retrace pulses. The entire signal is approximately 1-volt peak-to-peak with the sync level being about 0.2 volts and the video ranging between 0.5 and 1 volt. The video amplitude determines the intensity of the displayed picture.

In the checker, composite video/sync is generated by ANDing the video signal from IC8, the horizontal-retrace signal from IC5-a, and the vertical retrace signal from IC5-b at the base of Q1 through a voltage-divider network comprised of R4-R6. Transistor Q1, which is configured as an emitter follower, provides composite video/sync to both J3 (an RCA jack) and J4 (a BNC jack).

Although there aren't many monitors out there that use this format, the checker provides a monochrome graphics adapter (MGA) output at J1. All of the MGA-format outputs are TTL compatible except intensity. The intensity output mimics the video output, but at a maximum level of 0.7 volts. As with the composite video level, the greater the amplitude of the intensity signal, the brighter the picture.

Currently, the VGA format is the one of choice for monitor manufacturers and buyers. The VGA signal is made available through J2 (a 15-pin D-type connector). A 4017 decade counter/divider (IC11) divides the 1-MHz squarewave into three separate video signals: PRI. RED, PRI. GREEN, and PRI. BLUE. In the VGA format, video-color intensity is determined by an analog rep-

resentation of the signal level, with 0.7-volt representing the brightest illumination.

The outputs of IC11 are fed to a series of resistive voltage dividers—R8/R9, R10/R11, and R12/R13—to produce red, green, and blue drive signals, which are buffered by Q2, Q3, and Q4, respectively. Buffering is required because the mandated VGA video source impedance should be approximately 75 ohms. The sync signals are TTL/CMOS logic levels and are as-marked on the schematic.

The EGA output at J5 was the only one that we were unable to validate with an operational monitor. Apparently, EGA monitors are fairly rare "animals" and difficult to

and socket were used for making connections between the board, S2, and the various jacks. When making the connections, use small-gauge stranded wire. Twenty-four to twenty-eight gauge stranded wire serves nicely.

Mount R1 so that the alignment screw head faces out from the circuit board. Take note of the orientation of R1 when installing the circuit board into the enclosure and drill a small "tweaking" hole in the side of the enclosure for alignment purposes. Component R1 should be a multi-turn potentiometer rather than a less-expensive single-turn unit.

Operation. There are no special

TABLE 1—OUTPUT SELECTOR GUIDE

JACK	OUTPUT	CONNECTOR
J1	MPG	9-Pin D-Type
J2	VGA	15-Pin D-Type
J3	Composite Video	RCA Jack
J4	Composite Video	BNC Jack
J5	EGA	9-Pin D-Type

get a hold of. However, through research, it was discovered that EGA signals and format conform to a hybridization of the MGA and VGA outputs.

The primary EGA color outputs—PRI. RED, PRI. GREEN and PRI. BLUE—which are TTL/CMOS compatible, are provided by IC11. Color intensity is controlled by the output of Q5 at its emitter. The output of Q5 is split among the three intensity outputs available at J5. The voltage level at those outputs, approximately 0.7 volt, gives maximum intensity.

Construction. The PC Monitor Checker was assembled using wire-wrap techniques and some point-to-point soldering. For those of you who crave printed-circuit boards for your projects, you're welcome to design one for the checker if you have the means to do so.

In order to minimize the amount of perfboard "real estate," headers were used for all but two of the resistors. A twenty-four pin header

requirements for using the checker. However, some precautions are in order. Chief among them is knowing what kind of monitor you're testing. Use the appropriate cable type with the required plugs for a particular monitor. Plug the monitor connector into the appropriate checker jack.

As mentioned, the checker does not produce elaborate test patterns. When it's connected to an operational composite-video monitor operating with a 15-kHz horizontal-sweep frequency, six vertical, evenly-spaced bars of video should be seen. When testing MGA monitors, which have horizontal-sweep frequencies of about 18 kHz, set S2 to the 20-kHz position, and the monitor should display four to five vertical bars.

Finally, EGA and VGA monitors have sweep frequencies (automatically adjustable from 31kHz to 37 kHz) that are internally set. Choose the 32-kHz position for S2 for these monitors. Two to three groups of

RETAILERS THAT SELL OUR MAGAZINE EVERY MONTH

Arizona

Circuit Specialists, Inc.
220 S. Country Club Dr.
Bldg 2
Mesa, AZ 85210

California

California Electronics
221 N. Johnson Ave.
El Cajon, CA 90202

Ford Electronics
8431 Commonwealth Ave
Buena Park, CA 90621

All Electronics
14928 Oxnard Street
Van Nuys, CA 91411

Electronics Warehouse
2691 Main Street
Riverside, CA 92501

Orvac Electronics
1645 E Orangethorpe Ave.
Fullerton, CA 92631

Sav-On Electronics
13225 Harbor Blvd.
Garden Grove, CA 92643

JK Electronics
6395 Westminster Blvd.
Westminster, CA 92683

Kandarian Electronics
1101 19th Street
Bakersfield, CA 93301

Minute Man Electronics
37111 Post St., Suite 1
Fremont, CA 94536

HCS Electronics
6819 S. Redwood Drive
Cotati, CA 94931

Halted Specialties Co.
3500 Ryder Street
Santa Clara, CA 95051

Metro Electronics
1831 J Street
Sacramento, CA 95814

HSC Electronics
4837 Amber Lane
Sacramento, CA 95841

Connecticut

Cables & Connectors
2198 Berlin Turnpike
Newington, CT 06111

Electronic Service Prod.
437 Washington Avenue
North Haven, CT 06473

Illinois

Tri State Elex
200 W. Northwest Hwy.
Mt. Prospect, IL 60056

Maryland

Mark Elec. Supply Inc.
5015 Herzel Place
Beltsville, MD 20705

Michigan

Purchase Radio Supply
327 East Hoover Avenue
Ann Arbor, MI 48104

The Elec. Connection
37387 Ford Road
Westland, MI 48185

Minnesota

Acme Electronics
224 Washington Avenue N.
Minneapolis, MN 55401

New Jersey

Lashen Electronics Inc.
21 Broadway
Denville, NJ 07834

New York

LNL Distributing Corp.
235 Robbins Lane
Syosset, NY 11791

Unicorn Electronics
Valley Plaza
Johnson City, NY 13790

Ohio

Philcap Electronic Suppliers
275 E. Market Street
Akron, OH 44308

Oregon

Norvac Electronics
7940 SW Nimbus Avenue
Beaverton, OR 97005

Texas

Tanner Electronics
1301 W Beltline
Carrollton, TX 75006

Mouser Electronics
958 N. Main Street
Mansfield, TX 76063

Electronic Parts Outlet
3753 B Fondren
Houston, TX 77063

Computers Electronics Etc.
110 E. Medical Center Blvd.
Webster, TX 77598

**If you'd like to sell our magazine in your
store, please circle 180 on free information card
or
Contact Gina Gallo at (516) 293-3000 ext 223**

red, green, and blue vertical bars should be seen on the display. There should be evenly spaced dark regions between these groups. Additionally, the red bar in the first group may be slightly narrower than those in the remaining groups. This is not a problem and simply reflects the influence of the horizontal retrace width.

In Conclusion. Computer monitors that use a cathode ray tube for the display have been around for a long time and judging by their continued proliferation will continue to be a big-ticket item when new computer systems are purchased. As complex as they may seem, however, they are nothing more than glorified television sets; minus the sound, of course. In fact, if some of you can remember back that far, many of the first personal computer systems offered the option of using the home television set as the monitor (remember the TRS-80 and the Sinclair ZX-80?).

Taken into perspective, troubleshooting a computer monitor should be no different than testing a television. One key ingredient is the availability of a good signal source. The PC Monitor Checker fits the bill in this regard. ■

ELECTROLYTIC METER

(continued from page 46)

if desired. That comes in handy when it's necessary to test a larger capacitor on a lower range. If you suspect, for instance, that the capacitor being tested has high ESR, testing it on a lower range gives better accuracy because of the lower test current. It is also possible to test a capacitor larger than 1 F on the $\times 100$ range using that method. Let's look at a couple of examples.

Example 1: While testing a 300,000- μF computer-grade capacitor on the $\times 100$ range, the meter's readout displayed 3855. In that case, the actual measured capacitance is $3855 \times 100 = 385,500 \mu\text{F}$. On the $\times 10$ range, the meter was allowed to roll over 3 times, producing a finished count of 9556. The $\times 10$ -range capacitance would

then be $39556 \times 10 = 395,560 \mu\text{F}$. Both readings are high compared with the capacitor's specified value, and both readings are within 10% of each other. Referring to Table 1, note that some leakage is indicated, but the capacitor is otherwise OK, and that the high-range reading is correct (the higher range reading is *not* the same as the high reading!). That means this capacitor is actually about 385,500 μF , and that its capacitance is about 29% higher than manufacturer's specifications—well within tolerance.

Example 2: While testing a memory backup capacitor (specified as 0.047 F) on the $\times 100$ range, the meter produced a readout of 30,100 μF . On the $\times 10$ range, the meter displayed 47,020 μF . The two readings, of course, are *not* within 10% of each other. It is not difficult to recognize that the reading on the $\times 10$ range is closer to the correct value because the series resistance of memory backup capacitors can cause erroneous readings on the $\times 100$ range. In such cases, you could just accept the reading obtained on the $\times 10$ range or use the formula in Table 1 to find the correct capacitance and ESR. Anyway, the high-range reading is too low and the low-range reading is too high. Table 1 indicates that the capacitor has either leakage or series resistance and should be tested with an ohmmeter. Since we're checking a memory-backup capacitor, it becomes obvious that the erroneous reading is probably due to series resistance. In such cases, we'd use the low-range reading of 47,020 μF . Using the formulas for ESR and capacitance:

$$\text{ESR} = (47020 - 30100) / (.011 \times 47020) = 32.7 \text{ ohms}$$

$$C = ((11 \times 47020) - 30100) / 10 = 48,712 \mu\text{F}$$

Example 3: While testing a 2200- μF capacitor on the $\times 10$ range, the display produced a readout of 1610 μF . On the $\times 1$ range, the reading was 1636 μF . Both readings are low and within 10% of each other. Table 1 says the capacitor has low capacitance and to use the high-range reading (1610 μF) as the cor-

rect capacitance. As it turned out, the capacitor was low by 27% and unusable!

Conclusion. I hope that you've gained some insight from this article on how to correctly test capacitors; and how to use the Electrolytic Meter to find ESR and leakage. That should enable you to put together a power supply or repair electronic equipment with confidence.

The accuracy of the meter can be increased in many ways. For example, the counter/display driver (IC2) can be replaced by a 74C926 and using its carry-out line to feed another counter, thereby adding another 7-segment display. That would allow you to see the rollover, instead of counting the number of rollovers. Or you could divide the 105 Hz by 10 (when you know you'll roll over), producing an additional range— $\times 1000$. Another improvement would be to design a more accurate constant-current source. You may even come up with other improvements to the circuit.

I hope you enjoy testing those capacitors on your shelf as much as I did. Have fun! ■

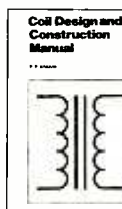

YOU CAN WIND YOUR OWN COILS?

There's no trick to it except knowing what you are doing. In a unique, 106-page book you can become expert in winding RF, IF,

audio and power coils, chokes and transformers. Practically every type of coil is discussed and necessary calculations are given with the mathematical data simplified for use by anyone. Get your copy today!

Mail coupon to:

Electronics Technology Today, Inc.
P.O. Box 240
Massapequa Park, NY 11762-0240

Please send me my copy of *Coil Design and Construction Manual* (BP160). I enclose a check or money order for \$8.99 to cover the book's cost and shipping-and-handling expenses. NY state residents must add local sales tax.

Name _____

Address _____

City _____ State _____ ZIP _____

All orders must be paid in U.S. funds only. Sorry, no orders accepted outside of USA and Canada. Please allow 6-8 weeks for delivery. ET07

HAM Radio

Building a Top-Notch HF Receiver

JOSEPH J. CARR, K4IPV

Like many hams my age, I cut my electronic teeth building kits. At one time, kit manufacturers abounded. Allied Radio's Knightkits, Eico, and the venerable Heath Company's Heathkits all had significant offerings for the radio enthusiast (both ham and SWL). For many of us, the first really serious excursion into electronics was building a receiver or transmitter from a kit. The kit approach has a distinct advantage for the newcomer because it offers a guided pathway over territory that might not be familiar. Heathkits in particular had an extremely well done assembly manual to provide that guidance.

My fondness for well-done kits was aroused anew when I saw the advertisements for the Ten-Tec Corporation (1185 Dolly Parton Parkway, Sevierville, TN, 37862; Tel. 423-453-7172 or 800-833-7373; Web: www.tentec.com). Ten-Tec has been a ham-gear manufacturer for many years. If you own a top-end, American-made HF transceiver, then chances are pretty good that it's a Ten-Tec. I've always found their HF rigs to be well engineered and well built, so I figured their kits were equally well done—I was right.

TEN-TEC MODEL 1254

The Ten-Tec Model 1254 is a first-class, general-coverage shortwave receiver that handles bands from 100 kHz to 30 MHz and costs only \$195. To put the price into some sort of perspective, let me point out that I once paid \$249 for a Heathkit receiver of considerably less performance in a time when those dollars were a lot bigger and took a lot more working time to earn. Also by way of contrast, today ready-built shortwave receivers with the specifications of this model cost \$700 to \$1000. So, by building the Ten-Tec Model 1254 you not only get a first-class SW receiver for a super budget price, but also a lot of experience

building a high-tech product.

The Model 1254 has CW, AM, and both SSB modes. The local oscillator (LO) for the receiver is a frequency synthesizer locked to a crystal frequency, so it has a great deal of stability. The synthesizer allows both "fast" and "slow" tuning modes of 2.5 kHz (SSB mode), 5 kHz (AM mode), or 100 kHz. Because the LO is a digital frequency synthesizer, the Model 1254 can offer fifteen programmable memories for favorite or frequently used frequencies.



Here's the front panel of the Model 1254 receiver. When assembled, the kit looks like (and performs like) a receiver worth hundreds more than its reasonable price.

The architecture of the Model 1254 follows modern principles. It is a double-conversion superheterodyne in which the 0.1- to 30-MHz bands are up-converted to a 45-MHz first-IF, where preliminary selectivity is provided by a 45-MHz crystal filter. This architecture is better than those used in the past because of its superior image response.

For example, suppose your older receiver has a 455-kHz IF and is tuned to the 10,000-kHz (i.e. 10 MHz) WWV frequency. The LO frequency may be on either the high or low side, so let's assume that it's on the low side. The LO frequency will be 10,000 kHz - 455 kHz, or 9545 kHz. The difference between the LO of 9545 kHz and 10,000 kHz is the IF, or 455 kHz. But there is another frequency that also produces a 455 kHz difference frequency: 10,000 kHz + 455 kHz =

10,455 kHz! As the frequency gets higher, the image more easily passes through the front-end tuning. But if the first IF is 45 MHz, then the image is so far away that it cannot harm reception.

The Model 1254 down-converts the 45-MHz first-IF to 455 kHz. The majority of the gain and selectivity of the Model 1254 are provided in the latter band. This is the classic trade-off of well-engineered double-conversion HF SW receivers. The gain and selectivity are easier and cheaper to provide at a low frequency, so by using 45 MHz for the first-IF and 455 kHz for the second-IF, the best of both selections are obtained.

The Model 1254 offers 2.5 μ V for 10-dB signal-to-noise ratio (SNR) sensitivity in the AM mode, and 0.5 μ V for 10-dB SNR in SSB mode.

The -6-dB selectivity is 4 kHz. Frequency readout is via a six-digit LED numerical display.

The receiver operates from a 12- to 15-volt DC power supply and requires 250 mA of current. A transformer is included with the kit, although you can also operate it from any DC power source. One application, for example, is to use this receiver as part of a battery-operated QRP or "mountain topping" station. In that case, a 12-volt battery would be used for power.

The antenna connector on the rear panel of the Model 1254 is an RCA-style phono jack; the antenna input impedance is 50 ohms. The loudspeaker is internal, but an external speaker or earphones can be operated through a standard $\frac{1}{8}$ -inch phone jack. Output from the Model 1254 IC audio amplifier is 1.5 watts. The receiver contains ten ICs, 26 transistors, and 16 diodes. The physical dimensions are 2.25 \times 6.5 \times 6.5 inches (HWD).

The Ten-Tec advertisement claims 25 hours to build this kit. I beat that time, but only by a few hours. Plan to

spend at least that much time on this project. If you have never built anything electronic, then I recommend that you first attempt a less complex kit.

One of the really brilliant things about the way Ten-Tec designed the assembly instructions for this receiver is what I call their "build-a-little-test-a-little" philosophy. The printed-circuit board is divided into zones. You will be instructed to build in a particular zone first, and as you finish each zone certain tests will be performed before you go forward. As a result, you are reasonably certain that the receiver will work when you finally finish it.

When you build this kit, be sure to use the right tools. The solder should be 50/50 or 60/40 lead/tin resin-core solder intended for radio and electronic applications. In case this is your first circuit: **do not use acid-core solder.** That form of solder is used in plumbing applications and will make a real mess of an electronic circuit (in the process of destroying it). So buy your solder in a radio store, not a hardware store.

The tools that I used include a 25-watt pencil type soldering iron, small-size needlenose pliers, small diagonal side cutters, a 1/8-inch blade screwdriver (e.g. Xcelite red), and a small-size Phillips screwdriver (e.g. Xcelite blue). You will also need a multimeter, preferably a digital one. The latter are relatively low cost these days, so I recommend that hams have one in any event, regardless of whether or not you are building a kit.

Alignment tools will also be needed. And this is where you might be tempted to use what's on hand. Look at the coils and IF transformers, and buy a small collection of alignment tools to fit them exactly (and use no others).

Use of the wrong alignment tools is one of the principal mistakes made by inexperienced builders. Can you guess what is the most common kit builder's mistake? It's really quite simple. Indeed, it's predictable. The A-number one error made by kit builders is *not following instructions*. The instructions for the Model 1254 are uncommonly detailed and clearly written. Follow them with great specificity and you will be ahead of the game.

The finished receiver performed exactly as advertised and proved to be sensitive. The only thing I would add to the receiver is an external audio filter to provide better selectivity on SSB and

CW modes. The 4-kHz selectivity is a reasonable compromise and works well (especially on the shortwave broadcast bands), but for really crowded ham bands an external active filter is recommended. Such audio filters are made by a number of companies (indeed, check the Ten-Tec Web site).

SUMMER'S COMING

One of the interesting aspects of the summer season is the odd VHF Sporadic-E propagation that takes place, resulting in distant VHF signals becoming audible or peaking up to higher values. On the FM broadcast band, for example, one can often hear signals during the summer that are inaudible other times of the year. For a while I was making a 72-mile, one-way commute to my job and would listen to a country-music station on 100.1 MHz that would only barely stick above the noise under most conditions, but when Sporadic-E popped up it was >S9 strength!

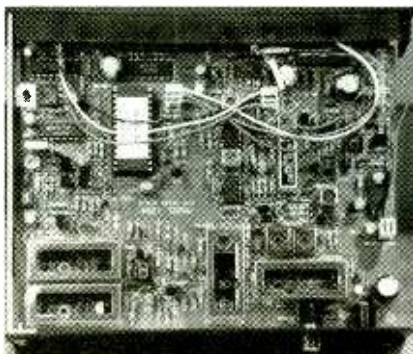

While you might not be able to tell from this shot of the Model 1254's internal circuitry, the parts are top notch, including a ceramic filter for the IF selectivity. Sensitive front-end circuitry is enclosed in several different shielded compartments.

During the Sporadic-E event you will be able to pick up signals that are not normally audible and work states and Canadian provinces that are normally beyond your range. So if you do 2-meters, or other VHF bands, then make sure the ol' beam is working right, and wait for the right opportunity.

Summer also affects other bands as well. In the 10-meter band, for example, you will see frequent examples of short-skip. From my home in northern Virginia I normally cannot work North Carolina stations on 10-meters (Florida is easy, but not North Carolina). But during short-skip North Carolina is easily available to me.

Many of these summer propagation changes occur because the Sun is able to ionize the atmosphere to a lower level than before. That's why short-skip works. But summer also brings a higher noise level on the low bands, so there is a kind of seasonal trade-off involved.

Another summer phenomenon is lightning. Although the bolts can occur any time of year, they are more common during summer and spring over most of the country. Now is a good time for you to review your lightning protection. A good ground rod is necessary. It should be at least eight feet long. I use the copper-clad steel type that you get at electrical supply stores, rather than the puny little four-footers (or less!) found in some radio stores. Also, a heavy grade of approved ground wire is needed.

A lightning arrester is absolutely essential to protecting your rig. Will it protect against a direct hit? No, but direct hits are not the only thing that can cause problems. Any lightning in the area, whether an air-to-air or air-to-ground burst, represents an electrical current in motion ... and that means it can induce a high-voltage transient into your antenna. That transient can burn out circuitry in the front-end of a receiver or even a transmitter, even though it won't exactly melt the parts like a direct hit would.

Here is a bit of wisdom: *read your homeowners' insurance policy*. Some policies discriminate against radio antennas unless they are correctly installed according to local electrical codes. Your opinion as to the fitness of the installation is essentially irrelevant if it differs from the electrical code. So make sure that your installation complies with the law. And if inspections are required, be sure that you obtain the signed certificate from the inspector and keep it in a safe place. A guy I once knew had a problem collecting because he could not produce either mechanical or electrical inspection certificates when his 50-foot tower fell over and damaged his house. He prevailed, but it took a lot more effort than if he had complied with his policy's guidance in the first place.

IMPORTANCE OF LOGS

Hams don't keep radio-contact logs like we used to (I still do). Unless you
(continued on page 60)

DX LISTENING

X Marks The Spot

DON JENSEN

Almost shortwave: That's what I considered the frequencies just above 1600 kHz back when I was just getting started in the listening hobby. Back in the ancient 1940s, when this inquisitive kid first tuned the family console and Heterodyne-osaurs still roamed the Earth, you could listen to police calls up here, just beyond the last broadcasting station on the AM dial. That was pretty exciting stuff for an 11-year-old.

When public safety agencies moved up to VHF and UHF, the old police band became a radio ghost town, abandoned and vacant. Now, though, that's all changed, and listener hobbyists again are venturing back to the frequencies between 1610 and 1700 kHz to what now is called the Extended or X-Band.

New occupants of the nearly shortwave frequencies began moving back in the late 1970s and 80s, the Travelers' Information Stations. Today you can find these very low-powered 10-watt stations near airports, parks, and sports stadiums, airing repeated tape-loop messages to motorists. Although several-hundred-mile reception of TIS signals is not unheard of, these stations are intended for local coverage, and a range more like 10 to 20 miles is normal.

But the real change came in the 1990s, when the Federal Communications Commission, faced with a jam-packed AM broadcasting band (540 to 1600 kHz), decided to open up the next one thousand kilohertz of spectrum to new station applicants and to existing AM stations looking for better, less crowded channels.

In 1991, the FCC first invited broadcasters to consider migrating to a new X-Band. After two false starts, the agency in March 1997 issued a band allotment that allows 88 AM stations on 10 new frequencies between 1610 and 1700 kHz. Here they can broadcast 24 hours a day, with 10,000 watts daytime and 1000 watts of power at night.

For those already on the air with

limited power on a crowded channel within the 540-1600 kHz AM band, there is the option of using both new and old frequencies simultaneously. After five years, though, they must choose one or the other.



Here's a verification card from Rikisutvarpid, the shortwave Voice of Iceland, currently transmitting on 13,860 kHz.

Slowly stations have come on the air in the X-Band. The first was WJDM (now WBAH), Elizabeth, NJ on 1660 kHz. As this is written, more than 50 stations have been authorized to begin broadcasting, and 17 actually are on the air.

Veteran DXer Jerry Berg observes that the current X-Band situation must be akin to the pioneering 1920s, when AM stations began popping up, one by one, in a previously vacant radio spectrum. "This is a rare opportunity to DX the way it was in the early days," says Berg.

While in some urban areas there

may be competition on one or two of the X-Band channels from local TIS stations, mostly the frequencies between 1610 and 1700 kHz have little or no interference.

"And," Berg notes, "the new X-Band broadcast stations use only a thousand watts of power at night. From Massachusetts, I have heard two California X-Banders at 1 kilowatt. That's pretty good DX in my book ... a real kick!"

Because there's still a newness to it all, Berg and other X-Band DXers say the stations seem to be good verifiers, readily replying to listeners' reception reports.

"Now is the time to start monitoring the X-Band," says well-known DXing writer Harry Helms. "This is a once-in-a-lifetime opportunity to hear a new broadcasting segment come to life!"

THE X-FILES

The Federal Communications Commission currently envisions nearly 90 American AM broadcasting stations in 36 states, Puerto Rico, and the Virgin Islands eventually operating on the X-Band's ten frequencies.

At this writing, 17 stations reportedly are on the air (see Table 1).

Mexico has announced allocations for 20 X-Band stations, all within about 100 miles of the U.S. border, according

TABLE—1

1620 kHz	WPHG, Atmore, AL
	KRIZ, Renton, WA
1640 kHz	KDIA, Vallejo, CA
	KKJY, Lake Oswego, OR
	WKSH, Sussex, WI
1650 kHz	KGXL, Costa Mesa, CA
	KCZN, Cedar Rapids, IA
1660 kHz	KXOL, Brigham City, UT
	WBAH, Elizabeth, NJ
	WQSN, Kalamazoo, MI
1670 kHz	WTDY, Madison, WI
	WNML, Warner Robins, GA
1690 kHz	KQXI, Arvada, CO
	WMDM, Lexington Park, MD
1700 kHz	WCMQ, Miami Springs, FL
	KBGG, Des Moines, IA
	KSDX, Sherman-Denison, TX

to Helms. None have been reported on the air at this time. Australia and several other countries also have or soon will have X-Band broadcasting stations.

BITS AND PIECES

The World DX Club's bulletin, *Contact* reports that currently there are no shortwave broadcasts actually transmitted from the mid-Mediterranean island nation of Malta. The Maltese broadcast, *Voice of the Mediterranean* formerly was aired from the so-called Cyclops SW transmitter of Germany's Deutsche Welle, located on the island. But Cyclops closed down for good several years ago.

Today, the *Voice of the Mediterranean* uses Italian and Russian shortwave facilities to broadcast its shortwave programming. *VoMs* 9,600 kHz transmissions are via a RAI transmitter at Prato Smeraldo, Italy. The 12,060 kHz service comes from a transmitter near Moscow, and the 17,570 kHz transmission is via a station at Khabarovsk, in the Russian Far East.

Australian Defense Forces Radio airs SW programming for troops training at home and serving aboard, and for navy forces on the high seas, from 10-kilowatt upper sideband (USB) transmitters located at Belconnen, Australia.

The station on 14,790 kHz is for forces performing exercises in Australia or ships at sea, while 15,635 kHz is beamed to New Guinea, where Australian troops are on disaster relief missions, and to Bougainville, where they serve as peace monitors following lengthy civil strife. ADFR broadcasts from 0300 to 0500 UTC.

Two separate Colombian clandestine stations have been operating for years from somewhere in this South American country. The *Voz de la Resistencia* announced its schedule as 2000 to 2200 UTC daily on 6,226 kHz, although Henrik Klemetz in the Colombian capital of Bogota noted the station near 6,239 kHz.

CREDITS: Brian Alexander, PA; Bruce Barker, PA; Bill Bergadano, NJ; Dustin Brann, MO; David Clark, ONT; Mark Fine, VA; Mark Humenyk, ONT; David Krause, OH; Bob Montgomery, PA; Ed Newbury, NE; Jay Novello, NC; Takayuki Inoue Nozaki, Japan; Gary Otteson, PA; Chuck Rippel, VA; Betsy Robinson, TN; David Ross, ONT; John Sgrulletta, NY; Ed Tilbury, AK; Fred Trescher, PA; North American SW Association, 45 Wildflower Road, Levittown, PA 19057.

Klemetz also noted Radio Patria Libre on 6,250 kHz, also in Spanish, announcing its daily schedule as 1800 to 1830 UTC and 2200 to 2230 UTC. If you hear this station, you can send your reception report to Colombia Popular, c/o Tommy Weisbeckerhaus, Wilhelmstrasse 9, 10963 Berlin, Germany.

DOWN THE DIAL

Looking for some shortwave stations to tune? Try these.

ASCENSION ISLAND—17,830 kHz, British Broadcasting Corp. program *Focus Tonight* was noted at 1745 UTC. This signal is relayed by a transmitter on this remote South Atlantic island.

BELARUS—11,960 kHz, Radio Minsk can be found here in English at 2040 UTC with a discussion program and music, followed by ID and frequency announcements. Low modulation of the signal can be a problem.

CZECH REPUBLIC—21,745 kHz, Radio Prague's English transmission is noted at 1320 UTC with identification, interval signal and music. This also broadcasts on 13,580 kHz at the same time.

ECUADOR—4,920 kHz, Radio Quito was logged here about 0650 UTC with kick-by-kick coverage — probably recorded at that hour—of a soccer match. "Gooooooooooal!"

HUNGARY—11,685 kHz, Radio Budapest's English news program, *Hungary Today* is heard at 0100 UTC.

ICELAND—1 3 , 8 6 0 k H z , Ríkisutvarpid is the Icelandic name for the national SW outlet at the capital of Reykjavik. Look for this one around 1950 UTC with programming in Icelandic.

IRAQ—11,785 kHz, Radio Iraq International has English at 0300 UTC, with schedule information, news, and a musical segment. Signal is often plagued by muffled audio quality and a hum.

MEXICO—6,105 kHz, XEQM in Merida is a rarely heard low powered domestic SW broadcaster. It has been noted here around 1100 UTC with up tempo Latin songs, Spanish language identifications, and commercials.

NAMIBIA—3,230 kHz, Namibia Broadcasting Corp. in southern Africa operates here at 0500 UTC, when it airs a news program, *The World At 6*.

ABBREVIATIONS

AM = Amplitude Modulation, the transmission mode used by broadcasting stations in the medium wave frequencies, 540–1600 kHz, and the 1610–1700 kHz extended band.

DX, DXing, DXer = Distant broadcasting stations; the hobby of listening to such stations; one who listens to DX.

FCC = Federal Communications Commission, government agency that regulates U.S. broadcasting.

ID = Station identification.

kHz = kilohertz, unit of frequency measurement.

SW, SWLing = Shortwave.

SWL, SWLing = Shortwave Listener, Shortwave Listening.

UHF/VHF = Ultra/Very High Frequency bands.

UTC = Universal Coordinated Time, time standard used by most international SW broadcasters and SWLs; equivalent to Eastern Daylight Time plus 4 hours; CDT plus 5 hours; MDT plus 6 hours or PDT plus 7 hours.

NIGERIA —7,255 kHz, Voice of Nigeria in Lagos signs on at 0500 UTC in English, with African songs, pop music, and a commentary.

PAPUA NEW GUINEA—3,220 kHz, Radio Morobe is one of the domestic service shortwavers in remote Papua New Guinea. It has been reported around 0925 UTC with a rather exotic sound, the blowing of a conch shell horn and the cry of seagulls.

SLOVAKIA—5,930 kHz, Radio Slovakia has English around 0120 UTC and has been noted with identification and Slovakian music.

SOLOMON ISLANDS—5,020 kHz, Solomon Islands Broadcasting Service has Pacific islands type music around 1055 UTC. It was noted signing off at 1200 UTC.

SRI LANKA—15,425 kHz, Sri Lanka Broadcasting Corp. was heard in English from 0100 UTC with a DJ morning program of mixed music, from Hawaiian melodies to country and western. It announced parallel frequencies of 6,075 and 9,730 kHz also in use.

SURINAM—4,991 kHz, Radio Apintie occasionally can be heard here with popular music about 0315 UTC

(continued on page 60)

Circuit Circus

More Hall-Effect Circuits

CHARLES D. RAKES

Last month we were deep into magnetic experiments using ITT's CMOS Hall-effect sensors, and time ran out before we could finish. So this column we're going to continue with more circuits and experiments using these fascinating miniature IC sensors (all available from Digi-Key—Tel. 800-344-4539—as well as other sources).

All of the sensors we'll be working with come in the same package and have the same pin configuration (see last month). They all operate with a supply of 4.5 to 24 volts and will supply 10 mA to an external load. I'll repeat the following warning: These are very small devices, measuring only $4 \times 3 \times 1.5$ mm, and will quickly disappear if dropped on a busy workbench.

SIMPLE DETECTOR

Our circuits last month used the HAL115UA-C sensor, which outputs a low when there is no magnetic field present. This month, our first circuit

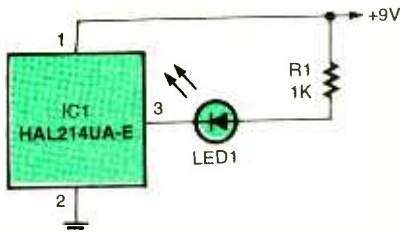

Fig. 1. The LED in this simple detector will light when the south pole of a magnet is brought near the branded side of IC1.

PARTS LIST FOR THE SIMPLE DETECTOR (FIG. 1)

- IC1—HAL214UA-E Hall-effect sensor, integrated circuit
- LED1—Light-emitting diode, any color
- R1—1000-ohm, 1/4-watt, 5% resistor

(Fig. 1) uses the HAL214UA-E sensor (Digi-Key part number HAL214UA-E-ND), which outputs a low when a magnetic field is present. The "E" extension of the part number designates the IC's operating temperature range, which is

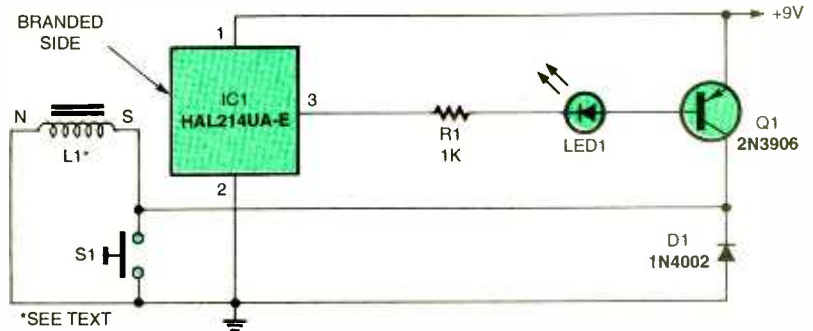

Fig. 2. When building this latching detector, be certain to position the south pole of electromagnet L1 next to the branded side of IC1.

–40° to 100° C (compare to the HAL115UA-C's range of 0° to 100° C). Like the other ITT sensors, the HAL214UA-E has a branded side, or side where the part number is printed. The branded side of the HAL214UA-E responds to the south pole of a magnet, and the unbranded side responds to the north pole of a magnet.

The detector circuit in Fig. 1 shows the sensor operating in its simplest form. Sensor IC1's output is high until a magnet is positioned in the proper polarity to either side of the chip. This sensor is not as sensitive as the HAL115UA-C and will only respond to a small donut magnet at a distance of no greater than half an inch or so. When a magnet is brought close, LED1 will light.

A simple way to check the hysteresis sensitivity range of the chip is to slowly move a magnet with the correct polarity toward the sensor and note the distance at which the magnet turns on LED1. Then slowly back the magnet away from the sensor and note the distance where LED1 turns off. The difference in the turn-on and turn-off points indicates the sensor's hysteresis range. This feature keeps the sensor's output stable during the on/off transition.

LATCHING DETECTOR

Our next circuit (see Fig. 2) contains a bias coil, L1, positioned next to the sensor. With the south pole of the

PARTS LIST FOR THE LATCHING DETECTOR (FIG. 2)

SEMICONDUCTORS

- IC1—HAL214UA-E Hall-effect sensor, integrated circuit
- Q1—2N3906 general-purpose PNP silicon transistor
- D1—1N4002 1-amp, 100-PIV silicon rectifier diode
- LED1—Light-emitting diode, any color

ADDITIONAL PARTS

- R1—1000-ohm, 1/4-watt, 5% resistor
- L1—See text
- S1—Normally open pushbutton switch

electromagnet coil (L1) facing the branded side of sensor IC1, the circuit is a latching detector. When power is first applied to the circuit and no magnets are near the sensor, the output is high and Q1 is turned off. Pressing S1 sends current through the bias coil, which produces a south-pole field at the branded side of the sensor. This magnetic field turns the sensor on, producing a low output at pin 3 of IC1. Next the base of Q1 goes to ground through R1, turning on LED1 and supplying constant current to L1, the bias coil.

The circuit can be unlatched by positioning the south pole of a magnet near the unbranded side of the sensor, or by interrupting the power source. This latching circuit can be used in alarm

PARTS LIST FOR THE POLE IDENTIFIER (FIG. 3)

IC1, IC2—HAL214UA-E Hall-effect sensor, integrated circuit
 LED1, LED2—Light-emitting diode, any color
 R1, R2—1000-ohm, ¼-watt, 5% resistor

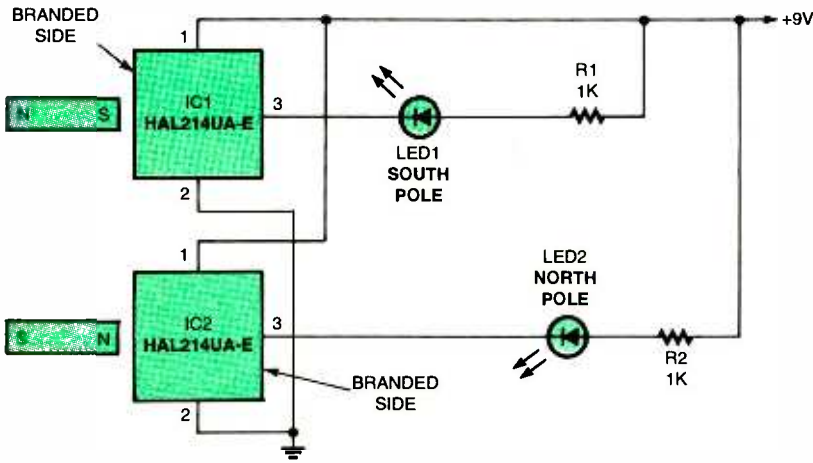

Fig. 3. Wave a magnet over each of the Hall-effect sensors in this circuit and let LED1 and LED2 identify the magnet's polarity.

systems or any similar application where it's desirable to have an external magnetic field be the catalyst that deactivates a circuit.

Bias-coil L1 can be an old relay coil with a DC resistance of 100 to 200 ohms. You can also make your own by winding about 1000 feet of 30-gauge, enamel-covered copper wire on a soft iron core. A soft iron bolt with a diameter of ¼ to ½ inches and a length of about 2 inches will do for the coil's core. Just jumble-wind the copper wire in a solenoid fashion along the length of the bolt.

To determine which side of the coil is the south pole, use a magnet with

known poles to determine attraction/repulsion (opposites attract, and like poles repel). Again, position the south pole against the branded side of sensor IC1.

If the circuit doesn't latch when S1 is pressed, the problem could be that the bias coil is either positioned incorrectly or the field developed by the bias coil is too weak. Here you will need to experiment with either a different bias coil or try operating the bias coil at a slightly higher voltage.

POLE IDENTIFIER

A pair of the HAL214UA-E sensors,

connected as shown in Fig. 3, can be used as a simple magnet-pole identification circuit. Readers may recognize this design as being similar to one that was discussed last month. Of course, this month's offering doesn't use the HAL115-UA-C sensors.

The HAL214UA-E sensors may be mounted side by side, with the branded side of IC1 facing out and the unbranded side of IC2 facing in. This allows the poles of a magnet to be easily identified by sweeping the magnet over the ICs. You can also mount the two sensors with their unbranded sides positioned face-to-face. The latter will provide a very small footprint, but you'll obviously have to move the pole of the magnet being tested in a different manner. In either case, the function will be the same. A magnet with its south pole placed near the branded side of sensor IC1 will light LED1, and a north pole positioned at the unbranded side of IC2 will light LED2.

MODERN REED SWITCH

A common item used in most burglar-alarm systems is the magnet-operated reed switch. However, since reed switches are mechanical they can fail in several ways: They are fragile and easily broken, their contacts

PARTS LIST FOR THE MODERN REED SWITCH (FIG. 4)

SEMICONDUCTORS

IC1-IC3—HAL214UA-E Hall-effect sensor, integrated circuit
 Q1, Q2—2N2222 general-purpose NPN silicon transistor
 D1-D3—1N914 silicon signal diode

RESISTORS

(All resistors are ¼-watt, 5% units.)
 R1-R4—4700-ohm
 R5—47,000-ohm
 R6—1000-ohm

ADDITIONAL PARTS

C1-C3—0.1-µF, ceramic-disc capacitor

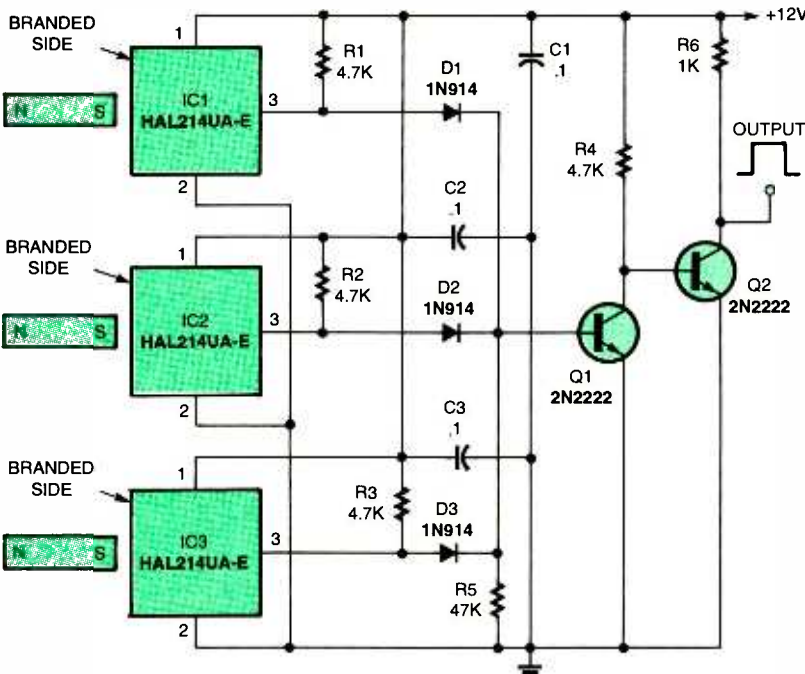

Fig. 4. Replace fragile reed switches with this solid-state version, which is sure to be more reliable.

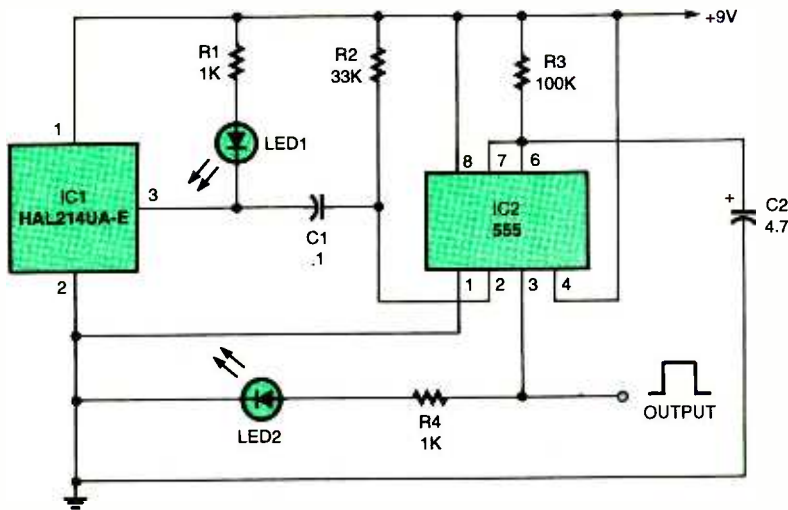

Fig. 5. This magnetic pulser (the duty cycle is set by R3 and C2) can interface with a counter or other digital circuitry.

sometimes stick in the closed position, and in rarer cases their contacts fail to make a good connection.

One solution to these problems is to replace a reed switch with a Hall-effect sensor—exactly what we've done with the circuit in Fig. 4. Here we have a three-sensor input circuit with a common alarm output. In the "set" condition all of the magnets are in place next to the Hall sensors (south pole to branded side) and all outputs are low. The voltage at the base of Q1 is low and the alarm output at Q2's collector is low. If one of the magnets is removed from one of the sensors, the latter's output will go high. A positive voltage is then supplied through the diode to the base of Q1 turning it on and Q2 off, thereby producing a high output. Any number of sensors can easily be added to the circuit by duplicating one of the sensor circuits and feeding its output to the base of Q1 through a 1N914 diode.

MAGNETIC PULSER

Our next circuit, shown in Fig. 5, adds a timed, pulsed output to the basic Hall-effect sensor. The output of the circuit can be used to interface with a counter or some other type of digital circuitry.

If no magnetic field is present, sensor IC1's output at pin 3 is high and the output of 555 timer IC2 at pin 3 is low. Placing a magnet's south pole near the branded side of IC1 produces a low at the chip's output that lights LED1 and sends a negative pulse through C1 to pin 2 of IC2. The timer then produces

a one-second positive output pulse at pin 3.

The duty cycle of the 555's output pulse is determined by the values of R3 and C2. You'll have to experiment with the values of these components to find the right time for your particular application (hint: make either or both greater in value for a longer time period, or less for a shorter time period).

SIMPLE LATCHING DETECTOR

The circuit in Fig. 6 uses a HAL502UA-E (Digi-Key part number HAL502UA-E-ND) latching Hall-effect

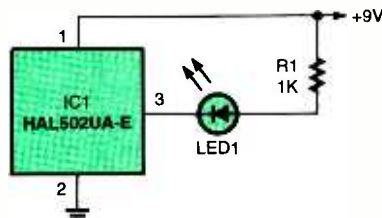

Fig. 6. This Hall-effect sensor will remain latched after detecting a magnetic field. See text to learn how to deactivate it.

PARTS LIST FOR THE SIMPLE LATCHING DETECTOR (FIG. 6)

- IC1—HAL502UA-E Hall-effect sensor, integrated circuit
- LED—Light-emitting diode, any color
- R1—1000-ohm, 1/4-watt, 5% resistor

sensor. This sensor has the same operating temperature range and voltage requirements as the HAL214UA-E. Also, the sensor's output is normally high and goes low when the south pole of a magnet is brought close to the

PARTS LIST FOR THE MAGNETIC PULSER (FIG. 5)

SEMICONDUCTORS

- IC1—HAL214UA-E Hall-effect sensor, integrated circuit
- IC2—555 oscillator/timer, integrated circuit
- LED1, LED2—Light-emitting diode, any color

RESISTORS

- (All resistors are 1/4-watt, 5% units.)
- R1, R4—1000-ohm
 - R2—33,000-ohm
 - R3—100,000-ohm

ADDITIONAL PARTS

- C1—0.1- μ F, ceramic-disc capacitor
- C2—4.7- μ F, 25-WVDC, electrolytic capacitor

branded side of the sensor. However, the HAL502UA-E's output latches low, remaining in that state even after the magnet has been removed.

The LED in the circuit lets you know that a magnet has been detected. To reset the circuit, you can either interrupt the power source or bring the north pole of a magnet to the branded side of the sensor.

MAGNETIC LOCK AND KEY

The magnetic locking/unlocking circuit shown in Fig. 7 will be our last entry this time around. This circuit may also be used as a magnetic puzzler for fun and frustration. The "key" for the circuit is made of three small rod magnets. Mount each of the Hall sensors in a hole in a block of wood so that magnets can slide into and make contact with the sensors. You'll have to determine whether the branded or unbranded side of each sensor faces out—in this way you'll set the correct "combination" of magnet polarities that opens the lock.

Why three magnets? They coincide with IC1-IC3, which are HAL214UA-Es. The fourth sensor, IC4, is the normally high HAL502UA-C latching sensor, and acts as a lock primer. Before you can unlock the circuit with the right combination of magnets, you need to first latch IC4 by placing a single magnet over it in the correct polarity (you determine which side of the IC faces out—as with all the sensors, branded sides require a south pole to activate).

After you latch IC4, you have to 59

HAM RADIO

(continued from page 54)

are seeking an award such as DXCC, WAS, or WAC, then you might be less interested than when it was the law. But there is one good reason to do so: science. Every now and then some propagation event occurs that baffles scientists. Last summer, for example, a massive gamma source appeared for a short time, and then died out. It affected HF communications all over the world, especially on the dark side of Earth. Scientists at the National Radio Astronomy Observatory (NRAO) asked hams and SWLs for log details of their reception on that day. Your ham log could have been useful to them ... if you'd had one. The ARRL still sells logbooks, so I recently went out and bought one.

I can be reached by snail mail at P.O. Box 1099, Falls Church, VA, 22041, or by e-mail at carrjj@aol.com. ■

DX LISTENING

(continued from page 56)

despite interference from Peruvian Radio Ancash.

TURKEY—6,900 kHz, Turkish Meteorological station is a seldom-logged SW outlet. While weather news seems to be its reason to exist, it has been heard on the East Coast of the U.S. signing on at 0412 UTC with Turkish music and no announcements.

UGANDA—4,976 kHz, Radio Uganda is heard with English news, advertisements, and public service announcements from 0400 UTC.

UNITED ARAB EMIRATES—15,395 and 21,605 kHz, UAE Radio at Dubai airs its English segment from 1600 to 1640 UTC.

URUGUAY—6,140 kHz, Radio Monte Carlo in the capital of Montevideo has a Spanish news broadcast, *Diario Oral Matutino* after 1000 UTC, followed by ID.

VENEZUELA—4,830 kHz, Radio Tachira begins its programming day around 1016 UTC, with the Venezuelan national anthem, Spanish identification, and some tropical music. This is followed by a religious program at 1030 UTC. ■

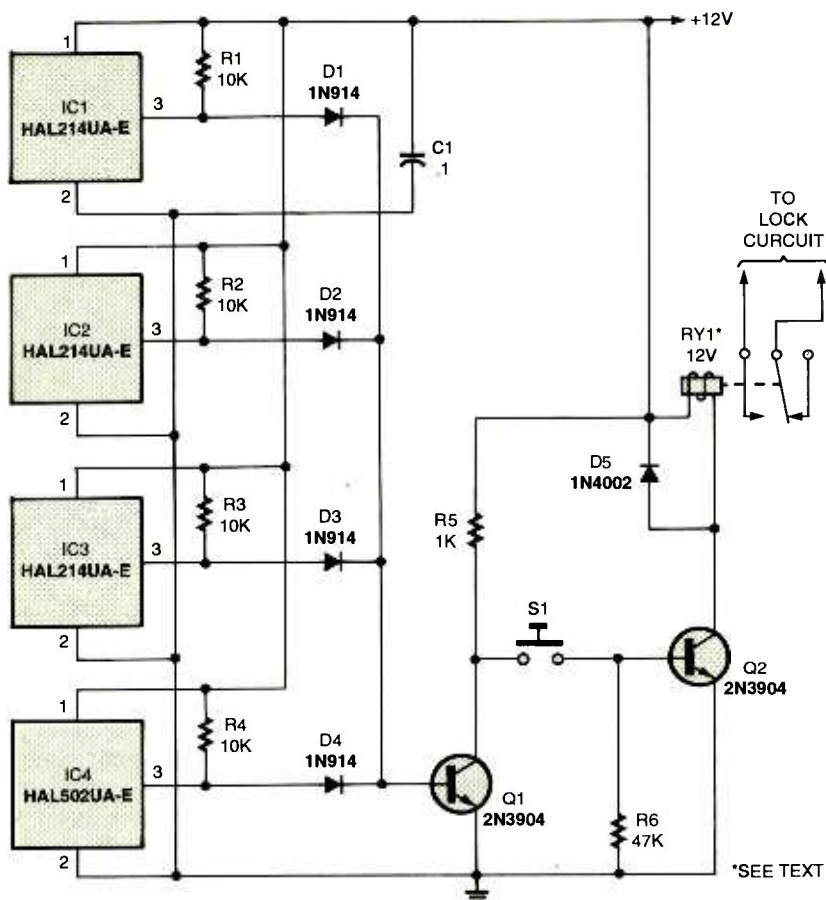

Fig. 7. As explained in text, this magnetic lock-and-key circuit can make it quite difficult for someone to open a circuit, unless they know the secret combination of magnet poles required to activate relay RY1.

PARTS LIST FOR THE MAGNETIC LOCK AND KEY (FIG. 7)

SEMICONDUCTORS

IC1-IC3—HAL214UA-E Hall-effect sensor, integrated circuit

IC4—HAL502UA-E Hall-effect sensor, integrated circuit

Q1, Q2—2N3904 general-purpose NPN transistor

D1-D4—1N914 silicon signal diode

D5—1N4002 1-amp, 100-PIV silicon rectifier diode

RESISTORS

(All resistors are 1/4-watt, 5% units.)

R1-R4—10,000-ohm

R5—1000-ohm

R6—47,000-ohm

ADDITIONAL PARTS

C1—0.1-μF, ceramic-disc capacitor

RY1—12-volt DC relay (coil resistance of 100 ohms or greater)

sensor outputs will all go low and Q1 will be turned off (with its collector high at 12 volts). Pressing S1 will turn Q2 on, pulling in relay RY1 and activating any external circuitry connected to the lock. If any of the magnets are incorrectly installed, consequently causing one or more of the sensors' outputs to be high, the circuit will not allow the lock to be activated.

If unlocking the puzzle becomes too easy, try using unmarked magnets and don't allow a compass to be used. Any number of additional stages of sensors may be added to increase the difficulty in opening the magnetic lock.

I hope you have as much fun working and playing with these unique magnetic sensors as I've had. If you are a true experimenter these devices are made for you. So melt some solder and build something, then meet me back here next month at the same time and place.

Until then, may all of your circuits operate as you planned them to the first time around. ■

insert the proper combination of three magnets to activate IC1-IC3. When all three magnets are in place correctly, the

Lights on with Photodiodes

ALEX BIE

The photodiode semiconductor is used within the electronics industry in a variety of areas, from detectors in CD players to wide-bandwidth optical telecommunications systems. This device regulates electric current in response to the variation in intensity of light on its surface and owes much of its success to its simple and low-cost (yet rugged) structure.

Structure

Although an ordinary PN junction can be used as the basis of a photodiode, the PIN junction is far more satisfactory and the most widely used type. This structure was developed in the late 1950s from the more conventional PN diode, over which it has many advantages.

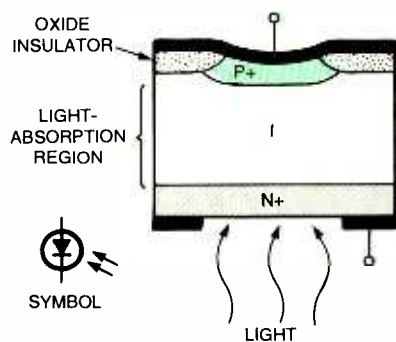

Fig. 1. Here is the buildup of a PIN photodiode.

In the fabrication process, a thick intrinsic layer (I) is inserted between the P- and N-type layers, as shown in Fig. 1. The middle layer may be either completely intrinsic, or very lightly doped to make it an N-layer. In some instances it may be grown as an epitaxial layer onto the substrate, or alternatively it may be contained within the substrate itself.

One of the main requirements of the diode is to ensure that the maximum amount of light reaches the intrinsic layer. One of the most efficient ways of achieving this is to place the electrical contacts at the bottom of the structure as shown. This enables the maximum amount of light to reach the

active area. It is found that when the substrate is heavily doped, there is very little loss of light due to the fact that this is not the active area.

As light is mostly absorbed within a certain distance, the thickness of the intrinsic layer is normally made to match this distance. Any increase in thickness over this absorption distance will tend to reduce the speed of operation—a vital factor in many applications. Increasing the thickness of the intrinsic layer any further will not improve the efficiency greatly.

It is also possible to have the light enter the diode from the side of the junction. By operating the diode in this fashion, the intrinsic layer can be made much thinner to increase the speed of operation, although the efficiency is reduced.

Operation

The diode is operated under a moderate reverse bias. This keeps the depletion layer free of any carriers, and normally no current will flow. However when a light photon enters the intrinsic region it can strike an atom in the crystal lattice and dislodge an electron. In this way a hole-electron pair is generated. The hole and electron will then migrate in opposite directions under the action of the electric field across the intrinsic region, and a small current can be seen to flow. It is found that the size of the current is proportional to the amount of light entering the intrinsic region. The more light, the greater the numbers of hole-electron pairs that are generated, and the greater the current flow.

When not exposed to light, the diode follows the normal voltage-current (VI) characteristics expected of a diode. In the reverse direction, virtually no current flows, but in the forward direction it steadily increases, especially after the knee or turn-on voltage is reached. This characteristic is modified in the presence of light as shown in Fig. 2. When used as a photodiode, the greatest effect is seen in the

reverse direction. Here the largest changes are noticed, and the normal forward current does not mask the effects due to the light.

Standard hobbyist photodiodes can be found in numerous catalogs. For example, Digi-Key (Tel. 800-344-4539) can supply photo sensors and detectors in a number of configurations, wavelength sensitivities, VI parameters, and size of the active area.

Applications

The PIN photodiode does not have any gain, and for some applications this may be a disadvantage. Despite this, it is still one of the most widely used forms of a diode, finding applications in audio CDs as well as computer CD drives. In addition photodiodes are used in optical-communication systems.

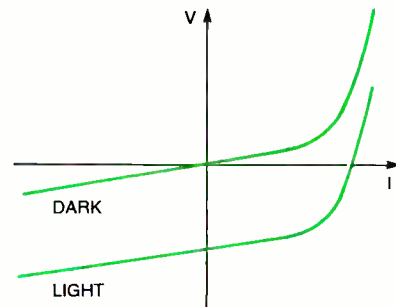

Fig. 2. These curves illustrate the VI characteristic of a PIN photodiode.

These diodes are also used in nuclear-radiation detectors. Nuclear radiation may be in the form of high-energy charged or uncharged particles, or it may also be electromagnetic radiation—the diode can detect all these forms of radiation. Electromagnetic radiation, of which light is a form, generates the hole-electron pairs as already mentioned. The particles have exactly the same effect. However, because only a small amount of energy is required to generate a hole-electron pair, a single high-energy particle may generate several hole-electron pairs.

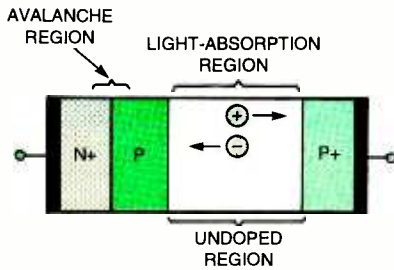

Fig. 3. Here's the structure of an avalanche photodiode.

Avalanche Detector

In addition to the PIN photodiode, avalanche photodiodes or detectors are used in some applications. This device is a modified photodiode, biased just below the avalanche breakdown region. These have the advantage that they use the avalanche process to give high levels of gain. The structure is somewhat more complicated than that of the ordinary PIN device (see Figs. 3 and 4). It can be seen that this structure consists of four layers. There are N+, P, undoped, and P+ regions. Light absorption takes place in the undoped region, which may be relatively thick. The avalanche region

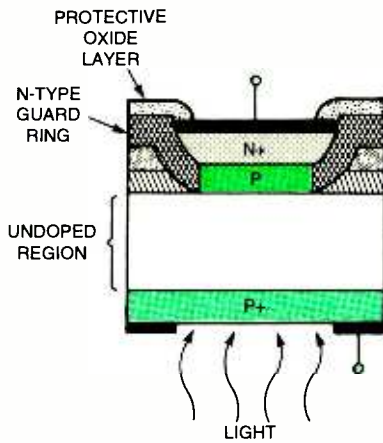

Fig. 4. This is a cross-section of a typical avalanche photodiode.

occurs between the N+ and P regions.

Light enters the undoped region and causes the generation of hole-electron pairs. Under the action of the electric field, the electrons migrate towards the avalanche region. Here the electric field causes their velocity to increase, to the extent that collisions with the crystal lattice create further

"Photodiode" introduction by Ian Poole, 5 Meadway, Staines, TW18 2PW, England; reprinted with permission.

hole-electron pairs. In turn, these electrons may collide with the crystal lattice to create even more hole electron pairs. In this way, a single electron created by light in the undoped region may result in many more electrons being created.

The avalanche diode has a number of differences when compared to the ordinary PIN diode. The avalanche process means that a single electron produced by light in the undoped region is multiplied several times. As a result, the avalanche detector is far more sensitive. However it is found that its operation is not nearly as linear, and additionally the avalanche process means that the resultant signal is far noisier than one from a PIN diode. The structure of the avalanche diode is also more complicated. An N-type guard ring is required around the PN junction to minimize the electric field around the edge of the junction. It is also found that the current gain is dependent not only on the bias applied, but also thermal fluctuations. As a result, it is necessary to ensure the devices are placed on an adequate heat sink.

The avalanche diodes are not as widely used as their PIN counterparts. They are used primarily where optical gain is of paramount importance and wide bandwidths are necessary. Due to the high voltages required, combined with a lower reliability, this type of photodiode is less convenient to use.

The definitions of many semiconductor terms can be found in Ian Poole's *Radio and Electronics* Web site: http://website.lineone.net/~ian_poole.

In next month's column, we will look at the thyristor. Well, enough theory for now—now let's get to our readers' circuits!

BRIGHTER BICYCLE BULBS

My name is Paul, and I live in Bellingham, WA. I am a home-schooled eighth grader. I enjoy your column and have built many of the published circuits. I like programming on our computers in BASIC, and I am working on learning assembly language. I recently finished an interface that allows me to control three motors from a computer, and now am working on making a computer-controlled robot arm.

Here is a tip on how to make bike

lights—which are powered by a standard dynamo—many times brighter. The idea requires that the headlight and taillight bulbs be exactly the same type. In the simple circuits shown in Fig. 5, I recommend using two krypton bulbs for L1 and L2, but normal lights will work also. Try riding—the light bulbs, when connected as shown in Fig. 5A, should both glow, but may be dimmer than you'd expect.

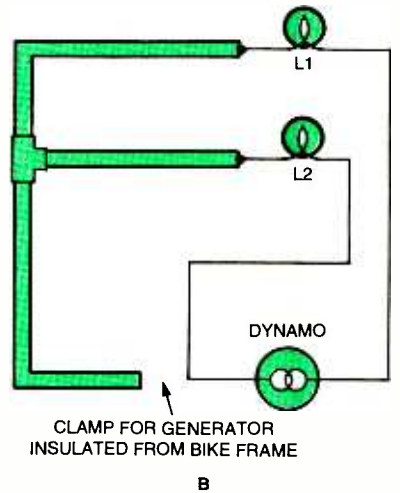
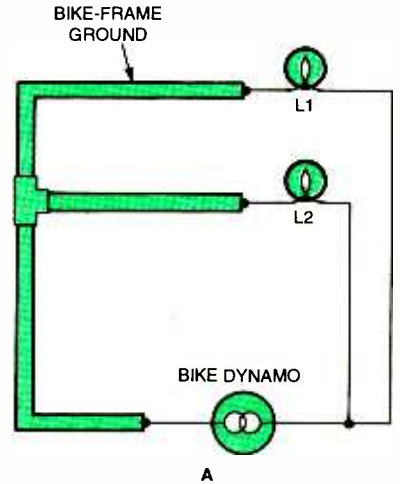

Fig. 5. Change the configuration of your bicycle lamps from A to B to get them to light up brighter.

The reason for the dimness is that bike dynamos are constant-current generators. After reaching a certain speed, pedaling faster will not make the light bulbs any brighter. When pedaled fast enough, the voltage applied to the bulbs will rise until the bulbs consume a factory-set amount of current. Installed according to the manufacturer's directions, the two light bulbs are wired in parallel (again, see Fig. 5A). This means that the light

transistor amplifier, whose output is variable (through potentiometer R8). The signal is then applied to the base of Q2, a 2N2219A transistor set up in a low-impedance, emitter-follower configuration. One watt of peak power is available from this output into a 50-ohm load (14-volt peak, unloaded). The current sinking capability is limited; however, the generator can be used to trigger SCRs, etc.

A simple AC power supply has been included that develops the required 18- and 5-volt DC supplies for the generator. The transformer used is rated at 18-VAC, 0.5A, while BR1 is a standard full-wave bridge, such as the RadioShack 276-1146. To use the generator, turn the power on, turn the pulse width to minimum, set the PRF, and then adjust the pulse width and output level as required.

Those who wish to obtain a foil pattern of the circuit can do so by sending

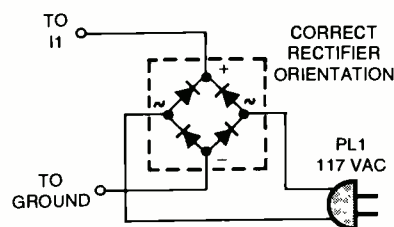

Fig. 7. Here's the correct way to orient the bridge rectifier in Fig. 6 of our February 1999 column.

me a self-addressed stamped envelope. —Craig Kendrick Sellen, Mallard Meadows RHC, 476 Belmont St., Waymart, PA 18472.

Fine job, Craig. This circuit has many uses on the workbench. However, as Craig pointed out and we confirmed, the NE562 PLL chip might be discontinued and hard to locate. A source which still has stock is Alltronics, 2300 Zanker Road, San Jose, CA 95131; Tel. 408-943-9773; Web: www.alltronics.com. They also stock the other parts, though you can use substitutions for several.

A CORRECTION

As a reader pointed out, I made an error in the February 1999 issue. In Fig. 6 from that issue, the bridge rectifier composed of diodes D1–D4 was improperly oriented. To correct it, rotate the entire rectifier diamond shape 90 degrees to the left, as shown in Fig. 7 of this month's column.

That's about it for this month's column. Remember this is *your* column. Keep those circuits, solutions, and ideas coming in for your special gift. Write me at *Think Tank*, **Popular Electronics**, 500 Bi-County Blvd., Farmingdale, NY 11735.

LETTERS

(continued from page 10)

chase one, and I need to know which are the best for recording; is the sound muffled, is there any hiss, and can I record from cassettes, records, or even the radio? I would appreciate any information.

W.K.
Chicago, IL

Besides the recorder review in this month's *Gizmo*, here's a piece of advice about CD recorders: While the sound quality of most, if not all, of these devices is superior to older media, you have to have a good quality source to record from. To record from the radio or other less-than-CD-quality media, you'll need to invest in noise-cancellation hardware or software that can prepare or clean up the audio before you record it digitally.

—Editor

A READER RESPONDS

Your March issue got right to me, especially your fine editorial. I was even more intrigued with the *Letters* column. I have to agree with the general feelings of D.V. from Los Angeles. Many of your readers want the heavy-duty projects, but don't always have the resources, time, and money for the bigger more complex projects. There are many who also like a smattering of small, simple circuits. They are usually easy to build and enjoy, and they come with easy-to-obtain spare parts or RadioShack parts.

Regarding the letter from John Agugliaro, I also got sick of using those new-fangled volt ohmmeters and got out my old trusty Simpson 260, circa 1965. I too would love to have its schematic.

In response to Leon Howe's request, I don't have what he wanted but I do have a box full of 8-inch reel-to-reel blank tapes, new condition, never opened. If anyone is interested, I would be happy to pass them along. I

also have a set of 78-rpm records: a course in phonetics.

Lastly, if given enough time, I think I can dig up an old article on the project that Bill Englander wants, or I may be able to design such an indicator.

I've been a reader of **Popular Electronics** for 36 years or so. It's still the best out there in this competitive field. Keep this fine magazine going.

David Larkin
225 Broad Street, Apt. 1
New London, CT 06320

HAVES & NEEDS

I have a problem trying to find a schematic for a Rosac amp. The power transistors blew, and it's hard to find a match. SEN t73 is on the power transistor. Are there any old books for a reference for a crossover?

Are there any kits to build a preamp for a piezo musical pickup?

Michael Elias
P.O. Box 390494
Anza, CA 92539

THE COLLECTED WORKS OF MOHAMMED ULLYES FIPS

#166—By Hugo Gernsback. Here is a collection of 21 April Fools Articles, reprinted from the pages of the magazines they appeared in, as a 74-page, 8½ × 11-inch book. The stories were written between 1933 and 1964. Some of the devices actually exist today. Others are just around the corner. All are fun and almost possible. Stories include the Cordless Radio Iron, The Visi-Talkie, Electronic Razor, 30-Day LP Record, Teleyeglasses and even Electronic Brain Servicing. Get your copy today. Ask for book #166 and include \$9.99 (includes shipping and handling) in the US (First Class), Canada and Overseas (surface mail), and order from **CLAGGK Inc., P.O. Box 4099, Farmingdale, NY 11735-0793**. Payment in US funds by US bank check or International Money Order. Allow 6-8 weeks for delivery.



MA05

Great consumer information is a shoe-in with our free Catalog. Call toll-free 1 (888) 8-PUEBLO or go to www.pueblo.gsa.gov.

Get your copy of the CRYSTAL SET HANDBOOK



Go back to antiquity and build the radios that your grandfather built. Build the "Quaker Oats" type rig, wind coils that work and make it look like the 1920's! Only \$10.95 plus \$4.00 for shipping and handling. **Claggk Inc., P.O. Box 4099, Farmingdale, NY 11735**. USA Funds ONLY! USA and Canada—no foreign orders. Allow 6-8 weeks for delivery.

MA01

ANTIQUE Radio

Those Magnificent Philco Cathedrals

MARC ELLIS

Last month, we discussed the downsizing techniques that made it possible for radio manufacturers to produce modestly priced receivers for cash-starved, but entertainment-hungry, folks during the 1930s depression years. The new "midgets"—many brands of which were produced by small, unknown manufacturers—were enormously

month—particularly the downsizing of components, the integration of the power supply into the radio chassis, and the inclusion of the speaker within the cabinet—offered economies that would permit sets to be sold at attractively low prices while maintaining decent profit margins.

But Philco decided to put its own spin on this trend. Rather than churn-

in a table model cabinet.

It sported a TRF circuit with three type-24 screen-grid tubes as RF amplifiers, a type-27 detector, and a pair of push-pull 71As as audio amplifiers. The speaker was an eight-inch electrodynamic. The heavy-duty transformer-type power supply employed the usual type-80. All this was crammed into a 16 × 17.5-inch case with a nice walnut-finish veneer. The price: \$49.50—quite a bit more than the minimal midgets, yet a serious saving over competitive sets having comparable performance.

Eventually over 300,000 Model 20 Baby Grands were cranked out, making Philco the foremost radio manufacturer of the era. The Model 20 was a rather plain-looking set, and Philco later dressed it up to some degree by changing the veneer surrounding the top arch to a light-colored curly maple. The company also added a pair of applied grooved columns "supporting" the arch on both sides of the cabinet front.

THE IMMORTAL COMBS DESIGN

The year 1931 saw the introduction of the Model 21, which employed the same chassis as the Model 20, but sported a beautiful new cabinet by crack industrial designer Edward L. Combs. Combs retained the columns that had appeared in the later Model 20, simplified the speaker grille treatment, and added a few other deft touches. The result of these changes was a classic cabinet that is arguably the most beloved by today's antique-radio hobbyists.

As proof of this, next time you see an illustration of a cathedral radio in an advertisement or publication of some kind, compare it with the Combs Model 21 patent drawing shown with this article. More often than not you'll find a rather close resemblance!

Philco certainly understood the 65

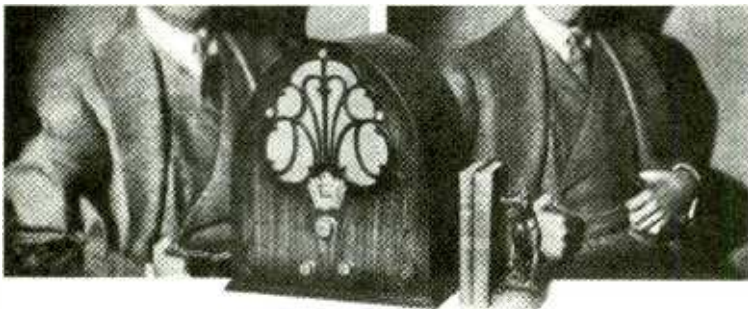

The great little name in radio

PHILCO BABY GRAND... \$49.50

... one month old ...
years ahead in popular favor

one was of. Never before have trade and public seen
such a VALUE.
Always is one of for an EXTRA radio of
The. Got her, some, too, who many people find
this. And THE radio sets
in. Inexpensive appearance. Got that too as gift at college,
the Baby Grand. 4.5% installment no higher educa-
tion at a monthly rate custom rate. And what a gift to
make for all occasions?
The Philco Baby Grand is all-electric. It just plugs
in.

Here's one of the ads that introduced the Model 20 Baby Grand to entertainment-starved Americans during the depths of The Great Depression.

popular. Their sales figures caused more than a few raised eyebrows in the executive offices of the major radio firms. However, most of these firms chose to ignore this trend and stick with their prestige images, continuing to push inlaid wood cabinets and battleship construction. One company did see things a little differently.

Philco took a look at the new downsized radios and identified many marketing points. The portability of the small table models made them more useful and versatile. The family receiver no longer had to remain anchored in the living room, trapped in its magnificent cabinetry; it could follow the family to wherever the action was. Furthermore, the new techniques of integrated construction discussed last

ing out minimal midget sets, the canny firm took a compromise approach. They adapted the downsizing methods to produce a line of lower-cost models that still retained some quality features. The result was the famous "Philco Cathedral" that found a very profitable marketing niche at the time and has captured the interest of so many collectors today.

THE ORIGINAL PHILCO CATHEDRAL

Philco's first entry into the so-called "midget" market was the Model 20 Baby Grand, introduced in 1930. The original display ads pictured it next to a bookend, as if it might neatly slide into place on a bookshelf. However, this set was really a serious console radio

Fig. 1.

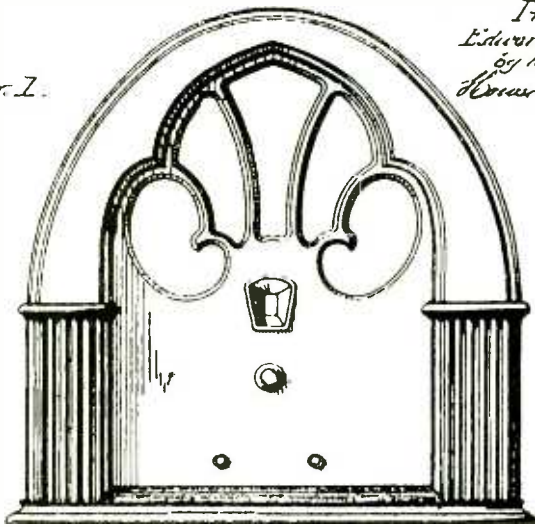

*Inventor:
Edward L. Combs
by his Attorneys
Conrad & Brown*

UNITED STATES PATENT OFFICE

EDWARD L. COMBS, OF PHILADELPHIA, PENNSYLVANIA, ASSIGNOR TO PHILADELPHIA STORAGE BATTERY COMPANY, OF PHILADELPHIA, PENNSYLVANIA, A CORPORATION OF PENNSYLVANIA

DESIGN FOR A RADIOCABINET

This illustration is taken from the design patent for Edward L. Combs' immortal cathedral design.

drawing power of this cabinet, because it was used in four more sets after the Model 21 was discontinued. These were the famous Model 70 and Model 90 superheterodynes, the Model 35 (a battery-operated Model 70), and the Model 46 (a 110-volt DC TRF similar to the Model 21). Though the firm made many cathedral models after this period, the Models 21, 70, and 90 are certainly among those best known to collectors.

MODEL 90 VARIATIONS

Introduced in June 1931, along with the smaller Model 70, the Model 90 was priced at \$69.95. It is now proba-

bly the most sought-after of the Philco cathedrals. Calling this behemoth superheterodyne a "midget" radio (though it technically might be considered to be one) is a bit of a laugh. Collectors will find three major variations of this interesting set, all with nine tubes.

What appears to be the earliest variation uses four type 24s (as RF amplifier, mixer, IF amplifier, and detector), two type 27s (local oscillator and first audio), a pair of 45s (push-pull audio output), and a type-80 rectifier. Volume control was accomplished by the rather archaic technique of varying cathode bias on the RF and IF amplifiers. And

puzzling over the schematic of this version of the Model 90, I was not able to find an automatic volume control (AVC) circuit. There is a 3-position tone control, which is a refinement not found on the predecessor Models 20 and 21.

A second variation is rather similar electronically, but uses a single-ended (type-47) audio output stage. Type 24s are used as the RF amplifier, mixer, and IF amplifier; 27s as the local oscillator, detector and first and second audio stages; and an 80 for the rectifier. The volume control is a conventional potentiometer circuit at the first audio grid; there is a 3-position tone control.

The most sophisticated variation of the Model 90 is immediately distinguishable by its use of a pair of push-pull type 47s as the audio-output stage. The newly introduced type-35, remote cut-off or "supercontrol" tube is substituted for the 24s previously used as RF and IF amplifiers. The new type offered smoother, more gradual, control of stage gain by the AVC circuit. The local oscillator tube has disappeared in this model, replaced by a single 24 used as an oscillator-mixer. As in the previous variation, type 27s are used as the detector and in the first and second audio stages, and there is also an 80 rectifier. Volume control is conventional, and the 3-position tone control is retained.

MODEL 70 VARIATIONS

Collectors may find that the popular "baby 90" set is a little easier to locate than its big brother. Over 288,000 of them were made, compared to about 106,000 Model 90s. The difference in volume is accounted for by the fact that the Model 70 sold for twenty dollars less. Two variations are out there to be found: one with automatic volume control and one without it; both use seven tubes.

The front end of the Model 70 *without* AVC is quite similar to that of the first variation of the Model 90. Type 24s are used as RF amplifier, local oscillator, mixer, and IF amplifier. Volume control is by the same cathode-bias method. The major difference is in the audio section, which lacks the "punch" of the 90 variation mentioned—having only a single detector-amplifier (type 24) in place of the 90's separate detector and first audio amplifier, and having a single-ended output stage (type 47) in place of the push-pull 45s. There's the

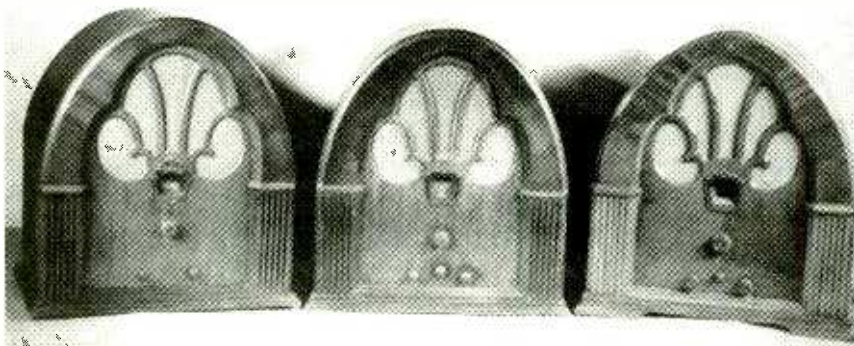

Budget Project and Computer Books

BP317—Practical Electronic Timing \$6.99. Time measurement projects are among the most constructed gadgets by hobbyists. This book provides the theory and backs it with a wide range of practical construction projects. Each project has how-it-works theory and how to check it for correct operation.

BP415—Using Netscape on the Internet \$8.99. Get with the Internet and with surfing, or browsing, the World Wide Web, and with the Netscape Navigator in particular. The book explains: The Internet and how the World Wide Web fits into the general scenario; how do you go about getting an Internet connection of your own; how to download and install the various versions of Netscape browsing software that are available; and how to use Netscape Navigator to surf the Web, and to find and maintain lists of useful sites. There's a heck of a lot more, too!

BP325—A Concise User's Guide to Windows 3.1 \$6.99. Now you can manage Microsoft's Windows with confidence. Understand what hardware specification you need to run Windows 3.1 successfully, and how to install, customize, fine-tune and optimize your system. Then you'll get into understanding the Program Manager, File Manager and Print Manager. Next follows tips on the word processor, plus how to use Paintbrush. There's more on the Cardfile database with its auto-dial feature, Windows Calendar, Terminal, Notepad, etc.

BP327—DOS: One Step at a Time \$5.99. Although you spend most of your time working with a word processor, spreadsheet or database, and are probably quite happy using its file management facilities, there will be times when you absolutely need to use DOS to carry out 'house-keeping' functions. The book starts with an overview of DOS, and later chapters cover the commands for handling disks, directories and files.

PCP119—Electronic Music and Midi Projects \$12.95. Save cash by building the MIDI gadgets you need. Want a MIDI THRU box, program change pedal, Metronome, analog echo unit, MIDI patchbay or switcher? Over 16 practical and very useful music and MIDI projects—all in this book! The projects are explained in detail with full instructions on assembly.

PCP120—Multimedia on the PC! \$14.95. What is Multimedia? What can it do for you? It can do lots of nice things! This 184-page book helps you create your own multimedia presentation. Multimedia applications by people like you can revolutionize educational and business applications as well bring more fun, fun, fun into your leisure computer activities.

BP404—How To Create Pages for the Web Using HTML \$7.99. Companies around the world, as well as PC users, are fast becoming aware of the World Wide Web as a means of publishing information over the Internet. HTML is the language used to create documents for Web browsers such as Mosaic, Net-scape and the Internet Explorer. These programs recognize this language as the method used to format the text, insert images, create hypertext and fill-in forms. HTML is easy to learn and use. This book explains the main features of the language and suggests some principles of style and design. Within a few hours, you can create a personal Home Page, research paper, company profile, questionnaire, etc., for world-wide publication on the Web.



BP377—Practical Electronic Control Projects \$7.99. Electronic control theory is presented in simple, non-mathematical terms and is illustrated by many practical projects suitable for the student or hobbyist to build. Discover how to use sensors as an input to the control system, and how to provide output to lamps, heaters, solenoids, relays and motors. Also the text reveals how to use control circuits to link input to output including signal processing, control loops, and feedback. Computer-based control is explained by practical examples.

BP411—A Practical Introduction to Surface Mount Devices \$6.99. This book takes you from the simplest possible starting point to a high level of competence in working with Surface Mount Devices (SMD's). Surface mount hobby-type construction is ideal for constructing small projects. Subjects such as PCB design, chip control, soldering techniques and specialist tools for SMD are fully explained. Some useful constructional projects are included.

BP136—25 Simple Indoor and Window Aerials \$2.99. Many people live in flats and apartments where outdoor antennas are prohibited. This does not mean you have to forgo shortwave listening, for even a 20-foot length of wire stretched out under a rug in a room can produce acceptable results. However, with experimentation and some tips, you may well be able to improve further your radio's reception. Included are 25 indoor and window antennas that are proven performers. Much information is also given on shortwave bands, antenna directivity, time zones, dimensions, etc. A must book for all amateur radio enthusiasts.

BP379—30 Simple IC Terminal Block Projects \$6.99. Here are 30 easy-to-build IC projects almost anyone can build. Requiring an IC and a few additional components, the book's 'black-box' building technique enables and encourages the constructor to progress to more advanced projects. Some of which are: timer projects, op-amp projects, counter projects, NAND-gate projects, and more.

BP401—Transistor Data Tables \$7.99. The tables in this book contain information about the package shape, pin connections and basic electrical data for each of the many thousands of transistors listed. The data includes maximum reverse voltage, forward current and power dissipation, current gain and forward transadmittance and resistance, cut-off frequency and details of applications.

ETT1—Wireless & Electrical Cyclopedia \$4.99. Step back to the 1920's with this reprinted catalog from the Electro Importing Company. Antiquity displayed on every page with items priced as low as 3 cents. Product descriptions include: Radio components, kits, motors and dynamos, Leyden jars, hot-wire meters, carbon mikes and more. The perfect gift for a radio antique collector.

BP93—Electronic Timer Projects \$2.99. This book covers many of the possible applications of timer circuits. These circuits may turn on or off at either some preset time or after an elapsed time. Some of the more complicated timer and clock circuits are made up from a number of simpler circuits that the author deals with individually. Also included are several special interest circuits such as cars windshield wiper delay unit, a darkroom timer, metronome, etc.

BP88—How To Use Op-Amps \$5.99. Written as a designer's guide covering many operational amplifiers, serving both as a source book of circuits and a reference book for design calculations. There are chapters on Meet the Operational Amplifier, Basic Circuits, Oscillators, Audio Circuits, Filters, Miscellaneous Circuits, Common Op Amps, Power Supplies and Construction Notes and Fault Finding.

BP76—Power Supply Projects \$3.99. Presents a number of power-supply designs including simple unbiased types, fixed voltage-regulated types and variable voltage stabilized designs. All are low-voltage types intended for use with semiconductor circuits. Apart from presenting a variety of designs that will satisfy most applications, the data in this book should help the reader to design his own power supplies. An essential addition to the experimenters electronics library.

ELECTRONIC TECHNOLOGY TODAY INC.
P.O. BOX 240, Massapequa, NY 11762-0240

Name _____
Address _____
City _____ State _____ Zip _____

SHIPPING CHARGES IN USA AND CANADA

\$0.01 to \$5.00.....	\$2.00
\$5.01 to \$10.00.....	\$3.00
\$10.01 to \$20.00.....	\$4.00
\$20.01 to \$30.00.....	\$5.00
\$30.01 to \$40.00.....	\$6.00
\$40.01 to \$50.00.....	\$7.00
\$50.01 and above.....	\$8.50

SORRY No orders accepted outside of USA & Canada

	No. of Books Ordered <input type="text"/>
Total price of books	\$ _____
Shipping (see chart)	\$ _____
Subtotal	\$ _____
Sales Tax (NYS only)	\$ _____
Amount Enclosed	\$ _____

All payments must be in U.S. funds!

NW2

Allow 6-8 weeks for delivery

usual 80 rectifier and a two-position tone control.

The Model 70 with AVC is quite similar to the third variation of the Model 90 and, like it, uses the Type 35 remote-cutoff amplifier in the RF and IF stages, as well as a type-24 oscillator/mixer. This newer Model 70 variation still has seven tubes because a separate first audio stage has been added (another type 35), following the type-27 detector. Again, there is a single-ended audio output using a type 47.

SOME ACKNOWLEDGEMENTS

Some of the information for this article comes from Ron Ramirez's excellent reference: *Philco Radio 1928-1942*. I'm also indebted to Ron for permission to reproduce illustrations from the book here this month. Other sources are two of Ron's articles on Philco in *Antique Radio Classified Magazine* (February 1991 and June 1993) and the Philco schematics published by John Rider. Those interested in purchasing the Ramirez book (8 1/2 x 11, softcover; 160 pages; slick paper; over 800 illustrations; \$29.95) will find it on sale at *Antique Radio Classified* (ARC; PO Box 2-V127, Carlisle, MA 01741) or Antique Electronics Supply (AES; 6221 South Maple Ave., Tempe, AZ 85283). You may write ARC for a free sample copy of their magazine and/or AES for a free catalogue—both of which include a complete booklist.

AN IMPORTANT NOTE—MOVING TIME

Readers, it's time to bid you a sad goodbye! With this column, *Antique Radio* leaves the pages of **Popular Electronics**. But the good news is that we won't be going very far; in fact, we're moving just across the aisle to our sister magazine *Electronics Now*. The move is part of an ongoing reorientation of the editorial balance of both **PE** and *EN*.

I have to be a bit wistful about the change, because I cut my teeth in radio writing as an Associate Editor on the staff of the original **PE**, back when it was a Ziff-Davis publication with offices in midtown Manhattan. When Gernsback Publications purchased and revived the title several years ago, I was pleased to be working for the magazine again. (I had already put in a

two-year stint as *Antique Radio* columnist for Gernsback's *Hands-On Electronics*, which became **Popular Electronics**.)

That was in November 1988 and I've been doing a column a month for **PE** ever since. However, I'm looking forward to putting in *at least* another ten years at *EN*. Look for the next "Antique Radio" in the May issue of *EN*, where we'll continue talking about depression radios. ■

NEW PRODUCTS

(continued from page 12)

The BNC Model 625A costs \$995. For more information, contact Berkeley Nucleonics, 3060 Kerner Blvd. #2, San Rafael, CA 94901; Tel. 800-234-7858 or 415-453-9955; Fax: 415-453-9956; Web: berkeley-nucleonics.com/smartarb/smartarb.htm.

CIRCLE 83 ON FREE INFORMATION CARD

NOISE GENERATOR

The *Noise Plug* is a complete precision pink-noise generator built in an XLR microphone connector. Simply plug it into a phantom-powered microphone input on your mixer and turn up the volume.



Inside is an ultra wideband, avalanche-junction white-noise source. The output of the source is frequency limited, amplified, and passed through a precision -3dB per-octave low-pass filter. The result is a full audio spectrum noise source with equal energy distribution in all octaves.

The Noise Plug can be used to check over-all audio-system operation; adjust speaker crossover points and balance; check frequency response of amplifiers, tape decks, and other audio components; and adjust system equalization.

Pink noise is also often used in noise-masking systems for the purpose of reducing annoyance from other noise sources.

The Noise Plug costs \$49.95. For more information, contact GTC Industries, Inc., P.O. Box 2493, Napierville, IL 60567; Tel. 630-369-9815; Fax: 630-369-9198.

CIRCLE 84 ON FREE INFORMATION CARD

HANDHELD GPS RECEIVER

Combining a world-wide background map with detailed inland cartography and a database of marine navigational aids, the *Map 410* handheld GPS receiver is versatile enough to meet the needs of motorists, mariners, and campers.



The built-in basemap includes coastlines, cities, lakes, rivers, railroads, and highways. Also included is a database of marine navigation aids, such as floating and fixed buoys, lighthouses, and radio beacons. All the data is presented on an ultra-sharp display (240 by 120 pixels).

Because the Map 410 is PC-compatible, users can also download saved locations and routes into their PCs for editing and storage. The easy-to-learn menu interface uses an intuitive operating system and on-screen instructions. Nine graphical-navigation screens, including a real-time multiple-track plotter with adjustable scale show the user where he's going, the path traveled, and the distance to the destination.

The Map 410 has an expected street price of \$349.99. For more infor-

mation, contact Magellan Corp., 960 Overland Court, San Dimas, CA 91773; Tel. 800-611-7955 or 909-394-5000; Fax: 909-394-7050; Web: www.magellan.com.

CIRCLE 85 ON FREE INFORMATION CARD

DIGITAL ANEMOMETER

Ideal for field service, engineers, and repair technicians, the *Digital Mini Anemometer* measures air velocity in four different units with 3% basic accuracy. Measurements are displayed on a bright 3-1/2 digit LCD (1999 count) with low-battery indication. Its battery power and plastic housing, along with its fast sampling rate (0.4 secs.) make the pocket-size vane anemometer and its remote probe very useful for field work.



Measurements range from 160 to 5900 ft./min, 1.6 to 58 knots, 0.8 to 30 m/sec, and 2.8 to 108 km/hr. The low-friction, ball-bearing, twisted-arm vane structure ensures precise low and high readings.

Applications for the anemometer include installation, service, and testing of airways, air-ducts, and ventilation systems; environmental, wind, temperature, and humidity testing; and air-conditioning and heating-system checks, repairs, and optimization.

The Digital Mini Anemometer costs \$149. For more information, contact Extech Instruments, 335 Bear Hill Road, Waltham, MA 02451; Tel. 781-890-7440; Fax: 781-890-7864; Web: www.extech.com.

CIRCLE 86 ON FREE INFORMATION CARD

TWO-WAY RADIO

One of the world's smallest Family Radio Service Two-Way UHF radios, the *ENC 5040* measures only 4 3/8 by 2

3/8 by 1 inches and weighs only a little over 5 ounces. It is a great way for families, sportsmen, or campers to keep in touch just about anywhere indoors or outdoors—at work, at home, at a campsite, out shopping, or at an amusement park. No licenses are required, and there are no monthly fees.



It is a full-featured model with 14 UHF Family Radio Service Channels, a 9-digit backlit LCD display, and with up to a two-mile transmission range. Other features include low-battery warning indicator, power-save mode, volume control, scan, total time select, busy lock, and a rugged, impact-resistant case.

The ENC 5040 has a suggested retail price of \$139.95. For more information, contact ENC Electronics, Inc., 13620 Cimarron Avenue, Gardena, CA 90249; Tel. 800-530-9386 or 310-366-1314; Fax: 310-366-1314; Web: www.etri.com.

CIRCLE 87 ON FREE INFORMATION CARD

METAL DETECTOR

The *CZ-7a Quicksilver Metal Detector* is a microprocessor-controlled, target-I.D. unit. It includes a built-in, sealed weatherproof speaker and a round



double-locking, fiberglass lower stem.

Features of this detector are 7-category visual target I.D., 3-tone audio target I.D., a bell tone for unidentifiable targets, programmable notch discrimination, a wide-scan all-metal auto-tune mode, a wet-sand mode, touchpad VCO pointing, and an LCD display.

The CZ-7a Quicksilver Metal Detector has a suggested retail price of \$1050. For more information, contact Fisher Research Laboratory, Dept. PE, 200 W. Wilmott Road, Los Banos, CA 93635; Tel. 800-M-SCOPE or 209-826-3292; Fax: 209-826-0416; Web: www.fisherlab.com.

CIRCLE 88 ON FREE INFORMATION CARD

DIGITAL MULTIMETERS

Meant for use in electronic and electrical field service, plant maintenance, and engineering/R&D applications, the *Models 2880A* and *2890* high-performance, dual-display DMMs are handheld devices (37 x 90 x 192 mm) offering true RMS measurements. Both models offer RS-232 computer interface and in-depth, long-term signal analysis using the dual display.



The meters provide two user-selectable operating resolutions (4000/40,000 counts), voltage to 1000 VDC/750 VAC, current to 10A, a dual-display offering frequency to 200 kHz with AC signal measurement, resistance to 40 megohms, capacitance to 9999 µF, and diode check and continuity. These instruments feature data hold, relative mode, and MAX/MIN/AVG of inputs with an elapsed timer counting the time to the event.

Single quantity pricing for the Model 2880A is \$199 and for the 2890 is \$299. For more information, contact B&K Precision Corp., 1031 Segovia Circle, Placentia, CA 92870-7137; Tel. 714-237-9220; Web: www.bkprecision.com.

CIRCLE 89 ON FREE INFORMATION CARD

The Electronics Industry is looking for a lot of good people!

Here is your chance to get in on the ground floor as an Associate CET. Is your job title "Electronics Service Technician?" Would you like to have that title? You can prove you qualify for the title with a CET Associate Certificate. It can be your career door-opener and begin your rapid advancement!

A technician or student of electronics with less than a total of four years of basic experience may take the Associate Level Exam. The exam is the basic electronics portion of the full-credit CET exam. The 75-question, multiple-choice test covers basic electronics, math, DC and AC circuits, transistors and semiconductors, instruments, measurements and troubleshooting. A successful Associate CET will receive a wall certificate valid for four years and is eligible to join ISCET as an Associate Member. ISCET is the International Society of Certified Electronics Technicians.

The ISCET Computer-Aided Associate-Level Study Guide prepares you for the Associate CET Certificate by randomly selecting sample questions with appropriate diagrams, provides multiple-choice answers, grades the test and provides a summary of your strong and weak points.

Diskette requires IBM computer or compatible with VGA color monitor, 3.5-in. drive and a hard-disk drive.

CLAGGK INC. - CET Computer-Aided Study Guide Offer
PO Box 4099, Farmingdale, New York 11735

YES, I want to step up to a career in servicing. Here is my order for the CET Computer-Aided Study Guide on a 3.5 diskette. I am enclosing **\$39.95** (price includes U.S. shipping and handling) in U.S. funds. Canadians and overseas add \$6.00 per order for shipping.

Bill my VISA MasterCard Expire Date / /
 USA Bank Check US or International Money Order

Card No. _____

Signature _____

Name (Please Print) _____

Address _____

City _____ State _____ Zip _____

New York residents add local sales taxes. Do not send cash. Checks drawn on US Bank and International Money Orders in US funds only. Credit card users may telephone or FAX orders. Telephone 516-293-3751 or FAX 516-293-3115. Price subject to change. Allow 6 to 8 weeks for delivery.

CB06

Proof Positive that you are a Certified Electronics Technician



A New

Computer Software Program — ISCET Computer-Aided Associate-Level Study Guide

Prepare yourself for the 75-question CET Associate Examination. Model examinations provide the technician with a study program and introduction to the actual examinations. The model examinations are automatically graded in decimal numbers and bar graphs that can be outputted on your printer. The questions for each exam are selected randomly from a loaded data base—no two exams are exactly the same. When you answer a question, the correct answer is displayed and an explanation is given. From the printouts you will determine whether you need more practice and in which topic areas, or if you are ready to take the real test and continue to promote your electronics career today!

Market Center

5 Axis Robotic Arm \$195.00 Plus S&H



You can build this Robotic Arm

Impressive, fast, accurate, and repeatable motion. Any computer or micro capable of sending 2400 or 9600 baud serial data can control the arm. It can even be controlled from a Basic Stamp. This robot arm makes a great foundation for many AI and motion control experiments. Position the arm in an X, Y, Z, grid with a joystick or keyboard using the new RoboMotion for Windows. The kit includes the hardware, structural components, Hitec servos, pre-assembled SSC servo controller, DOS and Windows software, and an illustrated assembly manual. Camouflage paint not included.



We have many more cool robots, check out our web page or ask for our free catalog!

Lynxmotion, Inc.
104 Partridge Road
Pekin, IL 61554-1403
www.lynxmotion.com



Tel: 309-382-1816
Fax: 309-382-1254
sales@lynxmotion.com
tech@lynxmotion.com



EPROM+

A device programming system for design, repair and experimentation

- ◆ EXCEPTIONAL POWER FOR THE PRO
- ◆ EASY-TO-USE FOR THE NOVICE
- ◆ INCLUDES STEP-BY-STEP TUTORIAL

Here's what you get: A rugged, portable programming unit including the power pack and printer port cable both of which store inside the case. A real printed user and technical manual which includes schematic diagrams for the programming unit plus diagrams for all technology family adapters.* Comprehensive, easy-to-use software which is specifically designed to run under DOS, Windows 3.1, 95 and 98 on any speed machine. The software has features which let you READ, PROGRAM, COPY and COMPARE plus much more. You have full access to your system's disk including LOADING and SAVING chip data plus automatic processing of INTEL HEX, MOTOROLA S-RECORD and BINARY files. For detailed work the system software provides a full screen buffer editor including a comprehensive bit and byte tool kit with more than 20 functions.

Broad device support: FIRST GENERATION EPROMS (2708, 2716, 2732, 2764, 27128, 27160, 27C1024, 27C160) SECOND GENERATION EPROMS (28F20C, 29EE, 29F), EEPROMS (2816, 28C, 01D), NVRAMS (12XX, X2210/12) 8 PIN SERIAL EEPROMS* (24, 25, 85, 93, 95, 8001A) PI (S, ERI, 400/M58657) AND ERS911 BIPOLAR PROMS* (72S/82S), FPGA CONFIGURATORS (17K, XXX) MICROCONTROLLERS* (874X, 875X, 87C, 5XX, 87C, 75X, 89C, 5X) ATMEL MICROS* (8-40 PIN, 89C, X051, 89S, XXXX, (AVR), 90S, XXXX PIC MICROS* (8, 18, 28, 40 PIN, 12C, XXX, 16C, XXX, 16F, XXX, 17C) MOTOROLA MICROS* (68705P, 3A13, R3, 68HC705, 68HC711)

\$289

REQUIRES SNAP-IN ADAPTER (FOR THE FACTORY DIRECT OR BUILT YOURSELF) \$5.00 SHIPPING + \$5.00 C.O.D. 1 YEAR WARRANTY - 30 DAY MONEY BACK GUARANTEE. VISA MASTERCARD* AMEX

ANDROMEDA RESEARCH, P.O. BOX 222, MILFORD, OH 45150
(513) 831-9708 FAX (513) 831-7562 website - www.arlabs.com

CABLE TV CONVERTERS

Equipment & Accessories
Wholesalers Welcome
Call C&D ELECTRONICS
1-888-615-5757 M-F 10a-6p

BROADCAST EQUIPMENT

We manufacture & carry Stereo FM Transmitters, RF Amplifiers, Low Pass Filters, Antennas, DJ Mixing Boards & Consoles, Mics, Compressor/Limiters, Digital Reverbs, Automation Software, RF Test Equipment, RF Parts including BGY133's, and much more! Call For Free Catalog.

Progressive Concepts
PO BOX 586 STREAMWOOD, IL 60107
(630) 730-9822 FAX: (630) 736-0353

PRINT YOUR OWN CIRCUITS

TURN ANY ORDINARY PAPER INTO A HIGH QUALITY TONER TRANSFER. Join over 5,000 satisfied customers

www.starletsystems.com/now/

Weeder Technologies



Visit our ON-LINE CATALOG



Pro-Kit

PO Box 2426, Ft. Walton Beach, FL 32549

www.weedtech.com

Voice/Fax 850-863-5723

Stackable RS-232 Kits

Digital I/O - 12 I/O pins individually configurable for input or output. DIP switch addressable; stack up to 16 modules on same port for 192 I/O points. Turn on/off relays. Sense switch transitions, button presses, 4x4 matrix decoding using auto-debounce and repeat. **\$32**

Analog Input - 8 Input pins. 12-bit plus sign self-calibrating ADC. Returns results in 1mV steps from 0 to 4095. Software programmable alarm trip-points for each input. DIP switch addressable; stack up to 16 modules on same port for 128 single-ended or 64 differential inputs. **\$49**

Home Automation (X-10) - Connects between a TW523 and your serial port. Receive and transmit all X-10 commands with your home-brewed programs. Full collision detection with auto re-transmission. **\$39**

Caller ID - Decodes the caller ID data and sends it to your serial port in a pre-formatted ascii character string. Example: *12/31 08:45 850-863-5723 Weeder, Terry <CR>*. Keep a log of all incoming calls. Block out unwanted callers to your BBS or other modem applications. **\$35**

Touch-Tone Input - Decodes DTMF tones used to dial telephones and sends them to your serial port. Keep a log of all outgoing calls. Use with the Caller ID kit for a complete in/out logging system. Send commands to the Home Automation or Digital I/O kits using a remote telephone. **\$34**

Telephone Call Restrictors

Two modes of operation; either prevent receiving or placing telephone calls (or call prefixes) which have been entered into memory, or prevent those calls (or call prefixes) which have "not" been entered.

Block out selected outgoing calls. Bypass at any time using your password. **\$35**

Block out selected incoming calls. Calls identified using Caller ID data. **\$48**

Phone Line Transponder

7 individual output pins are controlled with buttons 1-7 on your touch-tone phone. Automatically answers telephone and waits for commands. Monitor room noises with built in mic. "Dial-Out" pin instructs unit to pick up phone and dial user entered number(s). Password protected. **\$49**

IR Remote Control Receiver

Learns and responds to the data patterns emitted by standard infrared remote controls used by TVs, VCRs, Stereos, etc. Lets you control all your electronic projects with your TV remote. 7 individual output pins can be assigned to any button on your remote, and can be configured for either "toggle" or "momentary" action. **\$32**

DTMF Decoder/Logger

Keep track of all numbers dialed or entered from any phone on your line. Decodes all touch-tones and displays them on a 16 character LCD. Holds the last 240 digits in a non-volatile memory which can be scrolled through. Connect directly to radio receiver's speaker terminals for off-air decoding of repeater codes, or numbers dialed on a radio program. **\$55**

Any waveform you want!



New Features:

- ✓ 21.5 MHz
- ✓ .01 Hz steps
- ✓ multi-unit phaselock

Telulex Inc. model SG-100A

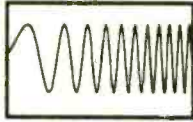

DC to 21.5 MHz linear and log sweeps



Int/Ext AM, SSB, Dualtone Gen.

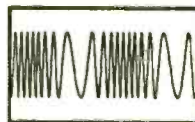

Int/Ext FM, PM, BPSK, Burst

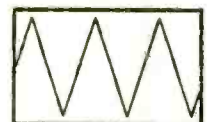

Ramps, Triangles, Exponentials

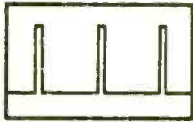

Pulse Generator



Noise



Arbitrary Waveforms

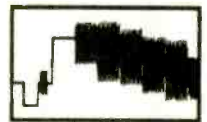

Unlimited Possibilities!

Telulex Inc.

2455 Old Middlefield Way S Tel (650) 938-0240 <http://www.Telulex.com>

Mountain View, CA 94043 Fax (650) 938-0241 Email: sales@Telulex.com

CIRCLE 137 ON FREE INFORMATION CARD

INTERNET SECURITY

The latest tricks and methods hackers use on the Net to pirate software (warez), and hack websites. Includes examples, countermeasures, password defeats, Packet-Switched Networks, UNIX, Sprintnet, X.25, anonymous FTP, brute force techs, lots of tips. *More!* \$29. wvds=29AK

INTERNET TRACKING & TRACING Scammers, spammers, stalkers, infectors, and others hide behind the Internet's anonymity to commit serious offenses. Learn from master hackers best methods to track, trace IDs and origins, and to protect your own privacy. *More!* \$29. wvds=17OK

INTERNET FRAUDS DATABOOK Internet cons, scams and related frauds now rake in \$2+ Billion annually! Most are done anonymously with impunity. Details how they're done, how to ID them, how to protect yourself. *More!* \$25. wvds=19IK

THE COOKIE TERMINATOR Many websites track your every move! Browser cookie, history and cache files contain personal data readily accessible to Internet predators, scammers, spammers and snoops. Your financial, medical, political, habits, lifestyle, future plans data is exposed to the world! Step-by-step how to remove and stop cookies from destroying your privacy. \$25. wvds=8AK
Any 2 for \$49, 3 for \$64, all 4 for \$79!

PBX SECURITY

PBXs hacking losses of \$5-\$10 Billion/yr! Detailed vulnerabilities (especially for out-dial), countermeasures. Exclusive author interview in Forbes! \$24. wvds=17.4K

ATM SECURITY

100+ ATM crimes, abuses, vulnerabilities, defeats exposed - TEMPEST, mag stripes, false fronts, supercool. *More!* Case histories, labeled internal photos, figures. \$39. wvds=41OK



CONSUMERTRONICS

2430 Juan Tabo, NE, #259, ABQ, NM 87112

P.O. Box 23097 ABQ, NM 87192

Fax: 505-292-4078 (all hours, orders only) Voice: 505-237-2073 (9-5 M-S)

Full Web Catalog: www.tsc-global.com

Special Projects: spaf-spp.html

Established in 1971 by John Williams, MSEE, former DOD weapons engineer and NIH physicist. Featured on CBS' '60 Minutes,' Forbes, New York Times. Add \$5 total S/H (US, Canada). Postal MO is fastest! VISA, MC OK. No CODs. 10% OFF all Orders over \$100. \$2.00 OFF all New Orders over \$20 placed by Mail or Fax. wvds=Estimated Word Count

Sold for legal educational purposes only. Some publications are controversial! We take no responsibility for anything we publish. See Catalog for WARRANTY, SPECIAL PROJECTS and all other applicable policies.

CELLPHONE/CORDLESS GUIDE

How cellphones operate; mods. Vulnerabilities to hack attack; countermeasures. Cloning details for NAMs, ESNs, etc, control data formats, computing encoded MINs, ESNs, SIDHs, Op Sys, PROMs, forcing ACK, test mode and resets, cable diagrams, scanning, tracking, scanner restorations, freq allocations, roaming, step-by-step to keypad-reprogram 100+ popular cellphones. One FREE database search. Plus much on Cordless phones. *More!* \$49. wvds=80OK

PAGER (BEEPER) MANUAL How Pagers work, different types and uses, freqs, advantages over and uses with cellphones, and tips and tricks. How pagers hack Pagers; countermeasures. Plus plans for a Personal Pocket Paging System (xmitter and receiver). *More!* \$29. wvds=11.7K
Both for only \$69!

CALLER ID & ANI SECURITY

How they work and the many vulnerabilities of Caller ID, ANI, '69, '87, Call Blocking, '67, et al. Describes ESS, SS7, CNA, CAMA, DNR, Diverters, Centrex! \$25. wvds=15.2K

FAX MACHINE SECURITY

All known methods used to hack Faxes and countermeasures. Includes computer fax modems, crimes, interceptions, fax servers, fax-on-demand, protocols, parameters, compression, encryption, and fax surveillance-type mods. *More!* \$29. wvds=28OK

VOICE MAIL SECURITY

VMSs are hacked to penetrate PBXs to make outgoing calls, get free VMB usage, secretly read/change/delete messages, control or damage the VMS (or its PBX) itself. Details how hackers do it, countermeasures. A must for users, sysops, security personnel! \$29. wvds=14.2K

STOPPING POWER METERS

As reported on "60 MINUTES"! 6th Edition! Details devices that can slow down (even stop) power meters while loads draw full power - great science projects! Devices plug into one outlet and normal loads into other outlets. Describes meter creep, overload droop, pole meters, etc. \$29. wvds=10AK

SPM THE VIDEO Now its easier to learn about KW-HR Power Meters than ever before! This educational video shows you how they work and their anatomy. Demonstrates SPMEM device and external magnetic methods used to slow and stop meters! Hosted by a top expert in the field. From the novice to the pro, an excellent source of info on these exciting devices! Great in combo with our SPM-related manuals! \$29. (20 min)

THE I.G. MANUAL Details external magnetic ways (applied to meters) outlaws use to slow down and stop power meters while drawing full loads. \$25. wvds=4.9K

KW-HR METERS How watt-hour energy meters work, calibration, error modes (many), ANSI Standards, etc. Demand and Polyphase Meters. Experimental results to slow, stop power meters by others. \$25. wvds=24.2K
Any 2 for \$49, 3 for \$64, all 4 for \$79!

COMPUTER SECURITY

Describes in detail how computers penetrate each other, and how VIRUSES, TROJAN HORSES, WORMS are implemented. Dozens of computer crime and abuse methods and countermeasures. Includes disk filled with hacker text files and utilities, and the legendary FLUSHOT+ protection system. Internet advice, password defeats, glossary - much more! Manual + PC Disk! \$39. wvds=49.5K

THE HACKER FILES Expose 3 HD PC disks filled with choice raw, colorful, highly informative hacker, phreaker text files covering many topics! \$39.
Both for only \$69!

BEYOND VAN ECK TEMPEST

Remote eavesdropping plans of TV video "noise" signals. Range up to 1 KM. Describes how van Eck systems work, and are also used in surveillance of computer systems. Plus TVRO vs phone privacy detailed! \$29. wvds=14.9K
Van Eck Demo Tape is \$29. (15 min). Both for only \$49!

MANY MORE TITLES!

(See Catalog for prices & descriptions)
BEYOND PHONE COLOR BOXES
ANSWER, MACHINE SECURITY
CASINO SECRETS
CHECK & M.O. SECURITY
CREDIT CARD SECURITY
CONS & SCAMS DATABOOK
SOCIAL ENGINEERING
POLYGRAPH SECRETS
BY AN ORDER OF THE MAGNITUDE
ULTIMATE SUCCESS MANUAL
STEALTH TECHNOLOGY
SIMPLE/CHEAP SECURITY ELEC.
SECRET & SURVIVAL RADIO
THE "GOLDFINGER"
THE "SILKWOOD"
SECRETS OF SOLDERLESS BBS
HIGH VOLTAGE DEVICES
MIND CONTROL
UNDER ATTACK!
RADIONICS MANUAL
HEAL THYSELF!
SECRET & ALTERNATE IDs
CRYPTANALYSIS TECHNIQUES
GOVERNMENT LAND GRAB
ROCKET'S RED GLARE
SURVIVAL GUNS & AMMO
THE ULTIMATE DRIVER

THE DIRTY-2 DOZEN!

The Hot Hack Phreak, Expose, Disk!

See CATALOG!

SPECIAL PROJECTS

We will design & build just about anything electronic!
Hardware done as SPECIAL PROJECTS.
Send #10 SASE or \$1 for SP Application Form, else get at: www.tsc-global.com/spaf-spp.html

NOW MAKE AN EXTRA \$600 PART TIME WEEKENDS -- UP TO \$2,000 A WEEK FULL TIME IN *Explosive* SATELLITE DISH TV/ELECTRONICS FIELD!

Hottest Career Opportunity Since Invention of the VCR!

See How Fast The Money Rolls In!

Part time: *Here's what you can earn
over a typical weekend:*

Install 2 Satellite dish systems at \$200 = \$400
Repair 4 TV's at \$50 each = \$200

Total Weekend Income = \$600

Full time: *Working just five days a week
you could easily earn:*

Install 5 Satellite dish systems at \$200 = \$1,000
Repair 10 TV's, average \$50 each = \$500
Clean and adjust 10 CD players, average \$35 each = \$350
Service 2 Home entertainment centers at \$75 = \$150

Total Weekly Income = \$2,000

**In addition you can make big extra profits
on other supplies you furnish!**

Get in *THE FAST LANE* on the NEW "INFORMATION SUPERHIGHWAY" Everyone's Talking About!

It's exciting! It's gigantic! The technology of tomorrow is here today! You've been reading and hearing about the amazing Information Superhighway. It's so new that few technicians are equipped to service

this fast emerging field! Foley-Belsaw gives you Satellite dish technology (including new mini-dish) along with the electronic expertise you need to make big money servicing TVs and other electronic equipment.

Be your own boss! It's quick and easy to become an expert at home in your spare time. Earn really BIG money adjusting, installing and repairing · *Satellite dish systems* · *TVs* · *Amplifiers* · *CD players* · *AM/FM tuners* · *Home entertainment centers*. Every home, every business, every office in your area desperately needs your expertise!

Your timing just couldn't be better! Never before and probably never again will you have a ground-floor opportunity like this to get into a booming business of your own, make really big money starting right away, be your own boss and enjoy financial freedom and security. The fact you're reading this message shows you're smart enough to realize this!

Satellite dish/TV/Electronics is easy

to learn in your spare time at home. This modern, practical hands-on course combines simple step-by-step lessons with easy-to-follow video cassette guidance. No special experience or electronics background is necessary. Just average mechanical aptitude and the ability to follow simple A-B-C repair procedures that are clearly outlined for you.

And when you complete the course you will receive Foley-Belsaw's official diploma attesting to your expertise.

**30-DAY
NO RISK TRIAL**
Send for details



Send coupon today for FREE Fact Kit. No obligation.

Don't miss out on this once-in-a-lifetime opportunity. Send in the coupon NOW. Get all the facts and study them in the privacy of your own home. There's absolutely no obligation and no salesman will call on you. So don't delay. Mail the coupon today!

MAIL TODAY FOR FREE INFORMATION PACKAGE

Foley-Belsaw Institute
6301 Equitable Road
Kansas City, MO 64120-1395



- YES!** Without obligation send free information kit so I can learn how to become a professional Satellite Dish/TV/Electronics Specialist, in order to earn high extra income. Dept. 31693
- VCR Repair**-Unlimited profits in this growing field. Dept. 62922
- Interested in an exciting, money making career in **Computer Repair, Maintenance and Upgrade?** Dept. 64831
- Personal Computer Programming**-Learn fast at low cost for big earnings. Dept. 35640

Name _____

Address _____

City _____ State _____ Zip _____

Call toll-free 1-800-487-2100

Kenwood CS-4125 Sale!!!

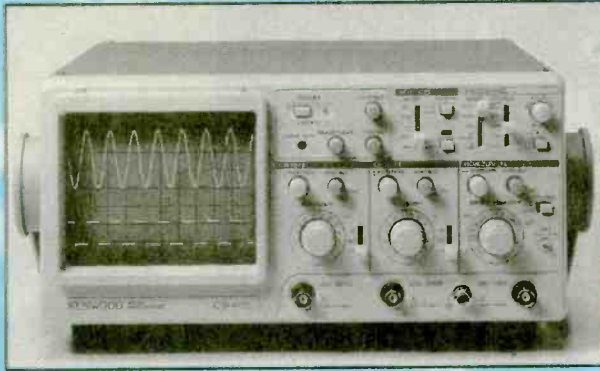

Free **KENWOOD** t-shirt
with purchase of
CS-4125 oscilloscope!!!



KENWOOD

MODEL CS-4125
20 MHz, 2 Channel, includes probes
Suggested Price \$595.00
SUPER SPECIAL \$389.00!!!



8931 Brookville Rd * Silver Spring, MD, 20910 * 800-638-2020 * Fx 800-545-0058
www.prodintl.com

SPARE SCOPE PROBE SPECIAL:

Kenwood PC-35 - 10:1, DC to 50 MHz
Regular \$62.00 **SALE \$29.95**
Kenwood PC-41 - 10:1/1:1, DC to 50 MHz
Regular \$62.00 **SALE \$29.95**

Call today for your free 84 page test & measurement instrument catalog!

CIRCLE 142 ON FREE INFORMATION CARD

Electronic Training Videos



Learn electronics quickly and easily with UCANDO's computer-animated training videos. Students can learn at their own pace and professionals will find the UCANDO videos to be a valuable source of reference material. If these videos aren't the best learning tools you've ever seen, return them within 30 days for a

complete refund. These videos are being used by Tech-Schools, CET's, Military Branches, Ham Operators, Industries, and more, across the United States and around the world. Order today and see how UCANDO is ...

"Changing The Way The World Learns Electronics."

VCR Maintenance & Repair ... \$29.95 All others ... \$44.95 each
• Intro to VCR Repair • Direct Current • Alternating Current • Semiconductors • Power Supplies • Amplifiers • Oscillators • Digital 1 • Digital 2 • Digital 3 • Digital 4 • Digital 5 • Digital 6 • AM Radio • FM Radio Part 1 • FM Radio Part 2 • TV Part 1 • Intro to TV • TV Part 2 • The Front End • TV Part 3 • Audio • Fiber Optics • Laser Technology •

SAVE!!! 6 videos for only \$240 or 12 videos for only \$450



1-800-678-6113

or mail check or money order to:
UCANDO Videos
P.O. Box 928
Greenville, OH 45331



FREE Shipping ... FREE Catalog

CIRCLE 147 ON FREE INFORMATION CARD

CAD FILES TO CASH PILES

IMAGINE THE POSSIBILITIES!

STARTING AT
\$895.00



NOW YOU CAN
TURN YOUR
DREAMS
INTO
REALITY!

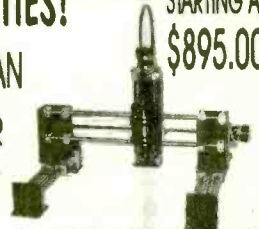

3 AXIS UNITS FROM
12" X 12" TO 60" X 60"
MACHINING AREAS

THE
ROBOPRO X50
CNC ROBOTIC MACHINING SYSTEM

YOUR WISH IS ITS COMMAND!

FREE 3D

ROUTE, MILL, DRILL, CARVE,
ENGRAVE, PAINT, ETC. ...
IN WOOD, PLASTIC, VINYL,
PC BOARD, & LIGHT METALS



CAD/CAM

U.S. CYBERLAB, INC., 14786 SLATE GAP ROAD
WEST FORK, AR 72774 (501) 839-8293

Visit us at www.uscyberlab.com

27pc•kit

\$12.95

**K2637
MINIATURE AUDIO AMPLIFIER KIT**

Big sound from a small unit !
Small PCB with both pre- and power amp
Short circuit protected
Input sensitivity : 20mV
Max. output power : 2.5W
Power supply : 4.5 to 15VDC

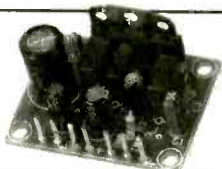

28pc•kit

\$12.95

**K1771
FM OSCILLATOR KIT**

Use for home broadcasts, baby monitoring, security
Frequency range : 100-108MHz
Microphone input
No coils to wind
Power supply : 9-12VDC

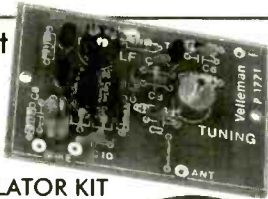

17pc•kit

\$9.95

**K1803
UNIVERSAL MONO
PRE-AMPLIFIER KIT**

Boost any audio signal up to 40dB (x100)
Max input signal : 40mV
Frequency range : 20Hz to 20KHz
Power supply : 10-30VDC/10mA

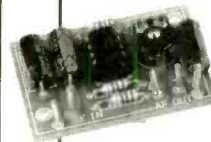

19pc•kit

\$19.95

**K5300
STROBOSCOPE KIT**

Stage effects at home
Adjustable flash rate: 2-20 flashes/second
Powerful flash tube
Supply voltage : 110-125V AC



36pc•kit

\$18.95

**K4304
10 LED VU METER KIT**

Visualise any audio level
Line or speaker inputs
DOT or BAR mode. Range : -20 to +3dB
Front panel included. Vertical or horizontal mounting. Power supply : 10-15VDC

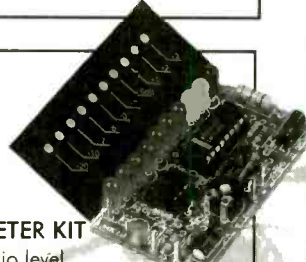

27pc•kit

\$24.95

**K5002
HALOGEN
LAMP DIMMER KIT**

Light control at the touch of a button
Suitable for loads up to 3A
Can control small motors with brushes
Push button operation
Add any number of buttons
Power supply : 110-125V AC

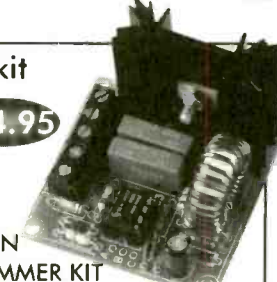

16pc•kit

\$14.95

**K6708
IR REMOTE
CONTROL KEY CHAIN
TRANSMITTER For K6709 Kit**

Range : Up to 24 feet
LED operation indicator
8748 different code settings
Power supply : 12V battery



66pc•kit

\$24.95

**K6709
IR REMOTE
RECEIVER**

For K6708 Kit
The easy way to add a remote control
10A relay with mom. or pulse change-over contact
Allows control of alarm systems, garage doors, outdoor lighting, garden pumps, etc
LED reception indicator
Accepts multiple transmitters K6708
Power supply 2x9VAC or 12 to 16VDC

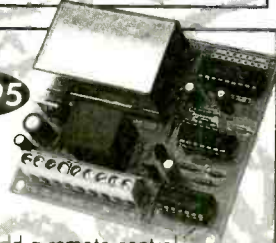

12pc•kit

\$12.95

**K1823
1 AMP
POWER SUPPLY**

Just add a transformer
Adjustable output voltage
1.5V to 35V/1A max.
Short circuit and thermal protection
Max input voltage : 37VDC
Max dissipation : 15W

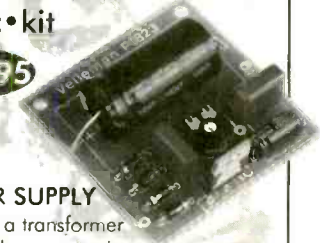

18pc•kit

\$14.95

**K6700
2-WIRE REMOTE
CONTROL TRANSMITTER**

Transmitter For K6701 Kit
Control up to 16 devices*, with only 2 wires ! Remotely control 8 (*16 with 2 units) devices up to 160 feet away. Transmitter is powered over the data wires. Simple operation by means of switches (not included)
Transmitter can drive multiple receivers

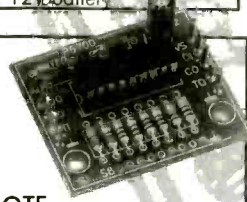

**K6701
2-WIRE REMOTE CONTROL
RECEIVER For K6700 Kit**

8 open collector outputs (max 200mA)
LED output status indication
Daisy chain 2 units for 16 outputs
Power supply : 6-16V DC

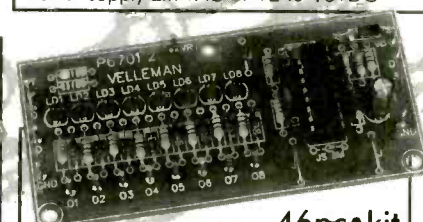

46pc•kit

\$24.95

18pc•kit

\$14.95

**K2579
UNIVERSAL START STOP TIMER KIT**

0-15 Minutes Adjustable Delay
3A changeover relay contact
Start and Stop button included
LED function indicator
Can be modified for longer delays
Power supply : 12V/55mA

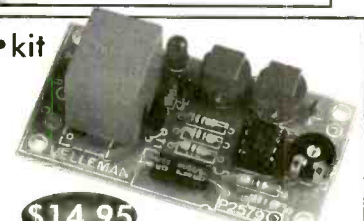

velleman

7415 Whitehall Street Suite 119
Fort Worth, TX 76118
(817) 284-7785 F : (817) 284-7712
www.velleman.be email : velleman@earthlink.net

Questions ? Contact us for a list of US distributors or to get your **FREE** catalogue

CIRCLE 163 ON FREE INFORMATION CARD

CALL TOLL FREE
 (800) 292-7711 orders only
 Se Habla Español

C&S SALES
 EXCELLENCE IN SERVICE

LOOK FOR OTHER
 MONTHLY SPECIALS
 ON OUR WEBSITE

XK-700 Digital / Analog Trainer

Elenco's newest advanced designed Digital / Analog Trainer is specially designed for school projects. It is built on a single PC board for maximum reliability. It includes 5 built-in power supplies, a function generator with continuously sine, triangular and square waveforms and a 1560 tie point breadboard area. Tools and meter shown optional. (Mounted in a professional tool case made of reinforced metal).

XK-700
 Assembled and Tested
\$189.95

XK-700 - SEMI KIT
 w/ Fully Assembled PC Board
\$174.95

XK-700K - Kit
\$159.95



Made in the USA

Digital Multimeter
Model M-1740

\$39.95
 Free Holster

- 11 functions
- Freq to 20MHz
- Cap to 20µF
- AC/DC Voltage
- AC/DC Current
- Beeper
- Diode Test
- Transistor Test
- Meets UL-1244 safety specs



DIGITAL LCR METER
Model LCR-1810

\$99.95

- Capacitance .1pF to 20MF
- Inductance 1µH to 20H
- Resistance .01Ω to 2000MΩ
- Temperature -20°C to 750°C
- DC Volts 0 - 20V
- Frequency up to 15MHz
- Diode/Audible Continuity Test
- Signal Output Function
- 3 1/2 Digit Display



15pc. VCR Service Tool Kit
Model TK-1400

- Inclined Base Screwdriver
- Eccentric Screwdriver
- 2mm & 3mm Fine Adjust Screwdriver
- VHS VCR Head Puller
- Retaining Ring Remover
- 3 Reversible Screwdrivers
- Spring Hook Tool
- Micro Screwdriver
- Hex Wrench Set

Special
\$24.95



Model M-6100

The M-6100 is Elenco's most sophisticated meter with almost every possible feature available. The M-6100 even has a computer interface for viewing and storing data on a personal computer. It comes complete with software, RS-232 cable, test leads and manual.

\$99.95

Model XP-581

4 Fully Regulated DC Power Supplies in One Unit
 4 DC voltages: 3 fixed - +5V @ 3A, +12V @ 1A, -12V @ 1A
 1 Variable - 2.5 - 20V @ 2A

\$79.95



Tektronix DMMs

For high performance digital multimeters that are accurate, reliable, and rugged, the DMM900 series extends the Tektronix line of already affordable DMMs. Twice the accuracy. Up to 10 times the resolution. And a full range of capabilities that span voltage, current, dual numeric display, 3 year warranty, and autorange capability. All backed by the reliability of the Tektronix brand.



912 \$179
914 \$229
916 \$275

Power Supply Kit
Model XP-720K

3 fully reg. DC supplies
 1.5VDC - 15VDC @ 1A
 -1.5VDC to -15VDC
 5VDC @ 3A

Plus
 6.3VAC @ 1A and
 12.6VAC C.T. @ 1A

\$54.95



Available assembled Model XP-720 \$84.95

Sweep Function Generator
 with built-in Frequency counter

Model GF-8036

\$225

- Range .02Hz - 2MHz
- Sine, Square, Triangle, Pulse, Ramp
- Ext. counter 1Hz - 10MHz



Kit Corner

over 100 kits available

AK-700

\$15.95

Phone kit with training course
 4 Flashing neon lights
 See thru case



RADIO CONTROL CAR KIT
MODEL AK-870

- 7 functions
- Remote control included

\$24.95

No Soldering Required



Digital Capacitance Meter
Model CM-1555

\$44.95



- Capacitors from .1pF to 20MµF
- 3 1/2 Digit LCD
- Zero adjust
- special insertion jack
- 1/2% basic accuracy
- Tilt stand

Digital Audio Generator
 with built-in Counter

SG-9300

- 10Hz - 1MHz
- Low Distortion
- Sine/Square waves
- Built-in 150MHz Frequency Counter

\$175



SG-9200 Analog/No counter \$119.95

Model AM/FM-108K
Transistor Radio Kit
 with training course

\$29.95



Free Stand

35mm Camera Kit
 Learn all about photography
AK-540

\$14.95



No Soldering Required

SATELLITE FINDER
Model SF-01

- Aligns Satellite Dishes
- Range 950-2050MHz
- Compact Size
- Self Power Check



\$39.95

RF Generator
 with Counter

Model SG-9500 \$225

- 100KHz - 150MHz
- Internal AM Mod of 1KHz
- RF Output 100MV - 35 MHz
- Audio Output 1KHz @ 1V rms



SG-9000 Analog/No counter \$119.95

WE WILL NOT BE UNDERSOLD C&S SALES, INC.

150 W. CARPENTER AVENUE
 WHEELING, IL 60090
 FAX: (847) 541-9904 (847) 541-0710
http://www.elenco.com/cs_sales/



15 DAY MONEY BACK GUARANTEE
FULL FACTORY WARRANTY
 PRICES SUBJECT TO CHANGE WITHOUT NOTICE

CIRCLE 32 ON FREE INFORMATION CARD

Same Day
Shipping

C & S SALES
Your one stop source for
all your electronic needs!

CALL OR WRITE FOR OUR
NEW FREE 64 PAGE
CATALOG!
(800) 445-3201

Fluke Scopemeters



- 123.....NEW.....\$1140
- 92B.....\$1445
- 96B.....\$1695
- 97.....\$1695
- 99B.....NEW.....\$2095
- 105B.....\$2495

**ALL FLUKE
PRODUCTS
ON SALE**

**B & K PRECISION
SCOPES**

20MHz DUAL-TRACE
Model 2120B - 2 Year Warranty

Special **\$375**

Model 2125A with delayed sweep
\$539.95



- 1mV/division sensitivity
- AUTOMORF triggered sweep operation
- AC, TVH, TVV and line coupling
- Calibrated 19 step time-base with x10 magnifier
- Compact low-profile design

**Affordable Spectrum
Analyzers by B&K**

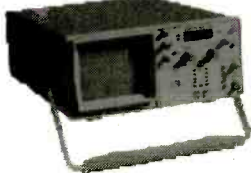

- 500MHz Series** BK2615A **\$1250**
BK2620A **\$1675**
- 150KHz to 500MHz
- Dynamic Range 80dB(113dB with attenuation)
- +20dB maximum input
- 12.5 and 400KHz resolution bandwidth
- 150KHz/hour stability
- Built-in tracking generator(Model 2620A)
- 1.05GHz Series** BK2625A **\$1925**
BK2630A **\$2595**
- 150KHz to 1050MHz
- Dynamic Range 80dB(113dB with attenuation)
- AM & FM demod included
- 20 and 400KHz resolution bandwidth
- 150KHz/hour stability
- Built-in tracking generator(Model 2630A)

PORTABLE SEMICONDUCTOR TESTER

B&K 510

\$199.00

- In or out-of-order circuit tests for transistor, FETs, SCRs and darlington.

**20MHz Sweep / Function
Generator with Freq Counter**

B&K 4040

- 0.2Hz to 20MHz
- AM & FM modulation
- Burst Operation
- External Frequency counter to 30MHz
- Linear and Log sweep



\$399

- 10MHz B&K 4017 **\$309**
- 5MHz B&K 4011 **\$239**

Quality Scopes by Elenco
Lowest Prices of the Year!



60MHz
DS-603 **\$995**

- Analog / Digital Storage
- 20MS/s Sampling Rate
- RS232 Output

S-1360 **\$749**

- Analog with Delayed Sweep
- Component Tester

100MHz

S-1390 **\$895**

- Analog w/ delayed sweep
- Dual Time Base
- TV Sync

Includes
Free Dust
Cover and
Probes

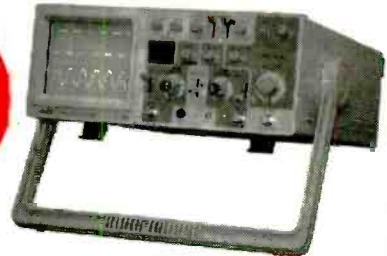

25/30MHz
DS-303 30MHz **\$895**

- Analog / Digital Storage
- 20MS/s Sampling Rate
- RS232 Output

DS-203 20MHz **\$695**

- Analog / Digital Storage

S-1330 **\$439**

- 25MHz Analog
- Delayed Sweep

S-1325 **\$325**

- 25MHz Analog
- TV Sync
- 1mV Sensitivity

**2 Year
Warranty**

Fluke Multimeter Specials



F-73III
\$119

List
\$135



F-T1III
\$165

List
\$185



F-79II
\$175

List
\$199



F-87
\$289

List
\$335

B&K Precision Multimeter Specials



- Accurately measures capacitance, resistance and inductance.
- Measures dissipation factor of capacitors and Q of inductors.
- Simultaneously displays measured value and Q or dissipation factor.
- Displays the difference between measures and reference values.

Model 878 **\$219.95**



- 50,000 count
- 0.025% DCV
- 0.1% ohms
- Min/Max/Avg
- True RMS, AC, or AC+DC
- 100kHz AC response
- Capacitance to 50,000µF
- Frequency, duty cycle, pulse width
- 4B across 1Ω to 10kΩ

- Disturbance indicator
- Autograph, bargraph with zoom
- Sealed case, splashproof
- IEC 1010, class 2 safety compliance

Model 5390
\$295.00

MX-9300

Four Functions in One Instrument

Features:

- One instrument with four test and measuring systems:
 - 1.3GHz Frequency Counter
 - 2MHz Sweep Function Generator
 - Digital Multimeter
 - Digital Triple Power Supply
- 0-30V @ 3A, 15V @ 1A, 5V @2A



\$459.95

GUARANTEED LOWEST PRICES C&S SALES, INC.

UPS SHIPPING: 48 STATES 5%
OTHERS CALL FOR DETAILS
IL Residents add 8.25% Sales Tax

150 W. CARPENTER AVENUE
WHEELING, IL 60090
FAX: (847) 541-9904 (847) 541-0710
http://www.elenco.com/cs_sales/



15 DAY MONEY BACK
GUARANTEE
FULL FACTORY WARRANTY
PRICES SUBJECT TO CHANGE WITHOUT NOTICE
Most Major Credit Cards Accepted

CIRCLE 32 ON FREE INFORMATION CARD

EARN MORE MONEY!

Be an FCC LICENSED ELECTRONIC TECHNICIAN!



Learn at home in spare time.
No previous experience needed!

No costly school. No commuting to class. The Original Home-Study course prepares you for the "FCC Commercial Radio-telephone License." This valuable license is your professional "ticket" to thousands of exciting jobs in Communications, Radio-TV, Microwave, Maritime, Radar, Avionics and more...even start your own business! You don't need a college degree to qualify, but you do need an FCC License.

No Need to Quit Your Job or Go To School
This proven course is easy, fast and low cost! **GUARANTEED PASS**—You get your FCC License or money refunded. **Send for FREE facts now. MAIL COUPON TODAY!**
Or, Call 1-800-932-4268 Ext. 240

COMMAND PRODUCTIONS

FCC LICENSE TRAINING, Dept. 240
P.O. Box 2824, San Francisco, CA 94126
Please rush FREE details immediately!

NAME _____
ADDRESS _____
CITY _____ STATE _____ ZIP _____

CONTROL MEASURE INPUT

RELAYS • LIGHTS • MOTORS
TEMPERATURE • PRESSURE • LIGHT LEVELS • HUMIDITY
SWITCH POSITIONS • THERMOSTATS • LIQUID LEVELS

MODEL 30 \$79

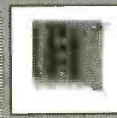

- PLUGS INTO PC BUS
- 24 LINES DIGITAL I/O
- 8 CHANNEL-8 BIT A/D / IN
- 12 BIT COUNTER
- UP TO 146 CMP/SEC

MODEL 45 \$189



- RS-232 INTERFACE
- 8 DIGITAL I/O
- 8 ANALOG INPUTS
- 2 ANALOG OUTPUTS
- 2 COUNTERS-24 BIT

MODEL 100 \$279



- 12 BIT 100 KHZ A/D
- 4 ANALOG OUTPUTS
- 3 TRIGGER COUNTERS
- 24 DIGITAL I/O

MODEL 150-02 \$179



- RS-232 INTERFACE
- TRMS, 20 AMPS
- 12 BIT A/D
- OPTO-ISOLATED
- COMPLETE DMM

MODEL 40 \$109



- RS-232 INTERFACE
- 28 LINES DIGITAL I/O
- 8 ANALOG INPUTS
- PWM OUTPUT

MODEL 70 \$239



- RS-232 INTERFACE
- 12 BIT A/D
- 8.5 DIGIT
- UP TO 68 CMP/SEC

Prairie Digital, Inc.

PHONE 608-643-8599 • FAX 608-643-6754
920 SEVENTEENTH STREET • PRAIRIE DU SAC, WISCONSIN 53578

CIRCLE 150 ON FREE INFORMATION CARD

DATA ACQUISITION & CONTROL

AFFORDABLE PLUG-IN BOARDS FOR PC'S ISA BUS

ANA100 Analog I/O \$ 99



- 8 Channel 8-Bit
- 0 to 5 Volt Input
- 14 TTL I/O lines
- Analog Output
- 400KHz Sampling

DIG100 Digital I/O \$ 39



- 82C55 PPI
- 24 or 48 TTL I/O Lines option
- Selectable Base Address

ANA150 Analog/Counter... \$ 89



- 8 Channel 8-Bit
- 0 to 5 Volt Input
- 3 16-Bit Counters
- 400KHz Sampling

DIG200 Counter I/O \$ 79



- 3 16-Bit Counters
- 8 TTL Input lines
- 8 TTL Output lines
- Selectable Clock Frequency Input

ANA200 Analog I/O \$ 79



- 1 Channel 12-Bit
- 0 to 5 Volt Input
- optional bi-polar
- 100KHz / 300KHz Sampling rate
- 24 TTL I/O lines

ANA201 Analog \$ 119



- 8 Channel 12-Bit
- x1, x5, x10, x50 Programmable Channel gain
- 100KHz Sampling rate

On-Line Product Catalog at Our Web Site
<http://www.Bsof.com>
E-Mail: Sales@Bsof.com

BSOFT Software, Inc.

444 COLTON ROAD * COLUMBUS, OH 43207
PHONE 614-491-0832 * FAX 614-497-9971

Learn MICROCONTROLLERS EMBEDDED SYSTEMS and PROGRAMMING...

...with the AES learning system/ embedded control system. Extensive manuals guide you through your development project. All programming and hardware details explained. Complete schematics. Learn to program the LCD, keypad digital, analog, and serial I/O. for your applications.

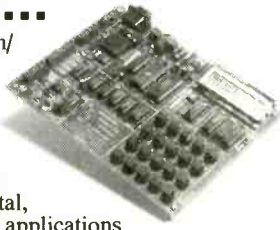

THREE MODELS AVAILABLE. Choose from an Intel 8051, Intel 8088, or Motorola 68HC11 based system. All models come with:

- 32K Byte ROM, 32K Byte RAM • 2 by 16 Liquid Crystal Display • 4 by 5 Keypad • Digital, Analog, and Serial I/O • Interrupts, timers, chip-selects • 26 pin expansion connector • Built-in Logic Probe • Power Supply (can also be battery operated) • Powerful ROM MONITOR to help you program • Connects to your PC for programming or data logging (cable included) • Assembly, BASIC, and C programming (varies with model) • Program disks with Cross Assembler and many, well documented, program examples • User's Manuals: cover all details (over 500 pages) • Completely assembled and ready to use • Source code for all drivers and MONITOR • Optional Text Book

Everything you need. From \$279. Money Back Guarantee

Call for Free Info Pack, or see WEB at <http://www.aesmicro.com> 714-550-8094, FAX 714-550-9941



Call 1-800-730-3232

AES 575 ANTON BLVD., SUITE 300, COSTA MESA, CA 92626, USA

Since 1971



You'll "Bookmark" This Site!

B/W Board Camera with Infra-Red ONLY \$59
Part #VMCB-21
And that's not all!



Color Board Cameras with Audio Function ONLY \$144
Part #VM3010-A
We also have great deals on bullet (B/W & color) cameras, pinhole cameras (B/W & color), some with audio. Get specs, details & prices from our web site.

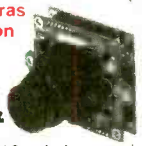

Full-Sized, Full Featured DMM ONLY \$19
Part #9300G
Even includes the rubber boot



Hard Drive Slide Rack for 3.5" IDE Drives ONLY \$14.95
Part #RH-10C-IDE
Allows for easy removal of hard drives. Includes key-lock!



Electronic Soldering Station with Ceramic Heating Element, 3-Conductor Grounded Power Cord, 250-480°C (470-900°F) Fast Heating ONLY \$39
Part #SR-976
Extra tip selection on our web site.



Get all of the specifications and details on these items and thousands of other electronic components, test equipment, PCB supplies, computer parts, and much much more at www.web-tronics.com. Secure on-line ordering, or by FAX, toll free, or snail mail.



Circuit Specialists, Inc.
800-528-1417/(602)464-2485
FAX (602)464-5824

ALFA ELECTRONICS HIGH QUALITY TEST EQUIPMENT

Visit www.alfaelectronics.com for complete info
Call 1-800-526-2532 for Order and Free Catalog

DMM	POP/COUNTER	JUKE	SPECIALTY
DMM-899 (\$179.00): true rms, AC/DC (V,A), Ω, bar graph, freq, capac., dBm, logic, diode	CAP-15 (\$49.95): 3 1/2 digit, 0.1pF-20mF, 9 Ranges, 0.1pF resolution, zero adjustment.	12B \$ 94.95	• AC Current Probe \$34.95
DMM-23T (\$99.95): 4 1/2 digit, true rms, high resol (10µV, 10nA, 10mΩ), hFE, diode, contin.	LCR-24 (\$119.95): 0.1µH-200H, 0.1pF-2000µF, 0.01Ω-20MΩ, diode test. <i>New Model.</i>	70-III \$ 99.00	• DC/AC Current Probe \$79.95
DMM-20 (\$74.95): AC/DC (V, A), Freq, cont., Capac, Induct., Ω, hFE, diode, duty cycle	LCR-131D (\$219.95): autorange, 0.1µH-10kH, 0.1pF-10mF, 1mΩ-10MΩ, Q Factor, serial/parallel, 120Hz/1kHz testing mode.	73-III \$125.00	• Mini AC Clamp \$59.95
DMM-122 (\$59.95): DC/AC (V,A), Ω, hFE, diode, capacitance, freq, logic, continuity	FC-1200 (\$729.95): 1.25GHz Handheld, 8 digits display, 10ppm accuracy, sensitivity 5mV (130-350MHz), 30mV (440MHz)	75-III \$155.00	• AC Clamp w/temp \$89.95
DMM-123 (\$44.95): DMM + capacitance, DC/AC (V,A), Ω, hFE, diode, continuity		77-III \$173.00	• DC/AC Clamp \$109.95
DMM-10 (\$19.95): 3 1/2 digit, DC/AC V, Ω, hFE, diode, signal output(+3V, -0.5Vsq., 50% duty)		79-III \$195.00	• Thermometer \$69.95-\$89.95
		87-III \$325.00	• IR Thermometer \$189.95
		92B-III \$1,445	• Sound Level Meter \$169.95
		99B-II \$1,695	• Tachometer \$169.95-\$219.95
		99B-III \$2,095	• EMP Tester \$69.95
		105B \$2,495	• Pressure Meter \$299.95
		123-III \$1,130	• Watt Meter \$299.95
		863E \$555	• High Voltage Probe \$79.95
		867B \$740	• pH Meter \$79.95
			• Light Meter \$79.95-\$89.95

Single Output DC Power Supplies	Triple Output	AUDIO/RF/FUNCT. GEN.
• Constant current, constant voltage mode • Short Circuit and overload protected	• Independence or Tracking operation (PS-8102 & PS-8103 only) • Parallel to double current output (PS-8102 & PS-8103 only)	RF Generator • SG-4160 (\$124.95) 100kHz-150MHz sinewaves in 8 Ranges • SG-4162AD (\$229.95) with 6 digit counter
Analog Meters Display PS-303 (\$159.00) 30V/3A PS-305 (\$219.95) 30V/5A PS-8112 (\$399.95) 60V/5A PS-1610 (\$289.00) 16V/10A PS-8107 (\$399.95) 30V/10A	Digital Volt, Analog Current PS-8200 (\$179.95) 30V/3A PS-8201 (\$239.95) 30V/5A Digital Volt & Current Display PS-8300 (\$199.95) 30V/3A PS-8301 (\$259.95) 30V/5A	Audio Generator • AG-2601 (\$124.95) 10Hz-1MHz, 0.8Vpp sine, 0-10Vpp squarewave • AG-2603AD (\$229.95) with 6 digit counter Function Generator • FG-2100A (\$154.95) 0.2Hz-2MHz, 5mV-20Vpp • FG-2103 (\$329.95) Sweep 0.5Hz-5MHz

20 MHz Scope	Cursor Readout	Triple Output	Single Output	Programmable	FUNCTION GENERATOR	BENCHTOP DMM
OS-620 \$324.95 • Most economical scope • Dual CH/X-Y operation • 1mV/div sensitivity • Z-axis input, CH1 output • TV syn, ALT trigger • 2 probes (x1, x10)	OS-626G \$599.95 • Readout & Cursor meas • Dual CH / Delay sweep • Built-in delay line • ALT trigger, Hold-Off • Z-axis input, CH1 output • 2 probes (x1, x10)	• 2 variable out 0-30V, 0-3A • One fixed 5V, 3A output • Auto track, serial, parallel • Const. volt, current mode • 4 analog or 2 digital display PC-3030 (\$499.95) PC-3030D (\$549.95) digital	• Const voltage, current mode • Voltage regulation ≤0.01% • Current regulation ≤0.2% PS-1830 (\$198.95) 18V/3A PS-1850 (\$214.95) 18V/5A PS-1830D (\$214.95) 18V/3A PS-1850D (\$244.95) 18V/5A	• Auto serial/parall (PPT ser) • Auto track (PPT series), IEEE-488, 2 and SCPI compatible command set PFS-1860C (\$1,149.95) 18V/6A PFS-3635C (\$1,149.95) 36V/5A PFS-1830C (\$1,499.95) 18V/3A PPT-3615C (\$1,499.95) 36V/1.5A	FG-8020G (\$209.95) • 0.02Hz-2MHz w/counter • Sine/Sqr/Tri/pulse/Ramp FC-8020G (\$209.95) • 0.02Hz-2MHz w/counter FC-8050 (\$449.95) Sweep • 0.05Hz-5MHz w/counter • INT/EXT AM/FM mod	DM-8034 (\$179.95) 3 1/2 digit • AC/DV (V,A), C, Ω, diode DM-8040 (\$339.95) 3 1/2 digit • ACV to 50kHz, true rms DM-8055G (\$889.95) 5 1/2 digit • 0.006% accuracy, GPIB • dBm, auto, REL, min/max

ALFA ELECTRONICS P.O. BOX 8089 PRINCETON, NJ 08543-8089
TEL: (800)526-2532 / (609) 897-1135 FAX: 609-897-0206
E-mail: sales@alfaelectronics.com
Call / Write / Fax / Email for FREE CATALOG
Visa, MC, AMEX, COD, PO Accepted. OEM Welcome.
1 Year Warranty (2 Years for GW/insteK)

CABLE TV EQUIPMENT

Converters, Test Cubes & Chips
Video Stabilizers

1 Year Warranty
30 Day Money
Back
Guarantee

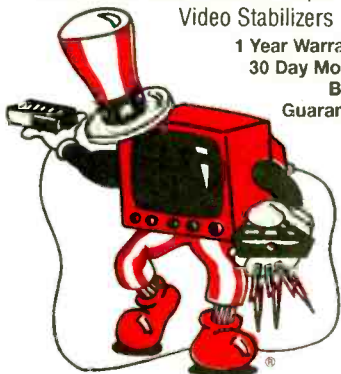

**"ABSOLUTE LOWEST
WHOLESALE &
RETAIL PRICES"
CABLE U.S.A.
1-888-388-CUBE**

Turn Your Multimedia PC into a Powerful Real-Time Audio Spectrum Analyzer

Features

- 20 kHz real-time bandwidth
- Fast 32 bit executable
- Dual channel analysis
- High Resolution FFT
- Octave Analysis
- THD, THD+N, SNR measurements
- Signal Generation
- Triggering, Decimation
- Transfer Functions, Coherence
- Time Series, Spectrum Phase, and 3-D Surface plots
- Real-Time Recording and Post-Processing modes

Applications

- Distortion Analysis
- Frequency Response Testing
- Vibration Measurements
- Acoustic Research

System Requirements

- 486 CPU or greater
- 8 MB RAM minimum
- Win. 95, NT, or Win. 3.1 + Win.32s
- Mouse and Math coprocessor
- 16 bit sound card

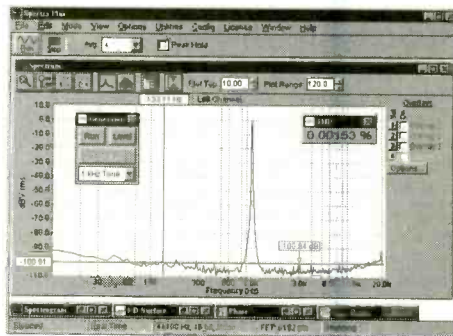

Priced from \$299

(U.S. sales only - not for export/resale)

DOWNLOAD FREE 30 DAY TRIAL!

www.spectraplus.com

PHS Pioneer Hill Software
24460 Mason Rd.
Poulsbo, WA 98370
a subsidiary of Sound Technology, Inc.



Spectra Plus
FFT Spectral Analysis System

Sales: (360) 697-3472

Fax: (360) 697-7717

e-mail: pioneer@telebyte.com

Start an exciting career as a Telecommunications Technician

Train at home in your spare time for an exciting new career! Earn as much as \$35,000 a year and more working with fiber optics, radar and cellular networks.



This ICS program is endorsed by the National Association of Radio and Telecommunications Engineers (NARTE) and features a voucher for the NARTE Class IV Technician Certification exam.

Mail Coupon below for FREE facts or call toll free

1-800-595-5505 ext. 3029

Call Anytime - 24 hours a day, 7 days a week
<http://www.icslern.com> AG01

YES! Please send me free information on how I can train at home for a career as a Telecommunications Technician. There's no obligation.

Name _____ Age _____
Street _____ Apt. # _____
City/State _____ Zip _____
Phone () _____



**International
Correspondence Schools**

A Subsidiary of Harcourt Brace & Company
Dept. AEM049S, 925 Oak Street, Scranton, PA 18515

ATTENTION DEALERS: WHOLESALE ONLY!



**BEST PRICES!
FAST SERVICE
SAME DAY SHIPPING**

EXCLUSIVE:

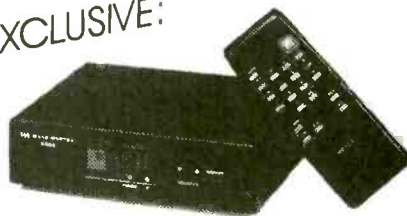

2 PIECE SETUPS: \$85⁰⁰

10 lot • 1 Year Warranty

**Latest Technology • Universal Combo's - Ask For Details
CALL US LAST! LOWEST PRICES GUARANTEED!**

**TOLL FREE:
800-375-3682**



**FAX:
516-246-5634**



**No
Calories.
No Fat.
No
Cholesterol.**

NO KIDDING. Our free Consumer Information Catalog serves up over 200 free and low-cost government booklets you can really sink your teeth into. Perk up your appetite with subjects like saving money, buying a house, educating your children, getting federal benefits, getting right, staying healthy, and many more.

So come 'n get it! Whatever your taste, you can feast on the free Catalog. It's filled with plenty of satisfying booklets. Just call toll-free **1-888-8 PUEBLO**.

Or get a bite on the Consumer Information Center website: **www.pueblo.gsa.gov**

U.S. General Services Administration

ELECTRONIC COMPONENTS

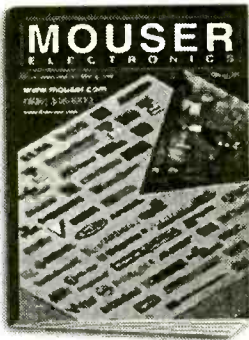

Visit our web site!
www.mouser.com

Subscribe, download, or
view catalog online!

- Over 84,000 Products
- More than 145 Suppliers
- Same Day Shipping
- No Minimum Order

800-992-9943

817-483-6828 Fax: 817-483-6899
catalog@mouser.com

958 North Main St., Mansfield, TX 76063

CABLE T.V. EQUIPMENT

Friendly, Knowledgeable Service



**ORDERS CALL:
1-800-361-4586**



- All Equipment New
- Convertors & Descramblers
- 30 Day Money Back Guarantee
- 6 Month Warranty
- Visa, MC, C.O.D. Welcome

KDE ELECTRONICS, INC.

P.O. Box 1494
Addison, IL 60101

Info. 847-233-0621 HRS: Mon-Fri, 9-6 CST
Fax 847-233-0623 Sat, 10-2 CST

**New and Pre-Owned
Test Equipment**

Goldstar



Model OS-5100 → \$899.00
Full 100 MHz Bandwidth!

- Dual-Channel, High Sensitivity
- TV Synchronization Trigger
- Calibrated Delayed Sweep
- Includes Two Probes, 2 Year Warranty

Spectrum Analyzer
Avcom PSA-37D

Satellite Downlink
Installation
Maintenance & Service

- Band 1 10 - 1750 MHz
- Band 2 3.7 - 4.2 GHz
- Built-in DC Block & Power for LNA/LNB's
- Line or Battery Powered

Only \$2,475.00!

Pre-Owned Oscilloscope Specials

Tektronix 2213	60 MHz	\$549.00
Tektronix 2215	60 MHz	\$649.00
Tektronix 465	100 MHz	\$599.00
Tektronix 465B	100 MHz	\$729.00
Tektronix 475	200 MHz	\$829.00
Tektronix 475A	250 MHz	\$999.00

- Professionally Refurbished
- Aligned & Calibrated to Original Specifications
- The Industry Standard of Oscilloscopes
- **1 Year Warranty - The Longest Available!!!**

**We Buy Surplus
Test Equipment**

**SIMCHECK®II PLUS
Module Tester**

- * Tests SIMMs/168 p DIMMs
 - * Stand alone/portable
 - * Identifies Module properties
 - * Advanced Setup Capabilities
- Only \$2750.00!**

(1-800-996-3837)

Leader CATV Signal Level Meter Model LF 941
✓ TV/CATV Coverage from 46 - 870 MHz
✓ Video/Audio Carrier Measurements **\$695.00!**

Just Released! → "Series III" Multimeters
Fluke Model 87III \$319.00 !!!

See us on the Web!
www.fotronic.com

Test Equipment Depot

A FOTRONIC CORPORATION COMPANY
99 Washington St. Melrose, MA 02176
(781) 665-1400 • FAX (781) 665-0780

email: sales@fotronic.com



TOLL FREE 1-800-99-METER

LEADER

For Professionals Who Know The Difference

- Oscilloscopes
- Video Sync/Test Generators
- Waveform Monitors/Vectorscopes
- EFP/ENG Instruments
- RF Signal Level Meters
- Audio Generators & Meters
- Frequency Counters
- Meters & Bridges
- Power Supplies
- Function Generators
- RF Generators

PRINT™ 
Products International

Test Instruments, Equipment, Tools & Supplies For Electronic Production, Maintenance & Service
8931 Brookville Road, Silver Spring, MD, 20910 * 800-638-2020 * Fax 800-545-0058

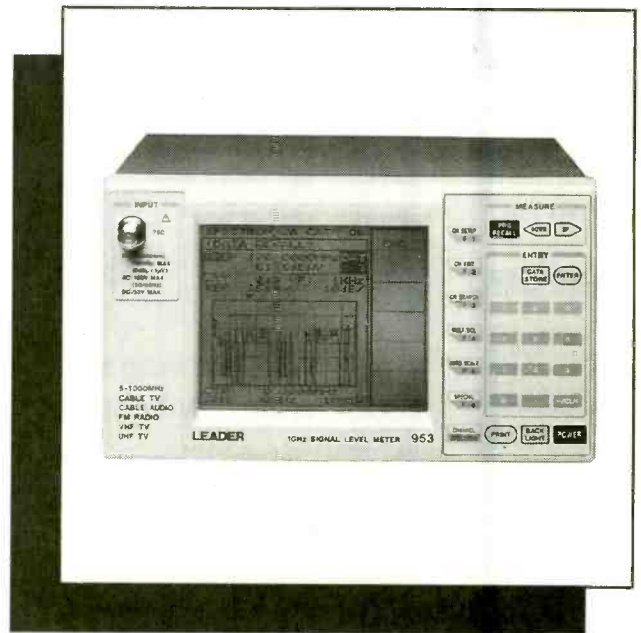

Call, fax or email for your free test and measurement instrument catalog today!
800-638-2020 * Fax 800-545-0058
www.prodintl.com

CIRCLE 143 ON FREE INFORMATION CARD

COPY RENTAL TAPES

WITH OUR VIDEO STABILIZERS

BEFORE



AFTER



FREE CABLE TV CATALOG!

The clearest picture possible playing back movies. **GUARANTEED** to eliminate copy protection.

- No Rolls/Jitters/Flickers/Fading
- Works on all TV's, VCR's Beta & Cable
- Gold Video Connectors & Cables Included
- 1 Year Warranty
- Money Back Guarantee



VISION ELECTRONICS
1-800-562-2252

2609 S. 156TH CIRCLE • OMAHA, NE 68130
<http://www.modernelectronics.com>

ATTENTION CABLE VIEWERS

CABLE VIEWERS ... get back to your

BASIC Cable Needs

Call 1-800-577-8775

For information regarding all of your BASIC cable needs.

5 GOOD REASONS TO BUY OUR FAR SUPERIOR PRODUCT

- ❖ PRICE
- ❖ EFFICIENT SALES AND SERVICE
- ❖ WE SPECIALIZE IN 5, 10 LOT PRICING
- ❖ ALL FUNCTIONS (COMPATIBLE WITH ALL MAJOR BRANDS)
- ❖ ANY SIZE ORDER FILLED WITH SAME DAY SHIPPING



BASIC ELECTRICAL SUPPLY & WAREHOUSING CORPORATION

It is not the intent of B.E.S.W. to defraud any pay television operator and we will not assist any company or individual in doing the same. *Refer to sales personnel for specifications.

P.O. Box 8180 • Bartlett, IL 60103-8180 • 847-584-2099

We handle NEW equipment ONLY -

Don't trust last years OBSOLETE and UNSOLD stock!
COMPETITIVE PRICING - DEALERS WELCOME

Whaddya Say To A Guy Who's Had The Same Job For 50 Years. Has Never Called In Sick Or Showed Up Late. Never Taken A Vacation Or A Holiday. Never Asked For A Raise Or Griped About His Bonus And, Believe It Or Not, Has No Plans For Retirement?



Thanks.

Remember - only you can prevent forest fires.

**OVER
30,000
ITEMS
IN STOCK**

**LARGE VARIETY
SAME DAY SHIPPING**
Minimum Orders \$20.00
Not Including Shipping & Handling

Dalbani®
The Ultimate Saving Source

SEMICONDUCTORS

Original #	Brand	Replaces
7805	Tesla	960
7806	Ank	962
7809	Ank	1910
7810	Samsung	1968
7812	Tesla	966
7815	Tesla	968
7818	Tesla	958
7824	Tesla	972
7905	Tesla	961
7906	Tesla	963
7908	Tesla	965
7912	Ank	967
7918	Tesla	959
7924	Tesla	971



YOUR CHOICE

\$45¢
each

POPULAR FUSE KIT 180 Piece Kit

Kit Contains 10 Pieces of each of these items:

- AGC Type : 0.5A, 1A, 1.5A, 2A, 2.5A, 3A, 4A, 5A, 6A, 10A, 15A
 - Ceramic Type : 15A
 - GMA Type : 1A, 1.5A, 2A, 3A, 4A, 5A
- Everything Comes in a Durable Plastic Box



\$13.95

Item # 10-2050

TUN-O-WASH® (CFC Free)

Fast drying electronics grade cleaner for tuners, controls and PC boards.
• CFC and HCFC free
• Not for use on energized equipment
• Due to the chemical content, this product can be only shipped by UPS ground service.



\$11.75

Item # 30-0100
(12.5 Oz aerosol)

DALCO DIGITAL MULTIMETER

- DC Voltage: 200m-1K
- AC Voltage: 200-750V
- DC Current: 20m-20
- Transistor and Diode Test
- Continuity Buzzer
- Polarity indicator appears on LCD
- Test Probes Included
- Dimensions: 4.96" x 2.76" x 9.4"
- Weight: 6 oz.
- 9V Battery included



\$9.95

Item # 50-2895

Dalco® ECONOMICAL SOLDER WICK

5 Feet

Removes solder easy



\$1.10

- Length: 5 feet
- Width: 0.15"
- Safer Desoldering
- Fast Response

Item # 51-1050

SOLDER ROLL

- 1 LB Spool
- 370° F melting point
- Fastest solder
- Alloy 60/40, 1in lead, non corrosive flux, Diam. 1.0mm



\$5.49

Item # 51-1005

DUAL HELPING HANDS

- Hold Work in any Position to leave hands free for soldering



\$3.45

Item # 50-1325

SOLDERING IRON

- General Purpose Applications
- 117V AC, 30 Watts



\$3.25

Item # 51-1335

WELLER WLC100 SOLDERING STATION

Weller



\$38.90

- Ideal for the professional, serious hobbyist
- Variable power control (5-40W)
- 40W pencil iron and ST# inter changeable tip
- Replaceable heating element
- Cushioned foam grip • Safety guard iron holder
- On/off switch with "power-on" indicator light

Item # 51-1505

SHIP UP TO 5 lbs FOR ONLY

\$3.95

UPS
2ND DAY AIR



Plus handling & C.O.D. charge if it applies

THE MOST POPULAR VCR ALIGNMENT TOOL KIT

\$24.99

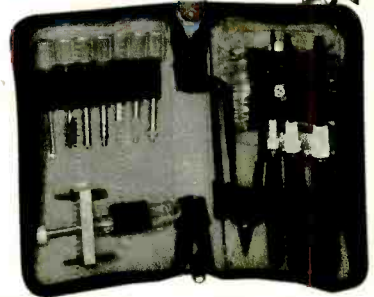

- VCR Head pull
- Retaining ringremover
- Micro screwdriver
- Fitted vinyl Case
- 7 Assorted head & guide aligner
- Dimensions: 9 1/2"(W) X 12 1/4"(L)
- 3 Reverseable screwdrivers (Small-Flat-Phillips)
- Spring hook
- Hex key set
- Soft zippered case

Item # 50-888

HEAVY DUTY COLOR CODED LEADS

- 10 Leads
- 11" Long Wire Lead
- Insulated 11/2" Alligator Clips
- 20 Gauge Wire Size
- Black, Green, Red, Yellow, White



\$2.95

Item # 56-500

Dalco® SWING ARM MAGNIFYING LAMP

\$36.72

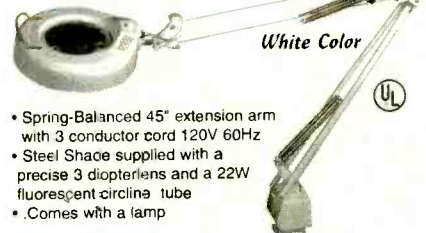

White Color

- Spring-Balanced 45" extension arm with 3 conductor cord 120V 60Hz
- Steel Shade supplied with a precise 3 diopter lens and a 22W fluorescent circline tube
- Comes with a lamp

Item # 54-0120

Dalbani®

4225 NW 72ND AVE. MIAMI, FLORIDA 33166
TEL : (305) 716-1016 ----- FAX : (305) 594-6588

Free 400 Page Color Catalog
With your First Order

1-800-325-2264

CIRCLE 164 ON FREE INFORMATION CARD

PLASMA BALLISTIC GUN

SHOOTS A HIGH VELOCITY PROJECTILE
Uses New Technology to Generate High Propellant Pressure Without Chemical Reactions

Velocities Up To 3000 m/sec with 50mg Projectile!!
Easily Scaled Up or Down
Easy to Build-Kit and Parts Available
Approximately .16 Caliber Bore

PPR01 Plans, Parts Lists and Sources.....\$20.00

Includes Our HEP Series Plans Used for RAILGUNS, COIL GUNS, EMP LEVITATION, ANTIGRAVITY, MASS WARPING, LATTICE SNAPPING etc



Labelled Dangerous

BURNING LASER RAY GUN

BLASTS THRU THE HARDEST OF METALS!

All Parts Available

LAGUN2 Plans.....\$20.00

BURNING CO2 BENCH LASER

HOTTER THAN MOST TORCHES!
Easy to Assemble

LC7 Plans.....\$20.00



A FUTURISTIC CONCEPT!!



TAKE CONTROL!!

ELECTRONIC HYPNOSIS & MIND MACHINES

Electronic Circuitry Induces Hypnotic as Well as ALPHA Relaxed States of the Mind. Place Subjects "Under" Your Control. Enhances Hidden PSYCHIC Ability in Many People!

MIND Plans.....\$15.00
MIND2K Kit and Plans.....\$49.95
MIND20 Assembled.....\$89.95

TELEPHONE TAPING SYSTEM EXTENDED X4 PLAY

Tapes Both Sides of Phone Conversation - Check Laws!
TAP30X Ready to Use.....\$84.95
BEEP10 Beeper Alert.....\$29.95

TRANSISTORIZED TESLA COIL

URNS A LIGHT BULB INTO A SPECTACULAR PLASMA DISPLAY

Transmits Wireless Energy. Brush and Corona Discharge. Noiseless Operation. Pyrotechnic Effect. 12 VDC/5 Amps or Battery 115 VAC Optional Converter. Adjustable Frequency Control For Effect.

Shown With Oil Fill Option
TCL5 Plans.....\$8.00
TCL5K Kit/Plans.....\$59.95
TCL50 Ready to Use.....\$109.95
12DC/7 12VDC@7Amps.....\$39.95

JACOBS LADDER

Observe a pyrotechnical display of "traveling" fiery plasma. Starts off as 1/2" arc and expands to over 3" before evaporating into space. This is an excellent attention getting display as well as a winning science project!! With arc control.



JACK1 Plans.....\$8.00
JACK1K Kit Minus Case.....\$129.95
JACK10 Ready to Use.....\$249.95
12KVGEN20 Pwr Supply Only.....\$99.95
12KVGEN2K Kit of Pwr Supply.....\$79.95

3Mi FM VOICE TRANSMITTER

Safety Product Allows Listening to Children or Invalids in Hazardous Areas, Pools, Ponds etc. Great Security Intrusion Alert! Uses FM Table Top Radio. Become the local neighborhood D.J.

FMV1K Kit/Plans.....\$39.95



ALL NEW CYBERNETIC EAR!

Enhances Normal Hearing 3 to 4 Times. Provides That Extra "Edge" for Hunters, Trackers Nature Enthusiasts

Adjustable Volume Control Fits into Either Ear Built In Long Lasting Batteries
CYBEREAR Ready to Use.....\$19.95



PHASOR PAIN FIELD PISTOL

Blast out rats and rodents with high power Shock Waves Handheld and Battery Operated

PPPI Plans.....\$8.00
PPPIK Kit/Plans.....\$49.50
PPPI0 Ready to Use.....\$79.50



HOVERBOARD PLANS

Research Project

Kit Soon to be Available
28 Pages of "how to" build a magnetic force field capable of containing a column of ionized air up to several psi! Includes theory on how to build a HOVERBOARD prototype capable of lifting 200 lbs.

HOVER Plans and Data.....\$25.00



MICRO TESLA COIL

Lights up a 4 ft Fluorescent Tube Without Contact!! Yet Only 3" Tall!

Super Magic Trick Low Cost Science Project 12 VDC/115 VAC Operation

MTC1K Kit/Plans.....\$19.95
MTC10 Ready to Use.....\$34.95



1 800 221 1705 ORDERS ONLY! FAX 1 603 672 5406 INFO 9-5pm 1 603 673 4730 FREE CATALOG ON REQUEST
Pay by MC, VISA, Cash, Chk, MO, COD. Please Add \$5.00 S&H plus \$5.00 if COD. Overseas Please Contact for PROFORMA

MECI 340 East First Street
Dayton, Ohio 45402
Your Electronics Value Company

Tons of Electronics

Get your FREE catalog today and discover some of the best deals in electronics. We have thousands of items ranging from unique hard-to-find parts to standard production components. Call, write or fax today to start your subscription to one of the most unique catalogs in the industry, filled with super values on surplus electronic and hobbyist type items.



FREE CATALOG!
Checkout our 10,000 item on-line catalog <http://www.meci.com>
Order Toll Free 1-800-344-4465
Why pay more? Call today!
Fax Order Line 1-800-344-6324

Call Today And SAVE!
Unbeatable PRICES!

CABLE TV

DESCRAMBLERS
CONVERTERS · FILTERS
VIDEO STABILIZERS

FREE > 30 Day Trial
FREE > Product Catalog
FREE > 1 Year Warranty
100% MONEY BACK GUARANTEE



Let us point you in the right direction ...
Arrow Technologies
Omaha, Nebraska
TOLL FREE 888-554-ARROW
888-554-2776

Introducing The Epic Series **NEW**

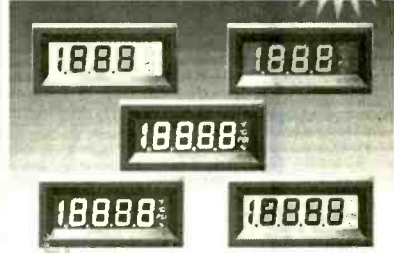

280 different configurations in a single size, snap-in mounted case
Create a look of conformity on panels

- Choose from:
- ▼ 3 1/2 or 4 1/2 digit displays
 - ▼ voltage or process loop inputs
 - ▼ black, red, amber or green numerals
 - ▼ black numerals with lighted green background
- Features:
- ▼ selectable, displayed engineering units
 - ▼ resistant to RF and EMI
 - ▼ economically priced
 - ▼ five year warranty

800-356-4920
Visit our catalog on the web www.knsinstruments.com
KNS Instruments
PO Box 10158 Bedford, NH 03110-0158
Fax 800-356-1250

BREAST CANCER BEGINS EVEN SMALLER THAN THIS. THAT'S WHY YOU NEED A YEARLY MAMMOGRAM, ESPECIALLY AS YOU GET OLDER. MAMMOGRAMS CAN DETECT LUMPS TOO SMALL FOR YOU TO FEEL AND EARLY DETECTION MAY SAVE YOUR LIFE, SO CALL 1-800-ACS 2345.

GET A MAMMOGRAM. EARLY DETECTION IS THE BEST PROTECTION.

BEST DEALER PRICING!

CABLE DIRECT

CONVERTERS • FILTERS
DESCRAMBLERS

IMPROVE YOUR IMAGE WITH
VIDEO STABILIZERS

FREE CABLE TV CATALOG!

100% MONEY BACK GUARANTEE!

Now you can tune-in your favorite cable TV programming and **SAVE \$100'S - EVEN \$1000'S** on premium CABLE TV EQUIPMENT.

VISA MASTERCARD DISCOVER AMEX

MODERN ELECTRONICS

1-800-906-6664

2609 S. 156TH CIRCLE • OMAHA, NE 68130
<http://www.modernelectronics.com>

OSCILLOSCOPES

from \$169 !!!

ATC O-Scope uses printer port to turn PC-AT into Digital Storage Oscilloscope, Spectrum Analyzer, Freq. Counter, Logger, DVM. DC-500KHz

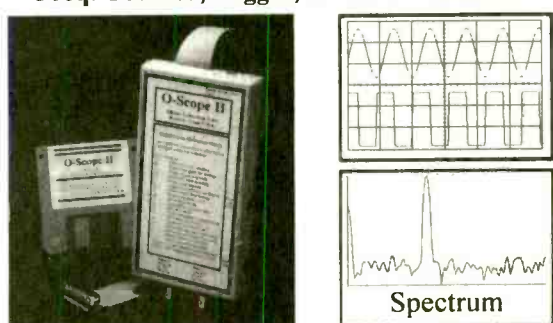

- Print, log to disk, or export data
- Accepts standard scope probes
- Uses standard printer port
- Small and portable
- Works with laptops
- Same day shipping
- Made in U.S.A.
- Single channel units from \$169
- Dual channel units from \$349

Options:

- Probe sets
- Automotive probes
- Battery packs

Order yours today.

800 980 9806 MC/Visa/Amex

Allison Technology Corporation
2006 Finney-Vallet, Rosenberg, TX 77471
PH: 281 239 8500, FAX: 281 239 8006
<http://www.atcweb.com>

Website www.j-tron.com

Visit us online and enter our contest for a test meter. Call J-Tron today!

- Components
- Kits
- Meters

888-595-8766

VIDEO SYNC GENERATOR

Restores Horizontal and Vertical Sync Lines from Distorted Video



Lost Sync



Restored Sync with VSG



For Free Information Package and Pricing

VISA MASTERCARD

Call (219) 233-3053
www.south-bend.net/rcd

R.C. Distributing, PO Box 552, South Bend, IN 46624

PicC C Compiler \$59
for Microchip's PIC microcontrollers
Supports PIC16C55x, 16C6x, 16C8x, 16C8x, 16C92x PIC families

SnXC C Compiler \$59
Supports Snc1X ax18ac and sx28ac microcontrollers

Both compilers based on ANSI C standard. Arrays, unions, structures, pointers, strings, function calls, if, for, switch, while, interrupt vectors, in-line assembler code, 8 & 16 bit variables, etc. Outputs Intel Hex format and assembly code. Code optimizer included. Excellent development tools!

DebugIDE Debugger \$79

C source level debugger for PicC and SnXC compilers. Integrated Development Environment. Step, Run, Stop, Reset. Variable monitoring and modification. Oscillator/cable kit (\$39)
732-873-1519 fax: 732-873-1582 e: grichre@aol.com
Grich RC Inc. 120 Cedar Grove Ln, Ste 340, Somerset NJ USA 08873
URL: <http://members.aol.com/picccompile>

Zagros Robotics
World Class Engineering and Programming



PO Box 460342
St. Louis, MO 63146-7342
(314)768-1328
info@zagrosrobotics.com
www.zagrosrobotics.com

CABLE TV BOXES



(WE'LL BEAT ANY PRICE!)
30 DAY TRIAL* 1YR. WRNTY. *FREE CATALOG QTY. DISCOUNTS * DEALERS WELCOME!

1-800-538-2225

HABLAMOS ESPANOL

VISA MASTERCARD DISCOVER AMEX C.O.D.

<http://www.tvcableboxes.com>
GLOBAL ELECTRONICS INC.

Quality Microwave TV Systems

WIRELESS CABLE - IFTS - MMDS
ATV - INTERNATIONAL - DIGITAL
Amplifiers • Antennas • Books • Components
• RF Frequency 2100-2700 Mhz
• SASE For "FREE" Catalog or Send \$1

PHILLIPS-TECH ELECTRONICS
P.O. Box 18074 • Scottsdale, AZ 85267-3074
CATALOG/INFO: 602-947-7700
ORDER LINE: 800-880-MMDS
FAX LINE: 602-947-7799
WEBSITE: www.phillips-tech.com
E-MAIL: product@phillips-tech.com
Visa • M/C • AmEx • Discover • C.O.D. • Quantity Pricing

CHALLENGER SYSTEM
31-Channels Complete \$240
Other Systems Available
5 Year Warranty
FREE SHIPPING

LEARN COMPUTERS

Accredited Home Study. Learn computer hardware and software. Computers are a great career path in business. Computers in the home open up a whole new world of opportunity. Journey into the world of computers in only a few short months. FREE, no obligation information: Lifetime Career Schools, Dept. PEL10X3
101 Harrison Street, Archbald, PA 18403
CALL TOLL FREE 1-800-326-9221

EARN \$85/hr!
APPLIANCE REPAIR

In almost no time at all you can learn to repair Washers, Dryers, Refrigerators, Dishwashers, and Ranges!

HUGE DEMAND!
FREE INFO: 1-888-329-0880

Name _____
Address _____
City/State _____ Zip _____

Appliance Repair Schools Corp.
31855 Date Palm Dr. Suite 3-456
Cathedral City, CA 92234 Dept. PE

May 1999, Popular Electronics

USE POPULAR ELECTRONICS

READ BY BUYERS OF ELECTRONIC EQUIPMENT ACCESSORIES AND PARTS

INSTRUCTIONS FOR PLACING YOUR AD!

HOW TO WRITE YOUR AD

TYPE or **PRINT** your classified ad copy **CLEARLY** (not in all capitals) using the form below. If you wish to place more than one ad, use a separate sheet for each additional one (a photo copy of this form will work as well). Place a category number in the space at the top of the order form (special categories are available). If you do not specify a category, we will place your ad under miscellaneous or whatever section we deem most appropriate.

We cannot bill for classified ads. **PAYMENT IN FULL MUST ACCOMPANY YOUR ORDER.** We do permit repeat ads or multiple ads in the same issue, but, in all cases, full payment must accompany your order.

WHAT WE DO

The first word and company name of each ad are set in bold caps at no extra charge. No special positioning, centering, dots, extra space, etc. can be accommodated.

RATES

Our classified ad rate is \$1.75 per word. Minimum charge is \$26.25 per ad per insertion (15 words). Any words that you want set in bold are each .40 extra. Indicate bold words by underlining. Words normally written in all caps and accepted abbreviations are not charged anything additional. State abbreviations must be post office 2-letter abbreviations. A phone number is one word.

If you use a Box number you must include your permanent address and phone number for our files. **ADS SUBMITTED WITHOUT THIS INFORMATION WILL NOT BE ACCEPTED.**

For firms or individuals offering Commercial products or Services. **Minimum 15 Words.** 5% discount for same ad in 6 issues within one year; 10% discount for same ad in 12 issues. **Sorry, no discounts on credit-card orders. Boldface (not available as all caps), add .40 per word additional. Entire ad in boldface, add 20%. Tint screen behind entire ad, add 25%. Tint screen plus all boldface ad, add 45%. Expanded type ad, add \$2.25 per word.**

General Information: A copy of your ad must be in our hands by the 13th of the fourth month preceding the date of issue (i.e. Sept issue copy must be received by May 13th). When normal closing date falls on Saturday, Sunday or Holiday, issue closes on preceding work day. Send for the classified brochure.

DEADLINES

Ads not received by our closing date will run in the next issue. For example, ads received by November 13 will appear in the March issue that is on sale January 17. **POPULAR ELECTRONICS** is published monthly. No cancellations permitted after the closing date. No copy changes can be made after we have typeset your ad. **NO REFUNDS, advertising credit only. No phone orders.**

CONTENT

All classified advertising in **POPULAR ELECTRONICS** is limited to electronics items only. All ads are subject to the publishers approval. **WE RESERVE THE RIGHT TO REJECT OR EDIT ALL ADS.**

AD RATES: \$1.75 per word, Minimum \$26.25

Send you ad payments to:

POPULAR ELECTRONICS 500 Bi-County Blvd, Farmingdale, NY 11735-3931

CATEGORIES

100 - Antique Electronics	270 - Computer Equipment Wanted	450 - Ham Gear Wanted	630 - Repairs-Services
130 - Audio-Video Lasers	300 - Computer Hardware	480 - Miscellaneous Electronics For Sale	660 - Satellite Equipment
160 - Business Opportunities	330 - Computer Software	510 - Miscellaneous Electronics Wanted	690 - Security
190 - Cable TV	360 - Education	540 - Music & Accessories	710 - Telephone
210 - CB-Scanners	390 - FAX	570 - Plans-Kits-Schematics	720 - Test Equipment

CLASSIFIED AD COPY ORDER FORM

Place this ad in Category # _____ Special Category \$20.00 Additional _____

1 - \$26.25	2 - \$26.25	3 - \$26.25	4 - \$26.25	29 - \$50.75	30 - \$52.50	31 - \$54.25	32 - \$56.00
5 - \$26.25	6 - \$26.25	7 - \$26.25	8 - \$26.25	33 - \$57.75	34 - \$59.50	35 - \$61.25	36 - \$63.00
9 - \$26.25	10 - \$26.25	11 - \$26.25	12 - \$26.25	37 - \$64.75	38 - \$66.50	39 - \$68.25	40 - \$70.00
13 - \$26.25	14 - \$26.25	15 - \$26.25	16 - \$28.00	Total words _____		\$1.75 per word = \$ _____	
17 - \$29.75	18 - \$31.50	19 - \$33.25	20 - \$35.00	Bold Face _____		\$0.40 per word = \$ _____	
21 - \$36.75	22 - \$38.50	23 - \$40.25	24 - \$42.00	Special Heading _____		\$20.00 = \$ _____	
25 - \$43.75	26 - \$45.50	27 - \$47.25	28 - \$49.00	Other _____		= \$ _____	

Total classified ad payment \$ _____ enclosed **TOTAL COST OF AD \$ _____**

Check Mastercard Visa Discover Card # _____ Expiration Date ____/____

Signature _____

Name _____ Phone _____

Address _____ City State Zip _____



One tree can make
3,000,000 matches.



One match can burn
3,000,000 trees.



A Public Service of This Magazine
& The Advertising Council

The Pocket Programmer

\$129.95

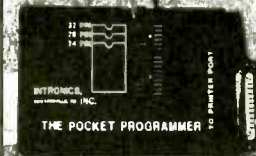

The portable programmer that uses the printer port of your PC instead of an internal card.

Easy to use software that programs E(E)prom, Flash & Dallas Ram. 27(C)/28(C)(F)/29(C)(F)/25 series from 16K to 8 Megabit with a 32 pin socket. Adapters available for MCU's 874X, 875X, Pic, 40-Pin X 16 & Serial Eprom's, PLCC, 5-Gang and Eprom Emulator to 32K X 8.

Same Name, Address & Phone # for 13 Years.... Isn't it Amazing ?

Intronics, Inc.

Box 13723 / 612 Newton St.
Edwardsville, KS 66113 Add \$4.75 COD

Tel. (913) 422-2094 Add \$4.00 Shipping

Fax (913) 441-1623 Visa / Master Charge

Home Automation

- World's Largest Selection!
- Best Customer Service
- Top Technical Support

Take a step into the future -- discover the latest in innovative home technology, from remote controls to high-tech toys to voice-activated systems. We will show you the *smart* (and easy!) way to automate your home.

Lowest Prices Guaranteed!

Call **800-SMART-HOME**
800-762-7846

or visit us on the web @
smarhome.com
to order your **FREE** catalog today!

Order 24 Hours • 7 Days

**HOME AUTOMATION
SYSTEMS, INC.**

Dealers/Resellers ask about our
SmartHome PRO Dealer Program 800-649-6295

FCC License Preparation

Electronics Tech., Avionics, Marine & Radar
HOMESTUDY—Fast, Easy & Inexpensive
Manuals, Audio, Video, PC disks, latest Q&As
Free 1-800-800-7555 "Guaranteed Pass"
See at <http://www.worldaccessnet.com>
BusinessShowcase/wpt. 4701 NE 47th St.
Vancouver, WA 98661 - WPT Publications

SURVEILLANCE

The Latest High Tech
Professional Electronic Devices

Our latest catalog offers a HUGE
selection of surveillance, counter-
surveillance/privacy devices: **pinhole
camera \$129⁰⁰**, hidden video,
**"realtime" 12-Hour telephone
recorder \$139⁰⁰**, 12 hour VOX recorder,
phone call register, scanners,
bug/phone tap detectors, voice
disguisers, locksmithing tools,
vehicle tracking, wireless video,
and much more. Wholesale/retail.

We will not be undersold.

Catalog \$5.00 or

www.spyoutlet.com

SPY OUTLET

PO Box 337, Buffalo NY 14226
(716) 691-3476/(716) 695-8660



ATTENTION CABLE VIEWERS
Own Your Own Unit Today
Cable TV Converters &
Descramblers
All Makes / All Models

Call **1-800-577-8775**

Technical Info: **847-584-2099**



PROGRAMMERS OVER 50 MODELS

ADVANTECH EETOLS NEEDHAMS DATA I/O ICE TECHNOLOGY HLO
SYSTEM GENERAL CHROMA MODULAR CIRCUIT TECHNOLOGY XELTEK



PROMAX EMP-20 MEGAMAX MEGAMAX4 SIMM/SP TESTER EMUPA

CALL ADVANTECH LABTOOL	599 EETOLS SIMMAX
629 ICE TECH MICROV	795 CHROMA SIMM/SP
650 EETOLS ALLMAX +	359 MOD-MCT-EMUPA/R
409 EETOLS MEGAMAX	279 MOD-MCT-EMUPA/R
509 EETOLS MEGAMAX4	49 EPROM 1G TO 512K
369 XELTEK SUPERPRO II	69 EPROM 1G TO 1MEG
409 XELTEK SUPERPRO II P	99 EPROM 4G TO 1MEG
249 XELTEK SUPERPRO L	199 EPROM 16G TO 1MEG
165 XELTEK ROMMASTER II	89 EPROM 1G TO 8MEG
479 MOD-MCT-EMUPA	129 EPROM 4G TO 8MEG
739 3TAG ORBIT-32	250 EPROM 8G TO 8MEG



LABTOOL48 MICROMASTER SUPERPRO ALLMAX II US ROMMASTER2

General Device Instruments

Sales 916-393-1655 Fax 916-393-4949 BBS 983-1234

Web www.generaldevice.com E-Mail edivice@best.com

BUGGED??

FAVESDROPPING is unbelievably widespread! Electronic
Devices with amazing capabilities can be monitoring your
telephone and room conversations **RIGHT NOW!** Are you
sure you're safe? **FREE CATALOG** tells you fast! Includes
Free Bonus details on fantastic opportunities now open in
Counter-Surveillance field. Exciting, immensely interesting
and **EXTREMELY** profitable (up to \$250 hr) full/part-time
come. Call Now! **1-800-732-5000**

\$139* Laser LightShow



Draw with a laser beam! Animation, text,
music & more! Includes galvos, mirrors,
servo amp, demo software disk, analog and
digital computer interface. Use an inexpen-
sive pen pointer or high power gas laser.



Computerized Motors \$39*

Includes: 2 Stepper motors,
2 DC motors, computer interface, training
manual, & demo software disk. Expandable!
Up to 12 motors, up to 3 amps per phase.

Now with 4 Axis Linear Interpolation

* Add \$6 for shipping. Computer with parallel printer port
& cable, assembly, power supply, & laser are required

FREE FLYER

Voice 510-582-6602 Fax 510-582-6603



1273 Industrial Pkwy West Bldg. 660
PO Box 55125 Hayward CA 94545-0125

SINGERS! REMOVE VOCALS

(Unlimited, Low Cost, Instantly Available
Background Music from Original Standard
Recordings!) Does Everything Karaoke
does... **Better** and gives you the
Thompson Vocal Eliminator
Free Brochure & Demo Tape.
LT Sound Dept PE
7988 LT Parkway, Lithonia, GA 30058
Internet: <http://www.LTSound.com>
24 Hour Demo/Info Request Line (770)482-2485 - Ext 49
When You Want Something Better Than Karaoke!

Do You Repair Electronics?

Repair Databases for	- Over 76,000 records
TV, VCR, Monitor, UL	- Private user forums
Audio, FCC, and more.	- Live on-line chat rooms

RepairWorld.com

Edgemoor, C 711 Herald Sq, Fairport, NY 14524 (937) 376-2878

Cable T.V. Converters & Equipment

Lower
Prices
Dealer
Discounts
30-Day
Money back
1-year
warranty
MC, Visa,
AE, COB



No Florida Sales

www.cable4you.com

1-(800) 888-5585

Direct from Manufacturer
We will beat any competitor's price

World's Smallest Wireless Video Camera!

- Transmits video up to 1000 ft.
- Runs on 9V battery for 12 hrs.
- Can be built into just about anything (beeper, clock, etc.)

World's smallest plug & play system about 1" x 1"

- We also carry:
- Color micro video cameras
 - B&W micro video cameras
 - Hidden cameras
 - Custom video systems
 - Countersurveillance & More

Looking for Distributors



Call for a free catalog (305) 667-4545
SECURETEK Fax (305) 667-1744
7175 SW 47 St. #205 • Miami, FL 33155

PIC Programmer Kits Super Value!

Our PIC Programmer kits of parts attach to the parallel port of a PC and contain the following: PCB, parts and instructions. S&H: USA \$4.95, Canada \$7.95 Other \$11.95.

P16PRO PIC Programmer
• Program all 8, 18, 28 & 40 pin PICs in the 12C5xx, 14000 and 16Cxx series (except 16C54-58). • Use straight through (25 pin) cable (not supplied). • This kit uses the P16PRO shareware which is downloaded from the web and registered for \$25. • Visit www.electronics123.com for the complete list of PICs that can be programmed. • Can Program 64 pin PICs with adapter (not supplied).

Code: CPS96
\$14.95

PICALL PIC Programmer: As above but can also program 16C54-58. Price includes PICALL software. (need internet for latest upgrade) Price \$79.95 Order Code: CPS117

PIC 16F84 Programmer: Software supplied on disk is for 16F84 • 16F84-4MHz PIC Included! • Separate erase command • Test command: to test Programmer & cable (25 pin cable is included) • Vpp (programming voltage) is under software control • Microchip data sheets on disk • Software can read, verify & load (Win95/3.x/Dos)

Code: CPS81
\$23.95

Toll Free 1-888-549-3749 (USA & Canada)
Tel (330) 549-3726. Request a FREE catalog or visit us at: www.electronics123.com for more products.
Amazon Electronics, Box 21 Columbiana OH 44408

ADAPT-11
68HC11 Modules for Solderless Breadboards

- miniature 2.0" by 2.8" module
- plugs vertically into solderless breadboard for easy development
- BOOT/RUN switch for easy programming via PC serial port
- all I/O lines on dual row connector

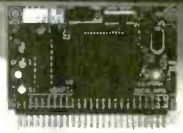

Complete modular prototyping system! Expansion accessories available!

For Just US\$74.95, our Starter Package (AD11SP) provides everything you need to get going fast! Now you can harness the power of the popular 68HC11 in your projects! Includes ADAPT-11 with 68HC11E2, providing 2K EEPROM (re-programmable), 8 channel 8-bit Analog-to-Digital Converter (ADC), hardware timers, counters, interrupts, Serial Peripheral Interface (SPI), Serial Communications Interface (SCI), & more! On-board RS-232 interface (cable included), 5-volt regulator, 8MHz crystal, reset circuit, and convenient program/run switch. Comes with non-commercial version of HC11 Assembler, BASIC, & C, as well as handy utilities & example code. Includes Motorola 68HC11 Pocket Programming Reference Guide and manual with schematic. All you need is a PC to write & program your software, a DC power supply, and a solderless breadboard (or protoboard) to build your application circuits on for use our modular accessories).

Visa • MasterCard • American Express • Discover
TECHNOLOGICAL ARTS
309 Aragona Blvd., Suite 102, Box 418, Va. Beach, VA 23462
1844 Bayview Avenue, Box 1704, Toronto, ON M4G 3C2
voice/fax:(416) 963-8996 www.interlog.com/~techart

POPTRONIX

Awaiting your call! Online Edition

<http://www.poptronix.com>

SURVEILLANCE HIDDEN CAMERAS
DIRECT FROM MANUFACTURER—BEST PRICE IN THE MARKET

Ultra miniature hidden camera, in dome, smoke or motion detector w/ mic. B/W or Color. Wide view angle. Low light sensitivity & super sharp images, plus video and audio output. From \$159.00. Also 1/2" B/W board camera w/mic, only \$99.00 USD. Wireless hidden camera, still at only \$249.00 USD. Plus \$5.95 for S&H. Wholesale/Palnet Welcome. COD, Check, Money Order or Visa/MC.

BOLIDE INTERNATIONAL CORPORATION
PH: (800) 355-0895 or (626) 575-8178
9660 Flair Drive #218, El Monte, CA 91731
<http://www.bolideamazingproducts.com/>

LEARN ELECTRONICS REPAIR

Home study. Learn to repair, service, and install stereos, TVs, VCRs, camcorders, sound/lighting systems. Free literature: send or call now.

CALL 800-223-4542

The School of Electronics
430 Technology, Dept. ELF341
PCDI, Norcross, GA 30092

CABLE EQUIPMENT
LOW, LOW WHOLESALE PRICES!

1-800-521-0512

New 1-piece Jerrald-5 units \$109/ea; 10 u. \$99/ea; 20 u. \$89/ea.
New RFT-M -5 units \$109/ea; 10 u. \$99/ea; 20 u. \$89/ea.
Basic Converter -5 units \$75/ea; 10 u. \$65/ea; 20 u. \$55/ea.

WHOLESALE ELECTRONICS
Check out our website: www.whe.net

BEST BY MAIL

Rates: Write National, Box 5, Sarasota, FL 34230

\$3,000 WEEKLY! Mailing 400 brochures AT HOME! Guaranteed. FREE postage, supplies. Rush Self-Addressed Stamped Envelope: F.S.I., 60 East Chestnut, Suite #300-(PE), Chicago, IL 60611.

"ANARCHIST COOKBOOK" AVAILABLE AGAIN! Complete Uncensored Edition. \$25.00, delivered. Barricade Books, Box 1401-G, Secaucus, NJ 07096.

Plant Trees for America

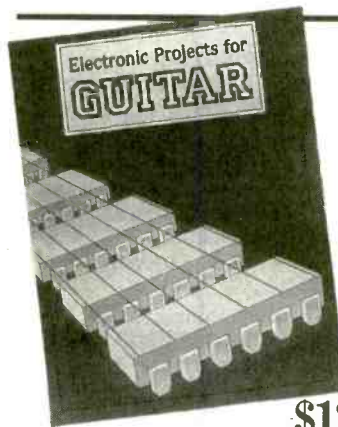

\$12⁹⁵

Whether you wish to save money, boldly go where no guitarist has gone before or simply have fun building electronic gadgets designed for your musical pleasure, then read

Electronic Projects for GUITAR

Some of the add-on guitar gadgets you can build are:

- Preamplifier • Headphone Amplifier • Soft Distortion Effects Unit • Compressor • Auto-waa • Waa-waa Pedal • Phaser • Dual Tracking Effects • Distortion Unit • Expander • Dynamic Treble Booster • Direct Injection Box • Dynamic Tremelo • Thin Distortion Unit • and Guitar Tuner.

Anyone with some previous electronic project building experience should have no problem assembling the projects.

ELECTRONICS TECHNOLOGY TODAY INC.
P.O. Box 240, Massapequa Park, NY 11762-0240

Yes, send my copy of PCP117 ELECTRONIC PROJECTS FOR GUITAR by RA Penfold to the address at right. I am enclosing \$12.95 including shipping charges in USA and Canada. All payments must be made in US funds. Sorry, no orders accepted outside of USA and Canada. New York State residents add local sales tax. Allow 6-8 weeks for delivery.

Check or International Money enclosed.

Please charge my Visa MasterCard
Signature _____
Account No. _____ Expir. Date _____
Name _____
Address _____
City _____ State _____ ZIP _____

MA10

CLASSIFIED

AUDIO-VIDEO-LASERS

Unique Video Products Pattern Generators with character identification, composite, s-video, RGB, distribution amplifiers, kits also available. Free catalog, **GEKCO Labs**, PO Box 642 Issaquah, WA 98027-0642, 425-888-5756, www.gekco.com

BUSINESS OPPORTUNITIES

Inventions/new products. ISC, America's leading invention firm, helps submit to companies. Patent Services. 1-800-288-IDEA.

\$400 Weekly Assembling electronic circuit boards/products form home. For free information send SASE: **Home Assembly-PE**, Box 216, New Britain, CT 06050-0216

Easy Work! Excellent Pay! Assemble Products At Home. Call Toll Free 1-800-467-5566 Ext. 5730.

Create Fantastic Wealth developing revolutionary generator that would enable anyone to economically produce electricity for their home or business. Full particulars \$25.00 **WW Sharp**, Box 327, Grimsley, TN 38565-0327.

CABLE TV

Cable TV Descramblers. One-piece units. Scientific Atlanta, Jerrold, Pioneer, and others. Lowest Prices Around. **Precision Electronics**, Houston, TX, anytime 1-888-691-4610.

CABLE BOXES ALL MODELS, ALL CHANNELS, lowest prices in the United States. Open seven days a week till midnite, Pacific Time. Call (877) 789-7337 Toll Free.

CABLE DESCRAMBLERS, UNIVERSAL, WHOLESALE AND VOLUME PRICING. FULL TECHNICAL SUPPORT. 1-888-922-0671

Descramblers, Converters, Activators, Rft's, Ftg's, Bullet Snoopers, All Options Explained, Best Prices, Services, 2yr. Warranty, Free Catalog 1-800-854-1674 www.resource-leader.com/aapc

Free Cable Descrambler Plans. For Detail Write: Sierra Publishing, 909 E. Yorba Linda Blvd., Suite H-181, Dept PEA, Placentia, CA 92870.

CABLE Descrambling, New secret manual. Build your own Descramblers for Cable and Subscription TV. Instructions, schematics for SSAVI, Gated Sync, Sinewave, some free methods \$12.95. \$2 postage. **CABLETRONICS**, Box 30502PE, Bethesda, MD 20824.

CB-SCANNERS

CB Radio Modifications! Frequencies, kits, high-performance accessories, books, plans, repairs, amps, 10-Meter conversions. The best since 1976! Catalog \$3.00. **CBCL**, Box 1898PE, Monterey, CA 93942. www.cbclint.com

MISC. ELECTRONICS FOR SALE

RF Transistors & Tubes MRF454, SD1446, 2SC2879, 2SC1969, 2SC2166, 3-500ZG, 4CX250B, 572B, 3CX3000A7, Westgate 800-213-4563.

PLANS-KITS-SCHEMATICS

ELECTRONIC PROJECT KITS: 49 McMichael St, Kingston, ON., K7M 1M8. \$3.00 catalog. www.qkits.com. **QUALITY KITS**

"HEATHKIT COMPANY is selling photocopies of most Heathkit manuals. Only authorized source for copyright manuals. Phone: 616-925-5899, 8-4 ET."

AWESOME KITS: Voice Changers, Levitators, Lasers, Solar Robots and more! Catalog \$1.00. **LNS Technologies**, PO Box 67243, Scotts Valley, CA 95067. www.ccnnet.com/~1nstech

MONITORS MADE SIMPLE. Learn to repair computer monitors! Case studies, illustrations, parts sources, manufacturers included! 136 pages, soft-cover, \$19.95 + \$2.50 shipping. Order today! Send check or money order to **Pikes Peak Press**, 321 W. Henrietta Ave., PO Box 1801, Woodland Park, CO 80866. (719) 687-1499.

CATALOG: Broadcasting/micro transmitters, amplifiers, antennas. Start your own radio station books. Audio, TV, Ham, CB, Surveillance, Science projects and more. www.panaxis.com **PAN-COM Int'l**, PO Box 130-5, Paradise, CA 95967.

SATELLITE EQUIPMENT

FREE CATALOG-Satellite TV/GPS-DIY Technical Books. Installation Videos, Computer Analysis Software. www.baylin.com 800-483-2423.

DSS Test card. Authorizes all channels for information, plus free bonus. Call toll free 1-888-416-7296.

FREE Satellite TV Buyer's Guide. Best Products - Lowest Prices - Fastest Service! Dish Network, Direct TV, C/Ku-band, including 4DTV, Parts-Upgrades-Accessories! **SKYVISION** -800-543-3025. International 218-739-5231. www.skyvision.com

DSS Hacking: How to construct and program smart cards, w/pic 16C84. Complete DSS system schematics. \$16.95 Software \$25 **CABLETRONICS**, Box 30502PE, Bethesda, MD 20824.

VIDEOCYpher II descrambling manual, Schematics, video and audio. Explains DES, EPROM, CloneMaster, Pay-per-view \$16.95, \$2 postage. Schematics For Videocypher II Plus, \$20. Schematics for Videocypher II 032, \$15. Software to Copy and alter EPROM codes, \$25. VCII Plus EPROM, binary and source code, \$30. **CABLETRONICS**, Box 30502R, Bethesda, MD 20824.

TEST EQUIPMENT

Large assortment of used test equipment for sale. Request catalog or visit our website. **Stevenson Equipment Company** 609-888-2846 Fax: 609-888-2847 <http://www.stevensonlabs.com>

THE TRANSDUCER PROJECT BOOK



1992T—From TAB Books. A unique collection of practical transducer devices that you can put together simply and inexpensively. You can build a seismic sensor, a temperature survey meter, an open-door annunciator, a moisture detector, an automatic night light, and more. To order—ask for book **1992T**, and include your check for **\$6.99 - clearance** (includes s&h) in the US and Canada, and order from —**Electronic Technology Today Inc.**, P.O. Box 240, Massapequa Park, NY 11762-0240. US funds only; use US bank check or International money order. Allow 6-8 weeks for delivery. MA06

ALL ELECTRONICS CORPORATION

Switching Power Supply

Voltek Corp # SPEC7188B

Input: 100 - 240 Vac

Outputs: + 5 Vdc @ 3.70 A,

+12 Vdc @ 0.60 A,

-5 Vdc @ 0.05 A,

+5 Vdc Trickle

@ 0.1 A

Metal encased

switching supply.

Standard three-prong IEC socket power

input. 7 conductor, Molex-type connec-

tor output. 9" x 2.1" x 1.36".

UL recognized. Removed

from new equipment.

CAT# PS-27

\$3.50
each

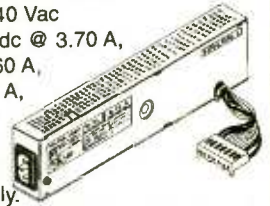

250uA PANEL METER

Good-looking 1.65" x 1.68" panel

meter. Matte-black frame

with a 1.43" x 0.84" viewing

window. Scale calibrated

from 1 to 10, divided into

green (1-4), yellow (4-6)

and red (6-10) areas. Logo,

"The Seeker" is written under the scale.



\$1.50
each

CAT# MET-51

10 for \$12.50

3000 MCD Ultra-Bright RED LED

25c each in 1,000 Quantities

Everight # 383URC-2/TR1-C(R)

Red, "Ultra-bright" T 1 3/4 LEDs

now at our lowest price ever

Due to a special purchase of

"tape-and-reel" parts we are able

to offer these LEDs at an incredi-

bly low price when purchased

on the reel. These are 5 mm diameter water-

clear LEDs that light bright red at 20 ma.

CAT# LED-50

2 for \$1.00

100 for \$35.00
1000 for \$250.00

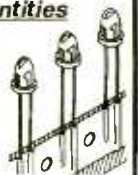

ORDER TOLL FREE

1-800-826-5432

CHARGE ORDERS to Visa, Mastercard,
American Express or Discover

TERMS: NO MINIMUM ORDER. Shipping and handling for the 48 continental U.S.A. \$5.00 per order. All orders including AK, HI, PR or Canada must pay full shipping. All orders delivered in CALIFORNIA must include local state sales tax. Quantities Limited. NO COD. Prices subject to change without notice.

CALL, WRITE
FAX or E-MAIL
for our FREE

96 Page
CATALOG
Outside the U.S.A.
send \$3.00 postage.

MAIL ORDERS TO:
ALL ELECTRONICS
CORPORATION
P.O. Box 567
Van Nuys, CA 91408
FAX (818)781-2653

e-mail allcorp@allcorp.com
internet - <http://www.allcorp.com/>

ADVERTISING INDEX

Popular Electronics does not assume any responsibility for errors that may appear in the index below.

Free Information Number	Page	Free Information Number	Page
— AES	79	— Intronic, Inc.	87
— Alfa Electronics	79	— James Electronic Services	80
— All Electronics	89	— KDE Electronics	81
— Allison Technology	85	— KNS Instruments	84
— Amazon Electronics	88	— Lynxmotion	71
— Andromeda Research	71	161 MCM Electronics	CV3
— Arrow Electronics	84	139 Mendelson's	84
— Basic Electrical Supply	82	174 MicroCode Engineering	CV2
— Bsoft	78	— Modern Electronics	85
32 C&S Sales, Inc.	76	165 Mouser	81
— Cable USA	80	— NRI Schools	19
173 Cadsoft	33	— PHDI	85
— Circuit Specialists	79	— Pioneer Hill Software	80
— CLAGGK, Inc.	7, 70	150 Prairie Digital Inc.	78
— Cleveland Inst. of Electronics	35	142 Print	74
— Command Productions	78	143 Print	82
— Consumertronics	72	— ProPlanet	87
164 Dalbani	83	— Securetek	88
— EDE Spy Outlet	87	— Silicon Valley Surplus	87
— Electronic Tech. Today	11, 67, 88	— Technological Arts	88
— Foley-Belsaw	73	137 Telulex	72
— General Device Instruments	87	— Test Equipment Depot	81
— Global Electronics	85	147 UCANDO Videos	74
— Grantham College of Eng.	4	— US Cyberlab	74
— Grich RC Inc.	85	163 Velleman Inc.	75
— Home Automation Systems	87	— Vision Electronics	82
— ICS	80	— Weeder Technologies	71
— Information Unlimited	84	— Zagros Robotics	85
26 Interactive Image Technologies	CV4		

ADVERTISING SALES OFFICES

Gernsback Publications, Inc.
500 Bi-County Blvd.
Farmingdale, NY 11735-3931
Tel. 516-293-3000
Fax: 516-293-3115

Larry Steckler, EHF/CET
 President (ext. 201)
 e-mail: advertising@gernsback

Adria Coren
 Vice-President (ext. 208)

Ken Coren
 Vice-President (ext. 267)

Christina Estrada
 Assistant to the President (ext. 209)

For Advertising ONLY
Tel. 516-293-3000
Fax: 516-293-3115

Larry Steckler
 Publisher

Marie Falcon
 Advertising Director (ext. 206)

Adria Coren
 Credit Manager (ext. 208)

**Subscription/
 Customer Service/
 Order Entry**
 Tel. 800-827-0383
 7:30 AM - 8:30 PM EST

ADVERTISING SALES OFFICES EAST/SOUTHEAST

Megan Mitchell
 9072 Lawton Pine Avenue
 Las Vegas, NV 89129-7044
 Tel. 702-240-0184
 Fax: 702-838-6924
 e-mail: mmitchell@gernsback.com

MIDWEST/Texas/Arkansas/ Oklahoma, Colorado, Arizona

Ralph Bergen
 One Northfield Plaza, Suite 300
 Northfield, IL 60093-1214
 Tel. 847-559-0555
 Fax: 847-559-0562
 e-mail: bergenrj@aol.com

PACIFIC COAST/Mountain States

Anita Bartman
 Hutch Looney & Assoc., Inc.
 6310 San Vicente Blvd.
 Suite 360
 Los Angeles, CA 90048-5426
 Tel. 323-931-3444 (ext. 227)
 Fax: 323-931-7309
 e-mail: anita@hlooney.com

MCM ELECTRONICS®

The Source For All Of Your Electronics Needs

When ordering, please provide this code: ► SOURCE CODE: POP64



ONLY \$48.50

Order #55-1930

18" Low Frequency PA Speaker

Poly treated paper cone and accordion surround make this perfect for PA or home applications. 45 oz. magnet and 2" voice coil combine for power capacity of 125W/250W RMS/peak and frequency response of 20Hz-3.5KHz. 8ohm. **Regular price \$64.95**



ONLY \$49.00

Order #82-2990

DEFENDER SECURITY

Micro PC Board Camera

Ultra compact black and white CCD camera measures only 1 1/4" x 1 1/4" x 1". Provides NTSC composite video output. Built-in 3.6mm lens provides viewing angle of 92°. Requires 12VDC, 300mA. **Regular price \$64.95**



12V Sealed Lead Acid Battery

Ideal for alarm panels, lighting or any type of battery back-up application. Rated 4.5Ah. 1/2" tabs accept standard female quick disconnects. Dimensions: 3 1/2" x 2 1/4" x 4". **Regular price \$26.95**

ONLY \$14.95

Order #29-1335

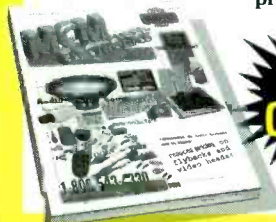

FREE Catalog!

Prices Effective March 16 through May 28, 1999

As Low As \$5.99

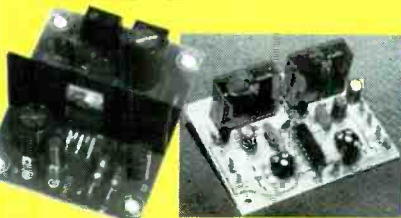

CEBEK Pre-Assembled Circuit Modules

Ideal for repairing old equipment, prototype work or your latest project. These well constructed PC boards are fully assembled, tested and ready to use. Supplied with application instructions and technical specifications. All operate from a single 12VDC source. Call your MCM Sales Representative for more information on over 120 available modules.

Order #	Description	Reg.	Sale
28-4795	1W audio amplifier	\$7.49	\$5.99
28-4796	5W audio amplifier	13.95	11.15
28-4800	5W x 2 stereo amplifier	24.95	19.96
28-4801	15W x 2 stereo amplifier	39.95	31.96
28-4851	88-108MHz FM transmitter	24.95	19.96
28-5115	Flip-flop relay	14.95	11.96
28-4825	VOX relay	17.95	14.36
28-4815	Electric guitar preamplifier	8.85	7.16



ONLY \$49.95

Whistler Automobile DC to AC Inverter

Order #72-6451

Provides 110VAC from the cigarette lighter. Ideal for laptops, portable radios, televisions, small tools and lamps. Provides 140 watts continuous, 250 watts surge. Measures 7 1/2" x 2" x 10". **Regular price \$69.95**



ONLY \$24.50

Order #72-2055

TENMA®

Portable DMM

A portable hand held meter features 3 1/2 digit LCD display, DC voltage measurement to 600V, transistor and battery test. Input impedance 10Mohm. Includes holster and test leads. **Regular price \$31.95**

Order #26-2200

ONLY \$9.95



Multi-Voltage Power Supply

Fully regulated supply provides up to two amps, at the following selectable voltages: 3, 4, 6V, 7 1/2V, 9V, 12V. **Regular price 16.95.**



ONLY \$8.99

Order #22-1875

32 Piece Security bit Set

Ideal for all of those difficult service applications including computer monitors, cable, telephone and vending equipment. Removes most types of security screws including security hex, torx, spanner and tri-wing. **Regular price \$15.99.**

1-800-543-4330

www.mcmelectronics.com

Hours: M-F 7 a.m.-9 p.m., Sat. 9 a.m.-6 p.m., EST.

Same Day Shipping!

In stock orders received by 5:00 p.m. (YOUR TIME), are shipped the same day.



MCM ELECTRONICS®

650 CONGRESS PARK DR.
CENTERVILLE, OH 45459
A PREMIER FARNELL Company

SOURCE CODE: POP64

THE WORLD'S MOST POPULAR
DESIGN TOOL CHOSEN BY OVER
100,000 USERS!

Electronics Workbench[®] Personal Edition

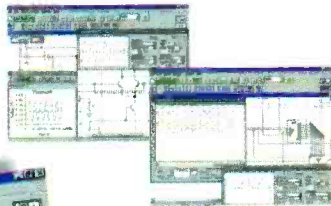
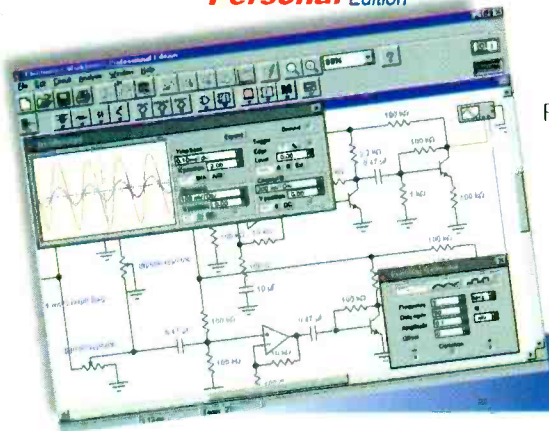

TRUE MIXED ANALOG/DIGITAL
FULLY INTERACTIVE SIMULATION
PRO SCHEMATIC EDITOR
6 VIRTUAL INSTRUMENTS
ON-SCREEN GRAPHS
OVER 4,000 MODELS
8 POWERFUL ANALYSES
FREE TECHNICAL SUPPORT

\$299

Full-featured schematic capture and SPICE circuit simulation!

The world's most popular circuit design tool that sets the standard for powerful, insightful SPICE simulation. Create professional looking schematics and then with the flick of a switch, display simulated waveforms live on a suite of virtual instruments. Includes 15 powerful analyses and a library of over 4,000 robust component models.

Electronics Workbench[®] Layout Personal Edition

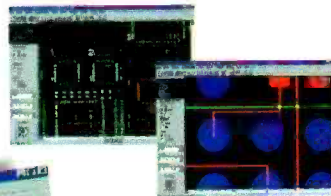
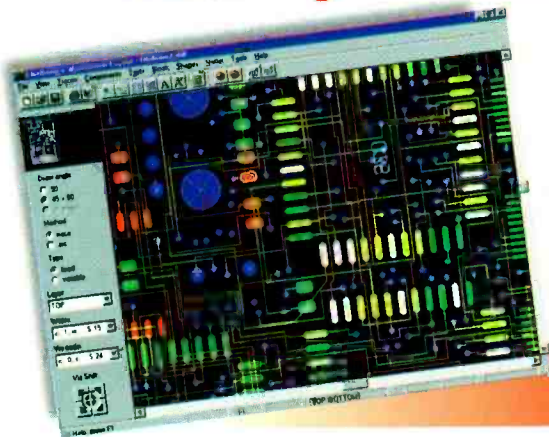

AUTOROUTING
REROUTE WHILE MOVE
32 ROUTING LAYERS
50" X 50" BOARD SIZE
OVER 3,500 LIBRARY SHAPES
EXTENSIVE OUTPUT
REAL TIME DESIGN RULE CHECK
DENSITY HISTOGRAMS
FREE TECHNICAL SUPPORT

\$299

Power-packed PCB layout with autorouting and real-time DRC!

EWB Layout is a powerful board layout package for producing high-quality, multi-layer printed circuit boards. Offering tight integration with our schematic capture program, EWB Layout is the best way to quickly produce well-designed boards.

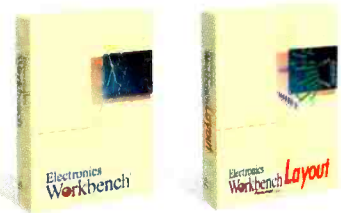

BUY BOTH AND SAVE! ~~\$598~~ \$548

CALL FOR INFORMATION
AND PRICING ON OUR
PROFESSIONAL EDITION.

800.263.5552

30-DAY MONEY-BACK GUARANTEE

Fax: 416-977-1818

E-mail: ewb@interactiv.com



For a free demo, visit our website at www.electronicworkbench.com

CIRCLE 26 ON FREE INFORMATION CARD