

FEBRUARY 1999

Popular Electronics®

PLUS!
IC Logic Gates
& Inverters

Liquid-Crystal Displays— The Easy Way

With the aid of the driver circuitry presented, LCD readouts are sure to find a way into your projects

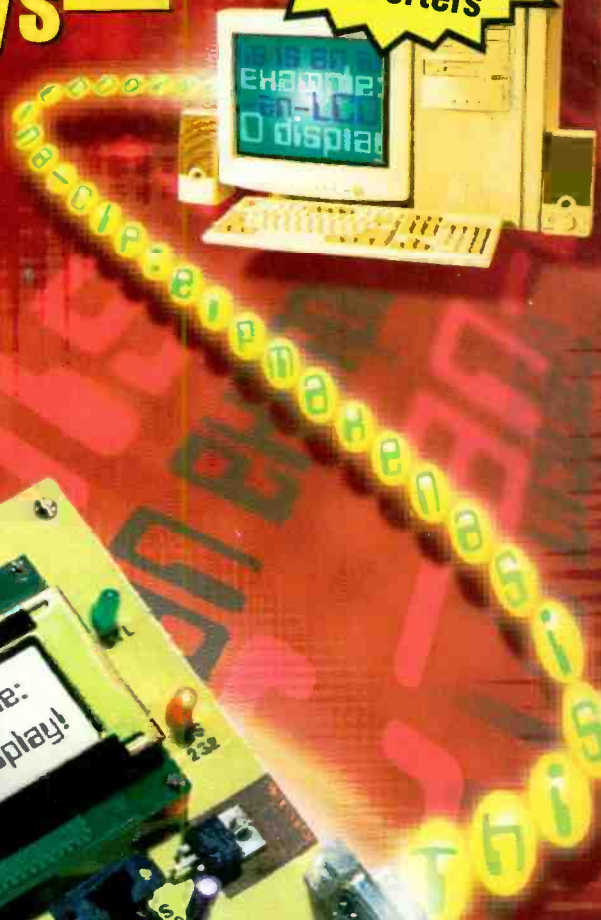

Adventures With Circadian Rhythms

Observe how living organisms react to changes in their normal environment with these easy-to-build circuits

Build the Sentinel

Add this early-warning system to your home-defense arsenal and foil would-be burglars



Gizmo®

Divisive DIVX, Desktop Camcorder, CD Jogger, The Sounds of Music, Games, Software, and more—plus Here Comes HDTV!

Also Inside:

- Better Bangladesh Betar
- High-Speed Connectivity
- Tunnel Diodes and Other Goodies
- Exeter Technologies' Park-Zone System



A GERNSBACK PUBLICATION

\$4.99 U.S.
\$5.99 CAN.



High-end features. Low-end price.

\$299

CircuitMaker 6:
Schematic design
and simulation
software

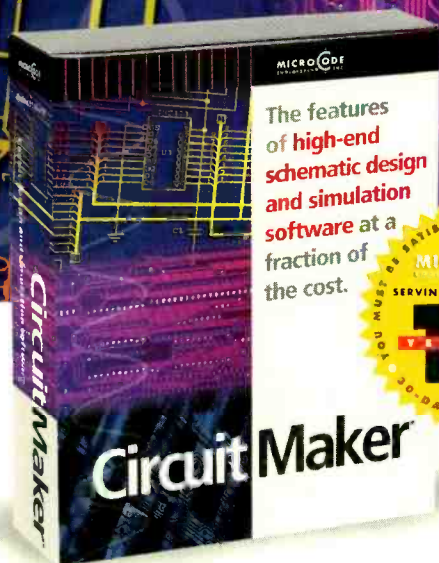

\$299

TraxMaker 3:
Printed circuit
board layout
software

CircuitMaker Version 6 and TraxMaker Version 3 give you the features of professional, high-end software at a fraction of the cost. Plus, with exceptional ease-of-use you'll spend less time learning to use the software and more time designing. Both applications are compatible with your existing software, and feature outstanding technical support. Call now for your free functional demo.

CircuitMaker 6 is a powerful schematic design and simulation program featuring:

- Professional schematic features including printout borders, title block and barred pin names
- Symbol editor and Macro feature for custom devices
- Fast, accurate SPICE3f5/XSPICE-based simulation
- Complete array of analysis types, including Fourier, AC, DC, Parameter sweep, Transient and more
- Virtual instruments including a digital oscilloscope, multimeter, Bode plotter, curve tracer and more
- Extensive library of over 4,000 models
- Tight integration with TraxMaker® for quick PCB layout
- Output PCB netlists in Protel®, Tango® and TraxMaker® formats for use in a variety of PCB layout programs
- Windows 3.1, 95 and NT

TraxMaker 3 is a powerful printed circuit board layout program featuring:

- Over 2,000 component footprints in a fully-documented, indexed library. Documentation shows footprints actual size
- Built-in autorouter and Design Rules Check
- Supports up to 6 signal layers plus power and ground planes, silk screen overlays and solder and paste masks
- Board sizes up to 32" x 32", with no pin limitations
- Intelligent manual routing with unrout capabilities
- Import any PCB netlist in CircuitMaker®, Protel® or Tango® format
- Output RS274X Gerber files, Excellon N/C drill files and Bill of Materials
- Print to any Windows-compatible printer or plotter
- Windows 3.1, 95 and NT

MICRO CODE ENGINEERING INC For free demo software, or to order, call **1-800-419-4242**
927 West Center Street • Orem, UT 84057 • Phone (801) 226-4470 • Fax (801) 226-6532 • www.microcode.com

©1998 MicroCode Engineering, Inc. All rights reserved. CircuitMaker, TraxMaker, SimCode and MicroCode are registered trademarks of MicroCode Engineering, Inc. All other brand and product names are trademarks or registered trademarks of their respective companies.
CIRCLE 174 ON FREE INFORMATION CARD

Popular Electronics®

THE MAGAZINE FOR THE ELECTRONICS ACTIVIST!

CONSTRUCTION ARTICLES

LIQUID-CRYSTAL DISPLAYS—THE EASY WAY	Carl J. Bergquist	31
<i>With the aid of the driver circuitry presented in this article, LCD readouts will find their way into your projects.</i>		
BUILD THE SENTINEL	Anthony J. Caristi	45
<i>Add this early-warning system to your home-defense arsenal and foil would-be burglars before they can gain entry to your home.</i>		

FEATURE ARTICLE

ADVENTURES WITH CIRCADIAN RHYTHMS	Newton C. Braga	41
<i>Observe how living organisms react to changes in their normal environment with these easy-to-build circuits.</i>		

PRODUCT REVIEWS

HANDS-ON REPORT		4
<i>Exeter Technologies' Park-Zone System</i>		
PRODUCT TEST REPORT		15
<i>Samsung LCD Monitor</i>		
GIZMO		21
<i>Divisive Divx, Desktop Camcorder, Writable Rex, CD Jogger, The Sounds of Music, Games, and Software!</i>		

COLUMNS

COMPUTER BITS	Jeff Holtzman	6
<i>Information Appliances and the HP CapShare 910</i>		
HAM RADIO	Joseph J. Carr	8
<i>Want to Zap AM BCB QRM?</i>		
MULTIMEDIA WATCH	Marc Spiwak	18
<i>Graphics and Dolls, Hardware and Software</i>		
ANTIQUÉ RADIO	Marc Ellis	49
<i>Evolution of a Collector</i>		
CIRCUIT CIRCUS	Charles D. Rakes	51
<i>IC Logic Gates and Inverters</i>		
THINK TANK	Alex Bie	54
<i>Tunnel Diodes and Other Goodies</i>		
NET WATCH	Konstantinos Karagiannis	59
<i>High-Speed Connectivity</i>		
DX LISTENING	Don Jensen	61
<i>Better Bangladesh Betar</i>		
SCANNER SCENE	Marc Saxon	63
<i>Pack Your Trunks—Let Your Computer Do the Tracking!</i>		

DEPARTMENTS

EDITORIAL	2
LETTERS	3
ELECTRONICS LIBRARY	13
NEW PRODUCTS	30
POPULAR ELECTRONICS MARKET CENTER	67
ADVERTISING INDEX	92
FREE INFORMATION CARD	92A

POPULAR ELECTRONICS (ISSN 1042-170-X) Published monthly by Gernsback Publications, Inc. 500 Bi-County Boulevard, Farmingdale, NY 11735. Periodicals postage paid at Farmingdale, NY and at additional mailing offices. One-year, twelve issues, subscription rate U.S. and possessions \$24.99, Canada \$33.15 (includes G.S.T. Canadian Goods and Services Tax Registration No. R125166280), all other countries \$33.99. Subscription orders payable in U.S. funds only, International Postal Money Order or check drawn on a U.S. bank. U.S. single copy price \$4.99. Copyright 1998 by Gernsback Publications, Inc. All rights reserved. Hands-on Electronics and Gizmo trademarks are registered in U.S. and Canada by Gernsback Publications, Inc. Popular Electronics trademark is registered in U.S. and Canada by Electronics Technology Today, Inc. and is licensed to Gernsback Publications, Inc. Printed in U.S.A. Postmaster: Please send address changes to Popular Electronics, Subscription Dept., P.O. Box 338, Mount Morris, IL 62054-9932

A stamped self-addressed envelope must accompany all submitted manuscripts and/or artwork or photographs if their return is desired should they be rejected. We disclaim any responsibility for the loss or damage of manuscripts and/or artwork or photographs while in our possession or otherwise.

As a service to readers, Popular Electronics publishes available plans or information relating to newsworthy products, techniques, and scientific and technological developments. Because of possible variances in the quality and condition of materials and workmanship used by readers, Popular Electronics disclaims any responsibility for the safe and proper functioning of reader-built projects based upon or from plans or information published in this magazine.

Larry Steckler, EHF, CET,
editor-in-chief and publisher

EDITORIAL DEPARTMENT

Edward Whitman, managing editor
Robert Young, technical editor
Evelyn Rose, assistant editor
Teri Scaduto, assistant editor
Janine Abitabile, editorial assistant
Alex Bie, contributing editor
Joseph J. Carr, K4IPV, contributing editor
Marc Ellis, contributing editor
Jeffrey K. Holtzman, contributing editor
Don Jensen, contributing editor
Konstantinos Karagiannis,
contributing editor
Charles D. Rakes, contributing editor
Marc Saxon, contributing editor
Marc Spiwak, contributing editor

PRODUCTION DEPARTMENT

Ruby M. Yee, production director
Ken Coren, desktop production director
Melissa Giordano, desktop production
Kathy Campbell, production assistant

ART DEPARTMENT

Andre Duzant, art director
Russell C. Truelson, illustrator

CIRCULATION DEPARTMENT

Theresa Lombardo, circulation manager
Gina L. Gallo, circulation assistant

REPRINT DEPARTMENT

Christina M. Estrada, Reprint Bookstore

BUSINESS AND EDITORIAL OFFICES

Gernsback Publications, Inc.
500 Bi-County Blvd.
Farmingdale, NY 11735
516-293-3000
FAX: 516-293-3115

President: **Larry Steckler**
Vice-President: **Adria Coren**
Vice-President: **Ken Coren**

SUBSCRIPTION CUSTOMER SERVICE/ ORDER ENTRY

800-827-0383
7:30 AM - 8:30 PM EST

Advertising Sales Offices listed on page 92

Composition by Mates Graphics
Cover by Loewy Design

VISIT US ON THE INTERNET AT:
www.gernsback.com



Since some of the equipment and circuitry described in POPULAR ELECTRONICS may relate to or be covered by U.S. patents, POPULAR ELECTRONICS disclaims any liability for the infringement of such patents by the making, using, or selling of such equipment or circuitry, and suggests that anyone interested in such projects consult a patent attorney.

EDITORIAL

NIMBYism

In the October and November issues of last year, we featured a two-part series on putting together your own PC and the methods to get your PC up and running. This series generated quite a bit of controversy. While some of this mail related to technical questions, a good many other remarks were negative—what I refer to as “NIMBYism,” (“Not In My Back Yard” type of comments). By that I mean, some readers indicated that they really enjoyed reading the series, but not in *their Popular Electronics*. Interesting as this series was, some readers felt these topics were inappropriate for this electronics-oriented magazine. Such topics should appear instead in one of the countless number of computer- or PC-type magazines on the market today (and I always thought that computers had something to do with electronics!).

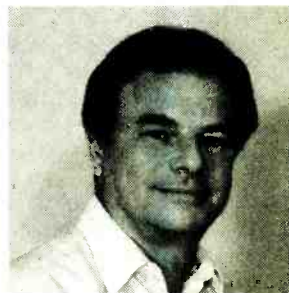

As I indicated in my editorial in the October issue, the ultimate goal of such PC-building articles is not to save money or to give readers the latest scoop on PC components, but to provide plenty of practical, hands-on experience with the internal workings of a PC. A reader who never cracked open the case of a computer would be very wary of starting a project on PC-controlled equipment, which may involve installing a custom-built PCI card into a slot on their motherboard. The confidence that comes with building one's own PC goes a long way toward quelling such fears and may prevent costly mishaps later. There are a lot of electronic hobbyists who may need to be brought up to speed with current PC technology. By including a small number of articles like these, we can build a knowledge and experience base upon which to develop more interesting projects.

Unfortunately, it seems that a lot of oldtimers (and some “young-timers” too) are reluctant to embrace the truth that computers are here to stay. What's more, computers can make many of life's endeavors a lot easier, more understandable, and more interesting. This applies to the efforts of electronics hobbyists and electrical engineers as well. Some of the newest developments in electronics are the result of the marriage between PCs and analog/digital circuitry. As a result, hobbyists who do not have the luxury of working in a corporate-funded laboratory can now easily undertake previously unthinkable circuit developments. This does not apply just to Computer-Aided Design (CAD) projects. Fully-functional digital and analog circuits can now be created and tested as real hardware (e.g. Field-Programmable Gate-Arrays, or FPGAs). However, such projects require at least a familiarity with the internal components of a PC. The scope of the articles in question covers most of the concepts and hands-on skill required by electronic hobbyists, as the PC becomes an indispensable tool for tinkerers.

I am sorry that some of our readers felt so strongly opposed to this type of article in **PE**. Our magazine does not stress and will not stress computer articles. But we cannot dismiss computers, as they encompass just about everything in this modern world. In fact, just about every **PE** column deals with something computer-related, even if it is just a Web address. On a final note, rest assured we will always remember to emphasize the term *Electronics* in **Popular Electronics**, as the focal point for all construction articles in our magazine.

Ed Whitman
Managing Editor

LETTERS

TRAFFIC ON THE TEXT

Due to production problems, the text on the opening page of the article "Automated Highway Systems," page 33, in some copies of last December's issue may have been overprinted with a very dark highway traffic illustration, making it difficult to read. If your text was obscured by the "roadway," we have reproduced the text only of this page on our Web site editor's board: (www.gernsback.com/HNeditor/get/editor/board.html). Or if you prefer, drop us a note by regular mail, and we will send you a copy of the page, text only.

To avoid chances of this problem happening in future articles or projects, we will have art silhouetted or run separately. Readability and accuracy are our top concern. Once again, we are sorry for the problem.—Editor

A READER RESPONDS TO READERS

In his letter in the November 1998 issue of **Popular Electronics**, Fred Lehman states in response to the request by George Wroe (August issue) that you need another VCR to record more than one radio station. You actually need *only* one VCR. Many newer VCRs have both a rear and a front set of input jacks. On some models—such as RCA Models VR688HF and VR689HF, either of these jacks can be specifically programmed with the VCR's timer, just as any one of the TV channel numbers can be programmed. I have both models; and on each one, the rear jacks are programmable as VIDEO2.

Method #1: If you only need two radio stations, plug one radio into the rear (VIDEO1) of the VCR and tune this radio to your first station. Plug a second radio into the front jacks (VIDEO2) of the VCR and tune it to our second station. Set the VCR timer to appropriately record VIDEO1 and VIDEO2. Use AC adapters for the radios, and leave both radios on all the time.

NOTE: This method will not work will all VCRs. I have an expensive JVC VCR that mechanically switches and overrides the rear jacks any time anything is plugged into the front jacks. So, only one set of jacks is available to

the VCR timer without your mechanical intervention. I have another TV/VCR combination that apparently switches by electronically sensing if a signal is present on the front jacks. Again, this would be difficult to use for multiple stations.

Method #2 (four stations): Use Method #1 for the first two stations, then you can add two more fairly easily by using two surplus RF modulators (see advertisers in **Popular Electronics**) and two more radios. These modulators are usually switchable to Channel 3 or 4. Set one to Channel 3 and one to Channel 4 and connect through splitters/combiners to the VCR's antenna input connection. We can now select VIDEO1, VIDEO2, Channel 3, or Channel 4 for a total of four stations.

There are also other ways to program more than four stations using either a universal programmable remote control or a PC.

W. A. Dozier
via e-mail

HAVES & NEEDS

I need a schematic diagram for a *Marquette, Dyna-Vision, Engine Analyzer*, Model 1000 or 1001.

Marquette Manufacturing Company, Inc. of Minneapolis, MN made this unit. It has seven tubes in the circuit plus three tubes in the RF high-voltage section to drive the seven-inch CRT.

I also need a schematic on a *Heathkit* scope, Model IO-102-3. Any help on this matters would be greatly appreciated.

Craig Kendrick Sellen
Mallard Meadows R.H.C.
476 Belmont Street
Waymart, PA 18472

Can you supply me with a schematic or source for a low-power AM radio transmitter or "phono oscillator?" It must have sufficient power to cover an area of about 15 acres and be tunable over the AM radio band. The application will be to "pipe" paging announcements from the main facility to nearby outlying buildings. Those buildings will have AM receivers tuned to the appropriate announcement frequency.

Conway Chester
17100 Gillette Avenue
Irvine, CA 92614
E-mail: conway@pacbell.net

For many years now I have not been able to listen to my shortwave radio when my computer is on. It radiates interference, which produces noise that swamps any radio stations that do not transmit a strong signal. I have tried filtering out this noise, but it seems too broadband. I have a *Sangean 803A* receiver with an outside antenna right in the center of the city of Christchurch in New Zealand.

I have long watched advertisements for a filter that will do the job; however, I can not find a company that offers such a product. I have also noticed that there are very few letters about this problem, which I find hard to understand—there must be others in the same boat. Does anyone know of any such product; or can anyone supply me with a simple circuit which I can install on my monitor and/or receiver lines?

Derek H. Rout
1/359 Worcester Street
P.O. Box 4603
Christchurch, New Zealand
E-mail: ucandonz@southern.co.nz

I recently purchased an RF cordless mouse manufactured by *Mitsumi Electronics*. Its transmitter has a 9-pin serial connector, but I would like to be able to plug it into my computer's PS/2 port. I tried using a 9-pin to PS/2-adaptor, but the mouse does not work. The adaptor is not defective, because it works on another computer. The PS/2 port is working properly, because I can plug a standard mouse into it that works with no problem.

My question is: Can I rewire the cordless mouse with a standard PS/2 cable. If so, what pin arrangement would the mouse have? I already have the pinouts for the PS/2 port from the owner's manual for the computer.
Lawrence Ferrara
4820 98th Street
Corona, NY 11368

(Continued on page 7)



Exeter Technologies' Park-Zone System

A space-age traffic light to help you park the family chariot in your cramped garage!

Park-Zone by Exeter Technologies Inc. is a precision-parking device that provides electronic depth perception in the home-garage environment. It is an easy-to-install signaling system that works on any vehicle in any garage.

Operation of *Park-Zone* is comparable to that of a traffic light. A green light comes on as the car enters the garage, indicating contact was made. As the car draws nearer, a yellow light cautions the driver to approach slowly and be ready to stop. A red light comes on when you are precisely in the park zone—red being symbolic for stop. At other times to save battery energy, all the lights in the system are out.

Park-Zone's ultrasonic transducer sensor is active at all times. When you listen carefully, the almost-ultrasonic pinging sound of the sensor is barely audible. Each ping represents a sound wave, which is used to determine that there is a vehicle within the sensing range and to determine how far it is from the wall as it approaches. The sonar-like device detects the time interval between the initial sound ping and echo being returned to the sensor after bouncing off the car's hard surfaces. This time interval is proportional to the distance between the ultrasonic transducer and the front (or back, if you back in) of the car.

The brains behind the entire operation is an advanced, on-board micro-controller, which sets the ping's timing interval; performs the necessary ranging calculations (similar to a radar system); and controls the function of each mode, as well as the shifts from one mode to the other.

INSTALLATION

4 The display unit should be mounted comfortably within the driver's view. For



driving straight in, anywhere in the driver's field of view is acceptable. If required to park close to a side wall, place the display unit near that wall so you can observe both while parking. For backing in, keep the display unit in view from the mirror that is used during the final few feet of parking. Once the loca-

tion of the display unit is determined, attach the unit to the wall. If the wall is concrete, mount a 3/4-inch thick board (a piece of scrap wood from common shelving) to the wall and attach the display unit to it. A template is provided with the unit for locating the exact spacing of two wood screws.

The manufacturer recommends that the sensor unit be mounted (with its connector facing up) below the display unit at the same height as the bumper; usually about 12 to 18 inches off the ground. The reviewer suggests mounting two 6- to 12-inch lengths of 2 x 4-inch scraps of wood studs on either side of the sensor; thus, the car's bumper cannot accidentally crush the sensor. The sensor unit has a very low compacting resistance.

Different vehicles may trigger the sensor at different points. For this reason, it is not recommended parking any vehicle that was not set for use with the *Park-Zone* unit. The reviewer used a *Ford Crown-Victoria* model car, and it activated *Park-Zone* from 24 feet out. The manufacturer claims that the *Park-Zone* sensing unit has a range of 16 to 25 feet.

With both units securely mounted, connect the two components with the five-foot length of cable cord provided. With this cable, there is ample room to position the display unit where it can be best observed.

With the units installed and the car in its parking place, no closer than six inches to the transducer, depress the ON/OFF activation button on top of the display unit. The flashing of yellow and green LEDs five times each indicates that the unit was successfully calibrated and that the set distance has been programmed into the memory. *Park-Zone* is now set to guide your car into your garage every time you park.

MODES OF OPERATION

There are four modes of operation: Home-Mode, Away-Mode, Park-Mode, and Default-Mode. No matter what mode *Park-Zone* is in, the sonic transducer is always on. Once your car is parked and the *Park-Zone* system calibrated, it is in the Home-Mode. The unit pings, verifying that your car is in the right spot. This calibration can only be erased by depressing the activation button again. While away from home, *Park-Zone* enters the Away-Mode and becomes more active. Whenever the car enters the garage, the *Park-Zone* system senses it and triggers the Park-Mode. In this mode, the ping rate escalates to its highest level. This ensures precision sensing and parking. The Park-Mode continues until the red light signifies a successful and accurate park. Subsequently, *Park-Zone* automatical-

ly returns to the Home-Mode and the red light goes out.

When the car leaves the garage, *Park-Zone* switches from the Home-Mode to the Park-Mode which, in turn, acts as a transition for the Away-Mode. The reasoning is that in the Park-Mode you can park again should you forget something in the house and need to re-enter.

The red light acts as a low-battery indicator. Flashing on and off repeatedly, it alerts you that the batteries need to be replaced. When this happens, turn off the unit by depressing

the ON/OFF activation button. Replace the batteries, which should last about one year under normal usage; then, with your car parked, re-activate the unit.

To put your car in the *Park-Zone*, you can purchase it for \$79.95 at many electronic products stores in North America. For more information, write to *Exeter Technologies, Inc.*, One Penn Plaza, Suite 4025, New York, NY 10019; Tel. 888-EXETER1; or check out their Web site: www.park-zone.com; or circle number 120 on free information card. ■

Get our Freeware version
and you will know
why more and more PC-boards
are designed with EAGLE.



EAGLE 3.5

Schematic Capture • Board Layout
Autorouter

for Windows® 95/NT

Windows 95 and Windows NT are registered trademarks of Microsoft Corporation.

EAGLE Professional offers the full EAGLE power: 99 schematic sheets, pc-boards up to 64 x 64 inches, 16 signal layers
With **EAGLE Standard** you can use 4 signal layers and place components on an area of 6.4 x 4 inches
EAGLE Light is limited to 1 schematic sheet (of any size) and to 2-layer boards. Components can be placed on an area of 4 x 3.2 inches. All other features are equivalent to EAGLE Professional and Standard.

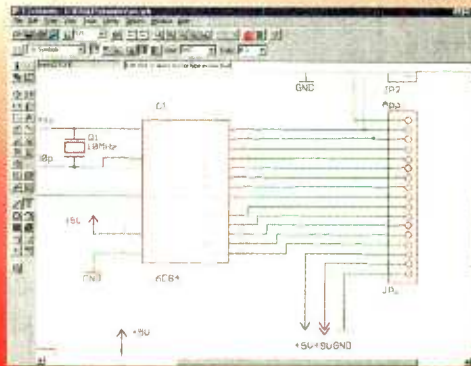

FREE Support!
No Maintenance Fee!

EAGLE 3.5 Light is Freeware!

EAGLE Light is now available free for non-profit and evaluation use! Download it from our Internet Site or order our free CD. Registered users (49 \$ for the complete package) get the commercial license, the reference manual, and free hotline support.



Prices	Light	Standard	Professional
Layout		199\$	399\$
Layout + Schematic		398\$	798\$
Layout + Autorouter		398\$	798\$
Layout + Schematic + Autorouter	49\$	597\$	1197\$

Pay the difference for Upgrades.

<http://www.CadSoftUSA.com>

800-858-8355

CadSoft Computer, Inc., 801 S. Federal Highway, Delray Beach, FL 33483
Hotline: (561) 274-8355, Fax: (561) 274-8218, E-Mail: info@cadsoftusa.com

COMPUTER BITS

Information Appliances and the HP CapShare 910

JEFF HOLTZMAN

What image does the term *Information Appliance* conjure up? An Information Appliance doesn't try to be all things to all people, like some electronic "Veg-O-Matic." Nor does it aim for general-purpose ubiquity, like the PC. Instead, an Information Appliance tries to do one thing really well. The best example to date is the wildly successful *PalmPilot* series of hand-held computers. According to manufacturer *Hewlett-Packard* (HP), "Information Appliances are a breed of task-specific devices designed to improve how we capture, process, use, and share information. These devices are simple to use, optimized to perform a narrow range of tasks, and PC-independent." In fact, HP sees the emergence of whole new categories of simple, dedicated, easy-to-use devices that you just plug in, turn on, and use. HP's initial contribution to this product category is their *CapShare 910*, a kind of portable handheld scanner/copier that helps you get paper-based information into electronic form. As the name suggests, the idea is to capture and share.

The CS910 is a handheld device, about the size of a portable CD player. It measures 4.1 x 5.5 x 1.5 inches, and weighs 12.5 ounces, including batteries. The CS910 runs off two AA batteries, which may be standard alkaline or rechargeable NiCd or NiMh cells. One charge should be good for about 50 letter-size sheets of paper, the capacity of the device's 4 MB of memory.

A 160 x 160 pixel monochrome LCD (just like the *PalmPilot*'s) provides image preview. Images are captured in black and white, and stored in PDF

FOR MORE INFORMATION

HP CapShare 910
www.capshare.hp.com

pSOSystem
Integrated Systems, Inc.
www.isi.com



The Hewlett-Packard CapShare 910 is a hand-held scanner with built-in image preview, smart document assembly, and smart IR-based communications. Watch for it as a harbinger of a new breed of Information Appliance.

(compressed PostScript format), and can be beamed via an IrDA port to a PC, printer, mobile communicator, or other device, where it can be e-mailed, faxed, printed, or stored. The *CapShare 910* also contains a standard serial port. On-board software is contained in flash memory, so updates should be painless. And no, it does not do OCR; nor does it have any PDA functionality, or even keyboard or stylus input. It is what it is. I was unable to determine what type of CPU the CapShare uses, but it runs a real-time embedded OS known as *pSOSystem*, made by *Integrated Systems, Inc.*

The CapShare supports two IR protocols: Serial IR (maximum 115 kbps) and Fast IR, (maximum 4 Mbps). With Serial IR, it takes 15–30 seconds to send a page. With Fast IR, the time drops to 5–15 seconds per page. The CS910 can function seamlessly with a *Nokia 9000* wireless digital communicator—if you have GSM coverage in your geographic area—not a great prospect in the U.S. Otherwise, the IR works just

fine with HP printers and newer laptops. You can always fall back to the RS-232 port. The IR communications use HP's fledgling *JetSend* technology, which allows devices like the CapShare to print directly to a printer, without any intervening software (e.g., image processing) or user interaction.

To use the CapShare, you just press a button and swipe the unit across whatever it is you're trying to capture. The scanning element is about 4.7-inches wide. The built-in smarts can do things like stitch multiple swipes of a page together and combine "continued on page X" newspaper columns.

MARKET RESEARCH

Hewlett-Packard is targeting a market it calls "mobile professionals," a group that HP's market research says totals almost 58 million people in the U.S. and Europe alone. This type of person works while away, carries work tools with him or her, and has unmet needs for conducting business on the road. Studies from the *Boston Research*

Group, and others, reveal that in the U.S., 49% of professionals (in general) are away from their desks more than 20% of the time, and mobile professionals in particular are away 55%. Between 1993 and 1997, cell phone usage increased more than 20% to 56% of mobile professionals. In addition, more than 65% of frequent travelers need to fax an average of 82 documents per month at a cost of \$2 per page.

What kinds of things can you scan with the *CapShare 910*? How about: business cards, newspaper and magazine articles, documents, books, irregularly shaped objects, photocopies, reference material, sales orders, notes, diagrams, and cocktail napkins. (Most successful business and technical ventures start out as blurry diagrams on cocktail napkins!)

Do you have to be a mobile professional business person to use a *CapShare 910*? No, not as long as you can cough up the \$699 list price. One area I could see this thing being useful in is as a research aid. When I go to the library, it would be useful to be able to capture information and later transfer it

directly to my PC for further analysis. However, some sort of OCR capability would be useful in that scenario. I could see a school library keeping several on hand for use by student researchers. However, this type of device is very fragile, so that would definitely be a risk.

Sometimes, when a new gadget is released, I'm just dying to have one. In this case I'm not. However, I think the device is interesting technically, and as an indicator of a coming trend toward use of small, dedicated information appliances. I don't think the *CapShare 910* will be the "killer app" of this category, but I think the category itself is poised to explode. We'll see.

That's it for now. Next time, more AVR. In the meantime, stay in touch: jeff@ingeninc.com. ■

LETTERS

(continued from page 3)

I would be obliged to receive a circuit diagram for a *Hallicrafter's* 53 receiver and the *Bush* DAC10. I can be reached

via e-mail at rbasu@drgtre.ren.nic.in.
Dr. Rahul Basu
via e-mail

I am trying to repair a car stereo amplifier, and I need to track down a copy of the schematic diagram. The amplifier is a *MEI, High Definition Two-Channel Bridgeable Power*, Model DA7230. I would really appreciate any assistance that could be offered.

Roscoe Ferguson
e-mail: crx@batelnet.bs

I need the wired remote control and owner's and service manuals for a *Barco Data P/C Three-Gun Front-Video Projector*. This particular projector is quite similar to the *Barco Data 600* projector. If any reader has these items, I would appreciate it if they contacted me to discuss terms.

I also have a large number (close to 100) of "orphaned" remote controls that work quite well, since I repair remote controls as a hobby.

Don Davis
201 Knoll Crest Drive
Birmingham, AL 35209 ■

SCANNER USERS • COMMUNICATIONS PROFESSIONALS

We've Got Your Numbers!

POLICE CALL

1999 EDITION

COMPLETELY REVISED

CURRENT THROUGH OCTOBER, 1998

- 17,000 Codes and Signals.
- Complete trunking information.
- Includes Glossary of Slang and Terms.
- Illustrated Listener's Guide Book.

GOT A SCANNER? GET POLICE CALL

At your scanner dealer and all Radio Shack stores.

More People Buy **POLICE CALL** Than All Other Frequency Guides (VHF/UHF) Combined.



HAM Radio

Want to Zap AM BCB QRM?

JOSEPH J. CARR, K4IPV

You don't have to live very close to an AM broadcast band (BCB) station to have interference (QRM) from their signals. Many people live in the shadow of AM BCB antennas, and they have a lot of problems. Amateur-radio operators using the high-frequency (HF) bands and shortwave listeners (SWLs) often hear odd signals that seem to originate in the AM BCB. They are caused by a pair of old bugaboos: harmonics and intermodulation (IM) products.

These signals are generated when strong signals (or a number of signals that collectively add up to "strong") drive your receiver into a non-linearity mode. Your ham or SWL receiver can only handle so much signal. The receiver-input signal variation, from 3 dB above the noise floor (low-level input signals) and the point where gain compression (high-level input signals) begins, is called the dynamic range of the receiver. Any time signals present in the receiver front end add up to anything close to the top end of the dynamic range, two problems will show up in your receiver—IM products and harmonics.

Let's consider a hypothetical example that is very likely to occur. Suppose there is an AM BCB station nearby operating on, say, 1600 kHz (i.e. 1.6 MHz). We will further assume that the station is operating "clean" and has no appreciable harmonics. If your receiver input is overloaded by the AM BCB signal, then spurious harmonics are generated in the receiver. For our 1.6-MHz AM BCB signal, these harmonics appear on your receiver at 3.2, 4.8, 6.4, 8, 9.6, 11.2 MHz, etc. You will hear the AM BCB programming appearing at these odd spots on the shortwave dial.

Normally, the higher-order harmonics are not heard unless the AM BCB station is really close at hand. A friend of mine had such a problem in the late 1950s. He lived so close to a BCB transmitter transmitting near 1600 kHz that if the tower from that 1000-watt station fell over it would have smashed his roof! Since it was so close, his *Hammalund HQ-110* receiver was perpetually driven into non-linearity, until

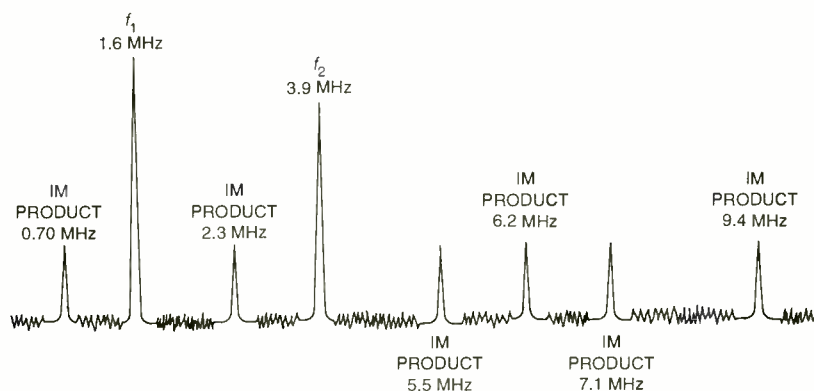

Fig. 1. Shown here is the intermodulation effect of two strong signals, f_1 and f_2 , getting into your receiver's front end. Second-order effects are noted at 2.3 MHz and 5.5 MHz, while third-order products can be found at 700 kHz, 6.2 MHz, 7.1 MHz, and 9.4 MHz.

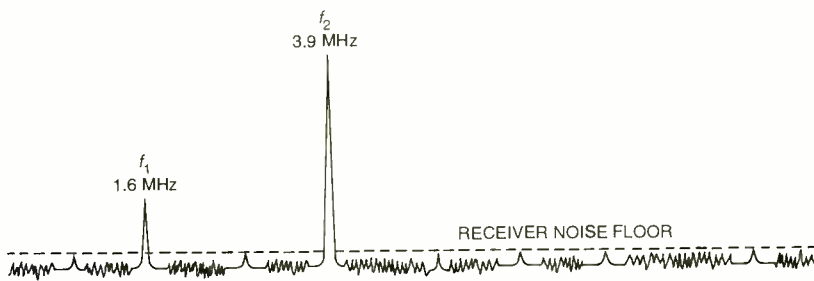

Fig. 2. Use of a good AM broadcast-band filter will suppress the broadcast signal overload at 1.6 MHz, which in turn may reduce the IM products below the receiver noise floor.

he filtered the front end using a high-pass filter.

My friend's receiver used a tuned front-end input circuit. A lot of modern receivers use front ends with band-pass filtering rather than sharply tuned resonant circuits. Some of these filters are marginal at best, so they pass rather large signals to the RF amplifier or mixer—and that leads to problems.

The IM problem is illustrated in Fig. 1. Suppose a ham operator a few blocks away from my friend comes on at 3.9 MHz. And because he is on 75 meters, he might be running a kilowatt amplifier. So his signal would be quite strong too, but not as strong as the 1.6-MHz, 1-kW BCB station with its 100-foot plus radiating tower. In the receiver's front end, those two input signals produce second-order IM products at 2.3 MHz and 5.5 MHz ($3.9 \text{ MHz} \pm 1.6 \text{ MHz}$), and third-

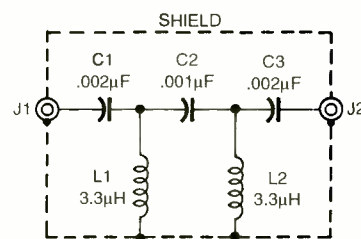

Fig. 3. Here is a schematic for a simple AM BCB high-pass filter that reduces the amplitude of standard BCB signals before they can overload your receiver.

order products at 6.2 MHz and 9.4 MHz ($2 \times 3.9 \pm 1.6$), 700 kHz and 7.1 MHz ($2 \times 1.6 \pm 3.9$). Since both of the input signals (f_1 and f_2 in Fig. 1) are strong, then these products are quite high and audible in the receiver output.

Learn Valuable Skills At Home In Your Spare Time...

Earn \$\$\$ As A PC Repair Technician!

Train with the world's acknowledged leader in distance education to enter a fast-growing, high-paying computer career!

Now you can train quickly and easily to begin a successful career as a PC Repair Technician. ICS® distance training offers you complete, comprehensive and affordable instruction that will prepare you for promotions, pay raises — even a new career — in less time than you ever thought possible!

Why pay more for an outdated PC? ICS shows you how to get the computer you want — at a price you can afford!

Unlike other schools, which include a generic, outdated PC with their PC repair training — and add as much as \$1,500 to their tuition fees — ICS lets you make your own decision. That's why our training is so much more affordable than theirs. Take advantage of the savings to buy a PC that suits your individual needs — or pocket the cash if you already own a computer.

What's more, ICS gives you invaluable instruction on how to make the best PC purchase. Your lessons teach you how to get the computer you want and give you tips on getting the best price and warranty.

PC Repair Technicians are in demand!

The U.S. Department of Labor forecasts phenomenal growth in this field in the years to come. With millions of PCs going online every year, the world needs men and women with the skills to keep them running. ICS will give you the skills to take advantage!

Only ICS — the world's leader in distance education — offers you all these outstanding benefits:

- **Experience.** In our 100 years of existence, ICS has trained more than 10,000,000 students!
- **Recognition.** Nearly 2,000 American corporations — including General Electric, IBM, Mobil, General Motors, Ford* and many others have used our training for their employees.
- **Accreditation.** ICS is nationally accredited by the Accrediting Commission of the Distance Education and Training Council in Washington, D.C.



*These companies have chosen ICS to train their employees. It does not imply an endorsement.

Call or send for FREE information — and start toward your bright future today!

Get the facts about ICS PC repair training. We'll send you a free information package that tells you how you can start toward an exciting, successful career as a PC Repair Technician.

Mail the post-paid card at left today!

If card is missing, send coupon, or

CALL TOLL FREE:

1-800-596-5505 ext. 9038

CALL ANYTIME —

24 hours a day, 7 days a week.

<http://www.icsearn.com>



ADVANCE YOUR CAREER WITH A+® CERTIFICATION! ICS HAS THE TEST PREPARATION MATERIALS YOU NEED!

A+® Certification is fast becoming the standard by which PC Repair Technicians are measured. In fact, many computer manufacturers and servicing companies won't hire you without it! ICS provides a valuable A+® Certification Test Preparation Kit along with our complete PC Repair Program, as well as making it available as a separate program. We want to make sure you get the credentials that will get you the job!



Sponsor

A+® Certification Program is an industry-wide, vendor-neutral program developed and sponsored by The Computing Technology Industry Association®. The Computing Technology Industry Association and A+® are registered trademarks. All rights reserved.



**International Correspondence Schools
School of Computer Training**

A Division of Harcourt Brace & Company

Dept. PEMS19S, 925 Oak Street, Scranton, PA 18515

YES! Please send me FREE information about how I can learn PC repair skills at home. *No obligation. Please check one of the following:*

- 27 Send me information about the complete ICS PC Repair Program (includes A+® Certification Test Preparation materials).
- 44 Send me information about the A+® Certification Test Preparation (materials only). *Certificate Program.*

Name _____ Age _____
 Street _____ Apt. # _____
 City/State _____ Zip _____
 Phone (_____) _____

February 1999, Popular Electronics

DIAGNOSIS

Before you call the engineer at the local AM BCB station to tell him about his harmonics, you might want to try a little test. Tune in the "harmonic," or spurious signal, and note the output level on an AC voltmeter hooked to the speaker. Alternatively, read it off the S-meter. If your receiver has a built-in attenuator, then make this measurement with the attenuator set to 0 dB ("off"). Next, turn on the attenuator and note the new level. It should have dropped by the value of the attenuation factor. If it dropped more than the attenuation level, then the problem is generated in your receiver, not at the radio station.

This test also serves for testing IM products. Tune in the IM product with 0-dB attenuation, and note the output level. Crank in some attenuation and note the change. If you use the S-meter as an indicator, then you need to understand the calibration of your receiver's S-meter. Most receivers seem to have either a 3-dB (rare) or 6-dB per S-unit calibration.

THE FIX

So what does a ham or SWL do about such a situation? If you place a suitably designed high-pass filter ahead of the receiver, then it will suppress the AM BCB signal (f_1 in Fig. 1). When that happens, the receiver's front end is no longer overloaded or at least not quite as much, so the IM products drop down to a lower level (possibly below the noise floor). Figure 2 shows this condition.

Figure 3 shows a simple design of an AM BCB filter you can easily build. The circuit of Fig. 3 is not the most optimized filter, but it has a couple of nice features. One "feature" is that I've built and tested several of them, both on-the-air on various receivers and by sweeping them with a signal generator.

Perhaps the real reason why the circuit of Fig. 3 is so nice is that it uses very easily obtained components: 0.001- μ F and 0.002- μ F capacitors and 3.3- μ H inductors. All of these are standard values. You can obtain them from parts suppliers, such as *Digi-Key*, Tel. 800-344-4539; Web: www.digikey.com. If you want to wind your own coils, then use the powdered-iron toroid form T-50-15 (red/white paint code; suggested source is *Amidon Associates, Inc.*, Tel. 800-898-1883; Web: www.amidoncorp.com).

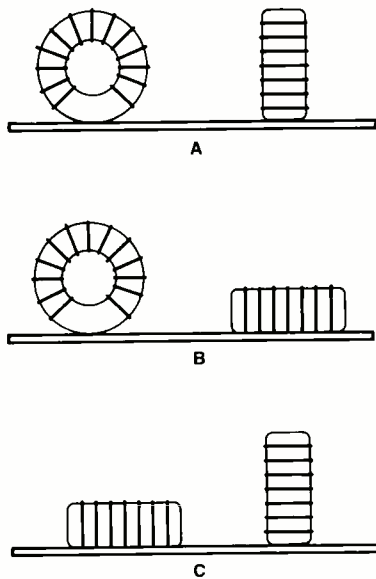

Fig. 4. This series of illustrations shows three recommended ways of mounting neighboring coils (used in the circuit of Fig. 3) to avoid interaction. In (A) the vertical planes of the coils are at right angles to one another. In (B) one of the coils is on its edge while the other one is horizontal. Finally in (C), one coil is down (horizontal), while the other one is on its edge with their planes perpendicular to one another.

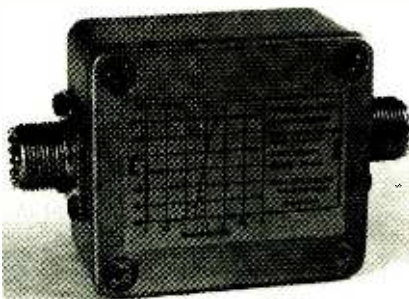

Fig. 5. Here a commercially available BCB rejection filter is shown. The 3-dB cutoff frequency is 1.75 MHz, while frequencies below 1.22 MHz are down by 60 dB. The filter has almost a flat response above 3 MHz.

Use 16 turns of number 26 enameled wire. Toroid coils are easier to work with than solenoid coils because they do not interact as much. The magnetic fields surrounding the coils are contained, so the flux lines don't cut the turns of nearby coils. Nonetheless, it's still considered smart construction to mount the coils with their planes at right angles to one another (see Fig. 4A). I usually stand one of the coils on its edge and lay the other down (see Fig. 4B), or I lay one down and mount the other one on its edge—with their planes perpendicular to one another (see Fig. 4C).

Whatever convention works in your enclosure should be OK.

The capacitors used can be ordinary ceramic-disk type, but I prefer to use either silver mica or one of the newer forms; such as polyester or polypropylene capacitors. Some of those types may not be available in 0.002- μ F values (they use 0.0022 μ F), in which case you can use two standard 0.001- μ F capacitors in parallel. Note that these capacitors might be marked "1000 pF" or "102" for a 0.001- μ F capacitor, and "2200 pF" or "222" for a 0.0022- μ F unit.

If you don't feel like building your own filter, then you might want to consider buying a commercial AM BCB filter. Figure 5 shows the *Kiwa Electronics'* (Tel. 800-398-1146; Web: www.wolfe.net/~kiwa) AM BCB filter. It has a very good roll-off below the 3-dB design frequency, so it should eliminate AM BCB signals at your shortwave receiver quite nicely.

If you are using a receiver mounted inside a transceiver, then you will have to install the AM BCB filter inside the cabinet at the input of the receiver. Be sure to check the schematic of the unit, as well as the mechanical installation, to see if this is a feasible approach—it might not be!

LEGAL STUFF

Many amateur-radio operators, SWLs, CBers, scanner enthusiasts, and others who use outdoor antennas discover to their chagrin a rather nasty little reality of modern homes: the restrictive covenant concerning antennas. Long a staple of townhouse and condo real-estate contracts, they also appear in single-family detached house contracts in new subdivisions. They are very difficult, probably impossible, to overcome. But I keep hearing rumors that courts have been upholding ham rights in this regard and overturning the covenants. *Popular Electronics* Editor Ed Whitman kindly passed along an e-mail suggesting that the FCC sides with hams because of Federal ruling PRB1, et. al. If any reader has any first-hand knowledge (not just opinion or hearsay) of a situation where a court—local, state, or other—upheld ham rights by overturning or restricting the application of such a covenant, then please contact me at my postal or e-mail addresses. I can be reached by snail-mail at P.O. Box 1099, Falls Church, VA, 22041 or by e-mail at carrj@aol.com. ■

ELECTRONICS LIBRARY

THE HOME SATELLITE TV INSTALLATION AND TROUBLESHOOTING MANUAL, 5th EDITION

by Frank Baylin with Brent Gale and Ron Long

An invaluable working tool, this 326-page, 8 1/2" x 11-inch manual includes valuable information about the transition from analog to digital C-band, and large-dish technology. Written in a concise style that can be easily understood by an interested layman, the book contains all the information necessary to make installing and maintaining trouble-free satellite systems easy. The text contains over 300 up-to-date illustrations, photographs, and tables.

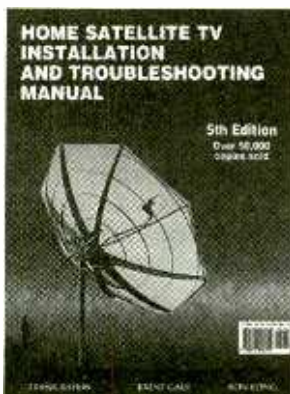

Largely rewritten and re-organized, the fifth edition includes background theory and details on how satellites and TVROs operate, as well as methods to select and judge satellite TV components. A detailed step-by-step installation and dish-aiming guide—complete with all the necessary charts and tables, thorough diagrams and text—is provided. Conventional and IF multiple-receiver and multiple-television hookups, methods to install unusually large dishes, as well as details on a complete strategy of troubleshooting any satellite TV system, are explained.

The manual provides a thorough understanding of the MPEG-2 digital television standard, video-compression methods, the IF distribution of satellite signals, and a brief overview of digital-link analysis. In addition, the appendix includes a collection of useful equations, a glossary, and a complete list of

manufacturers of satellite equipment as well as reference books and magazines.

The Home Satellite TV Installation and Troubleshooting Manual costs \$30 plus \$4 for shipping and handling and is published by Baylin Publications, 1905 Mariposa, Boulder, CO 80302; Tel. 800-483-2423; Web: www.baylin.com.

CIRCLE 90 ON FREE INFORMATION CARD

ECG SEMICONDUCTOR MASTER REPLACEMENT GUIDE, 18TH EDITION

from Philips ECG

The 18th Edition of this guide features new products, new product families, additions to existing lines, and approximately 300,000 cross-references. It is the most comprehensive, single source of replacement information available today. With an expanded cross-reference guide, selector guides and other refinements, selecting the best ECG part for an application was never easier.



Philips ECG has been supplying semiconductor replacement parts for over 32 years. Today, the latest *ECG Master Replacement Guide* encompasses a wide variety of high quality devices that meet the replacement needs of the entertainment and industry/commercial companies.

With the entire data base updated from the recently published 212T Master Guide and the software upgrades, ECG now offers the most complete user cross-reference library in the industry today. The *Philips ECG Instant Cross* program is available in both DOS format and *Microsoft Windows 3.1* and *95*. ECG semiconductors are available through a global network of distributors.

ECG Semiconductor Master Replacement Guide, 18th Edition is free upon request from your local distributor. To locate an ECG distributor, contact Philips ECG; Tel. 800-526-9354; Web: www.ecgphilips.com.

MEASUREMENT PRODUCTS CATALOG, 1998-1999

Tektronix, Inc.

Meant for design engineering, manufacturing, service, communications, and television test applications, The *Measurement Products Catalog, 1998-1999* presents a broad offering of test equipment including innovative products such as the Digital Phosphor Oscilloscope (DPO). With more than 1400 test and measurement products, Tektronix is able to provide a broad selection of low-cost instrumentation and handheld products, conventional measurement products, and advanced mixed-signal test solutions.



The 700-page, soft-cover catalog features innovative products for every signal type; and it includes a full-color, new product section that features over 70 new products and measurement solutions. Throughout, the catalog highlights products manufactured in Tektronix' ISO 9001-compliant facilities as well as

BooksNow To order books in this magazine or, any book in print. Please call anytime day or night: **(800) BOOKS-NOW (266-5766)** or (801) 261-1187 ask for ext. 1456 or visit on the web at <http://www.BooksNow.com/popular-electronics.htm>. Free catalogs are not available.

Accredited B.S. Degree in Computers or Electronics

by studying at Home

Grantham College of Engineering
offers 3 distance education programs:

- B.S.E.T. emphasis in Electronics
- B.S.E.T. emphasis in Computers
- B.S. in Computer Science

NEW
-Electronics Workbench Professional 5.0
included in our B.S.E.T. curriculums
-Approved by more than 200 Companies,
VA and Dantes, (tuition assistance avail.)

For your free catalog of our programs dial
1-800-955-2527

<http://www.grantham.edu>

GCE

Your first step
to help yourself
better your future!



Grantham College of Engineering
34641 Grantham College Road
Slidell, LA 70460-6815

Some Say Watching Tropical
Fish Lowers Blood Pressure
& Relieves Stress...



They Could Be On To
Something.



Discover the Caribbean aboard a Tall Ship.
6 & 13 day adventures from \$650.
For more information call your travel agent
or 1-800-327-2601.

 **Windjammer**
Barefoot Cruises INC.

P.O. Box 190120, Dept. 5568 Miami Beach, FL 33119

CIRCLE 172 ON FREE INFORMATION CARD

products meeting CE certification. In addition to its comprehensive detailed product descriptions, the catalog lists tutorials, application notes, and technical briefs. Extensive indexes list products by name; by function; and by categories such as oscilloscopes, logic analyzers, VXI systems, telecommunications, and television test.

In addition, measurement product information is available on both CD-ROM and on the Tektronix Web site listed below. The CD-ROM catalog and the Web site contain all the information found in the 1998-1999 paper catalog, plus the latest updates; as well as educational material, including interactive product demos; application notes; and technical briefs. New Web-technology-based viewing and searching software allows users to navigate the CD-ROM as if it were a Web site, so that information can be updated directly from the Web. The Web site also provides users with an oscilloscope product selector that helps them choose the right oscilloscope or download the latest software drivers.

To receive a free *Measurement Products Catalog, 1998-1999 (paper or CD-ROM)*, write on company letterhead to Tektronix Measurement Business Division, P.O. Box 3960, Portland, OR 97208-3960; Tel. 800-426-2200 (code 1094); Fax: 503-222-1542; Web: www.tek.com/Measurement.

ROBOT STORE CATALOG

from Mondo-tronics, Inc.

Meant for educators, engineers and electronics hobbyists throughout the world, the latest *Robot Store* catalog includes more than 250 new items. Among the new products are *CYBURG*, the living robot; the *Rug Warrior Pro*



BooksNow To order books in this magazine or any book in print. Please call anytime day or night: (800) BOOKS-NOW (266-5766) or (801) 261-1187 ask for ext. 1456 or visit on the web at <http://www.BooksNow.com/popular-electronics.htm>.

Free catalogs are not available.

robot kit developed at Massachusetts Institute of Technology (MIT); components for home-animatronics systems; the *Lynxmotion* line of unique robot kits; a book entitled *Build Your Own Underwater Robot*; and a special re-release of the classic 1960s *Lost in Space Robot* plastic model kit.

This catalog is aimed at builders of all experience levels. It begins with a helpful guide suggesting which robots to build at different skill and age levels. Each skill level (beginner, intermediate, and advanced) is broken down into projects appropriate for ages 7 to 12, 12 to 15, and 15 and up. The guide also briefly explains what principles are taught in each project. For example, the *Hyper Preppy* for the youngest beginner teaches basic mechanical skills, while their *Rug Warrior Pro Kit*—their most advanced kit—teaches advanced electronics, C programming, and subsumptive behavior. This last robot is used in courses at universities worldwide. In addition to kits, the catalog includes robot parts, platforms, muscle wires and shape-memory alloy devices, BASIC stamps and boards, software, and books and videos featuring robots.

Mondo-tronics' founder Roger Gilbertson started building robots in college, but his designs really took off when he discovered thin metal wires that shorten in length when powered. These unique *Shape Memory Alloys*, discovered in the 1930s, were rare, expensive, and difficult to use; but that changed in the early 1980s. *Mondo-tronics* is now the largest distributor of these *Muscle Wires*. Gilbertson took it a step further by creating the *Robot Store* mail order collection, among other developments. *Muscle Wires* have even found their way off the planet, as part of the Mars Pathfinder/Sojourner mission.

Robot Store Catalog 15 is published by Mondo-tronics, Inc., 4286 Redwood Highway #226, San Rafael, CA 94903; Tel. 800-374-5764 or 415-491-4600; E-mail: info@mondo.com; Web: www.RobotStore.com.

CIRCLE 91 ON FREE
INFORMATION CARD

(Continued on page 66)

Product Test Report

Samsung LCD Monitor

STEPHEN A. BOOTH

When we first began testing PC monitors, a *Liquid Crystal Display* (LCD) for the desktop was merely a concept. The cost of the thin, flat monitors would have been prohibitive, and peak demand for their use in less price-sensitive portable PCs kept it so—until recently.

When *Samsung* introduced its *Syncmaster 320TFT* with a \$799 sticker on the 13.3-inch LCD desktop, we thought something had to be wrong. Perhaps a missing digit after the dollar sign?—Desktop LCDs in the 13- to 15-inch range were running from \$1500 to \$2500. Or maybe we thought, it was one of those passive-scan LCDs of the type used in entry-level notebook PCs, on which graphics and motion images appear less crisp than active-matrix monitors.

But no, as the 320TFT's name denoted, it was a true *Thin-Film Transistor* (TFT) active-matrix LCD, and at a breakthrough price at least \$400 less than competitive models. That's a bargain in the truest sense of the word—and documented by our subsequent use and by electrical testing at the *Advanced Product Evaluation Laboratory* (APEL), our independent testing facility in Bethel, CT.

What makes *Samsung's* entry even more impressive is its no-compromise performance and features, and its elegant and thoughtful styling. To start off with, in the features department, the 320TFT offers user-selectable color temperature, including three factory presets. Color temperature in LCD monitors is seldom variable—ditto for most entry-level computer CRT displays. Among LCDs, we could find the feature in only one other brand and at a price of \$2000. As for styling, it's what we've come to expect from *Samsung* products lately: handsome and functional.

For example, whereas many desktop LCDs use an uninspired easel-mount, the 320TFT's monitor sits on top of a pedestal that houses its amplified stereo speakers and various connectors (including USB ports). More



important, this design enables the monitor to tilt either backward (30 degrees) or forward (10 degrees), so you can adjust it for the best viewing angle or to eliminate glare from ambient light. Other desktop LCDs we've seen lack this flexibility. The easel-mounts either have a fixed position or permit only a slight tilt from the perpendicular. For the record, the *Syncmaster* can be detached from its pedestal, for mounting on a wall or pivoting arm. The multimedia base works independently when detached.

As for performance, we'll let the lab results tell the tale. But one item is noteworthy, and you wouldn't need a test bench you discover it—just your eyes. The 320TFT emerged from the box without a single dead pixel. You'd notice dead cells the minute you fire up an LCD. The eye is drawn to these dots of light or darkness, where an individual pixel's switch has died and

the backlight either passes through the wide-open portal or is completely blocked. To say the eye is drawn to these spots is to say one dead pixel (or more) is distracting.

Dead pixels usually occur during manufacturing of the LCD panel (though they can appear subsequently), and can't really be fixed. The percentage yield of flawless panels is much greater than in the technology's infancy, thanks to improved clean-room techniques. Early on, higher reject rates for the panels are what made LCD prices so high.

In APEL's past experience testing other LCDs, one or more dead pixels were evident in most brand-new displays—including one where the dead cell was dead center on the screen. Whence this cautionary note: Although the *Samsung* model we tested was flawless in this regard, there's no guarantee that every LCD panel will be. So, when shopping, demand that the retail-

er set up and operate the display you buy so you can see if it has any dead pixels. If you do, don't leave the store until you've found a perfect monitor. Also, carefully check the retailer's return policy and the manufacturer's warranty in case cells malfunction subsequent to your purchase.

LAB MEASUREMENTS

Samsung's SyncMaster 320TFT earned high marks in *APEL's* physical and electrical measurements. Viewing angle is excellent, at 70 degrees off axis horizontally and vertically. This means you don't have to face the monitor square-on to see an image, as you

would with passive-scan LCDs. And, you have even more positioning flexibility owing to the previously-mentioned ability to tilt the screen up and down.

Display resolution checked out at *Samsung's* promised 1024 × 768 pixels. The monitor also will display other PC video modes in their native resolutions (e.g., VGA 640 × 480)—or let you zoom them up to the full-screen 1024 × 768.

Brightness and contrast complement the resolution. At 82.3 candelas/square meter (cd/m²), the *Syncmaster* is about midrange for LCD monitors and quite adequate. Others *APEL* has tested range from 55 to 137 cd/m². Contrast, at 94%, means the monitor's factory-preset level resolves 15 of 16 steps of the gray-scale test. Not to worry, though: Slightly adjusting the brightness yields perfect contrast.

Color temperature for *Samsung's* three pre-set modes measured at a sufficient spread for the differences to be noticeable. Mode 1, which *Samsung* characterizes as "natural," weighs in at a pretty neutral 8020 degrees Kelvin, or °K, (that's noticeably less "warm" than the redder-toned Mode 2 (7450 °K). Mode 3 is cooler, more to the blue side of the color spectrum, at 9350 °K (typically a factory setting for many fixed-temperature CRT and LCD monitors). Mode 2 is closest to the NTSC standard for color temperature (6500 °K), so you might want to use it for viewing TV or DVD movies if your PC is equipped with these video sources. Since you can make further color variations in any of the color-temperature modes, essentially you can adjust the display however it suits you—perhaps making Mode 2 warmer still and closer to the NTSC spec.

Speaking of using a PC for viewing entertainment, *APEL's* two tests for streaking and latency indicate that the *SyncMaster* will perform well with moving images. The first test looks at the edges on a black and white grid for any evidence of streaking. The second looks for latency, or image retention, on-screen. latency, in the form of "trailers" following moving images, would be a concern when viewing video or playing games. In our eyes-on evaluation using DVD movies and CD-ROM games, we found no problems. As for the *SyncMaster's* aspect ratio, the slight error from a perfect 1.33:1 (or, 4:3) is negligible.

TEST RESULTS—SAMSUNG SYNCMASTER 320TFT

The following results were furnished by the *Advanced Product Evaluation Laboratory*, an independent testing facility located in Bethel, CT. Many of the measurements were taken using the *Soneira Display Mate* test program from *Professional Video Utilities*. All reflect factory-preset conditions and were made in the 1024 × 768 resolution mode.

Brand: Samsung Electronics America
Model: SyncMaster 320TFT LCD Monitor
Price: \$799

LAB MEASUREMENTS

Viewing Angle (horizontal):	70 degrees
Viewing Angle (vertical):	70 degrees
Tilt (up):	30 degrees
Tilt (down):	10 degrees
Resolution:	1024 × 768 pixels (XGA)
Brightness:	82.3 cd/m ²
Contrast (16-step linearity):	94%
Contrast (brightness adjusted):	100%
Color Temperature (Mode 1):	8020 °K
Color Temperature (Mode 2):	7450 °K
Color Temperature (Mode 3):	9350 °K
Display Image Height:	20.5 cm (8.1 in.)
Display Image Width:	26.9 cm (10.6 in.)
Display Image Diagonal (TL/BR):	33.9 cm (13.3 in.)
Aspect Ratio:	1.31 (:1)
Aspect Ratio Error:	-1.6%
Squareness Error:	0.0%
Two-dimensional streaking (V/H):	Good
LCD Display Streaking, Latency:	Good
Automatic Synchronization:	10 resolution modes
Dimensions (H × W × D, inches):	15.5 × 14.0 × 7.75 (pedestal)

ADDITIONAL DATA

DISPLAY TYPE: Amorphous silicon, thin-film transistor, active matrix LCD
DISPLAY SIZE: 13.3 inch diagonal (viewable)
WEIGHT: 14.25 pounds
POWER: 23.5 watts

FEATURES

- Resolutions Supported: 640 × 480, 800 × 600, 832 × 624 (Macintosh), 1024 × 768
- Scanning: Non-interlaced
- Vertical Scan Range: Auto-synchronizing, 50–75 Hz
- Horizontal Scan Range: Auto-synchronizing, 30–61 kHz
- Video Input: 26-pin MDR connector
- User Controls: Menu Display; Brightness, Contrast, Horizontal/Vertical position and size, Auto Adjustment, Image Lock, Color Temperature, Color Control, Image Size, Display Mode, Language (via on-screen menu); Audio Volume, Bass, Treble, Microphone on/off (via front-panel recessed buttons).
- Amplified stereo speakers (1 watt per channel, 4 ohms)
- Headphone jack
- External microphone jack
- Plug-and-Play compatible (VESA DDC/2B)
- Power Use: EPA Energy Star, NUTEK, TCO '95 and VESA-DPMS compliant
- Electromagnetic Emissions: MPR-II and TCO '92 compliant
- Certifications: FCC Class B, CSA, DHHS, TUV, UL, and others

CONCLUSION

Although desktop LCDs are still expensive compared with CRTs, there are good reasons to want one. First, obviously, is the amount of desktop space that their shallower dimensions free up. Power consumption is another consideration, as is heat generation; LCDs run much more efficiently and cooler than CRTs. LCDs also do not emit radiation, although this is less a concern now that CRTs are more MPR-II compliant than they originally were.

For all these generic reasons, and for its fine performance, unique features, and thoughtful ergonomics, *Samsung's SyncMaster 320TFT* is a compelling choice. Its on-screen menu is easy to use (and offers a choice of five languages), the LCD configures itself to a PC and video card virtually automatically, and the owner's manual is clearly written. All of these superlatives are hard to come by elsewhere—certainly at this price, which might be lower still in the future.

For more information on the *Samsung SyncMaster 320TFT*, contact *Samsung Electronics America*, 105 Challenger Road, Ridgefield Park, NJ 07660; Tel. 201-229-4000; Web: www.sosimple.com; or circle 100 on Free Information Card. ■

ANTIQUE RADIO CLASSIFIED Free Sample!

Antique Radio's
Largest Circulation Monthly
Articles, Ads & Classifieds
6-Month Trial: \$19.95. 1-Yr: \$39.49 (\$57.95-1st Class).
A.R.C., P.O. Box 802-L22, Carlisle, MA 01741
Phone:(978) 371-0512 VISA/MC Fax:(978) 371-7129



"So then I blew open the vault, not a sound, then in come the cops and I realized the batteries on my hearing aide were dead."

ELECTRONICS CD ROMs

The most effective way of learning Digital Electronics

Complete Course
on CD ROM!
Only \$75⁰⁰

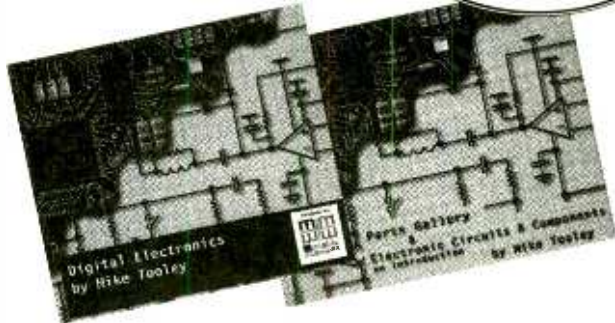

Digital Electronics builds on the knowledge of logic gates covered in Electronic Circuits and Components, and takes users through the subject of digital electronics up to the operation and architecture of microprocessors. The included virtual laboratories allow users to operate many circuits on screen.

Digital Fundamentals

Starting from the very basic principles of logic gate operation, Digital Electronics guides users through Boolean algebra, combinational and sequential logic to complex digital systems such as A/Ds and DACs, memories and microprocessors. Virtual Laboratories and worked examples help to build students' confidence and promote understanding.

Combinational Sequential Logic

Multiple gate circuits, equivalent logic functions, and specialised logic functions such as majority vote, parity checker, scrambler, half and full adders. Includes fully interactive virtual Laboratories for all circuits.

Sequential Logic, Digital Systems, and a Gallery of commonly used IC schematics are also included!

- Virtual Laboratories
- Worked Examples
- Full Audio Commentary

See and Test a demo version at <http://www.MatrixMultimedia.co.uk>

Claggk Inc., PO Box 4099
Farmingdale, NY 11735-0792
e-mail: claggk@poptronix.com



Name _____ Phone _____
Address _____
City _____ State _____ Zip _____

Enclosed is \$75 for each student version of *Digital Electronics* on a single CD ROM, shipping included inside the U.S. Shipping costs to Canada an additional \$3.00. Overseas orders please contact CLAGGK, Inc. for shipping costs.

I am ordering (...) copies at \$75 each. NY State residents must include sales tax.

I have enclosed my check for \$ _____
 Please charge my credit card for \$ _____
 Visa MasterCard Discover Expiration Date ____/____/____

MULTIMEDIA WATCH

Graphics and Dolls, Hardware and Software

MARC SPIWAK

This month I thought I'd start off with a complaint about the software industry in general, in hopes that the right people might read this and do something about the problem. My complaint concerns the resolution and color depth required by various games.

Most readers probably know what computer screen resolution is all about. In a nutshell, the picture you see is composed of tiny dots, or pixels, with the basic PC resolution stuck at 640×480 —that's 640 pixels horizontally by 480 pixels vertically. To fit more information on a monitor, the pixels are reduced in size. Resolutions of 800×600 , 1024×768 , and higher are quite common today.

Next you add color to the pixels—the more bits used to represent color, the more colors can be shown. Color depth generally starts at 8 bits, which allows up to 256 (or 2^8) colors. But true-color images viewed in only 256 colors can look a bit strange. That's why even the lowliest of graphics cards today can show a lot more than 256 colors. High color, or 16-bits, gives you about 65 thousand (or 2^{16}) colors, which is good enough for most purposes. True color supports about 16 million colors (24 bits).

Getting a computer to display higher resolutions and color depths is easy and not even expensive anymore. But because lots of PCs out there still might have trouble or even not be able to run at high resolution, software developers write code that will run on the most basic PCs, within reason. For example, most decent software requires at least a *Pentium 100* or so. Lots of games still run in 640×480 resolution and in only 256 colors, while some games insist on high color.

Now getting back to my problem. Believe it or not, my 3-1/2-year-old son spends more time now on my computer than I do. Without being able to read, he knows how to hunt for certain icons and gets his games to work. He can



Microsoft's ActiMates Barney doll is an interactive plush toy that moves his arms and head, talks, and plays games. He also contains a receiver that works in conjunction with PC and TV accessory packs that come with special transmitters.

turn on the computer, put in a disc, and usually start a game up—but *not* if the game requires a 256-color display. That requires me to go into my display settings and turn down the color depth. I don't bother to turn down the resolution to 640×480 , even though most games then only play in a small centered window on my 1024×768 display. Reducing the resolution always screws up the positioning of my icons.

The way my son (and probably most other children) plays with software, he can go through three different games all in the time that I'm getting ready for work. If he sees a new disc he has to run it. Even though reboots are no longer required, it can be a real nuisance to have to run and set the color depth every time my son swaps games. Now here's my pitch—good software will run in any resolution, though it usually warns that there could be trouble. Not surprisingly, *Microsoft* has gone even further, with some children's games automatically setting the required resolution when started, and then setting

everything back to normal when the game ends. The games play with nice full-screen displays, and my icons are positioned properly afterward.

Every software developer should take a good look at how *Microsoft* and various other software vendors have gotten around this graphics problem. Any children's software that children can't get to run is really just a nuisance to parents. It makes no sense to me that a computer can't be made to change its own resolution. Why should it need help from me? *Windows* games should have the computer set what is necessary, press OK a few times, and get back to me when the game is ready to start!

INTERACTIVE DOLLS

My children and I have been playing with some pretty incredible dolls. I'm talking about *Microsoft's* ActiMates line of plush toys, in particular *Barney* and *Arthur*, those famous characters from children's television. I had heard about these dolls but never played with them until I received a couple of samples.

Barney is a plush toy that accepts six AA batteries and contains motors and circuitry that make the doll move his arms and head, talk, and play games with children. Not only can *Barney* make noise, but also he can hear as well, so he can interact with kids. In addition, his eyes are light sensitive, so covering them makes him ask who turned out the lights, say peek-a-boo, and so on. His hands and feet contain squeeze switches. *Barney* also contains a receiver that works in conjunction with PC and TV accessory packs that come with special transmitters.

Arthur is similar to *Barney* in the way he moves and talks, but his eyes are not light sensitive. Instead, he wears a watch that is set interactively by squeezing his hands and feet. You actually set the time, date, and an important birthday for *Arthur* to remember. If you squeeze *Arthur's* watch, he tells you the time and date. He can also play timing

games with kids since he has a working watch. He does a lot more than just tell time, though.

These *ActiMates* dolls are amazing, and I don't think my family has even heard everything that they can say just yet—their vocabulary is so extensive. Not only that, but they are unbelievably tough as well, standing up to having kids tumble all over them. They sell for about \$109.

The PC Pack accessory allows *ActiMates* characters to work with a PC, with the *ActiMates* character working as a learning guide coaching a child with the PC. The PC Pack comes with a transmitter that plugs into a PC game port. A software demo CD contains samples of *Arthur* and *Barney* software titles that can be used as stand-alone games or with the *ActiMates* dolls. *Arthur's* vocabulary increases to more than 10,000 words when you add the PC Pack. The *ActiMates* PC Pack costs \$54.95. One software title that works with *Barney* and the PC Pack is *Fun on the Farm with Barney*. My son loves this fun game, with or without the *Barney* doll's interactions. This title costs \$34.95.

The TV Pack is an accessory that lets *ActiMates* characters work with compatible videotapes and daily TV shows. The TV Pack comes with a transmitter that plugs into the video-out jack on a VCR. An introductory tape provides instructions and examples of how the TV Pack operates. The dolls can then interact with special videos and TV shows. The same TV Pack works with all *ActiMates* characters. It has an estimated retail price of \$64.95. Kids watch the tape for clues to pieces that form surprise puzzles. Kids seem to like watching this tape, especially when the *ActiMates Barney* doll joins in the fun.

NEW HARDWARE

I've got another new portable CD-ROM drive for notebook computers this month. This one's a 10× from *Teac America*. The *PortaCD 10×* has a Type II PCMCIA, or PC Card interface, so it really does deliver 10× performance. Portable CD-ROM drives are useful for notebook computers that have PC Card slots but lack a factory CD-ROM option. They are also useful for notebooks that can use only the CD-ROM drive or floppy drive at once. You leave the floppy drive in the notebook and connect the CD-ROM drive to the card slot and then use both drives concurrently.



Teac's *PortaCD 10×* is a 10× portable CD-ROM drive with a Type II PCMCIA interface.



Addonics Technologies' *PocketSuperDisk* is an LS-120 SuperDisk drive that connects to notebook computers through the PCMCIA slot. It can access data on 120 megabyte LS-120 disks as well as regular floppy disks.

Whether you're installing software, running a CD-ROM title, or simply playing an audio CD, a CD-ROM drive is a must-have on the road. The *PortaCD 10×* has a 1500-kilobyte-per-second data-transfer-rate and a 200-millisecond-average-access time, which helps free up notebook processing power. The plug-and-play drive receives power through the PC Card or through a removable AC adapter. It does not have a clam shell design like other portables, but rather a disc tray that extends outward. The drive has a headphone jack, volume control, and a line-output jack. It measures 5.92 inches wide by 1.6 inches high by 6 inches deep and weighs only 1.23 pounds. The *Teac PortaCD 10×* drive costs \$199.

Another useful drive for people on the go is *Addonics Technologies' PocketSuperDisk*—an LS-120 SuperDisk drive that connects to notebook computers through the PCMCIA slot. These drives can access data on 120-megabyte LS-120 disks, which look like regular floppy disks. The drive can also read and write to 720-kB and 1.44-MB floppy disks. You won't have to travel with an external floppy drive with the *PocketSuperDisk* in hand. The *PocketSuperDisk* has a maximum data transfer rate of 1.4-megabytes-per-second and access time of 29 milliseconds. Power comes from the PCMCIA connection, or an included keyboard power cord, or even

an optional AC adapter. The *PocketSuperDisk* drive measures 6.9 inches deep by 4.9 inches wide by 0.9 inches high and weighs 13 ounces. It costs \$111.

I've got a couple of new peripherals from *ACS Innovations*. The *COMPRO Real3D 128* PCI sound card provides 3-D audio from only two speakers. Games that use *Microsoft DirectSound* are accelerated for improved playback quality and reduced load on the host CPU. The card provides emulation for *Soundblaster* and *Soundblaster Pro* with OPL3 FM synthesis for games that need it. It's also bundled with *Yamaha* wavetable synthesis. This sound card costs only \$39.99.

The *COMPRO PS39* is a digital video camera that captures motion video at up to 40-frames-per-second (fps) and still images at 1280 × 960 pixels in true color. It takes advantage of the Enhanced Printer Port (EPP) so you don't have to open or install a card in your PC. The camera works in *Windows 3.1x*, *Windows 95*, or *Windows NT* and comes with TWAIN drivers for third-party software. Also included are *SnapShot!* image-capturing software and *Microsoft NetMeeting 2.0* video-conferencing software. You have to shell out \$129 for this one.

I've got similar peripherals from *AOpen America*, the component manufacturer of the *Acer Group*. The *AW300* is a sound card based on the *ESS Maestro-2* PCI audio processor. The card has 64-voice wavetable synthesis and an internal modem connector; it offers *Soundblaster Pro*, *Windows Sound System*, and full DOS compatibility. It also supports *DirectSound* and *DirectSound 3-D*, AC3 speaker virtualization, and downloadable samples. This costs less than \$40.

AOpen's CD-940E CD-ROM drive can reach maximum speeds of 40×! The *CD-940E* has an approximate 90-millisecond access time. Its interface is designed for Ultra DMA 33 support, which improves CPU efficiency. The drive includes advanced anti-shock protection, and music is read at 8× speed and stored into a data buffer. If the drive is jarred, CD-audio continues to play. This drive costs about \$80.

AOpen's VC324 Lite offers video and audio conferencing over the Internet. It provides real-time video capture with a *Phillips Color CCD* camera and PCI capture card. Full-color video capture up

to 60 frames per second is possible. Software is included for video e-mail, telephony, motion or still-frame video capture, and video conferencing. This is also around \$140.

NEW SOFTWARE

Like all kids with access to cable television, my kids love *Blues Clues* on Nickelodeon, an animated show featuring a blue-spotted dog named Blue and a live actor character named Steve. Blue, and young viewers, help Steve find clues to solve basic riddles. Humongous Entertainment has hit the high note with the release of two new *Blues Clues* CD-ROM games. The games look very much like the TV show, but they let kids interact and really look for clues.

Blue's Birthday Adventure lets kids take part in a birthday party. This 2-CD set has kids helping Blue figure out what



Humongous Entertainment's *Blues ABC Time Activities* help preschooler's skills by identifying familiar household objects.

to give her guests, what to eat at the party, what to do at the party, and what games to play. Help Steve, Tickety, Slippery, and all of Blue's friends prepare for Blue's birthday party. *Blue's Birthday Adventure* costs \$29.99 and features hours of entertainment. *Blue's ABC Time Activities* helps preschoolers

strengthen pre-reading skills by exploring letters, sounds, and words with help from Blue and Steve. The difficulty level automatically adjusts to kids' abilities. Games in *Blue's ABC Time Activities* include *Safari Snapshots* and *Snack Time with Mr. Salt and Mrs. Pepper*. *Blue's ABC Time Activities* costs \$19.99.

Stone's Throw for Windows 95/98/NT from Latticework Software features three challenging dice games with 3-D graphics, realistic sound effects, and music. You can play against three levels of computer opponent or against a friend. Games include *Shut the Box*, *Poker Dice*, and *10,000*. This \$14.95 set of games can be purchased and downloaded over the Internet to save shipping and handling costs.

Cavedog Entertainment's *Total Annihilation: Battle Tactics* is an expansion pack for the *Total Annihilation* game featuring 100 new missions, six new maps, and four bonus battle units. The new smaller, quicker battles are satisfying without requiring three hours to complete. Combined with both the original *Total Annihilation* game and the first expansion pack, *Total Annihilation: The Core Contingency*, the set provides more than 245 3-D battle units, 175 missions, over 90 maps, and 12 3-D worlds. *The Battle Tactics* CD-ROM expansion pack costs \$19.99.

Grolier Interactive's 1999 *Grolier Multimedia Encyclopedia Deluxe* 2-CD edition is a great value for \$59.99. It's packed with reference information, 15 hours of sound, 21,000 Internet links, more than 15,000 images, 1200 maps, 400 photographs, and a whole lot more. Information is contained in 36,000 articles. New for 1999 are one hundred 360-degree panoramas that show wrap-around images of famous locations such as the Roman Coliseum, Stonehenge, and the Grand Canyon.

I have two new titles from Rand McNally Software: *TripMaker Deluxe 1999 Edition* and *StreetFinder Deluxe 1999 Edition*. *TripMaker Deluxe* helps you plan trips, print maps and directions, and more. The disc includes *Weekend Getaways*, which are pre-planned weekend adventures. Included are ratings of restaurants and lodging. *StreetFinder Deluxe* helps pinpoint addresses and locations on detailed street maps. It includes a trip organizer that tracks expenses. These discs cost \$49.95 each for the deluxe edition, and \$29.95 for the basic versions. ■

WHERE TO GET IT

Addonics Technologies

48434 Milmont Drive
Fremont, CA 94538
800-787-8580

www.addonics.com

CIRCLE 60 ON FREE INFORMATION CARD

ACS Innovations, Inc.

3171 Jay Street
Santa Clara, CA 95054
408-566-0900

www.acscompro.com

CIRCLE 61 ON FREE INFORMATION CARD

AOpen America, Inc.

1911 Lundy Ave.
San Jose, CA 95131
800-733-2237

www.aopenusa.com

CIRCLE 62 ON FREE INFORMATION CARD

Cavedog Entertainment

3855 Monte Villa Parkway
Bothell, WA 98021
888-477-9369

www.cavedog.com

CIRCLE 63 ON FREE INFORMATION CARD

Grolier Interactive, Inc.

90 Sherman Turnpike
Danbury, CT 06816
203-797-3530

www.grolier.com

CIRCLE 64 ON FREE INFORMATION CARD

Humongous Entertainment

16932 Woodinville-Redmond Rd. NE
Woodinville, WA 98072
800-499-8386

www.humongous.com

CIRCLE 65 ON FREE INFORMATION CARD

Latticework Software, Inc.

PO Box 362
Lafayette Hill, PA 19444
www.latticeworksw.com

CIRCLE 66 ON FREE INFORMATION CARD

Microsoft Corporation

One Microsoft Way
Redmond, WA
800-426-9400

www.microsoft.com

CIRCLE 67 ON FREE INFORMATION CARD

Rand McNally Software

8255 N. Central Park Ave.
Skokie, IL 60076
800-284-6565

www.randmcnally.com

CIRCLE 68 ON FREE INFORMATION CARD

Teac America, Inc.

7733 Telegraph Road
Montebello, CA 90640
213-726-0303

www.teac.com

CIRCLE 69 ON FREE INFORMATION CARD

GIZMO®

Divisive Divx

Heaven forbid a new technology ever should be introduced without format wars. A little more than a year ago, DVD—an elegant digital video delivery system that's PC-compatible—made its debut. Within minutes (it seemed), another consumer-electronic faction was heralding the coming of Divx, a feature that would be available on some, but not all, DVD players, which meant that not every DVD could be played on every DVD player.

The Divx feature enables “pay-per-view” DVD watching. Instead of buying a disc outright, in effect, you rent it (for \$4.50) for a 48-hour period—48 hours from the time the disc is loaded into the DVD player, that is. There are a few major advantages over renting a videotape. First, of course, DVD video and audio quality far surpasses that of VHS. Second, there's no need to go out and return the disc when the rental time is up, and no late fees to pay. Instead, the

player enforces the time limit, and the disc will no longer play when the time is up—unless you opt to renew it. And that brings us to the third advantage: If you really like a movie that you've rented, you can pay an additional charge to convert it to a “Divx Silver” disc, for unlimited play, which is pretty much the same thing as buying it outright, except that you can watch it free only on one machine or other Divx DVD players on your account. If you like it, but not enough to own it, you can keep the disc in your collection and “reactivate” it for another 48 hours when you want to see it again.

The big drawback to Divx, at least in our eyes, is that it divides the DVD market into “haves” and “have-nots”—and that important marketing group of early adapters falls into the have-not category. Divx-equipped decks can play Divx-encoded and standard DVD discs, while standard DVD decks cannot play back Divx discs.

Among the first wave of Divx-equipped DVD players is the *RCA RC5230Z* (\$599) from *Thomson Consumer Electronics* (10330 North Meridian Street, Indianapolis, IN 46290-1024; Tel. 317-587-4450; Web: www.rca.com). Besides Divx playback, it offers the usual DVD features, including excellent video quality, the ability to play Dolby Digital soundtracks, (although a 5.1-channel amplifier and six speakers are required to get the full effect), and quick access to specific scenes.



Desktop Camcorder

Have you discovered video mail yet? You can attach a video file to your outgoing e-mail—and the *Zoom/Video Cam* (\$129) from *Zoom Telephonics, Inc.* (207 South Street, Boston, MA 02111; Tel. 800-631-3116; Web: www.zoomtel.com) makes it easy to do so. The *Zoom/Video Cam Model 1575* is a full-motion, full-color video camera for *Windows 95* computers. It comes packaged with a *Zoom/Video* capture card, *Windows 95* drivers, video application software, and a microphone. The camera plugs into the capture card, which installs in any 16-bit ISA slot.

An advanced CMOS CCD array provides high-resolution, color, live-action video, or point-and-click still-image capture. Real-time video can be used for videoconferencing, home security, quality control, and remote problem-solving. Image capture can be used for desktop publishing, graphic design, Web site development, and to enhance manufacturing and engineering documentation. Of course, you might just want to e-mail a still shot of your kids to their faraway grandparents. With the right sound card, you can include audio as well as moving images of the little darlings. The frame rate is software-selectable for up to 15 frames per second.

The compact unit can sit right on top of your computer monitor or desk, and it's compatible with a standard tripod mount. The *Zoom/Video Cam*

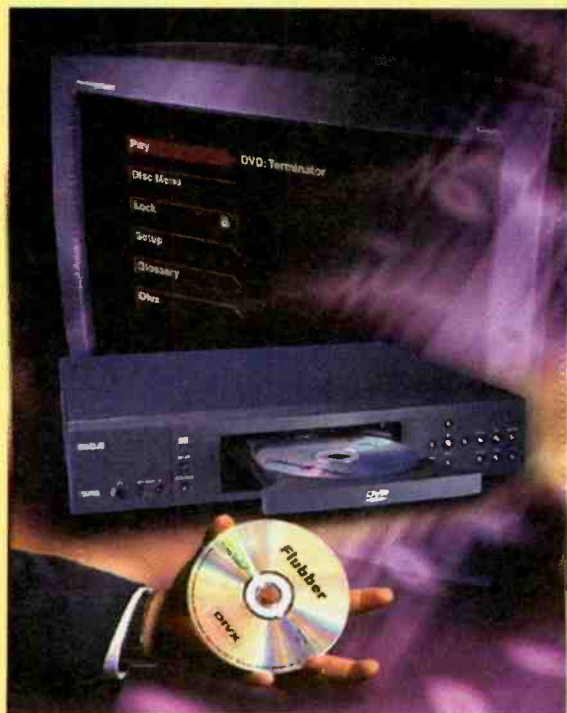

focuses from two inches to infinity and features a 50° wide-angle field of view that allows you to capture an entire room. It features an f1.9 multi-element, anti-reflection-coated lens. The camera automatically adjusts for exposure, gain, black-level calibration, and fluorescent-light flicker.

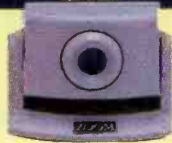

Writable Rex

When last we wrote about Franklin Electronic Publishers' (One Franklin Plaza, Burlington, NJ 08016-4907; Tel: 888-REX-6400; Web: www.franklin.com/rex) REX PC-card organizer, its main claim to fame (besides its diminutive proportions) was that users were not required to input data on some impossibly tiny keypad. Instead, the entire credit-card-sized organizer could be plugged right into a PC-card slot in a laptop, or into a special docking station, and information that had been comfortably input on a computer could be downloaded to the tiny personal organizer.



Well, it seems that there is a small but outspoken group of REX users who want to be able to input data even when their laptops and PCs are

Gizmo® is published by Gernsback Publications, Inc., 500 Bi-County Blvd., Farmingdale, NY 11735. Senior Writers: Christopher Scott and Teri Scaduto. Copyright 1998 by Gernsback Publications, Inc. Gizmo® is a registered trademark. All rights reserved.

not available—but who don't want to give up the benefits of the PCMCIA (PC card) form factor. The new 1.4-ounce REX PRO (\$299.95) allows those "road warriors" to use the *Starfish SuperKey Light Data Entry System* to enter, edit, or view appointments, contact information, to-do lists, and memos. SuperKey Light Data Entry lets users

input data using context-sensitive menus, intelligent QuickLists, and an intuitive user interface. You can't use the REX PRO to pen the next *War and Peace*, but you can easily input new contact information when you're on the road.

REX PRO can hold up to about 6000 records in its 512K RAM. The PC-card organizer also includes *Starfish True-Sync Plus* software for direct two-way synchronization with *Microsoft Outlook 97/98* and *Microsoft Schedule+*, *Symantec ACT!*, *Lotus Organizer*, and *Sidekick 98*. A home clock and world clock, both with alarms, allow users to switch appointments to their local time zone.

Home-Theater Insurance

If you've shelled out big bucks for your home-theater gear, you might want to think about getting a little protection for it. The *Optimus Home-Theater Power Center* (\$99.99) from *RadioShack* (100 Throckmorton Street, Suite 700, Fort Worth, TX 76102; Tel. 800-THE-SHACK) provides centralized power distribution and power protection for home-theater and DSS systems. The device includes a limited warranty (of up to \$10,000) against damage to properly connected equipment during the warranty period.

The slim-line accessory lets you plug in up to six devices and leave them all switched on, and then use the master power switch to turn off four outlets. The other two remain permanently on. You can also route a satellite or pay-per-view phone line and two pairs of coax lines through the power center.

The Power Center also provides surge protection for power, phone line, and coaxial surge circuits to help prevent damage to A/V equipment from sudden increases in electrical power inside or outside your home. It absorbs spikes and surges, including those that occur when air-conditioners or refrigerators kick on. Finally, it is said to improve the performance of connected equipment by filtering electromagnetic and RF interference.



Long-Playing CD Jogger

Music makes exercise easier—it provides a beat and relieves some of the boredom. But exercise can take a toll on music. The bumps and bounces inherent in jogging, roller-blading, or cycling can cause portable CD players to mistrack or skip.

The *SL-SW505J ShockWave CD Jogger* (\$179.95) from *Panasonic* (One Panasonic Way, Secaucus, NJ 07094; Tel. 800-211-PANA; Web: www.panasonic.com) has a 40-second memory buffer and the company's exclusive anti-shock memory system to handle that problem. The included neoprene ShockWave carrying case further cushions the player from shocks, and it is water-resistant.

Using the ASM II system, the CD player spins discs faster than normal, and a buffer stores the extra audio



data. When a tracking error occurs, the system plays the music from the buffer until correct tracking resumes. Horizontal shocks, which can cause the disc to momentarily spin either slower or faster, are also corrected by the ASM II's chip set.

Planning to run a marathon? The SL-SW505J can keep pace. Its *Power Star* power system allows it to play for up to 20 hours on two AA batteries.

The Sounds of Music ... Games ... Software

Remember the days when television sets were stand-alone components? Back before the networks and cable stations began broadcasting surround-sound programming, and the manufacturers began touting home-theater? If so, then you certainly remember the not-so-distant past when PCs were, for the most part, silent. Sure, they'd emit the odd beep now and again. That was before manufacturers began touting multimedia, and programmers began adding sound to just about every piece of software out there.

Nowhere does sound come so fully into play as in the gaming world. Today's PC games rely almost as much on their soundtracks as on their visuals to draw players into the action. And the speakers that come packaged with most multimedia computers do about as much justice to those soundtracks as do built-in TV speakers for DVD soundtracks.

It has become commonplace to set up a surround-sound speaker system to fully experience movies at home. That trend is now moving toward PCs as well, with several companies offering speaker systems specifically designed to maximize the sounds

generated by multimedia computers.

Some members of the gaming industry believe that their products are the driving force behind that trend. Research conducted by *InterAct Multimedia Products*, for instance, has found that

"75% of the people who buy computer speakers that cost over \$60 at retail are hardcore gamers" who want to hear earth-shattering explosions and ear-splitting screams, and who want to "feel" the car crashes and punches as well as see them.

InterAct Accessories' (10999 McCormick Road, Hunt Valley, MD 21031; Tel. 410-785-5661) *Advent Powered Partners Model AV390PL* (\$200) is a three-piece system designed to deliver all that, and more. The system, which was designed by speaker designer Cary Christie, best known as the creator of the respected *Infinity* line of speakers, handles music CDs as well as CD-ROM games with equal grace.

Each of the two putty-colored, wedge-shaped, satellite speakers features a full-range, three-inch neodymium driver and a one-inch polycarbonate tweeter. They're magnetically shielded, so they can be placed on either side of the monitor without risk of interference or distortion. The stand-alone subwoofer is the third piece of the system. It contains a built-in 40-watt amplifier for itself. It's designed to be wall mounted (with rear-panel keyhole slots provided for so doing) next to or below a desk, or it can just sit on the floor or desktop either vertically or horizontally.

The subwoofer also contains the system's power supply, and the system's power switch is found on its front panel. There's no need to strain your back reaching under the desk every time you begin working on a sound-free application, however, because the *Advent Powered Partners'*

system automatically powers down when no audio signal is detected and turns itself back on again when it detects a signal.

Connection is simple using the supplied cables. The AC power cord plugs into the subwoofer's front panel. So does the "Dual Power/ Audio Cable," which delivers DC power to the satellites to power their 15-watt amplifier (built into the right satellite) and also accepts the left- and right-channel audio from the satellites. It has two plugs at each end, a larger barrel plug, and a stereo mini-plug. The computer's stereo output is fed to the right satellite. (A second stereo input on the speaker allows you to connect the system to a second audio source, although a second stereo cord is not provided.) The left satellite is connected directly to the right one.

When setting up the *Powered Partners'* system for the first time, you must set the bass gain control to your preferred level using the gain control found on the bass module and the master volume control, which is found on the right satellite. Once the gain is set, you shouldn't have to play with it again; the system provides other ways of adjusting the sonic characteristics.

The AV390PL has three *Digital Signal Processing* (DSP) sound modes. "Line Straight" is simply unprocessed stereo audio. "Enhanced Stereo" provides dimensional texture, an ambient "feel" to the sound. It's recommended for use with games and can also be used with other multimedia software and even CDs. *Dolby Virtual Surround* creates "virtual" center and rear channel in an effort to replicate (with just two speakers) the movement from



sound field to sound field for which *Dolby Surround* is known. All three are selected using the DSP button on the front of the right satellite.

Finally, the Advent Powered Partners feature Gaming Contour Control—an adjustable, variable crossover for bass frequencies. Because PC games rarely require audio reproduction lower than 150 Hz (unlike music selections, which demand lows down to 40 Hz or lower), the subwoofer isn't really needed for most games. The power it draws can best be used elsewhere—and the Gaming Contour Control redirects it to 150 Hz and above, allowing the satellites to boom out dynamic sound effects to be heard as the producers intended them to sound. When you're ready to listen to a music CD, simply readjust the control. This convenient desktop bass control is what really keeps you from ever having to crawl down to adjust the subwoofer gain again.

Another convenient feature on the speaker's front panel is a mute control. A press of the main volume control mutes the system. A second press releases the button, and the sound resumes at the same volume level as before. That feature comes in handy in home-office situations (particularly when a business call interrupts a noisy game-playing session).

But you won't want to mute these speakers unless you really have to (another option is to plug in headphones to the headphone jack found on the right satellite). Whether you're playing an action game, listening to rock-and-roll, jazz, or opera on CD, watching a DVD movie, or surfing Internet radio sites, the Advent Powered Partners will reproduce the sounds clearly and faithfully. The Gaming Contour Control allows you to fully experience gaming soundtracks, without sacrificing stereo audio when listening to CDs—and without any of that boominess that's usually generated by PC speakers designed specifically for game playing, making them poor candidates for straight stereo listening. The *Advent Power Partners AV390PL*, on the other hand, performs excellently whether the audio source is a game, a movie, or a CD.

PC Silence

When we pick up our son at the sitter's house, we walk into a cacophony of sound. Granted, much of it is generated by a horde of youngsters, running and shouting, playing and fighting, as kids tend to do. Underlying the kiddie racket, however, is a digital score emanating from the computer, which occupies a place of honor at the far end of the living/dining room. Late afternoon is PC time for the sitter's 12-year-old, who listens to CDs, plays games, checks his voice mail, and maybe even does some of his homework.

There's no question that computers have become sound machines. They all come equipped with built-in speakers, most of which can't do justice to the sound tracks of today's games, the music "broadcast" on Internet radio, or the CDs—and even DVDs—that can be played on any multimedia PC's CD-ROM drive. One way to get superior audio quality from your PC is to add an external speaker system, like the Advent Powered Partners reviewed elsewhere in this issue of *Gizmo*. But an additional—or, perhaps, better—choice in many homes just might be a wireless headphone system, such as the *UnWired Multimedia Headphone System Model IR1000* (\$59.95) from *Laral Group* (500 Eastern Parkway, Farmingdale, NY 11735; Tel. 516-293-6900).

How do you decide which way to go? Ask yourself this question: Where does your family keep its computer(s)?

We've asked around, and often have found the answer—particularly in families that include preteens and teens—to be in some centrally located, heavily used room. Kitchens are becoming popular spots for PCs, as are family rooms. There are a few common reasons for choosing such "public" locations. First, not many families can afford one computer per kid, and neutral territory provides fair access

for everyone. Second, PCs are homework and project tools, and parents who supervise homework are better able to do so if the PC is placed at the equivalent of the kitchen table. Third, parents of Internet-connected kids feel more comfortable if they can monitor on-line activities.

But centrally located computers can cause some conflicts. What if Mom likes listening to NPR's "All Things Considered" while she cooks dinner—but that just happens to be the time her son gets home from soccer practice and needs to immediately check his PC voice mail on the kitchen PC? What if he'd prefer that the audio message from his girlfriend is not heard by the whole family?

What if one child wants to play a multimedia game, while the others want to watch TV, or the soundtrack from one child's PC research material is distracting the other kids who are trying to do their homework with plain old pencil and paper?

The IR1000 system can solve all of those dilemmas. The system consists of an infrared transmitter and wireless headphones/IR receiver. Installation is a no-brainer: The included mini-stereo plug is used to connect the transmitter to the PC's sound card, and the power supply plugs into a wall outlet.

The transmitter is a sleek, rounded, computer-beige unit that bears a slight resemblance to a computer mouse. It's intended to sit atop the PC monitor or CPU, with its deep-red-plastic-covered IR transmitter facing forward. It contains four high-power IR LEDs, providing a range of up to 25 feet. A power switch is found on the back panel. The headphones feature a white-plastic, adjustable headband, and padded, over-the-ear speakers. Twin IR sensors are located on the earpieces. The volume control and on/off switch are found on the right earpiece. Two "AAA" batteries, which aren't included, fit in the battery com-



partment in the left earpiece.

IR technology offers one major advantage over RF (Radio Frequency): It isn't subject to interference, static, or hissing that can be caused by other electronics, including cordless phones and even the computer itself. Infrared is a line-of-sight system however; it won't transmit through walls. The IR1000 has a mute circuit that cuts off all sound cleanly when you move out of range, so you won't hear the signal break up.

Of course, if you're using the headphone system for its intended purpose, you won't be moving out of range during actual use—you'll be sitting in front of your computer monitor, working, playing, or both. And the output of the IR transmitter is strong enough that you don't have to be able to literally see it—it will bounce off walls with enough power to reach the headphones.

Although the headphones are comfortable, you know that they are there. They're not so comfortable that you'll forget you're wearing them. We always remembered to remove them when taking a break. (On the other hand, the thing we find most uncomfortable about most headphones is the wire that tethers us to the equipment.)

The headphone's frequency response is rated at 35-18,000 Hz. Its signal-to-noise ratio is rated as 60 dB—we were able to hear a slight hiss during the quietest passages of some musical selections. Because the headphones are intended for use with a multimedia PC, the transmitter has a mini (1/8-inch) stereo plug; no adapter is provided for use with stereo systems with 1/4-inch phono jacks. However, with the addition of such an adapter, we found that the IR1000 performed equally well when receiving IR signals from our stereo.

The headphones don't create the three-dimensional soundstage of the Advent Powered Partners; nor are they as sonically true. But, if not perfect, the sound they produce is perfectly listenable—and certainly much improved by not having to compete with "Turn that thing down!"

Master of Its Domain

We're old enough to remember the days when our TV and our stereo were separate entities. They didn't even reside in the same room. What's more, when we wanted to change the channel or our music source, we had to stand up, walk across the room, and press a button or flip over an LP.

Boy, how things have changed! Our TV is now flanked by a center-channel and two front-surround speakers. On nearby shelves sit two VCRs (for tape dubbing), a laserdisc player, a DVD player, and two satellite receivers. (Remember, we do this for a living!) The central controller/amplifier for a whole-house audio system is located in the same cabinet, along with a receiver and a CD player.

As you might imagine, the rest of our living room resembles a breeding ground for remote controls. They are *everywhere*—but try to find the one you need at any given time, and it's missing. And playing a DVD requires the use of three separate remotes, for TV, sound system, and DVD player. What makes matters even worse is that, because of our job, we have a constantly changing assortment of gear and remotes.

We have never been able to find a universal remote that could handle everything in our entertainment center. So when we heard about the *Home Theater Master SL-9000* preprogrammed/learning remote from *Universal Remote Control* (271 North Avenue, New Rochelle, NY 10801; Tel. 914-235-2610; Web: www.universalremote.com), we were understandably skeptical. And \$139.95 seemed a high price to pay simply to add another semi-universal remote to our ever expanding pile.

We sure were in for a pleasant surprise. The SL-9000 is preprogrammed to operate more than 1000 different models of audio and video components, including many high-end models that are generally ignored by universal-remote manufacturers. It handles not only the basic TV/VCR/Cable/CD array, but also more esoteric components including Internet/PCTV devices, DSS, DBS, and C-Band satellite IRDs; line doublers; DVD players; A/V receivers and A/V switchers; sound processors; preamps; MiniDisc and DAT players; and home-automation controllers.

Getting the Home Theater Master to master your components is most likely a simple matter of looking up each device's three-digit code in the charts found in the manual, selecting a device button, and entering the code. If none of the set-up codes work on a device, or the particular brand or model isn't found in the 20 pages of charts, you can try auto-search to have the SL-9000 try to locate the proper code on its own.

We were amazed at how well the SL-9000 did with our eclectic assortment of electronics. Within minutes, we had it smoothly performing basic operations on seven out of the eight components we tried. Even the *AudioAccess* whole-house A/V controller was covered! (The SL-9000 was the first remote we've found that could do that.) There were a couple of quirks: A jukebox-style CD changer would not respond to the remote's on/off command, for instance, but if it was already powered up, its other functions could be controlled.

The one component for which there was no pre-programmed code was the *Sharp* DVD player reviewed last month (perhaps because it was introduced after the SL-9000 hit the market). Fortunately, we were able to "teach" it to operate the DVD, simply by lining it up head-to-head with the



GIZMO®

original remote, selecting the DVD device button, and then pressing corresponding buttons on the original remote and the SL-9000 to teach it those functions.

Considering the comprehensive library of preprogrammed codes, it's much more likely that you'll use the SL-9000's learning capabilities to teach it the finer points of the pre-programmed devices than to teach it to control new ones from scratch. The Home Theater Master can learn up to 376 commands from your original remote controls. That means you never have to resort to using the original remotes to set your VCR's timer, activate picture-in-picture, select specific CD tracks, access on-screen menus, or operate any of those other convenient features you've come to know and love.

By the time we had all eight components set up and had taught the SL-9000 (an apt student, by the way) all our favorite commands, we were already feeling an incredible sense of mastery over our entire home-theater system. But the remote had even more pleasant surprises in store for us.

One such nicety is its automatic audio mode. "Double-click" on any device button (other than AUD) to enter that mode and simultaneously activate automatic audio. The display will show the mode selected, preceded by the letter "A," and you will have full control over your A/V receiver or preamplifier's volume and surround controls while in that mode.

The SL-9000 also offers several "punch-through" functions, i.e., functions on one device that can be operated even though another device has been selected. The most basic (and most convenient) is punch-through volume control. You can program the remote so that either the TV's or the receiver's volume up, volume down, and mute controls will operate in any mode. "Channel control" punch-through allows the VCR or cable-box channel controls to operate in any mode, and "transport control" punch-through allows VCR or CD player to access the play, stop, 26 fast forward, rewind, pause, and

record functions in any mode.

Five memory buttons are available in five different modes for further customization. Each of those "25" buttons can be programmed to send out up to ten different commands. You might decide to store your favorite channels, create macro commands, or even "relocate" functions from one mode to another. For example, in satellite mode, you could program each of the five buttons to send out the three-digit channel number for one of your favorite DSS stations. Macro commands can be used to turn on the audio system, TV, and satellite receiver—and even dim the room lights—with one button push.

There's no need to worry about the Home Theater Master forgetting its settings. When its four AAA batteries begin to run low, the display flashes a warning. Even if you don't get around to changing them for a while, the SL-9000 will retain its programming for up to a year after the batteries are removed and up to 10 years after the batteries go dead.

The time required to program the SL-9000 depends entirely upon how complex you wish to get. Stick with the basic functions, and you can have it controlling eight components in a matter of minutes. Start with punch-

throughs, macros, favorite commands—in a lot of different modes—and you can spend the better part of the afternoon programming. If that's the route you choose to travel, be sure to take a few extra minutes to jot down all the customized commands as you enter them. You might even want to tape them to the back of the remote for quick reference. The SL-9000 might have an incredible memory, but we mere mortals often need reminders.

Once you get the hang of it, the Home Theater Master is easy to use. Its buttons are laid out logically, and a press of the LIGHT button causes all the keys to glow a bright blue. The current mode is clearly displayed on the remote's LCD.

This is one remote control that lives up to its "universal" promise—and up to its "Home Theater Master" name.

GIZMO NEWS

Here Comes HDTV

HDTV and a bunch of other Digital TV formats are being broadcast. What do you need to know, and how much will you have to spend, to jump on the DTV bandwagon?



This Thomson PROSCAN 61-inch rear-projection TV, which carries a suggested retail price of \$7,999, is one of the first wave of DTV sets hitting the market. It can receive all digital formats, including HDTV, and NTSC programming, too.

Times Are Tough...



Today's headlines scream of the lack of qualified individuals to fill new and existing high-tech job openings. If you feel the robust economy is passing you by, there is something you can do about it. **Become CIE Qualified.** Since 1934, The Cleveland Institute of Electronics has been providing its students with the necessary technical and academic credentials employers are seeking. In fact, CIE was started in 1934 to fill a similar void in the radio/television industry.

Since then, CIE boasts of over 150,000 worldwide graduates who have benefited from a patented, independent-study program that lets the student complete a Career Course, Associate Degree program, or through our affiliate school

World College, a Bachelor Degree program.

If you are currently "under-employed" and want to increase your level of income, the most proven method is an education. With CIE's independent-study program you study when and where you wish with no time constraints on how quickly you can proceed. And though it is an independent-study program you have the full support of the faculty and staff at CIE's Cleveland Campus.

To discover all the Benefits, Career Courses and Degree Programs available from CIE send for your Free Course Catalog Today!

The Cleveland Institute of Electronics has been approved for the training of eligible veterans and active duty military service members, under the G.I. Bill. Military tuition assistance (Up-Front and Basic) is also available under the DANTES Distance Learning Program.

...For Employers



BUSINESS NEWS
Employers Searching For
Qualified Candidates

F R E E C A T A L O G



Cleveland Institute of Electronics
1776 E. 17th Street
Cleveland, Ohio 44114-3679
Visit Our Web-Site: www.cie-wc.edu

*A School of Thousands.
A Class of One. Since 1934.*

YES! Please send me a catalog. AH134

Name: _____

Address: _____

City: _____ State: _____ Zip: _____

Phone Number: _____

Check Box for a Bulletin on Military Education Benefits:

VA Benefits DANTES Benefits

GIZMO®



Any set bearing this logo will be capable of receiving all digital TV formats, and NTSC signals—but they won't necessarily display true HDTV images.

As we go to press in late October, HDTV is poised to make its debut in a matter of weeks. So how many of you, reading these words two months later, have actually been watching it?

Not many, we'd guess. HDTV is here, now—sort of. It's here if you live in one of the ten major metropolitan areas in which programming is being broadcast. You can watch it if you have a set that can tune in the digital signals, and if you manage to tune in the right channel at the right time.

Confusing? Yes. That's because this is not just another new product roll out. Digital TV, high-def or standard, represents a whole new era in television. Think of it as the birth of a new TV system. New products, sure, but also a host of new formats, and a remaking of the existing TV production and broadcasting infrastructures. It heralds the imminent (though not immediate) death of TV as we know it. (NTSC's analog signal is going away. Maybe not today, but it's going away nonetheless.)

Let's take a look at the way things stand at the dawn of the digital television age.

What Is DTV?

Digital TV, or DTV, is actually an umbrella term that encompasses a slew of different formats, including, but not limited to, *High Definition TV* (HDTV) and *Standard Definition TV* (SDTV). The digital television system adopted in 1996 by the FCC does set certain standards: All DTV formats offer improved picture quality, and the possibility of widescreen presentation, and 5.1-channel surround

sound. The digital signal is more reliable, more resistant to multipath distortion, and more consistent over the entire broadcast coverage area. The Commission also has issued a recommended timeline for making the switchover from NTSC to DTV. Within that framework, however, broadcasters are allowed a tremendous amount of flexibility in selecting how they will implement DTV.

As many as 18 different technologies, most with different picture resolutions, are available. Those range from better-than-NTSC to absolutely superb, all with that 5.1-channel digital surround sound. SDTV will deliver about 300,000 pixels per frame (similar to DVD), compared to HDTV's astonishing 2,000,000 pixels per frame.

The various formats differ not only in picture resolution (ranging from 480 × 640 for the lowest resolution SDTV to 1080 × 1920 for the highest resolution HDTV), but also in the scanning method used. Some formats use interlaced scanning, like conventional TV displays. Others use progressive scanning, like computer monitors. But you won't have to worry about which formats different stations are using to deliver digital programming. Every product that bears the DTV logo must be able to handle all DTV platforms.

Why all the different platforms? The answer is twofold: bandwidth and bucks. HDTV uses many more bits, and so consumes much more bandwidth, than does SDTV. It's possible to broadcast simultaneously as many as six SDTV channels using the same amount of bandwidth as required for one HDTV channel. That translates to a potential of six times more subscribers/viewers and advertisers.

The FCC mandates that every broadcaster must provide at least one free DTV channel. Thus, a station might have one free DTV channel and charge for the rest. A broadcaster could show one HDTV channel during prime time, and several DTV channels the rest of the time. The possibilities are mind boggling.

When Will We See It?

We mentioned that the FCC has a DTV timetable worked out. At the time of this writing, the first HDTV broadcasts were scheduled to be held in November 1998, but only in the top ten U.S. markets. By May 1st of this year, all major network affiliates in those top ten markets must transmit at least one digital signal, and the target date is November 1, 1999 for affiliates in the next 20 media markets. May 1, 2002 is the deadline for commercial stations in all other markets, and public television stations have been granted an extra year.



Sharp's SharpVision 64LHP5000 Rear-Projection HDTV set displays a true 1080 picture on a 64-inch diagonal widescreen. Its suggested retail price is \$9999.

What about NTSC broadcasts? There's also a timetable for their demise. It's predicted that 85% of U.S. households will be equipped for DTV viewing by 2006, and January 1st of that year is when the FCC expects to pull the plug on NTSC.

Who Will Be Broadcasting?

We could give you a rundown on the DTV plans announced by each of the major networks. But what's more important to you is what the local affiliates plan to do with that programming, and there are as many answers to that question as there are local affiliates.

One thing's definite, and that's that cable providers will not be providing DTV programming any time soon. First-generation DTV sets are not cable-compatible. Now that a standard for connecting a digital cable box to a DTV set or converter box is complete, it's expected that second-generation sets will be cable compatible—if there's any digital cable programming to receive, that is. Because the inclusion of extra DTV channels would necessitate the removal of some popular channels from the cable lineup, cable companies have been dragging

their feet when it comes to implementing DTV.

DBS companies apparently have no such reservations; they're all welcoming with open arms the switch to DTV. *DirecTV*, *USSB*, and *EchoStar* all have announced plans to transmit HDTV programming to their subscribers.

Broadcast, cable, or DBS, the transition will be gradual, and you can expect to see mostly NTSC programming for some time to come.

What Equipment Do I Need?

You needn't buy a fancy new TV to receive digital signals. A set-top converter box can prolong the life of your current set during the transition period—but that set won't have the resolution necessary to display HDTV images. In fact, you can go out and buy a DTV set, and still not be able to see true HDTV images displayed.

Any ATSC-certified digital television—recognizable by a special logo they'll carry—can receive and decode every one of the DTV formats and display a usable picture. If a particular DTV set does not have the resolution to display an HDTV picture, it might convert that signal to a lower quality SDTV image. A true HDTV set must also be able to display 1080 and 720 HDTV formats in widescreen (16:9) mode. So far, there is no HDTV logo to identify such sets. You have to do some research, and closely question the salesperson, to be sure to get what you want.

The large, 16:9 screens needed to take full advantage of DTV's improved resolution make projection sets better choices than today's popular direct-view TVs. But to get your foot in the door quickly, for the least possible money, you could buy a 36-inch direct-view set from *Panasonic* that, with the addition of a \$1500 converter box, will decode DTV. Most

first-generation sets are rear-projection models with separate receiver/decoder boxes (which will make it easier to later add cable), with prices ranging from just over \$6000 to as high as \$10,000. Front-projection DTV sets can provide larger pictures (with price tags sized to scale). And in the near future, you can expect to see flat-panel plasma displays offered as well.

When you do decide to take the plunge, all DTV sets are NTSC compatible, so they'll see you through the transition nicely.

Is DTV For Me?

DTV is for *everyone*, whether you think you want it or not. It might not happen as quickly as the FCC predicts, but NTSC is on its way out, and DTV is the wave of the future. It's expected that within ten years, half of the sets sold in the U.S. will be fully HDTV compatible; the other half will be DTV sets.

But if your NTSC TV dies tomorrow, don't take out a loan to replace it with a digital model. The DTV phase-in will take years to complete, and the life expectancy for a new television is seven or eight years. Should yours live to a ripe old age, you'll still be able to use it for watching videotapes and DVDs and playing Nintendo.

Unless you're the type that has to be the first on the block with every new technology, you might as well cool your heels for a while. Prices are sure to drop, and programming is sure to become more varied and widely available over the next few years.

When you do take the plunge, you won't regret it. All DTV images are far superior to NTSC pictures, and CD-quality sound is part and parcel of the DTV package. As for HDTV, the viewing experience is almost indescribable. The colors are true; the image is almost realer than life. The widescreen aspect ratio provides more peripheral vision, which makes sporting events in particular seem as if they're being played right in front of you. See a demo in your area: You'll find it hard to look away, and even harder to go back to your old analog set.

Say hello to DTV. It's here to stay! ■ 29



Toshiba's 65-inch TW65H80 65-inch Theaterwide TV with DTV interface terminal.

New Products

CONTINUITY TESTER

A high-speed continuity tester that eliminates the tedious, time-consuming, point-to-point testing method, the *Wavetek Short Finder Brush (SF 10)* is ideal for every-day use by personnel in electronics, PCB manufacturing, and in production testing; by field-service engineers; and by electronics-, telephone-, electronic service repair-, and field-installation technicians. The continuity tester's ergonomic design (8.4- × 1.3- × 1-inches) makes it easy to use for anyone in the electronics manufacturing industry.



The reference probe of the *Short Finder Brush* is held in contact with the point of test by the technician, and then the circuit is swept by the low-voltage stainless steel brush-tipped probe until continuity is localized with an audible tone. Conducting a point-to-point search within the area previously identified by the brush, the search probe identifies the actual point of continuity. Low-test voltage, which is limited to 0.5 volts DC at 100 μ A, protects the sensitive circuitry and eliminates any false continuity indications.

Enabling technicians to make sweeps over multiple test points, the brush probe instantaneously finds the location of shorts in complex electrical circuits, such as printed-circuit-card assemblies, multi-conductor cables, mass-termination systems, backplanes, connectors, and IC sockets. Two AAA batteries provide portable operation. The *Short Finder Brush (SF 10)* has a list price of \$35.95. For more information, contact *Wavetek Corp.*, 9405 Balboa Avenue, San Diego, CA 92123; Tel. 800-854-2708 or 619-279-2200; Fax: 619-450-0325; Web: www.wavetek.com.

CIRCLE 80 ON FREE INFORMATION CARD

SURVEILLANCE CLOCKS

The *MC-985 Mahogany Clock Cam* (7 inches wide by 8 inches high)—shown here—and the *CL-985 Carriage Clock Cam* (4 inches wide by 5 inches high), the two latest *I-Spy* cameras from *American Innovations, Inc.*, are ideal for surveillance operations.



Blending into any home or office setting, each clock covertly conceals a color video camera with a horizontal resolution of 380 lines and a super low 2-lux sensitivity rating. Built-in backlight compensation enables each camera to function in a room with minimal lighting, and the custom-designed pinhole lens offers a 92-degree viewing field through an opening measuring only 2 mm.

Designed to be used in the office, in the store, or in the home, the clock cameras can monitor the performance of employees; they can protect retail merchandise and prevent losses; and they can keep an eye on the nanny and/or housekeeper while the parents are at work.

Since the cameras employ standard video signals, they can be connected to a TV or VCR. The timer function on the VCR can be set to monitor an area at predetermined times and/or intervals. The special introductory price for these two *I-Spy* color clock cameras is \$350 each. For more information, contact *American Innovations, Inc.*, 119 Rockland Center, Suite 315, Nanuet, NY 10954; Tel. 914-735-6127; Fax: 914-735-3560; Web: www.spysite.com.

CIRCLE 81 ON FREE INFORMATION CARD

PC RADIO

TEN-TEC, Inc.'s *PC Radio (Model RX-320)* adds shortwave listening to your *Windows*-based PC. You can surf the Web and listen to shortwave at the same time. On this unit, you can listen to local AM broadcasts; catch programs from around the world on nearly a dozen international bands; and hear hams, military operations, commercial airlines, and CB radio.



PC Radio is a stand alone, black box (measuring 3- by 6.25- by 6.5-inches) that connects to a serial port. The true Digital-Signal-Processing- (DSP) based receiver tunes from 100 kHz to 30 MHz. Unlike conventional receivers, its revolutionary design reduces the number of individual electronic components making it possible to provide a wealth of features at a reasonable price. It runs on either *Windows 3.1* or *95* and requires only one Mb of hard-drive space. The receiver software can be downloaded for free from the Web site listed below.

A telescoping whip antenna is built in; however the listening range can be significantly improved with a simple external wire antenna. A beginner's guide (written by **Popular Electronics** columnist, Joseph Carr) is included with the unit. The *PC Radio (Model RX-320)* sells for \$295. For more information, contact *TEN-TEC, Inc.*, 1185 Dolly Parton Parkway, Sevierville, TN 37862; Tel. 800-833-7373 or 423-453-7172; Fax: 423-428-4483; E-mail: sales@tentec.com; Web: www.tentec.com.

CIRCLE 82 ON FREE INFORMATION CARD

(Continued on page 66)

LIQUID-CRYSTAL DISPLAYS—THE EASY WAY

CARL J. BERGQUIST

Ever since the introduction of the first Liquid-Crystal Display (LCD) modules, hobbyists and experimenters have searched for simple and inexpensive ways to use them in their projects. Unfortunately for them, nearly all LCD modules are designed to process ASCII (American Standard Code for Information Interchange) character code, which mandates some form of microcontroller or microprocessor.

Using microcontrollers/microprocessors isn't necessarily a bad thing. However, not everyone is prepared or willing to program processing devices. Fortunately, over the past few years several approaches have been devised to help experimenters clear some of the hurdles. Among the innovative solutions to appear, one—based on *Microchip Technologies' Peripheral Interface Controller (PIC for short)*—stands out.

Our circuit—called "PIC-an-LCD"—is comprised of a pre-programmed PIC coupled with a suitable LCD module. The circuit can display the ASCII character set, while also handling text-supervision tasks, such as carriage returns, line feeds, backspace, scrolling, and so forth. The PIC controller provides a simple but comprehensive system for controlling LCD modules that have up to four lines of text (80 characters total). Now that we've got a little background on the PIC-an-LCD, let's take a quick look at the PIC16C621 microcontroller itself.

Theory. A block pinout diagram of the PIC16C621 microcontroller is shown in Fig. 1. The 16C621, based on advanced RISC (Reduced Instruction Set Computing) architecture, is an 8-bit, fully static CMOS (Complimentary Metal-Oxide Semiconductor) device. Our pre-programmed PIC uses separate data



LCD readouts don't often find their way in hobbyist-level projects because of the complicated circuitry required to drive such devices.

But with the aid of the LCD/driver circuitry presented in this article that predicament should change.

(8-bits wide) and instruction (14-bits wide) buses. A two-stage pipeline allows instructions to be executed in one cycle. The PIC's instruction set, which consists of only 35 instructions, makes programming considerably easier than with many other microcontrollers. In addition, 80 bytes of on-board RAM (Random Access Memory), 13 I/O (Input/ Output) lines, and an 8-bit programmable prescaler all contribute to the PIC's high performance. It has an internal clock that can be controlled by a resistor/capacitor (RC) tank circuit or a crystal or ceramic resonator.

The 16C621 is available in two styles: EPROM (Electrically Pro-

grammable Read Only Memory) and OTP (One-Time-Programmable) permanent memory versions. The necessary program information is "burned" into the PIC's internal memory. The actual code used is unavailable; however, a quick trip to Microchip's Web site at www.microchip.com yields several programs that are suitable for that type of operation.

The PIC-an-LCD sees incoming serial data as either commands or printable characters. Data determined to be characters are displayed on the screen. The commands, on the other hand, tell the display what to do with the char-

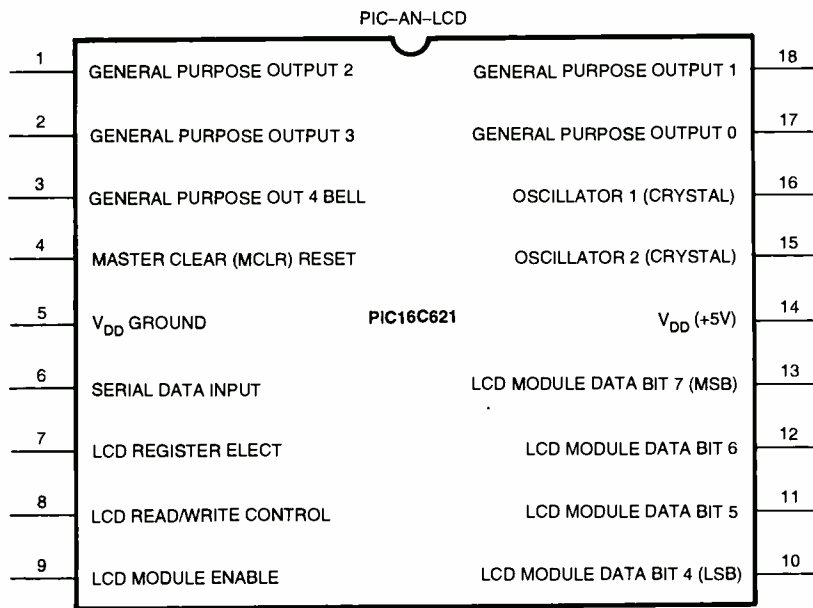

Fig. 1. The PIC16C621 microcontroller—a block pinout diagram of which is shown here—is an 8-bit, fully static CMOS (Complimentary Metal-Oxide Semiconductor) device based on advanced RISC (Reduced Instruction Set Computing) architecture.

acters. The commands, which are referred to as "invisible" (not printable), govern all text placement, as well as electronic functions that emulate a mechanical printer. Table 1 lists all ASCII commands to which the PIC-an-LCD responds.

A Look at the Circuit. A schematic diagram of the PIC-an-LCD circuit is shown in Fig. 2. The circuit is designed to accept either TTL (via SO1) or RS-232 (via SO2, a D-sub connector) input signals. Note that only pins 3 and 5 of SO2 are used; pin 3 is the "transmit data" (TD) line, while pin 5 is the ground connection. Data fed to the circuit via SO2 is made TTL compatible by IC2, which also serves to isolate IC1 from RS-232 level signals. Only one of the RS-232 to TTL converters of IC2 is used: Pin 13 is the R1 input, while pin 12 is the R1 output.

The output of IC2, along with the

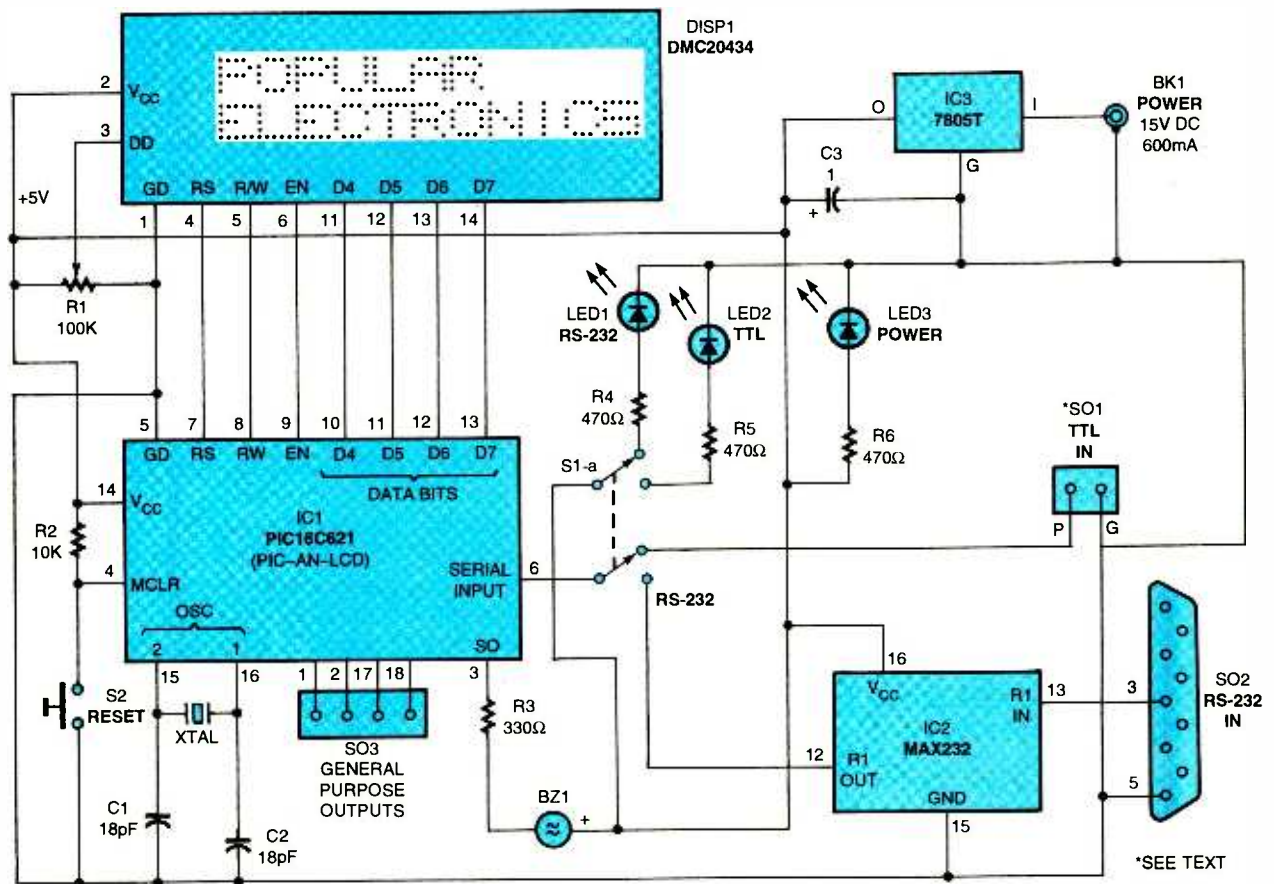

Fig. 2. The PIC-an-LCD circuit, a schematic diagram of which is shown here, is comprised of a PIC16C621 microcontroller (IC1); an Optrex DMC20434 LCD module (DISP1, which uses a Hitachi HD44780 controller/driver chip set); a 7805T fixed 5-volt regulator (IC3); and MAX232 RS-232 transmitter/receiver (IC2), along with several support components.

TTL input applied to the circuit through SO1, is fed to S1-b (which is used as the $\overline{TL}/RS-232$ selector). The other half of S1 (S1-a) is used to indicate which input has been selected. The selected signal is fed to the SERIAL INPUT of IC1 at pin 6, where the data is processed. Once IC1 has processed the incoming data and instructions, the information is output to the LCD module via seven output lines: four data lines (D4, D5, D6, and D7)

and three control lines (EN, RW, and RS). The four data bits output at pins 10, 11, 12, and 13 are fed to data inputs D4, D5, D6, and D7 of DISP1 at pins 11, 12, 13, and 14, respectively. The register select (RS), read/write (R/W), and enable (EN) inputs—pins 4, 5, and 6, respectively—of DISP1 are controlled by the outputs of IC1, pins 7, 8, and 9, respectively. Pin 1 is grounded, pin 2 is tied to +5 volts, and pin 3 is used as the logic, or con-

trast-bias, input. The contrast-bias input is controlled by potentiometer R1, which is connected across the supply voltage with the center tap (or "wiper") connected to pin 3 of DISP1.

A crystal, XTAL1, which is connected between pins 15 and 16, determines the circuit's baud (or data transfer) rate. Table 2 illustrates the correlation between frequency and baud rate. Pins 1, 2, 17, and 18 of IC1 (four of the five general-purpose outputs) can be used to activate Light-Emitting Diodes (LEDs), or other TTL-compatible loads. The fifth general-purpose output at pin 3 is used to drive BZ1. The buzzer is connected to the circuit's positive supply rail through dropping resistor R3.

The master clear (MCUR) line, pin 4, is connected between pull-up resistor R2 and momentary contact switch S2. Resistor R2 holds the line high until the system is reset by pressing S2. Pressing S2 pulls pin 4 low, clearing the screen and sending the cursor to the upper left corner of the display, while BZ1 sounds to indicate a reset.

Power for the circuit is supplied by a 15-volt, 600-mA power adapter. The output of the adapter is fed to the circuit through PL1 (a board-mounted coaxial plug), and on to IC3 (a 7805T +5-volt, fixed regulator), which clamps the supply voltage at +5 volts. Capacitor C3, connected across the ground and +V output of the regulator, filters any residual ripple voltage, while LED3 and resistor R6, which are wired from the output to ground, form a "POWER"-on indicator.

Construction. PIC-an-LCD was assembled on a printed-circuit board, measuring $4\frac{7}{16}$ by $4\frac{7}{8}$ inches. A template of that printed-circuit pattern is shown in Fig. 3, for those inclined to etch their own printed-circuit board. For those not so inclined, the board is offered as part of a kit specified in the Parts List.

Once you've etched (or purchased) the board and obtained all of the parts listed in the Parts List, construction can begin. Guided by the parts-placement diagram shown in Fig. 4, install the jumper wires first. Note that one jumper extends partially under the IC2 socket. Next, install the IC sockets and SIP pins for

PIC PROGRAMMER SOURCES

The following companies carry PIC programmers, microcontroller programmers, or information regarding chip programming.

ALLTRONICS

2300 Zanker Road
San Jose, CA 95131
Tel. 408-943-9773

ANDROMEDA RESEARCH

PO Box 222
Milford, OH 45150
Tel. 513-831-9708

B.G. MICRO

PO Box 280298
Dallas, TX 75228
Tel. 972-271-9834

CIRCUIT SPECIALISTS, INC.

PO Box 3047
Scottsdale, AZ 85271-3047
Tel. 800-528-1417

DATA BURST SOFTWARE

Box 1193
Medicine Hat, AB
Canada T1A 7H3
Tel. 403-526-7676

DC ELECTRONICS

PO Box 3203
Scottsdale, AZ 85257
Tel. 800-467-7736

DIGI-KEY

701 Brooks Avenue South
Thief River Falls, MN 56701-0677
Tel. 800-344-4539

INTRONICS, INC.

612 Newton Street
Edwardsville, KS 66113
Tel. 913-422-2094

JAMECO ELECTRONICS/COMPUTERS

1355 Shoreway Road
Belmont, CA 94002-4100
Tel. 800-237-6948

JDR MICRODEVICES

1850 South 10th Street
San Jose, CA 95112-4108
Tel. 800-538-5000

MARLIN P. JONES & ASSOC.

PO Box 12685
Lake Park, FL 33403-0685
Tel. 800-652-6733

MICROCHIP TECHNOLOGIES

2355 West Chandler Boulevard
Chandler, AZ 85224
Tel. 800-786-7200

MICRO ENGINEERING LABS, INC.

Box 7532
Colorado Springs, CO 80933
Tel. 719-520-5323

MOUSER ELECTRONICS

958 North Main
Mansfield, TX 76063-4827
Tel. 800-346-6873

M2L ELECTRONICS

3526 Jasmine #4
Los Angeles, CA 90034
Tel. 310-837-7818

MVS

Box 850
Merrimack, NH 03054
Tel. 508-792-9507

NEEDHAM'S ELECTRONICS

4630 Beloit Drive, Suite 20
Sacramento, CA 95838
Tel. 916-924-8037
BBS: 916-924-8094

PARALLAX

3805 Atherton Road #102
Rocklin, CA 95765
Tel. 916-624-8333

SQUARE 1 ELECTRONICS

PO Box 501
Kelseyville, CA 95451
Tel. 707-279-8881

SYNERGETICS

Box 809-EN
Thatcher, AZ 85552
Tel. 520-428-4073

the TTL input, general-purpose outputs, crystal, and the LCD module's 14-pin header. Follow that with the resistors and potentiometer, capacitors, switches, piezoelectric buzzer, and jacks. Install the regulator and LEDs. Once that phase of construction is completed, a voltage check is in order.

Connect the external DC adapter to PL1 and check the voltage at IC1 pin 14, IC2 pin 16, and pin 2 of the DISP1. You should read a voltage of between 4.97 and 5.02 volts. Also note whether LED3 (the POWER-ON indicator) lights. If the LED does not light, re-check your wiring, especially the orientation of IC3. If all is well, disconnect the power, and install IC1, IC2, and DISP1. Support the display above the main board with stand-

offs and bolts. Don't forget to plug the crystal of your choice into its socket.

As a final touch, the author mounted the completed board on a 5- × 6-inch base fabricated from 1/4-inch thick, clear Plexiglas. The Plexiglas provides a protective base for the unit; the circuit should not be mounted to the base until it has been thoroughly tested.

Test and Troubleshooting. The first test requires no serial input. Connect the DC power source to J1, and the POWER indicator should light, along with either the TTL or RS-232 LED, depending on the position of S1. You'll also hear a beep from BZ1. The display should first show the current chip revision (ex: REV 0100) for a few sec-

onds, after which the uppermost left block (cursor) will begin to flash. The length of time it takes for the revision statement to change to the cursor depends on the baud rate. The faster the baud, the faster the change.

If, however, you see nothing on the display, the contrast control is probably not set correctly. Try adjusting potentiometer R1 until the screen displays the flashing cursor. In the event the display fills with 80 solid blocks, or there is still nothing displayed, the PIC-an-LCD has not properly initialized the LCD module. That could be due to several problems. The "all solid blocks" situation does indicate that the LCD readout is working and is correctly connected to the power supply. That's the response you'll get with the module

PROGRAMMING AND PROGRAMMERS

It wasn't long after microprocessors hit the market that microcontrollers (microcomputers) followed. The idea was to add the needed electronics to a microprocessor to produce a complete single-chip, stand-alone computer. Granted, the new devices were limited in capability, but they did give rise to the far more powerful present-day microcontrollers.

Over the last quarter century, this field has grown by leaps and bounds, resulting in some very sophisticated integrated circuits (ICs) in terms of both architecture and functionality. One shining star among the pack is *Microchip Technologies' Peripheral Interface Controllers* or PICs.

As of this writing, there are some forty-eight different PIC chips available. Other than a few exceptions, they all fall into one of three basic families; the 16C5Xs, 16C6X/7X/9Xs and the 16C8Xs. Each group has its own special traits, but for the most part, they share a common style of architecture and operational characteristics.

For example, each uses a form of Harvard architecture that allows for separate program and data memory access paths. All use RISC (Reduced Instruction Set Computing) with just 35 instructions, and each has unusually wide instruction words (either 12 or 14 bits). Except for "jump" commands, that allows single-cycle instruction programming. Jumps require two cycles.

As for differences, they lie primarily in the type of data input (parallel or serial), and the style of permanent program information memory (PROM, EPROM or EEPROM).

The 5X devices have to use the parallel mode, while the 8Xs are restricted to serial programming. The 6X/7X/9X chips can be done either way. An advantage to the serial mode is that the device can be programmed "on the run." That is, in the system itself. The EEPROM memories make the process even easier, as they are not UV erased like their EPROM cousins.

As for programming, the method is very similar in all devices. Each requires a system voltage (V_{DD}) and a program voltage (V_{pp}). Both supplies have limitations, with V_{pp} in the 12- to 14-volt range, and V_{DD} running from 4.5 to 5.5 volts during the programming mode.

The programming routine is, again, very similar for all PICs. It begins with a "blank check" to confirm that the memory area is clear and ready. If the chip passes, using the correct voltages, the first location is programmed. If that is successful, three additional pulses are sent to assure a reliable "burn."

Next, the software asks if all locations have been programmed. If not, the Program Counter (PC) is incremented to the next address, and the subsequent instruction is put in memory. If all is well, the three repeat pulses are applied. Once the entire program is in place, it is verified at both the minimum and maximum V_{DD} voltages. That's a requirement for all PIC chips.

When those tests are completed, the "configuration word" is installed in a special memory address. That feature controls the PIC's hardware, while also providing "code protection." Code protection shields the internal operational

instructions from unauthorized copying or changes. With that step verified, you're done!

At any point along the way, problems encountered by the programming sequence result in an error message, which includes statements like "program failure," "verify failure," "erase failure," etc.

The programming process is, of course, the result of a marriage between software and hardware.

Presently, a vast number of development systems are available from a number of sources. The included "source list" (elsewhere in article) provides the names, addresses, and phone numbers of every company I could find that carries either PIC, or universal microcontroller programmers, and/or related items.

Using the programmers is as simple as attaching a cable to either a serial or parallel PC port, and installing the software. Once run, the software will guide you through the various steps.

Some good news! PIC programmers, by comparison, are rather inexpensive. They start at about \$40, with an average price of between \$90 and \$120. All are accompanied by PC software that controls the device. These factors make the PIC ideal for experimenters and hobbyists with a limited budget.

So, give the PICs a try. Presented here is just a basic overview of these chips. All of that information, and more, is available in the data sheets. It's well worth reading! Additionally, *Microchip Technologies* has an enormous amount of information available, either on CD-ROM, or at their Web site (www.microchip.com).

Take control of today's technology!

NRI Schools now gives you a fast, easy way to break into the high-tech industry as a PC Servicing Technician

Your training includes a **Pentium® II 400 personal computer, with MMX™ technology, 64 meg RAM, 5 gigabyte hard drive, Super VGA color monitor, 32X CD-ROM drive, and 56K baud fax/modem**



With NRI's PC Servicing course, you can get the practical skills and experience to service any computer with confidence. From diagnostic software to CD-ROM tutorials to a high-end computer system, NRI gives you the technological tools and training you need to carve out a successful new career, even start a business of your own!

Learn essential PC servicing skills with these unique course features:

- CD-ROM training from Norton interactive—designed by acclaimed software developer Peter Norton, this unique training tool has realistic simulations, special effects, full-color graphics, and role-playing lessons.



- ForeFront Troubleshooter™ Software and CD-ROM pinpoints system failures and diagnoses faulty components.

- Troubleshooting training—includes McGraw-Hill's easy-to-follow guides on troubleshooting and interactive computer-aided electronics diskettes relating to four key areas: AC electronics, DC electronics, semiconductors, and electronic circuits.

- Windows 98—this long-awaited version of Windows has more power, a new Web look, e-mail capabilities, single-click functionality, and System File Checker.

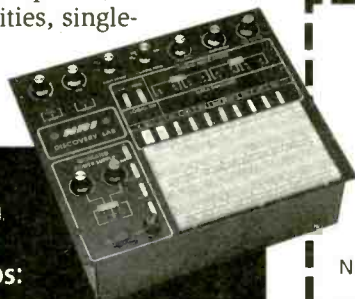

You'll also perform hands-on experiments with NRI's exclusive labs: computer-aided electronics demonstrations, 8085 Microprocessor, and NRI Discovery Lab, a complete breadboarding system.

A+ Certification—a credential that counts!

Your value as a computer service technician will soar with coveted A+ Certification. With NRI, you get essential study tips, test-taking strategies, and supplemental lessons, plus interactive tutorials and practice tests on CD-ROM. As you prepare for the exam, you'll also benefit from online support from NRI's personal instructors

You cover these important exam subjects:

- Diagnosing & Troubleshooting
- Memory Management
- Networks
- Operating Systems
- Printers
- Portable Systems
- and more!



**Call or send for FREE information:
1-800-321-4634**

Ext. 3492

or reach us online at: www.nrischools.com

NRI Schools 4401 Connecticut Avenue, NW
Washington, DC 20008

YES! Send me free information on how NRI can prepare me for a high-tech computer career. Check one box only.

- | | |
|---|---|
| <input type="checkbox"/> PC Servicing | <input type="checkbox"/> Computer Programming |
| <input type="checkbox"/> Networking With Windows NT | <input type="checkbox"/> Telecommunications |
| <input type="checkbox"/> Industrial Electronics | <input type="checkbox"/> Computer-Aided Drafting |
| <input type="checkbox"/> Mastering Microsoft Office | <input type="checkbox"/> Bookkeeping & Accounting |

Name _____
Street _____ Apt. # _____
City _____ State _____ Zip _____

A Division of The McGraw-Hill Companies

Accredited Member, Distance Education and Training Council 0018-0299

PARTS LIST FOR THE PIC-AN-LCD

SEMICONDUCTORS

- IC1—PIC16C621 pre-programmed micro-controller, integrated circuit (see text)
 IC2—MAX232CPE +5-volt, dual RS-232 transmitter/receiver, integrated circuit
 IC3—7805T positive 5-volt, 100-mA, fixed-voltage regulator, integrated circuit
 DISP1—DCM20434 (*Optrex*) 20-character-by-4-line liquid-crystal display (see text)
 LED1—Jumbo orange T-1³/₄ light-emitting diode
 LED2—Jumbo green T-1³/₄ light-emitting diode
 LED3—Jumbo red T-1³/₄ light-emitting diode

RESISTORS

- (All fixed resistors are 1/4-watt, 5% units.)
 R1—100,000-ohm PCB-mount potentiometer
 R2—10,000-ohm
 R3—330-ohm
 R4, R5, R6—470-ohm

CAPACITORS

- C1, C2—18-pF ceramic-disc
 C3—1-μF, 16-WVDC, aluminum electrolytic

ADDITIONAL PARTS AND MATERIALS

- BZ1—Piezo element
 PL1—Coaxial power jack for DC supply
 S1—DPDT slide switch
 S2—Normally-open, momentary-contact pushbutton switch
 SO1—SIP pins (See text)
 SO2—D-sub female 9-pin jack
 XTAL1—14.318-MHz quartz-crystal for 9600 baud (see text)
 Printed-circuit materials, DIP sockets, SIP sockets, epoxy adhesive, dry-transfer lettering, wall-type DC power supply, solder, wire, hardware, etc.

Note: The following items are available from *B.G. Micro*, PO Box 280298, Dallas, TX 75228 (Tel. 800-276-2206; Web: www.bgmicro.com/): A pre-programmed PIC16C621 (IC1) with 14.318-MHz (9600 baud) crystal for \$18.45; the *Optrex* DCM20434 20 × 4 liquid-crystal display for \$8.95; the pre-programmed PIC16C621 (IC1), 14.318-MHz crystal, and a printed-circuit board for \$33.50; the pre-programmed PIC16C621 (IC1), 14.318-MHz crystal, printed-circuit board, and 20 × 4 LCD module for \$41.55. An optional parts kit, containing a MAX232, piezo buzzer, DB-9 connector, and contrast potentiometer, is also available for \$3.49. Add \$5 shipping/handling to all orders. Texas residents, add 8.25% sales tax. Orders over \$50, add 85 cents for insurance.

wired to the power supply, and nothing else.

As to why there is no revision announcement and/or flashing cursor, it could be that the data lines are crossed. If the board is assembled according to the template and the DMC20434 is used, that shouldn't be the case, but double-check the wiring and the data

sheet just to be sure. It's possible you have a module that doesn't follow the normal data configuration. As stated earlier, crossed data lines will not hurt anything, but the LCD is not going to display properly. Crossed data lines could also cause a blank display. After checking everything, if the display still doesn't work, you may have either a bad module or a

TABLE 1—ASCII COMMANDS

COMMAND	ACTION
CURSOR HOME (CTRL-A)	Places the cursor in any desired location as defined by a single byte binary address (0X00 = Zero)
HOME CURSOR (CTRL-B)	Cursor returned to start, or the upper left corner display does not change
CURSOR LEFT (CTRL-C)	Moves cursor one space to left. Character is unchanged.
CURSOR RIGHT (CTRL-D)	Moves cursor one space to right. Character is unchanged.
SAVE CURSOR POSITION (CTRL-E)	Saves cursor to present position. Cancels any previously saved position.
RESTORE CURSOR POSITION (CTRL-F)	Previously saved position can be restored. Can be performed as often as desired.
BELL (CTRL-G)	Sounds speaker (piezo element). Doesn't affect display and crystal. Determines frequency and duration of sound.
BACKSPACE (CTRL-H)	Destructive backspace that moves cursor one place, replacing existing character with space.
HORIZONTAL TAB (CTRL-I)	Cursor is moved to the next tab position. Tabs are located at every fourth space.
LINE FEED (CTRL-J)	Cursor is moved to the same location in next line. Display scrolls up one line.
VERTICAL TAB (CTRL-K)	Display is scrolled up one line but remains in the same location. Bottom line is cleared.
FORM FEED (CTRL-L)	Display cleared. Cursor moved to upper left corner.
CARRIAGE RETURN (CTRL-M)	Cursor returned to left edge of current line.
SHIFT LEFT (CTRL-N)	Display shifted one space to left.
SHIFT RIGHT (CTRL-O)	Display shifted one space to right.
SEND LCD INSTRUCTION (CTRL-Q)	Sends characters to LCD module's instruction register. Allows great flexibility in module configuration.

TABLE 2—BAUD RATE

BAUD RATE	FREQUENCY
1200	1.790 MHz
2400	3.579 MHz
4800	7.159 MHz
9600	14.318 MHz

bad PIC-an-LCD chip.

(By the way, the folks at *B.G. Micro* aren't completely satisfied with the name "PIC-an-LCD." So they are sponsoring a contest to re-name the product. I'll tell you more about that in the conclusion. OK, back to business.)

If the display is showing "glibberish" or seems to be having trouble initializing, it could be the 18-pF capacitors that are tied to the crystal. Microchip does suggest their use, but also cautions against too

much capacitance. Try replacing them with a lower value or removing them altogether. Hopefully, at this point, all is working well, and each time you press S2, the display shows the revision and then goes to the flashing cursor. You can now install the Plexiglas base and put the system through its paces.

Operation. With the unit off, connect a serial data source (either a TTL or RS-232). Set switch S1 to the proper input and apply power. The buzzer should sound, as the display runs the initialization routine. Now, start sending ASCII character/command data to the PIC-an-LCD, and if the baud rate and data format are correct, the module will begin to display the text. The data format, by the way, is 8 data bits, no parity, and 1 stop bit. That's a very common format that is

often referred to as "8N1".

Try sending the "bell" instruction (CTRL-G), and the buzzer again sounds. The display won't be affected. Next, send CTRL-B (home cursor), and the flashing block will return to the upper left-hand corner. Again, displayed text will remain unchanged. With the form feed command (CTRL-L) the cursor returns to the left or starting position, and the screen is cleared. Referring to Table 1, try the various commands. That helps you get a handle on the system's operation.

If you want to use a personal computer (PC) and DOS, the following steps will put a text file on the LCD screen through the RS-232 input. At the DOS prompt, type "MODE COM1:9600,N,8,1," and hit <ENTER>. That assumes you are using the COM1 serial port, and the PIC-an-LCD is configured for 9600 baud. The PC monitor will display "COM1: 9600,N,8,1," and then the DOS prompt. At this point, type "copy con com1," press <ENTER>, then type in the text you want to exhibit (hello world!, testing 1-2-3, help!!!, etc.). Again, hit <ENTER>. Now type control-Z (CTRL-Z) to end the program.

If all is in order, the text will appear on the LCD. However, this will only work if you are using a "loop-back" serial cable. With a standard (null modem) serial cable, you will get the error message, "write fault error writing device com1." This is because the PC is sending a signal (handshake) to the device at the other end, and if it doesn't get a return signal (answer), it assumes there isn't a device at the other end. Hence, it displays the error message. Loop-back cables, in effect, allow the PC to answer itself, and then send the text information. If you don't have a loop-back cable handy, the QBASIC program in Table 3 (Courtesy of Dale Wheat) allows you to send text to the PIC-an-LCD system via any type cable. It permits the PC to ignore the handshaking signals, and simply transmit the text file.

With the PIC-an-LCD board connected to the com1 port, bring up QBASIC. Type the program in, and run it. You will receive a "Press (Esc)

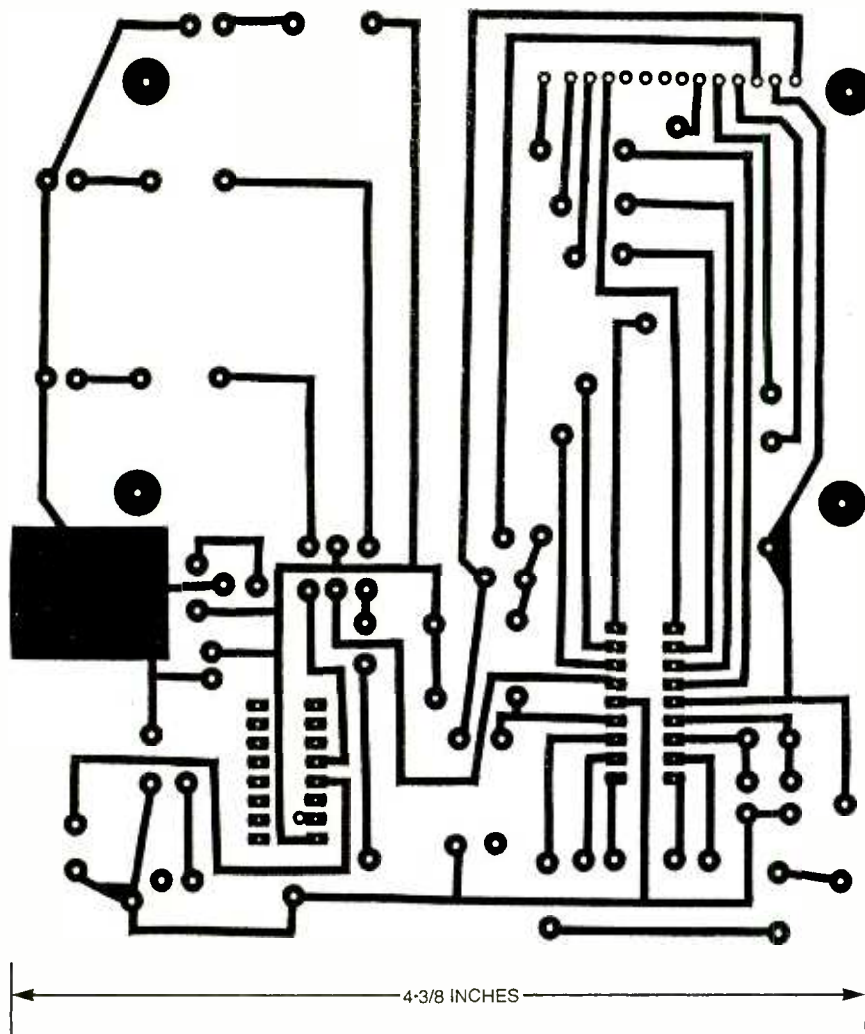

Fig. 3. PIC-an-LCD was assembled on a printed-circuit board, measuring $4\frac{3}{8}$ by $4\frac{7}{8}$ inches. A template of that printed-circuit pattern is shown here, for those who prefer to roll their own.

to quit" message, which indicates QBASIC is ready for text. Now, simply type whatever bulletin you want. As you enter the characters, they will appear on the LCD screen. Notice that when you come to the end of line one, the cursor will jump down to line three, not line two. This is due to the memory structure of the module itself. The 80 characters are divided into two separate forty character sets, with the first forty assigned to lines one and three, and the second to lines two and four. (With a 2-line by 40-character display, you won't have that problem. Line one handles the first forty, and line two the remaining forty characters).

The way to get around that is to hit the return key before reaching the end of line one: That brings the cursor back to the first position. Next, hit control-J (CTRL-J), and the cursor drops to the beginning of line two. Now, the new text appears on line two instead of line three.

Once entered into QBASIC, the program was saved to both floppy disk and hard drive. That allows it to be easily brought up whenever it's necessary to send information from the PC to the PIC-an-LCD system. In the event the screen displays garbage when data is sent, the format or baud rate may be wrong. Check the format or baud rate again to be sure they are what's needed. Also, no display after data transmission could indicate a bad cable or an incorrect port connection. You guessed it! Check them too.

If you decide to use a display with

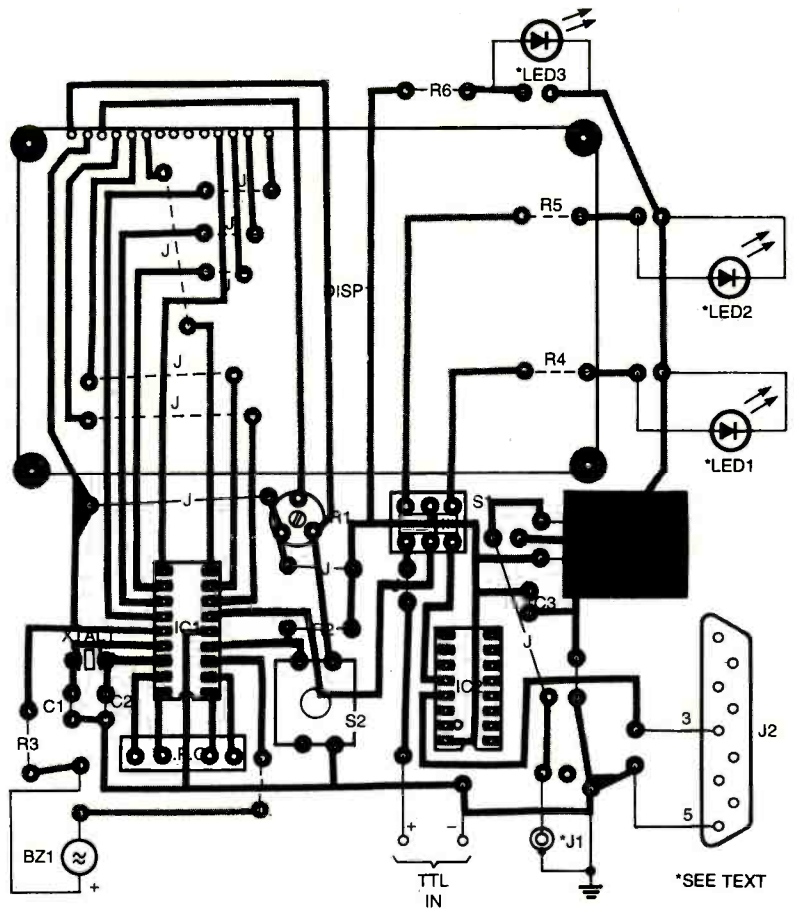

Fig. 4. Guided by this parts-placement diagram, install the jumper wires first, followed by the IC sockets and passive components (resistors and potentiometer, capacitors, switches, piezo buzzer, and jacks), and finally the semiconductors.

fewer lines, a line number setting will be in order. Use the "set number of lines" command (CTRL-S) followed by the number of lines available on the LCD module. For example, a two-line display requires a "CTRL-S" command,

followed by the digit 2.

Conclusion. Well, there it is. With this unit in hand, you'll be able to display ASCII data from any number of sources

That, of course, makes the device ideal for microprocessor trainers, remote data terminals, displays for dedicated and/or embedded systems, as well as a visual information source for prototypes and completed projects. All in all, the combination of the PIC-an-LCD chip and an LCD module is a powerful team.

As promised, here is more about the B.G. Micro contest. Actually, there are two contests. One to rename the "PIC-an-LCD" chip, and another for the best application. So, if you have an idea for a new name, or come up with a stupendous design, submit it to B.G. Micro. You may win a complete PIC-an-LCD kit.

TABLE 3—QBASIC TEST PROGRAM

The following is a simple program written in QBASIC that will allow a PC to communicate with the PIC-an-LCD without the need for a "loop-back" style serial cable.

```

REM PIC-an-LCD QBASIC test program
REM (c)1998 by Dale Wheat

REM Adjust COM port and baud rate as necessary; leave other
parameters alone
OPEN "COM1:9600,N,8,1,CD0,CS0,DS0,RS" FOR RANDOM AS #1

PRINT "Press [Esc] to quit"

WHILE a$ <> CHR$(27)
  a$ = INKEY$
  IF a$ <> "" THEN
    PRINT #1, a$; : REM Send character to PIC-an-LCD
    PRINT a$; : REM Also send it to the screen
  END IF
WEND
  
```

ADVENTURES With CIRCADIAN RHYTHMS

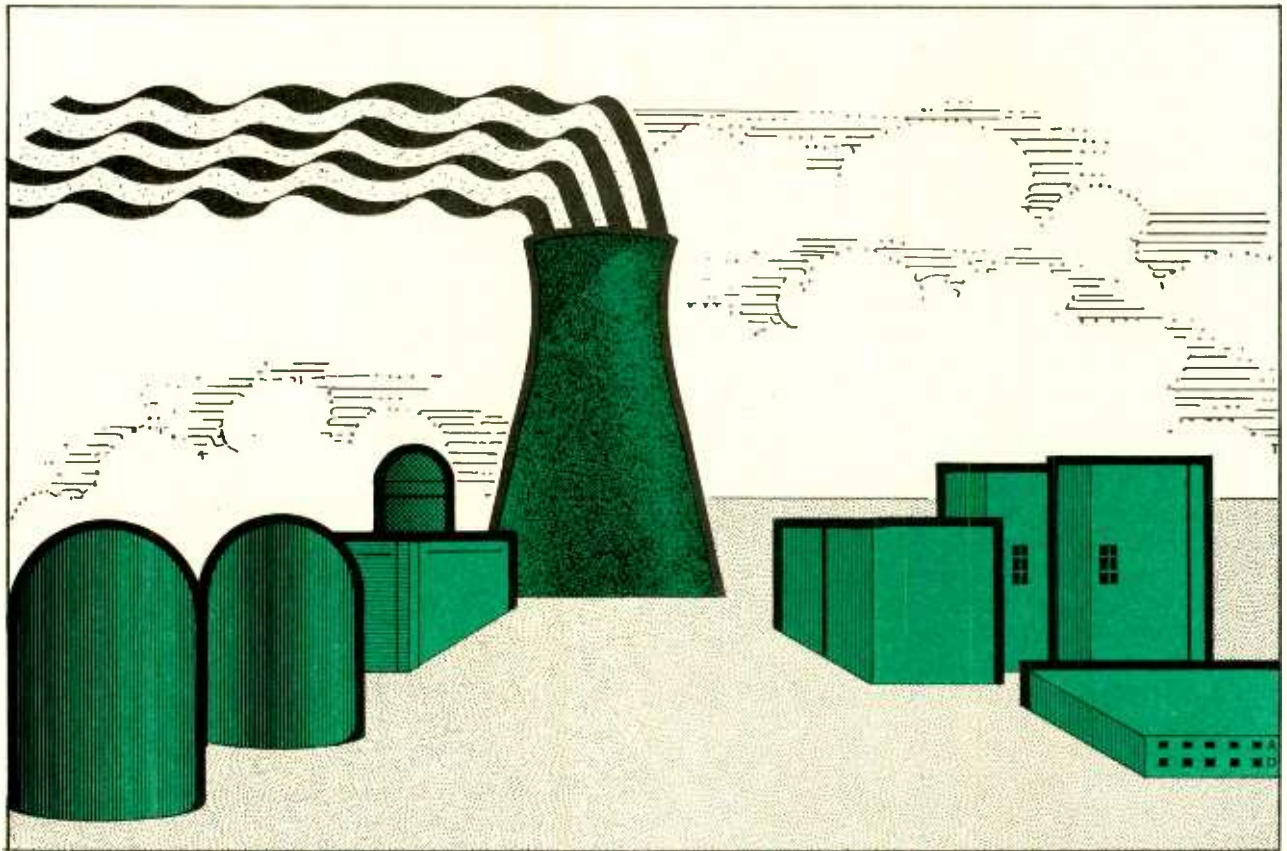

Circadian rhythms, the study of the internal biological clocks of various living organisms, have been the subject of scientific research for some time now. Studies have shown the internal clocks of living organisms to be sensitive to light, as well as to other forms of external stimuli (such as ultraviolet, infrared, and nuclear radiation, magnetic and electric fields, etc.) that can affect hormonal levels and other physiological functions (see Fig. 1). Thus, it follows that by subjecting living organisms to various forms of external stimuli and observing their reactions, scientists can extrapolate how various external forces can affect changes in growth, physiology, reproductive functions, etc.

Such scientific inquiry needn't

Ever wonder how living organisms react to changes in their normal environment?

Whether you're an amateur scientist, a student, or just have a healthy scientific curiosity, you can investigate the realm of circadian rhythms with any of the easy-to-build circuits presented here.

NEWTON C. BRAGA

involve elaborate, high-tech (read high-priced) laboratory equipment, facilities, and conditions. Such studies can be pursued using common, fast-growing, domestic vegetation (such as tomatoes, beans, corn, flowers, etc.) as subjects. A dark room or a cardboard box can be used as a controlled environment, wherein the subject (in this case a plant) can be bombarded with var-

ious forms of artificial stimuli, as shown in Fig. 2. For example, a coil fashioned on a cardboard form can be used to produce magnetic fields with which to conduct radiation experiments. Exposing several plants to different sources and levels of radiation allows the researcher to gain an understanding of how growth and development are influenced by external forces.

Of course, in order to get meaningful results, the researcher must use two subject groups for the experiments. One group—serving as the control group—can be exposed to the light following the normal day/night cycle. The second group might be exposed to different forms of radiation (modulated light, ultraviolet, infrared modulated, pulsed light sources), or the usual day/night cycle

might even be reversed. The researcher then can compare the growth and development of the two groups.

Experimentally Yours. As all of the experiments outlined herein are conducted using common, readily available subjects and equipment (such as incandescent or fluorescent lamps), the experimenter needs no special background in behavioral studies to perform this scientific research. In addition, the subjects can be exposed to light, radiation, and magnetic fields simultaneously to perform complex experiments.

For our studies, we've selected an assortment of practical electronic circuits that can be used to discover how the circadian rhythms of various plants and insects are affected by environmental changes. The selected circuits can produce light, ultraviolet radiation, and magnetic fields in several patterns that can be adjusted to various operating conditions. The circuits can be used to study the effects of external forces on plants or other living organisms, such as insects or even humans (with specialized aid). Of course, we're certainly not advocating that you put a human being in a coil and crank up the "juice" to observe what happens when a magnetic field is produced. But, a trial that involves stress would certainly make an interesting experiment in psychology.

For example, you might put several volunteers in a darkened room with a pulsed light to cause stress, and then measure respiration, heart rate, and blood pressure. (Sessions of about 10 minutes are sufficient.) By repeating the experiment (with the same group), you can determine if the subjects become more or less affected by unusual ambient conditions.

Now let's take a look at a few circuits that can be used in your quest for knowledge.

Stroboscopic Lamp. Our first circuit, see Fig. 3, is a simple arrangement that's comprised of four 1-amp 400-PIV rectifier diodes (D1-D4), four resistors (three fixed and one variable), a capacitor (C1), an incandescent lamp (I1), and an SCR. The pulse rate of the circuit can be adjusted (via

R1) over a wide frequency range, from about four pulses per second (4 Hz) to one pulse every five seconds (approx. 0.2 Hz). A single capacitor, C1, sets the overall operating-frequency range of the circuit. The range of frequencies produced by the circuit can be altered by substituting different capacitor values for C1.

The circuit, which can be used to drive common incandescent lamps rated up to 100 watts, is simple enough to be assembled using any construction technique with which

you are most comfortable. When assembling the circuit, the SCR should be mounted to a heatsink to dissipate heat generated by the SCR during operation. When mounting the circuit in an enclosure, take care that any exposed parts of the circuit are kept away from any conductive surface.

Day/Night Conditioner. Our next circuit takes a slightly different approach to the exploration of circadian rhythms. The circuit shown in Fig. 4 is designed to help the ama-

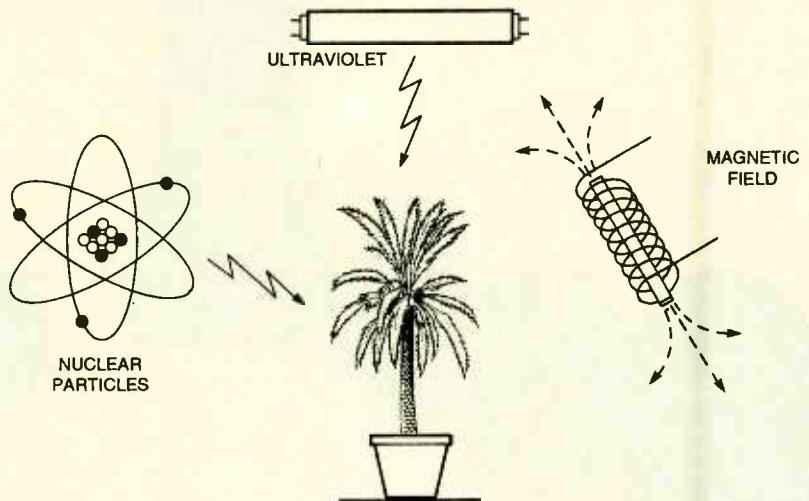

Fig. 1. All living organisms exhibit hormonal levels and/or other physiological functions that are "governed" by the day/night cycle and/or other external influences, including ultraviolet and infrared radiation, magnetic and electric fields, nuclear radiation, etc.

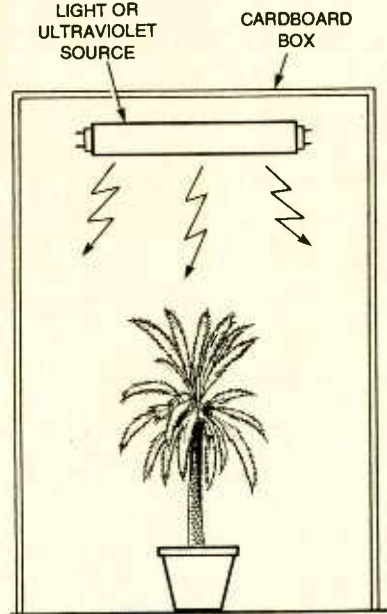

Fig. 2. A dark room or a cardboard box can be used as a controlled environment, wherein a plant or other subject can be exposed to various forms of artificial stimuli.

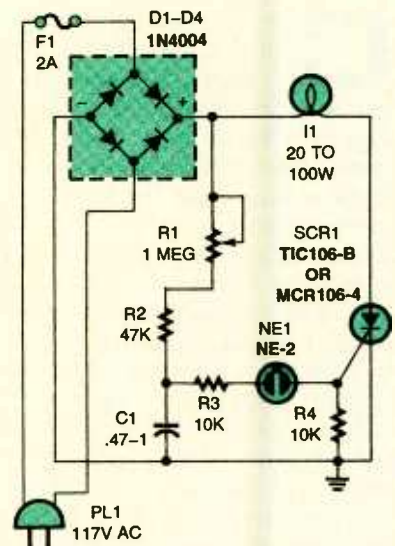

Fig. 3. The Stroboscopic Lamp—comprised of four 1-amp 400-PIV rectifier diodes (D1-D4), four resistors (three fixed and one variable), a capacitor (C1), an incandescent lamp (I1), and an SCR—is designed to produce short light pulses.

teur researcher ascertain the effects of artificially altering the test subject's 24-hour (day/night) cycle using a common low-voltage incandescent lamp. The circuit, built around a 555 oscillator/timer (IC1), a 4520 dual synchronous up counter (IC2), TIP120 Darlington transistor (Q1), and an assortment of support

components, can be set for a flash rate ranging from several minutes to more than 24 hours.

In the Day/Night conditioner, the 555 (IC1) is configured as an astable multivibrator (or oscillator), the frequency of which is determined by R1, R2, R3, and C1. Potentiometer R1, a 2.2-megohm unit, allows the oscil-

lator output to be adjusted over a wide range of the frequencies. The output of the oscillator is fed to the ENABLE input of up counter IC2 (only half of which is used in this application) at pin 2, while IC2's CLOCK input (at pin 1) is tied low. The output of the counter is fed through a 10k resistor (R4) to the base of Q1. Each time the counter output goes high, the Darlington transistor (Q1) turns on, completing I1's ground return path, causing the lamp to light. During negative excursions of the output waveform, I1 is cut off.

When assembling the circuit, Q1 should be mounted to a heatsink. The Darlington transistor can be replaced by a power-FET, such as the IRF640, without any additional alteration in the circuit. The circuit can be powered from a 6- or 12-volt power source. The lamp (I1) can be a 6- or 12-volt incandescent unit depending on the supply voltage selected. The lamps can be placed in a cardboard box along with the subject (plant or insects) to be studied.

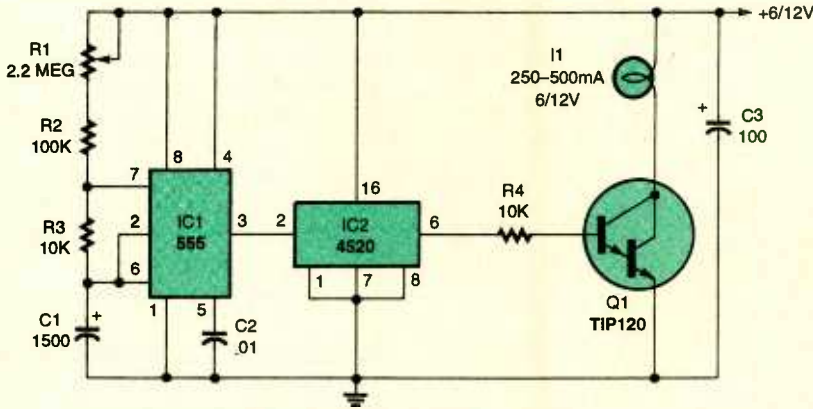

Fig. 4. The Day/Night Conditioner, taking a slightly different approach to the exploration of circadian rhythms, is designed to help ascertain the effects of artificially altering the test subject's 24-hour (day/night) cycle.

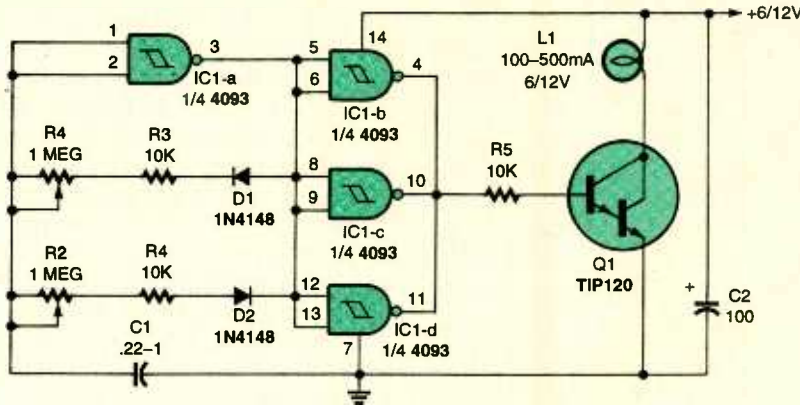

Fig. 5. This circuit, with its controlled duty-cycle, is built around a 4093 quad two-input NAND Schmitt trigger. One gate of the NAND Schmitt trigger, IC1-a, is configured as an astable oscillator, with a duty-cycle that can be adjusted via R1 and R2.

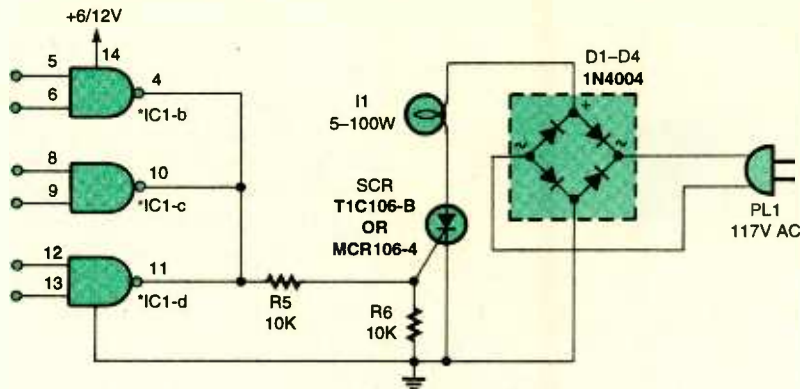

Fig. 6. The previous circuit (see Fig. 5) can be altered, as shown here, allowing the reconstituted circuit to control AC-line-powered lamps up to 100 watts through SCR1.

Controlled Duty-Cycle Light-Source.

Figure 5 shows another circuit that can be used for circadian-rhythm experiments. The circuit, built around a 4093 quad two-input NAND Schmitt trigger, allows both on-time and off-time periods to be controlled. In that circuit, one gate from IC1 (IC1-a) is configured as an astable oscillator, whose duty-cycle can be adjusted via R1 and R2. The setting of potentiometer R1, along with the fixed-resistor value of R3, determines the charge period of C1 and, by extension, the time that IC1-a's output is at logic high. The setting of potentiometer R2, along with the value of fixed-resistor R4, combine to determine the discharge period of C1. It also determines, in an analogous way, the time the transistor—as well as the lamp—is on.

The other three gates (IC1-b, IC1-c, and IC1-d), which are connected in parallel, are used to boost the output drive current of the oscillator, while inverting the signal. That means that when the output of IC1-a is high, the combined outputs of IC1-b, IC1-c, and IC1-d are at logic low. That logic-low output, which is applied to the base of transistor Q1, holds the transistor at

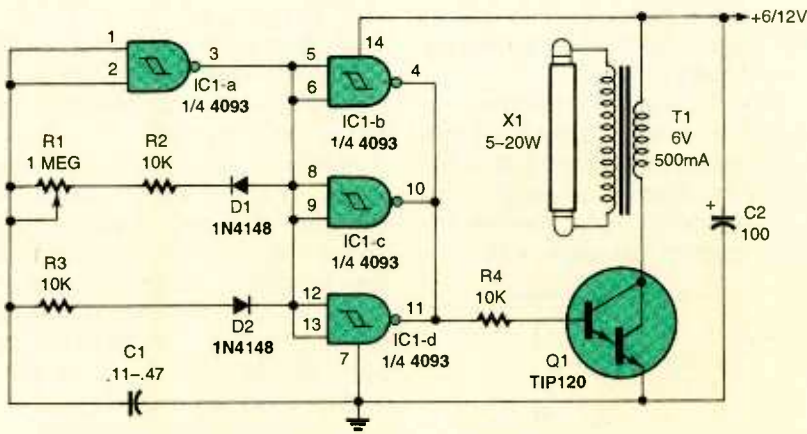

Fig. 7. The Fluorescent UV Light-Source, although nearly identical to the circuit in Fig. 5, is designed to produce short pulses of visible light or ultraviolet radiation.

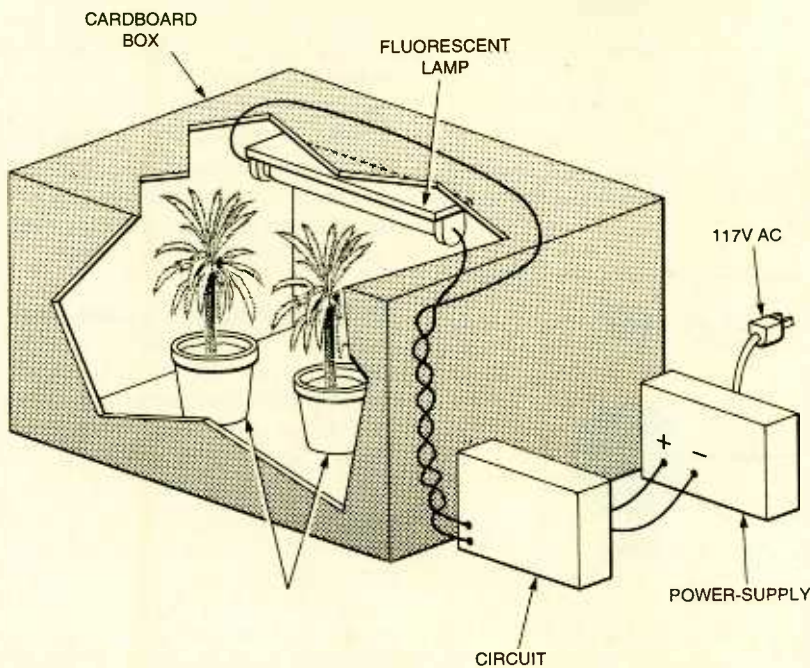

Fig. 8. Ultraviolet experiments, as illustrated here, should be performed with the ultraviolet light source enclosed in a cardboard box.

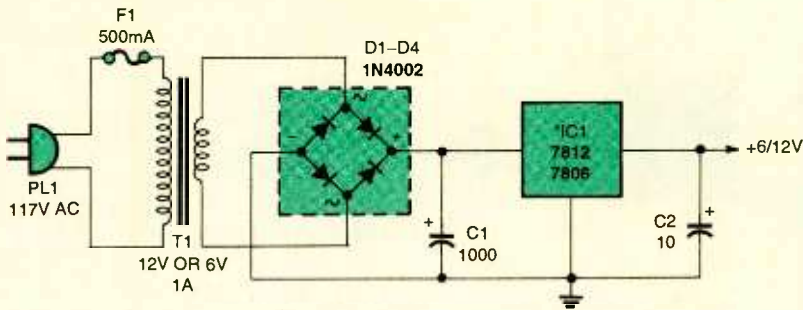

Fig. 9. This Power Supply circuit can be used to operate all of the circuits presented in this article. Note: IC1 can be a 12- (7812) or 6- (7806) volt regulator, depending on how your circuit is configured and what parts are used in the circuit.

cutoff, so the lamp does not light. However, when the output of the oscillator swings low, the combined output of the three parallel NAND Schmitt triggers (IC1-b, IC1-c, and IC1-d) goes positive. That positive output causes Q1 to turn on, illuminating I1.

The circuit—which is capable of driving lamps up to 600 mA—can be powered from 6- or 12-volt supplies. The circuit in Fig. 5 can be altered, as illustrated in Fig. 6, thereby allowing the reconstituted circuit to control a lamp that's powered from the AC line. The circuit can drive lamps up to 100 watts. As the SCR may be required to dissipate considerable heat, that unit should be mounted to a heatsink.

Fluorescent UV Light-Source. Our next circuit (see Fig. 7), although nearly identical to the circuit in Fig. 5, is designed to produce short pulses of visible light or ultraviolet radiation. The only difference between this circuit and the one in Fig. 5 is that instead of directly driving a fluorescent lamp, the output of the transistor is used to drive a step-up transformer (T1), which in turn provides sufficient voltage to light a fluorescent lamp (FL1).

The lamp's flash rate is determined by the RC time constant established by R1 and C1. The flash rate can be altered by varying the value of C1 within the range indicated in Fig. 6. Transformer T1 is a common power transformer, whose primary winding (rated at 117 volts AC) is connected as the secondary and its secondary winding (which can be either 6 or 12 volts at 800 mA) is connected as the primary winding.

That allows T1 to function as a step-up transformer, boosting the low-voltage pulses produced by the circuit to a level that's strong enough to ionize the gas inside the fluorescent lamp. The high-voltage output of the transformer, pulses that can reach up 400 volts, is sufficient to cause even very weak lamps to glow. Common white, colored, or even ultraviolet lamps (ranging between 6 and 25 watts) can be driven by the circuit in Fig. 7.

When experimenting with ultravi-
(Continued on page 65)

BUILD THE SENTINEL

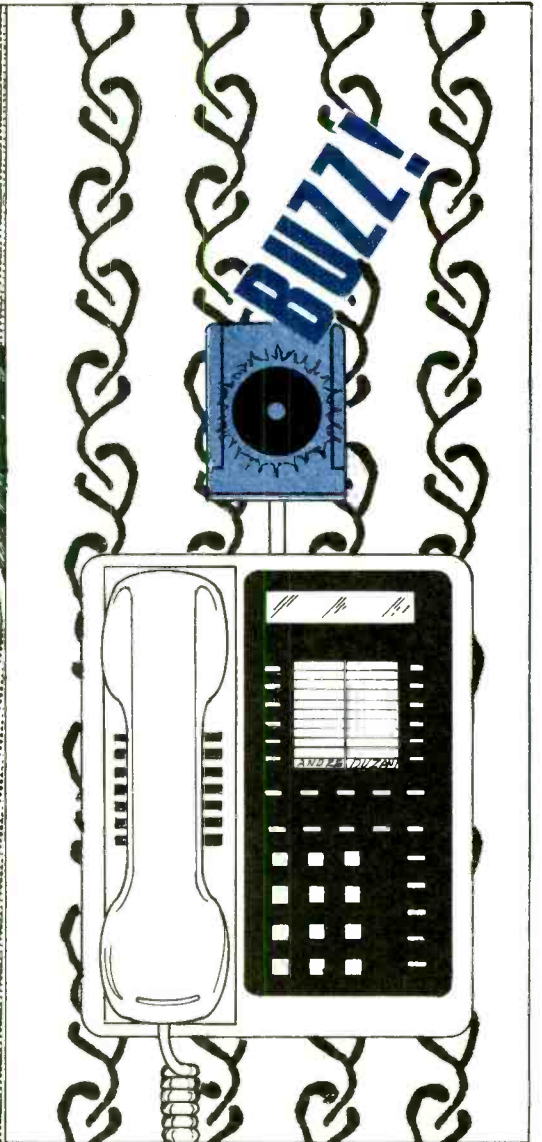

It is common knowledge that when burglars plan to enter a home, they are smart enough to cut the telephone lines before entering. Doing so disables most monitored alarm systems, even those that are equipped with automatic telephone dialing (excluding those equipped for radio transmission). With the telephone line disabled and a break-in in progress, you are cut off from the 911 operator and anyone else who might help you. Obviously, unless your home is protected by a very sophisticated alarm system, your home is vulnerable to break-in. You're vulnerable unless your alarm system includes

Add this early-warning system to your existing home-defense arsenal and foil would-be burglars before they can gain entry to your home!

ANTHONY J. CARISTI

an early-warning device, like the *Sentinel*.

The *Sentinel* is not intended as a replacement for your existing alarm system. It is, instead, designed to complement your working installation. The *Sentinel* is a very simple electronic circuit that monitors the status of the telephone line at all times. Should the line go dead for

any reason, an audible alarm, capable of "shrieking" even the deepest sleeper back to consciousness, sounds. And although you *still* won't be able to use the land-line to phone for help, at the very least, you'll be given ample advance warning before the break-in to take any corrective action that seems prudent.

The *Sentinel* is simply plugged into any modular telephone jack in your home, preferably in your bedroom, through a duplex adapter (which can be purchased from any telephone-accessories dealer). The duplex adapter allows the unit to share a jack with a telephone set. The circuit is powered by a com-

mon 9-volt, transistor-radio battery, allowing it to operate even when both the AC power and the phone line fail simultaneously. And once the Sentinel is connected to the telephone line, it requires no attention from you other than to replace its internal battery once a year or so. The Sentinel also includes a built-in voltage monitor that provides advance warning whenever the battery needs replacement.

As a final feature, the Sentinel is assembled on a printed-circuit board that has provisions for an optional, small, low-current, single-pole, single-throw relay. The relay can be used to activate a conventional alarm, such as a wailing siren, that could conceivably frighten off the malefactor.

Telephone Line Fundamentals.

Telephone company equipment provides a 50-volt DC potential that appears across voice- and ringing-signal wires (usually red and green) at all times except when the phone is in use. (Green is usually positive and red is negative.) The line impedance from the phone company's central office to your phone varies, depending on the distance, but it is usually in the 600- to 900-ohm range.

When the telephone set is taken off-hook during use, the current drawn by the telephone causes a voltage drop (usually about 40 volts) across the telephone-line impedance, leaving perhaps 10 volts across the line at the modular telephone receptacle. Obviously, that DC voltage can be used to monitor the condition of the telephone line. Should the voltage ever fall to zero, the line has been disconnected and an alarm should be initiated.

The Circuit. A schematic diagram of the Sentinel—which is comprised of a pair of CMOS 555 oscillator/timers (IC1 and IC2), a voltage monitor (IC3), an N-channel JFET (Q1), a pair of P-channel MOSFETs (Q2 and Q3), five diodes (D1–D5), and a few additional support components—is shown in Fig. 1. The Sentinel is connected to the telephone line through a modular telephone plug. Line voltage is applied to the gate of Q1 (a 2N5457 JFET) through R1 (a 1-megohm resistor). Resistors R1 and R2 form a high-impedance voltage divider stick. Under normal conditions, the voltage across R2 is at least –4 volts or more (limited by Zener diode D1), whether or not the telephone is in use.

In order to comprehend the circuit's operation, remember that JFETs operate in the depletion mode—which is defined as a transistor having finite drain-to-source resistance with zero gate-to-source voltage. That means that with no gate voltage applied to Q1, it is turned on. Applying a negative bias voltage (usually –1 volt or more) to the gate of Q1 causes a depletion region to form—the greater the negative bias, the larger the depletion region, and the larger the depletion region the less current flow through the device.

So, with the Sentinel connected to the phone line as shown, Q1 is turned off as long as the telephone line is operational. With Q1 turned off, its drain terminal is pulled high through R3. That high is applied to the gate of Q1 (a BS250P P-channel enhancement MOSFET), maintaining Q2 at cutoff. With Q2 cutoff, no operating power is delivered to IC1, keeping it off. Under those conditions, no signal is output at pin 3 of IC1, so the buzzer (BZ1) remains silent. At the same time, no voltage is delivered to relay RY1; therefore, it, too, is turned off.

However, if the telephone line is cut or fails, the bias applied to the gate of Q1 is removed. This causes

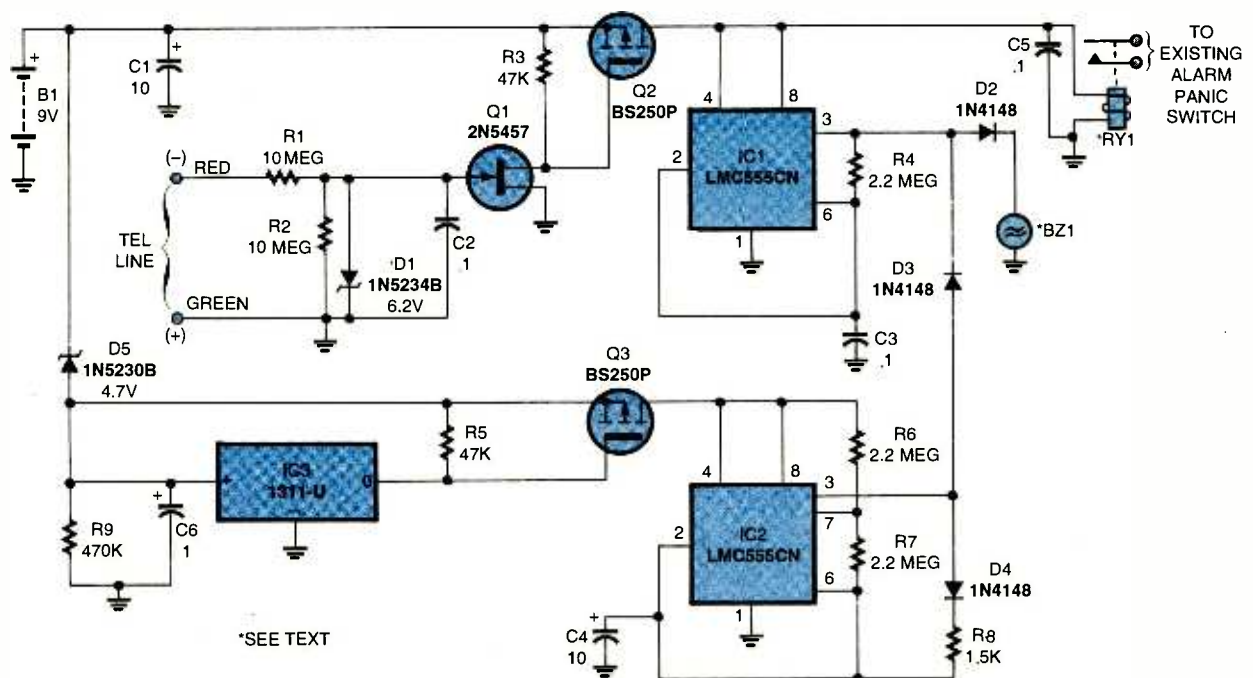

Fig. 1. The Sentinel is comprised of a pair of CMOS 555 oscillator/timers (IC1 and IC2), a voltage monitor (IC3), an N-channel JFET (Q1), a pair of P-channel MOSFETs (Q2 and Q3), five diodes (D1–D5), and a few additional support components.

Q1's depletion region to decrease, thereby turning Q1 on. With Q1 turned on, the gate of Q2 is pulled low through Q1, causing Q2 to turn on. With Q2 turned on, operating power is applied to both the alarm and relay circuits. At that point, relay RY1 turns on, activating the alarm circuit, while at the same time triggering IC1 (which is configured as a free-running astable multivibrator or oscillator) into operation. The output of IC1 at pin 3 is fed through diode D2 to BZ1, causing it to sound off.

PARTS LIST FOR THE SENTINEL

SEMICONDUCTORS

- D1—1N5234B 6.2 volt, 1/2-watt, Zener diode
 D2, D3, D4—1N4148 small-signal silicon diode
 D5—1N5230B 4.7-volt, 1/2-watt, Zener diode
 IC1, IC2—LM555CN CMOS oscillator/timer, integrated circuit
 IC3—MN13811-U voltage detector, integrated circuit (*Digi-Key*)
 Q1—2N5457 N-channel JFET
 Q2, Q3—BS250P P-channel MOSFET

RESISTORS

- (All resistors are 1/4-watt, 5% carbon units.)
 R1, R2—10-megohm
 R3, R5—47,000-ohm
 R4, R6, R7—2.2-megohm
 R8—1500-ohm
 R9—470,000-ohm

CAPACITORS

- C1, C4—10- μ F, 25-WVDC, radial-lead, electrolytic
 C2, C3, C5—0.1- μ F, ceramic-disc
 C6—1- μ F, 25-WVDC, radial-lead, electrolytic

ADDITIONAL PARTS AND MATERIALS

- B1—9-volt, alkaline, transistor-radio battery
 BZ1—Piezoelectric buzzer (*RadioShack* 273-060 or similar)
 RY1—SPST 5-volt, 500-ohm coil, relay (*Mouser* 431-1415 or equivalent; optional, see text)
 Printed-circuit materials, telephone line cord w/modular connector, battery connector, enclosure, wire, solder, hardware, etc.

Note: The following parts are available from A. Caristi, 69 White Pond Road, Waldwick, NJ 07463: An etched and drilled printed-circuit board for \$12.95; Q1, Q2, Q3, IC1, IC2, IC3 for \$3 each. Please add \$5 postage/handling to all orders. Allow 6 to 8 weeks for delivery.

Now let's turn our attention to the battery-monitoring circuit.

Battery Monitor. The condition of the battery is monitored by IC3, a dedicated chip that responds to the voltage level applied between its positive and negative input terminals. (Its threshold voltage is about 4.8 volts.) Battery voltage is continuously applied to IC3 through Zener diode D5, which in this circuit has a voltage drop of about 3 volts. A fresh battery (with a 9.0-volt terminal voltage) feeds about 6 volts (9-3) to IC3, causing its output terminal to go to +6 volts, via pull-up resistor R5. As the battery becomes depleted over time, its terminal voltage falls.

When battery voltage dips below 7.8 volts, the voltage applied to IC3 drops below its threshold voltage, causing its output to go to zero volts. That low is applied to the gate of Q3, causing it to turn on. When Q3 turns on, power is applied to IC2 (the second CMOS 555 oscillator/timer), which is configured as a low-duty cycle, astable multivibrator with a period of about 15 to 20 seconds. When activated, a series of 20-ms, positive-going pulses (output at pin

3) are applied to the piezo buzzer through D3, producing a series of short audio bursts, indicating that battery replacement is necessary.

Construction. The author's prototype of the Sentinel was assembled on a printed-circuit board, measuring 17/8 by 2 1/4 inches. A full-scale template of that foil pattern is shown in Fig. 2 for those who prefer to etch their own printed-circuit boards. For those otherwise inclined, an etched and drilled printed-circuit board can be obtained from the source specified in the Parts List; or, if you prefer, the circuit can be hard wired on perfboard.

Once you've obtained the printed-circuit board and all of the parts listed in the Parts List, construction can begin. Assemble the Sentinel's printed-circuit board guided by the parts-placement diagram shown in Fig. 3. Those planning to hard-wire the Sentinel should assemble the circuit according to Fig. 1. Regardless of the construction method selected, be sure that all polarized components (such as the electrolytic capacitors and solid-state devices) are properly connected to the cir-

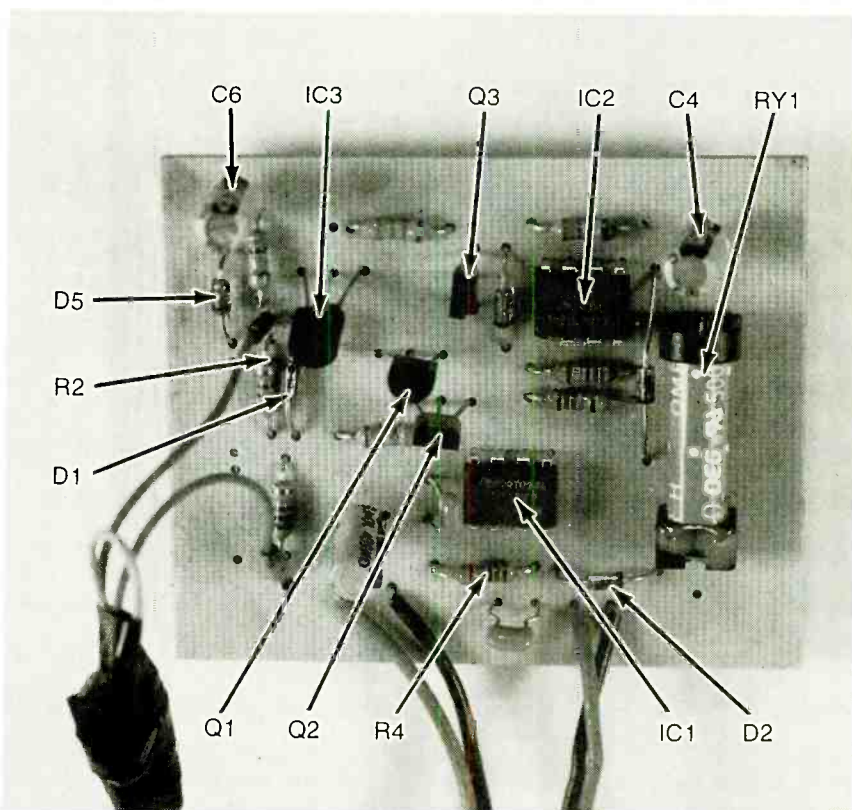

Here is the Sentinel's printed-circuit board ready to be installed in a suitable enclosure. If not required, the relay can be eliminated from the layout.

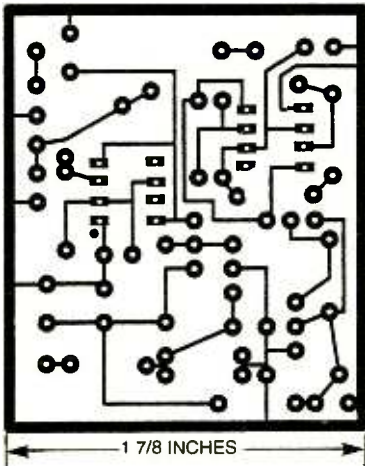

Fig. 2. The author's prototype of the Sentinel was assembled on a printed-circuit board, measuring $1\frac{7}{8}$ by $2\frac{1}{4}$ inches. A full-scale template of that foil pattern is shown here for those who prefer to etch their own printed-circuit boards.

cuit. A solitary part placed in the circuit backwards will render it inoperative, and it stands a good chance of self-destructing, taking one or more components with it.

While not strictly necessary, it is a good idea to provide sockets for the two 555 oscillator/timers (IC1 and IC2). Aside from removing the possibility of thermal damage to the ICs during installation, sockets also allow

the ICs to easily be replaced, should it ever become necessary. (It is difficult to remove a multi-pin device from a printed-circuit board without damaging the copper pads once it has been soldered in place.) Note that IC1 and IC2 are CMOS devices; make sure that the units you select are also CMOS parts, and not standard devices.

Begin assembly by installing the passive, on-board components first—IC sockets, capacitors, and resistors. Follow the passive components with the active, on-board components. **Do not** install the ICs in their sockets at this time. Next connect the off-board components to the circuit through appropriate lengths of hook-up wire. Note: BZ1 should first be mounted to an enclosure of sufficient size to accommodate the Sentinel's printed-circuit board and its battery power source, and then connected through hook-wire to the circuit board. Next drill a hole in the enclosure through which to pass the Sentinel's telephone line cord, and then prepare the telephone line cord, but do not connect it to the board at this point. One end of the line cord connects directly to the printed-circuit board as indicat-

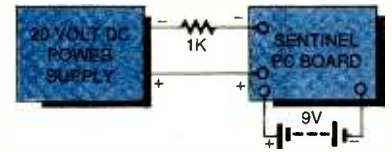

Fig. 4. Using a DVM or VOM, a 20-volt or more DC power supply, and a 1000-ohm resistor, set up as illustrated here, test the Sentinel's operation to ensure that it works as described.

ed in Fig. 3. The other end of the line cord is terminated in a 4-conductor modular phone plug.

Once all of the components (excluding IC1, IC2, and the line cord) have been installed, check your work for construction errors—cold solder joints, solder bridges, short circuits, misoriented or misplaced components, etc. If all appears OK, proceed to the next phase of construction.

Telephone Line Polarity. It is imperative that the Sentinel be connected to the telephone line with the correct polarity; otherwise it won't work. Many telephone systems use the green and red wires of a multi-conductor cable to carry voice and "ring" signals; the green is usually positive, while the red is negative. However, check the polarity of your telephone line with a DC voltmeter to be sure. To test the line polarity, plug the modular connector of the line cord into the telephone receptacle that will be used for the Sentinel. Set the DC voltmeter to the 200-volt range and locate the pair of wires that produces a 50-volt reading. Carefully mark the wires with the proper polarity (+ and -) as indicated by the voltmeter. Those are the wires that are to be connected to the positive and negative telephone-line input terminals of the circuit board.

Checkout. In order to test the Sentinel, you need a DVM or VOM, a DC power supply capable of outputting 20 volts or more, and a 1000-ohm resistor; the resistor is used to simulate the voltage that appears across the telephone line. Figure 4 illustrates a hookup that can be used to test the circuit. Before inserting the battery into its connector, (Continued on page 65)

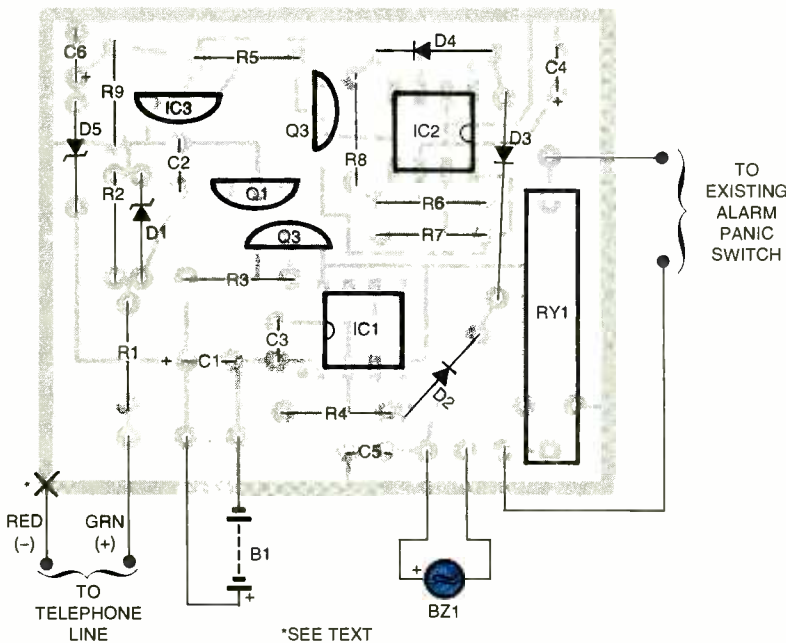

Fig. 3. Assemble the Sentinel's printed-circuit board guided by this parts-placement diagram, starting with the passive components followed by the semiconductors and off-board wiring. When assembling the circuit, be sure that all polarized components (such as the electrolytic capacitors and solid-state devices) are properly connected to the circuit.

ANTIQUE Radio

Evolution of a Collector

MARC ELLIS

Several months ago, I received a long and detailed letter (he called it a "novella") from reader Victor Smedstad (Bainbridge Island, WA). Victor described how he got started as an appreciator of old radios; explained how his approach to, and interest in, the vintage sets evolved; and discussed some of his most recent projects (one can't exactly call them "restorations," as you will see). Many will not agree with Vic's approach to radio rehabilitation. However, his letter was so articulate and interesting that I felt it was worth turning the column over to him for a while.

Without further ado, then, I give you Victor Smedstad. Most of what you will read is in his own words. And rather than put in a lot of annoying ellipses to show you where copy has been left out, I will simply tell you that some details have been eliminated to save space. Where necessary, I have inserted connective material so that the remaining copy can be read seamlessly—Marc Ellis

THE EARLY YEARS

In about 1942 or -43, my grandparents had a *Kennedy* console housed in an elaborately carved cabinet. It had a 12-inch speaker as I recall and housed a phonograph in a top compartment accessed through the hinged top of the cabinet. It apparently malfunctioned, because it was replaced with an *RCA* or *GE* radio-phonograph in an entirely undistinguished cabinet.

I inherited the guts of the *Kennedy*, which I housed in a makeshift cabinet that I cobbled together with typical 13-year-old skills. While it did receive radio stations, my sense of smell warned me that a catastrophe might well occur if it were kept on for much more than 15 minutes. At the time, I didn't understand what was wrong with it, though I now suspect it had a leaky filter capacitor.

Perhaps ten years later, a friend of my grandmother's kindly gave me a *Westinghouse* one-tube battery set. Naturally, instead of preserving it, I tore it apart and (ignoring the "guts") used the cabinet for a parts box.

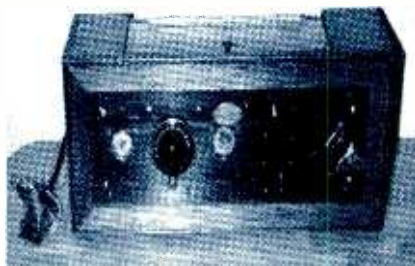

Vic's nicely-crafted A-K 32 cabinet may not look original, but it boasts a Plexiglas front panel and a top-access door that reveals the handsome components inside. Note the circuit card at end of power cord.

COMING TO MY SENSES!

I finally came to my senses perhaps 20 years later. A client was cleaning out his basement and asked me if I wanted the two old radios sitting there. One was a *Clarion Jr. (Transformer Corp. of America) Model 40 TRF*. The other was a *Radiola Model 60* with a speaker. The Model 60 had a 25-cycle transformer, so I assume it had been made for the Canadian market. It had a complete complement of tubes and was missing only one item, a knob, as far as I could tell.

In any event, I smoke tested the "60" with a new line cord and it worked! One of its tubes, conveniently the untuned RF amplifier, was dead. I cleaned it up, refinished the cabinet (the inside of the lid was pristine, but the outside finish was shot), and replaced the dead tube. I even duplicated the missing knob, using liquid rubber to make a mold and casting it in black resin plastic. Finally, I obtained documentation, including xerographic copies of some original ads for the "60," which had a retail price of \$135 without speaker or tubes.

Adding a 5-ohm resistor in the AC-input circuit to reduce the voltage to the ancient innards for longer life, I placed the radio on my display shelf. That was 20 some years ago, and the "60" is still called on to perform now and then to show visitors just what 1930 technology could produce.

All but one of the capacitors in the *Clarion*, which dates from 1933 or so,

were either open or shorted. One of the tubes had a loose top cap. But the speaker was functional and the transformers were still in working order. I stuffed the loose tube cap with conducting foam (the stuff ICs used to come embedded in) and glued it back on the top of the tube so that the foam made the connection between the wire lead from its grid to the cap. (As no appreciable current flows in the grid circuit, the resistance of the foam is really irrelevant.)

All the capacitors have been replaced, along with the bleeder resistor that terminated the high-voltage DC from the rectifier and furnished bias-, screen-, and plate-voltages for the four tubes. The veneer has been repaired and refinished. This set, too, works when asked.

The only problem with the *Clarion* stems from its lack of an Automatic-Gain-Control (AGC) circuit. About one mile from me is the antenna of a local radio transmitter at 1590 kHz, which swamps everything not protected by AGC. To solve that problem, I put together a simple wave trap tuned to 1590 kHz.

This radio, too, sports 5 ohms in its AC primary to lower the voltages and lengthen the life of the circuitry and tubes. I can detect no reduction in performance. (**Note:** *Line voltages in the early 30s averaged 110 volts, while today, 115–120 volts is typical. So, with the resistors in place, Vic's sets may be operating very close to their intended supply voltages—Ellis.*)

GETTING HOOKED

Those two sets got me hooked on looking at old radios that I once scoffed at. A trash day in the late 70s netted me a *GE Model 155* floor model: push-pull 6L6s, driving a 15-inch speaker, with a total of 13 all-metal tubes, including dual rectifiers, and a frequency coverage from 140 kHz to 70 MHz!

The cabinet needed a new base, and its finish reflected 15 years in a garage. I refinished the cabinet and made a new base similar to, but not identical with, the

original. Two knobs were cast to replace missing ones. I dug in to my stock to replace several 400-volt capacitors, all of which reposed in circuits which came very close to 400 volts on start up.

The *Model 155* was from 1936 or so. If one reads the instructions for the *RCA Model 60* and compares them with the features of the *GE Model 155*, one will be amazed. The *Model 155* sported the expanded-frequency coverage already noted, automatic-frequency control on the broadcast band, a dial which changed color from red to green when a broadcast station was tuned in, and a muting switch on the tuning mechanism so one could avoid hearing interstage noise when tuning. The *Model 60's* primitive superhet circuit tuned both the broadcast band with no frills, and its minimal audio output also drove a separate magnetic speaker. What a difference in technology those few years made!

Also on my display shelf are a *Lafayette* three-tube regenerative all-wave receiver alongside an AC/DC/battery *Spartan* four-tube portable and a half-dozen home-brew crystal sets. Sitting beside the computer on which I am writing this is a *Wells-Gardner*-manufactured *National All-Wave Navy Receiver* with an extraordinary band-switching arrangement that, by itself, must weigh more than a modern all-wave receiver, cabinet and all.

FLEA-MARKET FINDS

A couple of years ago, I visited an Antique Radio Swap Fest in Seattle and picked up the guts of an *Atwater-Kent Model 32* and most of a *Radiola Model 20*. The *Atwater-Kent* had no cabinet, only a couple of parts of the wood front panel, and no tubes. The chassis was apparently made of armor plate. But the remaining parts were and are beautiful.

Restoring the Atwater-Kent

The four tuning capacitors of the *Atwater-Kent (A-K)* are coupled by a beryllium copper band coordinating four brass pulleys attached to the capacitor shafts. All of the machine screws are brass. The capacitors, not being encumbered with rivets or pressed fittings, are completely "disassembleable." Other than tubes, coils, and the variable capacitors, it has almost no parts. A resistor in each grid circuit helps eliminate oscillation (binocular coils also help). Then there are the filament-voltage rheostats

and the grid-leak resistor, and that is about it.

Since I was very impressed by the brass "works" and also unwilling to reproduce the original wood cabinet, I eliminated the steel chassis/front panel and substituted an aluminum chassis and a 1/4-inch Plexiglas front panel. The variable capacitors were disassembled and polished. All of the brass was polished and a new wooden cabinet put together.

Rebuilding the Radiola

The *Radiola Model 20* was more of a challenge. It had a water-damaged cabinet, which could not be repaired, and it also had no tubes. Its grid-leak resistor had skyrocketed in value to about 20 megohms.

I noted that 01As such as were used in the *A-K* and the 199s used in the *Radiola* shared pinouts with 30s and had similar transconductance and amplification factors. New 30s cost a lot less than either used 01As or used X199s. And 31s (obtainable at comparable cost savings) are similar to the 71A and 120 used in the output stage of the *A-K* and *Radiola*, respectively.

The biggest difference between these tubes lies in the filament voltage/current requirements. So I decided to use 30s and 31s in both the *A-K* and the *Radiola Model 20*. After all, I would not be able to provide these sets with original cabinets anyway, and almost no visitor would know the difference between the substituted tubes and the originals.

Because the *Model 20* does not have an effective gain control, the volume of my nearby station is annoyingly loud. Since I intended to run the sets with a speaker, I installed a 5-inch, 4-ohm speaker in a home-made cabinet, which looks sort of late 1920-ish, and included a three-position L pad. The input to the L pad/speaker has parallel pin jacks and a 1/4-inch phonograph jack. The *Radiola* has 1/4-inch phonograph jacks in the driver stage as well as in the final output stage. The *Atwater-Kent* has pin posts in its final output stage. So I put together a speaker cord with pin connectors on one end and a 1/4-inch phonograph plug on the other, so it can connect either set to the speaker.

As I already noted, I am plagued with this terrible transmitter at 1590 kHz. When I first tried the *Radiola*, it



This view of Vic's *Radiola 20* cabinet shows one of the removable side panels.

worked fine up to about 1000 kHz. But above that point its regenerative circuitry screamed and made tuning in any station within 300 kHz of 1590 impossible. (On the other hand, with a 2-foot hunk of wire as an antenna, it pulls in a Canadian station at 530 kHz that most of my modern receivers do not know exists.)

Part of the problem was the fact, I believe, that 30s are hotter (higher amplification factor) than 199s. So I put a resistor across the secondary of the coil in the grid of the detector/regenerative circuit to detune it a bit and replaced the grid leak resistor. Works fine!

The "20" receives broadcast stations only a little bit better than a \$10-transistor set, but its innards are fascinating. So I built a new cabinet of 3/4-inch mahogany, which is 99% identical to the original boxwood and veneer in appearance. However, the side panels have detachable inserts so that the coils and mechanisms are visible.

I fabricated a dial plate for the battery rheostat by making a mold from an existing one and modifying a casting made from the mold. I also cast a new knob to replace a missing knob using the technique already described.

Power Supplies

In the photos, you will see that the power-supply cords are terminated with modern-looking electronic cards. These are part of my "universal-power-supply" system for powering battery sets. (Both the *A-K Model 32* and the *Radiola Model 20* were designed to use batteries.)

The two sets do not use identical B+ or C- voltages, though all require the

(Continued on page 58)

Circuit Circus

IC Logic Gates and Inverters

CHARLES D. RAKES

Over the years here at the *Circuit Circus*, we've shared a large number of circuits using the Complementary Metal-Oxide Semiconductor (CMOS) and Transistor-Transistor-Logic (TTL, or T²L) line of integrated circuit logic gates. We've built oscillators, low-powered RF transmitters, speed-control circuits, light dimmers, stepper-motor controllers, and many other circuits using these versatile devices—but I don't recall ever taking the time to go over the basic functions and characteristics of these devices. Understanding just how each of the gates operates can make the job of troubleshooting much easier and make designing your own circuitry a real possibility. In this month's column, we'll take a look at the 7400 line of TTL logic gates and inverters and the 4000 family of CMOS gates and inverters, and we'll leave the newer series of gates for a later date.

THE 7400-TTL FAMILY

The 7400 family of TTL ICs has been around for about thirty years and is still going strong in many circuit applications. Most commercial TTL ICs in the 74XX family are useful over a 0° to 70°C operating environment. The one or two letters following the "74" indicate the special TTL family (if applicable), as follows: (74XX)—standard, or regular TTL, (74LXX)—low-power, (74HXX)—high-power, TTL (74SXX)—Schottky, (74LSXX)—low-power Schottky, etc. Which sub-family to select depends upon several design considerations, such as speed, power consumption, frequency of operation, and, of course, price and availability. The sub-family designation is then followed by a 2, 3, or 4-digit device-identification number. For example, a 74L04 is a low-power hex inverter (six inverters in one IC package).

Since these are digital gates, we only have to be concerned with a logic "1" (high) and a logic "0" (low) for their input/output levels. The ideal operating power-supply voltage for these devices is 5 volts, but they are designed to func-

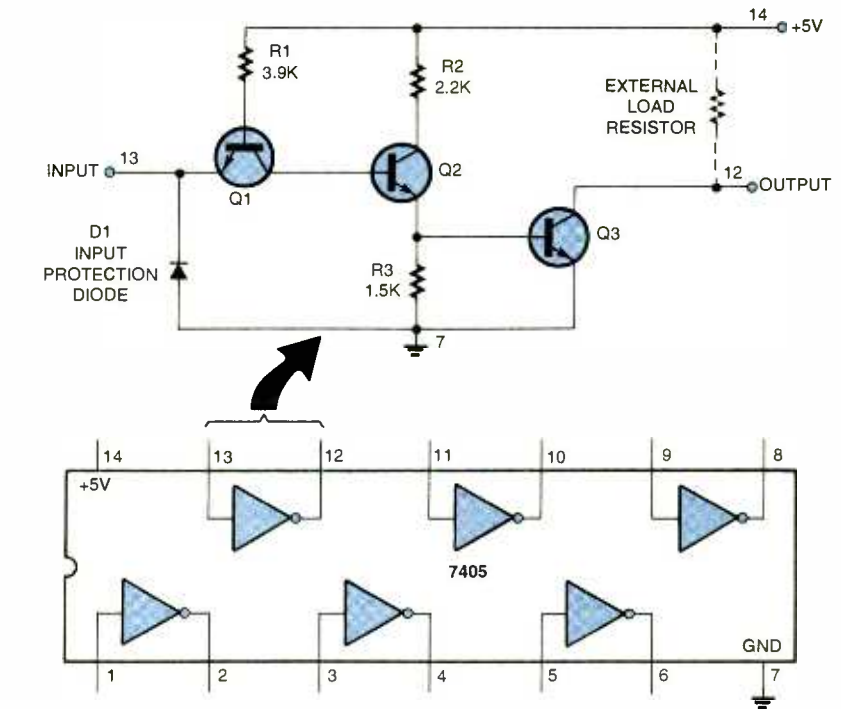

Fig. 1. Circuit topology illustrating one of six open-collector inverter circuits in a typical open-collector hex inverter IC. Identifications of transistors, etc. are for reference only and do not represent discrete components.

tion with a supply of 4.5 to 5.5 volts. The ideal signal input low, or "0" logic level would be zero volts. However, in the real world this doesn't happen often, so a recommended maximum "Low" voltage level is 0.8 volts. Any voltage above 0.8 volts and less than about 2 volts is considered a non-logic level and does not represent either a "Low-" or a "HIGH-" logic level. A typical "Low" for the TTL gate is about 0.1 to 0.4 volts.

The ideal "HIGH-"output logic level for a TTL gate would be 5 volts, but in reality the actual value will be somewhere between 3.0 to 4.5 volts—with a minimum allowable level of 2.5 volts. A typical "HIGH" output is about 4.0 volts.

A TTL gate supplies a maximum "HIGH-"(source) output current of 0.4 mA and a maximum "Low" (sink) current of 16 mA. The current requirement for single-gate input is only 40 μ A when the input is "HIGH" and 1.6 mA when the input is "Low." Each TTL output can drive 10 input gates, which is referred to

as the IC's fan-out capabilities.

A typical TTL open-collector inverter circuit is shown in Fig. 1. This is the equivalent circuit that makes up one of the six inverters in a 7405 hex inverter. A pull-up resistor must be tied to the open collector and the 5-volt source for the circuit to operate.

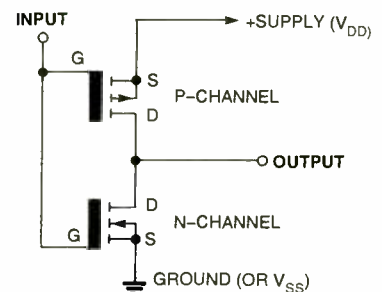

Fig. 2. Schematic diagram of a CMOS device, consisting of a P-channel and N-channel enhancement-type MOSFET, fabricated on a single substrate.

THE 4000-CMOS FAMILY

The CMOS 4000 logic family is one of the most popular and user-friendly lines of digital ICs available to the experimenter. Like the TTL family, there are numerous subfamilies associated with CMOS devices. For simplicity CMOS sub-families are assigned numbers similar to the TTL-numbering system, with one to three letters indicating the sub-family and as many as five numbers indicating the specific device, as follows: (40XX)—standard CMOS; (74CXX)—CMOS version of TTL; (74HCXX)—high-speed CMOS; (74HCTXX)—high-speed CMOS, TTL-compatible, etc. For example, a 74HC04 IC is a high-speed CMOS hex inverter.

CMOS devices require very little operating power, and during standby almost no current is required. The supply voltage requirements are anything

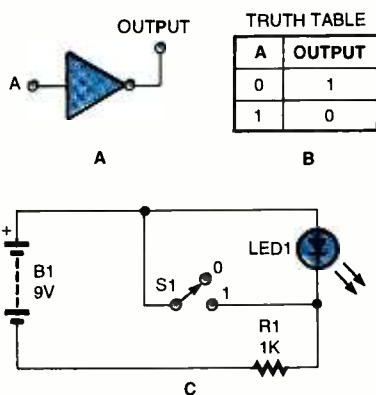

Fig. 3. In (A) is shown the logic symbol for an single inverter, with truth table in (B), and the resulting hard-wired equivalent in (C).

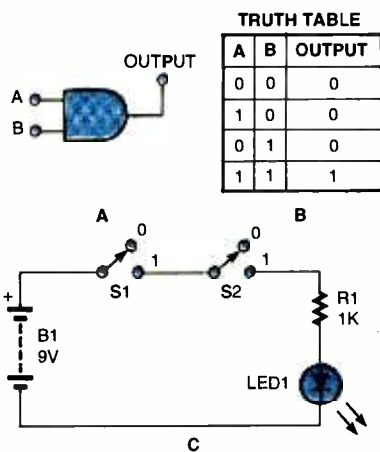

Fig. 4. Here we have the AND logic symbol in (A) and its truth table representation in (B). The equivalent logic circuit is given in (C).

but critical, allowing voltages of 3 to 16 volts to be used. The CMOS inputs require almost zero drive current because their input impedance is like an open circuit. Also, due to the wide range between the logic voltage levels, these devices offer excellent noise immunity.

Since the CMOS devices can operate over a wide voltage range, an exact digital-input "HIGH-" or "LOW-"voltage level can not be given. A logic-input "LOW" level is defined as any voltage less than 30% of the supply voltage. If the circuit is operating with a 10-volt supply, the maximum voltage for a logic "LOW" is about 3 volts. A logic input "HIGH" is any voltage greater than 70% of the supply voltage, and with a 10-volt supply the minimum logic "HIGH-"voltage level would be 7 volts. The output "HIGH-"logic voltage level rises to about 99% of the supply voltage, and the "LOW-"logic level drops to near-zero volts or circuit ground.

There are several CMOS characteristics that can be disadvantages in some circuit designs, and the following points should be remembered. CMOS devices are slower than similar devices in the TTL family, with propagation delays in some devices as high as 100 ns. Static discharge can kill any CMOS device with a single strike, so extra care must be taken in handling. All unused CMOS inputs must be tied to either ground or battery positive; and if any are left open, strange things will happen. Always check all inputs and make sure they go somewhere. Use a grounded soldering iron when installing a CMOS IC on a circuit board.

CMOS-COMPLEMENTARY MOSFET PAIR

Figure 2 illustrates a typical CMOS-complementary MOSFET pair that is found in the basic 4000 IC family. Two enhancement-mode MOSFET transistors are connected across the power source with the P-channel device connecting to the positive source and the N-channel to circuit ground.

Taking the input to positive supply turns on the N-channel MOSFET (P-channel is off) and sets the output to about zero volts, giving a "LOW" output. With the input at ground, the P-channel MOSFET turns on (N-channel is off) and brings the output up to the source voltage, producing a "HIGH" output. The output is the opposite of the input, as in an inverter stage.

LOGIC NOT GATES

The logic gate, no matter what IC family, is the basic building block for all digital circuitry. The simplest of all logic gates is the NOT gate or inverter. Figure 3A shows the schematic symbol for a NOT gate or inverting buffer. The truth table in Fig. 3B indicates that a logic low at the gate's input produces a logic-high output, and a logic-high input results in a logic-low output. Figure 3C shows an equivalent hard-wired circuit that will help you understand the logic. If switch S1 is in the "0" position, the LED is lit or on. Moving the switch to the "1" position turns the LED off.

The 4049 hex-inverting buffer and the 4050 hex non-inverting buffer are two very popular CMOS ICs that exhibit the NOT function. Each buffer, operating from a 5-volt supply, can fan out to drive two TTL-input gates.

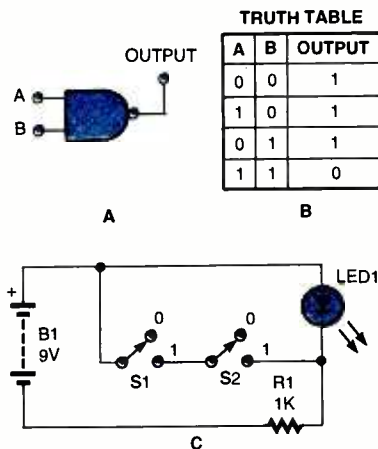

Fig. 5. The versatile NAND circuit is shown symbolically in (A), with truth table in (B), and an equivalent configuration in (C).

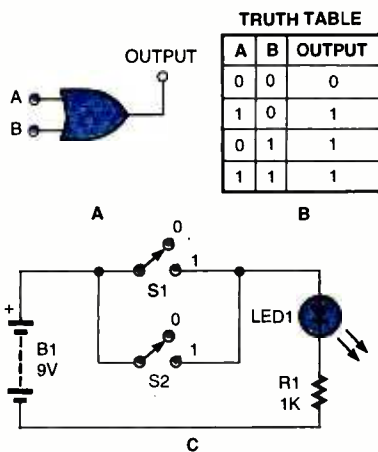

Fig. 6. Here we have the OR logic symbol in (A) and its truth table representation in (B). The equivalent logic circuit is given in (C).

LOGIC AND GATES

The next gate we're going to look at is the two-input AND gate that is shown in Fig. 4A. Let's compare the logic results defined in the truth table of Fig. 4B to the operation of the equivalent circuit in Fig. 4C. It is obvious that both switches, S1 and S2, must be closed to turn the LED on. Any other combinations of inputs will not give a "HIGH" output. In an AND gate, all inputs must be high before a high output will occur—any other combination of inputs only produces a logic-low output. The 4081 IC is a typical quad 2-input AND gate.

LOGIC NAND GATES

Figure 5 shows a NAND gate, which actually is an AND gate with an inverter connected to its output. Compare the AND gate and the NAND gate truth tables, and you will see what I mean. In a NAND gate, all inputs must be logic high to produce a logic-low output. Any other input combinations produce a logic-high output. Check out the equivalent logic circuit in Fig. 5C, and you can prove this to yourself. To turn on the LED (logic high), either/both switches must be opened ("0" position). A 4011 IC is a typical quad 2-input NAND gate.

LOGIC OR GATES

Next on the list is the OR gate. The OR gate symbol is shown in Fig. 6A, along with the truth table in Fig. 6B, and the equivalent logic circuit in Fig. 6C. All inputs of an OR gate must be logic low to produce a logic-low output. Any other input combination will produce a logic-high output. If any input is logic high, the output also is a logic high (LED lit in Fig.

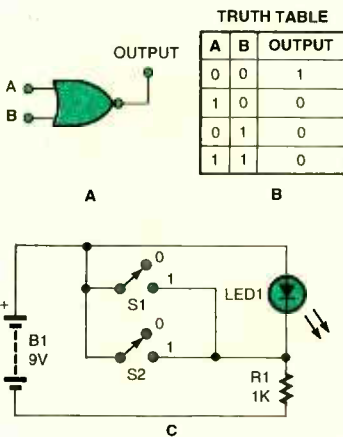

Fig. 7. The logic symbol of a NOR circuit is shown symbolically in (A). The truth table is defined in (B), while the circuit in (C) represents the NOR operation.

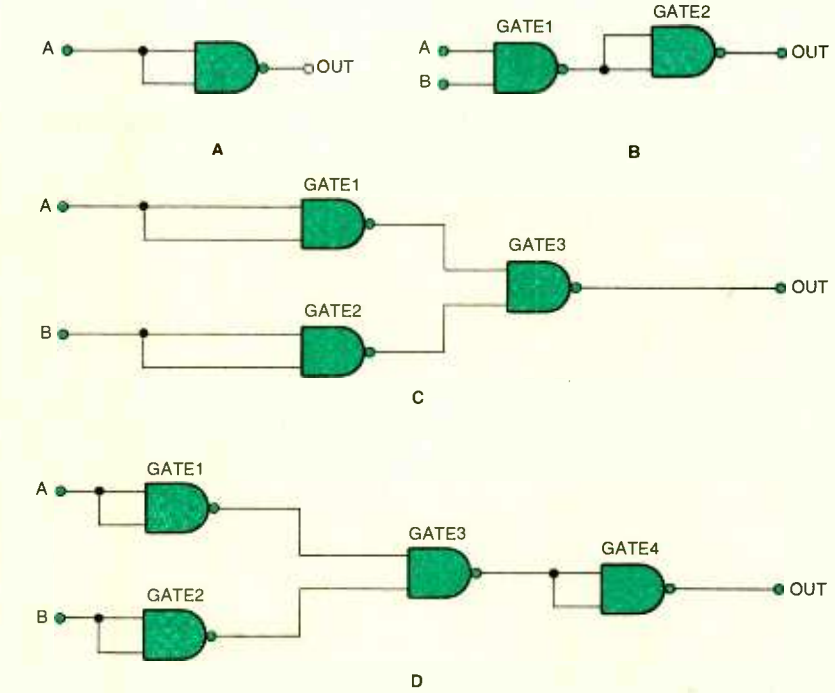

Fig. 8. This sequence of circuits shows how NAND circuits are the "building blocks" of other common logic circuits. Tying the two inputs of a single NAND gate together is used in (A) to define an inverter operation (or NOT logic). Two series-connected NAND gates are used to make up the AND gate of (B). The OR gate of (C) can be constructed with three NAND gates, two of which are paralleled as inverters and series-connected to a third NAND gate. The NOR gate of (D) is constructed with the OR gate circuit of (C), but with a NAND-inverter added at its output.

6C). The 4071 IC is a typical quad 2-input OR gate.

LOGIC NOR GATES

The NOR gate, see Fig. 7, is nothing more than an OR gate with an inverter connected to its output. Compare the OR and NOR truth tables, and you'll see that this is true. All inputs of a NOR gate must be logic low to produce a logic-high output. All other input combinations will only produce a logic-low output. Check out the equivalent circuit in Fig. 7C, and you can prove the truth table true. If either/both S1 or S2 are closed, then the LED cannot go on. A 4001 IC is a typical quad 2-input NOR gate.

LOGIC AND, OR, AND NOR GATES

We have just covered the five most valuable and often-used gates in digital circuitry. Look these over and see if you can determine which of the five gates can easily be used to make any and all of the remaining four gates. Here's a hint. The most popular and often-used gate is the NAND gate. Now take a look at the four gates in Fig. 8—all are made up out of standard NAND gates.

Our first constructed gate is the NOT

gate in Fig. 8A. To turn a NAND gate into a NOT gate or an inverter, just tie the two inputs of gate1 and gate2 together and apply the common input. If a non-inverting buffer is needed, just cascade another NAND gate.

Moving on to the AND gate shown in Fig. 8B, this development uses two standard NAND gates, gate1 and gate2, connected in series to form an AND gate. Go back to the truth table in Fig. 4B. All gates in an AND gate must be high to produce a logic-high output. If inputs "A" and "B" (in Fig. 8A) are logic high, its output at gate1 is low. This logic low is inverted by the second NAND gate, gate2, which produces a high output. Inputs high/output high equals an AND gate.

The OR gate, see Fig. 8C, is made up of three NAND gates. gates1 and 2 are connected in an inverter configuration with their outputs driving the inputs of gate3. Go back and look at the OR gate's truth table in Fig. 6B, and we see how the constructed OR gate operates. All inputs of the OR gate must be a logic low to produce a logic-low output. If we connect inputs "A" and "B" (in Fig. 8C) to ground (low), the output of the two

(Continued on page 58)

Think Tank

Tunnel Diodes and Other Goodies

ALEX BIE

One type of diode that was widely used in the 1960s in many applications where transistors did not operate well was the tunnel diode. Its mode of operation enabled it to be used at frequencies in excess of those that could be achieved by many other semiconductor devices.

Although tunnel diodes are not nearly as widely used today, they are still mentioned; and it's well worth investigating how they work. Sometimes they are encountered today, and their mode of operation is very interesting.

Background

The diode was discovered in 1958 by a Ph.D. research student named Leo Esaki. He was investigating the properties of heavily doped germanium PN junctions for applications associated with high-speed bipolar transistors. In this application a narrow, but heavily doped PN junction was required. Subsequently the tunnel diode, also referred to as the "Esaki diode," was demonstrated in a number of other materials including gallium arsenide. In 1973, Esaki was awarded the Nobel Prize for Physics for his pioneering work with the tunnel diode.

The tunnel diode (like the Gunn diode—see *Think Tank*, December 1998) has no rectifying properties. The diode's unusual characteristic, as a negative resistance device, proved that it could be useful commercially as a microwave oscillator, since it was smaller than the tubes or transistors of the time.

Tunnel-Diode Structures

The tunnel diode is similar to a standard PN junction, except that the doping or impurity levels are very high; and the depletion region (or the area between the P-type and N-type materials) is infinitesimally thin, typically in

(“What is A...?” series by Ian Poole, G3YWX, reprinted by permission from *Practical Wireless*, Arrowsmith Court, Station Approach, Broadstone, Dorset BH18 8PW, England.)

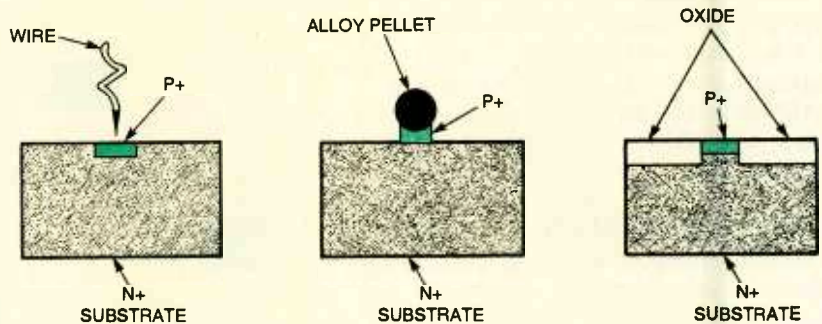

Fig. 1. Here we see several structures of tunnel diodes. In (A) we illustrate the pulse-bonded process, in (B) the ball-alloy structure is seen, while the fabrication shown in (C) uses normal planar technology to produce the required PN junction.

the range five to ten nanometers (or 50 to 100 angstroms). This very narrow depletion region width indicates that the capacitance of the diode is high. That means that when the diode is to be used for high-frequency operation, where a low value of capacitance is required, the diode area must be made very small. (Recall that the capacitance for a parallel-plate capacitor varies inversely with the thickness of the structure but directly with the area of the plates.)

There are a number of methods that can be used to fabricate a tunnel diode. These are shown in Fig. 1. The first structure, Fig. 1A, is made with the pulse-bonded method. Here a heavily doped substrate is taken, and a wire coated with the dopants is pressed against it. A voltage pulse is then applied, which causes local alloying; and a small junction is formed. As can be seen, this method is not very controllable, but it produces a very small junction suitable for RF applications.

The second structure is known as the ball-alloy structure. Here an alloy containing the required dopants is brought into contact with a heavily doped substrate. The structure is heated to a temperature of around 500° C. At this point, the alloy melts and the dopants diffuse into the substrate. The area around the alloy is then etched to reduce the size of the junction, as shown in Fig. 1B.

The third structure uses normal pla-

nar technology (shown in Fig. 1C). A small area of a heavily doped substrate is left exposed; and the area is exposed to diffusion, epitaxial growth, or alloying to give the required PN junction

Characteristic Curves

The combined current-voltage curve for a tunnel diode is shown in Fig. 2, superimposed with similar characteristic curves for its component elements; namely normal diode current and tunnel current. The composite curve for the tunnel diode can be seen to rise at first and “peak,” then fall back to a “valley,” and then start to rise again. The reason for this “peak” and “valley” effect is that there are a number of different components needed to form the overall curve.

The two main components are the normal diode current across the junction and the current arising from the tunneling effect. It is this last component that is of interest in a tunnel diode. The phenomenon of “tunneling” is a complicated mechanism resulting from a quantum mechanical effect. It occurs when electrons pass through a potential barrier in a way that can be visualized as tunneling. It has been found that the tunneling current peaks at a certain voltage and then falls away giving a negative resistance. This effect can be used in a variety of ways, which permits the tunnel diode to be used as an amplifier and also an oscillator—depending upon the diode's bias and input-source characteristics.

The tunnel diode can be placed in a circuit like that shown in Fig. 3. The steady DC voltage supplies the bias voltage for the diode. In this simple gain circuit, the output signal is an amplified form of the changing input signal.

Advantages and Disadvantages

The success of the tunnel diode resulted not only from its negative resistance but also its high speed of operation. This results from the fact that it only uses majority carriers; *i.e.*, holes in a P-type material and electrons in an N-type material. The tunneling effect is inherently fast, while many other devices are slowed down by their minority carriers (*i.e.*, holes in an N-type material and electrons in a P-type material).

However, there are a number of disadvantages, and these have meant that in recent years tunnel diodes have not been as widely used. In the first instance, they only have a low tunneling current; and this implies an oscillator generating low-output power (under 10 mW). Secondly, they are only two-terminal devices, and they do not provide sufficient isolation between the input and output stages. The third drawback results from the manufacturing problems in reproducibility, especially in integrated circuits.

Uses

Although tunnel diodes are not widely used today, they had found widespread use in the late 1960s in UHF and microwave amplifiers and oscillators. In these applications, they were able to offer good high-frequency performance coupled with low levels of noise. Today they are still occasionally used in low-noise amplifiers.

In next month's column, we will continue looking at unusual semiconductor devices as we examine the laser diode, which is used in various commercial applications ranging from CD drives, copy machines, *etc.* to specialized optical communications. But enough theory, let's look at a couple of interesting reader circuits.

SELECTABLE PULSE-WIDTH GENERATOR

Our first entry, see Fig. 4, is a pulse-generator circuit that can be programmed for a number of different outputs by closing one or a combination of ten switches. The output of the 4093 IC oscillator circuit clocks the input of a 4017 CMOS IC. The 4017 CMOS IC is a divide-by-ten counter with ten individual outputs. With each input clock pulse, the 4017 steps one position and brings that output high. The next pulse steps the next output high while return-

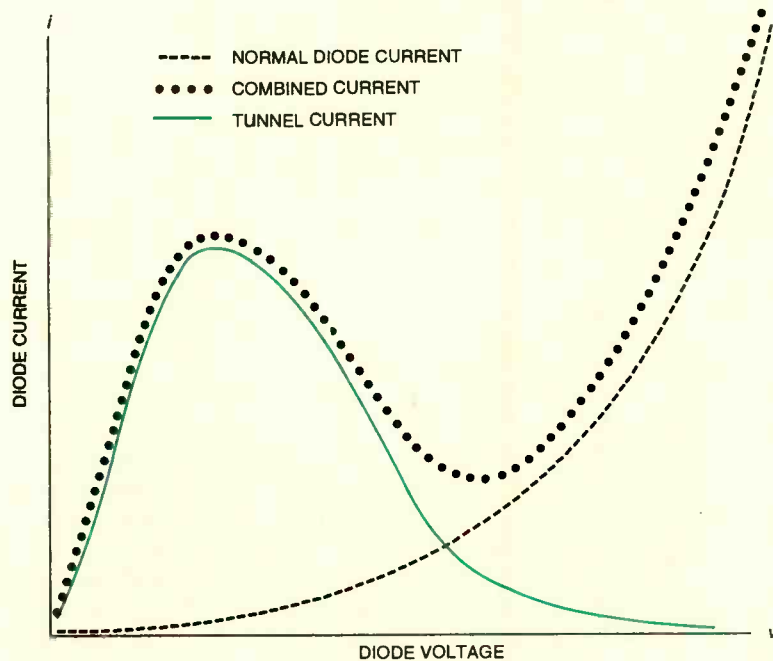

Fig. 2. These curves illustrate the various currents present in a tunnel diode. The combined current (dotted) is shown as the superposition of normal diode current (dashed) and tunnel current (solid).

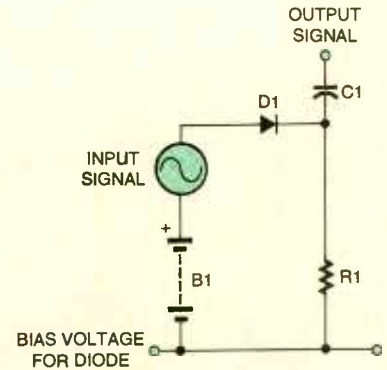

Fig. 3. A basic circuit for an amplifier using a tunnel diode (D1).

ing the previous output back low. This process continues for a count of ten in a sequential manner. Each output occurs only one time in ten input pulses. So to obtain a 100-Hz output, the clock oscillator would operate at 1000 Hz, or ten times the single output frequency.

The waveform chart in Fig. 5 shows the output for each switch closure. As shown, any combination of switch closures can be used to create a desired output waveform. Closing S2, S3, S6, and S7 produces the bottom waveform.—C. Rakes, Bentonville, AR

This is a fine circuit to experiment with at home or in the lab. By selecting any one or more of the SPST switches, you can create many different outputs. By the way, good substitutes for the 4093 Schmitt trigger IC are NTE4093B or Thomson SK4093B; the 4017 decade counter/divider IC can be replaced with an NTE4017B or SK4017B unit.

AN AUDIO Q-MULTIPLIER

It's a busy night on the 80-meter band. You're trying to listen to a CW message in an extremely crowded spot on the dial, but the constant grind of QRN and QRM (atmospheric noise and signal interference, respectively) makes you just about climb the wall. Before you swing a baseball bat at the receiver, consider building this audio Q-multiplier. Connecting it to your receiver's output jack will give you interference-free CW reception of the quality you would expect from a high-priced receiver.

Instead of requiring an internal receiver connection, as does the usual IF (Intermediate Frequency) Q-multiplier, this audio Q-multiplier connects to your receiver's speaker or headphone output jack. Just as the IF Q-multiplier narrows the bandpass of the IF amplifier

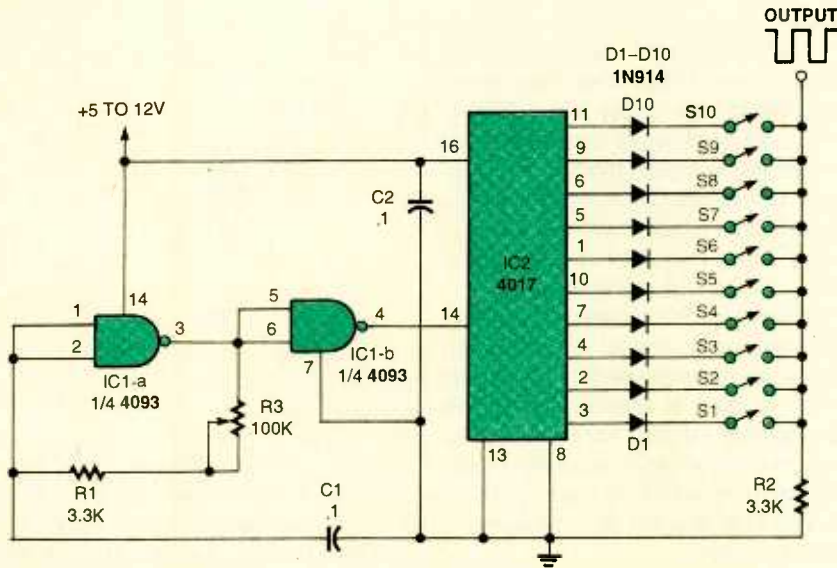

Fig. 4. Want to experiment with pulse-generator circuits? This design uses ten SPST switches to select output pulse timing and pulse width. Potentiometer R2 in the 4093 IC oscillator section sets the base frequency of operation.

by putting the stage on the verge of oscillation, this audio Q-multiplier increases the Q (or selectivity) of an external audio stage, by setting it at the point of oscillation. The result is that the Q-multiplier's output amplifier, which follows its tuned audio stage, receives primarily the desired tone frequency—all other background noise is sharply attenuated.

The heart of the device is Q1, an N-channel dual-gate MOSFET that provides a slight amount of AF amplification via its input gate G2 and output drain D. The signal at the drain is divided as it passes through capacitor C3. It is then applied to both IC1, an LF351 op-amp IC (which is used as a buffer), and to the parallel-T filter network—consisting of capacitors C4, C5, C6, and C7, and resistors R5, R6, R7, and R8. The values of parts used in the parallel-T have been chosen to provide a voltage across potentiometer R8, which is in phase (positive with respect to G2's gate-input signal) at one specific frequency. The positive feedback is applied via R8's wiper to Q1's other gate, G1, where it combines in the drain circuit with the input signal, (if too much feedback is applied through R8, the stage will break into oscillation).

The total signal at the drain is therefore peaked at the resonant frequency of parallel-T network, around 1.5 kHz. Because control R7 is variable, the network tunes a range of approximately 800 Hz to 2 kHz. Capacitors C6 and C7 can be replaced by a single 0.003- μ F capacitor. However, we have illustrated two standard capacitor values in parallel to allow for trimming to the desired value. If you prefer your CW tones at a lower center frequency of 600 Hz, use C4 = C5 = 0.0013 μ F and C6 = C7 = 0.003 μ F (or replace with a single 0.006- μ F capacitor). For a higher center frequency, around 2.5 kHz, use C4 = C5 = 330 pF and C6 = C7 = 750 pF (or replace with a single 1500-pF capacitor).

In addition to suppressing tones other than the one peaked, background noise is sharply reduced because of the narrow audio bandpass. Signal diodes D1 and D2, which provide overload protection for Q1, also act as an audio-noise limiter to further reduce the background impulse noise.

In this circuit the output amplifier, IC2, a LM386 low-power amplifier, has a maximum power of about 500 mW;

4017
OUTPUTS

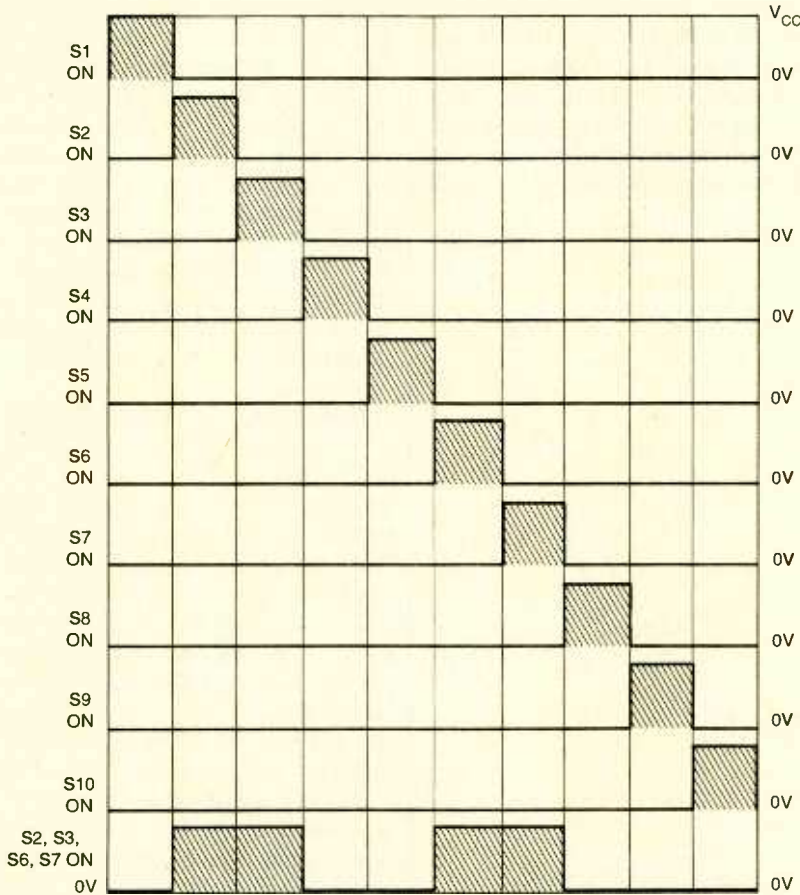

Fig. 5. This chart illustrates the different outputs obtainable with the ten SPST switches. Combinations of two or more switches increase the corresponding pulse widths.

PARTS LIST FOR THE AUDIO Q-MULTIPLIER

SEMICONDUCTORS

- D1, D2—1N60, germanium, general-purpose diode
 IC1—LF351 low-noise, JFET-input, op-amp, integrated circuit (NTE857M, or equivalent)
 IC2—LM386 low-voltage, audio-power amplifier, integrated circuit (NTE823, SK9210, or equivalent)
 IC3—7824 fixed, 24-volt, 1-amp, regulator, integrated circuit (NTE972, SK3670, or equivalent)
 IC4—7812 fixed, 12-volt, 1-amp, regulator, integrated circuit (NTE960, SK3592, or equivalent)
 Q1—3N140 dual-gate MOSFET (NTE221, Thomson SK3065, or equivalent)

RESISTORS

(All fixed resistors are 1/4-watt, 5% units.)

- R1, R15—1-megohm
 R2, R10—100,000-ohm
 R3—6800-ohm
 R4—1200-ohm
 R5, R6—240,000-ohm
 R7—250,000-ohm, linear-taper potentiometer
 R8—1-megohm, linear-taper potentiometer
 R9—500,000-ohm, audio-taper potentiometer
 R11, R13—1000-ohm
 R12—560-ohm
 R14—5000-ohm, trimmer potentiometer
 R16, R17—4700-ohm
 R18—10-ohm

Use the minimum amount of receiver signal necessary to obtain a clean output tone. Excessive receiver output will cause the circuit to generate noise bursts. If you want to connect headphones at the circuit's output, connect an 8.2- to 10-ohm, 1-watt resistor from the output (negative end of C12) to ground.

Keep in mind that the Q-multiplier cannot eliminate all QRM. If you are monitoring a CW signal with a tone around 1 kHz and the interfering signal has a tone near 800 Hz, there will be little suppression of the interfering signal. The Q-multiplier works best at suppressing a signal that is at least double the frequency of the desired tone.—*Craig Kendrick Sellen, Waymart, PA*

Fine circuit, Craig; this project should be useful to every ham and SWL.

That's about it for this month's column. Remember—this is **your** column—keep those circuits, solutions, and ideas coming in. Besides the fame of seeing your circuit in print, for each circuit that appears, you will receive a special gift. Write me—Alex Bie, *Think Tank*, Popular Electronics, 500 Bi-County Blvd., Farmingdale, NY

CAPACITORS

- C1, C11—0.05- μ F, ceramic-disc
 C2, C15, C17—10- μ F, 16-WVDC, electrolytic
 C3, C8, C9, C16—0.1- μ F, ceramic-disc
 C4, C5—620-pF, ceramic-disc
 C6—1000-pF, ceramic-disc
 C7—2000-pF, ceramic-disc
 C10—50- μ F, 35-WVDC, electrolytic
 C12, C19—220- μ F, 16-WVDC, electrolytic
 C13—500- μ F, 35-WVDC, electrolytic
 C14—0.005- μ F, 500-WVDC, ceramic-disc
 C18—100- μ F, 35-WVDC, electrolytic

ADDITIONAL PARTS AND MATERIALS

- BR1—1-amp, 100-PIV, full-wave bridge rectifier (RadioShack 276-1152, or equivalent)
 J1—Phone jack
 S1—SPST switch (part of R9)
 SPKR1—8-ohm speaker
 T1—25.2-volt AC, 450-mA, standard power transformer (RadioShack 273-1366, or equivalent)

NOTE: Transistor Q1, and the ICs and diodes, are available from DC Electronics, P.O. Box 3203, Scottsdale AZ 85257; Tel: 800-467-7736 or 800-423-0070.

CIRCUIT CIRCUS

(continued from page 53)

gates is high. Both inputs of gate3 are also high, producing a logic-low output, as in a standard OR gate.

Our last constructed gate is the NOR gate shown in Fig. 8D. If we just think about it for a minute, we can save some logic tracing by briefly going back and looking at the description of the NOR gate. The NOR gate is an OR gate with an inverter connected to its output. Therefore, gate4, in Fig. 8D, simply inverts the output of the OR gate of Fig. 8C, turning it into a NOR gate.

Any time in the future when you are breadboarding a new circuit and find that you are short an OR, NOR, AND, or NOT gate, scratch around in the junk box and see if you can find a NAND gate and continue on. I also hope that the basic logic-gate information we covered here will be helpful as well.

It's time to close for now—see you here again next month, same station, same time—logically speaking!

Comments? Via e-mail at cdrakes@ipa.net, or snail-mail at P.O. Box 445, Bentonville, AAR 72712,

ANTIQUE RADIO

(continued from page 50)

same (2 volts at 0.06 amps DC) filament supply because I substituted 30-series tubes for the originals in both radios. Other battery sets I might want to operate could have 01-A tubes (whose filaments require 5 volts at 0.25 amps) or X199s (3.3 volts at 0.06 amps).



Newly-minted cabinet for the Radiola 20 is very similar in style to the original. Power-supply circuit card can be seen at left.

Accordingly, I decided to put together a universal-battery substitute, which has a female-edge connector as its output. The circuit cards on the A-K 32 and Radiola 20 are equipped with male-edge connectors to mate with that female, and they have resistor networks to adjust the voltages, as necessary, for the particular set. In order to demonstrate either set, I slip the relevant edge connector into the output connector on the power supply and away we go.

Vic has supplied excellent documentation for his ingenious power-supply scheme, so we'll turn the column over to him again next month and go on with his letter. See you then!—Ellis

POPTRONIX®

Online Edition

We're on the web **FREE**

<http://www.poptronix.com>

NET WATCH

High-Speed Connectivity

KONSTANTINOS KARAGIANNIS

Having just returned from the 1998 *Internet World* show, I'm not surprised to see that a big concern for all "Netizens" is still the question "How do I get faster Internet access?" Sure, 56-kbps (kilobytes-per-second), or 56K-modems are much peppier at downloading than their ancestors were, and they are even appearing on the most inexpensive, budget computers; but are they really fast enough to deliver the rich experience that people are starting to expect from the Web?

This month, rather than sticking to our regular format of Web site reviews, we'll begin with a look at what types of equipment you can be using to connect to the world of the Internet at speeds that will surely bring magic back to the experience for you. Why settle for streaming radio-quality music when you can hear crystal, CD-like sound? Why watch choppy, 8-frames-per-second video, when you can see almost TV-like broadcasts?

With the two new technologies you'll read about, it will be possible to connect at speeds ranging from the several-hundred kilobytes per second to Local Area Network- or LAN-type transfer rates measured in megabits per second. Imagine downloading a 1.5-megabyte file in seven seconds!

If you loved the Net before, you'll find it to be an even more compelling environment now. Read on!

MORE THAN JUST MOVIES

Right away, we should point out that the access methods we're about to describe are not available in all areas. In fact, most of them rely on

HOT SITES

Compaq
www.compaq.com

DirecPC
www.direcpc.com

DSL Communications
www.dsl-com.com

OptimumOnline
www.optimumonline.com

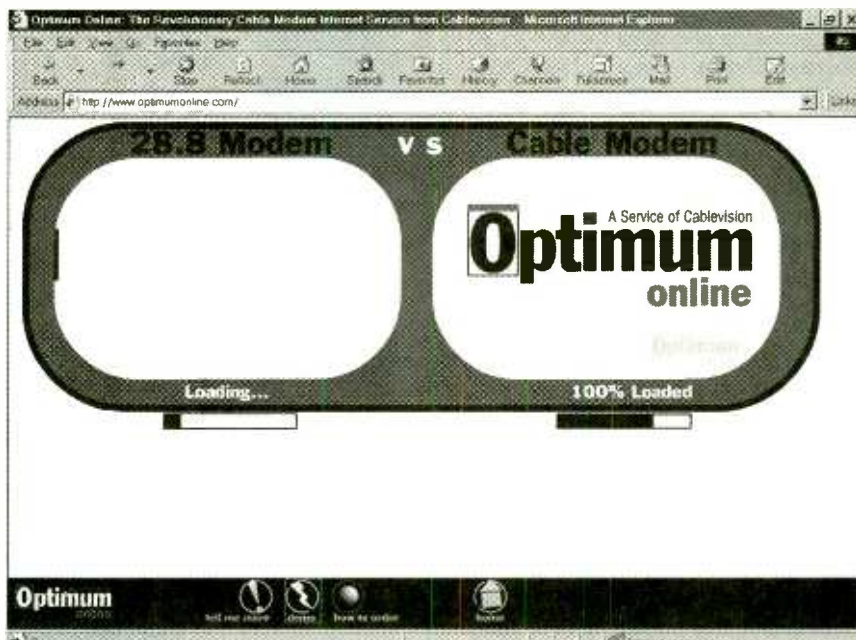

While only a New York and Connecticut provider, OptimumOnline has a site that lets you get an idea of how much faster cable modems are than their analog counterparts. Check to see if your local cable company has a site, too, and get ready for up to 10-Mbps speed.

regional providers, making it impractical to write this as a how-to section—we're a national and international magazine, after all. Just like we wouldn't try to tell you which local *Internet Service Provider* (ISP) is best for your needs, we can't fully comment on where you should go to get connected to the new, high-speed alternatives. We can, however, use examples from our New York area and help you start looking in the right direction.

For starters, let's examine what's clearly the fastest option for home access for now. If your area can get cable television, then you might already have this technology available to you. We're talking here about cable Internet access. As it turns out, those new lines cable companies have been installing for years to prepare for interactive-television features can carry a lot more than pay-per-view movie request signals.

The cable infrastructure now in place in most areas can also handle 10 Mbps (megabits per second) of data bandwidth. That's the amount of speed

available to most small networks; and it is about 188 times faster than what you can get out of a 56-kbps modem, which because of telephone-line restrictions tops out at usually 52 or 53 kbps.

Now, this bandwidth is shared by each neighborhood, which means at best you'll probably only connect at a maximum of about five or six Mbps—only 100 times faster than you can get now (the "only" in that statement was obviously sarcastic). At these speeds it will appear to you like your machine's accessing data off a floppy disk rather than the Net. Cable companies are promising to limit subscribers to match their bandwidth so that your access shouldn't eventually end up back in the analog-modem range.

Check with your local cable company to see if Net access is available. In our area, it costs \$35 a month if you agree to a year's worth of service (you still pay monthly, though, not all up front like some yearly ISP deals). Five bucks of that fee is to cover the rental of a cable modem. This is an external

device that connects to your computer via an Ethernet port. In other words, you have to have at least a 10BaseT (10-Mbps Ethernet) Network Interface Card (NIC) in your computer. Some cable companies are giving these away to get you started, but they are very affordable in any case (well under \$100 and often under \$70).

To get started, your cable company will come to add another line to your room of choice. If you've been adding up the costs so far, you'll find that cable is no more expensive than analog access. Adding a phone line to a house can cost more than twice as much as the install fee of cable, and when you consider that cable has no per-minute charges and that you don't need to pay an ISP any longer, it comes to about the same.

Cable is always online, so when you start up your computer, you're connected to the Net. From the live demos we've seen, it's really amazing. Even if you don't live in the New York Tri-State area, you can get an idea of cable's speed by checking out the virtual demo at *OptimumOnline's* Web site. You may also want to visit your own local cable company's Web site—chances are it has one.

AN ALMOST WIRELESS APPROACH

Another currently available service is *DirecPC*. Like cable, this uses existing technology to bring faster Net access. However, we can't say that we're as impressed. *DirecPC*, from *Hughes Electronics*, uses an 18-inch satellite dish like the ones you've seen for digital satellite television. What are the major drawbacks that this technology has compared to cable? For one, it's not as fast, topping out at 400 kbps, and is for download only.

This means that you'll still need a modem to surf the Web. Viewing Web pages is, after all, a bi-directional process. Type in a URL or click on a link, and your Web browser has to send out requests to get the information. These small chunks of data you'll have to send out over a telephone line won't really slow down your online experience, though if you do a lot of uploading of files or send lots of e-mail, you might be frustrated by the limitations of analog once again.

Because you'll still need a phone line, *DirecPC* can get expensive. First of

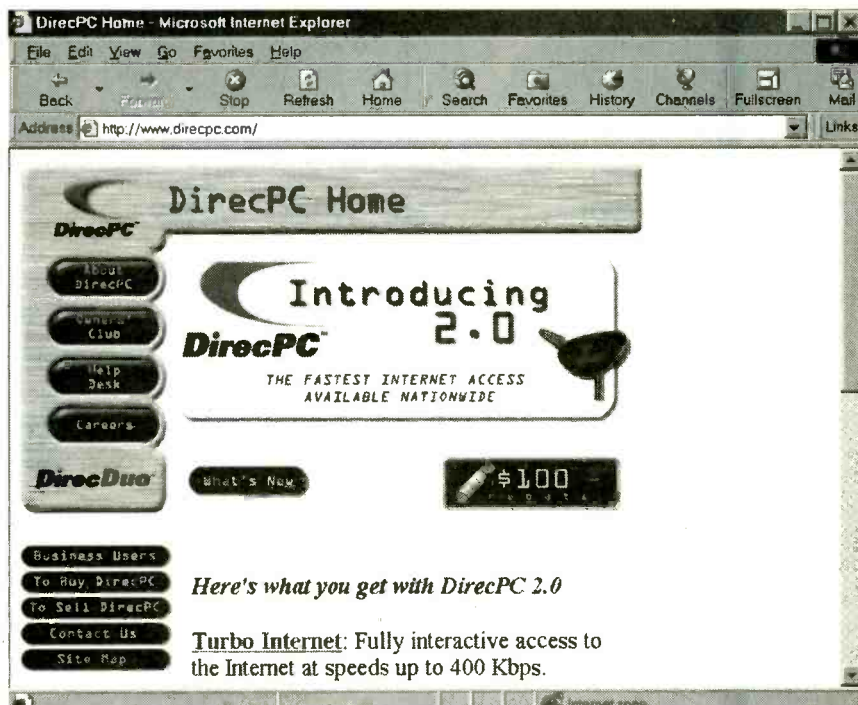

If you live far away from a hard-wired, high-speed Internet service, consider giving DirecPC a try. With this satellite-dish service, you'll still get respectable downloads of 400 kbps, though it's a bit costly.

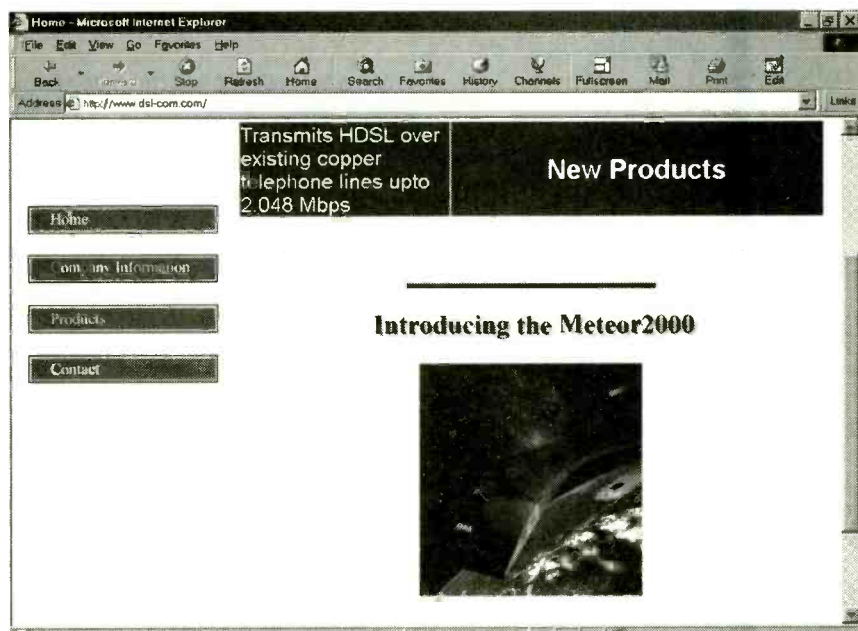

Modem companies are beginning to prepare for the arrival of high-speed xDSL lines in neighborhoods across the country. Shown here is DSL Communications' Meteor2000, which can hit speeds of just over 2 Mbps.

all, you'll need to buy and install a dish, which could total \$300 to \$500 (the lower end representing your installing it yourself). Then, there's the monthly service that costs \$20 for 25 hours of downloads, with each additional hour costing 99 cents. You could pay more, up to \$35 to get 100 hours (each additional minute remains the same). Add to this the cost of maintaining a monthly phone line and

some local calls, and the cost of an ISP (you'll still need one), and you end up paying quite a bit.

Overall, cable is the better way to go if it's available. If you're in a rural area, though, and your nearest cable company doesn't even know your town exists yet, then you might want to consider going almost wireless.

(Continued on page 64)

DX LISTENING

Better Bangladesh Betar

DON JENSEN

Last month, you'll remember, we focused on the great subcontinent of southern Asia, a region of tightening tensions following last summer's testing of nuclear devices by both India and Pakistan. With attention still directed to this potential global hotspot, SWLs, not surprisingly, have taken an interest in the shortwave broadcasters operating in the area.

Previously, we considered *Radio Pakistan*, which like its chief rival, *All India Radio*, had its origins in colonial British India with a privately owned station at Bombay, established in 1927. But there is a third shortwave presence on the Indian subcontinent, the less formidable but equally interesting radio voice of the much smaller nation of Bangladesh.

Not as widely heard as the *Radio Pakistan* and *All India Radio* outlets, *Bangladesh Betar*, as the station is called, is a nice DX-tuning target for any SW listener.

The end of British imperial India in 1947 resulted in independence for India and Pakistan, the latter formed from two separate parts of the former colony where Islam is the dominant religion. *Radio Pakistan* established SW stations in both the non-contiguous eastern and western parts of the new country. Separated by some 900 miles of Indian territory, the two parts, east and west Pakistan, were not a good fit. And, in a 1971 civil war, with heavy military assistance from India, the eastern portion of Pakistan won independence as Bangladesh.

The eighth most populous country in the world, with more than 100 million people crowded into an area only a little

(CREDITS: Ray Bauernhuber, NY; Jerry Berg, MA; David Clark, ONT, Canada; J. Findlater, CA; Bill Flynn, OR; Bob Fraser, MA; Garie Halstead, WV; David Krause, OH; David Norrie, New Zealand; Jay Novello, NC; John Sgrulletta, NY; Dan Ziolkowski, NY; North American Shortwave Association, 45 Wildflower Road, Levittown, PA 19057; World DX Club, c/o Richard A. D'Angelo, 2216 Burkey Drive, Wyomissing, PA 19610).

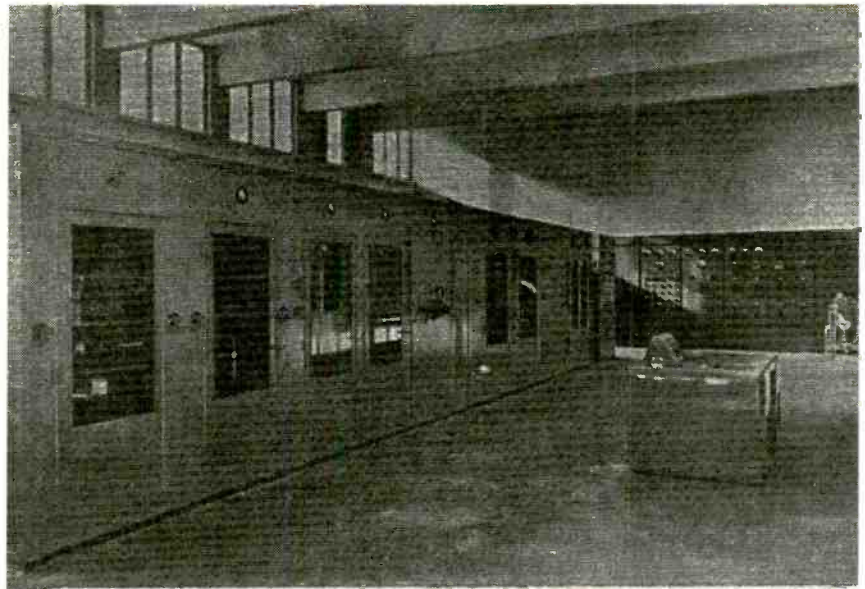

The 100 kW transmitter you have heard.

The Finnish Short Wave Broadcasting
Transmitter at Porv, Suomi (Finland)
Geogr. loc. 21° 52' E, 61° 28' N

Mr. Donald Jensen

We acknowledge with thanks your report on our short wave transmitters. It checks well with our own log and we would be pleased to receive further reports from you of the audibility of our other transmitters. They are:

M. Kc. Station

OIX1. — 49,02 — 6120

OIX2. — 31,40 — 555

OIX4. — 19,75 — 15190

OIX5. — 16,85 — 17830

S U O M I

Our short wave transmitters are daily on the air.



Oy. Yleisradio Ab.
Porin Yleisradioasema
Porv, Suomi (Finland)

Shown on this SWL card is Northern European broadcaster Radio Finland, where listeners can hear intelligent conversation on the weekly talk show "Capital Cafe."

larger than Arkansas, Bangladesh economically is the weak sister of the three Asian subcontinental nations. But as is the case with other Third World countries, it is important for Bangladesh to maintain a global-shortwave profile.

Over the past two and a half decades, *Radio Bangladesh*, as the short-

wave service formerly was known, evolved into today's *Bangladesh Betar*, which in the native Bangla (or Bengali) tongue means approximately the same thing. The SW service is headquartered at Dhaka, with its shortwave transmitters operating from Khibirpur, approximately 25 kilometers from the capital city.

Bangladesh Betar has only two shortwave transmitters—unless you count a sometimes-operating older 50-kW unit—but they run a reasonable amount of power, 250 and 100 kilowatts. This may help to account for occasional reception in North America, although none of the stations' programming is especially beamed our way.

The SW service has daily programs in Bangli, the local language, as well as programming directed to neighboring countries in Hindi, Urdu, Nepalese, Arabic, plus twice daily English broadcasts. The English segments begin with daily newscasts and end with Bangladeshi or other featured music, plus, depending on the day of the week, commentary from local and national newspapers, sports reports, economic review and feature programs.

Bangladesh Betar English programs beamed to south and southeast Asia are aired from 1230 to 1300 UTC on 7185 kHz (the most powerful transmitter) and 9550 kHz; and to Europe from 1815 to 1900 UTC, on the same two frequencies, plus, sometimes transmissions on 15520 kHz.

While not an easy logging, *Bangladesh Betar* may make it to your ears. And if so, reception reports can be sent to the Director, External Services, *Bangladesh Betar*, PO Box 2204, 121 Kazi Nazrul Islam Avenue, Dhaka 1000, Bangladesh.

GOOD CONVERSATION

When John Figliozzi talks about shortwave programming, wise SWLs pay attention. Figliozzi, among his other writings, conducts the monthly "Easy Listening" column in *The Journal of the North American SW Association*, in which he reviews and previews shortwave programming.

The first is "Late Night Live" on *Radio Australia*, heard Monday through Thursdays at 1205 UTC on 6020, 6080, 9580, and 9770 kHz. This "refreshing" conversational program, Figliozzi says, "is a feature of *Radio National*, the *Australian Broadcasting Corporation's* primary national network, that now serves as a significant source of programming for the resource-depleted international (shortwave) service."

Figliozzi continues: "Its low-key nature may in part be due to the fact that it is a late evening program on that network, but it probably has more to do with the level-headed and rational approach

taken by its host, the much traveled and experienced Phillip Adams.

"Topics range widely from national and international affairs, to the arts and literature, even to broad philosophical matters. But regardless of the guest or subject, all matters are consistently handled intelligently, civilly and in quiet, respectful and conversational tones."

A somewhat more narrowly focused talk show of similar genre is *Radio Finland's* "Capital Cafe," Sundays at 0205 UTC (remember, that because of time differences between UTC and local time in the U.S. and Canada, that time is Saturday evening here) on 9780 and 11900 kHz. It is repeated at 1235 UTC Sundays on 11900 and 15400 kHz.

Figliozzi says, "Capital Cafe...is a very pleasant 25 minutes of quiet, engrossing conversation with a prominent Finnish or Scandinavian personality from the fields of politics, literature, the arts or other aspect of Northern European life. The program never fails to reveal to me new ideas or interests about Finland and its surrounding regions; and I'm always surprised at the end that the half-hour went by so quickly."

IT'S THE PROGRAMS, STUPID!

I sometimes think I get too hung up on the traditional DX aspect of shortwave listening. DX means listening to distant broadcast signals, mostly because they are from far-away places. Shortwave DXing, like sport fishing, can be more about the adventure, the thrill of landing, in the case of shortwave, a first-time reception of a seldom-logged station. But to the stations themselves, and, I suspect, many of you listeners out there, it is the result of the hunt that matters most—the programs themselves.

Realizing that I may be giving too little attention in this column to the programs that, bottom line, are the reason for shortwave transmissions, I would like to highlight more of the programming on shortwave, as John Figliozzi does so well in his listener club bulletin and other writings.

To a large degree, however, I need your input. I'd be delighted to receive specific program reviews from readers so this could be a regular part of the *DX Listening* column.

What are your favorite shortwave programs?—be they talk, music, sports, comedy, or whatever. When can they be

heard? Time? Day of the week? Monthly? Weekly? Daily? What are the frequencies? Tell me in some detail just what you like and why. What is good, different, or unique about your favorite shows? These reviews may be 100 to 300 words. Just remember though that to be most useful, they should highlight a regular series of programs, not just a one-shot show you especially liked. This column has a three month preparation lead time, and I want to be sure that the programs you like are still continuing on the air so that other readers can tune in.

Shortwave program reviews should be sent to me, Don Jensen at *DX Listening*, **Popular Electronics**, 500 Bi-County Blvd., Farmingdale, NY 11735. If you like the idea of having more shortwave programming information in this column, I need your thoughts on favorite shows.

DOWN THE DIAL

Now here are some opportunities for tuning interesting shortwave stations.

AUSTRALIA—17795 kHz, *Radio Australia* has a call-in program called "Australian Talk-Back," which was heard at 0355 UTC. A parallel frequency at the same time is 17750 kHz.

BRAZIL—5952 kHz, *Radio Guaraja* is noted during the early morning hours, around 0930 UTC, with a fast-moving program of Brazilian music and Portuguese language deejay patter.

CANADA—6130 kHz, *CHNX*, one of a handful of Canadian private shortwave stations, is located at Halifax, Nova Scotia. It has been heard around 1045 UTC with a musical program of "Good Time Oldies." The shortwave outlet relays the programs of its sister medium-wave outlet, *CHNS*, and identifies as such, even on SW.

CHILE—21550 kHz, *Voz Cristiana* in Santiago was logged here in both Spanish and English, between about 2100 and 0030 UTC, asking for reception reports from listeners.

EGYPT—9475 kHz, *Radio Cairo* broadcasts in English at 0300 UTC with Middle-Eastern news, Arabic music, and, later in the program, light jazz.

GABON—7260 kHz, *Radiodifusion Gabonaise*, broadcasting from Moyabi, is noted on this frequency around 0525 UTC with popular music and guitar solos, accompanied by voice-over announcements in French.

(Continued on page 64)

SCANNER SCENE

Pack Your Trunks—Let Your Computer Do the Tracking!

MARC SAXON

What a good idea! Certain sophisticated scanners can now be interfaced with your computer in order to enable them to decode trunked communications systems. Good news for those who shelled out big bucks for top-of-the-line MHz inhalers only to have primary local public-safety networks shift to 800-MHz trunked systems.

What you might now think about adding to your station is the new *OptoTrakker*. This is a hot device that interfaces your existing scanner with your computer, permitting the scanner to receive *Motorola* Type I and II 800- and 900-MHz systems. It was designed to work with the *ICOM* R7000, R7100, R8500, R900, and R10, and also with *AOR* models AR3000, AR5000, and AR8000. With available software options, the *OptoTrakker* will also work with the *RadioShack* PRO-2005/6 and PRO-2035/42. Discriminator audio modifications may be necessary on some receivers.

But wait—using the software supplied with the *OptoTrakker*, you can also scan multiple systems such as *Motorola* trunk groups, LTR trunk groups, and other frequencies simultaneously. The thing even decodes CTCSS (PL tones), DCS, and DTMF tones and codes.

So don't put that great old scanner in a trunk; use it to monitor a trunk! The *OptoTrakker* costs less than \$300, which includes interface cables and *ScanStar* software. It's available from *Optoelectronics*, 5821 NE 14th Ave., Ft. Lauderdale, FL 33334; Tel. 800-327-5912; Web: www.optoelectronics.com.

BIG BLAST

One of the more useful monitoring station aids is a preamplifier. It can boost weak signals above 100 MHz up to 20 dB (increase signal power by 100 times), which is a definite asset. These devices are equipped with a control that allows the user to vary the signal-output level to the scanner. But some scanner owners always leave this gain

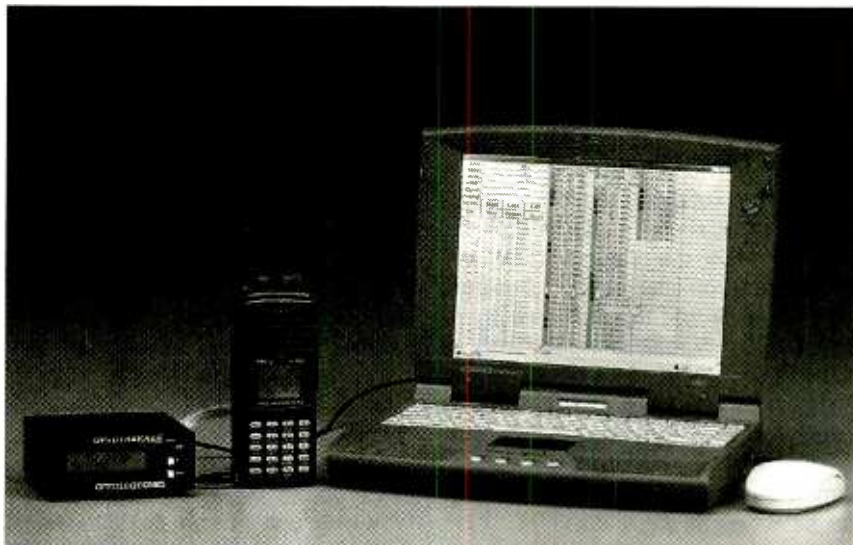

The OptoTrakker from Optoelectronics is a hot device that interfaces your existing scanner with your computer, enabling them to decode trunked communications systems.

control set at maximum. This serves no purpose beyond causing front-end overload from strong signals. It leads to interference, and it could damage delicate circuits within the scanner. Turn it down!

THIS 'N THAT

Last month we mentioned scanner-related subscription lists that you can join via computer. Once you've joined, you receive free daily e-mail postings from others who share your same specialty monitoring interests. You are also invited to contribute postings. A hefty number of inquiries came in from scanner fans wondering if and how it might be possible for them to start and host their own scanner-related specialty e-mail lists.

I can't provide details of the nitty-gritty about exact procedures, responsibilities, and what's involved. I do know there are services that permit the free use of their facilities for this purpose. For information about one such service, check the Web at: www.makelist.com.

Good monitoring when it comes to the *U.S. Navy's Blue Angels* and *U.S. Air Force's Thunderbirds*. In case you weren't aware, these are precision fly-

ing teams who provide amazing demonstrations at air shows around the nation. Frequencies reported have included air/ground, air/air, as well as those used by ground crews. Although it seems an enormous number of different channels have been reported in use during recent years, here are a selection of those commonly reported lately.

U.S. Navy Blue Angels: Air/air—307.7, 318.9, 319.8, 345.9, 360.4, 382.5, 384.4, 391.1, 391.9, 395.5, 395.9 MHz. Air/ground—369.9, 383.4 MHz. Ground services—141.46, 142.625, 143.60 MHz.

U.S. Air Force Thunderbirds: Air/air—140.40, 235.5, 238.15, 241.4, 245.9, 246.4, 250.8, 263.45, 263.5, 263.65, 264.55 MHz. Solos—251.6, 251.8, 254.55, 275.35, 322.95 MHz. Ground services—413.10 MHz. Miscellaneous—138.875, 141.85, 143.85, 236.6, 241.6, 250.4, 250.5, 250.85, 251.4, 273.5, 294.7, 295.7, 302.1, 322.3, 322.6, 382.9, 394.0 MHz.

Keep in mind that frequencies shown below 143 MHz could be either AM or FM, but are most likely AM. Frequencies from 225–400 MHz are AM, but those above 400 MHz are FM. 63

AN OLD CUSTOM

Charles R. (Cape Cod, MA) asks us for the name of the agency he regularly monitors on 165.2375 and 169.45 MHz. Units have identifications like 1-Alpha-511, 1-India-502, etc. That would be the *U.S. Customs Service*, as these are two of the frequencies used nationally by that agency.

Alpha identifications are used by Customs agents, while India identifications are Customs Service investigators. Other alphabetical designators have also been reported, including Mike and Papa for patrol vessels, and Tango for Customs Service Enforcement Support Team. The first digit probably refers to the particular sector (Customs Service region), while the three-digit number designates both the specific Customs Service office and the individual agent or unit. So 1-Alpha-511 would be Customs Agent 511 from the Boston office. Similarly, I-India-305 would be Customs Inspector 305 from the Buffalo, NY office. Customs aircraft usually identify simply as Omaha, followed by two digits, as in Omaha 32.

SPACED-OUT FREQUENCIES

Here's an interesting and frequently-asked question—this time from Joe Youngerrman, Las Vegas, NV. Joe notes that in the 225–400-MHz UHF military aeronautical band, frequencies are nearly always spaced at 100-kHz intervals (such as 323.7, 323.8, 323.9 MHz, etc.), and only rarely does one encounter assignments on 50-kHz splits, such as 323.75 MHz. Joe wonders what that's all about.

At one time, it was true that every 225–400-MHz band assignment was spaced at 100-kHz intervals. Then, a few years ago, assignments began to be given out on 50-kHz splits. But today, there's actually activity on 25-kHz splits. For instance, 252.525 MHz has become a popular informal air-to-air channel for military pilots. Its nickname is Three Quarters (25-25-25). In my area, 300.175 MHz is often monitored in use by *Air National Guard* and *USAF* during fighter-training exercises.

Let's hear from you with frequencies, questions, and suggestions. On the Net, e-mail us at: Sigint@aol.com, or write to *Scanner Scene*, **Popular Electronics**, 500 Bi-County Blvd, Farmingdale, NY 11735. ■

NET WATCH

(continued from page 60)

NAME A LETTER

The last technology we'll discuss does exist, but hasn't rolled out in anything but test areas yet. While the final versions will go by a number of different names, the core system is called xDSL, which essentially stands for one of several types of digital subscriber lines.

Like ISDN, which we won't ever address as a viable home Internet solution because of its high cost (and relatively slow maximum speed, when compared to the newer options—ISDN can hit 128 kbps), xDSL is a system that requires an area to be equipped with special digital lines. Also like ISDN, you can use the lines to also have standard telephone equipment.

Both asynchronous and synchronous forms of xDSL, or ADSL and SDSL, respectively, can work with your standard phone lines. Once an area's wired for one of these xDSL-service types, you'll be able to connect with an appropriate modem. The difference between the two is that ADSL is designed to have more bandwidth for downloads, making it perfect for Web use, while SDSL has synchronized speeds in both directions, making it a great solution for video conferencing and file uploads. Maximum speeds for xDSL are expected to be about two megabits per second, which is nice considering that you'll get this speed on a regular basis (it's not shared in the way cable is).

The pricing plans for xDSL are not in place yet (and neither is the service, for the most part), but expect it to cost a bit more than cable. On the bright side, you might be able to be on the Net and the phone at the same time with one line (one bill), without too much degradation in your line speed. Watch for xDSL announcements in your area in the coming months. Computer vendors like *Compaq* are already planning on shipping machines with modems that can handle both xDSL and standard analog lines, and companies like *DSL Communications* are already shipping products for use with any computer.

Comments? E-mail at netwatch@comports.com, or snail-mail to *Net Watch*, **Popular Electronics**, 500 Bi-County Blvd., Farmingdale, NY 11735. ■

DX LISTENING

(continued from page 62)

ABBREVIATIONS

ID = Station identification.
kHz = kiloHertz, unit of frequency; equals 1000 cycles per second.
kW = kilowatt, unit of transmitting power; equals 1000 watts.
SW, SWL, SWling = Shortwave, shortwave listener, the hobby of shortwave listening.
UTC = Universal Coordinated Time, used by most major SW stations; equal to the military's Zulu or Z-Time; equivalent to Eastern Standard Time plus 5 hours; CST+6; MST+7, and PST+8 hours.

HUNGARY—9580 kHz, *Radio Budapest* has English at 0115 UTC. It has been logged at that time with economic news and feature programming.

ITALY—9675 kHz, *Radio Roma-RAI* broadcasts in English from 0050 UTC to 0110 UTC. It is reported here with Italian popular songs, and transmitting in parallel on 6010 and 11800 kHz.

JAPAN—21610 kHz, *Radio Japan* is heard on this frequency after 0115 UTC, in English with a news review of events as originally aired by various other Asian stations.

NORWAY—15640 kHz, *Radio Norway International* is probably the station heard on a Sunday at 1323 UTC with English programming and a show called "Listener's Corner."

THAILAND—17790 kHz, the *British Broadcasting Service's* Asian relay from Thailand is noted in English after 2300 UTC with ID and "East Asia Today" program.

TUNISIA—7475 kHz, *Radiodifusion TV Tunisienne* is not the most commonly heard of the North African countries on shortwave, mostly because its programming is in Arabic, not English. Still, you may find this one with popular Arabic music and talks at around 0415 UTC.

TURKEY—7190 kHz, *Voice of Turkey's* English transmission was heard on this frequency from around 2205 UTC, with international news and commentary and station identification.

VENEZUELA—9540 kHz, *Radio Nacional* in Caracas is heard with all Spanish-language programming around 1100 UTC. Modulation levels reportedly are weak. ■

BUILD THE SENTINEL

(continued from page 48)

measure the resistance between the positive and negative sides of the battery connector to be sure there is no short-circuiting in the wiring. You should get a reading of 20k or more. If you get a reading of zero or some low resistance, troubleshoot the circuit and correct the fault before proceeding. Pay particular attention to C1 and all other polarized components, and check the circuit board for any possible solder bridging.

If all seems OK, proceed to the next phase of the test. Snap a fresh 9-volt battery into the battery clip. The piezo buzzer should immediately emit a series of 1/2-second tone bursts. If the buzzer remains silent, check battery polarity and voltage under load to be sure it is at least 8 1/2 volts. Then check the wiring to the piezo buzzer to be sure its polarity is correct. Also check D2 and D3. If everything looks normal, check all components associated with IC1. Measure the voltage from pin 4 or pin 8 to ground to be sure the chip is receiving at least 8 1/2 volts. If so, try a new chip.

If IC1 is not receiving battery voltage at pins 4 and 8, check Q1, Q2, and all associated components. Check the part numbers for the transistors to be sure the parts are properly wired into the circuit. Measure the voltage across R3 to be sure that Q1 is conducting current. You should read about 8 volts. If not, replace Q1. If Q1 is conducting and Q2 is not, replace Q2. With the fault corrected and tones emanating from the piezo buzzer, continue with the test.

Connect the DC power supply, set to 20 volts or more, to the telephone input terminals, "+" and "-", as shown in Fig. 4. The piezo buzzer should become silent. If the 20-volt DC potential does not silence the buzzer, find out if it's properly polarized. Troubleshoot the circuit by verifying that the gate-to-source voltage of Q1 is at least -4 volts, with the gate negative with respect to the source. Check R1, R2, D1, Q1, and Q2. Try new transistors. When the 20-volt DC potential is present, the voltage at pins 4 and 8 of IC1 must fall to zero, silencing the buzzer.

The battery-monitor circuit can be checked by using a variable DC power supply in place of the battery or by inserting a worn but not exhausted battery (about 7.7 volts or less terminal voltage) onto the clip. With the battery source voltage at 7.7 volts or less and the 20-volt DC power supply connected to the telephone line terminals, the piezo buzzer should emit a short tone every 15 or 20 seconds. If not, troubleshoot the circuit composed of IC2, IC3, and Q3.

Verify that the gate voltage of Q3 is zero with respect to circuit common. If not, check IC3 and D5. Then check IC2 pins 4 and 8 to be sure there is about 4 or 5 volts DC potential there. If not, check Q3 and, if necessary, try a new transistor. With DC power present at pins 4 and 8, IC2 should oscillate at a repetition rate of about 1 pulse every 15 or 20 seconds as indicated by a short positive pulse appearing at pin 3. Check D3, D4, and all components associated with IC2. Try a new chip.

Once the fault has been corrected and the circuit detects a low-battery condition, the checkout procedure has been completed. Remove the exhausted battery and disconnect the DC power supply.

Optional Relay Circuit. Provision has been made on the Sentinel's printed-circuit board for a single-pole, single-throw miniature relay with normally-open (form A) contacts. The relay contacts can be used to activate any other alarm system, such as a wailing siren, should the phone line be cut. The relay's contact rating is 1/2 amp, which should be sufficient to activate most commercial alarm systems. If a higher current is necessary, use the contacts of RY1 to drive the coil of a high-power relay, which would then carry load current. If the optional relay is not required, simply omit RY1 from the board.

Installation. If the unit is not going to be installed immediately, remove the 9-volt battery. Otherwise, install a new battery and plug the Sentinel into an appropriate telephone jack to monitor the status of the line. Your bedroom is a good choice. Once the telephone's line cord is connected to the jack, the piezo buzzer

should be silent. If not, check telephone-line polarity.

Simulate a telephone-line failure by disconnecting the modular plug from its receptacle. The piezo buzzer should respond with a series of tones. Reconnect the modular plug to silence the buzzer. The Sentinel requires no attention as long as it is connected to a working telephone receptacle. ■

CIRCADIAN RHYTHMS

(continued from page 44)

oilet radiation, **do not** look directly at the lamp! The radiation can seriously damage your vision. Ultraviolet experiments should be performed with the lamp enclosed in a cardboard box, as illustrated in Fig. 8.

Caution: The high voltage produced by the transformer can cause severe shock. Make sure that the transformer is isolated from all conductive surfaces when mounted into its enclosure.

Power Supply. All the circuits, intended for long operation periods, should be powered from power supplies and not batteries that can be drained in a short time. Figure 9 shows a power supply that can be used to power 6- or 12-volt projects that need currents up to 1 amp.

The IC should be mounted on a heatsink. The transformer should have a secondary winding rated at 1 amp. The reader should take care when mounting the transformer, as its primary winding is connected directly to the AC power line. An accidental touch when in operation can cause severe shocks. ■



"Of course I know what I'm making, or I will when it's finished."

NEW PRODUCTS

(continued from page 30)

UNDERCOVER PEN

Perfect for law-enforcement operations, private investigators, and undercover news reporters, the *VP-300 Color Video Pen Camera* conceals a micro-miniature color CCD camera inside. While it looks like an ordinary pocket pen, the small unit delivers excellent picture quality. It records images by either using a standard portable video recorder or by feeding the video to a transmitter for remote time recording and/or observation.

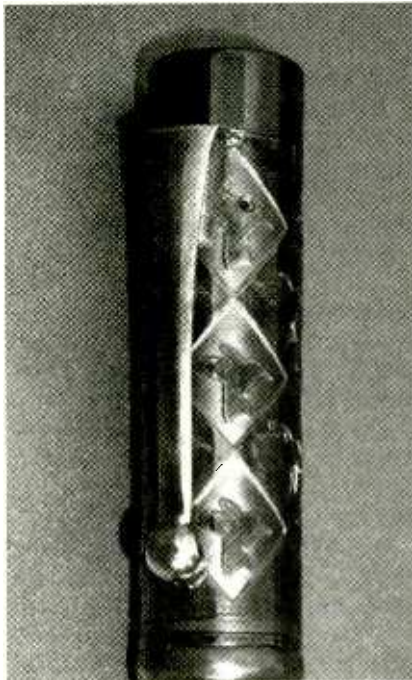

The VP-300 Pen boasts a TV resolution of over 330 horizontal lines, a low 2-lux sensitivity, and the ability to capture video in low-light settings. Its 3.6mm-pinhole lens delivers a field of vision of 92 degrees. This unit is a revolutionary way to record live events that require the utmost discretion. It will protect your next undercover assignment by making sure that everything is caught on tape.

The *VP-300 Color Video Pen Camera* fits neatly into a pack and sells for \$2400. For more information, contact *American Innovations, Inc.*, 119 Rockland Center, Suite 315, Nanuet, NY 10954; Tel. 914-735-6127; Fax: 914-735-3560; Web: www.spysite.com.

CIRCLE 83 ON FREE INFORMATION CARD

HOME-THEATER RECEIVER

A mid-line home-theater receiver from *Yamaha Electronics Corporation*, the *Model RX-V793* combines power and true Dolby Digital experience. It delivers 80 watts per channel to all five channels. The receiver uses Yamaha's exclusive Tri-Field Cinema DSP Processing. The *RX-V793* also incorporates Dolby Surround Pro Logic, as well as Cinema DSP, and Digital Sound Field Processing. The combination of Cinema DSP and Digital Sound Field Processing technology creates a true movie-theater experience in the home by developing independent enhanced sound fields for the front signals as well as for the left-surround and right-surround speakers.



A total of 13 different music and movie theater modes are offered on the receiver. The amplifier section provides pre-outs for all channels. Other features include dual center-channel outputs and an independent subwoofer output. The *RX-V793* also incorporates a high quality AM/FM stereo tuner with presets, which will automatically select the 40 strongest signals in the user's area. In addition, those presets can be user modified.

Its newly designed remote control provides up to 13 macro-command functions, learning capability, and luminous controls for easier home-theater operation. The remote keypad has a level control for the subwoofer output, and it is also allows A/B speaker switching.

Designed for the enthusiast, the *RX-V793* has four audio inputs and four A/V inputs, including a pair on the front panel. Two of the video inputs, VCR-1 and the front-panel AUX input, have S-Video terminals in addition to RCA jacks. Two inputs—DVD/LD and TV/DBS—have coaxial inputs and the DVD/LD has an optical input, as well. On-screen display makes it easy to monitor the receiver's status.

The *RX-V793* features a new V-notched contoured front panel and an LED display. It measures 17 $\frac{1}{8}$ " \times 6 $\frac{3}{4}$ "

\times 18 $\frac{1}{8}$ -inches and has a suggested retail price of \$799. For more information, contact *Yamaha Electronics Corporation, USA*, 6660 Orangethorpe Avenue, Buena Park, CA 90620; Tel. 800-4-YAMAHA or 714-522-9105; Web: www.yamaha.com.

CIRCLE 84 ON FREE INFORMATION CARD

ELECTRONICS LIBRARY

(continued from page 14)

GUIDE TO EMERGENCY SURVIVAL COMMUNICATIONS: HOW TO BUILD AND POWER YOUR SYSTEM

by Dave Ingram

Covering the subject in depth, this is a complete up-to-date book dealing with survival communications: How to receive accurate and timely information in a crisis. This guide discusses what types of communication system are available and where they can be found. Included in the discussion are short-wave, amateur radio, citizen's band, federal services, overseas services, and many other important sources of emergency information and programming.

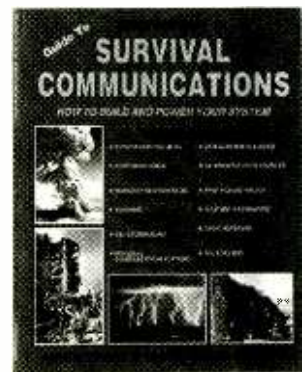

This 182-page guide provides information on building and setting up systems that use various types of emergency power sources, including solar power, small generators, and backup emergency battery systems that start working when a power grid goes down.

Guide to Emergency Survival Communications: How to Build and Power Your System costs \$20 and is published by *Universal Electronics, Inc.*, 4555 Groves Road, Suite 12, Columbus, OH 43232-4135; Tel. 800-241-8171.

CIRCLE 92 ON FREE INFORMATION CARD

Market Center™

Paperback Books

GREAT BOOKS AT BUDGET PRICES

100 RADIO HOOKUPS
—#7—\$3.00

First published in May, 1923 this popular booklet went into reprint editions nine times. It is packed with circuits, theory, antenna installation and tips on consumer radio receivers that were popular in the early 1920's. Antique radio buffs and those inquisitive about the early days of radio will find this booklet an exciting, invaluable and excellent reference into the minds of early-day radio listeners. Sorry, we cannot honor the original 25-cent cover price.

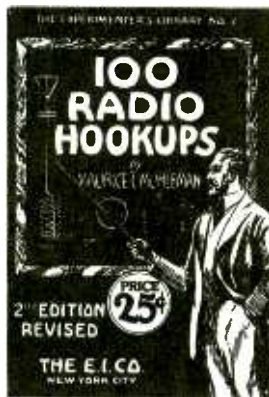

GUIDE TO THE WORLD'S RADIO STATIONS
—BP355—\$10.99

An easy-to-read guide for the casual listener and top notch QSL getter! The Guide is an essential reference work designed to steer the listener around the ever more complex radio bands. Listings cover world-wide shortwave stations with a special emphasis on international broadcasts in English. Medium and long-wave listings are also included for the US, Canada, European, Middle and Near East, and North Africa regions

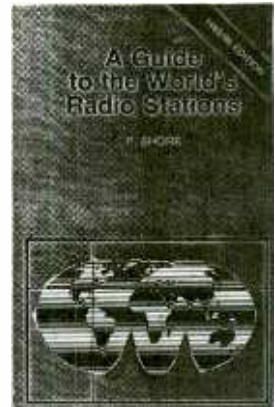

THE INTERNET AND WORLD WIDE WEB EXPLAINED —BP403—
\$10.99

Strip away the hype and mystery of the WWW and you'll be cruising on the information Superhighway! Understand the jargon used: ftp, protocols, TCP, hypertext, http, URL, home pages, threads, HTML, domains, FAQs, etc. Discover that e-mail is easy, fast and free! Learn how to guard against hackers and viruses. Develop friendships and "buddies" in Singapore, India, Cape Town, Peru—just about anywhere!

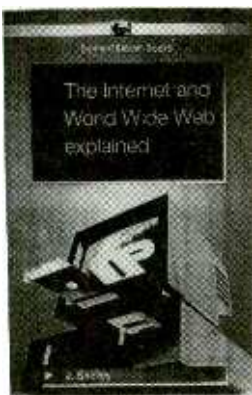

WIRELESS & ELECTRICAL CYCLOPEDIA
—ETT1—\$5.75

A slice of history. This early electronics catalog was issued in 1918. It consists of 176 pages that document the early history of electricity, radio and electronics. It was the "bible" of the electrical experimenter of the period. Take a look at history and see how far we have come. And by the way, don't try to order any of the radio parts and receivers shown, it's very unlikely that it will be available.



ELECTRONIC TECHNOLOGY TODAY INC.
P.O. BOX 240, Massapequa, NY 11762-0240

Name _____
Address _____
City _____ State _____ Zip _____

SHIPPING CHARGES IN USA AND CANADA

\$0.01 to \$5.00	\$2.00
\$5.01 to \$10.00	\$3.00
\$10.01 to 20.00	\$4.00
\$20.01 to 30.00	\$5.00
\$30.01 to 40.00	\$6.00
\$40.01 to 50.00	\$7.00
\$50.01 and above	\$8.50

SORRY No orders accepted outside of USA & Canada

Total price of merchandise	\$ _____
Shipping (see chart)	\$ _____
Subtotal	\$ _____
Sales Tax (NYS only)	\$ _____
Total Enclosed	\$ _____

Number of books ordered

All payments must be in U.S. funds!

ET01

LEADER

For Professionals Who
Know The Difference

- Oscilloscopes
- Video Sync/Test Generators
- Waveform Monitors/Vectorscopes
- EFP/ENG Instruments
- RF Signal Level Meters
- Audio Generators & Meters
- Frequency Counters
- Meters & Bridges
- Power Supplies
- Function Generators
- RF Generators

PRINT™ 
Products International

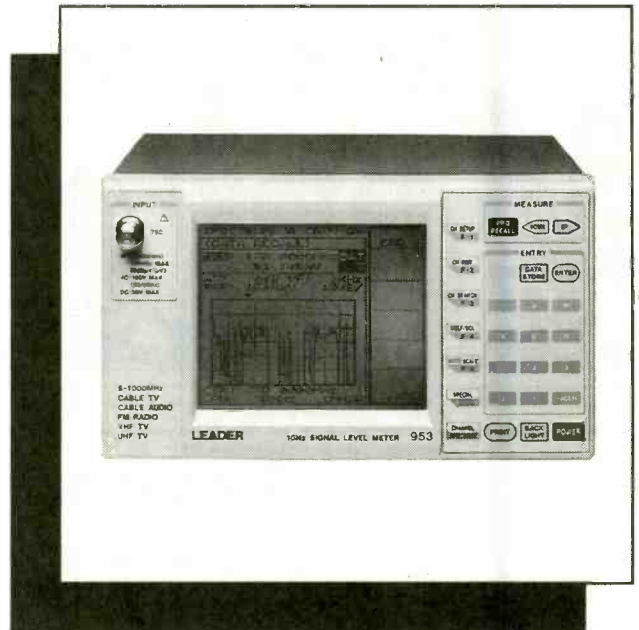

Call, fax or email for your free test and
measurement instrument catalog today!
800-638-2020 * Fax 800-545-0058
www.prodintl.com

Test Instruments, Equipment, Tools & Supplies For Electronic Production, Maintenance & Service
8931 Brookville Road, Silver Spring, MD, 20910 * 800-638-2020 * Fax 800-545-0058

CIRCLE 143 ON FREE INFORMATION CARD

❖ ATTENTION CABLE VIEWERS ❖

CABLE VIEWERS...get back to your **BASIC** Cable Needs

Call 800-577-8775

For information regarding all of your **BASIC** cable needs.



5 GOOD REASONS TO BUY OUR FAR SUPERIOR PRODUCT

- ❖ PRICE
- ❖ EFFICIENT SALES AND SERVICE
- ❖ WE SPECIALIZE IN 5, 10 LOT PRICING
- ❖ ALL FUNCTIONS (COMPATIBLE WITH ALL MAJOR BRANDS)
- ❖ **ANY SIZE** ORDER FILLED WITH SAME DAY SHIPPING

We handle **NEW** equipment **ONLY** - Don't trust last year's **OBSOLETE** and **UNSOLD** stock!
COMPETITIVE PRICING—DEALERS WELCOME

HOURS: Monday-Saturday 9-5 C.S.T.

It is not the intent of B.E.S.W. to defraud any pay television operator and we will not assist any company or individual in doing the same.
*Refer to sales personnel for specifications.

BASIC
ELECTRICAL
SUPPLY &
WAREHOUSING
CORPORATION

P.O. Box 8180 ■ Bartlett, IL 60103 ■ 800-577-8775

ALL ELECTRONICS

C O R P O R A T I O N

QUALITY PARTS

FAST SHIPPING

DISCOUNT PRICING

CALL, WRITE, FAX
or E-MAIL For A
Free 96 Page
CATALOG.
Outside the U.S.A.
send \$3.00 postage.

9 Volt Style Nickel-Cadmium Rechargeable Battery

Sanyo "Rechargacell"™ # N-6PT
7.2 v 120 mA/HR battery
for 9 Volt applications.

\$2.00 each
CAT # NCB-91
10 for \$30.00



"Hi-8" Video Cassette

SONY Hi-8 Top quality, metal particle 120 minute video cassettes. Used for a short time, then bulk-erased. Each cassette has its own plastic storage box.

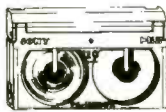

CAT # VCU-8 **\$3.00** each

10 for \$28.00 • 100 for \$250.00

3 Volt 35 mA/h Lithium Coin Cell

Sony CR1220
3 Volt, 35 mA/h. 0.48" (12 mm) diameter x 0.08" (2 mm) thick. Fresh, 1997 date code. Large quantity available.

CAT # LBAT-19 **2 for \$1.00**

100 for \$35.00 • 1000 for \$200.00

Surface mount holders available for coin cells.

Resettable Circuit Protector 0.65 - 1.3 Amp

Raychem "Polyswitch" # RXE-065S-1
General purpose circuit protectors for power supplies, alarm systems, speakers, motors etc. Unlike traditional fuses, they automatically reset when fault condition is cleared. Can be paralleled for higher ratings. Current: 0.65 Amps. Trip Current: 1.3 Amps. Max Voltage: 60 Volts. 0.33" diameter. UL, CSA listed.

CAT # RXE-065 **3 for \$1.00**

100 for \$20.00 • 500 for \$85.00
1000 for \$150.00

Mini-Right Angle Gearhead Motor with Control Circuit

Omron # R2DG-41
These unusual little motors have built-in control circuits that allow them to be used in a continuous or a pulsed mode. In continuous mode the final drive gear turns at 22-45 RPM (3-6 Vdc). In the pulsed mode the final drive gear turns one revolution each time the controller is momentarily pulsed. The motor assembly is 1.75" x 1.25" x 0.5" overall. The nylon final gear is 0.62 diameter and has a little nipple slightly off-center to which a small push-rod could be attached. Motors are in good condition, removed from equipment. Hook-up instructions included.

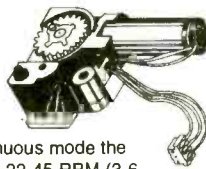

CAT # DCM-110 **\$7.50** each

7' Modular Phone Cord With Ferrite Bead



Standard RJ-11(4 pin) telephone cord with ferrite bead to reduce RFI interference. Bead is detachable if you want to use it in another application.

\$1.25 each

CAT # MT-260FB

10 for \$10.00
100 for \$85.00

Piezoelectric Element

1.32 DIAMETER X 0.16"

AVX/Kyocera # KBT-33RB-2CN

Metal encased piezoelectric acoustic generator. High durability. Small, thin shape. Designed for telephone use. Inside the metal case is a 1.28" diameter piezo element with 5.5" leads attached. If you're looking for a plain element with leads, the case can be pried apart fairly easily. CAT# PE-39

2 for \$1.00

100 for \$40.00
1000 for \$250.00
(25¢ each)

Projection TV Lens

Mitsubishi # 490P15706

Originally for use in a three-gun TV projection system. High-impact plastic lens housing and support bracket.

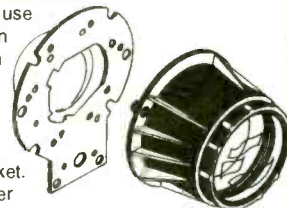

5.35" diameter x 2.92" long at maximum focal length. Lens can be disassembled to yield five elements including a 3.1" dia. glass concave / convex lens, a 2.93" diameter glass convex-convex lens and three plastic correction elements.

\$7.50 each

CAT # LNS-10

12 for \$72.00

S-VHS Tape (Used)



Super VHS tape users! Save a bundle on name-brand S-VHS, T-120 tapes. These tapes were used for a brief period, then bulk erased.

The record-protect tabs have been broken out, so you will have to cover the notch with a piece of tape, but they work great and cost a fraction of the "new" price. Try some, you'll be back for more.

CAT #S-VHS

\$3.00 each

10 for \$28.00 • 100 for \$250.00

Great Price! "EAR BUD" STEREO EARPHONES

Miniature "in-ear" ear-phones for use with most portable CD, radio and tape players. Gold-plated 3.5 mm stereo phone plug. 32 ohm impedance.

Large Quantity Available

CAT #HP-6

85¢ each

10 for \$7.50
100 for \$50.00



ORDER TOLL FREE

1-800-826-5432

MAIL ORDERS TO:
ALL ELECTRONICS CORP.
P.O. BOX 567
VAN NUYS, CA 91408-0567

FAX (818) 781-2653 • INFO (818) 904-0524
INTERNET <http://www.allcorp.com/>
E-MAIL allcorp@allcorp.com

NO MINIMUM ORDER • All Orders Can Be Charged to Visa, Mastercard, American Express or Discover • Checks and Money Orders Accepted by Mail • Orders Delivered in the State of California must include California State Sales Tax • NO C.O.D. • Shipping and Handling \$5.00 for the 48 Continental United States - ALL OTHERS including Alaska, Hawaii, P.R. and Canada Must Pay Full Shipping • Quantities Limited • Prices Subject to change without notice.

MANUFACTURERS - We Purchase EXCESS INVENTORIES... Call, Write, E-MAIL or Fax YOUR LIST.



Interactive catalog: www.tekview.com

TV cable
CONVERTERS & EQUIPMENT

Clearview Group



* 30 days money back guarantee
 * 1 yr warranty
 * Quantity Discounts
 * Dealers Welcome!

VISA MC AMEX C.O.D.

(800)739-2253

COPY RENTAL TAPES
 WITH OUR VIDEO STABILIZERS

BEFORE AFTER

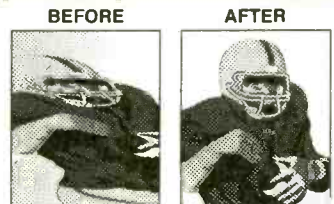

The clearest picture possible playing back movies. **GUARANTEED** to eliminate copy protection.

FREE CABLE TV CATALOG!

- No Rolls/Jitters/Flickers/Fading
- Works on all TV's, VCR's Beta & Cable
- Gold Video Connectors & Cables Included
- 1 Year Warranty
- Money Back Guarantee

VISA MasterCard Discover

VISION ELECTRONICS
1-800-562-2252
 2609 S. 156TH CIRCLE • OMAHA, NE 68130
<http://www.modernelectronics.com>

PicC C Compiler \$59
 for Microchip's PIC microcontrollers
 Supports PIC16C55x, 16C6x, 16C62x, 16C8x, 16C92x PIC families

SnXC C Compiler \$59
 Supports SconIX ex18ac and ex28ac microcontrollers

Both compilers based on ANSI C standard. Arrays, unions, structures, pointers, strings, function calls, if, for, switch, while, interrupt vectors, in-line assembler code, 8 & 16 bit variables, etc. Outputs Intel Hex format and assembly code. Code optimizer included. Excellent development tool!

DebugIDE Debugger \$79
 C source level debugger for PicC and SnXC compilers. Integrated Development Environment. Step, Run, Stop, Reset. Variable monitoring and modification. Oscillator/cable kit (\$39)

732-873-1519 fax: 732-873-1582 e: grichrc@aol.com
 Grich RC Inc. 120 Cedar Grove Ln, Ste 340, Somerset NJ USA 08873
 URL: <http://members.aol.com/piccompile>

ELECTRONIC COMPONENTS



Visit our web site!
www.mouser.com

Subscribe, download, or view catalog online!

- Over 78,000 Products
- More than 145 Suppliers
- Same Day Shipping
- No Minimum Order

800-992-9943
 817-483-6828 Fax: 817-483-6899
catalog@mouser.com

958 North Main St., Mansfield, TX 76063

CIRCLE 160 ON FREE INFORMATION CARD

Turn Your Multimedia PC into a Powerful Real-Time Audio Spectrum Analyzer

Features

- 20 kHz real-time bandwidth
- Fast 32 bit executable
- Dual channel analysis
- High Resolution FFT
- Octave Analysis
- THD, THD+N, SNR measurements
- Signal Generation
- Triggering, Decimation
- Transfer Functions, Coherence
- Time Series, Spectrum Phase, and 3-D Surface plots
- Real-Time Recording and Post-Processing modes

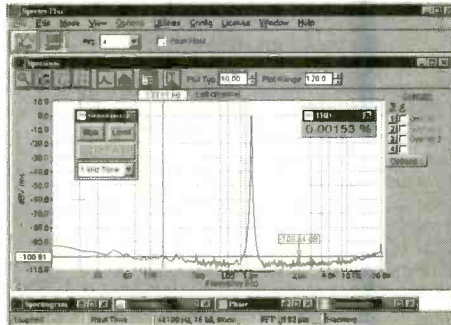

Applications

- Distortion Analysis
- Frequency Response Testing
- Vibration Measurements
- Acoustic Research

System Requirements

- 486 CPU or greater
- 8 MB RAM minimum
- Win. 95, NT, or Win. 3.1 + Win.32s
- Mouse and Math coprocessor
- 16 bit sound card

Priced from \$299
 (U.S. sales only – not for export/resale)

DOWNLOAD FREE 30 DAY TRIAL!
www.spectraplus.com

PHS Pioneer Hill Software
 24460 Mason Rd.
 Poughbo, WA 98370
 a subsidiary of Sound Technology, Inc.

Spectra Plus
 FFT Spectral Analysis System

Sales: (360) 697-3472 Fax: (360) 697-7717 e-mail: pioneer@telebyte.com

EARN \$85/hr!
APPLIANCE REPAIR

In almost no time at all you can learn to repair Washers, Dryers, Refrigerators, Dishwashers, and Ranges!

HUGE DEMAND!
FREE INFO: 1-888-329-0880

Name _____
 Address _____
 City/State _____ Zip _____

Appliance Repair Schools Corp.
 31855 Date Palm Dr. Suite 3-456
 Cathedral City, CA 92234 Dept. PE

Popular Electronics, February 1999
 70

MCM ELECTRONICS

The Source For All Of Your Electronics Needs

When ordering, please provide this code: SOURCE CODE: POP61

Prices Effective Dec. 17, 1998
Through Feb. 26, 1999

For over 20 years, MCM has been the leading supplier to the electronics service industry. Huge inventory, rapid delivery and competitive prices have made MCM the choice for:

- Hobbyists
- Educators
- Service Technicians
- Installers

Discover the MCM difference, call today for your free catalog.



Order #82-3015

ONLY \$149

DEFENDER SECURITY

Color PC Board Camera

Ideal for any observation, multimedia or security application. Provides NTSC composite video output. Features automatic white balance, 330 lines of horizontal resolution and AGC. Requires 12VDC, 240mA. **Regular price \$199.00.**



ONLY \$29.95

Order #72-4025

TENMA

DMM W/Logic Function

3 1/2 digit DMM measures AC/DC voltage from 200mV-600V, resistance to 2000Mohm, capacitance to 20µF, transistor hFE gain and audible continuity test. Requires 9V battery (#290-080) not included. Dimensions: 2 1/2" (W) x 5 3/4" (H) x 1 1/2" (D). **Regular price \$65.95.**



Order #82-2990

ONLY \$49.00

DEFENDER SECURITY

Micro PC Board Camera

B/W CCD camera measures only 1 1/4" x 1 1/4" x 1". Provides NTSC composite video output. Built-in 3.6mm lens provides viewing angle of 92°. Requires 12VDC, 300mA. (#58-3330 AC adaptor). **Regular price \$64.95**



Order #21-3460

ONLY \$34.95

Heavy Duty Aluminum Tool Case

Includes two tool pallets and adjustable compartments. Measures 19" x 14" x 6", ideal for hand tools and small test equipment. Rugged aluminum case is finished in black. **Regular price \$51.50.**



Order #50-4465

Subwoofer Amplifier Module

110W amp board handles speaker level or RCA inputs and may be installed in existing speaker or subwoofer enclosures. •60-160Hz continuously variable 12dB crossover •110W RMS @ 4ohm •Cut out 10" x 7" •**Regular price \$185.00**

ONLY \$159



ONLY \$12.50

Order #72-340

Solderless Breadboard

Perfect for circuit designing, prototyping and educational purposes. Usable for high frequency, high speed and low noise circuits. 1260 terminal strip tie points, 100 distribution strip tie points, two binding post connections. Dimensions: 4" x 8 1/2" x 3/4". **Regular price \$20.59**

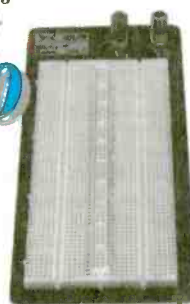

ONLY \$69.00

Order #80-190



50 Watt PA Amplifier

Perfect for auditoriums, churches and office buildings. Inputs include two 1/2" microphone, ceramic phono and aux. Special fader allows phono/aux mixing. Outputs include 4, 8 and 16ohm, plus 70V and 100V line. Requires 117VAC/12VDC. Measures: 13" x 4 1/2" x 10 1/2". **Regular price \$201.00**



your choice ONLY \$14.50

Order #72-7051
or #72-7043

Current Meters

Inexpensive ammeters are ideal for any DC current measuring application including charging systems. Induction type sensing only requires cable to be placed in slot frame on the rear of meter case, no electrical connections or leads to hook up. **Regular price \$19.95.**

Order #	Current range
72-7051	-100-0-100 Amp
72-7043	-30-0-30 Amp



FREE Catalog!

1-800-543-4330

www.mcmelectronics.com

Hours: M-F 7 a.m.-9 p.m., Sat. 9 a.m.-6 p.m., EST.

Same Day Shipping!

In stock orders received by 5:00 p.m. (YOUR TIME), are shipped the same day.



MCM ELECTRONICS

650 CONGRESS PARK DR.
CENTERVILLE, OH 45459
A PREMIER FARNELL Company

SOURCE CODE: POP51

CIRCLE 161 ON FREE INFORMATION CARD

CALL TOLL FREE
(800) 292-7711 orders only
Se Habla Español

C&S SALES
EXCELLENCE IN SERVICE

LOOK FOR OTHER
MONTHLY SPECIALS
ON OUR WEBSITE

XK-700 Digital / Analog Trainer

Elenco's newest advanced designed Digital / Analog Trainer is specially designed for school projects. It is built on a single PC board for maximum reliability. It includes 5 built-in power supplies, a function generator with continuously sine, triangular and square wave-forms and a 1560 tie point breadboard area. Tools and meter shown optional. (Mounted in a professional tool case made of reinforced metal).

XK-700
Assembled and Tested
\$189.95

XK-700 - SEMI KIT
w/ Fully Assembled PC Board
\$174.95

XK-700K - Kit
\$159.95



Made in the USA

Digital Multimeter
Model M-1740

\$39.95
Free Holster

- 11 functions
- Freq to 20MHz
- Cap to 20µF
- AC/DC Voltage
- AC/DC Current
- Beeper
- Diode Test
- Transistor Test
- Meets UL-1244 safety specs



DIGITAL LCR METER
Model LCR-1810

\$99.95

- Capacitance .1pF to 20MF
- Inductance 1µH to 20H
- Resistance .01Ω to 2000MΩ
- Temperature -20°C to 750°C
- DC Volts 0 - 20V
- Frequency up to 15MHz
- Diode/Audible Continuity Test
- Signal Output Function
- 3 1/2 Digit Display



15pc. VCR Service Tool Kit
Model TK-1400

- Inclined Base Screwdriver
- Eccentric Screwdriver
- 2mm & 3mm Fine Adjust Screwdriver
- VHS VCR Head Puller
- Retaining Ring Remover
- 3 Reversible Screwdrivers
- Spring Hook Tool
- Micro Screwdriver
- Hex Wrench Set

Special
\$24.95



Model M-6100

The M-6100 is Elenco's most sophisticated meter with almost every possible feature available. The M-6100 even has a computer interface for viewing and storing data on a personal computer. It comes complete with software, RS-232 cable, test leads and manual.

\$99.95

Model XP-581

4 Fully Regulated DC Power Supplies in One Unit
 4 DC voltages: 3 fixed - +5V @ 3A, +12V @ 1A, -12V @ 1A
 1 Variable - 2.5 - 20V @ 2A

\$89.95



Tektronix DMMs

For high performance digital multimeters that are accurate, reliable, and rugged, the DMM900 series extends the Tektronix line of already affordable DMMs. Twice the accuracy. Up to 10 times the resolution. And a full range of capabilities that span voltage, current, dual numeric display, 3 year warranty, and autoranging capability. All backed by the reliability of the Tektronix brand.



912 \$179
914 \$229
916 \$275

Power Supply Kit
Model XP-720K

3 fully reg. DC supplies
 1.5VDC - 15VDC @ 1A
 -1.5VDC to -15VDC
 5VDC @ 3A

\$54.95

Plus
 6.3VAC @ 1A and
 12.6VAC C.T. @1A



Available assembled Model XP-720 \$84.95

Sweep Function Generator
 with built-in Frequency counter
Model GF-8026

\$225

- Range .02Hz - 2MHz
- Sine, Square, Triangle, Pulse, Ramp
- Ext. counter 1Hz - 10MHz



Kit Corner

over 100 kits available

AK-700

\$15.95

Phone kit with training course
 4 Flashing neon lights
 See thru case



RADIO CONTROL CAR KIT
MODEL AK-870

- 7 functions
- Remote control included

\$24.95

No Soldering Required



Digital Capacitance Meter
Model CM-1555

\$48.95



- Capacitors from .1pF to 20M µF
- 3 1/2 Digit LCD
- Zero adjust
- special insertion jack
- 1/2% basic accuracy
- Tilt stand

Digital Audio Generator
 with built-in Counter
SG-9300

- 10Hz - 1MHz
- Low Distortion
- Sine/Square waves
- Built-in 150MHz Frequency Counter

\$175



SG-9200 Analog/No counter \$119.95

Model AM/FM-108K
Transistor Radio Kit
 with training course

\$29.95



Free Stand

35mm Camera Kit
 Learn all about photography
AK-540

\$14.95



No Soldering Required

SATELLITE FINDER
Model SF-01

- Aligns Satellite Dishes
- Range 950-2050MHz
- Compact Size
- Self Power Check



\$39.95

RF Generator
 with Counter

Model SG-9500 \$225

- 100KHz - 150MHz
- Internal AM Mod of 1KHz
- RF Output 100MV - 35 MHz
- Audio Output 1KHz @ 1V rms



SG-9000 Analog/No counter \$119.95

WE WILL NOT BE UNDERSOLD C&S SALES, INC.

150 W. CARPENTER AVENUE
 WHEELING, IL 60090
 FAX: (847) 541-9904 (847) 541-0710
http://www.elenco.com/cs_sales/



15 DAY MONEY BACK
GUARANTEE
FULL FACTORY WARRANTY

PRICES SUBJECT TO CHANGE WITHOUT NOTICE

UPS SHIPPING: 48 STATES 5%
 OTHERS CALL FOR DETAILS
 IL Residents add 8.25% Sales Tax

Same Day
Shipping

C & S SALES
Your one stop source for
all your electronic needs!

CALL OR WRITE FOR OUR
**NEW FREE 64 PAGE
CATALOG!**
(800) 445-3201

Fluke Scopemeters



- 123 NEW \$1140
- 92B \$1445
- 96B \$1695
- 97 \$1695
- 99B NEW \$2095
- 105B \$2495

**ALL FLUKE
PRODUCTS
ON SALE**

**B & K PRECISION
SCOPES**

20MHz DUAL-TRACE
Model 2120B - 2 Year Warranty
Special \$375

Model 2125A with delayed sweep
\$539.95



- 1mV/division sensitivity
- AUTO-NORM triggered sweep operation
- AC, TVH, TVV and line coupling
- Calibrated 19 step time-base with x10 magnifier
- Compact low-profile design

**Affordable Spectrum
Analyzers by B&K**



- 500MHz Series** BK2615A **\$1250**
- 150KHz to 500MHz BK2620A **\$1675**
- Dynamic Range 80dB(113dB with attenuation)
- +20dB maximum input
- 12.5 and 400KHz resolution bandwidth
- 150KHz/hour stability
- Built-in tracking generator(Model 2620A)
- 1.05GHz Series** BK2625A **\$1925**
- 150KHz to 1050MHz BK2630A **\$2595**
- Dynamic Range 80dB(113dB with attenuation)
- AM & FM demod included
- 20 and 400KHz resolution bandwidth
- 150KHz/hour stability
- Built-in tracking generator(Model 2630A)

PORTABLE SEMICONDUCTOR TESTER



B&K 510
\$199.00

- In or out-of-order circuit tests for transistor, FETs, SCR's and darlington's.

**20MHz Sweep / Function
Generator with Freq Counter**

- B&K 4040**
- 0.2Hz to 20MHz
- AM & FM modulation
- Burst Operation
- External Frequency counter to 30MHz
- Linear and Log sweep



\$399

- 10MHz B&K 4017 **\$309**
- 5MHz B&K 4011 **\$239**

Quality Scopes by Elenco

Lowest Prices of the Year!

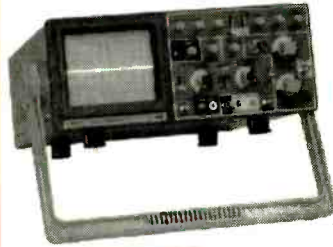

60MHz
DS-603 \$995

- Analog / Digital Storage
- 20MS/s Sampling Rate
- RS232 Output

S-1360 \$749

- Analog with Delayed Sweep
- Component Tester

100MHz

S-1390 \$895

- Analog w/ delayed sweep
- Dual Time Base
- TV Sync

Includes
Free Dust
Cover and
Probes

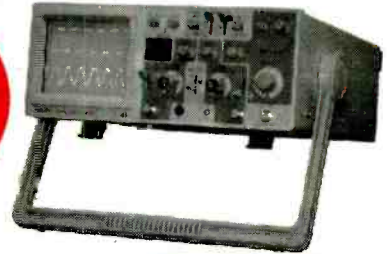

25/30MHz
DS-303 30MHz \$895

- Analog / Digital Storage
- 20MS/s Sampling Rate
- RS232 Output

DS-203 20MHz \$695

- Analog / Digital Storage

S-1330 \$439

- 25MHz Analog
- Delayed Sweep

S-1325 \$325

- 25MHz Analog
- TV Sync
- 1mV Sensitivity

**2 Year
Warranty**

Fluke Multimeter Specials



F-73III
\$119

List \$135



F-75II
\$129

List \$149



F-79II
\$175

List \$199



F-87
\$289

List \$335

B&K Precision Multimeter Specials



- Accurately measures capacitance, resistance and inductance.
- Measures dissipation factor of capacitors and Q of inductors.
- Simultaneously displays measured value and Q or dissipation factor.
- Displays the difference between measures and reference values.

Model 878 \$219.95



- 50,000 count
- ±0.025% DCV
- ±0.07% ohms
- MiniMax/Avg
- True RMS, AC or AC+DC
- 100KHz AC response
- Capacitance to 50,000µF
- Frequency, duty cycle, pulse width
- dB across 1Ω to 10kΩ

Model 5390 \$295.00

- Disturbance indicator
- Autograph, bargraph with zoom
- Sealed case, Splashproof
- IEC 1010, class 2 safety compliance

MX-9300

Four Functions in One Instrument

Features:

- One instrument with four test and measuring systems:
 - 1.3GHz Frequency Counter
 - 2MHz Sweep Function Generator
 - Digital Multimeter
 - Digital Triple Power Supply
- 0-30V @ 3A, 15V @ 1A, 5V @ 2A



\$459.95

GUARANTEED LOWEST PRICES

C&S SALES, INC.

150 W. CARPENTER AVENUE
WHEELING, IL 60090
FAX: (847) 541-9904 (847) 541-0710
http://www.elenco.com/cs_sales/



**15 DAY MONEY BACK
GUARANTEE**

FULL FACTORY WARRANTY

PROBES, PROBES, PROBES, PROBES, PROBES, PROBES
Most Major Credit Cards Accepted

UPS SHIPPING: 48 STATES 5%
OTHERS CALL FOR DETAILS
IL Residents add 8.25% Sales Tax

CIRCLE 32 ON FREE INFORMATION CARD

EARN MORE MONEY!

Be an FCC LICENSED ELECTRONIC TECHNICIAN!



No costly school. No commuting to class. The Original Home-Study course prepares you for the "FCC Commercial Radio-telephone License." This valuable license is your professional "ticket" to thousands of exciting jobs in Communications, Radio-TV, Microwave, Maritime, Radar, Avionics and more...even start your own business! You don't need a college degree to qualify, but you do need an FCC License.

No Need to Quit Your Job or Go To School
This proven course is easy, fast and low cost! **GUARANTEED PASS**—You get your FCC License or money refunded. **Send for FREE facts now. MAIL COUPON TODAY!**

Or, Call 1-800-932-4268 Ext. 240

COMMAND PRODUCTIONS

FCC LICENSE TRAINING, Dept. 240
P.O. Box 2824, San Francisco, CA 94126
Please rush FREE details immediately!

NAME _____
ADDRESS _____
CITY _____ STATE _____ ZIP _____

DATA ACQUISITION & CONTROL

AFFORDABLE PLUG-IN BOARDS FOR PC's ISA BUS

ANA100 Analog I/O \$ 99



- 8 Channel 8-Bit
- 0 to 5 Volt input
- 14 TTL I/O lines
- Analog Output
- 400KHz Sampling

DIG100 Digital I/O \$ 39



- 82C55 PPI
- 24 or 48 TTL I/O Lines option
- Selectable Base Address

ANA150 Analog/Counter... \$ 89



- 8 Channel 8-Bit
- 0 to 5 Volt input
- 3 16-Bit Counters
- 400KHz Sampling

DIG200 Counter I/O \$ 79



- 3 16-Bit Counters
- 8 TTL Input lines
- 8 TTL Output lines
- Selectable Clock Frequency input

ANA200 Analog I/O \$ 79



- 1 Channel 12-Bit
- 0 to 5 Volt input optional bi-polar
- 100KHz / 300KHz Sampling rate
- 24 TTL I/O lines

ANA201 Analog \$ 119

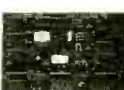

- 8 Channel 12-Bit
- x1, x5, x10, x50 Programmable Channel gain
- 100KHz Sampling rate

On-Line Product Catalog at Our Web Site

<http://www.Bsof.com>

E-Mail: Sales@Bsof.com

BSOFT Software, Inc.

444 COLTON ROAD * COLUMBUS, OH 43207
PHONE 614-491-0832 * FAX 614-497-9971

CONTROL

RELAYS • LIGHTS • MOTORS

MEASURE

TEMPERATURE • PRESSURE • LIGHT LEVELS • HUMIDITY

INPUT

SWITCH POSITIONS • THERMOSTATS • LIQUID LEVELS

MODEL 30 \$79



- PLUGS INTO PC BUS
- 24 LINES DIGITAL I/O
- 8 CHANNEL-8 BIT A/D / D/A
- 12 BIT COUNTER
- UP TO 14K SAMP/SEC

MODEL 45 \$189



- RS-232 INTERFACE
- 8 DIGITAL I/O
- 8 ANALOG INPUTS
- 2 ANALOG OUTPUTS
- 2 COUNTERS-24 BIT

MODEL 100 \$279



- 12 BIT 100 KHZ A/D
- 4 ANALOG OUTPUTS
- 3 TIMER COUNTERS
- 24 DIGITAL I/O

MODEL 150-02 \$179



- RS-232 INTERFACE
- 16A, 20 AMP
- 12 BIT A/D
- OPTO-ISOLATED
- COMPLETE DMM

MODEL 40 \$109



- RS-232 INTERFACE
- 28 LINES DIGITAL I/O
- 8 ANALOG INPUTS
- PWM OUTPUT

MODEL 70 \$239



- RS-232 INTERFACE
- 18 BIT A/D
- 8.5 DIGIT
- UP TO 60 SAMP/SEC

Prairie Digital, Inc.

PHONE 608-643-8599 • FAX 608-643-6754

920 SEVENTEENTH STREET • PRAIRIE DU SAC, WISCONSIN 53578

CIRCLE 150 ON FREE INFORMATION CARD

TOP SERVE !

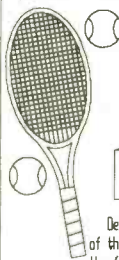

Measure the Speed of Your Tennis Serve with Sound!

129 MPH

Device measures the speed of the serve by listening to the first and second hits of the ball with a special microphone element and electronics. Plans come with the special microphone element, schematic of the electronics, a PC board layout, theory of operation, and all the information needed to build this small portable device.

For the complete package, send \$29.95 US plus \$1.50 S&H check or M.O. made payable to Top Serve, to:

Top Serve
P.O. Box 611335
Port Huron, MI 48061-1335
Manufacturer Inquiries Welcomed!
© 1998 E. J. Ureel

PLEDGING OUR ALLEGIANCE



United States
NAVY

1-800-USA-NAVY
www.navyjobs.com

Source Code: 029PE

Sale Ends: 1/28/99

www.spysite.com

COVERT SURVEILLANCE: Protect Your Assets



MC-985 \$350

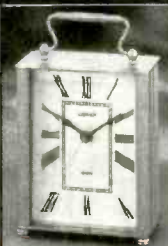

CL-985 \$350



SD-985 \$295



VL-985 \$350

EXIT SIGN
CAMERA
EX-985 \$295

EMERGENCY
LIGHT
CAMERA
EL-985 \$325

All "985" Series Color Cameras Feature:

- Sensor: 1/3" Sharp® Color CCD
- Resolution: Over 380 TV lines
- Sensitivity: Super Low, 2 Lux
- Built-In Backlight Compensation
- Lens: 3.7 mm Pinhole
- Viewing Angle: 92 FOV
- Video Output: Female RCA
- Power: 5V DC (included)

CLOSEOUT

Color Camera Kit:

- 1/2" Sony Color CCD
- 400 TV line Res.
- 2 lux Sensitivity
- Backlight Compensation
- 4 mm Standard Lens
- Wall Mounting Kit
- 5V Power Transformer

SONY-1002 \$175

Counter Surveillance: Protect Your Privacy

Protect Yourself From:

- Telephone Taps
- Room Transmitters
- Body Wires



Built-In White Noise Generator

AI-5500 \$380

Detects Concealed:

- Tape Recorders
- Video Cameras
- Body Transmitters
- Room Transmitters
- LED and Vibration Alert



TRVD-900 \$495

Your Payment Options: Credit Card, Cashier's Check, or Money Order

AMERICAN INNOVATIONS, Inc.

119 ROCKLAND CENTER ~ Suite 315 NANUET, NY 10954
Voice: (1)914-735-6127 Fax: (1)914-735-3560

CIRCLE 162 ON FREE INFORMATION CARD

Plant Trees for America™

SURROUNDDYNAMIX \$ 78.95 U.S.

Add theatre quality surround sound to your existing stereo TV, VCR or audio amplifier with this processor

Compatible with all commercial surround encoded audio signals

Will create 3D phantom hall effect if no surround information is encoded

Works from any stereo signal source

Home or automotive applications

Comes complete with speakers, cables and power supply



3D AUDIOPRODUCTS

PO Box 78035
Port Coquitlam B.C.
V3B 7H1 Canada
ph: (604) 944-7564

5 Axis Robotic Arm \$195.00 Plus S&H



You can build this Robotic Arm

Impressive, fast, accurate, and repeatable motion. Any computer or micro capable of sending 2400 or 9600 baud serial data can control the arm. It can even be controlled from a Basic Stamp. This robot arm makes a great foundation for many AI and motion control experiments. Position the arm in an X, Y, Z, grid with a joystick or keyboard using the new RoboMotion for Windows. The kit includes the hardware, structural components. Hitec servos, pre-assembled SSC servo controller, DOS and Windows software, and an illustrated assembly manual. Camouflage paint not included.

We have many more cool robots, check out our web page or ask for our free catalog!

Lynxmotion, Inc.
104 Partridge Road
Pekin, IL 61554-1403
www.lynxmotion.com



Tel: 309-382-1816
Fax: 309-382-1254
sales@lynxmotion.com
tech@lynxmotion.com

Any waveform you want!



Starting at

\$795

Quantity 1

Money back guarantee

Telulex Inc. model SG-100

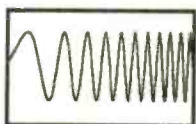

DC to 20 MHz linear and log sweeps



Int/Ext AM, SSB, Dualtone Gen.

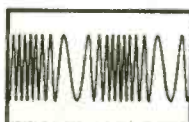

Int/Ext FM, PM, BPSK, Burst



Ramps, Triangles, Exponentials



Pulse Generator

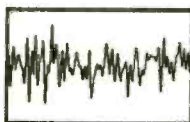

Noise

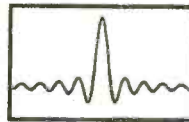

Arbitrary Waveforms

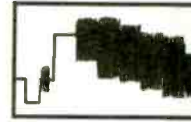

Unlimited Possibilities!

● Synthesized Signal Generator

Clean sinewaves DC-20 MHz with .001% accuracy! .1 Hz steps. DC Offset. RS232 remote control.

● Arbitrary Waveform Generator

40 Megasamples/Second. 32,768 points. 12 bit DAC

● Function Generator

Ramps, Triangles, Exponentials & more to 2 MHz!

● Pulse Generator

Digital waveforms with adjustable duty cycle

Telulex Inc.

2455 Old Middlefield Way S Tel (650) 938-0240 <http://www.Telulex.com>

Mountain View, CA 94043 Fax (650) 938-0241 Email: sales@Telulex.com

CIRCLE 137 ON FREE INFORMATION CARD



The 5360 DMM, one of the world's finest digital multimeters. The best of the ASYC II Series, it has the best accuracy, a built-in counter, and displays AC voltage as resistive power or dB (impedance selectable), saving you the time of making the calculation. A careful examination of the performance features and user-conscious design will tell you that you hold a superior DMM in your hand, designed with the measurement capability needed by users who demand the best. The 5360 DMM. You can depend on it anywhere. Regular \$249.00, On Special at \$195.00!!!

- 50,000 count
- 0.1% DCV
- True RMS, AC or AC + DC
- 0.1% ohms
- 30 kHz AC response
- Autoranging, bargraph
- Capacitance to 50,000 uF
- Frequency, duty cycle
- Sealed case, splashproof
- IEC 1010 class 2 safety compliance
- 3 year warranty

Call, fax or email for your free B&K Precision catalog and a copy of our 84 page test and measurement instrument catalog today!

PRINTTM
Products International

8931 Brookville Rd * Silver Spring, MD, 20910

800-638-2020 * Fx 800-545-0058 * www.prodintl.com * sales@prodintl.com

CIRCLE 153 ON FREE INFORMATION CARD

47pc•kit

\$12.95

**MK101
SWEETHEART**

Give him or her that special heartbeat. 28 leds form 2 blinking hearts. Power supply : 9V battery

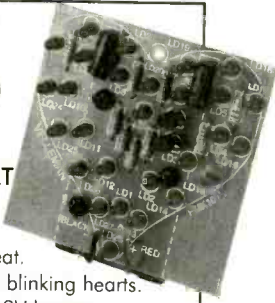

14pc•kit

\$5.95

**MK102
FLASHING LEDS**

For different applications (such as model construction) and educational purposes. Adjustable flashing speed. Power supply : 9V battery

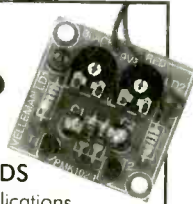

30pc•kit

\$14.95

**MK104
ELECTRONIC CRICKET**

This cricket turns on when it gets dark. Great as practical joke. The tone and repetition between two crickets is adjustable. Power supply : 9V battery

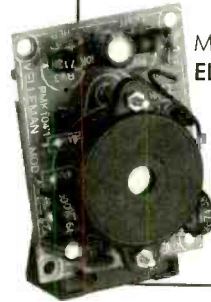

34pc•kit

\$9.95

**MK103
LED SOUND-TO-LIGHT UNIT**

For different funny and practical applications. 4 high-intensity leds light up and react simultaneously on every sound. Power supply : 9V battery



36pc•kit

\$10.95

**MK105
SIGNAL GENERATOR**

Several signal outputs, square wave, triangle, sine and integrator which are selectable with a jumper. The signal frequency is about 1KHz (fixed) Ideal to learn electronics! Power supply : 9V battery

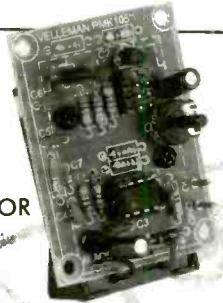

26pc•kit

\$14.95

**MK106
METRONOME**

The beats per minute are given by a built-in speaker and by a led. Adjustable volume, beats/sound. With on/off switch. Power supply : 9V battery

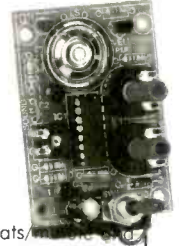

36pc•kit

\$12.95

**MK107
LED RUNNING LIGHT**

8 leds running light. Different running effects are selectable (by prog push button). Adjustable effect speed. Power supply stand-by by push button. Power supply : 9V battery

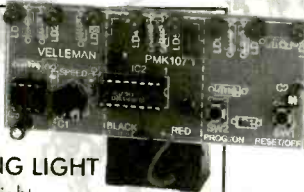

8pc•kit

\$7.95

**MK108
WATER ALARM**

Never let you surprise by flooding! Gives alarm sound when water is detected. Incorporated alarm buzzer. Water sensor can be placed at distance by cutting the board and using wires to connect the sensor. Power supply : 9V battery

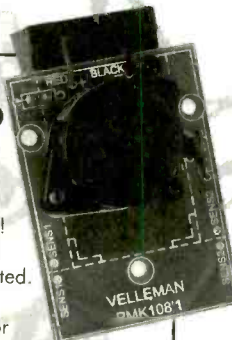

35pc•kit

\$9.95

**MK109
ELECTRONIC DIE**

No more cheating allowed ! The eyes of the die are leds. Rolls out when the push button is released. Power supply : 9V battery

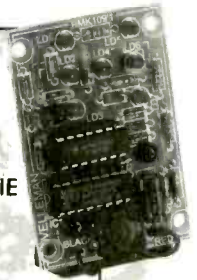

17pc•kit

\$12.95

**MK110
SIMPLE ONE CHANNEL LIGHT ORGAN**

With loudspeaker input. The lamp flashes on the beat of the music. Optical isolated loudspeaker input with adjustable sensitivity : 2W to 60W. Maximum load : 120W at 120Vac.

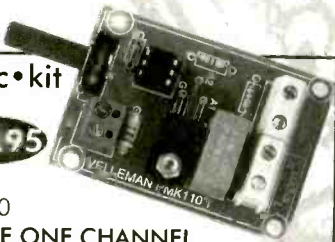

17pc•kit

\$19.95

**K5300
STROBOSCOPE**

Adjustable flash frequency : 5-15Hz. Power supply : 120Vac. Power consumption : 13W max.

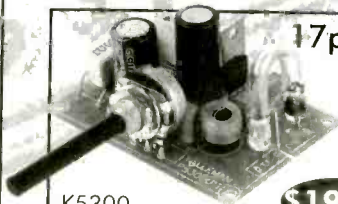

21pc•kit

\$12.49

**K2637
SUPERMINI 2.5W AUDIO POWER AMPLIFIER**

Superb audio amplifier with incredible tiny dimensions. Integrated circuit has a pre- and power amplifier which can be used separately. Max. output power : 2.5W @ 4ohm. Frequency characteristics : 60Hz to 15KHz. Power supply : 4.5V to 15Vdc / 400mA

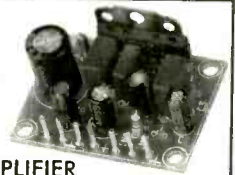

Exists also as module : M2637 **\$17.49**

velleman

7415 Whitehall Street Suite 119
Fort Worth, TX 76118
(817) 284-7785 F : (817) 284-7712
www.velleman.be email : velleman@earthlink.net

February 1999, Popular Electronics

Questions ? Contact us for a list of US distributors or to get your FREE catalogue

CIRCLE 163 ON FREE INFORMATION CARD

Direct from Manufacturer
We will beat any competitor's price

World's Smallest Wireless Video Camera!

- Transmits video up to 1000 ft.
- Runs on 1 qv. battery for 12 hrs.
- Can be built into just about anything (beeper, clock, etc.)

We also carry:

- Color micro video cameras
- B&W micro video cameras
- Hidden cameras
- Custom video systems
- Countersurveillance & More

World's smallest plug & play system about 1" x 1"



Looking for Distributors

Call for a free catalog (305) 667-4545
SECURETEK Fax (305) 667-1744
7175 SW 47 St. #205 • Miami, FL 33155

PIC 16C/F84 Development Programmer

• Software is for the 16C84 & 16F84 • Software can read, verify & load (Win95/3.x/Dos) • EEPROM space, program space & configuration fuses can be treated separately • Separate erase command • Test command to test Programmer & cable • Vpp (programming voltage) is under software control • Attaches to parallel printer port of PC • 9V battery powered • Microchip data sheets on disk • 16F84 programs made by other assemblers can also be used with programmer • All components, PCB and Instructions included • 16F84 4-MHz PIC included.

\$23.95 +S&H \$5*

Running Lights Kit

Ideal for parties, discos, shop windows and X-mas decorations. 8 LEDs switch on and off in 10 push button selectable patterns. 8 different speed levels for a total of 80 combinations! Includes PCB, components & instructions. Uses a £1 microcontroller. Can operate light bulbs by using TRIACS. (8xTRIACs is \$6 extra) *S&H to Canada is \$8

\$14.95 +S&H \$5*

Orders only: 1-888-549-3749 (USA & Canada)
Info: (330) 549-3726 For more information and lots of other products visit us at: www.electronics123.com
Amazon Electronics, Box 21 Columbus OH 44408

ADAPT-11 68HC11 Modules for Solderless Breadboards

- miniature 2.0" by 2.8" module
- plugs vertically into solderless breadboard for easy development
- BOOT/RUN switch for easy programming via PC serial port
- all I/O lines on dual row connector

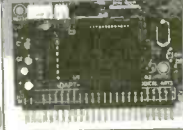

For just US\$74.95, our Starter Package (AD11SP) provides everything you need to get going fast! Now you can harness the power of the popular 68HC11 in your projects! Includes ADAPT-11 with 68HC11E2, providing 2K EEPROM (re-programmable), 8 channel 8-bit Analog-to-Digital Converter (ADC) hardware timers, counters, interrupts, Serial Peripheral Interface (SPI), Serial Communications Interface (SCI), & more! On-board RS-232 interface (cable included), 5-volt regulator, 8MHz crystal, reset circuit, and convenient program/run switch. Comes with non-commercial versions of 'HC11 Assembler, BASIC, & C, as well as handy utilities & example code. Includes Motorola 68HC11 Packet Programming Reference Guide and manual with schematic. All you need is a PC to write & program your software, a DC power supply, and a solderless breadboard (or proto-board) to build your application circuits on (or use our modular accessories).

Visa • MasterCard • AmericanExpress • Discover

TECHNOLOGICAL ARTS
309 Aragona Blvd., Suite 102, Box -18, Va. Beach, VA 23462
1844 Bayview Avenue, Box 170-, Toronto, ON M4G 3C2
voice/fax:[416] 963-8996 www.interlog.com/~techart

LASER MODULE



Auto Power Control
Collimated Laser
Compact Size
100,000 hr lifetime
No Electronics Required

Visible Laser Modules(635-670 nm) from \$29 (US)
TTL Modulated Laser Modules
Line Generator Laser Modules
Infrared Laser Modules(780-830 nm)

LASER POINTER



Focus Adjustable
Elegant Design
Solid Metal Body

Pen Style Laser Pointer (1500 ft visibility) \$19.95 (US)
Key Chain Laser Pointer (1500 ft visibility)
Available in silver and, black finish.

World Star Tech. Ask for free catalog
Tel:(416)204 6298 Fax:(416)596 7619
<http://www.worldstartech.com> e-mail: info@worldstartech.com

Notch Filters



Test Chips
Filter Kits
1 to 2 \$20 each
3 to 9 \$15 each
10 to 20 \$ 9 each
21 or more \$ 7 each

Adult Wholesale Video's \$ 379.00
Free Shipping

Video Media
P.O. Box 93/6025
Margate, Fl. 33093-6025
(954)-752-9202

www.nutnet.com

Call Today And SAVE! Unbeatable PRICES!

CABLE TV

**DESCRAMBLERS
CONVERTERS • FILTERS
VIDEO STABILIZERS**

- FREE 30 Day Trial
- FREE Product Catalog
- FREE 1 Year Warranty

100% MONEY BACK GUARANTEE



Let us point you in the right direction ...



TOLL FREE
888-554-ARROW
888-554-2776



If you are not getting this catalog you are missing out on some of the best deals in

electronics today! We have thousands of items ranging from unique, hard-to-find parts to standard production components. Call, write, or fax today to start your free subscription to the most unique catalog in the industry, filled with super values on surplus electronic and hobbyist type items. If you have a friend who would like to receive our catalog, send us their name and address and we will gladly forward them a complementary 100 page catalog.

Why pay more? Call today.



340 East First Street Fax Order Line
Dayton, Ohio 45402 1-800-344-6324

Order Toll-Free
1-800-344-4465

CIRCLE 139 ON FREE INFORMATION CARD

SURVEILLANCE

The Latest High Tech Professional Electronic Devices

Our latest catalog offers a HUGE selection of surveillance, counter-surveillance/privacy devices: pinhole camera \$129⁰⁰, hidden video, "realtime" 12-Hour telephone recorder \$139⁰⁰, 12 hour VOX recorder

phone call register, scanners, bug/phone tap detectors, voice disguisers, locksmithing tools, vehicle tracking, wireless video, and much more. Wholesale/retail.

We will not be undersold.

Catalog \$5.00 or www.spyoutlet.com

SPY OUTLET
PO Box 337, Buffalo NY 14226
(716) 691-3476/(716) 695-8660

"I earned \$1,000 on just 12 VCR repairs in one week"

A true statement by Paul B. of San Pedro, California*

How to cash in on skyrocketing field of VCR repair!

You too can earn up to \$85 an hour, pocket \$200 a day, double your income...in the high-profit field of VCR repair...part-time or full time. There are over 77 million VCR's currently in use in America today - a lot of business out there just waiting for you!

Here is a once-in-a-lifetime opportunity to go into a booming business of your own, make really big money starting right away, be your own boss and enjoy financial freedom and security.

It's easy to learn VCR cleaning, maintenance and repair at home in just a few short weeks through Foley-Belsaw's unique method which emphasizes the mechanics involved in 90% of all repairs, without dwelling on all the unnecessary basic electronics. This exclusive practical hands-on course was developed and proven over a long period of time in an actual VCR repair shop. It combines simple step-by-step lessons with easy-to-follow video cassette guidance. No special experience or electronics background is necessary. Just average mechanical aptitude and the ability to follow simple A-B-C repair procedures that are clearly outlined for you. And when you complete the course you will receive the School's official diploma attesting to your expertise.



Send coupon today for FREE Fact Kit. No obligation.

Don't miss out on this opportunity to give your income a tremendous boost. Send in the coupon NOW. Get all the facts and study them in the privacy of your own home. There's absolutely no obligation and no salesmen will call on you. So don't delay. Mail the coupon today!

"I started 3 months ago, now earn over \$900 a week."
D.K., New York, NY

"Took in over \$3,200 in the past 10 days!"
H.H., Denver, CO

"Doubled my income within 6 weeks."
R.B., Bakersfield, CA

MAIL TODAY FOR FREE INFORMATION PACKAGE

Foley-Belsaw Institute,
6301 Equitable Road
Kansas City, MO 64120-1395



CHECK ONE BOX ONLY FOR FREE INFORMATION KIT!

YES, without obligation send me information on how I can learn at home to become a VCR technician. 62877

- | | |
|--|--|
| <input type="checkbox"/> Computer Repair 64779 | <input type="checkbox"/> TV/Satellite Dish 31648 |
| <input type="checkbox"/> Computer Programmer 35595 | <input type="checkbox"/> Electrician 95456 |
| <input type="checkbox"/> Networking Specialist 39403 | <input type="checkbox"/> Computer Specialist 38416 |

Name _____

Address _____

City _____ State _____ Zip _____

*Last name withheld by request.

Since 1971

WWW.WEB-TRONICS.COM

You'll
"Bookmark"
This Site!

Check us last for the best deals on quality electronic parts, equipment & supplies!

- ◆ Easy to navigate site with loads of information
- ◆ Thousands of stock items
- ◆ Special deals found nowhere else
- ◆ New products added constantly
- ◆ Prices updated weekly on volatile computer products
- ◆ Order online, by FAX, by phone or snail mail

CCD Board Cameras & Surveillance Supplies
Printed Circuit Board Supplies
Computer Systems & Boards
Industrial Computer Products
NuDAQ DAQ Boards!
All Kinds of Do It Yourself Kits & Projects
Super Test Equipment Deals!
Cabinet & Enclosures

Switches
Passive Small Parts, Resistors, Diodes, Pots, Inductors, Capacitors, Lamps, LEDs, etc.

I.C.s
NTE Replacement Devices
Soldering Equipment & Electronic Tools
Prototyping & Breadboard Supplies
Connectors
Cable Ties, Heat Shrink & Wiring Products
Special Kitting Service for Educators
Lasers & Educational Laser Products
and much, much more!

Circuit Specialists, Inc.
800-811-5203
FAX 602-464-5824



Electronic Training Videos



Learn electronics quickly and easily with UCANDO's computer-animated training videos. Students can learn at their own pace and professionals will find the UCANDO videos to be a valuable source of reference material. If these videos aren't the best learning tools you've ever seen, return them within 30 days for a

complete refund. These videos are being used by Tech-Schools, CET's, Military Branches, Ham Operators, Industries, and more, across the United States and around the world. Order today and see how UCANDO is ...

"Changing The Way The World Learns Electronics."

VCR Maintenance & Repair ... \$29.95 All others ... \$44.95 each
• Intro to VCR Repair • Direct Current • Alternating Current • Semiconductors • Power Supplies • Amplifiers • Oscillators • Digital 1 • Digital 2 • Digital 3 • Digital 4 • Digital 5 • Digital 6 • AM Radio • FM Radio Part 1 • FM Radio Part 2 • TV Part 1 • Intro to TV • TV Part 2 • "The Front End" • TV Part 3 • Audio • Fiber Optics • Laser Technology •

SAVE!!! 6 videos for only \$240 or 12 videos for only \$450



1-800-678-6113

or mail check or money order to:

UCANDO Videos

P.O. Box 928

Greenville, OH 45331

FREE Shipping ... FREE Catalog



CIRCLE 147 ON FREE INFORMATION CARD

New and Pre-Owned Test Equipment

Goldstar



Model OS-5100 → \$899.00
Full 100 MHz Bandwidth!

- Dual-Channel, High Sensitivity
- TV Synchronization Trigger
- Calibrated Delayed Sweep
- Includes Two Probes, 2 Year Warranty

Spectrum Analyzer
Avcom PSA-37D

Satellite Downlink
Installation
Maintenance & Service

- Band 1 10 - 1750 MHz
 - Band 2 3.7 - 4.2 GHz
 - Built-in DC Block & Power for LNA/LNB's
 - Line or Battery Powered
- Only \$2,475.00!**

We Buy Surplus Test Equipment

Leader CATV Signal Level Meter Model LF 941
✓ TV/CATV Coverage from 46 - 870 MHz
✓ Video/Audio Carrier Measurements **\$695.00!**

Just Released! → "Series III" Multimeters
Fluke Model 87III \$319.00 !!!

SIMCHECK®II PLUS
Module Tester

- * Tests SIMMs/168 p DIMMs
 - * Stand alone/portable
 - * Identifies Module properties
 - * Advanced Setup Capabilities
- Only \$2750.00!**

(1-800-996-3837)

Pre-Owned Oscilloscope Specials

Tektronix 2213	60 MHz	\$549.00
Tektronix 2215	60 MHz	\$649.00
Tektronix 465	100 MHz	\$599.00
Tektronix 465B	100 MHz	\$729.00
Tektronix 475	200 MHz	\$829.00
Tektronix 475A	250 MHz	\$999.00

- Professionally Refurbished
- Aligned & Calibrated to Original Specifications
- The Industry Standard of Oscilloscopes
- **1 Year Warranty - The Longest Available!!!**

See us on the Web!
www.fotronic.com

Test Equipment Depot

A FOTRONIC CORPORATION COMPANY

99 Washington St. Melrose, MA 02176

(781) 665-1400 • FAX (781) 665-0780

email: sales@fotronic.com



TOLL FREE 1-800-99-METER

Sun Equipment Corporation Since 1988

P. O. Box 97903, Raleigh, NC 27624 E-mail: sunequipco@ipass.net
To request FREE CATALOG, please call, fax, write, or e-mail us.



1 Year Warranty. 15 Day Money Back Guarantee.
School purchase order accepted. Bids accepted.
DEALERS & SALES REP'S WELCOME.
DISTRIBUTOR & OEM WELCOME.

Quality Test Equipment for Professionals

LODESTAR VISA, Mastercard, Discover, AmrExpress
1-800-870-1955 / (919)870-1955 Fax: (919)870-5720

DC POWER SUPPLY (CC/CV)

All models protection of short ckt, overload, reverse polarity, over-voltage, Constant Current & Voltage (CC/CV) are fully adjustable.
Regulation: $\leq 0.1\% + 3mV$ (line), $\leq 0.1\% + 3mV$ (load), $\leq 1mV$ ripple.

SINGLE OUTPUT

- Analog Displays**
PS-303 \$159.00, 30V/3A.
PS-305 \$219.95, 30V/5A.
PS-1610S \$289.00, 16V/10A.
PS-2243 \$139.00, 12V/24V select, 3A.
PS-2245 \$159.00, 12V/24V select, 5A.
8107 \$399.95, 30V/10A.
8110 \$289.95, 60V/3A.
8112 \$399.95, 60V/5A.

Digital Voltmeter & Analog Ammeter

8200(8201) \$179.95(\$239.95), 30V/3A(5A)

Digital Displays 8210/8300 \$199.95, 30V/3A.

8211/8301 \$259.95, 30V/5A.

DUAL OUTPUTS

Independent/Tracking

Analog Displays

8108 \$549.95, 60V/3A.

8109 \$699.95, 60V/5A.

PS-303D \$314.95, 30V/3A

PS-305D \$399.95, 30V/5A.

TRIPLE OUTPUTS, a fixed 5V/3A output, Independent/Tracking

Digital Displays 8202(8203) \$499.95(\$549.95), dual 30V/3A(5A).

Analog Displays 8102(8103) \$399.95(\$489.95), dual 30V/3A(5A),

with Parallel (30V/6A) and Series (60V/3A) Mode operation.

NTSC/PAL TV COLOR BAR GEN.

CPG-1366A \$159.95, VHF NTSC;

Freq.: 45.75, 175.25, 187.25 MHz;

RF Output: 10mV;

Impedance: 75 Ohm;

Video Output: BNC, 1V_{p-p};

CPG-1367A \$159.95, VHF PAL.

SWR/RF/mW POWER METER

310 \$89.95, 1.8-150MHz, RF Power: 0-4W/20W/200W 3 ranges, SWR Measurement: 1.0-4W minimum. Accuracy: 5%-10%; Insert Loss: .3dB. Input/Output Imp.: 50Ω; SO-239 plug.

320 \$89.95, 130-520MHz. Spec. see 310.

SWR-3P \$26.95 1.7-150MHz.

RF Power: 0.5-10W, 0.5W-100W.

SWR-2P \$22.95, 1.7-30MHz; RF Power: 0.5-10W.

mW RF Power Meter 340 \$219.00, 1.8-500MHz, RF

Power: 20mW/200mW/2W 3 ranges; Imped.: 50Ω; Accuracy: ±10% full scale; SWR < 1.15; N-type connector; BNC type output.

FM STEREO MODULATOR

AG-2011A \$549.00

RF SECTION:

Carrier: 98MHz ±2MHz;

Output: 10mV, 1mV & 0.1mV

COMPOSITE SIGNALS:

Pilot: 19KHz ±2Hz, 0.8Vrms

INT. MODULATION: 400KHz;

1KHz ±1%, 1Vrms, distortion < .5%; L-R Separation: >50dB.

EXT. MODULATION: Freq.: 50Hz-15KHz;

L-R Separation: >45dB 100Hz-3KHz, >35dB 50Hz-15KHz.

WOW-FLUTTER METER

WF-3103A \$699.95

Freq. Range: 3KHz ±10% JIS/CCIR, 3.15KHz ±10% DIN.

Measurement: 03/1.1/3/1/3% full scale.

Accuracy: ±5% of full scale.

WF-3105A \$799.95, digital display;

Function: LIN/WOW/Flutter/WTD.

Freq. Counter: 10Hz-9.99MHz.

Indication: CCIR/DIN/JIS.

TOOLKITS - ELECTRONIC/PC

9245 \$29.99 U.S. Patented, 45-pcs. Contents: IC inserter/extractor with securers & bows, 3-prong part retriever, #0 phillips screwdriver, 1/8" flat screwdriver, self-hold tweezers, metal tweezers, extra parts tube, soldering iron, solder, crimping tool, long-nose plier, cutting plier, zipper vinyl case. Bits include: Phillips: #0/1/#2/#3; Flat: 1/8"/3/16"/1/4"/9/32"; PZ1/PZ2; T8/T9/T10/T11/T12/T15/T20/T25/T27/T30/T40/T45; Hex: 5/64"/3/32"/1/8"/5/32"/3/16"; Sockets: 3/16" (5mm)/3/32" (5.5mm)/1/4" (6mm)/9/32" (7mm)/5/16" (8mm).

8G23 \$34.99 23-pcs Contents: IC inserter/extractor with securer & bows, 3-prong part retriever, 3/16"/1/4" nutdriver, 3/16"/1/8" slot screwdriver, #0/#1 phillips, reversible T10/T15 bits, reversible #2 phillips/1/4" slotted bits, tweezers, long-nose plier, cutter, 6" adj. wrench, soldering iron, solder, crimping tool, zipper case, manual.

Various packages available, call/write/e-mail for details.

RF SIGNAL GENERATOR



SG-4160B \$124.95, 100KHz-150MHz up to 450MHz on 3rd harmonics in 6 ranges; AM modulation, Accuracy ±5%. RF Output: 100mVrms to 35 MHz, Modulation Int. 1KHz (AM) -30%; Ext. 50Hz-20KHz, at least 1V_{min} input. Audio Output: 1KHz, 2V_{min} minimum.

SG-4162AD (with Freq. Counter) \$229.95, Spec. see SG-4160B. **COUNTER SECTION:** 10Hz-150MHz, Max Input ±3V effective Gate Time: .1, Insec. Input Sensitivity: 35mV, 10Hz-200MHz. Input Impedance: 1MΩ(HF), 50Ω(VHF). Display: 7-digit LEDs.

AM/FM STD SIGNAL GEN.

SG-4110A \$1799.00, Freq. 0.1-110MHz, Display: 6-digit LED, Resolution: 100Hz (0.1-34.999MHz); 1KHz (35MHz-110MHz). Accuracy <±(5x10⁻¹ ± count); Output: -19dBu-99dBu, 1dB steps. Impedance: 50Ω VSWR 1.2; 100 preset frequency & store functions.

AUDIO GENERATOR



AG-2601A \$124.95, 10Hz-1MHz in ranges; Output: sine wave 0-8V_{max}; square 10V_{p-p}; Output Imped: 600 Ohm. Distortion: <0.05% 500Hz-50KHz, <0.5% 50KHz-500KHz. **AG-2603AD** \$229.95, with 6-digit, Int/Ext. Freq. Counter, 10Hz-150MHz.

Output Control: 0/-20/+40dB & Fine adjuster. Spec. see AG-2601A.

FUNCTION GENERATOR



FG-2100A \$169.95, 0.2Hz-2MHz in 7 ranges; sine, square, triangle, pulse & Ramp; Output: 5mV_{p-p}-20V_{p-p}, 1% distortion. VCF: 0-10V/freq. to 1000:1. **FG-2102AD** \$229.95 see FG-2100A; 4-digit counter display, TTL & CMOS outputs, 30ppm ±1 count accuracy.

FG-2020B \$159.00 0.5Hz-500KHz, Sine, Square, Triangle. **FG-2103** \$329.95, Digital sweep generator, 0.5Hz-5MHz in 7 ranges. Operating Mode: sweep, AM, gated burst, VCG. Freq. Counter: Int. 0.5Hz-5MHz; Ext. 5Hz-10MHz.

FG-513 \$769.95, 13 MHz, Microprocessor embedded digital sweep; Sine, Square, Triangle, Pulse, Ramp, TTL & DC, ±(0.1% ±1 dgt). Freq. Counter & TCXO: 5Hz-100MHz, 6.5 digits. x1/x20 attenuation.

AC MILLIVOLT METER



MV-3100A \$159.95 wide band 5Hz-1MHz, 3 scales, mV, dB & dBm, 300μV-100V in 12 ranges, 10μV resolution, -70-40dB in 12 ranges, 0dB=1Vrms, 0dBm=0.775V; ±3% accuracy; Input impedance 10MΩ; Noise <2%. **MV-3201B** \$309.95 dual channels, simultaneous measurement.

OSCILLOSCOPES



OS-7305B \$249.00 DC-7MHz, 3" CRT, Horiz: 25V/div, 10Hz-100KHz in 4 ranges; Vert: 10mV/div, Int. & Ext. Sync, Input: 1MΩ/35pF. **OS-7010A** \$299.95 10MHz, 5" CRT, Horiz: 2V/div, Vert: 10mV-10V/div. **OS-622G** \$389.95 20MHz, 2 CH/X-Y

Alt trigger, trigger lock, hold OFF, TV syn., 8x10 div., 1mV/div., Horiz: 2μs-5s/div; Vert: 1mV-5V/div. **OS-653G** \$699.95 50MHz, 2 CH/delay sweep, Alt trigger, TV syn. **OS-6101G** \$1499.95 100MHz, 4ch/8 traces, delay sweep, cursor readout. 2 years warranty for OS-622G, OS-653G, & OS-6101G.

UHF ATTENUATORS



RT-8815U (50Ω) \$299.00 / **RT-8817U** (75Ω) \$299.00, 950MHz, 81dB, 0.5W max.; Steps: 1/2/3/5/10/20/20, 8 switches. **085E-2** (50Ω) \$399.00 / **087E-2** (75Ω) \$399.00, 950MHz, 81dB, 0.5W max.; Steps: 10dB+7.1dBx10, Electronic adjustment knob.

MICROPROCESSOR TRAINER



BCC-8088 \$699.00, learn computer theory. Excellent for school & individual who want to learn about ROM, RAM, I/O ports, programming, & run a 8088 Microprocessor. An easy to understand step-by-step manual guides you to achieve your goal 56-key keyboard, LCD display, RS-232 UART.

GRID DIP METER

DM-4061 \$89.95 1.5-250MHz, 6 bands; 6 plug-in coils, 2 transistor; and 1 diode. Modulation = 2KHz Sine wave. Crystal Oscillator: 1-15MHz. Wave absorption meter: 9VDC battery.



FREQUENCY COUNTER



FC-5250C \$119.95 10Hz-220MHz (HF) 10Hz-20MHz (VHF) 10-200MHz. Gate Time: .1, 1sec. Max. Input: 10V_{p-p}. Input Sensitivity: 35mV/10Hz-200MHz. Input Imped: 1MΩ(HF), 50Ω(VHF). Display: 7-digit LEDs, 9V adapter (\$6).

FC-5260A \$129.95, 600MHz. **FC-5270** \$149.95, 1.2GHz/8-dgt. **FC-5600** \$219.95, 600MHz/10-dgt. **FC-5700** \$299.95, 1.3GHz/10-dgt. **FC-1200** \$189.95, 1.25GHz/8-dgt LCD Handheld; Microprocessor counter.

SIGNAL TRACER/INJECTOR



SE-6100 \$134.95. **TRACER:** Gain 60dB maximum. Attenuation: 0/20/40/60dB. Input Imped: 100KΩ; Meter: Vu 100μA. Output Imped: 600Ω; Speaker: 8Ω. **INJECTOR:** ±1KHz Squarewave; Output Level: Variable 0-4.5V_{p-p}; 9V battery or adapter (\$6.00).

LCR METERS



MIC-4070D \$179.95, Induct.: 0.1μ-200H, Capacit.: 0.1p-20mF, Resist: 1mΩ-20MΩ, 2Ω range, Dissipation factor measurement, Zero adjust. Surface mount device (SMD) test probe: LT-06 \$21.95.

DIGITAL MULTIMETER

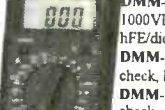

DMM-120 \$24.95, 3 1/2 digit, 600VDC, 2ADC 500VAC, 2MΩ, hFE/diode/continuity test; 1.2% **DMM-1230+Cap+Freq** \$59.95, 3 1/2 dgt, 20MHz 1000VDC/750VAC, 10ADC/AC, 20MΩ, 20μF, hFE/diode test, continuity beeper, 0.5% accuracy **DMM-1240+Cap+Freq+Logic** \$69.95, Battery check, Logic level measurement, + DMM-1230. **DMM-1250+Cap+Freq+Temp** \$89.95, Battery check, -58-1999°F/-50-1300°C, + DMM1230. **DMM-125** \$54.95, Autorange/Bargraph, 32MΩ, 600VDC/AC, 10ADC/AC, diode/continuity test, **MIC-35** \$59.95, Autorange, 3 1/2 LCD, 20MΩ, 1000VDC/750VAC, 20ADC/AC, data hold, diode/continuity test, free holster, 0.5% accuracy



MIC-39 \$129.95, Autorange/Bargraph, True RMS, 3% LCD, 40μF, 40MΩ, 1000VDC/750VAC, 20ADC/AC, 600KHz freq. cnt, data hold, sleep mode, memory, read functions, holster, 0.3% accuracy.

POCKET ANALOG MULTIMETER

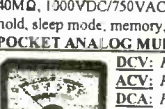

ANM-9810P \$14.95. **DCV:** Range: 10/50/250/500V, ±4%. **ACV:** Range: 50/250/500V, ±4%. **DCA:** Range: 25mA, 250mA, Accuracy: ±4% full scale; Protection: 0.5A/250V fuse. **Resistance:** Range: 500kΩ (x1k), ±5%. **dB Test:** +4 to +56 dB on ACV range, Accuracy: ±5% of full scale. **Battery Test:** 1.5V and 9V. **Max. Input:** 500VDC/AC, or 250mADC.

AUTO. CAPACITANCE METER



CMJ300A \$139.40 10 ranges, 99.9pF - 99.9nF, fully automatic. Resolution: 0.1pF lowest, 0.1% full scale. Accuracy: 0.5% of full scale = 1 digit to 99.9μF, 1% of full scale ±1 digit to 99.9μF. Display: 3 digit LED. Unit: pF, nF, μF, mF. Overrange indicators.

AUTO DISTORTION METER

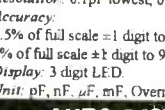

DM-J104A \$799.95. **DISTORTION MEASURE** Range: 0.01% to 30%, 0.1/0.3/1/3/10/30% 6 ranges. Freq: 400Hz±10%, 1KHz±10% (HPF). Input: 3mV-100V, Ratio measure 20dB. Auto. Freq. Switching Ranges: Fundamental Freq = (fo)±10%; Fund. Rejection: >80dB at (fo)±5%, >70dB at (fo)±10%. Harmonic Accuracy: ±0.5dB, 1.8(fo)-20KHz. **LEVEL MEASURE** Range: 0 to 100V in 03/1.1/3/1/3/10/100V. Freq Response: ±0.5dB/20-50KHz, ±1dB/20-100KHz. **DM-3204** \$1,599.00 dual channels. Spec see DM-3104A.

Kenwood CS-4125 Sale!!!

Free **KENWOOD** t-shirt
with purchase of
CS-4125 oscilloscope!!!



KENWOOD

MODEL CS-4125

20 MHz, 2 Channel, includes probes
Suggested Price \$595.00

SUPER SPECIAL \$389.00!!!

PRINTTM
Products International

8931 Brookville Rd * Silver Spring, MD, 20910 * 800-638-2020 * Fx 800-545-0058
www.prodintl.com

SPARE SCOPE PROBE SPECIAL:

Kenwood PC-35 - 10:1, DC to 50 MHz
Regular \$62.00 **SALE \$29.95**
Kenwood PC-41 - 10:1/1:1, DC to 50 MHz
Regular \$62.00 **SALE \$29.95**

Call today for your free 84 page test & measurement instrument catalog!

CIRCLE 142 ON FREE INFORMATION CARD

INTERNET SECURITY CELLPHONE/CORDLESS GUIDE

The latest tricks and methods being used on the Net by software pirates (warez) and their newest hacking websites. How they do it, countermeasures, password defeats, UNIX, Sprintnet, brute force techs, lots of tips. *More!* \$29. EWC=29.4K

INTERNET TRACKING & TRACING

Scammers, spammers, stalkers, infectors, and others hide behind the Internet's anonymity to commit serious offenses. Learn from master hackers best methods to track, trace IDs and origins, and to protect your own privacy. *More!* \$29. EWC=17.0K

INTERNET FRAUDS DATABOOK

Internet cons, scams and related frauds now rake in \$2+ Billion annually! Most are done anonymously with impunity. Details how they're done, how to ID them, how to protect yourself. *More!* \$25. EWC=18.9K

THE COOKIE TERMINATOR

Many websites track your every move! Browser cookie, history and cache files contain personal data readily accessible to Internet predators, scammers, spammers and snoops. Your financial, medical, political, habits, lifestyle, future plans data is exposed to the world! Step-by-step how to remove and stop cookies from destroying your privacy. \$25. EWC=8.4K
Any 2 for \$49, 3 for \$64, all 4 for \$79!

PBX SECURITY

PBXs hacking losses of \$5-\$10 billion/yr! Detailed vulnerabilities, countermeasures. Author interview in Forbes! \$24. EWC=17.4K

How cellphones operate; mods. Vulnerabilities to hack attack; countermeasures. Cloning details for NAMs, ESNs, etc, control data formats, computing encoded MINs, ESNs, SIDHs, Op Sys, PROMs, forcing ACK, test mode and resets, cable diagrams, scanning, tracking, scanner restorations, freq allocations, roaming, step-by-step to keypad+reprogram 100+ popular cellphones. One FREE database search. Plus much on Cordless phones. *More!* \$49. EWC=80.2K

PAGER (BEEPER) MANUAL

How Pagers work, different types and uses, freqs, advantages over and uses with cellphones, and tips and tricks. How phreaks hack Pagers; countermeasures. And plans for a Personal Pocket Paging System (xmitter and receiver). *More!* \$29. EWC=11.4K

Both for only \$69!

CALLER ID & ANI SECURITY

How they work and the many vulnerabilities of Caller ID, ANI, *69, *57, Call Blocking, *67, et al. Describes ESS, SS7, CN/A, CAMA, DNR, Diverter, Centrex! \$25. EWC=15.2K

FAX MACHINE SECURITY

All known methods used to hack Faxes and countermeasures. Includes computer fax modems, crimes, interceptions, fax servers, fax-on-demand, protocols, parameters, compression, encryption, and fax surveillance-type mods. *More!* \$29. EWC=28.7K

VOICE MAIL SECURITY

VMSs are hacked to penetrate PBXs to make outgoing calls, get free VMB usage, secretly read/change/delete messages, or damage the VMS (or its PBX) itself. Details how hackers do it, countermeasures. \$29. EWC=14.2K

CONSUMERTRONICS

2430 Juan Tabo, NE, #259, ABQ, NM 87112
P.O. Box 23097 ABQ, NM 87192
Fax: 505-292-4078 (all hours, orders only) Voice: 505-237-2073 (9-5)

Full Catalog: www.tsc-global.com Special Projects: www.spaf-spp.html

Established in 1971. Featured on CBS '60 Minutes', Forbes, New York Times. Add \$5 total S/H (US Canada). Postal/MO is fastest! VISA, MC OK. No CODs. 10% OFF all Orders over \$100. \$2.00 OFF all New Orders over \$20 placed by Mail or Fax. Catalog \$1 w/order \$3 w/o. EWC=Estimated Word Count

Sold for legal educational purposes only to protect you from hi-tech crimes and abuses. See Catalog for LIMITED WARRANTY, SPECIAL PROJECTS and all other applicable policies.

SPM - THE MANUAL

As reported on "60 MINUTES"! 6th Edition! Details devices that can slow down (even stop) power meters while loads draw full power - great science projects! Devices plug into one outlet and normal loads into other outlets. Describes meter creep, overload droop, pole meters, etc. \$29. EWC=10.4K

SPM THE VIDEO

Now its easier to learn about KW-HR Power Meters than ever before! This educational video shows you how they work and their anatomy. Demonstrates SPMEM device and external magnetic methods used to slow and stop meters! Hosted by a top expert in the field. From the novice to the pro, an excellent source of info on these exciting devices! Great in combo with our SPM-related manuals! \$29. (20 min)

THE I.G. MANUAL

Details external magnetic ways (applied to meters) hackers use to slow down and stop power meters while drawing full loads. \$25. EWC=4.9K

KW-HR METERS

How watt-hour meters work, calibration, error modes (many), ANSI Standards, etc. Demand and Polyphase Meters. Experimental results to slow and stop meters by others. \$25. EWC=24.2K

Any 2 for \$49, 3 for \$64, all 4 for \$79!

COMPUTER SECURITY

Describes in detail how computers penetrate each other, and how VIRUSES, TROJAN HORSES, WORMS are implemented. Dozens of computer crime and abuse methods and countermeasures. Includes disk filled with hacker text files and utilities, and the legendary FLUSHOT+ protection system. Internet advice, password defeats, glossary - much more! Manual + PC Disk! \$39. EWC=54.7K

THE HACKER FILES

Expose 3 HD PC disks filled with choice raw, colorful, highly informative hacker, phreaker text files covering many topics! \$39. **Both for only \$69!**

BEYOND VAN ECK TEMPEST

Plans for remote eavesdropping of TV video signals. Range up to 1 KM. Describes how van Eck systems work, and are also used in surveillance of computer systems. \$29. EWC=10.6K. Van Eck Demo Tape is \$29. (15 min). Both for only \$49!

MANY MORE TITLES!

(See Catalog for prices & descriptions)

- BEYOND PHONE COLOR BOXES ANSWER. MACHINE SECURITY
- CASINO SECRETS
- ATM SECURITY
- CHECK & M.O. SECURITY
- CREDIT CARD SECURITY
- CONS & SCAMS DATABOOK
- SOCIAL ENGINEERING
- POLYGRAPH SECRETS
- BY AN ORDER OF THE MAGNITUDE
- ULTIMATE SUCCESS MANUAL
- STEALTH TECHNOLOGY
- SIMPLE/CHEAP SECURITY ELEC.
- SECRET & SURVIVAL RADIO
- HIGH VOLTAGE DEVICES
- MIND CONTROL
- UNDER ATTACK!
- RADIONICS MANUAL
- HEAL THYSELF!
- SECRETS OF SOLDERLESS BBS
- SECRET & ALTERNATE IDs
- CRYPTANALYSIS TECHNIQUES
- GOVERNMENT LAND GRAB
- ROCKET'S RED GLARE
- SURVIVAL GUNS & AMMO
- THE ULTIMATE DRIVER

THE DIRTY-2 DOZEN!

24+ Hot Hack/Phreak Expose Disks!

See **CATALOG!**

SPECIAL PROJECTS

We will design & build just about anything electronic! Hardware

done as **SPECIAL PROJECTS**

only. See Catalog for details

and SP Application Form, else:

www.tsc-global.com/spaf-spp.html

Low Cost CAD Software Now In Windows™ 95

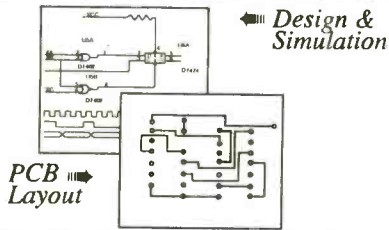

- Easy to use schematic entry program (**SuperCAD**) for circuit diagrams, only \$149. Includes netlisting, bill of materials, extensive parts libraries.
- Digital simulator (**SuperSIM**) allows you to check logic circuitry quickly before actually wiring it up. Works directly within SuperCAD and displays results in "logic analyzer" display window. Starting at \$149 this is the lowest cost simulator on the market. Library parts include TTL, and CMOS devices.
- Analog simulator (**mentalSPICE**) for \$199. Allows AC, DC and transient circuit analysis. Includes models of transistors, discretes, and op amps.
- Circuit board artwork editor and autorouter program (**SuperPCB**), starting at \$149. Produce high quality artwork directly on dot matrix or laser printers. You can do boards up to 16 layers including surface mount. Includes Gerber and Excellon file output. Autorouter accepts netlists and placement data directly from the SuperCAD schematic editor.
- **New!**—Complete electronic design package (**mentalMAX**) including schematic editor, analog and digital circuit simulation, and printed circuit board layout with autorouter for only \$549!

Write or call for free demo disks:
MENTAL AUTOMATION, INC.
5415 - 136th Place S.E.
Bellevue, WA 98006
(425) 641-2141
Internet: <http://www.mentala.com>

CABLE T.V. EQUIPMENT

Friendly, Knowledgeable Service



ORDERS CALL:
1-800-361-4586



- All Equipment New
- Convertors & Descramblers
- 30 Day Money Back Guarantee
- 6 Month Warranty
- Visa, MC, C.O.D. Welcome

KDE ELECTRONICS, INC.

P.O. Box 1494
Addison, IL 60101

Info. 630-889-0281 HRS: Mon-Fri, 9-6 CST
Fax 630-889-0283 Sat, 10-2 CST

ALFA ELECTRONICS

HIGH QUALITY TEST EQUIPMENT

Visit www.alfaelectronics.com for complete info
Call 1-800-526-2532 for Order and Free Catalog

DMM	TOP/COUNTER	BLANK	SPECIALTY
DMM-895 (\$179.00): true rms, AC/DC (V,A), Ω , bar graph, freq, capac., dBm, logic, diode	CAP-15 (\$49.95): 3 1/2 digit, 0.1pF-20mF, 9 Ranges, 0.1pF resolution, zero adjustment	12B \$ 94.95	• AC Current Probe \$34.95
DMM-23T (\$99.95): 4 1/2 digit, true rms, high resol. (10 μ V, 10mA, 10M Ω), hFE, diode, contin.	LCR-24 (\$119.95): 0.1 μ H-200H, 0.1pF-2000 μ F, 0.01 Ω -20M Ω , diode test. <i>New Model</i>	70-III \$ 99.00	• DC/AC Current Probe \$79.95
DMM-20 (\$74.95): AC/DC (V,A), Freq, cont., Capac, induct., Ω , hFE, diode, duty cycle	LCR-131D (\$219.95): autorange, 0.1 μ H-10kH, 0.1pF-10mF, 1m Ω -10M Ω , Q Factor, serial/parallel, 120Hz/1kHz testing mode	73-III \$125.00	• Mini AC Clamp \$39.95
DMM-122 (\$59.95): DC/AC(V,A), Ω , hFE, diode, capacitance, freq, logic, continuity	FC-1200 (\$129.95): 1.25GHz Handheld, 8 digits display, 10ppm accuracy, sensitivity 5mV (130-350MHz), 30mV (400MHz)	75-III \$155.00	• AC Clamp w/temp \$89.95
DMM-123 (\$44.95): DMM + capacitance, DC/AC(V,A), Ω , hFE, diode, continuity		77-III \$173.00	• DC/AC Clamp \$109.95
DMM-10 (\$19.95): 3 1/2 digit, DC/AC V, Ω , hFE, diode, signal output(+3V,-0.5Vsq.,50% duty)		79-III \$195.00	• Thermometer \$69.95-\$89.95
		87-III \$325.00	• IR Thermometer \$189.95
		92B-III \$1,445	• Sound Level Meter \$169.95
		96B-II \$1,695	• Tachometer \$169.95-\$219.95
		99B-III \$2,095	• EMP Tester \$69.95
		105B \$2,495	• Pressure Meter \$299.95
		123-III \$1,130	• Watt Meter \$129.95
		863E \$555	• High Voltage Probe \$59.95
		867B \$740	• pH Meter \$79.95
			• Light Meter \$79.95-\$89.95

Single Output DC Power Supplies	Triple Output	AUDIO/RF/FUNCT. GEN.
• Constant current, constant voltage mode	• Independence of tracking operation	RF Generator • SG-4160 (\$124.95) 100kHz-150MHz sinewaves in 8 ranges
• Short Circuit and overload protected	• Parallel to double current output (PS-8102 & PS-8103 only)	• SG-4162AD (\$229.95) with 6 digit counter
<i>Analog Meters Display</i>	<i>Triple Output (Analog display)</i>	Audio Generator • AG-2601 (\$124.95) 10Hz-1MHz, 0-8Vpp sine, 0-10Vpp squarewave
PS-303 (\$159.00) 30V/3A	PS-8102 (\$399.95) 30V/3A/30V/3A	• AG-2603AD (\$229.95) with 6 digit counter
PS-305 (\$219.95) 30V/5A	PS-8103 (\$489.95) 30V/5A/30V/5A	Function Generator • FG-2100A (\$154.95)
PS-8112 (\$399.95) 60V/5A	<i>Digital Displays</i>	• FG-2100A (\$154.95)
PS-1610 (\$289.00) 16V/10A	PS-8202 (\$499.95) 30V/3A/30V/3A	• 0.2Hz-2MHz, 5mV-20Vpp
PS-8107 (\$399.95) 30V/10A	PS-8203 (\$549.95) 30V/5A/30V/5A	• FG-2103 (\$329.95) Sweep 0.5Hz-5MHz

DC POWER SUPPLIES					FUNCTION GENERATOR	BENCHTOP DMM
20 MHz Scope	Cursor Readout	Triple Output	Single Output	Programmable		
OS-620 \$324.95	OS-626G \$599.95	• 2 variable out 0-30V, 0-3A	• Const voltage, current mod	• Auto serial/parall (PPT ser)	FG-8020G (\$209.95)	DM-8034 (\$179.95) 3 1/2 digit
• Most economical scope	• Readout a Cursor meas	• One fixed 5V, 3A output	• Voltage regulation <0.01%	• Auto track (PPT series),	• 0.02Hz-2MHz w/counter	• AC/DV(V,A), C, Ω , diode
• Dual CH/X-Y operation	• Dual CH / Delay sweep	• Auto track, serial, parallel	• Current regulation <0.2%	• IEEE-488.2 and SCPI	• Sine/Squ/Tri/pulse/Ramp	DM-8048 (\$339.95) 3 1/2 digit
• 1 mV/div sensitivity	• Built-in delay line	• Const volt, current mode	PS-1830 (\$198.95) 18V/3A	compatible command set	FG-8020G (\$209.95)	• ACV to 50kHz, true rms
• Z-axis input, CH1 output	• ALT trigger, Hold-Off	• 4 analog or 2 digital display	PS-1850 (\$214.95) 18V/5A	PPS-1860G (\$1,149.95) 18V/6A	• 0.02Hz-2MHz w/counter	DM-8055G (\$389.95) 5 1/2 digit
• TV syn, ALT trigger	• Z-axis input, CH1 output	PC-3030 (\$499.95)	PS-1830D (\$214.95) 18V/3A	PPS-3635G (\$1,149.95) 36V/5A	• 0.05Hz-5MHz w/counter	• 0.006% accuracy, GPIB
• 2 traces (x1, x10)	• 2 probes (x1, x10)	PC-3030D (\$549.95) digital	PS-1850D (\$244.95) 18V/5A	PPT-1830G (\$1,499.95) 18V/3A	• INT/EXT AM/FM mod	• dBm, auto, REL, min/max
				PPT-3615G (\$1,499.95) 36V1.5A		

ALFA ELECTRONICS P.O. BOX 8089 PRINCETON, NJ 08543-8089

TEL: (800)526-2532 / (609) 897-1135 FAX: 609-897-0206 E-mail: sales@alfaelectronics.com

Call / Write / Fax / Email for FREE CATALOG
Visa, MC, AMEX, COD PO Accepted. OEM Welcome.
1 Year Warranty (2 Years for GW/Instek)

CIRCLE 213 ON FREE INFORMATION CARD

USE POPULAR ELECTRONICS

READ BY BUYERS OF ELECTRONIC EQUIPMENT ACCESSORIES AND PARTS

INSTRUCTIONS FOR PLACING YOUR AD!

HOW TO WRITE YOUR AD

TYPE or PRINT your classified ad copy **CLEARLY** (not in all capitals) using the form below. If you wish to place more than one ad, use a separate sheet for each additional one (a photo copy of this form will work as well). Place a category number in the space at the top of the order form (special categories are available). If you do not specify a category, we will place your ad under miscellaneous or whatever section we deem most appropriate.

We cannot bill for classified ads. **PAYMENT IN FULL MUST ACCOMPANY YOUR ORDER.** We do permit repeat ads or multiple ads in the same issue, but, in all cases, full payment must accompany your order.

WHAT WE DO

The first word and company name of each ad are set in bold caps at no extra charge. No special positioning, centering, dots, extra space, etc. can be accommodated.

RATES

Our classified ad rate is \$1.75 per word. Minimum charge is \$26.25 per ad per insertion (15 words). Any words that you want set in bold are each .40 extra. Indicate bold words by underlining. Words normally written in all caps and accepted abbreviations are not charged anything additional. State abbreviations must be post office 2-letter abbreviations. A phone number is one word.

If you use a **Box number** you must include your permanent address and phone number for our files. **ADS SUBMITTED WITHOUT THIS INFORMATION WILL NOT BE ACCEPTED.**

For firms or individuals offering Commercial products or Services. **Minimum 15 Words.** 5% discount for same ad in 6 issues within one year; 10% discount for same ad in 12 issues. **Sorry, no discounts on credit-card orders.** **Boldface** (not available as all caps), add .40 per word additional. **Entire ad in boldface**, add 20%. **Tint screen behind entire ad**, add 25%. **Tint screen plus all boldface ad**, add 45%. **Expanded type ad**, add \$2.25 per word.

General Information: A copy of your ad must be in our hands by the 13th of the fourth month preceding the date of issue (i.e. Sept issue copy must be received by May 13th). When normal closing date falls on Saturday, Sunday or Holiday, issue closes on preceding work day. Send for the classified brochure.

DEADLINES

Ads not received by our closing date will run in the next issue. For example, ads received by November 13 will appear in the March issue that is on sale January 17. **POPULAR ELECTRONICS** is published monthly. No cancellations permitted after the closing date. No copy changes can be made after we have typeset your ad. **NO REFUNDS**, advertising credit only. No phone orders.

CONTENT

All classified advertising in **POPULAR ELECTRONICS** is limited to electronics items only. All ads are subject to the publishers approval. **WE RESERVE THE RIGHT TO REJECT OR EDIT ALL ADS.**

AD RATES: \$1.75 per word. Minimum \$26.25

Send you ad payments to:

POPULAR ELECTRONICS 500 Bi-County Blvd, Farmingdale, NY 11735-3931

CATEGORIES

100 - Antique Electronics	270 - Computer Equipment Wanted	450 - Ham Gear Wanted	630 - Repairs-Services
130 - Audio-Video Lasers	300 - Computer Hardware	480 - Miscellaneous Electronics For Sale	660 - Satellite Equipment
160 - Business Opportunities	330 - Computer Software	510 - Miscellaneous Electronics Wanted	690 - Security
190 - Cable TV	360 - Education	540 - Music & Accessories	710 - Telephone
210 - CB-Scanners	390 - FAX	570 - Plans-Kits-Schematics	720 - Test Equipment

CLASSIFIED AD COPY ORDER FORM

Place this ad in Category # _____

Special Category \$20.00 Additional _____

1 - \$26.25	2 - \$26.25	3 - \$26.25	4 - \$26.25
5 - \$26.25	6 - \$26.25	7 - \$26.25	8 - \$26.25
9 - \$26.25	10 - \$26.25	11 - \$26.25	12 - \$26.25
13 - \$26.25	14 - \$26.25	15 - \$26.25	16 - \$28.00
17 - \$29.75	18 - \$31.50	19 - \$33.25	20 - \$35.00
21 - \$36.75	22 - \$38.50	23 - \$40.25	24 - \$42.00
25 - \$43.75	26 - \$45.50	27 - \$47.25	28 - \$49.00

29 - \$50.75	30 - \$52.50	31 - \$54.25	32 - \$56.00
33 - \$57.75	34 - \$59.50	35 - \$61.25	36 - \$63.00
37 - \$64.75	38 - \$66.50	39 - \$68.25	40 - \$70.00

Total words _____ \$1.75 per word = \$ _____

Bold Face _____ \$0.40 per word = \$ _____

Special Heading _____ \$20.00 = \$ _____

Other _____ = \$ _____

TOTAL COST OF AD \$ _____

Total classified ad payment \$ _____ enclosed

Check Mastercard Visa Discover

Card # _____ Expiration Date ____/____

Signature _____

Name _____ Phone _____

Address _____ City State Zip _____

Learn MICROCONTROLLERS EMBEDDED SYSTEMS and PROGRAMMING...

...with the AES learning system/
embedded control system.
Extensive manuals guide you
through your development
project. All programming and
hardware details explained.
Complete schematics. Learn to
program the LCD, keypad digital,
analog, and serial I/O. for your applications.



**THREE MODELS AVAILABLE. Choose from an
Intel 8051, Intel 8088, or Motorola 68HC11
based system. All models come with:**

- 32K Byte ROM, 32K Byte RAM • 2 by 16 Liquid Crystal Display • 4 by 5 Keypad • Digital, Analog, and Serial I/O • Interrupts, timers, chip-selects • 26 pin expansion connector • Built-in Logic Probe • Power Supply (can also be battery operated) • Powerful ROM MONITOR to help you program • Connects to your PC for programming or data logging (cable included) • Assembly, BASIC, and C programming (varies with model) • Program disks with Cross Assembler and many, well documented, program examples • User's Manuals: cover all details (over 500 pages) • Completely assembled and ready to use • Source code for all drivers and MONITOR • Optional Text Book

Everything you need. From \$279.
Money Back Guarantee

Call for Free Info Pack, or see
WEB at <http://www.aesmicro.com>
714-550-8094, FAX 714-550-9941

AES
Advanced Educational Systems

Call 1-800-730-3232

AES 575 ANTON BLVD., SUITE 300, COSTA MESA, CA 92626, USA

OSCILLOSCOPES from \$169 !!!

ATC O-Scope uses printer port to turn PC-AT into
Digital Storage Oscilloscope, Spectrum Analyzer,
Freq. Counter, Logger, DVM. DC-500KHz

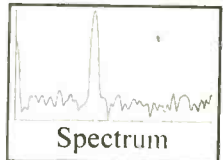
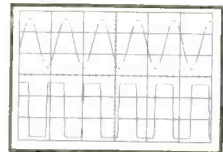

- Print, log to disk, or export data
- Accepts standard scope probes
- Uses standard printer port
- Small and portable
- Works with laptops
- Same day shipping
- Made in U.S.A.
- Single channel units from \$169
- Dual channel units from \$349

Options:

- Probe sets
- Automotive probes
- Battery packs

Order yours today.

800 980 9806

MC/Visa/Amex

Allison Technology Corporation

2006 Finney-Vallet, Rosenberg, TX 77471
PH: 281 239 8500, FAX: 281 239 8006

<http://www.atcweb.com>

CAD FILES TO CASH PILES



IMAGINE THE POSSIBILITIES!
ROUTE, MILL, DRILL, CARVE,
ENGRAVE, PAINT, ETC. . . .
IN WOOD, PLASTIC, VINYL,
PC BOARD, & LIGHT METALS.

THE **ROBOPRO X50**
CNC ROBOTIC MACHINING SYSTEM
YOUR WISH IS ITS COMMAND!



STARTING AT
\$895.00



3 AXIS UNITS FROM
12" X 12" TO 60" X 60"
MACHINING AREAS

Visit us at
www.uscyberlab.com

U. S. CYBERLAB, INC., 14786 SLATE GAP RD., WEST FORK, AR 72774
VOICE (501) 839-8293 / 24 HR. FAX BACK (501) 839-8293

BUGGED??

FAVESDROPPING is unbelievably widespread! Electronic
Devices with amazing capabilities can be monitoring your
telephone and room conversations RIGHT NOW! Are you
sure you're safe? **FREE CATALOG** tells you fast! Includes
Free Bonus details on fantastic opportunities now open in
Counter-Surveillance field. Exciting, immensely interesting
and EXTREMELY profitable (up to \$250/hr) full/part-time
come. Call Now! **1-800-732-5000**

CABLE TV CONVERTERS

Equipment & Accessories
Wholesalers Welcome
Call **C&D ELECTRONICS**
1-888-615-5757 M-F 10a-6p

!!! BROADCAST EQUIPMENT !!!

We manufacture & carry Stereo FM Transmitters,
RF Amplifiers, Low Pass Filters, Antennas, DJ Mixing
Boards & Consoles, Mics, Compressor/Limiters, Digital
Reverbs, Automation Software, RF Test Equipment, RF Parts
including 8GY133's, and much more! Call For Free Catalog.

Progressive Concepts
BOX 586 STREAMWOOD, IL 60107
(630) 736-3922 FAX: (630) 736-0353



LASER WINDOW BOUNCE LISTENING SYSTEM

Remarkable concept allows user to hear sounds within a premise over a beam of laser light reflected from a window or similar surface. Experimental device provides hours of interesting and educational use. Utilizes a visible red laser that simplifies alignment and discourages illegal use. Usable range will vary—expect about 20 to 50 meters. Optional lens will increase range 200 to 400 meters! Further range requires expensive optics. Basic system setup requires patience in alignment and a sturdy video tripod (not incl.)



Uses Scattered and Direct Reflections

- LWB5 Plans.....\$20.00 LWB5K Kit/Plans.....\$149.95
 LWB50 Basic System Assembled and Tested.....\$199.95
 LWB70 Higher Performance Version With High Coherence Laser Gun Sight, Extending Lens, Delux Headsets.....\$299.95

LASERS

SUPER BRIGHT VISIBLE RED POINTERS

- *Signaling Beacon Visible Over 25 Miles!!
- *Over 1/2 Mile Pointing Range
- *Light Up a Low Level Cloud
- *Great Fun At The Mo!
- *Drive The Cat Nuts!!
- *8Hrs On AAA Batteries

- LAPN65 15 mw equiv 2000ft.....\$24.95
 LAPN65F Above Focussable.....\$29.95
 LAPN63 30 mw equiv 4000ft.....\$49.95
 LAPN63F Above Focussable.....\$54.95

PRICE SLASH LASER "LIGHT SHOW" POINTERS

- *Projects 7 Complex Light Designs
 - *Produce a Small Light Show
- LAPN6SPT 640nm 7 Patterns.....\$19.95!!

FM TRANSMITTER KITS

ALL PARTS TO BUILD 8 LONG RANGE WIRELESS DEVICES

- 1 Super Sensitive Ultra Clear 1 Mile+ Voice Transmitter
- 2 1 Mile+ Telephone Transmitter
- 3 Line Powered Telephone Transmitter Never Needs Batteries!!
- 4 Tracking/Homing Beacon "Beeping Transmitter"
- 5 Transmitter Rebroadcasts Video or Audio Outputs
- 6 Short Range TV/FM Disrupter NEAT PRANK!! Discretion Advised

All 6 Above Kits Plus FREE Info Data Pack on HELPFUL HINTS Building and Tuning Wireless Devices

COMBO Parts and Plans for above.....\$59.95
 COMBO Plans for all the above!.....\$10.00

KINETIC ELECTRIC GUN

PIONEER A FUTURISTIC WEAPON!



PROTOTYPED IN OUR LABS Labeled A Dangers product JOIN THE RESEARCH!

500 Joules Energy Storage
 Constant Current Charging
 Triggered Spark Switch
 Ballistic Velocities
 Handheld Battery Operated

EGUN1 Plans with Parts List.....\$20.00
 All Parts are Individually Available

3 MI FM BROADCAST TELEPHONE TRANSMITTER

Tunable On FM Broadcast. Excellent Telephone Project. Only Transmits When Phone is Used
 WVPMTK Kit/Plans\$39.95
 BEEP1K Beeper Alert Kit.....\$19.95

10-14" of Explosive Bolts of Lightning 250KV TESLA COIL

Transmit Wireless Energy Strange and Bizarre pyrotechnical effects. Ion Motors Anti-Gravity Size 20" H x 8" Sq Weight - 25 Pounds 115 Volts/2 Amps AC Labeled "Use Caution"

- BTC3 Plans.....\$15.00
 BTC3K Kit/Plans.....\$399.95
 BTC30 Ready to Use.....\$499.95
 BTC4 Plans 24 to 30" Sprk.....\$20.00

HIGH POWER STUNGUNS

- STUN100 100KV StunGun...\$19.95
 STUN200 200KV StunGun...\$39.95
 STUN300 300KV StunGun...\$49.95

ION RAY GUN PROJECTS ENERGY!



Star Wars Technology Demonstrates Weapons Potential! See Ions In Motion!

- IOG719 Plans.....\$10.00
 IOG7K Kit/Plans.....\$99.95
 IOG70 Assembled and Tested.....\$149.95
HIGHER POWERED DEVICE
 IOG9K Kit/Plans.....\$149.95
 IOG90 Assembled and Tested.....\$199.95

ATTENTION!

Battery Powered Mini Sized Modules for research in: HOVERCRAFT, ION GUNS FORCE FIELDS, SHOCKERS
 MINIMAX4 4KV@10ma.....\$19.95

GRAVITY GENERATOR

Demonstrates a unique phenomena of electrical reactions that produce the effect of "anti-gravity". You build and levitate a small rock space ship from simple materials. Excellent scientific demonstration of a fascinating method of levitation. *Levitate an Object!*

- GRA1 Plans and Book.....\$20.00
 GRA1K Pwr Sup Kit/Plans.....\$99.95
 GRA10 Assbled Pwr Sup.....\$149.95

SHOCK FORCE FIELD/VEHICLE OBJECT ELECTRIFIER

Hand Shock Balls, Wands, Electrify Objects. Great Payback for Those Wiseguys!
 SHK1K Kit of Pwr Module.....\$19.95

1 800 221 1705 ORDERS ONLY! FAX 1 603 672 5406 INFO 9-5pm 1 603 673 4730 FREE CATALOG ON REQUEST
 Pay by MC, VISA, Cash, Chk, MO, COD. Please Add \$5.00 S&H plus \$5.00 if COD. Overseas Please Contact for PROFORMA

FCC License Preparation

Electronics Tech., Avionics, Marine & Radar HOMESTUDY—Fast, Easy & Inexpensive Manuals, Audio, Video, PC disks, latest Q&A's Free 1-800-800-7555 "Guaranteed Pass" See at <http://www.worldaccessnet.com> BusinessShowcase/wpt. 4701 NE 47th St. Vancouver, WA 98661 - WPT Publications

SINGERS! REMOVE VOCALS

Unlimited, Low Cost, Instantly Available Background Music from Original Standard Recordings! Does Everything Karaoke does... Better, and gives you the Thompson Vocal Eliminator! Free Brochure & Demo Tape... LT Sound Dept PE 7988 LT Parkway, Lithonia, GA 30058 Internet-<http://www.LTSound.com> 24 Hour Demo/Info Request Line (770)482-2485 - Ext 49 When You Want Something Better Than Karaoke!



ATTENTION CABLE VIEWERS Own Your Own Unit Today Cable TV Converters & Descramblers All Makes / All Models

Call 1-800-577-8775

Technical Info: 847-584-2099

Weeder Technologies



Visit our ON-LINE CATALOG



Pro-Kit

PO Box 2426, Ft. Walton Beach, FL 32549

www.weedtech.com

Voice/Fax 850-863-5723

Stackable RS-232 Kits

Digital I/O - 12 I/O pins individually configurable for input or output. DIP switch addressable; stack up to 16 modules on same port for 192 I/O points. Turn on/off relays. Sense switch transitions, button presses, 4x4 matrix decoding using auto-debounce and repeat. \$32

Analog Input - 8 input pins. 12-bit plus sign self-calibrating ADC. Returns results in 1mV steps from 0 to 4095. Software programmable alarm trip-points for each input. DIP switch addressable; stack up to 16 modules on same port for 128 single-ended or 64 differential inputs. \$49

Home Automation (X-10) - Connects between a TW523 and your serial port. Receive and transmit all X-10 commands with your home-brewed programs. Full collision detection with auto re-transmission. \$39

Caller ID - Decodes the caller ID data and sends it to your serial port in a pre-formatted ascii character string. Example: "12/31 08:45 850-863-5723 Weeder, Terry <CR>". Keep a log of all incoming calls. Block out unwanted callers to your BBS or other modem applications. \$35

Touch-Tone Input - Decodes DTMF tones used to dial telephones and sends them to your serial port. Keep a log of all outgoing calls. Use with the Caller ID kit for a complete in/out logging system. Send commands to the Home Automation or Digital I/O kits using a remote telephone. \$34

Telephone Call Restrictors

Two modes of operation; either prevent receiving or placing telephone calls (or call prefixes) which have been entered into memory, or prevent those calls (or call prefixes) which have "not" been entered.

Block out selected outgoing calls. Bypass at any time using your password. \$35

Block out selected incoming calls. Calls identified using Caller ID data. \$48

Phone Line Transponder

7 Individual output pins are controlled with buttons 1-7 on your touch-tone phone. Automatically answers telephone and waits for commands. Monitor room noises with built in mic. "Dial-Out" pin instructs unit to pick up phone and dial user entered number(s). Password protected. \$48

IR Remote Control Receiver

Learns and responds to the data patterns emitted by standard infrared remote controls used by TVs, VCRs, Stereos, etc. Lets you control all your electronic projects with your TV remote. 7 individual output pins can be assigned to any button on your remote, and can be configured for either "toggle" or "momentary" action. \$32

DTMF Decoder/Logger

Keep track of all numbers dialed or entered from any phone on your line. Decodes all touch-tones and displays them on a 16 character LCD. Holds the last 240 digits in a non-volatile memory which can be scrolled through. Connect directly to radio receiver's speaker terminals for off-air decoding of repeater codes, or numbers dialed on a radio program. \$55

**OVER
30,000
ITEMS
IN STOCK**

**LARGE VARIETY
SAME DAY SHIPPING**

Minimum Orders \$20.00

Not Including Shipping & Handling

Dalbani®

The Ultimate Saving Source

SEMICONDUCTORS

Original #	Brand	Replaces
7805	Tesla	960
7806	Ank	962
7809	Ank	1910
7810	Samsung	1968
7812	Tesla	966
7815	Tesla	968
7818	Tesla	958
7824	Tesla	972
7905	Tesla	961
7906	Tesla	963
7908	Tesla	965
7912	Ank	967
7918	Tesla	959
7924	Tesla	971



YOUR CHOICE

\$45c

each

**Dalco®
ECONOMICAL
SOLDER WICK**

5 Feet

- Length: 5 feet
- Width: 0.15"
- Safer Desoldering
- Fast Response

Item # 51-1050



Removes solder easy

\$1.10

SHIP UP TO 5lbs FOR ONLY

\$3.95

**UPS
2ND DAY AIR**



Plus handling & C.O.D. charge if it applies

**THE MOST POPULAR
VCR ALIGNMENT TOOL KIT**

\$24.99

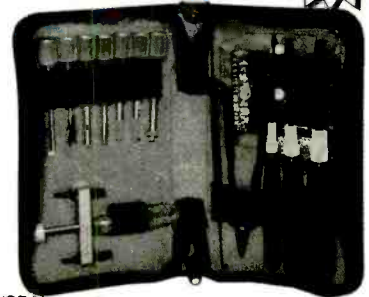

- VCR Head pull
- Retaining ringremover
- Micro screwdriver
- Fitted vinyl Case
- 7 Assorted head & guide aligner
- Dimensions: 9 1/2" (W) X 12 1/4" (L)
- 3 Reverseable screwdrivers (Small-Flat-Phillips)
- Spring hook
- Hex key set
- Soft zippered case

Item # 50-888

POPULAR FUSE KIT 180 Piece Kit

Kit Contains 10 Pieces of each of these items:

- AGC Type : 0.5A, 1A, 1.5A, 2A, 2.5A, 3A, 4A, 5A, 6A, 10A, 15A
- Ceramic Type : 15A
- GMA Type : 1A, 1.5A, 2A, 3A, 4A, 5A



\$13.95

Item # 10-2050

TUN-O-WASH® (CFC Free)

Fast drying electronics grade cleaner for tuners, controls and PC boards.

- CFC and HCFC free
- Not for use on energized equipment
- Due to the chemical content, this product can be only shipped by UPS ground service.

Item # 30-0100
(12.5 Oz aerosol)

\$11.75



SOLDERING IRON

- General Purpose Applications
- 117V AC, 30 Watts

Item # 51-1335



\$3.25

**WELLER WLC100
SOLDERING STATION**

Weller



\$38.90

- Ideal for the professional, serious hobbyist
- Variable power control (5-40W)
- 40W pencil iron and ST# inter changeable tip
- Replaceable heating element
- Cushioned foam grip • Safety guard iron holder
- On/off switch with "power-on" indicator light

Item # 51-1505

**HEAVY DUTY COLOR
CODED LEADS**

- 10 Leads
- 11" Long Wire Lead
- Insulated 11/2" Alligator Clips
- 20 Gauge Wire Size
- Black, Green, Red, Yellow, White

Item # 56-500



\$2.95

**DALCO DIGITAL
MULTIMETER**

- DC Voltage: 200m-1K
- AC Voltage: 200-750V
- DC Current: 20m-20
- Transistor and Diode Test
- Continuity Buzzer
- Polarity indicator appears on LCD
- Test Probes Included
- Dimensions: 4.96" x 2.76" x 9.4"
- Weight: 6 oz.
- 9V Battery Included

Item # 50-2895



\$9.95

**Dalco® SWING ARM
MAGNIFYING LAMP**

- Spring-Balanced 45" extension arm with 3 conductor cord 120V 60Hz
- Steel Shade supplied with a precise 3 diopter lens and a 22W fluorescent circline tube
- Comes with a lamp

Item # 54-0120



\$36.72

White Color

Dalbani®

4225 NW 72ND AVE. MIAMI, FLORIDA 33166
TEL : (305) 716-1016 ----- FAX : (305) 594-6588

**Free 400 Page Color Catalog
With your First Order**

1-800-325-2264

CIRCLE 157 ON FREE INFORMATION CARD

CABLE TV DESCRAMBLERS

***GUARANTEED
LOWEST PRICES*
*DESCRAMBLERS
FOR ALL SYSTEMS*
FREE SHIPPING
CRAZY LIZ'S ELECTRONIC
WAREHOUSE**

**CALL TODAY!
1-800-391-7803
EQUIPMENT IS NEW & GUARANTEED**

\$139* Laser LightShow

Draw with a laser beam! Animation, text, music & more! Includes galvos, mirrors, servo amp, demo software disk, analog and digital computer interface. Use an inexpensive pen pointer or high power gas laser.

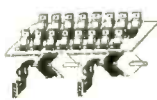
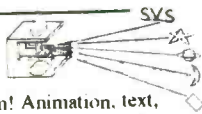

Computerized Motors \$39*

Includes: 2 Stepper motors, 2 DC motors, computer interface, training manual, & demo software disk. Expandable! Up to 12 motors, up to 3 amps per phase. Now with 4 Axis Linear Interpolation

* Add \$6 for shipping. Computer with parallel printer port & cable, assembly, power supply, & laser are required

FREE FLYER

Voice 510-582-6602 Fax 510-582-6603

SVS 1273 Industrial Pkwy West Bldg. 460
PO Box 55125 Hayward CA 94545-0125

World Passing You By?

Are you interested in Microprocessors & Embedded Control Systems? If not you should be! Look around, just about everything these days has an embedded microprocessor in it. TVs, cars, radios, traffic lights & even toys have embedded computers controlling their actions. The Primer Trainer is the tool that can not only teach you how these devices operate but give you the opportunity to program these types of systems yourself. Examples & exercises in the Self Instruction manual take you from writing simple programs to controlling motors. Start out in Machine language, then move on to Assembler, & then continue on with optional C, Basic, or Forth Compilers. So don't be left behind; this is information you need to know!

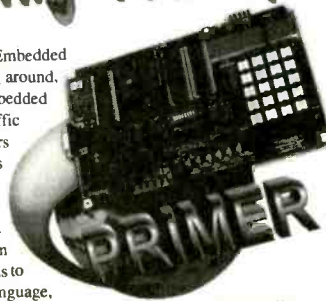

Examples Include:

- Measuring Temperature
- Using a Photocell to Detect Light Levels
- Making a Waveform Generator
- Constructing a Capacitance Meter
- Motor Speed Control Using Back EMF
- Interfacing and Controlling Stepper Motors
- Scanning Keypads and Writing to LCD/LED Displays
- Bus Interfacing an 8255 PPI
- Using the Primer as an EPROM Programmer
- DTMF Autodialer & Remote Controller (New!)

The PRIMER is only \$119.95 in kit form. The PRIMER Assembled & Tested is \$169.95. This trainer can be used stand alone via the keypad and display or connected to a PC with the optional upgrade (\$49.95). The Upgrade includes: an RS232 serial port & cable, 32K of battery backed RAM, & Assembler/Terminal software. Please add \$5.00 for shipping within the U.S. Picture shown with upgrade option and optional heavy-duty keypad (\$29.95) installed. Satisfaction guaranteed.

EMAC, inc.

11 EMAC WAY, CARBONDALE, IL 62901
618-529-4525 Fax 457-0110 BBS 529-5708
World Wide Web: <http://www.emacinc.com>

1985 - 1998
OVER
12
YEARS OF
SERVICE

BREAST CANCER BEGINS
EVEN SMALLER THAN THIS
THAT'S WHY YOU
NEED A YEARLY
MAMMOGRAM
ESPECIALLY AS
YOU GET OLDER.
MAMMOGRAMS
CAN DETECT
LUMPS TOO
SMALL FOR
YOU TO FEEL
AND EARLY
DETECTION
MAY SAVE
YOUR LIFE,
SO CALL
1-800-
ACS
2345.

GET A MAMMOGRAM
EARLY DETECTION IS THE BEST PROTECTION.

VIDEO SYNC GENERATOR



Restores Horizontal
and Vertical
Sync Lines from
Distorted Video



Lost Sync



Restored Sync
with VSG

For Free Information Package and Pricing

Call (219) 233-3053
www.south-bend.net/rcd
R.C. Distributing, PO Box 552, South Bend, IN 46624

Quality Microwave TV Systems

WIRELESS CABLE • IFTS • MMDS
ATV • INTERNATIONAL • DIGITAL
Amplifiers • Antennas • Books • Components
• RF Frequency 2100-2700 MHz
• SASE For "FREE" Catalog or Send \$1
PHILLIPS-TECH ELECTRONICS
P.O. Box 13074 • Scottsdale, AZ 85267-3074
CATALOG/INFO: 602-947-7700
ORDER LINE: 800-880-MMDS
602-947-7799
FAX LINE:
WEBSITE: www.phillips-tech.com
E-MAIL: product@phillips-tech.com
Visa • M.C. • AmEx • Discovery • C.D's • Quantity Pricing

Cable T.V. Converters & Equipment

Lower
Prices
Dealer
Discounts
30-Day
Money back
1-year
warranty
MC, Visa,
AE, COD



No Florida Sales
www.cable4you.com
1-(800) 888-5585

The Pocket Programmer

\$129.95

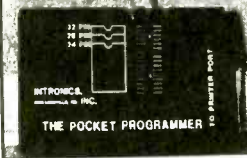

The portable
programmer
that uses the
printer port of
your PC
instead of a
internal card.

Easy to use software that programs
E(E)prom, Flash & Dallas Ram. 27(C)/
28(C)(F)/29(C)(F)/25 series from 16K to 8
Megabit with a 32 pin socket. Adapters
available for MCU's 874X, 875X, Pic, 40-
Pin X 16 & Serial Eprom's, PLCC, 5-Gang
and Eprom Emulator to 32K X 8.

Same Name, Address & Phone # for
13 Years.... Isn't it Amazing ?

Intronics, Inc.
Box 13723 / 612 Newton St.
Edwardsville, KS 66113 Add \$4.75 COD
Tel. (913) 422-2094 Add \$4.00 Shipping
Fax (913) 441-1623 Visa / Master Charge

PROGRAMMERS

ADVANTECH EETOOLS NEEDHAM'S DATA I/O ICE TECHNOLOGY HILO
SYSTEM GENERAL CHROMA MODULAR CIRCUIT TECHNOLOGY XELTEK

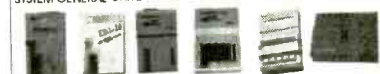

PROMAX EMP-20 MEGAMAX MEGAMAX4 SIMM/SIP TESTER EMUPA
CALL ADVANTECH LABTOOL 599 EETOOLS SIMMAX
629 ICE TECH MICRO 795 CHROMA SIMM/SIP
650 EETOOLS ALLMAX + 359 MOD-MCT-EMUPA/R
409 EETOOLS MEGAMAX 279 MOD-MCT-EMUP/R
509 EETOOLS MEGAMAX4 49 EPROM 1G TO 512K
369 XELTEK SUPERPRO II 69 EPROM 1G TO 1MEG
409 XELTEK SUPERPRO II P 99 EPROM 4G TO 1MEG
249 XELTEK SUPERPRO L 199 EPROM 16G TO 1MEG
165 XELTEK ROMMASTER II 89 EPROM 1G TO 8MEG
479 MOD-MCT-EMUPA 129 EPROM 4G TO 8MEG
739 STAG ORBIT-32 250 EPROM 8G TO 8MEG



LABTOOL48 MICROMASTER SUPERPRO ALLMAX PLUS ROMMASTER2
General Device Instruments
Sales 916-393-1655 Fax 916-393-4949 BBS 983-1234
Web www.generaldevice.com E-Mail icdevice@best.com

EPROM+ *The Professionals Choice!*

A rugged device programming system for bench and field

Uses parallel printer port!

Supports all standard parts!

Excellent, easy-to-use software!

- FIRST GENERATION EPROMS 2708, TMS2716*, 25XX
- SECOND GENERATION EPROMS (24, 28, 32 PIN) 2716 - 27C100 (8 MEG) *ADAPTER REQUIRED DIAGRAMS INCLUDED
- 16 BIT EPROMS* (40, 42 PIN) 27C1024 - 27C160 (16 MEG)
- FLASH EPROMS (28, 32 PIN) 28F, 29C, 29EE, 29F FAMILIES PLUS BOOT BLOCK DEVICES
- EPROMS/NVRAMS (24, 28, 32 PIN) 28C04 - 28C010, X2210/12, ER5901, PLUS DALLAS 12XX
- SERIAL EPROMS* (8, 14 PIN) 17XX, 24XX, 25XX, 35XXX, 59XX, 85XX, 93XX, 95XX+ER1400
- BIPOLAR PROMS* (16 - 24 PIN) 74SXXX AND 82SXXX FAMILIES
- MICROCONTROLLERS* (ALL FAMILIES) 874X, 875X, 87C5XX, 87C75X, 89C5X, 89CX051, 89SXXX, 916SXXX, 68705, 68711, PIC12CXXX - 16CXXX, 17C3X PLUS FLASH AND 14000

- READ, PROGRAM, COPY, COMPARE, FILE LOAD/SAVE (PLUS MUCH MORE!)
- FULL SCREEN EDITOR W/25 CMDs + BYTE/WORD MODES
- RUNS UNDER DOS, WIN3.1/95/98 AT ALL CPU SPEEDS
- SUPPORTS INTEL HEX, S-RECORD AND BINARY FILES
- MADE IN USA • 30 DAY MONEY BACK GUARANTEE

\$289

SYSTEM INCLUDES: PROGRAMMING UNIT, PRINTER \$5.00 SHIPPING + \$5.00 C.O.D.
PORT CABLE, POWER PACK, SOFTWARE & MANUAL VISA • MASTERCARD • AMEX

ANDROMEDA RESEARCH, P.O. BOX 222, MILFORD, OH 45150
(513) 831-9708 FAX (513) 831-7562 website - www.arlabs.com

The World's Largest Source for Home Automation

- The Best & Most Comprehensive Home Automation Catalog In the Industry
- Best Customer Service & Technical Support

Thousands of hard-to-find automation, X-10 and wireless control products. Computer interfaces, software development tools, lighting control, telephone systems, security systems, surveillance cameras, infrared audio/video control, home theater, touchscreen control, HVAC, pet care automation, wiring supplies, books and videos and much more!

FREE
160 page full color catalog!



World's Largest Selection!

Lowest Prices Guaranteed!

HOME AUTOMATION SYSTEMS, INC.

Questions: 949-221-9200 Fax: 949-221-9240

e-mail: catalog@smarhome.com

www.smarhome.com

Call for a **FREE** Catalog! 800-762-7846

800-SMART-HOME

Dealers/Retailers ask about our SmartHome PRO Dealer Program 800-949-6255

LEARN INTERNET SECRETS

- HOW TO:
- CONTROL OTHER COMPUTERS
 - ACCESS LIVE TV/RADIO WORLDWIDE
 - GET FREE ONLINE ACCESS
 - OBTAIN FREE SOFTWARE
 - MUCH, MUCH MORE!

1-900-740-4448 EX. 9477. \$2.99 per min
Must be 18 yrs. Serv-U (619) 645-8434

SURVEILLANCE HIDDEN CAMERAS

DIRECT FROM MANUFACTURER - BEST PRICE IN THE MARKET



Ultra miniature hidden camera, in dome, omnidirectional detector of mic, B/W or Color. Wide view angle. Low light sensitivity + super sharp images, plus video and audio output. From \$150.00. Also 1/2" B/W board camera, only \$90.00 USD. Wireless hidden camera, still or only \$249.00 USD. Plus \$5.95 for SH. Wholesale Welcome. CCD, Check, Money Order or Visa/MC.

BOLIDE INTERNATIONAL CORPORATION
PH: (800) 365-0898 or (626) 575-6178
9660 Flair Drive #218, El Monte, CA 91731
<http://www.bolideamazingproducts.com/>

CABLE EQUIPMENT

LOW, LOW WHOLESALE PRICES!
1-800-521-0512

New 1-piece Jerrold-5 units \$109/ea; 10 u. \$89/ea; 20 u. \$89/ea.

New RFT-M - 5 units \$109/ea; 10 u. \$99/ea; 20 u. \$89/ea.

Basic Converter - 5 units \$75/ea; 10 u. \$65/ea; 20 u. \$55/ea.

WHOLESALE ELECTRONICS

Check out our website: www.whe.net

BEST DEALER PRICING!

CABLE DIRECT

CONVERTERS • FILTERS
DESCRAMBLERS

IMPROVE YOUR IMAGE WITH
VIDEO STABILIZERS

FREE
CABLE TV
CATALOG!

100%
MONEY BACK
GUARANTEE!



Now you can tune-in your favorite cable TV programming and SAVE \$100'S - EVEN \$1000'S on premium CABLE TV EQUIPMENT.



MODERN ELECTRONICS

1-800-906-6664

2609 S. 156TH CIRCLE • OMAHA, NE 68130

<http://www.modernelectronics.com>

ATTENTION DEALERS: WHOLESALE ONLY!



Formerly JES, Inc.

EXCLUSIVE:



2 PIECE SETUPS: \$85⁰⁰

10 lot • 1 Year Warranty

Latest Technology • Universal Combo's - Ask For Details
CALL US LAST! LOWEST PRICES GUARANTEED!

TOLL FREE:
800-375-3682



FAX:
516-246-5634

MONDO • TRONICS

ROBOT STORE

* KITS *

Your

* BOOKS *

Mailorder

* PARTS *

Source

* VIDEOS *

For

* MODELS *

Robots!

* MORE! *

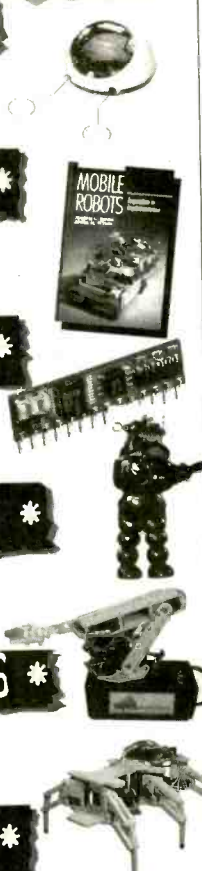

(REQUEST OUR FREE CATALOG)

www.robotstore.com

800-374-5764

Or write to us:

4286 Redwood Hwy #226-137
San Rafael CA 94903

Phone 415-491-4600 • Fax 415-491-4696

Email info@mondo.com

CLASSIFIED

AUDIO-VIDEO-LASERS

Unique Video Products Pattern Generators with character identification, composite, s-video, RGB, distribution amplifiers, kits also available, FREE catalog, **GEKCO Labs**, PO Box 642 Issaquah, WA 98027-0642, 888-435-7221, www.gekco.com.

BUSINESS OPPORTUNITIES

HUNDREDS OF INCOME OPPORTUNITIES! Receive 3 free issues! **Spare Time Magazine**, 5810 W. Oklahoma, Dept. PE299, Milwaukee, WI 53219. (414)543-8110.

Inventions/New Products. ISC, America's leading invention firm, helps submit to companies. Patent Services. 1-800-288-IDEA.

Marketing Firm-**Seeks New Products/Ideas**. Full Patenting & Marketing Services Available. For FREE Information kit, call anytime 1-800-846-8368 Ext. 202.

Microwave oven repair course. Universal training manual, schematics, free microwave power detector, technician's certificate. \$60.00, **MOTS TECH**, Box 29141, Thunder Bay, Ontario, Canada. P7B6P9.

CABLE TV

CABLE DESCRAMBLING, New secret manual. Build your own Descramblers for Cable and Subscription TV. Instructions, schematics for SSAV1, Gated Sync, Sinewave, \$12.95, \$2 postage. **CABLETRONICS**, Box 30502PE, Bethesda, MD 20824.

Cable TV descramblers. The New MAESTRO Universal works in 90% of the U.S. Dealers welcome. Call 1-800-846-5110.

CABLE TV Descramblers. One piece units. Scientific Atlanta, Jerrold, Pioneer, and others. Lowest prices around. **Precision Electronics** Houston, TX. Anytime. 1-888-691-4610.

Free Cable Descrambler Plans. For Details Write: Sierra Publishing, 909 E. Yorba Linda Blvd., Suite H-181, Dept PEX, Placentia, CA 92870.

Wholesale to the public. The industries leading distributor of cable electronics is now open to the public. We will beat all competitors pricing. **Dimension 1-800-474-2343.**

CUBE for Jerrold Model CFT-2200, 2014, 2024, 2254, Pioneer 6300-6310, Auto-Multimode, Zenith ST-1600 \$175.00. Lowest price call 800-822-8530.

All cable TV boxes. We'll beat any price. 30 day trial, 1 year warranty. 1-800-538-CABLE(2225).

CABLE TV EQUIPMENT & ACCESSORIES. Wholesalers Welcome! 30 Day Moneyback Guarantee! Free Catalog! **PERFORMANCE ELECTRONICS, INC.** 1-800-815-1512.

FREE TV CABLE CATALOG. Revolutionary new products. Converters, Full viewing boxes, Gold or Silver, that do all boxes. Open 7 days a week. 1-800-676-6342.

Free Cable TV t-shirt with the purchase of a radio frequency test cube, converter or video stabilizer. We will beat any price!!! **Cable USA, Inc.** 1-888-388-CUBE.

CB-SCANNERS

CB Radio Modifications! Frequencies, kits, high-performance accessories, books, plans, repairs, amps, 10-Meter conversions. The best since 1976! Catalog \$3.00. **CBCI**, Box 1898PE, Monterey, CA 93942. www.cbciintl.com

COMPUTER HARDWARE

New computers and parts at wholesale prices. www.techass.com Toll free 1-877-Techass. We ship all parts and computers. 1-877-832-4277.

MISC. ELECTRONICS FOR SALE

RF TRANSISTORS AND TUBES 2SC2879, MRF454, MRF422, 2SC1969, 2SB754, SD1446, 3-500ZG, 3CX3000A7, 4CX250B, **WESTGATE** 800-213-4563.

PLANS-KITS-SCHEMATICS

ELECTRONIC PROJECT KITS: 49 McMichael St, Kingston, ON., K7M 1M8. \$3.00 catalog. www.qkits.com. **QUALITY KITS.**

CATALOG: Broadcasting/micro transmitters, amplifiers, antennas. Start your own radio station books. Audio, TV, Ham, CB, Surveillance, Science projects and more. www.panaxis.com **PAN-COM Int'l**, PO Box 130-2, Paradise, CA 95967.

MONITORS MADE SIMPLE. Learn to repair computer monitors! Case studies, illustrations, parts sources, manufacturers included! 136 pages, softcover, \$19.95 + \$2.50 shipping. Order today! Send check or money order to **Pikes Peak Press** 321 W. Henrietta Ave. P.O. Box 1801, Woodland Park, CO 80866. (719) 687-1499.

AWESOME KITS: Voice Changers, Levitators, Lasers, Gas Sensors and more! Catalog \$1.00. **LNS Technologies**, PO Box 67243, Scotts Valley, CA 95067 www.ccnf.com/~lnstech.

HEATHKIT COMPANY is selling photocopies of most Heathkit manuals. Only authorized source for copyright manuals. Phone: 616-925-5899, 8-4 ET.

PUBLICATIONS

SHOCKING PLANS! 190+ Publications. Impossible to find underground info! Hacking, revenge, money-making, and lots more. Very unusual stuff! Free catalog. **TIC** PO Box 876PM Hurst, TX 76053, www.theinformationcenter.com

SATELLITE EQUIPMENT

FREE CATALOG - Satellite TV/GPS-DIY. Technical Books, Installation Videos, Computer Analysis Software www.baylin.com 800-843-2425.

SKYVISION! Your Satellite Home Entertainment Source. Best values: DBS and C/Ku-band equipment, including 4DTV. Most complete selection: Parts-Tools-Upgrades-Accessories! Free Discount Buyer's Guide. Call 800-543-3025. International 218-739-5231. www.skyvision.com.

DSS Hacking: How to construct and program smart cards, w/pic16C84, Complete DSS system schematics, \$16.95. Software \$25. CABLETRONICS Box 30502PE, Bethesda, MD 20824

WANTED

WANTED: HEATHKIT ID-4001, ID-1990, ID-1990, ID-2090 (working) Digital Weather Computers. Also, microprocessors for above. heathkit@USA.NET

CALLER ID ON TV

NEW! CALLER-TV \$49.95 NO MORE INTERRUPTIONS! Know who's calling immediately. Secure internet ordering www.caller-tv.com, 520-544-4567.

INVENTORS

INVENTORS: Free information package and initial phone consultation. Attorney JP Halvnik. Washington DC area, 800-876-6670.

BEST BY MAIL

Rates: Write National, Box 5, Sarasota, FL 34230

FINANCIAL

BAD CREDIT? Learn to increase, improve and repair bad credit. \$20 + \$4.00 (S&H). James Brown, 1201 Bethlehem Pike, Suite 105-(PE), North Wales, PA 19454.

INTEREST TO ALL

INSPIRATIONAL STORIES by Frank Jakubowsky. \$10.00. Jesus Books, 1565 Madison, Oakland, CA 94612-4511.

MAJOR RETAILER WANTS Your Invention! Send \$10.00 mailing fee to: Paradise, PO Box 11, Berwick, PA 18603.

PROTECTION! FREE CATALOG! Write to: EJ City, PO Box 545, Buffalo, NY 14201.

YOU WILL WIN EASILY AT CRAPS! GUARANTEED! Write for FREE information: Ames, Box 1360, Belmont, CA 94002.

POPTRONIX

Online Edition

We're on the web **FREE**

<http://www.poptronix.com>

ELECTRONIC GAMES

BP69—A number of interesting electronic game projects using IC's are presented. Includes 19 different projects ranging from a simple coin flipper, to a competitive reaction game, to electronic roulette, a combination lock game, a game timer and more. To order BP69 send \$8.00 (includes s&h) in the US and Canada to Electronic Technology Today Inc., P.O. Box 240, Massapequa Park, NY 11762-0240. US funds only. Use US bank check or International Money Order. Allow 6-8 weeks for delivery. MA07

Electronic Games



MICROTEST INC. CABLE TEST CHIPS FROM \$9.95

WE STOCK A COMPLETE LINE OF CHIPS WE ALSO HAVE CRYSTAL 119.MHZ117.MHZ

WARNING. ANYONE IMPLYING ILLEGAL USE WILL BE DENIED SALE. WE SELL PRODUCTS ONLY TO TECHNICIAN OR REPAIR FACILITIES ALL ORDERS SHIP VIA UPS/ECT THE BEST PRICE IN THE MARKET WE INCLUDE SWITCH & RESISTER MON-SAT 8 AM-7 PM EST. TECH SUPPORT E-MAIL WWW.MICRO-TEST@AOL.COM

FOR ORDERS 1-800-931-9440

SECRETS!

Unusual, detailed how-to books, manuals, references, old & new, for experimenters and

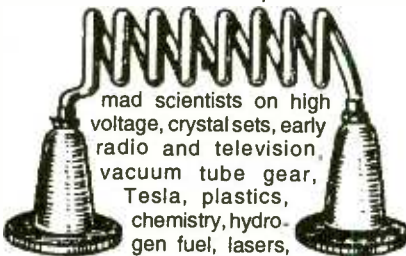

mad scientists on high voltage, crystal sets, early radio and television, vacuum tube gear, Tesla, plastics, chemistry, hydrogen fuel, lasers, boozie, solar cells, embalming, telegraphy, more! Highest quality how-to! Guaranteed! Big illustrated catalog! fax:815/935-5477 Write! • <http://www.lindsaybks.com>

Lindsay's Technical Books
PO Box 538-WJ7, Bradley, IL 60915



A public service of this magazine

Do You Repair Electronics?

Repair Databases for TV, VCR, Monitor, UL Audio, FCC, and more. - Over 76,000 records - Private user forums - Live on-line chat rooms

RepairWorld.com

© 1999 RepairWorld.com. All rights reserved.

CABLE TV CONVERTERS

Equipment & Accessories
Wholesalers Welcome

Call C&D ELECTRONICS
1-888-615-5757 M-F 10a-6p

CABLE TV EQUIPMENT

Converters, Test Cubes & Chips

1 Year Warranty
30 Day Money Back Guarantee



"ABSOLUTE LOWEST WHOLESALE & RETAIL PRICES"
CABLE U.S.A.
1-888-388-CUBE

GALEP-III
Pocket Multiprogrammer

This size fits all!



- Programs 8-bit and 16-bit EPROMs, EEPROMs, Zero Power RAMs, Flash, serial EPROMs • GAL, PALCE, ATF • 87xxx, 89xxx, PIC12/16/17Cxx • All DIL devices without adaptor • Lightning fast parallel data transfer (e.g. 27C512 read/compare 2 sec!) • Power supply independent due to rechargeable battery • Uses PC printer port • Hex, JEDEC, and binary file formats • Hex and fusemap buffer editor • Split & shuffle for 8-bit, 16-bit and 32-bit targets • Runs under Win3.1, 95, 98 • 'Remote control' by DDE scripts • Designed for the future due to flexible pin driver technology - new devices will be added every month • Device list, demo software and lifetime free updates from our website www.contec.com!

GALEP-III Set with cable, battery, recharger \$389.00
PLCC Adaptor for 8-bit EPROMs / 16-bit EPROMs / GALs each \$149.00

CONTEC 1951 4th Ave, Ste 301 • San Diego, CA 92101
Tel: (619) 702-4420 • <http://www.contec.com>

ULTIMATE HOME SHOP

Complete tools for metal & woodworking

Starting at \$995
Easy to use Versatile Affordable
FREE CATALOG
Call 1-800-345-6342

© 1999 Smithy Inc. P.O. Box 1517, Jax, FL 32236

HI-TECH SURVEILLANCE

Pinhole Cameras, Recording Devices, Bug Detectors, Lasers, Lockpicks, Pen Knives, Tracking Devices, Wireless Mics, Books/Videos, plus much more!!!!

FOR CATALOG - SEND \$5.00 TO:

Spy Way
P.O. Box 61805, Jax, FL 32236

ADVERTISING INDEX

Popular Electronics does not assume any responsibility for errors that may appear in the index below.

Free Information Number	Page	Free Information Number	Page
— AES	85	— James Electronic Services.....	89
— Alfa Electronics.....	83	— KDE Electronics	83
— All Electronics.....	69	— Lindsay Technical Books	91
— Allison Technology.....	85	— Lynxmotion	75
— Amazon Electronics.....	78	161 MCM Electronics	71
162 American Innovations.....	75	139 Mendelson's.....	78
— Andromeda Research.....	89	— Mental Automation	83
— Arrow Electronics.....	78	174 MicroCode Engineering	CV2
— 3D Audio.....	75	— Micro Test.....	91
— Basic Electrical Supply	68	— Modern Electronics	89
— Bsoft	74	— Mondo-tronics.....	90
32 C&S Sales, Inc.....	72	160 Mouser	70
— Cable USA	91	— NRI Schools.....	37
173 Cadsoft.....	5	156 Parts Express.....	CV3
— Circuit Specialists.....	80	— PHDI.....	70
— CLAGGK, Inc.....	17	— Pioneer Hill Software.....	70
— Clearview Group	70	150 Prairie Digital Inc.	74
— Cleveland Inst. of Electronics.....	27	143 Print	68
— Command Productions	74	142 Print	82
— Conitec.....	91	153 Print.....	76
— Consumertronics.....	82	— ProPlanet	88
— Crazy Liz's.....	88	— Securetek	78
157 Dalbani	87	— Silicon Valley Surplus	88
— EDE Spy Outlet	78	158 Sun Equipment	81
— Electronic Tech. Today.....	67	— Technological Arts	78
— Emac, Inc.....	88	137 Telulex.....	76
— Foley-Belsaw	79	— Test Equipment Depot.....	80
— General Device Instruments.....	88	— Top Serve.....	75
— Grantham College of Eng.....	14	147 UCANDO Videos	80
— Grich RC Inc.	70	— US Cyberlab	85
— Hollins Radio Data	7	163 Velleman Inc.	77
— Home Automation Systems.....	89	— Video Media	78
— ICS Computer Training.....	11	— Vision Electronics	70
— Information Unlimited.....	86	— Weeder Technologies	86
26 Interactive Image Technologies CV4		172 Windjammer Barefoot Cruises....	14
— Intronics, Inc.....	88	— World Star Technologies.....	78

ADVERTISING SALES OFFICES

Gernsback Publications, Inc.
500 Bi-County Blvd.
Farmingdale, NY 11735-3931
1-(516) 293-3000
Fax 1-(516) 293-3115

Larry Steckler, EHF/CET
President (ext. 201)
e-mail advertising@gernsback

Adria Coren
Vice-President (ext. 208)

Ken Coren
Vice-President (ext. 267)

Christina Estrada
Assistant to the President (ext. 209)

For Advertising ONLY
1-516-293-3000
Fax 1-516-293-3115

Larry Steckler
publisher

Marie Falcon
advertising director (ext. 206)

Adria Coren
credit manager (ext. 208)

**Subscription/
Customer Service/
Order Entry**
1-800-827-0383
7:30 AM - 8:30 PM EST

ADVERTISING SALES OFFICES

EAST/SOUTHEAST

Megan Mitchell
9072 Lawton Pine Avenue
Las Vegas, NV 89129-7044
Phone 702-240-0184
Fax 702-838-6924
mmitchell@gernsback.com

MIDWEST/Texas/Arkansas/ Oklahoma, Colorado, Arizona

Ralph Bergen
Midwest Sales
One Northfield Plaza, Suite 300
Northfield, IL 60093-1214
1-847-559-0555
Fax 1-847-559-0562
bergenrj@aol.com

PACIFIC COAST/Mountain States

Anita Bartman
Hutch Looney & Assoc., Inc.
6310 San Vicente Blvd.
Suite 360
Los Angeles, CA 90048-5426
1-323-931-3444 (ext. 227)
Fax 1-323-931-7309
anita@hlooney.com

PARTS EXPRESS

ELECTRONICS & MORE

Solid Brass Binding Posts

- ◆ Heavy Duty 5 Way Binding Posts
- ◆ Solid Brass Construction
- ◆ Ideal For High Power Applications
- ◆ Audiophile Quality

When only the best will do! These rugged 5 way solid brass binding posts are perfect for all high power and high performance applications. For use in speakers cabinets with walls up to 1-1/4" thick. Available in red or black color coded versions. Each post includes a plastic shoulder washer, flat washer, and nut. Can be tightened with 9/16" wrench or nut driver. 3-1/8" overall length.

#090-473 (Black)

#090-474 (Red) \$9.50 (1-9) \$8.50 (10-UP)



If you haven't received a copy of our current 268 page catalog ... have one added to your order or please give us a call and we will send one out to you immediately.



MOTOROLA

KSN1165A High Power Bullet Tweeter

◆ Power handling: 200 watts RMS/400 watts max ◆ Frequency response: 1,800-30,000 Hz ◆ SPL: 92 dB ◆ Manufacturer model number: KSN1165A ◆ Dimensions: A: 4-1/4", B: 4-1/4", C: 3"

#270-014 \$12.95 (1-3) \$11.50 (4-UP)



Amplified Video Switching Center

High quality video switching center gives you the flexibility to watch and/or record different sources simultaneously without the need to move complicated cables. Connect your VCR, CATV, satellite, video game, or home computer to two television sets. Gives you total control of your video system. 4 inputs, 2 outputs, all connections via "F" connectors. Pushbutton design. Amplified, broadband circuitry minimizes signal loss and cross-over. Simulated wood grain cabinet. Net weight: 4 lbs.

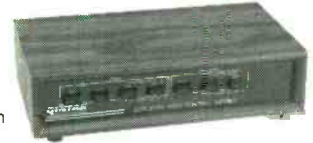

#180-155 \$42.90 (1-3) \$38.50 (4-UP)

Eminence Horn Drivers

Super quality, U.S. made compression horn driver features a huge 34 oz. magnet, 2" Kapton voice coil, and titanium diaphragm.

◆ 8 ohms ◆ 40 watts RMS power handling capability (conservative). ◆ Fs: 600 Hz. ◆ Response: 1,000-14,000 Hz. ◆ Sensitivity: 100 dB 1W/1m. ◆ Dimensions: diameter: 5-3/16", depth: 2-1/8". ◆ Net weight: 6 lbs.

◆ Replacement diaphragms: 16 ohm - #260-101, 8 ohm - #260-106, \$18.90 each.

#260-105 \$49.95 (1-3) \$44.50 (4-UP)



EMINENCE

Dayton Loudspeaker Co.®

5-1/4" Treated Paper Cone Woofer

Magnet structure is fully shielded to permit audio/video use. ◆ Power handling: 30 watts RMS/45 watts max ◆ Voice coil diameter: 1" ◆ Voice coil inductance: .33 mH ◆ Impedance: 8 ohms ◆ DC resistance: 6.0 ohms ◆ Frequency response: 45-6,000 Hz ◆ Magnet weight: 9.5 oz. ◆ Fs: 43.4 Hz ◆ SPL: 88dB 1W/1m ◆ Vas: .61 cu. ft. ◆ Qms: 1.82 ◆ Qes: .51 ◆ Qts: .40 ◆ Xmax: 2.5mm ◆ Net weight: 2-1/2 lbs. ◆ Dimensions: A: 5-1/4", B: 4-3/4", C: 3-1/8", D: 3-3/8", E: 1-3/8"

#295-300 \$13.50 (1-3) \$12.15 (4-UP)



CCD Board Cameras With Audio



#335-525 (Standard lens)

#335-530 (Pin hole lens) \$99.95 (1-3) \$88.90 (4-UP)

Soft Dome Tweeters

Part #	Model	Price (1-3)	Price (4-UP)
277-010	MDT-29	\$42.50	\$39.50
277-011	DMS-29	46.50	44.50
277-014	DMS-30	57.50	55.50
277-015	MDT-30	49.90	47.50
277-020	MDT-33 Pair	199.90	195.50
277-025	MDT-10	35.50	33.90
277-030	MDT-20	42.50	39.90
277-035	MDT-39	46.50	45.50
277-040	MDT-40	58.50	56.50



DYNAUDIO

AUTHENTIC TECHNOLOGY

ESOTEC Cast Frame Woofers

Part #	Description	Price (1-3)	Price (4-UP)
297-210	8 Ohm, 15W-75, 5-1/4"	\$127.50	\$119.90
297-215	4 Ohm, 15W-75, 5-1/4"	127.50	119.90
297-230	8 Ohm, 17W-LQ, 6-1/2"	131.90	125.95
297-235	4 Ohm, 17W-LQ, 6-1/2"	131.90	125.95
297-240	8 Ohm, 20W-75, 7-1/2"	145.90	139.90
297-245	4 Ohm, 20W-75, 7-1/2"	145.90	139.90

Professional Sound Reinforcement Drivers



NEW PRO SERIES

Part #	Size	RMS Power	Price (1-3)	Price (4-UP)
295-060	10"	250 W	\$70.50	\$64.80
295-065	12"	300 W	94.90	86.95
295-070	15"	300 W	99.80	91.30
295-075	18"	350 W	135.90	124.60

FLUKE

70 Series III Analog/Digital Multimeters

Part #	Model	Price
392-042	77-III	\$174.75
392-026	70-III	96.50
392-032	73-III	125.95
392-036	75-III	154.80
392-038	26-III	213.50
392-046	79-III	193.80



Advanced Speaker Designs For The Hobbyist And Technician

A MUST FOR SPEAKER DIVERS



#500-042 \$16.95 EACH

LARGEST SELECTION OF SPEAKER DRIVERS IN THE COUNTRY!

CALL TOLL FREE

1-800-338-0531

KEY COLE: POPOP

725 Pleasant Valley Dr., Springboro, Oh 45066-1158
Phone: 513-743-3000 ◆ FAX: 513-743-1677 ◆ E-Mail: sales@parts-express.com

CIRCLE 156 ON FREE INFORMATION CARD

THE WORLD'S MOST POPULAR
DESIGN TOOL CHOSEN BY OVER
100,000 USERS!

Electronics
Workbench
Personal Edition

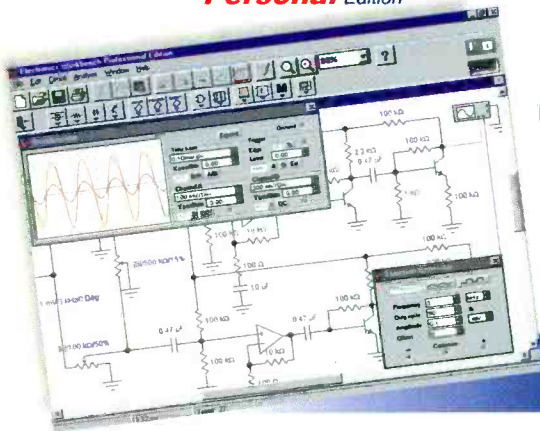

TRUE MIXED ANALOG/DIGITAL
FULLY INTERACTIVE SIMULATION
PRO SCHEMATIC EDITOR
6 VIRTUAL INSTRUMENTS
ON-SCREEN GRAPHS
OVER 4,000 MODELS
8 POWERFUL ANALYSES
FREE TECHNICAL SUPPORT

\$299

Full-featured schematic capture
and SPICE circuit simulation!

The world's most popular circuit design tool that sets the standard for powerful, insightful SPICE simulation. Create professional looking schematics and then with the flick of a switch, display simulated waveforms live on a suite of virtual instruments. Includes 15 powerful analyses and a library of over 4,000 robust component models.

Electronics
Workbench Layout
Personal Edition

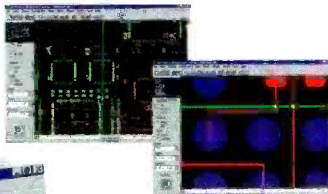
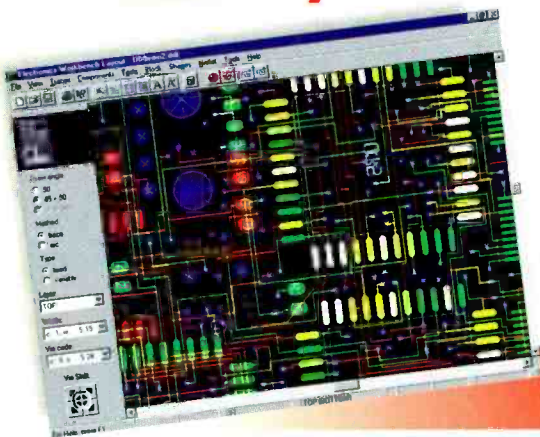

AUTOROUTING
REROUTE WHILE MOVE
32 ROUTING LAYERS
50" X 50" BOARD SIZE
OVER 3,500 LIBRARY SHAPES
EXTENSIVE OUTPUT
REAL TIME DESIGN RULE CHECK
DENSITY HISTOGRAMS
FREE TECHNICAL SUPPORT

\$299

Power-packed PCB layout with
autorouting and real-time DRC!

EWB Layout is a powerful board layout package for producing high-quality, multi-layer printed circuit boards. Offering tight integration with our schematic capture program, EWB Layout is the best way to quickly produce well-designed boards.

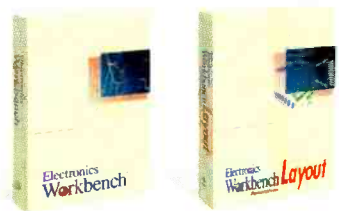

BUY BOTH AND SAVE! ~~\$598~~ **\$548**

CALL FOR INFORMATION
AND PRICING ON OUR
PROFESSIONAL EDITION.

800.263.5552

Fax: 416-977-1818

E-mail: ewb@interactiv.com



For a free demo, visit our website at www.electronicworkbench.com

CIRCLE 26 ON FREE INFORMATION CARD