

TESTS ON THE NEW HIGH-DRAIN ALKALINE AA-BATTERIES

JANUARY 1999

Popular Electronics®

PLUS!
Voltage-Monitoring
Circuits

Seeing Eye Robot

Build this roving robot that has "eyes," enabling it to avoid whatever is in its path, even in the darkness

Hybrid Electric Vehicles

Can the new "clean" vehicles compete with the internal combustion engine?

Flight Timer

Construct this simple flight timer to keep that electric airplane from flying away

Electromagnetic Fields in Your Home

Discover the cause and effects of EMF sources in your home

Also Inside:

- Name Your Price—Online
- This Diode Makes an IMPATT!
- Wire Vee Antenna
- Gizmo—Camcorder/Digital Camera



\$4.99 U.S.
\$5.99 CAN.



#BXBDCCH CAR-RT SORT ** C012
 #35802YUN711GR004# JUN00 P65
 |||||
 STEPHEN R YOUNG RESP 158
 7118 GARTH RD SE HUNTSVILLE AL 35802-1947

High-end features. Low-end price.

\$299
CircuitMaker 6:
Schematic design
and simulation
software

\$299
TraxMaker 3:
Printed circuit
board layout
software

CircuitMaker Version 6 and TraxMaker Version 3 give you the features of professional, high-end software at a fraction of the cost. Plus, with exceptional ease-of-use you'll spend less time learning to use the software and more time designing. Both applications are compatible with your existing software, and feature outstanding technical support. Call now for your free functional demo.

CircuitMaker 6 is a powerful schematic design and simulation program featuring:

- Professional schematic features including printout borders, title block and barred pin names
- Symbol editor and Macro feature for custom devices
- Fast, accurate SPICE3f5/XSPICE-based simulation
- Complete array of analysis types, including Fourier, AC, DC, Parameter sweep, Transient and more
- Virtual instruments including a digital oscilloscope, multimeter, Bode plotter, curve tracer and more
- Extensive library of over 4,000 models
- Tight integration with TraxMaker® for quick PCB layout
- Output PCB netlists in Protel®, Tango® and TraxMaker® formats for use in a variety of PCB layout programs
- Windows 3.1, 95 and NT

TraxMaker 3 is a powerful printed circuit board layout program featuring:

- Over 2,000 component footprints in a fully-documented, indexed library. Documentation shows footprints actual size
- Built-in autorouter and Design Rules Check
- Supports up to 6 signal layers plus power and ground planes, silk screen overlays and solder and paste masks
- Board sizes up to 32" x 32", with no pin limitations
- Intelligent manual routing with unrout capabilities
- Import any PCB netlist in CircuitMaker®, Protel® or Tango® format
- Output RS274X Gerber files, Excellon N/C drill files and Bill of Materials
- Print to any Windows-compatible printer or plotter
- Windows 3.1, 95 and NT

MICRO CODE ENGINEERING INC For free demo software, or to order, call **1-800-419-4242**
927 West Center Street • Orem, UT 84057 • Phone (801) 226-4470 • Fax (801) 226-6532 • www.microcode.com

Popular Electronics®

THE MAGAZINE FOR THE ELECTRONICS ACTIVIST!

CONSTRUCTION ARTICLES

SEEING EYE ROBOT.....	Joseph (Sabby) Cancemi	31
<i>Build this roving robot that has the ability to avoid whatever is in its path</i>		
FLIGHT TIMER.....	Tom Napier	43
<i>Keep that electric airplane from flying away</i>		

FEATURE ARTICLES

HYBRID ELECTRIC VEHICLES.....	Bill Siuru	37
<i>Can the new "clean" vehicles compete with the internal combustion engine?</i>		
ELECTROMAGNETIC FIELDS IN YOUR HOME.....	Albert Lozano-Nieto	45
<i>Discover the cause and effects of EMF sources in your home</i>		

PRODUCT REVIEWS

PRODUCT TEST REPORT.....		5
<i>High-Drain Alkaline AA-Batteries</i>		
GIZMO.....		22
<i>Panasonic Camcorder/Digital Still Camera, Sony Mini-System, Recoton Dual Remotes, Games, and more!</i>		

COLUMNS

MULTIMEDIA WATCH.....	Marc Spiwak	12
<i>Pack Your PC!</i>		
NET WATCH.....	Konstantinos Karagiannis	14
<i>Name Your Price</i>		
SCANNER SCENE.....	Marc Saxon	18
<i>This Scanner Makes It Easy</i>		
THINK TANK.....	Alex Bie	48
<i>This Diode Makes an IMPATT!</i>		
DX LISTENING.....	Don Jensen	52
<i>Radio Pakistan</i>		
ANTIQUE RADIO.....	Marc Ellis	54
<i>Radio Historians and Radio Books</i>		
CIRCUIT CIRCUS.....	Charles D. Rakes	56
<i>Voltage-Monitoring Circuits</i>		
COMPUTER BITS.....	Jeff Holtzman	60
<i>Microcontrollers VIII</i>		
HAM RADIO.....	Joseph J. Carr	62
<i>The Random Length Wire Vee Antenna</i>		

DEPARTMENTS

EDITORIAL.....		2
LETTERS.....		4
ELECTRONICS LIBRARY.....		16
NEW PRODUCTS.....		66
POPULAR ELECTRONICS MARKET CENTER.....		69
ADVERTISING INDEX.....		92
FREE INFORMATION CARD.....		92A

POPULAR ELECTRONICS (ISSN 1042-170-X) Published monthly by Gernsback Publications, Inc. 500 Bi-County Boulevard, Farmingdale, NY 11735. Periodicals postage paid at Farmingdale, NY and at additional mailing offices. One-year, twelve issues, subscription rate U.S. and possessions \$24.99, Canada \$33.15 (includes G.S.T., Canadian Goods and Services Tax Registration No. R125166280), all other countries \$33.99. Subscription orders payable in U.S. funds only. International Postal Money Order or check drawn on a U.S. bank. U.S. single copy price \$4.99. Copyright 1998 by Gernsback Publications, Inc. All rights reserved. Hands-on Electronics and Gizmo trademarks are registered in U.S. and Canada by Gernsback Publications, Inc. Popular Electronics trademark is registered in U.S. and Canada by Electronics Technology Today, Inc. and is licensed to Gernsback Publications, Inc. Printed in U.S.A. Postmaster: Please send address changes to Popular Electronics, Subscription Dept., P.O. Box 338, Mount Morris, IL 61054-9932

A stamped self-addressed envelope must accompany all submitted manuscripts and/or artwork or photographs if their return is desired should they be rejected. We disclaim any responsibility for the loss or damage of manuscripts and/or artwork or photographs while in our possession or otherwise.

As a service to readers, Popular Electronics publishes available plans or information relating to newsworthy products, techniques, and scientific and technological developments. Because of possible variances in the quality and condition of materials and workmanship used by readers, Popular Electronics disclaims any responsibility for the safe and proper functioning of reader-built projects based upon or from plans or information published in this magazine.

Larry Steckler, EHF, CET,
editor-in-chief and publisher

EDITORIAL DEPARTMENT

Edward Whitman, managing editor
Julian Martin, editorial advisor
Robert Young, technical editor
Evelyn Rose, assistant editor
Teri Scaduto, assistant editor
Janine Abitabile, editorial assistant
Alex Bie, contributing editor
Joseph J. Carr, K4IPV, contributing editor
Marc Ellis, contributing editor
Jeffrey K. Holtzman, contributing editor
Don Jensen, contributing editor
Konstantinos Karagiannis,
contributing editor
Charles D. Rakes, contributing editor
Marc Saxon, contributing editor
Marc Spiwak, contributing editor

PRODUCTION DEPARTMENT

Ruby M. Yee, production director
Ken Coren, desktop production director
Melissa Giordano, desktop production
Kathy Campbell, production assistant

ART DEPARTMENT

Andre Duzant, art director
Russell C. Truelson, illustrator

CIRCULATION DEPARTMENT

Theresa Lombardo, circulation manager
Gina L. Gallo, circulation assistant

REPRINT DEPARTMENT

Christina M. Estrada, Reprint Bookstore

BUSINESS AND EDITORIAL OFFICES

Gernsback Publications, Inc.
500 Bi-County Blvd
Farmingdale, NY 11735
516-293-3000
FAX: 516-293-3115

President: **Larry Steckler**
Vice-President: **Adria Coren**
Vice-President: **Ken Coren**

SUBSCRIPTION CUSTOMER SERVICE/ ORDER ENTRY

800-827-0383
7:30 AM - 8:30 PM EST

Advertising Sales Offices listed on page 92

Composition by Mates Graphics
Cover by Loewy Design

VISIT US ON THE INTERNET AT:
www.gernsback.com



Since some of the equipment and circuitry described in POPULAR ELECTRONICS may relate to or be covered by U.S. patents, POPULAR ELECTRONICS disclaims any liability for the infringement of such patents by the making, using, or selling of such equipment or circuitry, and suggests that anyone interested in such projects consult a patent attorney.

EDITORIAL

Replay—1999

This is my first editorial of the New Year, and like many people I get some uneasiness about the coming year and what it will bring, but also a little nostalgic about the past one. I think about recent events that have happened and, like the proverbial Monday-morning quarterback, comment about the things I should have done (or not have done)—if only I knew their consequences. What if...?



On this note, I can't help thinking about one of the best fantasy books I have read in the past decade, *Replay* by Ken Grimwood (still available in paperback from Ace publishers-ISBN: 0441715923). Very briefly—this book is the story of a forty-three-year-old man, who dies at the outset of the story (in 1988) and then wakes up twenty-five years younger in his college dorm (in 1963) at the physical age of eighteen, *but possessing all the memories and wisdom of the next twenty-five years*. He then begins his life anew to reclaim lost loves, make a fortune on sports betting and the stock market, and remedy past mistakes. Then at his "new" age of forty-three, he dies again, to replay his life in another cycle, memories intact, where he can now make new decisions, new adventures, only to die again in recurring replay time cycles.

Fascinating!—Imagine every world event or every decision you ever made being presented to you again! What would you do today if you had the past twenty-five years to "replay," with full knowledge of the impending future? Travel back to 1974—would you attempt to find your present sweetheart or look for a new love? Or would you try to get wealthy immediately by making high-odd bets (about which of course you happened to recall the outcome) or invest long term by buying stock in some all-time favorite companies such as *IBM* or *Xerox*, or perhaps those so-called high-tech companies such as *Intel*, *Microsoft*, or *Apple* (why would a fruit company be considered "high-tech"?—remember it's 1974!)? How would you have influenced or changed the amazing advances in technology over the last quarter century—knowing full well the present outcome?

With finances secured, would you try to save thousands of lives by warning passengers and/or airlines on many of the upcoming tragic airplane crashes to avoid flying that day? Would you attempt to advise *NASA* to re-inspect the O-rings of the *Challenger* shuttle prior to the January 28, 1986 launch? How would you warn the San Francisco Bay area residents of the impending earthquake of October 17, 1989, or alert the employees at the federal office building in Oklahoma City to evacuate their offices on the morning of April 19, 1995? What about telling Princess Di not to go out on the evening of August 30, 1997? Would anyone believe you when you predict that President Nixon would resign or that the "Cold War" would end peacefully, without any nuclear doomsday? "Woulda, coulda, shoulda"—the list is endless.

But the question remains, are these fates pre-ordained? Can you *really* change or modify the future? It's great speculation to play these mental gymnastics at the start of the New Year. In fact, with this year approaching the end of our present millennium, what fun it would be to mentally replay our lifetime, but with a cycle lasting a thousand years. Think about that!

Ed Whitman
Managing Editor

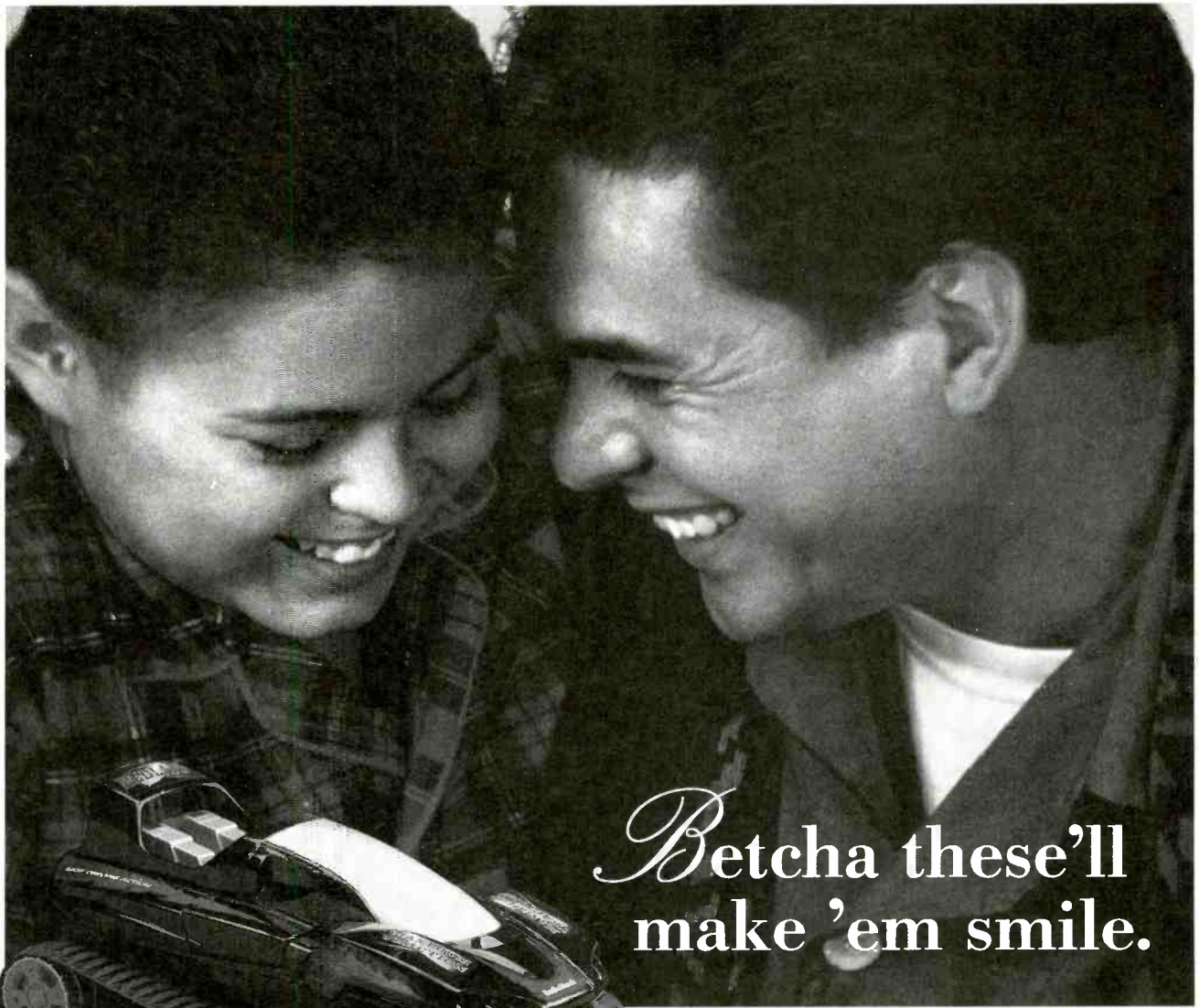

*Betcha these'll
make 'em smile.*



59⁹⁹
BEDLAM
#60-4212

**What kid wouldn't want
a remote-control car?**

Get ready for smiles on Christmas morning. Our '98 models are big on stunts, tricks and speed. *Bedlam*, with its side-slide drive, spins on a dime and even scoots sideways. *Intruder*, our tough off-roader, handles the hardest bumps and bounces childhood can deliver. *Road Raptor II* dazzles with unbelievable spins and wheelies. For all-out speed, nothing beats *Flashtron II*, our fastest RC car. Test drive America's most exciting vehicles at your nearby RadioShack. You might even put one on top of *your* list—after all, why should kids have all the fun?



59⁹⁹
INTRUDER
#60-4211



69⁹⁹
ROAD RAPTOR II
#60-4213



99⁹⁹
FLASHTRON II
#60-4215



RadioShack®
You've got questions.
We've got answers.®

CIRCLE 32 ON FREE INFORMATION CARD

www.americanradiohistory.com

LETTERS

CORRECTIONS/ CLARIFICATIONS

It appears that a couple of typos crept into the "Build the Millennium Clock" article featured in the November 1998 issue. In the schematic diagram of page 32, the LM7805 regulator is designated IC2, but in the text, on page 33, it is referred to as IC3 (which doesn't exist). Also the Parts List calls out an optional tie point SO2; change label SO1 to SO2 on page 34. The only required multiconductor socket is SO1, which is referenced throughout the text and shown in the schematic. Sorry for any confusion these typos may have caused our readers—Editor

PARTS SOURCE UNAVAILABILITY

Jameco Electronics has advised us that the LM2877 IC amplifier mentioned in the article "Build This Portable CD Amp" in the May 1998 issue is no longer available from them. The item can still be purchased from Digi-Key.

We always validate our parts sources at the time the article is edited, but unfortunately we cannot guarantee its availability when the magazine gets to the readers—Editor

RADIO-CONTROLLED CLOCKS UPDATE

In response to a recent query in the October Letters column regarding radio-controlled clocks and the time-code sent out by the National Institute of Standards and Technology (NIST), here is some information from the experts that may help.

The signal from radio station WWVB (near Fort Collins, CO) is a 1 pulse per second BCD time code that is broadcast continuously on a 60-kHz carrier. The complete code takes 1 minute to broadcast. Because it is a low-frequency ground wave, a commercial receiver clock may not always work due to variations in signal strength corresponding to changes in the ionosphere. Reflection and interference can also cause problems. Try placing the clock (or antenna) at different locations at different times of the day to find the ideal location for signal acquisition. Reflection, interference,

or shielding by local terrain (mountains, deep valleys, etc.) or large buildings can also cause problems.

Replacing the antenna and/or using a preamp might help. The antenna is most likely an air loop or ferrite-loop type, but a long whip will also work with proper matching. For more information, consult an LF antenna manual.

As of December 1997, a new transmitter and antenna system upgraded WWVB from 10 kilowatts of power to 23 kilowatts, and the station is currently undergoing another upgrade that will greatly increase the coverage area of the signal with 35–40 kilowatts of power.

For more information, go to the Web site: www.boulder.nist.gov/timefreq/. For details about the WWVB time code and signal generation, see www.boulder.nist.gov/timefreq/pubs/sp432/s_wwvb.htm.

Andrew Novick

Time and Frequency Division, NIST
E-mail: novick@boulder.nist.gov

FLYBACK WIRING

In response to the letter from K.J. in the October 1998 issue of **Popular Electronics** asking for information on flybacks, I would approach the problem as if it were an unknown power transformer. First, determine the copper continuity of the input leads with a VOM in Low-Ohms mode, and of the output leads (CRT anode and ground return leads) with an AF oscillator and a signal tracer. Output is generally high resistance. Use a small neon light tube as an indicator in series with output. A signal of about 15 kHz at the input should light the indicator. Voltage output of the oscillator must be sufficient to drive the flyback.

There may be three or four input leads in continuity. Select the combination that gives the stronger indicator response. Make sure you observe all the safety practices. High voltage devices have been discussed in previous articles in **Popular Electronics**, specifically September, October, and November 1992; January 1994; July and August 1996; May and December 1997; and July 1998 issues.

H. A. Campana
Atlanta, GA

HAVES & NEEDS

I am seeking information on a microcontroller manufactured by AZURESOFTECH, which is labeled "ELITE Universal Controls Interface." AZURESOFTECH was located in San Jose, CA in 1990 when the controller was made, but seems to have gone out of business. I need the interfacing software and the operating manual. I would appreciate any information.

Bert E. Williams

7441 Biltmore Dr.
Sarasota, FL 34231

E-mail: bertewilliams@worldnet.att.net

Many years ago, I purchased an Auto Sentry Model 8534 automobile alarm system from Lafayette Radio, which went out of business over ten years ago. The unit was manufactured by Radatron Corp. of N. Tonawanda, NY. This company also no longer exists. The alarm is a compact, solid-state device with five pushbutton switches for a combination alarm.

I never installed it, and the schematic and instructions for installation and setting a combination code are now lost. I would like to hear from anyone who knows about this device.

Ron Kallen, KB9D1
3528 89th St., #107
Kenosha, WI 53142

I am trying to locate two manufacturers of electronic equipment. I have two remote controls that were made to be used on different VCRs, TVs, CBL, D\CD, AUX, and AUD. The address and phone number on the Fox 600 was Fox Electronics & Tech., Inc., 2200-F Zanker Rd., San Jose, CA 95131; Tel. 800-229-7892. I tried contacting them, but they are no longer there. The second remote control, One For All, part URC 2060, had the telephone number: 800-394-3000. No one answered when I called; so I presume they too have moved or gone out of business. Any assistance in this matter would be greatly appreciated by me.

Robert Mirabella
145-06 133 Avenue
S. Ozone Park, NY 11436

PRODUCT TEST REPORT

High-Drain Alkaline AA-Batteries

STEPHEN A. BOOTH

Americans buy billions of alkaline batteries yearly, and a good portion of the billions of dollars spent coincides with that turn of the calendar represented by the holiday gift-giving season. Whether it's a radio-controlled toy for the kids or the parents' personal indulgence in a handheld PC, alkalines represent about 70% of U.S. battery consumption—and the AA-size battery is the most popular.

The alkaline AA isn't necessarily "popular" by acclaim, but it's the cell size most device manufacturers specify for their products—usually to balance power requirements with cosmetic considerations. So the "AA" size is what we put on the test bench last year (**Popular Electronics**, January 1998), and we're doing it again this January—but there's a difference.

Recently, most major battery brands have issued new alkaline formulations that are specifically designed to deliver greater performance from high-drain electronics. These include radio-control toys, film cameras with flash, digital cameras, halogen flashlights, camcorders, and cellular phones. Also fitting the classification are the newest "personal digital assistants" and handheld PCs—many with power-hungry backlit LCD screens. Portable Mini-Disc (MD) recorders also meet the qualifications. Unlike their relatively low-drain CD- and cassette-player cousins, these have to modulate a laser beam to burn the bits into their magneto-optical blank media.

According to *Duracell*, such high-drain devices now account for 18% of AA- and AAA-size battery consumption—and will increase to 28% of all portable products by 2002. The company describes this growing class of portables as "complex, multi-functional devices often requiring higher operating voltages and higher drain rates." *Eveready* meanwhile quantifies the power requirements as 400 to 800 mA for halogen lamps; 400–1000 mA for cellular phones; and 500–900 mA for camcorders. Digital cameras are in the



Eveready's new Advanced Formula Energizer cells are specifically engineered for high-drain, high-tech devices. The new advanced Energizer means increased playing power from battery-draining devices such as camcorders and palm-top computers.

800–1200-mA range, while photoflash units are the thirstiest of all—1000 to 2000 mA according to *Eveready*.

How the battery makers meet these power demands with their new cells runs pretty much by the same script, although each, as you might expect, has its proprietary techniques. Generally speaking, though, they've maximized the internal volume for active materials by reducing the thickness of the seal and cover, thereby increasing the cell's internal diameter and volume. At the same time, the manufacturers say they've optimized the discharge reaction, making the electro-chemical reaction more efficient. This involves more than using an improved zinc alloy. Among other things, they say they've lengthened the anode-cathode interface, increased the conductivity between the zinc particles and the current collector, and minimized the variability of the anode input. Higher current capability, meanwhile, is derived from better can-to-cathode contact, and greater corrosion resistance. Manufacturers' claims are that these new alkalines will

last up to 50% longer in high-tech devices. Present marketing is limiting these high-drain batteries to the AA and AAA configurations.

With this in mind, **Popular Electronics** decided to bench test a bunch of these premium batteries to see if there's any significant difference in performance among brands, as their advertising hype would claim. As you'll see in this report and the accompanying charts, there are differences—often quite significant ones.

We won't bother listing prices or manufacturer addresses here, as price varies by store and the batteries are widely available. For the record, though, *Duracell* said its *Ultra* formulation will be offered *separately* from its regular alkalines, and priced about 20% higher retail—\$4.99 compared with \$3.99 for a four-pack of regular AA "copper tops." *Eveready's Advanced Formula* 4-packs will sell for the same \$3.99 as the current *Energizer*, which they replace—other manufacturers are also replacing their "standard" alkaline with the new types.

LAB MEASUREMENTS

Life-testing on six popular brands (*Duracell*, *Eveready*, *Kodak*, *Panasonic*, *RadioShack*, and *Rayovac*) of AA cells was performed by the *Advanced Product Evaluation Laboratory* (APEL), our independent test facility in Bethel, CT. Coincidentally, that's just down the road from *Duracell's* headquarters—which made the *Eveready* folks uneasy (more so, considering the brand's poor showing in last January's tests)! The company finally consented to submit samples for this report after dispatching an engineer to make sure APEL doesn't share a connecting door with *Duracell's* lab. Lucky for *Eveready* that they participated, as their new *Advanced Formula Energizer* cell swept the field both in high-drain and conventional (low- to medium drain) performance. The *Energizer Bunny* lives!

To test these new high-drain alkalines, APEL had to obtain samples directly from the manufacturers, as some of the brands had yet to reach retail stores by our deadline for the tests. They all should be available nationally by the time you read this. The lab doesn't believe that stated expiration dates are a factor in the measurements, as all the cells were mint-new.

APEL performed two different sets of life-tests on the cells to simulate performance with different types of products. The tests are virtually industry standards (per American National Standards Institute, or ANSI, requirements), used by engineers at major battery companies.

Pertinent to these new alkalines, promoted for high-drain applications, is our "Pulse Test." Besides showing how the cells perform with juice-thirsty products, such as halogen flashlights or handheld PCs with LCD screens, this test gives an idea as to what you can expect when the battery is used with devices that demand intermittent power bursts and, often, fast recycling times (as with camera flashes, and digital cameras that use flash memory). For this test, the 1.8-ohm load was applied for 15 seconds then removed for 45 seconds (25% duty cycle), continuously, with voltage levels recorded each time down to the 0.9-volt finish line.

Our "Continuous Test" measures how many hours the cell will run under a constant, 10-ohm load. This is the typical application and load for batteries used in devices such as boom-



Duracell's Ultra, a line of high-tech alkaline batteries specifically designed for high-tech devices, including cellular telephones, digital and flash cameras, palmtop computers, and camcorders.

boxes and headphone audio portables, pagers, clocks, and some kinds of toys. For this test, APEL took voltage readings every 10 minutes until a fully-charged cell (nominally 1.5 volts) dropped to 0.9 volts—a typical cutoff point for most equipment.

For the record, both tests were performed at a constant 72-degrees Fahrenheit—the sweet-spot of the alkaline formulation's operating range. Additionally, the brands were measured three times for each test, and the results averaged. For each measurement, the brands were rotated in the test-bench

brackets to equalize the possible effect of any difference in resistance among the contacts.

Normally, we would have tested the batteries only for their pulse performance, as they're said to be optimized for high-drain applications, but we ran the continuous performance tests so you'll have an idea how the various brands operate in the many lower-drain devices that most households own. Except for *Duracell's* dual entries, you won't have a choice in the future between high-drain and regular alkalines from the other brands.

TABLE 1 PERFORMANCE MEASUREMENTS

The *Advanced Product Evaluation Laboratory*, using industry-standard performance tests at 72 degrees Fahrenheit, conducted all electrical measurements. Brands are listed in order of performance.

PULSE TEST

(On-Off cycles using 1.8-ohm load to 0.9-volt cutoff point)

Brand	Pulses
Eveready Advanced Formula	751
Duracell Ultra	713
Panasonic Plus	713
Kodak Photo Life	686
Rayovac Maximum	684
RadioShack Enercell	667

CONTINUOUS TEST

(Longevity under constant 10-ohm load to 0.9-volt cutoff point)

Brand	Time (hours)
Eveready Advanced Formula	19.7
Kodak Photo Life	19.0
RadioShack Enercell	18.8
Duracell Ultra	18.7
Rayovac Maximum	18.3
Panasonic Plus	18.2



The new Panasonic Plus alkaline battery is engineered to last longer in many of today's high-drain portable electronics.

VIEW FROM THE FINISH LINE

You'll find the brand-to-brand performance displayed in two forms in the Performance Measurements of Table 1. The charts rank the cells, in order, by the number of pulses sustained, and by longevity in of hours of operation. *Eveready* leads the pack in both categories and by considerable margins. Its *Advanced Formula Energizer* generated 38 more pulses than runners-up *Duracell Ultra* and *Panasonic Plus*. It lasted 42 minutes longer than *Kodak's Photolife* and an hour more than *Duracell's Ultra* in the marathon test for continuous run-time.

In Pulse Testing, there's clear differentiation among all the brands if you look at their scores in terms of, for example, how many camera flashes you'll get (and how quickly) or how many calls your cellular phone will handle on a set of batteries.

From the Continuous Testing, there's a lead of several lengths between *Eveready's* new entry and *Kodak's* place-horse, with *Duracell's Ultra* plodding in an hour behind *Eveready* for the show position. The difference in time between the leader and the last of the field (*Panasonic Plus*) is an hour and a half.

Panasonic, it seems, trained its second-placing "high drain" thoroughbred specifically for those pulse track conditions, whereas the other battery brands struck a clear balance between "running for the roses" at full-out drain, and being competent "mudders" under any track condition. No surprise, though. Among these battery brands, *Panasonic* also is the only one that originally manufactures a wide variety of high-drain consumer electronics devices (*Kodak* specs its cameras, but sources them

elsewhere). *Panasonic's* arch-rival, *Sony*, has followed a similar strategy of tailoring batteries to the specs of its portable products. (Unfortunately *Sony* did not have a "high-drain" alkaline cell available at our testing deadline).

To round out the field, *RadioShack* did manage to "place" in their Continuous Test, but came in last in the Pulse Test—clearly not a peak-producing contender, while *Rayovac* came in the running, but only as a next-from-last contender in both categories.

(Here's an apparent anomaly. Comparing the results of these new high-drain AA batteries with the "standard"

alkaline tests taken one year ago—where we could only relate equivalent Duracell, Eveready, Kodak, RadioShack, and Rayovac types—revealed that, except for the dramatic improved performance of the new Eveready Advanced Formulation, and slight improvement for select batteries in the Pulse Test (less than 5%), with corresponding Continuous Test increases (less than 8%), the majority of the performance results were only slightly improved, if at all. This is an interesting conclusion based upon the APEL test methodology and test data compared with manufacturer's claims!—Editor). ■

Get our Freeware version
and you will know
why more and more PC-boards
are designed with EAGLE.



EAGLE 3.5

Schematic Capture • Board Layout
Autorouter

for Windows® 95/NT

Windows 95 and Windows NT are registered trademarks of Microsoft Corporation.

EAGLE Professional offers the full EAGLE power: 99 schematic sheets, pc-boards up to 64 x 64 inches, 16 signal layers. With **EAGLE Standard** you can use 4 signal layers and place components on an area of 6.4 x 4 inches. **EAGLE Light** is limited to 1 schematic sheet (of any size) and to 2-layer boards. Components can be placed on an area of 4 x 3.2 inches. All other features are equivalent to EAGLE Professional and Standard.

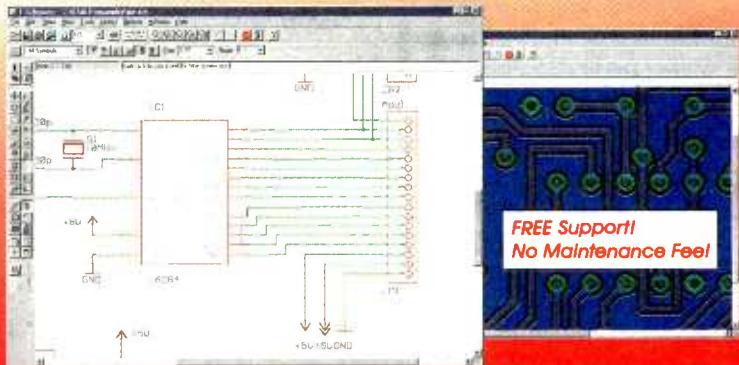

FREE Support!
No Maintenance Fee!

EAGLE 3.5 Light is Freeware!

EAGLE Light is now available free for non-profit and evaluation use! Download it from our Internet Site or order our free CD. Registered users (49 \$ for the complete package) get: the commercial license, the reference manual, and free hotline support.

<http://www.CadSoftUSA.com>

800-858-8355

CadSoft Computer, Inc., 801 S. Federal Highway, Delray Beach, FL 33483
Hotline (561) 274-8355, Fax (561) 274-8218, E-Mail: info@cadsoftusa.com

Prices	Light	Standard	Professional
Layout		199\$	399\$
Layout + Schematic		399\$	798\$
Layout + Autorouter		399\$	798\$
Layout + Schematic + Autorouter	49\$	597\$	1197\$

Pay the difference for Upgrades.

CIRCLE 30 ON FREE INFORMATION CARD

Multimedia WATCH

Pack Your PC!

MARC SPIWAK

It's 1999 already! Where did the millennium go? Well at least it will be 1999 soon after you read this, but as I write my column, it is the end of the summer. At work I'll soon be getting ready for the Fall Comdex show. That's one of the biggest computer shows in the world, held every year in Las Vegas. The worst thing about the show is the traveling and carrying around all the gear that I need out there. Let me explain.

I'm a technical editor for *Computer Reseller News*, the biggest weekly newspaper for the computer reseller channel. The channel is basically the pipeline that supplies the world with computers and networks. And "reseller" is a term used to describe any individual or company that buys and sells this new equipment and usually provides services, such as network installation and maintenance. That's where the real money is, as there is very little profit in just selling hardware.

Anyway, I work in the Test Center here, where we test and review computer hardware and software. We go out to the *Comdex* show for the entire week and test products live at the show. We set up an actual network at our booth, complete with Internet access, ISDN lines, phone lines, etc. We test some pretty, heavy-duty stuff.

We ship literally tons of equipment to the show, but I personally travel with a notebook computer and its accessories, plus magazines, paperwork, business cards, software, maybe a digital camera, and so on. And like anyone else at *Comdex*, I leave there with a lot more junk than I came with! None of the computer bags I've traveled with have been big enough, that is until I saw *Tenba's C437 Access Pak* at the last *PC Expo* show—now I'm ready to travel.

THE ACCESS PAK

The typical notebook bag is about 16 inches long by 11 inches high, and 4 to 6 inches deep. But *Tenba's C437 Access Pak* is 17 inches long by 12 inches high, and from 6 to 8 inches



The Tenba C437 Access Pak is the roomiest computer bag I've ever seen, and it's available with a removable or permanently affixed luggage cart.

deep—a zipper around the main compartment opens like an accordion giving the bag an extra 2 inches of depth. The extra inch or two here and there gives the bag a lot more room than most other bags—it's kind of like the difference between 15- and 17-inch monitors. The bag weighs 3 pounds, 9 ounces.

The C437 comes in heavy ballistic nylon or leather. It has pockets and compartments for a computer and plenty of accessories, keys, change, pens, eyeglasses, papers, magazines, and more. Zippers are all heavy-duty with oversize pull tabs. The main compartment holds a lightweight inner jacket that's padded well enough to protect the computer from damage even if the bag falls to the ground. The hand grips are real leather, and the shoulder strap has no-slip material on the underside. Specially positioned D-rings allow the bag to be used as a backpack with an optional shoulder harness. The basic

C437 Access Pak costs \$220.

When traveling, I often use one of those small luggage carts to wheel my bag around, which is usually well over 20 pounds. You have no idea how often the bag falls off the cart, how often the narrow cart tips over, or how far you have to walk at the Las Vegas Convention Center—or maybe you do. *Tenba* has a \$100 accessory that eliminates all that hassle. You can get the C437—and many other *Tenba* bags—with a wide-track, lightweight cart permanently attached, or get the bag with *Velcro* luggage-cart straps sewn on and a removable wide-track cart—this is how I got it. You can even have the straps sewn on without buying the cart from *Tenba*.

Because *Tenba* bags are custom-made in the United States, it's easy to get them the way you want them. You can even have custom logos put on them. I don't often rave about bags, but



FREE CATALOG! Send card or
call 1-800-321-4634, Ext. 3462

- CHECK ONE FREE CAREER CATALOG ONLY
- Computer Programming
- PC Servicing
- Game Programming Fundamentals
- PC Applications Specialist
- Desktop Publishing With PageMaker
- Telecommunications
- TV/ Video/Audio Servicing
- Electronic Music Technology
- Industrial Electronics & Robotics
- Networking With Windows NT
- Basic Electronics
- Building Construction
- Home Inspection
- Air Conditioning, Heating & Refrigeration
- Automotive Servicing
- Fiction/Nonfiction Writing
- Bookkeeping and Accounting
- Multimedia Programming
- Mastering Microsoft Office

Name (Please Print) _____ Age _____

Street (No P.O. Box numbers, please) _____

City _____ State _____ Zip _____

A Division of The McGraw-Hill Companies



Accredited Member Distance
Educator and Training Council

For career courses approved order G.I. Bill. check for details

3412-0199

www.mhcec.com

NRI Schools



NO POSTAGE
NECESSARY
IF MAILED
IN THE
UNITED STATES

BUSINESS REPLY MAIL

FIRST-CLASS MAIL PERMIT NO. 10008 WASHINGTON, D.C.

POSTAGE WILL BE PAID BY ADDRESSEE

***NRI* Schools**

4401 CONNECTICUT AVENUE NW
WASHINGTON DC 20078-3543



The demand for computer programmers will double by the year 2008...

Get a jump on the competition ... train now with NRI's new and improved Computer Programming course

Only NRI at-home training gives you in-demand programming skills in your choice among three of today's hottest computer languages: Visual Basic, C++, or Java.

Plus, you now train with and keep state-of-the-art programming tools: a Pentium® II 300 multimedia computer system, Windows 95 and Windows 98 upgrade, and more!

Opportunities are skyrocketing

The Bureau of Labor Statistics forecasts that job opportunities for computer programmers will increase much faster than the average over the next several years, with as many as 400,000 new jobs opening up by 2008.

Now, with NRI, you can get the new skills you need to build a top-paying career — even a full- or part-time business of your own — in this high-growth field.

Learn today's hottest languages!

With NRI's exclusive Discovery Learning Method, you get hands-on programming experience mastering one of three of today's most popular programming languages. Step by step, you learn to create the kinds of full-featured, powerful programs today's employers and clients demand.

Select:

Visual Basic

— through both Introductory and Advanced modules, you'll soon become a pro in Visual Basic's object-oriented, event-driven language, mastering data and decision structures, arrays and loops, arithmetic functions, graphics and sound, file management, and more! *OR*

C++ — create super-speedy applications with this incredibly fast and flexible language. You'll become an expert at writing tight, fast code, debugging, and avoiding common syntax and program errors. *OR*

Java — get a solid understanding of this language and how it is used, especially its

unique applicability to Internet programming. Learn how to create Java code, applets, applications, and more!

Send for your FREE catalog today!

See how NRI can give you the programming skills, the full-featured computer system, and the state-of-the-art software you need to get started in this top-paying field.

If the coupon is missing, write to us at NRI Schools, 4401 Connecticut Avenue, NW, Washington, DC 20008.

CALL 1-800-321-4634, Ext. 3462

<http://www.mhcec.com>



More equipment, more advanced software, and more real-world programming experience than any other school!



- Pentium® II 300 MHz processor
- MMX™ technology
- 32 meg RAM and 256K cache memory
- 5 gigabyte hard drive
- Super VGA color monitor; 1 meg video memory
- 32X CD-ROM drive and 16-bit sound card
- 56K baud fax/modem
- Netscape Navigator™ Web browser
- Visual Basic, C++, or Java compiler
- Windows 95/98 upgrade
- Exclusive access to NRI's Online Connection

Now, with NRI's new **PC Options Plan**, you can keep up with late-breaking advances in technology by upgrading your computer system at special student rates. You'll get all the details shortly before your computer is scheduled for shipment. It's NRI's state-of-the-art guarantee!

SEND TODAY FOR FREE CATALOG

NRI Schools

4401 Connecticut Avenue, NW, Washington, DC 20008

- Check one FREE catalog only
- COMPUTER PROGRAMMING
- PC Servicing
- Networking With Windows NT
- Desktop Publishing With PageMaker
- Bookkeeping & Accounting
- Multimedia Programming
- Mastering Microsoft Office

Name _____ Age _____
(please print)

Address _____

City _____

State/Zip _____

A Division of The McGraw-Hill Companies 5413-0199

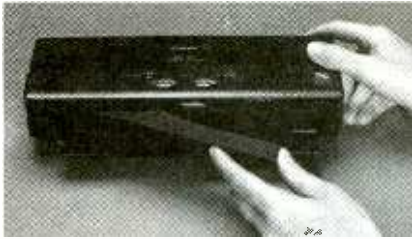

Tiny Canon BJC-50 Portable Color Ink-Jet Printer is only 11.9 inches wide by 1.9 inches high by 4.4 inches deep. It prints up to 5.5 pages-per-minute in black and up to 2 pages-per-minute in color.

WHERE TO GET IT

Canon Computer Systems, Inc.
2995 Redhill Avenue
Costa Mesa, CA 92626
800-OK-CANON
www.ccsi.canon.com

CIRCLE 60 ON FREE INFORMATION CARD

Eidos Interactive
651 Brannan Street
San Francisco, CA 94107
800-617-8737
415-547-1200
www.eidos.com

CIRCLE 61 ON FREE INFORMATION CARD

Microsoft Corporation
One Microsoft Way
Redmond, WA 98052
425-882-8080
www.microsoft.com

CIRCLE 62 ON FREE INFORMATION CARD

Psygnosis
919 East Hillside Blvd.
Foster City, CA 94404
800-438-7794
415-655-8000
www.psygnosis.com

CIRCLE 63 ON FREE INFORMATION CARD

Sheridan Software Systems, Inc.
35 Pinelawn Road
Melville, NY 11747
877-DISKCAT
516-753-0985
www.shersoft.com

CIRCLE 64 ON FREE INFORMATION CARD

Tenba Quality Cases Ltd.
503 Broadway
New York, NY 10012
212-966-1013
www.tenba.com

CIRCLE 65 ON FREE INFORMATION CARD

the *Tenba Access Pak* makes my job a lot easier. *Tenba's* mobile office catalog is loaded with many unique products that could help you in your travels.

CANON BJC-50

Though my *Tenba* bag could hold a much bigger printer, *Canon Computer Systems* recently introduced a tiny color printer that's perfect for traveling—the *Canon BJC-50 Color Bubble-Jet Printer*. The BJC-50 is a portable color ink-jet printer that's only 11.9 inches wide by 1.9 inches high by 4.4 inches deep. It weighs only 2.1 pounds with the battery. The Lithium ion battery will print up to 100 pages before a recharge, but the printer can also be plugged into an outlet. A printer cable is included, but the BJC-50 has an IrDA interface so you can print without a cable.

The BJC-50 prints up to 5.5 pages-per-minute in black and up to 2 pages-per-minute in color. Print resolution is 720 × 360. Like its bigger brother, the BJC-80, this BJC-50 accepts an optional IS-12 color image scanner cartridge that lets you scan text, artwork, and photos. You simply pop out the ink cartridge, and pop in the tiny 24-bit color scanning head, and the BJC-50 scans it at up to 360 dpi. Print and scan qualities are in line with much more gigantic peripherals. The BJC-50 has a street price of around \$349, and the optional IS-12 scanning head is \$99.

MICROSOFT USB SPEAKERS

Aside from being magnetically shielded, computer speakers are usually similar to home audio speakers, with the age-old analog audio signal used to drive them. Microsoft wants to change the way computer audio is handled by taking greater advantage of a computer's digital characteristics. The new *Microsoft Digital Sound System 80* uses the *Universal Serial Bus (USB)* to deliver crisp, powerful sound.

Ideally, the USB speaker system will never have to deal with analog audio. Instead, digital audio signals are fed directly through USB to the subwoofer of the *Sound System 80*, where the digital signals are converted to analog to drive the speakers—as such, a sound card is unnecessary. Also processing digital audio outside of a computer's cabinet eliminates the effects of electromagnetic interference from the computer circuitry.

The three-inch drivers in the satellite



The Microsoft Digital Sound System 80 uses USB to deliver crisp, powerful sound. It processes digital audio outside of a computer's cabinet to eliminate the effects of electromagnetic interference.

speakers have 16 watts of power each, and the 5.25-inch driver in the subwoofer has 44 watts. The right-channel satellite provides top-mounted volume and mute controls for the satellites and the subwoofer. The USB speaker system provides amazing 3-D positional sound using the *DirectX API* and *Microsoft Surround Sound* for home-theater-like sound. A software-based customizable 10-band equalizer is accessible from the taskbar.

One problem with USB sound today is that unless your CD-ROM drive can extract digital audio data from a music CD, a capability most new drives lack, you still need a sound card. Audio is then sent into the USB speaker system through a standard 3.5-mm stereo audio input jack. In such instances the 10-band software equalizer and surround sound features will not work. The sound system software detects whether the audio source is USB-compatible or not, and uses the appropriate pipeline. DVD-video soundtracks also play from the DVD-ROM drive's analog output, so this also requires a sound card.

Sound from the USB speaker system is powerful and clear, with plenty of bass. Custom equalizer settings can be saved for different types of audio. This is about as high-tech as PC audio gets, and the unusual looking speaker system surely is a conversation piece among us computer geeks. The *Microsoft Digital Sound System 80* USB speaker system costs about \$260.

NEW SOFTWARE

These three adventures from *Psygnosis* are apt to keep your adrenaline flowing and your mouse-hand sweating. We start in the not-too-distant-future, where after a war between nations, military resources are wiped out and giant corporations take over the

galaxy. The *G-Police* must keep things in order. In *G-Police*, from *Psygnosis*, you play Jeff Slater, a veteran flight ace piloting a heavily-armed jet helicopter. You'll be immersed in detailed flying with 360-degree freedom. There are four mission campaigns that take place in 51 futuristic environments on the Jovian moon, Callisto.

Also from *Psygnosis*, *Shipwreckers* makes you captain of an armed galleon out to destroy enemies and discover buried treasure. You build up a fleet of ships armed with cannons and other weapons in this shoot-'em-up strategy game. *Shipwreckers* roam through seas filled with secret passageways, sea monsters, and more.

Finally, *Global Domination* takes place in the year 2015, where you work for *ULTRA*, the Universal Tactical Response Agency. Eventually you rise to the top, and it's up to you to save the earth from the World Order Enterprises, or WOE, which threatens your position as supreme ruler of the planet. These three titles from *Psygnosis* cost about \$50 each, manufacturer's suggested retail price (MSRP).

Eidos Interactive's Tomb Raider Gold at \$29.99 MSRP, features the original *Tomb Raider* game plus four new levels. Our favorite heroine, Lara Croft, must recover a mysterious artifact from the tomb of Qualopec in Peru. Lara uncovers a mystery that started before the dawn of recorded time. The *Tomb Raider* world features Peruvian rain forests, Roman ruins, Egyptian pyramids, the Lost City of Atlantis, and more. Similar gaming action takes place in *Final Fantasy VII* (\$49.99 MSRP), also from *Eidos Interactive*. This game features over 60 minutes of video, more than 20 computer-generated cities and towns, and over 50 hours of gameplay.

A useful utility program I came across, *DiskCataloger* from *Sheridan Software*, automatically catalogs, displays, searches, and retrieves files, even if they are stored on removable media. Files are found quickly and easily, so you don't have to worry about where you save documents. *DiskCataloger* integrates with the *Windows Explorer*, providing a virtual representation of all cataloged removable media. *DiskCataloger* prompts the user to insert the proper disk when required, and automatically maintains the catalog as disk contents change. This product sells for \$39.95.

NEW! ELECTRONICS CD ROM

The most effective way of learning electronics

Two Courses on one CD ROM!
Only \$56⁰⁰

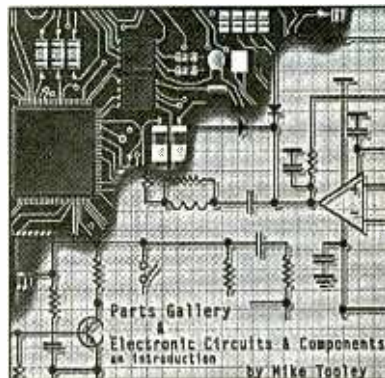

Electronic Circuits and Components

Discover the standards and application of common types of electronic components and how they are used to form complete circuits in **Electronic Circuits and Components**. Sections on the disk include: Fundamental Electronic Theory, Active Components, Passive Components, Analog Circuits and Digital Circuits. The CD ROM includes:

- Interactive laboratories • Supervisor notes
- Full audio commentary • Editable worksheets
- About 20 links to pre-designed Electronics Workbench circuits

The Parts Gallery

Many students have a good understanding of electronic theory but still have difficulty in recognizing the vast number of different types and makes of electronic components. **The Parts Gallery** has been designed to help overcome this problem; it will help students recognize common electronic components and their corresponding symbols in circuit diagrams. This CD ROM incorporates a quiz so that students can check their knowledge of electronic components and symbols. The CD ROM includes:

- Over 150 component and circuit photographs • Supervisors notes
- Self-test Component and Symbol quizzes • Hundreds of electronic symbols

To Be Released Soon!

A series of interactive CD ROMs provides a comprehensive and up-to-date introduction to the world of electronics. The series provides a sound understanding of the principles and behavior of electronic components and the circuits to which they are connected. Two new CD ROM disks are to be released in the very near future. They are **Analog Electronics** and **Digital Electronics**. As soon as they are released, information on their contents and availability will be published.

**Claggk Inc., PO Box 4099
Farmingdale NY 11735-0792
e-mail: claggk@poptronix.com**



Name _____ Phone _____
Address _____
City _____ State _____ Zip _____

Enclosed is \$56 for each Student version of **The Parts Gallery** and **Electronic Circuits & Components** on a single CD ROM, shipping included inside the U.S. Shipping costs to Canada an additional \$3.00. Overseas orders please contact CLAGGK, Inc. for shipping costs.

I am ordering (....) copies at \$56 each. NY State residents must include sales tax.

[] I have enclosed my check for \$ _____
[] Please charge my credit card for \$ _____
[] Visa [] MasterCard [] Discover Expiration Date: ___/___
Card Number _____ Signature _____

(Name on order and signature must be same as on Credit Card.)

NET WATCH

Name Your Price

KONSTANTINOS KARAGIANNIS

When shopping, we want to pay a certain price. Sure, stores advertise their prices and we have to try and find where the best deals are, but essentially, the consumer quest is always the same. When a certain price for a certain product is offered, we're motivated to buy. Wouldn't it be nice to skip the quest and just name your price flat out?

People have gone to auctions for years for this very purpose. It's exciting to think you'll be able to call out exactly what you'd like to spend on an item, and then maybe, just maybe, the gods of retail will smile upon you and prevent someone with a top hat and monocle from outbidding you.

Or perhaps you'd like to do your bidding in an environment that's not so strenuous and nerve wracking. (Did you ever hear how fast those auctioneers speak?) How does carefully considering a purchase price from your computer desk sound?

This month, we've gathered a couple of terrific sites that, together, let you name your price on everything from scanner radios to airplane tickets. One of our sites maintains a somewhat auction-like format—where you can see who made what bids—though it removes the edgy feeling by keeping items on auction for days, instead of seconds. The other site has you simply entering what you'd like to pay, and letting a dealer agree to meet your price.

So don't waste a moment. That item of your dreams might be waiting for you at this very moment online!

EBAY

Here it is—an online auction experience like no other. Whether you're looking to sell or buy an item, eBay is quite a hot spot. There are hundreds of thousands of items (651,684 items at the time of this writing!) being auctioned every day, which means you're certain to find something you've been looking for (or something you didn't realize you were looking for). To get an idea of how successful and established eBay really



At eBay, the whole world can (and does) participate in auctions, resulting in a site with hundreds of thousands of items to choose from. Search or browse for anything you're in the market for, or even sell some unwanted items.

is, consider that it has sold over 22 million items, after having received over 83 million bids. Pretty impressive, huh?

The selection of categories is staggering, with over 1000 to choose from. We can't list them here, obviously, but can give you an idea of the hierarchy. Major categories like Antiques; Books, Movies, Music; Coins & Stamps; Collectibles; Computers; Dolls, Figures; Jewelry, Gemstones; Sports Memorabilia; Toys & Beanie Babies; and Miscellaneous each have smaller groupings under them, bringing the total to the 1000 mark. To give you an idea, under Photo & Electronics you'll find Consumer Electronics, Photo Equipment, and Video Equipment, totaling approximately 10,000 items for auction!

One of the neatest things about the site is that anyone can sell something, so you're not limited to bidding on new items. There are tons of used (and sometimes rare) goodies ready for the taking. We found a signed first edition of a book we were looking for, for example, with bidding kept down to an awe-

some price.

Getting started with eBay is simple. Just point your Web browser to the site and register as a member. This step ensures that everyone actively participating remains honest. You can then begin browsing through the hierarchy of categories or you can type in a query to the site's search engine (which is how we found that first edition).

Once you find an item that you're interested in, click on it. If the item had a little icon that says "pic" next to it, there's an image (usually high quality) that will appear when you select the product. Listed for the item will be the highest bid price, the day and time that the auction ends (each usually lasts 3 to 7 days), and the number of bids made. Also, you'll find a very important value—the minimum bid increment. This is calculated depending on the price range of each item. For example, if something starts out anywhere from \$5 to \$24.99, you can only bid in increments of 50 cents, but if the item costs anywhere from \$250 to \$499.99 initial-

HOT SITES

eBay
www.ebay.com

Priceline
www.priceline.com

ly, you have to make bids in increments of \$5. This is to keep people from never-ending bidding wars on expensive items by only increasing their offerings by, say, a penny each time.

Once an auction is closed, the highest bidder gets the item. It is then the

seller's responsibility to attempt to make payment arrangements with the buyer. If the buyer backs out (warning: a bid is considered a binding contract in most states), the seller can offer the item to the next-highest bidder.

Because they deal directly with the seller at the end of the transaction, some consumers may feel uncomfortable about using *eBay*. To help keep its visitors and customers happy, *eBay* provides support to those experiencing difficulties with a deal, and lets members make comments on the business practices of a particular individual or company. Again, this helps keep everyone honest.

If you're planning on selling something at *eBay*, keep in mind that the site makes its money off vendors, not consumers. To sell something, you'll have to pay a nominal insertion fee, as well as a percentage of the final selling price of the item. We can't list all these here, but to give you an idea: Posting an item with an initial asking price of \$10 to \$24.99, costs you \$1. If it sells for anywhere between \$25.01 and \$1,000, you'll have to surrender 2.5% of the final price. For other rates, check the site.

PRICELINE

How would you like to name your own price for airline tickets or that new car you're planning to buy? As hard-to-believe as it may sound, these are exactly the options you have when visiting *Priceline*. While these two types of purchases might not seem related, they are both components of very volatile markets. "Lowest quoted fares" for each airline change daily, and as for buying a car, who knows which "Super Blowouts" are out there.

Let's deal first with the airline-ticket system at *Priceline*, since it's the first service the site offered. Essentially, the site lets you pick your days of travel, departing and destination airports, and how much you'd like to pay. You then give a credit-card number to secure your request, and wait. Within one hour (24 hours for international travel), you'll find out if you have a deal or not.

For starters, we have to stress that you have to be realistic when naming your price. Smart consumers will find what a typical "low" fare should cost, and keep their bids close to that number. Asking for a round-trip ticket from New York to San Francisco and offering

(Continued on page 36) 15

The screenshot shows a Microsoft Internet Explorer browser window displaying an eBay listing. The address bar shows the URL: <http://cgi.ebay.com/aw-cgi/eBaySAP.dll?ViewItem&item=29379385>. The listing title is "5-In-1 Laser Pointer" in red text, followed by "2000+ ft range!" in blue. Below the text is a photograph of a black laser pointer in its yellow carrying case, which contains five different lens attachments. The text below the photo reads: "This is an all aluminum, executive style laser pointer key chain." At the bottom of the listing, it says: "This laser Key Chain comes with 5 PREMIUM HIGH QUALITY HEADS!!!".

One of the goodies for sale in the Consumer Electronics category at *eBay* is this laser pointer. Many of the items at the site have images posted, so you can see what it is you're making a bid on.

The screenshot shows the Priceline.com homepage in a Microsoft Internet Explorer browser window. The address bar shows the URL: <http://www.priceline.com/>. The page features a large "priceline.com" logo with the tagline "WHERE YOU NAME THE PRICE!". Below the logo, there are two main promotional banners: "Name Your Price for a Leisure Airline Ticket" and "Name Your Price for a New Car". The "New Car" banner includes the text "NOW AVAILABLE IN NY METRO" and a quote from "The Leisure Market Insider" stating "MOST CREATIVE WAY TO GET A GOOD DEAL!". On the left side, there is a navigation menu with links for "What is priceline.com?", "How priceline.com works", "Site tour", "Future services", "Special events", and "Contact us". At the bottom of the page, there is a footer with the text: "All material herein © 1998 priceline.com LLC, all rights reserved. PRICELINE.COM and PRICELINE are service marks of priceline.com LLC".

Priceline lets you name your own price for airline tickets and automobile purchases. While you have to stay somewhat reasonable in your requests, thousands of users have made great deals at the site.

ELECTRONICS LIBRARY

SIMPLE, LOW-COST ELECTRONICS PROJECTS

by Fred Blechman

To learn electronics, you must do electronics. The act of creating a useful device from a pile of components, and then testing and troubleshooting it, teaches you more about electronics than any theoretical book or computer model. Filled with clear and readable explanations, this hands-on guide to real-world electronics begins with the simplest designs and progresses to more sophisticated projects.

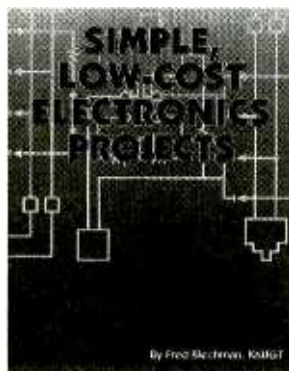

The 22 projects covered in the book include such devices as inductance and semiconductor testers, a variable-frequency audio oscillator, voltmeters and multimeters, a photoelectric counter, and telephone circuits such as a recording beeper, a line analyzer, and a remote FM transmitter. The first projects are simple but useful circuits that any builder can build successfully.

Each project comes with a complete discussion of circuit theory, circuit board and parts placement layouts, hints on building and testing each project, suggestions on placing the completed circuit, and a complete parts list with suggestions on where to obtain parts. Each project is illustrated with diagrams and photographs.

Simple, Low-Cost Electronics Projects costs \$19.95 and is published by LLH Technology Publishing, 3578 Old Rail Road, Eagle Rock, VA 24085; Tel. 800-247-6553 or 540-567-2000; Fax: 540-567-2539; E-mail: c.s.lewis@ieeee.org; Web: www.LLH-Publishing.com.

CIRCLE 90 ON FREE INFORMATION CARD

SATELLITE TECHNOLOGY TRAINING PACKAGE

by Mark Long

Satellite technicians and installers can update their technical knowledge with a two-tape video learning package. Whether you need to brush up on the latest digital DBS technology or train a new installer from scratch, this videotape/handbook package will be very useful. The tapes are filled with hundreds of graphics and charts, in addition to the live video, which make understanding detailed technical information much easier.



The "Satellite TV Technology Overview" videotape provides a thorough background in the technical aspects of geostationary communications satellites and the ground stations that receive their signals. It delves into the theory and principles of satellite technology, beginning with the basics and progressing to subjects like video compression techniques; and I, P, and B Frames.

"Satellite Installations" is a hands-on tutorial video on how to install a receiving system from the initial site survey and aiming the satellite belt to troubleshooting and tuning. All the steps involved in a professional installation—everything from C-band's big dishes to the latest digital, direct broadcast, tiny dish technology (like DirecTV)—are presented.

In addition to the two almost hour-long videotapes, there is a 100-page "Digital Satellite TV Installation Handbook," which provides hard copies of many of the more important graphics, plus charts, graphs, satellite footprints, and additional data. The included glossary is a resource for both the beginner and the professional.

The *Satellite Technology Training Package* costs \$383 (NTSC version) and \$463 (PAL version) and is pro-

duced by Shelburne Films, PO Box 6, Reedsville, OH 45772; Tel. 614-378-6297; Fax: 614-378-6191; Web: www.shelburnefilms.com.

CIRCLE 91 ON FREE INFORMATION CARD

THE COMPLETE SHORT-WAVE LISTENER'S HANDBOOK: FIFTH EDITION

by Andrew Yoder

Aimed at everyone from absolute beginners to advanced hobbyists, this profusely illustrated 408-page handbook has been completely updated. It covers every aspect of shortwave listening and includes a new chapter on computers and SW listening and a directory of popular shortwave Web sites. There is complete, up-to-date information on equipment, worldwide stations, clubs, satellites, and computers.

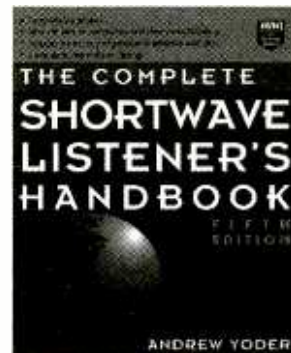

Help is provided in choosing and using equipment, and in finding newsworthy stations, espionage broadcasts, and pirate and illegal frequencies. An insider's guide, to Web sites with shareware for translating audio Morse code to text and to receiver-control demo programs is offered. There are also tips on simple and cheap ways to improve reception, as well as lists of addresses of stations and equipment dealers.

BooksNow To order books in this magazine or, any book in print. Please call anytime day or night: (800) BOOKS-NOW (266-5766) or (801) 261-1187 ask for ext. 1456 or visit on the web at <http://www.BooksNow.com/popular-electronics.htm>. Free catalogs are not available.

A 70-page chapter on international shortwave broadcasts lists frequencies, times, addresses, areas of the world targeted, telephone and fax numbers, computer addresses where available, and station features for countries from Albania to Zimbabwe. Other chapters cover CB radio, amateur radio, FM and TV DX listening, collecting radios, and reporting and verification.

The Complete Shortwave Listener's Handbook, 5th Edition costs \$19.95 and is published by Tab, McGraw-Hill, 1221 Avenue of the Americas, NY 10020; Tel. 800-2MCGRAW; Web: www.tabelectronics.com.

CIRCLE 92 ON FREE INFORMATION CARD

WORLD WIDE WEB: DATABASE PROGRAMMING FOR WINDOWS NT

by Brian Jepson

Providing all the knowledge, skills, and software tools needed to configure a new or existing Web site, the book/software package shows readers how to bring full database capabilities to a company's Windows NT Web site. With these tools, visitors to the site can access databases at that site or at other locations on your company's network. The techniques shown in the book allow users to connect a Windows NT Web site to a wide range of databases, including those available for Windows NT, UNIX, and other database server platforms.

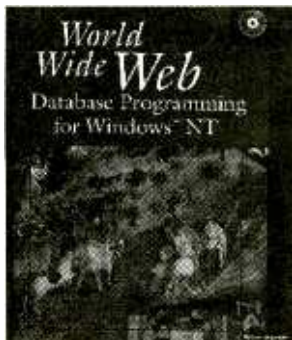

Web site databases help customers navigate through hundreds of pages of copy and several levels to find what they need, and they allow companies to add new information without taking the Web page down. These databases provide customized content based upon visitor queries, and they give the programmer the ability to add and update content on the fly.

An in-depth review of Internet database fundamentals is provided in the book—including TCP/IP Perl scripting, ODBC (Open Database Connectivity) standard, and SQL (Structured Query Language). Following this introduction, the book goes on to more sophisticated concepts. Expert advice is provided on how to: configure a Web server to support databases, use the full range of Web database publishing techniques, connect existing databases to a Web site, program a database to generate HTML pages in response to user inquiries, and design and develop an original database for the Web. Also discussed is how to support searches and queries.

The CD-ROM includes a complete Windows NT Web server, Perl and CGI scripting and programming software, ODBC extension libraries and modules for Web database access, and templates and tools for automating Web database access. *World Wide Web Database Programming for Windows NT costs \$39.95, including CD-ROM, and is published by John Wiley & Sons, Inc., 605 Third Avenue, New York, NY 10158-0012; Tel. 800-225-5945; Web: www.wiley.com.*

CIRCLE 93 ON FREE INFORMATION CARD

ELECTRICAL PAL

by Paul Rosenberg

This handy 4- by 6-inch, 350-page, pocket-size guide puts the answer to every electrical question at your fingertips. *Electrical Pal* makes your job easier by providing all the technical information that electrical professionals need instantaneously.



Packed with clear and concise charts, tables, diagrams, and troubleshooting

BooksNow To order books in this magazine or any book in print. Please call anytime day or night: (800) BOOKS-NOW (266-5756) or (801) 261-1187 ask for ext. 1456 or visit on the web at <http://www.BooksNow.com/popular-electronics.htm>. Free catalogs are not available.

tips, this reference tool, which easily fits in your pocket or tool box, helps solve any electrical problem quickly and safely. The book contains dozens of items that you won't find in any other single guide—some things you would have trouble finding anywhere.

Electrical Pal costs \$15.95 and is published by PAL Publications Group, Mediatek, Inc., 374 Circle of Progress, Pottstown, PA 19464-3800; Tel. 800-355-8812; Fax: 800-355-8816.

CIRCLE 94 ON FREE INFORMATION CARD

Accredited B.S. Degree in Computers or Electronics

by studying at Home

Grantham College of Engineering offers 3 distance education programs:

- B.S.E.T. emphasis in Electronics
 - B.S.E.T. emphasis in Computers
 - B.S. in Computer Science
- NEW!** -Electronics Workbench Professional 5.0 included in our B.S.E.T. curriculums
-Approved by more than 200 Companies, VA and Dantes, (tuition assistance avail.)

For your free catalog of our programs dial

1-800-955-2527

<http://www.grantham.edu>

GCE

Your first step
to help yourself
better your future!



Grantham College of Engineering
34641 Grantham College Road
Slidell, LA 70460-6815

ANTIQUE RADIO CLASSIFIED Free Sample!

Antique Radio's
Largest Circulation Monthly
Articles, Ads & Classifieds.

6-Month Trial: \$19.95. 1-Yr: \$39.49 (\$57.95-1st Class).
A.R.C., P.O. Box 802-L22, Carlisle, MA 01741
Phone: (978) 371-0512 VISA/MC Fax: (978) 371-7129



SCANNER SCENE

This Scanner Makes It Easy

MARC SAXON

Ready to use, right out of the box, the *RadioShack PRO-2056* mobile/base scanner makes things easy! Simply touch any of its special access buttons and you're instantly set to scan the unit's preprogrammed police, fire, emergency, VHF aircraft, maritime, and weather frequencies. The coverage of the PRO-2056 is 29-54, 108-174, and 380-512 MHz.

There's also a private or custom scan bank that can be programmed to band search in 11 preset frequency ranges to locate 30 additional channels that may be entered in the unit's memory. It searches at 100 channels per second and scans programmed channels at 50 channels per second. Other features are channel lockout and delay. A mobile mounting bracket, DC power cord, and an AC adapter are included.

Here's a compact, easy-to-use, low-cost (check with any *RadioShack* dealer for current price) scanner that's ideal for general service, and super for someone who's just getting started or who doesn't need or want all the bells and whistles.

THOSE LISTS

One aspect of the scanning hobby that has been gaining in popularity relates to getting onto (or subscribing to) computer mailing lists. There are quite a number of them, each dedicated to some specific interest within the hobby. These are similar to computer bulletin boards, and members are invited to post relevant e-mail messages or ask other subscribers relevant questions. Subscriptions are free, although each list is privately owned and usually the list owner reserves the right to individually approve subscribers. Of course, there are rules and regulations as to what each list owner will allow, and members who cause problems may be removed at the discretion of the owner.

However, some of these lists I have seen can be useful and informative, especially for disseminating late-breaking information. As a subscriber, when you turn on your e-mail, you see a listing of all of the postings since the



RadioShack's PRO-2056 mobile/base scanner makes things as easy as they can be. By simply touching a special access button users are able to instantly scan the preprogrammed frequencies.

last time you checked. There may be dozens every day! You are welcome to respond to the members with additional information you wish to contribute regarding any posting(s).

Yes, it's possible to subscribe to several lists, but then the e-mails really begin to total up big-time on a daily basis. Forget to check your mail for a couple of days, and your Internet server may squawk and cut off your incoming e-mail. So, you're well advised to only subscribe to those one or two lists that you'll really find most useful.

Personally, I've found a list named "milcom" (military communications) useful to my own interests. It carries HF, VHF, and UHF military postings from members all over the world. Some other scanner-related hobby computer subscription lists include those with the self-descriptive names of "acars," "acarslogs," "forsale-swap," "pro2006," "radio-astronomy," "tandy," "trunkcom," and "uniden."

Generally speaking, the way to initiate the subscription process to any of the above lists is to send an e-mail to majordomo@qth.net. In the body of the message put a command consisting of the word *subscribe* followed by the name of the list you want. For example, if you wanted to subscribe to the "trunkcom" list, the complete body of the message would read only: "subscribe trunkcom." What takes place after that, such as meeting any special policies or requirements, and the length of time involved, varies for each list. Some lists respond with the demand that you confirm your request with a code number they assign. Obviously I can't guaran-

tee a response from, subscription acceptance, or the quality of service of any list mentioned here. With a free subscription you also expect guarantees?

THE RUSSIANS ARE COMING!

Now that the Cold War has ended, the column has received several reports of Russian-language telephone conversations via their military satellites. These are in (narrow) FM mode and have been noted on 258.45, 265.45, and 268.45 MHz. Not that anyone here has the foggiest notion what they're talking about. But then, we never did quite understand these folks. But it's exciting stuff to monitor, anyway!

ONE FOR ALL

It's not very well known, but some federal agencies are getting together and chatting while we're neither looking nor even listening. Nothing especially sinister about this; it's just that various agencies each have their own discrete frequency assignments. Problems arose as more and more specific situations began appearing that called for these agencies to combine and coordinate their efforts towards particular tactical tasks. At that point, it was realized that despite their sophisticated communications equipment, the agencies were curiously unable to intercommunicate with one another.

A battery of frequencies were then designated that are available nationwide for exactly this type of use. These have subsequently been reported utilized by the FBI, BATF, DEA, FEMA, and other federal agencies. You may not have known that these existed. Keep in mind that they are used only on an irregular basis, and at times you'll find the communications to be digitally scrambled.

My suggestion is to program your scanner for: 163.10, 164.8625, 165.6625, 168.35, 173.7875, 408.40, 417.60, 417.70, 418.05, 418.075, 418.575, and 418.975 MHz. Also report-

(Continued on page 42)

Times Are Tough...



Today's headlines scream of the lack of qualified individuals to fill new and existing high-tech job openings. If you feel the robust economy is passing you by, there is something you can do about it. **Become CIE Qualified.** Since 1934, The Cleveland Institute of Electronics has been providing its students with the necessary technical and academic credentials employers are seeking. In fact, CIE was started in 1934 to fill a similar void in the radio/television industry.

Since then, CIE boasts of over 150,000 worldwide graduates who have benefited from a patented, independent-study program that lets the student complete a Career Course, Associate Degree program, or through our affiliate school

World College, a Bachelor Degree program.

If you are currently "under-employed" and want to increase your level of income, the most proven method is an education. With CIE's independent-study program you study when and where you wish with no time constraints on how quickly you can proceed. And though it is an independent-study program you have the full support of the faculty and staff at CIE's Cleveland Campus.

To discover all the Benefits, Career Courses and Degree Programs available from CIE send for your Free Course Catalog Today!

The Cleveland Institute of Electronics has been approved for the training of eligible veterans and active duty military service members, under the G.I. Bill. Military tuition assistance (Up-Front and Basic) is also available under the DANTES Distance Learning Program.

...For Employers



F R E E C A T A L O G



Cleveland Institute of Electronics
 1776 E. 17th Street
 Cleveland, Ohio 44114-3679
 Visit Our Web-Site: www.cie-wc.edu

*A School of Thousands.
 A Class of One. Since 1934.*

YES! Please send me a catalog. AH132

Name: _____

Address: _____

City: _____ State: _____ Zip: _____

Phone Number: _____

Check Box for a Bulletin on Military Education Benefits:

VA Benefits DANTES Benefits

GIZMO®

GREAT GIZMOS I

Camcorder/Digital Still Camera Combo

Do you lug along both camera and camcorder for family vacations and special events? Now you can carry just one unit: The *PV-L958* (\$1099.95) from *Panasonic* (One Panasonic Way, Secaucus, NJ 07094; Tel. 800-211-PANA; Web: www.panasonic.com). A *Palmcorder* at heart, the palm-sized Compact-VHS unit doubles as a digital still camera. A flip-out, 3.2-inch diagonal color monitor serves both functions.

The *Palmcorder PhotoShot* model can produce 640×480 -pixel images that can be viewed directly on the LCD or any television, or downloaded to a PC with an RS-232C connection and saved or printed with the included *Adobe PhotoDeluxe* software. Up to 30 photos can be stored.

Both video and still modes benefit from an optical $23\times$ high-definition zoom lens. With digital enhancement, images are blown up $50\times$, and a second "digital nudge" pushes it up to $300\times$.

Other convenience and performance features include the ability to record in as little as 1.4 lux, a built-in light, a dedicated five-head system, a color viewfinder, motion and audio sensors for use in home-security systems, holiday titles, and digital electronic image stabilization.



SmartFile VCR

How do you figure out which of the towering stack of sloppily labeled videotapes in your collection has enough blank tape to record another program? Which one contains the final episode of *Seinfeld* or that great Civil War documentary you've been planning to watch?

If you'd recorded them on one of Sony's (1 Sony Drive, Park Ridge, NJ 07656; Tel. 800-222-SONY; Web: www.sony.com) two hi-fi VCRs equipped with the *SmartFile* electronic indexing system, you'd be able to find out, quickly and easily. A chip in the *SmartFile* videotape label stores the tape's contents during recording, and

the VCRs can read the label's information. When the television is on, the VCRs can display the tape's contents, including program date, duration, channel, and time. Select the program you want to watch, and the VCR will find it for you and begin playing it. The top-of-the-line unit includes an electronic program guide that, when used to program the VCR to record, adds specific program information, such as the name and station.

To find a tape with enough blank time remaining to record your show, you can simply wave a tape tagged with a *SmartFile* label in front of either the *SLV-M20HF* (\$499) or the *SLV-M10HF* (\$449), and the longest available blank tape time will be displayed on the VCR's front panel. With the push of a button, the VCR will automatically advance an inserted tape to the beginning of the longest blank time.

Mini-Cinema

SHARP DOLBY DIGITAL MINI-SYSTEM, MODEL CD-C492 and COMPACT DVD PLAYER, MODEL DV-550U. From Sharp Electronics Corporation, Sharp Plaza, Mahwah, NJ 07430; Tel. 800-BE-SHARP; Web: www.sharp-usa.com. Price: \$749.95.

Home theater is everywhere. You read about it in every magazine, and probably pore over all those glossy photos of arena-sized living rooms with eight-foot-long reclining leather sectionals, from which you can enjoy endless views of mountains or ocean—until you press a button on your remote control, causing a 10-foot





sources), and the *CD-C492* gives A/V inputs and both optical and coaxial digital audio inputs.

But let's first look at the *CD-C492's* audio capabilities. The system boasts a 240-watt amplifier that delivers 40 watts to each of the five speakers and the subwoofer—the “5.1” channels used in *Dolby Digital* soundtracks. The *Dolby Digital* decoder is built in, along with decoders for *Dolby Pro Logic*, *Virtual Dolby Digital*, and *Virtual Dolby Surround*. The virtual modes, which allow you to enjoy a “three-dimensional sound image” using only two front speakers (even though the system comes with requisite speakers and decoders for “real” surround sound), can be used with listening material that has not been encoded with any surround sound. The QSound mode gives ordinary stereo material increased width and depth. A pre-programmed equalizer provides five different settings, and two X-Bass (extra bass) modes are offered. To get things really thumping, you can also adjust the subwoofer level (it offers a ± 10 dB adjustment). To simply enjoy a stereo recording as the artist and engineers intended, you can press the bypass button to cancel the surround mode. Only the front speakers and subwoofer will be active.

The AM/FM radio section features digital tuning with 40 preset memory locations available. The three-disc, front-loading CD player offers all of the features we've come to expect: automatic program search, cue and review, and random and repeat play modes. The dual-cassette deck can be used to dub from Tape 1 to Tape 2, to record programming from the radio, or for synchro-recording from the CD player.

The *CD-C492* offers timer and sleep functions. The timer can be set to begin and end either playback or recording from the tuner, CD player, or cassette deck. It cannot be used to power up or down any other components connected to the system (VCR, DVD, etc.) The sleep function turns off the selected sound source after a user-specified time period, ranging from one minute to two hours, has elapsed. It's possible to set both the timer and

screen to roll down over the picture window, the lights to dim, and each of the many components in the ultimate home-theater system to come on, customized to your viewing and listening preferences. Well, it's nice to dream, isn't it?

But what if, in real life, your “living room” doubles as your dining room and bedroom? If your reclining leather sectional is really an unmade futon? If your view is the dorm across the quad, or the apartment building across the alley? If you don't have much space—or much money—can you still have a home theater?

Sharp Electronics offers home theater for small spaces and small budgets with two complementary products. The *CD-C492* is a mini-system that's billed as the first such product ever to offer *Dolby Digital* decoding. It also comes with center, right- and left-front, right- and left-rear speakers, and a subwoofer. The second is an ultra-compact DVD player, the *DV-550U*, whose footprint matches that of the mini-system for easy stacking on a bookshelf or table. They're not cheap—but they're about the most affordable *DVD/Dolby Digital* home-theater system you can find.

The main unit of the *CD-C492* measures approximately 10- $\frac{1}{2}$ inches wide by 12- $\frac{1}{2}$ inches high by 13- $\frac{1}{2}$ inches deep. The DVD player has the same width and depth and stands just over 3- $\frac{1}{4}$ inches high. If you stack the mini-system and DVD player with the center-channel speaker

perched on top, the entire affair stands about 21 inches tall, and takes up less than a foot of shelf space, making it an easy fit in even the smallest studio apartment or dorm room.

A word of warning, however: The mini-system's amp, tuner, cassette-deck, and CD-player sections are integrated. That means that they can't be “unstacked” to fit into standard compartments in an entertainment center unless its shelves are adjustable.

Of course, that all-in-one arrangement makes setup a breeze. To use the mini-system for music listening, you need only connect the speakers (using the included wires). The front and center speakers and the subwoofer are magnetically shielded, so they can be placed near the TV. The surround speakers can be mounted on a wall or placed vertically or horizontally on a shelf or other flat surface.

Menus displayed on the front-panel LCD help you with speaker setup—even if you choose to use different speakers than those included with the system. One menu allows you to input the size of each speaker being used; another walks you through the speaker delay setting (so that the sound from all speakers reaches the listener at the same time, even if the speakers are not placed equidistant from the listener). Other menus are helpful for adjusting speaker level, dynamic range, and front-speaker balance. The *CD-C492* also provides a test tone to help you check and adjust the speaker level and balance the system by listening to the sound from each speaker individually while sitting in the place where you'll be doing your listening.

To create a home theater, you'll also need to connect a video source (or

Gizmo® is published by Gernsback Publications, Inc., 500 Bi-County Blvd., Farmingdale, NY 11735. Senior Writers: Christopher Scott and Teri Scaduto. Copyright 1998 by Gernsback Publications, Inc. *Gizmo®* is a registered trademark. All rights reserved.

sleep functions simultaneously, but the same source must be used for both.

Virtually all the mini-system's functions can be operated using the remote control. The remote is compact, and its buttons are reasonably arranged. We do have two gripes, however. First—and this seems a glaring omission—there's no mute button. Second, although the remote can be used to select two sources (labeled DVD1/VCR1 and DVD2/VCR2) other than the unit's integrated components, it cannot be used to control those auxiliary components—not even if one of them is the companion DV-550U DVD player. We'd have liked to be able to at least turn the unit on and start and stop play without having to use an additional remote control.

But, two remotes in hand, we did audition the DV-550U. Although it is designed to fit atop the CD-C492 mini-system, the DV-550U is not simply an accessory. It is a full-featured, stand-alone DVD player that makes up in features what it lacks in size. It can be stacked with any mini-system, and will hold its own among full-sized home-theater components as well.

One of the nicest things about DVD, from the consumer standpoint, is that certain features are standard to the format, meaning that any DVD player you buy will offer them. We'll do a quick rundown of those features for those of you who are not yet familiar with DVD.

First and foremost, DVD offers superb picture quality with a resolution approaching 500 lines. All DVD players can also play audio CDs, as well as video CDs. And the DVD format provides some of the same convenience features inherent in compact discs, such as instant access to specific tracks (which are called chapters on DVD discs), fast forward and fast reverse, programmed playback, and repeat playback. DVD players are compatible with Dolby Digital 5.1-channel soundtracks, although many of them, like the DV-550U, are not equipped with built-in Dolby Digital decoders (they require an external decoder to take advantage of the digital soundtrack). Finally, all DVD players allow users to select the

angle of vision and the subtitle and soundtrack language, when the software producer has chosen to include more than one of each.

Besides those impressive "basic" features, most DVD players try to give a little something to set them apart from the crowd—and to attract buyers. The DV-550U is no exception. Its biggest hook, of course, is its small size. It also boasts a couple of patent-pending technologies called *Digital Gamma Correction* and *Digital Super Picture*.

According to Sharp, the *Digital Gamma Correction* circuit "is a digital image quality enhancement function that gives a richer image by brightening the darker and more obscure portions of the image without altering the brightness of the brighter portions, thereby making the entire image easier to see." The system is recommended when viewing films with a lot of dark scenes (concerts, horror films with much skulking around in the night or in spooky basements), and when watching movies in a bright room.

We must admit to some initial skepticism, but we really put it to the test, watching *Interview With The Vampire* at 4 PM on a sunny afternoon in a west-facing room. Granted, that's an extreme situation, but there was a definite improvement in picture visibility when the *Digital Gamma Correction* circuit was in use. Details that had been lost in the shadows became clearly visible.

Four levels of digital gamma correction are available, and the strongest level wasn't always the best—colors tended to get washed out at times. Within the first few minutes of the film, however, we decided on a comfortable level, and could easily have left it at that setting for the remainder of the movie.

Instead, we disengaged *Digital Gamma Correction* and tried out *Digital Super Picture Selection*, which Sharp claims "gives a clearer image by sharpening the details and outlines in the image and reducing the



amount of picture noise." Well, it didn't give us a vampire's super vision. In fact, when we increased the super picture selection from its standard setting, we really didn't notice any difference in sharpness or detail. When we decreased it, however, there was a quite noticeable blurring of the picture.

Continually playing with picture settings does not enhance one's viewing pleasure. But Sharp makes it easy to switch on and off the two digital modes. A press of the THEATER MODE button activates both the gamma and the super picture features; pressing PICTURE NEUTRAL deactivates them. Those buttons come in handy when viewing a film with frequent switches from dark to light scenes.

The DV-550U is a well-rounded DVD player. Its small footprint, and relatively small price tag, make it a good choice for a small-scale home-theater system—particularly when combined with the CD-C492 mini-system. Add a decent-sized TV (a 10-foot screen would be overkill in a 10×12-foot room anyway), and you'll have a complete home-theater that fits your space and doesn't break the bank.

Racing Realism

GRAN TURISMO. From Sony Computer Entertainment America, 919 East Hillsdale Boulevard, Foster City, CA 94404; Tel. 605-655-8000; Web: www.playstation.com. Suggested price: \$40-\$60.

Many people dream about getting behind the wheel of a powerful racing machine, flooring the accelerator, and pitting their driving skills against some



of the best on some of the toughest courses in the country. One of the many perks of our job is that we've actually been able to do that—and then been *totally* embarrassed by the likes of Jackie Stewart at Ford's Dearborn proving grounds.

We're well aware of how lucky we were, and how rare an opportunity we had. Most people can only dream of it—or they can test drive Sony Computer Entertainment America's *Gran Turismo* racing game for the PlayStation, which does an excellent job of putting you in the driver's seat.

Plenty of video games let you race a car around a track. This one lets you become a race-car driver, selecting your vehicle, customizing it to suit your driving style, competing for large purses, and investing the winnings in still more upgrades or even in a new car.

If you're the type who pops in a video game and begins play without a glance at the manual, you might want to change your habits with this game. The program has an incredible number of variables, and the driving requires learning a whole new set of skills (not to mention the fact that the PlayStation controller button emblazoned with a forward-pointing arrow actually moves the car in reverse!). So a bit of time spent poring over the reference materials is sure to pay off.

First, *Gran Turismo* offers several play modes. Arcade Mode—which doesn't require any prior studying—is a traditional, but sophisticated, racing game allowing you to pit your skills against another player or against five computerized rivals in a two-lap race. You can select the level of difficulty, your car's make and model, automatic or manual transmission, and one of four different courses to start (there are a total of eight courses, but some

can be accessed only after you've proven your skills). You can compete in standard setting, in which you strive for the fastest time, or in drift setting, where performance and handling are top priority. During the race,

you can change your forward view and check your rear-view mirror to see if anyone is gaining on you. In two-player mode, the screen is split horizontally, and both players can change their view independently, but rear-view isn't available. Arcade Mode also offers Time Trial, in which you race around the track on your own or against "ghost cars" that represent your previous lap times.

In Simulation Mode, you can really let your imagination soar. The object here isn't just to win races, but to collect the prize money and use it to upgrade to faster cars. Then, you can compete in more advanced races, for bigger purses. Each driver begins with 10,000 credits to be put toward the purchase of a used race car. Each completed race earns you more money; the amount is based on your performance. The idea is to save up enough money to customize your present car, until you're eventually able to buy still faster cars and qualify for more difficult races.

The simulation game begins with the Map menu, which shows your "home," a licensing bureau, a machine-test shop, a car wash, and several car dealerships: *Aston Martin*, *Chevrolet*, *Dodge*, *Honda/Acura*, *Mazda*, *Mitsubishi*, *Nissan*, *Subaru*, and *Toyota*. Before you can start racing, you have to buy a car, keeping in mind that all you can afford at this point is a used one. Select a dealer, then select the used car menu, and a list of available models (the inventory changes frequently) is shown. Click on the one you're considering, and you can examine the specifications and info screens before plunking down your money.

You're still not quite ready to get on the track. First, you must get a license,

which requires taking a driving test. And that can be a bit tricky, at least until you get the hang of the controls. When you pass, you're awarded a B Class license. At subsequent levels of play (which we didn't reach), you'll be required to take additional tests to earn A Class and International A Class licenses.

Finally, you can register and enter a race—although you're still not quite ready to actually compete with other cars and drivers. First, you have the option of taking a couple of test runs with no other cars, to get a feel for the course. Then, you have to qualify by making it around the course in the fastest possible time. (A good time not only gets you into the race, but secures you a better starting position.) You can take a final test run if you like, and then you're finally ready to race.

Gran Turismo's game action is fast and realistic, and the software's 3D graphics bring the road to life—particularly when using Sony's *Dual Shock Analog Controller*, which we'll describe next. According to SCEA, a sophisticated physics model was created based on each car's own unique set of specifications, so that you can actually "feel" the difference in the handling and driving characteristics of each vehicle. The differences are subtle—at least on the lower-priced models that we could afford based on our meager winnings! We suspect that the performance of the Special Model cars—specially tuned, authentic racing cars with exorbitant prices—would demonstrate markedly better speed and performance.

Unfortunately, we didn't get to find out firsthand, because *Gran Turismo* is quite challenging. Racing enthusiasts will stay enthralled indefinitely, especially as they begin winning and customizing or upgrading to new model cars. Car fanatics might spend hours browsing through the "showrooms," checking out all the details on the fantasy cars exhibited. Weekend grease monkeys might find their way out of the garage for a change, and into the computer room instead, buying and installing new parts, adjusting the car's suspension and aerodynamics, and replacing parts without get-

ting their hands dirty.

When you are actually ready to race (or ready to take your licensing test) you might want to peruse the *Gran Turismo Reference Manual*, where you'll find detailed information on stuff you thought you already knew—accelerating, braking, shifting, cornering, and the like. (From our real-life runs on a NASCAR track—with instruction from knowledgeable, professional race-car drivers—we know that driving high-performance cars on a real track is *nothing* like driving on *any* parkway.) The manual describes the differences in handling front-engine front-wheel drive, front-engine rear-wheel drive, mid-engine rear-wheel drive, and four-wheel drive vehicles. It also gets into advanced techniques known collectively as “drift.” Those include sliding, spin turns, braking drift, faint motion, and inertial drift. There are charts of the more than 150 models of cars available for purchase, descriptions of the parts available for modifications, and detailed looks at the various races (including required licenses and the cars that are eligible to race) and all of the courses.

As we said, you won't soon get bored—unless you really have no interest in cars or racing. Between the technical and financial aspects of the racing circuit, the thrill of buying hot new cars, and excellent handling agility and throttle response as you whiz around a track, this game will keep you hooked.

Rockin' and Rollin' Controller

DUAL SHOCK ANALOG CONTROLLER. From Sony Computer Entertainment America, 919 East Hillsdale Boulevard, Foster City, CA 94404; Tel. 605-655-8000; Web: www.playstation.com. Suggested price: \$39.95.

To add a touch more realism to *Gran Turismo*—or any other *PlayStation* game carrying the “Analog Controller Compatible” icon—try using the *Dual Shock Analog Con-*



troller. Available as an accessory, or packaged with new *Sony PlayStations* (\$149), the controller's contact-sensing dual-vibration feature shakes whenever the game play includes any form of impact—crashing, punching, and the like—further immersing the player in the action.

The *Dual Shock Analog Controller* closely resembles the original *Sony PlayStation* controller. Both are designed for two-handed use, with a grip for each hand. Four control buttons on each side are accessible to either the right or left thumb; two buttons on the top of each side of the controller are easily reached with the right or left index finger. SELECT and START buttons are located in the center. The *Dual Shock Analog Controller* adds two hand “thumb sticks” to provide more precise control and maneuverability, and an analog mode switch for toggling between its digital and analog modes. A red LED remains lighted when the controller is in analog mode.

In its *Dual Shock Analog* mode, the controller is compatible with many new first- and third-party *PlayStation* games. Its digital mode assures full compatibility with all existing and new *PlayStation* game titles, and in that mode, there's no discernible dif-

ference between it and the standard *PlayStation* controller.

We expected the *Dual Shock Analog Controller* to vibrate almost continuously, particularly in light of the safety warnings included in the manual: Stop using it immediately if you experience unpleasantness or pain in your hands or arms. Absolutely do not use the vibrate function if you have any ailment in the bones or joints of your hands or arms. Absolutely do not use it when your fingers, hands, wrists, or arms are broken, dislocated, strained or if you have a pulled muscle. Take a rest at 30-minute intervals.

(And, for the stranger gamers out there: “Do not attempt to operate the controller with, or attach it to your head, elbows, other bony parts of your body, face, or stomach!”)

So it's no wonder that, while playing *Gran Turismo*, we expected to be able to feel every bump in the road through the controller. That wasn't the case. The controller vibrated whenever we ventured off the track and onto the shoulder or grassy stretches. It shook more noticeably when we crashed into another car or a wall. But the controller didn't—as the ad for it on the back of the *Gran Turismo* manual claimed it would—let us “feel the sweet revving of [the] engine ... or the tires skidding out across the track.”

Although the vibrations weren't constant, they did add another dimension to the game. And, no, we didn't experience any ill effects when we forgot to take a break every half hour or so. Will the *Dual Shock Analog Controller* improve your scores? Don't count on it. But count on just a bit more fun.

Talking To Yourself

Are there days when you actually miss having your mother remind you to do things? (Okay, so you called it nagging back then!) You know, those days when you misplace the charts for your presentation, you miss closing time at the video shop and get charged late fees on four films, you forget to pick up from the cleaners the suit you

need for tomorrow's big meeting, and you neglect to order flowers for your wife's birthday.

Sometimes there's nothing like a spoken reminder to help you get things done. Toshiba's (82 Totowa Road, Wayne, NJ 07470; Tel. 973-628-8000; Web: www.toshiba/tcpa) Model DMR-120ZE Digital Voice Bar (\$199.95) lets you nag yourself. Slightly larger than a pen and weighing in at just 4.3 ounces, the Voice Bar fits easily into a shirt pocket or clipped to a belt. Its 120 minutes of digital recording time lets you record as many as 120 separate voice messages. It can also be used to record conversations or lectures to be played back later. An index/search function provides quick and easy access to all messages. A 60-minute version, Model DMR-60ZE, carries a suggested price of \$149.95.



PC Protection

PCs are not perfect. In fact, they're prone to viruses and other "bugs" such as screen freezes or crashes and slow performance. Norton SystemWorks (\$99.95) from Symantec Corporation (2500 Broadway, Suite 200, Santa Monica, CA 90404-3063; Tel. 310-453-4600; Web: www.symantec.com) is a suite of five products geared to protect computers from the problems that plague them. It includes complete

versions of Norton Utilities, Norton AntiVirus, Norton Uninstall, Norton CrashGuard, and Norton Web Services.

The AntiVirus program uses Symantec's Bloodhound macro technology, which is said to be able to automatically detect and repair up to 95% of new and unknown macro, file, and boot viruses. It protects computers from all possible sources of infection, including the Internet, e-mail attachments, floppy disks, and shared files. Norton Uninstall makes it easy to remove unwanted programs and files, and allows users to "undo" a program that was just installed and is causing software conflicts. The CrashGuard crash and recovery program protects against data loss when a crash occurs, and it offers a unique anti-freeze capability that unfreezes locked up applications. Web Services is a library of Web-based programs that allow users to receive software updates and freeware/shareware via a simple point-and-click interface.

Dueling Dual Remotes

Are you and your spouse constantly fighting for control of the remote? Recoton's SoleControl (145 East 57th Street, New York, NY 10022; Tel. 800-742-3438; Web: www.recoton.com) promotes peace and equality with the SC-241H/H (\$49.95), a packaged pair of his-and-hers remote controls, one with keys backlit in cool blue and the other in warm pink.

Each of the remotes operates four components, including a TV, VCR, cable box, and CD player. The pre-programmed units are compatible with more than 6000



different devices. Customizing the remotes is a simple three-step process: press the XTRA key, select the type of device, and enter its specified three-digit code.

Husband and wife have equal chances to flip through channels, raise and lower the volume. But we doubt that dual remotes will facilitate peace at home when a new episode of *Allie McBeal* competes with *Monday Night Football*!

Wargames Revisited

Remember that great sci-fi movie, *WarGames*, in which a computer-savvy kid manages to activate NORAD's supercomputer's (WOPR) fail-safe countdown to nuclear war? The film's "action" was all about stopping the action before it got started, by outwitting the computer before it launched the missiles. The premise behind MGM Interactive's (2500 Broadway Street, Santa Monica, CA 90404; Tel. 310-449-3000; Web: www.mgm.com) *WarGames 3D* combat strategy game is that WOPR has finally come up with a way to put an end to war once and for all—by exterminating the human race.

The game, which is available for Windows 95-equipped PCs (\$44.95), or as *WarGames: Defcon I* for the Sony PlayStation (\$39.95), opens 20 years after the movie ends. The main character, David Lightman, now works for NORAD creating war simulations that he tests by posting them on the Web site of a game company that is a front for top-secret NORAD operations. The player assumes the role of a Web-surfing gamer who stumbles into a war simulation that passes from fantasy to

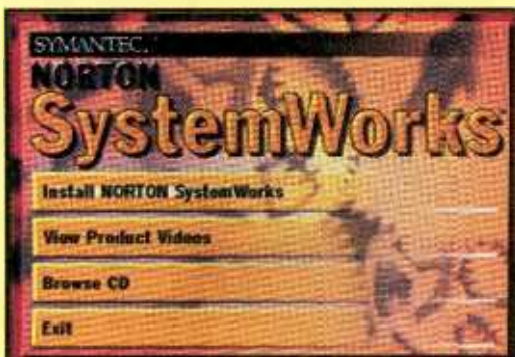



reality, engaging the player in a global war simulation that threatens the safety of the real world.

Players can opt to command either NORAD's conventional troops or the WOPR's futuristic forces as they engage in 30 campaign-based missions. In the mountains, countryside, desert, ocean, and cities, air, sea, and land units use an arsenal of weapons ranging from conventional tanks and planes to the "MK4 walker," a two-legged armored attack vehicle. In keeping with the original movie, *WarGames* players also have at their disposal a crew of hackers to infiltrate enemy intelligence, accrue money and information, and plant viruses. *WarGames* supports up to four players via LAN, modem, and on the Internet using MPlayer.

GIZMO NEWS

Tomorrow's Radio?

Over the years, we've seen many consumer technologies come and go—and for the past few decades, it's been primarily digital replacing analog. Now *Blaupunkt* believes that its new digital radio signal processing technology will make obsolete most of the circuitry in conventional AM/FM radios—even today's so-called "digital radios," which merely use digital ICs to generate analog reference signals.

Blaupunkt's DigiCeiver technology is said to offer major improvements in reception capability, sound quality, and convenience. It converts analog radio frequency signals into digital

data, and then digital software is used to produce high-quality stereo sound, reduce interference and distortion, extract RDS (Radio Data System) and other data subcarriers, and provide digital control over the functioning of the analog front-end circuitry. Direct digital inputs provide better integration with CD players, RDS receivers, computers, and navigation systems.

At the heart of the new technology is a high-speed A/D converter, operating at 14.25 MHz—about 325 times faster than the A/D converters used for digital audio. The high-speed converter digitizes the modulated 10.7-MHz IF carrier from the RF front-end circuitry. Then, all further filtering, demodulation, and multiplex processing are performed in the digital domain, as mathematical calculations. The only analog circuits are the antenna input RF amplifier, the mixer, and the first IF filter.

With just two ICs and the digital signal processing software, *DigiCeiver* eliminates most conventional radio circuits. IF filters, IF amplifiers, stereo detectors, demodulators, multiplex filters, RDS detectors, SCA detectors, FM deemphasis circuits, and more are all replaced by software code. That code can be reprogrammed as needed to change operating parameters, to fine-tune performance, or to accommodate new features.

The digital IF filter has automatic, dynamic bandwidth control that adapts instantly and continuously to changes in the signal, offering

far superior station separation. The shape of the IF bandpass has an almost vertical roll-off, compared to the broad, bell-shaped curve of a less selective, conventional filter.

The first consumer *DigiCeiver* units—car-stereo systems with digital loudness and tone controls, and select models offering digital parametric equalization—should be available by the time you read this at aftermarket retailers (800-950-BLAU or www.blaupunkt.com).

X-Ray-ted Camcorder

One of the big selling points of *Sony's* 1998 camcorder line was the ability of certain Handycams to operate in complete darkness, thanks

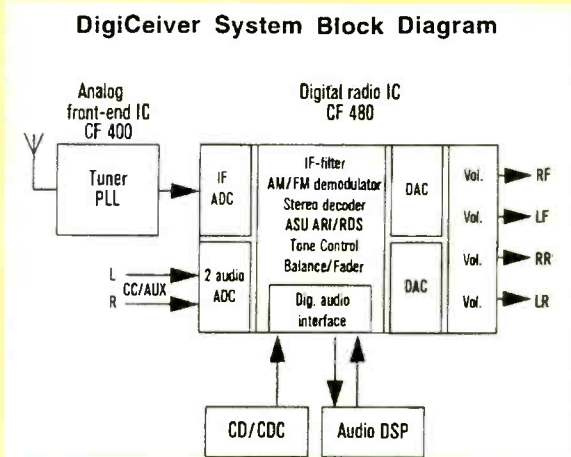

As a result of high-integration strategies, the complete functionality of a top-level car radio has been reduced to a two-chip set. The digital radio IC contains additional inputs for both analog and digital sources plus a communications interface for digital signal processing.

Automatic, Dynamic Bandwidth Control

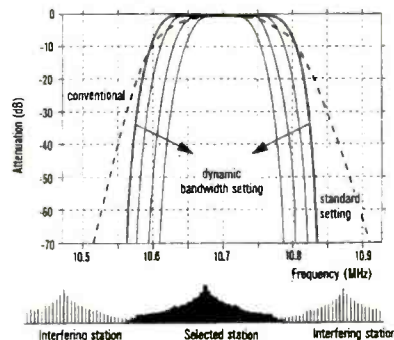

Digital IF filters provide superior performance compared to conventional technology. Automatic, dynamic bandwidth setting improves reception in the event of interference from neighboring stations.

Give a Friend a Year of Electronics Fun this Christmas...



Does fighting the crowds at Christmas short-circuit your holiday fun? Don't blow a fuse this year...for the friend who shares your love of project-oriented electronics — or a youngster who may need only a spark to ignite a life-long interest — give a gift subscription to Popular Electronics.

Popular Electronics readers get the know how they need to build exciting, educational, and useful projects like these...a professional-quality home-security system...an autoranging frequency counter...a nine-band shortwave receiver...a radio-controlled car...a telephone scrambler...an aviation receiver...and even a robot!

PLUS...Gizmo, our honest and straight-shooting review of the latest consumer-electronics gear...Market Center, featuring mail-order merchants that are ready to help you in all your hobby activities...articles and columns covering every aspect of the electronics hobby — including antique radio, shortwave listening, ham radio, computers, scanners, circuit design, and more!

SAVE MONEY...A great gift to receive, Popular Electronics is also a great gift for *you* to give! The Special Holiday Rate saves you \$41.89* off the newsstand price on each gift. You can save another \$41.89* when you start or extend your own subscription at the same time. It's our "thank-you" for sharing Popular Electronics with a friend at Christmas.

Send no money, unless you prefer. We'll be glad to bill you in January, 1999. Just take a brief moment to go over your gift list and make sure you haven't forgotten anyone who might appreciate the many benefits of Popular Electronics. Then write the names on the attached Gift Certificate and mail it back in the postage-paid reply envelope...we'll take it from there!

Your friends will receive a handsome gift announcement card signed with your name just before Christmas. And all through the new year they'll remember and appreciate your thoughtful gift! So don't blow a fuse...take it easy and enjoy the holidays. Give Christmas gifts of Popular Electronics!

Popular Electronics[®]

*Basic sub rate — 1 yr/\$24.99

to “NightShot” infrared technology. According to *Sony*, “This feature uses an infrared transmitter as an invisible light source so the camcorder can capture images that are invisible to the naked eye.”

Users of the NightShot feature got a bit more than they bargained for, however, when they discovered that what the naked eye was missing, but the camcorder was recording, was naked (or almost naked) flesh. It seems that when the feature is used in daylight, or with a special filter in a lighted room, the Handycam can see through clothing! Lightly clothed subjects are captured in their underwear, and people wearing bathing suits appear almost nude.

Sony, which intended the camera to be used for more innocent purposes such as parents monitoring sleeping children, or people recording the nocturnal habits of animals, was surprised to learn of the Handycam’s x-ray vision. The camcorder has been modified so that the NightShot mode operates only in the dark—but not before close to 900,000 of them had been sold worldwide, including 400,000 in North America.

See-in-the-Dark Cadillacs

We don’t like driving at night and, after reading some stats from the U.S. insurance industry, now we know why. Even though traffic volume at night is just 28% of the average daytime level, 55% of serious accidents occur after dark. According to the government’s national accident database reports, in 1996 alone, more than 18,000 fatal accidents occurred at night, killing some 3500 pedestrians and 368 bicyclists.

General Motors must have read the same figures: The company has announced that it will make available as an option on model-year 2000 *Cadillac DeVilles*, their *Night Vision* system, which uses infrared technology and a head-up display to warn nighttime drivers of potentially dangerous

situations existing beyond the range of the car’s headlights.

Night Vision puts to use the same thermal-imaging technology that helped U.S. military forces carry out night missions during the Gulf War. In *Cadillacs*, of course, the system’s object is to help you miss, not strike, various targets—pedestrians, cyclists, and wildlife. (In 1997, in Michigan alone, there were more than 68,000 reported deer/vehicle collisions.) The thermal imaging system produces images based on heat energy emitted by objects in the viewed scene. Humans, animals, and moving vehicles create the most heat, and thus are most visible in the image. The image that appears resembles a black-and-white photographic negative, with hotter objects appearing white and cooler objects appearing black.

Rather than using a flip-up screen somewhere inside the vehicle, the *Night Vision* system projects a “virtual image” that appears near the front of the car’s hood. Drivers can glance at the image without taking their hands off the wheel or their eyes off the road—or even refocusing their eyes. Depending on conditions, *Night Vision* allows drivers to see as much as three to five times farther ahead than the reach of low-beam lights.

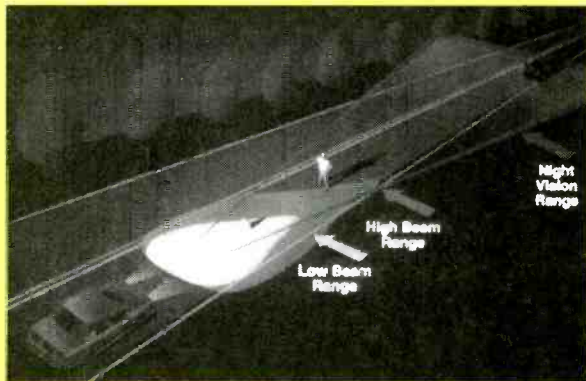

The *Night Vision* system enhances the driver's ability to detect potentially dangerous situations beyond the range of the headlamps.



The head-up display projects a virtual image onto the windshield, allowing the driver to keep his eyes on the road.

The consumer version will use a clear, flat-panel display that, when darkness falls, can be flipped into the driver’s field of view. An infrared camera projects a moving image of the road ahead onto the screen, positioned so as to be superimposed on top of the real-life view, helping the driver see farther. The *Night Vision* system also includes extra headlights to shine infrared light onto the road, and electronics to prevent the infrared camera from being blinded by oncoming headlights or street lights.



SEEING EYE ROBOT

Mention robotics to the average person and the image that springs to mind is that of the lovable robots made famous by the *Star Wars* saga—R2D2 and CP30—or the amicable android (DATA) of *Star Trek* fame. However, in the real world, the term robot refers to a host of electronics mechanisms, ranging from the megabuck monstrosities that, under computer control, assemble automobiles (and many other commercial products) to the simple electromechanical toys that are so popular with young children. All of them, within certain parameters, work fine.

Unfortunately, there is a minor problem (if you can call it that) with the low-cost children's versions. Most of them, if left unattended while in motion, run into obstacles, such as walls. At other times, they get caught in a corner, rocking from side-to-side in a fruitless attempt to free themselves from confinement. So the user is left with the tedium of "springing" them from their "prisons"—only to find them repeating the same acts time and again.

However, the Seeing Eye Robot described in this article does not suffer those maladies, nor the other problems that these amusing little gadgets tend to get into. That's because, as its name implies, the Seeing Eye Robot has "eyes" that allow it to "see" where it is going, thereby giving it the ability to avoid whatever obstacle happens to be in its path. Its electronic eyes also allow it to see in total darkness; thus, the unit can continue to operate as designed although its human operator may be unable to see. The robot can move freely on a smooth, flat surface, or even on a tight flat carpet.

Beside being a source of amusement, the Seeing Eye Robot (at a

Build this easy-to-assemble, highly educational, roving robot that has "eyes" that endow it with the ability to avoid whatever is in its path, even in total darkness!

JOSEPH (SABBY) CANCEMI



cost of approximately \$150.00) is an easy-to-build, educational, and rewarding endeavor.

System Overview. A block diagram of the Seeing Eye Robot is shown in Fig. 1. Note that the circuit is separated into three subsections—the vision circuit, the control (or brains) circuit, and the translation/motor-driver circuit. The front end of the vision section works somewhat like a sonar or radar system, in that it relies on reflected signal radiation to detect obstacles. That is, the vision circuit sends out a series of IR pulses. When the signal strikes an obstacle, the signal is reflected back to the source. Reflected signal strength depends on the color of the objects. Light colors have excellent reflection properties, while darker colors are somewhat less reflective. When the robot encounters a dark colored obstacle, it must move closer to the object before detection takes place.

The reflected signal, when detected by a receiver circuit, tells the robot that there is an obstruction

ahead. The receiver circuit, in turn, generates a signal that is fed to the control section of the robot. The control section determines how the robot responds. For example, if the obstacle is left of center of the robot, the left "eye" circuitry produces a signal that tells the control circuits that there is an obstacle to the left of the robot. At that point, the control circuit generates a signal that is fed to the translation/motor-driver circuit, which then commands the stepper motors so that the robot turns to avoid the obstacle.

On the other hand, if the obstacle is center of the robot, both the left and right eye circuits respond simultaneously, each sending a signal to the robot's control circuit. At that point, the robot responds by stopping, backing up, and turning either left or right to avoid the obstacle.

A Look At The Circuit. A complete schematic diagram of the Seeing Eye Robot—which is comprised of ten IR LEDs, ten phototransistors, ten integrated circuits, four general-purpose transistors, eight diodes, a pair of stepper motors, and several support components—is shown in Fig. 2. In the Seeing Eye Robot, the ten IR LEDs serve as transmitters, while the phototransistors are used as receivers. The ten IR LED/phototransistor pairs—five each for the left and right eyes—coupled with a 555 oscillator/timer (IC1, configured for stable operation, and operating at a frequency of about 1.5 kHz), and three transistors, form the vision circuit. The IR LEDs—which are pulsed by IC1 and coupled with the phototransistors (the eyes)—allow the robot to see obstacles at a distance of up to 6 inches and at angles up to 45 degrees.

The robot's control circuit consists

of three 555 oscillator/timers (IC2-IC4) that are configured for mono-stable (one-shot) operation. Two of the one-shots (IC2 and IC3, respectively) govern left and right motor rotation, while the third one-shot (IC4) is designed to drive the robot backwards. In operation, when the vision circuit detects a reflected signal, it generates a negative-going pulse that is applied to the control circuitry, causing IC2-IC4 to start their timing cycles. At that point, IC4 briefly takes charge, causing the robot to stop, and both stepper motors to immediately reverse, causing the robot to move backward for 1 second, as IC4 times out. While that's happening, IC2 and IC3 continue their timing cycles. One times out after 3 seconds, while the other times out after 4 seconds. As soon as the 3-second circuit times out, the stepper motor controlled by that circuit reverses directions. That means that one motor is rotating forward as the other spins in the reverse direction, causing the robot to make a tight swift turn. To further your understanding of the circuit's operation, refer to the timing diagrams shown in Fig. 3.

The outputs of the three (one-shots) control the operation of the two stepper motors (via the translation/motor-driver circuit). The timing interval of the backup one-shot (IC4) can be varied from 0.5 to 2

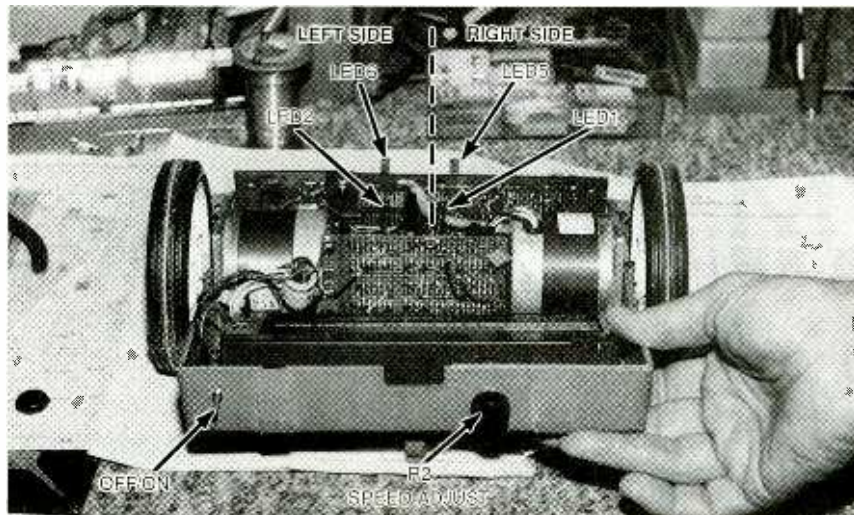

Looking at the Seeing Eye Robot from the rear, note the location of the on/off toggle switch (S1) and the speed-adjust control (R2).

seconds by adjusting R15. The periods of the left-turn (IC2) and right-turn (IC3) one-shots can be varied from 2 to 5 seconds via R3 and R10, respectively. Since the left- and right-turn circuits are identical, we'll discuss this portion of the circuit in terms of the left-turn circuit's operation.

Let's say that the left-eye vision circuit picks up a reflected IR signal, producing a negative-going pulse that is applied to pin 2 of IC2, causing it to begin its timing cycle. During the timing cycle, IC2's output (at pin 3) goes high. That high is applied to LED11, causing it to light, and to the base of Q14, turning it on. With Q14 turned on, its collector voltage goes

low. That low is applied to pin 12 of IC6 in the translation circuit, causing the left wheel to reverse directions. In the meantime, C5—a 33- μ F electrolytic capacitor connected between pins 5 and 6 of IC2—begins to charge toward V_{CC} . When the charge on C5 reaches about $2/3 V_{CC}$, C5 abruptly discharges through IC2. That causes IC2's output at pin 3 to return to a low state, waiting for the next input pulse or pulses to arrive. Note: IC3 (the right one-shot) works in the same manner.

The operation of IC4 (the backup circuit) is slightly different. The backup circuit contains 4 diodes (D1-D4) that provide an or func-

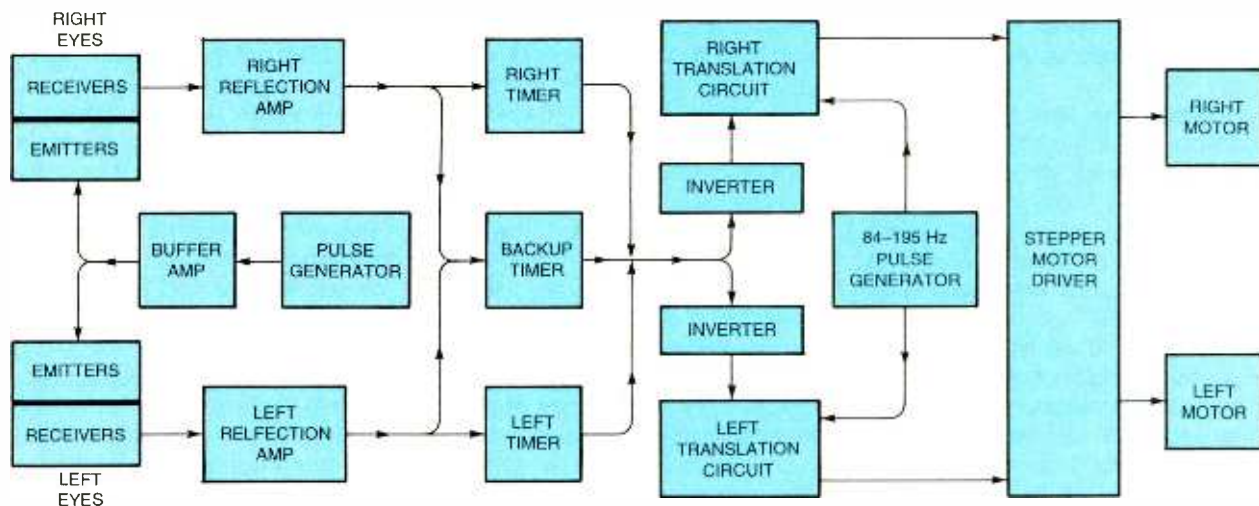

Fig. 1. For the sake of clarity, the Seeing Eye Robot (as shown by this functional block diagram) is separated into three subsections—the vision circuit (whose front end works somewhat like a sonar or radar system in that it relies on reflected signal radiation to detect obstacles), the control (which directs the robot to move left, right, or backward) circuit, and the translation/motor-driver circuit (which reverses signal phase in order to affect direction changes).

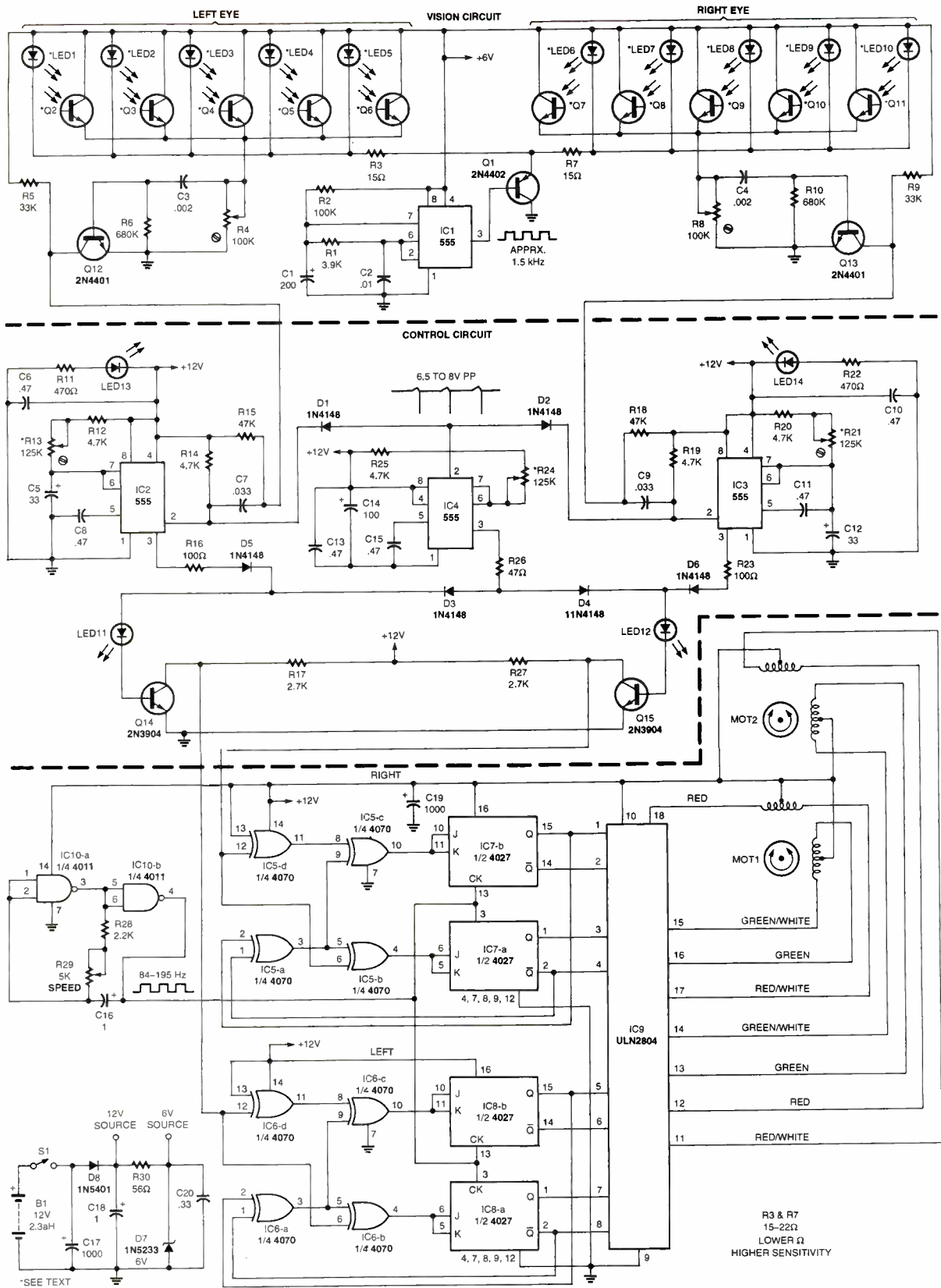

Fig. 2. The Seeing Eye Robot is comprised of ten IR LEDs, ten phototransistors, ten integrated circuits, four general-purpose transistors, eight diodes, a pair of stepper motors, and several support components. The ten IR LEDs and ten phototransistors are combined to form ten IR LED/phototransistor pairs, which serve as eyes, enabling the robot to see obstacles at a distance of up to 6 inches and at angles up to 45 degrees even in total darkness.

PARTS LIST FOR THE SEEING EYE ROBOT

SEMICONDUCTORS

- D1-D6—1N4148 general-purpose, small-signal diode
D7—1N5233B 6.0-volt, 500-mW. Zener diode (NTE5012A)
D8—1N5401 3-amp, 100-PIV silicon rectifier diode
IC1-IC4—NE555 oscillator/timer, integrated circuit
IC5, IC6—CD4070 quad, 2-input, exclusive OR-gate, integrated circuit
IC7, IC8—CD4027 dual, JK flip-flop, integrated circuit
IC9—ULN2804A octal high-current Darlington array, integrated circuit (*Future Active Components*)
IC10—CD4011 quad 2-input NAND gate, integrated circuit
LED1-LED10—High-output, IR-emitting diode (*RadioShack # 276-143*)
LED11, LED12—Light-emitting diode, red (*RadioShack # 276-044*)
LED13, LED14—Rectangular or jumbo round light-emitting diode (*RadioShack # 276-068*)
Q1—2N4402 general-purpose PNP silicon transistor
Q2-Q11—IR phototransistor (*RadioShack # 276-145*)
Q12, Q13—2N4401 general-purpose, NPN silicon transistor
Q14, Q15—2N3904 general-purpose, NPN silicon transistor

RESISTORS

(All fixed resistors are 1/4-watt, 5% units, unless otherwise noted.)

- R1—3900-ohm
R2—100,000-ohm
R3, R7—15-ohm
R4, R8—100,000-ohm horizontal-type trimmer

- potentiometer (*RadioShack #271-284*)
R5—33,000-ohm
R6, R10—680,000-ohm
R9—33-ohm
R11, R22—470-ohm
R12, R14, R19, R20, R25—4700-ohm
R13, R21, R24—125,000-ohm potentiometer (see text)
R15, R18—47,000-ohm
R16, R23—100-ohm
R17, R27—2700-ohm
R26—47-ohm
R28—2200-ohm
R29—5000-ohm potentiometer (*RadioShack # 271-1714 or 271-281*)
R30—56-ohm, 1-watt, 5% resistor

CAPACITORS

- C1—200- μ F, 25-WVDC, electrolytic
C2—0.01- μ F, ceramic-disc
C3, C4—0.002- μ F, Mylar
C5, C12—33- μ F, 25-WVDC, electrolytic
C6, C8, C10, C11, C13, C15—0.47- μ F, monolithic
C7, C9—0.033- μ F, Mylar
C14—100- μ F, 25-WVDC, electrolytic
C16—1- μ F, 25-WVDC, electrolytic
C17, C19—1000- μ F, 25-WVDC, electrolytic
C18—1- μ F, 25-WVDC, electrolytic
C20—0.33- μ F, ceramic-disc

ADDITIONAL PARTS AND MATERIALS

- B1—12-volt, 2.3-Ah rechargeable battery (*RadioShack # 23-187*)
MOT1, MOT2—Stepper motor (*C&H Sales part SSM9252 at \$32.50 each*)
S1—SPST switch (*RadioShack # 275-634*)
Universal component board, enclosure, 4-inch wheels, DIP sockets, wire, solder, hardware, etc.

tion, which causes IC3 to respond to the same signals as IC2 and IC3. If either IC2 or IC3 are activated, IC4 is also activated, with IC4 taking charge and causing the robot to stop and then reverse direction. The outputs of the control circuit are fed to the translation/motor-driver circuit.

PARTS SOURCES

C&H Sales

2176 Colorado Blvd.
Pasadena, CA 91107
Tel. 800-325-9465

Future Active Components

Dept. FAC 4
41 Main Street
Bolton, MA 01740
Tel. 800-655-0006

Translation Circuit. The main purpose of the translation circuitry is to provide properly phased signals for the motor driver (IC9, a ULN2804A octal, high-current, Darlington array). The translation circuit consists of a pair of CD4070 CMOS quad two-input exclusive OR gates (IC5 and IC6) and a pair of CD4027 CMOS dual JK flip-flops. The output of Q14 or Q15 places either a high or a low on pin 12 of both IC5 and IC6 to control the forward and reverse rotation of the stepper motors. A high output from either Q14 or Q15 causes the stepper motors to rotate in a forward direction. A low causes the motors to reverse rotation.

In addition, the translation circuit contains an adjustable (84 to 195 Hz) square-wave oscillator, built around a CD4011 CMOS quad two-

input NAND gate. Adjusting the oscillator (via R29, a 5000-ohm potentiometer) also alters the robot's speed. Setting R29 for a 160-Hz output frequency causes the robot to rove at a speed of 1 foot per second. The output of the oscillator is fed to the clock inputs of IC7 and IC8 at pins 3 and 13.

The \bar{Q} and Q outputs of IC7 and IC8 each provide four properly phased pulses that are fed to IC9, which is used to drive the unipolar four-phase stepper motors at 500 mA per phase.

Construction. The prototype of the Seeing Eye Robot was assembled in three universal experimenter's boards that were housed in a plastic case—measuring 10 inches wide, 9 inches deep, and 3.5 inches high—scavenged from a discarded digital voltmeter. Of course, the size and shape of the enclosure used to house your unit is up to you. A circular shape—with the eye elements mounted in a semicircle—would be ideal. If you prefer a square or a rectangular robot, you'll have to place a pair of eyes on both the forward-right and forward-left sides of the robot, giving the robot "peripheral vision," much like that associated with human vision. The IR LEDs and phototransistors should be mounted in pairs separated by $3/16$ inch, with each pair a $1/2$ inch from the next adjacent pair. Once the IR LED/phototransistor pairs have been mounted to the enclosure, wire all of the left-eye LEDs (LED1-LED5) in parallel with each other. Then do the same for the left-eye phototransistors (Q2 through Q6). Repeat the eye-wiring operation for the right-eye components (LED6 through LED10 and Q7 through Q11). Once that's done, wire the remainder of the vision circuit on a section of experimenter's board, and connect the two halves of the vision circuit together through hook-up wire. **Note:** Sockets should be provided for all ICs. Sockets allow the chips to easily be removed should you discover an error in your work, and also allow for easy component replacement should an IC fail.

Anyway, once the vision circuit has been completed, assemble the control and translation/motor-driver

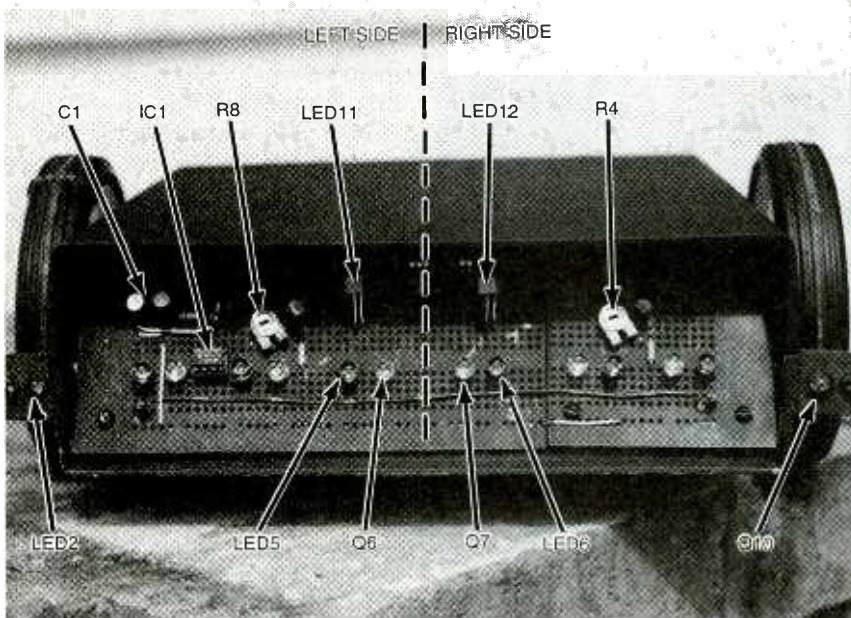

In the prototype of the Seeing Eye Robot, its vision circuit was assembled on a universal experimenter's board. In your rendition of the circuit, you might consider mounting the IR LED's and the phototransistors to the front panel of the enclosure, while the rest of the parts for the vision circuit are mounted elsewhere (out of sight), to give the unit a more finished appearance.

circuits on separate universal experimenter's boards. Note that the controller section contains three 125k potentiometers. Those potentiometers can be replaced by 100k units, if you can't find the value specified. Also, when assembling the translation/motor driver, don't forget to connect a very heavy heatsink to IC9 (the ULN2804A octal high current Darlington array) with a good glue or epoxy. And whatever you do, don't substitute a ULN2803 for the ULN2804—it *cannot* handle the load. (Note: The ULN2804 is available from *Future Active Components*; see Part Sources for additional information.) Once the control and translation/motor-driver circuits are complete, set them aside for now, and move on to the next phase of assembly.

Prepare the base of the robot's enclosure to accept the stepper motors, and mount the motors with their shafts protruding from the sides. The stepper motors used in the author's prototype are rated at 11.2 volts with a step angle of 1.8 degrees and a holding torque of 53 oz/in. **Warning:** DO NOT use stepper motors rated for less than 53 oz/in; otherwise, the robot will *not* move or move *very slowly*. The motors (which are available from *C&H Sales* as part SSM9851 for \$35.00 each) have a total current draw of 800 mA. At that rate and using the specified battery pack, the robot can rove for a couple of hours.

With the motors secured in place, fit the wheels to the shafts of the stepper motors. The author used 4-inch diameter wheels. Depending on the diameter of the motor shaft and the diameter of the wheels' axle opening, you may need a small bushing to fit the wheels to the shaft. A trailing wheel (small caster) can then be fitted to the center-rear underside of the enclosure in order to help maintain the robot's balance. The author used a small rubber pinch roller taken from a discarded VCR. Once the motors have been mounted to the base of the enclosure and the wheels installed, mount the three individual boards to the inside base of the enclosure. Inter-board connections can then be accomplished through hook-up wire.

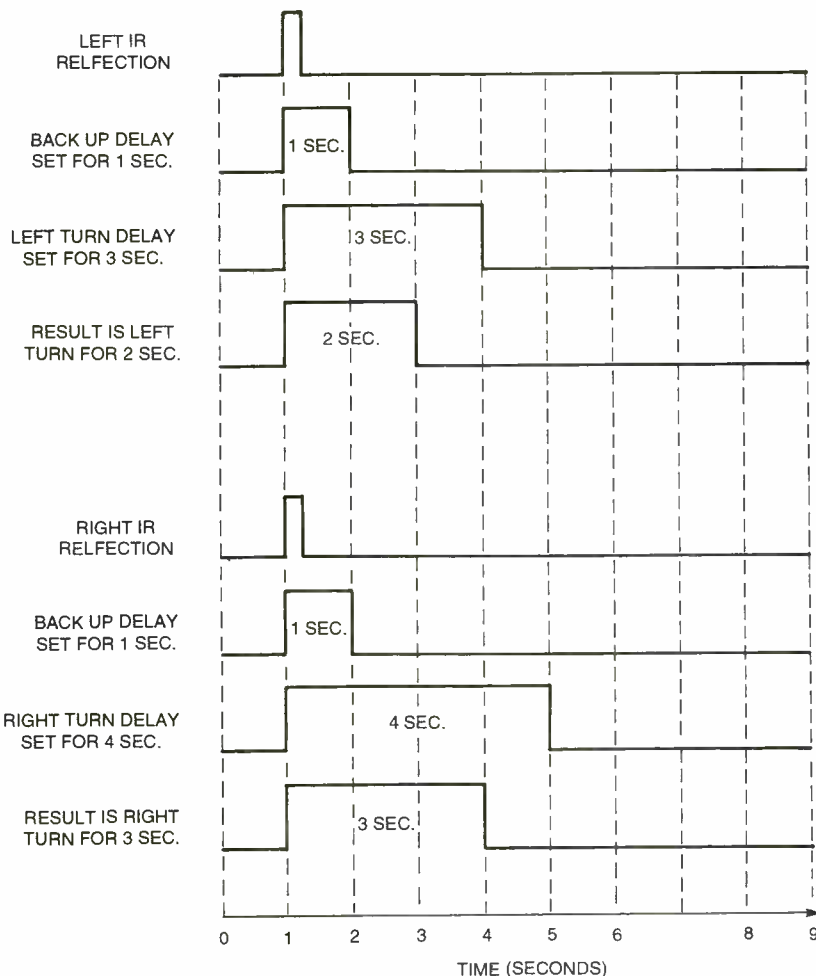
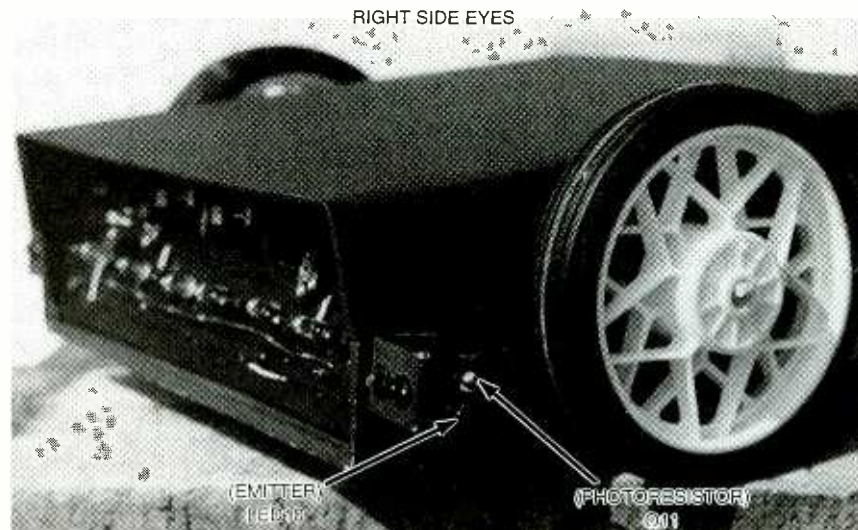

Fig. 3. As shown by these timing diagrams, the circuit's operation depends heavily on fairly precise timing/delay cycles that cause the two driven wheels of the robot to act independently and in concert.



Mounted on brackets to either side of the Seeing Eye Robot's enclosure are an IR LED/phototransistor pair that give the unit human-like peripheral vision. If the unit is housed in a semi-spherical enclosure, the shape of the enclosure and the positioning of the IR LED/phototransistor pairs allow the unit's vision circuit to more closely emulate human sight.

Before moving on to the next phase of assembly, it's a good idea to visually check your work for errors, particularly misconnected components, which is a common malady with this type of construction. When you are reasonably sure that the circuit contains no construction errors, move on to the calibration, testing, and troubleshooting phase of the operation.

Calibration, Test, and Troubleshooting. Start by making sure that S1 (POWER) is in the off position. With a VOM, check the resistance from the R30/D7 junction to ground for a resistance of no less than 1800 ohms. If that's okay, check that the battery is properly connected to the circuit. Try to work under a fluorescent or a low-level lamp—bright incandescent lamp lighting tends to keep LED1 and LED2 on constantly with the robot's wheels turning in reverse.

Flip S1 to the on position; LED13 and LED14 should light and stay on with both wheels rotating forward. Adjust R4, R8, to mid range. Also, adjust R13, R21, R24 to mid range. Next the robot's eyes must be checked. That task can be handled by passing your hand or a small block of wood about 6 inches in front of the robot (left side to check left eyes, right side to check right eyes, or in the middle for both.) Slowly bring your hand or block of wood toward the eyes. If you're

testing the left front, LED11 should light, and left wheel should reverse. If you're testing the right front, LED12 should light, and right wheel should reverse. If your hand or block of wood is in the middle, both LEDs should light with both wheels moving in reverse. That's normal.

If that doesn't happen, using an oscilloscope (assuming that you have access to one) check the signal at pin 2 of IC2 or IC3. Adjust the scope for a signal like that shown in the schematic diagram (Fig. 2). If you do not have access to an oscilloscope, an AC peak-to-peak meter works just fine. Again, bring your hand close to the eyes. Viewing the waveform using a scope, the closer your hand or the block of wood comes to the eyes, the deeper the spike. With the peak-to-peak meter, you should read about 6.5 to 8 volts peak-to-peak (as indicated in the schematic diagram).

You must have the robot's eyes working first, otherwise no other circuits can function. Once the eyes are working and LED11 and LED12 light up with wheels reversing, remove your hand. LED11 and LED12 should extinguish after a time delay and the wheels should once again reverse, rotating in the forward direction. You now have the seeing eye robot functioning normally and ready to do its thing.

For optimum results, do not use the robot under bright sunlight or under high incandescent light. ■

NET WATCH

(continued from page 15)

\$99 will not likely get you anywhere.

How does the site do it? Well, we can't get into the mechanics, but put simply: an empty airline seat doesn't make an airline any money. If there are seats available on a flight, an airline might accept your offer when it's presented by *Priceline*. This is not unusual—many tour companies have similar agreements with airlines.

The most notable caveat is that tickets are non-changeable. You can't pay a fee and stay an extra day, for instance, like you could when buying from the airline or a travel agent. Also, you won't get frequent flyer mileage when you buy the ticket.

To get the best prices it helps to indicate that your travel times are flexible. Normally, *Priceline* will search for flights departing between 6 AM and 10 PM—the ones chosen usually arrive the same day. If you expand the search parameters to include "red-eye" flights (when you leave late at night and arrive the next day), your low price has an even better chance of being accepted.

The other service available from *Priceline* is at the time of this writing only available in the New York Metro area. That is, you can now name the price you'd like to pay for a particular new car. *Priceline* keeps your identity a secret—so no salespeople will call—and tries to find you a dealer that will commit in writing to selling you your dream car at a dreamy price. As in the case of airline tickets, you'll have to make your offers somewhat realistic. No new *Corvettes* will be sold for \$1,000, and so on.

Considering the haggling that *Priceline* will save you, its car-price service is pretty fast. You'll have an answer within one business day, as opposed to the weeks it may take you to buy on your own. If *Priceline* succeeds in finding you a car, you'll get charged \$25. If no dealers nibble at your offer, *Priceline* won't charge you a cent. For obvious reasons, you should only use *Priceline* if you're really ready to buy.

Well, that's all the time we have this month. Until next time, if you've got a question, comment, or somewhat digitally related rambling, e-mail me at net-watch@comports.com, or send mail to *Net Watch*, **Popular Electronics**, 500 Bi-County Blvd., Farmingdale, NY 11735. ■

HYBRID ELECTRIC VEHICLES

The battery-powered electric vehicle (EV) has been touted as the ultimate Zero-Emission Vehicle (ZEV). However, its limited range between recharging cycles could limit its use to shorter urban and suburban trips. And while much development is underway to advance battery technology to increase range, many experts believe that pure EVs will never become truly competitive with the more versatile Internal Combustion Engine (ICE). Another problem is the relatively long time needed to recharge batteries compared to the few minutes that it takes to pump a tank of gasoline.

Recognizing that, many automakers are working on a Hybrid Electric Vehicle (HEV) that could be much more competitive with vehicles with ICEs under their hoods. While not ZEVs, they still produce much lower emissions. It should be noted that even EVs are not truly ZEVs unless the electricity used to recharge the batteries is produced from solar, wind, hydroelectric, or geothermal sources. If the electricity is produced by combusting fossil fuels, then there are emissions—not from the EV, but from the power plants that produce the electricity.

HEV Designs. There are almost as many HEV configurations as there are automakers developing them. The typical HEV uses a small internal-combustion (heat) engine, motor/generator, and an energy-storage device, usually a battery, but it could also be a flywheel or ultra



Can the new “clean” vehicles compete with the internal combustion engine?

BILL SIURU

capacitor. HEVs can be divided into two basic categories—*series* and *parallel* hybrid. Basically, while both include an ICE and electric motor, with the series HEV (see Fig. 1) only the electric motor drives the wheels directly. With the parallel system, both the ICE and electric motor deliver power to the wheels (as illustrated in Fig. 2). Virtually all HEV concepts incorporate regenerative braking, a system wherein much of the braking and deceleration energy is recouped and returned to the battery to increase overall efficiency rather than being wasted as heat, as is the case with ICE-powered vehicles.

Beside significant improvements in performance, especially range, HEVs are typically as easy to “recharge” as an ordinary car or truck. Recharging requires only refilling the fuel tank, which takes minutes versus hours for recharging a battery. That also means today’s

refueling facilities (i.e., gasoline stations) can still be used. And while battery-charging ports can be used, they are not absolutely necessary as is the case with EVs. Recharging ports could be used to charge batteries while the HEV is parked for extended periods; for example, to take advantage of low-cost electricity or to further reduce emissions.

General Motors. General Motors’ experience with its EV1 definitely indicates that the public is not ready to purchase a *purely electric* vehicle. As of the first quarter of 1998, less than 300 people had leased EV1s, the only way GM is marketing its battery-powered coupe. Therefore, GM recently showed a whole family of “earth-friendly” vehicles that could be more appealing to consumers. They are based on a stretched version of the EV1, with a 19-inch longer wheelbase to provide more interior space for other advanced-technology propulsion methods—including fuel cells, compressed natural gas, and both parallel and series HEV concepts. GM says it could have a hybrid vehicle in production by 2001.

GM’s series HEV’s internal-combustion engine uses a small, gas, turbine engine that functions as an Auxiliary Power Unit (APU) by driving a high-speed, permanent-magnet, AC generator that supplies energy to the motor and provides battery charging. The single-stage “micro-turbine” APU (see Fig. 3), which runs at 100,000 to 140,000 rpm on reformulated gasoline, was developed jointly by GM and aerospace tur-

bine manufacturer, *Williams International*. It is the smallest (20 inches in diameter and 22 inches long), lightest (220 pounds), and most efficient device of its kind ever made. The APU's 40 kW output is sufficient to power the car's electric-drive system and accessories, as well as charge the battery pack's 44 NiMH batteries.

The front wheels are driven by a 137-horsepower, 3-phase, AC induction motor obtaining electrical power from the battery pack and APU. With a flip of a switch, the driver can choose between an emissions-free, electric-only ZEV mode, running on the battery, or an "infinite"-range, hybrid mode with electrical energy supplied by the batteries, which now are constantly recharged by the APU. In the hybrid mode, the APU automatically starts and produces power whenever the batteries' state-of-charge drops below 40%.

Assuming the car is starting with a full charge, that would be about 25 miles of "ZEV-mode" driving. After the APU starts, it normally delivers just enough electrical power to run the propulsion motor and slowly return the batteries to a 50% state-of-charge. In the ZEV mode, the car has a range of 40 miles; while in the hybrid mode, the 6.5 gallons of gasoline in the fuel tank gives a range of 350 miles, which is better than many cars with ICEs. The vehicle—with a regulated top speed of 80 mph—can accelerate from 0-60

mph in 9 seconds.

The parallel HEV uses a 3-cylinder, 1.3-liter, 75-horsepower *Isuzu* turbo-charged, direct-injection diesel engine located in the rear that drives the rear wheels via a 5-speed *Opel*-

developed manual transaxle (Fig. 4). The engine also drives a 6.5-horsepower, permanent magnet, DC brushless motor/generator, which is used as a starter for the diesel engine, provides extra power for maximum acceleration, recoups regenerative braking energy through the rear drum brakes, and charges the vehicle's battery pack. Up front, there is the same 137-horsepower electric motor that drives the front wheels and provides regenerative braking for the front-disc brakes. The battery pack again consists of 44 NiMH batteries. In the pure ZEV mode, the car operates on battery power that drives the front wheels. When extra power is needed, the rear diesel engine kicks in, providing not only more power, but also four-wheel-drive to handle slippery road conditions.

The parallel HEV turns in performance numbers that are as good as a car equipped with an internal-combustion engine. With a total of

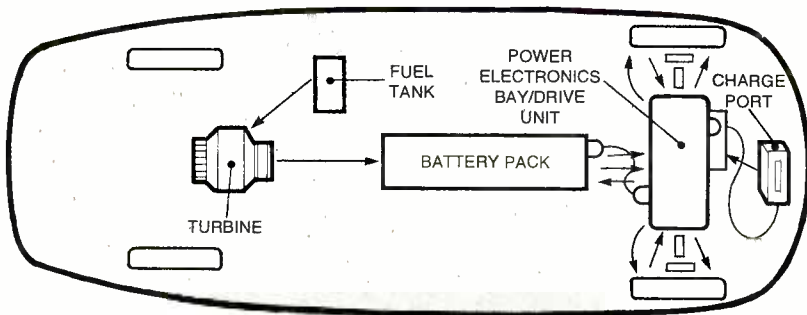

Fig. 1. The typical HEV has a small internal-combustion engine, motor/generator, and some form of energy-storage device—usually a battery, although a flywheel or ultra capacitor might be used. Only one power source, usually an electric motor, is used for propulsion in a series HEV system. The other source, typically an ICE, is used for battery charging and an additional source of power when needed such as for acceleration or high climbing. (General Motors)

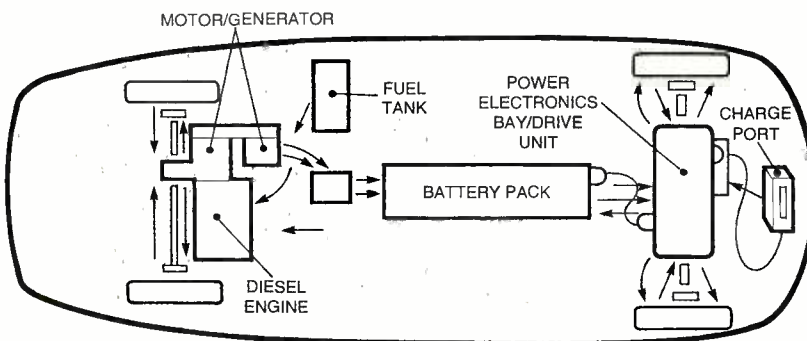

Fig. 2. In a parallel HEV system, both the ICE and electric motor deliver power to the wheels for propulsion. Virtually all HEV concepts incorporate regenerative braking where much of the braking and deceleration energy is recouped and returned to the battery to increase overall efficiency rather than wasted as heat, as is the case with ICE-powered vehicles. (General Motors)



GM has stretched its EV1 and incorporated alternative propulsion methods like hybrid-electric and fuel cells. (General Motors)

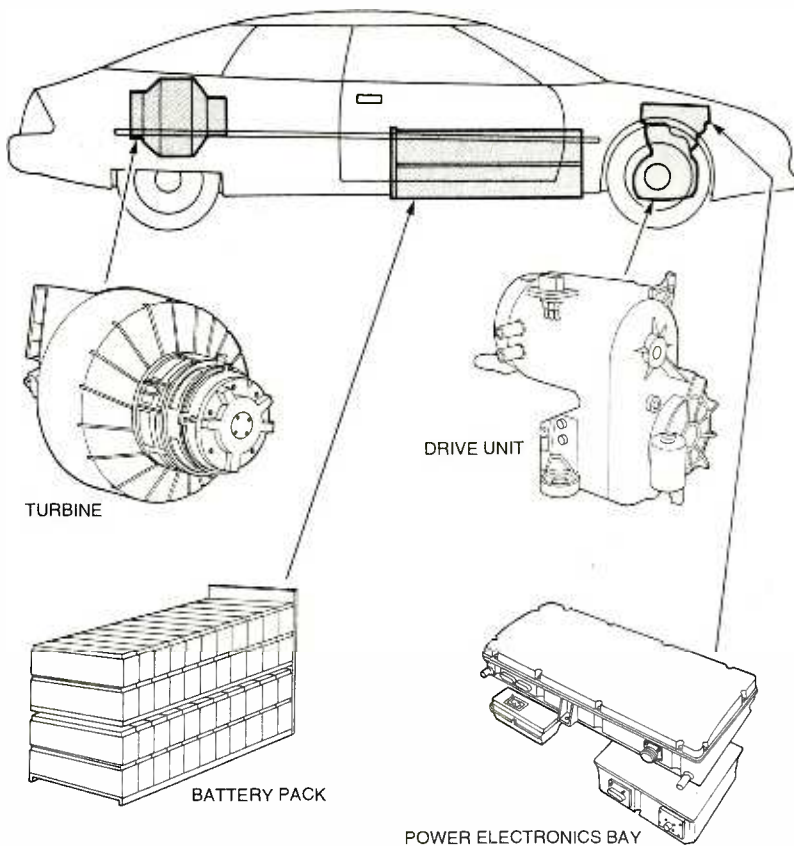

Fig. 3. Components comprising GM's series hybrid electric vehicle. GM's series HEV has an ICE that uses a small, gas turbine that functions as an Auxiliary Power Unit (APU). The turbine is used to drive a high-speed, permanent-magnet, AC generator that supplies energy to the motor and provides battery charging. (General Motors)

219-horsepower available from the electric motor, diesel engine, and motor/generator working together, it can accelerate from 0-60 mph in seven seconds. Its top speed is a regulated 80 mph. Fuel economy is an impressive 80 mpg, for a total range of 550 miles. When operating in the zero-emission mode (i.e., completely on batteries), the range is 40 miles. Charging the battery from an external 220-volt source takes less than two hours.

Ford. Ford is developing HEV concepts as part of its P2000 project, using Ford's innovative DIATA (Direct Injection Aluminum Through-bolt Assembly). The DIATA is a Compression-Ignition engine, Direct-Injection (CIDI) designed to pack high performance into a small package. The 1.2-liter diesel engine has 4 cylinders and produces 74 horsepower.

The "Through-bolt" assembly comes from the way the cylinder heads are bolted to the engine

block; e.g., by 16-inch long bolts that pass from the head to beneath the block. One of Ford's HEV developments is a parallel setup called a Low Storage Requirement (LSR) powertrain. Here a small but very high-power battery is used. An integral high-power starter-alternator replaces the conventional starter

and alternator. That provides quick engine restart capability, which allows the engine's operation to be optimized by shutting it off during idling and deceleration. The starter-alternator is also used to capture small amounts of "braking energy" to further improve fuel efficiency and to supplement the engine for enhanced performance. Ford could have its hybrid ready by the time you read this, but no production plans have been announced.

Chrysler. Chrysler has taken another approach with its Dodge Intrepid ESX2, which it calls a *mybrid* for "Mild hYBRID." The goal in designing the ESX2 was to reduce the incremental cost of hybrid vehicles above an ICE-powered car to \$15,000, where Chrysler believes a hybrid could attract sufficient customers. According to Chrysler, people would pay a premium if it could be recouped through savings in fuel costs as well as the more intangible benefit of being more eco-friendly through lower emissions.

To accomplish that, Chrysler engineers went after the highest cost items—especially the battery, which alone can add \$4000 to \$15,000 to the price of the vehicle, as well as 500 pounds of additional weight. Most of the time, the ESX2 runs on a very efficient Detroit Diesel four-stroke, 3-cylinder, direct injection, 1.5-liter diesel engine that produces 74 horsepower. A small advanced, lead-acid battery pack and AC induction electric 20-horsepower motor/generator would be used to power accessories and pro-

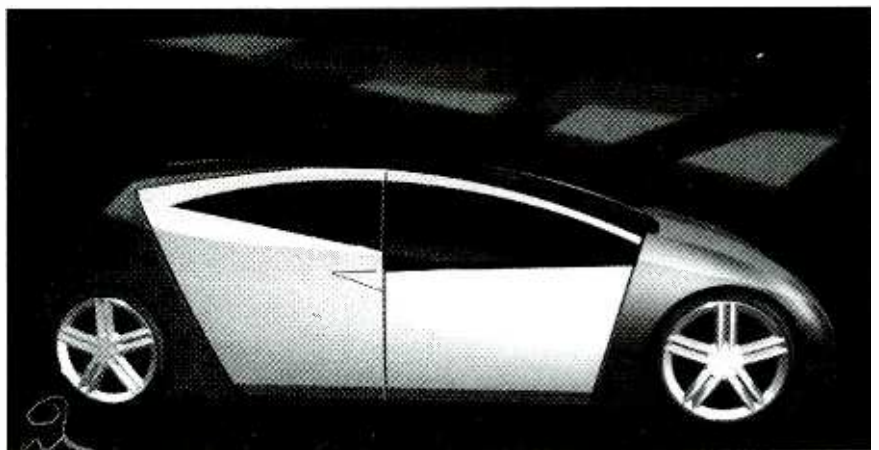

Artist concept of the Ford P2000. If put into production, the styling would probably be less radical. (Ford)

vide a boost during hard acceleration, such as a 40-60-mph passing maneuver.

Additional fuel economy comes from the vehicles' efficient aerody-

namics (0.19 drag coefficient) and low weight. While about the same size and carrying ability as the 1998 Dodge Intrepid, it weighs 35% less. Low weight comes mainly through

the use of a main structure of only six panels that weigh 50% less than the 80 steel pieces they replace on a traditional car. The composite material is made from thermoplastic polyester—the same basic material from which plastic beverage bottles are made. To further increase the mpg, the ESX2 uses a very efficient 5-speed, electronically shifted manual transmission, regenerative braking, and low rolling resistance tires with a run-flat capability that eliminates the need for a weight adding spare.

While accessories—such as air conditioning and lights—use only 2% of the available energy in a traditional car, when a vehicle achieves up to 80 mpg, running the accessories with the air conditioner on can reduce fuel economy by 30 mpg. In the ESX2, accessories are run off the battery, which is charged by the diesel using power not needed for propulsion.

The bottom line is 70 mpg and the ability to meet more stringent emission standards of the future. Performance includes a 0-60 mph time of 12 seconds with a 420-mile driving range. And unlike electric vehicles, Chrysler's hybrid would not require overnight charging. The battery is charged as the car is driven and regenerative braking is used. The ESX2 could be in production by 2003, if it meets all goals and there is a sufficient market for it.

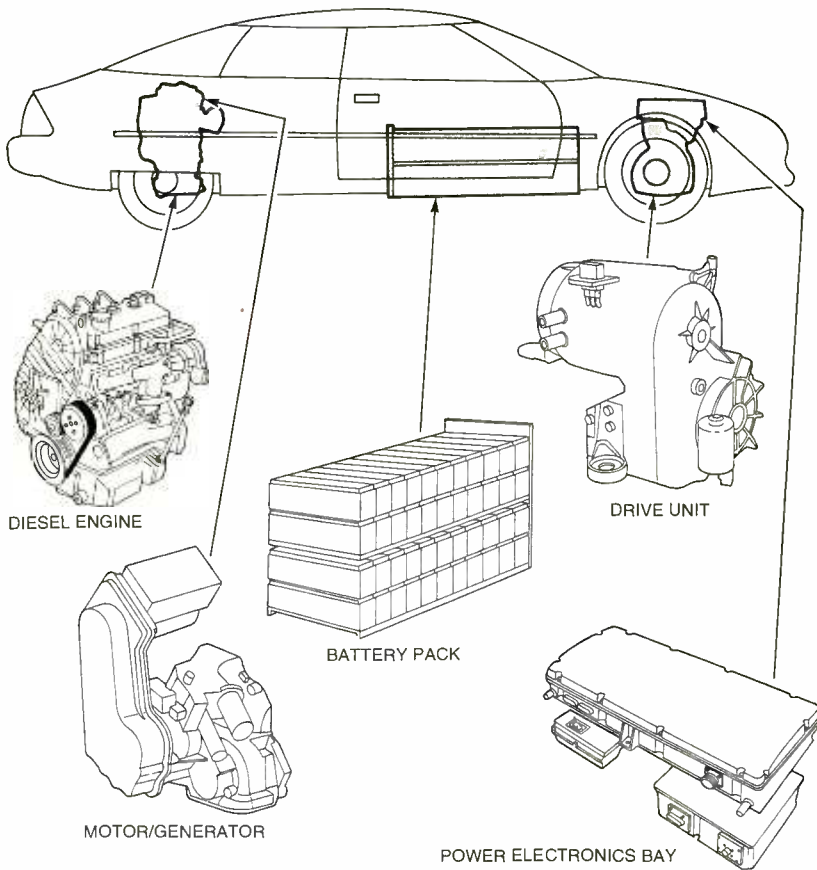
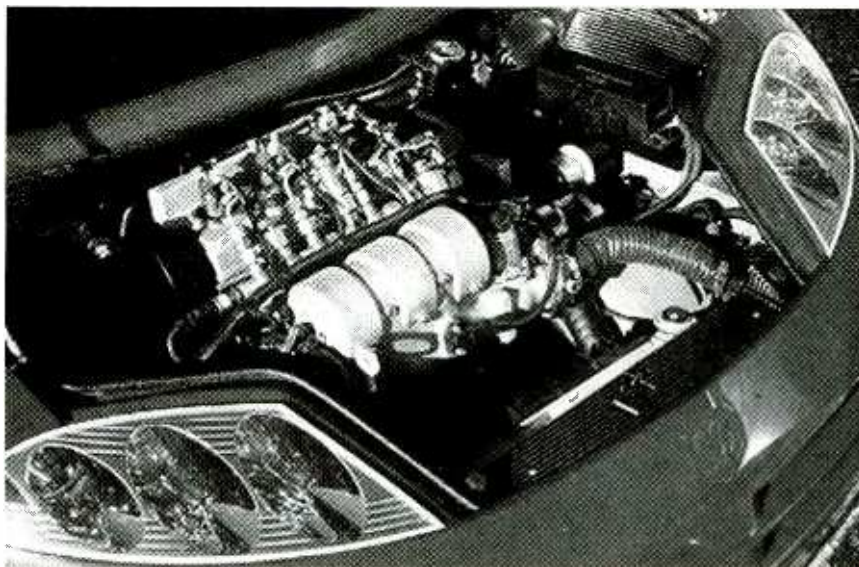

Fig. 4. Components comprising GM's parallel HEV. GM's parallel HEV has a 3-cylinder, 1.3-liter, 75-horsepower Isuzu turbo-charged, direct-injection diesel engine that drives the rear wheels via a 5-speed Opel-developed, manual transaxle, and a 6.5-horsepower, permanent magnet, DC brushless motor/generator, which is used as a starter for the diesel engine. (General Motors)

Toyota. While other automakers are still developing their HEVs, Toyota is already selling its Prius sedan in Japan. The Prius features the parallel Toyota Hybrid System (THS) and it could come to the US in the future. The Toyota Prius has a price tag of \$17,300, but reportedly it costs Toyota much more to build them.

The THS uses a small 1.5-liter, 58-horsepower gasoline engine, a 30-kW motor-generator, a constantly-variable transmission, and a NiMH battery pack (see Fig. 5). At low speeds, the Prius operates on the battery and motor. The 1.5-liter engine never idles wasting fuel since it is not started until extra power is needed for hill climbing, acceleration, and so forth. In low-speed, stop-and-go city driving, only the electric motor is used. At higher speeds, the gasoline engine cuts in to supply



Although it looks like the 1998 Dodge Intrepid, the ESX2 is significantly lighter and has a hybrid electric powerplant. (Chrysler)

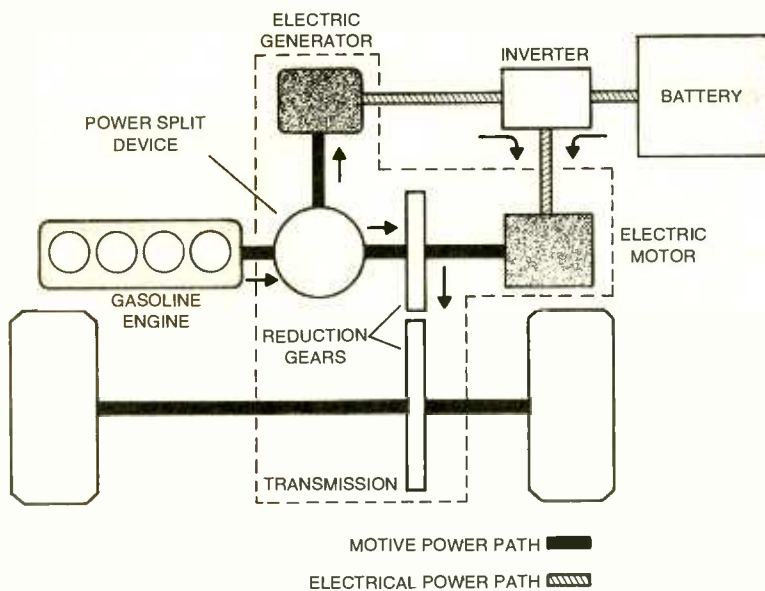

Fig. 5. The Toyota Hybrid System used in the Prius. The Toyota Hybrid System uses a small 1.5-liter, 58-horsepower gasoline engine, a 30-kW motor-generator, a constantly-variable transmission, and a NiMH battery pack. (Toyota)



While other automakers are still developing HEVs, Toyota is already marketing its Prius sedan—which features the parallel Toyota Hybrid System, and has a price tag of \$17,300—in Japan. (Toyota)

extra power and to recharge the batteries. An engine-management system determines the proportion of gasoline and electric power needed for most efficient operation. The gasoline engine automatically shuts down when the vehicle is at a standstill. The Prius can get 70–80 mpg while meeting the most stringent California emission standards.

Toyota is not the only Japanese automaker with a HEV. For instance, the Honda J-VX HEV uses a direct fuel injection, 1.0-liter VTEC engine;

an electric *Integrated Motor Assist*; and an *ultra capacitor* rather than batteries. Nissan has several parallel hybrids, the *Prairie Joy*, *AI-X* and *Stylishó*, while Subaru has its *Elfen HEV*. Over in Europe, Mercedes-Benz, Audi, Volvo, Renault, and others are working on HEVs.

Military Interested In Hybrids Too!

The development of hybrid electric propulsion is getting a boost from the military, which is interested in hybrid-electric power plants for its

land combat vehicles. They like the *stealthiness* offered by hybrid electric propulsion's quietness, low infrared signature, and lack of telltale smoke when operating in the electric mode. The hybrid's better fuel economy—up to twice the mpg—not only saves on operational costs, but also reduces the logistics problem when fuel has to be supplied on the battlefield.

The Defense Advanced Research Projects Agency (DARPA) is currently sponsoring research and demonstration programs on hybrid electric-propulsion technology for future Marine Corps and Army land-combat vehicles. For instance, the Marine Corps' Joint Reconnaissance, Surveillance and Targeting System (RST-V) will probably be fitted with such a propulsion system. The Army is interested in hybrid propulsion for its Future Scout Cavalry System armored reconnaissance vehicle and its Future Combat Vehicle, a replacement for the Army's main battle tank.

DARPA is spending millions of dollars to integrate hybrid electric-propulsion systems into existing vehicles—including installation in the Hummer, M113 Armored Personnel Carrier, and the Bradley Fighting Vehicle—to demonstrate the potential of hybrid propulsion. The first of the hybrid electric vehicles, the Hybrid Electric HMMWV or Hummer (see Fig. 6) was recently unveiled. It was designed and built by PEI Electronics, Inc. McKee Engineering modified the Hummer chassis. The series hybrid setup uses five permanent-magnet motors supplied by Unique Mobility. The four 100-horsepower motors each power one of the four wheels. The fifth 73-horsepower motor/generator functions as a generator on the high-efficiency 1.9-liter, inter-cooled, turbo-charged diesel power-plant. Electrical energy is stored in advanced technology Electrosorce lead-acid batteries.

The four compact electric motors provide truly independent four-wheel drive, allowing the Hummer to actually turn around in place, just like a tank. That's because each wheel can turn in different directions. The diesel motor generator system can also be used to provide auxiliary power—for instance, for a

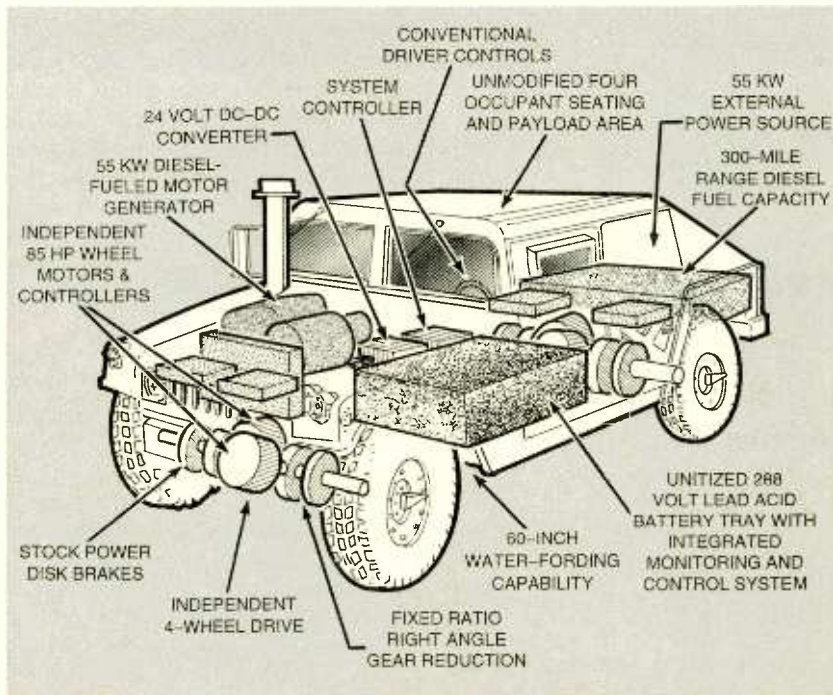

Fig. 6. The Hybrid Electric HMMWV not only has better performance, but it also is quieter, has a minimal IR signature, and puts out no smoke when operating on its batteries. (Unique Mobility)

ABBREVIATIONS

- APU—Auxiliary Power Unit
- CIDI—Compression-Ignition, Direct-Injection
- DARPA—Defense Advanced Research Projects Agency
- DIATA—Direct-Injection Aluminum Through-bolt Assembly
- EV—Electric Vehicle
- HEV—Hybrid Electric Vehicles
- ICE—Internal Combustion Engine
- LSR—Low Storage Requirement
- mybrid—Mild hYBRID
- THS—Toyota Hybrid System
- ZEV—Zero-Emission Vehicle

field hospital, communication center, or while providing assistance after a flood, hurricane, or other natural disaster.

With 400 horsepower and 440 ft-lbs of torque available, performance is spectacular. Recently, a drag race was staged between a conventional Hummer and the hybrid electric version. With a 0-50 mph time of about 7 seconds, it was no contest. The other comparisons are given in Table 1.

Within the 300-mile range, the hybrid electric Hummer can make a stealthy run of about 20 miles at

speeds of about 10 mph without telltale smoke and little noise or IR signature. With advanced batteries, such as nickel-metal hybrid types, that could increase to 40 miles. Finally, reduced emissions make hybrid electrics much more environmentally friendly. Rather than putting out emissions like a large truck, emissions are more like those from a small economy car. And when running on batteries, there are no emissions.

Will they be driving HEVs in the 21st century? Well, that depends largely on whether or not they can be sold for a price that the public is willing to pay. The HEV must also compete with another attractive propulsion technology, the fuel cell. To hedge their bets, automakers are working on fuel cells as well as HEVs.

And don't sell the ICE short. It seems that this versatile power plant always seems to have the potential to be improved so it can be further "cleaned up" to meet ever more stringent emission standards. That's because automakers already have the experience and facilities for producing ICEs, and the motoring public mostly wants to buy a well-known technology, like ICE, rather than an unknown and more expensive technology such as HEVs or fuel cells. ■

SCANNER SCENE

(continued from page 18)

ed in use at that time were the National Disaster Medical System (NDMS) on 419.60 MHz (also 418.05 MHz interagency), as well as two FEMA Nationwide Military Liaison frequencies: 138.225 MHz (repeater with 141.875 input), and 141.725 MHz (simplex), plus the U.S. Dept. of Health and Human Services on 41.47 and 413.425 MHz.

Reader G. Cobb, of New York City, writes to offer several new simplex NYPD tactical frequencies: CW TAC-F is 485.4375 MHz for ESU and others; CW TAC-G is 473.6875 MHz; CW TAC-H is 473.7125 MHz; CW TAC-I is 485.4125 MHz. NYPD radio techs use 471.1125 (PL 110.9 Hz).

Send us your comments and frequency information. Our e-mail address is Sigintt@aol.com. Our postal address is: **Scanner Scene, Popular Electronics**, 500 Bi-County Blvd., Farmingdale, NY 11735. ■

TABLE 1—A COMPARISON OF THE STANDARD HMMWV TO THE HEV VERSION

	STANDARD HMMWV	HEV HMMWV
RANGE (miles)	300	300
TOP SPEED ON GRADE (mph)		
0%	70	80
60%	6.8	17
ACCELERATION (0-50 mph/sec)	14	7
WEIGHTS		
Scout Version		
Payload (lbs)	2240	1700
GVW (lbs)	9100	9100
MILES PER GALLON	9	18

FLIGHT TIMER

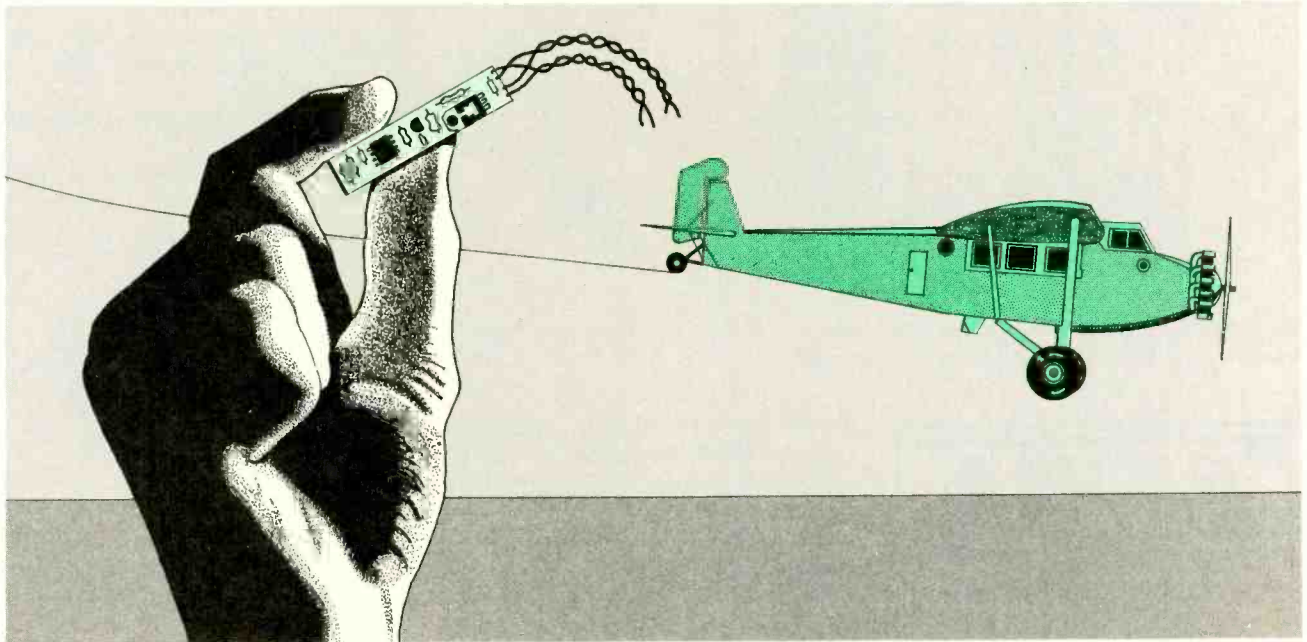

For years I've wanted to build a plane that could be flown without annoying the neighbors. That pretty much screamed electric power. But having no stomach for one of those five pound monsters with radio-control, I came up with something more suited to my humble needs. So I developed a small, light-weight aircraft that could be operated using a small motor and a few NiCd batteries. Sounds easy, doesn't it. Well, it's not as easy as it sounds.

Even after the weight and size problems were overcome, I still had to contend with the chance that the plane might fly out of sight or at least into traffic. Even if neither occurred, I'd still have to scamp after the plane to turn off the motor once it landed to conserve battery power. Because the plane often landed upside down (stalling the motor), it used more battery power on the ground than in the air. What was needed was a timer to turn the motor off after, say, ten seconds.

Such a timer would have to be light and yet pass a substantial current with a low voltage drop. At the same time, the circuit had to be capable of working from different battery voltages (in order to

Keep that electric airplane from flying away.

TOM NAPIER

accommodate design changes). The design that I came up with—dubbed the *Flight Timer*—allows the circuit to be used with various supply voltages by changing a single resistor.

About the Circuit. A schematic diagram of the Flight Timer is shown in Fig. 1. Power for the circuit is provided by a 3.6-volt battery (B1). At the heart of the circuit is a CMOS 555 oscillator/timer (IC1), which is configured for monostable operation. When power is applied to the circuit by closing S1, C2 (a 10- μ F capacitor) begins to charge through R3.

When the charge on the capacitor reaches the preset level, the threshold terminal of IC1 goes high, initiating the timing cycle. That causes the output of IC1 (at pin 3) to go high. That high is delivered to the base of Q1 (a 2N4001 NPN silicon transistor), causing it to turn on. When Q1 turns on, a bias current is fed to the base of Q2 (through R5), causing Q2 to turn on. With Q2 turned on, the low side of the motor is connected to the ground return line, energizing the motor, causing it to rotate. While that's going on, the charge on C2 drains into pin 6 of IC1, until the charge on C2 reaches the timer's lower threshold. At that point, IC1's output toggles low, causing Q1 to turn off, which, in turn, causes Q2 to turn off. With both Q1 and Q2 at cutoff, the motor ceases to rotate.

Diode D1 ensures that the timing capacitor discharges quickly when the power switch is turned off, while diode D2 is included in the circuit to protect transistor Q2 from the inductive kick generated by the motor when the power is shut off. Capacitor C3 holds the trigger input low until everything is up and running. Resistor R5 must be chosen to accommodate the number of batteries used. Since it supplies about 75

TABLE 1—TIMING RESISTOR VALUES

Cells	Resistor
3	22
4	33
6	68
8	100
10	120

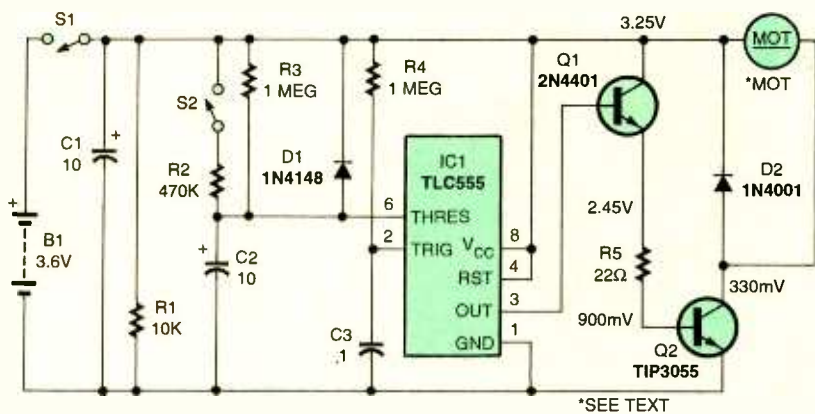

Fig. 1. The Flight Timer is a very simple circuit built around a single integrated circuit, a pair of transistors, a motor, and a handful of support components.

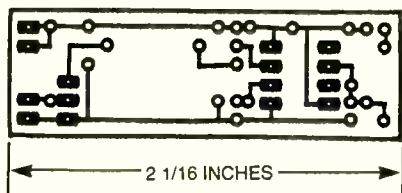

Fig. 2. The bulk of the Flight Timer's circuitry was assembled on a printed-circuit board, measuring $2 \frac{1}{16} \times 7 \frac{7}{16}$ inches. A full-size template of the author's printed-circuit foil pattern is shown here.

mA of base current to Q2, its value in ohms can be computed from:

$$R5 = 13 (1.1N - 1.7)$$

where N represents the number of 1.2-volt batteries used to power the circuit. Table 1 gives the optimum R5 resistance for various cell combinations. Aside from the value of resistance used for R5, the resistor's wattage must also be taken into consideration. At low voltages, R5 can be a 1/4-watt unit. However, at higher voltages—say, where the circuit is powered by ten 1.2-volt batteries—the resistor

would be required to dissipate greater heat, requiring a resistor with a higher wattage rating (say a half watt or so).

Construction. There is nothing critical about the construction of the Flight Timer. The entire circuit, minus the two switches, the charging socket, and the charging resistor (if any) was assembled on a printed-circuit board, measuring $2 \frac{1}{16} \times 7 \frac{7}{16}$ inches. A full-size template of the author's printed-circuit foil pattern is shown in Fig. 2. The layout can be copied from the page and used to etch your own printed-circuit board.

Once you've etched your board and obtained all of the parts listed in the Parts List, assemble the board guided by the parts-placement diagram shown in Fig. 3. Start by installing the passive components first, followed by the semiconductors. In order to conserve space, IC1 is mounted directly to the board.

With Q2 mounted to the board, its leads are bent so that the front surface of its body (the surface

PARTS LIST FOR THE FLIGHT TIMER

SEMICONDUCTORS
 D1—1N4148 general-purpose, small-signal diode
 D2—1N4001 1-amp, 50-PIV rectifier diode
 IC1—TLC555 CMOS oscillator/timer, integrated circuit
 Q1—2N4401 general-purpose NPN silicon transistor
 Q2—TIP3055 power NPN silicon transistor

RESISTORS
 (All resistors are 1/4-watt, 5% resistors.)
 R1—10,000-ohm
 R2—470,000-ohm
 R3, R4—1-megohm
 R5—See Table

CAPACITORS
 C1, C2—10- μ F, 16-WVDC tantalum
 C3—0.1- μ F, ceramic-disc

ADDITIONAL PARTS AND MATERIALS
 S1, S2—SPST toggle or slide switch
 Printed-circuit materials; wire solder, hardware, etc.

where the part number is printed) lies flush against the board; a dab of silicone adhesive is then placed between Q1's body and the board to secure it in position—doing so also protects it from hard landings. Because the transistor is mounted metal-side-out, it runs cooler. A couple of pins taken from an IC socket were placed on the board to serve as a timing socket; using a socket allows the timing resistor (R3) to be easily changed in order to vary the plane's flight time.

When all of the on-board components have been soldered in position, solder a couple of pairs of leads to the board at the points shown in Fig. 3 for the B1/S1 combination, the motor, and S2.

The completed board can be slipped into the fuselage of the plane with the power switch mounted in any handy location. However, it may be more convenient to adopt a T-configuration, wherein the battery-charging connector, the power switch (S1), and the timer switch (S2) are mounted on a piece of printed-circuit board, which is then fitted flush to the side of the fuselage. In such a configuration, the timer board is glued to the secondary board at a right angle. ■

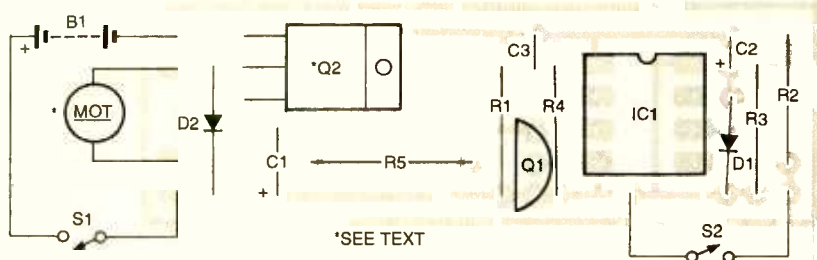

Fig. 3. Assemble the Flight Timer's printed-circuit board guided by this parts-placement diagram, starting with the passive components, followed by the semiconductors.

ELECTROMAGNETIC FIELDS IN YOUR HOME

In the last several years, our society has become seriously concerned about electromagnetic pollution. Because of that, there is a genuine concern about the health effects of *ElectroMagnetic Fields* (EMF) on humans. Today, the major cause of concern about EMF resides in the effects of cellular telephony—in particular, the construction of cell towers close to residential areas. In addition, other sources of EMF have been steadily increasing over the last few years.

The effects of low-level EMF on humans are highly controversial in the scientific arena. There are scientific studies that support the existence of effects on human health as a consequence of the body interacting with electromagnetic radiation, while other research does not confirm such evidence and claims that the first studies are biased and not reproducible. It is not the purpose of this article to present scientific evidence supporting either contention, but rather to briefly “voice” both opinions and to help the readers identify the possible and most common domestic EMF sources.

EMF and Health Effects. Studies that link health effects with human exposure to electromagnetic fields are based on the production of small currents that change the body’s natural ionic equilibrium. For example, they affirm that an electrical field of 2.5 kV/m at 60 Hz produces approximately one billionth of an amp per square centimeter. That current level is smaller than the human *perception threshold*—defined as the minimum amount of current that we can perceive passing through our bodies. However, some researchers believe that those extremely small currents have the ability to interact with body cells,

Electric and magnetic radiation has reached epidemic proportions, permeating nearly all aspects of our daily lives. In this article, we look at some of the sources from which this modern-day scourge emanates.

ALBERT LOZANO-NIETO

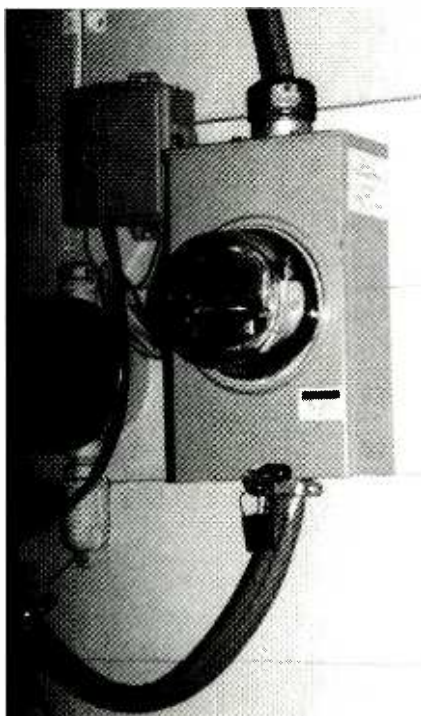

modifying their normal production of proteins, thus increasing the odds for contracting several diseases. On the other end of the spectrum, other researchers contend that conclusion is purely speculative, since the effects have not been reproducible in laboratory experiments as science demands. The latter researchers believe that since there is no reasonable and reproducible explanation of how low-level EMF interacts with human cells (known as *bioeffects* in scientific literature), there is no reason for alarm. In either case, independent research agen-

cies agree that although there is no proven link between low-level EMF and biological effects, it is recommended that we try to keep away from electromagnetic fields whenever possible.

In this article, we’ll talk about low-level EMF,

as opposed to stronger EMF that can produce well-known effects, such as electric shock when a live electrical wire is touched. We’ll also examine the most common EMF sources and give some relative values of EMF that might be encountered in our daily lives. It is important to keep in mind that the field strength measured in a typical American household is well below the safety threshold issued by different agencies. However, if we know where the “hot spots” are located inside the house, things can be rearranged so as to be less exposed. The electric and magnetic field strengths that are presented in this article were obtained with a *TriField* meter—an instrument that measures electric and magnetic fields separately, as well as radio and microwave leakage. It is important to emphasize that the *TriField* meter is a simple low-cost instrument that probably wouldn’t comply with specifications set forth by regulatory agencies regarding safe exposure limits to EMF. However, the instrument is more than useful for our purposes.

Some Technical Details About EMF. Electric fields are created when there is a voltage difference between two conductors. On the other hand, magnetic fields are created by the flow of electrons that originate in electrical current, and become stronger as the level of current increases. Because we are interested in measuring field strengths in close proximity to their sources (the household appli-

ance), we are in an area known as *near field*. In "near field," the electric and magnetic fields are separate entities and have an independent existence (that is, we can have a magnetic field without an electric field or an electric field without a magnetic field). In *far field*, unlike near field, electric and magnetic fields are linked together.

Electric fields can be easily shielded by conductive material or even the human body. On the other hand, magnetic fields penetrate buildings and the body. They are more difficult to shield against than electric fields, requiring the use of expensive ferromagnetic material that is not normally used in general applications or construc-

tion. Because of the difficulty in shielding and because they are created by high-current consuming appliances, magnetic fields are most commonly found in the home. Electric fields are measured in kV/m or kV/cm (1 kV/cm = 100 kV/m). Magnetic fields are measured in Teslas (T) or Gauss (G) that are related as:

$$1\text{T} = 10,000\text{ G}$$

Because the magnitude of the magnetic fields usually found in residential environments is small, they are measured in milligauss (mG).

As mentioned earlier, voltages and currents create electromagnetic fields. The fields propagate in a manner similar to that of radio waves, inducing currents when they come into contact with a conductive material. A major division of electromagnetic fields is based on frequency relationships.

Static (DC) Fields—Static Fields are generated, for example, by static magnets or by the Earth's magnetic field. Because they are DC and have a zero frequency, their interaction with the human body is considered safe at medium and even moderate strength levels, as they do not induce electric currents in the body. Examples of those fields are the Earth's magnetic field with a strength of 500 mG; magnetic fields used in industry where some workers are safely exposed to up to 500 G for long periods of time; and Magnetic Resonance Imaging (MRI), where the patients are also safely exposed to fields up to 40,000 G—although only for brief periods of time.

Low-Frequency Fields—Low-frequency fields have frequency levels below 3 kHz. The main contributor to such fields in residential and industrial environments is the electrical distribution network, which creates fields at 60 Hz, as well as harmonics at 120 Hz, 180 Hz, etc. Those are the fields that are measured inside a household.

High-Frequency Fields—High-frequency fields have frequencies above 3 kHz and are mainly created by transmissions in all spectrums, such as commercial AM and FM radio signals, 2-way radio, etc.

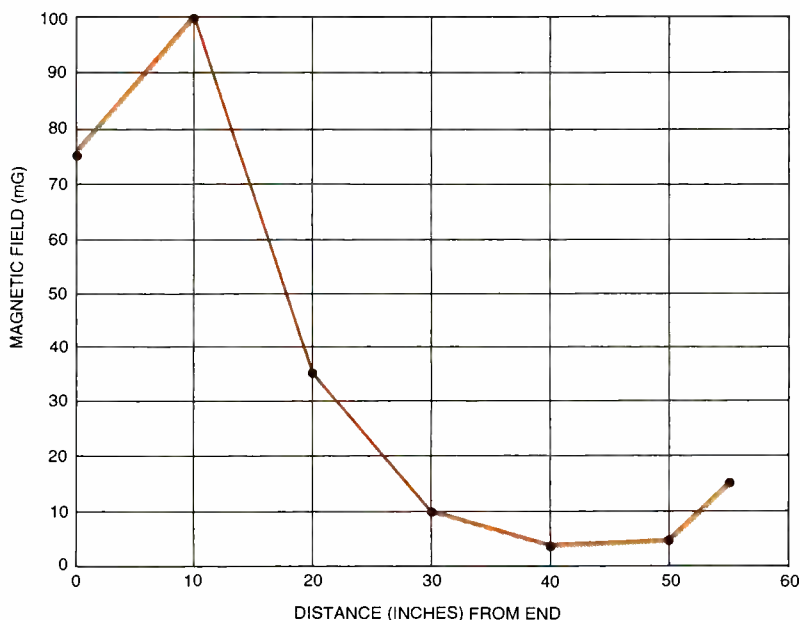

Fig. 1. Magnetic field strength measured at a distance of 6 inches from the fluorescent lamps; 0 corresponds to the level measured at one end of the fixture, while 55 represents the level detected at the other end.

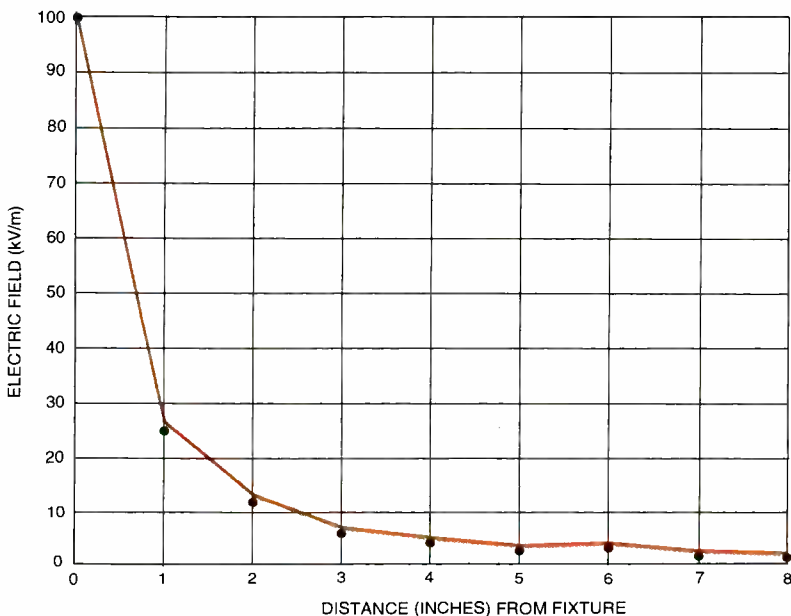

Fig. 2. Illustrated here is the electric field measured while the probe was displaced vertically from the fixture to a distance of 8 inches away from the light fixture.

TABLE 1—EMF CREATED BY FLUORESCENT LAMPS ALONG LIGHT FIXTURE

Distance (inches)	Magnetic Field (mG)	Electric Field (kV/m)
0	75	6
10	100	100
20	35	100
30	10	35
40	3.5	18
50	4.5	5
55	15	5

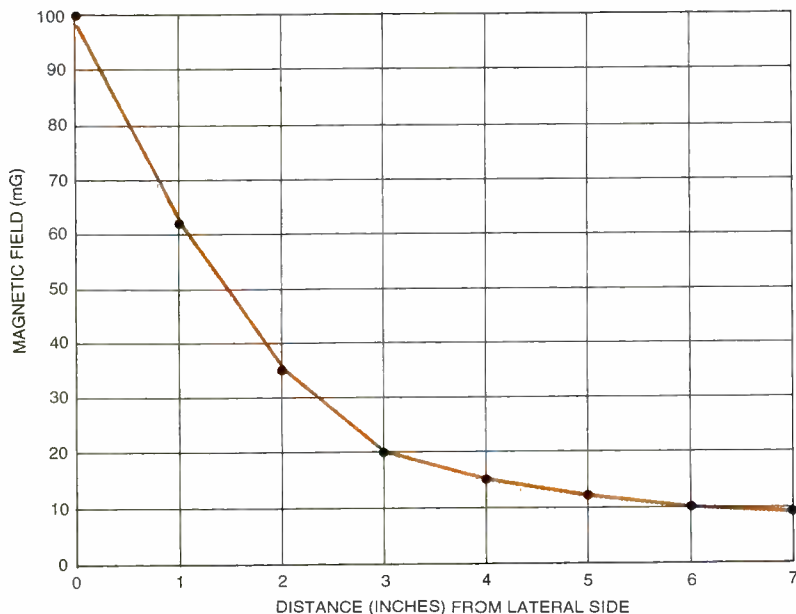

Fig. 3. Shown here are variations in the strengths of the magnetic field generated by a steam iron depending on the distance from its lateral side.

The Basement and the Effects of Fluorescent Lights. Because of its size and concentration of electrical appliances, the laundry room, normally located in a basement, is probably the area with the strongest magnetic fields. The background level of magnetic field strength (all appliances turned off) measured in the basement at the operator's

chest level was found to be 2 mG, while at the head level it was 3 mG. The reason for the increase in magnetic field as the detector was moved closer to the ceiling is the electrical wiring system that runs between the basement ceiling and the main floor in my house.

Fluorescent lamps—commonly used in laundry rooms, basements,

and garages—are not only a major source of magnetic radiation, but also of electric fields. The background magnetic field that was measured in the same room, after turning on the fluorescent lamps, was 2 mG at chest level (the same value as measured with the lights off) and 5 mG at the head level. The increase in the latter measurement was due to the additional flow of current in the fluorescent lights. Although it is a small background increase, the magnetic field at 6 inches away from the light fixture is much higher as shown in Fig. 1. Table 1 lists the magnitude of the electric and magnetic fields measured along a fluorescent-light fixture that's 55 inches long.

By comparing the values listed in Table 1 to those indicated in the graph of Fig. 1, it can be seen that the distribution of EMF generated by the fluorescent lamps is highly unbalanced, although the regions with stronger magnetic fields have strong electric fields, as well. The region with the strongest electric field was measured at a distance of 10 inches from one end of the fixture. It can be seen from the graph in Fig. 2 that the electric fields are attenuated as the distance from the source increases. For the EMF-level measurements indicated in Fig. 2, the EMF detector was kept at a constant distance of 10 inches away from the end that resulted in the strongest electric field and was then moved away from the fluorescent lamp. Note that the initial field strength reading decreases very quickly as the detector moves away from the source.

The Effects Of Large Appliances.

As previously discussed, the magnetic field found at the chest level was 2 mG in the basement whether the fluorescent lights were on or off. The measurements were taken in an area close to the location of a washer and dryer with the appliances themselves turned off. When the washer was turned on, the magnetic field measured at chest level was 3 mG, in a circle 2 feet away from the washer. The appliance, as well as the dryer measured, later did not produce electric fields.

TABLE 2—MAGNETIC FIELDS CREATED BY A WASHER AT DIFFERENT HEIGHTS AND DISTANCES FROM THE APPLIANCE

Distance From Floor*	Magnetic Field In Front Of Dryer (mG)	
	0.25" Away From Appliance	4" Away From Appliance
0 inches	> 150	100
10 inches	100	35
20 inches	25	4
30 inches	8	2.8 (background level)

(Continued on page 68) 47

Think Tank

This Diode Makes an IMPATT!

ALEX BIE

In this month's "What is a ...?" series, we cover a semiconductor device that is a cross between an ordinary semiconductor diode and a Gunn diode (discussed in last month's issue). This device, the *IMPact Avalanche Transit Time* (IMPATT) diode is used for generating radio-frequency signals in the microwave region from about 3 to 100 GHz and beyond. There are a number of different types of diodes used for generating microwave signals, but the IMPATT diode produces the most output power, generally in the 0.1- to 1.0-watt class.

The basic idea for this diode can be traced back to a paper written by W. Shockley of *Bell Telephone Labs* back in 1954, where he first proposed the use of a PN junction. A further idea for a slightly different type of structure using a P⁺/N⁺/I/N⁺ was proposed by W.T. Read in 1958. However, it was not until 1965 that a working diode was made, and the first IMPATT oscillations were observed at Bell Labs. Since then a number of different types of structures have been used, but all employ the same basic principle of operation.

Different Structures

A variety of different structures can be used for the IMPATT diode. In general, they are variations of a standard PN junction, often with a large center intrinsic ("I") or drift region area in the structure, as shown in Fig. 1. The "+" symbol indicates a higher than normal doping concentration for the specified P and N regions. This ensures an electric field distribution that is higher in the N-region in order to confine avalanching to a small zone. The I-region is an intrinsic semiconductor that is specially doped (negative) to have a low charge density. It is a near-insulator conductively, except when charge carriers are

("What is A...?" series by Ian Poole, G3YWX, reprinted by permission from *Practical Wireless*, Arrowsmith Court, Station Approach, Broadstone, Dorset BH18 8PW, England.)

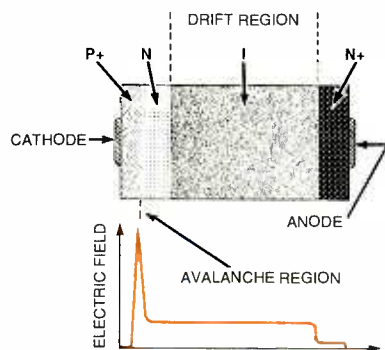

Fig. 1. An example of a typical IMPATT diode structure.

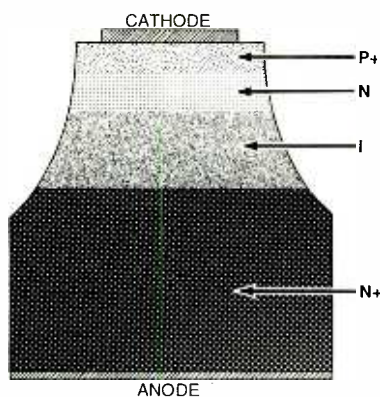

Fig. 2. A vertical IMPATT diode structure.

injected into it from other regions. For example, at reverse-breakdown for the PN junction, the I-region is fully depleted and a very small electric field can force velocity saturation of electrons.

The most common form of IMPATT diode, the Read diode is shown here for simplicity, as it illustrates the mode of operation particularly well. Other forms are generally variations of a PN junction, where avalanche breakdown is made to occur in a high field region. The typical realization of the Read diode is also shown in Fig. 2. Here it can be seen that the diode is made in a vertical structure with vertical current flow. Typically the N layer is about 1–2 mm thick and the intrinsic layer is between 3–20 mm, although a thickness of only 0.5 mm may be used for frequencies in excess of 100 GHz.

A variety of materials is used for this device. Silicon and gallium arsenide are the most common, although germanium, indium phosphide, and others have been used.

Diode Operation

The operation of the IMPATT diode occurs inside the structure of the device in two basic areas. The first is called the avalanche or injection region. Here the current carriers (electrons or holes) are generated. The second area is a drift region. Here the carriers move across a region of the diode taking a certain amount of time. The fact that the carriers take time to cross this region is crucial to the operation of the diode.

The IMPATT diode is operated under reverse bias so that avalanche breakdown occurs in the PN junction. The electric field at the PN junction, formed by the heavily-doped P and N regions, is very high. Here a voltage appears across a very narrow gap. In this circumstance any carriers will be accelerated very quickly. When they collide with the crystal lattice they may free one or more carriers, which in turn may be accelerated and will collide again freeing more carriers. Avalanche breakdown due to this impact occurs when one carrier frees more than one other carrier from the lattice. However, for this to occur a certain voltage must be exceeded across the junction. But, this is only the first part of the story.

The way in which an IMPATT diode operates relies on a phenomenon called *negative resistance* to cause and sustain the oscillation. This effect occurs when an increase in voltage gives a decrease in current. Normally an increase in voltage would give a corresponding increase in current. The negative resistance effect does not occur with direct current. Instead, here it is an alternating current effect that is brought about by phase differences that are seen at the frequency of operation. When an AC signal is applied,

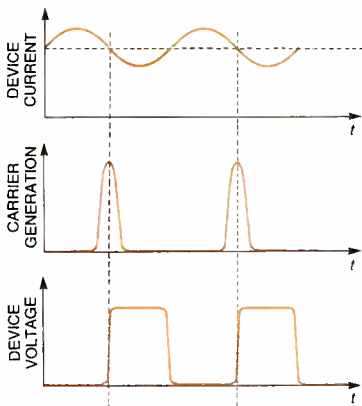

Fig. 3. Examples of IMPATT voltage and current waveforms.

the current peaks are found to be 180 degrees out of phase with the voltage; *i.e.*, when the voltage is positive the current is negative. This results from two delays which occur in the device. These are injection delay and a transit time delay, as the current carriers migrate or drift across the device.

A summary of the two effects, which cause this delay, are seen in Fig. 3. As the voltage rises a point is reached where breakdown occurs. The rate of breakdown does not occur when the voltage peaks—instead it is delayed. The reason for this is that the generation of carriers results not only from the electric field that is present, but also from the number of carriers that are already present. After the field passes its peak value the number of carriers continues to grow. This results in the maximum generation of carriers occurring about a quarter of a cycle (90°) after the peak of the voltage waveform. Once the field falls to zero and becomes negative, the generation process stops and the current starts to fall. When the charge carriers have been created, they move across the N^+ region creating an external current. In Fig. 3 you can see the current takes a finite time to flow across the drift region, and it is out of phase with the voltage.

The second delay causes another phase shift of the current of about 90° , giving a total delay of about 180° . In other words, the voltage and current are out of phase with one another. The result of the phase difference is that when the correct voltage is applied across the device, an oscillation starts and is chiefly dependent upon the delays across the device. In this way, the IMPATT diode can be used as a very simple microwave oscillator.

Applications

In view of the high-power capability of the IMPATT diode when compared to other microwave generators, it is used in a variety of applications from alarm circuits to communication transmitters to low-power radar systems. The diode typically operates at DC potentials in the 75- to 150-volt range. Its main drawback is the high level of phase noise, which results from the statistical nature of the avalanche process. Nevertheless, IMPATT diodes still make excellent microwave generators in many applications.

Next month, we will continue our "What is a ...?" series with tunnel diodes. Now here are some novel circuits from our readers.

AUTOMOBILE POWER SUPPLY FOR HANDHELD TRANSCEIVER

Some mobile ham-radio operators use handheld transceivers in their cars and trucks, and DC supply power is often a problem. Some of these hand-

helds cannot withstand input voltages exceeding 13.8 volts, which can possibly come from directly hooking up the transceiver to the car battery (via the cigarette lighter jack). To eliminate this problem, I designed the converter, shown in Fig. 4, with six different regulated voltages, from about 4.5 to 13 volts DC and capable of delivering up to 3 amps. Use is made of two *National Semiconductor* LM317 adjustable voltage regulators wired in parallel to provide more current. Each IC has its own programming resistor network (resistors R1–R6 for IC1 and R7–R12 for IC2—all resistors are $\frac{1}{2}$ -watt, 5% units). Capacitor C4 filters the output voltage, and the position of switch S3 determines if the tip of the plug is negative or positive.

This supply can also be used for low-power portable CD players to be used in the car. Change S2 to a DP7T switch, and put 500-ohm trimmer potentiometers in each network between the extra contact and ADJ of the IC2 voltage regulator—then adjust the output voltage to 3 volts.

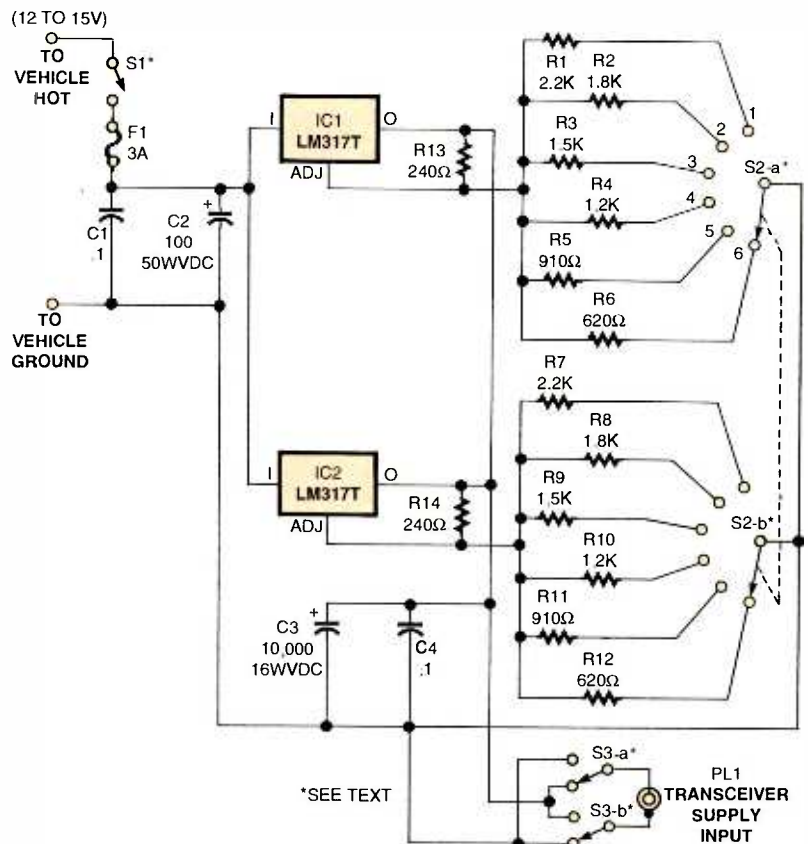

Fig. 4. This handy adjustable DC power supply, driven by your automobile's battery, can provide regulated voltages from 4.5 to 13 volts with output currents up to 3 amps. It's ideal to power up a handheld ham transceiver in your car.

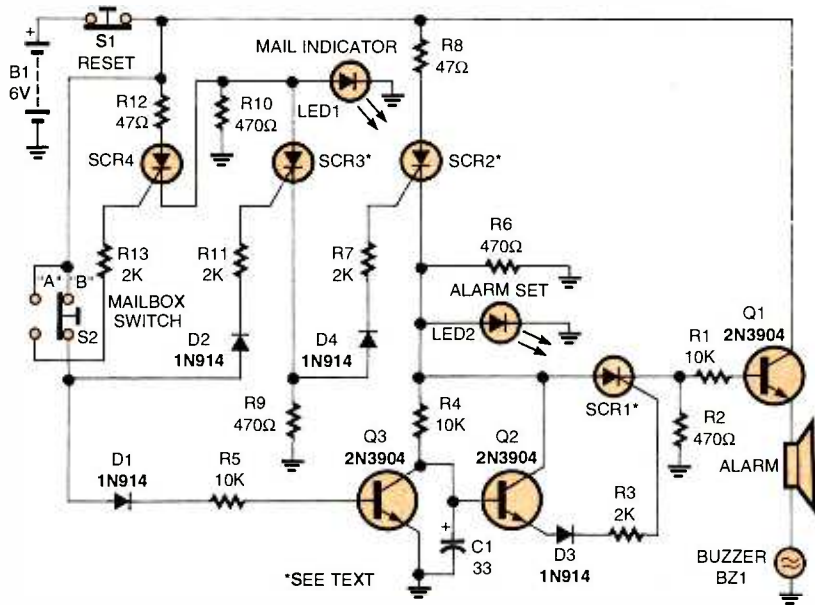

Fig. 5. Here's a mailbox monitor circuit that not only alerts you when the mailbox is opened, but incorporates an alarm feature which goes off when the box is opened by unauthorized personnel.

When hooking this power supply to the vehicle, you can tap the hot line to the fuse box or bring a wire directly to the battery. The ground wire must be brought directly to the battery to ensure a good ground. Be sure to use a large heatsink for the voltage regulators—they will get hot!

—Marc Colette, St. Malo, Manitoba, Canada

Very nice, Marc. This adjustable supply can also be used on your workbench with any 12- to 15- volt fixed source. An equivalent IC for the LM317 regulator is a NTE956 or Thomson SK9215.

MAIL-MONITOR CIRCUIT WITH A LITTLE EXTRA

In reference to the mailbox monitor circuits in the *Circuit Circus* column of the September 1998 issue of **Popular Electronics**, I designed a mail-monitor circuit (see Fig. 5) with a little extra feature. It's probably more of a novelty than something really useful, but it was fun designing this circuit anyway. The extra feature is a mail burglar alarm incorporated into the monitor circuit.

My design works as follows. Switch S2 is a SPDT switch, which is the "On-Momentary" type. As shown in the figure, the switch contacts are in the "momentary" mode (position "B") when the mailbox door is shut. When the door

is opened, the switch springs to its "On" position, (position "A"), thereby applying a potential to the gate of SCR4 and firing it. This in turn lights LED1 as the mail indicator. Positive voltage is now applied at the anode of SCR3, but since there is no gate input at this point, SCR3 remains in a non-conducting mode.

When the mailbox door is shut, switch S2 is pressed back to its "momentary" position, connecting the supply voltage to the gate of SCR3. This voltage causes SCR3 to fire, which applies positive voltage to the gate of SCR2, making it fire as well. SCR2 turns on the alarm circuitry. However, with switch S2 in the closed door position ("B"), the positive voltage from SCR2 is bypassed through the base of transistor Q2 (through transistor Q3) to ground. The switch in this position applies positive input to the base of Q3, saturating this transistor, steering all current away from the base of Q2, and keeping it out of conduction.

At this point, the user only needs to press switch S1 to deactivate the circuit and get the mail. If the mailbox door is opened without pressing S1, then S2 switches transistor Q3 out of conduction, thereby allowing positive current to flow into Q2 from SCR2. Transistor Q2 conducts to fire SCR1, locking it and applying current to the base of transistor Q1, turning on a DC buzzer alarm.

Diodes D1 and D2 are switching diodes to keep isolation between transistor Q3 and SCR3, while D3 and D4 are used to keep negative currents away from the gates of the SCRs; otherwise the currents could cause the SCRs to shut down, instead of remaining on. The transistors are general-purpose NPN 2N3904 types (equivalent replacements are NTE123AP or Thomson SK3854), and the SCRs are the "garden-variety" types, such as RadioShack part 276-1067. The alarm could be any kind of DC buzzer in the 2–5 volt range.

—David Kazinski, Chambersburg, PA

Good job, David. This circuit certainly incorporates several unique features. And for all the builders, make sure to weatherproof any exposed switches or wiring.

HIGH-PERFORMANCE STETHOSCOPE

The first modern stethoscope, invented in 1816 by R.T.H. Laennec, was simply a perforated wooden tube used by doctors of that era to listen to patient's chest sounds. Since then the stethoscope developed into the more familiar diaphragm/bell attached to ear pieces through rubber tubing. The drawbacks of today's stethoscopes include low amplification or low sound intensity, uncomfortable ear pieces, and uncontrollable frequency response.

Here is an easy solution to these problems—build the electronic stethoscope of Fig. 6! Not only will this circuit amplify heart sounds to earthquake proportions, it is also more comfortable with headphones, and good headphones also reduce background noise. Furthermore, an active lowpass filter complements the frequency response of the diaphragm to produce an excellent overall audio response. Besides listening to chest/stomach sounds, you'll find your electronic stethoscope useful in hunting mechanical noise sources. The electronic output can be applied to a tape recorder or high-wattage audio amplifier if desired.

In the course of designing this circuit we have experimented with many diaphragm, bell, and combination stethoscope heads in a variety of quality ranges, from cheap to expensive, with surprising results. A plain diaphragm head has better mid-frequency response than a bell-shape, and less background noise than a fancy

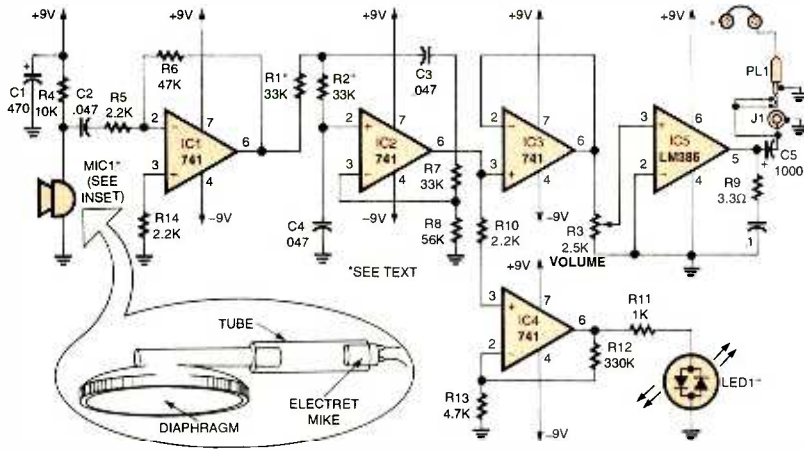

Fig. 6. This high performance electronic stethoscope is much more sensitive than the standard mechanical types, and can also be used in any number of different projects.

combination diaphragm/bell type. Also, a cheap diaphragm performs almost as well as an expensive one; maybe the electronics account for this equalization.

Let's begin with the head or sensor construction (MIC1). Acquire an inexpensive student's or nurse's diaphragm stethoscope (try a nursing supply or college store, or you can purchase one for \$8.50 from *American Science and Surplus*, 3605 Howard St., Skokie, IL; Tel. 847-982-0870, part 11077). With a razor knife, cut the rubber tubing 1 to 2 inches from the diaphragm, and squeeze a 1/4-inch diameter sub-miniature electret microphone (*Hosfelt Electronics*, 2700 Sunset Blvd., Steubenville, OH 43952; Tel. 888-264-6464, part 13-303) with a 4-inch piece of shielded microphone cable already soldered to the back end into the tube. Tape or heat shrink the tube securely in this area so the wires cannot break off or move, which might cause unwanted noise during operation. This finishes the head or microphone construction.

The electronics section is equally simple. DC power is supplied via two 9-volt batteries (or 9-volt AA battery packs) in a split supply (not shown in the schematic diagram). Make certain that the batteries are fresh or performance will suffer. Construction and layout is not critical. The microphone output is capacitively coupled to IC1, an LM741 integrated circuit configured as a gain amplifier. The output of IC1 is fed to IC2, another 741 configured as a lowpass filter. With the values of resistors R1 and R2 as shown (33k), the cut-

off frequency is slightly over 100 Hz, which we qualitatively feel gives the all-around best response. By installing dual-linked 50k or 100k potentiometers in place of R1 and R2 you can obtain an adjustable response, but you'll probably end up leaving these controls set in the 30k range anyway.

Beware using significantly higher cutoff frequencies which make the circuit much more sensitive to feedback (truly painful with headphones!), and produce a sound like an explosion when moving the diaphragm around on your patient's chest. IC2's filtered output now splits off to both IC3 and IC4. IC3 is another 741 set up as a buffer for the low-voltage audio amplifier, IC5, an LM386 IC that drives the headphone speakers. Potentiometer R3 is the volume control. Note that standard 8-ohm stereo headphone speakers are connected and driven in parallel, meaning that the impedance is 4 ohms instead of 8 ohms, which the LM386 can handle fine.

Going back to the output circuitry, IC4 is another 741 configured as a gain amp with the sole purpose of driving a bipolar or two-color LED, which creates a very interesting visual interpretation of the heartbeat, or other, audio signal. If you can't find a dual-color LED (such as *RadioShack* part 276-012), use a common red and a green LED in parallel, one of which is reverse-polarized (put in backwards). To save some space, you could also design the circuit using a quad op-amp for IC1 through IC4 (such as a *National Semiconductor* LM2900, or equivalent).

In operation, turn the volume control down to the 10%–20% level, put on the headphones and apply the diaphragm to your volunteer patient's chest. Slowly crank up the volume to about 50%. The booming sounds are not an approaching dinosaur, but the heart sounds instead. The hilarious squeals, gurgles, pops, and claps are not circuit problems; they are the sounds of a normally functioning stomach! Bring the volume back down before moving the diaphragm, and keep the diaphragm well away from the headphone speakers to avoid feedback. The loudness of this circuit, set to about 10% volume, approximately matches the volume of a traditional stethoscope. Enjoy it and good listening!

—Nick Cinquino and Gordon Macmillan, Schaumburg, IL

Real nice circuit, and I am sure it should find many uses for medical personnel, auto mechanics, or would-be safe crackers!

MAILBAG

Have you ever finished a project, but had several wires that you had to splice together, and you either forgot to put the shrink-wrap tubing on the wire before soldering or just didn't have any shrink-wrap at all? Don't despair; I have found something just as good as the shrink-wrap, can be cut to any size or length, and you probably have it already—plastic bags!

Just cut a strip, any width, from the plastic bag, wrap the strip around the joint several times, as tight as possible. Using a lighter or match, carefully move the flame along the wrapping, not too close—or the plastic will burn. After the plastic has shrunk, let it cool. I've saved a lot of money using these bags and not buying the shrink wrap, recycling the bags at the same time!

—Derek Fox, Sapulpa, OK

That's about it for this month's column. Remember—this is **your** column—keep those circuits, solutions and ideas coming in. For each of your circuits that appear, you'll receive a book from our library. Send in enough circuits to fill a whole column and you will get a nifty kit or electronics tool to make your construction easier. Write me—Alex Bie, *Think Tank*, **Popular Electronics**, 500 Bi-County Blvd., Farmingdale, NY 11735.

DX LISTENING

Radio Pakistan

DON JENSEN

With tension between India and Pakistan tightening in the wake of last summer's nuclear tests, it is not surprising that SWLs are targeting the broadcasters of this corner of the world. Among these stations is *Radio Pakistan*, the voice of the Islamic nation that shares with India and Bangladesh the great Asian sub-continent.

Once part of British India, Pakistan gained independence along with India in 1947, and the following year established its first shortwave-broadcasting service with a tiny 500-watt transmitter at Rawalpindi, and an even smaller 100-watt unit at Karachi.

But subcontinental radio began 20 years earlier, with a medium-wave station at Bombay, India, operated by the privately owned *Indian Broadcasting Company*. In 1930, radio broadcasting was put under the control of the governmental *Indian State Broadcasting Service* (ISBS). Six years later, ISBS became *All India Radio*, an identity still used today by India's broadcasting service.

With its independence, Islamic Pakistan went its own way, establishing the *Pakistan Broadcasting Service*, later shortened to, simply, *Radio Pakistan*. A new broadcasting house was built at Karachi, and two 50-kilowatt shortwave transmitters, powerful units for their time, were added.

Today, as it was five decades ago, news of Pakistan, the region, and the world are an important part of this radio service's transmissions, with more than 100 newscasts daily on the domestic and external radio schedules. *Radio Pakistan* began its World Service for listeners abroad in April 1973 and soon was broadcasting with powerful 100-



Radio Pakistan *gratefully acknowledges your communication of recent date and confirms your reception report as correct.*

Time : West Pakistan=GMT. + 5 hrs. East Pakistan=GMT. + 6 hrs.

GPPK—H 11 RP—27-8-55—4,000

A QSL card from Radio Pakistan listing some of its shortwave and medium wave stations.

Radio Pakistan

KARACHI :	
APK-1	363.6 M 825 Kc/s
APK-2	Shortwave.
APK-3	Shortwave.
APK-4	Shortwave.
APK-5	Shortwave.
HYDERABAD :	
APH-1	297.03 M 1010 Kc/s
LAHORE :	
APL-1	275.2 M 1090 Kc/s
APL-2	Shortwave.
RAWALPINDI :	
APR	260.9 M 1150 Kc/s
PESHAWAR :	
APP-1	379.7 M 790 Kc/s
APP-2	Shortwave.
DACCA :	
APD-1	256.4 M 1170 Kc/s
APD-2	Shortwave.
APD-3	Shortwave.
RAJSHAHI	223.9 M 1340 Kc/s
CHITTAGONG	344.8 M 870 Kc/s

kilowatt shortwave transmitters. Today, the Pakistan Broadcasting Corporation, which controls *Radio Pakistan*, has some 40 transmitters operating on medium and shortwaves. These include two 250-kilowatt and four 100-kilowatt units at Islamabad, the capital city; two older 50-kilowatt transmitters at Karachi; several modest 10-kilowatt SW home service/regional stations at Quetta, near the Afghanistan border, and at Peshawar, gateway to the famed Khyber Pass; and transmitters at Islamabad/Rawalpindi. Plans to replace the two 50-kilowatt units with modern 500-kilowatt transmitters presently are on hold, reportedly for financial reasons. Still, its 250-kilowatt transmitters offer solid signals worldwide, under the right conditions.

Radio Pakistan's World Service programs mainly for Pakistanis living and working abroad. The World Service airs 10 hours of daily shortwave programming in five two-hour transmission blocks, one aimed at Southeast Asia, and two each directed to the Middle East and Europe. None, though, are specifically beamed to North America

during our peak listening times. In addition, the broadcaster's external shortwave services are beamed to neighboring countries in a dozen languages: India, Bangladesh, Iran, Turkey, and parts of the former Soviet Union, China, Southeast Asia, the Middle East, and East Africa.

You can look for *Radio Pakistan* English transmissions at 0230 UTC on 7485, 11760 or 15485 kHz; at 1100 UTC on 15530 kHz; at 1400 UTC on 9645 kHz; at 1600 UTC on 9650, 11570, 15170, 15495, 15570, or 17720 kHz. Reception reports may be sent to *Radio Pakistan*; External Services; Broadcasting House; Constitution Avenue; Islamabad, Pakistan 4400.

IN THE MAIL

Let's take a look at some of the letters received here at the "DX Listening" post.

"Last fall, my son told his teacher that his Dad listens to stations all around the world," writes Sam Danvers, of St. Joseph, MO. "Now his class is studying China, and the teacher sent a note home asking if I could tape record

CREDITS—Gene Borowski, NY; Bob Fraser, MA; David Krause, OH; William McGuire, MD; Ed Newbury, NE; Betsy Robinson, TN; Sheryl Paszkiewicz, WI; Robert Yajko, PA; Dan Ziolkowski, NY; North American SW Association, 45 Wildflower Road, Levittown, PA 19057; World DX Club, c/o Richard A. D'Angelo, 2216 Burkey Drive, Wyomissing, PA 19610.

some Chinese music off shortwave, so the kids could hear what it sounds like. Help! When and where should I tune?"

Not to worry, Sam! At 0300 UTC Mondays—that's Sunday night in the U.S., of course—look for the "Music from China" segment from Beijing's shortwave *China Radio International* on 9690 kHz. A repeat, also beamed to North America, is aired at 0400 UTC on 9560 or 9730 kHz. These should not be too tough to log and tape. The 9690-kHz broadcast is relayed from a transmitter in Costa Rica; 9560 kHz, from *Radio Canada's International* transmitter; and 9730 kHz from French Guiana in South America—all considerably closer to us than mainland China.

Next, there's a letter from John Allen, of Phoenix, AZ, who asks about *Radio Yugoslavia* on shortwave.

"I haven't heard Belgrade for some time. Has the conflict in the Balkans affected Radio Yugoslavia's broadcast schedule?"

I don't think so, John. Radio Yugoslavia, whose main transmitting site is at Bijeljina in the Serbian part of Bosnia, still transmits English programming from 0000 to 0030 UTC, Monday through Saturday, and daily from 0430 to 0500 UTC, on both 9580 and 11870 kHz. I'd think the latter transmission might be better for you in Arizona.

SINPO INFO

Sue Tueley of Wichita Falls, TX, also has a question.

"What is SINPO?" she asks. "An SWL pen pal in England mentioned SINPO in a letter, apparently assuming I'd know what it means. Well, I don't. Can you help?"

Sure, Sue. SINPO is a numerical code once commonly used to report shortwave reception conditions. It is a bit of SWLing history, really not used much anymore, though some longtime listeners may still use the SINPO code when reporting reception to shortwave stations.

In earlier years, shortwave listeners were told that the stations they heard wanted detailed information about the technical aspects of their signals. How well were they being received in, say, East Podunk, Ohio? Somebody—I think it might have been one of the major SW stations—devised a subjective reporting code that was supposed to make it easier for listeners to do that when they wrote to a station.

SINPO was an acronym for five aspects of a received signal: Strength, Interference, Noise, Propagation and Overall. The listener rated each with a value, 1 to 5, depending on how well the station was heard. "Strength" of signal was, of course, significant. "Interference" indicated there were other stations interfering with clear reception. "Noise" signified atmospheric interference, static. "Propagation," well, that did confuse some SWLs, but, in practice, it meant to measure the degree of fading of the shortwave signal. Finally, "Overall" simply summarized the four preceding reception factors. SINPO implied an qualitative analysis of a shortwave signal. In fact, though, it was entirely subjective. The listener simply rated the factors on a 1 to 5 scale, with 5 being the best.

If the signal was excellent, the SWL was supposed to assign the value 5, for S. If there was only slight interference from another station, 4 (good) would be assigned to I. If static crashes made the programs somewhat difficult to hear, N might get a 3 (fair) rating. Perhaps the reception was plagued by deep fading. Then the P factor would be rated 2 (poor). Overall, the SWL might well rate this reception as too much for his ears to stand. Then O would get a 1 rating, for useless. In this example cited, the broadcasting station would be informed that reception at that particular date and time was SINPO 54321. A loud and clear signal with no fading could get a perfect SINPO score: 55555.

For some years, SINPO was quite widely used, and there also was a simplified version called SIO, which included Strength, Interference (whatever the source, another station or simply static) and an Overall rating. In time, though, the use of SINPO faded away. Today, few SWLs—apparently your English pen pal is one of them—use the reporting code, which, of course, is why you never heard of it.

But in a recent issue of *Contact*, the monthly newsletter of the World DX Club, G. B. Bramhall, another British listener commented on the now seldom used code. "SIO or SINPO are meaningless to 90 percent of tropical-band stations (small, local or regional SW broadcasters in Third World countries) and the big international broadcasters no longer need SIO or SINPO either, because of the present efficiency of modern transmitters and beam

aerial arrays. The words GOOD, FAIR, POOR (reception) say it all. SIO and SINPO should go back into the Ark from whence they came!" And now, Sue, you NOAH all about SINPO!

DOWN THE DIAL

Looking for some listening targets? Try these:

BRAZIL—9645 kHz, *Radio Bandeirantes* is a longtime Brazilian shortwave broadcaster that is noted with Portuguese programming, including some great music, around 0215 UTC. Reception is spoiled, however, by *Vatican Radio* signing on just before at 0230 UTC. You might try parallel frequencies of 6060 and 11925 kHz.

CANADA—6160 kHz, CKZN, St. John's Newfoundland, is one of only a couple of Canadian SW home service stations. Those listeners, especially in eastern North America, may find this one around 0845 UTC with early morning programming, including weather forecasts for the Maritime Provinces.

FRENCH GUIANA—13625 kHz, *Radio France International* English programs are relayed around 1230 UTC by the station's SW relay transmitter in this small overseas territory on the northern "shoulder" of South America.

HAWAII—11565 kHz, KWHR, *World Harvest Radio's* outlet at Naalehu, Hawaii, has been heard in English, with rock music, news and sports after 1300 UTC.

IRAQ—11785 kHz, *Radio Iraq International* has English language programming at 0315 UTC, when it is heard with identification, news, commentary, and anti-US diatribe.

NEW ZEALAND—9795 kHz, *Radio New Zealand International* is always a treat to tune in, usually during the wee small hours, say around 0800 to 1030 UTC. On weekends, its "Saturday Night" music program is a treat.

RUSSIA—9665 kHz, *Voice of Russia*, though relayed from independent Moldova, one of the former republics of the USSR, is noted in English at 0200 UTC. Following world news, you still can hear "Moscow Mailbag," the listeners' letters program that dates back to Radio Moscow and Cold War days.

SLOVAKIA—7300 kHz, *Radio Slovakia International's* English programs, including a feature called "Slovakia Today," is aired at 0100 UTC. ■

ANTIQUE Radio

Radio Historians and Radio Books

MARC ELLIS

As I contemplate the deadline for submission of this column, I've just returned from four days of total immersion in antique radio hardware, software, and history at the 37th annual conference of the Antique Wireless Association (AWA) at Rochester, NY. This 4000-odd member national organization of radio historians and collectors puts on what is arguably the biggest and best radio meet in this hemisphere. As many of you know, I'm pleased to be editor of the AWA's quarterly publication *The Old-Timer's Bulletin*.

The four-day flea market, which sprawls over a huge expanse of the *Thruway Marriott* parking lot and surrounding grass, is always the main focus of attention on the first day (in this case, Wednesday, September 2). By Thursday, most of the heated trading was over, and bargain hunters could begin to peruse the booths in a more leisurely manner. The traditional communication equipment auction was also held on Thursday. The next day marked the beginning of the also-traditional extended auction, beginning with vacuum tubes, then moving to paper collectibles, and finally on to the mammoth general category.

Sprinkled throughout the conference was the usual wonderful potpourri of seminars and talks, and I particularly enjoyed the presentations on "Shortwave History" by California lawyer and radio historian, Bart Lee, "The Zenith Wincharger" by Dale Goodwin, "Radio Restoration Clinic" by Bob Macintyre of Canada, and "Life of Alexander Graham Bell" by Morgan Wesson, author of the recently published and profusely illustrated biography of the inventor.

The conference theme this year was *Zenith*, which brought many rarely seen artifacts from that firm to the extensive yearly "show and tell" contest. Entertainment at the annual Historical Banquet was provided by a local little theater group, who presented recreations of old-time radio shows, as well as a trio of girl singers who recreated 1940's Andrews Sisters numbers in uncannily accurate style. A good time

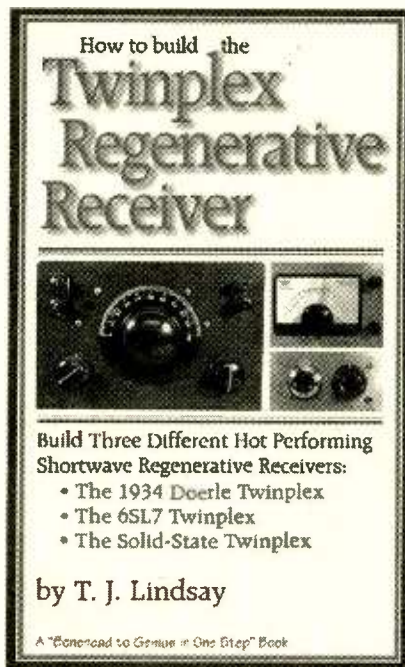

was definitely had by all!

Those interested in joining AWA (and thereby receiving its most estimable *Old-Timers Bulletin*) may send \$15.00 for one year, or \$27.00 for two, to AWA Secretary, J. Peckham, Box E, Breesport, NY 14816. Then you'll receive all of the information about next year's conference (Theme: *Philco*) in time to make your travel arrangements!

NEW PUBLICATIONS

Crystal Set Building and More (Volumes 6 and 7 of "The Xtal Set Society Newsletter," Rebecca Hewes, Editor). Published 1998 by The Xtal Set Society, P.O. Box 3026, St. Louis, MO 63130; 168 pages; \$15.95 plus \$2.50 S & H.

Periodically The Xtal Set Society republishes, in book form, a year or two of its very popular newsletter for crystal-set enthusiasts. This one covers all issues from January 1996 through November 1997. Included are not only crystal-set circuits, but also some of the simple, elegant old-time tube designs—many built with semiconductors for ease

of construction and simpler power requirements. Among the large collection of interesting projects in this volume are: "An FM Xtal Set," "A Crystal Headphone from a Cat Food Can," "The Simple TRF Set," "Flame Detector for the Xtal Set," "The Foxhole Set," "WWII Underground Xtal Radio," and "A JFET Shortwave Regenerative Receiver." For more information on this and other Xtal Set Society publications and products, you might like to check the Society's web site at www.midnightscience.com.

Come Quick, Danger: A History of Marine Radio in Canada, by Stephan Dubreuil. Published 1998 by Minister of Public Works and Government Services Canada; 136 pages; \$21.95. Available through bookstores or from Canadian Government Publishing, PWGSC, 350 Albert St., Ottawa, Ontario, K1A 0S9; Tel. 800-635-7943; Fax: 819-994-1498; Fax for credit card orders: 800-565-7757; Web: publications.pwgsc.gc.ca.

This is the history of radio communications as employed by the Canadian Coast Guard in their mission to protect and save the ships and crews sailing off the country's three coasts. Author Dubreuil takes us from the dawn of radio at the turn of the century to the satellite era of today. The book's seven long chapters are organized according to the major regions served by the Coast Guard and titled: "The Laurentian Region: They Came Out of the Backwoods to Build a Radio Station;" "Newfoundland and the Titanic;" "Calling Nova Scotia;" "Radio and the Great Lakes System;" "The Sinking of the Aigle D'Océan and the Arctic Region;" "The Pacific Region;" and "Safe Passage—Clean Seas: Maritime Communications and Traffic Services."

Equipment and history of the Coast Guard's key stations are described, as well as the role of radio in the Service's response to various marine disasters and other incidents. Wherever possible, the book is based on first-person accounts of people who were there when the ships were in trouble and who

used radio to protect and rescue the seafarers and their cargoes. A generous photo section in the center of the book offers over 100 images of the radio stations, their equipment, and their operators.

Play Things of the Past—Catalog #7. Published by Gary B. Schneider, 9511 Sunrise Blvd. #J23, Cleveland, OH 44133; 116 pages; Price by mail: \$6.00.

Like all Gary Schneider's previous *Play Things of the Past* catalogs, this one is chock-full of antique radio parts, tubes, literature, and restoration supplies. The 116 pages contain over 13,000 individual listings including almost everything one might need to troubleshoot, restore, research, or maintain a vintage set. Gary must be a master organizer and cataloger, because even though most of his items are "one of a kind," each has a unique stock number and is carefully described. He advises calling to check stock before sending in an order. Any item may be returned for a refund within 5 days. Minimum order is \$25.00.

How to Build the Twinplex Regenerative Receiver by T.J. Lindsay. Published 1998 by Lindsay Publications Inc., PO Box 538, Bradley, IL 60915; 64 pages; \$7.95.

This is yet another labor of love by publisher Lindsay, whose main stock in trade is the reprinting of obsolete, arcane, bizarre, and otherwise offbeat publications dealing mostly with technology and technological processes. If

you haven't seen a Lindsay catalog, by all means write for a free one!

Though he caters to technological interests of all kinds, Lindsay himself is a radio buff, with a special soft spot for the regenerative receivers of the 1930s. In his introduction to this book, Lindsay tells us: "As a kid I listened to shortwave broadcasts with regenerative receivers. In high school I built them, but they never quite lived up to my expectations. Now, in middle age, I've gone back to build those early receivers armed with the tools and knowledge I lacked then."

This is the third of a Lindsay-published series on regenerative receivers. The first two: *Secrets of Homebuilt Regenerative Receivers* by C.F. Rockey, and *Building Your First Vacuum Tube Receiver* by Mr. Lindsay, are still in print and highly recommended. The present volume deals with the construction of three versions of the famous "Twinplex" receiver. The Twinplex was a 1934 variation of the wildly popular Doerle regenerative receiver of the early 1930s, substituting the then-newly-developed type 19 dual triode for the two type 30 single triodes used in the original design. Lindsay offers versions of the set utilizing the original type 19; the much later and much higher-gain 6SL7; and, finally, a pair of transistors.

As the icing on the cake, the book closes with a circuit specially designed to tune a very narrow frequency band, including the WWV time-signal and frequency-standard transmissions on 10.0 MHz. You'll certainly enjoy Lindsay's breezy and very readable writing style even if you never build one of his very nostalgic-yet-practical projects!

OUR READERS SPEAK

Jerry Snyder (2500 Satsuma St. NE, Palm Bay, FL 32905) needs a schematic and servicing information for his RCA model 128. Several amateur repairers have butchered the wiring, and he'd like to put it to rights. Major performance problem is a loud 60-Hz hum, unaffected by the volume control (an almost sure sign of defective power-supply filter capacitors).

Another info request comes from R. Gibson (315 South Ave., Aurora, IL 60505). He recently restored an inductance bridge made by s and would like to acquire documents, or copies of them, relating to this company. Paul also has a large supply of cannibalized PC memory chips and will provide some free to those who propose interesting projects.

Carl Stone (PO Box 892, Claresholm, Alberta, T0L 0T0 Canada), who has built many battery sets over the years, wonders whether the 01-A and other battery tubes will have longer life with filaments that are rheostated down to the minimum practical voltage (3 to 4 for the 01-A), or run constantly at the rated voltage (5 for the 01-A). I vote for the former. He has also noted that radios operating from farm battery plants providing only 32 volts for the plate supply seem to operate better if the tubes are run at a reduced filament voltage. For example, substituting a 50L6 for the usual 35L6 output tube seemed to provide better audio. I draw a blank on this, but Carl would like to hear from readers with good ideas.

A belated thanks to Victor I. Smegstad (Bainbridge Island, WA) for his 5-page, single-spaced letter (he calls it a novella) describing his unusual approach to restoring and powering battery sets. Vic provides such complete detail and excellent documentation for his ideas that I'll be devoting space in one or more upcoming columns to share them with other readers.

Paul Hoehn sends a photo of a 3-dialer he purchased at an auction and asks for an identification. I'd say the set is almost certainly a kit-built variation of the famous *Freed-Eisemann* NR-5 (a restoration of the latter was covered in a recent series in this column). The kit version in my collection has an identical panel layout (which is different from that of the NR-5), but is built on a wooden baseboard instead of on *Bakelite* sub-

(Continued on page 59)

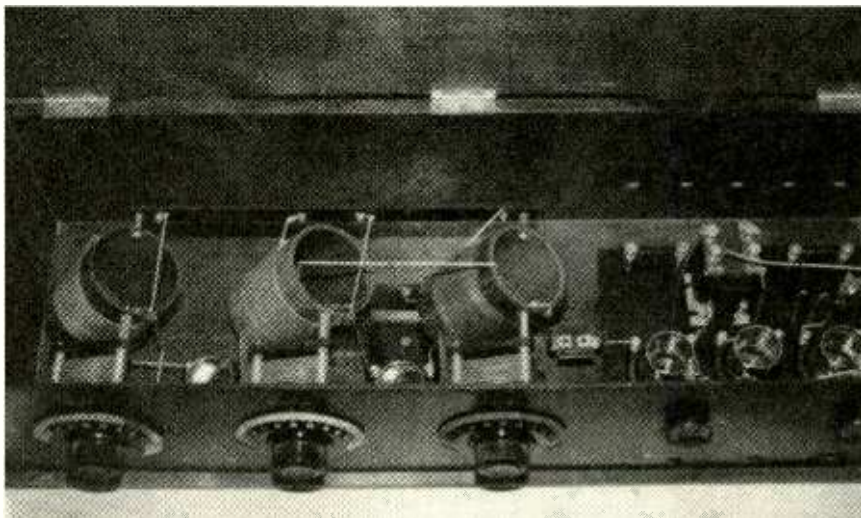

Paul Hoehn's "mystery set" is most likely a Freed-Eisemann kit.

Circuit Circus

Voltage-Monitoring Circuits

This time around we're going to look over several different voltage-monitoring circuits and show where they can be used. Some electronic equipment that is battery operated can fail to function, or function in a strange way, when the battery voltage drops below a specified value. The same equipment can be damaged from a voltage source that is too high, as in an AC-operated supply that has lost regulation. Most equipment can be saved from receiving permanent damage if the problem is discovered in time and corrective measures are taken.

SIMPLE LOW-VOLTAGE MONITORING CIRCUIT

Our first voltage monitoring circuit, in Fig. 1, lights an LED and turns on a piezo buzzer when the supply voltage drops below a preset value. The low voltage monitor circuit is an ideal accessory to use with a battery-operated amateur transceiver. Most of today's solid-state transceivers don't function properly when the supply voltage drops below 11 volts, and some transceivers begin to fail as soon as the supply voltage drops below 12 volts. Since our circuit is powered from the very source it is monitoring, no batteries or other power source is required.

The heart of the first monitoring circuit is one section of a LM339 quad voltage-comparator integrated circuit. The comparator's negative input voltage is set with a 6-volt Zener diode reference, and the positive IC input is variable. As long as the voltage at the comparator's positive input is greater than the voltage at its negative input, the output at pin 2 of the IC will be high, keeping the LED dark and the sounder silent. As soon as those conditions reversed, the comparator's output goes low, lighting the LED and powering the piezo sounder.

In setting up this circuit, determine the low voltage limit and adjust potentiometer R3 to give an output at that voltage level. Just about any 5000-ohm potentiometer will do for R3, but a multi-turn trimmer potentiometer makes precise adjustment much easier.

SIMPLE OVER-VOLTAGE MONITORING CIRCUIT

Our next circuit, see Fig. 2, sends out a signal when the supply voltage goes above a preset limit. The circuit is the same as the previous one with a single exception; the comparator's inputs are reversed. As long as the voltage at the comparator's negative input is less than the voltage at its positive input the output remains high, and no output will be given. Reversing that condition causes the comparator's output to go low, lighting the LED, and powering the piezo sounder.

Just about any piece of expensive equipment that receives DC power from an AC-operated supply would be a good candidate for this over-voltage indicator circuit.

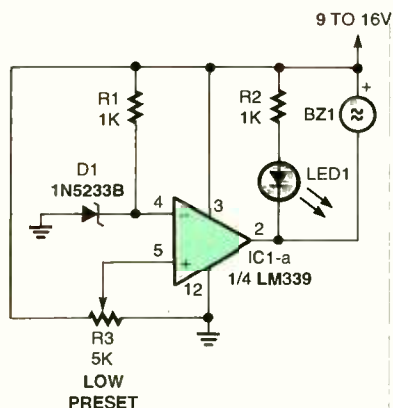

Fig. 1. When the supply voltage falls below the nominal 6-volt Zener reference, the LED lights and the buzzer sounds.

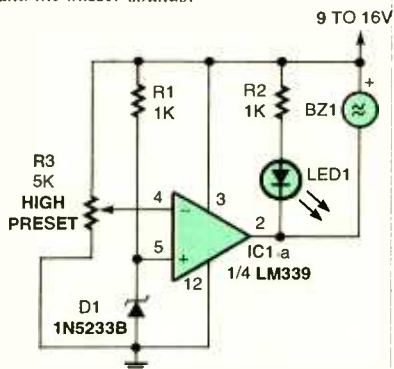

Fig. 2. In this over-voltage monitoring circuit, should the supply voltage rise above the nominal 6-volt Zener reference, the light and buzzer are activated.

CHARLES D. RAKES

DUAL VOLTAGE-MONITORING CIRCUIT

Figure 3 shows the first two circuits combined in a dual voltage-monitoring circuit. The operation of this combined circuitry is slightly different than either of the original circuits of Figs. 1 and 2. In this circuit, the LEDs light when the supply voltage being monitored is within its preset limits. The circuitry of IC1-a is preset to monitor the low-voltage setting, while the circuitry of IC1-b keeps tab on the upper voltage limit. Potentiometer R3 is set to extinguish LED1 when the monitored voltage goes below the lower limit, while potentiometer R4 is set to extinguish LED2 when the voltage goes above the upper limit. The reference supply voltage Zener in the first two circuits has been replaced with a single 78L05 IC 5-volt regulator. A single Zener also will work in this circuit.

DUAL VOLTAGE-MONITORING CIRCUIT WITH ALARMS

An add-on alarm circuit, for Fig. 3, is shown in Fig. 4. This circuit will give out an audible and visual alarm, if either the upper or lower voltage limit is exceeded. The negative input to comparator IC1-c is connected to the outputs of IC1-a and IC1-b (see Fig. 3) through steering diodes D1 and D2, respectively. If either LED1 or LED2 (of Fig. 3) goes out, a positive voltage is sent through one of the steering diodes to the negative input of IC1-c. In turn, the output of IC1-c goes low, turning on this circuit's piezo sounder and lighting the LED.

PARTS LIST FOR THE SIMPLE LOW-VOLTAGE MONITORING CIRCUIT (FIG. 1) and THE SIMPLE OVER-VOLTAGE MONITORING CIRCUIT (FIG. 2)

- BZ1—Piezo sounder, or piezo buzzer
- D1—1N5233B, or similar 6-volt, 1/2-watt, Zener diode
- IC1—LM339 quad voltage comparator integrated circuit (NTE834, SK3569, or equivalent)
- LED1—Light-emitting diode, any color
- R1, R2—1000-ohm, 1/2-watt, 5% resistor
- R3—5000-ohm potentiometer

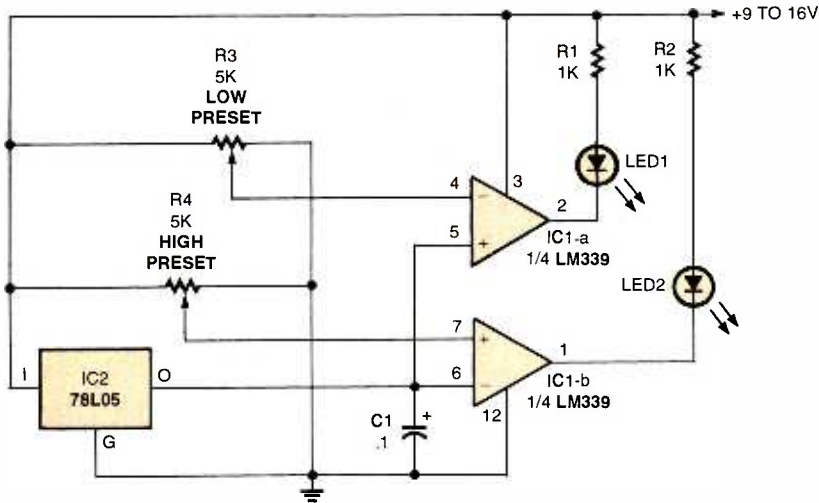

Fig. 3. By combining features from the previous circuits, this circuit turns off the LEDs when the supply voltage falls outside the preset voltage range.

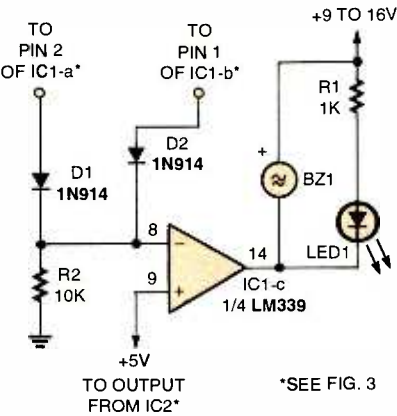

Fig. 4. Here's the same dual voltage monitoring circuit with a light and buzzer alarm added.

PARTS LIST FOR THE DUAL VOLTAGE-MONITORING CIRCUIT (FIG. 3)

- C1—0.1- μ F, ceramic-disc capacitor
- IC1—LM339 quad voltage comparator integrated circuit
- IC2—78L05, 5-volt, 100-mA low-power voltage regulator, integrated circuit (NTE977, SK3462, or equivalent)
- LED1, LED2—Light-emitting diode, any color
- R1, R2—1000-ohm, 1/4-watt, 5% resistor
- R3, R4—5000-ohm potentiometer

PARTS LIST FOR THE DUAL VOLTAGE-MONITORING CIRCUIT WITH ALARMS (FIG. 4)

- BZ1—Piezo sounder, or piezo buzzer
- D1, D2—1N914 silicon signal diode
- IC1—LM339 quad voltage comparator, integrated circuit
- LED1—Light-emitting diode, any color
- R1—1000-ohm, 1/4-watt, 5% resistor
- R2—10,000-ohm, 1/4-watt, 5% resistor

PARTS LIST FOR THE DUAL VOLTAGE-MONITORING CIRCUIT WITH RELAY DISCONNECT (FIG. 5)

- D1—1N4004 1-amp, 400-PIV, silicon rectifier diode
- IC1—LM339 quad voltage comparator, integrated circuit
- Q1—2N3906 general-purpose PNP silicon transistor (NTE159, SK3466, or equivalent)
- R1—2200-ohm, 1/4-watt, 5% resistor
- RY1—12-volt SPDT relay (Mouser Electronics part 528-7880-97, or equivalent)

the output voltage could fall below the preset limit, causing the relay to go into a chattering mode. If this condition occurs, immediately kill the power supply and troubleshoot the problem.

OVER-VOLTAGE CIRCUIT WITH DISCRETE COMPONENTS

Our next entry, see Fig. 6, is an over-voltage indicator circuit that uses discrete components in place of the IC-based design. This circuit's operation is similar to the over-voltage circuit in Fig. 2. The emitter of transistor Q1 is connected to a 6-volt Zener reference, and the base of Q1 is tied to the preset potentiometer, R4. As long as the voltage at the base of Q1 is below 6.6 volts, no collector current flows and the indicator LED1 does not glow. If the base voltage increases above this value, Q1 turns on, lighting the LED.

LOW-VOLTAGE CIRCUIT WITH DISCRETE COMPONENTS

A low-voltage limit-indicator circuit is shown in Fig. 7, which is similar in operation to our circuit in Fig. 1. A second transistor is added to our previous

DUAL VOLTAGE-MONITORING CIRCUIT WITH RELAY DISCONNECT

Another add-on circuit for Fig. 3 is shown in Fig. 5. This circuit can be used to disconnect the load from the power source if either of the preset voltage limits are breached. The positive input to comparator IC1-d is referenced to the 5-volt source (the 78L05 reference of Fig. 3), and the negative input is connected to pin 8 of IC1-c (see Fig. 4). If IC1-c's circuitry is not used, simply tie IC1-d's negative input, pin 11, to the output of the two steering diodes and the 10,000-ohm resistor of Fig. 3.

If the voltage preset limit conditions for either input is violated, the input at pin 11 goes high, and the output of IC1-d goes low, turning on transistor Q1, which pulls in the relay interrupting the power circuit. When the errant supply voltage returns to its normal voltage, the relay drops out and power is reconnected to the load. If, for some reason, the load is drawing too much current,

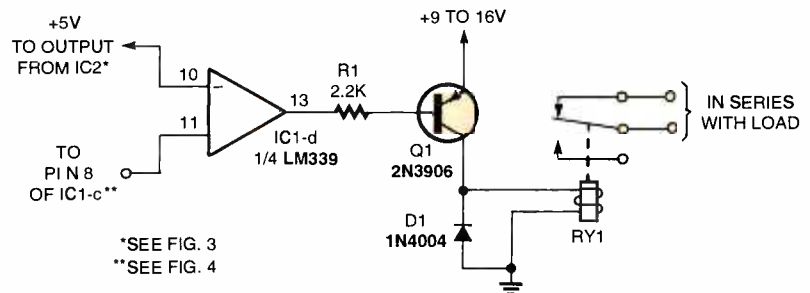

Fig. 5. In this circuit, the dual monitoring system opens up a load relay should the supply voltage fall outside the preset voltage range.

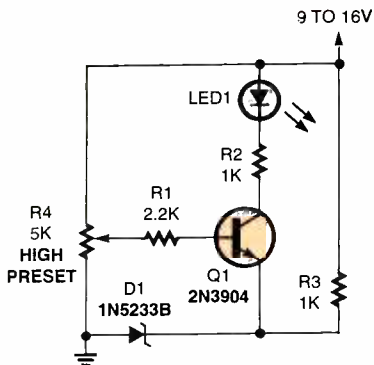

Fig. 6. Here's a simple over-voltage monitoring circuit, but designed with discrete components.

PARTS LIST FOR THE OVER-VOLTAGE CIRCUIT WITH DISCRETE COMPONENTS (FIG. 6)

- D1—1N4004 1-amp, 400-PIV, silicon rectifier diode
- LED1—Light-emitting diode, any color
- Q1—2N3904 general-purpose NPN silicon transistor (NTE123AP, SK3854, or equivalent)
- R1—2200-ohm, $\frac{1}{4}$ -watt, 5% resistor
- R2, R3—1000-ohm, $\frac{1}{4}$ -watt, 5% resistor
- R4—5000-ohm potentiometer

circuit, which converts the over-voltage circuit into an under-voltage indicator circuit.

Here's how it works. Potentiometer R6 is initially adjusted to turn transistor Q1 off at the low-voltage limit. With Q1 turned off, the voltage at its collector goes high, supplying a positive bias for transistor Q2. This bias turns on Q2 and lights LED1. When the supply voltage returns to normal, transistor Q1 turns back on, and transistor Q2 and the LED turn off.

OVER-VOLTAGE CUTOFF CIRCUIT

Our next entry, see Fig. 8, is an over-voltage cutoff circuit, similar to the IC-based circuit in Fig. 5. The input circuitry is the same as the one used in Figs. 6 and 7. As long as the supply voltage is below the preset value, transistors Q1 and Q2 are turned off, and the relay, RY1, remains in its non-operational condition. When the supply voltage goes above the preset limit, transistors Q1 and Q2 turn on, pulling in the relay and removing the load from the supply.

PARTS LIST FOR THE LOW-VOLTAGE CIRCUIT WITH DISCRETE COMPONENTS (FIG. 7)

- D1—1N5233B 6-volt, $\frac{1}{2}$ -watt, Zener diode, or similar type
- LED1—Light-emitting diode, any color
- Q1, Q2—2N3904 general-purpose NPN silicon transistor
- R1, R2—2200-ohm, $\frac{1}{4}$ -watt, 5% resistor
- R3—R5—1000-ohm, $\frac{1}{4}$ -watt, 5% resistor
- R6—5000-ohm potentiometer

OVER-VOLTAGE MONITORING CIRCUIT WITH LATCHING RELAY

A latching relay cutoff circuit, shown in Fig. 9, can be substituted for the relay circuit portion of Fig. 8. A single over-voltage condition causes the relay in Fig. 9 to pull in and remain operational until the power supply is turned off. When an over-voltage condition occurs, transistor Q2 turns on, supplying gate current to silicon-controlled rectifier SCR1 that turns on and latches the relay. This circuit would be a good choice to use when operating a voltage-sensitive piece of equipment on an AC-operated DC supply.

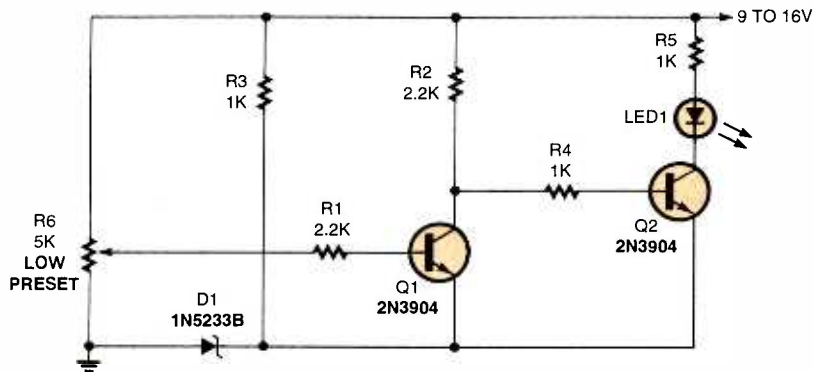

Fig. 7. Use this simple low-voltage monitoring circuit to check any drop in the supply voltage below a preset level.

OVER-VOLTAGE MONITORING CIRCUIT USING FUSE PROTECTION

Our last entry, see Fig. 10, is an electronic crowbar circuit that disconnects the load from a supply by blowing a fuse. The circuit is very similar to our over-voltage circuit in Fig. 2. When an over-voltage condition occurs, the output of comparator IC1-a goes low, turning on LED1 and the silicon-controlled rectifier. SCR1 supplies gate current to turn-on transistor Q1, which places a short across the power supply. The

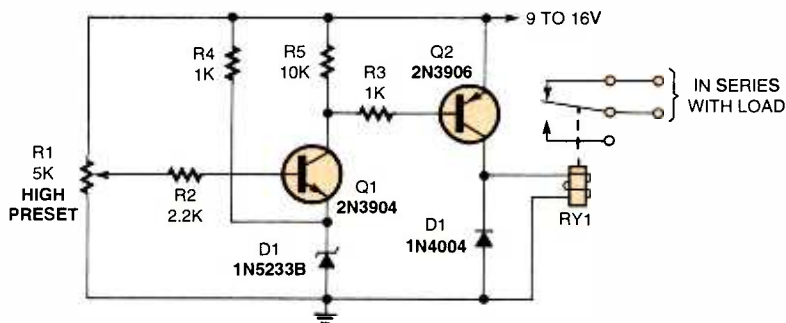

Fig. 8. In this over-voltage monitoring circuit, the relay removes the load from the supply should the supply voltage exceed a preset value.

PARTS LIST FOR THE OVER-VOLTAGE CUTOFF CIRCUIT (FIG. 8)

- D1—1N5233B 6-volt, $\frac{1}{2}$ -watt, Zener diode, or similar type
- D2—1N4004 1-amp, 400-PIV, silicon rectifier diode
- Q1—2N3904 general-purpose NPN silicon transistor
- Q2—2N3906 general-purpose PNP silicon transistor
- R1—5000-ohm potentiometer
- R2—2200-ohm, $\frac{1}{4}$ -watt, 5% resistor
- R3, R4—1000-ohm, $\frac{1}{4}$ -watt, 5% resistor
- R5—10,000-ohm, $\frac{1}{4}$ -watt, 5% resistor
- RY1—12-volt SPDT relay

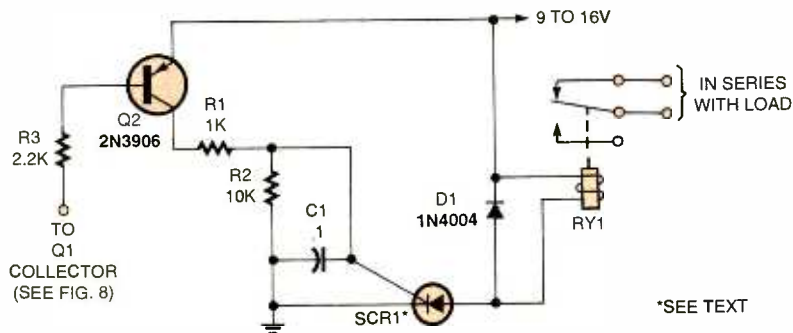

Fig. 9. In this circuit, a latching condition is added to the relay function. The relay remains operational (load disconnected) until the supply voltage is turned off.

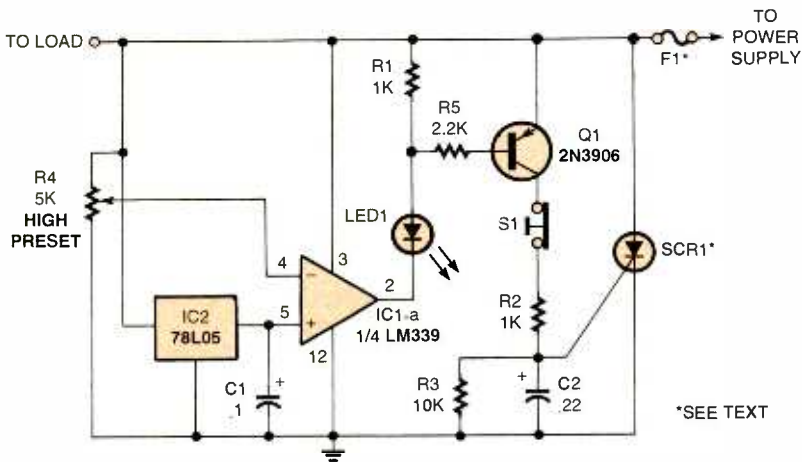

Fig. 10. This circuit places a short across the power supply (should the supply voltage exceed a preset value). This short, in turn, blows a fuse which protects any sensitive equipment.

fuse, being the weak link, blows to protect the connected equipment. Switch S1, a normally-closed push-button switch, should be depressed before the power is applied to the load and held open for a few seconds after the power is turned on. This allows the supply and load to stabilize before the crowbar circuit is activated. The current rating of

the SCR depends on the size of the fuse used and the maximum output current of the power source. A good rule of thumb is to use a SCR with a current rating of two times the fuse

PARTS LIST FOR THE OVER-VOLTAGE MONITORING CIRCUIT WITH LATCHING RELAY (FIG. 9)

C1—0.1- μ F, ceramic-disc capacitor
 D1—1N4004 1-amp, 400-PIV, silicon rectifier diode
 Q2—2N3906 general purpose PNP silicon transistor
 R1—1000-ohm, $\frac{1}{4}$ -watt, 5% resistor
 R2—10,000-ohm, $\frac{1}{4}$ -watt, 5% resistor
 R3—2200-ohm, $\frac{1}{4}$ -watt, 5% resistor
 RY1—12-volt SPDT relay
 SCR1—Silicon-controlled rectifier, 6-amp, 200 volt (RadioShack #276-1067, or equivalent)

PARTS LIST FOR THE OVER-VOLTAGE MONITORING CIRCUIT USING FUSE PROTECTION (FIG. 10)

C1—0.1- μ F, ceramic-disc capacitor
 C2—0.22- μ F, ceramic-disc capacitor
 F1—Fuse, see text for size
 IC1—LM339 quad voltage comparator, integrated circuit
 IC2—78L05, 5-volt, 100-mA, low-power voltage regulator, integrated circuit
 LED1—Light-emitting diode, any color
 Q1—2N3906 general purpose PNP silicon transistor
 R1, R2—1000-ohm, $\frac{1}{4}$ -watt, 5% resistor
 R3—10,000-ohm, $\frac{1}{4}$ -watt, 5% resistor
 R4—5000-ohm potentiometer
 R5—2200-ohm, $\frac{1}{4}$ -watt, 5% resistor
 S1—Normally-closed push-button switch
 SCR1—Silicon-controlled rectifier, 6 amp, 200 volt

size. Slow-blow fuses should not be used with the crowbar circuit.

FEEDBACK

Sharp-eyed reader D. Beezley of Sunnyvale, CA picked up an error in my October column featuring circuits using the novel *Texas Instruments* TSL245 integrated circuit. In that issue, on page 62, we spoke about this IC's limited sensitivity to visible light. The wavelength range for visible light should have been defined over a wavelength of 400–700 nanometers ($\text{nm} = 10^{-9}$ meters). The text defined visible light over a 4000–7000 nm range spread. In this case, the wavelength units should have been in angstroms ($\text{\AA} = 10^{-10}$ meters)—then the ranges would be dimensionally equivalent.

Well gang, it looks like we have monitored about all we can this month, but be sure to join us again—same time, same station. ■

ANTIQUE RADIO

(continued from page 55)

chassis as Paul's was.

Another belated thank you to Russ Worthy (North Adams, MA) for his detail-filled letter covering volume-control and power-supply issues in 3-dialers (among many other things) and including a low-profile, modern 1- μ F capacitor to replace the ceramic one that didn't quite fit inside the can of the vintage 1- μ F bypass in my NR5.

Finally, Camillo Castillo wants to thank the many folks who sent him



Camillo Castillo with his Minerva restoration project.

information on the RAX-3 radio in response to an appeal we carried in an earlier column. He included shots of some current projects, two of which were covered in previous *Antique Radio* restoration series.

That's all she wrote this time, folks. See you same time next month! ■

COMPUTER BITS

Microcontrollers VIII

JEFF HOLTZMAN

Last time we talked about generating time delays in hardware. In addition, it was promised that this time we would talk about reading analog values. However, that will have to wait for a month. A while back we promised to provide the complete code for a science-fair project based on the *Atmel Corporation's* AVR family of microcontrollers. We'll also show how to store and access data in the built-in EEPROM. We will also show how to use assembler macros, and discuss the tradeoffs involved.

Before we get started, mention should be made of a newcomer to the AVR world, *ITU Technologies*. They have been a long-time supporter of the PIC architecture, and just introduced an AVR chip programmer. Their AVR-1 AT Programmer is designed to program 8, 20-, and 40-pin AVR microcontrollers, and runs off a standard PC parallel port. *ITU Technologies* is selling the AVR-1 AT assembled, as a kit, and as a bare board with software, the latter for \$10, although costs may change by the time this reaches print. There's not much to the board: a 74LS07, a 40-pin ZIF socket, connectors, power supply, LEDs, etc. That makes it the lowest cost entry to safe AVR chip programming around.

GETTING STARTED

If you're just getting started, the chief topic of this column during the last eight installments has been microcontrollers—small computers with built-in RAM, ROM, and I/O capabilities. There are lots of different microcontrollers on the market, some old, some new. The PIC series, made by *Microchip Technology*, is probably the most popular. *Motorola* has several popular device families; and many vendors support *Intel's* venerable 8051 and derivatives. And there are many others. I chose *Atmel's* AVR series because it is new and interesting, and because I like the architecture. You can read prior installments in back issues of this magazine. Visit the "Tech Corner" section of the *Ingenieur Inc.* web site for links to AVR-related sites, and for file downloads, including source code for all programs presented in this series.

Now let's get to the science-fair project. By the way, this project is field tested; and it proved very popular at my daughter's 4th grade science fair.

HI-LO GAME

The project is a HI-LO guessing game that runs on the AVR evaluation board. As you recall, the board has eight readable pushbuttons and eight controllable LEDs. You could build your own little board with switches, LEDs, current-limiting resistors, a 4-MHz crystal, a couple of capacitors, power source, and a custom case. But that's a proverbial exercise for the reader—our topic is the software.

The game works like this. When the MCU resets, it presents a fancy display on the LEDs; then it waits for a *KEYPRESS*. After the *KEYPRESS*, the game starts. The object of the game is to guess a number between 1 and 7. Number 1 corresponds to the right most LED and switch, and so forth, from right to left. (We don't use bit 8 because with the *Atmel* AT90S1200 microcontroller, only seven bits of the input port are connected; a result of the pin count). If you guess correctly, you get the fancy display, then another game starts. If you guess too low or too high, the LEDs flash sequentially, or 'point' in the correct direction (low or high), and allow you to guess again. There is no limit to the number of guesses that may be taken.

After the thrill of playing wears off, you'll want to know how it works. The program summarizes the techniques we've learned the past few months, and adds two new elements: EEPROM access and macro programming in the AVR assembler. The source code is about 270 lines, so it's too long to print here. However, I have it posted on my *Ingenieur Inc.* web site: www.ingeninc.com.

Note: If you're having trouble running programs that you're pretty sure should work, make sure you have configured the assembler to output data in *Intel* format. Also, make sure you're using version 1.21 or later of the assembler.

HOW IT WORKS

To provide some element of randomness to the games, a table of values that function as the guess targets is furnished. A pointer called *EPTR* that moves through the table sequentially, provides a new guess value each time. To enhance randomness, *EPTR* is initialized to a random value each time the MCU resets, during the period while waiting for the user to press a key. Every time you make a new guess value, *EPTR* is incremented. To prevent it from indexing beyond the end of the table, *EPTR* is always ANDed with the binary value 00011111. In effect, that causes *EPTR* to cycle from 0 to 31, then start over.

So, after reset occurs, the timer is enabled and waits for the user to press a key. During the waiting period, every time the timer times out, it generates an interrupt, which increments a counter. After the user presses a key, the value of the counter is used as the initial value of *EPTR*. After that, the program just cycles through the table sequentially, recycling as necessary.

At the point in the code labeled *CONTINUE*, the byte in EEPROM currently pointed to by *EPTR* is read, and that value is saved in a register called *CURVAL*. The reason it is read and saved is that EEPROM reading (and writing) is a multi-step process. Rather than go through all four steps every time the current value is needed, the program gets the reading once and saves it in a register where it can be accessed efficiently and quickly (one-clock cycle).

READING EEPROM

Listing 1 is a code fragment that shows how to read a value from EEPROM. The AVR EEPROM is in a separate memory space. However, you cannot simply read or write with *IN* or *OUT* or *LOAD* or *STORE* instructions. Instead, you must use three registers in the AVR's I/O space: The *EEPROM Address Register* (*EEAR*), the *EEPROM Data Register* (*EEDR*),

and the EEPROM Control Register (EECR). To read a byte, you place the address (0—63) in the EEAR, strobe a bit in the control register, and then read the value from the EEDR into an MCU register. (Writing is similar, except that you strobe a different bit.)

So we get a byte into CURVAL, then we go into another wait-for-a-key loop (WAIT_GUESS in the complete program listing). This time, we OR a 1 into the high bit of the accumulator (register 16), which corresponds to an unpressed switch. The high bit corresponds to the inaccessible eighth switch. Then we compare the result with a value of 255, which would indicate no pressed switches. If it's equal, we continue waiting. Otherwise, we determine whether the guess was low, correct, or high, and jump to an appropriate routine.

There is one trick. The data table specifies the guess number by bit position, *i.e.*, with values of \$01, \$02, \$04, \$08, \$10, \$20, and \$40. However in the actual input port, bits are normally high; pressing a switch forces a low. For example, pressing the LSB switch would produce a value of \$FE. To allow the convenience of expressing guesses using positive logic, we must do a bit-wise complement on the value read from the input port. Continuing the example, the complement of \$FE is \$01. So after we get the complemented value in the accumulator, we compare it with CURVAL. If the value is equal, we provide the fancy LED display and begin a new game. If the value is low or high, we call the appropriate display routine, and continue the current game.

The remainder of the code consists of several tedious delay and display routines. See this complete program on my Web site. Given what we've covered in the past, it should be pretty obvious how they work. The only trick here is the use of a macro, which bears further explanation.

MACRO ASSEMBLER PROGRAMMING

The term *macro* means different things in different languages. It could refer to a set of recorded keystrokes that can be replayed multiple times. It could refer to a simple interpreted programming language, like *JavaScript*. It could refer to a moderately complex programming language like *Visual Basic*. In assembly programming, macro usually implies text substitution,

LISTING 1 CODE FRAGMENT—READING DATA FROM EEPROM

```
.def      EPTR = R23           ; EEPROM pointer
.equ      ST_RD = 1           ; read an EEPROM location
...
outEEAR, EPTR                 ; setup address register
ldi STROBE, ST_RD             ; load read bit
outEECR, STROBE; strobe control register
in CURVAL, EEDR; read data register
...
etc.
```

LISTING 2 MACRO—CREATING A 100-MS DELAY

```
.macro      mDELAY100:
ldi        OLD, OLC;          delay for 1/10th second
DL1a:     ldi        ILD, ILC
DL1b:     or         SCRATCH, SCRATCH; waste 7 cycles
          or         SCRATCH, SCRATCH
          or         SCRATCH, SCRATCH
          or         SCRATCH, SCRATCH
          or         SCRATCH, SCRATCH
          or         SCRATCH, SCRATCH
          or         SCRATCH, SCRATCH
          dec        ILD
          brne      DL1b
          dec        OLD
          brne      DL1a
          .endmacro
```

similar to a "#define" in C programming.

Listing 2 shows the macro used for creating a 100 ms delay in the HI-LO game. The macro begins with an assembler directive (".macro"), followed on the same line by the name of the macro, one or more lines of instructions, and finally an ".endmacro" directive.

In this case, I gave the macro the name "mDELAY100." The 'm' prefix is just a convention I follow in my own coding to distinguish between a macro and a subroutine call. And that brings up an important point: What is the difference between a macro and a subroutine call?

When a program is assembled, any macros are *expanded*, so that *all* the code defined by the macro gets inserted *every* time the macro is called. Whereas with a subroutine, the workhorse code exists in only one place, and is accessed by CALL/RETURN instructions.

The tradeoffs between a macro and a subroutine are as follows. Our macro uses 26 bytes of program memory every time it is called. A subroutine would use only four. On the other hand, the macro executes faster, which is not important here, but could be in an interrupt service routine, or elsewhere. A

subroutine also requires stack, definitely a scarce resource on the 1200. In our case, the macro is used only twice, once in the core of a 200-ms delay routine, and once in a 500-ms delay. Overall, the HI-LO game uses less than a third of the overall program memory space, so space was not an issue. Just beware of this in your own designs.

As for the macro itself, it is similar to the do-nothing loops we've seen in the past. One difference here is that we don't use a dummy call-return to waste cycles. The reason is that the AT90S1200 has only a three-level stack. Inadvertent subroutine calls or interrupts nested greater than three deep can create hard-to-debug problems—trust me!

BURNING SILICON

There's one more issue to cover: how do we get the data table into the EEPROM? From the point of view of the assembler, we use an ".eseg" directive to specify that the following code or data should be placed in EEPROM. We also specify an origin of 0, to ensure that the data is placed where we want it. Specifying ".eseg" does not actually get

(Continued on page 65)

The Random Length Wire Vee Antenna

JOSEPH J. CARR

Some years ago I had a random length antenna connected to my receiver. A lot of experience with that antenna showed a distinctly different directional performance on different frequencies. I could not quantify those differences at the time because off-the-air observations and S-meter readings are notoriously poor ways of making engineering measurements on antennas (although some amateurs often take them as infallible truth!). Recently I got to thinking about that antenna, so I ran some patterns using my antenna modeling software. This article presents the results which, incidentally, were consistent with my experience with the "Vee" antenna.

THE ANTENNA

Figure 1 shows the basic form of the Vee antenna fed at one end. The center was raised about 45 feet off the ground, and the ends of the wire were about 10 feet off the ground. The center is supported by a mast. Each wire segment in the old antenna was 50 feet long, totaling 100 feet overall. The length suggests a resonant (half wavelength) frequency somewhere around 4500 to 5000 kHz. Recall that the total length (L in feet) for a "real" half-wavelength dipole operating at frequency (f in MHz) is found by the equation $L = 468/f$. This includes the "end effects" caused by the dielectric end insulators and the velocity factor of the wire.

The center of the antenna in one version was supported on a 40-foot telescoping slip-up mast. The mast was originally designed for holding television antennas. These masts come in lengths of 20 to 50 feet, but collapse to about 8 to 10 feet. At one time, these masts were easily available because they were used for television antennas. But with cable TV being everywhere these days, and homeowners associations taking a dim view of any outdoor antenna, it's less likely that you will find them in the local distributors. (RadioShack sells a 36-

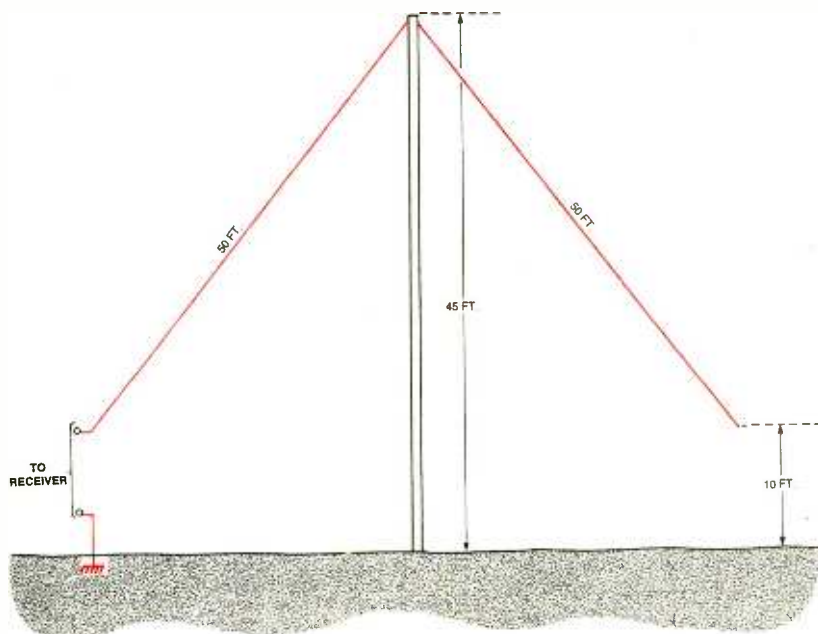

Fig. 1. Basic layout of a 100-foot end-fed Vee antenna.

foot telescoping mast, part 15-5067, for \$69.99—Editor). You can, however, often find them in mail-order catalogs or at dealers that sell antennas (they make good supports for ham radio and Citizen's Band verticals).

The feedline is connected between ground and one end of the antenna (see Fig. 1 again). The impedance will vary all over the place as the frequency changes, so an antenna tuner is in order if impedance matching is important.

Is impedance matching important? Most generally, yes it is. However, for most shortwave receiver owners it is less necessary than might be supposed. Unless you are very interested in weak signal DXing, the few decibels that most impedance mismatch loss causes is often not worth the trouble and cost. However, if you want to optimize the system, buy an antenna tuner. If you want to use the antenna for ham radio transmission, then an antenna tuner is essential, since the high VSWR encountered will either damage or shut down most modern transmitters. Also, even if the rig isn't damaged,

the fact is that the antenna will radiate on harmonics, which is a no-no.

ANTENNA MODELING

The software used for modeling the Vee antenna was the *Nec-Win Basic for Windows* program. This program appears to be a DOS-based NEC engine, run with a Windows graphical user interface written in *Visual Basic 3.0*. The vendor offering *Nec-Win Basic for Windows* is *Nittany Scientific Inc.* (1700 Airline Highway, Suite 361, Hollister, CA, 95023; Tel. 408-634-0573; Web site: www.nittany-scientific.com). The basic version (which I test drove and now use) lists for \$75 plus shipping.

This software is an antenna computer modeling program that is designed for a wide range of users. Beginners can model antennas immediately by following the examples included in the user-friendly manual. Within a short time, novice antenna designers can create complex antenna structures, analyze radiation patterns, obtain elevation and azimuth plots, and even create three-dimensional views of the results. With

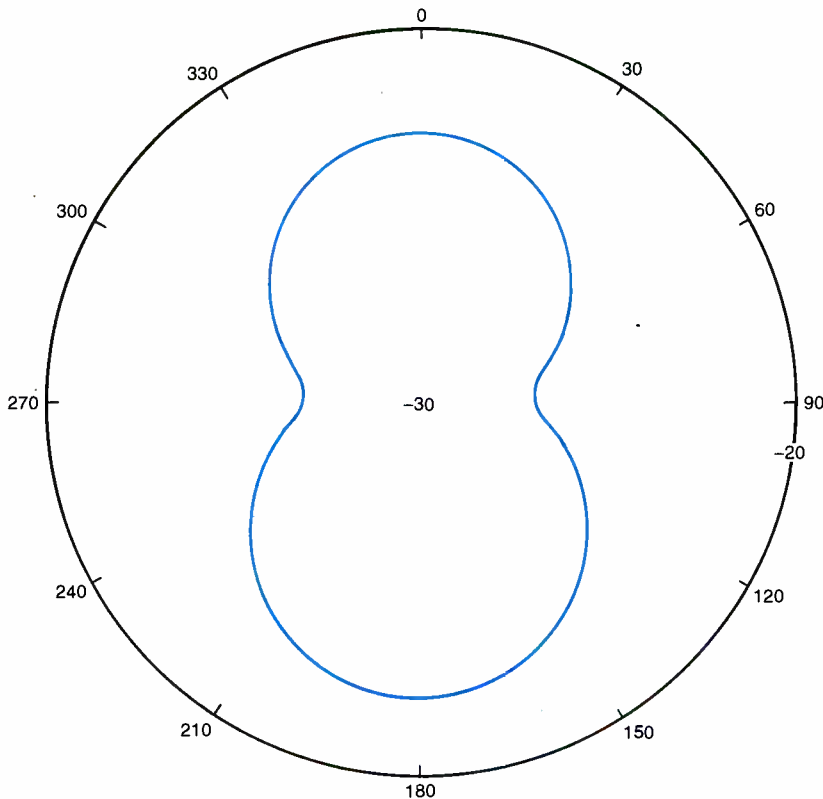

Fig. 2. Azimuthal antenna pattern for the 100-foot Vee antenna end-fed configuration at 5 MHz. Note that the pattern is similar to a dipole but shifted 90 degrees.

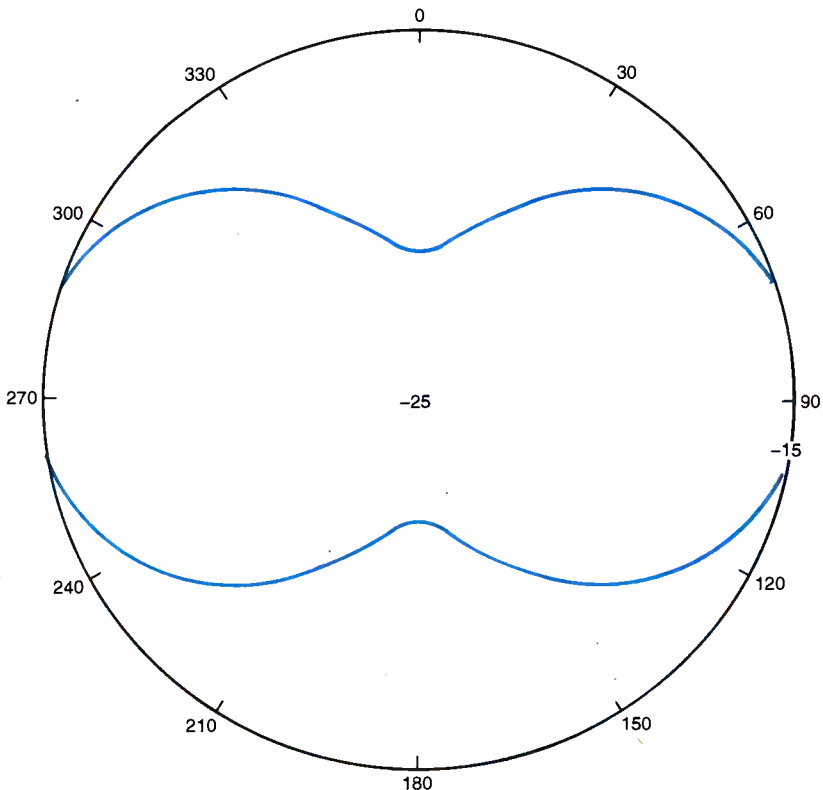

Fig. 3. Azimuthal antenna pattern at 9.75 MHz. Here the pattern is similar to the conventional dipole—both in gain and orientation.

the 3-D pattern displayed, the surface pattern can be rotated 360 degrees on any axis or translated or zoomed, allowing complete visualization of the pattern. A few of the user features include: transmission lines; antenna wire conductivity and gauge; ground constants; radial wire screen considerations, tabular data for VSWR and input impedance; etc.

System requirements for *NEC-Win Basic* are, as a minimum, a DOS system computer with an *Intel* or compatible 80386 DX 40-MHz microprocessor or greater, with a hard-disk drive for program files of 10 MB as a minimum, at least 8-MB of RAM, and a VGA or SVGA monitor.

There is also a professional version of the program, *NEC-Win Pro*, which sells for \$425 plus shipping, and provides an easy-to-use tool for antenna designers that facilitates the design and analysis process. Features like 3-D visualization, real-time rotate, pan, and zoom with the mouse, let you see more views of your design interactively. Spread-sheet style data entry of the wire coordinates, and the copy, cut, and paste commands, make it simpler to place your information into commercial spread sheet programs to run formulas and variables. *NEC-Win Pro* encourages you to push the design parameters to levels you may have been reluctant to build and test in the past.

System requirements for the *NEC-Win Pro* are similar to the basic version, except a 80486 or better, microprocessor is required, along with at least 12 MB of available hard disk for program files.

You can learn to use the public domain DOS version of mini-NEC software, and although it is not as good as a *Windows* version, the price is right.

If you are interested in doing some antenna modeling, then you also might want to check out my new books *Practical Antenna Handbook, Third Edition*, which has a chapter on modeling, (ISBN 0070111057) published by *McGraw-Hill*, or *Antenna Toolkit* (ISBN 0750637552) published by *Newnes*.

THE MODEL AND THE PATTERNS

The antenna patterns of the Vee antenna were run at frequencies of interest to most shortwave listeners: 5 MHz, 9.75 MHz, 11.75 MHz, 15 MHz, and 25 MHz. For the sake of simplicity only the horizontal (azimuthal) patterns

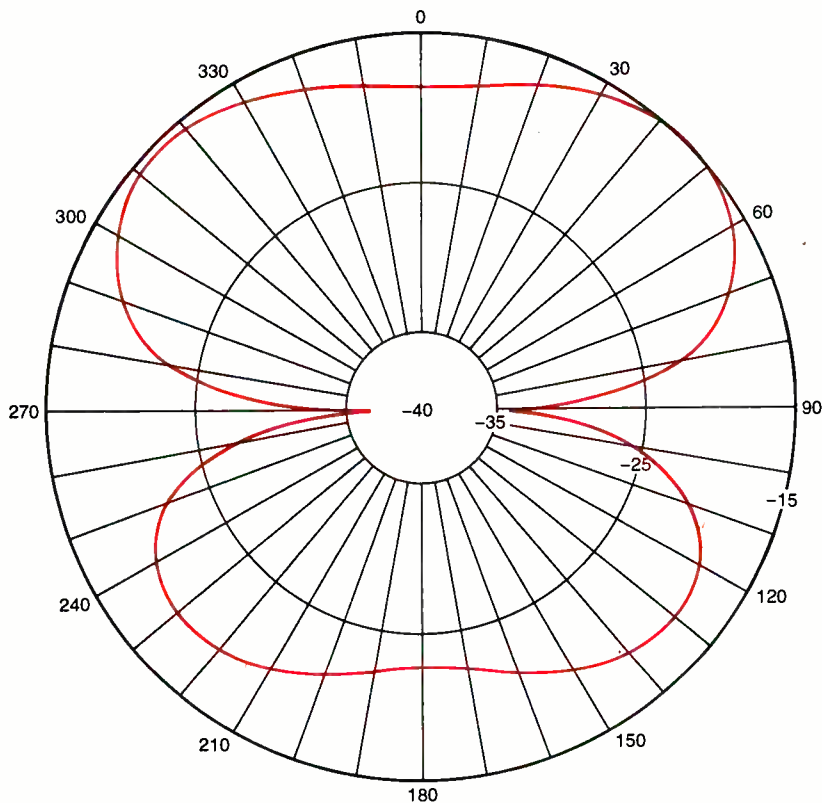

Fig. 4. Azimuthal antenna pattern at 15 MHz. Major lobes are now in North-South direction with sharp nulls broadside to the antenna orientation.

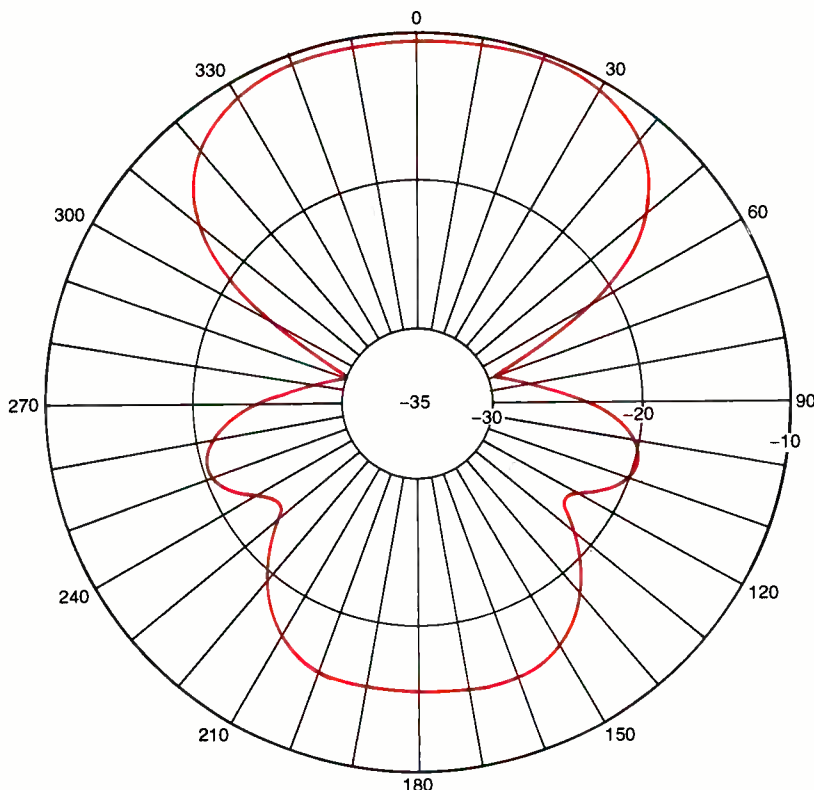

Fig. 5. Azimuthal antenna pattern at 25 MHz. Pattern appears in the shape of a "rag doll," with major and minor peaks and nulls.

are shown. The parameters entered into the *Nec-Win* software were the dimensions shown in Fig. 1. In addition, the model was set for a Sommerfield ground (which is something of an "average" value), and number 14 AWG copper antenna wire. In the patterns to follow, the antenna wire runs from 0 degrees ("North") to 180 degrees ("South"), with the broadside directions being 90 degrees ("East") and 270 degrees ("West").

Figure 2 shows the pattern for 5-MHz operation. This band is close to the resonant frequency of the Vee antenna. The pattern is something of a "Figure-8," with some gain in the *unusual* direction of the antenna wire (North-South), and the nulls not as deep as they would be on a dipole. Indeed, there are only a few decibels of pinch-in at the waists of the "Figure-8" pattern.

In Fig. 3 we see operation of the antenna at 9.75 MHz in the 31-meter band. Note that the gain has increased somewhat, and the pattern has flipped 90 degrees (in the "expected" dipole direction); it now has its major lobes at 90 degrees and 270 degrees. Otherwise, the pattern is quite similar to the 5-MHz pattern (except for the 90-degree rotation). It is a "Figure-8" with a slightly pinched waist.

At 15 MHz the pattern (see Fig. 4) again flips to have main lobes in the direction of 0 degrees and 180 degrees. The pattern is a "Figure-8" very much like the pattern of a West-East-oriented dipole. There are two sharp, deep nulls in the 90 degree and 270 degree directions. Note, however, that the lobes are asymmetrical, so the gain and directivity are different in the 0 degree and 180 degree directions.

I call the 25-MHz pattern (Fig. 5) the "rag doll" pattern. It is a highly distorted "Figure-8" pattern aligned with its maxima at 0 degrees and 180 degrees. The lobe in the 0-degree direction (the "head" of the rag doll) is larger than in the 180-degree direction. One reason is that energy is used to form two minor lobes or "sidelobes," at approximately 110 and 250 degrees (the "arms" of the rag doll). On either side of these minor lobes we see that nulls exist. One set of nulls ($\approx 75^\circ$ and $\approx 285^\circ$) are the main nulls for the entire pattern and are both sharp and deep; while the other nulls are minor nulls ($\approx 125^\circ$ and $\approx 235^\circ$), which are less deep and less sharp than the main nulls.

NEW PRODUCTS

IN-YOUR-EAR RADIOS

Designed for people on the go, these three compact radios, called *FM Sounds*, produce a rich, full sound. The radios all feature digital touch tuning and stereo buds, with 88-108 MHz tuning range.



Smallest of the three is the Model 110, which weighs less than one ounce and measures just $1\frac{3}{4} \times 1 \times \frac{3}{8}$ inches. Model 120 is slightly larger, with a built-in key ring, plus high-low volume control. It also weighs less than one ounce and is $2\frac{3}{8} \times 1 \times \frac{1}{2}$ inches. Two 1.5 V batteries are included. Both models, which come in black or silver, are available with a waterproof carrying case.

Model 150 is an all-weather, water-resistant radio, with protective ear-bud jackets that make it possible to actually listen while swimming. This radio weighs less than two ounces and measures $2\frac{7}{8} \times 1\frac{1}{2} \times 1$ inches. Its bright yellow waterproof body clips on to goggle strap, clothing, or belt.

The small size and the light weight of these three *FM Sounds* radios make them ideal for jogging, hiking, sunbathing, travel, and other activities. Suggested retail prices are \$11.99, \$13.99, and \$18.99 for Models 110, 120, and 150, respectively. For more information, contact *American Technology Corp.*, 13114 Evening Creek Drive South, San Diego, CA 92128; Tel. 800-41-RADIO or 619-679-2114; Fax: 619-679-0545; Web: www.atcsd.com.

CIRCLE 80 ON FREE INFORMATION CARD

SINGLE-FUNCTION CALIBRATOR

The *Fluke 715 Volt/mA Calibrator* measures and sources current to 24 mA and displays results as mA or as % of span. It can measure and source voltage output process signals from PLCs and transmitters with an accuracy of 0.025% + 1 count, and a resolution of 0.01 mV (110 mV scale) or 1 mV (10 volt scale). The Model 715 also offers 24-volt loop supply with simultaneous current measurement.



The Model 715 is part of the 710 series of process calibrators. All five of these calibrators have pushbutton interfaces. Their dust- and splash-resistant case and EMI shielding allow them to be carried on the technician's tool belt and used safely in the field.

The calibrator comes with a protective *Fluke*-yellow holster and stand, one 9-volt alkaline battery, instructions, and a statement of calibration practices. The Model 715 measures $7.35 \times 3.41 \times 1.25$ inches and retails for \$948.

For more information, contact *Fluke Corp.*, PO Box 9090, Everett, WA 98206-9090; Tel. 800-44-FLUKE or 425-356-5500; Fax: 800-FLUKE-FAX OR 425-356-5116; Web: www.fluke.com.

CIRCLE 81 ON FREE INFORMATION CARD

WIRELESS KEYBOARD

Designed for comfortable use both on tabletops and in the lap, the *BeamerPlus* wireless keyboard combines a complete Windows 95 keyboard, high-resolution trackball and universal remote control in a single compact enclosure. The keyboard uses wireless technology for error-free operation and long battery life. Its sculpted bottom surface rests comfortably in the user's lap. Palm rests under the trackball and mouse-click buttons allow the user's hands to be relaxed whether the keyboard is on the desktop or in the lap.



The *BeamerPlus* features an enhanced key layout including full-size cursor keys and large shift, enter, backspace, and spacebar keys. Full-size typing keys, embedded numeric key pad, inverted-T cursor arrows, separate insert and delete keys, and 12 function keys provide the full 104 key functions with only eighty-six keys, saving valuable space. The keyboard also provides a contaminant-resistant trackball and associated mouse-click buttons.

The integrated universal remote control is compatible with most TVs, VCRs, cable boxes, satellite receivers, and other popular home-entertainment systems. Fifteen additional "hot buttons" are dedicated to the universal remote control including: POWER, CHANNEL, VOLUME, MUTE, PLAY, STOP, REVERSE, FORWARD, RECORD, PAUSE, TV/VCR, MENU, SELECT, SLEEP, and DISPLAY. Many of the keyboard keys also provide advanced remote control functions including Navigate, Guide, TV-PC, Mute, Go Back, PIP, Swap, Freeze, Input, Power, Channel Control, and Size. For greater convenience, the universal remote mode buttons for PC/Internet, TV, cable/satellite, VCR, CD, and other home entertainment systems are illuminated when pressed.

Providing an impressive 30-foot range, the *BeamerPlus* permits use in even the largest living rooms. Three wide-angled LEDs offer a broad 220-degree range of operation, practically "wrapping" around the user. With three LED transmitters and the reflection of IR light from surfaces in the room, the IR transmissions are unlikely to be interrupted, even by someone passing by.

The *BeamerPlus* has a suggested retail price of \$219. For more information on the keyboard, contact *Sejin America*; Tel. 408-980-7550; Fax: 408-980-7562; Web: www.sejin.com. For purchasing information, contact the distributors: *Microspeed*, Tel. 800-232-7888; or *Key Source*, Tel. 800-722-6066.

CIRCLE 82 ON FREE INFORMATION CARD

VIRTUAL SCOPE

Combining the functions of a 100 million samples/sec dual-channel digital oscilloscope and a 50-MHz spectrum analyzer in a PC-based virtual instrument, *Pico Technology's ADC200-100 Virtual Digital Scope* performs all the operations of a standard oscilloscope and digital multimeter. It uses its computer capability to annotate and save, as well as print traces in black and white or color, and to cut and paste waveforms into word-processing documents.



A feature of the ADC200-100 is simultaneous display of the oscilloscope, spectrum analyzer, and digital multimeter functions provided by the *PicoScope* software supplied with the instrument. In addition, the autoranging multimeter features simultaneous display of multiple parameters, such as true rms or DC voltage, dB gain, and frequency measurements.

Easy-to-use features include overlaying a live trace with a stored reference trace, plus on-screen help and pull-down menus. Powerful triggering modes help to capture intermittent or

unusual events. The "Save On Trigger" option saves every trigger event to disk, complete with date and time stamps.

The 0–50 MHz range of the spectrum analyzer covers frequencies required for EMC-conducted noise testing. It simplifies identifying the source of noise on power lines. Even with multiple noise sources, the analyzer makes it easy to identify the signature of the noise and its source.

With the ADC200-100, transferring the data to other applications such as spreadsheets is easy. Users can also automate data collection and analysis with the software drivers supplied.

Previously available in Europe, the ADC200-100 is now available in the U.S. for \$799. For more information, contact *Saelig Company*, 1193 Mosely Road, Victor, NY 14564; Tel. 716-425-3753; Fax: 716-425-3835; Web: www.saelig.com.

CIRCLE 83 ON FREE INFORMATION CARD

CORD ORGANIZER

The easy-to-use *Big Tube Cord Control Kit* simplifies equipment hook-up and prevents accidents. The kit hides all the power cords by bundling them into an 8 foot 1½-inch diameter plastic tube with a full-length slit for easy access. Included are eight sets of self-adhesive, color-coded labels for the cord ends and jacks so anyone can reconnect the most complicated equipment by matching colors.

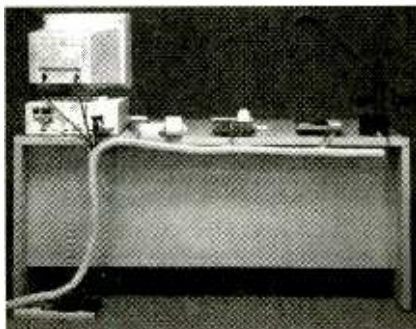

Also included are six reusable tie wraps for cords left outside the tube. The tube comes in either black, white, or light gray and retails for \$18.95.

For more information, contact *Get Organized*, 328 Canham Road, Scotts Valley, CA 95066; Tel. 831-438-0259; Fax: 831-438-0359; Web: www.getorg.com.

CIRCLE 84 ON FREE INFORMATION CARD

TRI-BAND TRANSCEIVER

The *ICOM T8A* tri-band handheld, which weighs only 9.9 ounces and measures approximately 2¼ × 4¼ × 1⅛ inches, is the only one of its size with 50-MHz coverage. Covering the 6-meter, 2-meter, and 440-MHz amateur bands—which includes "receive" coverage of the popular aircraft-band, 150- and 450-MHz public safety bands, and FM and TV broadcast bands—the transceiver is small but powerful.



The T8A has a memory capacity of 123 channels, including 10 scan edges and 1 call channel per band. Simply pressing the BAND switch selects the active band. Arranged in 10 groups of 20 channels, the channels are easy to scan using a variety of scanning methods. Output power is 5 watts on all bands.

Tone squelch and auto-squelch are standard features of the T8A, as is tone scan, which allows users to determine the subaudible tones required to

access repeaters. The pocket beep feature also provides a "pager-like" function. In addition, the T8A offers a DTMF decoder with nine DTMF memory channels.

Other features include auto-power saver, electronically controlled volume, and direct keypad input. A guide function allows display of the selected mode in the T8A's window, which has an LCD backlight with a timer. Power is provided by a lightweight Ni-MH battery pack. The transceiver is water-resistant and features a die-cast aluminum chassis for durability and reliability. The T8A has a suggested list price of \$392.

For more information, contact *Icom America*, 2380 116th Avenue NE, Bellevue, WA 98004; Tel. 425-454-8155; Fax: 425-454-1509; Web: www.icomamerica.com

CIRCLE 85 ON FREE INFORMATION CARD

JUMBO LCD CLOCK

The *MFJ-118 JUMBO LCD* 24/12 hour clock has 1.25-inch high-contrast digits that can be seen anywhere in the ham shack. The clock displays time, year, month, date, and day. Users can choose the time display in either 24-hour UTC or 12 hour format. The $\frac{3}{4}$ -inch day of week can be shown in English, Spanish, German, or French. The MFJ-118 has a 100-year full calendar and is quartz-controlled. It is synchronizable to WWV.



The sleek black designer case is made of tough scratch-resistant plastic. It measures a compact $5\frac{3}{4} \times 2\frac{1}{2} \times \frac{1}{2}$ inches. A convenient flip stand lets you place it anywhere or it can be easily hung on the wall using the built-in mounting holes. It sells for \$24.95.

For more information, contact *MFJ Enterprises, Inc.*, 300 Industrial Park Road, Starkville, MS 39759; Tel. 800-647-1800; Fax: 601-323-6551; Web: www.mfjenterprises.com.

CIRCLE 86 ON FREE INFORMATION CARD

ELECTROMAGNETIC FIELDS

(continued from page 47)

The point in the dryer (and all other appliances) where the power cord enters into the machine has a magnetic field stronger than the surrounding areas. For the washer it was 15 mG. However, the strongest magnetic field was measured at the bottom of the appliance, due to the location of the high-current consuming motor. Table 2 shows the magnitude of the magnetic field measured at the front of the washer at different distances from its bottom.

The former are peak values—*i.e.*, the strongest magnetic fields measured—since the magnitude of the magnetic field changes depending on the activity of the appliance. In any case, it shows that washers generate strong magnetic fields. When the electric dryer was turned on, the strongest magnetic fields were found where the power cord enters the machine, as well as by the power cord itself, with a value of 100 mG. Contrary to the washer, the magnetic fields generated by the electric dryer did not change as the measurement device was moved closer to the floor. When two or more appliances are turned on simultaneously, it is safe to assume that the strength of the EMF is the sum of the individual contributions.

The Effects Of Small Appliances.

The generation of strong magnetic fields is not limited to large electric appliances. Small, hand-held electrical appliances can also generate EMF at levels comparable to those produced by a washer. The magnetic field generated by a steam iron in the handle and around the power cord is 40 mG. The regions with the strongest fields are the lateral sides, with levels ranging up to 100 mG, which decrease as the distance from the iron increases, as illustrated in Fig. 3. In a light dimmer, the fundamental magnetic field magnitude was found to be 20 mG, with peaks of more than 100 mG, depending on its position.

Television sets and computers are another major source of both

electric and magnetic fields. At 2 feet away from a regular-size TV set, the measured magnetic field was 15 mG and the electric field was 5 kV/m. At a distance of 3 feet, the fields decreased by up to 5 mG and 1 kV/m, respectively. At 20 inches away from a computer monitor (normal distance for most users), the magnetic field strength was 35 mG. The magnetic field was found to be very constant around the different parts of the computer, such as the CPU, keyboard, speakers, *etc.*

What About Outside The House?

Contrary to popular belief, pole-mounted high-voltage transformers create a very small magnetic field strength despite the high levels of current that they handle. In the vicinity of the transformer, the magnetic field strength was only 3 mG. Because radiated electromagnetic fields represent energy losses for the electric companies, the transformers are extremely well shielded to minimize those losses. Because of the low EMF levels and the location of the transformers, the transformers produce a negligible contribution to the electromagnetic pollution inside the house. The main wiring system that goes through the outside electric meter produced magnetic fields of 100 mG on its surface. At 3 inches away from the meter, it measured a magnetic field of 100 mG, with no electric field.

Some Final Remarks. The purpose of this article, as stated, was to present an overview of how and why electromagnetic fields are created and to give a relative value for the field strength generated by some common domestic appliances. It is also important to understand how electric and magnetic fields quickly attenuate as we move away from their source, which needs to be kept in mind when placing appliances inside the house. As the relationship between EMF and health effects has not been established in the scientific community, readers are advised to extract their own conclusions and be informed through the latest research and scientific findings in this controversial area.

Market Center™

Paperback Books

GREAT BOOKS AT BUDGET PRICES

100 RADIO HOOKUPS
—#7—\$3.00

First published in May, 1923 this popular booklet went into reprint editions nine times. It is packed with circuits, theory, antenna installation and tips on consumer radio receivers that were popular in the early 1920's. Antique radio buffs and those inquisitive about the early days of radio will find this booklet an exciting, invaluable and excellent reference into the minds of early-day radio listeners. Sorry, we cannot honor the original 25-cent cover price.

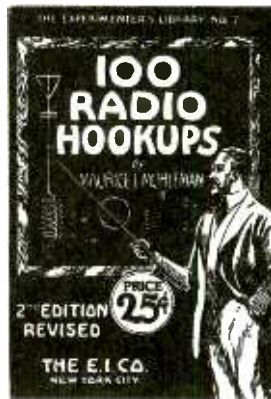

GUIDE TO THE WORLD'S RADIO STATIONS
—BP355—\$10.99

An easy-to-read guide for the casual listener and top notch QSL getter! The Guide is an essential reference work designed to steer the listener around the ever more complex radio bands. Listings cover world-wide shortwave stations with a special emphasis on international broadcasts in English. Medium and long-wave listings are also included for the US, Canada, European, Middle and Near East, and North Africa regions

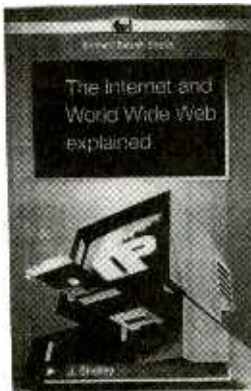

THE INTERNET AND WORLD WIDE WEB EXPLAINED —BP403—
\$10.99

Strip away the hype and mystery of the WWW and you'll be cruising on the information Superhighway! Understand the jargon used: ftp, protocols, TCP, hypertext, http, URL, home pages, threads, HTML, domains, FAQs, etc. Discover that e-mail is easy, fast and free! Learn how to guard against hackers and viruses. Develop friendships and "buddies" in Singapore, India, Cape Town, Peru—just about anywhere!



WIRELESS & ELECTRICAL CYCLOPEDIA
—ETT1—\$5.75

A slice of history. This early electronics catalog was issued in 1918. It consists of 176 pages that document the early history of electricity, radio and electronics. It was the "bible" of the electrical experimenter of the period. Take a look at history and see how far we have come. And by the way, don't try to order any of the radio parts and receivers shown, it's very unlikely that it will be available.

ELECTRONIC TECHNOLOGY TODAY INC.
P.O. BOX 240, Massapequa, NY 11762-0240

Name _____
Address _____
City _____ State _____ Zip _____

SHIPPING CHARGES IN USA AND CANADA

\$0.01 to \$5.00	\$2.00
\$5.01 to \$10.00	\$3.00
\$10.01 to \$20.00	\$4.00
\$20.01 to \$30.00	\$5.00
\$30.01 to \$40.00	\$6.00
\$40.01 to \$50.00	\$7.00
\$50.01 and above	\$8.50

SORRY No orders accepted outside of USA & Canada

Number of books ordered

Total price of merchandise	\$ _____
Shipping (see chart)	\$ _____
Subtotal	\$ _____
Sales Tax (NYS only)	\$ _____
Total Enclosed	\$ _____

All payments must be in U.S. funds!

ET01

January 1999, Popular Electronics

Since 1971

WWW.WEB-TRONICS.COM



You'll "Bookmark" This Site!

Check us last for the best deals on quality electronic parts, equipment & supplies!

- ♦ Easy to navigate site with loads of information
- ♦ Thousands of stock items
- ♦ Special deals found nowhere else
- ♦ New products added constantly
- ♦ Prices updated weekly on volatile computer products
- ♦ Order online, by FAX, by phone or snail mail

CCD Board Cameras & Surveillance Supplies
 Printed Circuit Board Supplies
 Computer Systems & Boards
 Industrial Computer Products
 NuDaq DAQ Boards!
 All Kinds of Do It Yourself Kits & Projects
 Super Test Equipment Deals!
 Cabinet & Enclosures
 Switches
 Passive Small Parts, Resistors, Diodes, Pots, Inductors, Capacitors, Lamps, LEDs, etc.
 I.C.s
 NTE Replacement Devices
 Soldering Equipment & Electronic Tools
 Prototyping & Breadboard Supplies
 Connectors
 Cable Ties, Heat Shrink & Wiring Products
 Special Kitting Service for Educators
 Lasers & Educational Laser Products
 and much, much more!



Circuit Specialists, Inc.
 800-811-5203
 FAX 602-464-5824

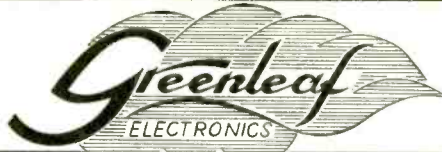

CABLE TV Converters & Descramblers

Compatible with
**Jerrold, Scientific Atlanta,
 Pioneer, Oak, & Hamlin
 Equipment**

BRAND NEW!

6-MONTH GUARANTEE

LOWEST PRICES

Volume Control & Parental Lockout Available

Greenleaf Electronics

1-800-742-2567

NO ILLINOIS SALES

It is not the intent of Greenleaf Electronics to defraud any pay television operator and we will not assist any company or individual in doing the same.



The 5360 DMM, one of the world's finest digital multimeters. The best of the ASYC II Series, it has the best accuracy, a built-in counter, and displays AC voltage as resistive power or dB (impedance selectable), saving you the time of making the calculation. A careful examination of the performance features and user-conscious design will tell you that you hold a superior DMM in your hand, designed with the measurement capability needed by users who demand the best. The 5360 DMM. You can depend on it anywhere. Regular \$249.00, On Special at \$195.00!!!

- 50,000 count
- 0.1% DCV
- True RMS, AC or AC + DC
- 0.1% ohms
- 30 kHz AC response
- Autoranging, bargraph
- Capacitance to 50,000 uF
- Frequency, duty cycle
- Sealed case, splashproof
- IEC 1010 class 2 safety compliance
- 3 year warranty

Call, fax or email for your free B&K Precision catalog and a copy of our 84 page test and measurement instrument catalog today!

PRINT™
 Products International

8931 Brookville Rd * Silver Spring, MD, 20910
 800-638-2020 * Fx 800-545-0058 * www.prodintl.com * sales@prodintl.com

CIRCLE 153 ON FREE INFORMATION CARD

MCM ELECTRONICS®

The Source For All Of Your Electronics Needs

When ordering, please provide this code: ► SOURCE CODE: POP60

Prices Effective Nov. 19, 1998 through Jan. 30, 1999

For over 20 years, MCM has been the leading supplier to the electronics service industry. Huge inventory, rapid delivery and competitive prices have made MCM the choice for:

- Hobbyists
- Educators
- Service Technicians
- Installers

Discover the MCM difference, call today for your free catalog.



Order #82-3015

DEFENDER SECURITY

Color PC Board Camera

Ideal for any observation, multimedia or security application. Provides NTSC composite video output. Features automatic white balance, 330 lines of horizontal resolution and AGC. Requires 12VDC, 240mA. **Regular price \$199.00.**

ONLY \$149



Order #72-4025

TENMA®

DMM W/Logic Function

3½ digit DMM measures AC/DC voltage from 200mV-600V, resistance to 2000Mohm, capacitance to 20µF, transistor h_{FE} gain and audible continuity test. Requires 9V battery (#290-080) not included. Dimensions: 2½" (W) x 5½" (H) x 1½" (D). **Regular price \$65.95.**

ONLY \$29.95



Order #82-2990

DEFENDER SECURITY

Micro PC Board Camera

B/W CCD camera measures only 1¼" x 1¼" x 1". Provides NTSC composite video output. Built-in 3.6mm lens provides viewing angle of 92°. Requires 12VDC, 300mA. (#58-3330 AC adaptor). **Regular price \$64.95**

ONLY \$49.00



Order #21-3460

Heavy Duty Aluminum Tool Case

Includes two tool pallets and adjustable compartments. Measures 19" x 14" x 6", ideal for hand tools and small test equipment. Rugged aluminum case is finished in black. **Regular price \$51.50.**

ONLY \$34.95



Order #50-4465

Subwoofer Amplifier Module

110W amp board handles speaker level or RCA inputs and may be installed in existing speaker or subwoofer enclosures. •60-160Hz continuously variable 12dB crossover •110W RMS @ 4ohm •Cut out 10" x 7" •**Regular price \$185.00**

ONLY \$159

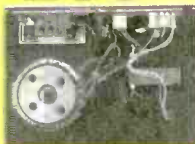

Order #80-190

50 Watt PA Amplifier

Perfect for auditoriums, churches and office buildings. Inputs include two ¼" microphone, ceramic phono and aux. Special fader allows phono/aux mixing. Outputs include 4, 8 and 16ohm, plus 70V and 100V line. Requires 117VAC/12VDC. Measures: 13" x 4½" x 10½". **Regular price \$201.00**

ONLY \$69.00

ONLY \$12.50

Order #72-340

Solderless Breadboard

Perfect for circuit designing, prototyping and educational purposes. Usable for high frequency, high speed and low noise circuits. 1260 terminal strip tie points, 100 distribution strip tie points, two binding post connections. Dimensions: 4" x 8½" x ¾". **Regular price \$20.59**



your choice ONLY \$14.50

Order #72-7051 or #72-7043



Current Meters

Inexpensive ammeters are ideal for any DC current measuring application including charging systems. Induction type sensing only requires cable to be placed in slot frame on the rear of meter case, no electrical connections or leads to hook up. **Regular price \$19.95.**

Order #	Current range
72-7051	-100-0-100 Amp
72-7043	-30-0-30 Amp



FREE Catalog!

1-800-543-4330

www.mcmelectronics.com

Hours: M-F 7 a.m.-9 p.m., Sat. 9 a.m.-6 p.m., EST.

Same Day Shipping!

In stock orders received by 3:00 p.m. (YOUR TIME), are shipped the same day.



MCM ELECTRONICS®

650 CONGRESS PARK DR.
CENTERVILLE, OH 45459
A PREMIER FARNELL Company

SOURCE CODE: POP60

CIRCLE 161 ON FREE INFORMATION CARD

Same Day Shipping

C & S SALES
Your one stop source for
all your electronic needs!

CALL OR WRITE FOR OUR
NEW FREE 64 PAGE
CATALOG!
(800) 445-3201

Fluke Scopemeters



- 123 NEW.....\$1140
- 92B.....\$1445
- 96B.....\$1695
- 97.....\$1695
- 99B..... NEW.....\$2095
- 105B.....\$2495

ALL FLUKE PRODUCTS ON SALE

B & K PRECISION SCOPES

20MHz DUAL-TRACE
Model 2120B - 2 Year Warranty
Special \$375

Model 2125A with delayed sweep
\$539.95



- 1mV/division sensitivity
- AUTONORM triggered sweep operation
- AC, TVH, TVV and line coupling
- Calibrated 19 step time-base with x10 magnifier
- Compact low-profile design

Affordable Spectrum Analyzers by B&K

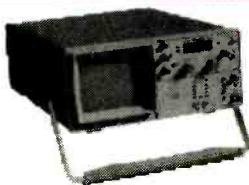

500MHz Series BK2615A \$1250
BK2620A \$1675

- 150KHz to 500MHz
- Dynamic Range 80dB(113dB with attenuation)
- +20dB maximum input
- 12.5 and 400KHz resolution bandwidth
- 150KHz/hour stability
- Built-in tracking generator(Model 2620A)

1.05GHz Series BK2625A \$1925
BK2630A \$2595

- 150KHz to 1050MHz
- Dynamic Range 80dB(113dB with attenuation)
- AM & FM demod included
- 20 and 400KHz resolution bandwidth
- 150KHz/hour stability
- Built-in tracking generator(Model 2630A)

PORTABLE SEMICONDUCTOR TESTER

B&K 510

\$199.00



- In or out-of-order circuit tests for transistor, FETs, SCRs and darlingtonts.

20MHz Sweep / Function Generator with Freq Counter

B&K 4040

- 0.2Hz to 20MHz
- AM & FM modulation
- Burst Operation
- External Frequency counter to 30MHz
- Linear and Log Sweep



\$399

10MHz B&K 4017 \$309

5MHz B&K 4011 \$239

Quality Scopes by Elenco
Lowest Prices of the Year!

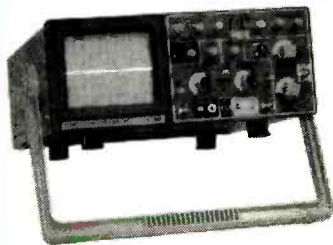

60MHz
DS-603 **\$995**

- Analog / Digital Storage
- 20MS/s Sampling Rate
- RS232 Output

S-1360 **\$749**

- Analog with Delayed Sweep
- Component Tester

100MHz

S-1390 **\$895**

- Analog w/ delayed sweep
- Dual Time Base
- TV Sync

Includes
Free Dust
Cover and
Probes

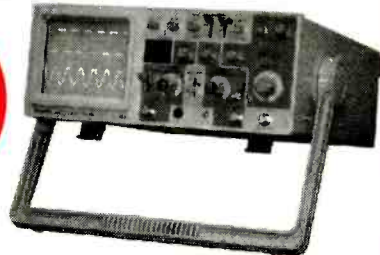

25/30MHz
DS-303 30MHz **\$895**

- Analog / Digital Storage
- 20MS/s Sampling Rate
- RS232 Output

DS-203 20MHz **\$695**

- Analog / Digital Storage

S-1330 **\$439**

- 25MHz Analog
- Delayed Sweep

S-1325 **\$325**

- 25MHz Analog
- TV Sync
- 1mV Sensitivity

40MHz

S-1345 **\$569**

- Analog with Delayed Sweep
- Component Tester

S-1340 **\$475**

- Analog / TV Sync
- 1mV Sensitivity

**2 Year
Warranty**

Fluke Multimeter Specials



F-73III
\$119

List \$135



F-75II
\$129

List \$149



F-79II
\$175

List \$199



F-87
\$289

List \$335

B&K Precision Multimeter Specials



- Accurately measures capacitance, resistance and inductance.
- Measures dissipation factor of capacitors and O of inductors.
- Simultaneously displays measured value and O or dissipation factor.
- Displays the difference between measures and reference values.

Model 878 **\$219.95**



- 50,000 count
- 0.025% DCV
- 0.07% ohms
- Min/Max/Avg
- True RMS, AC, or AC+DC
- 100kHz AC response
- Capacitance to 50,000µF
- Frequency, duty cycle, pulse width
- dB across 1Ω to 10kΩ
- Disturbance indicator
- Autograph, bargraph with zoom
- Sealed case, Splashproof
- IEC 1010, class 2 safety compliance

Model 5390
\$295.00

MX-9300

Four Functions in One Instrument

Features:

- One instrument with four test and measuring systems:
 - 1.3GHz Frequency Counter
 - 2MHz Sweep Function Generator
 - Digital Multimeter
 - Digital Triple Power Supply
- 0-30V @ 3A, 15V @ 1A, 5V @ 2A



\$459.95

GUARANTEED LOWEST PRICES

C&S SALES, INC.

150 W. CARPENTER AVENUE
WHEELING, IL 60090

FAX: (847) 541-9904 (847) 541-0710

http://www.elenco.com/cs_sales/



**15 DAY MONEY BACK
GUARANTEE**
FULL FACTORY WARRANTY
PRICES SUBJECT TO CHANGE WITHOUT NOTICE
Most Major Credit Cards Accepted

CIRCLE 130 ON FREE INFORMATION CARD

CALL TOLL FREE
(800) 292-7711 orders only
Se Habla Español

C&S SALES
EXCELLENCE IN SERVICE

LOOK FOR OTHER
MONTHLY SPECIALS
ON OUR WEBSITE

XK-700 Digital / Analog Trainer

Elenco's newest advanced designed Digital / Analog Trainer is specially designed for school projects. It is built on a single PC board for maximum reliability. It includes 5 built-in power supplies, a function generator with continuously sine, triangular and square wave-forms and a 1560 tie point breadboard area. Tools and meter shown optional. (Mounted in a professional tool case made of reinforced metal).

XK-700
Assembled and Tested
\$189.95

XK-700 - SEMI KIT
w/ Fully Assembled PC Board
\$174.95

XK-700K - Kit
\$159.95



Made in the USA

Digital Multimeter
Model M-1740

\$39.95
Free Holster

- 11 functions
- Freq to 20MHz
- Cap to 20µF
- AC/DC Voltage
- AC/DC Current
- Beeper
- Diode Test
- Transistor Test
- Meets UL-1244 safety specs



DIGITAL LCR METER
Model LCR-1810

\$99.95

- Capacitance 1pF to 20MF
- Inductance 1µH to 20H
- Resistance .01Ω to 2000MΩ
- Temperature -20°C to 75°C
- DC Volts 0 - 20V
- Frequency up to 15MHz
- Diode/Audible Continuity Test
- Signal Output Function
- 3 1/2 Digit Display



15pc. VCR Service Tool Kit
Model TK-1400

- Inclined Base Screwdriver
- Eccentric Screwdriver
- 2mm & 3mm Fine Adjust Screwdriver
- VHS VCR Head Puller
- Retaining Ring Remover
- 3 Reversible Screwdrivers
- Spring Hook Tool
- Micro Screwdriver
- Hex Wrench Set



Special
\$24.95

Model M-6100

The M-6100 is Elenco's most sophisticated meter with almost every possible feature available. The M-6100 even has a computer interface for viewing and storing data on a personal computer. It comes complete with software, RS-232 cable, test leads and manual.

\$99.95



Model XP-581

4 Fully Regulated DC Power Supplies in One Unit
 4 DC voltages: 3 fixed - +5V @ 3A, +12V @ 1A, -12V @ 1A
 1 Variable - 2.5 - 20V @ 2A

\$89.95



Tektronix DMMs

For high performance digital multimeters that are accurate, reliable, and rugged, the DMM900 series extends the Tektronix line of already affordable DMMs. Twice the accuracy. Up to 10 times the resolution. And a full range of capabilities that span voltage, current, dual numeric display, 3 year warranty, and autoranging capability. All backed by the reliability of the Tektronix brand.



912 \$179
914 \$229
916 \$275

Power Supply Kit
Model XP-720K

3 fully reg. DC supplies
 1.5VDC - 15VDC @ 1A
 -1.5VDC to -15VDC
 5VDC @ 3A
Plus
 6.3VAC @ 1A and
 12.6VAC C.T. @ 1A

\$54.95



Available assembled Model XP-720 \$84.95

Sweep Function Generator
 with built-in Frequency counter

Model GF-8026

\$225

- Range .02Hz - 2MHz
- Sine, Square, Triangle, Pulse, Ramp
- Ext. counter 1Hz - 10MHz



Kit Corner
over 100 kits available

AK-700

\$15.95

Phone kit with training course
 4 Flashing neon lights
 See thru case



RADIO CONTROL CAR KIT
MODEL AK-870

- 7 functions
- Remote control included

\$24.95



No Soldering Required

Digital Capacitance Meter
Model CM-1555

\$48.95



- Capacitors from 1pF to 20M µF
- 3 1/2 Digit LCD
- Zero adjust
- special insertion jack
- 1/2% basic accuracy
- Tilt stand

Digital Audio Generator
 with built-in Counter

SG-9300

- 10Hz - 1MHz
- Low Distortion
- Sine/Square waves
- Built-in 150MHz Frequency Counter

\$175



SG-9200 Analog/No counter \$119.95

Model AM/FM-108K
Transistor Radio Kit
 with training course

\$29.95

Free Stand



35mm Camera Kit
 Learn all about photography
AK-540

\$14.95



No Soldering Required

SATELLITE FINDER
Model SF-01

- Aligns Satellite Dishes
- Range 950-2050MHz
- Compact Size
- Self Power Check



\$39.95

RF Generator
 with Counter

Model SG-9500

\$225

- 100KHz - 150MHz
- Internal AM Mod of 1KHz
- RF Output 100MV - 35 MHz
- Audio Output 1KHz @ 1V rms



SG-9000 Analog/No counter \$119.95

WE WILL NOT BE UNDERSOLD C&S SALES, INC.

150 W. CARPENTER AVENUE
 WHEELING, IL 60090
 FAX: (847) 541-9904 (847) 541-0710
http://www.elenco.com/cs_sales/



15 DAY MONEY BACK
GUARANTEE
FULL FACTORY WARRANTY
 PRICES SUBJECT TO CHANGE WITHOUT NOTICE

UPS SHIPPING: 48 STATES 5%
 OTHERS CALL FOR DETAILS
 IL Residents add 8.25% Sales Tax

CIRCLE 130 ON FREE INFORMATION CARD

Kenwood CS-4125 Sale!!!

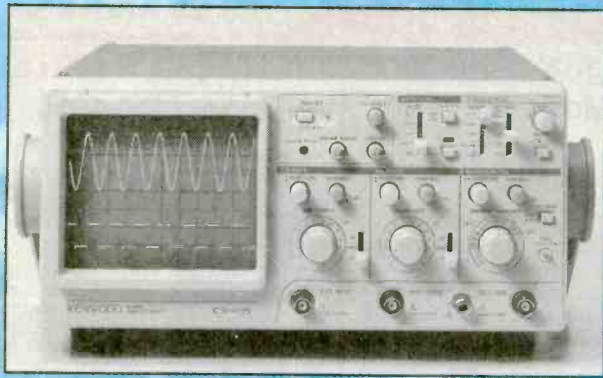

Free **KENWOOD** t-shirt
with purchase of
CS-4125 oscilloscope!!!

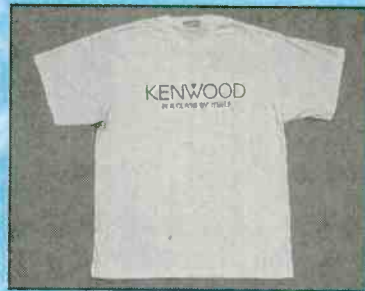

KENWOOD

MODEL CS-4125

20 Mhz, 2 Channel, includes probes
Suggested Price \$595.00
SUPER SPECIAL \$389.00!!!

PRINT™
Products International

8931 Brookville Rd * Silver Spring, MD, 20910 * 800-638-2020 * Fx 800-545-0058
www.prodintl.com

SPARE SCOPE PROBE SPECIAL:

Kenwood PC-35 - 10:1, DC to 50 MHz
Regular \$62.00 **SALE \$29.95**
Kenwood PC-41 - 10:1/1:1, DC to 50 MHz
Regular \$62.00 **SALE \$29.95**

Call today for your free 84 page test & measurement instrument catalog!

CIRCLE 142 ON FREE INFORMATION CARD

HACKING THE INTERNET

The latest tricks and methods being used on the Net to pirate software (warez) and the newest hacking websites. Includes examples, countermeasures, password defeats, UNIX, Sprintnet, brute force techs, lots of tips. *More!* \$29.

INTERNET TRACKING & TRACING

Scammers, spammers, stalkers, infectors, and others hide behind the Internet's anonymity to commit serious offenses. Learn from master hackers best methods to track & trace IDs and origins, and to protect your own privacy. *More!* \$29.

INTERNET CONS & SCAMS

Internet cons, scams and related frauds now rake in \$2+Billion annually! Most are done anonymously with impunity. Details how they're done, how to ID them, how to protect yourself. *More!* \$25.

THE COOKIE TERMINATOR

When online, many websites track your every move! Browser cookie, history and cache files contain personal data readily accessible to Internet predators, scammers, spammers and snoops. Your financial, medical, political, habits, lifestyle, future plans data is exposed to the world! Step-by-step how to remove and stop cookies from destroying your privacy. \$25.
Any 2 for \$49, 3 for \$64, all 4 for \$79!

PBX HACKING

PBXs hacking losses are at \$5-\$10 Billion annually! Details how PBXs are hacked, countermeasures. Author interview in Forbes! \$24.

TOP SECRET

CONSUMERTRONICS

2430 Juan Tabo, NE, #259, ABQ, NM 87112
P.O. Box 23097 ABQ, NM 87192
Fax: 505-292-4078 (all hours, orders only) Voice: 505-237-2073 (10-6 PM)

Full Catalog: www.tsc-global.com/consumer.html Adventure: www.tsc-global.com

Established in 1971. Featured on CBS '60 Minutes', Forbes, New York Times. Add \$5 total S/H (US, Canada). Postal MO is fastest! VISA, MC OK. No CODs. Take 10% OFF all Orders over \$100 and Take \$2.00 OFF all New Orders over \$20 placed by Mail or Fax. Catalog \$1 w/order. \$3 w/vo.

Sold for legal educational purposes only. See Catalog for LIMITED WARRANTY, SPECIAL PROJECTS and all other applicable policies.

CELLPHONE MODIF. GUIDE

How cellphones operate and are modified. Vulnerabilities to hack attack and countermeasures. Cloning details for NAMs, ESNs, etc, control data formats, computing encoded MINs, ESNs, SIDHs, Op Sys, PROMs, forcing ACK, test mode and resets, cable diagrams, scanning, tracking, scanner restorations, freq allocations, roaming, step-by-step to keypad-reprogram 100+ popular cellphones. One FREE database search. *More!* \$49.

PAGER (BEEPER) MANUAL

How Pagers work, different types and uses, freqs, advantages over and uses with cellphones, and tips and tricks. How Pagers are hacked/countermeasures. And plans for a Personal Pocket Paging System (xmitter and receiver). *More!* \$29.

Both for only \$69!

PHREAKING CALLER ID & ANI

How they work and dozens of ways of defeating Caller ID, ANI, *69, *57, Call Blocking, *67 etc. Describes ESS, SS7, CN/A, CAMA, DNR, Diverters, Centrex - *more!* \$25.

HACKING FAX MACHINES

Details all known methods of hacking Faxes and countermeasures. Includes computer fax modems, crimes, interceptions, fax servers, fax-on-demand, protocols, parameters, compression, encryption, and fax surveillance (typ. mods. *More!* \$29).

VOICE MAIL HACKING

VMSs are hacked to penetrate PBXs to make outgoing calls, get free VMB usage, secretly read/change/delete messages, or damage the VMS (or its PBX) itself. Step-by-step on how it's done, countermeasures. \$29.

STOPPING POWER METERS

As reported on "60 MINUTES"! New 6th Edition! Plans for devices that can slow down (even stop) watt-hour meters - while loads draw full power! Devices plug into one outlet and normal loads into other outlets. Describes meter creep, overload droop, pole meters, etc. \$29.

SPM THE VIDEO

Now it's easier to learn about KW-HR Power Meters than ever before! This educational video shows you how they work and their anatomy. Demonstrates SPMEM device and external magnetic methods used to slow and stop meters! Hosted by a top expert in the field. From the novice to the pro, an excellent source of info on these exciting devices! Great in combo with our SPM related manuals! \$29.

THE J.G. MANUAL: External magnetic ways (applied to meter) to slow down and stop power meters while drawing full loads. Plans \$25.

KW-HR METERS: How watt-hour meters work, calibration, error modes (many), ANSI Standards, etc. Demand and Polyphase Meters. Experimental results to slow and stop meters by others. \$25.
Any 2 for \$49, 3 for \$64, all 4 for \$79!

COMPUTER PHREAKING

Describes in detail how computers penetrate each other, and how VIRUSES, TROJAN HORSES, WORMS are implemented. Dozens of computer crime and abuse methods and countermeasures. Includes disk filled with hacker text files and utilities, and the legendary FLUSHOT+ protection system. Internet advice, password defeats, glossary - much more! Manual + PC Disk! \$39.

THE HACKER FILES: 3 HD PC disks filled with choice raw, colorful and highly informative hacker, phreaker text files covering many topics! \$39.
Both for only \$69!

BEYOND VAN ECK PHREAKING

Plans for remote eavesdropping of TV video signals. Range up to 1 KM. Describes how van Eck systems work, and are also used in surveillance of computer systems. \$29. The van Eck Demo Tape is \$29. Both for only \$49!

MANY MORE TITLES!

Beyond Phone Color Boxes - \$29
Hacking Answer Machines - \$19
Casino Hacking - \$25
Automatic Teller Machines - \$39
Credit Card Scams - \$29
Cons & Scams - \$29

Social Engineering - \$29
Polygraph Defeats - \$25
By an Order of the Magnitude - \$45
Ultimate Success Manual - \$19
Stealth Technology - \$19
Secret & Survival Radio - \$19
High Voltage Devices - \$29
Mind Control - \$29
Under Attack! - \$29

Radionics Manual - \$29
Heal Thyself - \$19
Secrets of Solderless BBs - \$24
Secret & Alternate IDs - \$15
Cryptanalysis Techniques - \$29
Government Land Grab - \$15
Rocket's Red Glare - \$29
Survival Guns & Ammo - \$19
The Ultimate Driver - \$19

THE DIRTY-2 DOZEN!

24+ Hot Hack/Phreak Disks!
See CATALOG!

SPECIAL PROJECTS

We will design & build just about anything electronic! Hardware done as SPECIAL PROJECTS only. See Catalog for details and SP Application Form, else: www.tsc-global.com/spaf-spp.html

done as SPECIAL PROJECTS only. See Catalog for details and SP Application Form, else: www.tsc-global.com/spaf-spp.html

We will design & build just about anything electronic! Hardware done as SPECIAL PROJECTS only. See Catalog for details and SP Application Form, else: www.tsc-global.com/spaf-spp.html

done as SPECIAL PROJECTS only. See Catalog for details and SP Application Form, else: www.tsc-global.com/spaf-spp.html

"Get the skills you need at a price you can afford!"

Earn up to \$45 an hour or more as a skilled Computer Programmer.

Cash in on the explosion of opportunities. Start your new career or even open a business of your own as a highly-paid computer programmer.

Computer programmers today can almost write their own ticket to financial well-being and job satisfaction. Only Foley-Belsaw's unique in-home training programs can give you the skills you need at a price you can afford.

You'll learn the three hot computer languages — QBasic, C and Visual Basic. You'll even work with the hot new C++. With this easy-to-learn knowledge, you'll write your first QBasic program by the end of the first SkillPak of lessons. Soon you'll be programming sound and graphics, and even learning how to program for the Windows environment — the most popular application program today.

It's easy to cash in!

Look at some of the things professional computer programmers do. "Wrote a C program to clean up a WordPerfect file; edited the resulting file as data errors were found." This work would take a trained programmer less than five hours to complete, and they could make over \$200 for the work. That's money you could be making — and soon — with training from the Foley-Belsaw Institute of Computer Programming.

Everything is included!

We provide you with all the materials you'll need to become a professional computer programmer. You'll receive 37 lessons, designed for you by the Foley-Belsaw Professional Programmer Staff. Other valuable materials include a *Programmer's Handbook*, *Programmer's Examples* on two 3.5 inch disks, *Programmer's Flowchart Template*, and a booklet, *Selecting the Right Computer*.

Other schools force you to buy a complete computer package as part of their training program. At Foley-Belsaw we understand that your needs as a programmer may not fit into a "one size fits all" approach. Why should you pay hundreds of dollars for a computer system that you may not need?

We'll tell you what you need to know so that when you're ready to buy your own computer, you can get the machine that fits your needs at the lowest possible price. That's the Foley-Belsaw way.

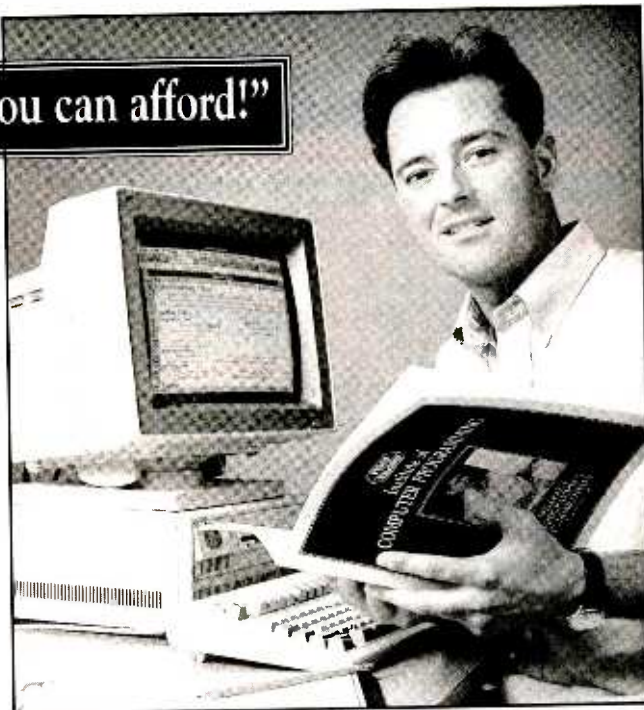

Get the free facts today.

Whether you want to change careers, have a profitable part-time job or start your own business, Foley-Belsaw Institute's new computer programming course is the first step. A profitable future in computer programming can be yours. Call or write today for a fact-filled information kit including a free copy of *Computer Programming — A Profitable Career In Your Spare Time*. See how easy it is to begin a money-making career as a sought-after computer programmer. Our free full-color information kit outlines the steps of the computer programming course and shows you everything you will receive as part of your training.



**Mail this coupon or call today
Toll Free 1-800-487-2100!**

Your free opportunity kit will be rushed to you!

If coupon is missing, write to: Foley-Belsaw Company, 6301 Equitable Road, Kansas City, MO 64120

Call or complete & return this coupon to: Foley-Belsaw Institute, 6301 Equitable Road, Kansas City, MO 64120

YES! Rush me a free information kit on Computer Programming right away. Dept. 35589

Other career courses:

- Locksmithing, Dept. 13170
- Small Engine Repair, Dept. 53044
- Saw & Tool Sharpening, Dept. 21976
- VCR Repair, Dept. 62871
- Computer Repair, Dept. 64773
- TV/Satellite Dish Repair, Dept. 31642
- Gunsmithing, Dept. 92678
- Woodworking, Dept. 43908
- Upholstery, Dept. 81580
- Vinyl Repair, Dept. 71511
- Electrician, 95450
- Computer Specialist, Dept. 38410
- Networking Specialist, Dept. 39397

I understand that there is ABSOLUTELY NO OBLIGATION and NO SALESMAN WILL CALL.

Name _____

Address _____

City _____ State _____ Zip _____



AMAZING PRODUCTS! INFORMATION

UNLIMITED DEPT PE 0498
BOX 716 AMHERST, N.H. 03031

VISIT OUR "ACTION" WEB SITE!
<http://www.amazing1.com>

ATTENTION!! RAILGUN EXPERIMENTERS HIGH ENERGY PULSER

RAIL GUN, COIL GUN, EXPLODING WATER, ANTIGRAVITY, MASS
WARPING, LEVITATION, PLASMA PROPULSION, LATTICE SNAPPING, EMP etc

- Lossless Energy Charging
- Programmable Voltage to 2 KV and Energy Control to 3 KJ
- Triggered Spark Switch (IKJ)
- Universal 12 VDC or 115 VAC
- 7.5 X 7.5 X 7" Light weight



HOTSHOT

- HEP3 Plans High Energy Pulser/Ignitor.....\$15.00
 - HEP3K Kit/Plans (With 500 Joules Energy Storage).....\$349.50
 - HEP30 Assembled (With 500 Joules Energy Storage).....\$449.50
- All Individual Parts and Subassemblies Available

BURNING LASER RAY GUN

BLASTS THRU THE HARDEST OF METALS!



All Parts Available

A FUTURISTIC CONCEPT!!

- LAGUN2 Plans.....\$20.00

BURNING CO2 BENCH LASER

HOTTER THAN MOST TORCHES!



All Parts Available

- LC7 Plans.....\$20.00

ELECTRONIC HYPNOSIS AND MIND CONTROL

Generates Highly Effective Audible and Visual Stimuli With Bio-Feedback That Can Induce Hypnotic as Well as ALPHA Relaxed States of the Mind. Place Subjects "Under" Your Control. Enhances Hidden PSYCHIC Ability in Many People!



- MIND Plans.....\$15.00
- MIND2K Kit and Plans.....\$49.50
- MIND20 Assembled.....\$89.50

TELEPHONE TAPING SYSTEM

EXTENDED X4 PLAY
Tapes Phone Conversation
20 Mega Input ZI Check Lowest

- TAP30X Ready to Use.....\$84.50
- BEEP10 Beeper Alert.....\$29.95

TRANSISTORIZED TESLA COIL

URNS A LIGHT BULB INTO A SPECTACULAR PLASMA DISPLAY

Transmits Wireless Energy
Noiseless Operation
Pyrotechnic Effect
12 VDC/5 Amps or Battery
115 VAC Optional Converter
Adjustable Frequency
Control For Effect



- TCL5 Plans.....\$8.00
- TCL5K Kit/Plans.....\$59.50
- TCL50 Ready to Use.....\$109.50
- 12CD/7 12VDC@7Amps.....\$39.50

JACOBS LADDER

Observe a pyrotechnical display of "traveling" fiery plasma. Starts off as 1/2" arc and expands to over 3" before evaporating into space. This is an excellent attention getting display as well as a winning science project!! With arc control.



- JACK1 Plans.....\$8.00
- JACK1K Kit Minus Case.....\$129.50
- JACK10 Ready to Use.....\$249.50

- 12KVGEN20 Pwr Supply Only.....\$99.50
- 12KVGEN2K Kit of Pwr Supply.....\$79.50

3Mi FM VOICE TRANSMITTER

Safety Product Allows Listening to Children or Invalids in Hazardous Areas, Pools, Ponds etc. Great Security Intrusion Alert! Uses FM Table Top Radio.



- FMV1K Kit/Plans.....\$39.50

ATTENTION! ANTI GRAVITY,

We Can Supply Low Cost HIGH VOLTAGE Current Producing Generators from 50 to 500 KV. Contact Factory For Details or Call 603 673 6493

MICRO MINI MITE TESLA COIL

LIGHTS UP A 4 FT FLOURESCENT TUBE WITHOUT CONTACT!! YET ONLY 3" TALL!
Super Magic Trick
Low Cost Science Project
12 VDC/115 VAC Operation



- MTC1K Kit/Plans.....\$19.50
- MTC10 Ready to Use.....\$34.50

PHASOR BLAST WAVE PISTOL

130 db of Directional Sonic Shock Waves Energy Handheld and Battery Operated



- PPP1 Plans.....\$8.00
- PPP1K Kit/Plans.....\$49.50
- PPP10 Ready to Use.....\$79.50

HOVERBOARD PLANS

Kit Soon to be Available

28 Pages of "how to" build a magnetic force field capable of containing a column of ionized air up to several psi. Proven theory may require additional experiment



- HOVER Plans.....\$25.00

1 800 221 1705 ORDERS ONLY! FAX 1 603 672 5406 INFO 9-5pm 1 603 673 4730 FREE CATALOG ON REQUEST
Pay by MC, VISA, Cash, Chk, MO, COD. Please Add \$5.00 S&H plus \$5.00 If COD. Overseas Please Contact for PROFORMA

DATA ACQUISITION & CONTROL

AFFORDABLE PLUG-IN BOARDS FOR PC's ISA BUS

- ANA100 Analog I/O \$ 99
- DIG100 Digital I/O \$ 39



- 8 Channel 8-Bit
- 0 to 5 Volt Input
- 14 TTL I/O lines
- Analog Output
- 400KHz Sampling



- 82C55 PPI
- 24 or 48 TTL I/O Lines option
- Selectable Base Address

- ANA150 Analog/Counter... \$ 89
- DIG200 Counter I/O \$ 79



- 8 Channel 8-Bit
- 0 to 5 Volt Input
- 3 16-Bit Counters
- 400KHz Sampling



- 3 16-Bit Counters
- 8 TTL Input lines
- 8 TTL Output lines
- Selectable Clock Frequency Input

- ANA200 Analog I/O \$ 79
- ANA201 Analog \$ 119



- 1 Channel 12-Bit
- 0 to 5 Volt Input
- optional bi-polar
- 100KHz / 300KHz Sampling rate
- 24 TTL I/O lines



- 8 Channel 12-Bit
- x1, x5, x10, x50 Programmable Channel gain
- 100KHz Sampling rate

On-Line Product Catalog at Our Web Site
<http://www.Bsof.com>
E-Mail: Sales@Bsof.com

BSOFT Software, Inc.

444 COLTON ROAD * COLUMBUS, OH 43207
PHONE 614-491-0832 * FAX 614-497-9971

Electronic Training Videos



Learn electronics quickly and easily with UCANDO's computer-animated training videos. Students can learn at their own pace and professionals will find the UCANDO videos to be a valuable source of reference material. If these videos aren't the best learning tools you've ever seen, return them within 30 days for a

complete refund. These videos are being used by Tech-Schools, CET's, Military Branches, Ham Operators, Industries, and more, across the United States and around the world. Order today and see how UCANDO is ...

"Changing The Way The World Learns Electronics."

- VCR Maintenance & Repair .. \$29.95
- All others .. \$44.95 each
- Intro to VCR Repair • Direct Current • Alternating Current • Semiconductors • Power Supplies • Amplifiers • Oscillators • Digital 1 • Digital 2 • Digital 3 • Digital 4 • Digital 5 • Digital 6 • AM Radio • FM Radio Part 1 • FM Radio Part 2 • TV Part 1 "Intro to TV" • TV Part 2 "The Front End" • TV Part 3 "Audio" • Fiber Optics • Laser Technology •

SAVE!!! 6 videos for only \$240 or 12 videos for only \$450



1-800-678-6113

or mail check or money order to:
UCANDO Videos
P.O. Box 928
Greenville, OH 45331



FREE Shipping ... FREE Catalog

CIRCLE 147 ON FREE INFORMATION CARD

velleman

HSS5 HANDHELD OSCILLOSCOPE

Your Ideal Tool For Service-Automotive-Education-Hobby, etc...

- Truly Handheld
- High contrast LCD screen
- Full Auto Setup (max sensitivity 5mV/div)
- True RMS, peak-to-peak, DC and dB readout (down to -74dB)
- On-screen markers for voltage, time and frequency
- Adjustable trigger level
- Triggering: normal, auto or single
- Trigger edge selection
- Screen hold function
- Waveform memory
- Built-in sine wave generator
- RS232 interface and FREE* software
- Battery pack and holster included

OPTIONS

- Carry case : BAG13X24
- Probe : PROBE20 or isolated probe : PROBE60S
- RS232-output cable+ Windows software : OPTRS232

* Available from www.velleman.be

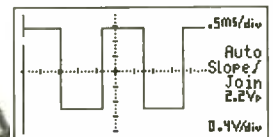
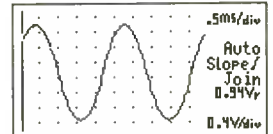
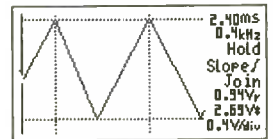
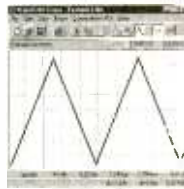

Simulated screenshots

\$249

PCS64i DIGITAL OSCILLOSCOPE FOR PC



- Uses an IBM compatible computer and its monitor to display waveforms
- All standard oscilloscope functions are available in the DOS or Windows program supplied.
- Operation is just like a normal oscilloscope
- Markers for indicating voltage and frequency provide considerable ease of use.
- Can also be used as a spectrum analyser up to 16 MHz, and as a transient signal recorder, for recording voltage variations or for comparing two voltages over a longer period (up to more than 1 year!).
- Connection is through the computer's parallel port.
- The oscilloscope and transient recorder have two completely separated channels with a sampling frequency up to 32 MHz in real time, oversampling of 64MHz is possible in the Windows software.
- Any waveform displayed on the screen can be stored for later use.

OPTICALLY ISOLATED FROM COMPUTER



OSCILLOSCOPE [DOS-screen]

- timebase : 100ns to 100ms per division
- input sensitivity : 10mV to 5V/division
- pre-trigger function (not in 64MHz mode)
- true RMS readout (only AC component)

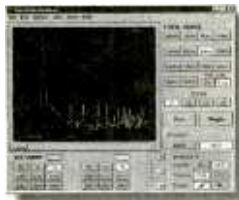

SPECTRUM ANALYSER [Windows-screen]

- frequency range : 0 .. 800Hz to 16MHz
- linear or logarithmic timescale
- operating principle : FFT (Fast Fourier Transform)



TRANSIENT RECORDER [Windows-screen]

- timescale : 20ms/Div to 2000s/Div
- max record time : 9.4hour/screen
- automatic storage of data
- automatic recording for more than 1 year
- record and display of screens
- data format : ASCII

SYSTEM REQUIREMENTS:

- IBM compatible PC
- Windows 95 or 3.11 or MS-DOS
- VGA display card (min. 800x600 for Windows) and mouse
- 480Kb free conventional memory (Dos software)

OPTIONAL ACCESSORIES

- NiCd battery pack : BP9 for battery operation
- oscilloscope probes (2x) : PROBE60S (isolated)
- carry case : BAG21X19

\$399

velleman

7415 Whitehall Street Suite 119
 Fort Worth, TX 76118
 (817) 284-7785 F : (817) 284-7712
www.velleman.be email : velleman@earthlink.net

Questions ? Contact us for a list of US distributors or to get your **FREE** catalogue

CIRCLE 163 ON FREE INFORMATION CARD

Any waveform you want!



Starting at

\$795

Quantity 1

Money back guarantee

- **Synthesized Signal Generator**

Clean sinewaves DC-20 MHz with .001% accuracy!
.1 Hz steps. DC Offset. RS232 remote control.

- **Arbitrary Waveform Generator**

40 Megasamples/Second. 32,768 points. 12 bit DAC

- **Function Generator**

Ramps, Triangles, Exponentials & more to 2 MHz!

- **Pulse Generator**

Digital waveforms with adjustable duty cycle

Telulex Inc. model SG-100

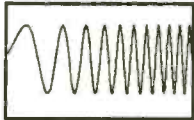

DC to 20 MHz linear and log sweeps

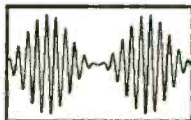

Int/Ext AM, SSB, Dualtone Gen.

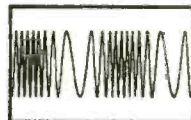

Int/Ext FM, PM, BPSK, Burst

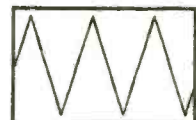

Ramps, Triangles, Exponentials

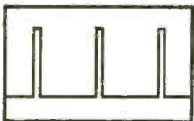

Pulse Generator



Noise

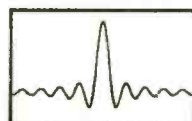

Arbitrary Waveforms

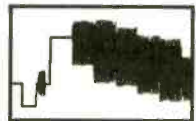

Unlimited Possibilities!

Telulex Inc.

2455 Old Middlefield Way S Tel (650) 938-0240

<http://www.Telulex.com>

Mountain View, CA 94043

Fax (650) 938-0241

Email: sales@Telulex.com

CIRCLE 137 ON FREE INFORMATION CARD

ATTENTION DEALERS: WHOLESALE ONLY!



**BEST PRICES!
FAST SERVICE
SAME DAY SHIPPING**

EXCLUSIVE:



2 PIECE SETUPS: \$85⁰⁰

10 lot • 1 Year Warranty

Latest Technology • Universal Combo's - Ask For Details
CALL US LAST! LOWEST PRICES GUARANTEED!

**TOLL FREE:
800-375-3682**



**FAX:
516-246-5634**

BEST DEALER PRICING!

CABLE DIRECT

CONVERTERS • FILTERS
DESCRAMBLERS

IMPROVE YOUR IMAGE WITH
VIDEO STABILIZERS

**FREE
CABLE TV
CATALOG!**

**100%
MONEY BACK
GUARANTEE!**



Now you can tune-in your favorite
cable TV programming
and **SAVE \$100'S -
EVEN \$1000'S** on premium
CABLE TV EQUIPMENT.

**30 DAY
FREE
TRIAL!**



**MODERN
ELECTRONICS**
1-800-906-6664

2609 S. 156TH CIRCLE • OMAHA, NE 68130
<http://www.modernelectronics.com>

Sun Equipment Corporation Since 1988

P. O. Box 97903, Raleigh, NC 27624 E-mail: sunequipco@ipass.net
To request FREE CATALOG, please call, fax, write, or e-mail us.

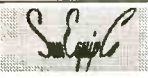

1 Year Warranty. 15 Day Money Back Guarantee.
School purchase order accepted. Bids accepted.
DEALERS & SALES REP'S WELCOME
DISTRIBUTOR & OEM WELCOME

Quality Test Equipment for Professionals

LODESTAR VISA, Mastercard, Discover, AmrExpress
1-800-870-1955 / (919)870-1955 Fax: (919)870-5720

DC POWER SUPPLY (CC/CV)

All models. protection of short ckt, overload, reverse polarity, over-voltage, Constant Current & Voltage (CC/CV) are fully adjustable. Regulation: $\leq 0.1\% + 3mV$ (line), $\leq 0.1\% + 3mV$ (load), $\leq 1mV$ ripple.

SINGLE OUTPUT

Analog Displays

- PS-303 \$159.00, 30V/3A
- PS-305 \$219.95, 30V/5A
- PS-1610S \$289.00, 16V/10A
- PS-2243 \$139.00, 12V/24V select, 3A
- PS-2245 \$159.00, 12V/24V select, 5A
- 8107 \$399.95, 30V/10A
- 8110 \$289.95, 60V/3A
- 8112 \$399.95, 60V/5A

Digital Voltmeter & Analog Ammeter

- 8200(8201) \$179.95(\$239.95), 30V/3A(SA)
- Digital Displays 8210/8300 \$199.95, 30V/3A
- 8211/8301 \$259.95, 30V/5A

DUAL OUTPUTS

Independent/Tracking

Analog Displays

- 8108 \$549.95, 60V/3A
- 8109 \$699.95, 60V/5A
- PS-303D \$314.95, 30V/3A
- PS-305D \$399.95, 30V/5A

TRIPLE OUTPUTS, a fixed 5V/3A output, Independ/Tracking

- Digital Displays 8202(8203) \$499.95(\$549.95), dual 30V/3A(SA)
- Analog Displays 8102(8103) \$399.95(\$489.95), dual 30V/3A(SA), with Parallel (30V/6A) and Series (60V/3A) Mode operation

NTSC/PAL TV COLOR BAR GEN.

CPG-1366A \$159.95, VHF NTSC,

Freq.: 45.75, 175.25, 187.25 MHz,

RF Output: 10mV

Impedance: 75 Ohm;

Video Output: BNC, 1V_{p-p}

CPG-1367A \$159.95, VHF PAL

SWR/RF/mW POWER METER

310 \$89.95, 1.8-150MHz, RF Power: 0-4W/20W/200W 3 ranges, SWR Measurement: 1.0-∞, 4W minimum. Accuracy: 5%-10%; Insert Loss: 3dB

Input/Output Imp.: 50Ω; SO-239 plug

320 \$89.95, 130-520MHz, Spec. 310.

330 \$119.95, 1.8-520MHz, Spec. see 310.

SWR-3P \$26.95 1.7-150MHz,

RF Power: 0.5-10W, 0.5W-100W

SWR-2P \$22.95, 1.7-300MHz, RF Power: 0.5-10W.

mW RF Power Meter 340 \$219.00, 1.8-500MHz, RF

Power: 20mW/200mW/2W 3 ranges, Imped.: 50Ω, Accuracy: ±10% full scale. SWR <1.15; N-type connector. BNC type output.

FM STEREO MODULATOR

AG-2011A \$549.00

RF SECTION:

Carrier: 98MHz ±2MHz,

Output: 10mV, 1mV & 0.1mV

COMPOSITE SIGNALS:

Pilot: 19KHz ±2Hz, 0.8Vrms

INT. MODULATION: 400KHz,

1KHz ±1%, 1Vrms, distortion < 5% L-R Separation: >50dB

EXT. MODULATION: Freq.: 50Hz-15KHz

L-R Separation: >45dB 100Hz-3KHz; >35dB 50Hz-15KHz

WOW-FLUTTER METER

WF-3103A \$699.95 Freq. Range: 3KHz±10% JIS/CCIR,

3.15KHz±10% DIN.

Measurement: 0.3/1/3/1/3% full scale.

Accuracy: ±5% of full scale.

WF-3105A \$799.95, digital display.

Function: LIN/WOW/Flutter/WTD

Freq Counter: 10Hz-9.999MHz

Indication: CCIR/DIN/JIS

TOOLKITS - ELECTRONIC/PC

9245 \$29.99 U.S. Patented, 45-pcs. Contents: IC inserter/extractor

with securers & bows, 3-prong part retriever, #0 phillips screwdriver,

1/8" flat screwdriver, self-hold tweezers, metal tweezers, extra

parts tube, soldering iron, solder, crimping tool, long-nose plier,

cutting plier, zipper vinyl case. Bits include: Phillips: #0/#1/#2/#3,

Flat: 1/8"/3/16"/1/4"/9/32"; PZ1/PZ2; T8/T9/T10/T15/T20/T25/

T27/T30/T40/T45; Hex: 5/64"/3/32"/1/8"/5/32"/3/16"; Sockets:

3/16" (5mm)/7/32" (5.5mm)/1/4" (6mm)/9/32" (7mm)/5/16" (8mm).

8G2J \$34.99 23-pcs Contents: IC inserter/extractor with securer &

bows, 3-prong part retriever, 3/16"/1/4" nutdriver, 3/16"/1/8" slot-

ed screwdriver, #0/#1 phillips, reversible T10/T15 bits, reversible

#2 phillips/1/4" slotted bits, tweezers, long-nose plier, cutter, 6" adj.

wrench, soldering iron, solder, crimping tool, zipper case, manual.

Various packages available, call/write/e-mail/fax for detail.

RF SIGNAL GENERATOR



SG-4160B \$124.95, 100KHz-150MHz up to 450MHz on 3rd harmonics in 6 ranges, AM modulation, Accuracy: ±5%. RF Output: 100mVrms to 35 MHz, Modulation: Int. 1KHz (AM) ±30%, Ext. 50Hz-20KHz, at least 1V_{min} input. Audio Output: 1KHz, 2V_{min} minimum.

SG-4162AD (with Freq. Counter) \$229.95, Spec. see SG-4160B. COUNTER SECTION: 10Hz-150MHz, Max Input: ±3V effective Gate Time: 1, 1sec. Input Sensitivity: 35mV, 10Hz-200MHz. Input Impedance: 1MΩ(HF), 50Ω(VHF). Display: 7-digit LEDs.

AM/FM STD SIGNAL GEN.

SG-4110A \$1799.00, Freq.: 0.1-110MHz, Display: 6-digit LED, Resolution: 100Hz (0.1-34.999MHz), 1KHz (35MHz-110MHz). Accuracy: $\leq (5 \times 10^{-3} \pm 1)$ count, Output: -19dBu-99dBu, 1dB steps. Impedance: 50Ω VSWR 1.2, 100 preset frequency & store functions.

AUDIO GENERATOR



AG-2601A \$124.95, 10Hz-1MHz in 5 ranges; Output: sine wave 0-8V_{p-p}; square 10V_{p-p}. Output Imped: 600 Ohm. Distortion: <0.05% 50Hz-50KHz; <0.5% 50KHz-500KHz.

AG-2603AD \$229.95, with 6-digit, Int/Ext. Freq Counter, 10Hz-150MHz, 4-digit counter display, TTL & CMOS outputs, 30ppm ±1 count accuracy.

Output Control: 0/20-40dB & Fine adjuster. Spec. see AG-2601A

FUNCTION GENERATOR



FG-2100A \$169.95, 0.2Hz-2MHz in 7 ranges; sine, square, triangle, pulse & Ramp. Output: 5mV_{p-p}-20V_{p-p}, 1% distortion. VCF: 0-10V/freq, to 1000:1.

FG-2102AD \$229.95, see FG-2100A; 4-digit counter display, TTL & CMOS outputs, 30ppm ±1 count accuracy.

FG-2020B \$159.00 0.5Hz-500KHz, Sine, Square, Triangle, Pulse

FG-2103 \$329.95, Digital sweep generator, 0.5Hz-5MHz in 7

ranges. Operating Mode: sweep, AM, gated burst, VCG.

Freq. Counter: Int. 0.5Hz-5MHz, Ext. 5Hz-10MHz.

FG-513 \$769.95, 13 MHz, Microprocessor embedded digital sweep,

Sine, Square, Triangle, Pulse, Ramp, TTL & DC; $\pm(0.1\% + 1)$ digit.

Freq. Counter & TCXO: 5Hz-100MHz, 6.5 digits, x1/x20 attenuatn

AC MILLIVOLT METER



MV-3100A \$159.95 wide band 5Hz-1MHz, 3 scales, mV, dB & dBm, 300μV-100V in 12 ranges, 10μV resolution, -70-40dB in 12 ranges, 0dB=1Vrms, 0dBm=0.775V, ±3% accuracy, Input impedance 10MΩ.

Noise <2%. MV-3201B \$309.95 dual channels, simultaneous measurement.

OSCILLOSCOPES



OS-7305B \$249.00 DC-7MHz, 3" CRT, Horiz: 25V/div, 10Hz-100KHz in 4 ranges; Vert: 10mV/div; Int & Ext. Sync; Input: 1MΩ/35pF.

OS-7010A \$299.95 10MHz, 5" CRT,

Horiz: 2V/div; Vert: 10mV-10V/div.

OS-622G \$389.95 20MHz, 2 CH/X-Y

Alt trigger, trigger lock, hold OFF, TV

syn., 8x10 div., 1mV/div, Horiz: 2μs-5s/div; Vert: 1mV-5V/div.

OS-653G \$699.95 50MHz, 2 CH/delay sweep, Alt trigger, TV syn.

OS-6101G \$1499.95 100MHz, 4ch/8 traces, delay sweep, cursor

readout, 2 years warranty for OS-622G, OS-653G, & OS-6101G.

UHF ATTENUATORS

RT-8815U (50Ω) \$299.00 / RT-8817U (75Ω) \$299.00, 950MHz, 81dB, 0.5W max., Steps: 1/2/3/5/10/20/20/20, 8 switches

08E-2 (50Ω) \$399.00 / 08E-2 (75Ω) \$399.00, 950MHz, 81dB,

0.5W max., Steps: 10dB+71dBx10, Electronic adjustment knob

MICROPROCESSOR TRAINER



BGC-8088 \$699.00, learn computer theory. Excellent for school & individual who want to learn about ROM, RAM, I/O ports, programming, & run a 8088 Microprocessor. An easy to understand step-by-step manual guides you to achieve your goal. 56-key keyboard, LCD display, RS-232, UART

GRID DIP METER

DM-4061 \$89.95 1.5-250MHz, 6 bands, 6 plug-in coils, 2 transistor, and 1 diode. Modulation = 2KHz Sine wave. Crystal Oscillator: 1-15MHz. Wave absorption meter. 9VDC battery.



FREQUENCY COUNTER



FC-5250C \$119.95 10Hz-220MHz (HF) 10Hz-20MHz, (VHF) 10-200MHz. Gate Time: 1, 1sec. Max Input: 10V_{p-p}. Input Sensitivity: 35mV/10Hz-200MHz. Input Imped: 1MΩ(HF), 50Ω(VHF). Display: 7-digit LEDs, 9V adapter (\$6)

FC-5260A \$129.95, 600MHz,

FC-5270 \$149.95, 1.2GHz/8-dgt.

FC-5600 \$229.95, 1.2GHz/10-dgt.

FC-5700 \$299.95, 1.3GHz/10-dgt.

FC-1200 \$189.95, 1.25GHz/8-dgt LCD

Handheld; Microprocessor counter.

SIGNAL TRACER/INJECTOR



SE-6100 \$134.95 TRACER: Gain 60dB maximum. Attenuation: 0/20/40/60dB. Input Imped: 100KΩ. Meter: Vu 100μA. Output Imped: 600Ω; Speaker: 8 Ω. INJECTOR: =1KHz Squarewave; Output Level: Variable 0-4.5V_{p-p}, 9V battery or adapter (\$6.00).

LCR METERS

MIC-4070D \$179.95, Induct.: 0.1μ-200H, Capacit.: 0.1p-20mF, Resist.: 1mΩ-20MΩ, 2 range, Dissipation factor measurement, Zero adjust. Surface mount device (SMD) test probe: LT-06 \$21.95

DIGITAL MULTIMETER



DMM-120 \$24.95, 3 1/2 digit, 600VDC, 2ADC, 500VAC, 2MΩ, hFE/diode/continuity test, 1.2% DMM-1230+Cap+Temp \$59.95, 3 1/2 dgt, 20MHz 1000VDC/750VAC, 10ADC/AC, 20MΩ, 20μF, hFE/diode test, continuity beeper, 0.5% accuracy DMM-1240+Cap+Temp+Logic \$69.95, Battery check, Logic level measurement, + DMM-1230 DMM-1250+Cap+Temp \$89.95, Battery check, -58°-1999°F/-50°-1300°C, +DMM1230 DMM-125 \$54.95, Autorange/Bargraph, 32MΩ, 600VDC/AC, 10ADC/AC, diode/continuity test. MIC-35 \$59.95, Autorange, 3 1/2 LCD, 20MΩ, 1000VDC/750VAC, 20ADC/AC, data hold, diode/continuity test, free holster, 0.5% accuracy MIC-39 \$129.95, Autorange/Bargraph, True RMS, 3 1/2 LCD, 40μF, 40MΩ, 1000VDC/750VAC, 20ADC/AC, 600KHz freq. cntr, data hold, sleep mode, memory, read functions, holster, 0.3% accuracy

POCKET ANALOG MULTIMETER AMM-9810P \$14.95



DCV: Range: 10/50/250/500V; ±4%. ACV: Range: 50/250/500V; ±4%. DCA: Range: 25mA, 250mA; Accuracy: ±4% full scale; Protection: 0.5A/250V fuse. Resistance: Range: 500kΩ (x1k); ±5%. dB Test: +4 to +56 dB on ACV range; Accuracy: ±5% of full scale. Battery Test: 1.5V and 9V. Max Input: 500VDC/AC, or 250mADC

AUTO. CAPACITANCE METER

CMJ300A \$139.00 10 ranges, 99.9pF - 99.9mF, fully automatic. Resolution: 0.1pF lowest, 0.1% full scale.

Accuracy: 0.5% of full scale ±1 digit to 99.9μF, 1% of full scale ±1 digit to 99.9μF. Display: 3 digit LED. Unit: pF, nF, μF, M. Overrange indicators

AUTO DISTORTION METER

DM-3104A \$799.95





DISTORTION MEASURE

Range: 0.01% to 30%, 0.1/0.3/1/3/10/30% 6 ranges. Freq: 400Hz±10%, 1KHz±10%(HPF) Input: 3mV-100V, Ratio measure 20dB Auto. Freq. Switching Ranges: Fundamental Freq. = (fo)±10%; Fund. Rejection: >80dB at (fo)±5%; >70dB at (fo)±10%. Harmonic Accuracy: ±0.5dB, 1.8(fo)-20KHz. LEVEL MEASURE Range: 0 to 100V in 0.3/1/3/10/30/100V Freq Response: ±0.5dB/20-50KHz, ±1dB/20-100KHz. DM-3204 \$1,599.00 dual channels. Spec. see DM-3104A

CIRCLE 158 ON FREE INFORMATION CARD

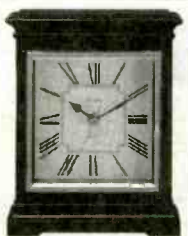
www.spysite.com

COVERT SURVEILLANCE: Protect Your Assets

				EXIT SIGN CAMERA EX-985 \$295 EMERGENCY LIGHT CAMERA EL-985 \$325
MC-985 \$350	CL-985 \$350	SD-985 \$295	VL-985 \$350	

All "985" Series Color Cameras Feature:

- Sensor: 1/3" Sharp® Color CCD
- Resolution: Over 380 TV lines
- Sensitivity: Super Low, 2 Lux
- Built-In Backlight Compensation
- Lens: 3.7 mm Pinhole
- Viewing Angle: 92 FOV
- Video Output: Female RCA
- Power: 5V DC (included)

CLOSEOUT

Color Camera Kit:

- 1/2" Sony Color CCD
- 400 TV line Res.
- 2 lux Sensitivity
- Backlight Compensation
- 4 mm Standard Lens
- Wall Mounting Kit
- 5V Power Transformer

SONY-1002 \$175

Counter Surveillance: Protect Your Privacy

Protect Yourself From:

- Telephone Taps
- Room Transmitters
- Body Wires



Built-In White Noise Generator

AI-5500 \$380

Detects Concealed:

- Tape Recorders
- Video Cameras
- Body Transmitters
- Room Transmitters



LED and Vibration Alert

TRVD-900 \$495

Your Payment Options: Credit Card, Cashier's Check, or Money Order

AMERICAN INNOVATIONS, Inc.

119 ROCKLAND CENTER ~ Suite 315 NANUET, NY 10954

Voice: (1)914-735-6127 Fax: (1)914-735-3560

CIRCLE 162 ON FREE INFORMATION CARD

Whaddya Say To
A Guy Who's Had
The Same Job
For 50 Years,
Has Never Called
In Sick Or
Showed Up Late,
Never Taken A
Vacation Or A
Holiday, Never
Asked For A
Raise Or Griped
About His Bonus
And, Believe It Or
Not, Has No
Plans For
Retirement?



Thanks.

Remember - only you can prevent forest fires.

PicC C Compiler \$49

for Microchip's PIC microcontrollers
Supports PIC16C55x, 16C6x, 16C62x, 16C8x, 16C92x PIC families

PicCSX C Compiler \$59

Supports **Scenix** sx18ac and sx28ac microcontrollers
Both compilers based on ANSI C standard. Arrays, unions, structures, pointers, strings, function calls, if, for, switch, while, interrupt vectors, in-line assembler code, 8 & 16 bit variables, etc. Outputs Intel Hex format and assembly code. Code optimizer included. Excellent development tool!

PicCDBG Debugger \$79

C source level debugger for PicC and PicCSX compilers. Integrated Development Environment. Step, Run, Stop, Reset. Variable monitoring and modification. Full speed oscillator kit (\$39) 732-873-1519 fax 732-873-1582 e. grichrc@aol.com
Grich RC Inc. 120 Cedar Grove Ln, Ste 340, Somerset NJ 08873
URL: <http://members.aol.com/piccompile>

**MICROTEST
INC.
CABLE
TEST CHIPS
FROM \$9.95**

WE STOCK A COMPLETE LINE OF CHIPS
WE ALSO HAVE CRYSTAL 119.MHZ/117.MHZ

WARNING.

ANYONE IMPLYING ILLEGAL USE WILL BE DENIED SALE. WE SELL PRODUCTS ONLY TO TECHNICIAN OR REPAIR FACILITIES
ALL ORDERS SHIP VIA UPS/ECT
THE BEST PRICE IN THE MARKET
WE INCLUDE SWITCH & RESISTER
MON-SAT 8 AM-7 PM EST .TECH SUPPORT
E-MAIL WWW.MICRO-TEST@AOL.COM

**FOR ORDERS
1-800-931-9440**

**SURVEILLANCE HIDDEN CAMERAS
DIRECT FROM MANUFACTURER - BEST PRICE IN THE MARKET**

Ultra miniature hidden cameras, in doors, private or motion detectors w/ mic. B/W or Color. Wide view angle. Low light sensitivity + super sharp images, plus video and audio output. From \$199.00. Also 1/3" B/W Infrared Camera remote, only \$89.00 USD. Viewers: hidden camera, still at only \$249.00 USD. Plus \$5.95 for S.M. Wholesale/Postal Welcome, COD, Check, Money Order or Visa/MC.

BOLIDE INTERNATIONAL CORPORATION
PH: (800) 355-0895 or (626) 575-8178
9660 Flair Drive #218, El Monte, CA 91731
<http://www.bolideamazingproducts.com/>

SINGERS! REMOVE VOCALS

Unlimited, Low Cost, Instantly Available Background Music from Original Standard Recordings! Does Everything Karaoke does. Better and gives you the Thompson Vocal Eliminator! Free Brochure & Demo Tape. LT Sound Dept PE
7968 LT Parkway, Lithonia, GA 30058
Internet: <http://www.LTSound.com>
24 Hour Demo/Info Request Line (770)482-2485 - Ext 49
When You Want Something Better Than Karaoke!



ATTENTION CABLE VIEWERS
Own Your Own Unit Today
Cable TV Converters &
Descramblers
All Makes / All Models

Call 1-800-577-8775

Technical Info: 847-584-2099

LEARN ELECTRONICS!

Home study. Learn to repair and install TVs, VCRs, cam-corders, stereos, sound and lighting, alarm systems, more!

FREE LITERATURE: 800-223-4542

Name _____ Age _____
Address _____ Phone _____
City/State _____ Zip _____

The School of Electronics, Dept. ELA341
PCDI, 430 Tech. Pkwy., Norcross, GA 30092

CONTROL RELAYS • LIGHTS • MOTORS

MEASURE TEMPERATURE • PRESSURE • LIGHT LEVELS • HUMIDITY

INPUT SWITCH POSITIONS • THERMOSTATS • LIQUID LEVELS

MODEL 30 \$79



- PLOGS INTO PC BUS
- 24 LINES DIGITAL I/O
- 8 CHANNEL
- 8 BIT A/D/ IN
- 12 BIT COUNTER
- UP TO 148 SMP/SEC

MODEL 45 \$189



- RS-232 INTERFACE
- 8 DIGITAL I/O
- 8 ANALOG INPUTS
- 2 ANALOG OUTPUTS
- 2 COUNTERS-24 BIT

MODEL 100 \$279



- 12 BIT 100 KHZ A/D
- 4 ANALOG OUTPUTS
- 3 TIMER COUNTERS
- 24 DIGITAL I/O

MODEL 150-02 \$179



- RS-232 INTERFACE
- TRMS, 28-AMPS
- 12 BIT A/D
- OPTO-ISOLATED
- COMPLETE DMM

MODEL 40 \$109



- RS-232 INTERFACE
- 28 LINES DIGITAL I/O
- 8 ANALOG INPUTS
- PWM OUTPUT

MODEL 70 \$239



- RS-232 INTERFACE
- 18 BIT A/D
- 5.5 DIGIT
- UP TO 60 SMP/SEC

Prairie Digital, Inc.

PHONE 608-643-8599 • FAX 608-643-6754

629 SEVENTEENTH STREET • PRAIRIE DU SAC, WISCONSIN 53570

CIRCLE 150 ON FREE INFORMATION CARD

Learn MICROCONTROLLERS EMBEDDED SYSTEMS and PROGRAMMING...

...with the AES learning system/
embedded control system.

Extensive manuals guide you
through your development
project. All programming and
hardware details explained.
Complete schematics. Learn to
program the LCD, keypad digital,
analog, and serial I/O. for your applications.

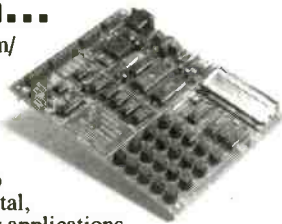

**THREE MODELS AVAILABLE. Choose from an
Intel 8051, Intel 8088, or Motorola 68HC11
based system. All models come with:**

- 32K Byte ROM, 32K Byte RAM • 2 by 16 Liquid Crystal Display • 4 by 5 Keypad • Digital, Analog, and Serial I/O • Interrupts, timers, chip-selects • 26 pin expansion connector • Built-in Logic Probe • Power Supply (can also be battery operated) • Powerful ROM MONITOR to help you program • Connects to your PC for programming or data logging (cable included) • Assembly, BASIC, and C programming (varies with model) • Program disks with Cross Assembler and many, well documented, program examples • User's Manuals: cover all details (over 500 pages) • Completely assembled and ready to use • Source code for all drivers and MONITOR • Optional Text Book

Everything you need. From \$279.
Money Back Guarantee

Call for Free Info Pack, or see
WEB at <http://www.aesmicro.com>
714-550-8094, FAX 714-550-9941

AES
Advanced Educational Systems

Call 1-800-730-3232

AES 575 ANTON BLVD., SUITE 300, COSTA MESA, CA 92626, USA

EARN MORE MONEY!

Be an FCC LICENSED ELECTRONIC TECHNICIAN!



Earn up to
\$60 an hour
and more!

Learn at home in spare time.
No previous experience needed!

No costly school. No commuting to class. The Original Home-Study course prepares you for the "FCC Commercial Radio-telephone License." This valuable license is your professional "ticket" to thousands of exciting jobs in Communications, Radio-TV, Microwave, Maritime, Radar, Avionics and more...even start your own business! You don't need a college degree to qualify, but you do need an FCC License.

No Need to Quit Your Job or Go To School
This proven course is easy, fast and low cost! **GUARANTEED PASS**—You get your FCC License or money refunded. **Send for FREE facts now. MAIL COUPON TODAY!**

Or, Call 1-800-932-4268 Ext. 240

COMMAND PRODUCTIONS

FCC LICENSE TRAINING, Dept. 240

P.O. Box 2824, San Francisco, CA 94126

Please rush FREE details immediately!

NAME _____

ADDRESS _____

CITY _____ STATE _____ ZIP _____

Turn Your Multimedia PC into a Powerful Real-Time Audio Spectrum Analyzer

Features

- 20 kHz real-time bandwidth
- Fast 32 bit executable
- Dual channel analysis
- High Resolution FFT
- Octave Analysis
- Distortion measurements
- Signal Generation
- Triggering, Decimation
- Transfer Functions, Coherence
- Time Series, Spectrum Phase, and 3-D Surface plots
- Real-Time Recording and Post-Processing modes

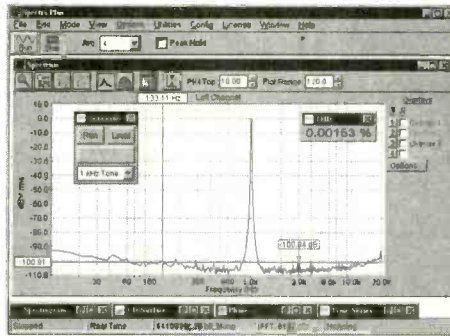

Applications

- Distortion Analysis
- Frequency Response Testing
- Acoustic Research

System Requirements

- 486 CPU or greater
- 8 MB RAM minimum
- Win. 95, NT, or Win. 3.1 + Win.32s
- Mouse and Math coprocessor

Priced from \$495

(U.S. sales only - not for export/resale)

DOWNLOAD FREE 30 DAY TRIAL!

www.spectraplus.com

PHS Pioneer Hill Software
24460 Mason Rd.
Poulsbo, WA 98370
a subsidiary of Sound Technology, Inc.



Spectra Plus
FFT Spectral Analysis System

Sales: (360) 697-3472

Fax: (360) 697-7717

e-mail: pioneer@telebyte.com

Call Today And **SAVE!** **Unbeatable PRICES!**

CABLE TV

**DESCRAMBLERS
CONVERTERS · FILTERS
VIDEO STABILIZERS**

- FREE** ➤ 30 Day Trial
FREE ➤ Product Catalog
FREE ➤ 1 Year Warranty

100% MONEY BACK GUARANTEE



Let us point you in the right direction ...



888-554-ARROW

888-554-2776

ALFA ELECTRONICS

HIGH QUALITY TEST EQUIPMENT

Visit www.alfaelectronics.com for complete info
Call 1-800-526-2532 for Order and Free Catalog

<p>DMM DMM-899 (\$179.00): true rms, AC/DC (V,A), Ω, bar graph, freq, capac., dBm, logic, diode DMM-23T (\$99.95): 4½ digit, true rms, high resol. (10µV, 10nA, 10mΩ), hFE, diode, contin. DMM-20 (\$74.95): AC/DC (V, A), Freq, cont., Capac, Induct., Ω, hFE, diode, duty cycle DMM-122 (\$59.95): DC/AC(V,A), Ω, hFE, diode, capacitance, freq, logic, continuity DMM-123 (\$44.95): DMM + capacitance, DC/AC(V,A), Ω, hFE, diode, continuity DMM-10 (\$19.95): 3½ digit, DC/AC V, Ω, hFE, diode, signal output(+3V, -0.5Vsq., 50% duty)</p>	<p>CAP-15 (\$49.95): 3½ digit, 0.1pF-20mF, 9 Ranges, 0.1pF resolution, zero adjustment. LCR-24 (\$119.95): 0.1µH-200H, 0.1pF-2000µF, 0.01Ω-20MΩ, diode test. <i>New Model</i> LCR-131D (\$219.95): autorange, 0.1µH-10kH, 0.1pF-10mF, 1mΩ-10MΩ, Q Factor, serial/parallel, 120Hz/1kHz testing mode. FC-1200 (\$129.95): 1.25GHz Handheld, 8 digits display, 10ppm accuracy, sensitivity 5mV (130-350MHz), 30mV (440MHz)</p>	<p>12B \$ 94.95 70-III \$ 99.00 73-III \$125.00 75-III \$155.00 77-III \$173.00 79-III \$195.00 87-III \$325.00 92B-III \$1,445 96B-II \$1,695 99B-III \$2,095 105B \$2,495 123-III \$1,130 863E \$555 867B \$740</p>	<p>SPECIALTY • AC Current Probe \$34.95 • DC/AC Current Probe \$79.95 • Mini AC Clamp \$59.95 • AC Clamp w/temp \$89.95 • DC/AC Clamp \$109.95 • Thermometer \$69.95-\$89.95 • IR Thermometer \$189.95 • Sound Level Meter \$169.95 • Tachometer \$169.95-\$219.95 • EMF Tester \$69.95 • Pressure Meter \$299.95 • Watt Meter \$129.95 • High Voltage Probe \$59.95 • pH Meter \$79.95 • Light Meter \$79.95-\$89.95</p>

<p>GW/INSTEK</p>		<p>DC POWER SUPPLIES</p>			<p>FUNCTION GENERATOR</p>		<p>BENCHTOP DMM</p>
<p>20 MHz Scope</p> <p>• OS-620 \$324.95 • Most economical scope • Dual CH/X-Y operation • 1 mV/div sensitivity • Z-axis input, CH1 output • TV syn, ALT trigger • 2 probes (x1, x10)</p>	<p>Cursor Readout</p> <p>• OS-626G \$599.95 • Readout & Cursor meas • Dual CH / Delay sweep • Built-in delay line • ALT trigger, Hold-Off • Z-axis input, CH1 output • 2 probes (x1, x10)</p>	<p>Triple Output</p> <p>• 2 variable out 0-30V, 0-3A • One fixed 5V, 3A output • Auto track, serial, parallel • Const. volt, current mode • 4 analog or 2 digital display PC-3030D (\$549.95) digital</p>	<p>Single Output</p> <p>• Const voltage, current mode • Voltage regulation <0.01% • Current regulation <0.2% PS-1830 (\$198.95) 18V/3A PS-1850 (\$214.95) 18V/5A PS-1850D (\$244.95) 18V/5A</p>	<p>Programmable</p> <p>• Auto serial/parall. (PPT ser) • Auto track (PPT series), IEEE-488.2 and SCPI compatible command set PFS-1860G(\$1,149.95)18V/6A PFS-3635G(\$1,149.95)36V/3A PPT-1800G(\$1,499.95)18V/3A PPT-3615G(\$1,499.95)36V/1.5A</p>	<p>FG-8020G (\$209.95) • 0.02Hz-2MHz w/counter • Sine/Squ/Tri/pulse/Ramp FG-8020G (\$209.95) • 0.02Hz-2MHz w/counter FG-8050 (\$449.95) Sweep • 0.05Hz-5MHz w/counter • INT/EXT AM/FM mod</p>	<p>DM-8034 (\$179.95) 3½ dgt • AC/DC(V,A), C, Ω, diode DM-8040 (\$339.95) 3½ dgt • AC V to 50kHz, true rms DM-9055G (\$889.95) 5½ dgt • 0.006% accuracy, GPIB • dBm, auto, REL, min/max</p>	

ALFA ELECTRONICS P.O. BOX 8089 PRINCETON, NJ 08543-8089

TEL: (800)526-2532 / (609) 897-1135
FAX: 609-897-0206
E-mail: sales@alfaelectronics.com

Call / Write / Fax / Email for FREE CATALOG
Visa, MC, AMEX, COD, PO Accepted. OEM Welcome.
1 Year Warranty (2 Years for GW/Instek)

Popular Electronics, January 1999

Hexapod Walker Kit \$150.00 Plus S&H



You can build this Hexapod Robot

This easy to build robot really walks using an alternating tripod gait. It can walk forward, reverse, and turn on a dime, left or right. With a payload of more than 12 oz., this robot is a real workhorse. The robot is programmed using simple BASIC instructions. It makes an excellent foundation for many simple and advanced robot experiments. The kit includes all the hardware, structural components, Hitec servos, First Step Micro kit, software, and an illustrated assembly manual. The Lynxmotion Hexapod Walker is a lot of fun to build and even more fun to operate.

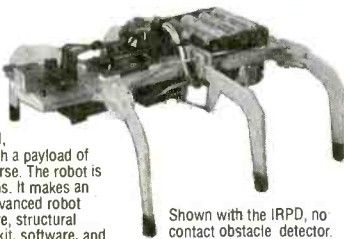

Shown with the IRPD, no contact obstacle detector.

We have many more cool robots, check out our web page or ask for our free catalog!

Lynxmotion, Inc.
104 Partridge Road
Pekin, IL 61554-1403
www.lynxmotion.com



Tel: 309-382-1816
Fax: 309-382-1254
sales@lynxmotion.com
tech@lynxmotion.com

1-800-USA-NAVY.

World Wide Web:
<http://www.navyjobs.com>

The World's Largest Source for Home Automation

- The Best & Most Comprehensive Home Automation Catalog in the Industry
- Best Customer Service & Technical Support



Thousands of hard-to-find automation, X-10 and wireless control products. Computer interfaces, software development tools, lighting control, telephone systems, security systems, surveillance cameras, infrared audio/video control, home theater, touchscreen control, HVAC, pet care automation, wiring supplies, books and videos and much more!

World's Largest Selection!

Lowest Prices Guaranteed!

HOME AUTOMATION SYSTEMS, INC.

Questions: 949-221-9200 Fax: 949-221-9240
e-mail: catalog@smarhome.com
www.smarhome.com

Call for a **FREE** Catalog! 800-762-7846

800-SMART-HOME

Dealers/Resellers ask about our SmartHome PRO Dealer Program 800-949-6255



Do You Repair Electronics?

Repair Databases for TV, VCR, Monitor, UL Audio, FCC, and more.

- Over 76,000 records
- Private user forums
- Live on-line chat rooms

RepairWorld.com

Electronics Corp 1 Herald Sq. Fairport, NY 14450 (937) 878-9878

!!! BROADCAST EQUIPMENT !!!

We manufacture & carry Stereo FM Transmitters, RF Amplifiers, Low Pass Filters, Antennas, DJ Mixing Boards & Consoles, Mics, Compressor/Limiters, Digital Reverbs, Automation Software, RF Test Equipment, RF Parts including BGY133's, and much more! Call For Free Catalog.

Progressive Concepts
BOX 586 STREAMWOOD, IL 60107
(630) 736-9822 • FAX (630) 736-0353



CABLE TV CONVERTERS

Equipment & Accessories
Wholesalers Welcome

Call **C&D ELECTRONICS**
1-888-615-5757 M-F 10a-6p

New and Pre-Owned Test Equipment

Goldstar

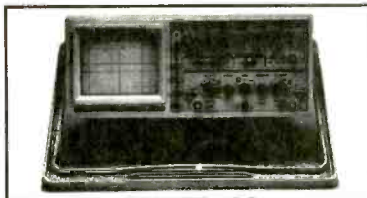

Model OS-5100 → \$899.00
Full 100 MHz Bandwidth!

- Dual-Channel, High Sensitivity
- TV Synchronization Trigger
- Calibrated Delayed Sweep
- Includes Two Probes, 2 Year Warranty

Spectrum Analyzer
Avcom PSA-37D

Satellite Downlink
Installation
Maintenance & Service

- Band 1 10 - 1750 MHz
 - Band 2 3.7 - 4.2 GHz
 - Built-in DC Block & Power for LNA/LNB's
 - Line or Battery Powered
- Only \$2,475.00!**

Pre-Owned Oscilloscope Specials

Tektronix 2213	60 MHz	\$549.00
Tektronix 2215	60 MHz	\$649.00
Tektronix 465	100 MHz	\$599.00
Tektronix 465B	100 MHz	\$729.00
Tektronix 475	200 MHz	\$829.00
Tektronix 475A	250 MHz	\$999.00

- Professionally Refurbished
- Aligned & Calibrated to Original Specifications
- The Industry Standard of Oscilloscopes
- **1 Year Warranty - The Longest Available!!!**

We Buy Surplus Test Equipment

SIMCHECK® II PLUS Module Tester

- * Tests SIMMs/168 p DIMMs
 - * Stand alone/portable
 - * Identifies Module properties
 - * Advanced Setup Capabilities
- Only \$2750.00!**

(1-800-996-3837)

TOLL FREE 1-800-99-METER

See us on the Web!
www.fotronic.com

Test Equipment Depot

A FOTRONIC CORPORATION COMPANY
99 Washington St. Melrose, MA 02176
(781) 665-1400 • FAX (781) 665-0780

email: sales@fotronic.com



CABLE T.V. EQUIPMENT

Friendly, Knowledgeable Service

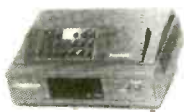

ORDERS CALL:
1-800-361-4586



- All Equipment New
- Convertors & Descramblers
- 30 Day Money Back Guarantee
 - 6 Month Warranty
- Visa, MC, C.O.D. Welcome

KDE ELECTRONICS, INC.

P.O. Box 1494

Addison, IL 60101

Info. 630-889-0281 HRS: Mon-Fri, 9-6 CST

Fax 630-889-0283 Sat, 10-2 CST

POPTRONIX®

Online
Edition

We're on the web

FREE

**We are starting up,
but you can watch us grow!**

Projects for beginners to experts!

New Product information!

Bookstore—discover what's new!

<http://www.poptronix.com>

WE'RE WITH YOU EVERY DAY

24 HOURS A DAY! DROP IN!

WE'D LOVE TO HAVE YOU VISIT!

VIDEO SYNC GENERATOR

Restores Horizontal
and Vertical
Sync Lines from
Distorted Video



Lost Sync



Restored Sync
with VSG

For Free Information Package and Pricing



Call (219) 233-3053

www.south-bend.net/rcd



R.C. Distributing, P.O. Box 552, South Bend, IN 46624

ULTIMATE HOME SHOP

Complete tools for metal & woodworking



Starting at \$995
Easy to use
Versatile
Affordable
FREE CATALOG

Call 1-800-345-6342 or write Smithy Dept. PEC, P.O. Box 1537, Ann Arbor, MI 48106-1537

LEARN INTERNET SECRETS

HOW TO: CONTROL OTHER COMPUTERS
ACCESS LIVE T.V./RADIO WORLDWIDE
GET FREE ONLINE ACCESS
OBTAIN FREE SOFTWARE
MUCH, MUCH MORE!

1-900-740-4448 EX. 9477. \$2.99 per min
Must be 18 yrs. Serv-U (619) 645-8434

SURVEILLANCE

The Latest High Tech
Professional Electronic Devices

Our latest catalog offers a HUGE selection of surveillance, counter-surveillance/privacy devices: **pinhole camera \$129⁰⁰**, hidden video, **"realtime" 12-Hour telephone recorder \$139⁰⁰**, 12 hour VOX recorder, phone call register, scanners, bug/phone tap detectors, voice disguisers, locksmithing tools, vehicle tracking, wireless video, and much more. Wholesale/retail.

We will not be undersold.

Catalog \$5.00 or

www.spyoutlet.com

SPY OUTLET

PO Box 337, Buffalo NY 14226
(716) 691-3476/(716) 695-8660

\$139* Laser LightShow

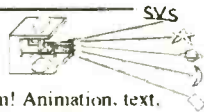

Draw with a laser beam! Animation, text, music & more! Includes galvos, mirrors, servo amp, demo software disk, analog and digital computer interface. Use an inexpensive pen pointer or high power gas laser.



Computerized Motors \$39*

Includes: 2 Stepper motors, 2 DC motors, computer interface, training manual, & demo software disk. Expandable! Up to 12 motors, up to 3 amps per phase.

Now with 4 Axis Linear Interpolation

* Add \$6 for shipping. Computer with parallel printer port & cable, assembly, power supply, & laser are required

FREE FLYER

Voice 510-582-6602 Fax 510-582-6603

SVS

1273 Industrial Pkwy West Bldg. 460
PO Box 55128 Hayward CA 94545-0125

PROGRAMMERS OVER 50 MODELS

ADVANTECH EETOOLS NEEDHAMS DATA VO ICE TECHNOLOGY HILO SYSTEM GENERAL CHROMA MODULAR CIRCUIT TECHNOLOGY XELTEK

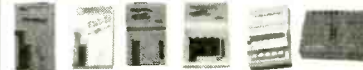

PROMAX EMP-20 MEGAMAX MEGAMAX4 SIMM/SIP TESTER EMUPA

CALL ADVANTECH LABTOOL	599 EETOOLS SIMMAX
629 ICE TECH MICROLV	795 CHROMA SIMM/SIP
650 EETOOLS ALLMAX +	359 MOD-MCT-EMUPA/R
409 EETOOLS MEGAMAX	279 MOD-MCT-EMUP/R
509 EETOOLS MEGAMAX4	49 EPROM 1G TO 512K
369 XELTEK SUPERPRO II	69 EPROM 1G TO 1MEG
409 XELTEK SUPERPRO II P	99 EPROM 4G TO 1MEG
249 XELTEK SUPERPRO L	199 EPROM 1G TO 1 MEG
165 XELTEK ROMMASTER II	89 EPROM 1G TO 8MEG
479 MOD-MCT-EMUPA	129 EPROM 4G TO 8MEG
739 STAG ORBIT-32	250 EPROM 8G TO 8MEG



LABTOOL48 MICROMASTER SUPERPRO ALLMAX PLUS ROMMASTER2

General Device Instruments

Sales 916-393-1655 Fax 916-393-4949 BBS 983-1234

Web www.generaldevice.com E-Mail icdevice@best.com

Low Cost CAD Software Now In Windows™95

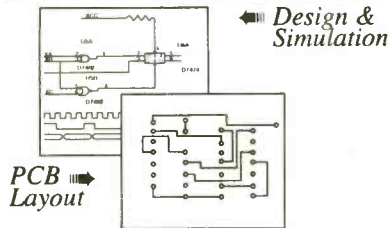

- Easy to use schematic entry program (**SuperCAD**) for circuit diagrams, only \$149. Includes netlisting, bill of materials, extensive parts libraries.
- Digital simulator (**SuperSIM**) allows you to check logic circuitry quickly before actually wiring it up. Works directly within SuperCAD and displays results in "logic analyzer" display window. Starting at \$149 this is the lowest cost simulator on the market. Library parts include TTL, and CMOS devices.
- Analog simulator (**mentalSPICE**) for \$199. Allows AC, DC and transient circuit analysis. Includes models of transistors, discretes, and op amps.
- Circuit board artwork editor and autorouter program (**SuperPCB**), starting at \$149. Produce high quality artwork directly on dot matrix or laser printers. You can do boards up to 16 layers including surface mount. Includes Gerber and Excellon file output. Autorouter accepts netlists and placement data directly from the SuperCAD schematic editor.
- **New!**—Complete electronic design package (**mentalMAX**) including schematic editor, analog and digital circuit simulation, and printed circuit board layout with autorouter for only \$549!

Write or call for free demo disks:
MENTAL AUTOMATION, INC.
5415 - 136th Place S.E.
Bellevue, WA 98006
(425) 641-2141
Internet: <http://www.mental.com>

OSCILLOSCOPES

from \$169 !!!

ATC O-Scope uses printer port to turn PC-AT into Digital Storage Oscilloscope, Spectrum Analyzer, Freq. Counter, Logger, DVM. DC-500KHz

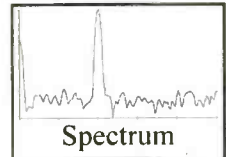
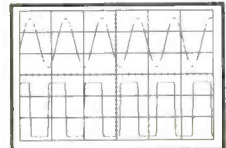

- Print, log to disk, or export data
- Accepts standard scope probes
- Uses standard printer port
- Small and portable
- Works with laptops
- Same day shipping
- Made in U.S.A.
- Single channel units from \$169
- Dual channel units from \$349

Options:

- Probe sets
- Automotive probes
- Battery packs

Order yours today.

800 980 9806

MC/Visa/Amex

Allison Technology Corporation

2006 Finney-Vallet, Rosenberg, TX 77471

PH: 281 239 8500, FAX: 281 239 8006

<http://www.atcweb.com>

LEADER

For Professionals Who
Know The Difference

- Oscilloscopes
- Video Sync/Test Generators
- Waveform Monitors/Vectorscopes
- EFP/ENG Instruments
- RF Signal Level Meters
- Audio Generators & Meters
- Frequency Counters
- Meters & Bridges
- Power Supplies
- Function Generators
- RF Generators

PRINT™
Products International



Call, fax or email for your free test and measurement instrument catalog today!
800-638-2020 * Fax 800-545-0058
www.prodintl.com

Test Instruments, Equipment, Tools & Supplies For Electronic Production, Maintenance & Service
8931 Brookville Road, Silver Spring, MD, 20910 * 800-638-2020 * Fax 800-545-0058

CIRCLE 143 ON FREE INFORMATION CARD

Direct from Manufacturer
We will beat any competitor's price

World's Smallest Wireless Video Camera!

- Transmits video up to 1000 ft.
- Runs on 1 qv. battery for 12 hrs.
- Can be built into just about anything (beeper, clock, etc.)

World's smallest plug & play system about 1" x 1"

- We also carry:
- Color micro video cameras
 - B&W micro video cameras
 - Hidden cameras
 - Custom video systems
 - Countersurveillance & More



Looking for Distributors

Call for a free catalog (305) 667-4545
SECURETEK Fax (305) 667-1744
7175 SW 47 St. #205 • Miami, FL 33155

ADAPT-11
68HC11 Modules for Solderless Breadboards

- miniature 2.0" by 2.8" module
- plugs vertically into solderless breadboard for easy development
- BOOT/RUN switch for easy programming via PC serial port
- all I/O lines on dual row connector



Complete modular prototyping system!
Expansion accessories available!

For just US\$74.95, our Starter Package (AD1ISP) provides everything you need to get going fast! Now you can harness the power of the popular 68HC11 in your projects! Includes ADAPT-11 with 68HC11E2, providing 2K EEPROM (re-programmable), 8 channel 8-bit Analog-to-Digital Converter (ADC), hardware timers, counters, Interrupts, Serial Peripheral Interface (SPI), Serial Communications Interface (SCI), & more! On-board RS-232 Interface (cable included), 5-volt regulator, 8MHz crystal, reset circuit, and convenient program/run switch. Comes with non-commercial versions of 'HC11 Assembler, BASIC, & C, as well as handy utilities & example code. Includes Motorola 68HC11 Pocket Programming Reference Guide and manual with schematic. All you need is a PC to write & program your software, a DC power supply, and a solderless breadboard (or protoboard) to build your application circuits on (or use our modular accessories).

Visa • MasterCard • American Express • Discover
TECHNOLOGICAL ARTS
309 Aragona Blvd., Suite 102, Box 418, Va. Beach, VA 23462
1644 Bayview Avenue, Box 1704, Toronto, ON M4G 3C2
voice/fax:(416) 963-8996 www.interlog.com/~techart

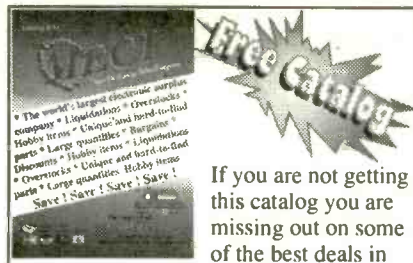

If you are not getting this catalog you are missing out on some of the best deals in electronics today! We have thousands of items ranging from unique, hard-to-find parts to standard production components. Call, write, or fax today to start your free subscription to the most unique catalog in the industry, filled with super values on surplus electronic and hobbyist type items. If you have a friend who would like to receive our catalog, send us their name and address and we will gladly forward them a complementary 100 page catalog.

Why pay more? Call today.
MECI
340 East First Street Fax Order Line
Dayton, Ohio 45402 1-800-344-6324

Order Toll-Free
1-800-344-4465
CIRCLE 139 ON FREE INFORMATION CARD

COPY RENTAL TAPES
WITH OUR VIDEO STABILIZERS

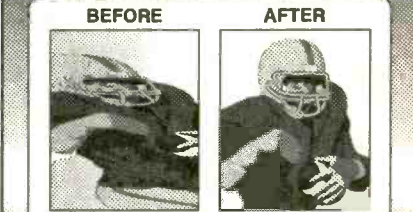

BEFORE AFTER
The clearest picture possible playing back movies.
GUARANTEED to eliminate copy protection.
FREE CABLE TV CATALOG!
• No Rolls/Jitters/Flickers/Fading
• Works on all TV's, VCR's Beta & Cable
• Gold Video Connectors & Cables Included
• 1 Year Warranty
• Money Back Guarantee

VISION ELECTRONICS
1-800-562-2252
2609 S. 156TH CIRCLE • OMAHA, NE 68130
http://www.modernelectronics.com

PIC 16C/F84 Development Programmer

Software is for the 16C84 & 16F84 • Software can read, verify & load (Win95/3.x/Dos) • EEPROM space, program space & configuration fuses can be treated separately • Separate erase command • Test command to test Programmer & cable • Vpp (programming voltage) is under software control • Attaches to parallel printer port of PC • 9V battery powered • Microchip data sheets on disk • 16F84 programs made by other assemblers can also be used with programmer • All components, PCB and Instructions included • 16F84-4MHz PIC included.

Running Lights Kit

Ideal for parties, discos, shop windows and X-mas decorations. 8 LEDs switch on and off in 10 push button selectable patterns. 8 different speed levels for a total of 80 combinations! Includes PCB, components & instructions. Uses a 51 microcontroller. Can operate light bulbs by using TRIACs. (8xTRIACs is \$6 extra) *S&H to Canada is \$8
\$14.95 +S&H \$5*
Orders only: 1-888-549-3749 (USA & Canada)
Info: (330) 549-3726 For more information and lots of other products visit us at: www.electronics123.com
Amazon Electronics, Box 21 Columbiana OH 44408

Notch Filters

Beep-Beep Buzz-Buzz
Brochure \$1.00
www.nutnet.com
Filter Kits
1 to 2 \$ 20 each
3 to 9 \$ 15 each
10 to 20 \$ 9 each
21 or more \$ 7 each

Adult Wholesale Video's
\$ 379.00
Free Shipping

Video Media
P.O. Box 93/6025
Margate, Fl. 33093-6025
(954)-752-9202

Popular Electronics, January 1999

CABLE TV CHANNELS
EQUIPMENT Direct! **FREE 30 DAY TRIAL**
GUARANTEED
SAVE \$1000's
The Nationwide source for cable TV equipment.
"BUY WHERE THE DEALERS BUY."
TV Cable Descramblers, Converters and Magic Box Catalog. Open Every Day!
FREE Your VCR TAPES CAN PLAY AS CLEAR AS DAY!
Eliminates copy protection on any tape.
UNJAM NOW WITH Video Decoder!
• Copy any rental/bought tape
• Power Cord and RC Plugs Included
2 Year Warranty
CALL NOW! Member Better Business Bureau
MEGA ELECTRONIC! 1-800-676-6342
FREE 30 Day Trial!
VISA • MC • COO

SECRETS!

Unusual, detailed how-to books, manuals, references, old & new, for experimenters and

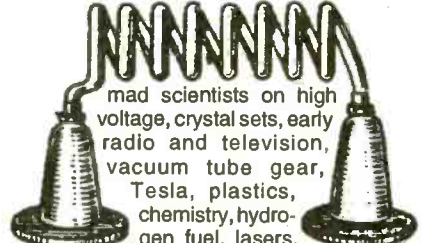

mad scientists on high voltage, crystal sets, early radio and television, vacuum tube gear, Tesla, plastics, chemistry, hydrogen fuel, lasers, booze, solar cells, embalming, telegraphy, more! Highest quality how-to! Guaranteed! Big illustrated catalog! fax:815/935-5477 Write! • http://www.lindsayybks.com

Lindsay's Technical Books
PO Box 538-WJ6, Bradley, IL 60915



If he weren't constantly hungry
he might never be called
"Shrimp."

Over 12 million children in America
are suffering from hunger.
Hunger that is stunting their growth.
We can help them grow.
Simply by feeding them.
Call Second Harvest,
America's food bank network,
at 1-800-532-5200.

**SECOND
HARVEST**

TOGETHER WE
HUNGER'S NEEDS

www.secondharvest.org

A WHOLE NEW WORLD IN SCIENCE KITS.

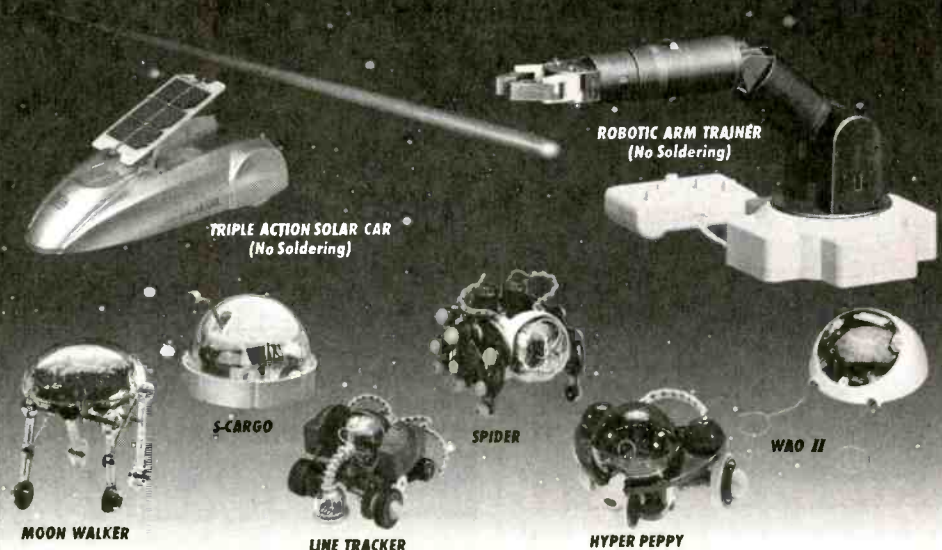

OWI's "Next Generation"
of affordable, rugged Robot
Kits challenge the enthusiast to
solder circuit boards and / or
mechanically assemble.

Visit our homepage
@ <http://www.owirobot.com>

Each OWIKIT also incorporates the
basic principles of robotic experiments,
sensing and locomotion, guaranteeing
an exciting, hands-on adventure of
knowledge and fun!

But remember! OWI is the recognized
founder and leader in Educational Robot
Kits. **ACCEPT NO IMITATIONS.**



1160 Mahalo Place, Suite B
Rancho Dominguez, CA 90220-5443
(310) 638-7970
Fax: (310) 638-8347



Order M - F: 8a.m. - 4p.m. PST

ROBOTIC ARM TRAINER	OWI-007	5 Axis Control	Avail. Aug. '98	69.95
TRIPLE ACTION SOLAR CAR	OWI-685	Solar Sensor	28 pg. Book	39.95
S-CARGO	OWI-936K	Sound Sensor	47 Pg. Book	36.95
WAO II	OWI-961K	Programmable - Graphic	59 Pg. Book	69.95
SPIDER	OWI-962K	Infrared Sensor	49 Pg. Book	49.95
LINE TRACKER	OWI-963K	Infrared Sensor	48 Pg. Book	49.95
HYPER PEPPY	OWI-969K	Sound / Touch Sensor	46 Pg. Book	24.95
MOON WALKER	OWI-989K	Solar Sensor	10 Pg. Book	34.95

CABLE TV CONVERTERS

Equipment & Accessories
Wholesalers Welcome
Call **C&D ELECTRONICS**
1-888-615-5757 M-F 10a-6p

FCC License Preparation

Electronics Tech., Avionics, Marine & Radar
HOMESTUDY—Fast, Easy & Inexpensive
Manuals, Audio, Video, PC disks, latest Q&As
Free 1-800-800-7555 "Guaranteed Pass"
See at <http://www.worldaccessnet.com>
BusinessShowcase/wpt. 4701 NE 47th St.
Vancouver, WA 98661 - WPT Publications

Filter Wiz v2.0

ACTIVE FILTER design software
for Windows. Provides mastery of lowpass,
highpass, bandpass and bandstop filters.
Enhance critical signal components while
controlling noise and other interference.
Meets the needs of both novice and
professional designer. Standard (LE)
version \$89, PRO version \$199.

Download: <http://www.schematica.com>
sales@schematica.com FAX:250-642-2644

www.cable4less.com



Best Service!
Best Prices!
Dealers Wanted!
30 days money back
1 year warranty

1-800-660-4180

Visa MC Amex Discover C.O.D.

The Pocket Programmer

\$129.95



The portable
programmer
that uses the
printer port of
your PC
instead of a
internal card.

Easy to use software that programs
E(E)prom, Flash & Dallas Ram. 27(C)/
28(C)(F)/29(C)(F)/25 series from 16K to 8
Megabit with a 32 pin socket. Adapters
available for MCU's 874X, 875X, Pic, 40-
Pin X 16 & Serial Eprom's, PLCC, 5-Gang
and Eprom Emulator to 32K X 8.

**Same Name, Address & Phone # for
13 Years.... Isn't it Amazing ?**

Intronics, Inc.
Box 13723 / 612 Newton St.
Edwardsville, KS 66113 Add \$4.75 COD
Tel. (913) 422-2094 Add \$4.00 Shipping
Fax (913) 441-1623 Visa / Master Charge

CABLE TV DESCRAMBLERS

***GUARANTEED
LOWEST PRICES*
*DESCRAMBLERS
FOR ALL SYSTEMS*
FREE SHIPPING
CRAZY LIZ'S ELECTRONIC
WAREHOUSE
CALL TODAY!**

**1-800-391-7803
EQUIPMENT IS NEW & GUARANTEED**

Transfer System for **30-DAY**
Printed Circuit **MONEY-BACK**
Use with regular **GUARANTEED**
Household iron

Fax 305 538 3648
8-oz. \$30.00 **25¢**
+4.00 S&H average per transfer

Toll free 1 888 698 3648



1348 Washington av. Suite #189
Miami Beach Florida FL 33139
www.starletsystems.com/elec/

**Make circuits easy from your
Laser or Photocopy Machine**

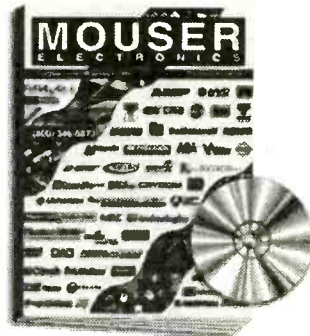

Visit our web site!
www.mouser.com

FREE catalog is available
on the internet, CD-ROM,
or in paper!

- Over 72,500 Products
- More than 145 Suppliers
- Same Day Shipping
- No Minimum Order

800-992-9943

817-483-6828 Fax: 817-483-6899
catalog@mouser.com

958 North Main St., Mansfield, TX 76063

ELECTRONIC COMPONENTS

CIRCLE 160 ON FREE INFORMATION CARD

Quality Microwave TV Systems
WIRELESS CABLE - IFTS - MMDS
ATV - INTERNATIONAL - DIGITAL
Amplifiers • Antennas • Books • Components
• RF Frequency 2100-2700 MHz
• SASE For "FREE" Catalog or Send \$1
PHILLIPS-TECH ELECTRONICS
P.O. Box 13074 • Scottsdale, AZ 85267-3074
CATALOG/INFO: 602-947-7700
ORDER LINE: 800-880-MMDS
FAX LINE: 602-947-7799
WEBSITE: www.phillips-tech.com
E-MAIL: product@phillips-tech.com
Visa • M/C • AmEx • Discover • COD's • Quantity Pricing

CHALLENGER SYSTEM
21 Channel Complete \$240
Direct Systems Available
3 Year Warranty
FREE SHIPPING

BUGGED??

EAVESDROPPING is unbelievably widespread! Electronic Devices with amazing capabilities can be monitoring your telephone and room conversations RIGHT NOW! Are you sure you're safe? **FREE CATALOG** tells you *fast!* Includes Free Bonus details on fantastic opportunities now open in Counter-Surveillance field. Exciting, immensely interesting and **EXTREMELY** profitable (up to \$250/hr) full/part-time come. Call Now! **1-800-732-5000**

❖ ATTENTION CABLE VIEWERS ❖

CABLE VIEWERS...get back to your BASIC Cable Needs

Call 800-577-8775

For information regarding all of your **BASIC** cable needs.

5 GOOD REASONS TO BUY OUR FAR SUPERIOR PRODUCT

- ❖ PRICE
- ❖ EFFICIENT SALES AND SERVICE
- ❖ WE SPECIALIZE IN 5, 10 LOT PRICING
- ❖ ALL FUNCTIONS (COMPATIBLE WITH ALL MAJOR BRANDS)
- ❖ **ANY SIZE** ORDER FILLED WITH SAME DAY SHIPPING

We handle **NEW** equipment **ONLY** - Don't trust last year's **OBSOLETE** and **UNSOLD** stock!
COMPETITIVE PRICING—DEALERS WELCOME

HOURS: Monday-Saturday 9-5 C.S.T.

It is not the intent of B.F.S.W. to defraud any pay television operator and we will not assist any company or individual in doing the same.
*Refer to sales personnel for specifications.

**BASIC
ELECTRICAL
SUPPLY &
WAREHOUSING
CORPORATION**

P.O. Box 8180 • Bartlett, IL 60103 • 800-577-8775



Precious Life

Not too many years ago, this nurse was a patient at St. Jude Children's Research Hospital. She fought a tough battle with childhood cancer. And won.

Until every child can be saved, our scientists and doctors must continue their research.

To find out how you can help, call 1-800-877-5833.



**ST. JUDE CHILDREN'S
RESEARCH HOSPITAL**
Danny Thomas, Founder

Don't lose sight of Glaucoma.

E NATIONAL
EYE
HEALTH
EDUCATION
PROGRAM

EPROM+ The Professionals Choice!

A rugged device programming system for bench and field

Uses parallel printer port!

Supports all standard parts!

Excellent, easy-to-use software!

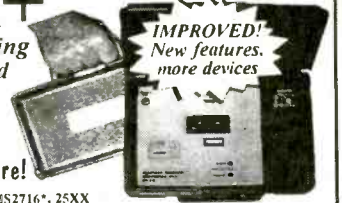

IMPROVED!
New features.
more devices

FIRST GENERATION EPROMS 2708, TMS2716*, 25XX
SECOND GENERATION EPROMS (24, 28, 32 PIN) 2716 - 27C100 (8 MEG) *ADAPTER REQUIRED DIAGRAMS INCLUDED
16 BIT EPROMS* (40, 42 PIN) 27C1024 - 27C160 (16 MEG)
FLASH EPROMS (28, 32 PIN) 28F, 29C, 29EE, 29F FAMILIES PLUS BOOT BLOCK DEVICES
EEPROMS/NVRAMS (24, 28, 32 PIN) 28C04 - 28C100, X2210/12, ER5901, PLUS DALLAS 12XX
SERIAL EEPROMS* (8, 14 PIN) 17XX, 24XX, 25XX, 35XXX, 59XX, 85XX, 93XX, 95XX+ER1400
BIPOLAR PROMS* (16 - 24 PIN) 74SXXX AND 82SXXX FAMILIES
MICROCONTROLLERS* (ALL FAMILIES) 874X, 875X, 87C5XX, 87C75X, 89C5X, 89CX051, 89SXXX, 90SXXX, 68705, 68711, PIC12CXXX - 16CXXX, 17C4X PLUS FLASH AND 14000

- READ, PROGRAM, COPY, COMPARE, FILE LOAD/SAVE (PLUS MUCH MORE!)
- FULL SCREEN EDITOR W/25 CMD5 + BYTE/WORD MODES
- RUNS UNDER DOS, WIN3.1/95/98 AT ALL CPU SPEEDS
- SUPPORTS INTEL HEX, S-RECORD AND BINARY FILES
- MADE IN USA • 30 DAY MONEY BACK GUARANTEE

\$289

SYSTEM INCLUDES: PROGRAMMING UNIT, PRINTER \$5.00 SHIPPING • \$5.00 C.O.D.
PORT CABLE, POWER PACK, SOFTWARE & MANUAL VISA • MASTERCARD • AMEX

ANDROMEDA RESEARCH, P.O. BOX 222, MILFORD, OH 45150
(513) 831-9708 FAX (513) 831-7562 website - www.arlabs.com

Timid about getting on the... World Wide Web?

You've heard about the *Information Superhighway* and all the hype that goes with it! Sort of makes you feel timid about getting on the Web. Put your fears aside! A new book, *The Internet and World Wide Web Explained*, eliminates all the mystery and presents clear, concise information to build your confidence. The jargon used is explained in simple English. Once the tech-talk is understood, and with an hour or two of Web time under your belt, your friends will believe you are an Internet guru!

To order Book #BP403 send \$10.95 plus \$4.00 for shipping in the U.S. and Canada only to Electronics Technology Today Inc., P.O. Box 240, Massapequa Park, NY 11762-0240. Payment in U.S. funds by U.S. bank check or International Money Order. Please allow 6-8 weeks for delivery.

WINDOWS 95 —One Step at a Time

Don't know what to do when confronted with Microsoft's Windows 95 screen? Then you need a copy of *Windows 95—One Step at a Time*. Develop your expertise with the straight-forward presentation of the frequently-used features that make Windows 95 so valuable to the PC user.



To order Book BP399 send \$8.99 plus \$3.00 for shipping in the U.S. and Canada only to Electronics Technology Today Inc., P.O. Box 240, Massapequa Park, NY 11762-0240. Payment in U.S. funds by U.S. bank check or International Money Order. Please allow 6-8 weeks for delivery.

Cable T.V. Converters & Equipment

Lower
Prices
Dealer
Discounts
30-Day
Money back
1-year
warranty
MC, Visa,
AE, COD



No Florida Sales

www.cable4you.com

1-(800) 888-5585



A public service of this magazine

Weeder Technologies



FREE
CATALOG!



Pro-Kit

PO Box 2426, Ft. Walton Beach, FL 32549

www.weedtech.com

Voice/Fax 850-863-5723

Stackable RS-232 Kits

Digital I/O - 12 I/O pins individually configurable for input or output. DIP switch addressable; stack up to 16 modules on same port for 192 I/O points. Turn on/off relays. Sense switch transitions, button presses, 4x4 matrix decoding using auto-debounce and repeat. **\$32**

Analog Input - 8 Input pins. 12-bit plus sign self-calibrating ADC. Returns results in 1mV steps from 0 to 4095. Software programmable alarm trip-points for each input. DIP switch addressable; stack up to 16 modules on same port for 128 single-ended or 64 differential inputs. **\$49**

Home Automation (X-10) - Connects between a TW523 and your serial port. Receive and transmit all X-10 commands with your home-brewed programs. Full collision detection with auto re-transmission. **\$39**

Caller ID - Decodes the caller ID data and sends it to your serial port in a pre-formatted ascii character string. Example: *12/31 08:45 850-863-5723 Weeder, Terry <CR>. Keep a log of all incoming calls. Block out unwanted callers to your BBS or other modem applications. **\$35**

Touch-Tone Input - Decodes DTMF tones used to dial telephones and sends them to your serial port. Keep a log of all outgoing calls. Use with the Caller ID kit for a complete in/out logging system. Send commands to the Home Automation or Digital I/O kits using a remote telephone. **\$34**

Telephone Call Restrictors

Two modes of operation; either prevent receiving or placing telephone calls (or call prefixes) which have been entered into memory, or prevent those calls (or call prefixes) which have "not" been entered.

Block out selected outgoing calls. Bypass at any time using your password. **\$35**

Block out selected incoming calls. Calls identified using Caller ID data. **\$46**

Phone Line Transponder

7 individual output pins are controlled with buttons 1-7 on your touch-tone phone. Automatically answers telephone and waits for commands. Monitor room noises with built in mic. "Dial-Out" pin instructs unit to pick up phone and dial user entered number(s). Password protected. **\$49**

IR Remote Control Receiver

Learns and responds to the data patterns emitted by standard infrared remote controls used by TVs, VCRs, Stereos, etc. Lets you control all your electronic projects with your TV remote. 7 individual output pins can be assigned to any button on your remote, and can be configured for either "toggle" or "momentary" action. **\$32**

DTMF Decoder/Logger

Keep track of all numbers dialed or entered from any phone on your line. Decodes all touch-tones and displays them on a 16 character LCD. Holds the last 240 digits in a non-volatile memory which can be scrolled through. Connect directly to radio receiver's speaker terminals for off-air decoding of repeater codes, or numbers dialed on a radio program. **\$55**

You can Build Gadgets! Here are 3 reasons why!



BP345—GETTING STARTED IN PRACTICAL ELECTRONICS...\$8.95

If you are looking into launching an exciting hobby activity, this text provides minimum essentials for the builder and 30 easy-to-build fun projects every experimenter should toy with. Printed-circuit board designs are included to give your project a professional appearance.

BP349—PRACTICAL OPTO-ELECTRONIC PROJECTS\$8.95

If you shun opto-electronic projects for lack of knowledge, this is the book for you. A bit of introductory theory comes first and then a number of practical projects which utilize a range of opto devices, from a filament bulb to modern infrared sensors and emitters—all are easy to build.



BP363—PRACTICAL ELECTRONIC MUSIC PROJECTS\$8.95

The text contains a goodly number of practical music projects most often requested by musicians. All the projects are relatively low-in-cost to build and all use standard, readily available components that you can buy. The project categories are guitar, general music and MIDI.



Mail to:
**Electronic Technology Today, Inc.
P.O. Box 240
Massapequa Park, NY 11762-0240**

Shipping Charges in USA & Canada

\$0.01 to \$10.00.....\$3.00	\$30.01 to \$40.00.....\$6.00
\$10.01 to \$20.00.....\$4.00	\$40.01 to \$50.00.....\$7.00
\$20.01 to \$30.00.....\$5.00	\$50.01 and above.....\$8.50

Sorry, no orders accepted outside of USA and Canada. All payments must be in U.S. funds only.

Number of books ordered.

Total price of books.....	\$
Shipping (see chart).....	\$
Subtotal.....	\$
Sales Tax (NYS only).....	\$
Total enclosed.....	\$

Name _____

Address _____

City _____ State _____ ZIP _____

Please allow 6-8 weeks for delivery.

CLASSIFIED

AUDIO-VIDEO-LASERS

Unique Video Products Pattern Generators with character identification, composite, s-video, RGB, distribution amplifiers, kits also available, FREE catalog, **GEKCO Labs**, PO Box 642 Issaquah, WA 98027-0642, 888-435-7221, www.gekco.com.

BUSINESS OPPORTUNITIES

\$400 WEEKLY ASSEMBLING Electronic circuit boards/products from home. For free information send SASE: Home Assembly-PE Box 216 New Britain, CT 06050-0216.

Descramblers, Converters, Activators, Rft's, Ftg's, Bullet Snoopers. All options explained, best prices, services, 2yr warranty, free catalog 1-800-854-1674, www.resourceleader.com/aapc.

Marketing Firm-Seeks New Products/Ideas. Full Patenting & Marketing Services Available. For FREE Information kit, call anytime 1-800-846-8368 Ext. 202.

Microwave oven repair course. Universal training manual, schematics, free microwave power detector, technician's certificate. \$60.00, **MOTS TECH**, Box 29141, Thunder Bay, Ontario, Canada. P7B6P9.

CABLE TV

CABLE DESCRAMBLING, New secret manual. Build your own Descramblers for Cable and Subscription TV. Instructions, schematics for SSAVI, Gated Sync, Sinewave, some free methods \$12.95, \$2 postage. **CABLETRONICS**, Box 30502PE, Bethesda, MD 20824.

CABLE TV Descramblers. One piece units. Scientific Atlanta, Jerrold, Pioneer, and others. Lowest prices around. **Precision Electronics** Houston, TX. Anytime. 1-888-691-4610.

Bewildered about descramblers? Call for your options. Same day shipping. M-F 9-8, SAT 12-5. **Global Electronics** 1-888-221-8365.

CABLE TV Signal Eliminator - Powerful, user tunable filter for removing severe interference OR unwanted channels! Eight models, for channels (2-3) (4-6) (7-13) (14-17) (18-22) (23-29) (30-36) (95-99). Each \$30, add \$4 for S/H. Quantity discounts. Money back guarantee. Visa, Mastercard or check. COD \$5 extra. Visit starcircuits.com. **Star Circuits**, PO Box 94917, Las Vegas, NV 89193. 1-800-433-6319.

Free Cable Descrambler Plans. For Details Write: **Sierra Publishing**, 909 E. Yorba Linda Blvd., Suite H-181, Dept PEV, Placentia, CA 92870.

CUBE for Jerrold Model CFT-2200, 2014, 2024, 2254, Pioneer 6300-6310, Auto-Multimode, Zenith ST-1600 \$175.00. Lowest price call 800-822-8530.

CABLE TV EQUIPMENT & ACCESSORIES. Wholesalers Welcome! 30 Day Moneyback Guarantee! Free Catalog! **PROFORMANCE ELECTRONICS, INC.** 1-800-815-1512.

Cable boxes all models, all channels, lowest prices in the United States. Open seven days a week till midnite, Pacific time. Call (877)789-7337 toll-free.

For all your cable needs, Quantity Discounts, low, low price. 30 day money back guarantee. Call now 888-898-3284, Skylab Sales Inc.

All cable TV boxes. We'll beat any price. 30 day trial, 1 year warranty. 1-800-538-CABLE(2225).

FREE TV CABLE CATALOG. Revolutionary new products. Converters, Full viewing boxes, Gold or Silver, that do all boxes. Open 7 days a week. 1-800-676-6342.

Free Cable TV t-shirt with the purchase of a radio frequency test cube, converter or video stabilizer. Video stabilizers remove video tape copy protection. We will beat any price!! **Cable USA, Inc.** 1-888-388-CUBE.

CB-SCANNERS

CB Radio Modifications! Frequencies, kits, high-performance accessories, books, plans, repairs, amps, 10-Meter conversions. The best since 1976! Catalog \$3.00. **CBCI**, Box 1898PE, Monterey, CA 93942.

MISC. ELECTRONICS FOR SALE

RF TRANSISTORS AND TUBES 2SC2879, MRF454, MRF422, 2SC1969, 2SB754, SD1446, 3-500ZG, 3CX3000A7, 4CX250B, **WESTGATE** 800-213-4563.

PLANS-KITS-SCHEMATICS

CATALOG: Broadcasting/micro transmitters, amplifiers, antennas. Start your own radio station books. Audio, TV, Ham, CB, Surveillance, Science projects and more. www.panaxis.com **PAN-COM Int'l**, PO Box 130-1, Paradise, CA 95967.

ELECTRONIC PROJECT KITS: 49 McMichael St, Kingston, ON., K7M 1M8. \$3.00 catalog. www.qkits.com. **QUALITY KITS.**

NEW AM Broadcast Band Transmitter kit from **SEASIDE ELECTRONICS.** Be your neighborhoods D.J., send check or M.O. for \$32.95 + \$10.00 S/H to 6920 Airport Blvd, Suite 117-114 Mobile, AL 36608 or call in COD orders to (334)341-0740. For full catalog send \$2.00 to above address. **WE BUILD ANY KIT, CALL FOR PRICE!**

MONITORS MADE SIMPLE. Learn to repair computer monitors! Case studies, illustrations, parts sources, manufacturers included! 136 pages, softcover, \$19.95 + \$2.50 shipping. Order today! Send check or money order to **Pikes Peak Press** 321 W. Henrietta Ave. P.O. Box 1801, Woodland Park, CO 80866. (719) 687-1499.

PUBLICATIONS

SHOCKING PLANS! 190+ Publications. Impossible to find underground info! Hacking, revenge, money-making, and lots more. Very unusual stuff! Free catalog. **TIC** PO Box 876PM Hurst, TX 76053, www.theinformationcenter.com

SATELLITE EQUIPMENT

FREE CATALOG - Satellite TV/GPS-DIY. Technical Books, Installation Videos, Computer Analysis Software www.baylin.com 800-843-2425.

SKYVISION! Your Satellite Home Entertainment Source. **Best values:** DBS and C/Ku-band equipment, including 4DTV. Most complete selection: Parts-Tools-Upgrades-Accessories! **Free** Discount Buyer's Guide. Call 800-543-3025. International 218-739-5231. www.skyvision.com.

DSS Hacking: How to construct and program smart cards, w/pic16C84, Complete DSS system schematics, \$16.95. Software \$25. CABLETRONICS Box 30502PE, Bethesda, MD 20824

CALLER ID ON TV

NEW! CALLER-TV \$49.95 NO MORE INTERRUPTIONS! Know who's calling immediately. Secure internet ordering www.caller-tv.com, 520-544-4567.

FREE CASH GRANTS

Free Cash Grants! College. Scholarships. Business. Medical bills. Never repay. Toll Free 1-800-218-9000 Ext. G-14087.

SEIZED CARS

SEIZED CARS from \$175. Porches, Cadillacs, Chevys, BMW's, Corvettes. Also Jeeps, 4WD's. Your Area. Toll Free 1-800-218-9000 Ext. A-14087 for current listings

PATENT

BEST RESULTS for design, utility, and plant patents. Best patent & trademark services/free information. 1-877-418-0800/P.O. Box 15607, Arlington, VA 22215-0607.

GALEP-III Pocket Multiprogrammer

**This size
fits all!**



- ◆ Programs 8-bit and 16-bit EPROMs, EEPROMs, Zero Power RAMs, Flash, serial EEPROMs ◆ GAL, PALCE, ATF ◆ 87xxx, 89xxx, PIC12/16/17Cxx ◆ All DIL devices **without adaptor** ◆ **Lightning fast** parallel data transfer (e.g. 27C512 read/compare 2 sec!) ◆ Power supply independent due to **rechargeable battery** ◆ Uses PC printer port ◆ Hex, JEDEC, and binary file formats ◆ Hex and fusemap buffer editor ◆ Split & shuffle for 8-bit, 16-bit and 32-bit targets ◆ Runs under Win3.1, 95, 98 ◆ 'Remote control' by DDE scripts ◆ Designed for the future due to flexible pin driver technology - new devices will be added every month ◆ Device list, demo software and **lifetime free updates** from our website www.conitec.com!

GALEP-III Set with cable, battery, recharger **\$389.00**
PLCC Adaptor for 8-bit EPROMs / 16-bit EPROMs / GALs each **\$149.00**

 CONITEC 1951 4th Ave. Ste 301 • San Diego, CA 92101
Tel: (619) 702-4420 • <http://www.conitec.com>

HI-TECH SURVEILLANCE

Pinhole Cameras, Recording Devices, Bug Detectors, Lasers, Lockpicks, Pen Knives, Tracking Devices, Wireless Mics, Books/Videos, plus much more!!!!

FOR CATALOG - SEND \$5.00 TO:

Spy Way
P.O. Box 61805, Jax, FL 32236

CABLE TV EQUIPMENT

Converters, Test Cubes & Chips

**1 Year Warranty
30 Day Money
Back Guarantee**



**"ABSOLUTE LOWEST
WHOLESALE &
RETAIL PRICES"
CABLE U.S.A.
1-888-388-CUBE**

CAD FILES TO CASH PILES



IMAGINE THE POSSIBILITIES!
ROUTE, MILL, DRILL, CARVE,
ENGRAVE, PAINT, ETC.
IN WOOD, PLASTIC, VINYL,
PC BOARD, & LIGHT METALS.

THE **ROBOPRO X50**
CNC ROBOTIC MACHINING SYSTEM
YOUR WISH IS ITS COMMAND!



STARTING AT
\$895.00

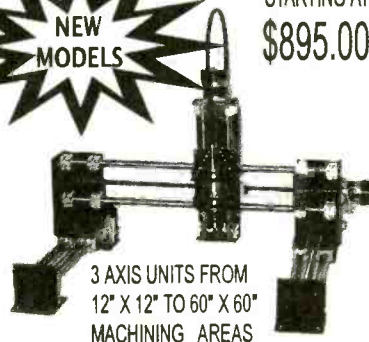

3 AXIS UNITS FROM
12" X 12" TO 60" X 60"
MACHINING AREAS

Visit us at
www.uscyberlab.com

U. S. CYBERLAB, INC., 14786 SLATE GAP RD., WEST FORK, AR 72774
VOICE (501) 839-8293 / 24 HR. FAX BACK (501) 839-8293

TRAVEL LIGHT.



American Heart Association 

EXERCISE.

ADVERTISING INDEX

Popular Electronics does not assume any responsibility for errors that may appear in the index below.

Free Information Number	Page	Free Information Number	Page
— AES	81	— Lynxmotion	83
— Alfa Electronics.....	82	161 MCM Electronics	71
— Allison Technology.....	85	— Mega Electronics	86
— Amazon Electronics.....	86	139 Mendelson's.....	86
162 American Innovations.....	80	— Mental Automation	85
— Andromeda Research.....	89	35 MicroCode Engineering	CV2
— Arrow Electronics.....	82	— Micro Test.....	80
— Basic Electrical Supply	88	— Modern Electronics	78
— Bsoft	76	160 Mouser	88
130 C&S Sales, Inc.	72	— NRI Schools.....	11
— Cable USA.....	91	— OWI	87
30 Cadsoft.....	7	— Pioneer Hill Software	82
— Circuit Specialists.....	70	150 Prairie Digital Inc.	81
— CLAGGK, Inc.....	13	142 Print	74
— Cleveland Inst. of Electronics.....	21	143 Print	85
— Command Productions	81	153 Print	70
— Conitec.....	91	— Pro Planet.....	89
— Consumertronics.....	74	32 Radio Shack	3
— Crazy Liz's	88	— Schematica Software	87
157 Dalbani.....	CV3	— Securetek	86
— EDE Spy Outlet	84	— Silicon Valley Surplus	84
— Electronic Tech. Today	69, 90	— Starlet Systems.....	88
— Foley-Belsaw	75	158 Sun Equipment	79
— General Device Instruments.....	84	— Technological Arts	86
— Grantham College of Eng.....	17	137 Telulex.....	78
— Greenleaf Electronics Inc.	70	— Test Equipment Depot.....	83
— Grich RC Inc.	80	— UCANDO Videos	76
— Home Automation Systems.....	83	— US Cyberlab	91
— Information Unlimited.....	76	163 Velleman Inc.	77
26 Interactive Image Technologies CV4		— Video Media	86
— Intronics, Inc.....	87	— Vision Electronics	86
— James Electronic Services.....	78	— Weeder Technologies	89
— KDE Electronics	84	— Z Products.....	87
— Lindsay Publications	86		

ADVERTISING SALES OFFICES

Gernsback Publications, Inc.
500 Bi-County Blvd.
Farmingdale, NY 11735-3931
1-(516) 293-3000
Fax 1-(516) 293-3115

Larry Steckler, EHF/CET
 President (ext. 201)
 e-mail advertising@gernsback

Adria Coren
 Vice-President (ext. 208)

Ken Coren
 Vice-President (ext. 267)

Christina Estrada
 Assistant to the President (ext. 209)

For Advertising ONLY
1-516-293-3000
Fax 1-516-293-3115

Larry Steckler
 publisher

Marie Falcon
 advertising director (ext. 206)

Adria Coren
 credit manager (ext. 208)

**Subscription/
 Customer Service/
 Order Entry**
 1-800-827-0383
 7:30 AM - 8:30 PM EST

ADVERTISING SALES OFFICES

EAST/SOUTHEAST

Megan Mitchell
 9072 Lawton Pine Avenue
 Las Vegas, NV 89129
 Phone 702-240-0184
 Fax 702-838-6924
Lorri88@aol.com

MIDWEST/Texas/Arkansas/ Oklahoma, Colorado, Arizona

Ralph Bergen
 Midwest Sales
 One Northfield Plaza, Suite 300
 Northfield, IL 60093-1214
 1-847-559-0555
 Fax 1-847-559-0562
bergenrj@aol.com

PACIFIC COAST/Mountain States

Anita Bartman
 Hutch Looney & Assoc., Inc.
 6310 San Vicente Blvd.
 Suite 360
 Los Angeles, CA 90048-5426
 1-323-931-3444 (ext. 227)
 Fax 1-323-931-7309
anita@hlooney.com

**OVER
30,000
ITEMS
IN STOCK**

**LARGE VARIETY
SAME DAY SHIPPING**

Minimum Orders \$20.-

Not Including Shipping & Handling

Dalbani®
The Ultimate Saving Source

SEMICONDUCTORS

Original #	Brand	Replaces
7805	Tesla	960
7806	Ank	962
7809	Ank	1910
7810	Samsung	1968
7812	Tesla	966
7815	Tesla	968
7818	Tesla	958
7824	Tesla	972
7905	Tesla	961
7906	Tesla	963
7908	Tesla	965
7912	Ank	967
7918	Tesla	959
7924	Tesla	971



YOUR CHOICE

\$45¢
each

**Dalco®
ECONOMICAL
SOLDER WICK**

5 Feet

Removes solder easy



\$1.10

- Length: 5 feet
- Width: 0.15"
- Safer Desoldering
- Fast Response

Item # 51-1050

SOLDER ROLL

- 1 LB Spool
- 370° F melting point
- Fastest solder
- Alloy 60/40, tin lead, non corrosive flux, Diam.1.0mm



\$5.49

Item # 51-1005

**DUAL
HELPING
HANDS**

- Hold Work in any Position to leave hands free for soldering



\$3.45

Item # 50-1325

SOLDERING IRON

- General Purpose Applications
- 117V AC, 30 Watts



\$3.25

Item # 51-1335

**WELLER WLC100
SOLDERING STATION**

Weller®

- Ideal for the professional, serious hobbyist
- Variable power control (5-40W)
- 40W pencil iron and ST# inter changeable tip
- Replaceable heating element
- Cushioned foam grip • Safety guard iron holder
- On/off switch with "power-on" indicator light



\$38.90

Item # 51-1505

SHIP UP TO 5 lbs FOR ONLY

\$3.95



Plus handling & C.O.D. charge if it applies

**THE MOST POPULAR
VCR ALIGNMENT TOOL KIT**

\$24.99



- VCR Head pull
- Retaining ringremover
- Micro screwdriver
- Fitted vinyl Case
- 7 Assorted head & guide aligner
- Dimensions: 9 1/2" (W) X 12 1/4" (L)
- 3 Reverseable screwdrivers (Small-Flat-Phillips)
- Spring hook
- Hex key set
- Soft zippered case

Item # 50-888

**HEAVY DUTY COLOR
CODED LEADS**

- 10 Leads
- 11" Long Wire Lead
- Insulated 11/2" Alligator Clips
- 20 Gauge Wire Size
- Black, Green, Red, Yellow, White



\$2.95

Item # 56-500

**Dalco® SWING ARM
MAGNIFYING LAMP**

- Spring-Balanced 45" extension arm with 3 conductor cord 120V 60Hz
- Steel Shade supplied with a precise 3 diopterlens and a 22W fluorescent circline tube
- Comes with a lamp

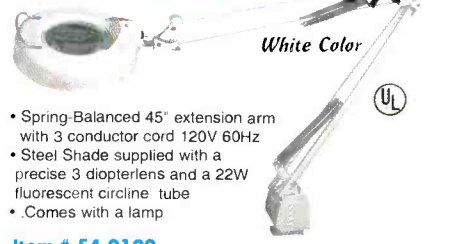

\$36.72

Item # 54-0120

POPULAR FUSE KIT 180 Piece Kit

Kit Contains 10 Pieces of each of these items:

- AGC Type : 0.5A, 1A, 1.5A, 2A, 2.5A, 3A, 4A, 5A, 6A, 10A, 15A
- Ceramic Type : 15A
- GMA Type : 1A, 1.5A, 2A, 3A, 4A, 5A



\$13.95

Everything Comes in a Durable Plastic Box

Item # 10-2050

TUN-O-WASH® (CFC Free)

Fast drying electronics grade cleaner for tuners, controls and PC boards.

- CFC and HCFC free
- Not for use on energized equipment
- Due to the chemical content, this product can be only shipped by UPS ground service.



\$11.75

Item # 30-0100 (12.5 Oz aerosol)

**DALCO DIGITAL
MULTIMETER**

- DC Voltage: 200m-1K
- AC Voltage: 200-750V
- DC Current: 20m-20
- Transistor and Diode Test
- Continuity Buzzer
- Polarity indicator appears on LCD
- Test Probes Included
- Dimensions: 4.96" x 2.76" x 9.4"
- Weight: 6 oz.
- 9V Battery Included



\$9.95

Item # 50-2895

Dalbani®

4225 NW 72ND AVE. MIAMI, FLORIDA 33166
TEL : (305) 716-1016 ----- FAX : (305) 594-6588

Free 400 Page Color Catalog
With your First Order

1-800-325-2264

CIRCLE 157 ON FREE INFORMATION CARD

www.americanradiohistory.com

THE WORLD'S MOST POPULAR
DESIGN TOOL CHOSEN BY OVER
100,000 USERS!

Electronics Workbench[®]

Personal Edition

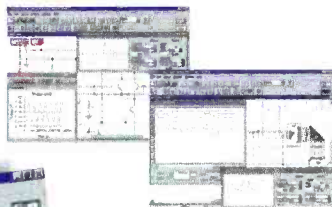
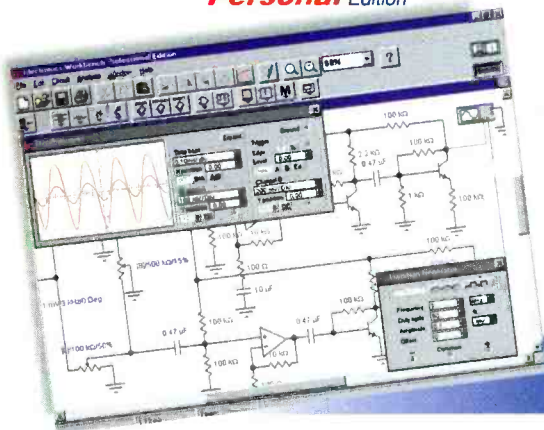

TRUE MIXED ANALOG/DIGITAL
FULLY INTERACTIVE SIMULATION
PRO SCHEMATIC EDITOR
6 VIRTUAL INSTRUMENTS
ON-SCREEN GRAPHS
OVER 4,000 MODELS
8 POWERFUL ANALYSES
FREE TECHNICAL SUPPORT

\$299

Full-featured schematic capture
and SPICE circuit simulation!

The world's most popular circuit design tool that sets the standard for powerful, insightful SPICE simulation. Create professional looking schematics and then with the flick of a switch, display simulated waveforms live on a suite of virtual instruments. Includes 15 powerful analyses and a library of over 4,000 robust component models.

Electronics Workbench[®] Layout

Personal Edition

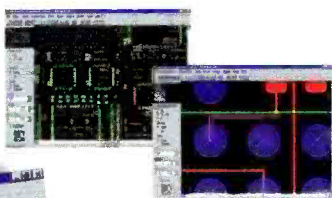
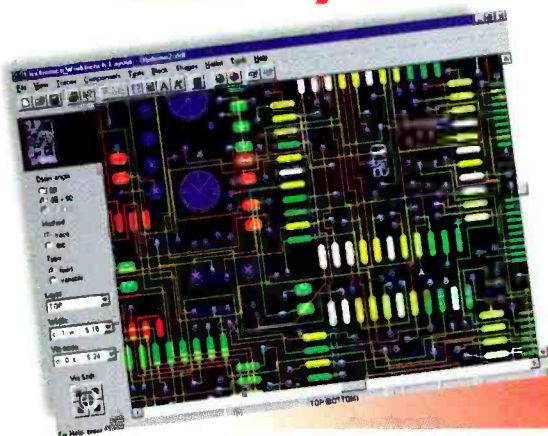

AUTOROUTING
REROUTE WHILE MOVE
32 ROUTING LAYERS
50" X 50" BOARD SIZE
OVER 3,500 LIBRARY SHAPES
EXTENSIVE OUTPUT
REAL TIME DESIGN RULE CHECK
DENSITY HISTOGRAMS
FREE TECHNICAL SUPPORT

\$299

Power-packed PCB layout with
autorouting and real-time DRC!

EWB Layout is a powerful board layout package for producing high-quality, multi-layer printed circuit boards. Offering tight integration with our schematic capture program, EWB Layout is the best way to quickly produce well-designed boards.



BUY BOTH AND SAVE! ~~\$598~~ **\$548**

30-DAY MONEY-BACK GUARANTEE

Fax: 416-977-1818

E-mail: ewb@interactiv.com



CALL FOR INFORMATION
AND PRICING ON OUR
PROFESSIONAL EDITION.

800.263.5552

For a free demo, visit our website at www.electronicworkbench.com

CIRCLE 26 ON FREE INFORMATION CARD