

COMPUTERS HELP THE BLIND AND DEAF

August 1997

Popular Electronics®

Hall-Effect Compass

Build a gadget that detects the direction of the Earth's Magnetic Field

Active Antenna for 100-kHz-30-MHz

Give your receiver added pull to catch weak signals

The New/Old Autodyne

Experiment with direct-conversion receiver circuits

The Laser Fridge

Generate cold from a device that can create extreme heat

Check Out Up-to-the-Minute Facts in Our Net Watch and Multimedia Watch Columns



GIZMO-Keeps You in Tune with Trends in Consumer Electronics



A GERNSBACK PUBLICATION

\$3.99 U.S.
\$4.99 CAN.



Better Designs -Faster

\$299

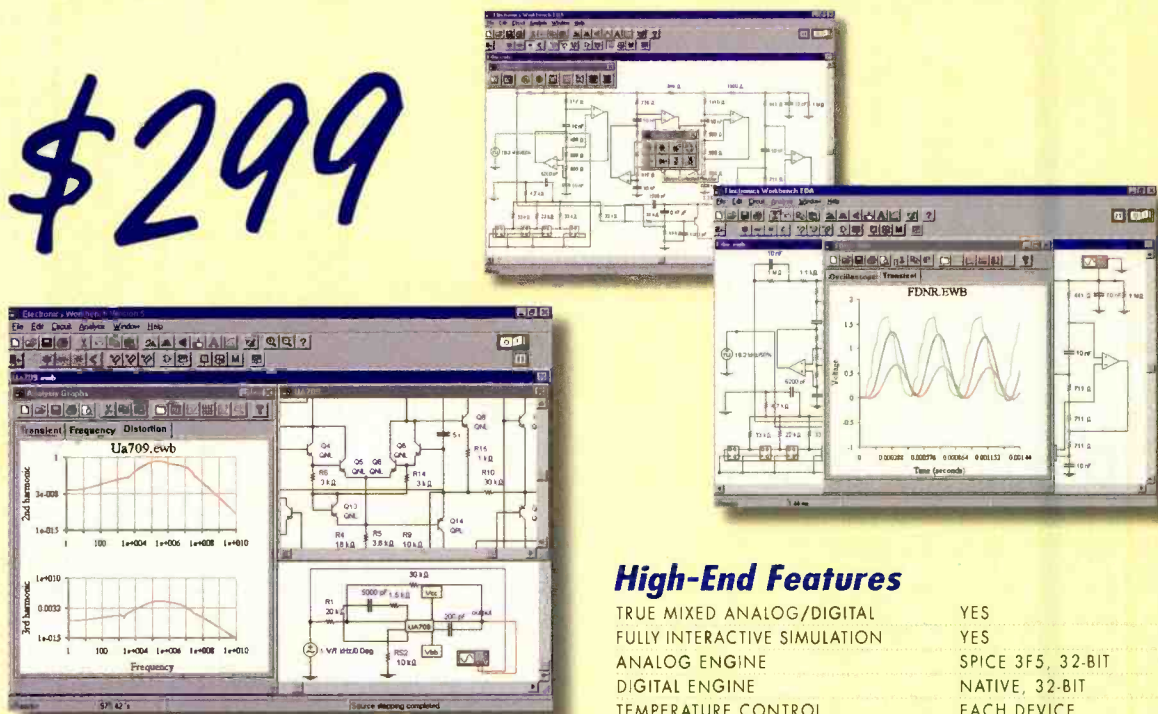

NEW!

Electronics Workbench Version 5 with analog, digital and mixed A/D SPICE simulation, a full suite of analyses and over 4,000 devices. Imports SPICE netlists. Exports to PCB layout programs. Still the standard for power and ease of use. Still the same low price.

Join over 75,000 customers and find out why more engineers and hobbyists buy Electronics Workbench than any other SPICE simulator. You'll be working productively in 20 minutes, and creating better designs faster. We guarantee it!

Check our web site at
<http://www.interactiv.com>
for a free demo

30-DAY MONEY-BACK GUARANTEE
VERSION 5.0 FOR WINDOWS 95/NT/3.1. Upgrades from previous versions \$79.

CALL 800-263-5552



Fax: 416-977-1818 Internet: <http://www.interactiv.com> CompuServe: 71333,3435/BBS: 416-977-3540/E-mail: ewb@interactiv.com

High-End Features

TRUE MIXED ANALOG/DIGITAL	YES
FULLY INTERACTIVE SIMULATION	YES
ANALOG ENGINE	SPICE 3F5, 32-BIT
DIGITAL ENGINE	NATIVE, 32-BIT
TEMPERATURE CONTROL	EACH DEVICE
PRO SCHEMATIC EDITOR	YES
HIERARCHICAL CIRCUITS	YES
VIRTUAL INSTRUMENTS	YES
ON-SCREEN GRAPHS	YES
ANALOG COMPONENTS	OVER 100
DIGITAL COMPONENTS	OVER 200
DEVICE MODELS	OVER 4,000
MONEY-BACK GUARANTEE	30-DAY
TECHNICAL SUPPORT	FREE

Powerful Analyses

DC OPERATING POINT	YES
AC FREQUENCY	YES
TRANSIENT	YES
FOURIER	YES
NOISE	YES
DISTORTION	YES

Electronics Workbench[®]

VERSION 5

INTERACTIVE IMAGE TECHNOLOGIES LTD., 908 Niagara Falls Boulevard, #068,
North Tonawanda, New York 14120-2060/Telephone 416-977-5550

TRADEMARKS ARE PROPERTY OF THEIR RESPECTIVE HOLDERS. OFFER IS IN U.S. DOLLARS AND VALID ONLY IN THE UNITED STATES AND CANADA. ALL ORDERS SUBJECT TO \$15 SHIPPING AND HANDLING CHARGE

Popular Electronics

AUGUST 1997

Vol. 14, No. 8



COVER STORY

33 The Hall-Effect Electronic Compass

If you do much traveling outside of your home state or even your neighborhood, for that matter, eventually you are going to get lost. But with the easy-to-assemble electromagnetic direction locator described in this article, staying on the right course will be a cake walk—*David Williams*

CONSTRUCTION

48 A 100-kHz–30-MHz Active Antenna

If you've encountered any of the drawbacks usually associated with the ham or SWling hobby, then just maybe the low-cost solution presented here will be of interest to you. Our active antenna gives your ham rig or DX station the pull it needs to catch the communications that you most want to hear!—*William Sheets, K2MQJ, and Rudolf F. Graf, KA2CWL*

54 DTMF Frequency Counter

Put that old inoperative tone telephone back in service with the aid of this easy-to-build frequency detection circuit—*William K. McKellips*

FEATURES

39 The New/Old Autodyne

Over the years, many different receiver designs have been tried, some of which were immediately found wanting, and others achieved popularity for a while but fell out of favor when superior designs came along. But the direct-conversion receiver is a design that has come and gone, and is now being resurrected using the new generation of electronics components—*Joseph J. Carr*

44 The Laser Fridge

Learn how scientists have found a way to manipulate a device that's been shown to generate extreme heat to produce cold—*Douglas Page*

45 Computers Are Helping The Blind And Deaf

Here's a look at some new sophisticated software technology, which enables persons with minimal vision or profound hearing loss to see and hear again—*Bili Siuru*

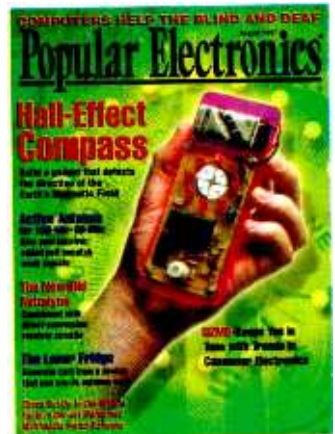

Page 33

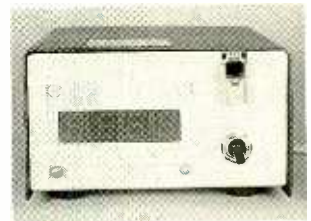

Page 54



Page 12

POPULAR ELECTRONICS (ISSN 1042-170-X) Published monthly by Gernsback Publications, Inc. 500 Bi-County Boulevard, Farmingdale, NY 11735. Second-Class postage paid at Farmingdale, NY and at additional mailing offices. One-year, twelve issues, subscription rate U.S. and possessions \$21.95, Canada \$28.84 (includes G.S.T. Canadian Goods and Services Tax Registration No. R125166280), all other countries \$29.45. Subscription orders payable in U.S. funds only. International Postal Money Order or check drawn on a U.S. bank. U.S. single copy price \$3.99. Copyright 1997 by Gernsback Publications, Inc. All rights reserved. Hands-on Electronics and Gizmo trademarks are registered in U.S. and Canada by Gernsback Publications, Inc. Popular Electronics trademark is registered in U.S. and Canada by Electronics Technology Today, Inc. and is licensed to Gernsback Publications, Inc. Printed in U.S.A.

Postmaster: Please send address changes to Popular Electronics, Subscription Dept., P.O. Box 338, Mount Morris, IL 61054-9932.

A stamped self-addressed envelope must accompany all submitted manuscripts and/or artwork or photographs if their return is desired should they be rejected. We disclaim any responsibility for the loss or damage of manuscripts and/or artwork or photographs while in our possession or otherwise.

As a service to readers, Popular Electronics publishes available plans or information relating to newsworthy products, techniques, and scientific and technological developments. Because of possible variances in the quality and condition of materials and workmanship used by readers, Popular Electronics disclaims any responsibility for the safe and proper functioning of reader-built projects based upon or from plans or information published in this magazine.

PRODUCT REVIEWS

20 Hands-on Reports
Texas Instruments PS-6800 Personal Organizer

21 Gizmo
WEBTV Internet Terminal, DVD Debuts, Panasonic DVD-A300U DVD Player, Pleasure++ Home Contractor, Protape 16 Model HC-500, Prolevel Model HC-200, and much more!

COLUMNS

8 Multimedia Watch
About the changes taking place in the world of PC sound hardware—*Marc Spiwak*

12 Net Watch
Apartment-Hunting Online—*Dan Karagiannis*

15 DX Listening
Is it Asia? Is it Europe?—*Don Jensen*

58 Scanner Scene
Of Scanners and Things—*Marc Saxon*

59 Ham Radio
A Couple of Neat Things For Hams—*Joseph J. Carr*

61 Antique Radio
This 'n' That—*Marc Ellis*

63 Think Tank
Jose Returns—*John Yacono*

67 Circuit Circus
No Trouble in Troubleshooting—*Charles D. Rakes*

73 Computer Bits
Getting Organized—*Jeff Holtzman*

DEPARTMENTS

- 4 Editorial**
- 6 Letters**
- 14 New Products**
- 79 Popular Electronics Market Place**
- 110 Advertiser's Index**
- 110A Free Information Card**

Larry Steckler, BHF, CET,
editor-in-chief and publisher

EDITORIAL DEPARTMENT

- Julian Martin**, editor
- Robert Young**, technical editor
- Edward Whitman**, associate editor
- Teri Scaduto**, assistant editor
- Evelyn Rose**, editorial assistant
- Joseph J. Carr, K4IPV**, contributing editor
- Marc Ellis**, contributing editor
- Jeffrey K. Holtzman**, contributing editor
- Don Jensen**, contributing editor
- Charles D. Rakes**, contributing editor
- Marc Saxon**, contributing editor
- Marc Spiwak**, contributing editor
- John Yacono**, contributing editor

PRODUCTION DEPARTMENT

- Ruby M. Yee**, production director
- Ken Coren**, desktop production director
- Lisa Baynon**, desktop production
- Kathy Campbell**, production assistant

ART DEPARTMENT

- Andre Duzant**, art director
- Russell C. Truelson**, illustrator

CIRCULATION DEPARTMENT

- Theresa Lombardo**, circulation manager
- Gina L. Gallo**, circulation assistant
- Michele Torrillo**, POPULAR ELECTRONICS bookstore

BUSINESS AND EDITORIAL OFFICES

Gemsback Publications, Inc.
500 Bi-County Blvd.
Farmingdale, NY 11735
1-516-293-3000
FAX: 1-516-293-3115
President: **Larry Steckler**

SUBSCRIPTION
CUSTOMER SERVICE/
ORDER ENTRY
1-800-827-0383
7:30 AM - 8:30 PM EST

Advertising Sales Offices
listed on page 110

Composition by Mates Graphics
Cover by Loewy Design
Cover Illustration by Chris Gould

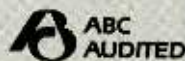

Since some of the equipment and circuitry described in POPULAR ELECTRONICS may relate to or be covered by U.S. patents, POPULAR ELECTRONICS disclaims any liability for the infringement of such patents by the making, using, or selling of such equipment or circuitry and suggests that anyone interested in such projects consult a patent attorney.

Announcing **mentalMAX™**

The First All-In-One Circuit Design Software Package!
Only \$549!

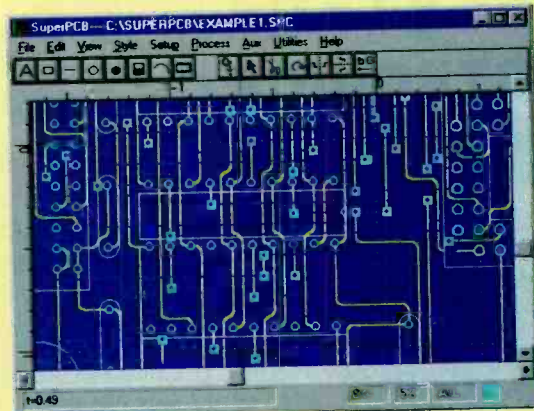
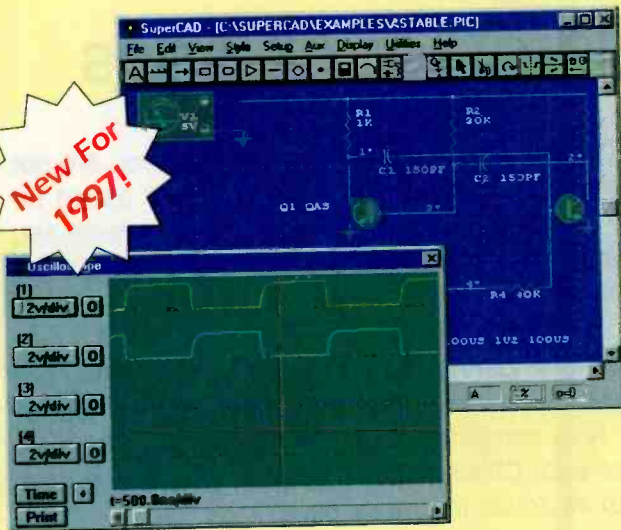

Complete Schematic Entry Software

mentalMAX includes the easy-to-use, powerful SuperCAD schematic entry software. SuperCAD comes with nearly 1800 parts including most TTL and CMOS logic, opamps, discrete symbols, and others—plus you can easily add custom symbols.

Because of our association with McGraw-Hill in producing the **Encyclopedia of Electronic Circuits** CD ROM (available separately for \$99), the SuperCAD schematic editor is fast becoming a standard for schematic entry. The Encyclopedia includes 1000 SuperCAD schematics in 142 different categories (audio, radio, etc) that can be used as a starting point for designs.

Mixed Mode SPICE Simulator

For simulating purely analog circuits or circuits with some digital components, mentalMAX includes mentalSPICE. This simulator is based on the Berkeley SPICE 3F5 simulator and allows you to do timing analysis, frequency analysis, DC curve analysis and others. It comes with over 350 semiconductor and 250 IC models. Signals can be introduced into a circuit using a virtual function generator, and the resulting waveforms can be viewed in the Oscilloscope window.

Digital Simulator

For heavy-duty analysis of computer interfaces, timers, state machines, controllers, and others, mentalMAX provides the digital simulator SuperSIM. This comes with 150 common TTL and CMOS models. You can stimulate circuits with a built-in virtual pattern generator and view results in a logic analyzer window. You can also single-step a circuit and monitor its progress using virtual LEDs and displays.

Circuit Board Layout Software

mentalMAX comes with the popular SuperPCB program for doing layouts on printed circuit boards up to 32" x 32". SuperPCB features 1 mil (.001") resolution, 2 signal layers, silk-screen, paste and solder mask layers. It includes industry-standard Gerber and Excellon outputs, and you can also print your artwork on laser and other printers. SuperPCB comes with 150 package parts for both through-hole and surface-mount devices; you can add your own parts.

In many cases SuperPCB can automatically build a circuit board from just a SuperCAD schematic input, using the built-in autorouter and auto-placement tools. You can also layout or edit circuit board artwork using SuperPCB's intuitive, easy to learn editing features.

Buy With Confidence

Our products come with a 30-day money-back guarantee and free, unlimited technical support.

Free Functional Demo

You can obtain a free demo from the Internet at <http://www.mental.com>, or give us a call.

Call now for more information or
to order

800-794-2141



EARN YOUR B.S. DEGREE IN COMPUTERS OR ELECTRONICS



By Studying at Home

Grantham College of Engineering, now in our 47th year, is highly experienced in "distance education" – teaching by correspondence – through printed materials, computer materials, fax, modem, and phone.

No commuting to class. Study at your own pace, while continuing on your present job. Learn from easy-to-understand but complete and thorough lesson materials, with additional help from our instructors.

Grantham offers three separate distance-education programs, leading to the following accredited degrees:

(1) the B.S.E.T. with Major Emphasis in Electronics. (2) The B.S.E.T. with Major Emphasis in Computers. (3) The B.S.C.S. – the Bachelor of Science in Computer Science.

The B.S.E.T. programs now include Electronics Workbench Professional 5.0.

An important part of being prepared to *move up* is holding the right college degree, and the absolutely necessary part is knowing your field. Grantham can help you both ways – to learn more and to earn your degree in the process.

Write or phone for our free catalog. Toll free, 1-800-955-2527, or see mailing address below.

Accredited by
the Accrediting Commission of the
Distance Education and
Training Council

GRANTHAM
College of Engineering
Grantham College Road
Slidell, LA 70460

EDITORIAL

For Children of All Ages

It appears to me that the older you are, the more apt you are not to explore the computer's possibilities. My opinion is based on watching children dive into exploring activities on the computer, thereby investigating parts of programs that I never even knew existed. Why is this so?

Children are known to singe their finger tips while discovering hot and cold. We adults cut down our exploration activities for fear of hurting ourselves. Now computers cannot burn you, but they sure can stomp on your ego. Children don't respond to ego and peer pressures as much as adults think they do.

With this amateur philosophy in the back of my mind, I undertook the learning of QuarkExpress—a complex page-maker program used in publishing. Let me tell you that after a few jolts to my ego, I got defiant (back to my childhood) and responded by poking and prodding my way through the complex program. Guess what I found out? I'm as tough as any teenager, maybe as tough as a ten-year-old!

We all agree that many program manuals fail to explain things in a complete, precise style, or, if they do, the material is over complex or much too technical for the unskilled user. I discovered that kids whiz through the on-screen tutorials and then dive into the menus with gusto. The help button is pressed frequently, and when a menu item or button function is mysterious or unknown—the kids press it! That was the approach I used with great success. It is true that the computer burned me a few times, but I never said, "Ouch!"

So I say to all you oldtimers, from ages 20 through 95, turn on your computers and jump into a program! You have nothing to fear but the mouse itself, and the mouse does not bite.

Julian Martin
Editor

How to make your car invisible to radar and laser...legally!

Rocky Mountain Radar introduces a device guaranteed to make your car electronically "invisible" to speed traps—if you get a ticket while using the product, the manufacturer will pay your fine!

by Phil Jones



The Spirit II will "jam" radar, preventing police from measuring your speed.

If your heart doesn't skip a beat when you drive past a speed trap—even if you aren't speeding—don't bother reading this. I can't tell you how many times that has happened to me. Driving down the interstate with my cruise control set at eight miles over the limit, I catch a glimpse of a police car parked on the side of the road. My heart skips a beat and for some reason I look at my speedometer. After I have passed the trap, my eyes stay glued to my rear view mirror, praying the police officer will pass me up for a "bigger fish."

It seems that as speed-detection technology has gotten more and more advanced, speeding tickets have become virtually unavoidable. And although devices exist that enable motorists to detect these speed traps, they are outlawed in many states... including mine.

The solution. Today, Rocky Mountain Radar offers drivers like me a perfect solution—the Spirit II. Utilizing a passive radar scrambler, The Spirit II makes your automobile electronically "invisible" to police speed-detecting equipment.

The radar scrambler works by mixing an X, K or Ka radar signal with an FM "chirp" and bouncing it back at the squad car by way of a waveguide antenna, effectively confusing the computer inside the radar gun.

Perfectly legal. Some radar devices have been outlawed because they transmit scrambling radar beams back to the waiting law enforcement vehicle. The Spirit II, however, reflects a portion of the signal plus an added FM signal back to the police car. This, in effect, gives



the waiting radar unit an electronic "lobotomy." Best of all, unless you are a resident of Minnesota, Oklahoma or Washington, D.C., using the Spirit II is completely within your legal rights.

How it scrambles radar. Police radar takes five to 10 measurements of a vehicle's speed in about one second. The Spirit II sends one signal that tells the radar the car is going 15 m.p.h. and another signal that the car is going 312 m.p.h. Because police radar can't verify the speed, it displays no speed at all. *To the radar gun, your car isn't even on the road.*

HOW TO MAKE YOUR CAR DISAPPEAR

Radar and laser scramblers are devices that foil speed traps by making vehicles electronically "invisible" to police radar. Radar scramblers mix a portion of the radar signal with background clutter and reflect it back to the squad car. This technique, pioneered by Rocky Mountain Radar, creates an unreadable signal that confuses the computer inside the radar gun.

The laser scrambler in the Phazer works in a similar manner. It transmits a special infrared beam with information designed to scramble the laser signal. The result? Readouts on police radar and laser guns remain blank. As far as the police officer is concerned, your vehicle is not even on the road.

The Spirit II makes your car invisible to police radar or the manufacturer will pay your speeding ticket!



Range up to three miles.

The Spirit II begins to scramble radar signals as far as three miles away from the speed trap. Its range of effectiveness extends to almost 100 feet away from the police car, at which point you should be able to make visual contact and reduce your speed accordingly.

Encourage responsible driving. While the Spirit II is designed to help you (and me) avoid speed traps, it is *not* intended to condone excessive speeding. For that reason, there is an optional one-year Ticket Rebate Program for just \$19.95, the manufacturer will pay tickets where the speed limit was not exceeded by more than 33%, or 15 miles per hour, whichever is less.

Double protection from speed traps.

Radar isn't the only weapon the police use in their revenue-generating speed traps. The latest weapon in their arsenal is the Lidar gun. To counter the latest threat, Rocky Mountain Radar created the Phazer. Like the Spirit II, the Phazer also scrambles laser in a similar manner as the radar scrambler. It uses light-emitting diodes (LEDs) to fire invisible infrared pulses. It confuses the computer inside the laser gun by giving false indication of the car's distance, blocking measurement of your speed. It includes the exclusive Ticket Rebate Program.



Triple your protection against speed traps.

If either the Spirit II or the Phazer sounds good, but you prefer to be notified when you are in range of a police radar, the Phantom is for you. The Phantom combines the Phazer (including the Ticket Rebate Program) with a radar detector. It's legal in every state except Minnesota, Oklahoma, Virginia and Washington, D.C. Ask your representative for more details!



Scrambles Radar



Risk-free. Thanks to Rocky Mountain Radar, speed traps don't make my heart skip a beat anymore. Try the Spirit II, the Phazer or the Phantom yourself. They're all backed by our risk-free trial and a three-year manufacturer's warranty. If you're not satisfied, return them within 90 days for a full "No Questions Asked" refund.

- The Spirit II \$99 \$9 S&H
- The Phazer \$199 \$14 S&H
- The Phantom \$349 \$18 S&H

Please mention promotional code 2351-11045.

For fastest service call toll-free 24 hours a day
800-399-7863



comtradindustries

2820 Waterford Lake Drive, Suite 102 Midlothian, VA 23113

LETTERS

Whooping It Up

Timeless Strobe Light

I just completed a project that's been on the back burner for almost a decade. Here's what happened. The February 1987 issue of **Hands-on Electronics** former title of **Popular Electronics** contained an excellent construction article: "Variable Strobe Light" by Marty Knight. I'd always wanted to build one, and the circuit itself wasn't very complicated. But I was stymied by trouble in obtaining all the parts. After a while, all the parts I did have (including a bulb bought many years ago at RadioShack) migrated into my junk box. I still thought about the strobe light project periodically.

Then, last week, a friend of mine cleaned out his garage and gave me a commercially-available strobe light that had seen better days. It was at least 15 years old, with broken wires and poor solder connections. It had its own wood-grain cabinet, power supply, and cord, but no bulb. As I examined it, I thought, "This circuit looks very familiar..." I dug out the old article and found that the circuitry in the cabinet-based strobe unit was about a 90% match with the circuit in the article.

I scattered kajillions of electronic parts all over creation until I finally found that bulb I had bought so long ago, still in its package. Fortunately, the article labeled the electrodes, because RadioShack didn't label them at all. I hooked everything up, double-checked everything, crossed my fingers, and turned it on.

It worked! I let out a whoop so loud you could have heard it clear down at the post office. Thanks for printing the article, and thanks to Marty Knight for writing it. You never know how long readers will hang onto their electronics magazines, for some circuits never go out of date.

M.J.McC, KJ5BA
Arlington, TX

Output Omission

In the schematic diagram that accompanied my article, "Build a Four-Mode Counter" (**Popular Electronics**,

March 1996), the output of U2-b was not drawn in; the input is shown. In fact, the second half of flip-flop U2 has no actual role in the circuit. I connected it as a divide-by-2 of the clock for convenience, but the user can employ it in any way desired.

Clement S. Pepper

Parts Search

I read the article, "Build an Automatic Headlamp Control," which appeared in the February, 1997 issue of **Popular Electronics**. I would like to build the device, but I'm having trouble finding parts. Mouser Electronics says that the IRF9Z30 P-channel MOSFET (Q1) found in the parts list has been discontinued by Thomson. No substitution is listed. Any suggestions?

I'd also like to know where to get a heat sink like the one used by the author. Mouser doesn't show anything similar. Thanks.

B.W.

Greenville, SC

If you are unable to obtain the IRF9Z30 P-channel MOSFET described in the Automatic Headlight Control construction article, a good substitute is the IRF9Z34 unit, which is available from Digi-Key. Page 186 in the January/February 1997 catalog.) General-purpose heatsinks can be found from a number of sources. Again, try Digi-Key (page 161). If you still have trouble finding parts, you can always obtain them from the author as indicated in the article. Hope this helps!—Editor

KEEP IN TOUCH

Now there are more ways than ever to contact us at **Popular Electronics**.

You can write to:

Letters

Popular Electronics

500 BI-County Blvd.

Farmingdale, NY 11735

Or you can send e-mail to:

peeditor@gernsback.com

And don't forget to visit our Web site at:

<http://www.gernsback.com>

Haves & Needs

I bought a couple of really nice clocks at a surplus outlet. The only information on them reads: Favag Neuchatel, Made in Switzerland. There must have been some kind of power supply that operated them. Each one has a geared wheel that is turned by a small armature that only turns a half turn with each pulse. But the first half turn has got to be negative. It will stop there; if you change it to a positive pulse, it will go another half turn. Each half turn is one second, and it looks like 12 volts works it fine, but I notice it will operate on a lower voltage.

I would like to build a power supply that can change from negative to positive with enough current to operate my clocks. I would need some kind of supply that would pulse negative and positive every second, and I am not sure how to build one. If anyone can help me out there with a circuit, I sure would appreciate it.

THOMAS A. BROWN, W3AKP
P. O. Box 259
Crownsville, MD 21032-0259

Help! I need an operator's manual for a metal locator. The model is XR8, manufactured by Techna Inc., El Paso, Texas. Can anyone help me out? Thanks.

JIM MAZIES

22911 Valley Drive
Richton Park, IL 60471

I have read many articles on GPS and Loran-C, and the NMEA data and 0183 format that they output. But I have never seen anything about an interface and simple software for using that data with a computer. I would appreciate any information from your readers on an interface for IBM and Commodore computers, and a simple software program (Basic, DOS, etc.) for using the NMEA data, 0183 format.

Thanks for any help you can provide.
GEORGE C. BOONE, KB4GTZ
116 Sixth Avenue
Radford, VA 24141

Study at home with the

Electronics Technician CD-ROM

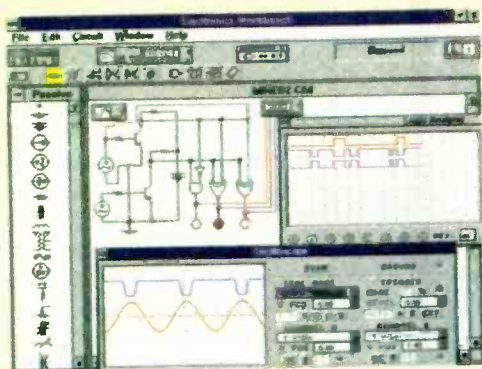

The only product of its kind

This unique CD-ROM based learning program includes 23 courses which are equivalent to a two-year Electronics Technician program and is recognized as the standard for Certified Electronics Technician programs across North America.

Purchase the CD-ROM separately or earn College credits.

The choice is yours. Buy the CD-ROM and use it as the ultimate electronics reference tool to refresh your knowledge of electronics, or enroll in the program and earn College credits. The course material is delivered using video, text, 2-D and 3-D animations color photos, audio, and over 450 laboratory projects. Use the CD-ROM in the home, office, or shop as a troubleshooting/design tool and reference guide.

Industry Recognition

The course content for the CD-ROM was developed in association with some of the top corporate trainers in North America, and focuses on practical applications and troubleshooting techniques.

Best Price

The CD-ROM costs \$249 and comes with **ElectronicsWorkbench 4.1**, laboratory software simulation package. Complete all 23 courses on the CD-ROM and receive certification as an Electronics Technician. Tuition for the program includes computer-based tests, tutorial help via 1-800 numbers and the internet.

Public Sector Standards

The CD-ROM was designed by George Brown College, one of the largest and most innovative community colleges in North America. Graduates of the program can continue their studies towards an undergraduate degree through the Minnesota University (Bemidji State) distance education program.

Easy at-home learning

All you need is the CD-ROM, no expensive books or lab equipment is required. Complete each course at your own pace, schedule the time that's best for you and decide how quickly you finish each course. The typical completion time is 48 weeks of part-time study, but there are no time limits.

Call now! Toll Free!

Call our 24-hour toll-free hotline to find out more about the Electronics Technician CD-ROM or the distance education program.

1-888-553-5333

George Brown College, 160 Kendall Ave., Toronto, Canada
M5R 1M3 Fax: 416-415-4727, web site: <http://www.gbrownc.on.ca>

MULTIMEDIA WATCH

About the Changes Taking Place with PC Sound Hardware

BY MARC SPIWAK
TECHNICAL EDITOR
WINDOWS MAGAZINE

There haven't been any big changes to PC sound card architecture for some time now. Sound cards are pretty much all 16-bit stereo with 32-note polyphony, and most of them use wave-table synthesis. But you will soon see some very different products coming on the scene, including some of the first PCI sound cards. You'll also see or, rather, hear true 3-D sound.

AWE64 now has 64-voice polyphony and improved sound quality over the AWE32. It also provides hardware acceleration for DirectSound and DirectSound3D. While the AWE64 Gold is more sound card than most people need, it's still relatively affordable, and there's a non-Gold version which costs \$50 less that offers the same basic capabilities.

multiple instruments are layered on top of one another, can use up the 32 notes rather quickly.

Electronic musicians and software developers now have the option of using the AWE64's 64-voice polyphony. Half of the AWE64's voices are provided by an EMU8000 wave-table synthesizer that's now been completely integrated into the AWE chip. The other 32 voices are produced by Creative WaveSynth/WG, a software wave-table synthesizer. This synthesizer lets the AWE64 remain compatible with 32-note MIDI sound boards and lets 64-voice MIDI files be played on any Windows MIDI player.

Unfortunately, a software synthesizer needs assistance from a CPU, so the AWE64 cannot be installed in anything less than a Pentium 90. Creative WaveSynth uses Sondius WaveGuide technology, which incorporates mathematical models of real instruments to generate sounds. The AWE64 also offers 3-D Positional Audio, which lets it steer sounds—bundled software demonstrates this effect.

The AWE64 Gold has 4 MB of RAM, upgradable to 28 MB, but only with Creative Labs' memory modules and not with standard 30-pin SIMMs like the AWE32. The plug-and-play card installs in a 16-bit ISA slot. It has a line input, a microphone input, a joystick/MIDI connector, and gold-plated line-level RCA output jacks. The SPDIF output is located on a separate bracket with a cable connecting it to the sound card. Bundled software applications include: players and recorders for all types of multimedia files, control panels for the sound card, a mixer, a program that lets you link and embed sound files into other documents, text readers, voice-recognition software, and so on. But the best thing about the AWE64 Gold is how good it sounds! It's got the best sounding MIDI I've ever heard from a sound card. If you've got the \$249, then go for the Gold.

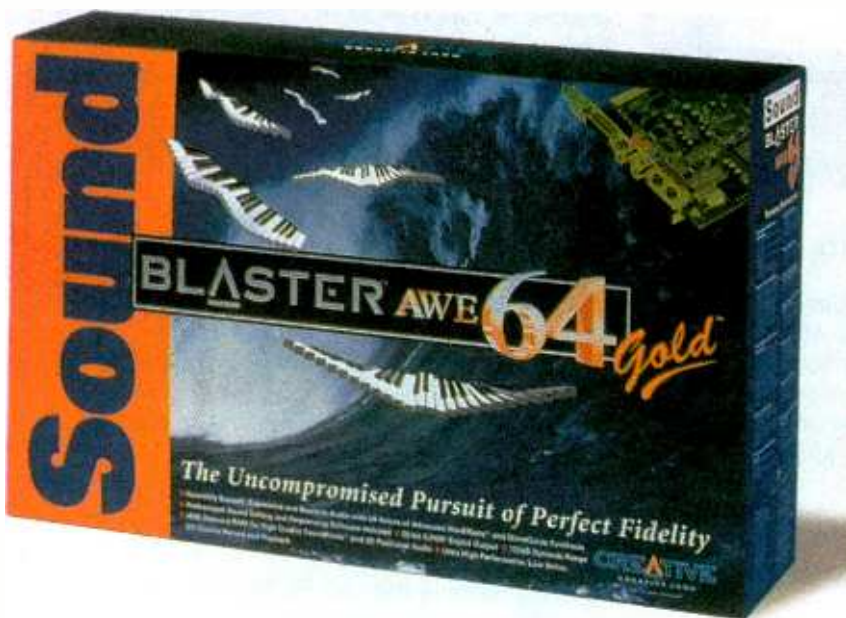

Creative Labs Sound Blaster AWE64 Gold has 64-voice polyphony, improved sound quality, and hardware acceleration for DirectSound and DirectSound3D.

Not just an effect that opens up the sound field, true 3-D sound is steered on the fly by what's happening on the screen. For example, if you steer to the left or the right of an object, its sound can be steered accordingly. If you shoot at something and blast it into five pieces, each piece hurtling toward you can create its own soundtrack, as it moves around you.

Even the most popular sound card in the business has changed! Creative Labs new *Sound Blaster AWE64 Gold* sound card system is the first major change to the Sound Blaster line in quite some time, yet it still offers genuine Sound Blaster compatibility. The

To eliminate noise from the audio circuitry, the AWE64 Gold has no amplifier or IDE controller on board. Instead the AWE64 Gold has a SPDIF (Sony/Philips Digital Interface) output for a direct digital connection to DAT recorders or other equipment. The non-Gold AWE64, like the AWE32 before it, still has the amplifier and IDE controller. The AWE32, like most other sound cards, is a 32-note polyphony sound card that can play 32 notes simultaneously. But every single sound—gun shot, flute note or whatever, needs a separate note or voice. Complex compositions, where multiple notes are played simultaneously and

New breakthrough clones TV signals and sends them to any other TV in your home

Recoton's new development duplicates cable, TV, VCR and satellite signals and transmits them...without any wires!

by Charles Anton

Today, television choices are virtually unlimited. Between cable, satellite TV, videos and network programming, it's almost a full-time job trying to keep up with all the alternatives. And it promises to get more complicated in the future. Breakthroughs in fiber optic technology will bring over 500 channels into your home.

Home broadcasting breakthrough. The problem with all this technology is the expense required to maintain your system and keep it up-to-date. Now, a wireless video broadcasting system from Recoton gives you the power to utilize this technology without the hassle and expense of re-wiring your entire home.

Today, Recoton introduces the next generation in wireless broadcasting. The wireless video broadcaster transmits (re-broadcasts) cable, TV, VCR or satellite programs to any other TV in your home...wirelessly!

Wave of the future. Never drag your VCR from room to room again: Recoton's wireless video broadcasting system transmits video or TV signals to any other TV in your home.

Because the system is totally wireless, you won't have to worry about running miles of wires. Besides, who wants to install cable in every room of their home? With Recoton's wireless video broadcasting system, you



won't have to. You can even watch one program on your main TV while someone else watches something different on another TV. It's just like having a personal broadcasting system in your home—and it's legal in every state.

Hi-tech home broadcast. Recently, the Federal Communications Commission allocated a band of radio frequencies specifically for wireless, in-home product applications. Recoton took advantage of the FCC ruling by creating and introducing wireless equipment that can transmit within the prescribed frequency over distances of up to 150 feet.

Wireless Video Breakthrough...

Cable Broadcast cable channels, even premium channels, to other TVs in your home that are not wired for cable.

Videos Transmit signals from one VCR to any room, even if someone is watching TV in the room that the VCR is in.

Satellite programs Watch satellite programs throughout your home without stringing miles of cable everywhere.

Live video View home videos as you film them or turn your camcorder into a security camera.

Network programs If the main TV is hooked up to an antenna, you can broadcast its clear signal to all the others.

Recoton's video broadcasting system clones the accessories (cable, satellite, VCR, etc.) of one TV and broadcasts it to any other TV in your home...without wires!

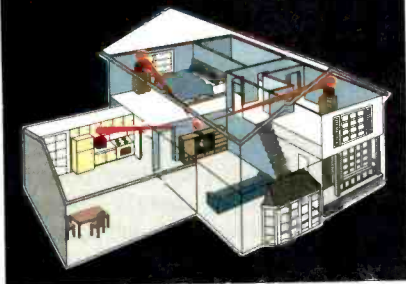

Exclusive factory-direct offer. With this breakthrough in home video broadcasting technology, you can have the convenience of your

own personal wireless broadcasting system for a fraction of the cost of owning your own TV station. For a limited time only, we are offering Recoton's wireless video broadcasting system (one transmitter and one receiver) for the low price of \$99. You can order additional receivers for other TVs for just \$59 each.

Risk-free offer.

The wireless video broadcasting system by Recoton is backed by Comtrad's exclusive risk-free home trial. Try it, and if you are not completely satisfied, simply return it within 30 days for a full "No Questions Asked" refund. It also comes with a 90-day manufacturer's limited warranty. Most orders are processed within 72 hours and shipped UPS.

Video Broadcasting System \$99 \$9 S&H
Includes one transmitter and one receiver.

Additional receivers (each) \$59 \$7 S&H

Please mention promotional code 173-11046

For fastest service, call toll-free 24 hours a day

800-704-1201



To order by mail, send check or money order for the total amount including S&H (VA residents include 4.5% sales tax). Or charge it to your credit card by enclosing your account number and expiration date.

COMTRAD INDUSTRIES

2820 Waterford Lake Drive, Suite 106
Midlothian, Virginia 23113

ADD A TV TOWER?

Buying your own TV tower would cost you about \$3.5 million. The video broadcasting system is like buying your own TV station, but without the expense. For just \$99, the Recoton system is like adding a cable box, VCR and satellite dish to every TV in your home.

WHERE TO GET IT

Access Software

4750 Wiley Post Way
Building 1, Suite 200
Salt Lake City, UT 84116
800-800-4880, 801-359-2900
<http://www.accesssoftware.com>

**CIRCLE 60 ON FREE
INFORMATION CARD**

Books That Work

2595 E. Bayshore Road
Palo Alto, CA 94303
800-242-4546, 415-326-4280
<http://www.btw.com>

**CIRCLE 61 ON FREE
INFORMATION CARD**

Broderbund Software, Inc.

500 Redwood Blvd.
P.O. Box 6121
Novato, CA 94948
800-548-1798, 415-382-4400
<http://www.broderbund.com>

**CIRCLE 62 ON FREE
INFORMATION CARD**

Comfy

305 Madison Avenue, Suite 1165
New York, NY 10165
800-99COMFY, 212-599-2000
<http://www.comfyland.com>

**CIRCLE 63 ON FREE
INFORMATION CARD**

Creative Labs

1901 McCarthy Blvd.
Milpitas, CA 95035
800-998-5227, 408-428-6600
<http://www.creativelabs.com>

**CIRCLE 64 ON FREE
INFORMATION CARD**

Discovery Channel Multimedia

7700 Wisconsin Avenue
Bethesda, MD 20814
800-678-3343, 317-579-0413
<http://www.multimedia.discovery.com>

**CIRCLE 65 ON FREE
INFORMATION CARD**

Expert Software, Inc.

800 Douglas Road, Executive Tower
Coral Gables, FL 33134
305-567-9990, Fax: 305-443-0786
<http://www.expertsoftware.com>

**CIRCLE 66 ON FREE
INFORMATION CARD**

Proview Technology, Inc.

12272 Monarch Street
Garden Grove, CA 92841
800-PRO-VIEW, 714-379-4455

**CIRCLE 67 ON FREE
INFORMATION CARD**

Psygnosis

919 East Hillside Blvd.
Foster City, CA 94404
800-438-7794, 415-655-8000
<http://www.psygnosis.com>

**CIRCLE 68 ON FREE
INFORMATION CARD**

Symantec Corporation

10201 Torre Avenue
Cupertino, CA 95014
800-441-7234, 541-334-6054
<http://www.symantec.com>

**CIRCLE 69 ON FREE
INFORMATION CARD**



Take a trip with *Koala Lumpur: Journey to the Edge* through an animated comic book world.

Norton Utilities 2.0 for NT set of tools has an estimated retail price of \$99.

Valhalla, a beautiful golf club in Louisville, Kentucky, was the chosen location for the 1996 PGA Championship. Now you can play a few holes at Valhalla right in your very own living room—or wherever you have your computer. Access Software is the biggest name in virtual golf, with a virtual course for your computer to match almost every famous golf resort in the world. *Valhalla Golf Club* combines Scottish-style links on the front nine, with a more traditional back nine. Valhalla supports all versions of Access's Links and Microsoft Golf as well. *Valhalla Golf Club* has a suggested retail price of \$29.95.

If one of your summer projects is to build a new dream deck outside your house, then you'll want help in designing and building it from *3D Deck 3.0* from Books That Work. This disc helps you design single- and multi-level decks, as complex as you want to go. For example, you can design in openings for hot tubs and landscaping. The program even lets you place furnishings, trees, shrubs and more around your yet unbuilt deck to see what different things would look like. A little help from *3D Deck 3.0* can mean the difference between a nice deck and a magnificent one. This one sells for about \$50.

Kids love pirates—it's that simple. Now kids ages nine and up can climb aboard an 18th century pirate ship and sail through history. Discovery Channel Multimedia's new adventure game *Pirates: Captain's Quest* takes you on 47 unique adventures and to 34 Caribbean ports. Players can board as a pirate, merchant, or privateer, and can even decide to be a male or female captain. There are plenty of activities, too, including sailing, sword fighting, trading, and more. Much of the content

New Hardware

Another neat new piece of hardware this month is the *TV Box* from Proview Technology. This 181-channel cable-ready tuner connects to any VGA monitor. You can switch between TV and your PC, but cannot watch TV in a window. You don't even need a computer; all you need is an antenna or cable TV—the *TV Box* turns an old color 14-inch monitor into a low-emission, high-resolution, remote-controlled color TV. The *TV Box* even has a built-in speaker, so your monitor doesn't need one. And for you couch potatoes out there, everything is controlled by a 23-key infrared remote. The *TV Box* costs only \$119—less than most color TV sets.

A detailed review of this product

appeared in the June 1997 issue of **Popular Electronics**.

New Software

Windows NT 4.0 is a new operating system that requires updated tools for housekeeping. Fortunately, Symantec is keeping up with Microsoft, and has recently released *Norton Utilities 2.0* for NT 4.0. The utilities are for use with NT 4.0 workstations and servers. In short, these tools let you defragment hard drives, repair disk problems with both NTFS and FAT, monitor resources, and maximize performance while eliminating problems as they occur. The Norton System Doctor runs in the background, and it will alert you to any potential problem or performance drain. The

is historically accurate, so *Pirates: Captain's Quest* is a learning experience as well as entertaining. This voyage has an estimated street price of \$29.95.

Multimedia is one of the best ways to learn a new language. Expert Software's new *Speak German* is just what you need if you want to learn German. The disc transports users to a virtual German city, where they can explore things, meet people, and learn German along the way. You can hear perfect pronunciation, see the correct spelling of any word, record your voice and even compare it to a native speaker. The program keeps track of multiple users, remembering where each student left off on the last visit. For only \$14.95, *Speak German* is a no-risk enrollment in a beginning German language class.

Destruction Derby 2 is now available from Psygnosis. This is the sequel to the original automobile smash-up derby game with realistic crashes and smash-ups. Instead of displaying pre-rendered crash routines, accidents are now rendered in real time—everything but the crunching bumps.

There are also longer, wider tracks, with tunnels, jumps, alternate routes, and banking corners. Seven new tracks and improved special effects make this game even more exciting than the original. *Destruction Derby 2* is one way to smash out your frustrations without damaging the family car—and for only \$50.

New from Broderbund Software comes *Koala Lumpur: Journey to the Edge*. In this game you play Fly, Koala's spirit guide through an animated comic book world. You'll visit The Land of Lost Things, Stream of Consciousness, Eye in the Sky, and many more exotic locales. We rate this one as a twisted comic adventure. *Koala Lumpur: Journey to the Edge* has an approximate street price of \$39.

Last this month is Comfy's *Didi & Boo* for children ages 12 to 30 months. *Didi & Boo* is the latest software for the Comfy Activity Center, a special children's keyboard that connects to a PC's parallel port. This toy of a keyboard features large, colorful buttons, spinning wheels, a toy telephone, and other goodies.

Didi & Boo comes with a special overlay for the keyboard and a host of new activities for very young children. Kids can participate in exciting guessing games, role playing, make believe, and much more. Suggested price for the *Didi & Boo* package is \$35.

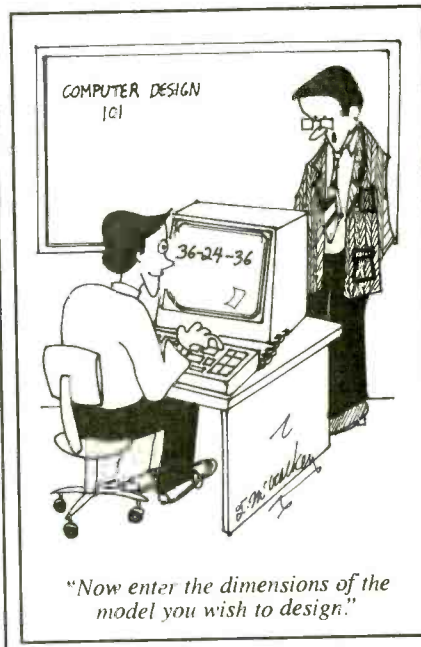

A (Real) Atlanta Company
Howard W. Sams

Will the Cubs win the pennant?
Will there be peace in the Middle East?
Will the big one rock California?

**America Wants to Know,
But They'll Need Their TVs to Find Out.
That's Where You Come In.**

**Fix the TVs that keep Americans captivated
with the help of PHOTOFACT.**

Howard W. Sams offers complete schematics for televisions, VCRs, and other popular consumer products.

(800) 428-7267 <http://www.hwsams.com>

CIRCLE 176 ON FREE INFORMATION CARD

NET WATCH

Apartment-Hunting Online

DAN KARAGIANNIS

Looking for an apartment is rarely easy. Finding the right number of rooms, in the right location, for the right price, often takes many months. And then, when you think you've found your dream pad—a place that not only fits your requirements but also feels great to be in—the broker showing you the place gets a phone call saying another agent has already accepted a deposit from someone else! The word frustration takes on whole new meanings when you are in this situation.

I know what this process is like firsthand, as less than a year ago I went through a four-month, grueling search that finally culminated in my ideal apartment. But what if there was a way to learn more about an apartment before investing the time to go see it? What if you could read more than just a ten-word description in your local newspaper?

Thanks to a few innovative sites on the Web, it's now possible to get in-depth descriptions of prospective places to live, and even see images of most of them online. There is even a site that, as we'll see in a moment, that also lets you take a virtual 360-degree look at an apartment's interior, right over the Web. These visual features of the site come in especially handy if you're planning on relocating to another state and can't afford to fly out to see just any place.

Rent. Net

With over one million-and-a-half available rentals across the contiguous 50 states and Canada displayed, Rent.Net, using the latest in Web technology, is an excellent first stop on your search for a place to call home. The database is free and easy to use, and can help you find a place to live in one of 1,200 cities.

When you first log onto the site you are presented with a few choices. The link most people will click on is the Unfurnished Apartments one, but you can also select from Temporary Furnished Suites, International Rentals, and Self-Storage Facilities.



One of the most innovative features of Rent.Net is its use of the Total View BubbleViewer, which lets you take a 360-degree tour of the rooms in an apartment.

Unfurnished Apartments lets you choose where you would like to begin your search. Click on a state or province and you're on your way. You'll then get to choose what type of place you are interested in—studio through three or more bedrooms—and then pick from various price ranges. Once you have made a realistic selection, a list of links showing possible places for you to live will then come up on-screen. Each apartment will have a checked-off list of amenities, such as whether the place has air conditioning,

parking, or even a pool. Below this are several paragraphs worth of information that should answer most questions you would ask a real-estate agent. For example, you'll find out what important places are nearby, such as shops and the like, as well as specific rules regarding whether you can have pets, smoke, etc. There are usually floor plans you can bring up, too, which will give you an idea of whether your sectional sofa will fit in the living room. An outside view of the building is often available, as are maps of the area. But what about inside views? Well, as I mentioned earlier, some of the apartments listed at Rent.Net allow you to download a simple plugin, Total View, and go through a virtual, 360-degree tour of your prospective new place to live. These tours tend to look best on Pentium machines with 16 megabytes or more of RAM, but if you don't mind a little jerkiness of motion, the tour should run on a 486 with at least 8 megabytes of RAM. Once you're ready to get serious about a certain place, you can either send e-mail to the particular office

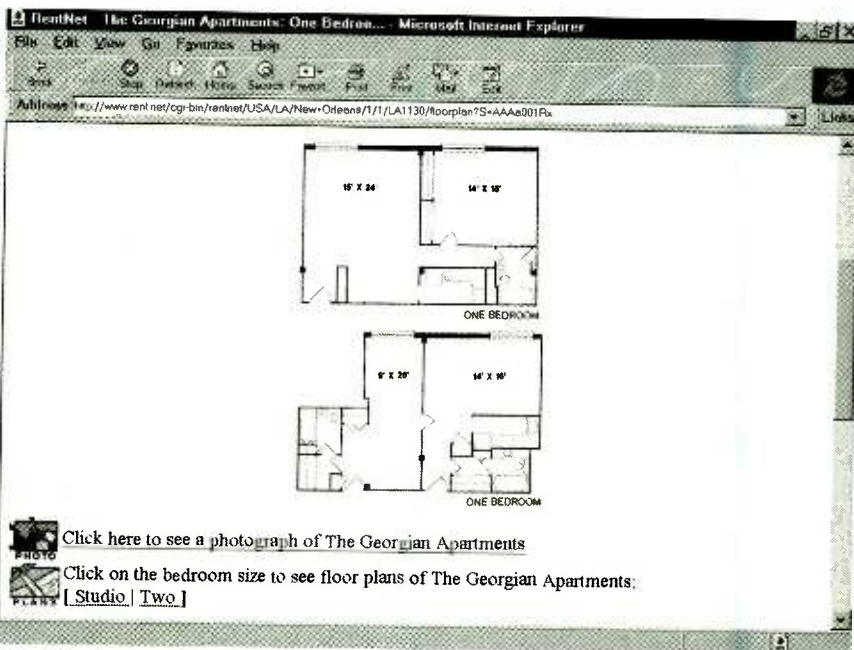

Rent.Net lets you do more than just read descriptions of apartments. You can actually download a floor plan to help you figure out if the place is right for you and your furniture.

handling the apartment, or call the number given at the top of the listing. Some offices let you get a head start by filling out an online credit application. Either way you go about it, the process is made as simple as can be.

For those who need a short-term place to live, Temporary Furnished Suites is the link to select. While not as interactive as the part of Rent.Net we just described, the Furnished Suites section provides you with links to companies that specialize in finding temporary places to live in particular areas. So if you pick New York, for example, you'll be able to fill out an e-mail form that describes what you're looking for in a place. You can also call a company to see what they have available.

Selecting International Rentals involves a similar process. Except here you pick a country and then choose from different types of services. For example, there's a chain called Apartment Hotels that lets you rent with a minimum of one night only. There are also some non-rental links, such as a resource for traveling in Europe by train.

Self-Storage Facilities links you to companies in each state that provide you with lockup storage. I should also point out that throughout all the main sections of Rent.Net, you will find ads that link you to assorted relocation-related services, including rental-truck agencies and sites that will give you a current credit report, just so you'll know what your future landlord will be reading about you.

For Rent Magazine Online

As much as I loved the power of the Rent.Net site, it's always best to have options. This next site, For Rent Online, based on the national magazine *For Rent*, lets you search through 10,000 rental communities across the country.

Similar to Rent.Net, with For Rent Online you can search by state, although not all states are represented, and you'll find fewer choices in each one. Once you pick a location, you're presented with a pull-down menu of the particular suburbs or towns in the area you are searching through. A number next to each shows you how many apartments are in the individual areas. You can narrow your search by selecting certain prefer-

ences, and then go. Results come up on the screen in a form that looks similar to the magazine's print listings (you might have seen this publication in a local supermarket). For Rent Online lets you also pull up floor plans and additional pictures of most apartments as well, though. Also like Rent.Net, this site lets you see maps of the area you are considering in, and gives you an opportunity to contact the agents directly involved with each place. There is also a nice little feature that lets you listen to a real audio description of the apartment. While what you hear is the type of sales pitch you might imagine it to be, it is interesting having this multimedia option.

HOT SITES

Rent.Net

<http://www.rent.net>

For Rent Magazine Online

<http://www.aptsforrent.com>

Overall, this site isn't as innovative as Rent.Net, but there are still different apartments to be found here than at the other site. For that reason alone it's

worth visiting. Although you will miss the convenience of being able to do a virtual walkthrough of apartments, you do eventually have to physically walk through a place you are interested in anyway.

That's about all for this month. If you'd like to get in touch with me, you can send snail-mail to *Net Watch*, Popular Electronics, 500 Bi-County Blvd., Farmingdale, NY 11735, or e-mail to netwatch@comports.com ■



Turn Your Multimedia PC into a Powerful Real-Time Audio Spectrum Analyzer

Features

- 20 kHz real-time bandwidth
- Fast 32 bit executable
- Dual channel analysis
- High Resolution FFT
- Octave Analysis
- THD, THD+N, SNR measurements
- Signal Generation
- Digital Filtering
- Triggering, Decimation
- Transfer Functions, Coherence
- Dynamic Data Exchange (DDE)
- Time Series, Spectrum Phase, Spectrogram and 3-D Surface plots
- Real-Time Recording and Post-Processing modes

Applications

- Distortion Analysis
- Frequency Response Testing
- Vibration Measurements
- Acoustic Research

System Requirements

- 486 CPU or greater
- 8 MB RAM minimum
- Win. 95, NT, or Win. 3.1 + Win.32s
- Mouse and Math coprocessor
- 16 bit sound card

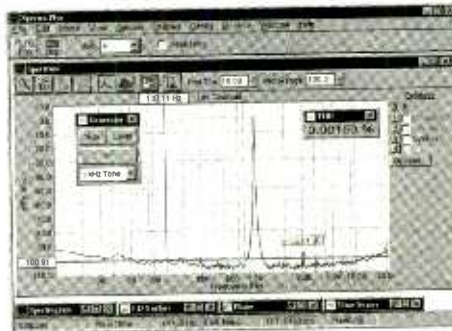

Priced from \$299

(U.S. sales only - not for export/resale)

Professional Quality Sound Cards Available...Call

DOWNLOAD FREE 30 DAY TRIAL!

www.telebyte.com/pioneer

PHS

Pioneer Hill Software
24460 Mason Rd. N.W.
Poulsbo, WA 98370

Spectra Plus 4.0
Affordable Signal Processing Software

Sales: (360) 697-3472

Fax: (360) 697-7717

e-mail: pioneer@telebyte.com

CIRCLE 175 ON FREE INFORMATION CARD

NEW PRODUCTS

Stand-Alone Windows 95/NT DSP Applications

The Hypersignal Application Interface (or HAppi) Wizard quickly generates stand-alone digital signal processing (DSP) applications for Windows 95 and NT. It does this directly from visually designed, real-time DSP worksheets created in Hyperception's Block Diagram editor. Those applications can then be applied internally or shipped to an end customer. The product leverages the many off-the-shelf DSP/acquisition boards supported by the company's Hypersignal RIDE (Real-time Integrated Development Environment),

The HAppi Wizard can be used for creating virtual instruments, sharing simulation/test results with others, and creating easy-to-use real-time DSP systems for non-technical personnel. Because the initial design is based on an open software architecture and employs a device-independent DSP board driver, users can create a virtually limitless number of applications. It can be used in the design of such DSP-based products as speech and telecommunications products, arbitrary function generators, modem test sets, spectrum analyzers and other virtual instruments, and multimedia applications.

capability in the palm of the hand. The GSC 100 also features an integrated GPS receiver for positioning and navigation, allowing users to navigate and communicate from anywhere on earth. Field professionals in disciplines ranging from seismology to oil exploration, outdoorsmen, hikers, pilots, international travelers, and all kinds of mariners can benefit from the technology.

The GSC 100 communicates via ORBCOMM, the first low-Earth-orbit satellite communications system. Users can send and receive text messages in an e-mail format to and from anywhere in the world, including another GSC 100. It can be used as a handheld terminal, operating on its rechargeable NiCd battery pack, or it can be bracket-mounted and operated by a 10–35-volt DC external power source. The self-contained, 8×3.5×1.75-inch, 37-ounce unit includes everything needed for satellite communications and navigation: ORBCOMM communications transceiver and telescoping antenna, GPS receiver and internal patch antenna, alphanumeric keypad, backlit LCD, and rechargeable battery pack.

To send an e-mail message, the user types it on the GSC 100, enters the destination e-mail address, and transmits the message. Using a standard narrow-band VHF radio frequency, the user's e-mail message goes up to the nearest of the 28 ORBCOMM satellites and down to a Gateway Earth Station. From the gateway, the e-mail message is routed via local land lines to the desired Internet e-mail destination, or transmitted to either another GSC 100 or to an ORBCOMM receiver. Future service options will allow outbound messages to be completed and incoming e-mail to be originated by a voice call or fax.

Messages are received in the reverse manner, with e-mail stored until the GSC 100 handset is activated and the satellite queried for unread messages. The portable unit will store up to 100 text messages and an address book with up to 150 entries.

The unit's integrated GPS receiver features six graphic navigation displays, customizable navigation screens, a real-

(Continued on page 75)

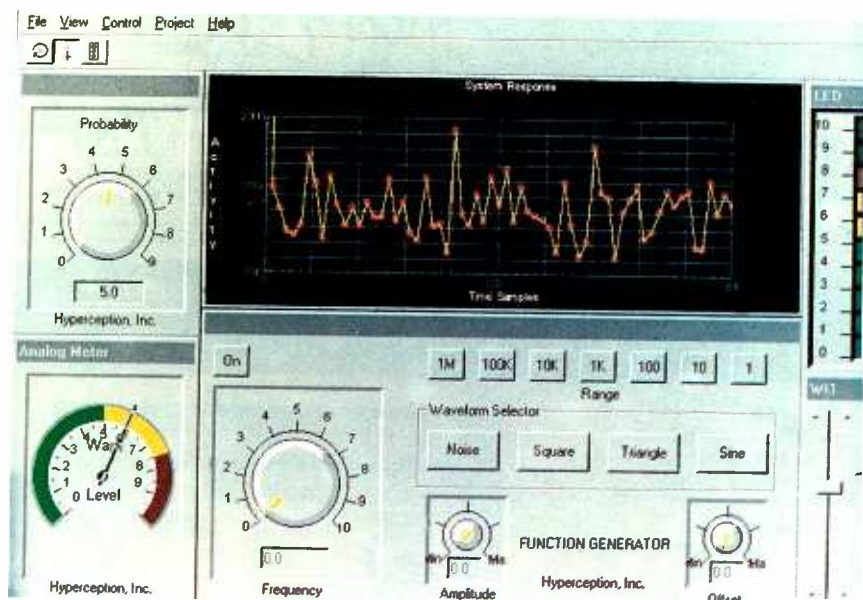

which reduces overall product development time. It also dramatically minimizes the technical expertise required for the simultaneous development of 32-bit Windows applications, data transfer software, and multiple-platform real-time DSP code.

The HAppi Wizard provides an executable version of their project. Within the visual design, user controls that represent inputs, outputs, and tunable parameters are used to accomplish I/O. (Objects such as knobs, sliders, keypads, meters, and displays among others are typical user controls.) After a project is designed graphically, the worksheet is saved as a file, which is then applied by HAppi to create the Windows application.

The HAppi Wizard costs \$1495. For more information, contact Hyperception, Inc., 9550 Skillman, LB 125, Dallas, TX 75243; Tel: 214-343-8525; Fax: 214-343-2457; E-mail: info@hyperception.com; Web: <http://www.hyperception.com>; BBS: 214-343-4108.

CIRCLE 80 ON FREE INFORMATION CARD

Handheld GPS Communicator

For people whose business or recreational pursuits take them off the beaten path and out of reach of conventional communications, the Magellan GSC 100 Global Satellite Communicator allows them to stay in touch wherever they roam. The portable receiver-transmitter puts worldwide, two-way e-mail

DX LISTENING

Is it Asia? Is it Europe?

DON JENSEN

Cyperus is a ruggedly beautiful Mediterranean island, a scenic country of mountains, valleys, and golden beaches, hilltop castles and old churches, with a pleasant California-like climate.

Here on this isle an interesting shortwave broadcaster is back on the air and is being heard with substantially better signals. Before going into detail about this station, let's first have a little history.

Turkish Republic of Northern Cyprus, (TRNC) an independent nation, but one recognized by only Turkey.

BRT Is Born

The Turkish Republic of Northern Cyprus runs a semi-official broadcasting organization that is called Bayrak R. and Television Corp. It was founded in 1963, says Mustafa Tosun, head of the Transmitting Department of BRT, when Turkish Cypriots were deprived

SW equipment has been delayed due to financial problems."

Hopefully by the time this column sees print, the station will be operating with a new U.S.-made CCA Electronics 25-kilowatt SW transmitter and a folded half-wave dipole transmitting antenna made by Kintronics Laboratories.

BRT's broadcasting center is in Lefkosa, capital of the TRNC. There it has its administrative and TV broadcasting facilities, plus eight radio production and continuity studios. Of its 400 employees, Bayrak International, as its shortwave service now is called, has about 25.

"Bayrak has three main radio and TV transmitting sites on the island and several repeater locations. Shortwave facilities are at the Yeni Yskele AM radio transmitting center in the eastern part of the Turkish Republic of Northern Cyprus," Tosun says.

He lists the current schedule on SW as 0700 to 2200 UTC, with English news at 1215 and 1730 UTC—not very good times for reception in North America.

However U.S. and Canadian DXers have reported hearing the station. It has a variety of musical programming, from blues to heavy metal, until sign off just after 2200 UTC.

"Reception reports are welcomed," Tosun told me. You can send them a letter, although the mail, which must be forwarded to the TRNC via Turkey, is slow. The address is Bayrak International, Bayrak Radio and Television, Ataturk Square, PO Box 417, Lefkosa, via Mersin 10, Turkey.

A faster way is via e-mail: brt@cc.emu.edu.tr. And if you want to plug in to BRT's Internet Web site, try www.cc.emu.edu.tr/press/brt/brt.htm.

Web Radio

I've talked in previous columns about using your computer as a tool to assist your shortwave listening. The paragraph above is one example of that.

Now it's possible to listen to foreign (and domestic) stations on your computer.



QSL card from Bayrak Radio and TV on Cyprus.

Cyperus is Asian, and lies only two score miles off the coast of Turkey. Cyperus is also European; the majority of its people are Greek. And it is that split that has resulted in major problems for this island nation.

Cyperus, a former British crown colony, gained independence in 1960. Greek and Turkish Cypriots found they could live together under a single government. However, in 1974, Turkey invaded and took over a substantial area of the island. Nine years later, Turkish Cypriots declared this territory the

of access to the existing Cyprus Broadcasting Corp. It has local AM and FM radio and TV services, plus an overseas SW operation.

The SW voice was small, only 7.5 kilowatts of power, but Bayrak R. sometimes was heard in North America on 6,150 kHz. Over the years, however, other stronger stations began overpowering its signals. For this and other reasons, the shortwave outlet left the air a little more than a year ago.

In 1997, though, the SW station returned on a new frequency, 6,159 kHz, where it again has been heard by U.S. and Canadian SWLs.

"These are tests for new frequencies on the 49-meter band," Tosun says. "We hope for better reception. But new

(Credits: Brian Alexander, PA; Erik Bueneman, MO; Jim Moats, OH; North American SW Association, 45 Wildflower Road, Levittown, PA 19057)

The demand for computer programmers will double by the year 2005...

Train now for a high-paying career as a computer programmer!

Only NRI at-home training gives you in-demand programming skills in three of today's hottest computer languages: BASIC, C, and Visual Basic.

Plus, you now train with and keep state-of-the-art programming tools: a Pentium® 166 multimedia computer system, Visual Basic, Windows 95, and more!

Prepare for today's newest programming opportunities

The Bureau of Labor Statistics forecasts that job opportunities for computer programmers will increase much faster than the average over the next 10 years, with as many as 400,000 new jobs opening up by 2005.

Now, with NRI, you can get the new skills you need to build a top-paying career — even a full- or part-time business of your own — in this high-growth field.

Learn today's hottest languages!

With NRI's unique Discovery Learning Method, you get hands-on programming experience as you master today's most popular languages and programming environments. Step by step, you learn to

create the kinds of full-featured, powerful programs today's employers and clients demand:

- You **start with BASIC**, building your confidence enough to create and modify several programs of your own.
- You move on to **master C**, a sophisticated language that's become the programming tool of choice for a variety of applications.
- You're then ready to **explore Visual Basic**, a high-level, object-oriented language designed specifically for creating programs in a Windows 95 environment.

Best of all, you master these important languages as you train with and keep the

most powerful computer system available from any school!

Send for your FREE catalog today!

See how NRI can give you the programming skills, the full-featured computer system, and the state-of-the-art software you need to get started in this top-paying field.

If the coupon is missing, write to us at NRI Schools, 4401 Connecticut Avenue, NW, Washington, DC 20008.

CALL 1-800-321-4634, Ext. 2564

<http://www.mhcec.com>



NEW!
Powerful 166 MHz
Pentium® processor-
based computer!

More equipment, more advanced software, and more real-world programming experience than any other school!



NEW!
Internet
Training!

- Pentium® 166 processor
- 16 meg RAM and 256K cache memory
- 1.6 gigabyte hard drive
- Super VGA color monitor; 1 meg video memory
- 8X CD-ROM drive and 16-bit sound card
- 33,600 baud fax/modem
- Netscape Navigator™ Web browser
- BASIC interpreter
- Power C and Visual Basic compilers
- Windows 95
- Exclusive access to NRI's Online Connection

Now, with NRI's new PC Options Plan, you can keep up with late-breaking advances in technology by upgrading your computer system at special student rates. You'll get all the details shortly before your computer is scheduled for shipment. It's NRI's state-of-the-art guarantee!

SEND TODAY FOR FREE CATALOG

NRI Schools

4401 Connecticut Ave., NW, Washington, DC 20008

Check one FREE catalog only

- COMPUTER PROGRAMMING
- PC Applications Specialist
- Visual Programming in C++
- Networking with Windows NT
- Microcomputer Servicing
- Desktop Publishing with PageMaker
- Bookkeeping & Accounting
- Multimedia Programming
- Mastering Microsoft Office
- Webmaster Series

GET YOUR DEGREE ONLINE!

- AAS Degree in Accounting
- AAS Degree in Business Management

Visit our Home Page at
<http://www.mhcec.com>

Name _____ Age _____
(please print)

Address _____

City _____

State/Zip _____



TEXAS INSTRUMENTS PS-6800 PERSONAL ORGANIZER

Get organized and plan ahead. You can even create and exchange information with your PC.

Palm-sized electronic organizers have been available for years, but few pack as many useful features in such a small space as Texas Instruments PS-6800 Personal Organizer. In a field dominated by two of Japan's biggest companies (Casio and Sharp), an American manufacturer has finally produced a highly competitive instrument.

Consider the following specifications. In a package measuring only 3- by 5-inches and roughly a half-inch thick, TI has managed to squeeze in one of the largest liquid crystal displays (6 lines with 24 characters per line) found in devices of this type. A necessarily cramped, 67-key entry pad occupies the remaining exposed surface. Internally, a full 128K of storage memory provides space for thousands of personal reminders, addresses and notes. An identical Organizer with only 64K of memory is offered by TI as the model PS-6700.

The built-in software includes a calculator (albeit, only four-function), a clock (with times shown in major cities around the world), a secret note area which is password-protected, and a full-feature database program for addresses of unlimited record length.

Packed with options

The PS-6800 Organizer is menu-driven and provides for a host of user-defined options. Included in these is the ability to change the displayed information into either English, Spanish, French, Italian or German. An indicator shows the status of the two lithium batteries, one of which serves as backup in a clever arrangement that lets you change either one without losing any of your valuable data.

Other thoughtful options let you



change the contrast level of the LCD screen, set the date and time, lock (or unlock) the unit with your chosen password, set daily alarms and check on the amount of memory you've used even to the next page. The sound made by each of your keystrokes can be changed from a "click" to a "beep" or silenced, if preferred.

The PS-6800 may be alone in its capability to allow address and phone number entries to run to as many lines as you wish. This eliminates the need to create imaginative abbreviations that other organizers impose because of their rigid data entry format.

A Scan button lets you quickly browse through your entire database of names and addresses, which are conveniently arranged alphabetically. No need to call up the entire record, if all you want to see is the phone number associated with your selection.

Of even greater value is the Find button that lets you search the entire data base for the occurrence of any keyword. Thus, if you have stored the names of service people whom you need to call upon, their records can be displayed by entering "Plumber,"

"Caterer," "Computer Repair," etc. This feature, not commonly found on more expensive organizers, raises this unit above the level of being just another electronic Rolodex.

A Bookmark function lets you mark any record as the one you may want to quickly return to the next time you turn on the Organizer. While of limited value, this feature epitomizes the innovations that TI's engineers chose to program into the PS-6800's read-only-memory.

Typical of these pocket wonders is the ability to store both daily and yearly reminders that trigger an alarm alerting you to the upcoming event. You can even set the advance notice time you want to be notified of any appointment or task. A variety of choices let you scan by week, month or year for birthdays, anniversaries or other special occasions you've opted to enter. The built-in calendar (good to the year 2059) aids in planning engagements.

Use your PC

TI offers the PS-6155 PC Connectivity Kit. No user of the PS-6800 Organizer would want to be without this compact docking station that permits exchange of information between the unit and your pc.

The Connectivity Kit comes with its own special Windows software package that installs easily and provides a user-friendly, full-featured means of downloading (and uploading) data between machines. The "Backup and Restore" function alone makes this a worthwhile buy, by providing the capability to both archive your time-consuming entries and prevent the total loss of data if your lost.

Beyond that, the Connectivity Kit

(Continued on page 77)

GIZMO®

Hey, Couch Potatoes, Surf's Up!

WEBTV INTERNET TERMINAL.
Manufactured by Philips Magnavox,
One Philips Drive, Knoxville, TN
37914-1810; Tel: 1-800-597-1790;
Web: <http://www.magnavox.com>.
Price: \$329.

If the cost of a computer is keeping you from getting on the Internet, then the Philips Magnavox WebTV terminal might be your gateway to it.

A TV might not seem like the best way to access the Net. After all, TV was not designed to deliver text. It was designed to deliver moving images—something that the Internet doesn't do very well. In short, however, the Philips Magnavox WebTV terminal can do a remarkable job of bringing the Internet to non-computer users.

Let's start out by saying that the \$329 price of the box is a little bit misleading. While it is possible to use only the supplied remote control to access the Web, it is inconceivable that many people would have the patience to do so. Entering text via an on-screen keyboard manipulated by a handheld remote is ... cumbersome, to use a polite phrase. So plan on adding another \$69 to get the wireless infrared keyboard. It is possible, we should point out, to use a standard IBM-compatible keyboard (mini DIN plug) with the WebTV terminal, but normal TV-viewing distances make that an inconvenient solution at best.

WebTV is not only an Internet service provider (ISP) but also an online service itself—much like America Online or CompuServe. When the box is turned on, it automatically connects to a WebTV "main page."

The main page is designed to allow users to surf the Web using only the remote control. New users will probably

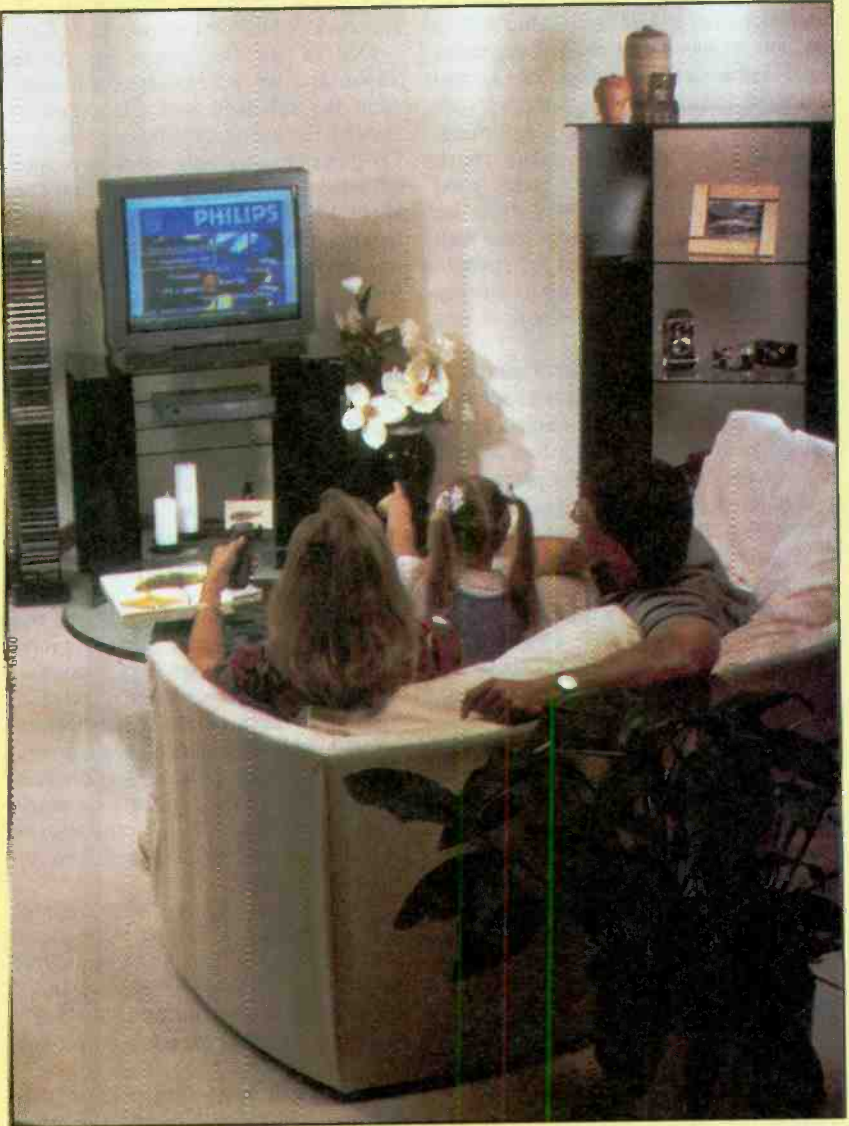

find it to be pretty good. Experienced Internet users won't—they'll just want to get to where they're going. But they can do that easily enough by choosing "option" and "go to."

Launch WebTV—by pressing the POWER button on the remote keyboard—and you're greeted by a city skyline accompanied by some suitably hip music

as the unit's modem connects to the WebTV network. The modem is fast—33.6 kilobits per second (Kbps)—and the WebTV's basic menu is inviting, offering icons for mail, favorites (otherwise known as bookmarks), explore, search, sports, news, and more.

If you're interested in just browsing the Web—or surfing, as many people call

it—then the WebTV interface is perfect. And you might even be happy using just the remote control, because WebTV is designed just for that. Because of that, there is some adjustment needed if you're coming to WebTV from the PC side.

We'll admit that it was difficult to get ourselves in the position to objectively evaluate WebTV because we are used to full-time Internet access over the corporate LAN (local area network). At home, we were inclined to stay away from online activities just because the response time became unbearable.

Even with our jaded outlook, however, WebTV lived up to its promise. Its modem is fast, and its basic menu system lets you wander in interesting, yet undefined and unrestricted, ways. The system is designed to deliver Web content speedily—which is probably a good thing. After all, even the most sedate couch potato is used to seeing a pretty good multimedia experience every time he turns on the TV. The relatively static Web can't hope to compete. WebTV Networks has some interesting tricks up its sleeves regarding video delivery, but more on that later.

WebTV has one major disadvantage: It uses a TV set as a display device. For text delivery, the TV doesn't present a problem because WebTV uses a font that is easily readable. However, for graphics—or text that is presented in a graphic—the TV can be a hindrance. A good example is the Popular Electronics Web site (start at <http://www.gernsback.com>), where the main navigation tool is a rotary "switch." Although the switch labels are perfectly readable on a VGA monitor, they are illegible on a TV—especially at normal viewing distances.

While WebTV Networks refuse to provide details on the number of subscribers it has, current industry estimates are that there are about 300,000 WebTV boxes in living rooms across the country. TV-set manufacturers—including Mitsu-bishi and Zenith—are beginning to build Web-access capabilities into their sets. Web masters will have to decide whether they want to alter their page designs to be readable on a TV screen.

We encountered a few other instances where our TV's screen resolution just wasn't up to where we'd like it, most notably, when viewing seating charts for sports stadiums or concert halls. Granted, many of these charts aren't really usable

on VGA monitors either, because many institutions scan paper versions of their charts and post the file as a .GIF image, unaware that they're essentially unusable. Most Web pages, however, look just fine on the TV.

The WebTV interface attempts to deliver some of the most popular Internet content in an easy-to-use menu system. For example, when first launched, the service provides icons for Mail, Favorites, Explore, Search, Around Town, Sports, News Briefs, and a highlighted WebTV content provider. Clicking any of the icons brings up submenus, making it possible to find interesting things with just a few clicks of the remote control.

One of our first stops was Around Town, and we selected area restaurants from the submenu that was presented. Instead of seeing information on local Long Island restaurants, we were presented with restaurants in New York City, about 40 miles away. We had better luck looking for local movie listings, which was able to show us the selections for the five theaters closest to our home.

The Explore icon makes surfing with the remote palatable. Click it, and you're presented with a host of options including Arts and Books, Community, Education, Entertainment, Kid's Club, Lifestyle, and Science and Technology. Click on any of those, and you're presented with other options—for example, Newsstand—to get you where you want to go ... even if you didn't know you wanted to go there when you started.

You can easily move from link to link with the remote control. WebTV is more of a link-based browser than a standard PC running, say, Netscape Navigator. Four cursor keys on the remote control are used to highlight links. They surround a central GO button that selects the link. Image maps are highlighted as a single link. When selected, an arrow cursor appears, allowing you to access any part of the image map.

Other keys on the top of the remote include up and down scroll buttons, and BACK and HOME buttons. In the middle of the remote are keys labeled OPTIONS, RECENT, SEARCH, FAVORITES and TV/WEB. Below the central section is a power button.

If nothing of interest is presented, then you can hit the OPTIONS button, and select "go to" on the screen. Enter any location you want, and the WebTV terminal will take you there.

Most of the pages you will encounter will present no problems to the WebTV terminal, which is compatible with most Internet "standards" including RealAudio. It's not compatible with everything, however. But one of the strong points about the WebTV terminal is that if

it's not compatible with a given technology now, it might be in the future. WebTV Networks can download software upgrades directly to your box.

One of the exciting technologies that WebTV has in store is VideoFlash, a technique for sending video over the Web. Sure, video exists on the Web now—mainly as grainy images in small windows that take forever to download. And streaming video such as RealVideo is available. But VideoFlash promises to outdo what's out there now.

One of the interesting things that VideoFlash does is take advantage of the TV screen's inherently low-resolution (when compared to a computer), interlaced display. By not sending video that is better than can be appreciated on a TV, performance is improved.

VideoFlash, however, is not based on IP, the Internet protocol. Therefore, it won't work on the Internet, but it will work only on WebTV Network's proprietary network. Industry analysts think that WebTV could end up fracturing the Internet in two, one half being a traditional computer-centric Internet, and the other being a TV-centric Internet with loads of multimedia—the kinds of things you're used to seeing when you turn on your TV. For example, instead of calling up a Web page just to check the latest scores, you could call up a page and see not only the scores, but the game highlights, too.

The fracturing of the Internet might not be the worst thing in the world. Moving some of the most popular sites—including CNNs and ESPNs—from the traditional Web and onto a proprietary network that can do a good job in delivering video might just open up some space for the rest of us.

Even without video, WebTV Networks and the Philips Magnavox WebTV terminal have some good things going for them. For example, the box is smart enough to keep an ear out for call-waiting signals. When it hears one, it can hang up and let the call come through. When the call is finished, the box can automatically connect again to the service. It can automatically check incoming e-mail periodically, and flash a light on the front of the box to alert users that mail is waiting.

Knowing that the terminal was not designed for computer users, ease of setup was of paramount importance. If you can handle plugging something into a phone line and into the back of your TV, you can hook up the WebTV terminal. You don't need to know anything about modems, and you don't even need to find the closest number to connect the WebTV Networks—it's all done automatically.

We still don't think that the living room
(Continued on page 30)

DVD Debuts

It's new, it's hot, and it's available!

Odds are, you haven't spent the last few weeks camped out in front of your local Circuit City, anxiously awaiting the day you could bring home your own DVD player. In fact, if you're not someone who goes out of your way to read about consumer electronics (and you're not a regular reader of *Gizmo*), you might not even have heard of DVD. In fact, you might not even know what DVD stands for—which, officially, is nothing, although many people take it to mean digital video disc or digital versatile disc. But you'll be hearing plenty now that several major manufacturers introduced DVD players.

It's been a long time coming, but DVD has finally become a reality. This month, we review one of the first-generation DVD players, *Panasonic's DVD-A300U*. First, though, let's take a look at the format, and what it might mean for you.

The DVD format offers better-than-laserdisc-quality video, Dolby Digital 5.1-channel surround sound, and digital convenience on a five-inch disc that looks just like a CD, but has a much larger storage capacity. A single-sided, single-layer DVD disc can store up to 4.7 gigabytes of information, enough to hold a 135-minute movie. A dual-layer disc holds 8 gigabytes, and a two-sided, dual-layer disc can store a whopping 17 gigabytes.

A single DVD can easily hold a full-length motion picture, with plenty of room to spare. Even epic films like *Lawrence of Arabia* or *Gone With the Wind* can be viewed without having to flip over the disc (which is considered a major drawback with laserdiscs). Disc manufacturers can include soundtracks in up to eight languages and subtitles in as many as 32 languages. One of the most talked-about applications is to include on a single disc multiple versions of the same film, with different ratings, perhaps, or your choice of endings. In fact, thanks to MPEG-2 video compression and the discs' unique double-layer design, there's enough room on a dual-layer DVD disc for as many as four films.

DVD also offers Dolby Digital sound capability, formerly known as AC-3. Dolby Digital sound provides the sense of continuously moving sound, through six discrete channels—full-bandwidth (3 Hz to 20,000 Hz) for the front left, center, and right, and the left and right surround channels, plus a dedicated low-frequency (3 Hz to 120 Hz) effects channel. To take full advantage of Dolby Digital, a decoder is required. Some high-end DVD players have built-in decoders; the rest

have outputs that allow a stand-alone decoder or receiver equipped with a decoder to be connected. If your AV system does not yet include a Dolby Digital decoder, don't worry; DVD works perfectly well with a Dolby Pro Logic setup, too. DVD players are also backward compatible with audio CDs and video CDs.

The DVD format boasts the convenience and durability factors that helped make compact discs so popular. DVD video discs provide instant access to specific scenes in a movie, and there's never any tedious rewinding required. They can be played literally millions of times without degradation of quality.

All of that translates to exceptional home-theater entertainment. But there's a good reason that some people call DVD digital *versatile* disc instead of digital video disc. After all, watching videos is only one DVD application.

By the time you read this, DVD-ROM drives for personal computers also should be available. DVD-ROM discs will hold up to 20 times more than CD-ROMs. (A single-sided, single-layer DVD has 3400 times the capacity of a floppy disk.) That's good news for multimedia users, since it will allow for enhanced game play with improved graphics, faster action, and extended 3D animation. DVD-ROM drives could also give computer manufacturers a new way to get PCs into American living rooms, since DVD-ROM drives will be able to play DVD video discs.

But, for now, the primary focus is on DVD players and movies. DVD supporters hope to see at least 200 titles available by year's end. Some of the earliest releases include *Twister*, *The Fugitive*, *Space Jam*, *Eraser*, *The Wizard of Oz*, *Batman*,

Blade Runner, *Raging Bull*, *Interview with the Vampire*, *The Mask*, and *Seven*, retailing for less than \$25. But fewer than 50 titles were available as we went to press, and only in seven major markets: Chicago, Dallas, San Francisco, Los Angeles, Seattle, New York, and Washington, D.C.

Therein lies the potential for format failure. Without a large library of videos on hand, DVD has little to offer the consumer. And if consumers aren't buying, there's little incentive to the motion-picture industry to produce more DVD discs.

Looking on the bright side, DVD has much more initial support than did the new compact disc format back in the early 1980s. And the long and rocky road to market that DVD has already traveled could actually place the format in a stronger selling position.

Because DVD bridges three major industries—consumer electronics, computers, and motion pictures—each with its own agendas and concerns, several sticky issues had to be resolved before a DVD standard could be agreed upon by all three groups, and the warring factions within each. Of utmost importance was developing a copy-protection scheme that would satisfy the major studios without compromising storage capacity and access times for DVD-ROMs. (In-depth discussions of DVD history and technical specifications can be found in the May 1995 and May 1996 issues of *Gizmo*.)

Because those problems were addressed and solutions hammered out before the market release, the public will not be subjected to varied incompatible versions of DVD products. Instead, the viewing public will be presented with a

(Continued on page 30)

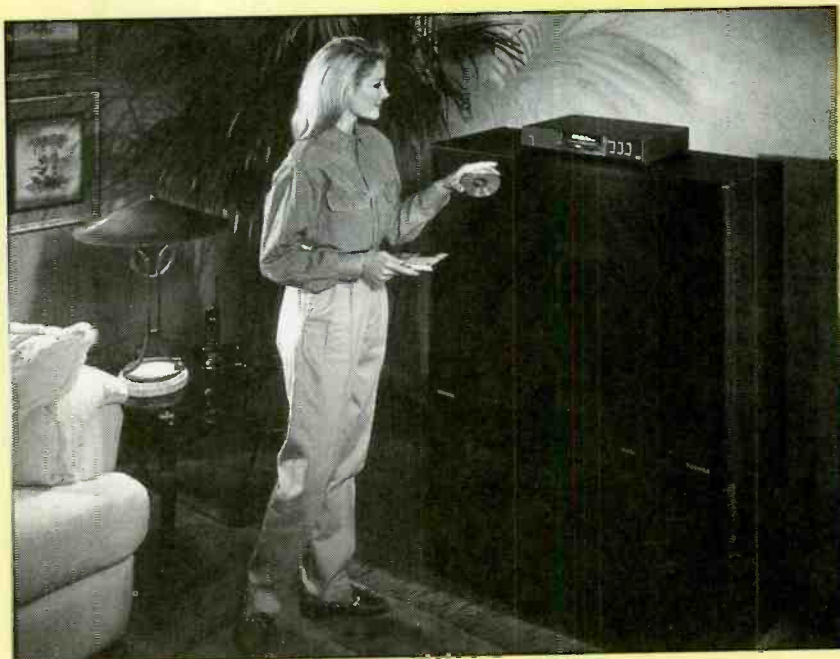



Digital Video Deck

PANASONIC MODEL DVD-A300U DVD PLAYER. From Matsushita Consumer Electronics Company, One Panasonic Way, Secaucus, NJ 07094; Tel: 201-348-7000. Suggested retail price: \$749.95.

At the past two Winter Consumer Electronics Shows, we've been treated to demonstrations of DVD players from several manufacturers. Now, we actually have our hands on the real thing—and so can you, as the first wave of DVD players hits the stores. All of them offer the digital video and audio benefits of the DVD format, including 500 lines of resolution, Dolby Digital six-channel surround sound, tremendous storage capacity, and flexible, convenient playback options. The first unit to cross our desks is the *Panasonic DVD-A300U*, Matsushita's top-of-the-line model with a built-in Dolby Digital decoder.

The DVD-A300U doesn't look revolutionary. With its slide-out disc tray and large jog/shuttle dial, it resembles a cross between a CD player and a VCR—which, in a way, it is. After all, it plays both music and videos. The disc tray is centered on the front panel, with a large display just above it. To the right can be found the jog/shuttle dial topped by two SKIP buttons; the OPEN/CLOSE control; and PLAY, STOP, and STILL/PAUSE buttons. To the left of the tray are the POWER button, level controls for echo and optional headphones and microphone, and jacks for phones and mic.

Several possible setup scenarios are described in the manual. The most basic involves the DVD player and a mono TV; the optimum arrangement includes an AC-3 amplifier and six speakers plus a subwoofer to take full advantage of the player's digital surround-sound capability. Our setup fell somewhere on middle ground—a large-screen TV with a Dolby Pro Logic receiver.

With the system hooked up, we were ready to jump right in and watch a movie. That's easy enough to do: Pop in a disc, select "play" from the main menu, and you're in business. If you want to take full advantage of DVD's many features, however, plan to spend a little time reading the manual and familiarizing yourself with the remote control.

(In an unfortunate design choice, the manual presents instructions in English, French, and Spanish on every page, presumably so that the illustrations wouldn't have to be repeated in three separate sections. The result is confusing to the eye, and requires three times the page turning on the part of the user.)

The remote control is chock full of buttons. Centered in the upper portion of the remote is a tiny joystick-style control, which also serves as a SELECT button. The joystick is ringed by four buttons: TITLE, MENU and two SKIP buttons. Between the SKIP buttons is the RETURN key. Rounding out the top portion are STOP and PLAY buttons. At its top are POWER and OPEN/CLOSE buttons. The remote control's midsection contains a numeric keypad along with a host of buttons for operating DVD functions, modes, and setup. The bottom portion of the remote features POWER and channel and volume up/down buttons that can be programmed (using the two-digit TV-manufacturer codes supplied in the manual) to operate your TV's basic functions.

For the most part, though, you'll be using the joystick and the buttons that surround it. To use any of the on-screen menus, you pull or push the joystick to move up and down through the lists of options, and then press it to select your choice. (If the options are numbered, you can also use the numeric keypad to indicate your choice.)

To pause the video and get a still picture, tilt the joystick up. Still images remain clear, unlike paused frames of videotape. When in still-picture mode, tilting the joystick up again advances the video one frame at a time with each movement; pushing it to right or left results in forward or reverse slow-motion

play. Tilting it to the right or left in play mode advances or reverses the video faster with each subsequent push. (The front-panel shuttle dial can be used for the same purpose.) The skip buttons found below the joystick are used to skip ahead or back chapter by chapter.

Most DVD discs contain menus from which you can choose the spoken language, subtitle language, and select the chapter you'd like to view. Pressing the MENU button displays the main menu available on the disc; submenus can be reached using the joystick/select control. Some DVD discs contain more than one movie or version of a movie; the TITLE button brings up an on-screen list of titles. By pressing DISPLAY during play, you can select the scene you want to view by its chapter number, or by time.

If there's a particular scene (or up to three particular scenes) that you know you'd like to see more than once, you can press MARKER and then SELECT while in play mode to mark and number it. Later, press MARKER and then use the joystick to select the marked scene number; play will resume from that scene. The marker function is especially convenient if one member of the family is habitually called away in the middle of a movie—perhaps your teenage daughter with her marathon

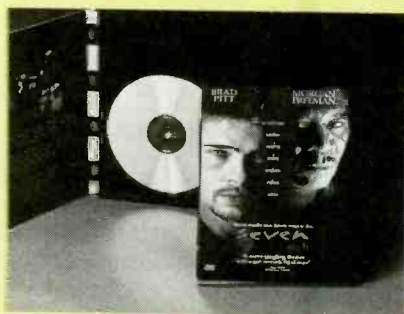

The DVD version of *Seven* allows viewers to jump directly to each of the horrifying seven deadly sins, which are split between each side of the double-sided disc.



The Mask on DVD disc features a commentary voice-over from the director, Charles Russell, as well as two additional scenes that were not included in the original theatrical release.

phone calls. With the scene marked, the rest of the family can finish watching the film, and she can come back later and easily pick up where she left off—as long as the disc hasn't been removed from the player.

The DVD-A300U offers a few other "convenience" buttons. Those include AUDIO, SUBTITLE, and ANGLE, which allow you to change the audio soundtrack or subtitle language, turn subtitles on or off, or select a different viewing angle during play without going to the menu. (Of course, those options must be available on the disc being watched.)

Like all other DVD players, the DVD-A300U is backward compatible with audio CDs and video CDs. The DVD controls described above work similarly for those older formats. In addition, the PLAY MODE button can be used to program the playing order of up to 18 audio tracks. Offering a microphone input and the ability to turn off the vocals on video discs, the DVD player can also be used for karaoke sessions.

The first DVD disc we opened was *Twister*—a film we'd yet to see other than at manufacturers' DVD demo sessions. It's a good pick for the DVD format, with lots of action and plenty of high-decibel sound effects. The disc offered a chapter menu consisting of thumbnail stills that represented a dozen or so scenes. That came in handy because we had an unusually large number of interruptions that afternoon (including a real-life thunderstorm that offered some serious competition to the on-screen weather action). As promised (and expected), both video and audio were a quantum leap superior to that of videotape.

Next, we watched *The Wizard of Oz*. Judy Garland never sounded better. Other than one slight glitch that resulted in a slight pause/skip in play, the picture was also of superior quality. That glitch was created in the encoding process.

The addition of DVD—even to a less-than-perfect home-theater setup—measurably improved our viewing pleasure. In fact, it made us think seriously about doing some equipment upgrades. (A definite plus as far as the consumer-electronics industry is concerned!) The screen size certainly could have been larger and its resolution sharper, and we wished that we had a Dolby Digital AC-3 amplifier.

While we weren't able to experience the full-blown maelstrom of the digital *Twister* soundtrack, the DVD sound delivered on our system still left us feeling a bit battered and windswept. And even though our television cannot deliver 500 lines of resolution, the DVD images were crystal clear in comparison to standard broadcast fare or VHS tapes.

(Continued on page 30)

Measure for Measure

PROMEASURE++ HOME CONTRACTOR MODEL HC 1000. From Seiko Instruments USA Inc., 2990 West Lomita Boulevard, Torrance, CA 90505; Tel: 1-800-873-4508; Web: <http://www.seiko-usa-cpd.com/cpd>. Estimated street price: under \$50.

We were rapidly approaching the end of a period of traumatic physical, emotional, and financial upheaval—otherwise known as a major home remodeling project. To accommodate our growing family—not to mention all the home-office space required for testing products and writing *Gizmo*—we had been faced with the difficult choice of either moving to a larger house or adding on to our existing home. After a few weekends spent roaming the town with realtors, we'd decided to take the plunge and convert our two-bedroom, one-bath, 1100-square-foot Cape Cod into an 1850-square-foot colonial-style home, with three bedrooms, a large office, a second bath, and a stand-up attic.

Finally, after weeks of noise, dust, confusion, and check-writing, the end was in sight. The contractors promised to be completely finished by the end of the week. What a relief it would be to actually be able to live in our palatial (well, at least in comparison) new home.

Unfortunately, "moving day" wasn't the following Saturday. Our budget simply didn't allow us to hire painters, or to have flooring professionally installed. Working weekends and evenings, we hoped to be furniture-ready in another couple of weeks.

Like thousands of other American homeowners who save money by making their own home improvements, we found ourselves heading to Home Depot to check out primers and paint as well as wood flooring for the office and hallway. Then we headed over to the carpet outlet center to search for the perfect rugs for the master bedroom and the nursery.

Paint chips in hand, we strolled through the aisles of rolled-up rugs, trying to match colors. We actually found a carpet in a soft shade of green that could work in both the master bedroom and the nursery, and the price was good. We wanted to buy it on the spot (to save another trip to that store), but we realized that we had no idea how much we would need.

Three rolls were available: 12×28 feet, 12×35 feet, and 12×50 feet. The nursery is 11×10½ feet, the master bedroom, 14½ by 15—plus that little section by the door, one standard closet, and a large walk-in. Shouldn't they be carpeted



too? And, if the price was so reasonable, how much might we save by carpeting the office also, instead of installing a hardwood floor in there?

It was at that point that we realized that we had no idea how much paint we would need either. All of our previous painting jobs had involved one small room at a time—a gallon generally did the trick.

We figured we'd better go home and pull out the tape measure and the calculator before we pulled out any credit cards. We'd get accurate measurements of each room, and then try to determine how much of each material would be required for the job. Even if we couldn't calculate gallons of paint per area of room, at least we could give the guy at the paint store a real figure to work with.

Serendipity struck, in the form of a package from Seiko Instruments, Inc. Inside we found a selection of electronic tools for home improvements, including the ProTape 16', the ProLevel, and the ProMeasure+++ Home Contractor—an electronic tape measure, level, and a tapeless measuring tool that also performs material estimates.

The ProMeasure++ was exactly what we needed. It measures distances electronically, calculates area and volume, and then computes the amount of materials needed to paint, panel, carpet, wallpaper, heat, or cool a room. But we ended up putting all three tools to use before we had finished painting, carpeting, and then decorating the new upstairs. (Short reviews of the other two tools follow.)

The ProMeasure++ (Model HC1000) is a lightweight, handheld device about the size of a remote control or a small flashlight. In fact, it looks a bit as if a

flashlight had been somehow inserted into a remote. Six inches long, $2\frac{1}{2}$ inches wide, the ProMeasure++ is about $\frac{3}{4}$ -inch thick at its bottom. At its top, however, the device measures just under two inches in diameter. The top is the electronic "Golden Eye," which measures distances using ultrasonic waves.

The ProMeasure++ serves as both a measurement "computer" and a "conversion calculator," and separate control pads are found on the "front" and "back" of the device. The measurement computer features an LCD readout and nine turquoise buttons: SUM, CLR SUM, MODE, RECALL, L, W, H, AREA, and VOLUME. Along the sides of the unit are two ON buttons, used to trigger the measuring system. The conversion calculator has its own LCD, an array of calculator keys (numbers and functions), and several touch-pad "conversion" buttons for selecting the material to be calculated: AIR, HEAT, TILE-C, TILE-F, PAINT, RUG, 4x8, and ROLL. In addition, there are soft keys labeled RECALL, ON/CE, and MODE.

Measuring a room couldn't be easier. You just place the base of the ProMeasure Plus against one wall, hold it parallel to the floor, and press and release the +sc+xsc key. Make sure that the unit has a clear line of sight, with no furniture to get in its way. When the measurement is complete (a matter of seconds), you'll hear four beeps.

The MODE button is used to select one of the three different display modes: English standard (feet and tenths of feet), Imperial (feet and inches), and metric (meters and centimeters). On-screen indicators let you know if the measurement displayed is in feet, feet and inches, or meters. For instance, if a room is 22 feet, 10 inches long, the default (English standard) display will read 22.8, with the foot indicator lit, or 22.8 feet. Pressing the MODE button once switches the reading to 22.10, with the inch indicator also lit.

Although the display's precision is only $\frac{1}{10}$ foot, one inch, or 1 centimeter, the ProMeasure's internal precision is higher.

and measurements can be stored with that higher precision.

Measurements are saved by pressing the L, W, or H key to indicate if you are measuring the room's length, width, or height.

Formulas for area and volume are built into the ProMeasure++. Once a room's basic dimensions are entered, a press of the VOLUME key automatically calculates the volume of the room. To determine the area of the ceiling or floor, you would measure the room's length and store it by pressing L, measure and store into W the room's width, and then press AREA. To find out the area of the walls, however, you must be a bit tricky and input the length into L and the height into W.

Once you've obtained the area and volume figures, it's time to begin calculating how much of each material you'll need in the room. Unfortunately, the figures determined by the measurement computer are not automatically transferred to the conversion calculator; you must input them manually, using the tightly spaced numeric keypad. Particularly if you're using the same materials in several rooms, you'll need to carry along a pad and pencil to keep track of all the area/volume figures that the ProMeasure++ has determined.

Actually, we also ended up carrying around a traditional calculator as well as a pad, pencil, and the ProMeasure++. We found the ProMeasure++'s conversion calculator to be too small and "mushy" for comfortable, accurate use. We preferred using our old, familiar pocket calculator to add up the long list of wall and ceiling areas we'd obtained with the ProMeasure++'s measurement computer.

Because we'd be using different paint colors in the various rooms, we obtained and jotted down subtotals for each room, then added those to the entire wall/ceiling area to be primed and painted: a whopping 3881.59 square feet. It was at that point that we seriously considered hiring a professional painter. Then we remembered our diminished finances, and bravely pressed PAINT. We learned that we

would need 11.50 gallons of primer to do one coat throughout.

Because we'd written down the subtotals for each room, it was then easy to determine how much flat white paint we'd need for the hallway, kid's rooms, and all the ceilings; how much "opal" we'd need for the master bedroom, walk-in closet, and office; and how much moisture-resistant white we'd need for the bathroom. We still didn't have a clue as to how much white semi-gloss would be needed for the doors and trim; and the ProMeasure++ wouldn't be much help there.

The same basic steps are used to calculate the required amounts of wallpaper, which is quoted in numbers of rolls, based on the standard size of 20.5 inches wide by 11 yards long; carpeting (in square yards); and heat (in BTUs).

Other factors come into play when figuring amounts of paneling, floor or ceiling tile, and heating and air-conditioning BTUs. If 4x8-foot sheets of paneling are being used, you simply input the areas of the walls, press memory recall, and then press 4x8. If you are installing a different size wall panel, you must add another step in the form of a "multiplier" (provided in the user's manual). For instance, if you are installing 2x8 panels, you would multiply the original results by 2. The default ceiling-tile size is 2x4 feet; the manual supplies multipliers for five other common sizes of ceiling tiles. As for floor tiles, the default setting tells you the number of 10x10-inch tiles required; multipliers are listed for six other sizes ranging from one-inch-square to one-foot-square. The manual's appendices include conversion tables for non-standard sizes of floor tiles, ceiling tiles, and wall panels, allowing you to find the proper multiplier for just about any size materials imaginable.

While the main factor that determines the BTU requirement for a room air conditioner is room volume, the manual lists a number of other factors—the number of people, windows, doors, arches, and lights in the room—that require adjustments, along with the amount of BTUs to be added for each. In addition, the manual provides a "Geographical Factor Map for Air Conditioning," which gives multipliers to use according to region.

While the ProMeasure++ has a lot to offer do-it-yourselfers, it can also be used by professionals. Realtors should appreciate the ability to easily measure each room in a just-listed house. And, while we're sure that contractors must have their own established ways of estimating materials requirements, we doubt they could be easier than this.

The ProMeasure even allows professionals to determine pricing, with mark-up and percentage functions. If a painter wanted a 40% profit margin on supplies,

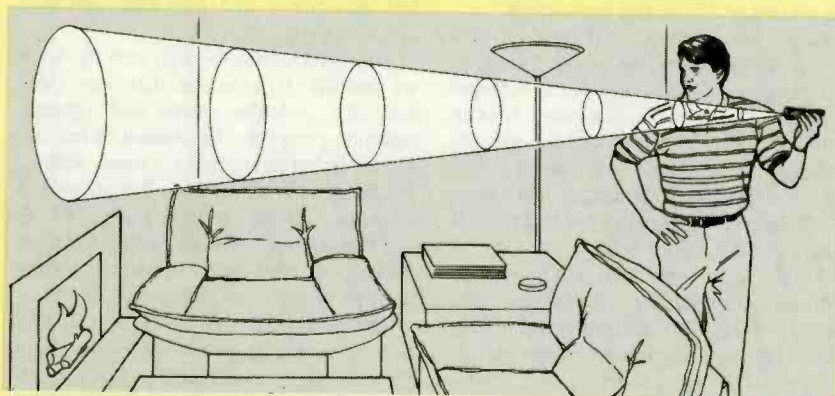

for instance, and had determined that paint would cost \$150, he would enter 150, press the MU (markup) key, enter the desired profit margin percentage (40), and then press “=.” The device would let him know what the sell price should be. Similarly, if he wanted to realize a 40% return on his investment, he would add 40% to the cost of materials.

We didn’t have much use for those functions, but we did put many of the others to good use—and then some. For instance, armed with the figures for how much paint and primer we’d need, it was easy to determine how much more we’d spend on \$19.99/gallon Benjamin Moore brand compared to the \$12.99/gallon Behr brand sold at Home Depot, or the stuff Sears had on sale for \$9.99/gallon. Although the ProMeasure++ offers no WOODFLOOR button, we were able to take the carpet figure (square yards) and divide it by 9 to figure out square footage instead. From there, it was simple to determine how much more it would cost to put wood instead of carpet in the hallway and office.

The ProMeasure++ has its drawbacks. Our biggest complaint is with the keys on the conversion calculator, which were so mushy that we often had to press them several times before they would respond—until we finally reverted to using a standard calculator and only using the conversion calculator’s keypad to enter our final tallies. We also would have preferred the conversion calculator to be linked electronically to the measurement computer, so that all of those figures could be entered as the measurements were being made. Measuring, writing down, adding up on a calculator, and then finally entering the total on the ProMeasure++ was somewhat cumbersome. And, while a completely accurate measurement is stored internally for use in computations, the displayed measurement is rounded off. That could lead to trouble if you’re measuring for something that can’t be figured with the conversion calculator—the exact length of a closet rod, for instance.

It was, however, quite a bit easier to measure a room using the ProMeasure++ than with a standard tape measure. It was also gratifying to be able to make informed decisions as we shopped for materials. Even better, though, was that—for the first time ever—we completed two major home-improvement jobs without having to run back to Home Depot for more supplies! And, when the job was finished, we didn’t have any unopened cans of custom-mixed paint left over, and had just enough carpet scraps to make a few doormats.

Now if only Seiko could come up with a tool to make painting an easier job. ■



Measure Once, Cut Once

PROTAPE 16' MODEL HC-500. From Seiko Instruments USA Inc., 2990 West Lomita Boulevard, Torrance, CA 90505; Tel: 1-800-873-4508; Web: <http://www.seiko-usa-cpd.com/cpd>. Estimated street price: under \$30.

“Measure twice; cut once.” It’s one of the fundamental rules of carpentry. If you don’t take accurate measurements at the outset of a project, you’ll end up in trouble sooner or later. That’s why every toolbox contains a tape measure.

Yet a standard tape measure leaves something to be desired. Even when it is equipped with a tape lock, the tape often shifts a fraction of an inch when you try to get close enough to read the measure-

ment. And even the longest tapes won’t reach completely around a room to determine the amount of baseboard molding required.

Enter the *ProTape 16'* electronic tape measure from Seiko. It looks like a standard tape measure, with a metal clip for wearing it on a belt, although it’s encased in non-traditional black with turquoise trim. A large LCD readout and five buttons reveal its true nature. The ProTape 16’ works just like a standard tape measure—pull out the tape, check the measurement, retract the tape. But when you have it stretched across a floor, you don’t have to bend down or lift it up to take a reading, and run the risk of the tape retracting slightly. Instead, you simply push a button, and the measurement appears on the LCD.

At first, an electronic tape measure seems gimmicky and unnecessary—one of those Father’s Day gifts bought out of

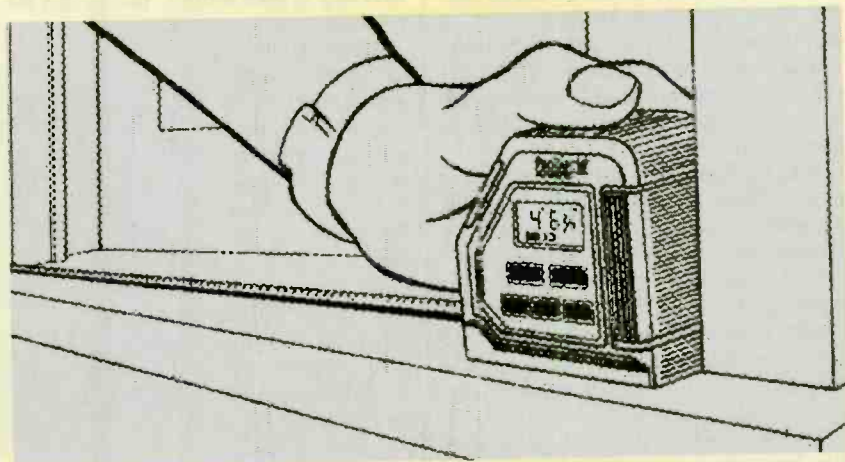

With the press of a button, the ProTape automatically adds the case length for inside measurements.

desperation that never sees the light of day. That's what we thought, until we used the ProTape 16'.

Getting accurate measurements is so easy with the ProTape. You simply stretch the tape from one end of the surface to be measured to the other, and the precise measurement appears in the LCD. Press the MR/DISP button, and the measurement is locked in place—before you move the tape measure and, possibly, the tape. If you're taking inside measurements—the interior of a closet, for instance—there's no need to either bend the tape and try to read the figure in the angle or to add the dimensions of the tape-measure case to the measurement on the tape itself. The ProTape does the arithmetic for you. With a press of the CASE button, the size of the case (3½ inches) is added to the displayed measurement and a plus sign appears in the display.

A 16-foot tape measure might seem too short for many jobs. But what the ProTape lacks in length, it more than makes up for in brains. The device allows you to take cumulative measurements. If your living room is 18 feet long, for instance, you can measure 16 feet, enter it into memory by pressing the M++ button, measure the remaining two feet, and enter that into memory. A press of the MR/DISP button then shows the total length of both stored memories.

That feature comes in handy for many tasks. If you need to determine the total linear feet of a room that you plan to wallpaper, for instance, you can measure along each wall, storing the measurements as you go along, and eventually come up with an accurate total. If you have a stack of wood sitting out in the garage, and want to know if there's enough for the shelving project you have planned, you can measure each one, and the ProTape quickly tallies the total for you. It even keeps a running score of how many measurements are stored, up to a maximum of 99. After that, it keeps storing them, but stops keeping count. It can't, however, display any of the individual stored measurements. The LCD can display maximums of 299.999 meters or 984 feet, 3 inches. A press of the MC button clears the memory.

The ProTape offers a handy non-electronic feature as well. It allows you to accurately draw any size circle or arc. By flipping out a panel that is normally folded into the case, a small pinpoint is revealed. Position that pinpoint at the center, extend the tape measure to the desired radius length, and insert a pencil through the holes that are punched at evenly spaced intervals on the tape.

Yes, the ProTape 16 is a bit gimmicky. But, hey, some gimmicks work—and this is one of them. The only easier way we've

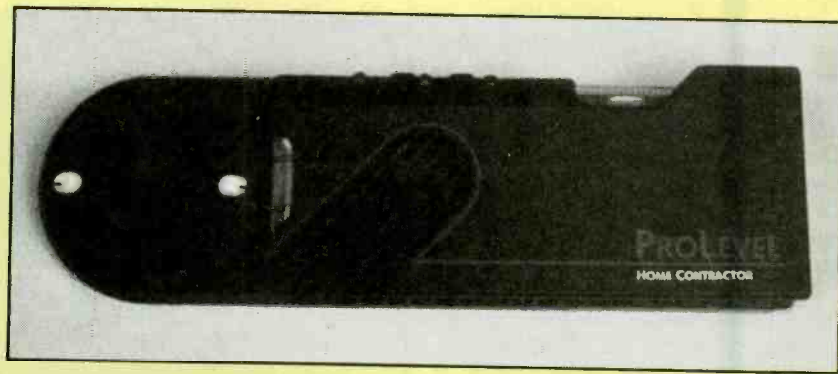

found to measure a room is with the ProMeasure++ (reviewed above). The ProTape 16' does what it's supposed to do, quickly and easily. And it's priced reasonably enough to fit into just about anyone's toolbox. ■

On an Even Keel

PROLEVEL MODEL HC-200. From Seiko Instruments USA Inc., 2990 West Lomita Boulevard, Torrance, CA 90505; Tel: 1-800-873-4508; Web: <http://www.seiko-usa-cpd.com/cpd>. Estimated street price: under \$30.

Another tool that can be found in every home workshop is a level. Whether you're framing a house, or hanging a picture, you need to know if your horizontal surfaces are level, and your vertical surfaces are plumb.

Traditional levels are models of elegant simplicity. An air bubble in a curved tube filled with liquid centers itself between two lines on the tube when the device is placed on a level surface. If the bubble floats off to the right or left, you must correct the problem before moving on to the next step in your project. You can get the results instantly, at a glance.

When it comes to levels, we're not sure if Seiko has built a better mousetrap with its electronic ProLevel. Besides the usual bubble indicator, the ProLevel features red and green LED indicators, and audible beeps to let you know if a surface is level. Personally, we can't see how anything could be easier to

use than a standard level. But those people who can't tell whether or not a bubble is centered can now attempt to interpret colored lights and different pitched sounds with the ProLevel. What's more, they can judge surfaces in the dark, and even those that are completely out of sight.

Our first thought was: "How will they manage to fix what they can't see?" Seiko offers a couple of possible "out of sight" applications, however. First, you can set the ProLevel inside a parked RV, use a jack to level it off, listening for the beeps to stop to tell when it is level. Or you can place the ProLevel on top of a picture frame as you adjust the picture's level.

The ProLevel is made of black ABS plastic, and measures approximately 7½ × 2½ × 1½ inches. Its bottom edge is an inverted "V," which allows it to rest upon pipes or other rounded surfaces. Along its top edge can be found a three-position slide switch, three LEDs, and a standard bubble level. The switch can be placed in off, LED, or LED/audio mode. In LED visual mode, a level surface is indicated by the center green LED. If either the left or right LEDs light up, it means that either the left or right side of the surface is too high. With the switch in audio position, no sound means that the surface is level. Two different sounds indicate that the right or left side is too high; the high-

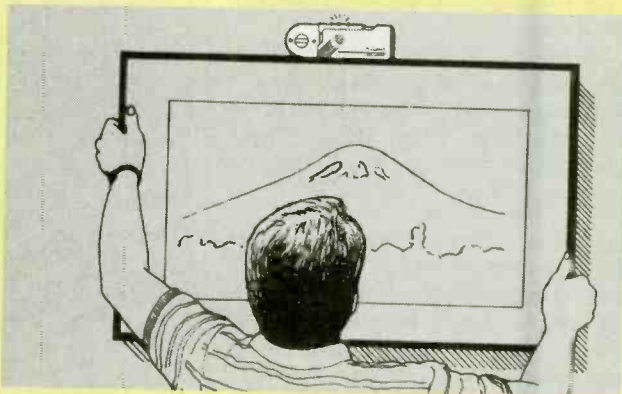

The ProLevel's flashing lights and audible beeps make easy work of leveling even when it is difficult to see the bubble.

ELECTRONICS WISH LIST

Handheld PC

The pocket-sized *Cassiopeia* handheld PCs from *Casio, Inc.* (570 Mt. Pleasant Avenue, Dover, NJ 07801) weigh less than a pound and come with the Microsoft Windows CE operating system installed. That operating system ensures a high level of data compatibility between the Cassiopeia and Windows 95-based desktop computer and offers the same user interface as found in Windows for desktop PCs. *Model A-10* offers 2 megabytes (MB) of RAM and 4 MB of ROM, which *Model A-11* has 4 MB of RAM and 4 MB of ROM. The Cassiopeia features a 480×240-dot, backlit display, a touch-sensitive screen, and a standard PC card expansion slot. Other pre-installed applications include Information Manager (which is synchronized with Microsoft Schedule++ for Windows 95), Microsoft Pocket Word and Pocket Excel, e-mail capabilities, Microsoft Pocket Internet Explorer, fax-transmission capability, remote e-mail access, information service reception using a one-way pager, and wireless e-mail when using a two-way pager. The pocket PC also includes QV Camera Connection software and a financial calculator. Two docking stations are available optionally. Prices: Model A-10, \$499; Model A-11, \$599.



Casio Cassiopeia Handheld PC

Self-Hiding Car Stereo

Kenwood USA Corp. (P.O. Box 22745, Long Beach, CA 90801) offers an alternative to fixed or removable car-stereo faceplates. Its new line of CD and cassette players, including the *KDC-9007* shown here, features the Mask self-hiding faceplate, which never leaves the unit yet disappears completely when not in use. Two motorized arms lift the faceplate off the unit, turn it over, and reseal it, exposing only a blank panel. Users don't have to worry about losing a removable faceplate. And, the display is larger and easier to read, because no space is taken up by an opening for the CD or cassette. Instead, the opening is behind the faceplate. To insert a CD or cassette, the user pushes a button, and the faceplate slides down and forward to uncover the opening. An additional security feature is an optional user-selected code that makes the unit useless to anyone who doesn't know the code. Prices: N/A.

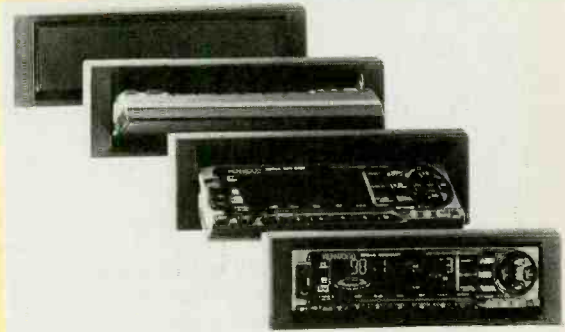

Kenwood "Mask" Car Stereo

Mini Component System

Sansui (4251 Burton Drive, Santa Clara, CA 95054) is celebrating its golden anniversary with the introduction of the *Model AH-7* Dolby Pro Logic mini system, styled in champagne-gold. At the heart of the system is a six-channel (two front, two rear, and two center) A/V amplifier with ten surround modes and twin-mode DSP (front/normal). Its "Artificial Intelligence Field Control" system automatically adjusts the surround field and mode based upon the surround information embedded in the software being played. The AM/FM tuner includes a three-program timer and allows you to enter station call letters or name for instant recall. A CD player and double cassette deck are included. The system's magnetically shielded speakers use a rear-ported bass-reflex enclosure design with curved corner edges for maximum sound dispersion. Price: \$1799.

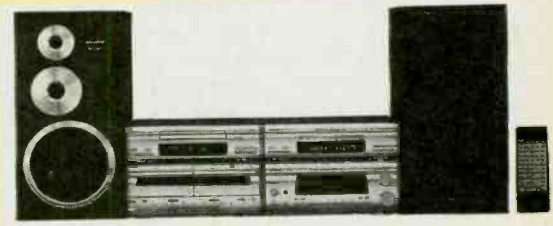

Sansui AH-7 Mini Component System

Thermal Fax Machine

Sharp Electronics Corporation (Sharp Plaza, Mahwah, NJ 07430-2135) offers a less expensive, but feature-laden, alternative to plain-paper facsimiles with its *Model UX-187* thermal fax machine. Compact enough to use anywhere in the home, the UX-187 also offers features attractive to home-office workers. Its PC Link allows users to turn the fax machine into a printer or scanner by connecting it to a personal computer, and a PC's fax modem and software, eliminating the need to buy a separate printer, scanner, and fax. The UX-187 supports caller-ID and distinctive-ring detection, to help manage incoming calls on up to four telephone lines (using services offered by local phone companies). It offers 64 levels of gray, which retains graphic detail quality. A super-fine resolution setting improves the transmission image and clarity of detailed documents. Price: \$399.99.



Sharp US-187 Fax Machine

ON AN EVEN KEEL

Continued from page 28

er pitched sound is for the left side.

We rarely used the audio mode—the sounds, which are made whenever you move the ProLevel, are just too annoying.

Instead, we relied upon the three LEDs and, of course, the good old bubble. We went around our entire office, examining every work surface, and never got a single green light. Even when the bubble appeared to be centered, the LEDs would flash green-red-green ... and always end up in the red. (A bit like our checkbook.) In fact, we were able to get a green light only on a stack of papers sitting atop a desk that had proven to be uneven.

At first we thought that the entire office was built on a slant, but some surfaces sloped to the left, others to the right. Besides, when we finally got around to checking out the floor, it was level. Oh well, none of the computers are sliding off our desks, so we won't worry too much about that.

A ruler/protractor is built into the ProLevel. The knob at the left side of the device can be loosened to allow the ruler to swing up or down. Small round windows at either side of the knob then indicate outside (drawn along the outside edge of the ruler) and inside angles. Tightening the knob keeps the angles precise as you draw.

The ProLevel's visual and audible indicators cannot be used to measure plumb lines. You can use the device's second bubble level—and trust your eyes—for that purpose. If you've become too dependent upon lights and sounds, however, you can adjust the protractor to a 90° angle, line that up with the vertical surface, and then use the ProLevel horizontally to measure a plumb line.

Perhaps we've become jaded, being exposed to so many gizmos all the time. But when it comes to levels, we don't believe any bells and whistles are required. Of the features offered by the ProLevel and not found on standard models, we most appreciated the manual one—the protractor. ■

HEY, COUCH POTATOES

Continued from page 22

is the place where we want to access the Internet. But the Philips Magnavox WebTV terminal has convinced us that it's far better than using a bad ISP and a slow modem. (The terminal's built-in modem runs at 33.6 kilobits per second.) It can't download data, and it can't print—not yet. But the terminal has an expansion connector, so like everything else about WebTV, expect it to get even better in the future. ■

DVD DEBUTS

Continued from page 23

(somewhat) united functioning front.

We add that qualifier because, while industry support among consumer-electronics and computer manufacturers is quite strong, the motion-picture industry is not as firmly committed to the format. Columbia TriStar (which is owned by consumer-electronics giant and DVD proponent, Sony), Sony Music Video, MGM Home Entertainment, New Line Home Video, and Warner Home Video are releasing movies on DVD. Other major players, including Universal, Disney, Paramount, and 20th Century Fox are cautiously waiting to see how well DVD is accepted by the public before jumping on the bandwagon.

We're not sure what the future holds for DVD, but we can tell you what it's like to use a DVD player right now. Read on for a description of the Panasonic DVD-A300U. ■

DIGITAL VIDEO DECK

Continued from page 25

When we switched from the VHS to the DVD version of *The Wizard of Oz*, DVD's sharpness and clarity jumped out at us with the same startling intensity that Dorothy must have experienced as she stepped out of her dull, sepia-toned Kansas farmhouse into the brilliant colors of *Oz*. ■

Gizmo News

Digital Imaginations

As if you didn't have enough ways to spend your money out at a Major League ballpark, the Eastman Kodak Company has come up with yet another—although it's available only at Atlanta's new Turner Field, so far.

This season, fans will be able to pose for their own rookie cards, get classic photo prints from the Atlanta Braves' archives, or even create photos that digitally place them in action scenes. The three different systems—"Braves Rookie Card," "Braves Memories," and "Braves Scrapbook"—will be available at all home games.

"Braves Memories," arguably the most interesting of the systems, features real-time "video posing" in which fans see themselves on a video screen interacting with players in the "great moment" that they choose—such as the scene shown here after an Andruw Jones homer. The fans can adjust their poses to best fit the chosen scene.

If you don't live in Atlanta—or if you just hate the Braves—don't despair:

Kodak is working to bring its Kodak Digital Science photo systems to other stadiums.



Kodak's chroma-key technology was used to insert a fan into a home-plate celebration picture with (left to right) Brave's first baseman Fred McGriff, outfielder Andruw Jones, and catcher Javy Lopez.

HDTV IS COMING!

Well, OK, not HDTV, but DTV. What happened to the "H?" It's gone in the pursuit of profits.

Perhaps that's a bit too cynical. But while few people were looking, HDTV, or high-definition television became DTV, or digital television. The difference is that DTV *can* be high-definition, but it doesn't have to be. Instead, broadcasters can cram several standard-definition signals into the space where one high-definition signal would fit.

In the words of the FCC, "The Commission will not require broadcasters to air 'high definition' programming or initially to simulcast their analog programming on the digital channel. Broadcasters will be able to put together whatever package of digital product they believe will best attract customers and to ... make the most productive and efficient use of their channels." The FCC specifically mentions non-video services including data transfer, subscription video, interactive materials, and audio signals as potential uses for the new spectrum.

The FCC is requiring the affiliates of the top four networks in the top ten markets to be on the air with a digital signal by May 1, 1999. Affiliates in the rest of the top 30 markets will have an extra six months to begin airing digital signals.

Are you worried about your TV becoming obsolete? Don't be—and don't put off buying that big-screen TV you've been eying. Set-top boxes to convert digital signals into old-fashioned NTSC signals will be available. They won't provide high-definition pictures, of course, but we don't expect too much high-definition programming to be available for some time to come. ■

Where do more people go for electronics accessories?



Surprised?
Of course you weren't.

RadioShack has the accessories people need for all sorts of personal electronics. Need a case for your cellular phone, a longer-lasting battery, a universal remote control, an adapter for your portable CD player? We can provide accessories that will help you get the most enjoyment and greatest benefit from thousands of products. No matter who made it or where you bought it—you already know who'll get you connected. For our store near you, call 1-800-THE-SHACK.



RadioShack®

You've got questions. We've got answers.®

Circle 14 on FREE INFORMATION CARD

Buyers' Budget Books Better Buys

BP294-A Concise Introduction to Microsoft Works \$6.95. In the shortest and most effective way, you can use the word processor to advantage to type, edit, print and save documents. It goes on to explain how Works can be used to build up simple spreadsheet examples, edit them, save them, print them and retrieve them. It informs you how to create simple macros, and enables you to simplify long repetitive tasks and to customize the program to your own needs.

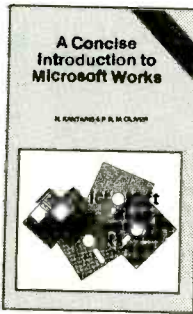

BP349-Practical Opto-Electronic Projects \$5.95. If you shun opto-electronic projects for lack of knowledge, this is the book for you. A bit of introductory theory comes first and then a number of practical projects which utilize a range of opto devices, from a filament bulb to modern infrared sensors and emitters.

BP350-Electronic Board Games \$6.00. Twenty novel electronic board games that you can build from the plans in this book. Whether you are interested in motor racing, searching for buried treasure on a barren island or for gold in Fort Knox, spinning the wheel of fortune, or doing a musical quiz—there is something for you to build and enjoy!

BP351-WordPerfect 6 Explained \$6.95. This is a practical, hands-on, book and the routines described will help you get the most out of WordPerfect 6. The book explains the hardware requirements for the package and steps you through a standard installation. It guides you through the WordPerfect program environment to enter, edit and enhance text and shows how to get the best from the three different operating modes, depending on the type of PC you are using. The formatting codes, button bars, ribbon, tabs, graphic manipulation and styles will no longer be a mystery.

BP388-Why Not Personalize Your PC? \$6.95. Find out how to: Set up and organize groups of programs and data files, and change the opening logo; use the Control Panel to personalize your working environment; use screen savers and wallpaper files; manage the DOS prompt; and transfer your customization files to a new Windows installation. In DOS, you discover how to: Write batch files and create specialist programs using the debug program, design professional looking menus, and more.

BP367-Electronic Projects for the Garden \$6.95. Electronics enters the Garden! New exciting book points out how gardeners can build simple gadgets to promote success where the elements work against you. Some of the projects are: over/under temperature monitoring, dusk/dawn switching, automatic plant watering, warming cables, etc.

BP368-Practical Electronics Musical Effect Units \$5.95. There is a constant hullabaloo for musical effects projects by the hobbyist community. This book provides practical circuits for several projects that range in complexity and are sure to work. All the circuits are easy to build and use readily-available parts.

BP363-Practical Electronic Music Projects \$5.95. The text contains a goodly number of practical music projects most often requested by musicians. All the projects are relatively low-in-cost to build, and all use standard, readily-available components. The project categories are guitar, general music and MIDI.

100% NEW TITLES LISTED EACH MONTH—CHECK US OUT!

BP385-Easy PC Interfacing \$6.95. The built-in ports in your PC provide an easy and hassle-free way of interfacing your circuits. This book provides useful PC add-on circuits including the following: Digital input/output ports; analog-to-digital and digital-to-analog converters; voltage and current measurement circuits; resistance and capacitance meters, temperature measurement interface, biofeedback monitor, and many other useful interfaces.

BP393-Practical Concise Introduction to UNIX \$5.95. If you are using or intend to use the UNIX multi-user operating system and want to get the most out of your computer system in terms of efficiency and productivity, then you must learn its operating system. The book explains how the UNIX operating system is structured so that you understand what happens when you first approach your computer.

BP396-Electronic Hobbyists Data Book \$5.95. This book provides a wide range of data. If, for example, you require details of a modern five-band resistor code or an old color code for a ceramic capacitor, the formula for parallel resistance, or basic data on an NE5534AN operational amplifier, it is contained within these pages. The subjects covered are numerous and widespread to cover all hobbyist interests.

BP343-A Concise Introduction to Microsoft Works for Windows \$7.95. The book explains and details: How the Works for Windows package fits into the general Microsoft Windows environment; how to use the word processor to advantage; how to use Microsoft Draw to create and edit graphics and place them in your documents; how to build up simple spreadsheet examples; and how single, and multiple charts, or graphs, of different types can be generated. And there's much more!

BP282-Understanding PC Specifications \$7.25. This book explains PC specifications in detail, and the subjects covered include the following: Differences between types of PC (XT, AT, 80386, 80486, Pentium etc.); math co-processors; input devices (keyboards, mice, and digitizers); memory, including both expanded (EMS) and extended RAM; RAM disks and disk caches; floppy disk drive formats and compatibility; hard disk drives; and display adapters (CGA, Hercules, super VGA, etc.).

BP298-Concise Intro to the Macintosh System and Finder \$6.25. Although the Mac's WIMP user interface is designed to be easy to use, much of it only becomes clear when it is explained in simple terms. The book explains: The System and Finder, what they are and what they do; how to use the System and Finder to manipulate disks, files and folders; configuring and printing files from the Finder, getting the most from the system utility programs; and running MultiFinder.

BP301-ANTENNAS FOR VHF AND UHF \$6.00. From installing a TV or FM antenna to setting up a multi-antenna array for shortwave listening or amateur radio, this book explains the essential basics of VHF and VHF antenna operation and installation. In easy-to-understand terms it helps you understand how antennas work, the advantages of different antenna types, and how to get the best performance out of an antenna.

BP316-Practical Electric Design Data \$7.95. A builder's bargain book—a comprehensive ready-reference manual for electronic enthusiasts with over 150 practical circuits. It covers the main kinds of components (from pig-tail leads to surface mount), pin-outs, specs and type selection. Basic units are defined and most used formulae explained. Five additional sections are devoted to circuit design, covering analog, digital, display, radio and power supply circuits.

BP319-Making MS-DOS Work For You \$6.50. This book could help you improve your system set-up and provide you with a simple-to-use, but professional looking, menu system. The routines described will help you understand more of the workings of MS-DOS and help you get the most out of your computer in terms of efficiency, productivity and enjoyment.

BP341-MS-DOS 6 Explained \$7.95. The book covers: How the DOS operating system of your computer is structured so that you can understand what happens when you first switch on your computer; How directories and subdirectories can be employed to structure your hard disk for maximum efficiency; how to use the DOS Shell program, and much, much more.

BP345-Getting Started In Practical Electronics \$5.95. If you are looking into launching an exciting hobby activity, this text provides basic essentials for the builder and 30 easy-to-build fun projects with which every experimenter should toy. Printed-circuit designs are included to give your project the professional touch.

ELECTRONIC TECHNOLOGY TODAY INC.
P.O. BOX 240, Massapequa, NY 11762-0240

Name _____
Address _____
City _____ State _____ Zip _____

SHIPPING CHARGES IN USA AND CANADA

\$0.01 to \$5.00.....	\$2.00
\$5.01 to \$10.00.....	\$3.00
\$10.01 to \$20.00.....	\$4.00
\$20.01 to \$30.00.....	\$5.00
\$30.01 to \$40.00.....	\$6.00
\$40.01 to \$50.00.....	\$7.00
\$50.01 and above.....	\$8.50

SORRY No orders accepted outside of USA & Canada

	No. of Books Ordered <input type="checkbox"/>
Total price of books	\$ _____
Shipping (see chart)	\$ _____
Subtotal	\$ _____
Sales Tax (NYS only)	\$ _____
Amount Enclosed	\$ _____

All payments must be in U.S. funds!

THE HALL-EFFECT ELECTRONIC COMPASS

Popular Electronics

AUGUST 1997

It's easy to stay on the right course with this easy-to-assemble electromagnetic direction locator.

DAVID WILLIAMS



Let's face it. If you do much traveling outside of your home state or even your neighborhood, for that matter, eventually you are going to get lost. Ask someone for directions, and it's "Go north about a quarter mile, then head east another half mile 'til you come to a creek"—you get the picture. Somehow, people seem to think that travelers either carry or have a built-in compass guiding them through life. Well, it *just ain't so!* Of course, if you are in your car, provided that it is equipped with a GPS (Global Positioning System) receiver, you

don't have to worry about losing your way. But for casual hiking, biking, camping, or even excursions into the next county, there is a simpler and cheaper alternative—the *Hall-Effect Electronic Compass*.

The electronic compass, described in this article uses a Hall-effect sensor that can detect the earth's magnetic field and convert that information into a directional indication. Powered from a single 9-volt battery, the compass is easy-to-build and makes a great learning project that will provide many hours of fun!

PARTS LIST FOR THE HALL-EFFECT ELECTRONIC COMPASS

SEMICONDUCTORS

- U1—1490 digital compass, integrated circuit (see text)
- U2—74HC154, CMOS, 4- to 16-line decoder, integrated circuit
- U3—78L05 5-volt, 100-mA, voltage regulator, integrated circuit
- D1—15-volt Zener diode
- LED1—LED8—Light-emitting diode

RESISTORS

- (All resistors are 1/4-watt, 5% units.)
- R1—10-ohm
 - R2—820-ohm
 - R3—R6—100,000-ohm

CAPACITORS

- C1, C2—0.1- μ F, 50-WVDC, monolithic
- C3—100- μ F, 16-WVDC, electrolytic

ADDITIONAL PARTS AND MATERIALS

- B1—9-volt transistor radio battery connector
- JP1—2-pin jumper post and shorting block
- Printed-circuit materials, battery connector, 28-pin IC socket, insulated hook-up wire, hardware, solder, etc.

Note: The following items are available from: LNS Technologies, 20993 Foothill Blvd., Suite 307R, Hayward, CA 94541-1511, Tel: 800-886-7150; a complete kit of parts for the Electronic Compass including etched and drilled printed-circuit board, 1490 sensor, battery holder, ICs, and all other components listed above for \$32.00; the 1490 digital compass sensor (IC1) for \$15.00; the PC board only for \$10.00. Please add \$5.00 shipping/handling for all orders. California residents add local sales tax. MC/VISA orders accepted. No C.O.D.s.

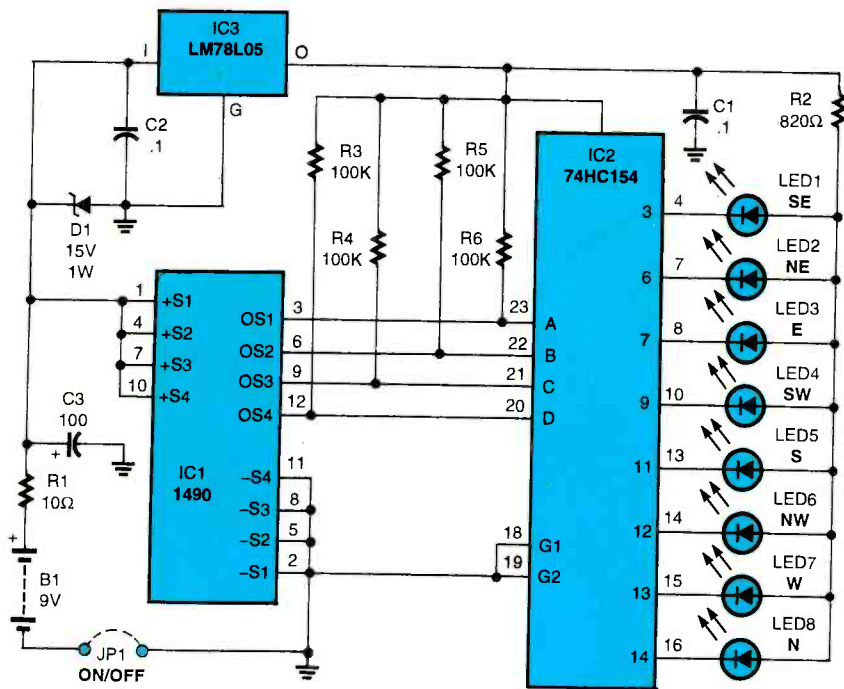

Fig. 1. At the heart of the Hall-Effect Electronic Compass is a 1490 digital compass—a unique magnetic sensor, containing a miniature rotor on jewel bearings surrounded by four solid-state, Hall-effect ICs. The sensor is supported by a 74HC154 high-speed CMOS 4-to-16 line decoder that's used to drive eight LEDs.

Circuit Description. A schematic diagram of the Hall-Effect Electronic Compass is shown in Fig. 1. At the heart of the circuit is IC1, a 1490 digital compass—a unique magnetic sensor (available from Dinsmore Instrument Co., 1814 Remell St., Flint, MI 48503) that is based on the Hall-effect. The Hall-effect, named for its discoverer (physicist Edwin Herbert Hall), is based on the principle that a voltage will develop at the edges of certain current-carrying materials when they are placed in a mag-

netic field.

The 1490 digital compass (IC1) contains a miniature rotor on jewel bearings surrounded by four solid-state, Hall-effect IC's. The 1490 has four outputs that correspond to each of the four main compass directions (North, South, East, and West). However, because the range of adjacent outputs overlap each other by 45 degrees, a total of eight different compass directions can be resolved with proper decoding.

The 1490 sensor is internally damped to give a smooth response to directional changes without over-swing. It has built-in hysteresis to prevent unstable output signals. The 1490 is designed to operate in a vertically-mounted position only. If held off vertical, some directional error will occur. The 1490 operates from a wide range of supply voltages, ranging from 5 to 20 volts DC. The sensor can be damaged, however, from over-voltage spikes or reverse power polarity. Its power consumption is approximately 30 milliamps (mA), and the four outputs, which are comprised of open-collector (NPN) transistors, can sink up to 25 mA each.

As shown in Fig. 1, the four out-

puts of IC1 are fed to the BCD inputs of IC2, a 74HC154 high-speed CMOS 4-to-16 line decoder that's used to decode the output of the sensor. The four pull-up resistors (R3-R6) are needed, since the sensor has open-collector outputs. The 74HC154 can directly drive the LEDs, as long as the current is no more than 6 mA. Resistor R2, an 820-ohm unit, is used to limit current to the LEDs.

The author's circuit is powered from a single 9-volt transistor radio

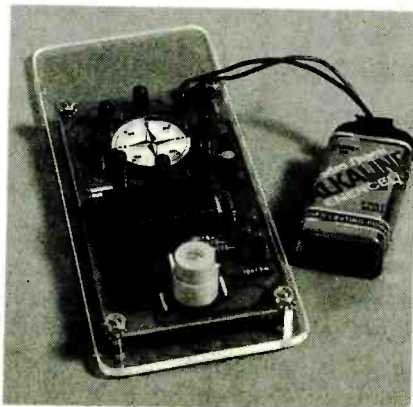

The author's unit was simply mounted on spacers to a small section of Plexiglas. Note: When using the unit, it is important to keep the sensor horizontal.

It's Not Just Training...

"I needed a refresher in fundamentals and a piece of paper that said I had a degree. CIE gave me both."

Louis P. Briant
Senior Engineer
Sentel Corp.

"CIE allowed me to use my G.I. Bill benefits and independent study allowed me to continue my studies while deployed."

Charles Hopper
Electronics Senior Chief
U.S. Navy

"The fact that I wanted to continue pursuing my Associate Degree with CIE was a key factor in being considered for my current position."

Annamarie Webster
Project Engineer -
Instrumentation
Kitchikan Pulp

"My associates at work recommended CIE... The lessons were structured so they were easy to comprehend."

Vincent R. Buescher
Communications Technician
AT&T

"I reenrolled and received my A.A.S. degree from CIE because of the good experiences I had in one of CIE's career courses."

Maurice M. Henthorn, Jr.
Electronic Technician
The Denver Post

Independent study from CIE will give you the skills you need to win your own independence in a successful career.

At CIE, we pride ourselves in keeping pace with the latest developing technologies. In turn, this assures our students that upon graduation they can mesh seamlessly into a variety of exciting and rewarding technology-based careers.

Back in the 1930's, we specialized in teaching radio and television sciences. Today, it's computer technology, programming, robotics, broadcast engineering, information systems management, and the electronics behind it all.

But some things have not changed, like the desire of CIE's faculty and staff to see their graduates succeed.

That is why at CIE we teach not only the hands-on, practical aspects of electronics technology, but also delve into the "why" behind today's technology. Why does it work the way it does?

The insights to be gained from such a broad, rich and comprehensive

education at CIE matches or exceeds those gained through traditional commuter institutes while providing an education schedule to match your commitments and lifestyle.

Our patented learning program is specifically tailored for independent study and backed up by a caring team of professional educators who are at your call whenever you need their help.

At CIE, we'll match our training with your background and career goals and help you decide which of the many career courses that we offer suits you best. We offer an Associate Degree Program and through our affiliation with World College a Bachelor Degree



Computer Programming



Electronics Technician

Program.

If you have the sincerity, the smarts and the desire, CIE can make it happen. CIE is already the institute of choice for many Fortune 1000 companies. Why shouldn't you be next?

...It's an Education.



1776 East 17th Street
Cleveland, OH 44114
(216) 781-9400 • 1-800-243-6446

YES! Please send me more information on:

- CIE's Associate Degree Program
- CIE's Career Courses
- World College's Bachelor Degree Program

Name _____

Address _____

City _____ State _____ Zip _____

Phone: _____

Check for G.I. Bill Active Duty Veteran

AH98

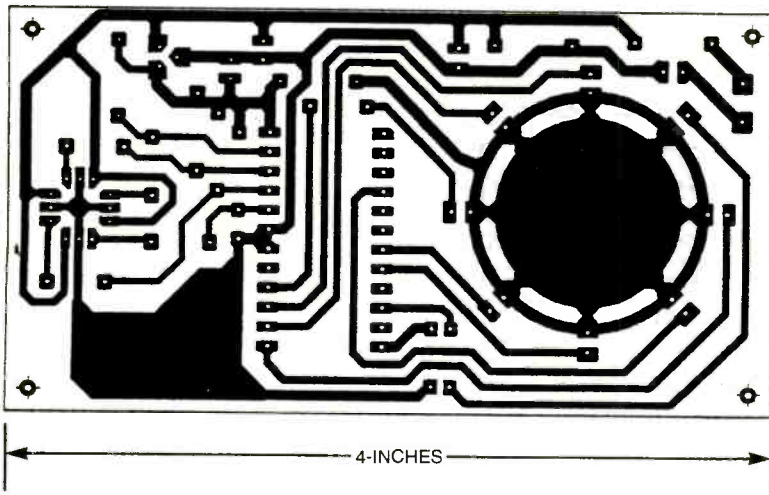

Fig. 2. The Hall-Effect Electronic Compass was built on a small printed-circuit board, measuring 4 by 2-1/8 inches. A full-sized template of that printed circuit pattern is shown here for those who don't mind etching their own board. For those who'd prefer not to fabricate their own board, a pre-etched and drilled board can be purchased from the supplier given in the Parts List.

battery, but, if you prefer, the unit can also be powered from the 12-volt supply of your car or boat. Components R1, C3, and Zener diode D1 provide voltage spike protection. Integrated circuit IC3, a 78L05 5-volt, 100-mA voltage regulator, is used to regulate the 9-volt output of the battery to 5-volts for IC2. Since the circuit draws over 30 mA of current, JP1 is used to switch the battery source on and off, otherwise battery power will be lost. Of course, JP1 can be replaced by a switch if desired.

Assembly Instructions. The Hall-Effect Electronic Compass was built on a small printed-circuit board, measuring 4 by 2-1/8 inches. A full-sized template of that printed circuit pattern is shown in Fig. 2. The pattern can be lifted from the page and used to etch your own board. If, on the other hand, you'd prefer not to fabricate your own board, a pre-etched and drilled board can be purchased from the supplier given in the Parts List.

Once you obtain all of the components shown in the Parts List,

assemble the circuit using the parts-placement diagram shown in Fig. 3. Note that the printed-circuit board contains seven short jumper wires. Install them first using bits of solid insulated or bare bus wire. After that, install the Zener diode, while paying close attention to its proper orientation. Next move on to the resistors and ceramic capacitors, followed by the electrolytic unit. Be sure to observe proper polarities when installing the electrolytic capacitor. Install the voltage regulator (IC3), again observing the proper polarity. It may be necessary to bend the leads of IC3 to fit the printed-circuit board. With that done, install a 24-pin IC socket in the board position reserved for IC2.

Before continuing, clean the foil side of the PC board with alcohol or flux remover. Then install a 9-volt battery connector where indicated. Be sure to attach the connector to the board, with the polarity shown. Install the 74HC154 CMOS 4-to-16-line decoder (IC2). Since both IC1 and IC2 are CMOS devices, they can be easily damaged by static discharge. Take proper anti-static precautions when handling those chips. Refer again to Fig. 3 before installing IC2 to make sure of the proper orientation of pin 1, then press the IC firmly into the 24-pin socket, making sure that it is properly seated.

Install the 1490 sensor (IC1). It may be necessary to bend the leads of the Hall-effect compass slightly so that they fit into the holes on the PC board. Note: There is no absolute orientation of U1. It may be installed in any one of four rotated positions and will still work properly. Fig. 4 shows the label (approximately 1 inch in diameter) that was placed on the author's unit to show the direction indicated by the lit LED, along with a table showing the direction corresponding to each of the eight LEDs. You can photocopy that pattern and scale it to fit your unit, or you can devise a design of your own. If you choose, you can even omit it all together.

Operation. Before applying power, verify that the power-source input
(Continued on page 78)

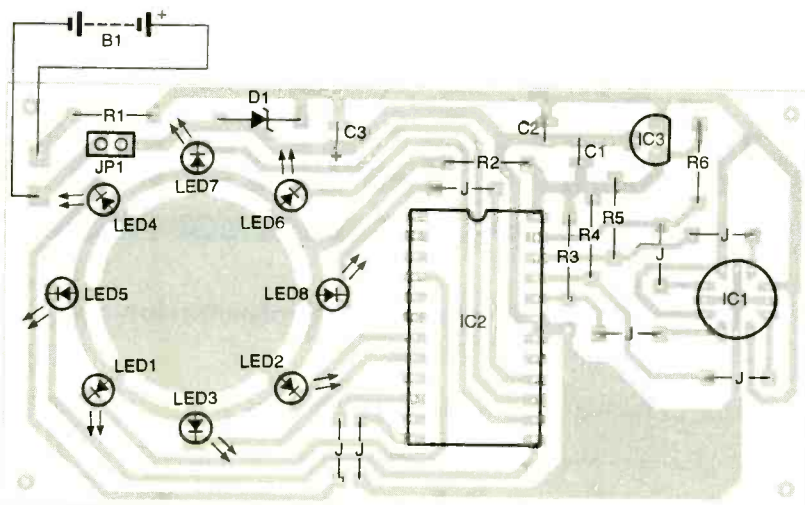

Fig. 3. Once you've obtained all the components needed for the project, assemble the circuit, guided by this parts-placement diagram. Be sure that IC2, IC3, the Zener diode, the LEDs and other polarized parts—including the battery connector—are properly oriented or polarized.

The New/Old Autodyne

Experimenting With Direct Conversion Receiver Circuits

JOSEPH J. CARR

Over the years many different receiver designs have been tried out by designers. Some of them were immediately found wanting. Others were popular for a while, but fell out of favor when superior designs came into play. For example, the tuned radio frequency (TRF) radio went out of fashion in the late 1920s or early 1930s, when the RCA-owned superheterodyne design became more widely used (and it is still used today!). Other designs were popular for a while, went into eclipse, and then were resurrected when newer technologies made them viable again. One such receiver design is the autodyne or direct conversion design.

If you understand the principles behind the superheterodyne receiver, then you will find it very easy to understand the autodyne, for it is similar in basic concept. Therefore, let's start our discussion with the more familiar superheterodyne design, which forms the basis for almost all modern radio and television receivers.

Heterodyne Receivers. The word heterodyne implies a process whereby two different frequencies are brought together in a nonlinear mixer circuit to produce several new frequencies. Figure 1 shows a block diagram of the typical superheterodyne receiver front-end circuit. The mixer stage receives

two input frequencies: one is the incoming RF signal (f_1) that we want to receive, and second there is a signal (f_2) from the local oscillator. Tuning a superhet radio is accomplished by varying the frequency of f_2 . The mixer, in turn, outputs several frequencies: f_1 , f_2 , the sum of f_1 and f_2 , the difference of f_1 and f_2 , plus the sums and differences of the galaxy of harmonics of f_1 and f_2 . Those frequencies are defined by the relationship $mf_1 \pm nf_2$, where n and m are integers (1, 2, 3, ...). A frequency selective filter at the mixer output selects which of all the frequencies is to be used—let's label it f_3 , the intermediate frequency (IF).

In most superhet radios the IF, f_3 ,

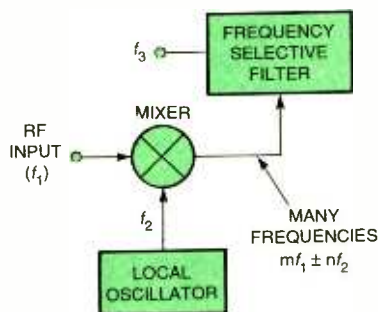

Fig. 1. Shown here is a block diagram of the typical superheterodyne receiver front-end. The mixer stage receives two input frequencies: one is the incoming RF signal (f_1) and the other is from the local oscillator (f_2). Tuning the superhet receiver actually varies the frequency of f_2 .

is the difference between f_1 and f_2 , so the front-end is called a down-converter. In modern communications receivers, however, the sum frequency is sometimes used, and is therefore called an up-converter. The detection process depends on the type of signal being received. If the signal is frequency modulated (FM), then a frequency or phase sensitive detector is used. If the RF signal (f_1) is amplitude modulated (AM), on the other hand, an envelope detector is required. And if the RF input is a CW (Morse code) or single sideband (SSB) signal, then a product detector is used. A product detector is very similar to the front-end of the superhet radio (see Fig. 1), except that f_1 is replaced with the IF signal (called f_3), and the local oscillator is replaced with a beat-frequency oscillator (BFO) that operates at a frequency (f_2) that is very close to the IF signal.

The frequency selective filter at the output is a low-pass audio filter. If the signal is an SSB signal, then the BFO frequency (f_2) must be about 1.8 kHz from the IF frequency (i.e., $f_1 - f_2 = 1.8$ kHz). When those frequencies are heterodyned together, then the audio passband of the original SSB input signal is the difference signal. CW signals, which are on/off telegraphy, but are not otherwise modulated, are also difference signals.

In order to demodulate those

signals, it's necessary to use a BFO operating at 300 to 2000 Hz from the IF signal, so the difference frequency will be 300 Hz to 2000 Hz (the exact BFO frequency depends on the tone that is comfortable to you). AM signals can be tuned on the autodyne (direct conversion) receiver if the local oscillator is tuned exactly on the carrier frequency of the AM signal. That point is indicated by the beat note squeal dropping to zero (i.e., the "zero-beat" point).

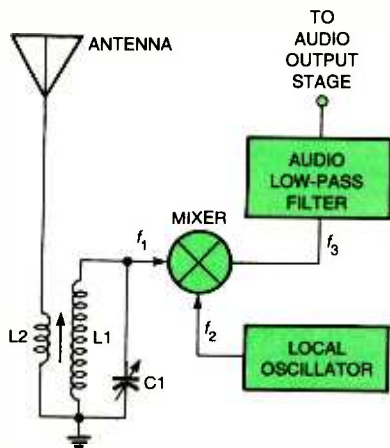

Fig. 2. In the direct conversion receiver, the mixer is tuned to f_1 by a resonant tank circuit. The local oscillator frequency (f_2) is mixed with f_1 to produce f_3 , which is then fed to the low-pass audio filter, which, in turn, selects the audio difference frequency.

"So what?" You wonder, "What's all this superhet stuff got to do with autodyne receivers?" An autodyne, or direct conversion, receiver is nothing more than a product detector that uses input RF tuning that is on the desired frequency of operation (rather than the IF), and whose local oscillator or BFO tuning is at or near the RF. The difference frequency is the desired audio frequency.

Direct Conversion Receivers. Figure 2 shows the most basic form of direct conversion receiver. The mixer input circuit is tuned to f_1 by a resonant tank circuit. A local oscillator operates on a frequency, f_2 , that is only 1800 Hz from f_1 when SSB is received, or 300 to 2000 Hz for CW. A low-pass audio filter selects the audio difference frequency. In

some CW receivers, a narrow bandpass audio filter is used instead of a low-pass filter. For example, if you prefer an 800 Hz tone for CW, then an 800 Hz bandpass filter would be used for the output filter stage. From the output of the filter, the signal is passed to an audio amplifier (not shown).

A more sophisticated direct conversion receiver block diagram is shown in Fig. 3. That radio design retains the mixer, local oscillator, and low-pass audio filter, but adds an audio output stage (which can drive either a loudspeaker or earphones), as well as an RF amplifier stage. The latter stage is used to amplify weak input signals and reject unwanted signals. It also prevents leakage of the local oscillator signal applied to the mixer from being radiated from the antenna to interfere with other receivers. (Note: One of the dangers of some direct conversion designs is that the local oscillator signal can be erroneously coupled to the antenna, causing illegal local interference to other receivers.)

Simple Direct Conversion Mixers.

Any type of mixer circuit can be used for the front-end of the direct conversion receiver, and both passive and active designs have been developed. For example, consider the circuits shown in Fig. 4. In Fig. 4A, a junction field-effect transistor (JFET) is used as the autodyne mixer. The RF signal is applied to the gate of the JFET, while the LO signal is applied to the source. Note that the source bias resistor is not bypassed to ground as it would be in a JFET amplifier.

The output signal is taken from the drain of the JFET. The low-pass filter consists of an RF choke (L1), which is connected in series with the signal line, while two capacitors (C3 and C4) are shunted across the signal line. Together, those components form a low-pass filter that removes the RF and local oscillator signals, leaving the difference signal, which is the desired audio. The output capacitor, C5, is used to block the DC applied to the drain of the JFET.

The particular JFET used in that design (an MPF102) will work to the

VHF region. The JFET, easily available from a number of sources, can be replaced by an NTE312.

Another circuit, shown in Fig. 4B, uses a MOSFET (metal-oxide semiconductor, field-effect transistor). The device selected, the 40673, is also easily available and can be replaced by an NTE222. In Fig. 4B, the incoming RF is applied to G1 (gate 1), while the local oscillator signal is applied to G2. The other parts of the circuit are similar to the

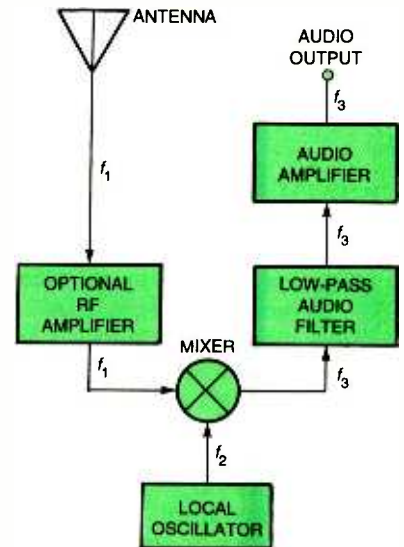

Fig. 3. A more refined direct conversion receiver block diagram is shown here. This design, while retaining the mixer, local oscillator, and audio low-pass filter stages, introduces an RF amplifier to the input of the circuit while adding an audio amplifier to the output.

circuit of Fig. 4A.

A passive direct conversion detector circuit is shown in Fig. 4C. That circuit uses a pair of diodes and a broadband RF transformer (L2) in a balanced detector scheme. The transformer consists of a single toroidal core (Amidon Associates, 12033 Otsego Street, North Hollywood, CA, 91607) that is trifilar wound; i.e., three separate wires are wound together, parallel to each other, on the same core. The dots on the three windings shown in Fig. 4C indicate the same ends. Although the diodes shown are 1N4148 (or 1N914) silicon small signal diodes, somewhat better sensitivity can be gained by using germanium units such as the 1N34A, 1N60, or 1N270 devices. The germa-

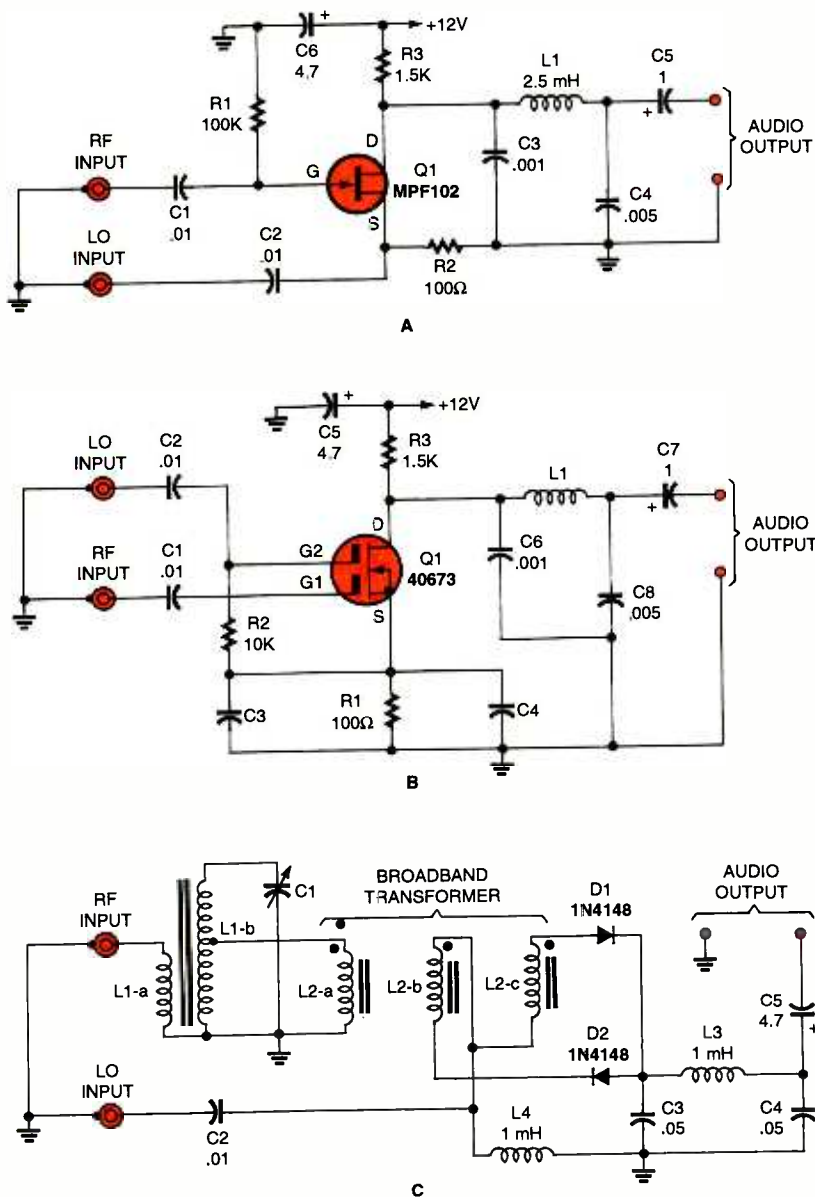

Fig. 4. Mixer circuits for the front-end of the direct conversion receiver can be either passive or active. In A, a junction field-effect transistor (JFET) is used as the autodyne mixer. In B, we see a dual-gate MOSFET is used as the mixer. A passive direct conversion mixer is shown in C.

nium units can be replaced by NTE109 and ECG109 devices from replacement parts distributors.

IC Direct Conversion Mixers. Several different integrated circuits have been used successfully for direct conversion mixers, among them the CA3028A and NE602. Figure 5 shows the CA3028A-based direct conversion circuit. The CA3028A (IC1) is basically a DC to RF differential amplifier that has a separate signal input on the cur-

rent source (pin 2), which is used, in this circuit, as the LO input. The differential input amplifier is tuned by C1 and L1-a; the coil (L1-a) has a low impedance tap to match the impedance of antennas (typically 50 ohms). The secondary of the input coil (L1-b) is a low impedance winding that is applied to the differential inputs of IC1.

The output signal is also differential, so an audio output transformer is connected across IC1's output terminals, with one end connected

to the 12-volt source as well. Use an audio transformer that has a 10-kilohm primary, and either 1- or 2-kilohm secondary winding. The audio output of the transformer must be routed to a high-gain audio amplifier.

Another direct conversion receiver, this one based on the NE602, is shown in Fig. 6A. The NE602 is a one-chip approach to both RF and LO functions. It uses a double balanced mixer "Gilbert cell" circuit in the front end, and contains its own internal oscillator stage, all within an 8-pin DIP package. The double balanced mixer provides a cleaner output than other mixers because only the sum and difference signals exist; the LO and RF signals are suppressed in the output. The input circuit is tuned by a transformer (comprised of coils L1-a and L1-b) and variable capacitor C1. The transformer coils are wound on a toroidal core. Coil L1-a consists of several turns (2 to 6) wound over L1-b. The main tuning inductor is L1-b, which must have an inductance that will resonate with C1 at the desired operating frequency. The operating frequency is given by:

$$f = \frac{1}{2\pi\sqrt{L1b \times C1}}$$

where f is frequency in hertz, L1-b is inductance in henrys, and C1 is capacitance in farads. The exact values required depend on the desired frequency range, but typical maximum capacitance values for C1 are 50 pF for high HF, 140 pF for all of HF, and 365 pF for lower frequencies. Of course, any of those capacitance values can be used for any of the frequencies in the VLF to VHF range, but a suitable inductor must be provided in each case. Keep in mind that the equation is for the ideal case. In the real world, the inductor and capacitor values are not exact, and there will be a small amount of stray capacitance and inductance in the circuit to throw the resonant frequency off a little bit.

The input transformer can be air wound over a form of your own making, or wound on either a toroidal core or a slug-tuned coil

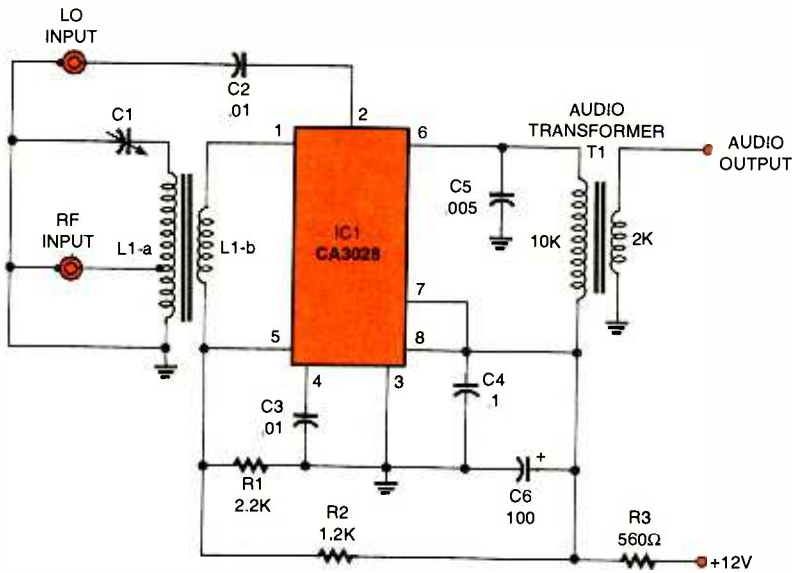

Fig. 5. Shown here is a CA3028 differential amplifier-based direct conversion circuit. In that circuit, one input (pin 2) to the amp receives the LO signal, while the RF signal is applied through L1-a/L1-b to the amp's differential inputs.

form (both available from Amidon Associates). Another alternative is to use a tuned transformer intended for IF amplifier service in radios. The 455-kHz transformers in AM radios can be used for VLF and AM broadcast-band applications, while those from FM broadcast radios (10.7 MHz) can be used for shortwave receivers. The best ones are those that have the resonating capacitor in a small hollow space on the bottom of the transformer. Those capacitors can be crushed to remove them from the circuit.

The power for the NE602 double-balanced mixer is provided by a 5-volt DC power supply. The NE602 wants to see a lower voltage (less than 8-volts DC) than many popular ICs, so if you need to use a higher voltage (such as 9 or 12 volts), then include a low-power voltage regulator in the circuit to drop the voltage to the desired range. For example, a 78L05 (which is housed in a small plastic transistor package) will work nicely.

Some people have used a 1k resistor for R2 when using the NE602 in 9-volt battery operated circuits. In other cases, people have used a 1k resistor for R2, and a 6.8 volt Zener diode shunted by a 0.1- μ F capacitor at the power supply terminal (pin 8) of the NE602.

The local oscillator signal is

applied through a 0.047- μ F DC blocking capacitor (C4) to pin 6 of IC1. The signal level should be approximately 700 millivolts peak-

to-peak (mV p-p) at a frequency close to the RF (see rules above). The output signal, taken from the differential output terminals at pins 4 and 5, is applied through a low-pass RC filter to a differential amplifier circuit (A1), which supplies sufficient boost to drive a loudspeaker or earphones. The circuit in Fig. 6A can use either an external oscillator for the LO, or the internal LO stage.

Alternate output circuit schemes are shown in Figs. 6B and 6C. In Fig. 6B, the output signal taken from pins 4 and 5 of the NE602 is applied to the primary of an audio transformer. Bypass capacitors C8 and C9 are used to decouple the RF signal, while retaining the low-frequency audio signals. Again, the output signal must be fed to an audio amplifier circuit. The output circuit shown in Fig. 6C is similar to those used on circuits presented earlier. It consists of a π -network low-pass filter (comprised of C8, C9, L1). The value of L1 should be 1 or 2.5 mH (use 2.5 mH below 7 MHz). The output capacitor (C10) is used

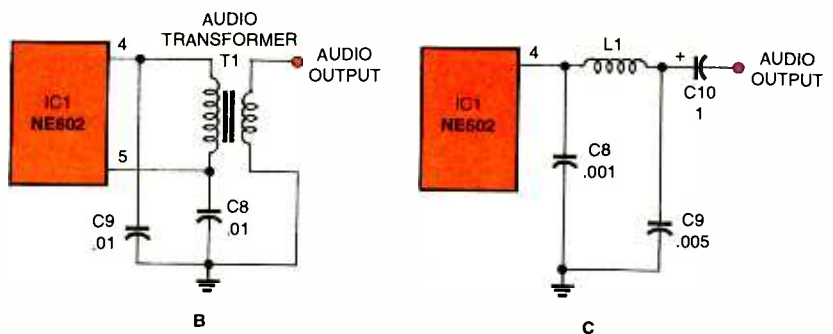
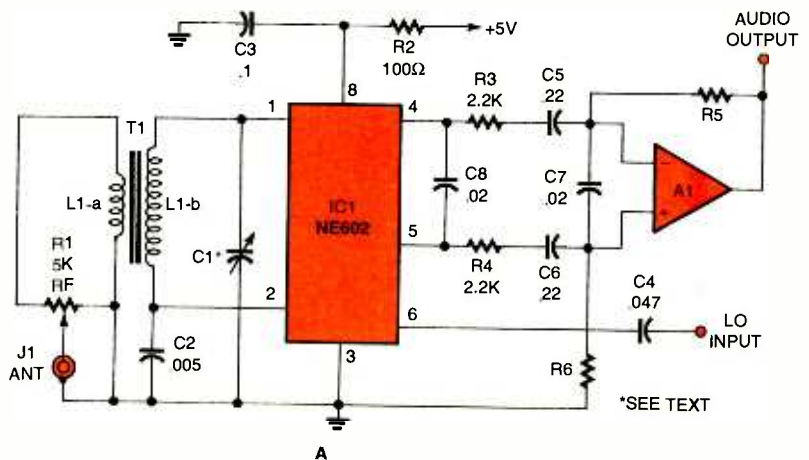

Fig. 6. Another direct conversion receiver design, this one using an NE602 double balanced mixer (DBM) in the front end, is shown in A. The output of the DBM is fed to a differential amplifier. In B, the output of the NE602, from pins 4 and 5, is applied to an audio transformer. In C, the output of the DBM is applied to a low-pass π -network filter.

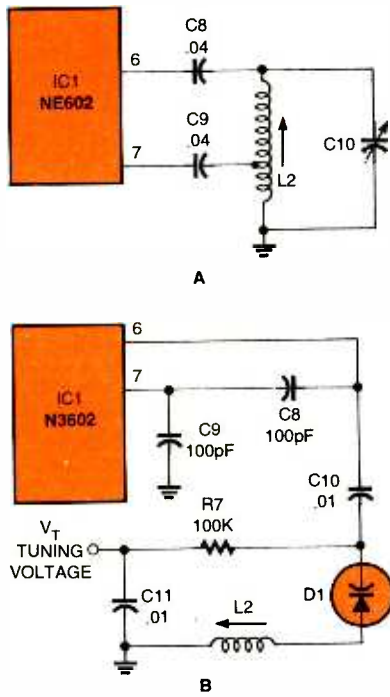

Fig. 7. The illustration in A shows how to use an external inductor and a few capacitors to turn the DBM's internal oscillator into a variable frequency LO. A voltage-tuned local oscillator, using a varactor diode for tuning, is shown in B.

for DC blocking.

Figure 7A shows how to use an external inductor and a couple of capacitors to provide a variable frequency LO. A pair of DC blocking capacitors connect the NE602 to a Hartley oscillator (i.e., tapped coil) circuit. The required oscillator feedback is provided by the tap on L2; that tap is at a point about 25 percent above the ground end. The inductor (L2) is resonated by capacitor C10. The inductor in Fig. 7A should be an adjustable type if maximum flexibility is desired, otherwise use a toroidal inductor. The capacitor can be either a single air variable capacitor, or a parallel combination of an air variable, a trimmer capacitor, and perhaps one or more NPO ceramic or silvered-mica capacitors in order to obtain the desired capacitance and capacitance range.

A voltage-tuned local oscillator circuit is shown in Fig. 7B. That circuit uses a varactor diode for tuning. A varactor diode offers a capacitance that is a function of the applied DC voltage (V_T). The particular varactor used depends on

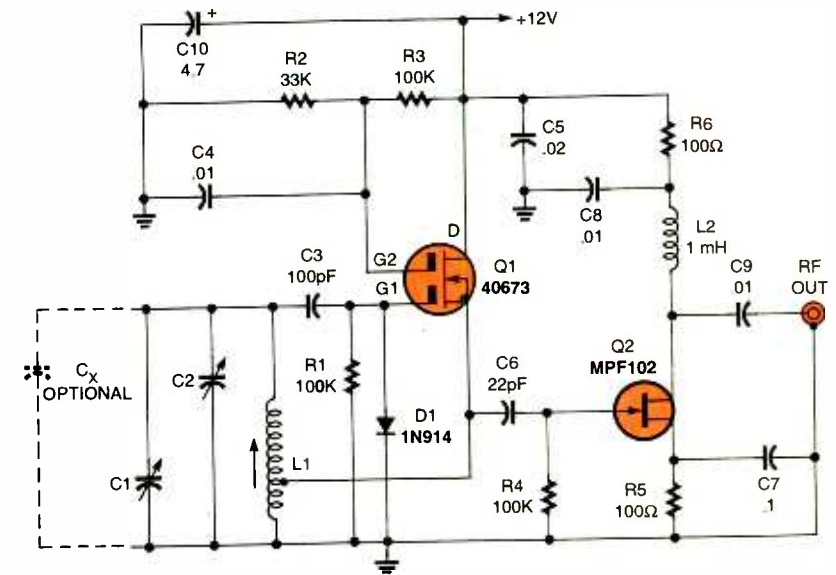

Fig. 8. A variable-frequency oscillator (VFO), built around a 40673 dual-gate MOSFET, Q1, that can operate well into the shortwave region is shown here. The output of the VFO is fed to a buffer amplifier, built around an MFE102 JFET (Q2) that is used to isolate the oscillator from the following stage.

the desired frequency coverage. The NTE catalog and other sources offer versions with values ranging from 11 to 440 pF.

Outboard Circuits. Thus far, the circuits that we've discussed are centered around the direct conversion process. In this section, we'll present a couple of circuits that can be used to augment the converter, including a variable-frequency oscillator (VFO) and high-gain audio amplifier. Figure 8 shows a VFO circuit that can operate well into the shortwave region (20 MHz or so). The actual oscillator circuit is built around a 40673 dual-gate MOSFET, Q1 (which can be replaced by an NTE222). Tuning is accomplished by way of coil L1, plus the combined capacitance of C1 (main tuning), C2 (trimmer, tuning, or bandspread) and the optional capacitor C_x (which is used to provide the balance of the required capacitance). Because L1 is tapped, the circuit is a Hartley oscillator. As in the previous case, the tap is about 25 percent above the ground end of the coil.

At the output of the VFO is a buffer amplifier built around JFET Q2 (an MPF102 or NTE312) that is used to provide isolation to the oscillator

circuit. Unbuffered oscillators tend to "pull," i.e., change output frequency, when the load impedance changes.

Figure 9 shows a high gain audio amplifier for use with direct conversion receivers. The circuit is built around an LM386 audio amplifier (housed in an 8-pin DIP package) that is used to drive an 8-ohm speaker or earphones through C1

(Continued on page 75)

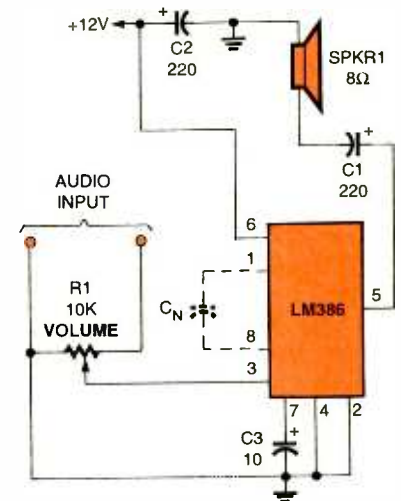
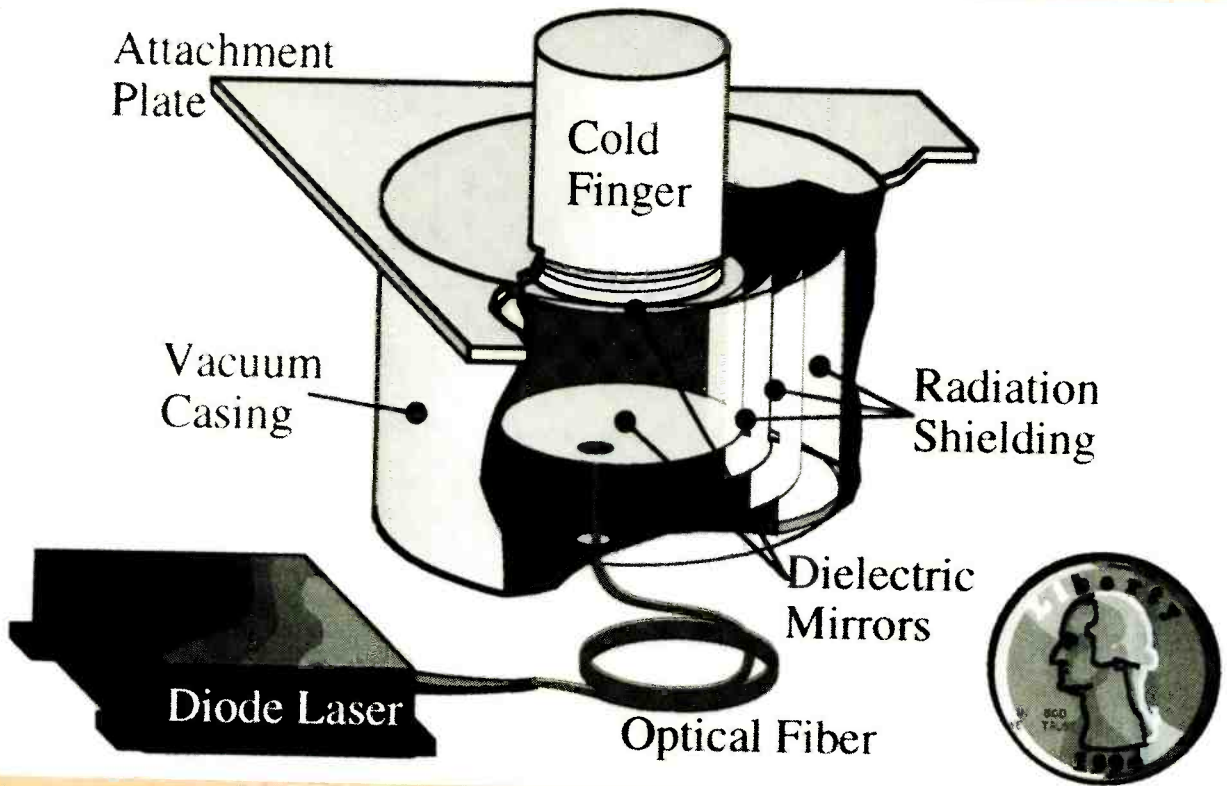

Fig. 9. Here we have a high gain audio amplifier for use with direct conversion receivers. The circuit, built around an LM386 audio amplifier, is used to drive an 8-ohm speaker or earphones through C1.

THE LASER FRIDGE—IT'S COOL!

Who would have ever thought that a device that's been shown to generate extreme heat could be used to generate cold. Well, science has found a way to do just that!



DOUGLAS PAGE

Government scientists are cooling it with lasers. Using a 70-year old theory, for the first time researchers have proven that under the right conditions the searing radiation in laser beams can actually be used to cool solid material. It is the first successful demonstration of an optically cooled solid. Los Alamos National Laboratory experiments have shown *optical refrigeration* to be not only possible but efficient enough that someday the process could provide reliable cooling for cryogenic electronic instruments in space and ultra-fast computer circuits on your desk, as well as other uses.

Data from laboratory measurements, combined with computer simulations, indicate that a "fluores-

In this conceptual design for the Los Alamos Solid-State Optical Refrigerator, a pump light supplied by a laser diode is carried through an optical fiber and enters the optical refrigeration element (ORE) through a small hole in one of its mirrored surfaces. The mirrors trap the light in the ORE until it is absorbed and then re-emitted at a higher energy level. The ORE cools and the higher energy light escapes and is absorbed by the walls of the vacuum casing. Radiation shields that transmit the higher energy light, but block thermal radiation from the vacuum casing, keep the ORE cool through an inverse greenhouse effect. The object to be cooled is attached to a cold finger connected to the ORE.

cent cryo-cooler" could operate for years with efficiencies and cooling powers comparable to current commercial systems. The cryo-cooler, however, boasts several improvements: it would produce no vibrations since it has no moving parts; it would neither generate nor react to electromagnetic interference; it could cool to 77°K; weigh less than 3 kg/watt; and could operate continuously for 10 years.

Using laser heat for cooling may at first seem to violate common sense, to say nothing of the "Second Law of Thermodynamics." Yet, physicists have theorized since the 1920s

that bright light should be able to chill objects. Usually, when light falls on a solid object, it deposits heat or energy. However, under certain circumstances, light can absorb energy from thermal vibrations in a solid, thus decreasing the object's temperature. When an object excited by radiation at one frequency can be caused to emit radiation at a higher frequency, which carries more energy, the net result is the object cools.

"You can think of the principle here as something like cooling an object by washing it with cool light,"

(Continued on page 78)

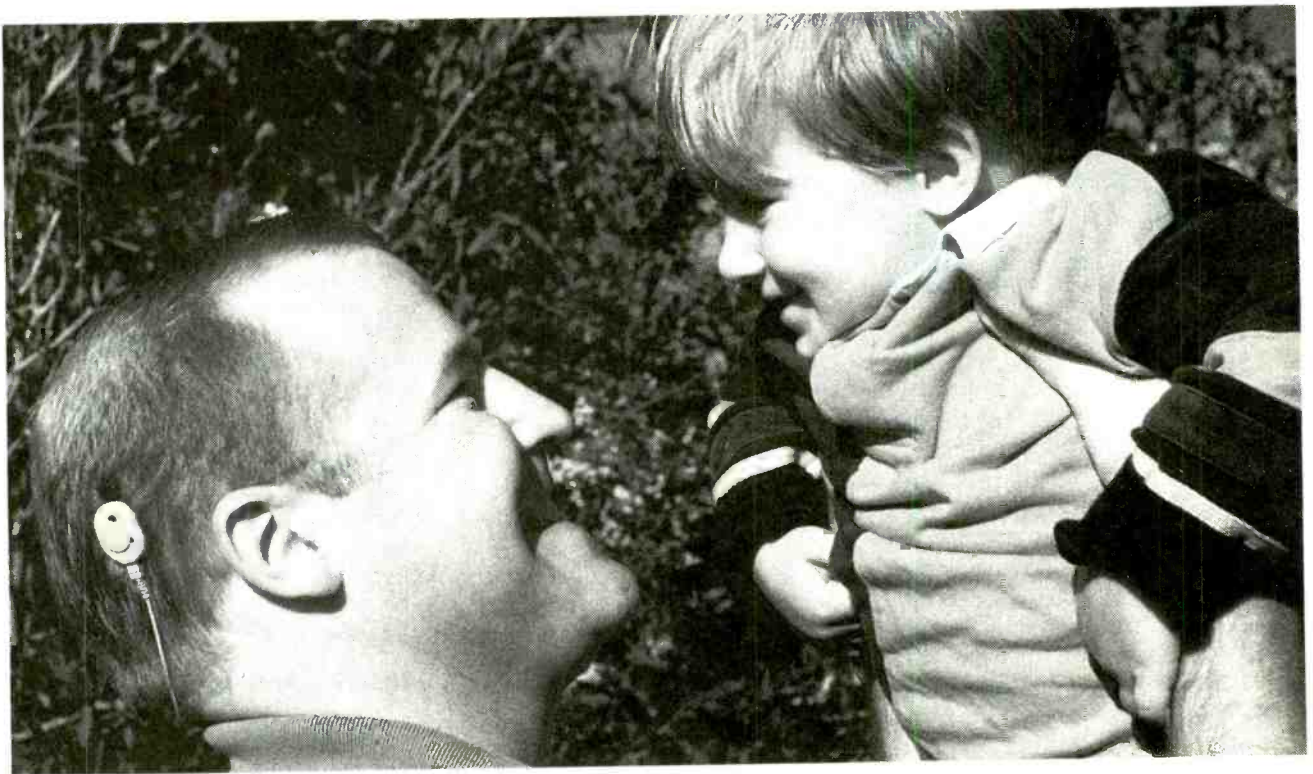

COMPUTERS ARE HELPING THE BLIND AND DEAF

*Here's a look at some new sophisticated software technology
which enables persons with minimal vision or profound hearing loss
to see and hear again.*

Surgery and corrective lenses cannot help persons with minimal vision—therefore they are legally blind. Likewise even the best hearing aids are of little value to people with profound sensorineural hearing loss. New technology based on the power of the computer can now help both the profoundly blind and deaf.

Allowing the Blind to See Again.

Advances in computer technology, coupled with novel design in optical lenses, provide people declared legally blind with sufficient sight to be considerably more independent. A computer program called

BILL SIURU

Soltis has been developed in France. The Windows-based *Soltis* software is used to calculate the optical dimensions for corrective eyeglasses that maximize the amount of light transmitted to the portion of the retina, which is still functional, even though the area may be quite small. As an optic instrument, measurements on the eye can be quantified to determine under what conditions light is transmitted correctly to the retina. The *Soltis* program utilizes photometric calculations that determine each

ray of light through the lens from object to image. According to M. Yves Maigret, the French optician at Espace Vision, who, along with a team of researchers at the University of Tours, developed the technique for designing the corrective lenses, their results show about 50 percent improvement of the patient's vision in the straight-on direction. This is enough vision so that the previously sightless can get around without a cane or seeing eye dog.

Soltis software, offered commercially by Optis Ze La Farlede located in Toulon, France, is a real-time, ray-tracing computer program used in designing a variety of pho-

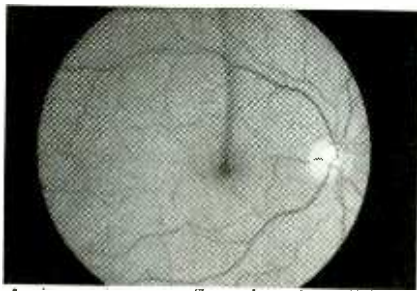

An image is seen reflected on the still functional portion of the retina.

tometric, optic and laser systems. In this application, *Soltis* uses data from several different measurements of the eyes to determine the optimum prism parameters and level of magnification needed to maximize vision. The *Soltis* calculations, which take only about five minutes, result in about a 95 percent accuracy. The software also calculates the eye's physical parameters and most importantly, the location and size of the portion of the retina that is still functional.

Input data to the *Soltis* software includes measurements of the external radius of the patient's cornea. Data on eye parameters are also determined using a variety of optometry and ophthalmology techniques; such as, echography or sonography, angiography, and retinography. The precise location and size of the portion of the eye that is still active is determined by using a dual laser scanning laser ophthalmoscope (SLO). One laser of the SLO projects an optotype image onto the retina. The second laser scans the retina to locate the precise area that reflects the optotype. Areas of the retina that reflect are the portions that are still active and, with properly designed lenses, they can be used for vision.

The results of some five years of research are quite impressive. The technique has been used to design glasses for patients of whom 80 percent were over 75 years old, with the rest being younger than age 15. The test group (women—65 percent and men—35 percent) included 1242 eyes with acuity lower than 10 percent for far vision. The patients suffered a wide variety of eye defects including ametropia, retina and optic nerve diseases, and even those that could not be exactly pinpointed. Nearly all fittings were suc-

cessful, with the few failures in people who did not complete the training needed to use the regained vision and subsequent increased mobility. Training that takes three months includes learning how to recognize and focus on objects. The *Soltis* technology has recently been approved by the French government and is now being used in ten French hospitals, often on even younger patients. It is to be hoped that the technology will spread to other countries, including the United States.

Cochlear Implants for the Deaf.

Sensorineural hearing losses, or "nerve deafness," result from damaged or depleted hair cells in the inner ear. Without healthy hair cells, there is no way to convert sound into electrical current to stimulate the auditory nerve. Sensorineural hearing loss can come from loud noises, head injuries, medications, infections or can be hereditary.

For individuals with a profound hearing loss, even the most powerful hearing aids may provide little to no benefit. Unlike hearing aids that collect sounds entering the ear and amplifying them, the cochlear implant can help people with sensorineural hearing losses by bypassing the damaged hair cells, and electronically converting sound into electrical signals that are sent

FOR MORE INFORMATION:

Advanced Bionics Corporation
12740 San Fernando Road
Sylmar, CA 91342
Tel: 800-678-2575; 818-362-7588
Fax: 818-362-5069
Web: <http://www.cochlearimplant.com>

M. Yves Maigret
Espace Vision
16 Boulevard Joliot Curie
Nantes, France 44200
Tel: 33-40 75 03 97
Fax: 33-40 75 13 60

Newborn Hearing Centre
The Duchess of Kent Maternity Unit
Hillington Hospital
Uxbridge, Middlesex
England UB8 3NN
Tel: 011-44-895-279669
Fax: 011-44-895-811687

Optis Ze La Farlede
BP 275
Toulon, Cedex 9
FRANCE 83078
Tel: 33-94 08 66 90
Fax: 33-94 08 66 94

directly to the auditory nerve. While they do not restore normal hearing, the implants can benefit most profoundly deaf people to varying degrees. Candidates for implants are those unable to understand speech through the use of hearing aids, and who have lost their hearing after some speech and lan-

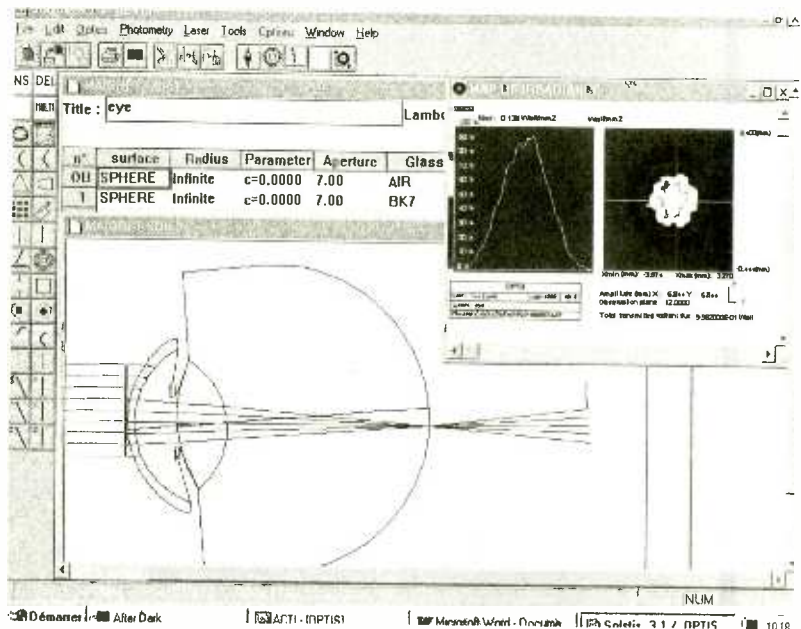

The Windows-based *Soltis* software uses various measurements to calculate the appropriate corrective lens parameters.

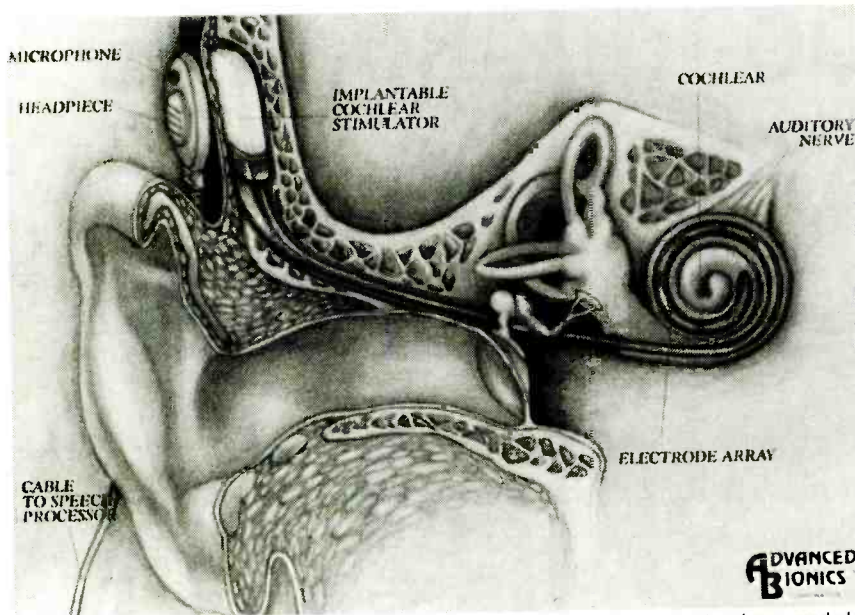

In this cross-section of the skull, the implanted cochlear receiver or stimulator and the electrode array transmits/receives signals directly to the auditory nerve, thereby bypassing damaged parts of the auditory system and directly stimulating the auditory nerve. The headpiece is mounted adjacent to the implant, behind the patient's ear.

guage skills have been learned. Some users say the sounds they hear are similar to those they heard before becoming deaf. Others say the sounds are different from those they remember or are sounds that they never heard before. Benefits from implants include awareness of speech and sounds around them, improved control of the loudness and quality of their voice, improved ability to lip-read, better speech understanding without lip reading, and the ability to better use the telephone. For individuals with a profound hearing loss, even the most powerful hearing aids may provide little to no benefit.

There are several types of cochlear implants. The single channel implant has one electrode located in the cochlea. These simple implants can help lip reading and provide general awareness of sound. Next there is the multi-channel implant with multiple electrodes in the inner ear to simulate different regions of the cochlea. Multi-channel cochlear implants often make speech recognition possible without lip reading. The most sophisticated implant is the multi-strategy, multi-channel implant, which provides the best sound to maximize speech recognition.

One advanced cochlear implant system is the CLARION® Multi-

Strategy™ Cochlear Implant System offered by Advanced Bionics of Sylmar, California. The CLARION sys-

tem consists of both surgically implanted and externally worn components. The internal components include a single cochlear receiver or simulator, implanted under the skin behind the ear, and the connecting electrode array of 16 tiny wires inserted into the ear's fluid-filled cochlea, which, when healthy, contains thousands of tiny hair cells. Implants are done under general anesthesia in two to three hours either on an inpatient or outpatient basis. Four to six weeks after surgery, the patient is given the external parts of the system—the headpiece (worn behind the ear), a battery-powered speech processor (usually carried on the belt like a pager or in a pocket), and a thin cable that connects the two units. The speech processor is programmed specifically for the individual user by a trained hearing technician using Windows-based software running on a personal computer.

(Continued on page 76)

"Baby In A Briefcase" Tests Newborn's Hearing

The earlier a child with a hearing impairment is identified, the sooner corrective action can start. Hearing is critical in a baby's first years for proper development of language, cognitive, and emotional skills. The Auditory Response Cradle, (ARC), developed jointly by the Hillington Hospital and Brunei University in London, provides very early screening—when the infant is only a couple of days old.

The ARC looks like a large briefcase with a built-in cradle. The just-fed baby, the optimum time for testing, is placed in the cradle and earphones are placed on the infant's head. A range of audio sounds are transmitted to either or both ears. Responses to the sounds, like turning of the head, startling motions, and other body activity is monitored by the pressure sensitive mattress and headrest. Another sensor in a polyethylene band around the baby's abdomen monitors breathing. The responses are recorded by the microprocessor in the ARC's computer. The computer is programmed to detect lack of normal responses and automatically indicates either "PASS" or "REFER."

The entire test only takes a few minutes and is designed only for screening. It refers babies with potential hearing problem for more extensive, traditional testing. With a unit cost of only about \$3600, the ARC means that all infants can now be screened. Previously, because of the time and expense involved, only children at risk, because of rubella, physical abnormalities or premature birth, were tested very early in life. So far, some 6000 babies have been successfully tested with the ARC. ■

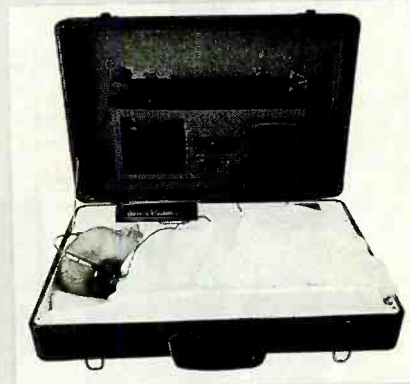

Hearing of a newborn infant being tested with the Auditory Response Cradle.

A 100-kHz-30-MHz ACTIVE ANTENNA

*Give your ham rig or DX station the pull
it needs to catch the communications
that you most want to hear!*

WILLIAM SHEETS, K2MQJ AND RUDOLF F. GRAF, KA2CWL

If you're an SWL or AM radio DX fan living in or near a large city, you've no doubt been plagued by one or more of the common antenna maladies. For example, no outside antennas are allowed in your community, or you live near an electric plant where high RF noise levels abound. Perhaps you simply have no room in your yard for an outside antenna. Other problems include theft and vandalism; esthetics and unsightly appearances; restrictive covenants; legal liability (kids, pets, etc.); fear of lightning strikes; and on and on, *ad nauseam*. And all ham radio fans know that even a good communications receiver is literally hobbled by a poor antenna.

In restricted use areas (high-rise apartment buildings, or dense-packed private homes) the anten-

na (usually a length of wire) is strung around the room in a vain attempt to pluck signals from the air. But an indoor antenna, surrounded by RFI-infested AC wiring, is, unfortunately, a very poor substitute for a well-constructed long-wire antenna. Adding to the problem are light dimmers, computers, fluorescent lighting, TV sets and video equipment, all of which can be real noisemakers. In addition, many newer electrical and electronic appliances and assorted gadgets are microprocessor controlled, which generates lots of RFI. Not to mention that with the frames of modern buildings comprised of various types of metals, it's like living inside a shielded can with RFI generators going full blast.

If you've encountered any of the drawbacks usually associated with the ham or SWLing hobby, then just maybe this article will be of interest to you. Presented here is a reasonable solution to most long-wire problems—the 100-kHz-30-MHz Active Antenna.

Circuit Operation. A schematic diagram of the 100-kHz-30-MHz Active Antenna is shown in Fig. 1. The incoming signal is picked up by the antenna wire, and coupled via C1 to the gate of Q1 (an MFP102 FET, configured as a source follower). Capacitor C1 has a very high impedance to stray 60 Hz and 120

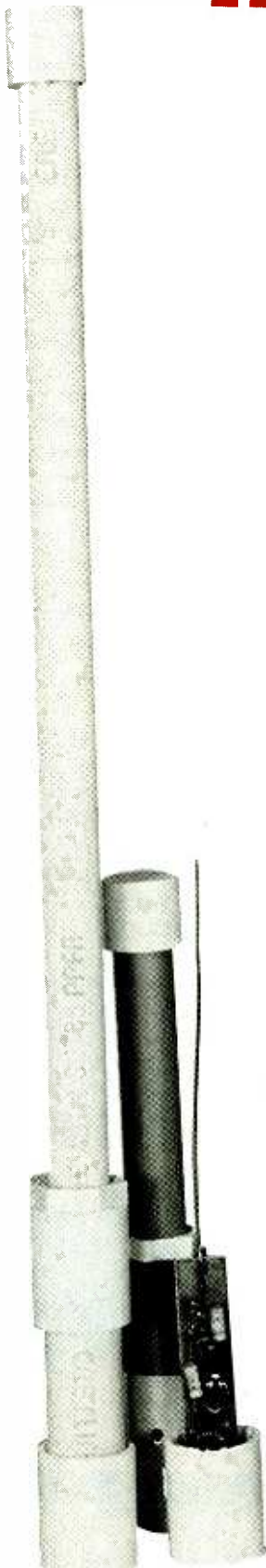

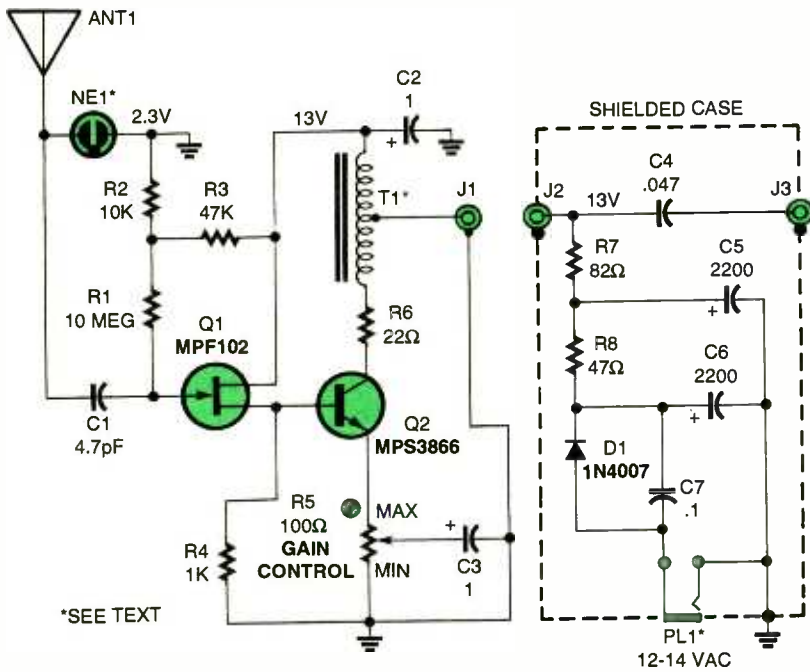

Fig. 1. In the 100-kHz-30-MHz Active Antenna, incoming signals are picked up by an antenna wire and coupled through C1 to Q1 (an MFP102 FET, configured as a source follower), where the signal is amplified and applied to the base of Q2 (an MPS3866 UHF transistor). The bandwidth and signal handling capability of the circuit are determined by transformer T1 (a home-brewed trifilar-wound toroidal unit).

Hz power line hum. A neon lamp, NE1, is used to protect the gate of Q1 from excessive static charge. That's because the PVC enclosure in which the antenna is housed tends to develop high static charge levels when handled, inducing a charge on the antenna wire. That charge might, in turn, cause C1 to break over and damage the gate of Q1. Transistor Q1 is biased at 2.5 volts by R1-R3. The signal that's fed to Q1 is amplified and applied to the base of Q2 (an MPS3866 UHF transistor), which can deliver 100 milliwatts output power. Transistor Q2 operates at 30 to 40 mA, allowing it to handle large signals with good linearity.

Potentiometer R5 (the gain control), connected in the emitter circuit of Q2, provides a variable resistance to boost or decrease the gain of the input signal. Capacitor C3 is connected in the wiper circuit of R5 as a bypass for AC signals. With the gain control set so that all of the R5 is not bypassed, Q2 provides a voltage gain of about 6, with an overall antenna to cable gain of 2. When impedances are factored in, the circuit has an output gain of

about 36 dB. Potentiometer R5 is adjusted for best results on a weak signal, and it should be set for the lowest useable gain to allow for the best dynamic range.

Transformer T1 (a toroidal wide-band transformer, with a 9:1 impedance ratio) determines the bandwidth and signal handling capability of the preamp. The 50-75 ohm antenna input of the receiver is transformed to 450 to 680 ohms as seen at the collector of Q2. Resistor R6 suppresses Q2's tendency toward VHF parasitic oscillation. DC bias for Q1 and Q2 is fed to the circuit through the tap on T1. Capacitor C2 AC grounds the cold

end of T1 and bypasses the drain of Q1.

The amplifier band width is about 10 MHz at 3 dB down, but that's allowable as the antenna is more efficient at the higher frequencies, where less gain is needed. That's also desirable since SW stations on 12 and 15 MHz are sometimes very strong and can cause cross modulation. Below 1 MHz, antenna pickup is the poorest and higher gain is needed. The amplifier's low frequency point is around 80 kHz, depending mainly on T1. That covers the lower limit of the long-wave band (140-425 kHz or thereabouts) found on some receivers with coverage below the AM broadcast band.

Signals from J1 are fed through a length of coax to the signal input/DC output jack of the power supply circuit, J2. From J2, the RF signal is AC coupled through C4 to J3 and on to the receiver. Capacitor C4 is used to block DC while passing the AC signal.

Power is delivered to the preamp through the same cable that delivers the RF signal to J2. That power is supplied by an AC wall transformer connected to PL1, which feeds 12 to 14 volts to a simple half-wave rectifier circuit, consisting of D1, R7, R8, and C4-C7. Diode D1 rectifies the incoming AC voltage to provide a DC source that is filtered by C5 and decoupled by C6, while C7 acts as a bypass.

Construction. The 100-kHz-30-MHz Active Antenna was assembled in two sections—the preamp and the DC block. We'll look at the preamp first. The authors' prototype of the preamp was built on a small printed-circuit board, measuring 3-1/8 by

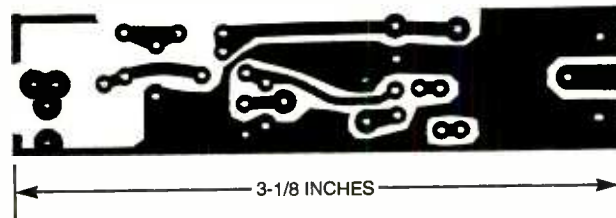

Fig. 2. The 100-kHz-30-MHz Active Antenna was assembled in two sections—the preamp and the DC block. The preamp section was built on a small printed-circuit board, measuring 3-1/8 by 3/4 inches. A full-size template of that printed-circuit pattern is shown here.

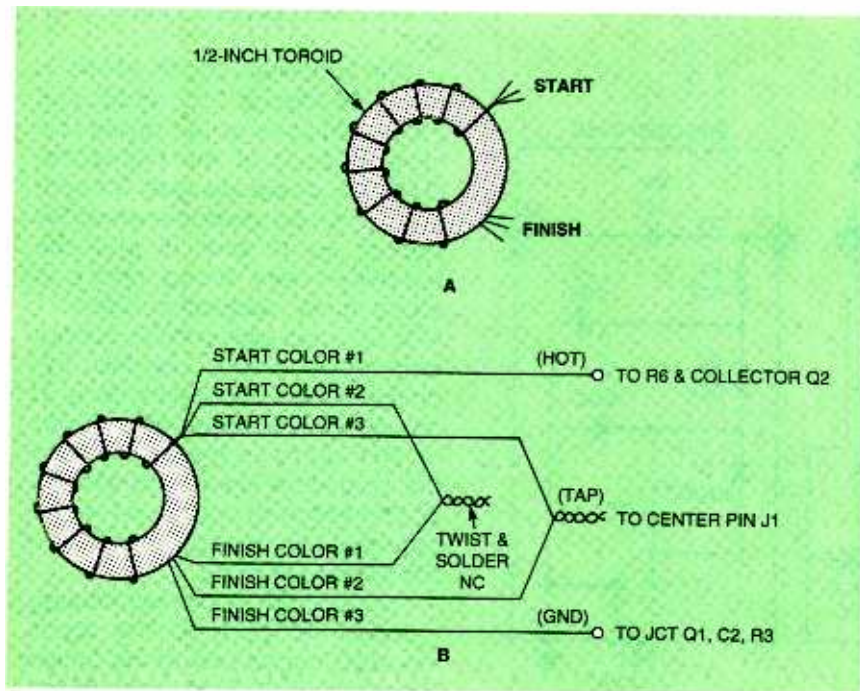

Fig. 3. Transformer T1 was wound on a 1/2-inch toroid core, using color-coded 3-x-32 trifilar wire. Wind 20 inches of the trifilar wire on the toroid core, as shown in A, leaving about 1-1/2 inches of wire at each end of the winding. After separating the leftover wire at each end of the winding, strip, twist, and solder them as shown in B, and mark the joints and remaining ends accordingly.

3/4-inches. A full-size template of that printed-circuit pattern is shown in Fig. 2. Once you've etched your board, it's time to turn your attention to the transformer (T1), a hand-wound unit whose construction details are shown in Fig. 3.

Transformer T1 was wound on a 1/2-inch toroid core, using 3 x 32 trifilar wire (three strands of 32 gauge wire that will be wound as a single unit). The trifilar wire should be color coded. If you cannot find color coded trifilar wire, don't despair, you can always color code individual wires by painting what you have on hand. Otherwise, you can use an ohmmeter to perform continuity tests to determine which wire is which, and then mark both ends of the wires accordingly. In any event, start by winding 20 inches of the trifilar wire on the toroid core, as shown in Fig. 3A, leaving about an inch and a half at each end of the winding. Separate the individual wires as illustrated, and then strip, twist, and solder them as shown in Fig. 3B; e.g., one end of color 1 is connected to one end of color 2, and other end of color 2 is connected to one end of color 3. Note that the connection between color

2 and color 3 forms the tap of the transformer, whereas there is no connection (NC) to the color 1/color 2 junction. Mark those connections accordingly.

Connect the finished transformer to the printed-circuit as shown in the parts-placement diagram (Fig. 4), and then install the rest of the pre-amp components in the positions indicated. Because Q1, Q2, T1 (as well as the wire used to wind the transformer), and NE1 are critical to proper circuit operation, no substitutions or modifications to those com-

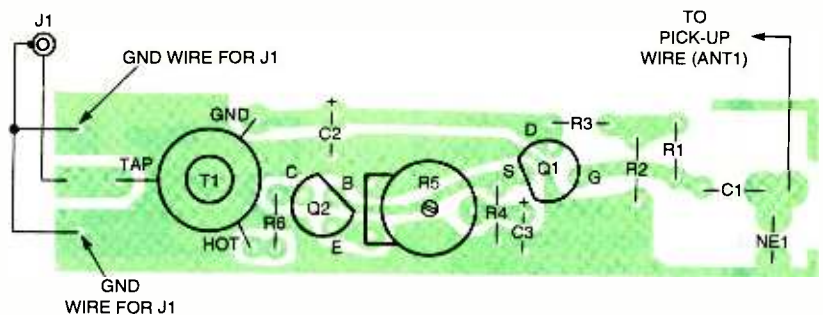

Fig. 4. Once you've etched your board and prepared the transformer, assemble the pre-amp board guided by this parts-placement diagram. When installing the components, be sure to connect the transformer as shown, and also see that the polarized components are properly oriented. Note that although NE1 appears to be mounted to the component side of the board, it is actually soldered to the copper side.

ponents are permissible. Make sure T1 is properly connected, and that Q1, Q2, C1, and C3 are installed with the proper orientation. Note: Although NE1 appears to be mounted to the component side of the board in Fig. 4, in the authors' prototype, it is actually soldered to the copper side of the board. Install a flange-type F-connector (which is used to mount the board to its enclosure, as well as connect the circuit to its power source) to the board where indicated, and then solder the antenna wire to the opposite end of the board.

The antenna pickup is little more than a length of #18 or #20 bare steel wire, but any similar diameter copper wire should suffice. The wire was soldered in line with and directly to the end of the board. The length of the pick-up wire is pretty much up to the builder; but a pick-up of from 16 to 24 inches is a good starting point for most applications. In severe cases, however, (if you live close to a transmitter) the pickup wire can be shortened as needed, but be warned that too short a pick-up wire (less than 12 inches) may reduce weak signal performance. A longer pick-up wire, up to 4 feet, can be used in weak signal areas. Pick-ups longer than 4 feet will not improve performance, and may lead to excessive signal input, resulting in spurious signal generation. Therefore, longer pick-ups are not recommended. If excessive interference and/or noise is heard with R5 at minimum and a shorter antenna, try relocating the antenna to a quieter location.

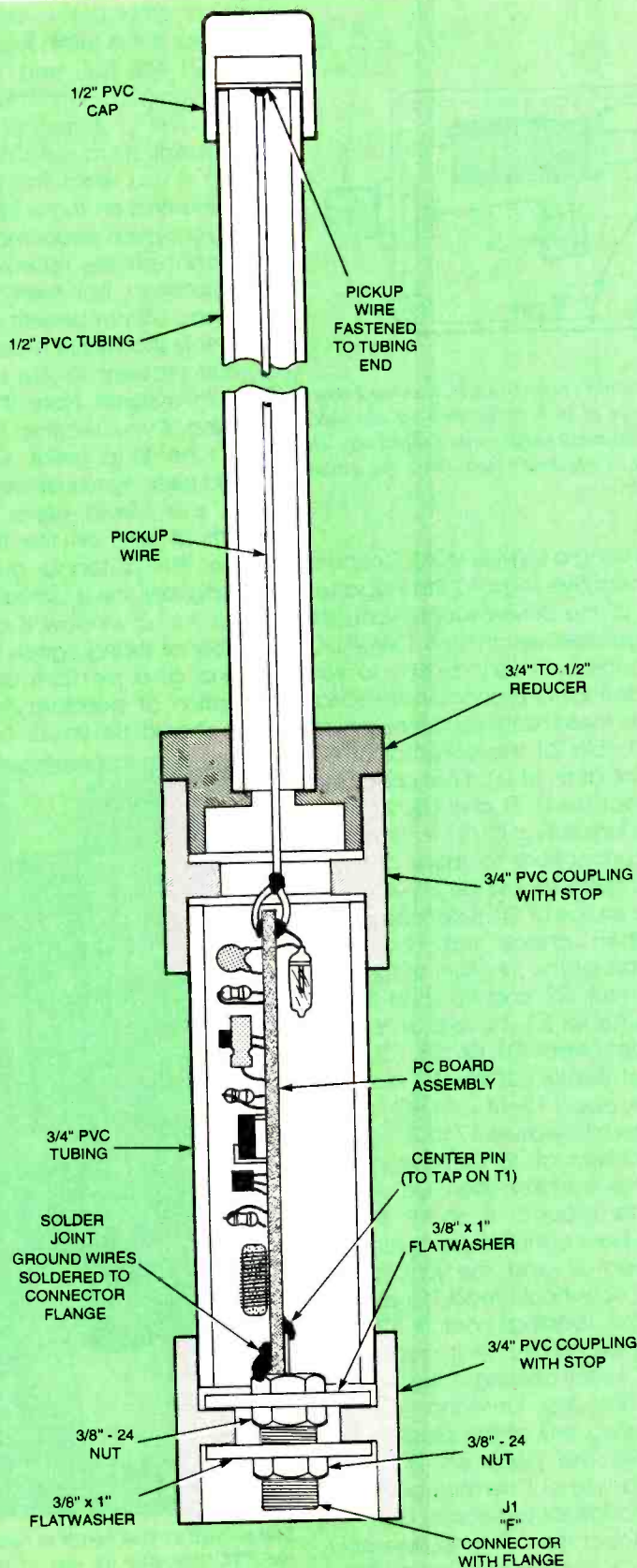

Fig. 5. The completed preamp board, along with its antenna wire is housed in a length of plastic PVC pipe. The board is first mounted into a $\frac{3}{4}$ -inch (ID) PVC coupling with stops using a pair of $\frac{3}{8}$ - \times 1-inch flat washers and mounting hardware. See text for complete construction details.

Once the board is completed, put the circuit to the side and prepare the plastic PVC pipe that will house the preamp. The board is mounted into a $\frac{3}{4}$ -inch (ID) PVC coupling with stops using a pair of $\frac{3}{8}$ \times 1-inch flat washers, and mounting hardware. The coupling acts as a water shield for F connector J1. Note: Use gray or white PVC fittings. Black fittings may be ABS type and possibly the carbon pigment used could cause RF losses. Do not use metallic fittings. Figure 5 shows details of the preamp assembly and its PVC housing. First a nut is threaded onto the F connect to serve as a back stop. Then the washers are positioned one on each side of the coupling stop, and the F connector is threaded through the washers and secured with a nut.

Cut a piece of $\frac{3}{4}$ -inch (OD) PVC pipe to an appropriate length to cover the board (see Fig. 5.). The open end of the pipe is outfitted with another $\frac{3}{4}$ -inch pipe coupling, the coupling mates with a reducer and the reducer mates with a length of $\frac{1}{2}$ -inch pipe or conduit that holds the pickup antenna. A cap is placed at the end of the $\frac{1}{2}$ -inch PVC pipe that holds the far end of the antenna wire in place. The wire is folded over the pipe end and the cap forced over it. Do not use a screw as this will result in exposed metal and possible water leakage. Once that step is completed, check out all wiring and the component placement.

Now turn your attention to the DC Block. The DC block has hardware into a small metal box, as shown in Fig. 6. A good source of such enclosures are old video game switches or junked TV assemblies. You can also use a small metal project box. Do not use a nonmetallic enclosures, as RF shielding is necessary here. Wire the circuit together using Fig. 1 and Fig. 6 as a guide. The DC Block can be mounted in any convenient spot, as location is not critical. It would be best to choose a spot more than 2 feet from AC wiring to minimize the chance of noise pickup.

Checkout Procedure. After all wiring has been checked out and found to be OK, apply power to J1.

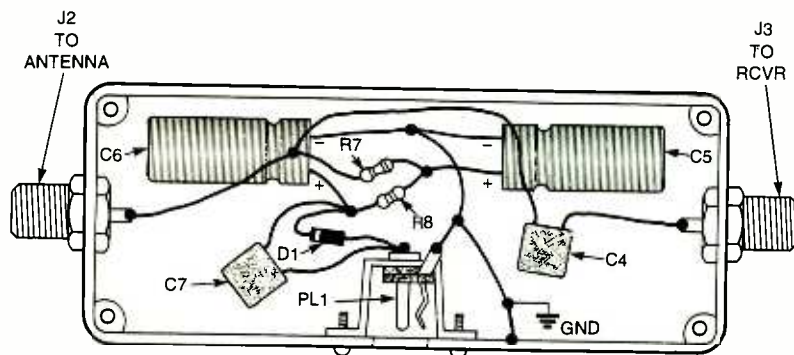

Fig. 6. The DC block, which serves as the preamp section's power supply, was hard-wired into a small die-cast metal enclosure. A good source of such enclosures are old video game switches or junked TV assemblies. You can also use a small metal project box. Do not use a nonmetallic enclosures, as RF shielding is necessary here. Wire the circuit together, using Fig. 1 and this illustration as a guide.

For the checkout procedure, use a positive 13-volt DC source with the negative lead connected to the preamp's ground plane. Set R5 to the default position as follows:

If you live in a city, set R5 at minimum gain (fully CCW). Also use that setting for the less expensive solid state receivers that may be susceptible to overload and spurious responses, as this antenna can deliver a lot of signal. Amplifier linearity will also be best at lower gain settings.

If you live in the country far away from strong AM signals, set R5 about halfway to two thirds CW from minimum.

Next, check for the following volt-

ages using a DVM or VOM. Connect the negative lead to the negative lead of the power supply. Voltages are specified assuming a 13-volt DC input. This can vary $\pm 20\%$, so you may see some proportionate variations in these readings: There should be 13 volts at the collector of Q2 and the drain of Q1, if not check the connections to T1 and C2; 2.3 volts at the junction of R2/R3, if not check the connections to those components; there should be 2.8-4.2 volts at the source of Q1, if not check Q1, R2; then check that 2.3 volts appears at the junction of R2/R3, if not check R2 and R3; and finally, check Q2 for 2.1-3.5 volts at its emitter, if not check Q1, Q2, R5, C3.

Next, check out the DC block as follows: Apply 12-14 volts AC to PL1. You should measure 17 to 22 volts at J2 and zero at J3. Remove power and momentarily short C6 with a lead to ground. A spark should occur. Next connect an ohmmeter between J2 and the junction of C6/C7. You should read 129 ohms $\pm 10\%$. The reading from PL1 to J3 should be infinity. That completes the DC block checkout. Temporarily assemble the antenna without cementing any of the plastic parts together. The parts will fit snugly together without cement and hold well enough for temporary use.

Connect the antenna assembly, DC block, and receiver as outlined in Fig. 7, and try out the antenna. For best results, your receiver should have a coaxial cable antenna connector. If the receiver has a

whip or other built-in antenna, disconnect it. If a ferrite loop antenna is used for AM and long-wave reception (as is often the case), you may have to disconnect the loop and substitute a suitable antenna coil(s) if you want the benefits of this antenna on those frequencies. If SW reception is your main interest, you can use the receivers' built-in AM antenna, but then the active antenna will not benefit AM reception, only shortwave reception.

Set receiver to AM broadcast. Tune in a signal. Note the S-meter reading (if your receiver has one). If not, tune in a weak signal. You should hear signals as well or better than you would using a 20-foot length of wire on the floor. Next, place the antenna outside the building, or if this is difficult, you can place it in a window. If all is OK, a number of strong signals should be heard, and performance and reception of standard AM broadcasts should be similar to a good

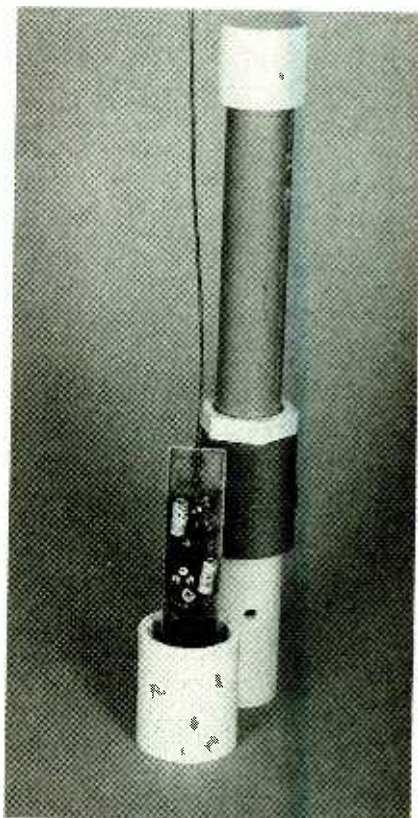

The printed circuit board is mounted into the PVC coupling by way of the board-mounted F connector, a couple of washers, and hardware. This holds the board rigidly in an upright position (as shown here), so that the unit's PVC tube housing can easily be slipped into position over it.

CAUTION!!!

Use care when connecting this or any other antenna to certain older tube-type SW receivers that may use a hot chassis (AC/DC types), as a shock hazard may exist with these receivers. The S38D used as one of our test sets is this type. Check your receiver documentation to determine what it is. If in doubt, either consult a qualified technician or do not use this receiver with this antenna. Do not install this or any antenna or associated lead-ins near, over or under any power lines; or where there is a possibility of accidental contact with power lines. Performance will suffer, and you could be electrocuted.

Note that this antenna is for receiving only. Active antennas such as this are not designed for transmitting. Attempting to transmit with this antenna will destroy the preamplifier and may also damage the transmitter.

PARTS LIST FOR THE 100-kHz-30-MHz ACTIVE ANTENNA

SEMICONDUCTORS

- Q1—MPF102 N-channel JFET
 Q2—MPS3866 NPN silicon transistor
 D1—1N4007 1-amp, 1000-PIV, rectifier diode

RESISTORS

(All resistors are 1/4-watt, 5% units, unless otherwise noted.)

- R1—10-megohm
 R2—10,000-ohm
 R3—47,000-ohm
 R4—1000-ohm
 R5—100-ohm potentiometer
 R6—22-ohm
 R7—82-ohm
 R8—47-ohm

CAPACITOR

- C1—4.7-pF, ceramic disc
 C2, C3—1-μF, 50-WVDC, electrolytic
 C4—0.047-μF, 50-WVDC, Mylar
 C5, C6—2200-μF, 25-WVDC, electrolytic
 C7—0.1-μF, 50-WVDC, Mylar

ADDITIONAL PARTS AND MATERIALS

- NE1—Small neon lamp (100-volt breakdown, CM1 type)
 T1—Ferrite toroid core (P/N 768T188-3E2A)

J1–J3—Chassis mount F connector with flange

PL1—2.1 or 2.5 mm connector.

Printed-circuit materials, 3 × 32 trifilar wire, 12–14-volt AC, 100 mA wall transformer, metal enclosure, 16- to 48-inch length of 1/2-inch PVC pipe, 3- to 41-inch length of 3/4-inch PVC pipe, 3/4-inch PVC couplings, 3/4- to 1/2-inch PVC reducer bushing, 3/8- × 1-inch washer, 3/8-24 Hex nuts, PVC cement, wire solder hardware, etc.

Note: The following items are available from North Country Radio, PO Box 53, Wykagyl Station, New Rochelle, NY 10804: A complete kit of parts (minus the wall transformer) for the 100-kHz–30-MHz Active Antenna for \$19.50 plus \$4.50 S/H. The plastic parts (pipe and fittings) are not included in the kit to reduce shipping costs. A suitable wall transformer is available for USD \$9.50 plus \$1.00 S/H. NY residents add 8.25% sales tax. A catalog of kits for amateur radio projects, ATV transmitters, downconverters, receiver and video accessory kits, video and surveillance cameras and lenses is available for \$2 (refundable with first order) plus SASE with \$0.75 postage and handling from the above address.

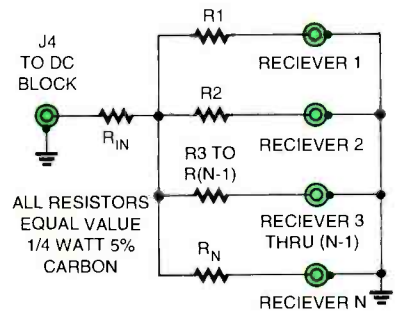

NUMBER OF RECIEVERS	50Ω CABLE	75Ω CABLE
2	16Ω	24Ω
3	24Ω	36Ω
4	30Ω	43 OR 47Ω
5	33Ω	51Ω
N	$50 \left(\frac{N-1}{N+1} \right) \Omega$	$75 \left(\frac{N-1}{N+1} \right) \Omega$

RESISTOR VALUES
(NEAREST 5% TOLERANCE)

Fig. 8. If you are one of the many SWLers who own more than one receiver, perhaps a signal splitter may be of use to you. The signal splitter can be built using a few jacks, a metal case, and a few resistors.

putty before outdoor use as water could leak in and destroy the PC board. Such sealants are easily removed and replaced. The antenna can be mounted almost anywhere, but a location in the clear, well away from AC and telephone lines and buildings (30 to 50 feet, or more) is always the best. The small inconspicuous size of the antenna helps greatly in that regard.

You can also mount the antenna on a post, fence, railing, vent pipe, on the terrace, etc. You can use another length of 3/4-inch PVC pipe as a mounting support, inside of which the coax can be run. The antenna will fit snugly on the 3/4-inch PVC pipe, and no cementing is necessary. You can use a small self-tapping sheet metal screw to secure the antenna, if desired, but it is unnecessary in most cases. For ground mounting, the coax can be fed through a drilled hole in the support and buried underground for a completely hidden installation. Make sure J1 and coax connectors are at least 6 inches above ground—12 inches would be better to allow for snow and ice. If you are

(Continued on page 76)

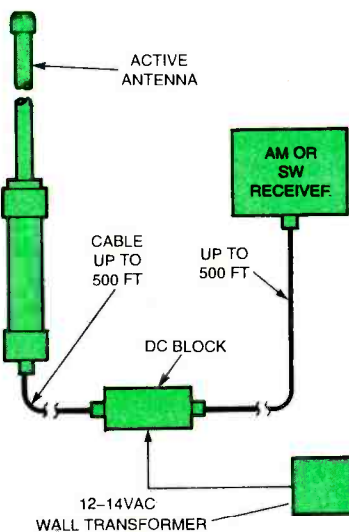

Fig. 7. Connecting the 100-kHz–30-MHz Active Antenna to your receiver is a simple task. As outlined here, you simply connect the antenna assembly to the DC block, and the DC block to your receiver. Coaxial cable runs of up to 500 feet can be placed between the antenna/preamp and the DC block or between the DC block and your receiver. Don't forget to plug a 12 to 14 volt AC wall transformer into PL1—after all, the preamp really could use the power.

AM auto radio. If not, check all wiring and the cables, and connections to T1. If reception is noisy try another location as indoor locations are usually noisy. Next, try the antenna on shortwave signals.

Adjust R5 for best performance. Use R5's default setting at first, and if the setting seems OK or doesn't seem to matter, then it is best to keep it. You may want to experiment with R5's setting for various reception conditions for a time before deciding. Use as low a gain setting as possible, and if any cross modulation or intermodulation is noted, adjust R5 to reduce gain.

Final Assembly. When you are satisfied that all is well, you can permanently assemble the antenna, using PVC plastic cement at all joints. If you've not yet decided on a setting for R5, or if you want to change it some time, you can drill an access hole in the 3/4-inch PVC pipe to allow a small screwdriver blade or alignment tool to get at it. A 1/8- or 3/16-inch hole will do. Be sure to seal it with silicone rubber or electricians

DTMF FREQUENCY COUNTER



*Put that old inoperative tone telephone back in service
with the aid of this easy-to-build frequency detection circuit.*

If you'd like to add an extension to your home phone network, but don't want to pay a premium price for a spare phone, then maybe you should attend a Hamfest or Computerfest. You'll be amazed at the telephone equipment that can be found there at rock-bottom prices. Most of the time the phones have been cleaned up and checked out to make sure they're 100% operational. All you need to do is take them home, plug them in, and you're in business. Unfortunately, you'll also find a few really cheap ones that have minor malfunctions. For example, you might find a telephone that has audio and produces tones but won't access the local telephone office. Or maybe the phone won't produce any tones at all.

A Little Background. In a fully functional tone phone, pressing a numbered button on its key pad activates a pair of oscillators in the

WILLIAM K. MCKELLIPS

phone that produce two special audio tones; one for the row and the other for the column. If the frequency of one or both of the tones is not "within tolerance," then the local telephone switching center will not recognize the tones and will either connect you to the wrong number or simply ignore your signal altogether. If you simultaneously push two buttons in the same row on most tone phones, you will get a single frequency tone: the row's oscillator frequency. If you push two buttons in the same column of the pad, you will get that column's oscillator frequency. That gives you an easy way to separate the row from the column tones, thereby allowing you to independently measure each of the pad's audio frequencies. And that's where the DTMF Frequency Counter described in this article comes into play.

In addition to the DTMF Frequency Counter, you'll need a regulated 5-volt power supply. If you already have one, you can build the DTMF Frequency Counter for about \$16.00, even if you have to buy every part new! For those of you who don't have a power supply, we'll present a simple regulated power supply that you can incorporate into your unit for a just few dollars more.

The DTMF Frequency Counter uses a quartz crystal taken from a digital watch for its frequency standard. You probably have seen brand-new digital watches for children, selling for less than a buck at large drug or discount stores. Better yet, you may have a cast-off digital watch in a junk drawer. When you open the back of the watch, (this may take some doing) you'll find a small tubular can with two tiny wires sticking out of one end. That's the timebase crystal, which is designed to oscillate at 32,768 Hz.

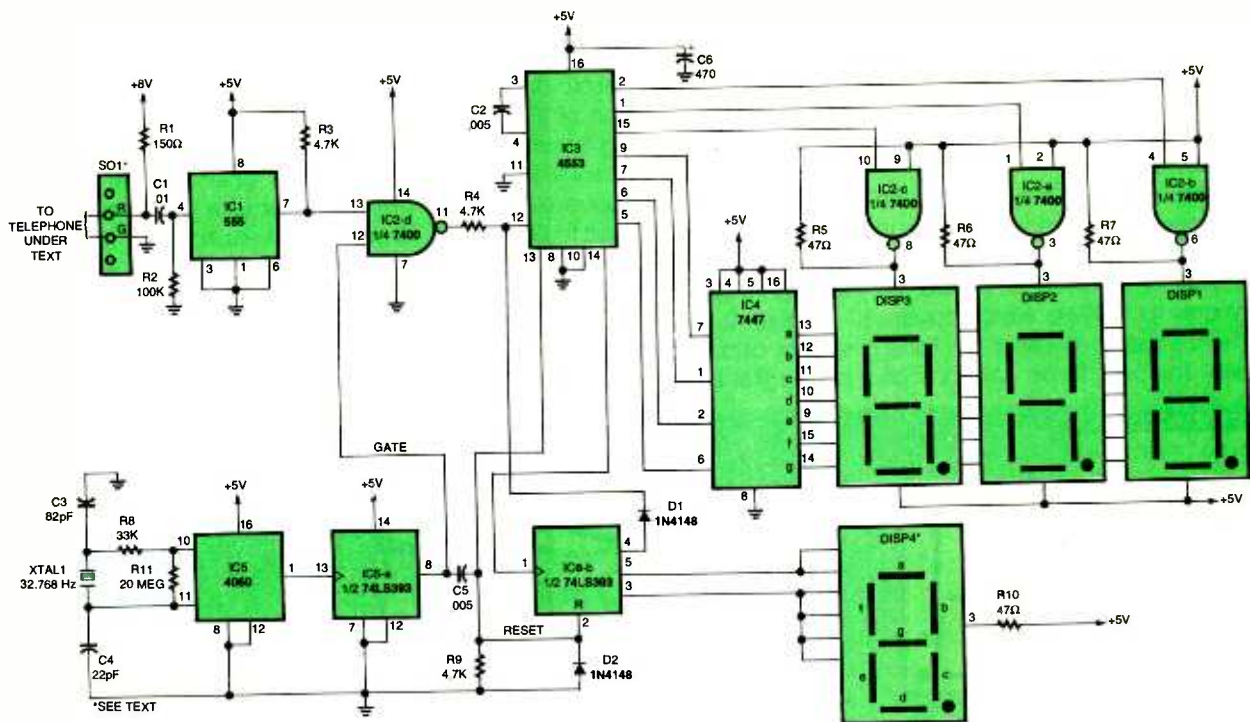

Fig. 1. The DTMF Frequency Counter is built around six integrated circuits (IC1, a 555 oscillator/timer; IC2, a 7400 quad 2-input NAND gate; IC3, 4553B 3-digit BCD counter; IC4, a 7447 BCD-to-7-segment decoder/driver; IC5, a 4060 14-stage ripple binary counter/divider; IC6, a 74LS393 dual 4-bit binary counter), four FND507 common-anode, seven-segment displays (DISP1–DISP4), and a handful of support components.

Circuit Description. A schematic diagram of the DTMF Frequency Counter is shown in Fig. 1. The circuit is built around six integrated circuits (IC1, a 555 oscillator/timer; IC2, a 7400 quad 2-input NAND gate; IC3, 4553B 3-digit BCD counter; IC4, a 7447 BCD-to-7-segment decoder/driver; IC5, a 4060 14-stage ripple binary counter/divider; IC6, a 74LS393 dual 4-bit binary counter) four FND507 common-anode, seven-segment displays (DISP1-DISP4), and a handful of support components.

In the DTMF Frequency Counter, IC5's built-in oscillator (which requires only a crystal, plus a few resistors and capacitors) is set to operate at 32,678 Hz. The oscillator frequency is internally divided by its built-in counter circuitry. The output of IC5 at pin 1 is fed to the clock input of IC6-a (half of the 74LS393 dual 4-bit binary counter) at pin 13. The output of IC6-a at pin 8 divides along two paths. In the first path, the output signal is fed to IC2-a at pin 12 and used to trigger (gate) the NAND gate. In the other path, the signal is applied to C5 (a 0.005- μ F capacitor), transforming the leading edge

of the squarewave output to a very fast, positive-going spike. The spike is applied to the reset terminals of IC3 and IC6-b, causing them to reset just before the count begins. IC6-b—which functions as both a “count = 1000” latch and an over-range detector (counting “overflow pulses”)—is used to illuminate the thousands display (DISP4).

On the first overflow pulse (count = 1000), pin 3 of IC6-b goes high,

causing four segments (a, d, e, and f) of DISP4 to go dark. Pin 5 of IC6-b is at ground potential, causing segments a and b to light, in turn causing DISP4 to display a “1.” On the second overflow pulse (count = 2000), pin 3 returns to its low state. At the same time, pin 4 goes high, feeding that high through D1 (a 1N4148 diode) to the input of U3 at pin 12, clamping the input high, and, thereby, stopping the count. At this

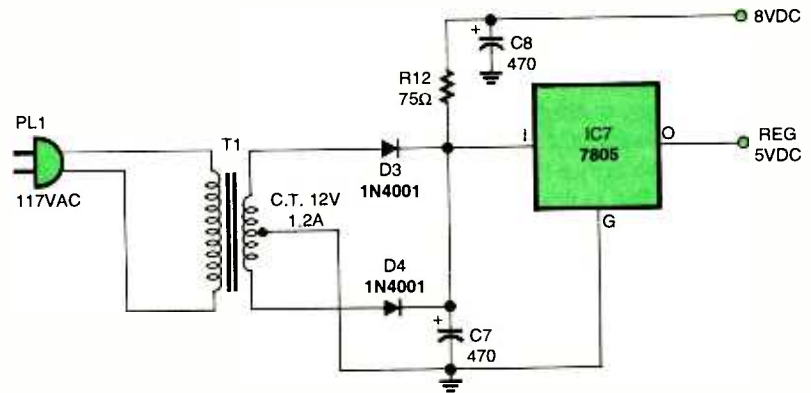

Fig. 2 Here is a simple power-supply circuit—consisting of a 12-volt, 1.2 amp center-tapped, step-down transformer (T1), a pair of diodes (D3 and D4) configured for full-wave rectification, a 5-volt, 1-amp, voltage regulator (IC7) and a few additional components—that can be used to power the DTMF Frequency Counter.

point, all of the display digits have returned to zero. When the counter has visibly gone through its count and all the digits return to zero, you'll know for certain that the count has gone overrange.

The counter actually will count well above the audio range, but would only display the last three digits. The circuit was simplified to count only to 1999 Hz, which covers all the frequencies used by tone phones. The last three sections of

itor connected between pin 3 and pin 4 of IC3. The overflow output of IC3 at pin 14 is tied the clock input of IC6-b. The BCD output of IC3 is fed to the corresponding inputs of IC4 (the 7447), which converts the BCD output of IC3 into seven-segment code. That code is used to illuminate the appropriate segments of DISP1 through DISP3.

Figure 2 shows a simple power supply circuit that can be used to power the DTMF Frequency Count-

Construction. The author's prototype was built in two sections—one section containing the four display modules (DISP1-DISP4) and the other containing the remainder of the circuitry (the counter section). The counter was assembled on a RadioShack catalog # 276-154A card-edge protoboard, which has copper traces and solder pads for the ICs. When assembling your unit, be sure to use sockets for all of the ICs. Start by attaching sockets for

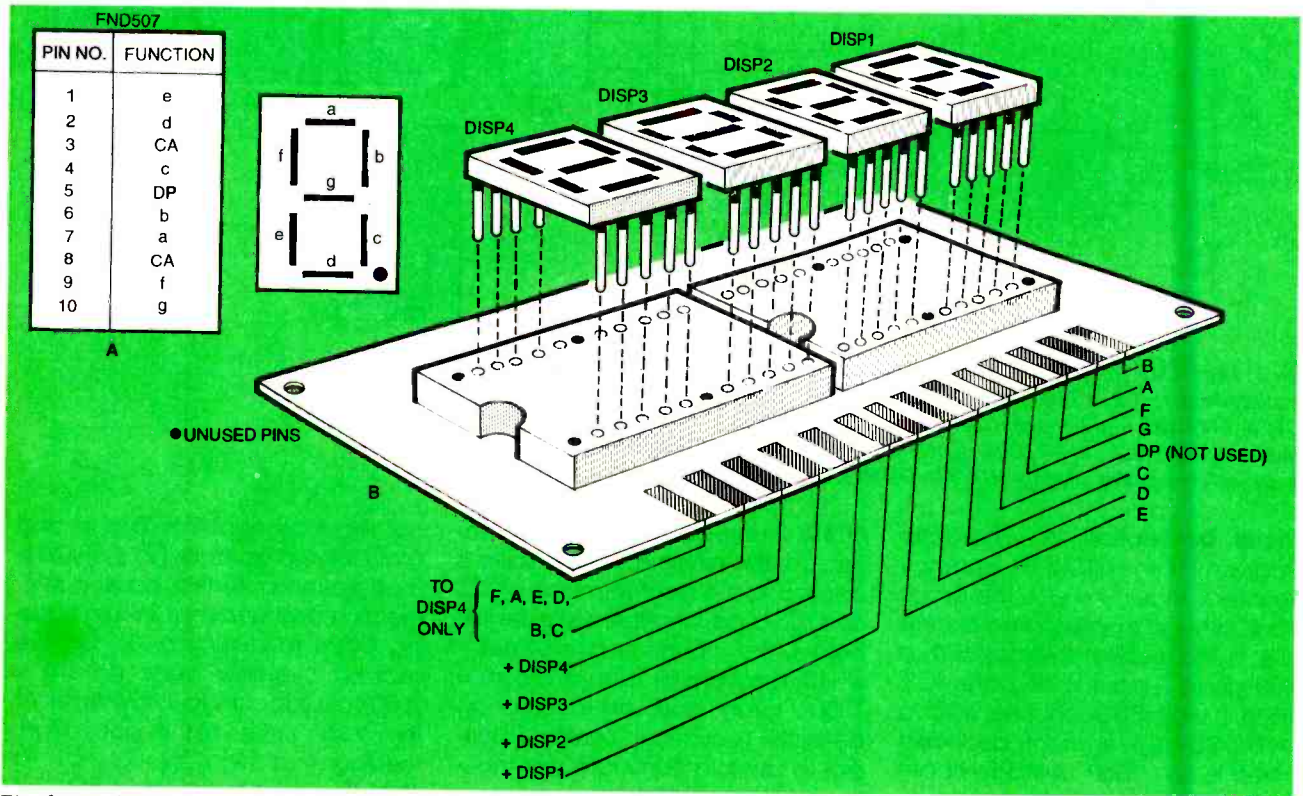

Fig. 3. The four 7-segment modules of the display board mounted in a pair of 24-pin IC sockets positioned end-to-end, are shown here. Note the locations of the four unused pins on each 24-pin socket when wiring the sockets.

the 74000 IC are used to handle the current consumed by the common-anode LED displays.

The low-voltage output of the telephone is applied to IC1, which is used to amplify the signal to the full TTL voltage level. The output of the 555 is fed to one input of NAND gate IC2-d at pin 13. The other leg of IC1-d is tied to the output of IC6-a, which is used as a gating signal for IC2-d. When the gate is high, the output of IC1 is allowed to pass through IC2-d to the input of IC3 (the heart of the counter circuit) at pin 12. The 4553 has built-in multiplex capabilities, whose frequency is determined by C2, a .005- μ F capac-

itor. The circuit uses a 12-volt center-tapped, 1.2 amp step-down transformer, whose output, after fullwave rectification by D3 and D4, is about 8 volts.

The 8-volt output divides along two paths. In the first path, the rectified output of the transformer provides an 8-volt source that is filtered by C7 and C8 (a pair of 470- μ F, 25-WVDC, electrolytic capacitors). The 8-volt output is provided because some tone phones may require a little more than 5 volts DC to operate. In the other path, the transformer output is clamped at 5 volts by the action of IC7 (a 7805, 5-volt, 1-amp, voltage regulator).

the ICs to the board. Install the support components as needed, while using point-to-point wiring to make all of the interconnections between the ICs and the support components. Carefully check wiring.

When wiring up the counter board be sure to keep the input leads to the LM555 IC short and away from wires carrying 60 cycle AC, otherwise you could pick up 60 Hz hum. Be sure the 8-volt DC to R1, at the LM555 input, is well filtered for the same reason. Remember that the crystal in the author's prototype unit was salvaged from a discarded watch. The crystal (XTAL1) was very carefully unsoldered, and the crystal

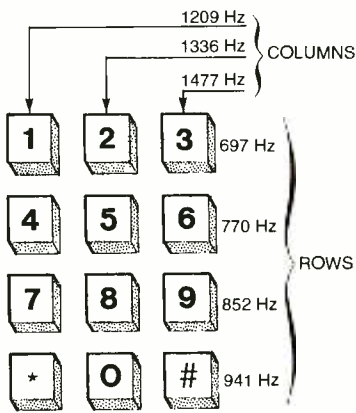

Fig. 4. The DTMF Frequency Counter is amazingly easy to use. Once properly connected to the telephone to be tested, apply power to the circuit, and press any two row or column keys on the telephone keypad. The readout should display, depending on which keys were pressed, a value consistent with the frequencies shown here.

can's leads were soldered to two pins of a cut-down 14-pin header, making it much easier to handle. Some glue was then dabbed onto the assembly to hold the crystal in place; the assembly was then set aside to dry, while the rest of the counter circuit was assembled onto the board. Resistor R9, 20-megohms, is actually two series-connected 10-

megohm 1/4-watt 5% resistors. When you finish wiring the board, check your work for faults; i.e., cold solder joints, misoriented components, misconnected components, etc. Once the counter board is complete and verified to be properly wired, put it to the side and start on the display board.

Like the counter section, the display portion of the circuit was assembled on a Radio-Shack (catalog # 276-150) protoboard. Begin by attaching two 24-pin IC sockets on the board end-to-end, as shown in Fig. 3. Note that there will be four unused pins on each 24-pin socket, so be careful when wiring these sockets. When completed, the four FND-507 display modules are plugged into the two 24-pin IC sockets, side-by-side. Please note that the IC socket pins for DISP4 ("Count = 1000"), will be wired differently so leave its wiring for last.

Modules DISP1-DISP3 are multiplexed. That means that all of the like segments are connected together (e.g., segment "a" of DISP1 connects to segment "a" of DISP2 and DISP3), and are connected to the card-edge labeled "a." The same is true of all the "b," "c," "d," "e"

PARTS FOR THE DTMF FREQUENCY COUNTER

SEMICONDUCTORS

- IC1—555 oscillator/timer, integrated circuit
- IC2—7400 quad 2-input NAND gate, integrated circuit
- IC3—4553B 3-digit BCD counter, integrated circuit
- IC4—7447 BCD-to-7-segment decoder/driver, integrated circuit
- IC5—4060 14-stage counter with oscillator, integrated circuit
- IC6—74LS393 dual binary counter, integrated circuit
- D1, D2—1N4148 general-purpose, small-signal diodes
- DISP1-DISP4—FND507 seven-segment, common-anode LED display

RESISTORS

- (All resistors are 1/4-watt, 5% fixed units unless otherwise noted.)
- R1—150-ohm
 - R2—100,000-ohm
 - R3, R4, R10—4700-ohm
 - R5-R7, R11—47-ohm
 - R8—33,000-ohm
 - R9—20-megohm (see text)

CAPACITORS

- C1—0.01- μ F ceramic disc
- C2, C5—0.005- μ F, ceramic disc
- C3—82-pF, silver mica
- C4—22-pF silver mica
- C6—470- μ F, 25-WVDC, electrolytic

ADDITIONAL PARTS AND MATERIALS

- SO1—4-conductor modular telephone jack
- XTAL1—327-Hz quartz watch timing crystal
- Protoboards, IC sockets, switch, 14-conductor ribbon cable, 14-pin header, wire, solder, hardware, etc.

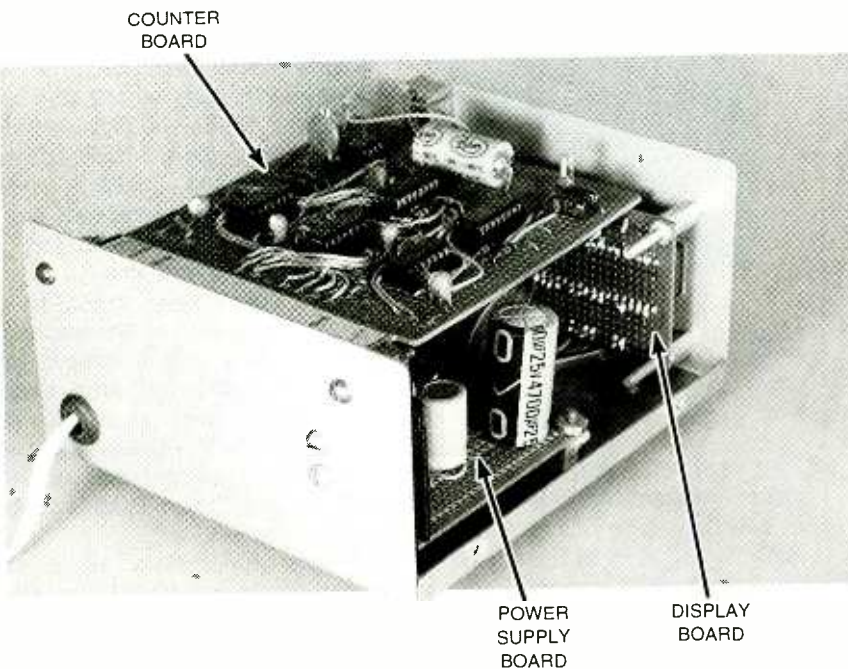

All three of the boards that make up the DTMF Frequency Counter were mounted in a metal enclosure. Located in the bottom of the enclosure is the power supply board; the display was mounted to the front panel; and the counter board was placed above the power supply, using a card-edge connector mounted to the rear panel of the enclosure.

"f" and "g" segments. The three positive (+) common anode leads of the modules are brought out separately as DISP1, DISP2, and DISP3.

Remember that DISP4 is not multiplexed along with the other three display modules. When you get to the socket pins for DISP4, wire the pins for segments "b" and "c" together, and label that line IC6 pin 5. Then wire the socket pins for DISP4 segments "a," "d," "e" and "f" together and label this line IC6 pin 3. Bring the common-anode line out separately, and label it DISP4. These lines are soldered to the edge con-

(Continued on page 77) 57

SCANNER SCENE

Of Scanners and Things

MARC SAXON

The company *Relm Communications* has made a fine reputation for itself in the FM two-way radio field, producing VHF and UHF portables, mobiles, bases, repeaters, antennas, and more, including standard and trunked systems. Now they have entered the scanner market with two programmable handheld units, the RELM models *HS-100* and the *HS-200*. To be more accurate, we should say that the company has *re-entered* the scanner market. You might not know that RELM was formerly known as Regency Electronics, which had been a leading manufacturer of quality scanners prior to the mid-1980s.

The HS-100 scanner has 100 memory channels set up in ten banks. It covers a dozen two-way action bands from 30 to 512 MHz, including the VHF aeronautical band. The more formidable HS-200 covers 13 bands, set up in ten banks, including 800 MHz. Advanced features in the HS-200 include PL/CTCSS and DPL/DCS programming capabilities.

Both scanners provide fast scan, selective bank scan, weather band scan, priority scan (with hierarchy), direct channel access, search, search hold, channel lockouts, birdie lockouts, and LCD display. Both units come standard with AC adapter, ear piece, carrying strap, and a metal belt clip. They are powered by four "AA" penlight batteries, easily accessible on the side of the unit.

RELM scanners are sold through the company's dealer network. RELM Communications is located at 7505 Technology Drive, West Melbourne, FL 32904. Tel: 407-984-1414.

Battery Hints

If you use standard alkaline batteries to power your handheld, you find that eventually they run out of steam. The natural inclination is to throw out the dead batteries and replace them with a set of fresh ones. My advice is *not* to ditch those dud batteries. Just because they don't have enough moxie left to power a scanner doesn't mean that

they're drained out. You might be surprised to find that such apparently dead batteries will still provide enough zip to operate small, low-current devices like remote controls for months.



The former Regency Electronics, now known as RELM Communications, has re-entered the scanner market with two handhelds, including the HS-200, pictured here.

Another hint—be wary of the accuracy of those self-test meters provided on several brands of batteries. They seem all too quick to pronounce batteries in poor shape when, in fact, the batteries are a long-way from quitting. Manufacturers probably don't mind if customers replace batteries a bit sooner than necessary!

Mad Scientists on the Air?

Several exciting things that can be

monitored on scanners are given little publicity. For instance, you seldom get information about stations that the FCC licenses in the Experimental Radio Service. For some unknown reason, the subject never comes up. Yet those off-beat stations often represent new and unusual uses for radio. The majority of experimental stations operate on microwave frequencies, but here's a sampling of some recently licensed ones operating in the scanner bands.

Kyler Abarnathy of Hawaii tracks endangered seals via the ARGOS satellite system. He is licensed as WA2XEE on 401.65 MHz.

Alenco Communications, Inc. in Texas, as WA2XEK, tests the feasibility of a "BETRS wireless local loop" on 454.70, 454.975, 459.70, and 459.975 MHz.

California State University is licensed as WA2XD1 on 401.7025 MHz to collect weather information from the GEOS satellite system. The state of Alaska does the same, as WA2XFE, on 401.7355 Mhz.

Digital Radio Technology Inc. operates as WA2XD0, on 112.45, 136.125, 136.15, 136.75, 136.775, and 136.80 MHz. This signal is broadcast throughout the United States to develop datalink radio equipment for both aircraft control and differential GPS navigational landing systems.

Harris Corporation, in Florida, operates as KB2XEM to test and demonstrate mobile data, automatic vehicle location, computer-aided dispatch, and digital voice on 811.00–816.00 and 856.00–861.00 MHz. The same company also operates on 136.00, 136.40, and 136.425 MHz to test a VHF digital link.

Oregon Emergency Management uses the callsign WA2XF0 on 406.025 MHz to test and develop personal locator beacons.

Radian International, based in Texas, operates a wind profiler radar on 915.00 MHz as WA2XEA. This is for air-pollution studies in Houston.

(Continued on page 74)

A Couple of Neat Things For Hams

JOSEPH J. CARR

Jingle Bells! Jingle Bells! No, I haven't gone whacky, and I'm sweating as much as you are this summer. But if you plan your Christmas list this early in the year (as I do), then you might want to consider a lot of neat products that are on the market for hams. In this month's column, we will look at several items that you might find interesting.

Good Antenna Book

I believe that all hams (especially those who like technical stuff) should have a relatively recent copy of *The ARRL Handbook* (see December 1996 review in this column). This book is known as the "bible" in ham radio circles, so buy a new edition from time to time. As a guy who writes a lot about antennas and has built more than a few over the years, I buy just about everything that comes out in that field, and *The ARRL Antenna Book* is a necessary addition to your bookshelf.

The 17th edition of *The ARRL Antenna Book* comes with an antenna software disk that runs on IBM-compatible computers. If you haven't seen this book, it is a winner! For ordering information, contact ARRL (225 Main Street, Newington, CT, 06111-1494; Tel. (860) 594-0250; Fax: (860) 594-0259; Order No. 4734; ISBN 0-87259473-4, \$30; e-mail: pubsales@arrl.org), or see a local ham dealer. Most technical book dealers carry these books even though they are intended for amateurs...and that a lot of pros use them too.

Das Loudenboomer

It seems that there is a never-ending series of "loudenboomers" on the ham market. A recent news release from Ameritron (owned by the popular MFJ Enterprises, Inc.), announced their model AL-800H Linear Amplifier for the high frequency (HF) ham bands (see Figure 1). The output power is rated at what Ameritron calls "1,500 watts plus." The list price is \$2,295, which, given the price of everything

else these days, isn't too terribly bad for a major hobby item (photography fans would scoff at that price...and you know what I mean if you've ever priced lenses and accessories for cameras that take 120 or 220-size film). There

tubes are pricey!), automatic load control (ALC), and ball bearing vernier reduction drives for tuning and loading. The tuned input circuit uses adjustable slug tuned coils, which is common practice on HF linear amplifiers. The output



Fig. 1. The Ameritron AL-800 Linear Amplifier has a rated output of 1250-watts PEP. Its big brother, the AL-800H, uses two Eimac 3CX800A7 tubes to smash through the ionosphere with over 1500-watts.

are actually two models of the AL-800 amplifier. The straight AL-800, which lists at \$1595, uses a single Eimac 3CX800A7 power amplifier tube, and runs up to 1,250 watts peak envelope power (PEP). The addition of the "H" suffix, to make the model number AL-800H, means that the amplifier uses a pair of Eimac 3CX800A7 power amplifier tubes, with final output power exceeding 1,500-watts.

The AL-800 and AL-800H are designed for legal operation over the range of 160 to 15 meters, and can be user modified by licensed ham operators to operate on the 12-meter and 10-meter bands. It is likely that some enterprising CBer will figure out how to make the antenna tune the 11-meter band, but as we all know, that's strictly illegal!

Both the AL-800 and AL-800H linear amplifiers feature a tuned input circuit, output network, tube protection (those Eimac 3CX800A7 power amplifier

network is a Pi/Pi-L design, which is supposed to provide smoother tuning and a wide impedance matching range. A heavy duty power supply (particularly important in power amplifiers) is featured along with a *Step-Start Inrush Protection™* design which limits initial inrush current (means longer life for those expensive bottles).

The AL-800 and the AL-800H also have a grid circuit that limits grid current and thereby protects the tubes. Again, as ads in this and other ham magazines demonstrate, the Eimac 3CX800A7 power amplifier tubes are a major contributor to the price tag of linear amplifiers, so any protection is well warranted (grid current violations are a major murderer of RF power tubes...I whacked my share of a 6146B, 807, 1625, 813 and an occasional 4-400A in my misspent youth—when I didn't understand grid current and overdrive!).

The illuminated front-panel meters use the popular cross-needle design.

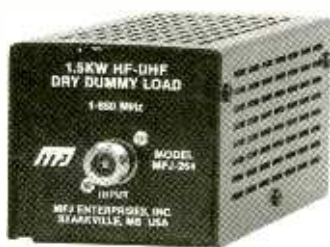

Fig. 2. The MFJ-264 dummy load is a necessary addition to your ham station.

These meters read peak forward power, reflected power, voltage standing wave ratio (VSWR), high voltage, grid current and DC plate current. The power supply of these linear amplifiers can be set for operation over a line voltage of 90 to 140-volt AC, or 200 to 250-volt AC; 14 settings of the AC primary voltage are possible. My own prejudice, by the way, calls for operation of kilowatt-and-up RF power amplifiers from the 220-volt AC line. It requires a special outlet, of the sort that electric clothes dryers use, but not necessarily as many amperes. My linear amplifier is connected to a 220-volt AC, 20-ampere line that is dedicated to the amplifier only.

For information, contact Ameritron (116 Willow Road, Starkville, MS, 39759; Tel. (800) 647-1800 for catalog or (601) 323-8211; Fax: (601) 323-6551; Web: <http://www.ameritron.com>).

Dummy Load

The dummy load is a noninductive resistor used to simulate an antenna when adjusting a transmitter. It is the mannerly thing to do when adjusting transmitters, linear amplifiers (especially), or antenna tuning units. These devices consist of a noninductive, 50-ohm resistor inside a shielded enclosure. Some of them are installed in an oil bath while others are air cooled. Pictured in Fig. 2 is the MFJ-264 UHF/VHF/HF Dry Dummy Load which can handle 100 watts for ten minutes or up to 1500 watts for ten seconds. Price is a reasonable \$59.95; contact MFJ Enterprises (P.O. Box 494, Mississippi State, MS, 39762; Tel. (800) 647-1800 for catalog or (601) 323-5869; Fax: (601) 323-6551; Web: <http://www.mfjenterprises.com>). Some models, like the Drake 2,000-watt unit that I have, are designed with a cut-out on one end to accommodate a small 3.5 inch blower fan, which keeps the load resistor

cool at extended high power and high duty cycles (that is—the ratio of on-time to off-time).

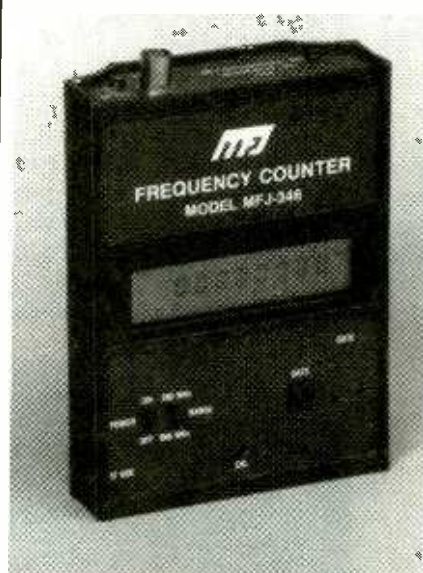

Fig. 3. Here's the MFJ-346 digital frequency counter. This compact frequency counter is only a little larger than a pack of cigarettes—and a lot more useful!

The dummy load offers benefits over regular antennas for the serious tester. First, it is a nearly constant impedance over the entire HF frequency range, and that is a tremendous advantage. Sometimes, when you are adjusting an antenna tuning unit or transmitter, you don't know whether an anomaly is in the unit or in the antenna, especially those which are frequency dependent. Second, it does not present any appreciable reactance. Impedance is actually a combination of resistance, capacitive reactance and inductive reactance. When an antenna's impedance is quoted, it is usually the resistive part that is meant. This is the situation at resonance (reactances are zero). Off resonance, however, the impedance begins to see a reactive component. Third, and perhaps most important, the dummy load provides the ability to conduct tests off the air where you won't cause television interference (TVI) or broadcast interference (BCI), or interference to other users of the test frequency that you select. Besides, it is illegal and just plain rude to radiate when you don't have to!

One "tune-up" use for dummy loads is to adjust antenna tuners. You can connect the dummy load to the antenna output of the tuner, and then adjust the

controls for best VSWR at a number of frequencies. By recording the knob settings, you can "rough in" the antenna tuner when repositioning.

Digital Frequency Counter

At one time, a digital frequency counter (DFC) was terribly expensive. Even "cheap" models cost about the same as new cars of that era. They were heavy to carry and were power hogs. I can remember lugging one of those things up four flights of stairs to a rooftop penthouse where a bunch of commercial radio transmitters were located...I've come to appreciate the modern types.

Those early DFCs were really open only to professionals and that top elite of rich hams. The rest of us used a receiver and crystal calibrator to measure frequency, more or less. Today, the situation is different. While the best DFCs are still costly, there are a number of ham-grade instruments on the market. The MFJ-346 DFC, shown in Fig. 3, features frequency measurement to 600 MHz with 10-digit LCD precision—and for only \$189.95. A number of very similar models that are also very reasonably priced are available from about a half dozen sources, and they allow you to measure frequency accurately enough for most ham uses. These battery-powered devices make the use of the DFC a game for all.

A Personal Note

Every month at the end of my column, I provide my e-mail and snail-mail addresses in the hope that readers will contact me. A number of readers take advantage of this and either write or e-mail questions, criticisms, requests for information and so forth.

Not long ago I got a letter from a reader who asked where he could get parts for his old Vibroplex "bug" (a semi-automatic telegraph key for you "young-un's"). I recognized his name from my ham activities in northern Virginia about 35 years ago, so I called him on the telephone. He was surprised, but it was obvious that he didn't remember me. I asked him "Do you still have that Hammarlund HQ-180?" He was now really surprised—how does a guy at Popular Electronics know about a receiver he had when he was a kid?

I can be reached by snail mail at P.O. Box 1099, Falls Church, VA, 22041, or by e-mail at carrji@aol.com.

ANTIQUE Radio

This 'n That

MARC ELLIS

Let's start off with an interesting letter from David Booth. Usually, letters appearing in this column are shortened or paraphrased in order to conserve room. However, Dave's letter is so packed with lore on early Westinghouse/RCA production that I've decided to run it in its entirety.

Which Was the Senior Aeriola?

"I was recently rereading the October, 1989, issue of *Popular Electronics* (I save all my back issues), and noted that you responded to a Mr. Ray Shetrone concerning an Aeriola (or Radiola) Senior, which was missing the inside card from the lid. My grandfather, James D. Booth, who died in 1970, worked for Westinghouse from 1919 to 1962. He said in his 1962 retirement speech [quoted below] that the Aeriola Senior was produced in the L-80 section of Springfield Works.

'Later in 1921 we moved into larger quarters known as L-80. There we built RC receivers and that little marvel of the age—the Type LV Vocarola. I'll have to skip lightly over the Aeriola Senior Type RF, which was actually produced a little before the Aeriola Junior Type RE The *Aeriola* [my italics] Type RS was really a very good receiver when used with headphones. Davenport, Iowa, came in loud and strong

'In 1922, radio suddenly became big business, and cost reduction hit the fan. Cabinets were the most costly item, so we built samples of the Aeriola Junior in tomato cans. RCA wouldn't go along with this, but we cost-reduced the Type RS cabinet from about \$7 to less than \$1. It then became the Radiola III, and we built thousands of them. In fact, we probably sold more of them than any other type.'

"I used to wonder why my grandfather called the RF the Aeriola Senior, when most of the texts I had seen called the RS a Senior. Following my grandmother's death in 1995, my father and I cleaned out the house, and found a large quantity of papers from

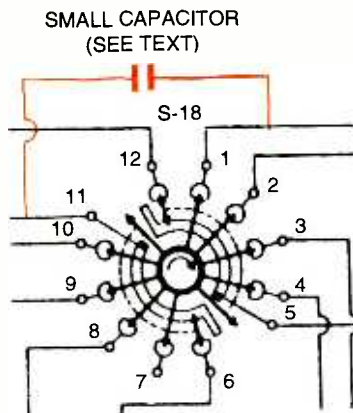

Fig. 1. A small capacitor, connected as shown to the antenna segment of the *Star Roamer's* bandswitch, makes an outside antenna work on the broadcast band. The drawing of the bandswitch is a copy from the original manual.



Aeriola Sr. (RF) from *Radio Manufacturers of the 1920's*.

Westinghouse that my grandfather had saved. Among them was a notebook containing outer shipping labels and inner instruction cards for all Westinghouse home use radio production for 1921 and 1922. They are pasted onto Westinghouse watermarked paper, and many labels are stamped with a circular time and date received stamp. The dates range from mid-March 1921 to August of 1922.

"All of the labels and instruction sheets for Aeriola Seniors show that

they are designed as Type RF. They are all shown as one-tube receivers. Alan Douglas, in *Radio Manufacturers of the 1920's, Volume 3*, shows an Aeriola Senior (RF) on pages 6 and 11. Both of them have one tube. But beneath the photograph of the Aeriola Senior Type RF, on page 11, is a single-tube unit that contains an RCA *Radiola Senior* label. Also on page 11, he shows a *Radiola Senior* (Type RS), which is a two-tube unit.

"These photographs, combined with my grandfather's papers and retirement speech, seem to suggest that the Type RF was originally called an Aeriola Senior, later called a Radiola Senior, and later improved to a Type RS, but still called a Radiola Senior. My remaining question is why my grandfather called the RS an Aeriola Senior. Because he typed his speech, and did not save the draft copies, I do not know whether this was intentional or not. In any case, I have never seen the RS called an Aeriola by anyone else.

"I have two of the Type RS Seniors, which were my grandfather's. Neither of them has any label, and there are no signs of labels ever having been installed. I assume he purchased them through Westinghouse's surplus-sales-to-employees policy.

"I would be very interested in hearing from anyone who can shed light on the Aeriola/Radiola question. If I find more information on this arcane matter, I will follow with another letter."

David E. Booth
318 Fairfield Avenue
Westminster, MD 21157-5913.

Latest Lindsay Reprints

Lindsay Publications, long a source of reprints of early technical books, has scored again with the release of *1928 Radio Trouble Shooting*, by Enno R. Haan, E.E., Associate Editor of *Popular Mechanics* magazine. In the preface, the author grandly claims that this book was the first-ever volume devoted, in its entirety, to the maintenance and repair of broadcast radio receivers. He goes on to say that while

simple enough for "the veriest amateur," the volume is complete and exhaustive enough to be useful to the radio serviceman.

Appearing just prior to the age of AC (or "socket power") radio receivers, *1928 Radio Trouble Shooting* contains information only on battery sets (and on plug-in battery eliminators). But while repair data on early AC sets is fairly common, detailed repair information on battery sets is harder to come by. And there is more of the latter between the covers of this excellent book than I have ever seen in one place before.

The book is organized in a logical and intelligent manner. Its eight chapters deal, in order, with tools and instruments, propagation conditions, antenna troubles, batteries and chargers, battery eliminators, tube troubles and remedies, "internal disorders" in radio receivers, and reproducer troubles and maintenance. The book is also extremely well illustrated, containing 257 numbered figures and charts—many of them charming line drawings.

Thanks very much, Lindsay, for making this valuable compendium of battery-set lore available once again! The soft-cover book has 317 pages. It costs \$12.95, plus \$1 shipping and handling (book rate mail); UPS shipping is available for an extra cost. Illinois residents add 1/4% sales tax. Write to Lindsay Publications, P.O. Box 538, Bradley, IL 60915.

In the "Spring Supplement 1997" catalog included with the review copy of *1928 Radio Trouble Shooting*, Lindsay also marked a two-page spread announcing another new reprint: the 1912 edition of *Maver's American Telegraphy and Encyclopedia of the Telegraph*. The 700-page classic reference contains 34 chapters, including 544 illustrations, detailing the state of the art of that technology as it was in the early years of the century. It looks like a very important book for those who are interested in the history of telegraphy. The hard-cover book has over 700 pages. It costs \$34.95 plus shipping and handling, and tax as mentioned above.

Tube Lore Supplement

I just received a note from Lud Sibley, author of *Tube Lore*, which was reviewed in the February 1997 column. Thanks to a great deal of interaction with readers of the new book, not to

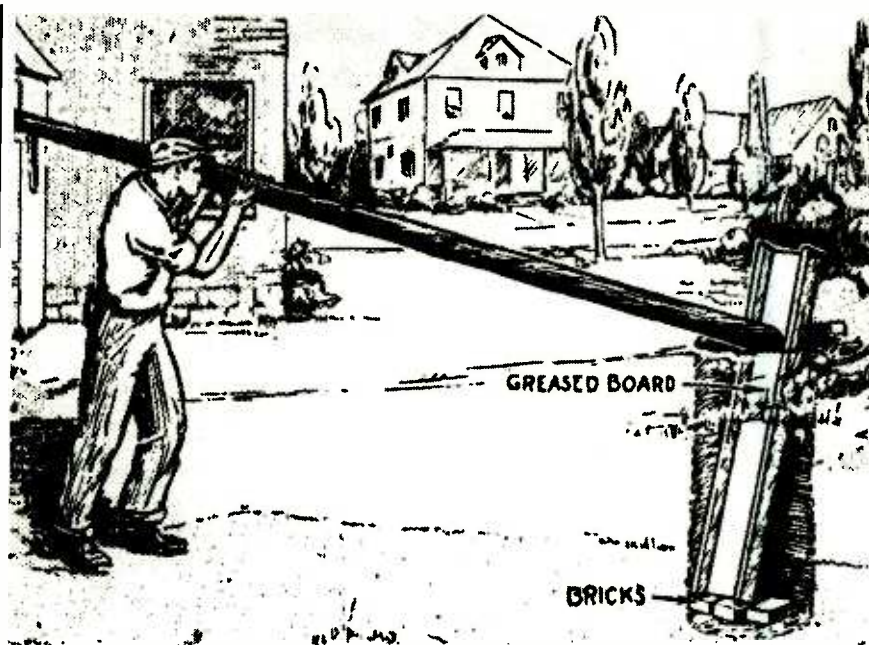

How one man can erect an antenna mast from *1928 Radio Trouble Shooting*.

mention his ongoing research, Lud has acquired enough additional material to publish an eight-page supplement. The supplement is included with all books shipped since mid-February.

Those who received their books earlier can get a copy in one of two ways: (1) Send a business-size, self-addressed, stamped envelope to Lud Sibley at 44 East Main Street, Flemington, NJ 08822-1224; or (2) Download the file from the New Jersey Antique Radio Club Home Page (<http://globalent.net/oldradio>, but currently being changed to <http://www.eht.com/oldradio>.)

Lud anticipates that additional supplements will be released from time to time as new discoveries continue to surface.

Star Roamer Echoes

Reader Ed Gold (Ezec, KY) writes: "Thank you for the series on the Star Roamer! I spent a summer mowing grass and baling hay to save enough to buy a Star Roamer kit. At the time I was 12 years old. Somehow, the radio actually worked. I couldn't tell you how many hours I spent listening to the world.

"I got away from shortwave listening for many years, but last year I was in RadioShack and found a DX394. This is a good receiver, but lacks the personality of my old Star Roamer. I'd give a lot to find out what happened to it 25 or 30 years ago. Thanks again for all the great memories."

I was impressed by Ed's achievement. He put together a working Star Roamer at age 12. That was no mean task! From my own experience, I can testify that, while the Star Roamer receiver was inexpensive and had a low tube count, it included some fairly sophisticated circuitry.

Now, from Arthur L. Manning (Brunswick, GA), comes this tip on using an external antenna on the Star Roamer's broadcast band:

"I have a Star Roamer radio and have been following your articles on it with interest. If you use an outside antenna for long wave and shortwave reception, you will find it does no good on the broadcast band (band 2). That uses only a loopstick mounted on the rear of the set.

The addition of a very small coupling capacitor between terminals 11 and 1 of the bandswitch will allow loose coupling of the antenna into the loopstick and dramatically improve broadcast reception. (Fig. 1 shows a portion of the original schematic diagram in the manual with the added capacitor.) I used a 4.5 pF capacitor because it was in my junkbox, but any very small capacitor will do. Do not use a large-value capacitor as the loopstick resonance will be affected."

See you next month, when we'll get back to our exploration of the Freed Eisemann NR-5 Neutrodyne "three-dialer." If anyone has a unit, we'd like photos of it!

Think Tank

JOHN J. YACONO
LAB TESTING COORDINATOR
WINDOWS MAGAZINE, IEEE

Jose Returns

Jose has sent in another big batch of quality circuits for us this month, so he gets a kit and another MCL1010 chip along with the book awarded for single submissions.

transformer to reduce the voltage. To refresh your memory about how that works, take a look at Fig. 1A. That circuit is plugged into an AC outlet via PL1, and 117-volts AC is applied to the

age as shown by the waveform diagram in Fig. 1B. This diode in the circuit forms what is called a "half-wave rectifier," and the resulting current is called "pulsating direct current." Now we have lower voltage with current flowing in only one direction, although this current is intermittent.

What we need is a circuit that fills in the gaps, so current continues to flow through the resistor when the diode is cut off. Perhaps we could use another diode receiving bias current that is out of step with the one we have already. Figure 1C is exactly that. Here we are taking advantage of a center-tapped transformer. Relative to the center tap, the polarity of the secondary voltage at point AA is always opposite to that at point BB (except for those brief moments when the voltage is zero). So when diode D1 is reverse-biased, diode D2 is forward biased and steps in to provide current to the load.

Let's look at the operation of the circuit one step at a time. When point AA goes positive with respect to the center tap, diode D1 conducts. Conventional current flows through D1, returning to the center tap by way of the load. Also when the voltage at AA is positive, the voltage at BB is negative. At this time, diode D2 is reverse-biased and no current flows through it. Eventually the voltage at AA drops and goes negative with respect to the center tap—diode D1 stops conducting. When the voltage at AA becomes negative, the voltage at BB is positive. Then, diode D2 conducts current, which flows through the load back to the center tap. Note how the direction of current through the load remains the same regardless of which diode is conducting at the time.

This diode/transformer configuration makes up a "full-wave center-tap rectifier" circuit, although the resulting waveform is still termed "pulsating DC." Can you think of a way to use four diodes and a plain transformer to achieve the same result? We will explore the answer to that next time. Now let's get to the letters!

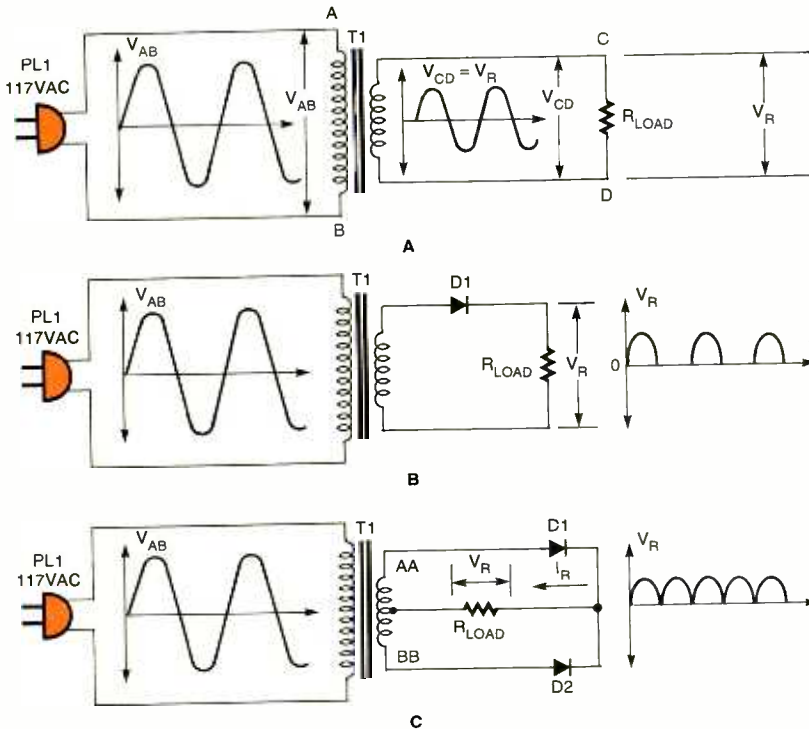

Fig. 1A. The voltage across the load resistor is a reduced value of the input voltage. Fig. 1B. With one diode, current flows only half the time—producing pulsating voltage across the load resistor. Fig. 1C. When the circuit has two diodes, pulsating voltage flows all the time across the load resistor.

Remember friends, if you would like to try winning a book, send a schematic and a description of the theory for a working circuit to Think Tank, **Popular Electronics**, 500 Bi-County Blvd., Farmingdale, NY 11735. Send enough suitable circuits to fill a column, and a chip and kit will be on the way, too.

Getting back to our discussion topic, last month I mentioned household current is delivered as 117-volts AC. That's okay for heavy-duty appliances containing just AC motors, but it is not suitable for most devices, which typically require DC and at a low voltage. Such circuits usually contain a

primary of step-down transformer T1. The transformer reproduces the waveform at its secondary winding, but at a reduced voltage. That gets us closer to what we want, since the voltage to the load is now at a lower value.

Consider what happens if we place diode D1 in series with the load. The diode permits current to flow only when it is forward biased, effectively cutting current off when the diode is reverse biased. When current does flow, it creates a voltage drop across the load. When current is cut off by the diode, the current through the resistor is also close to zero, producing only negligible volt-

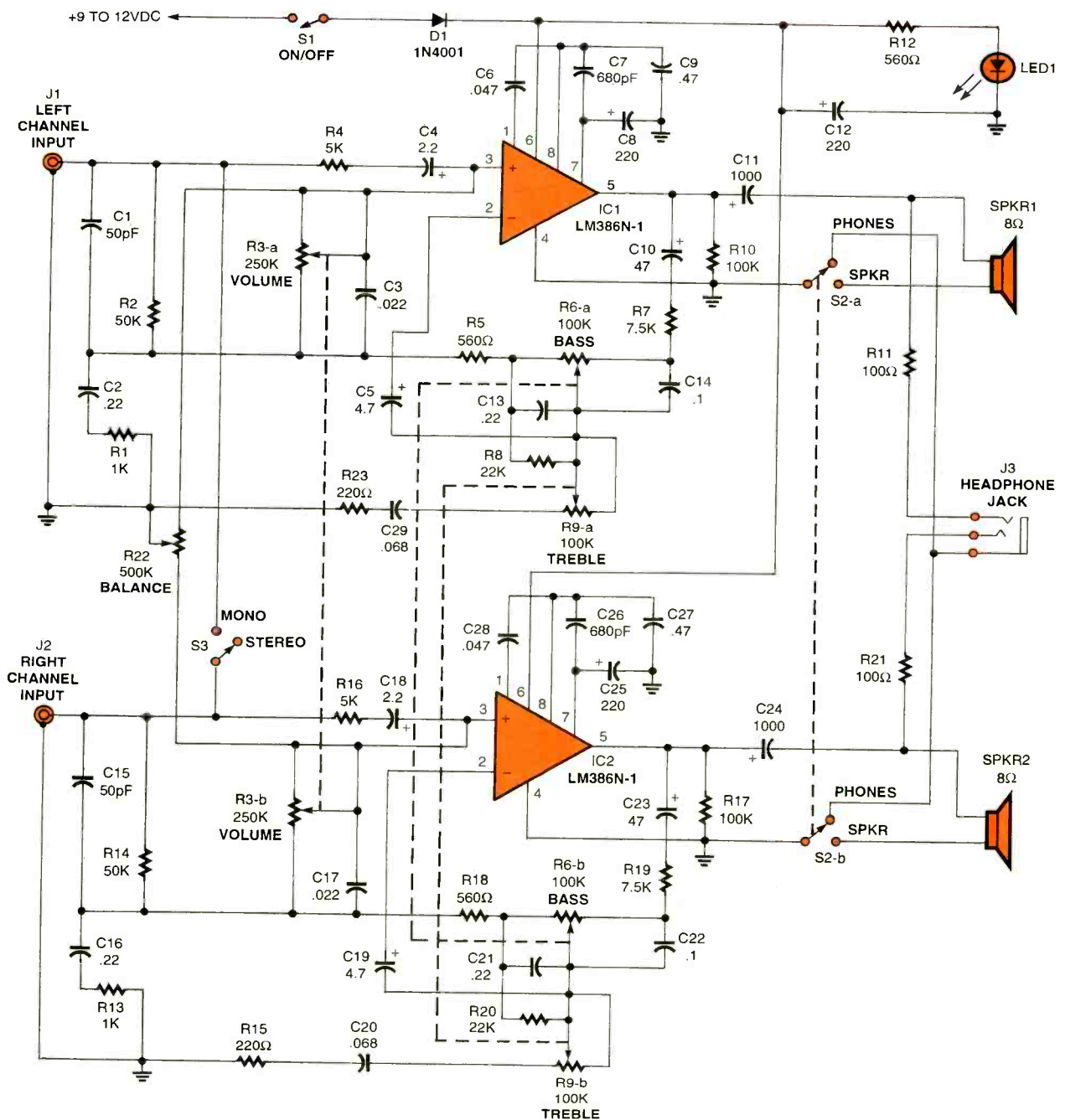

Fig. 2. This mini-CD player stereo amplifier works better than commercially available units. Equivalent substitutes for the LM386N-1 ICs are the Thompson SK9210 chips.

Mini-Stereo Power Amplifier

The circuit in Fig. 2 is a mini-CD player stereo amplifier that works better than commercially available power amplifiers. The circuit requires only a few parts and uses the inexpensive National Semiconductor LM386N-1 low voltage audio power amplifier IC. This circuit features tone controls, so you can separately alter the amount of

bass and treble at each output.

The headphone output channels of the CD player are fed to amplifier input jacks J1 and J2. The jacks are coupled to the non-inverting inputs at pin 3 of IC1 and IC2, by way of the resistor/capacitor series connection R4/C4 and R16/C18, respectively. The input signals are filtered by C1/R2 and C2/R1 for the left channel, and by

C15/R14 and C16/R13 for the right channel. The dual volume control, R3, and tone controls (bass-R6, and treble-R9), also act as filters in the negative feedback loop. Capacitors C3 and C17, which are connected to each side of the volume control, boost low frequency signals for each channel.

The amplifier outputs of IC1 and IC2 are correspondingly coupled to the

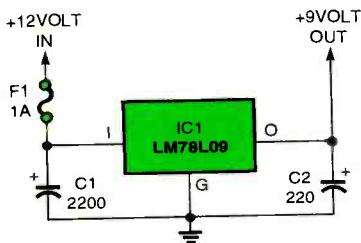

Fig. 3. With this compact voltage regulator, you can power the mini-stereo power amp from your auto battery. A 1- x 2-inch metal heatsink will keep this regulator cool.

speakers or headphone through capacitors C11 and C24. Switch S1 is a power on/off switch, while switch S2 lets you choose between the speakers and headphones. Switch S3 is a stereo/monaural switch. Closing this switch produces a monaural output, while opening it selects stereo sound.

The circuit can be powered by a 9- to 12-volt DC adapter. For operation in a car, use the simple three-terminal positive voltage regulator circuit shown in Fig. 3, which sets the DC output for the amplifier at 9 volts.

Your CD player's output power must be sufficient to prevent loss of high frequency signals. Just to show how small the whole amplifier is, I have assembled the circuit on a 2-3/4-x 3-3/4-inch circuit board. All parts are available from Digi-Key or local parts distributors.

—Jose Ignatius A. Alea, Cebu, Philippines

I'm really surprised that this unit can be built so small. The car voltage regulator is a really nice touch. Note, builders can dispense with switch S2 by using a headphone jack that cuts the signal to the speakers when a plug is present.

Stereo Power Amplifier

If you want an amplifier that produces more audio power than the one in the last letter, take a look at the circuit in Fig. 4. This stereo power amplifier is built around two LM383T 7-watt audio power amplifier ICs. Although the circuit exhibits maximum performance and fidelity with a preamplifier, the head-

phone output from a CD player can be fed directly to jacks J1 and J2. It can then be coupled to the non-inverting input of IC1 and IC2 through resistor/capacitor pairs R11/C5 and R12/C6, respectively. Balance between channels is accomplished with potentiometer R8. An automatic gain system is formed using components C1, C4 and R6 for the left input, and C2, C3, and R7 for the right input. Dual potentiometers R5, R17 and R18 are used to uniformly vary the volume, bass and treble control for each channel. Again, the tone controls are part of a negative feedback loop.

The outputs of IC1 and IC2 are coupled to the speakers or headphone, through capacitors C21 and C22, respectively. Switch S1 is a power on/off switch. The fuse you need in series with this switch depends upon how much current you want to supply for the amplifier. National Semiconductor recommends 3.5 to 4.5-amps per LM383. Since this is a stereo circuit, it needs at least 7 to 9 amps. In

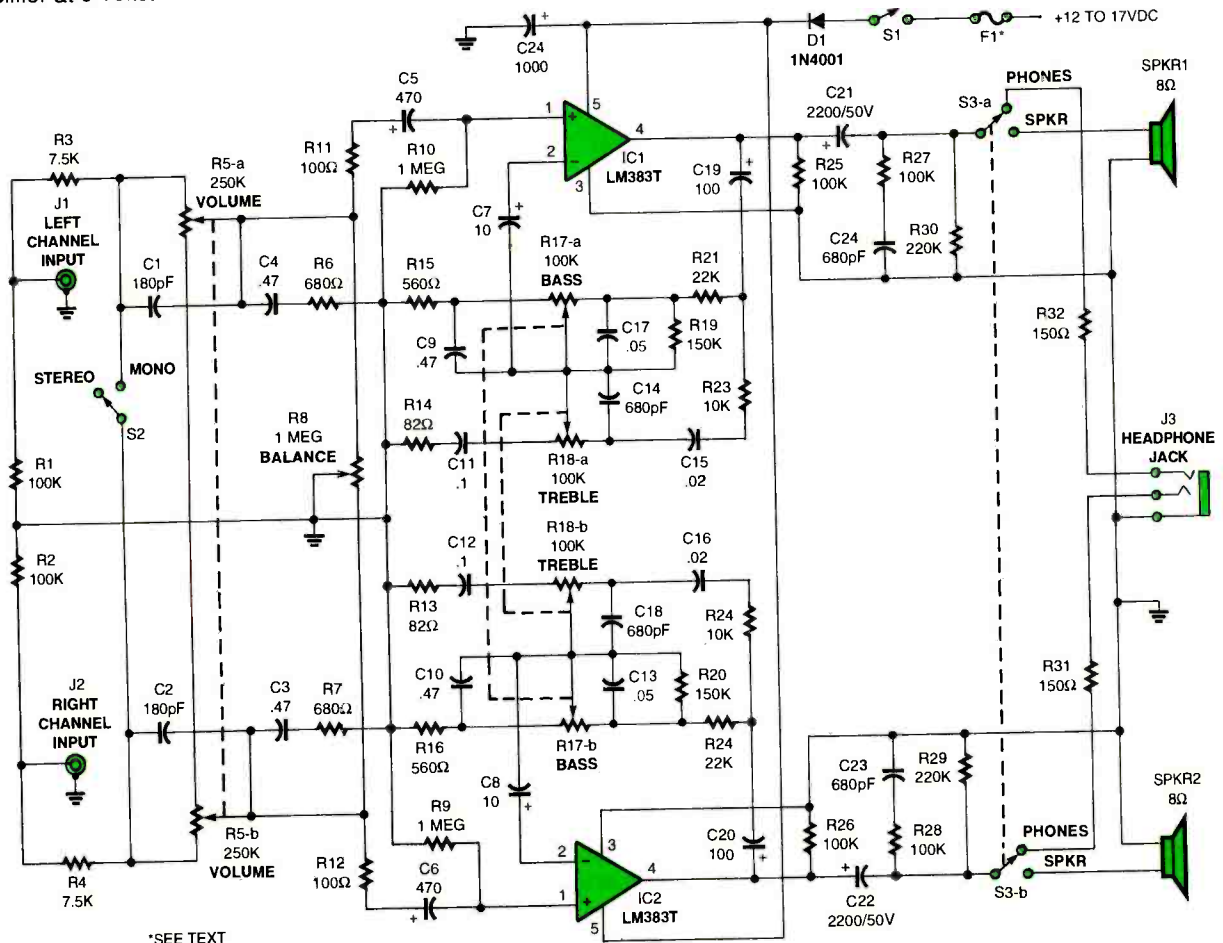

*SEE TEXT

Fig. 4. This stereo power amplifier provides up to 7-watts per channel. Good substitutes for the LM383T ICs are the NTE1232 devices.

my experiment, I tried supplying 12 to 17 volts at 10 amps, and it worked well. Switch S2 allows you to choose between stereo and monoaural. Closing S2 selects monoaural operation and opening it selects full-stereo reproduction. Switch S3 selects the headphones or the speakers.

A heatsink should be used for both ICs. If you are using an aluminum chassis for your enclosure, you can use it as a heatsink, but don't forget to use heatsink compound.

—Jose Ignatius A. Alea, Cebu, Philippines

That's an interesting implementation of a balance control. Again folks, you can dispense with S3 by using a headphone jack that cuts the signal to the speakers. Jose recommends using the next circuit as a preamplifier for the Power Amplifier.

Power Amplifier/Preamplifier

Here's an amplifier circuit (see Fig. 5) designed to boost low power audio signals, such as the headphone output of portable CD players. It is sufficient to drive a loudspeaker or a high impedance power amplifier. This circuit not only amplifies—it filters the input signal at the same time, so you can hear the highs and lows clearly.

The audio channels are coupled to the input terminals of IC2 and IC3 (LM386N-1) by way of the resistor/capacitor pairs R3/C5 and R4/C6 for the respective left and right channels. A band pass filter, consisting of C3/R7/C1/ and R5 for the left input, and C4/R8/C2/ and R6 for the right input, passes both high and low frequency audio depending on the volume of your CD player. A low level input loses some of the high frequencies, and too much volume produces a distorted signal—so adjust the volume.

The gain of the left channel output is determined by C9/C11/R9/ and R11 and the gain of the right channel is determined by C10/C12/R10/ and R12. The outputs of IC2 and IC3 are coupled to speakers or the inputs of a high impedance amplifier via capacitors C11 and C12, respectively.

This circuit is designed primarily for use as a preamplifier for the power amplifier presented earlier, but if you want it as a low power amplifier you can connect an 8-ohm speaker to each of its outputs. The circuit can be powered by a 9 to 12-volt adapter. The

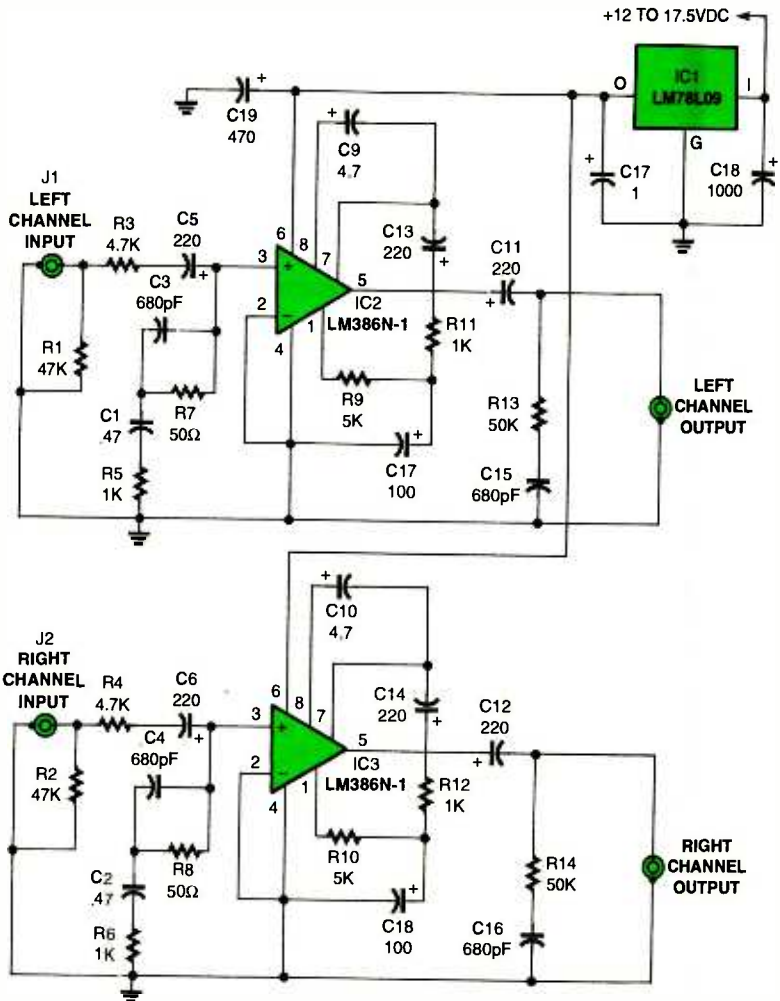

Fig. 5. You can use this circuit as a stand-alone amplifier or as a preamp for the 7-watt stereo power amp.

purpose of the LM78L09 voltage regulator here is to match the power supply of this preamplifier to the supply of the mini-stereo power amplifier—should you use this circuit as its preamplifier. Exclude IC1 if you use an external 9 to 12-volt supply, and connect the DC directly to pin 6 of IC2 and IC3.

—Jose Ignatius A. Alea, Cebu, Philippines

It looks as if all the parts for this circuit are available at local distributors too. For stand-alone use, you will need a volume control. Perhaps placing a stereo potentiometer at the input will do.

Fuzz Amplifier

John, I have an electric guitar, locally made, but it sounds like the big names. As you already know, guitar for rock or heavy metal is not complete without "fuzz." So I threw some parts together, and the result (shown in Fig. 6) is a superb circuit that makes my

guitar sound very fuzzy. The circuit, built around an LM386N-1 low-power voltage amplifier IC, not only produces fuzz, but can also amplify the signal from the guitar.

The guitar signal is fed to jack J1, and coupled to the inverting input of IC1 by way of C1 and R2. The input coupling capacitor should be a ceramic type. The input signal is clipped by back-to-back diodes D1 and D2 and produces a distorted signal. When the signal appears at output pin 5, it is fed back to pins 1, 7, and 8. The return signal to pin 7 is limited by diodes D5 and D6, and the feedback signal to pin 8 is limited by diodes D3 and D4. These diodes distort the signal feedback to pins 7 and 8. Most of the output signal at pin 5 is coupled to the output jack, J2, through capacitor C4. Diodes D7 and D8 clip the output signal for the last time. Potentiometer R7 and resis-

(Continued on page 75)

CIRCUIT CIRCUS

No Trouble in Troubleshooting

CHARLES D. RAKES

This edition of the Circuit Circus is for all of you who enjoy troubleshooting and solving problems using your electronic knowledge and skill. Whether you are just a beginner or a seasoned technician, there is something here for you. All of the troubleshooting circuits used in the following examples are both inexpensive to build and simple to use, and they could prove invaluable in solving a future electronic problem.

Automobile Testers

Don't let the simplicity of the first three test circuits fool you. The test circuit of Fig. 1 has been around for a very long time and is still being used. It is an ideal voltage tester that anyone can use in troubleshooting the electrical systems of most cars and trucks. Just connect the alligator clip to the auto's metal frame and start to probe away. The quality of the battery and circuit resistive losses are indicated by the brilliance of the lamp. I've seen mechanics do an excellent job troubleshooting auto battery problems with this simple test instrument and only basic electrical troubleshooting knowledge.

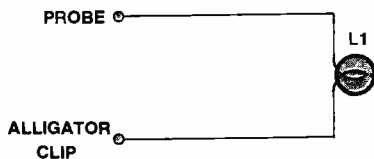

Fig. 1. Just about the simplest automobile voltage tester around!

PARTS LIST FOR THE SIMPLE VOLTAGE TESTER (Fig. 1)

L1—Auto lamp, type 1891 (14-volt, 240 mA)
 Meter probe (RadioShack 278-704 or equivalent), heavy-duty alligator clip (RadioShack 270-344, or equivalent), etc.

The second circuit, shown in Fig. 2, is a modern version of the first circuit but with a built-in polarity indicator. Here we have replaced the miniature incan-

descent lamp with two LEDs. When the probe is connected to the positive voltage and the clip to the negative voltage source, LED2 lights up. When the probe and clip are reversed, LED1 lights up. Noting the polarity can be useful when troubleshooting in areas where a common ground is not easily accessible.

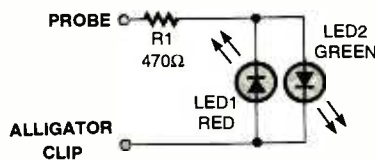

Fig. 2. This little auto voltage tester will note the polarity of the test voltage. Green light is for positive voltage, and red light is for a negative value.

PARTS LIST FOR THE VOLTAGE TESTER WITH POLARITY INDICATOR (Fig. 2)

LED1, LED2—Light-emitting diode, any color or type
 R1—470-ohm, 1/4-watt, 5% resistor
 Meter probe (RadioShack 278-704 or equivalent), heavy-duty alligator clip (RadioShack 270-344, or equivalent), etc.

Let me share the solution to one auto battery problem that I'll bet every one of you has had at least once. Your car was starting and running fine when you parked it. You took care of business and returned to your car minutes later, but now it would not start. All you could hear was a clicking noise—no motor turn-over.

Nine times out of ten the problem can be traced to the junction where the heavy battery cable connects to the battery post. The connection can look just fine, but a thin layer of oxidation can be hidden between the cable connector and the battery post, adding resistance to the circuit. Since the car's starter takes several hundred amperes to bring the engine to life, any added resistance keeps the starter from doing its job.

Examine the battery cables and post

connections. Since both battery terminals must be checked, start with either post terminal. Take the first of our two troubleshooting circuits and connect the clip to one of the battery cable clamps, and then press the probe in on the center of that battery post. Unless the connection is really bad, the indicator should be dark. When the starter is engaged, the lamp should glow if you are on the bad connection. If not, go to the other battery cable clamp and its corresponding battery post, and repeat this test. Once you find the bad junction, proper cleaning will cure the problem. Caution! Before removing or cleaning any battery post, refer to your car manual. In some cars, the computers don't like to have their power source interrupted.

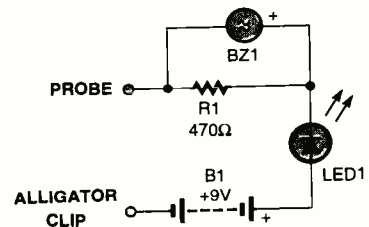

Fig. 3. This compact general purpose continuity tester is an indispensable tool for checking cables, connectors and switches. Its audiovisual output will keep you awake. Make sure all power is removed from the circuit under test!

PARTS LIST FOR THE CONTINUITY TESTER (Fig. 3)

LED1—Light-emitting diode, any color or type
 R1—470-ohm, 1/4-watt, 5% resistor
 B1—9-volt alkaline battery
 BZ1—Piezo-buzzer (RadioShack 273-060, or equivalent)
 Meter probe (RadioShack 278-704 or equivalent), heavy-duty alligator clip (RadioShack 270-349, or equivalent), etc.

Our next circuit, in Fig. 3, shows a simple continuity tester with an audible and visual output. This is a great little tester to use in checking for low resistance shorts and circuit continuity between cables and connectors. It's

also handy in checking out switches. All power must be removed from any circuit used with this tester!

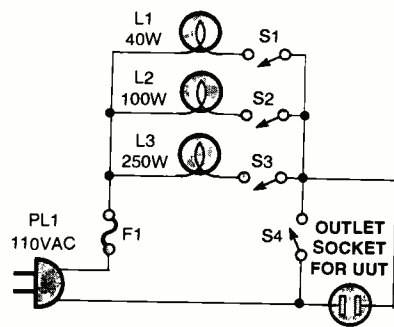

Fig. 4. Use this handy little circuit to avoid smoke-testing some unknown equipment. The lamps provide a safe method to limit current flow.

PARTS LIST FOR THE LINE VOLTAGE TESTER USING LAMP LOADS (Fig. 4)

- S1-S4—SPST toggle switch, 110 volts AC, 10-amp (RadioShack 275-324, or equivalent)
- L1—Incandescent lamp, 110 volts AC, 40-watt
- L2—Incandescent lamp, 110 volts AC, 100-watt
- L3—Incandescent lamp, 110 volts AC, 250-watt
- F1—10-amp fuse
- Fuse holder, lamp sockets, AC outlet sockets, power line cord, etc.

Line Voltage Testers

Our next two circuits are helpful in checking out equipment that operates on 110-volt AC line voltage. If you frequent hamfests and/or search out the flea markets for neat old radios or test equipment, you definitely need a non-destructive way to check them out. Why smoke test, when you can safely check out your treasures with one of the simple circuits shown in Figs. 4 or 5?

If you don't have a variable transformer, the circuit in Fig. 4 is the least expensive way to go. Three 110-volt AC incandescent lamps with different wattages are used to pre-set current limiting. Switch S1 limits the maximum short circuit current to about 360 mA, S2 to about 900 mA, and S3 to about 3.6 amperes. The only drawback to this circuit is the high initial turn-on current of a lamp. The internal resistance of an incandescent lamp is much lower when its filament is cold and increases greatly when hot. That is where switch S4 comes into play. Always close S4

before closing any of the power-on switches of your unit-under-test (UUT), so that the lamp's high inrush current will flow through S4 and not the UUT. After the lamp lights, open switch S4 and let power reach your UUT.

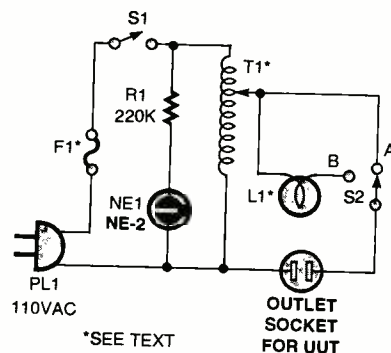

Fig. 5. With a variable voltage transformer included in this tester, you can safely apply power to just about any unknown piece of AC operated electronic equipment.

PARTS LIST FOR THE LINE VOLTAGE TESTER WITH VARIAC (Fig. 5)

- R1—220,000-ohm, 1/4-watt, 5% resistor
- S1—SPST toggle switch, 110 volts AC, 10-amp (RadioShack 275-324, or equivalent)
- S2—SPDT toggle switch, 110 volts AC, 10-amp (RadioShack 275-325, or equivalent)
- T1—Transformer with variable tap, 110 volts AC primary, 3-amp or greater (see text)
- L1—Incandescent lamp, 110 volts AC, 100-watt or greater (see text)
- NE1—Neon lamp, type NE-2
- F1—Fuse (see text)
- Fuse holder, lamp sockets, AC outlet sockets, power line cord, etc.

The better of the two AC test circuits is shown in Fig. 5. Here we have a variable transformer or Variac, T1, connected through a current limiting lamp L1 or through switch S1, to an outlet test socket. If you don't have a variable transformer on hand and are planning to purchase one, go for a 5-amp unit. This will give you up to a 500-watt testing output. Select a fuse size that matches the transformer's maximum output current. If you are planning on checking out old radios or other low-powered equipment, select a low wattage lamp for L1.

Here's one method to use in checking out a piece of electronic equipment that hasn't been powered up in years.

Set T1 for a minimum output voltage and set switch S2 to position "B." Plug the UUT into the outlet and turn on switch S1. Slowly increase the voltage by varying the tap on T1 while watching L1. If there is a short in the UUT's power supply, L1 will light up big-time. If L1 only barely glows—everything is probably okay.

Transformer Tester

Our next test circuit, shown in Fig. 6, can be used to check out unknown power and audio transformers for shorted windings. A transformer winding may be checked with a VOM for continuity and, in some cases, to determine the primary and secondary windings. However, a VOM cannot indicate if the unknown transformer has a shorted winding. A single shorted turn in either the primary or secondary winding can render the transformer useless.

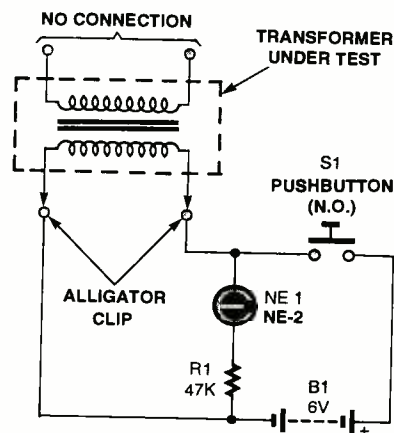

Fig. 6. This simple circuit provides a unique method to check out transformers for shorted or defective windings.

PARTS LIST FOR THE TRANSFORMER TESTER (Fig. 6)

- NE1—Neon lamp, type NE-2, or equivalent
- R1—47,000-ohm, 1/4-watt, 5% resistor
- S1—SPST momentary push-button switch, normally open (RadioShack 275-1556, or equivalent)
- B1—6-volt lantern battery
- Alligator clips (RadioShack 270-349, or equivalent), etc.

This test circuit is both quick and easy to use. Momentarily closing switch S1 applies a DC current to the

Get Plugged Into Great Savings

When You Join The Electronics Book Club

GET 5 BOOKS FOR ONLY \$4.95

Values to \$313.35!

plus 1 book FREE upon prepayment

Benefits you'll receive as a member of The Electronics Book Club...

- Club bulletins every 3-4 weeks containing exciting offers on the latest books
- Savings of up to 50% off the regular publishers' prices.
- The Main Selection will be shipped automatically. If you want another book, or no book at all, return the reply form by the date specified. You'll have at least 10 days to decide. If you ever receive a book you don't want due to late delivery of the bulletin, you can return it at our expense.
- **FREE BOOKS** through the Bonus Book Program.
- Great Club Terms: simply buy 3 more books during the next 12 months with no further obligation.

If card is missing, write to

The Electronics Book Club®
A Division of the McGraw-Hill Companies
P.O. Box 549
Blacklick, OH 43004-9918

All books are softcover unless otherwise noted. Publishers' prices shown. A shipping/handling charge & sales tax will be added to all orders. ©1997 EBC

Phone: 1-614-759-3666
(8:30 am to 5:00 pm EST Monday-Friday)

Fax: 1-614-759-3749
(24 hours a day, 7 days a week)

PE897



0112738 \$47.95
Hardcover

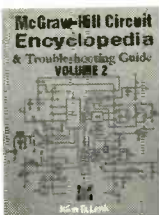

0376115 \$36.95



0157537-XX \$44.95
Hardcover/Counts as 2



0487375 \$24.95



0535469 \$29.95

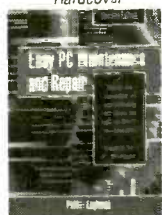

036432X \$29.95
Hardcover

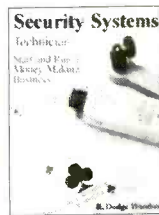

0717753 \$19.95



155016X \$34.95



1570519 \$17.95

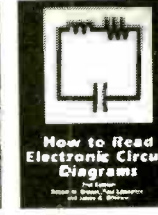

1554637 \$16.95



0241996 \$44.35
Hardcover

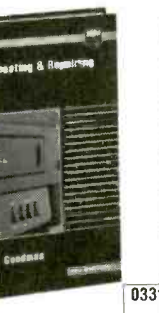

0331898-XX \$89.50
Counts as 2

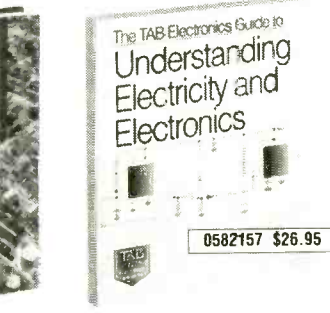

0582157 \$26.95



073092X \$19.95



1577564 \$24.95



0304068 \$17.95



0053146 \$24.95



0157626 \$24.95



1574875 \$19.95

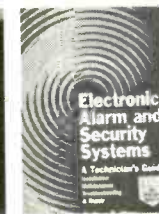

0305285 \$39.95
Hardcover



0376581 \$39.50



0765359 \$34.95
Hardcover



1573119 \$19.95

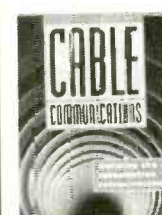

0053553 \$50.00



0359768 \$19.95



0044392 \$12.95



0317917 \$60.00



0957311 \$44.95



0304122 \$17.95



5869349 \$44.00

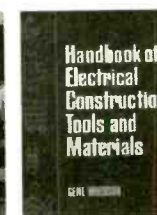

0699208 \$65.50

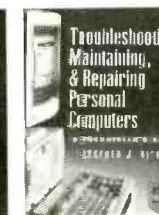

9120999-XX \$69.50
Hardcover/Counts as 2



0215286 \$19.95

winding of the transformer. When S1 is released, the transformer's stored energy appears across the winding, briefly lighting the neon lamp. If one of the transformer's windings has a short, most of the stored energy will be dissipated within the shorted section and very little will appear across the lamp. The lamp will remain off or just barely flicker.

Here's an easy way to demonstrate the effect of a shorted winding in a multi-tap transformer. Connect a good transformer to the test circuit and briefly operate switch S1 to confirm that the neon lamp glows. Tie the leads of any other winding of the transformer together and repeat the test. The neon lamp should remain dark.

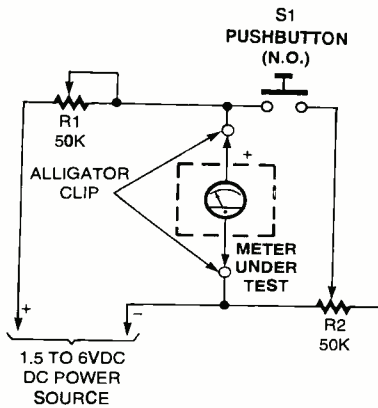

Fig. 7. Don't throw away your old analog DC meters! With this circuit you can measure the internal resistance of the meter. Then use Ohm's law to calculate an external shunt resistor to give you an extended full-scale meter range.

PARTS LIST FOR THE METER RESISTANCE TESTER (Fig. 7)

- R1, R2—50,000-ohm, ¼-watt, 5% potentiometer
- S1—SPST momentary push-button switch, normally open (RadioShack 275-1556, or equivalent)
- Alligator clips (RadioShack 270-349, or equivalent), adjustable 1.5 to 6 volts DC power source, etc.

Meter Under Test

Many times bargain analog DC meters can be obtained at flea markets or hamfests. These meters are great to use in your equipment, providing that you place an external shunt resistance across the meter's terminals. In order to calculate this shunt resistor value, you must know the

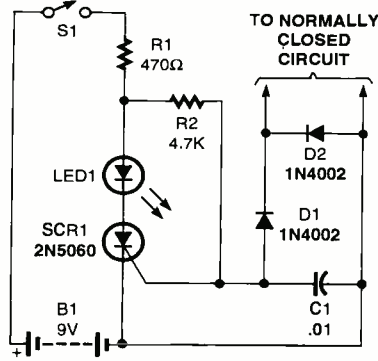

Fig. 8. Here's a handy little tester, which will alert you when "Murphy's little gremlins" intermittently open a connection.

PARTS LIST FOR THE INTERMITTENTLY-OPEN CIRCUIT TESTER (Fig. 8)

- C1—0.01-µF, ceramic-disc capacitor
- D1, D2—1N4002 diode
- LED1—Light-emitting diode, any color or type
- R1—470-ohm, ¼-watt, 5% resistor
- R2—4700 ohm, ¼-watt, 5% resistor
- S1—SPST toggle switch (RadioShack 275-612, or equivalent)
- SCR1—Silicon-controlled rectifier, 2N5060 (RadioShack 276-1067, or equivalent)
- B1—9-volt alkaline battery
- Alligator clips (RadioShack 270-349, or equivalent), etc.

internal resistance of the meter movement. Our next test circuit in Fig. 7 shows a simple and safe method to determine this resistance. You might ask why not use an ohmmeter and be done with it? A few of the newer digital ohmmeters might be safe to use, but even some of these can produce several milliamperes of current in the low ohm scale. Such a current could cause the meter's sensitive needle to peg full scale—leaving a permanent kink in the needle. A somewhat safer way to use an ohmmeter is to connect the negative probe of the VOM to the positive meter terminal and the positive probe to the negative meter terminal. This method will peg the needle on the low end, and in most cases, the needle will not sustain any damage. But why take a chance on messing up a good expensive meter?

This circuit shows how to do it the safe way. Set both potentiometers, R1 and R2, to their maximum resistance

rotation and connect the meter under test to this circuit. Adjust control R1 for a full-scale reading on the meter. Press momentary switch S1 and now adjust R2 for a half-scale reading on the meter. Release switch S1 and measure the resistance of R2. This value will be the same resistance as the internal movement of the meter.

Murphy's Circuit

If you have been around the electronic scene for a while, it is almost assured that you've been exposed to our nemesis, "Mr. Murphy." One game Murphy really likes to play is to add a pinch of intermittence to an otherwise perfectly good operating circuit.

Murphy's intermittent trap circuit is shown in Fig. 8. This tester can be attached across a suspected intermittent open connection in just about any circuit under test. As long as there's no break in the external circuit, LED1 remains off. However, when the circuit becomes a little nervous and momentarily opens, the SCR's gate receives a positive current through R2, turns the SCR on, and lights the LED. The LED remains on until the power is removed by opening switch S1. Diodes D1 and D2 protect the SCR from reverse gate voltage and prevent a positive input voltage from the monitored circuitry from false triggering the tester.

The clock on the wall says it is time to hit the old kill switch for this visit. All that I ask is you keep these simple troubleshooting circuits in mind the next time an electronic problem comes your way. Who knows—one of these might be the very circuit needed to outfox Murphy.

Good hunting until next month. ■

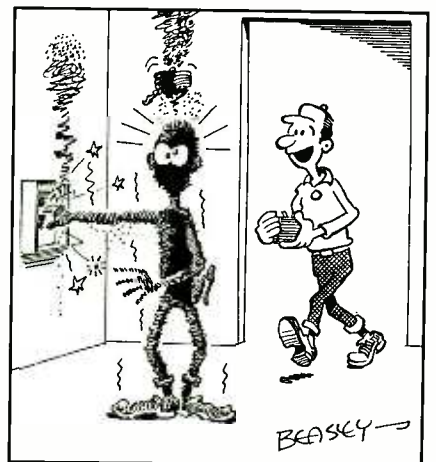

"Here's the ground-fault interrupter I was supposed to install yesterday!"

COMPUTER BITS

Getting Organized

JEFF HOLTZMAN

One of my resolutions this year (as every year...) was to get better organized. For that reason, I have been experimenting with several Personal Information Managers (PIMs). What is a PIM? It's hard to define. A given PIM may combine any or all of the following: contact management and/or address book classifications; project planning and appointment scheduling; task tracking and prioritizing; e-mail management; utility functions, such as calculator, phone dialer and URL tracker; and organizing large amounts of miscellaneous information.

The hardest part of picking a PIM is not choosing one. It's figuring out what your needs are. For example, do you need a full-blown contact manager, or would a simple address book suffice? A contact manager takes a rigorous approach to tracking every single communication with an extensive list of contacts, whereas an address book is usually a simple database of names, addresses, and telephone numbers. Sales personnel are usually most interested in full-blown contact management; however, an address book will usually suffice for the rest of us. Having said that, it is important to point out that not all address books are the same. The number and type of fields, the ability to customize and add fields and other features—these vary all over the place.

This month and next, I'm going to talk about my PIM selection process and several specific software products: *Outlook 97*, *InfoSelect 3.0*, and *Ecco Pro 4.0*, published respectively by Microsoft, MicroLogic, and NetManage. This is not going to be a product review per se. Rather it will be more of an exploration of the issues involved, along with some specific tips on how different products address different issues.

Primary Needs and Wants

For years I have tried various homebrew and commercial solutions to getting organized, both computer and paper-based. These solutions all had their strengths and weaknesses, but



Don't let the small size fool you. PalmPilot gives you all the power and features you need to organize your busy life.

ultimately all failed for one of the following reasons:

- Slow or cumbersome to use
- Too much manual labor
- Expensive in terms of system resources
- Not integrated with my overall information system.

One of my most important requirements for a PIM was for something to do what I call "random information management." Little yellow sticky notes, lined and bound lab notebooks, and paper file folders just weren't cutting it. I needed a way of getting things in the computer, categorizing them, and then later finding them—even if the original categorization I selected turned out to be incorrect.

I gradually came to realize that what I wanted was a dynamic, hierarchical, hyperlinked, full-text searchable database. The database had to be dynamic, because experience had taught me long ago that no matter how much thought or cleverness I applied to devising some scheme of classification, it would end up changing. It had to be hierarchical (categories with sub-categories with sub-subcategories, and so on), because, to the extent that any fixed scheme would work, I found a hierarchical system to be the best.

A hierarchical system would also be useful for browsing. Ideally, items at

arbitrary locations within the hierarchy could be linked, although that was not an absolute requirement in my opinion. Experience showed that things would become lost, so searching would have to be supported across the full hierarchy, or, ideally, any branch thereof. OK. So hierarchy information management was important.

But I had other requirements of the PIM as well. I needed some basic scheduling functions—nothing too sophisticated. I needed a task tracking, prioritization, and reminder scheme. My dentist was literally tired of my missing appointments, and I had a few close calls with important business engagements as well. (The problem is that when I get deeply into some technical activity, I totally lose track of time and place).

Other Requirements

Along with the primary requirements for a PIM that I just summarized, I had subsidiary requirements as well—objectives I probably a better word. These were features I would really like, but could live without if there were other compelling features to compensate. One was to eliminate the need to carry my daily planner/address book with me all the time. I needed some electronic way of tracking my time, billable and otherwise. Another objective was some electronic way to easily capture information at any time or place. I needed a method to centralize and simply record lots of personal information that my family would require in case I became disabled or worse. And finally, I required a simple procedure to integrate all the information involved with these seemingly random activities. Then there were the hardware requirements.

Hardware

I had an old 386-based subnotebook lying around, a HP OmniBook 300. It runs Windows 3.1, has ROM-based versions of Word and Excel, and is quite portable. It also has a nice keyboard, which made it attractive for remote work. It turned out that the



You're never more than a phone-line away from the information that's important to you. Just snap on the PalmPilot Modem and press a button to connect with your desktop computer.

machine just didn't have the horsepower to run any of the target applications, even after a memory upgrade. The biggest problems were lack of space and frequent program crashes (which didn't happen on a desktop machine). Very reluctantly, I gave up the idea of using it.

I looked into purchasing a more modern sub-notebook, but the costs seemed way out of line. I looked into used machines and previous generation machines, but was unable to find anything locally. And I was unwilling to purchase so personal an item via mail order, even though there always seem to be lots of good deals available.

Then a friend showed me his new toy: a US Robotics, *PalmPilot™*—a stylus-input device about the size of a calculator. Several lights went on in my head. I knew this device was basically an electronic PIM. I knew it could exchange data with leading PIM packages, including some of those I was already looking into. The *PalmPilot* was portable, even more so than the old *OmniBook*, and was well within my price range. The big question concerned the stylus input system. I knew that early versions of several products in this category were all but unusable, but I had read positive reviews about *Pilot's* handwriting recognition ability. There was only one way to find out—so I took the plunge!

Vendor Information

The prices shown below are suggested retail prices.

Outlook 97 (\$99.95), Microsoft Corp., One Microsoft Way, Redmond, WA 98052-6399. Tel: 206-882-8080. Web: <http://www.microsoft.com>

InfoSelect 3.0 (\$149.95), MicroLogic, P.O. Box 70, Hackensack, NJ 07602. Tel: 800 342-5930. 201-342-6518, Web: <http://www.miclog.com>

Ecco Pro 4.0 (\$139), NetManage, 10725 North De Anza Blvd., Cupertino, CA 95014. Tel: 206-885-4272. Web: <http://www.netmanage.com>

PalmPilot (\$299), **PalmPilot Pro** (\$399, includes built-in memory upgrade), memory upgrade alone (\$129), snap-on modem (\$129). U.S. Robotics, 1565 Charleston Road, Mountain View, CA 94043. Tel: 800-881-7256. Web: <http://www.usr.com/palm>

I am extremely happy to report that, while not perfect, *Pilot's* recognition system is definitely usable without a lot of training and without any significant real time slow down. *Pilot* comes with its own PC-based PIM. Part of the process of using *Pilot* involves performing periodic one-button "Hot-Sync" between the unit and the desktop PIM. The PIM is all but worthless—except as a means of getting data from *Pilot* to the PC. However, because of *Pilot's* popularity, most major PIMs can sync with *Pilot*, and that was the solution I eventually settled on—even though the story is still not over! More next time on the software packages.

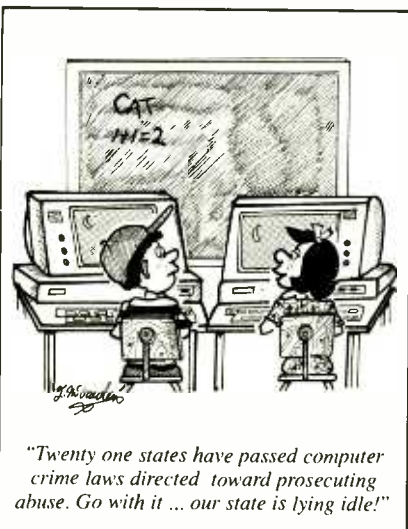

SCANNER SCENE

Continued from page 58

Wireless Online, Inc. in California, as WA2XEH, is testing narrow-band PCS on 901.35–901.45, 901.8375–901.90, 930.75–931.00, and 940.90–941.00 MHz.

Spaced-out Radio

Did you know that your scanner can monitor some of the frequencies used to tune in natural and man-made transmissions from the cosmos? Owning an externally mounted antenna and preamplifier will substantially aid in your pursuit of this interesting, but little promoted, area of the hobby.

Radio astronomers tune to 37.50–38.25 and 73.00–74.60 MHz to detect the naturally occurring radio signals from the galaxies, interstellar clouds, Jupiter, and the sun. Pulsars are monitored from 322.00–328.60, 406.10–410.00, and 608.00–614.00 MHz. The hydrogen line frequency, at 1420.4 MHz, is one of the most important monitored by the Search for Extra Terrestrial Life (SETI) researchers.

The bands from 137.00–138.00, 243.855–269.95, 400.05–402.00, 467.735–470.00, and 1215–1240 MHz are used for satellite data and/or voice (FM mode) downlinks. In the 243-MHz band, you can copy NFM and WFM mode traffic from military satellites, although it's scrambled at times. Don't confuse this with the AM mode transmissions from military aircraft. The 1215-MHz band is used by the GPS navigational satellites. The 467-MHz band (shared with land mobile radio services) is one of those used by the GOES (Geostationary Operational Environmental Satellite).

Space Shuttle? Keep the frequencies 259.7 and 296.8 MHz (AM mode—don't let them tell you otherwise) punched up on your scanner. You might just get lucky; some communications have been logged there. But keep in mind that the majority of shuttle voice communications are on frequencies and in a mode that cannot be accommodated by your scanner. Of course, the shuttle also has been regularly monitored in the 2-meter amateur band. The Russian *MIR* space station (it's very active now) is most often reported on 143.625 MHz using FM mode.

NEW PRODUCTS

Continued from page 14

time track plotter, 200 user-defined waypoints, five reversible routes of 15 legs, six coordinate systems, and differential GPS capability. Users can go anywhere in the world and know their exact location. They can save that location in memory, store the coordinates for other locations, navigate between any of the locations or waypoints that are saved in memory.

The GSC 100 has a suggested retail price of \$999. For more information, contact Magellan Systems, 960 Over-



land Court, San Dimas, CA 91773; Tel: 909-394-5000; Fax: 909-394-7050.

CIRCLE 81 ON FREE INFORMATION CARD

THINK TANK

Continued from page 66

tor R8 form a feedback loop. Fuzz intensity is also controlled by R7. By adjusting the wiper position, the amount of fuzz produced by the amplifier changes. The DPDT switch, S1, bypasses the amplifier and turns it off for normal guitar sound. It saves your

battery from draining when you prefer the normal sound of your guitar. The LED is a simple on/off indicator. The circuit can also be powered by a 9-volt battery or adapter.

—*Jose Ignatius A. Alea, Cebu, Philippines*

I wish I could hear that thing. Between the clipping and non-linearity of the diodes, it looks as the circuit can really mess up an audio signal!

Tapeless Videotape Cleaner

The *Trackmate Video HyperBRUSH™* is the world's only tapeless cleaning cassette. It uses a patented brush process to safely and effectively clean without abrasion and reach where other cleaning cassettes cannot. Absorbent fiber brushes housed in cassette shells automatically clean and maintain the inner components of a video system.

As dirt, dust, and oxides collect in a VCR's mechanism, they accumulate above and below the tape contact area, as well as in gaps and grooves of the video drum and video heads. Failure to clean those areas can cause picture and color loss, as well as permanent tape damage. Traditional flat

The Video HyperBRUSH has a suggested retail price of \$19.95. For more information, contact Trackmate, 5209-B Davis Blvd., North Richland Hills, TX 76180; Tel. 800-486-5707; Fax: 817-428-0567.

CIRCLE 82 ON FREE INFORMATION CARD

AUTODYNE

Continued from page 43

(a 220- μ F DC blocking capacitor). The input to the circuit is applied to pin 3 of IC1 through a 10k audio gain (VOLUME) control. Capacitor, C2, connected from the DC power supply to ground, is used to filter the source voltage applied to pin 6 of IC1. In some designs, there will be a 220- μ F capacitor close to the IC, and a 0.1- μ F capacitor right at the IC body. In doing some experiments with the LM386, the use of C2 proved sufficient. Also, some circuits do not use C3.

The gain of the circuit can be varied via a capacitor shunted between pins 1 and 8 of the LM386 (C_N in Fig. 9). If C_N is not used, then the circuit will have a gain of about 20, but if a 10- μ F capacitor is used the gain will be about 200.

Conclusion. Direct conversion autodyne receivers are easy to build, and work well. They are particularly suited to experimenter and hobbyist use, and they will provide results that will surprise you.

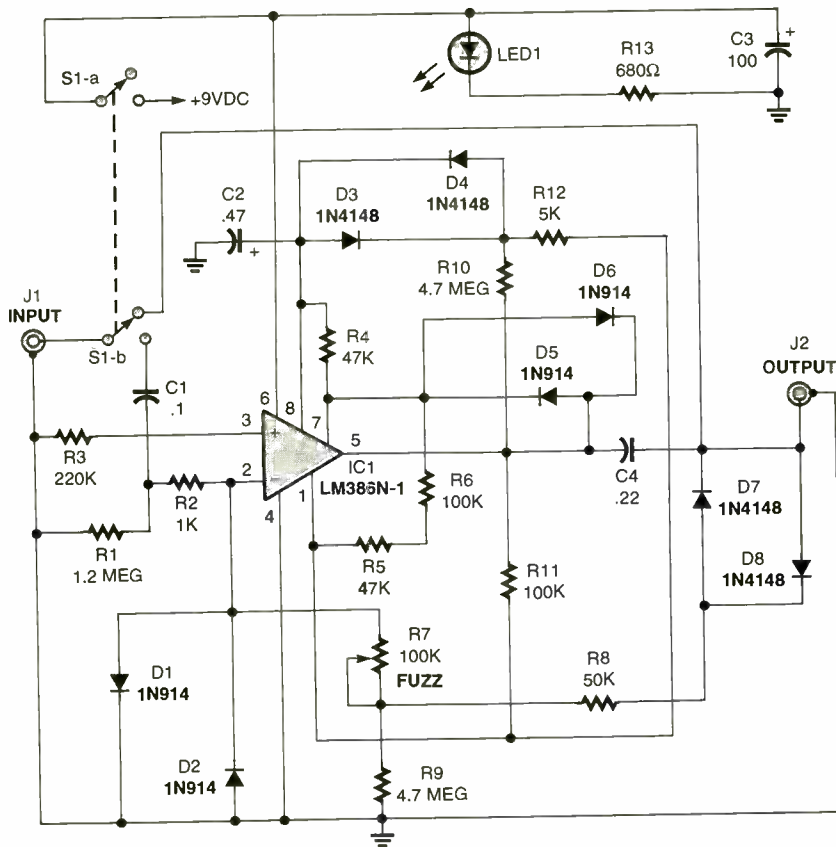

Fig. 6. This little fuzz amplifier circuit will put hair on most guitar signals!

COMPUTERS ARE HELPING

Continued from page 47

In operation, sound is picked up by the external microphone in the user's headpiece placed adjacent to the implanted receiver. The sound is then carried down the cable to the speech processor. Using sophisticated software with customized digital and analog processing strategies, the processor converts the sound into an electrical signal that is returned through the same cable, back to the headpiece. A small transmitter in the headpiece sends the signal across the skin via radio waves to the implanted receiver. The signal then travels to the electrode array in the inner ear, bypassing damaged parts of the auditory system and directly stimulating the auditory nerve. Finally, the auditory nerve carries the electrical signal to the brain to be interpreted as sound.

The CLARION system underwent several years of clinical trials with patients ranging in age from two-year-old children to 80 year olds who have been profoundly deaf for up to 75 years. The experiments have been very successful, and now surgeons in many cities are performing the implants. The CLARION system is the first cochlear implant system that was cleared by the U.S. Food and Drug Administration (FDA) in a decade, and it is the only FDA-approved cochlear implant manufactured in the United States. ■

ACTIVE ANTENNA

Continued from page 53

hiding the antenna, you may want to make several dummy units out of PVC pipe and arrange them around a bush, tree, terrace, etc., so they look like plant stakes.

The cables can be 50 or 75 ohms, any type, and are not critical, but it is best to use a good grade of cable if runs longer than 100 feet are planned. Miniature coax such as RG174/U can be used to keep things inconspicuous, but remember to use suitable connectors and avoid mechanical strain. Use coax suitable for direct burial. Ask for the kind with a non-contaminating jacket. Black or dark brown cable jackets are easiest to obtain and camouflage well. If an underground run is necessary and rodents are plentiful in your location, you may want to think about running the cable through some 1/2-inch PVC conduit to discourage rodents from chewing on the cable.

You will find that the antenna will perform as well as any prohibited or illegal long wire antenna you might try to install, and probably better, since it can be placed away from noisy AC wiring. It will also improve the performance of some inexpensive SW receivers as well. The antenna was tested on several receivers, including Hallicrafters S38D, SX99, SX122, SX62 and an old National NC-98, as well as the receiver section of an Icom 726 all-band ham trans-

ceiver. In each case, performance was excellent.

The antenna really did wonders for the old S38D and SX99 (40 years old). And, indoors, the antenna was compared to a 5 foot telescoping whip. A 10 to 30 dB improvement on signals from AM BC to some local 27 MHz CB signals was noted. We think you will be pleasantly surprised at the performance that this antenna can provide.

Use With A Multiple Receiver Setup.

Many SWL hobbyists have more than one receiver and this antenna can drive several short-wave receivers at the same time. A signal splitter can be built using a few suitable jacks, a metal case, and a few resistors, as shown in Fig. 8. Commercially available signal splitters sold for TV and FM reception may be used, but make sure that they will handle frequencies down to the lowest frequency that you want to receive. Be warned, some do not work below 30 MHz. Remember that all signal splitters have losses since they are power dividers. Potentiometer R5 can be advanced a little to make up any losses, but most SW receivers have enough gain so that another 6 to 10 dB loss will not be troublesome. A simple selector switch can also be used, but that does not allow simultaneous use by more than one receiver. This switch is best purchased ready made. Splitters and switches must be placed between the DC block and the receiver(s). ■

**TRANSFER PAPER
FOR PRINTED CIRCUITS**

USE WITH REGULAR
HOUSEHOLD IRON

• Will not shrink

• 30 sheets for \$24.00
8 1/2" x 11"

S&H
INCLUDED

Send check or
money order to

**STARLET
SYSTEMS**

1348 Washington av.
Suite # 189, Miami Beach
Florida, FL 33139

**MAKE CIRCUITS EASY
FROM YOUR LASER
OR PHOTOCOPY MACHINE**

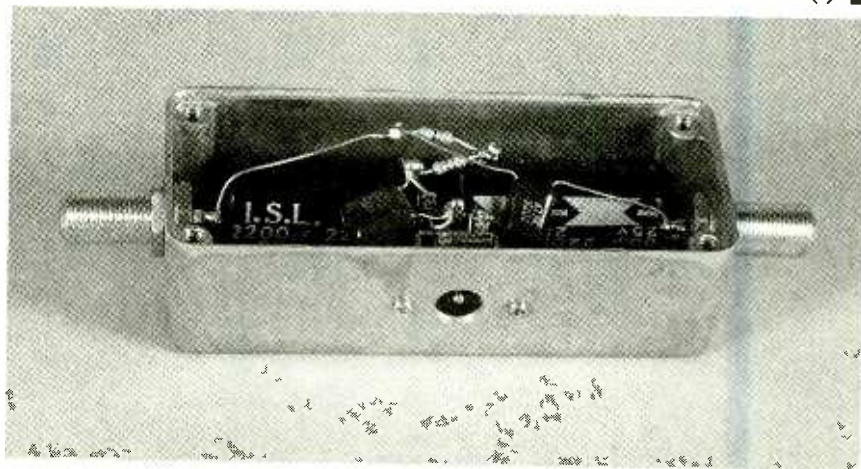

The DC block fits neatly into its metal enclosure. On the sides of the unit are the jacks (J2 and J3) that are used to connect the unit between the preamp and the receiver input. To the front of the unit is the power plug, which is selected to mate with the connector of a wall-mount transformer.

HANDS-ON REPORT

Continued from page 20

relieves you of having to peck your way around the mini-keyboard of the Organizer by shifting this task to your full-sized PC keyboard. The program allows full editing capability before transmitting the additions or changes back to the Organizer. A print option permits the selection of several predefined formats, so that the hard copy produced will match the page size of your favorite pocket organizer.

The program also provides the means for importing or exporting the data between your unit and another PIM (Personal Information Manager). Additionally, either field-separated or text-delimited data such as is found in most popular database programs can be moved into your existing group of records. Thus, data previously entered into other popular database programs (dBase, FoxPro, Paradox, etc.) can be manipulated and imported into the connectivity software.



TI's PS-6800 Personal Organizer and its PS-6155 PC Connectivity Kit (docking station) gives the Organizer power to create and exchange information with a PC.

Within the necessary limitations of an index card-sized pocket organizer, TI has produced a feature-rich unit that provides the information portability we all too frequently require.

Vendor information

The PS-6800 retails for \$99.95 but the street price be less. For another \$49.95, you can pickup the PS-6155 PC Connectivity Kit. The PS-6800 Personal Organizer and the PS-6155 Connectivity Kit are available from Target, Good Guys, Circuit City, Staples and other consumer electronic outlets. Texas Instruments will take your order directly at 1-800-TI-CARES or by Fax at 817-774-6074 or you can write to Texas Instruments, P.O. Box 6118, Temple, TX 76503-6118. ■

DTMF FREQUENCY COUNTER

Continued from page 57

connector on the display board. After the board is completed, solder the wires from one end of a piece of 14-conductor ribbon cable to the edge connector. Be sure to keep track of the color-coding. That cable will connect the display board to the main counter board. Plug in your four LED displays, as shown in Fig. 3.

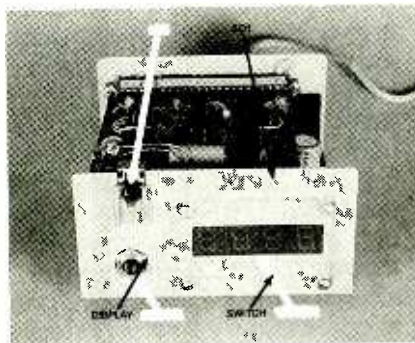

The 4-conductor telephone jack was mounted in a cutout in the front panel, along with the display, and the power switch.

The author opted for an internal power supply; the one shown in Fig. 2. Most of the power supply circuitry was assembled on a small piece of perfboard, with only the power transformer mounted off-board to the chassis. If you build the power supply, the 7805 voltage regulator will require a heatsink. Also use an extra 10- μ F tantalum capacitor on the counter circuit board VCC bus if there is any instability. Once all three boards are completely assembled, and have been checked for possible trouble spots, it's time to consider an enclosure for the unit.

The author's unit was housed in a small metal enclosure (Radio Shack catalog # 270-253), measuring 6 by 5- $\frac{1}{4}$ by 3 inches. A 2- $\frac{1}{2}$ -by 3- $\frac{3}{4}$ -inch square cutout was made in the front panel of the enclosure for the display board. The display board was then bolted in place on the inside of the enclosure, using 1- $\frac{1}{4}$ -inch bolts with $\frac{1}{2}$ -inch spacers, so that the LED displays show through the square hole. A 1-by 3-

PARTS LIST FOR THE POWER SUPPLY

IC7—7805T 5-volt, 1-amp voltage regulator, integrated circuit
D3, D4—1N4001, 1-amp, 50-PIV rectifier diode
R12—75-ohm, $\frac{1}{4}$ -watt, 5% resistor
C7—4700- μ F, 25-WVDC, electrolytic capacitor
C8—470- μ F, 25-WVDC, electrolytic capacitor
T1—12.6-volt, 1.2-amp, center-tapped, step-down, power transformer
Protoboard, line cord with plug, wire, solder, hardware, etc.

inch piece of $\frac{1}{4}$ -inch clear plastic was used to cover the display.

Use The DTMF Frequency Counter is amazingly easy to use. Simply plug in the line cord or connect an external power supply to the circuit. Connect four-conductor modular telephone line cord between the phone to be tested and SO1 on the DTMF Frequency Counter. Apply power to the circuit. The display should light, and the readout should show zeros across the board. Press any two row or column keys on the telephone keypad. Depending on the row or column in which the keys are located, the display should show one of the numbers shown in Fig. 4. For instance, if you press 1 and 4 in the first column, the readout should display 1209. Or if you press 1 and 2 in the first row, the readout should show 677. Note: The values displayed are in hertz (Hz).

The DTMF Frequency Counter should make a very handy companion to a telephone test box. Maybe you already have a telephone put away in the closet that sounds OK but won't dial out. The DTMF Frequency Counter might be able to tell you why! On some phones, you can even adjust the powdered iron slugs in the telephone pad's oscillator and put the oscillator on frequency!

You may run into a phone that is wired with the green and red wire swapped inside the phone. The polarity of the 5-volt supply to the phone would be reversed and there would be no tones at all. In such cases, just swap the red with the green wires on the connection block inside the phone. ■

THE LASER FRIDGE

Continued from page 44

explains physicist Richard Epstein of Los Alamos' Nonproliferation and International Security Division, the leader of the research team. "Light pours onto the object, soaks up some of the vibrational or heat energy of the object, then carries away the excess energy."

In work done previously in this field, attempts to cool solids with light resulted at best in a reduction in overall heating rates; no net cooling has been achieved until now. The researchers managed this breakthrough by using a tunable laser and modern fiber-optic material, in the process suppressing the usual heating, thereby making optical cooling dramatically apparent. "Nature wants to produce heat, but we've discovered how to use laser light to excite an object to special quantum states, in which it can trap thermal vibrations but can't create them," Epstein explained. "Essentially, we tune the laser to out-smart the normal tendency to produce heat."

How It's Done. To create laser cooling, the researchers focused a beam of infrared light nearly as intense as the light emitted at the surface of the sun at a sliver of ultra-pure glass, which had been doped with ions of the element *ytterbium*. "Ytterbium ions radiate over only a single band of frequencies, which are much higher than the possible frequencies at which the glass could radiate," Epstein said. "Therefore, when we pump the glass with laser light at the right frequency, it is unable to produce heat. That makes it ideal for this application." The cooling power produced was only a few percent of the absorbed laser power, too inefficient for cooling houses or refrigerating food, yet just about perfect for cooling high-tech electronic devices to cryogenic temperatures.

The experiments, funded by the Department of Energy, are a giant step toward the goal of initially creating what the researchers call the *Los Alamos Solid-State Optical Refrigerator*, or LASSOR, which would have the ability to cool instruments and devices to at least

the temperature of liquid nitrogen, 77 degrees above absolute zero. Epstein and his colleagues believe that future systems could be at least twice as efficient and be usable at much lower temperatures. A computer model of the system predicts that similar efficiencies should be achievable down to a temperature of 60°K.

In the Los Alamos design, LASSOR light is generated by compact, high-powered diode lasers in a device with no moving parts and weighing only a few pounds. A practical, first-generation, low-mass, vibration-free cryo-cooler would be functional in the temperature range useful for high- T_c superconductors, infrared detectors, and other cooled electronic devices. Such features would be well suited for space-based applications, where small, rugged, and reliable radiation sources are critical. A LASSOR mounted on a satellite could be used, for instance, to cool infrared cameras and superconducting relays.

Since the cryo-cooler would have no moving parts, its lifetime would be limited only by the longevity of the diode lasers. Current commercial diode lasers have mean failure times of approximately 14 months. The researchers believe cryo-cooler lifetimes could be extended by combining multiple, redundant, low-power diode lasers, effectively distributing the heat load. To achieve a 10-year lifetime, the cryo-system would require eight sets of diodes.

Ultimately, lasers could find their way into desk-top computers, enabling superconducting circuits to operate at speeds hundreds of times faster than current conventional electronic components.

The optical refrigeration process has received a patent. The next step is to attract industrial partners. Further information on the LASSOR is available on the World Wide Web at <http://labs3.lanl.gov>. ■

HALL EFFECT COMPASS

Continued from page 38

polarity is correct; reverse polarity will do serious damage to IC1. Once you check the polarity, attach a 9-volt battery to the battery connector and switch on the power. One of the eight LEDs should come on, indicating the compass heading. Remember that the compass must be held or mounted horizontal to the earth's surface for the correct compass readings.

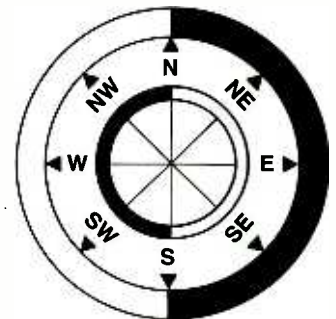

LED1	SE
LED2	NE
LED3	E
LED4	SW
LED5	S
LED6	NW
LED7	W
LED8	N

Fig. 4. A paper label (approximately 1 inch in diameter) was placed on the author's Hall-Effect Electronic Compass to show the direction indicated by the lit LED. That label, which is shown hereslightly enlarged, can be photocopied and scaled to fit your unit. Alternatively, you can devise a design of your own, or you can even omit it all together. The accompanying table shows the direction corresponding to each of the eight LEDs.

Like any magnetic compass, this one is affected by nearby external magnetic fields, which can present a problem when you are trying to use it inside of a car or boat. It will be necessary to experiment to find the best operating location in such cases.

Since the outputs of that circuit are digital, the compass could also be easily interfaced to mobile robots. It would be valuable, in that case, to have an absolute directional reference when the robots negotiate a room or even a rat-maze course. ■

ANTIQUE RADIO CLASSIFIED

Free Sample!

Antique Radio's
Largest Circulation Monthly.
Articles, Ads & Classifieds.

6-Month Trial: \$18.95. 1-Yr: \$38.95 (\$55.95-1st Class).

A.R.C., P.O. Box 802-L18, Carlisle, MA 01741

Phone:(508) 371-0512 VISA/MC Fax:(508) 371-7129

Market Center™

Paperback Books

GREAT BOOKS AT BUDGET PRICES

100 RADIO HOOKUPS
—#7—\$3.00

First published in May, 1923 this popular booklet went into reprint editions nine times. It is packed with circuits, theory, antenna installation and tips on consumer radio receivers that were popular in the early 1920's. Antique radio buffs and those inquisitive about the early days of radio will find this booklet an exciting, invaluable and excellent reference into the minds of early-day radio listeners. Sorry, we cannot honor the original 25-cent cover price.

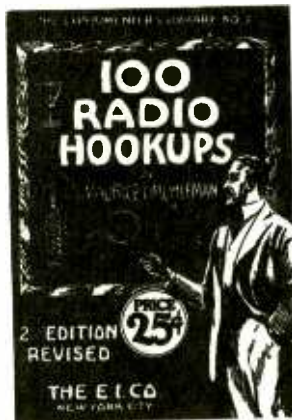

INTERNATIONAL RADIO STATIONS GUIDE—BP255
—\$9.95

Provides the casual listener, amateur radio DXer and the professional radio monitor with an essential reference work designed as a guide for listening to the complex radio bands. Includes coverage on Listening to Shortwave Radio, ITU Country Codes, Worldwide Radio Stations, European Long Wave and Medium Wave Stations, Broadcasts in English and more.

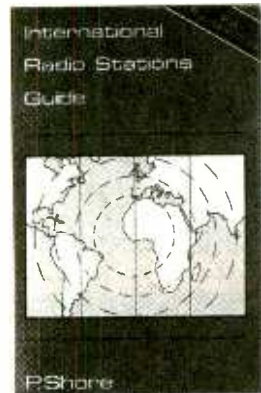

HOW TO USE OP AMPS
—BP88—\$5.95

The engineer's best friend is the op amp. This basic building block is found in many circuits, analog and digital alike. The op amp finds many useful purposes such as: oscillators, inverters, isolators, high- and low-filters, notch and band-pass filters, noise generator, power supplies, audio, MIDI, and much more. Prepared as a designer's guide, some limited math is used, however engineers and hobbyists alike find it a useful text for their design needs.



WIRELESS & ELECTRICAL CYCLOPEDIA
—ETT1—\$5.75

A slice of history. This early electronics catalog was issued in 1918. It consists of 176 pages that document the early history of electricity, radio and electronics. It was the "bible" of the electrical experimenter of the period. Take a look at history and see how far we have come. And by the way, don't try to order any of the radio parts and receivers shown, it's very unlikely that it will be available.

ELECTRONIC TECHNOLOGY TODAY INC.
P.O. BOX 240, Massapequa, NY 11762-0240

Name _____
Address _____
City _____ State _____ Zip _____

SHIPPING CHARGES IN USA AND CANADA

\$0.01 to \$5.00	\$2.00
\$5.01 to \$10.00	\$3.00
\$10.01 to 20.00	\$4.00
\$20.01 to 30.00	\$5.00
\$30.01 to 40.00	\$6.00
\$40.01 to 50.00	\$7.00
\$50.01 and above	\$8.50

SORRY No orders accepted outside of USA & Canada

Number of books ordered

Total price of merchandise	\$ _____
Shipping (see chart)	\$ _____
Subtotal	\$ _____
Sales Tax (NYS only)	\$ _____
Total Enclosed	\$ _____

All payments must be in U.S. funds!

ET01

TEST INSTRUMENT CATALOG !!!

Call, fax or email today for your free copy of our test instrument catalog, jam-packed with the **BEST VALUES** in test and measurement instruments available today!!!

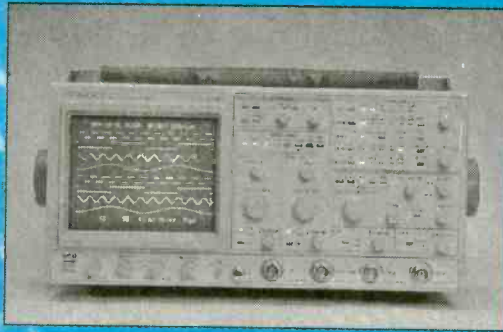

PRINT™ 
Products International

8931 Brookville Rd * Silver Spring, MD, 20910 * 800-638-2020 * Fx 800-545-0058 *
Email: SMPRODINTL@aol.com

CIRCLE 46 ON FREE INFORMATION CARD

❖ ATTENTION CABLE VIEWERS ❖

CABLE VIEWERS . . . get back to your **BASIC** Cable Needs

Call 800-577-8775

For information regarding all of your **BASIC** cable needs.

5 GOOD REASONS TO BUY OUR FAR SUPERIOR PRODUCT

- ❖ **PRICE**
- ❖ **EFFICIENT SALES AND SERVICE**
- ❖ **WE SPECIALIZE IN 5, 10 LOT PRICING**
- ❖ **ALL FUNCTIONS (COMPATIBLE WITH ALL MAJOR BRANDS)**
- ❖ **ANY SIZE ORDER FILLED WITH SAME DAY SHIPPING**

We handle **NEW** equipment **ONLY** - Don't trust last year's **OBSOLETE** and **UNSOLD** stock!
COMPETITIVE PRICING—DEALERS WELCOME

HOURS: Monday-Saturday 9-5 C.S.T.

It is not the intent of B.E.S.W. to defraud any pay television operator and we will not assist any company or individual in doing the same.
*Refer to sales personnel for specifications.

BASIC
ELECTRICAL
SUPPLY &
WAREHOUSING
CORPORATION

P.O. Box 8180 ■ Bartlett, IL 60103 ■ 800-577-8775

Digital Entertainment
also available through
 **Skyvision**



USSB



4D TV
FOR C-BAND



BEST Values from Skyvision!

Receivers
from \$249
including 4DTV

Dish Movers
12" to 52" for all
C- and Ku-band dishes

LNBs
All kinds
to heat up your picture

Tune-Up Kits
for C/Ku band & DBS

Programming
Save 30% - 50% with Skypac™

Support
Customers enjoy toll-free technical help

Keep your C-band System Running Strong

Everything on the air: for complete variety

Enjoy debut of new channels
Often in the clear for months

Wild feeds... Action as it happens

Programming you want at a price
you can afford to pay

Whether you're considering your first
satellite TV entertainment system or
looking for an upgrade to your
current system, Skyvision provides
the best in hardware, technical
support, convenience,
low cost and service.



1048 Frontier Drive
Fergus Falls, MN 56537

All marks shown are registered trademarks
of their respective owners.

Fax: 218-739-4879 Int'l: 218-739-5231

1-800-334-6455
www.skyvision.com

 **Skyvision**

SPECIAL PROJECTS

We design/build/modify/repair/consult on any device / system / process / project electronic / computer / mechanical / optical (eg: phone/auto/security/Radionic/lab/energy/HV/EM/RF/radar/ultrasonic/IR/UV/commo) for business and personal/invention needs. Describe & include nonrefundable \$30 pre-engineering fee. Time & cost estimates sent in 7-10 days. Confidentiality guaranteed!

OFF-THE-SHELF HARDWARE

Van Eck Systems ★ Data Card Reader/Writers ★ RF/EM/μWave/Radar/Ultrasonic/IR/Light/Sound Detectors/Xmitters/Jammers/Blasters ★ Security/Surveillance ★ EM Weapon Countermeasures ★ Neurophone/Rife/Crystal Radionics ★ Bug & Tap Detectors/Blasters ★ Lineman's Handsets ★ Phone Color Boxes ★ Voice Disguisers ★ ESS Infinity Devices ★ DTMF Decoders ★ Child Finder ★ Panic Button ★ Slot Machine Masters ★ Subliminal Mixer/Amps (Ultrasonic/Infrasonic) ★ TENS ★ Hearing Assistors ★ Electronic Dowzers ★ Shriek Modules ★ Ghost Detectors ★ Vortex Generators ★ Alien Brainblasters ★ 6th Sense Communicators ★ More! Order Catalog Today!!

AUTOMATIC TELLER MACHINES

ATM crimes, abuses, vulnerabilities and defeats exposed! 100+ methods detailed, include: Physical, Reg. E, cipher, PIN compromise, card counterfeiting, magnetic stripe, false front, TEMPEST, Van Eck, tapping, spoofing, inside job, super-cool, vibration, pulse, high voltage - others. Case histories, law, countermeasures, detailed security checklist, labeled internal photos, figures. ATMs contain up to \$250,000 in cash!

PAGER (BEEPER) MANUAL

Describes in detail how Pagers work, different types and uses, frequencies, advantages over and uses with cellphones, and tips and tricks. How Pagers are hacked and countermeasures. Includes plans for a Personal Pocket Paging System (xmitter and receiver).

HACKING FAX MACHINES

Describes in detail how Fax Machines are hacked and countermeasures. Includes G3 Fax protocols, commo parameters, compression algorithms, Class 1 & Class 2 commands, Spy Fax Switcher, Fax Servers, FODs/FOCs, and Makeup/Terminating Codes. And insights into designing Fax interception devices and modifying existing Faxes into Stealth Faxes. Eye-popping and invaluable!

PBX HACKING

PBXs are hacked to the tune of about \$8 Billion/yr! "PBX Hacking" exposes all issues relating to PBX hacking, including countermeasures. This manual was featured in Forbes Magazine! Shocking!

VOICE MAIL HACKING

Exposes how Voice Mail Box systems are used and specific ways they are hacked. Includes ASPEN, MESSAGE CENTER, BIX, GENESIS, RSVP, CENTAGRAM, EZ, AUDIX, SYDNEY, PHONE MAIL, CINDY, SPERRY LINK, etc. A must for all users, hackers, and security personnel!

10% OFF
Orders Over
\$100!!

TOP SECRET

CONSUMERTRONICS

P.O. Box 23097 ABQ, NM 87192

ORDER TODAY! 505-237-2073

Fax: 505-292-4078

Web Adventure: www.tsc-global.com

Established in 1971. Featured on CBS "60 Minutes," Forbes, New York Times.

Add \$5 total S/H (US, Canada). Sold for educational purposes only.

Postal M.O. is fastest. VISA, MC OK. COD (\$49-\$999), add \$7.

NOT
FOUND IN
BOOKSTORES!

INTERNET CONS & SCAMS \$19

Net cons and related frauds now rake in \$2+ Billion annually! Most are done with little fear of prosecution. Detailed, + countermeasures.

INTERNET TRACKING & TRACING \$29

The Net is infected with spammers, stalkers, scammers, infectors, and other wrongdoers who hide behind its anonymity. Learn how to trace them down in this comprehensive, eye-popping manual!

COMPUTER PHREAKING \$39

Describes in detail how computers penetrate each other, and how VIRUSES, TROJAN HORSES, WORMS, etc are implemented. Dozens of computer crime and abuse methods and countermeasures. Includes disk filled with hacker text files and utilities, and the legendary FLUSHOT+ protection system. Internet advice, password defeats, glossary - much more! Manual + PC Disk!

BEYOND VAN ECK PHREAKING \$29

Eavesdropping on TV and computer video signals using an ordinary TV described in detail. Includes security industry reports. Range up to 1 KM. Plans include both the Consumertronics and the original Top Secret Van Eck designs!

CREDIT CARD SCAMS \$29

Completely describes every known means of credit card fraud and scams, + countermeasures. Protect yourself!

OTHER EXCITING TITLES!

CONS & SCAMS \$29

Most comprehensive manual on C&S available! Details 100s, their many variations, and countermeasures!

STEALTH TECHNOLOGY \$24

Every known police radar error - stealth method and material used to minimize radar and laser reflections - tactic and strategy to fight speeding tickets!

THE PLACAK REPORT \$29

How to read and decrypt the magnetic flux-reversals on popular credit and debit card magnetic stripes. How to determine the decrypted PIN, PAN, bank number, dates, number of uses remaining. No hardware needed!

HIGH VOLTAGE DEVICES \$29

Many HV device plans: Stun Gun, Taser, Prod, Cane, Flasher, Blaster, Zapper, Radar Jammer, Jacob's Ladder, Fence Charger, Geiger Counter, Fish Stunner, much more!

RADIONICS MANUAL \$29

Exciting electromagnetic therapeutic, diagnostic devices (mostly experimental). Descriptions, plans, availability.

ROCKET'S RED GLARE \$29

The most definite and comprehensive source on solid-propellant survival and amateur rocketry! Many plans!

FREE! \$14

How you can get FREE money, jobs, land, housing, meals, medical care, equipment, merchandise, much more!

POLYGRAPH DEFEATS \$19

How anyone can tell "the truth" to a "lie detector". Many proven methods to beat the test, and what to avoid.

STOPPING POWER METERS \$29

As reported on "60 MINUTES"! How devices can slow down (even stop) watt-hour meters - while loads draw full power! Device plugs into one outlet and normal loads into other outlets. Describes meter creep, overload droop, etc. Plans!

THE I.G. MANUAL: External magnetic ways (applied to meter) to slow down and stop power meters while drawing full loads. Plans. \$25.

KW-HR METERS: How watt-hour meters work, calibration, error modes (many), ANSI Standards, etc. Demand and Polyphase Meters. Experimental results to slow and stop meters by others. A real eye-opener! \$25.

Special! All 3 (above), Only \$59!

BEYOND PHONE COLOR BOXES

Dozens of PCB's described - many circuits. Plus Call Forwarding, Conferencing, Phreak History, Glossary, Diverters, Extenders, Loops, REMOBS, Bridging Heads & Cans, Optocom, 3rd Party and many other non-box methods - more! \$29.

HACKING ANSWERING MACHINES

All the known ways answering machines are hacked to listen to and erase messages, and to convert them into mini-VMBs. Plus countermeasures - protect yourself from hackers/thieves! \$19.

PHREAKING CALLER ID & ANI

Details on how they work and dozens of effective ways of defeating Caller ID, ANI, *69, *57, Call Blocking, *67 etc. Also describes Caller ID, Orange, Beige, Cheese & CF Boxes, ESS, SS7, E-911, various Class services, CN/A, Non Pub DA, CAMA, DNR, 800-ECR, Diverters, LD Extenders, Centrex - much more! \$19.

CELLULAR AND CORDLESS MODS \$59

The ultimate cellular modification guide! See our Catalog for our infamous cellphone mod guide - very detailed, comprehensive, covers most makes - 10 times more info than any competitors' manual!

THE HACKER FILES

Compilation of 100s of the best eye-popping articles written by top hackers/phreakers. ASCII text. Covers every major topic in hackerdom! On 3 HD PC Disks! \$39.

MIND CONTROL

Fear increases over EM and ultrasonic mind control technologies - especially implants! Many more lies published than facts. Secret agents are often used for reporting back to covert organizations. Learn shocking truth about this bizarre phenomena! \$29.

HACKING THE INTERNET

The absolute latest tricks and methods being used on the Net to hack software (warez) and the latest, coolest hacking websites. Updated every two months, so you know its fresh. Comprehensive info on getting pirated software. Includes examples, countermeasures, and lots of tips! \$24.

BY AN ORDER OF THE MAGNITUDE

The most comprehensive, hard-hitting, hi-tech survival book ever written! Topics include electronic, computer, commo, chemistry, weaponry, cryptography, energy, concealment, revenge, alarm, disguise & ID change. Designs, tactics & strategies to survive an increasingly dangerous and brutal world. Field-expedient use of technology in various threat and conflict environments and scenarios. \$49.

THE ULTIMATE SUCCESS MANUAL

How to lie, cheat, steal, influence, and intimidate your way to success! Underpaid? Overworked? Harassed? Manipulated? Forget job performance. This manual outlines what it really takes to make it to the top in today's corporate BS world! \$15.

SHOCKING!

ALL-NEW TOP SECRET CATALOG. FEATURES 200+ SURVIVAL PRODUCTS! WILL ROCK YOUR WORLD! MAIL \$3, OR \$1 WITH ORDER!

ORDER TODAY!!

**FREE CATALOG
CALL TOLL FREE
1-800-338-0531**

E-Mail: xpress@parts-express.com



**Parts
Express**

**UNBELIEVABLE
VALUE!**

POWERHOUSE

Check our catalog for a full line of X-10 Home Security and Home Automation products.



Weller WLC100 Soldering Station

The Weller WLC100 solder station is ideal for the professional, serious hobbyist, or kit builder who demands a higher performance than usual of a standard iron, but without the high cost of an industrial unit. Power is adjustable from 5 to 40 watts. Includes 40 watt pencil iron. UL approved. Net weight: 1-3/4 lbs.



**SUPER
VALUE**

#PO-372-120 **\$39⁹⁵** EACH

**"The Sound Bridge" FM Stereo
Wireless Transmitter**

The Sound Bridge is a mini FM wireless transmitter that can be used to broadcast stereo sound from any audio source like portable CD players, TVs, electronic games, CD-ROM, even computer soundcards, to your home stereo receiver! Adjustable from 89 to 95.5 MHz.



**HOT
NEW
ITEM!**

#PO-249-220 **\$14⁹⁵** EACH

**3 Way Indoor/Outdoor
Speaker System**

These are the best sounding little speakers you can find at anywhere near this price! Perfect for rear channel use in a home theatre system or for outdoor use. Features 4" polypropylene woofer, 2" polycone midrange, 3/4" dome tweeter housed in a weatherized polystyrene enclosure. Frequency response: 90-20,000 Hz. Impedance: 4 ohms. Power handling: 30 watts RMS/60 watts max. Mounting brackets included. 7-1/4" H x 4-5/8" W x 4-3/8" D. Net weight: 6 lbs.



#PO-319-020 (Black) Compare To
#PO-319-025 (White) **\$45⁰⁰** PAIR
\$29⁹⁵ PAIR

Home Theatre In-Floor Subwoofer

To fully appreciate the potential of movie soundtracks, a dual voice coil subwoofer is a must! Many film special effects are extremely demanding in the low frequency range and require a subwoofer that can duplicate explosions, earthquakes, even the footsteps of Tyrannosaurus Rex! This subwoofer fits the bill by featuring a 10" dual voice coil woofer for true stereo operation and high pass filters for your main speakers. The most unique feature of this subwoofer is the fact that it is designed to be mounted in between the floor joists in new and existing home constructions. Simply mount the in-floor sub to the joists and mount a heat register grill above opening in subwoofer front enclosure. The subwoofer is now totally out of view and ready to rumble! Includes detailed installation manual.



Specifications: 10" dual voice coil treated paper cone woofer with poly foam surround
• Frequency response: 30-100 Hz
• Nominal impedance: 8 ohms per coil
• Power handling: 100 watts RMS channel/140 watts max
• SPL: 89 dB 1W/1m
• Dimensions: 27" D x 14-5/8" W x 9" H
• Net weight: 29 lbs.

#PO-300-445 **\$139⁹⁵** EACH

Peak Instrument Co.

"The Woofer Tester"

Peak Instrument Co. proudly introduces "The Woofer Tester". Just ask any loudspeaker engineer, and they will tell that the only way to design enclosures of the correct size and tuning is to measure the Thiele-Small parameters for the actual drivers to be used. The reason? Manufacturers published specs can be off by as much as 50%! But until now, measuring the parameters yourself required expensive test equipment and tedious calculations, or super expensive measurement systems (\$1,200 to \$20,000). The Woofer Tester changes all that. Finally, a cost effective, yet extremely accurate way to derive Thiele-Small parameters, in only minutes! The Woofer Tester is a combination hardware and software system that will run on any IBM compatible computer that has EGA or better graphics capability and an RS232 serial port. The Woofer Tester will generate the following parameters. Raw driver data: Fs, Qms, Qes, Qts, Vas, BL, SPL @ 1W/1m, Mmd, Cm, and Rm. Sealed box data: Fsb, ha, alpha, and Q loss. The Woofer Tester system includes hardware, test leads, serial cable, AC wall adaptor, detailed instructions, and software.



**QUICK! AND
ACCURATELY
MEASURES: Fs,
Qms, Qes, Qts, Vas,
BL, SPL @ 1W/1m,
Mmd, Cm, and Rm
IN MINUTES!**

• 30 DAY MONEY BACK GUARANTEE
• 1 YEAR WARRANTY • SAME DAY SHIPPING

#PO-390-800 **\$249⁰⁰** EACH

5 Foot Stereo RCA Patch Cord

High quality, Japanese made patch cord features color coded RCA plugs on each end for easy polarity identification. Molded strain reliefs for extra long life and durability. Limited availability.



Part #	Description	Price (1-9)	Price (10-UP)
PO-189-070	Red/white plugs	\$1.20	\$9.95
PO-189-072	Yellow/black plugs	1.20	9.95

Copper Clad PC Board

Now's the perfect time to start building your own PC boards! A factory buyout enables us to bring you this premium quality copper clad PC boards at unheard of low prices. Each board is coated with .0014" copper and is at least .060" thick. Limited availability.

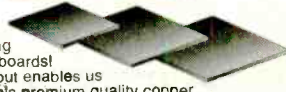

Part #	Description	Price (1-9)	Price (10-UP)
PO-055-204	6" x 18" single sided	\$1.50	\$1.35
PO-055-206	6" x 21" single sided	1.75	1.55
PO-055-222	8" x 24" single sided	2.65	2.40
PO-055-252	6" x 18" double sided	2.25	2.00

**Speaker
Surround
Repair Kits**



- ◆ Do it yourself
- ◆ Save Money
- ◆ Complete instructions
- ◆ Wide variety of sizes and styles
- ◆ Hard to find Advent Woofer and Red Foam kits available

**CALL NOW FOR
SIZES AND MORE
INFORMATION**

900 MHz Wireless Speaker System

- ◆ 900 MHz technology sends signal up to 180 ft., through walls, floors and ceilings.
- ◆ Ideal for use as rear surround speakers or for adding wireless sound to every room in the house!
- ◆ Full range, bass reflex design with built-in high power, low distortion amplifier.
- ◆ Weather resistant cabinet for outdoor use.
- ◆ Selectable battery (six C size for each speaker) or AC operation, adaptor included. Built-in recharging circuitry for ni-cad batteries.
- ◆ System includes: 900 MHz transmitter, wireless speaker pair, AC adaptors, and all cables necessary to hook up system.
- ◆ Limited availability. ◆ Net weight 9 lbs.
- ◆ Frequency response: 20-18KHz.



#PO-319-030 **\$169⁹⁵** EACH

◆ 30 day money back guarantee ◆ \$20.00 minimum order ◆ We accept Mastercard, Visa, Discover, and company C.O.D. orders ◆ 24 hour shipping ◆ Shipping charge = UPS chart rate + \$1.90 (\$5.00 minimum charge) ◆ Hours 8:00 am - 8:00 pm ET, Monday - Friday ◆ 9:00 am - 5:00 pm Saturday. Mail order customers, please call for shipping estimate on orders exceeding 5 lbs. ◆ Foreign destination customers please send \$5.00 U.S. funds for catalog. ◆ Quantity pricing available.
CIRCLE 146 ON FREE INFORMATION CARD



1-800-338-0531

340 E. First St., Dayton, OH 45402-1257
Phone: 937-222-0173 ◆ Fax: 937-222-4644

ALFA ELECTRONICS, INC.

HIGH QUALITY TEST EQUIPMENT PROVIDER

1-800-526-2532 (526-ALFA)

15 Days Money Back Guarantee!



DMM
DMM-10 (\$19.95): 3 1/2 digit, DC/AC V, Ω, hFE, diode, signal output(+3V, -0.5Vsq, 50% duty)
DMM-17B (\$39.95): 3 1/2 digit, DC/ACV, contin., DC/ACA, Ω, Capacitance, hFE, diode, Freq
DMM-20 (\$74.95): AC/DC (V, A), Freq, cont., Capac, Induct., Ω, hFE, diode, duty cycle
DMM-22 (\$89.95): 4000 counts, bar graph, Freq, AC/DC (V, A), Ω, Capacitance, diode, contin.
DMM-23T (\$99.95): 4 1/2 digit, high resol. (10uV, 10nA, 10mΩ), hFE, diode, contin., true rms
DMM-89S (\$179.00): true rms, AC/DC (V, A), Ω, bar graph, freq, capac., dBm, logic, diode
DMM-113 (\$24.95): Pocket Size, DC/ACV, Ω, diode, Continuity beeper
DMM-120 (\$24.95): economy type, DCV, ACV, DCA, Ω, hFE, diode
DMM-122 (\$39.95): DC/AC (V, A), Ω, hFE, diode, capacitance, freq, logic, continuity
DMM-123 (\$44.95): DMM + capacitance, DC/AC (V, A), Ω, hFE, diode, continuity
DMM-124 (\$69.95): Electrical+Temp, DC/ACV, capacitance, freq, 3 phase, diode, contin.
DMM-125 (\$54.95): Autorange + bar graph, DC/AC (V, A), Ω, diode, continuity beeper



LCR METER
CAP-15 (\$49.95): 3 1/2 digit, 0.1pF-20mF, 9 Ranges, 0.1pF resolution zero adjustment.
LCR-195 (\$89.95): 1uH-200H (induct.), 0.1pF-200uF (Capac.), 0.01Ω-20M Ω (resistance)
LCR-814 (\$189.95): 0.1uH-200H, 0.1pF-20mF, 0.1Ω-20MΩ, Q Factor, dissipation, zero adjust
LCR-131D (\$229.95): autorange, 0.1uH-10kH, 0.1pF-10mF, 1mΩ-10MΩ, Q Factor, serial/parallel, 120Hz/1kHz testing mode

FREQ. COUNTER
FC-1200 (\$129.95): 1.25GHz Handheld, 8 digits display, 10ppm accuracy, sensitivity 5mV (130-350MHz), 30mV (440MHz), 22m (800mhz), batteries or 9V adapter.
FC-5250C (\$119.95) 220MHz benchtop, 7 digit, 10ppm accuracy, 35mV sensitivity, 10V-p max input, power by 9V adapter
FC-5270A (\$149.95) 1.2 GHz bench type, 8 digit, 10 ppm, 35mV sensitivity, 10Vp-p max. input, power by 9V adapter.
FC-5700 (\$329.95) 1.3GHz bench type, 8 digit, 1 ppm accuracy, 20mV sensitivity, period 0.1us to 100ms. Ideal for test & repair of audio instrument.



DMM-113 (\$24.95): Pocket Size, DC/ACV, Ω, diode, Continuity beeper
DMM-120 (\$24.95): economy type, DCV, ACV, DCA, Ω, hFE, diode
DMM-122 (\$39.95): DC/AC (V, A), Ω, hFE, diode, capacitance, freq, logic, continuity
DMM-123 (\$44.95): DMM + capacitance, DC/AC (V, A), Ω, hFE, diode, continuity
DMM-124 (\$69.95): Electrical+Temp, DC/ACV, capacitance, freq, 3 phase, diode, contin.
DMM-125 (\$54.95): Autorange + bar graph, DC/AC (V, A), Ω, diode, continuity beeper

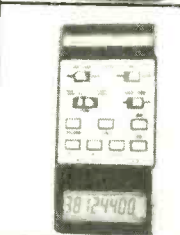

FLUKE DMM

HandHeld	Scope
12 \$ 84.95	92B \$1,399
70-II \$ 75.95	96B \$1,699
73-II \$ 97.95	99B \$1,999
75-II \$129.00	105B \$2,499
76-II \$175.00	863E \$469
77-II \$155.00	867E \$659
79/29-II \$175.00	
87 \$287.00	

SPECIALTY

- Sound meter \$169.95
- EMF Tester \$69.95
- Conductivity \$169.95
- Thermometer \$69.95-\$89.95
- Humid./Temp meter \$169.95
- Press. meter \$299.95
- Electr. scale \$89.95
- Watt Meter \$129.95
- High Voltage Probe \$59.95
- pH Meter \$79.95
- Light Meter \$80-\$90
- Light Adapter \$49.95
- Anemometer \$179.95
- Anemometer adapter (And More) \$89.95



OSCILLOSCOPE
 Dual Trace, Component Test, 6" CRT, X-Y Operation, TV Sync, CH2 Output, Graticule Illum, 2 Probes(x1, x10)

- PS-200 20 MHz Dual Trace \$339.95
- PS-205 20 MHz Dual w/ Delay Sweep \$429.95
- PS-400 40 MHz Dual Trace \$494.95
- PS-405 40 MHz Dual w/ Delay Sweep \$569.95
- PS-605 60 MHz Dual w/ Delay Sweep \$769.95
- PS-1000 100MHz Dual Trace \$999.95

Digital Scope

- DS-303 30MHz Digital, 20 Samples/sec \$849.95
- DS-303P RS-232 interface, 30Mhz \$1,049.95

Scope Probe

- HP-9060 (60MHz) \$15, HP-9150 (150MHz) \$22, HP-9250 (250MHz) \$29, HP-9258 (250MHz, 100:1) \$39

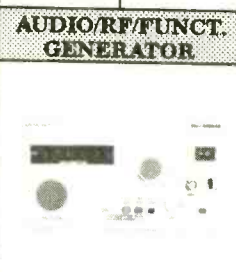

AUDIO/RF/FUNCT. GENERATOR
RF Generator

- SG-4160 (\$124.95) 100kHz-150MHz sinewaves in 8 ranges, 100mV at 35MHz
- SG-4162 (\$229.95): Generate same signal as SG-4160, but with int. counter (150MHz)

Audio Generator

- AG-2601 (\$124.95) 10Hz-1MHz, 0-8Vpp sine, 0-10Vpp squarewave
- AG-2603 (\$229.95): Same as AG-2601, but with additional counter and digital display.

Function Generator

- FC-2100A (\$169.95) 2Hz-2MHz, 5mV-20Vpp
- FC-2102AD (\$229.95) same as FC-2100A, but with int. counter and TTL, CMOS output
- FC-2103 (\$329.95) Sweep 0.5Hz-5MHz, linear/log, VCG, GCV, and int. counter

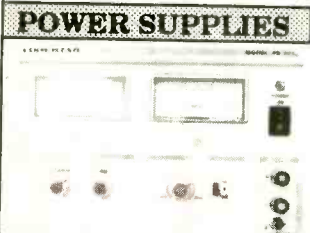

POWER SUPPLIES
Single Output DC Power Supplies

- Short Circuit and overload protected
- Constant current, constant voltage mode
- 0.02%+2mV line regulation; 0.02%+2mV load regulate

Analog Meters Display

- PS-303 (\$159.00) 30V/3A
- PS-305 (\$219.95) 30V/5A
- PS-8110 (\$289.95) 60V/5A
- PS-8112 (\$399.95) 60V/5A
- PS-1610 (\$289.00) 16V/10A
- PS-8107 (\$399.95) 30V/10A

Digital Voltage, Analog Current

- PS-8200 (\$179.95) 30V/3A
- PS-8201 (\$239.95) 30V/5A

Digital Volt & Current Display

- PS-8300 (\$199.95) 30V/3A
- PS-8301 (\$259.95) 30V/5A

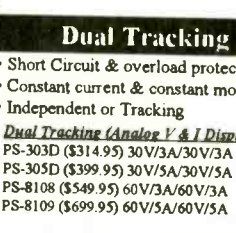

Dual Tracking

- Short Circuit & overload protected
- Constant current & constant mode
- Independent or Tracking

Dual Tracking (Analog V & I Displays)

- PS-303D (\$314.95) 30V/3A/30V/3A
- PS-305D (\$399.95) 30V/5A/30V/5A
- PS-8108 (\$549.95) 60V/3A/60V/3A
- PS-8109 (\$699.95) 60V/5A/60V/5A

Triple Output

- One fixed 5VDC, 3 Amp output
- Parallel to double current output (PS-8102 & PS-8103 only)

Triple Output (Analog displays)

- PS-8102 (\$399.95) 30V/3A/30V/3A
- PS-8103 (\$489.95) 30V/5A/30V/5A

Digital Displays

- PS-8202 (\$499.95) 30V/3A/30V/3A
- PS-8203 (\$549.95) 30V/5A/30V/5A

INSTEK® Test & Measuring Instrument ISO 9002 Cert. #934163 (2 Years Warranty)

OSCILLOSCOPE
OS-653 \$699.95 30MHz Triggering
OS-622B \$399.95 20 MHz Oscilloscope

- Dual CH / Delay sweep
- ALT trigger, trigger lock
- 1mV/div sen., delay line
- Zaxis input, CH1 output
- Xaxis input, CH1 output
- Hold off, TV syn.
- 2 probes (x1, x10)

- Dual CH/X-Y operation
- 1 mV/div sensitivity
- Z-axis input, CH1 output
- TV syn., trigger level lock
- 2 probes (x1, x10)

- OS-305 (\$209.95) - 5 MHz One Channel
- OS-310 (\$324.95) - 10 MHz One channel

DC POWER SUPPLIES
Triple Output

- 2 variable out 0-30V, 0-3A
- One fixed 5V, 3A output
- Auto track, serial, parallel
- Const. volt, current mode
- 4 analog or 2 digital display

- PC-3030 (\$499.95)
- PC-3030D (\$549.95)

Single Output

- Const voltage, current mod
- Voltage regulation <0.01%
- Current regulation <0.2%
- PS: 2 analog or 1 digital dis
- PR: 2 analog or 2 digital dis

Analog Meters Display

- PS-1830 (\$209.95) 18V/3A
- PS-1850 (\$219.95) 18V/5A

- PS-3030 (\$224.95) 30V/3A
- PS-6010 (\$209.95) 60V/10A

Programmable

- PR-3060 (\$314.95) 30V/6A
- PR-6030 (\$314.95) 60V/3A

Digital Meters Display

- PS-1830D (\$219.95) 18V/3A
- PS-1850D (\$244.95) 18V/5A
- PS-3030D (\$254.95) 30V/3A
- PR-6030D (\$399.95) 60V/3A

FUNCTION GENERATOR

- High stability, low drift
- One fixed 5V, 3A output
- 100point program (PPS ser)
- 50point program (PPT ser.)
- Auto serial/parall (PPT ser)
- Auto track (PPT series), IEEE-488.2 and SCPI compatible command set (optional)

- PPS-1860G (\$1,099.95)
- PPS-3635G (\$1,099.95)
- PPS-6020G (\$1,099.95)
- PPT-1830G (\$1,399.95)
- PPT-3615G (\$1,399.95)

- FG-830 (\$1,499.95) 30MHz Synthesized Function Gen
- Output: sine, tri, square, sync out, arb. waveform

BENCHTOP DMM

- 20mHz Freq. resolution
- Linear/log sweep
- Arbitrary modulation
- RS232, IEEE-488(option)

- DM-8034 (\$179.95) 3 1/2 dgt AC/DC (V, A), C, Ω, diode
- 1000V, 20A, 0.5% accu
- DM-8040 (\$339.95) 3 1/2 dgt ACV to 50kHz, true rms
- DM-8055 (\$649.95) 5 1/2 dgt • 0.006% basic accuracy
- 1uV, 1mΩ, 1nA resolution
- dBm, auto, REL, min/max
- DM-8055G (\$889.95) GPIB
- Same funct. as DM-8055

Frequency Counters

- FC-8131 (\$469.95) 1.3GHz
- FC-8270 (\$629.95) 2.7GHz
- UC-2010G (\$294.95)

Programmable Electronic Load (PEL-300) (Patent Nos 81011/8124)

- Operating Rating: voltage 3-60V, current 6mA-60A, power 300W, temp 0-40C (operate)/-10-70C (store)
- Over voltage, over current, over power protection
- Operation mode: constant voltage, current, resistance
- Transient Gen. Frequency 1Hz-1kHz; duty 10-90%
- High Resolution: 20mV, 0.2mA, 0.3mΩ
- Self-Test and Software Calibration
- Meet UL CSA IEC Safety regulation

*** NEW * \$1409.95**

ALFA ELECTRONICS P.O. BOX 8089 PRINCETON, NJ 08543
 TEL: (800)526-ALFA(2532) / (609)897-1135
 FAX: 609-897-0206
 Email: alfa0168@aol.com
 Call/Write/Fax/Email for FREE CATALOG
 Visa, MC, AMEX, COD, PO Accepted. OEM Welcome.
 1 Year Warranty (2 Years for Instek)

Popular Electronics, August 1997

MCM ELECTRONICS®

Prices Effective June 2 through August 29, 1997

YOUR Electronics Authority!

To take advantage of these prices, you must supply this special price code:

CODE: POP43

85 Channel Cable Converter

Includes last channel recall, channel memory, switched AC outlet and sleep timer. Remote requires two "AA" batteries (MCM #290-070).
Regular price \$59.95.

Order #33-2065



Sale \$49.95

ATC Lead Wire Fuses

Finally there is a fast, easy, low cost way to tap an automotive fuse box. Expanded fuse tap contacts can short out fuse boxes—but not ATC lead wire fuses!

Order #	Amps	Order #	Amps
60-3855	5	60-3875	20
60-3860	7.5	60-3880	25
60-3865	10	60-3885	30
60-3870	15		



Only \$2.25

Magnet Mount Cellular Antenna

Offer in effect only while supply lasts. Sturdy magnet mount antenna holds firmly in place at highway speeds. Also works well as a scanner antenna. Overall antenna length 13". Includes 12' RG-58U cable with attached molded TNC connector. **Suggested list \$9.95.**
Limited quantities

Order #58-2605

Limited
One Time Offer!

Only \$4.99



Replacement 3 1/2" Floppy Drive 1.44MB

Perfect replacement drive with standard IDC and Molex connectors for use in most PCs. Mitsumi model: D359T3. **Suggested list \$29.95.**

Order #58-2535

Sale \$24.95



Only \$24.95



VCR Model SuperCross™

Allows you to cross reference VCRs with all models that are mechanically the same. Great for second sourcing parts, service manuals and more. Crosses over 2000 VCRs. **Regular price \$29.95**

Order #81-2055

TENMA® DMM with Temperature Function

3 1/2 digit DMM also doubles as an accurate temperature meter. Ideal for appliance repair and many other applications. **Regular price \$79.95.**

Order #72-4030

Sale \$44



50 Watt 2 Meter Ham Amplifier

Operates with less than one watt input, achieves 50W output with 5W in. Switchable 18dB GaAs FET preamp. For the 144-148MHz amateur radio band only. **Regular price \$159.00.**

Order #111-2100

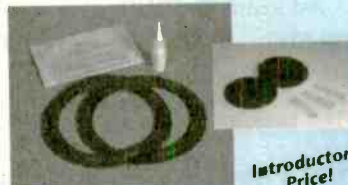

Introductory
Price!

Sale \$21.95

Speaker Repair Kits

Why replace the entire woofer when only the rotten foam surround is in need of replacement? Included in this kit are contents for repairing two speakers and consist of quality foam surrounds, advanced formulated adhesive to work with many cone materials and repair instructions.

Order #	Description	Kit
50-2726	6 1/2" kit	\$15.95
50-2731	8" kit	17.95
50-2736	10" kit	18.95
50-2741	12" kit	19.55
50-2746	15" kit	20.95
50-2751	2 1/2" dust caps	2.09
50-2756	3 1/2" dust caps	2.29
50-2761	4 1/2" dust caps	2.49

Same Day Shipping!

In stock orders received by 5:00 p.m. (YOUR TIME), are shipped the same day.

FREE Catalog!



1-800-543-4330

Hours: M-F 7 a.m.-9 p.m., Sat. 9 a.m.-6 p.m., EST.



MCM ELECTRONICS®
650 CONGRESS PARK DR.
CENTERVILLE, OH 45459
A PREMIER FARNELL Company

Visit MCM's website at www.mcmelectronics.com

CIRCLE 150 ON FREE INFORMATION CARD

CODE: POP43

CABLE T.V. EQUIPMENT

Friendly, Knowledgeable Service



**ORDERS CALL:
1-800-361-4586**



- All Equipment New
- Convertors & Descramblers
- 30 Day Money Back Guarantee
- 6 Month Warranty
- Visa, MC, C.O.D. Welcome

KDE ELECTRONICS, INC.

P.O. Box 1494
Addison, IL 60101

Info. 630-889-0281 HRS: Mon-Fri, 9-6 CST
Fax 630-889-0283 Sat, 10-2 CST

TRIDENT



\$699⁰⁰

SV150

**1000KHz to 1.00GHz
Spectrum Analyzer System
Up to 500MHz Span. Two bands.**

All the advantages of a Spectrum Analyzer at a very affordable price. Great for interference and signal hunting. RS232 connect for logging signals to disk. Real time display sweep outputs on any X,Y scope. Variable span and sweep rate. Marker function and selectable bandwidth. Demods in AM/NFM/WFM plus BFO for CW/SSB modes. For instant information use our fax back service at 317 849 8683, #405. Or, email Scanns@www.acecomms.com . http://www.acecomms.com/Scanns.



Order Line: 1 888 445 7717

10707 E. 106th, Fishers, IN 46038 International: 317 842 7115
Fax 317 849 8794 Email: Scanns@www.acecomms.com

CIRCLE 25 ON FREE INFORMATION CARD

PC-based Front Panel Access Computer

7-11 PC --- 24-hour Working Computer from \$600

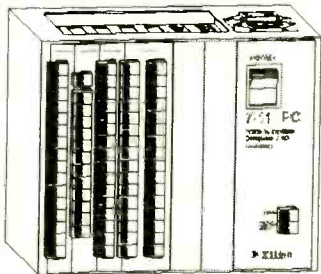

For Computer
Telephony Server or
Home Automation or
Network Computer
Fanless, compact size
9.0"W 7.5"H 6.5"D

**Handy PC --- Field
Computer** from \$700

In between of Laptop
& Desktop for the size,

Using regular CD-ROM, HD, FD and mini keyboard
Easy to carry around, 10.5"W 11"H 6.5"D

PLC PC --- Industrial Computer from \$900

Accessibility like PLC (Programmable Logic Controller)
Euro Bus and PCI
Bus for higher
reliability & better
performance.
17"W 11"H 6.5"D

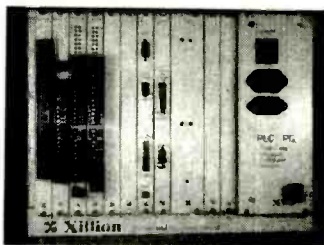

All above 3 models
accept ISA or PCI
interface cards, and
proprietary front panel
connecting cards: I/O, A/D, D/A, X-10, up to 10A/220V

NETWORK your phones !

Boost your telecommunication performance.
Make small business sounds big & professional.
FX207 is easy to use and very low cost.

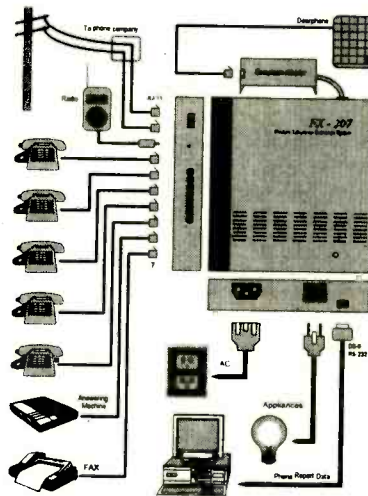

This small device provides same functions found in big, expensive PBX units; call transfer, conference, intercom, do not disturb, call restriction (blocking) call pickup, call waiting,.... Plus some extras you don't normally find in most regular PBX units such as: Voice direct incoming calls with your own message, transfer fax automatically, Tele-remote control your appliances or computer, Record and manage call numbers & time usage through your computer. You might even use it for phone projects - control phone operation with PC.

For home, For office, For home office.

FX207 handles two phone lines expanding to seven extensions using standard tone or rotary phones, FAX and answer machines. Plug in with regular phone plugs. Easy to install. Do it yourself.

\$298 limited time special !

(Plus S&H, California add sales tax, Discount Code X4PE, MSRP\$399)



RAINBOW KITS

Many of our kits are available completely built!

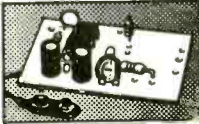

AUDIO PREAMP

Boost your microphones output up to line level!

Plug your mic into our AP-1 and drive your amp. to full capacity. Connect an AP-1 to a pair of amplified speakers, plug your mic in and you have an instant PA system. Requires 6 to 12v DC. Size: 1.75" X 1"

AP-1

KIT \$9.95

Read the code from any INFRARED Device



- Complete with Software for any 80386 or 80486 base machine, operating on DOS 3.3 or higher.
- Sampled data can be saved to disk for instant comparison & analysis.
- Zoom in on and view any 8 millisecond portion.

TIR-1

KIT \$89.95

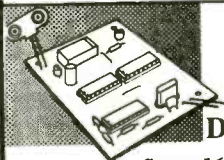

Sweet 16

16 TONE DECODER

Sweet 16 tone decoder operates great over phone lines, radios or scanners.

- 16 TTL Level Outputs
- DTMF Decoder Decodes 16 different touch tones using the phone, radios, or scanners.
- One relay & driver circuit on board.
- 9v battery powered. Size: 2 3/4" x 2 1/8"

TT-16

KIT \$34.95



MICRO-MINIATURE WIRELESS MIKE

So small you could hide this one on some real bugs! It's the smallest we've ever seen. With it's super sensitive mike it transmits a whisper or a room of conversation to an FM radio, tunable from 88 to 108MHz FM. With a proper antenna it transmits about 1/2 mile. The kit is made with surface mounted parts, we have already mounted these parts. You install the leaded parts. Power requirement 6 to 12v DC. Size: .35"x.9"

MMWM5

KIT \$34.95

TV NOTCH FILTERS FOR CHANNELS 2 thru 22 ONLY



Our TV filters eliminate unwanted TV channels or interference that alters both sound and video with a beep beep beep. Works on cable channels (2 thru 22) only.

NOTE: All TV Filter Kits are sold for educational purposes only. You must obtain permission from your local cable company before using these filters on your cable system.

DF-222

KIT \$14.95

AUTO CALL ID'ER

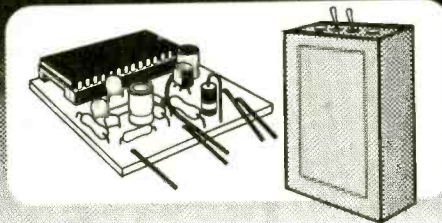

Send your call sign or call CQ automatically with the push of a button. Change your message as often as you like.

The AUTO CALL enables you to electronically store a 20 second message of your choice.

- (Your call sign or call CQ, for instance) and send it with the push of a button. Change your message as often as you like.
- Your message is stored in on board non-volatile memory cells, providing zero-power data storage. This is a high-quality voice recording and playback unit.

RX-1

KIT \$49.95

RX-1C SIZE: 1"H x 2.4"W x 3.8"D

CABINET \$12.95



This Manual contains schematics, parts lists & P.C. board layouts for many of the Rainbow Kits. Use your own parts to construct our kits.

KIT BOOK \$14.95

\$9.95 with the purchase of any kit.



ELECTRONIC RAINBOW

Please add sufficient postage First lb \$5.00 Canada \$7.00 Additional LB. Add \$1.00 US FUNDS ONLY We will accept telephone orders for Visa or Mastercard

Electronic Rainbow Ind., Inc.
6227 Coffman Rd. Indianapolis, IN 46268

CALL 317-291-7262 FAX 317-291-7269

INTERNET: www.rainbowkits.com

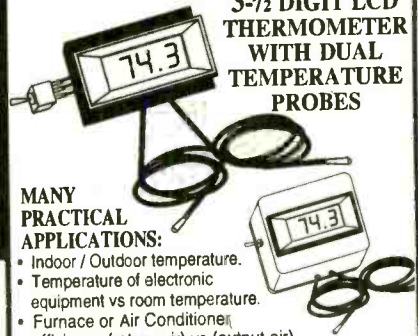

3-1/2 DIGIT LCD THERMOMETER WITH DUAL TEMPERATURE PROBES

MANY PRACTICAL APPLICATIONS:

- Indoor / Outdoor temperature.
- Temperature of electronic equipment vs room temperature.
- Furnace or Air Conditioner efficiency (return air) vs (output air).
- Temperature inside car / outside car
- Attic temperature / outside temperature.

LCD-T1
LCD-T1C

KIT \$34.95
CABINET \$9.95



STROBE LIGHT

Do you need an attention getter, warning light, or flashing light for model airplanes? Then this kit is for you. Use it as an emergency light for your auto, radio tower, even use it on your bicycle. Has a variable flash rate. Power requirement 6 or 12v DC.

Size 3.5"x1.9"

ST-1

KIT \$11.95



SUPER SNOOPER BIG EAR

Listen through walls, hear conversations across the room. Add a parabolic reflector and hear blocks away. The BIG EAR can be hidden about anywhere. Makes an ultra sensitive intercom. Can be used as a 1.5W AMP. We supply a mini-electret mike in the kit. Power requirement 6 to 12v DC. SIZE: 1.75" x 1"

AA-1

BUILT \$29.95 KIT \$10.95



PHONE TRANSMITTER

Small but mighty, it fits anywhere. Phone line powered, never needs batteries. Transmits both sides of a phone conversation loud and clear, wireless, to any FM radio at great distances. Variable tunes from 70MHz to 130MHz FM. You can also use it as a speaker phone. SIZE: 1.25" x .6"

TEL-B1

KIT \$12.95



WIRELESS FM MICROPHONE

Small but mighty this little jewel will out perform most units many times its price. It really stomps out a signal. The WM-2 kit is a buffered wireless mike that operates from 80MHz to 120MHz FM, the frequency of any broadcast FM radio. Includes a mini-electret mike. 6 to 12v DC. SIZE: 1.25" x 1"

WM-2

KIT \$14.95

WORLD'S SMALLEST

Wireless Video Transmitters

Used by hundreds of hobbyists and professionals alike in R/C models, Robots, Surveillance Video, movie Special Effects, and Law Enforcement.

"... previously, I used expensive wireless units from Peico, MVP, and Supercircuits. Nothing approaches the VidLinks in power, picture quality, size, and value. Thank you." *R. Leslie, CCTV Installer, NY.*
 "The best... Incredible color, resolution... very easy to use... cool." *P. Davis, Movie Props, CA.*

Actual Size!!!



Live Remote Video From \$99.00

- Full 100 mW RF Power. Range 500ft. to 1/2mile •
 - Crystal Controlled •
- High-Resolution Full Color/ B&W video •
- Fully epoxy encased- no exposed components •
- Fully assembled- only two wires to attach •
- **MONEY BACK GUARANTEE.** •

VidLink 100: 100mW Power- upto 1/4 Mile
\$199.00 New! High-Power!

VidLink 15: 15mW Power- upto 150 Feet
\$99.00 New! Low Price- Same Size!

Cover Camera: 1 1/4" sq. Pinhole Lens
\$169.00 Pro Grade Japanese Quality!

*** Audio Module Now Available. Call. ***
 Check/MO, COD +\$5.00, S&H \$5.50

**AEGIS
RESEARCH**

#671-1225 E. Sunset Dr.
 Bellingham, WA
 98226-3529 USA

1-604-224-0416

Visit our virtual catalog on the INTERNET at:
<http://www.lynx.bc.ca/virtualspy>



Are you overpaying . . .
 . . . your cable company?

You are if . . . 
 . . . you are leasing their equipment.

- Forest Electronics, Inc. offers a complete line of New Cable Decoders and Converters that are fully Compatible with your cable system.
- All systems come with: Remote Control, & Parental Guidance Feature. Volume Control is also available.
- All Equipment is fully guaranteed & comes with a 30 day money back option.

For More Information Call Us 24 Hours a Day At:

800-332-1996

FAX: 813-376-7801

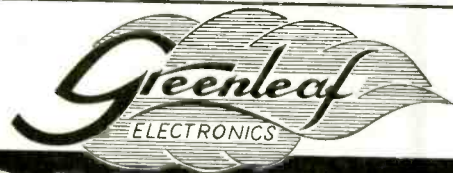

CABLE TV Converters & Descramblers

Compatible with
**Jerrold, Scientific Atlanta,
 Pioneer, Oak, & Hamlin
 Equipment**

BRAND NEW!

6-MONTH GUARANTEE

LOWEST PRICES

Volume Control & Parental Lockout Available

Greenleaf Electronics

1-800-742-2567

NO ILLINOIS SALES

It is not the intent of Greenleaf Electronics to defraud any pay television operator and we will not assist any company or individual in doing the same.

FM TRANSMITTERS! FUN PROJECTS! AND MORE!

PRICES SUBJECT TO CHANGE WITHOUT NOTICE



TOLL FREE ORDER LINE: 1-800-336-7389

FAX LINE: 1-602-731-4748

TECH SUPPORT NUMBER: 1-602-829-0755

XANDI ELECTRONICS, INC.

YOUR MANUFACTURER OF HIGH QUALITY KITS!

143.775 MHz CRYSTAL CONTROLLED TRANSMITTER KITS



XTR300EZ \$79.95
XTL3000EZ \$99.95
XTL1000EZ \$69.95

XTR300 TRACKING TRANSMITTER KIT
Transmits continuous beep-beep-beep
Ideal for locating lost or stolen items
Range up to 1 mile

XTL3000 LONG RANGE TRANSMITTER KIT
Sensitive built in microphone
Range up to 1 mile
Custom frequencies available

XTL1000 TRANSMITTER KIT
Sensitive built in microphone
Range up to 1/2 mile
Custom frequencies available

CRYSTAL TRANSMITTER KITS

- Ultra-miniature surface mount construction.
- E-Z kit approach makes assembly a snap.
- Miniature battery and holder will mount directly to the circuit board.
- Transmit to any scanner type receiver

BUG DETECTOR

XBD500
\$129.95

- Professional quality.
- Assembly is a snap.
- Covers 1 to 2,000MHz.
- Uses new Microwave Integrated Circuit amplifier.
- Adjustable sensitivity.
- Audio jack for privacy ear phone.



Any intercepted signal causes an audio tone that increases from a low pitched growl to a high pitched squeal as the signal strength increases.

88-108 MHz FM RECEIVER

XMR2000
\$29.95

- World's smallest FM radio.
- As small as a hearing aid.
- Weighs less than 1/4 oz.
- Digital touch tuning.
- Ideal for use with our 88-108MHz FM transmitters



88-108 MHz FM TRANSMITTER KITS



XST 500EZ \$49.95
XWB 1000EZ \$46.95
XFM 100C \$21.95

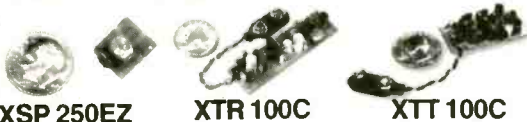

XSP 250EZ \$34.95
XTR 100C \$29.95
XTT 100C \$19.95

XST 500 Voice transmitter. Range up to 1 mile. Supersensitive mic. Uses 9 volt battery. Uses surface mount components.

XWB 1000 Voice transmitter. Range up to 1/2 mile. Includes mic and battery on circuit board. Uses surface mount components.

XFM 100 Voice transmitter. Range up to 1 mile. 9 v battery and leaded components.

XSP 250 Super-miniature telephone transmitter. Range 1/4 mile. Powered by phone line. Uses surface mount component.

XTR 100 Tracking transmitter. Range up to 1 mile. Uses 9 volt battery. Transmits a BEEP - BEEP - BEEP tone

XTT 100 Telephone transmitter. Range up to 1 mile. Uses 9 volt battery.

NEW!!



XPC 200 PIN HOLE CAMERA
400 LINE RESOLUTION
● Audio and Video outputs.
● See entire room through pin sized hole.
● Use with any TV or VCR with audio & video input connectors.
● Other models available.
Assembled \$169.95



XVS100 TV TRANSMITTER
● Use with XVC200, VCR, Camcorder, etc.
● Power cube included.
● Uses VHF TV Band.
● Transmits video & audio.
● Up to 100 foot range.
E-Z Kit \$29.95

"THE ENFORCER"!

NEW!



XXE-1000
as a kit \$39.95
assembled \$49.95

Use it to test radar detectors in other cars from your own vehicle! 10.450 to 10.550 GHz hand held transmitter. Extra high output level. Includes an input connector for keyed amateur band operation.

PHONE VOICE CHANGER KIT

16 levels of digital voice changing. Sound tougher, older or younger, female or male.

NEW!!

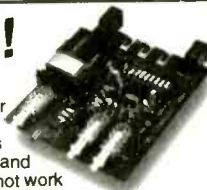

Works with regular or multi-line phones. Connects between handset and phone. Note: will not work with cordless or cellular type telephones.

XVC-2005C
\$59.95

XANDI ADVANCED HOBBY KITS



XPS 1000C
\$55.95
TELEPHONE SNOOP KIT
● Dial home from anywhere and hear inside your home.
● TouchTone coded for secure operation.
● Stop burglars and intruders.
● Reliable 24 hour protection.



XLC 900C
\$49.95
SCANNER CONVERTER KIT(800-950MHZ)
● Uninterrupted coverage of the 800 to 950 MHz band.
● Works with any 400-550MHz scanner.
● Gain: 6 dB typical.
● Noise figure: 3 dB typical.



XVA 250C
\$49.95
VOICE-STRESS ANALYZER KIT
● See at a glance if your being lied to!
● Subject need not be present. Works with voices from recordings, TV or radio.
● Has built-in microphone.
● Easy to use LED display output.



XFS 108C
\$39.95
88-108 MHz FM STEREO TRANSMITTER KIT
● Separate level control for both left and right channels.
● Output level circuit with test points for quick and easy tuning.
● Transmit from any stereo audio source to most any FM stereo receiver.

Serving the public since 1981

XANDI ELECTRONICS, INC.
1270 E Broadway Rd. # 113
Tempe AZ 85282

WE ACCEPT CHECK, VISA, MC, MO, COD
SHIPPING & HANDLING EXTRA



CALL FOR YOUR FREE CATALOG

SEND MAIL ORDERS TO:
XANDI ELECTRONICS, INC.
BOX 25647
TEMPE, AZ 85285-5647

CIRCLE 134 ON FREE INFORMATION CARD

Our Complete Catalog is now online

http://www.cir.com

CIRCUIT SPECIALISTS INC.

Check Out What We Have To Offer:

Fantastic DMM Offer!!!

Don't let the price fool you. This meter is a digital multimeter designed for engineers and hobbyists. Equipped with 5 functions and 19 ranges. Each test position is quickly and easily selected with a simple turn of the FUNCTION/RANGE selector rotary switch.



Our Best Offer Ever on a High Quality Full Sized DMM

\$19.00 any qty

General Rubber Boot Included

Display: 3-1/2 Digit LCD. 21mm Figure Height with Automatic Polarity

Overrange Indication: 3 Least Significant Digits Blank

Temperature for Guaranteed Accuracy: 23°C±5°C RH<75%

Temperature Ranges:

Operating: 0°C to 40°C (32°F to 104°F)
Storage: -10°C to 50°C (14°F to 122°F)

Power: 9V Alkaline or Carbon-Zinc Battery (NEDA 1604)

Low Battery Indication: BAT on Left of LCD Display

Dimensions: 188mm long x 87mm wide x 33mm thick

Net Weight: 400g

DC Voltage (DCV)

Range: Resolution: Accuracy:

200mV 100µV
2000mV 1mV ±(1%rdg+2dpts)
20V 10mV
200V 100mV
1000V 1V

Maximum Allowable Input: 1000V DC or Peak AC.

DC Current (DCA)

Range: Resolution: Accuracy:

200µA 100nA
2000µA 1µA ±(1.2%rdg+2dpts)
20mA 10µA
200mA 100µA
10A 10mA ±(1.2%rdg+2dpts)

Overload Protection: mA Input: 2A/250V fuse.

AC Voltage (ACV)

Range: Resolution: Accuracy:

200V 100mV ±(1.2%rdg+10dpts)
750V 1V

Frequency Range: 45Hz-450Hz

Maximum Allowable Input: 750V rms

Response: Average Responding. Calibrated in rms of a Sine Wave.

CAT NO	DESCRIPTION	PRICE
9300G	Rugged High Quality DMM with Rubber Boot	\$19.00

Switchable Scope Probe Sets

(Selectable X1/Ref/X10) These high quality scope probe sets are for oscilloscopes up to 60MHz (model HP 9060) or 50MHz (model HP9150). Both sets include a handy storage pouch and include an IC test-hook adapter for the probe. The BNC connector rotates to avoid cable tangle or kink. Cable length is 1.4 meters.

CAT NO	DESCRIPTION	1	10	100
HP-9060	Scope Probe Set DC~60MHz	\$16.49	\$14.49	\$11.58
HP-9150	Scope Probe Set DC~150MHz	24.95	21.95	18.62

Etching Chemicals/Ferric Chloride

A dry concentrate that mixes with water to make 1 pint of etchant, enough to etch 400 sq. inches of 1oz board.

CAT NO	DESCRIPTION	1	5
ER-3	Makes 1 pint	\$3.50	\$2.75



Positive Photo Resist Pre-Sensitized Printed Circuit Boards

These pre-sensitized printed circuit boards are ideal for small production runs. They provide high resolution and excellent line width control. High sensitive positive resist coated on 1oz. copper foil allows you to go direct from your computer plot or art work layout. No need to reverse art.

CAT NO	DESCRIPTION	PRICE EACH		
		1	10	50
PP101	100mm x 150mm/3.91" x 5.91"	\$2.55	\$1.90	\$1.70
PP114	114mm x 165mm/4.6" x 6.6"	2.98	2.45	1.98
PP152	150mm x 250mm/5.91" x 9.84"	5.40	3.98	3.60
PP153	150mm x 300mm/5.91" x 11.81"	6.15	4.48	4.10
PP1212	305mm x 305mm/12" x 12" NEW!	12.78	10.65	8.52

CAT NO	DESCRIPTION	PRICE EACH		
		1	10	50
GS101	100mm x 150mm/3.91" x 5.91"	\$ 3.90	\$2.98	\$2.60
GS114	114mm x 165mm/4.6" x 6.6"	4.80	3.49	3.20
GS152	150mm x 250mm/5.91" x 9.84"	8.69	5.98	5.78
GS153	150mm x 300mm/5.91" x 11.81"	10.20	7.20	6.80
GS1212	305mm x 305mm/12" x 12" NEW!	18.88	15.73	12.59

CAT NO	DESCRIPTION	PRICE EACH		
		1	10	50
GD101	100mm x 150mm/3.91" x 5.91"	\$ 5.07	\$3.68	\$3.38
GD114	114mm x 165mm/4.6" x 6.6"	5.95	4.29	3.99
GD152	150mm x 250mm/5.91" x 9.84"	10.47	7.39	6.98
GD153	150mm x 300mm/5.91" x 11.81"	11.95	8.69	8.30
GD1212	305mm x 305mm/12" x 12" NEW!	22.09	18.35	14.68



Developer This product is used as the developer on our positive photo-resist printed circuit boards. Includes instructions. 50 gram package, mixes with water, makes 1 quart.

CAT NO	DESCRIPTION	PRICE EACH		
		1	10	25
POSDEV	Positive Developer	\$.95	\$.80	\$.50



Etching Tank This handy etching system will handle PC boards up to 8" x 9", two at a time. Ideal for etching your PCB's! System includes an air pump for etchant agitation, a thermostatically controlled heater for keeping etchant at optimum temperature and a tank that holds 1.35 gallons of etchant. A tight fitting lid is also supplied to prevent evaporation when system is not being used. Typical etching time is reduced to 4 minutes on 1oz. copper board!

REDUCES ETCHING TIME!	CAT NO	DESCRIPTION	PRICE
			12-700
		Etch Tank System	\$37.95

Removeable Hard Drive Racks

The ideal solution for protecting highly sensitive data. Or, buy one computer and allow individual users to keep their hard drive with their own applications and set-ups. Just turn the system off, lift the handle and the hard drive pops right out. Key lock included to avoid accidental or unauthorized removal. Includes hard drive activity LED's. Rack includes mounting hardware, keylock, front panel LED, convenient pull out handle. Made from high impact ABS plastic. Fits in 5.25" bay.



Features: • Ideal for Hard Drive Portability • Solve Software Data Security Issues • Carry Your Hard Drive Between Home and Office • Each User Can Have His or Her Personal Hard Drive

CAT NO	DESCRIPTION	PRICE
SpecialHDRACK-IDE	For IDE Hard Drive	\$14.95

SEE OUR ON-LINE CATALOG AT
www.cir.com

Digital Panel Meters (LCD & LED)

Don't let the prices fool you. These digital panel meters are not surplus, so even if you design them into an ongoing manufactured product, you can be assured of continued availability. These high quality digital panel meters are decimal point selectable with guaranteed zero reading at zero volts input.

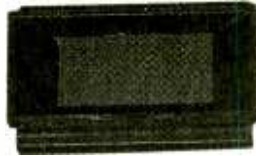

3-1/2 Digit LCD 3-1/2 Digit LED 4-1/2 Digit LCD PM-328: 4-1/2 Digit LCD Digital Panel Meter

Features

- 200.00mV Full Scale Input Sensitivity
- Single 9V DC Operation
- Decimal Point Selectable
- 11mm LCD Figure Height
- Automatic Polarity Indication
- Low Battery Detection and Indication
- High Input Impedance (>100 Mohm)

Specifications - PM-328

Maximum Input	: 199.99mV DC
Maximum Display	: 19999 counts (4-1/2 Digits) w/Automatic Polarity Indication
Indication Method	: LCD Display
Overrange Indication	: "1" Shown in the Display
Input Impedance	: >100 Mohm
Accuracy	: +/-0.05% (23+-5°C, <80% RH)
Power Dissipation	: 1mA DC
Decimal Point	: Selectable w/Wire Jumper
Supply Voltage	: 9V DC
Size	: 67mm x 44mm

Applications Include:

- Voltmeter
- Thermometer
- pH Meter
- dB Meter
- Watt Meter
- Current Meter
- Capacitance Meter
- LUX Meter
- LCR Meter
- Other Industrial & Domestic Uses

PM-128: 3-1/2 Digit LCD Digital Panel Meter

PM-129: 3-1/2 Digit LED Digital Panel Meter

Features

- 200mV Full Scale Input Sensitivity
- PM-128 - Single 9VDC Operation
- PM-129 - Single 9VDC Operation
- Decimal Point Selectable
- PM-128 - 13mm Figure Height
- Automatic Polarity Indication
- Guaranteed Zero Reading for 0 Volt Input
- High Input Impedance (>100Mohm)

Specifications - PM-128/PM-129

Maximum Input	: 199.9mV DC
Maximum Display	: 1999 counts (3-1/2 Digits) w/Automatic Polarity Indication
Indication Method	: PM-128 - LCD Display PM-129 - LED Display
Measuring Method	: Dual-Slope Integration A/D Converter System
Overrange Indication	: "1" Shown in the Display
Reading Rate Time	: 2-3 Readings per sec.
Input Impedance	: >100 Mohm
Accuracy	: +/-0.5% (23+-5°C, <80% RH)
Power Dissipation	: PM-128 - 1mA DC PM-129 - 60mA DC
Decimal Point	: Selectable w/Wire Jumper
Supply Voltage	: PM-128 - 9V DC PM-129 - 9V DC
Size	: 67mm x 44mm

AS LOW AS \$5.25 ea.

CAT NO	DESCRIPTION	PRICE EACH				
		1	10	25	100	250
PM-128	3-1/2 Digit LCD Panel Meter	\$ 9.90	\$ 7.09	\$ 6.40	\$ 5.86	\$ 5.25
PM-129	3-1/2 Digit LED Panel Meter	11.49	9.54	8.67	7.95	6.95
PM-328	4-1/2 Digit LCD Panel Meter	19.88	16.40	14.90	13.66	11.93



Ball Bearing 12V DC Fans These High Quality Fans feature Ball Bearings and Brushless DC Motors. All of them are designed to meet UL, CSA & VDE Standards. Design these fans into power supplies, computers or other equipment requiring additional air flows for heat removal. These fans are regular Circuit Specialists stock items — they are not surplus.

INDUSTRY BEST PRICING!

CAT NO	DIMENSIONS (MM)	RATED VOLTAGE (V)	START VOLTAGE (V)	INPUT CURRENT (A)	AIR FLOW (CFM)	STATIC PRESSURE (INCH-H ₂ O)	PRICE EACH			WEIGHT (g)
							1	10	25	
CSD 4010-12	40x40x10mm	12	7	0.06	5.1	0.19	5,500	26	20	
CSD 6025-12	60x60x25mm	12	5	0.13	13.7	0.165	4,500	28	65	
CSD 8025-12	80x80x25mm	12	5	0.16	37.8	0.177	3,000	31	80	
CSD 9225-12	92x92x25mm	12	5	0.32	42	0.18	2,800	37	95	
CSD 1225-12	120x120x25mm	12	5	0.35	62	0.180	2,500	42	135	

- SOLDER • SOLDER • SOLDER
- SOLDER • SOLDER • SOLDER

We stock high quality 60/40(Sn%/Pb%), .031" and 63/37, .031" diameter. This is prime JIS certified solder that we maintain as a regular stock item (It is not "Left-overs, Rejects or Surplus") and you can buy it from us at a fraction of the price that you are used to.



CAT NO	DESCRIPTION	PRICE EACH		
		1	10	25
RH60-1	1-lb. Spool, .031", 60/40	\$ 6.90	\$ 5.96	\$ 5.30
RH63-1	1-lb. Spool, .031", 63/37	6.95	6.10	5.41
RH60-4	4.4-lb. Spool, .031", 60/40	24.00	21.90	17.92
RH60-TUBE	6-oz. Tube, .031", 60/40	.99	.89	.79

CAT NO	DESCRIPTION	PRICE EACH	
		1	5
CA-H34A	PCB Mounted IRCCD Camera	\$99.00	\$85.00
A34	Power Supply Regulating Kit	\$6.95	---

CCD Camera - IR Responsive As Low As \$85!!

This black and white monochrome CCD Camera is totally contained on a PCB (70mm x 46mm). The lens is the tallest component on the board (27mm high from the back of the PCB) and it works with light as low as 0.1 lux. It is IR Responsive for use in total darkness. It comes with six IR LED's on board. It connects to any standard monitor, AUX or video input on a VCR or through a video modulator to a TV. Works with a REGULATED 12V power supply (11V-13V). Hooks up by connecting three wires: red to 12V, black to ground (power & video) and brown to video signal output.



Power Supply Regulating Kit for CA-H34 This simple kit is designed to fit onto the back of the CA-H34 CCD camera. It resolves the problem of hooking up the camera to an UNREGULATED supply (which damages the camera) by providing safe regulated power from any 12V-14V DC supply. It also provides regulated 12V DC from a 12V AC source.

SEE OUR ON-LINE CATALOG AT www.cir.com

CIRCUIT SPECIALISTS, INC.

SINCE 1971

800-811-5203

602-464-2485

602-464-5824 (FAX)

WE ACCEPT:



RECEIVE OUR LATEST 132 PAGE CATALOG!

It's chock full of all types of electronic equipment and supplies. We've got I.C.'s, capacitors, resistors, pots, inductors, test equipment, breadboarding supplies, PC supplies, industrial computers, data acquisition products, personal computers and computer parts, plus much, much more. FAX us your name and address or call 800-811-5203, ext. 5, to leave a message on our catalog request line.



**Why rent your
cable box?
You can buy your own
for as little as...**

\$25

Call for prices on...

**Zenith
Jerrold
Tocom
Pioneer
Scientific Atlanta
Pioneer**

KABLEWORKS

Your #1 source for
unmodified cable TV
converters & accessories!

**CALL
1-800-899-5000
TO ORDER!**

Radiotelephone - Radiotelegraph

FCC Commercial
License

Why Take Chances?

Discover how easy it is to pass the exams. Study with the most current materials available. Our Homestudy Guides, Audio, Video or PC "Q&A" pools make it so fast, easy and inexpensive. No college or experience needed. The new commercial FCC exams have been revised, covering updated Aviation, Marine, Radar, Microwave, New Rules & Regs, Digital Circuitry & more. We feature the Popular "Complete Electronic Career Guide" 1000's of satisfied customers

Guarantee to pass or money back.

Send for **FREE DETAILS** or call

1-800-800-7588

WPT Publications
4701 N.E. 47th Street
Vancouver, WA 98661

Name _____

Address _____

City _____ St. _____ Zip _____

1-800-800-7588

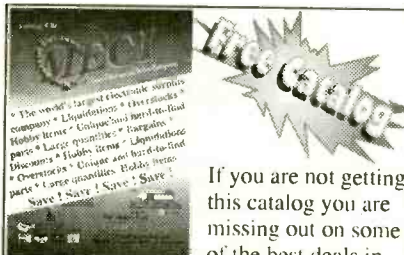

If you are not getting this catalog you are missing out on some of the best deals in electronics today! We have thousands of items ranging from unique, hard-to-find parts to standard production components. Call, write, or fax today to start your free subscription to the most unique catalog in the industry, filled with super values on surplus electronic and hobbyist type items. If you have a friend who would like to receive our catalog, send us their name and address and we will gladly forward them a complimentary 100 page catalog.

Why pay more? Call today.



340 East First Street Fax Order Line
Dayton, Ohio 45402 1-800-344-6324

**Order Toll-Free
1-800-344-4465**

CIRCLE 147 ON FREE INFORMATION CARD

**WE HAVE IT ALL!
Surveillance**

**Infinity Transmitters
FM Wireless Transmitter Kits
Vehicle Tracking Systems
Bug Detectors • Caller I.D.
Telephone Register with Printer
Long-play Recorders
Wired Mikes • Shotgun Mikes
Telephone Recording Adapters
Alcohol Testers • Drug Testers
Telephone Scramblers
Hidden Video Cameras
Telephone Tap Detectors
MUCH, MUCH, MUCH MORE.**

Our 27th Year!

Small catalog FREE. Larger catalog send \$5.
Mail Order only. Visa, MasterCard and
C.O.D. accepted for equipment only.
Inquire for dealers' prices.

A.M.C. SALES, INC.

193 Vaquero Dr. • Boulder, CO 80303

Mon.-Fri. 8 a.m.-5 p.m. Mtn. Time

800-926-2488

(303) 499-5405 • Fax (303) 494-4924

Internet: [http://www.siteleader.com/
catalogdepot/AMCSC-home.html](http://www.siteleader.com/catalogdepot/AMCSC-home.html)

E-mail: amc-sales@siteleader.com

MONDO • TRONICS

**ROBOT
STORE**

*** KITS ***

Your

*** BOOKS ***

Mailorder

*** PARTS ***

Source

*** VIDEOS ***

For

*** MODELS ***

Robots!

*** MORE! ***

(REQUEST OUR FREE CATALOG)

www.robotstore.com

800-374-5764

Or write to us:

524 San Anselmo Ave #107-129

San Anselmo CA 94960

Phone 415-455-9330

Fax 415-455-9333

Email info@mondo.com

DALBANI

PLEASE MENTION **CODE PE97** WHEN ORDERING
 Items are subject to availability. Prices are subject to change without any prior notice.

ORIGINAL JVC OPTICAL PICK-UP ASSEMBLY
 • Optima-6s
 Order N° 46-2705

\$53.80



\$20 MINIMUM ORDER
 CALL NOW FOR YOUR FREE CATALOG
1-800-325-2264

30 WATTS PENCIL SOLDERING IRON
 • 30 Watts Power
 • Bakelite Construction • 1/8" Tip
 Order N° 51-1055

\$3.65



HOT PRICES ON POPULAR SEMI'S

Order #	Brand	Min Price
BU-208	TESLA	10 \$1.49
BU-208/O	TOSHIBA	1 3.49
2N-3055	TESLA	10 0.29
2N-3773	TESLA	5 1.20
2SD-1398	SANYO	10 1.39
2SD-1650	SANYO	5 0.99
STR-30130	SANKEN	1 2.66
TA-7777N	TOSHIBA	1 5.25
TDA-2005	SGS	5 1.49

SOLDER PASTE
 • For soldering and tinning
 • net/content 50g
 Order N° 51-1920

92¢



Over 30,000 items to choose from

Semiconductors	Headphones	Tuners
Security Product	Cleaning kits	Triplers
Cellular Accessories	Telephones	Idle Tires
Educational Video	Connectors	Flybacks
Power Products	CATV/MATV	Lanterns
Remote Controls	Terminal	Pinch Rollers
Cable assembly	Switches	Clips & Ties
VCR Heads	Speakers	Multimeters
Power Supplies	Boombox	Chemicals
Soldering tools	Resistors	Antennas
Educational kits	Batteries	Microphones
Frequency Counters	Fuses	Capacitors
Car Audio Accessories	Tools	And many more
Microwave Accessories	Idlers	
Telephone Accessories	Belts	

DALBANI ITALY 17

CALL TOLL FREE 1-800-325-2264 **\$3.95**

UNIQUE REALTIME OSCILLOSCOPE BUILT-IN FUNCTION GENERATOR 2-CH DUAL TRACE 1 MHZ FUNCTION GENERATOR



Features: • Wider than specified frequency response • High deflection factor of 1mV/div. • Wide dynamic range up to 30MHz without waveform distortion • Algebraic sum of CH1 and CH2 • Low drift with compensation circuit • Superb trigger sensitivity • Maximum sweep rate of video signals with Internal TV sync. separator • Jitterless trigger circuitry • CH1 signal output terminal available • Variable trigger hold-off • High precision X-Y phase difference measurement up to 50kHz • Built-in function generator with BNC output of 50Ω and TTL • Three kinds of waveform are available with 50Ω output • Flat output waveform frequency up to 1MHz

Specifications: **Vertical deflection:** • Bandwidth: DC coupled (DC to 20MHz normal), AC coupled: (10Hz to 20MHz normal) • Deflection factor: 5mV/div to 5V/div in 10 calibrated steps of 1-2-5 sequence • Rise time: 17.5ns or less

Horizontal deflection: • Time Base A: 0.2μs to 0.2S/div in 19 calibrated steps. 1-2-5 sequence • Uncalibrated continuous control between steps of at least 1: 2.5.

20 MHZ
 Manuf # OS-9020G
\$450.00

The most popular VCR ALIGNMENT TOOL KIT

- VCR Head pulley
- Retaining ringremover
- Spring hook
- Micro screwdriver
- Hex key set
- Fitted vinyl
- Soft zippered case
- 7 Assorted head & guide aligners
- Dimensions: 9 1/2"(W) X 12 1/4"(L)
- 3 Reversible screwdrivers (Small-Flat-Fillips)

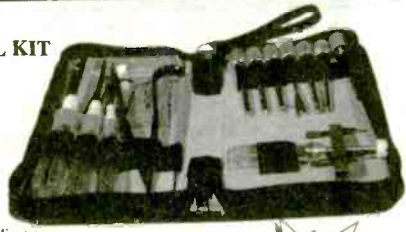

\$24.99

Order N° 50-888

Order N° 50-820

UNIVERSAL AUDIO/VIDEO REMOTE

- Controls basic functions of TV, VCR, cable box, and CD or laser player
- Ergonomic design! Main buttons are in line with natural thumb motion • Two-minute memory allows time to replace batteries without reprogramming • Programming reminder sticker inside battery compartment • Sleep time for 80, 30, or 15 minutes (according to your TV) • Set key recessed to prevent accidental deprogramming • Requires four AAA Batteries (not included)

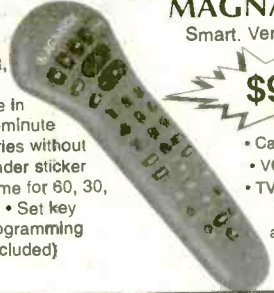

MAGNAVOX
 Smart. Very smart

\$9.95

- Cable (11 brands)
- VCR (68 brands)
- TV (77 brands)
- Compact disc and Laser Disc (94 brands)

Order N° 82-1055

DIGITAL MULTIMETERS DALCO

- Overload protect 1000V DC or peak AC on all other ranges • Input Impedance 10MΩ on all ranges • Base accuracy range ± 0.5 % to ± 1.0 % • Resistance 200Ω, 2K, 20K, 200K, 2M, 20M • Audible continuity response lower than 50Ω • DC Voltage 200mV, 2V, 20V, 200V, 1000VAC Voltage 200mV, 2V, 20V, 200V, 700V • Dim. : 6.75"(H) x 3.33"(W) x 1.15"(D)



\$19.95

Order N° 50-850

TUN-O-WASH (12.5 Oz aerosol)

- Fast drying electronics grade cleaner for tuners, controls and PC boards.**
- Designed for cleaning and degreasing consumer electronics
 - Cleans in one step, no rinsing required • Contains no ozone depleting compounds HCFC free • Not for use on energized equipment • CFC and

\$7.50

Order N° 30-0100



FLYBACK TRANSFORMERS

Replaces GOLDSTAR 154-074R

\$14.50

Order N° 63-850



TEMPERATURE CONTROLLED SOLDERING STATION

- Voltage Input: AC 110V (or 220V) 50 Hz/ 60 Hz • Power Consumption: 35 W
- Operating Voltage: AC 24V Warm-Up Time: 40 sec. • Ceramic Heater Element
- Temperature Indicator °C
- Digital LED Display • Heat Sensor At Element Tip • Controlled range from 150° To 420°C Fused Circuit • Low Power High Effectiveness-Compare with the majority it requires only 1/2 of electricity low consumption

DALCO Digital Auto-Temp
\$79.00

Order N° 51-1000

6-PIECES PRECISION SCREWDRIVER SET

- Three flat head : 2.4x75mm, 3x100mm, 3.8x150mm
- Three Phillips : No. 0x75mm, No. 1x100mm, No. 1x150mm
- A screwdriver with three sections, precision production with long life to be used
- Available for fixing and combination of computer TB set, communicated instrument, ratio, camera, glasses, clock, watch and kinds of precision units.

\$5.95

Order N° 50-1040

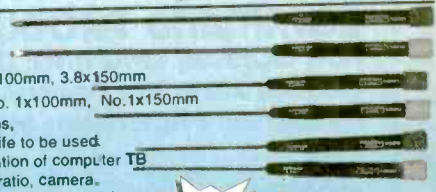

New

EARN MORE MONEY!

Be an FCC LICENSED ELECTRONIC TECHNICIAN!



No costly school. No commuting to class. The Original Home-Study course prepares you for the "FCC Commercial Radio-telephone License." This valuable license is your professional "ticket" to thousands of exciting jobs in Communications, Radio-TV, Microwave, Maritime, Radar, Avionics and more...even start your own business! You don't need a college degree to qualify, but you do need an FCC License.

No Need to Quit Your Job or Go To School
This proven course is easy, fast and low cost! **GUARANTEED PASS**—You get your FCC License or money refunded. **Send for FREE facts now. MAIL COUPON TODAY!**

Or, Call 1-800-932-4268 Ext. 240

COMMAND PRODUCTIONS

FCC LICENSE TRAINING, Dept. 240
P.O. Box 2824, San Francisco, CA 94126
Please rush FREE details immediately!

NAME _____
ADDRESS _____
CITY _____ STATE _____ ZIP _____

CONTROL MEASURE INPUT

RELAYS • LIGHTS • MOTORS
TEMPERATURE • PRESSURE • LIGHT LEVELS • HUMIDITY
SWITCH POSITIONS • THERMOSTATS • LIQUID LEVELS

MODEL 30 \$79



- PLUGS INTO PC BUS
- 24 LINES DIGITAL I/O
- 8 CHANNEL
- 8 BIT A/D IN
- 12 BIT COUNTER
- UP TO 14K SAMP/SEC

MODEL 45 \$189



- RS-232 INTERFACE
- 8 DIGITAL I/O
- 8 ANALOG INPUTS
- 2 ANALOG OUTPUTS
- 2 COUNTERS-24 BIT

MODEL 100 \$279



- 12 BIT 900 KHZ A/D
- 4 ANALOG OUTPUTS
- 3 TIMER COUNTERS
- 24 DIGITAL I/O

MODEL 60 \$179



- 8 2-AMP RELAYS
- 16 DIGITAL I/O
- 1 8-BIT ANALOG INPUT

MODEL 40 \$109



- RS-232 INTERFACE
- 28 LINES DIGITAL I/O
- 8 ANALOG INPUTS
- PWM OUTPUT
- OPTIONAL 12 BIT A/D

MODEL 70 \$239



- RS-232 INTERFACE
- 16 BIT A/D
- 8.5 DIGIT
- UP TO 60 SAMP/SEC

NEED A CUSTOM PCB? TRY US.

PRAIRIE DIGITAL, INC.

PHONE 608-643-8599 • FAX 608-643-6754
920 SEVENTEENTH STREET • PRAIRIE DU SAC, WISCONSIN 53578

CIRCLE 45 ON FREE INFORMATION CARD

Don't rent! Own!

Cable TV

Descramblers

We'll Beat Any Price!

- Same Day Shipping!
- 30 Day Money Back Guarantee!
- Credit Cards/C.O.D.
- One Year Warranty!

Have make and model number of equipment used in your area
REPLACEMENTS FOR MOST SYSTEMS

CALL TOLL FREE

CD Electronics

1-800-684-9135

NO NEW JERSEY SALES!

Anyone implying theft of service will be denied assistance.

AMAZING ELECTRONIC & SCIENTIFIC DEVICES

Lasers, Tesla, Ions, Anti-Gravity, Magnetics & More!

Plans • Ready-to-Use • Easy-to-Build Kits

Laser Ray Gun
Handheld, battery operated. Produces an intense burst of light capable of burning holes.
LAGUN2 Plans \$20.00
LAGUN2K Kit / Plans Price on Req



250KV Tesla Coil
10-14" of Explosive Bolts of Lightning!
• Transmit Wireless Energy
• Ion Motors
• Anti-Gravity
• Strange and bizarre pyrotechnical effects
• Many other experiments shown in detail
• Award winning science project!

BTC3 Plans \$15.00
BTC3K Kit/Plans with coil \$299.50
BTC30 Assbl'd Ready to Use \$399.50
BTC4 Plans, 500KV unit \$20.00



ATTENTION: Experimenters & Researchers!
Anti-Gravity, Rail & Coil Guns, Mass Warping, Levitation Research, Exploding Water, Propulsion Drivers, Lattice Snapping, EMP etc. Loss-less Energy Charger with triggered spark switch. • Adjustable 500 to 3KV out
• Charges up to 25KJ • Programmable Output

HEP1 Plans \$15.00
HEP1K Kit/Plans with 500J \$399.50
HEP10 Lab Assembled - to your specs. Write, call or fax for price & delivery



...shown connected to potential rail gun system

Visible Beam Gas Lasers
Millions degree temp equiv. Illuminates low level clouds
• Light Shows
• Window Listener
• Optical Projects
• 12/115V
• Science Project

LAS1KM 1 mw, low cost Kit \$69.50
LGU6K 2-3mw Kit \$119.50
HNE70 5-7mw, ready to use \$299.50



Gravity Generator
Levitate an object! Great science fair project!

GRA1 Plans \$15.00
GRA1K Power Supply Kit/Plans ... \$99.50
GRA10 Assbl'd Kit/Plans \$149.50
Includes text book on Anti-Gravity theory!



Solid State Tesla Coil
• Generate fiery electrical plasma discharge
• Powers light and objects without contact
• Experiment with electrical and mechanical fields. TCL5 Plans \$399.50
TCL5K Kit/Plans 12VDC \$49.50



Pioneer a Futuristic Weapon!
Electric Gun - prototype designed in our lab - Join the research!
• Ballistic Velocities
• Handheld • Battery Operated
• Labelled as DANGEROUS Product
Experiment now before it is classified as a firearm! EGUN1 Plans \$20.00
(Must be 21 for purchase of hardware)



Ion Ray Gun
Project Energy! Star Wars technology demonstrates weapons potential. IOG7K Kit/Plans \$99.50



4000 Volts 10ma High Voltage Module - Ready to use - for many projects from hoverboards to pyrotechnics.
MINMAX4 While they last! \$19.50

"Talking" Plasma Globe
Spectacular color. Pulsates to music, sounds! 8-9", with intensity and sound controls. PLASMA1 Ready to Use . \$79.50



Electronic Hypnotizer *Caution Required*
Control their minds! Programmable audible and visual stimuli induces hypnotic trances. HYP2K Kit with Book \$39.95
EH2 Hypnosis Book & Plans \$14.95



We can design and build high voltage systems - to your specs!
Call or fax us with your requirements!

TACTICAL ELECTRONICS

Cybernetic Ear!
Enhances normal hearing 3-4 times!
Adjustable volume control, fits easily into either ear. Many, many uses.
Ready to Use!
CYBEREAR \$19.95



ALL NEW Telephone Line Grabber/Infinity Transmitter
Use tone phone anywhere in the world to:
• Monitor your premises - avoid break-ins
• Access ongoing calls - longwinded kids
• Control up to 8 appliances in your home!
• Re-direct costly toll calls from pay phones!
TELCON3 Plans (credit to purch) ... \$ 10.00
TELCON3K Plans/Kit \$99.50
TELCON30 Ready to Use \$149.50



Long Range "Ultra-Ear"
20" dish uses satellite technology to capture distant sounds. PMS5 Plans \$8.00
PMSK Kit/Plans \$149.50

Parabolic Mic can hear a distant whisper!
BUG Mother Nature!

• Optional Wireless Retrofit transmits captured sounds to an FM radio.
WMSK Kit for Wireless Option \$29.50



Phasor Sonic Blast Pistol
Rids areas of unwanted pests. Trains and conditions wild and domestic animals. Great for barns, attics, cellars, gardens.
PPP1K Kit/Plans \$39.50



3 Mi Telephone Xmitter
• Tune-able 80-130 Mhz • Undetectable
• Only transmits when phone is used
VWPM7K Kit/Plans \$39.50

3 Mi Voice Transmitter
• Ultra-Sensitive Mike
• Crystal Clear
• Tunes 80-130 MHz.
FMV1K Kit/Plans \$39.50



FireBall Gun
Shoots flaming ball - two shot capacity. Great for special effects and remote fire starting. CAUTION REQUIRED!
FIREBALL Plans (dangerous product) . \$10.00



Shocker Force Field/Vehicle Electrifier
Make hand and shock balls, shock wands and electrify objects. Great payback for those wiseguys!
SHK1K Easy to Assemble Kit \$19.50



Extended Play Telephone Taping System
• Tapes Phone Conversation • Extends Tape X4 • Check Local Laws before using!
TAP30X Ready to Use \$84.50



"Drop-In" (Imi) Telephone Transmitter
Easily tunable over FM radio. Never needs battery! #DROPIN Kit/Plans \$ 19.95



See in Total DARKNESS!
• High Quality IR Night Vision Scope with IR illuminator.
SD10 Ready to Use \$199.50



Electric Charge Gun
Life is Precious - PROTECT IT!
Stuns & immobilizes attackers 15 feet away! Check your state laws for legality. More knockdown power than most handguns. No permanent injury. ID coded.
ECG1 Data
(Creditable to purch) \$10.00
ECG10 Charge Gun, Ready to Use, includes FREE Stun Gun! \$249.50
STUN GUNS - sold separately:
STUN100 100,000 Volts \$34.50
STUN200 200,000 Volts \$49.50



3 Mi Tracker Transmitter
• Tunable Output
• Uses FM Radio
• Excellent Signal Beacon
HOD1K Kit/Plans \$39.50



MIND CONTROL!
Places subjects under your control. Programmable audible & visual stimuli with biofeedback, induces strange & bizarre hallucinations without drugs. Caution - not FDA approved.
MIND2 Plans \$15.00
MIND2K Kit and Plans \$49.50
MIND20 Assembled Unit \$69.50



FANTASTIC BRIGHTNESS!
High Quality Laser Pointer
LAPN64 15mw equiv, 2000' \$39.50
LAPN61 50mw equiv, 4000' \$84.50



Window Bounce Laser Listener
Aim at window and listen to sounds from reflected light. CAUTION - Not for illegal use. LWB3 Plans \$10.00
LWB3K Kit/Plans (req's vid tripod) \$149.50



1000' Potato Cannon
Not a Toy! Uses electronic or piezo ignition. CAUTION REQUIRED!
POT1 Plans (dangerous product) ... \$10.00



VISIT US ON THE WEB!
<http://www.amazing1.com>

INFORMATION UNLIMITED

Dept PEM-7, Box 716, Amherst, NH 03031
Phone: 603-673-4730 FAX: 603-672-5406
MC, VISA, COD, Checks accepted Please add \$5.00 S & H

CATALOG!
FREE with Order or send \$1 P&H

24 Hour Phone
800-221-1705
Orders Only Please!

ALL ELECTRONICS

C O R P O R A T I O N

QUALITY PARTS

FAST SHIPPING

DISCOUNT PRICING

CALL, WRITE, FAX
or E-MAIL For A
Free 96 Page
CATALOG.
Outside the U.S.A.
send \$3.00 postage.

NOTEBOOK COMPUTER CARRYING CASE

Great looking, padded carrying case, suitable for most notebook computers or similar equipment.



Black leatherette exterior with separate zippered compartment for papers or accessories. Detachable nylon web shoulder strap. Interior space is 13.5" X 9" X 2.5"

CAT # CSE-12 **\$9⁷⁵** each

AUTOMOBILE VOLTAGE CONVERTER

Run audio, communications and other battery operated devices from your car cigarette lighter. Regulated DC-DC converter supplies selectable voltages from 1.5 Vdc to 12 Vdc at up to 800 milliamperes.

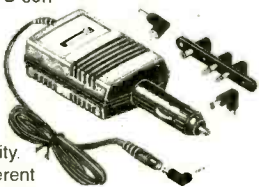

Adjustable polarity. Includes six different adapter plugs that fit most equipment.

CAT # APC-800 **\$4⁰⁰** each

MINIATURE SOLENOID

Bicon Electronics 3 - 5 vdc miniature solenoid with spring return.

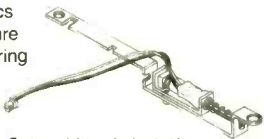

12 ohm coil. Suitable for intermittent use. Solenoid body is 0.9" x 0.27" x 0.31". Plunger extends 0.47". Mounted on 3.37" long bracket. 4" long leads.

CAT # SOL-45 **2 for \$1⁰⁰**



470 UF, 450 VOLT SNAP-IN CAPACITOR

Nichicon LGQ2W471MHSC 1.375" diameter x 2" high. 0.4" lead spacing.

\$4⁵⁰ each

CAT# EC-4745

10 for \$40.00

CHERRY D43 SNAP-ACTION SWITCH

S.P.D.T. snap-action switch with roller positioned above switch actuator. Rated 5 amps @ 125/250 vac. Switch body: 1.1" x 0.63" x 0.375". Solder or qc terminals. UL and CSA listed.



\$1²⁵ each

CAT# SMS-150

10 for \$10.00

SMALL NEODYMIUM RARE EARTH MAGNETS

Semi-circular, irregularly-shaped magnets. Shiny finish with a polarity marking dot. 0.93" long x 0.3" x 0.07" thick. Powerful for their size.



\$1⁰⁰ each

CAT# MAG-30

160 pcs. - \$100.00

"HI-8" VIDEO CASSETTE (USED)

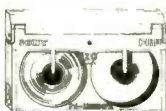

CAT # VCU-8

\$3⁰⁰ each

SONY Hi-8 Top quality, metal particle 120 minute video cassettes. Used for a short time, then bulk-erased. Each cassette has its own plastic storage box. Satisfaction Guaranteed.

10 for \$28.00
100 for \$250.00



410 UF, 300 VOLT PHOTOFLASH CAP.

Rubycon # 1A2304A 0.7" dia. X 1.7" long. Right angle PC or solder leads on 0.25" centers.

\$2⁰⁰ each

CAT# PPC-410

10 for \$18.50
200 for \$320.00

6-12 Vdc MOTOR

Mabuchi # RS-375S-16115 1.08" dia. x 1.75" long. 0.9" dia. shaft is 0.5" long. Solder terminals.



\$1⁷⁵ each

CAT# DCM-80

AUTOMOTIVE POWER CORD



3 foot wire. Cigarette lighter plug to 2.1mm co-ax plug, center positive polarity.

CAT# CLP-33

\$1⁵⁰ each

10 for \$12.50
100 for \$100.00

12 Vdc CPU FAN

Enertron# NX586-Q2Z-20 7 blade, mini 12 vdc fan on a heatsink. Assembly is 2" square X 1.22" high. Heatsink has a 0.87" square flat area on side opposite fan from which fins radiate. One fin extends 0.63" beyond the others. Includes two mounting clips.

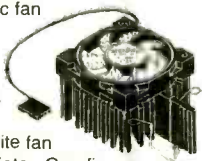

CAT # CF-40

\$6⁵⁰ each

ORDER TOLL FREE

1-800-826-5432

MAIL ORDERS TO:
ALL ELECTRONICS CORP.
P.O. BOX 567
VAN NUYS, CA 91408-0567

FAX (818) 781-2653 • INFO (818) 904-0524
INTERNET <http://www.allcorp.com/>
E-MAIL allcorp@allcorp.com

NO MINIMUM ORDER • All Orders Can Be Charged to Visa, Mastercard, American Express or Discover • Checks and Money Orders Accepted by Mail • Orders Delivered in the State of California must include California State Sales Tax • NO C.O.D. • Shipping and Handling \$5.00 for the 48 Continental United States - ALL OTHERS including Alaska, Hawaii, P.R. and Canada Must Pay Full Shipping • Quantities Limited • Prices Subject to change without notice.

MANUFACTURERS - We Purchase EXCESS INVENTORIES... Call, Write, E-MAIL or Fax YOUR LIST.



Our #1 Best-Selling Home Electronics Repair Manual

**FREE
30-DAY TRIAL**



WEKA'S GIANT 900-PAGE BIBLE OF **EASY ELECTRONICS REPAIR**

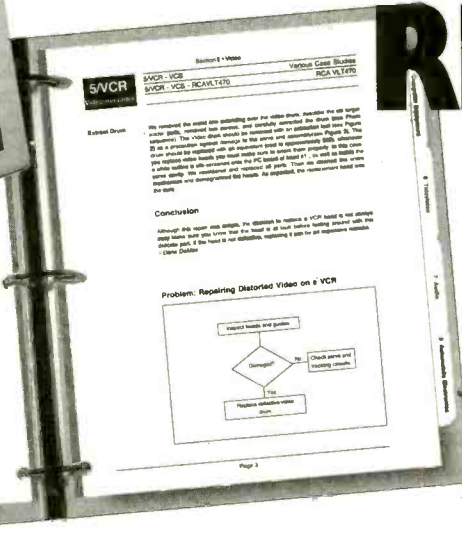

**SAVE
\$16⁵⁰**
when you enclose payment!

**FILLED WITH
Troubleshooting
Diagnostic Tips...
Step-By-Step "Model
Specific" Instructions...
Charts, Photos & Easy-
To-Follow Diagrams...
PLUS Directory Of
Parts Dealers!**

**ALL THE INSTRUCTIONS YOU NEED TO FIX
TVs, VCRs, STEREOS, CAMCORDERS, PHONES, CD PLAYERS, FAXES,
COMPUTERS, WALKMANS, AUTO RADIOS, VIDEO GAMES, & MORE!**

**Don't Waste Time & Money At Electronics Repair Shops!
NOW FIX IT YOURSELF FOR SAVINGS,
PROFIT... AND SATISFACTION!**

Now you don't have to be a professional technician to get PERFECT electronics repairs at home...at a fraction of repair shop costs! Whether you enjoy doing your own repairs or want an extra part-time income, this famous nationally advertised **WEKA ELECTRONICS REPAIR MANUAL** gives you easy-to-follow instructions for fixing nearly every electronic device you can think of...from popular manufacturers like SONY, RCA, IBM, NINTENDO and more! Plus, you get more than just easy instructions, YOU GET A FULL ELECTRONICS BIBLE that teaches you everything from basic

electronics principles to advanced troubleshooting and repairs!

UPDATED SUPPLEMENTS!

About 4-5 times a year, we'll send you updated 140-page repair supplements for all the newest electronic products available. Examine these supplements at home FREE for a full 30-days. If you decide to add them to your Manual, they're yours for just \$35.00 each plus shipping and handling. There's NO RISK, NO OBLIGATION! ORDER YOUR 900-PAGE ELECTRONICS REPAIR MANUAL NOW!

Yes, 900 Instruction-Filled Pages In Wipe-Clean Vinyl Binder!



- LOOSE-LEAF FORMAT!
- PAGES LIE FLAT!
- TABBED CHAPTER PAGES!
- PHOTOS, CHARTS, DIAGRAMS!
- EXPLODED VIEWS!
- STEP-BY-STEP FIXES!
- TROUBLESHOOTING INSTRUCTIONS!
- TEST EQUIPMENT PRIMER!
- SAFETY PRECAUTION CHECKLIST!
- ELECTRONICS REFERENCE GUIDE!
- PREVENTIVE MAINTENANCE TIPS!
- HOW TO USE TOOLS OF THE TRADE!
- MANUFACTURERS' DIRECTORY!
- PARTS SUPPLIERS!
- PLUS MUCH MORE!

CALL TOLL-FREE NOW FOR 30-DAY HOME TRIAL!

1-800-222-WEKA

FAX: 1-800-256-5915 E-MAIL: WEKA_Publishing@compuserve.com

WEKA PUBLISHING, INC., 1077 Bridgeport Ave.,
P.O. Box 886, Shelton, CT 06484

YES! Please rush my ELECTRONICS REPAIR MANUAL. I'll pay now by check or credit card and save \$10 off the regular price plus the \$6.50 shipping & handling! If I'm not 100% satisfied, I may return the book within 30 days for a full refund of the purchase price.

SAVE! Bill my credit card \$49.95.

VISA* MASTERCARD* Exp. Date

Account #

Signature

Phone

SAVE! My check is enclosed for \$49.95.

Add \$10.00 for EXPRESS DELIVERY guaranteed within 5 business days from receipt of order. (Prepaid U.S.A. orders only, no P.O. Boxes.)

Bill me later for the regular price of \$59.95 plus \$6.50 shipping & handling, subject to credit approval. Signature and phone number required to process your order. P.O. Box addresses must be prepaid.

Name

Company

Address

City State Zip

In Canada, please add \$10. Overseas orders add \$15 (foreign orders must be prepaid). U.S. funds only. CT residents add 6% sales tax. Supplements are just \$35 each plus shipping & handling. They will be sent 4-5 times a year on a fully-guaranteed, 30-day trial basis. They may be cancelled at any time.

33549

CIRCLE 319 ON FREE INFORMATION CARD

RS-232 Networkable Devices

Only 2 Wires are Required to Operate Most NCD Devices from a Single RS-232 Serial Port.



NEW: RS-232 programmable 240x64 Graphic Display Module. Upload your BMP/GIF Image Files at 9600/19200/38400/115200 Baud. Complete Support for 30x8 and 40x8 Text. Documentation and QBasic Software Gets You Running FAST!!! Counts as 2 Devices on the NCD RS-232 Network, use up to 8 GDSPs on a Single Serial Line. Many Price Options Available \$99-\$299.

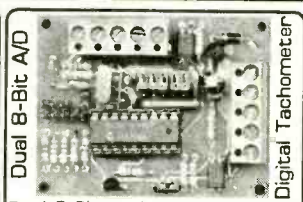

Dual 8-Bit A/D
Dual 8-Bit Analog Inputs, 3 Programmable Outputs, Pulse Width Mod, Period Measurement, Use as a Digital Tachometer: Optoisolated, RS-232 Networkable. Easy to Program. Requires \$12 RSB booster. NCD-ADB Kit \$34, Assembled \$49

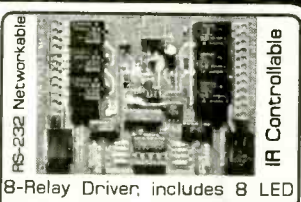

RS-232 Networkable IR Controllable
8-Relay Driver, includes 8 LED Status Lights. 12V Operation. Includes Infrared Receiver for Remote Operation. Attach 16 per serial port. With Omron Mechanical Relays. 4-Relay Model available. R85 (5A) Kit \$89 Asm \$139 R810 (10A) Kit \$109 Asm \$159

Includes Drivers in QBasic, Mac & Amiga Software Also Supported.

RS-232 Combine 16 Devices in ANY Combination to Your RS-232 Port

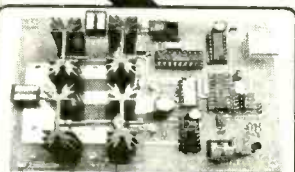

High-Power DC Motor Controller: 9-12 Volt Operation for Motors Up to 4 Amps. Forward/Reverse 64 Speeds. With Infrared Receiver. Hexfet H-Bridge Driver stage. NCD-M1 Kit \$89 Asm \$149



Audio/Video Switcher: 8 Inputs, 2 Outputs, Infrared Controllable, Routes Any Input to Any Output. 12-18 volt DC operation. For Low-Power (Line-Level) Signal Switching/ Routing of Most Analog Signals. AVSB Kit \$89 Asm \$139

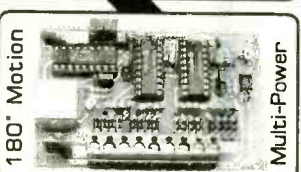

180° Motion Multi-Power
8/16 Hobby Servo Controller. Futaba-J Compatible, Infrared Receiver Included with SV16 upgrade. Designed for all animatronic applications. SV8 Kit \$39 Asm \$54 SV16 Upgd Kit \$19 Asm \$29

National Control Devices
Contact Ryan Sheldon
Phone: (404) 244-2432
FAX: (417) 646-8302
Include \$5 Shipping.
Visa/MC Accepted.
NCD, Box 384, Osceola, MO 64776

Infrared Transceiver for Remote RS-232 Communication with 16 IR Controllable Devices. IRTA Kit \$24 Asm \$39 RSB Serial Booster Gives your RS-232 Port the Power It Needs to Drive 16 NCD Devices. RSB Kit \$12 Asm \$24

On-Line Catalog: <http://members.aol.com/ncdcat/index.html> E-mail: ncdryan@aol.com

New and Pre-Owned Test Equipment

Goldstar

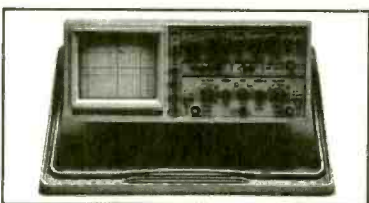

Model OS-9100P → **\$899.00**
Full 100 MHz Bandwidth!

- Dual-Channel, High Sensitivity
- TV Synchronization Trigger
- Calibrated Delayed Sweep
- Includes Two Probes, 2 Year Warranty

FREE SHIPPING!
ON GOLDSTAR EQUIPMENT
ANYWHERE IN THE U.S.
Excluding AK & HI

BK PRECISION
MAXTEC INTERNATIONAL CORP. Model 4040 \$499.00
20 MHz Sweep/Function Generator

- 0.2 Hz to 20 MHz, 5 digit LED Display
- AM & FM Internal or External Modulation
- Sine, Square, Triangle, TTL, CMOS Outputs
- Burst Operation
- External 30 MHz Frequency Counter

NEW!

Pre-Owned Oscilloscope Specials

B + K Precision 1476 10 MHz \$229.00
Great Starter Scope!

Tektronix 465	100 MHz	\$599.00
Tektronix 465B	100 MHz	\$699.00
Tektronix 475	200 MHz	\$799.00
Tektronix 475A	250 MHz	\$899.00

- The Industry Standard of Oscilloscopes
- Dual Channel, Calibrated Delayed Sweep
- Professionally Refurbished
- Aligned & Calibrated to Original Specifications
- 6 Month Warranty - The Longest Available!

LOWEST PRICES EVER!

NEW FLUKE MULTIMETERS & TEKTRONIX OSCILLOSCOPES

The Industry Standard in Multimeters

Fluke Model 87 ..\$285.00

TEKTRONIX TDS SERIES ON SALE!

See us on the Web!
www.fotronic.com

1-800-996-3837

Test Equipment Depot

A FOTRONIC CORPORATION COMPANY
P.O. BOX 708 Medford, MA 02155
(617) 665-1400 • FAX (617) 665-0780
email: afoti@fotronic.com

VISA MasterCard AMEX C.O.D. **TOLL FREE 1-800-99-METER**

NOW MAKE AN EXTRA \$600 PART TIME WEEKENDS -- UP TO \$2,000 A WEEK FULL TIME IN Explosive SATELLITE DISH TV/ELECTRONICS FIELD!

Hottest Career Opportunity Since Invention of the VCR!

See How Fast The Money Rolls In!

Part time: *Here's what you can earn
over a typical weekend:*

Install 2 Satellite dish systems at \$200	= \$400
Repair 4 TV's at \$50 each	= \$200
Total Weekend Income	= \$600

Full time: *Working just five days a week
you could easily earn:*

Install 5 Satellite dish systems at \$200	= \$1,000
Repair 10 TV's, average \$50 each	= \$500
Clean and adjust 10 CD players, average \$35 each	= \$350
Service 2 Home entertainment centers at \$75	= \$150
Total Weekly Income	= \$2,000

**In addition you can make big extra profits
on other supplies you furnish!**

Get In **THE FAST LANE** on the NEW "INFORMATION SUPERHIGHWAY" Everyone's Talking About!

It's exciting! It's gigantic! The technology of tomorrow is here today! You've been reading and hearing about the amazing Information Superhighway. It's so new that few technicians are equipped to service

this fast emerging field! Foley-Belsaw gives you Satellite dish technology (including new mini-dish) along with the electronic expertise you need to make big money servicing TVs and other electronic equipment.

Be your own boss! It's quick and easy to become an expert at home in your spare time. Earn really BIG money adjusting, installing and repairing • **Satellite dish systems** • **TV's** • **Amplifiers** • **CD players** • **AM/FM tuners** • **Home entertainment centers**. Every home, every business, every office in your area desperately needs your expertise!

Your timing just couldn't be better! Never before and probably never again will you have a ground-floor opportunity like this to get into a booming business of your own, make really big money starting right away, be your own boss and enjoy financial freedom and security. The fact you're reading this message shows you're smart enough to realize this!

Satellite dish/TV/Electronics is easy

to learn in your spare time at home. This modern, practical hands-on course combines simple step-by-step lessons with easy-to-follow video cassette guidance. No special experience or electronics background is necessary. Just average mechanical aptitude and the ability to follow simple A-B-C repair procedures that are clearly outlined for you.

And when you complete the course you will receive Foley-Belsaw's official diploma attesting to your expertise.

**30-DAY
NO RISK TRIAL**
Send for details

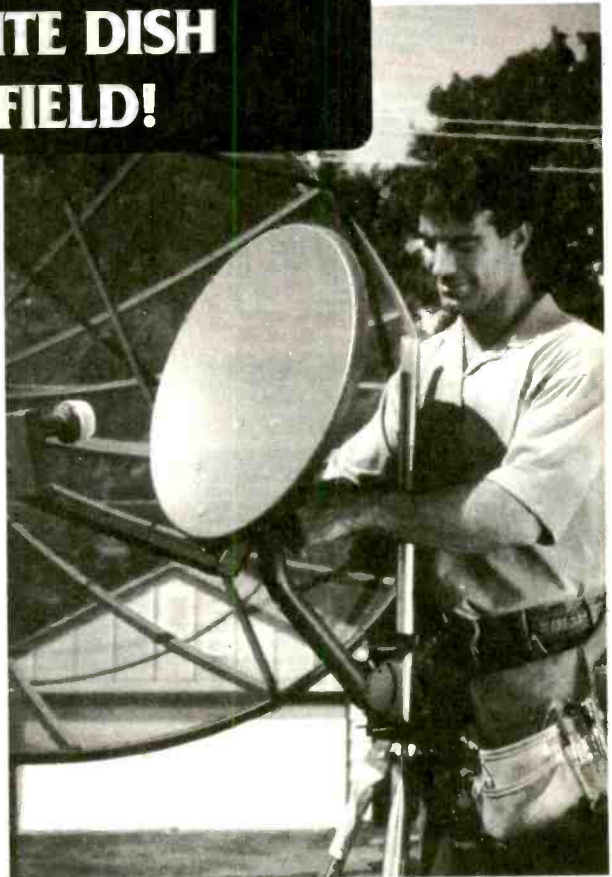

Send coupon today for FREE Fact Kit. No obligation.

Don't miss out on this once-in-a-lifetime opportunity. Send in the coupon NOW. Get all the facts and study them in the privacy of your own home. There's absolutely no obligation and no salesman will call on you. So don't delay. Mail the coupon today!

MAIL TODAY FOR FREE INFORMATION PACKAGE

Foley-Belsaw Institute
6301 Equitable Road
Kansas City, MO 64120-1395



- YES! Without obligation send free information kit so I can learn how to become a professional Satellite Dish/TV/Electronics Specialist, in order to earn high extra income. Dept. 31445
- VCR Repair-Unlimited profits in this growing field. Dept. 62673
- Interested in an exciting, money making career in Computer Repair, Maintenance and Upgrade? Dept. 64572
- Personal Computer Programming-Learn fast at low cost for big earnings. Dept. 35391

Name _____

Address _____

City _____ State _____ Zip _____

Call toll-free 1-800-487-2100

CABLE TV CHANNELS

EQUIPMENT *Direct!*
GUARANTEED

SAVE \$1000's
The Nationwide source
for cable TV equipment.
"BUY WHERE THE DEALERS BUY"

FREE TV Cable Descramblers,
Converters and
Magic Box Catalog.
Open Every Day!

Your VCR TAPES
CAN PLAY AS
CLEAR AS DAY!
Eliminates copy
protection on
any tape.

UNJAM NOW WITH
Video Decoder
• Copy any rental/bought tape
• Power Cord and RC Plugs included

2 Year Warranty
CALL NOW!
Member Better Business Bureau

MEGA ELECTRONICS!
1-800-676-6342

VISA • MC • COD

FREE 30 DAY TRIAL!

BEST DEALER PRICING!

CABLE DIRECT
CONVERTERS • FILTERS
DESCRAMBLERS

IMPROVE YOUR IMAGE WITH
VIDEO STABILIZERS

FREE CABLE TV CATALOG!

100% MONEY BACK GUARANTEE!

Now you can tune-in your favorite
cable TV programming
and **SAVE \$100'S -**
EVEN \$1000'S on premium
CABLE TV EQUIPMENT.

30 DAY FREE TRIAL!

VISA MasterCard

MODERN ELECTRONICS
1-800-906-6664
2609 S. 156TH CIRCLE • OMAHA, NE 68130
<http://www.modernelectronics.com>

ELECTRONIC COMPONENTS

MOUSER ELECTRONICS

Call for your **FREE 348**
page catalog TODAY!

- 68,000 + Products
- 130 + Manufacturers
- All Orders Ship Same Day
- No Minimum Order

800-992-9943
817-483-6828 FAX: 817-483-0931
www.mouser.com catalog@mouser.com
958 North Main St., Mansfield, TX 76063

CIRCLE 149 ON FREE INFORMATION CARD

Quality Microwave TV Systems
WIRELESS CABLE • ITFS • MMDS
ATV • INTERNATIONAL • S-BAND
Amplifiers • Antennas • Books • Components
Filters • Systems • Video Products
• RF Frequency 1990 - 2700 MHz
• Cable Ready - VHF - UHF Outputs
• SASE For "FREE" Catalog or Send \$1

PHILLIPS-TECH ELECTRONICS
PO Box 8533 • Scottsdale, AZ 85252

ORDER LINE 800-880-MMDS
CATALOG/INFO 602-947-7700
FAX LINE 602-947-7799

CHALLENGER SYSTEM
33-Channel 52dB+ Gain
Complete Grid 5245
Five Year Warranty
FREE SHIPPING

Visa • MC • Amx • Disc • COD's • Qty Pricing

CIRCLE 145 ON FREE INFORMATION CARD

LEADER

For Professionals Who Know The Difference

- Oscilloscopes
- Video Sync/Test Generators
- Waveform Monitors/Vectorscopes
- EFP/ENG Instruments
- RF Signal Level Meters
- Audio Generators & Meters
- Frequency Counters
- Meters & Bridges
- Power Supplies
- Function Generators
- RF Generators



Test Instruments, Equipment, Tools & Supplies For Electronic Production, Maintenance & Service
8931 Brookville Road, Silver Spring, MD, 20910 * 800-638-2020 * Fax 800-545-0058

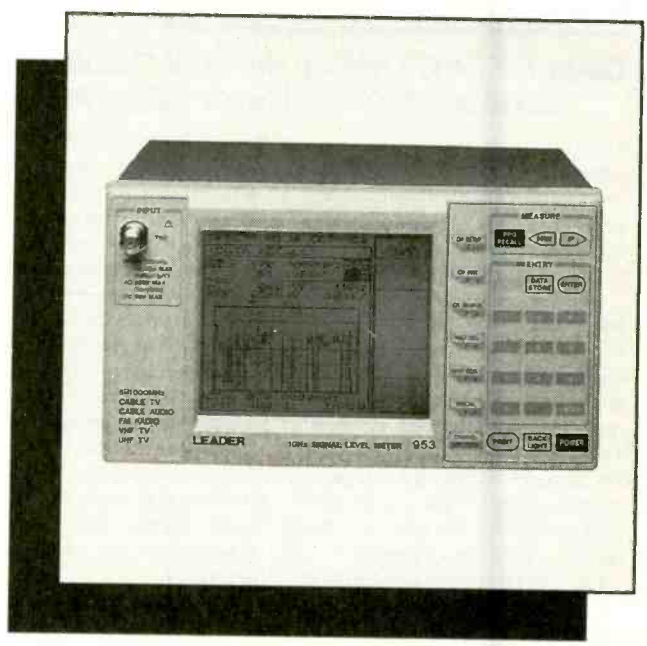

Call, fax or email for your free test and measurement instrument catalog today!
800-638-2020 * Fax 800-545-0058
Email: SMPRODINTL@aol.com

TURN YOUR PC INTO A DIGITAL STORAGE OSCILLOSCOPE!

The all new PC-MultiScope 2

10Mhz analog bandwidth!

At right: Actual scope screen as seen on your PC monitor.

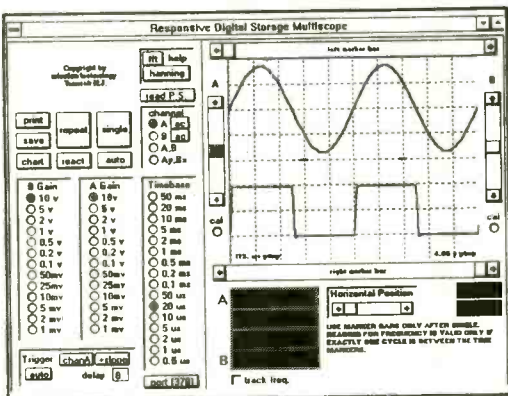

For industrial, educational, hobbyist, auto, and audio test & measurement

\$399 + S/H. Visa/MC/Check OK
Add \$99 for source code option

The top choice of corporations, universities and scientists worldwide

AMAZE ELECTRONICS CORPORATION
amaze@hooked.net www.hooked.net/users/amaze
Phone: 800-996-2008 Fax: 408-374-1737

FEATURES:

1. Dual channel; external triggered
2. Digital storage; Windows based
3. Connects to PC parallel port
4. 20Megasamples/sec sampling; 10Mhz max. analog bandwidth
5. 8 bit resolution/ 8K RAM buffer
6. Prog. gain: 10v/div to 1mv/div
7. Spectrum analyzer (fft) function
8. Strip chart recorder function
9. TTL output for control app's
10. Visual Basic source code avail.

OSCILLOSCOPES

from \$169 !!!

ATC O-Scope uses printer port to turn PC-AT into Digital Storage Oscilloscope, Spectrum Analyzer, Freq. Counter, Logger, DVM. DC-500KHz

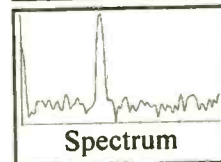
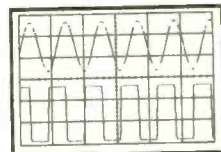

- Print, log to disk, or export data
- Accepts standard scope probes
- Uses standard printer port
- Small and portable
- Works with laptops
- Same day shipping
- Made in U.S.A.
- Single channel units from \$169
- Dual channel units from \$349

Options:

- Probe sets
- Automotive probes
- Battery packs

Order yours today.

800 980 9806

MC/Visa/Amex

Allison Technology Corporation

8343 Carvel, Houston, TX 77036 USA

PH: 713 777 0401, FAX: 713 777 4746, BBS: 713 777 4746

<http://www.atcweb.com>

CIRCLE 137 ON FREE INFORMATION CARD

Learn by Example!

The PRIMER 8085 Based Microprocessor Training and Control System shows you how to program by example. Examples & exercises in the Self Instruction manual take you from writing simple programs to controlling motors. Start out in Machine language, then move on to Assembler, & then continue on with optional C, Basic, or Forth Compilers. This trainer can be used stand alone via the keypad and display or connected to a PC with the optional upgrade (\$49.95). The Upgrade includes: an RS232 serial port & cable, 32K of battery backed RAM, & Assembler/Terminal software.

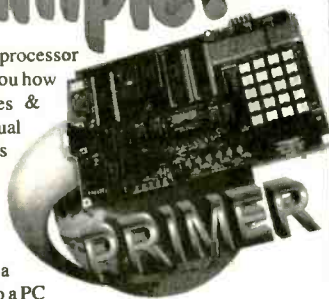

Examples Include:

- Measuring Temperature
- Using a Photocell to Detect Light Levels
- Making a Waveform Generator
- Constructing a Capacitance Meter
- Motor Speed Control Using Back EMF
- Interfacing and Controlling Stepper Motors
- Scanning Keypads and Writing to LCD/LED Displays
- Bus Interfacing an 8255 PPI (new)
- Using the Primer as an EPROM Programmer

The PRIMER is only \$119.95 in kit form. The PRIMER Assembled & Tested is \$169.95. Please add \$5.00 for shipping within the U.S. Picture shown with upgrade option and optional heavy-duty keypad (\$29.95) installed.

EMAC, inc.

11 EMAC WAY, CARBONDALE, IL 62901
618-529-4525 Fax 457-0110 BBS 529-5708
World Wide Web: <http://www.emacinc.com>

1985 - 1997

OVER
12
YEARS
OF SERVICE

REMOTES Remote Control for Any Application

NEW NEW NEW NEW NEW



\$69⁹⁵

- 3 Channel Receiver
- Channel 1 - 5 amp Relay, N/O, N/C
- Channel 2 and 3 Digital Outputs
- Compatible with 2 Button or 4 Button Remote
- Code Hopping Receiver at 434 Mhz
- Compatible with All Garage Doors and Some Car Alarms



\$99⁹⁵

- 6 Channel Receiver with Digital Outputs
- All Channels are Programmable for Momentary, Latched, Latched with Condition 30-60-90 Sec. Timed Outputs
- Code Hopping Receiver at 434 Mhz
- Compatible with 2 Button or 4 Button Remote
- Compatible with Some Car Alarms



\$29⁹⁵

- 2 Button - 3 Channel Remote
- Extra Long Range 434 Mhz with S.A.W. Resonator
- Push Both Buttons together for Channel 3



\$39⁹⁵

- 4 Button - 15 Channel
- Extra Long Range 434 Mhz S.A.W. Resonator
- Push Combination of Buttons together for Channel 5 through 15, i.e. Push Button 1 and 2 together for Channel 5

Street Smart Security ■ 800-908-4737

7147 University Avenue • La Mesa, CA 91941

Send, Fax or Call Order In - Use Credit Card or Check. Fax (619) 462-0652

Learn MICROCONTROLLERS EMBEDDED SYSTEMS and PROGRAMMING...

...with the AES learning system/
embedded control system.
Extensive manuals guide you
through your development
project. All programming and
hardware details explained.
Complete schematics. Learn to
program the LCD, keypad digital,
analog, and serial I/O. for your applications.

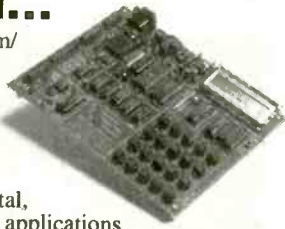

**THREE MODELS AVAILABLE. Choose from an
Intel 8051, Intel 8088, or Motorola 68HC11
based system. All models come with:**

- 32K Byte ROM, 32K Byte RAM • 2 by 16 Liquid Crystal Display • 4 by 5 Keypad • Digital, Analog, and Serial I/O • Interrupts, timers, chip-selects • 26 pin expansion connector • Built-in Logic Probe • Power Supply (can also be battery operated) • Powerful ROM MONITOR to help you program • Connects to your PC for programming or data logging (cable included) • Assembly, BASIC, and C programming (varies with model) • Program disks with Cross Assembler and many, well documented, program examples • User's Manuals: cover all details (over 500 pages) • Completely assembled and ready to use • Source code for all drivers and MONITOR • Optional Text Book

Everything you need. From \$279.
Money Back Guarantee

Call for Free Info Pack, or see
WEB at <http://www.aesmicro.com>
714-550-8094, FAX 714-550-9941



Call 1-800-730-3232

AES 970 W. 17TH STREET, SANTA ANA, CA 92706, USA

FM BROADCAST TRANSMITTER BOARD!
Assembled unit is crystal controlled with: ALC, 2:1
Compressor and Stereo Generator. Bandwidth is
75MHz to 125MHz with 500m W's RF power. Stereo
version \$295 US, Mono version \$245 US. Kits avail-
able! For catalog of video surveillance and profes-
sional broadcast equipment send \$2.00 to:
Wavemach Communications, 320 Dixon Road,
Suite 302, Etobicoke, Ontario, Canada, M9R-1S8.

PROGRAMMERS OVER 50 MODELS

ADVANTECH EETOOLS NEEDHAM'S DATA I/O ICE TECHNOLOGY HILO
SYSTEM GENERAL CHROMA MODULAR CIRCUIT TECHNOLOGY XELTEK



PROMAX EMP-20 MEGAMAX MEGAMAX4 SIMM/SIP TESTER EMUPA

CALL ADVANTECH LABTOOL	599 EETOOLS SIMMAX
629 ICE TECH MICROV	795 CHROMA SIMM/SIP
650 EETOOLS ALLMAX +	359 MOD-MCT-EMUPA/R
409 EETOOLS MEGAMAX	279 MOD-MCT-EMUP/R
509 EETOOLS MEGAMAX4	49 EPROM 1G TO 512K
369 XELTEK SUPERPRO II	69 EPROM 1G TO 1MEG
409 XELTEK SUPERPRO II P	99 EPROM 4G TO 1MEG
249 XELTEK SUPERPRO L	199 EPROM 16G TO 1MEG
165 XELTEK ROMMASTER II	89 EPROM 1G TO 8MEG
479 MOD-MCT-EMUPA	129 EPROM 4G TO 8MEG
739 STAG ORBIT-32	250 EPROM 8G TO 8MEG



LABTOOL48 MICROMASTER SUPERPRO ALLMAX PLUS ROMMASTER2

General Device Instruments

Sales 408-241-7376 Fax 241-6375 BBS 983-1234
Web www.generaldevice.com E-Mail icdevice@best.com

The Pocket Programmer

\$129.95

The portable
programmer
that uses the
printer port of
your PC
instead of a
internal card.

Easy to use software that programs
E(E)prom, Flash & Dallas Ram. 27(C)/
28(C)(F)/29(C)(F)/25 series from 16K to 8
Megabit with a 32 pin socket. Adapters
available for MCU's 874X, 875X, Pic, 40-
Pin X 16 & Serial Eprom's, PLCC, 5-Gang
and Eprom Emulator to 32K X 8.

**Same Name, Address & Phone # for
13 Years.... Isn't it Amazing ?**

Intronics, Inc.
Box 13723 / 612 Newton St.
Edwardsville, KS 66113 Add \$4.75 COD
Tel. (913) 422-2094 Add \$4.00 Shipping
Fax (913) 441-1623 Visa / Master Charge

Whaddya Say To
A Guy Who's Had
The Same Job
For 50 Years,
Has Never Called
In Sick Or
Showed Up Late,
Never Taken A
Vacation Or A
Holiday, Never
Asked For A
Raise Or Griped
About His Bonus
And, Believe It Or
Not, Has No
Plans For
Retirement?



Thanks.

Remember - only you can prevent forest fires.

Notch Filters

Zeinth Test Chip, Pre-owned software



Assembled	Kits
1 to 2 \$30 each	1 to 2 \$20 each
3 to 9 \$25 each	3 to 9 \$15 each
10 to 49 \$16 each	10 to 20 \$9 each
50 or more \$14 each	21 or more \$7 each

Video Media
P.O. Box 93/6025
Margate, Fl. 33093-6025
(954)-752-9202 Fax (954)-340-5201



www.tvfilter.com

ANY NEW APPLICATIONS?

COB & SMD on gold plated PCB

20-Second Voice Record & Playback Unit

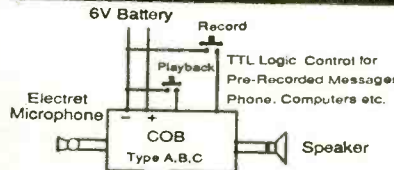

Type A	Type B	Type C
0.385"x0.75"	0.85"x1.05"	1.15"x1.15"

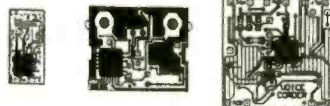

COB Design Specialist
KSL Microdevices, Inc.

(408)922-0800 FAX (408)922-0629

WHOLESALE PRICES STARTING AS LOW AS \$99.00 CABLE TV DESCRAMBLERS CONVERTERS FILTERS · VIDEO STABILIZERS

1 Year Warranty on All Products.
Affordable Extended Warranty.
FREE CATALOG!



Call the Cable Professionals 24 Hours A Day!

**Orion
Electronics**

1-800-379-3976
[HTTP://WWW.ORION-ELECTRONICS.COM](http://www.orion-electronics.com)



EPROM+ PROGRAMMING SYSTEM USES PARALLEL PORT

EPROMS (24,28,32 & 40 PIN*)+27C AND 25XX
1702*, 2708, TMS2716*, 32,32A, 64,64A, 128,128A
256,512,513,011,010,101,1001,1000,1024,2,10,020
2001,220,2048,4001/2,040,080,240,4096,68764/66

FLASH EPROMS 28F256, 28F512, 28F010
28F020,29C257,29C010,29C040,29F010,29F040
EEPROMS & NVRAMS (18,24 & 28 PIN+CXX)
2210, 2212, 2804, 2816, 2816A, 2817, 2864, 2865
28256, 28C010, DS1220, DS1225, DS1230

SERIAL EPROMS* (8 & 14 PIN PLUS CXX)
ER1400, M58657, 2401,02,04,08,16,32,65, 2444
59C11,80011A,9306,46,56,66,8572,82,92,168,9XX
BIPOLAR PROMS* (16 THROUGH 24 PINS)
74SXXX AND 82SXXX FAMILY

MICROCONTROLLERS* 8741, 42, 48, 49, 8751
C51, 52, C52, 87C5XXX, 87C75X, 89C5X, 68705
68HC705, 68HC711E9, PIC16CXX, TMS7742
*ADAPTER REQUIRED - DIAGRAMS INCLUDED

SOFTWARE - READ, VERIFY, PROGRAM, COPY
DISK FILE LOAD/SAVE, CHECKSUM, FULL
SCREEN BUFFER EDITOR W/20 COMMANDS
READS HEX, S-RECORD AND BINARY FILES
FAST-DEVICES PROGRAM IN UNDER 20 SEC
RUGGED (9"X6"X3") ENCLOSURE W/HANDLE
MADE IN USA - 1 YEAR WARRANTY

ANDROMEDA RESEARCH, P.O. BOX 222, MILFORD, OH 45150
(513) 831-9708 FAX (513) 831-7562



SYSTEM INCLUDES:
PROGRAMMING UNIT
PRINTER PORT CABLE
POWER PACK, MANUAL
AND SOFTWARE.

\$289

ADD \$5.00 SHIPPING
\$5.00 C.O.D.
VISA/MASTERCARD

HOME AUTOMATION

World's Largest Selection!

Widest Selection of
X-10 Devices Available

Hundreds of hard-to-find automation, X-10 and wireless control products. Computer interfaces, software, development tools, lighting control, telephone systems, security systems, surveillance cameras, infra-red audio/video control, HVAC, pet care automation, wiring supplies, books and videos and much more

Packed with Pictures
& Diagrams



HOME AUTOMATION SYSTEMS, Inc.

Questions: 714-708-0610 Fax: 714-708-0614

e-mail: catalog@smarhome.com

http://www.smarhome.com/smarhome

Lowest Prices
Guaranteed!

24 Hours **Call 800-SMART-HOME** 800-762-7846

Any waveform you want!



Starting at

\$795

Quantity 1

Money back
guarantee

Telulex Inc. model SG-100

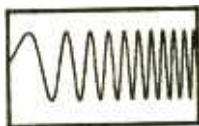

DC to 20 MHz linear
and log sweeps

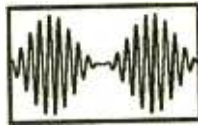

Int/Ext AM, SSB,
Dualtone Gen.



Int/Ext FM, PM,
BPSK, Burst



Ramps, Triangles,
Exponentials



Pulse Generator



Noise

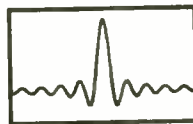

Arbitrary Waveforms

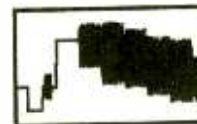

Unlimited Possibilities!

● Synthesized Signal Generator

Clean sinewaves DC-20 MHz with .001% accuracy!
.1 Hz steps. DC Offset. RS232 remote control.

● Arbitrary Waveform Generator

40 Megasamples/Second. 32,768 points. 12 bit DAC

● Function Generator

Ramps, Triangles, Exponentials & more to 2 MHz!

● Pulse Generator

Digital waveforms with adjustable duty cycle

Telulex Inc.

2455 Old Middlefield Way S Tel (415) 938-0240 <http://www.Telulex.com>

Mountain View, CA 94043 Fax (415) 938-0241 Email: sales@Telulex.com

CIRCLE 144 ON FREE INFORMATION CARD

CABLE TV CONVERTERS

Equipment & Accessories
Wholesalers Welcome

Call C&D ELECTRONICS
1-888-615-5757 M-F 10a-6p

Debco is a Kit Builders Paradise

Electronic Kits - Plans - Parts - Computers - Amateur Radio



Call Debco today for
your FREE copy of

The Electronic Experimenter's Journal

1 800 423 - 4499

Debco Electronics 4025 Edwards Rd. Cincinnati, OH 45299

BE AN ELECTRICIAN!

Home study. Maintain and install electrical
systems, wiring, utilities, phones, and more.
FREE LITERATURE: 800-223-4542

Name _____ Age _____

Address _____ Phone (____) _____

City/State _____ Zip _____

The Electrician School, PCDI, DEPT TEJ341
6065 Roswell Road, Atlanta, Georgia 30328



August 1997, Popular Electronics

CALL TOLL FREE
(800) 292-7711 orders only
Se Habla Español

C&S SALES
EXCELLENCE IN SERVICE

CALL OR WRITE FOR
A FREE 60 PAGE
CATALOG!
(800) 445-3201

XK-550 Digital / Analog Trainer

Elenco's advanced designed Digital / Analog Trainer is specially designed for school projects. It is built on a single PC board for maximum reliability. It includes 5 built-in power supplies, a function generator with continuously sine, triangular and square wave forms. 1560 tie point breadboard area.

XK-550
Assembled and Tested
\$169.95

XK-550K - Kit
\$139.95

Tools and meter shown optional



TK-3000
\$89.95

Tools Included:

- SR-2 - Deluxe Soldering Iron
- SH-1 - Soldering Iron Stand
- ST-1 - Diagonal Filers
- ST-2 - Long Nose Pliers
- ST-30 - Deluxe Wire Stripper
- SE-1 - Solder Ease Kit
- ND-3 - 3 pc. Nut Driver Set
- TL-8 - Precision Screw Drivers
- ST-5 - Screw Driver Slotted 3/16"
- ST-6 - Screw Driver #1 Phillips
- ET-10 - IC Puller
- SP-2 - Solder Pump
- ST-20 - Safety Goggles
- ST-9 - Pocket Screw Driver
- ST-4 - Solder Tube
- SW-3 - Solder Wick

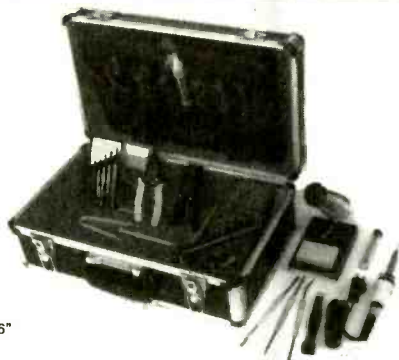

A professional technician service tool kit in a metal reinforced tool case with heavy-duty handle and locks. A removable pallet handles most of the tools listed with more room for tools and parts in the lower half.

GF-8026 w/ Frequency

- Linear and Log Sweep
 - .02Hz to 2MHz
 - Counter Range 1Hz to 10MHz
 - 4 Digit Display
- \$225**



MX-9300 Four Functions in One

• One Instrument with four test and measuring systems:
 1.3GHz Frequency Counter • 2MHz Sweep Function Generator
 Digital Multimeter • Digital Triple Power Supply
 (0-30V @ 3A, 15V @ 1A, 5V @ 2A)



\$479.95

Model XP-581

4 Fully Regulated DC Power Supplies in One Unit
 4 DC voltages: 3 fixed - +5V @ 3A, +12V @ 1A, -12V @ 1A
 1 Variable - 2.5 - 20V @ 2A



\$85



Auto Ranging Hand-Held DMM w/ Bar Graph
Model EDM-163

\$99.95

7 Functions with data hold
 Compares to Fluke Model 77II

Digital Multimeter
Model M-1700

\$39.95

11 functions including freq to 20MHz,
 cap to 20µF. Meets UL-1244 safety specs.



Fluke Multimeters

70 Series	80 Series
Model 70II \$69.95	Model 83 \$235.00
Model 73II \$97.50	Model 85 \$269.00
Model 75II \$135.00	Model 87 \$289.00
Model 77II \$154.95	
Model 79II \$175.00	

B&K Precision Multimeters

Model 391 \$159.00	Model 388A \$99.00
Model 390 \$139.00	Model 2707 \$79.00
Model 389 \$109.00	Model 2860A \$85.00

Kit Corner

over 100 kits available

PT-223K

\$15.95

Phone kit with training course.



Fiber Optics Technology

with training course
Model FO-30K

\$19.95

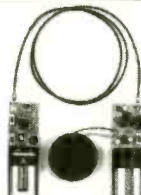

Model AM/FM-108K
Transistor Radio Kit

with training course

\$29.95

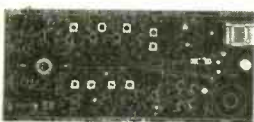

M-1005K
Compact Multimeter Kit

\$19.95

6 Functions & Transistor Test



Model M-6100

Programmable DMM

Includes **FREE** Computer Interface and **FREE** Software

- Analog Bar Graph
- Large 3 3/4" LCD Display
- Menu Driven
- Triple Display
- RS-232 Interface
- True RMS
- 9 Basic Functions including cap. & freq.
- Auto Power Off
- Easy-to-use

\$125



WE WILL NOT BE UNDERSOLD

UPS SHIPPING: 48 STATES 5%
 OTHERS CALL FOR DETAILS
 IL Residents add 8% Sales Tax

C&S SALES, INC.

150 W. CARPENTER AVENUE
 WHEELING, IL 60090
 FAX: (847) 541-9904 (847) 541-0710
http://www.elenco.com/cs_sales/



15 DAY MONEY BACK
GUARANTEE

FULL FACTORY WARRANTY

PRICES SUBJECT TO CHANGE WITHOUT NOTICE

CIRCLE 32 ON FREE INFORMATION CARD

**FREE PROBES
WITH ALL
SCOPES**

OSCILLOSCOPES

Lowest Prices of the Year!

**CALL OR WRITE FOR
A FREE 60 PAGE
CATALOG!
(800) 445-3201**

B&K Precision Scopes

60MHz ANALOG WITH DIGITAL STORAGE

Model 2560
• Cursors and readouts
• RS-232 port
• 20MS/s real time sampling
• 1GHz equivalent time sampling (at 0.1u/div)
• Prints via RS-232 port to any HP-GL plotter
\$1995



20MHz ANALOG WITH DIGITAL STORAGE

Model 2522A
• 20MHz analog bandwidth
• 20MS/s sampling rate
• 2K memory per channel
• 300MHz equivalent time sampling
• Pre-trigger capture
\$869.95



100MHz THREE-TRACE

Model 2190A
• 1mV/division sensitivity
• Sweeps to 5ns/division
• Dual time base
• Signal delay line
• 15KV accelerating voltage
\$1379.95



60MHz DUAL-TRACE

Model 2160A
• 1mV/division sensitivity
• Sweeps to 5ns/division
• Dual time base
• Signal delay line
• V mode - displays two signals unrelated in frequency
• Component tester
\$949.95



40MHz DUAL-TRACE

Model 1541C
• 1mV/division sensitivity
• Video sync separators
• 2-axis input
• Single Sweep
• V mode - displays two signals unrelated in frequency
• Component tester
\$695



60MHz, CURSORS & READOUTS, DUAL TIME BASE

Model 2260
• Cursors and readouts
• 1mV/div sensitivity
• 23 calibrated ranges - main time base
• 19 calibrated ranges - delayed time base
• Signal delay time
• V-mode - displays 2 signals unrelated in frequency
• Component tester
• Single sweep
\$1225



20MHz DUAL-TRACE

**Model 2120 - 2 Year Warranty
Special \$389.95**

**Model 2125 with delayed sweep
\$539.95**



• 1mV/division sensitivity
• AUTO/NORM triggered sweep operation
• AC, TVH, TVV and line coupling
• Calibrated 19 step time-base with x10 magnifier
• Compact low-profile design

Quality Scopes by Elenco



60MHz

DS-603 \$1350

- Analog / Digital Storage
- 20MS/s Sampling Rate

40MHz

S-1345 \$569

- Analog with Delayed Sweep

S-1340 \$475

- Analog

25/30MHz

DS-303 \$1095

- Analog / Digital Storage

S-1330 \$439

- 25MHz Analog
- Delayed Sweep

S-1325 \$325

- 25MHz Analog

**2 Year
Warranty**

OSCILLOSCOPE SELECTION CHART

ANALOG		Sensitivity (max)	No. of Channels	Sweep Rate Max ns/div	Delayed Sweep	Video Sync	Component Tester	Beam Find	Time Base
Model	Bandwidth MHz								
S-1360	60	1mV/div	2	10ns/div	Yes	Yes	Yes	Yes	2
S-1345	40	1mV/div	2	10ns/div	No	Yes	No	No	1
S-1340	40	1mV/div	2	10ns/div	Yes	Yes	Yes	Yes	2
S-1330	25	1mV/div	2	10ns/div	No	Yes	No	No	1
S-1325	25	1mV/div	2	10ns/div	No	Yes	No	No	1
DIGITAL STORAGE		Analog Sen (max)	No. of Channels	Sampling Rate	Memory Channel	Internally Backed Up	Pretrigger %	Output	
Model	Bandwidth MHz								
DS-303	30	1mV/div	2	20MS/S	2K	Yes	0, 25, 50, 75	RS232	
DS-603	60	1mV/div	2	20MS/S	2K	Yes	0, 25, 50, 75	RS232	

Affordable Spectrum Analyzers by B&K

500MHz Series

Model 2615 - \$1595
Model 2620 w/ tracking generator - \$1895

1.05GHz Series

Model 2625 - \$2395
Model 2630 w/ tracking generator - \$2995



HITACHI SCOPES

**Inventory Reduction Sale
Lowest Prices of the Decade!**

V-209 - 20MHz Battery Operated
Was \$1505, NOW \$1095 Save \$410

V-422 - 40MHz Was \$965,
NOW \$765 Save \$200

V-525 - 10MHz w/ Cursors
Was \$1355, NOW \$955 Save \$400

V-552 - 50MHz Was \$1195,
NOW \$850 Save \$345

V-555 - 50MHz w/ Cursors
Was \$1375, NOW \$975 Save \$400

V-695 - 60MHz w/ Cursors
Was \$1815, NOW \$1395 Save \$420

V-1065A - 100MHz w/ Cursors
Was \$2139, NOW \$1565 Save \$574

V-1560 - 100MHz Was \$1790,
NOW \$1490 Save \$300

V-1565 - 100MHz w/ Cursors
Was \$1960, NOW \$1595 Save \$365

V-252 - 20MHz **\$419**

Fluke Scopemeters



91 \$1225
92B \$1445
96B \$1695
97 \$1795
97A \$2945
99B \$2095

Call or write for complete specs.

WE WILL NOT BE UNDERSOLD

C&S SALES, INC.

150 W. CARPENTER AVENUE
WHEELING, IL 60090

FAX: (847) 541-9904 (847) 541-0710
http://www.elenco.com/cs_sales/



**15 DAY MONEY BACK
GUARANTEE**

FULL FACTORY WARRANTY

PRICES SUBJECT TO CHANGE WITHOUT NOTICE

UPS SHIPPING: 48 STATES 5%
OTHERS CALL FOR DETAILS
IL Residents Add 8% Tax

CIRCLE 32 ON FREE INFORMATION CARD

**MO-TECH DISRIBUTORS
YOUR MIDWEST PANASONIC
CONVERTER WHOLESALE**

PANASONIC

	10 PC	20 PC	50 PC
TZPC1453G2	\$63-	\$61-	\$59-

"Top of the line converter" featuring sleep timer, parental lock, standard/HRC switchable, last channel recall, favorite channel memory, and 83 channel capable.

TZPC1003	\$49-	\$44-	\$42-
----------	-------	-------	-------

One of our best selling converters featuring sleep timer, parental lock, last channel recall, favorite channel memory, and 80 channel capability.

TZPC175DG2	\$89-	\$85-	\$82-
------------	-------	-------	-------

Our "Top of the line" converter with volume control. Featuring sleep timer standard/HRC switchable, parental lock, last channel recall, favorite channel memory, and 83 channel capable.

**PHONE (810) 566-7262
FAX (810) 566-7253**

**CABLE T.V.
Converters & Equipment
WISE PRODUCTS**

30-day money back
1-year warranty



**Dealers
Welcome!**
1-(800) 434-2269
Visa, MC, Amex, COD

Pete's Wholesale

Wholesale distributors of cubes and one piece units works on all major systems call us last for the best price!

800-763-7277

COMPONENTS

STEPPER IC: EDE1200 is perfect for robotics, etc. E-LAB DIGITAL ENGINEERING, INC. (712) 944-5344. www.netins.net/showcase/elab

"FULL VIEWING" CABLE BOXES

FREE



Converter Box Catalog
Open Every Day!

**LOWER YOUR CABLE
BILL NOW!**
CHANNEL SURFERS

1-800-447-7634

BUGGED??

EAVESDROPPING is unbelievably widespread! Electronic Devices with amazing capabilities can be monitoring your telephone and room conversations RIGHT NOW! Are you sure you're safe? **FREE CATALOG tells you fast!** Includes Free Bonus details on fantastic opportunities now open in Counter-Surveillance field. Exciting, immensely interesting and EXTREMELY profitable (up to \$250 hr) full/part-time income. Call Now! **1-800-732-5000**

PROTOTYPES

Or large runs. PCBs, wave soldering, cabinets and other metal parts, silk screen printing, plastic injection, xformer/coil winding, etc. Assembly, wiring. Very low prices! Twin plant in Mexico. We ship to your door. V&V. PH. (713) 537-7518 Fax. 011 (525) 361-5996.

Weeder Technologies

Add \$4
Ship/Hand
US & Canada

**FREE
CATALOG!**



Pro-Kit™

PO Box 421, Batavia, OH 45103

weedtech@iglou.com

513-752-0279

Home Automation

Connects between a TW523 and an RS-232 serial port. Use your PC/Mac to receive and transmit all X-10 commands. Create your own program to control your home automation system, turning on/off any device plugged into an electrical outlet with response to time/date, other X-10 transmissions or any other computer input stimuli. **\$38.50**

Caller ID / RS-232

Connects between a telephone wall jack and an RS-232 serial port. Decodes the caller ID data sent over the phone line and sends it to your PC/Mac, in a pre-formatted ASCII character string. Create your own program to log the name, number, date, and time of all incoming calls. Block out unwanted callers to your BBS/modem. **\$34.50**

Telephone Call Restrictor

Connects to telephone wall jack. Disables all phones on the line if attempting to either dial a number that has been stored in memory "Block" mode or, dial a number that has not been stored in memory "Allow" mode. Use touch-tone phone to enter telephone numbers into memory, and choose mode. Program from any phone on the line using your password. **\$35.00**

50 MHz Frequency Counter

Reads frequency from 1Hz to 50MHz and displays up to 7 digits on a 16x1 character LCD display. Auto-range feature provides floating decimal point and automatic placement of suffix (Hz, KHz, or MHz). Microcontroller based provides for very small parts count, only 2" x 3" big. **\$48.50**

Telephone Scrambler

Scrambles your voice before sending it over the telephone line. Prevent eavesdropping from an extension or tap. Connects between your telephone and wall jack. No modifications are required to your telephone. Full duplex operation. **\$43.00**

IR Remote Control Receiver

Learns and records the data patterns emitted by standard infrared remote controls used by TVs, VCRs, Stereos, etc. Lets you control all your electronic projects with your TV remote. Seven individual I/O pins can be assigned to any button on your remote, and can be configured for either "toggle" or "momentary" action. **\$32.00**

RS-232 Digital I/O

Give your home-brewed PC/Mac programs a link to the outside world! 12 I/O pins can be configured individually for input or output. Turn on/off relays, triacs, etc. Respond to button presses, switch changes, 4x4 matrix decoding with auto-debounce. Stack up to 16 units on the same serial port for a total of 192 I/O points. **\$32.00**

DTMF Decoder/Logger

Keep track of all numbers dialed or entered from any phone on your line. Connects to your telephone wall jack. Decodes all 16 touch-tones and displays them on an LCD display. Holds the last 240 digits in a non-volatile memory. Scroll through and view all telephone numbers dialed, credit card numbers entered, etc. **\$54.50**

OWN A MACHINE SHOP

The Smithy 3-In-1 lathe-mill-drill gives you all 3 basic machine tools in one easy-to-use benchtop machine. Save time & money. For home or business.



Call for your FREE Info Pak.

1-800-345-6342

FREE Info Pak

Ask for Operator PE78 or write

Dept. PE78
PO Box 1517
Ann Arbor, MI
48106-1517

Smithy.

©1997 EDF

Buy recycled.



It would mean the world to them.

Recycling keeps working to protect their future when you buy products made from recycled materials. For a free brochure, write *Buy Recycled*, Environmental Defense Fund, 257 Park Avenue South, New York, NY 10010, or call 1-800-CALL-EDF.



COUNTERSURVEILLANCE COVERT SURVEILLANCE

VIBRATING TRANSMITTER DETECTOR

DETECTS:

- Body Wires
- FM Wireless Mics
- AM Transmitters
- UHF Transmitters



AI-2100 . . . \$189.95

TRVD-900

DETECTS:

- Body Wires • Transmitters
- Tape Recorders • Video Equipment



TRVD-900 . . . \$495

BLACK BOX COLOR CAMERA



BX-300 \$395

SMOKE DETECTOR COLOR CAMERA



SD-300 \$450

COVERT COLOR VIDEO LAMP

- 380 (H) TV Lines
- 2 Lux Sensitivity
- Undetectable Lens



VL-300 . . \$595

AI-5500 COMPLETE SAFETY SYSTEM

DETECTS:

- All Phone Taps
- All Body Wires
- All Transmitters



DISRUPTS:

ALL TRANSMITTERS & BODY WIRES WITH ITS BUILT-IN WHITE NOISE SIGNAL BREAKER

\$379.95

WSS-300 COLOR WIRELESS SURVEILLANCE SYSTEM

FEATURES:

- FCC Approved 2.4GHz Transmitter / Receiver
- Radio w/ Built-In Color Camera / Transmitter
- 380 (H) TVL Resolution • Super Low 2 Lux
- 4-Channel Receiver • 300' Transmission

Ncte: Cassette Player Non-Functioning **\$895**

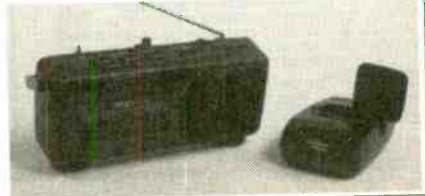

All 300 Series Color Cameras Feature: Superior Resolution - Over 380(H) TV Lines Super Low 2 Lux Sensitivity, 3.7mm Wide-Angle Lens. Built-In Backlight Compensation

Items May Be Purchased by Credit Card, Certified Check, Money Order or C.O.D.

Send \$6.00 for 32-Page Catalog (FREE w/ Purchase)

AMERICAN INNOVATIONS, INC.

119 ROCKLAND CENTER - SUITE 315 • NANUET, NY 10954

VOICE: (914) 735-6127 • FAX: (914) 735-3550

HTTP://WWW.SPYSITE.COM • E-MAIL: AMERICAN@SPYSITE.COM

Dealers & Distributors Welcome

ROBOTIC MACHINING

ROUTE, MILL, DRILL, CARVE, ENGRAVE, PAINT
IN WOOD, PLASTIC, VINYL, PC BOARD, & LIGHT METALS!

STARTING AT \$695.00

- 4 & 5 MOTOR GANTRY MILL CONFIGURATIONS
- PC COMPUTER CONTROLLED CNC/DNC
- IMPORT/ EXPORT FILES TO OTHER CADS
- AUTO-BACKLASH COMPENSATION
- PRE-MACHINED HEAVY CASTINGS
- SIMULTANEOUS 4 AXIS MOTION
- FREE 3D CAD/CAM SOFTWARE
- AVAILABLE IN KITS OR ASSEMBLED
- EXPEDITE SERVICE ALSO AVAILABLE
- OPTIONAL ALUMINUM WAY COVERS
- .0005" RESOLUTION / AMERICAN MADE



3 & 4 AXIS UNITS FROM 12" X 12" TO 66" X 66" MACH. AREA

U.S. CYBERLAB, INC. 14786 SLATE GAP RD., WEST FORK, AR 72774

CALL NOW FOR INSTANT SPECS 501-839-8293 24 HR. FAX-BACK

START A CAREER IN ELECTRONICS!

Accredited home study. Repair, install, and service audio equipment, microwave ovens, alarm systems, small appliances, and more. For free career literature, send or call.

CALL 800-223-4542

Name _____
 Address _____
 City/State _____ Zip _____
 Age _____ Phone (____) _____

The School of Electronics, Dept. ELJ341
 PCDI, 6065 Roswell Road, Atlanta, GA 30328



New Surveillance Devices!

Smoke Alarm and Table Clock Video Cameras
 Ultra miniature video cameras hidden in smoke alarm or alarm clock - your choice. Wide field of view and super 1 lux low light sensitivity! Undetectable!



TC-70 High quality B/W with 420 lines of resolution for ultra sharp images. Direct output of video and audio. **\$189.95 ea.**

Best price on surveillance cameras anywhere!

Telephone Transmitter Kit hidden in dual modular adaptor
 Transmits both sides of conversation to any FM radio up to 1/4 mile. "SnapKit" technology. Uses phone line for power and antenna. Goes completely unnoticed. **MA-100 \$25.95**

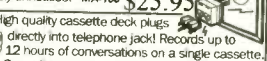

THR-12 12 Hour Telephone Recorder \$99.95
 High quality cassette deck plugs directly into telephone jack! Records up to 12 hours of conversations on a single cassette. Recording starts and stops automatically when phone is used! **Visa/MC (800)594-1047**
 Free shipping! Check/MO Question line: (972) 255-7490
 Seymour-Radix Inc. Box 166055-E Irving, TX 75016
 Now you can visit us on the internet at: <http://www.wtly.net/home/sr/>

SURVEILLANCE

The Latest High Tech

Professional Electronic Devices

Our latest catalog offers a HUGE selection of surveillance, counter-surveillance/privacy devices: hidden video equipment, pinhole camera w/audio \$159⁰⁰, electronic kits, telephone recording systems: 7-Hour \$125⁰⁰ - 16-Hour \$199⁰⁰ touch tone decoders, scanners, bug/phone tap detectors, voice disguisers, telephone scramblers, locksmithing tools, and more.

Catalog \$5.00

SPY OUTLET

P.O. Box 337, Buffalo, NY 14226
 (716) 691-3476 / (716) 695-8660

ELECTRONICS WORK at HOME

Part time! Full time up to \$35+/hour
 Just Published: "Home Based Electronics Businesses" Comprehensive GuideBook reveals secrets to using technical skills to make big money NOW! 250+ pages of insider info & sources. *Be your own boss & get out of the rat race NOW!*
 Send \$24. FREE SHIPPING USA. Canadians add \$2
 DCP Enterprises 24hr Recording & Faxback California residents add Sales Tax
 15 Mayflower (800)326-4560 x 218
 Aliso Viejo, CA 92656 | 30 day MONEY BACK GUARANTEE!

COPY RENTAL TAPES WITH OUR VIDEO STABILIZERS

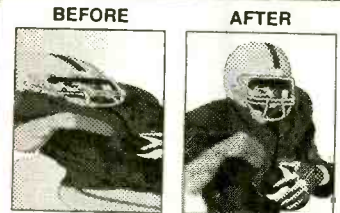

FREE CABLE TV CATALOG!

The clearest picture possible playing back movies. **GUARANTEED** to eliminate copy protection.

- No Rolls/Jitters/Flickers/Fading
- Works on all TV's, VCR's Beta & Cable
- Gold Video Connectors & Cables Included
- 1 Year Warranty
- Money Back Guarantee



VISION ELECTRONICS

1-800-562-2252
 2609 S. 156TH CIRCLE • OMAHA, NE 68130
<http://www.modernelectronics.com>

Electronic Training Videos



Learn electronics quickly and easily with UCANDO's computer-animated training videos. Students can learn at their own pace and professionals will find the UCANDO videos to be a valuable source of reference material. If these videos aren't the best learning tools you've ever seen, return them within 30 days for a

complete refund. These videos are being used by Tech-Schools, CET's, Military Branches, Ham Operators, Industries, and more, across the United States and around the world. Order today and see how UCANDO is ...

"Changing The Way The World Learns Electronics."

VCR Maintenance & Repair ... \$29.95 All others ... \$44.95 each
 • Intro to VCR Repair • Direct Current • Alternating Current • Semiconductors • Power Supplies • Amplifiers • Oscillators • Digital 1 • Digital 2 • Digital 3 • Digital 4 • Digital 5 • Digital 6 • AM Radio • FM Radio Part 1 • FM Radio Part 2 • TV Part 1 • Intro to TV • TV Part 2 • "The Front End" • TV Part 3 • Audio • Fiber Optics • Laser Technology •

SAVE!!! 6 videos for only \$240 or 12 videos for only \$450



1-800-678-6113

or mail check or money order to:

UCANDO Videos

P.O. Box 928

Greenville, OH 45331



FREE Shipping ... FREE Catalog

CIRCLE 136 ON FREE INFORMATION CARD

BROADCAST FARTHER !!!

The model 220 is a 80-110MHz RF amplifier that connects to mono or stereo FM transmitters and produces a powerful 2-15 watt signal which could broadcast up to 5 miles or more! Requires 50-150 mW drive. Step by step plans complete with part source information and antenna designs ... **ONLY \$14 PLUS \$2 S&H NO C.O.D.'s**
Progressive Concepts
 BOX 586 STREAMWOOD, IL 60107
 (630)736-9922 FAX: (630)736-0353

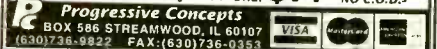

CABLE TV CONVERTERS

Equipment & Accessories
 Wholesalers Welcome

Call C&D ELECTRONICS
 1-888-615-5757 M-F 10a-6p

5 Axis Robotic Arm Kit \$195.00



Build your own functional Robotic Arm
 The kit comes complete with all hardware, base enclosure, structural components, 6 Hitec servos, MiniSSC servo controller kit, Quick Basic software and an illustrated assembly manual. This robotic arm can be controlled from any micro with a serial port! It makes an excellent addition to a small mobile robot base. It is a great foundation for artificial intelligence experiments and teaching motion control. Check out our web site for more information and other robot kits.
 • 3 Axis Version \$155.00 • Mobile Version \$250.00 • Mobile Robots Book \$40.00



10% academic discount! Quantity discounts available. Call for international and quantity shipping charges. \$7.50 S&H charges for USA and Canada. IL residents add 6.25% sales tax to total.

Many more robots, ask for our free catalog

Technical Service & Solutions

104 Partridge Road
 Pekin, IL 61554-1403 USA

Tel: 309-382-1816

Fax: 309-382-1254

www.lynxmotion.com
jfrye@lynxmotion.com



MISCELLANEOUS ELECTRONICS FOR SALE

THE Case Against Patents. Thoroughly tested and proven alternatives that work in the real world. \$28.50. **SYNERGETICS PRESS**, Box 809-C, Thatcher, AZ 85552. (520) 428-4073. Visa/MC.

FM Micro-Broadcasting 88-108MHz. Assembled PLL transmitters and rf amps mono/stereo 1/2-100 watts. Photo catalog/info call (250) 642-2859. **R. SCOTT COMMUNICATIONS, LTD.** We ship world wide from Canada.

SERVICE offered to international clients. We locate, acquire, ship U.S. technical vendor information, equipment, systems, parts to you worldwide. Tell us what you want. Engineering staff. Professional, confidential. Fax today: (806) 792-0207. Or, write **TESCO TECH** Box 53743, Lubbock, Texas, 79453, USA.

PLANS-KITS-SCHEMATICS

TRANSISTOR Data Tables — Given are the basic electronic parameters for the worlds popular transistors in one volume. A must for servicemen, hobbyists and engineers. Order "Transistor Data Tables" (BP401) for only \$9.95 (price includes shipping) from **ELECTRONIC TECHNOLOGY TODAY, INC.**, PO Box 240, Massapequa Park, NY 11762-0240. USA and Canada only. US funds.

CRYSTAL Set Handbook — Visit antiquity by building the radios your grandfather built. Assemble a "Quaker Oats" rig, wind coils that work and make it look like the 1920's! Only \$10.95 plus \$4.00 for shipping and handling. **CLAGGK INC.**, PO Box 4099, Farmingdale, NY 11735. US funds only! USA and Canada — no foreign orders.

HEATH COMPANY is selling photocopies of most Heathkit manuals. Only authorized source for copyright manuals. Phone: (616) 925-5899, 8-4 ET.

ELECTRONIC Project Kits. www.qkits.com. 1 (888) GO-4-KITS, 292 Queen St., Kingston, ON., K7K 1B8. **QUALITY KITS.**

TRANSFER paper for printed circuits with laser or copier, excellent quality. 30 sheets 8.5 X10 with instructions \$24.00, send check or money order to **G. SANTA MARIA**, 1602-A Washington Ave., Suite #915, Miami Beach, FL 33139.

ALL-in-one catalog, 60 mouth-watering pages. CB/HAM/audio/TV/spy/broadcast/science projects, **micropower broadcasting**, broadcast transmitters, amplifiers, antennas, "secret books", start your own radio station and more. Send \$1.00 to **PAN-COM INTERNATIONAL**, PO Box 130-P8, Paradise, CA 95967.

FREE catalog of fascinating electronics! 3D stereo, detectors, testers, tesla, jammers, robotics, much more! **QUANTUM RESEARCH**, 17919-77 Ave., Edmonton, Alberta T5T 2S1.

HOME automation ideas. Ideas, construction projects: speaker switch, vehicle detection, interactive control, speech recordings, more! Send \$15.00 to **CREATIVE CONTROL**, 937 S. Leyden, St., Denver, CO 80224.

ALTERNATIVE free energy (government suppressed) and electronic weapons. Many plans and kits available. Catalog \$1.00. **UNLIMITED UNDERGROUND ELECTRONICS**, 1639-D West Vistaway #515, Vista, CA 92083. nin-teach@incom.net. (619) 414-6631 VM.

CB-SCANNERS

SCANNERS, CB's antennas, accessories. New Trunk Tracking scanners. **HPR**, Box 621136E, Littleton, CO 80162.

TEACH YOURSELF AT HOME

TEACH yourself basic electronics at home. Free information, **HORAN PUBLICATIONS-PE**, 100 Carbon Street, Minersville, PA 17954. (717) 544-6870.

AUDIO-VIDEO-LASERS

VIDEO projectors: Sony VPH-1031Q 250", VPH-1030Q 100", VPH-1020Q 100", Ampro Aquastar 250", \$1,995.00 each. (916) 354-1990.

CABLE TV

CABLE TV equipment & accessories. Wholesalers welcome! 30 day moneyback guarantee! Free catalog! **PERFORMANCE ELECTRONICS, INC.**, 1 (800) 815-1512.

CABLE TV, descramblers, converters. Quantity discounts. 30 day free trial. Competitive prices. Call now! 1 (800) 322-0921 **REGAL SALES, INC.**

CABLE TV descramblers. One piece units. Pioneer 6310's, Scientific Atlanta 8580's, DPV7's and others. Lowest prices. Money back guarantee. Houston, TX (713) 691-4610.

CABLE - test chips; Jerrold; Pioneer; Tocom; Scientific Atlanta, Zenith, Jerrold cubes; Pioneer programmable cubes; **HUDSON**, 1 (800) 863-3237.

WE carry all Regal models, RR-92, RC-83, 550 MHz 99 Ch., DQN7 - 550 MHz 99 Ch., OAK-Micro 550 MHz 99 Ch., BC 4535 550 MHz 86 Ch., SA - 8529 550 MHz 99 Ch., SA - 8540 550 MHz with Vol. Crt. 99 Ch., DRZ-DIC, DP 5, DPV 5, Pioneer 5135 & Zenith 1086. Dealers are welcome. Please call us for the latest price!!!! Or, visit us at our website <http://www.vntechology.com>

MASTER files test modules & cable boxes for all types of CATV converter units. (909) 941-4858.

CONFUSED? Descramblers. Will explain all your options, all makes and models. Wholesale and retail. Open 6 days wk 9AM - 8 PM EST. Best tech support and friendly service. Toll free 1 (800) 238-0967 **ROYAL ENGINEERING INC.**

SMART/Phoenix!!! The most advanced cable FTG's/programmers. Jerrold compatible only. **MAKFI RESEARCH:** 1 (800) 220-3543.

ALL chips \$9.00-\$18.00. Security bits from \$9.95, converters, filters. Lowest price guarantee. Anytime. 1 (800) 760-0555.

SATELLITE EQUIPMENT

BEST pricing on 18" satellite TV systems for home and RV. DSS, DISH Network programming, multi-room viewing options, accessories. Call **SKYVISION®** 1 (800) 500-9264. www.skyvision.com.

MINIDISH Satellite systems, surround sound, big TVs, total home entertainment systems. Discount prices. **STAR VISION DIRECT:** 1 (800) 899-9707, 8am-10pm Pacific.

SECURITY

ELECTRONIC sales of security systems for home, apartment, or business. Will send information. Call (812) 295-4240.

BUSINESS OPPORTUNITIES

START your own technical venture! Don Lancaster's newly updated **Incredible Secret Money Machine II** tells how. We now have autographed copies of the Guru's underground classic for \$18.50. **SYNERGETICS PRESS**, Box 809-C, Thatcher, AZ 85552. (520) 428-4073. Visa/MC.

INVENTIONS, ideas, new products! Presentation to industry/exhibition at national innovation exposition. Patent services. 1-800-288-IDEA.

\$\$\$ millions in scrap gold from old electronics, computers, circuit boards, jewelry, 24 hours: (603) 645-4767.

SATELLITE Television Pays! 18" minidish sales force needed. **STAR VISION DIRECT:** 1 (800) 899-9707, 8am-10pm Pacific.

EASY work! Excellent pay! Assemble products at home. Call toll free 1 (800) 467-5566 Ext. 5730.

Converters & Descramblers Call 1-800-715-6789

30 Day Money Back Guarantee

FREE Catalog



- Panasonic
- Jerrold
- Pioneer
- Zenith
- Scientific Atlanta

ALL MAJOR CREDIT CARDS ACCEPTED

13492 Research Blvd • Suite 120-113 • Austin, TX 78750

\$139* Laser LightShow

Draw with a laser beam! Animation, text, music & more! Includes galvos, mirrors, servo amp, demo software disk, analog and digital computer interface. Use an inexpensive pen pointer or high power gas laser.



Computerized Motors \$39*

Includes: 2 Stepper motors, 2 DC motors, computer interface, training manual, & demo software disk. Expandable! Up to 12 motors, up to 3 amps per phase.

Now with 4 Axis Linear Interpolation

* Add \$6 for shipping, computer with parallel printer port & cable, assembly, power supply, & laser are required

FREE FLYER

Voice 510-582-6602 Fax 510-582-6603

SVS

1273 Industrial Pky West Bldg. 460
PO Box 55125 Hayward CA 94545-0125

CABLE TV CONVERTERS AND DESCRAMBLERS

WE CARRY A FULL LINE OF CONVERTERS AND DESCRAMBLERS COMPATIBLE WITH MOST MAJOR BRANDS INCLUDING:

- Scientific Atlanta™
- Jerrold™
- Tocom™
- Zenith™
- Pioneer™

30 DAY MONEY BACK GUARANTEE
BEST PRICES FREE CATALOG

ALLSTAR ELECTRONICS

800-782-7214

HOURS: 9-6 M-F 10-3 Sat EST

It is not the intent of Allstar Electronics to defraud any pay TV operator. Anyone implying theft of service will be denied assistance. All brand names are registered trademarks of their respective owners & are used for reference only. 110-84 Queens Blvd, #465, Forest Hills, NY 11375. NO NYS SALES.

ADVERTISING INDEX

Popular Electronics does not assume any responsibility for errors that may appear in the index below.

Free Information Number	Page	Free Information Number	Page
25	Ace Communications	—	KSL Microdevices
—	Aegis Research, Canada	150	MCM Electronics
—	AES	—	Mega Electronics
26	Alfa Electronics	147	Mendelson's
28	All Electronics	174	Mental Automation
137	Allison Technology	171	MicroCode Engineering
—	Allstar Electronics	—	Millennium Enterprises
—	Amaze Electronics	—	Mo-Tech Distributors
—	AMC Sales	—	Modern Electronics
—	American Innovations	—	Mondo-tronics
—	Andromeda Research	149	Mouser
—	Basic Electrical Supply	—	National Control Devices
32	C&S Sales, Inc.	—	NRI Schools
—	CD Electronics	—	Orion Electronics
—	Circuit Specialists	156	Parallax
—	Cleveland Institute of Electronics	146	Parts Express
—	Command Productions	175	Pioneer Hill Software
—	Comtrad Industries	45	Prairie Digital Inc.
—	Consumertronics	46	Print
48	Dalbani	47	Print
—	EDE Spy Outlet	14	Radio Shack
148	Electronic Rainbow	—	Silicon Valley Surplus
—	Electronic Technology Today	—	Skyvision Inc.
—	EMAC	—	Smithy Company
—	Foley-Belsaw	—	Starlet Systems
—	Forest Electronics	—	Street Smart Security
—	Fotronic Corporation	—	Tab Books
—	General Device Instruments	—	Tech Services & Solutions
—	George Brown College	144	Telulex
—	Grantham College of Engineering	136	UCANDO Videos
—	Greenleaf Electronics Inc.	—	US Cyberlab
—	Home Automation Systems	—	Vision Electronics
176	Howard W. Sams & Company	—	Visual Communications
—	Information Unlimited	—	Weeder Technologies
13	Interactive Image Technologies	—	Weka Publishing
—	Intronics, Inc.	—	WPT Publications
—	Kableworks	134	Xandi Electronics
—	KDE Electronics	—	Xillion

ADVERTISING SALES OFFICES

Gernsback Publications, Inc.
500 Bi-County Blvd.
Farmingdale, NY 11735-3931
1-(516) 293-3000
Fax 1-(516) 293-3115

Larry Steckler, EHF/CET
President (ext. 201)
e-mail advertising@gernsback

Christina Estrada
Assistant to the President (ext. 209)

For Advertising ONLY
1-516-293-3000
Fax 1-516-293-3115

Larry Steckler
publisher

Arline Fishman
advertising director (ext. 206)

Michele Torriolo
advertising assistant (ext. 211)

Adria Coren
credit manager (ext. 208)

**Subscription/
Customer Service/
Order Entry**
1-800-827-0383
7:30 AM - 8:30 PM EST

ADVERTISING SALES OFFICES EAST/SOUTHEAST

Stanley Levitan
Eastern Sales
1 Overlook Ave.
Great Neck, NY 11021-3750
1-516-487-9357, 1-516-293-3000
Fax 1-516-487-8402
slevitan26@aol.com

MIDWEST/Texas/Arkansas/ Oklahoma, Colorado, Arizona

Ralph Bergen
Midwest Sales
One Northfield Plaza, Suite 300
Northfield, IL 60093-1214
1-847-559-0555
Fax 1-847-559-0562
bergenrj@aol.com

PACIFIC COAST/Mountain States

Anita Bartman
Hutch Looney & Assoc., Inc.
6310 San Vicente Blvd.
Suite 360
Los Angeles, CA 90048-5426
1-213-931-3444 (ext. 227)
Fax 1-213-931-7309

BASIC STAMP[®] COMPUTERS

Tiny computers run PBASIC[™] programs

Visit us on the World Wide Web!

You'll Find:

- New Product News
- Application Notes
- Software Updates
- Customer Apps



<http://www.parallaxinc.com>



Little Green Men from Mars

Bjarne Bergheim, Ken Christian, William Jackson, and Ben Strayer worked on "the Flying Saucer Project" at the University of California, Irvine. Their project, which used two BASIC Stamp II modules, was a literal flying saucer. Although not as dramatic as Hollywood versions, their saucer did indeed fly! And fortunately, it didn't come on Independence Day.

BASIC Stamps[™] are component-sized computers that run PBASIC programs. They have 8 or 16 I/O lines, which can be used for a variety of digital and analog purposes. And their language is both familiar and extensive, including FOR...NEXT, IF...THEN, and GOTO, as well as XOUT, SHIFTOUT, DTMFOUT, and other special commands.

If you've heard about BASIC Stamps, but never took the plunge, now you can do so for less. We now offer a popular "Starter Kit" ranging from just \$79 to \$149. The kit contains everything you need to get your feet wet with BASIC Stamps.



FaxBack #6002

BS1-IC Module

8 I/O lines
80 instructions max.
2000 instructions/sec.
2400 baud serial I/O
14-pin SIP module

I/O instructions for pushbuttons, potentiometers, pulse measurement, PWM, serial I/O, sound, etc.



FaxBack #6002

\$34 BS2-IC Module \$49

16 I/O lines
500 instructions max.
4000 instructions/sec.
50k baud serial I/O
24-pin DIP module

Same I/O instructions as BS1, plus touch-tones, frequency generation, pulse counting, serial shift registers, X-10 powerline control, etc. I/O functions common to both modules have a higher resolution on the BS2-IC, due to its faster clock speed.

Parallax now offers Basic Stamp[®] Starter Kits.

All Starter Kits require use of an IBM PC running DOS.



New!

BASIC Stamp[®] Rev. D Kit \$79

Get started with Rev. D Stamps. Includes our original BASIC Stamp rev. D, manual, software, and programming cable.



New!

Basic Stamp[®] 1 Starter Kit \$99

Design your project today using the Basic Stamp 1. Includes a BS1-IC, carrier board, manual, software, and programming cable.



New!

Basic Stamp[®] 2 Starter Kit \$149

Take advantage of all the cool features of the Basic Stamp 2. This Starter Kit includes the BS2-IC, carrier board, manual, software, and programming cable.

For more information on the Starter Kits visit our Website at:
<http://www.parallaxinc.com>

PARALLAX  (888) 512-1024

3805 Atherton Road, #102 • Rocklin, CA 95765 • USA
Office/Tech.: (916) 624-8333 • Fax: 624-8003 • FaxBack: 624-1869
E-mail: info@parallaxinc.com • Web address: <http://www.parallaxinc.com>

Australia +61 39 720 5344, +61 67 722 777 • Austria +49 241 918 90 0 • Belgium +32 4 377 5151 • Bulgaria +359 2 72 77 50 • Brazil +55 11 453 5588, +55 11 801 0045 • Canada (514) 336-9426 • Czech Republic +42 49 5813 252 • Finland +358 31 266 1885 • France +33 3 20 52 98 52 • Germany +49 241 918 90 0 • Greece +30 1 902 0115 • Hungary +36 1363 6676 • India +91 422 232 561 • Ireland +44 1 977 683 665 • Israel +972 3 498 543 • Italy +39 0542 55400 • Japan +81 3 3251 1779 • Netherlands +31 10 450 4949 • New Zealand +61 39 720 5344, +61 67 722 777 • Poland +48 34 648 882 • Singapore +65 296 3995 • Slovak Republic +42 7 580 2574 • South Africa +27 11 493 6242 • Sweden +46 70 576 14 54, +46 431 41 00 88 • Switzerland +49 241 918 900 • Taiwan +886 2 647 1978 • United Kingdom +44 1 977 683 665 • United States (800) 344-4539 (Digi-Key), (800) 831-4242 (Jameco), (800) 538-5000 (JDR), (800) 652-6733 (Marlin P. Jones), (800) 467-7736 (DC Electronics), (415) 455-9330 (Mondo-Tron cs).

PBASIC, BS1-IC, and BS2-IC are trademarks and BASIC Stamp & the Parallax logo are registered trademarks of Parallax, Inc. Prices do not include shipping and applicable sales tax • Features and prices subject to change without notice. • Prices are U.S. prices only; prices in other countries may vary.

CIRCLE 156 ON FREE INFORMATION CARD

0497PESR

The **Only** Complete Virtual Electronics Lab™

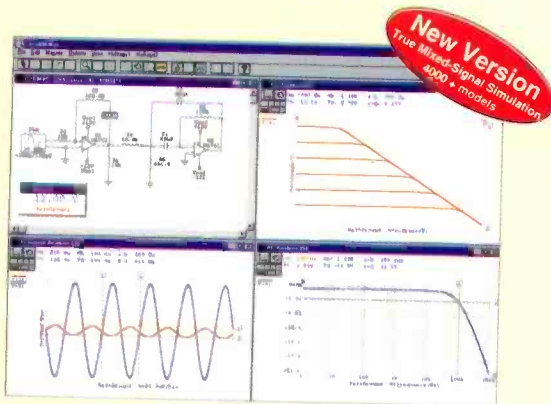

CircuitMaker 5

The Fastest, Most Accurate, True Mixed-Signal SPICE Simulator

CircuitMaker is a virtual electronics lab where you can quickly and easily design and verify digital, analog and true mixed-mode circuits. You layout your circuit design as a schematic, connecting an assortment of over 4000 indestructible components. Click on the simulation button and view the results as if you were looking at real laboratory instruments. It really is that easy!

New users love CircuitMaker's user friendly environment and short learning curve. Experienced users appreciate its time saving features and respect its accurate simulation and numerous in-depth analysis capabilities. No matter what level of electronics you are at, CircuitMaker, The Virtual Electronics Lab, will match your needs. We are so confident you will love its performance that we back every copy with our iron clad satisfaction guarantee!

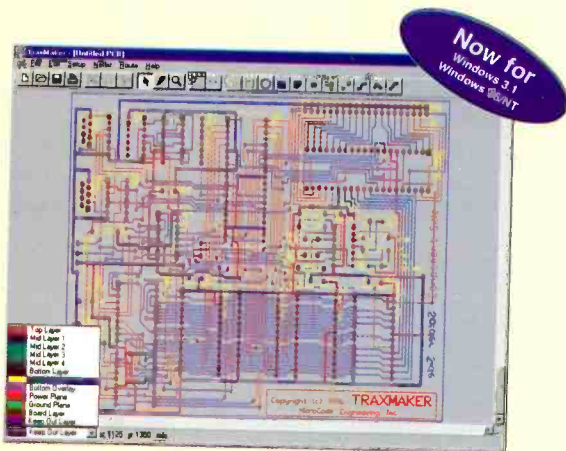

TraxMaker 2

The Most Affordable, Professional Quality, PCB Design Tool

TraxMaker is a Printed Circuit Board (PCB) layout program with advanced features such as a built-in autorouter, 8 layer capability, support for surface mount devices, and full design rule checking. Most importantly, TraxMaker provides these features while remaining exceptionally easy to use.

TraxMaker is a truly cost effective package which is sure to handle your most demanding PCB design tasks. TraxMaker can be used as a stand-alone product or with compatible schematic capture products. When used in conjunction with CircuitMaker, TraxMaker completes a powerful start to finish circuit design system. TraxMaker provides more power than any other product in its class!



CircuitMaker CBT

Electronics Training Featuring An Award Winning Curriculum

MicroCode Engineering and Lab-Volt Systems present CircuitMaker CBT comprising 28 analog and digital lessons organized into four modules covering DC Concepts, AC Concepts, Analog Device Concepts and Digital Device Concepts. This is not another one of those "textbooks on a computer", rather it is an interactive presentation in an intuitive multimedia CD ROM format providing over 200 virtual labs simulated in CircuitMaker.

The award winning curriculum provides the most powerful teaching/learning tool for electronics available today. This complete electronics program includes on-line instruction and testing, workbooks, and virtual labs. Best of all, you do not have to purchase any expensive laboratory equipment to have an exciting and accurate electronics training program. CircuitMaker CBT will help the user learn and understand electronics and troubleshooting of both analog and digital circuits. We guarantee it!

Total Customer Satisfaction

At MicroCode Engineering we are committed to total customer satisfaction. When you purchase one of our products you have the confidence of knowing that a trained staff of professionals is available to serve you after the sale. Our free unlimited customer service is second to none! Whether you have general or technical questions they will be answered promptly by a knowledgeable representative.

FREE Functional Demo

Additional literature and free functional demos of our products are available on the Internet at <http://www.microcode.com> and on CompuServe (GO MICROCODE).

CircuitMaker - \$299 TraxMaker - \$299

CircuitMaker CBT - \$75 per module

Call now to order or
request additional information
800-419-4242

