

HIGH-TECH BUILDING SECURITY

Popular Electronics®

December 1996

A **Holiday** **Gift Guide**

Find the right electronic gifts
for everyone on your list

Build the **Light Animator**

Add some motion to your Christmas
lights this year

Build the **Color-Blind Illusion**

This "magic" trick
will fool just
about anyone

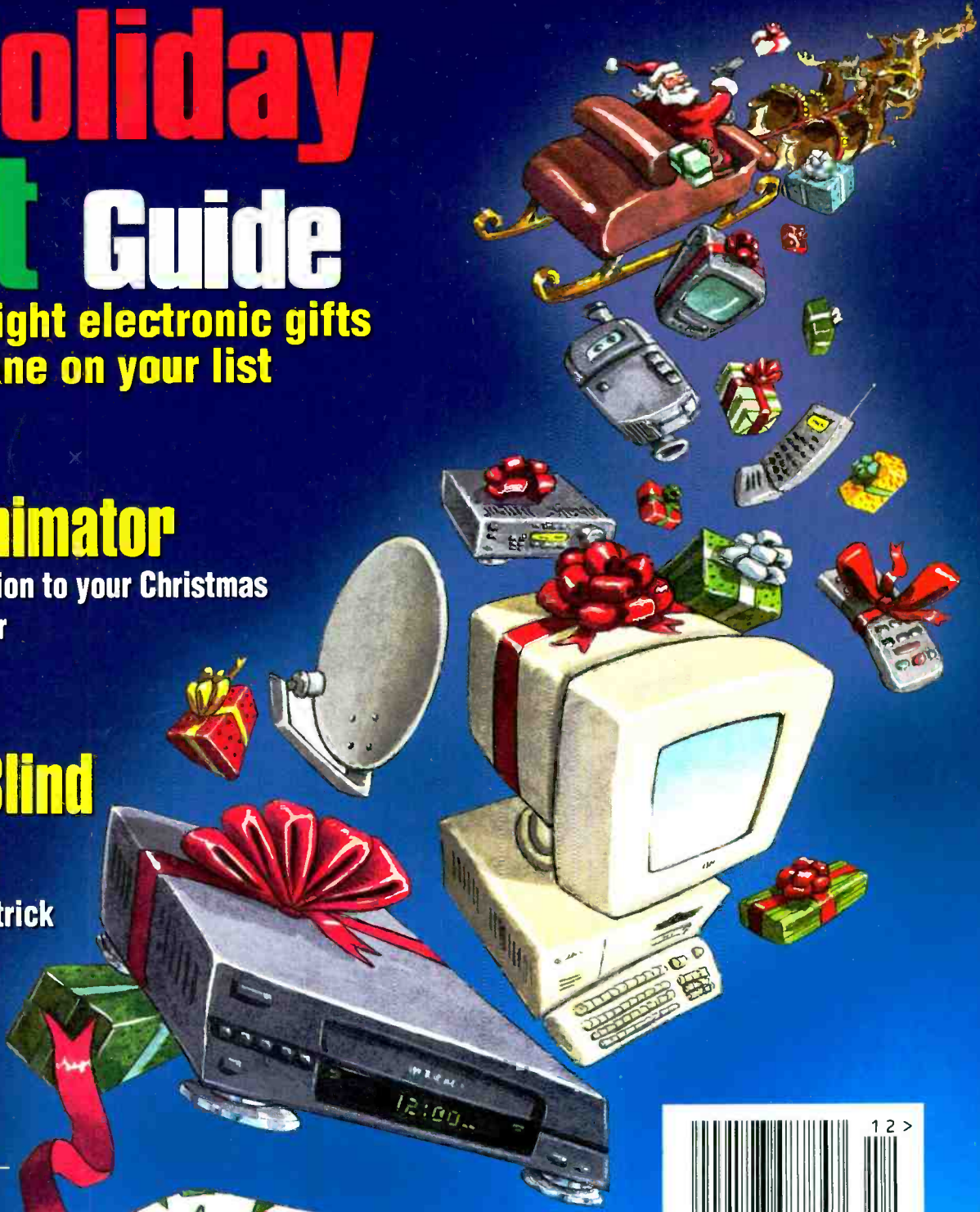

 A GERNSBACK
PUBLICATION

\$3.99 U.S.
\$4.50 CAN.



Better Designs —Faster

Guaranteed with Electronics Workbench!

Just click and drag to create and edit schematics. Mix analog and digital devices in any combination with full control over values, models and behavior. Try 'what if' scenarios and fine tune effortlessly. And on-screen waveforms always match actual circuit response. You'll create better designs faster — *Guaranteed!*

Guaranteed Satisfaction

Join over 70,000 customers and experience the power, flexibility and value that only Electronics Workbench offers. Receive unequalled service and free, unlimited technical support by phone, fax, e-mail, WWW, CompuServe and BBS. You'll be delighted. We guarantee it.*

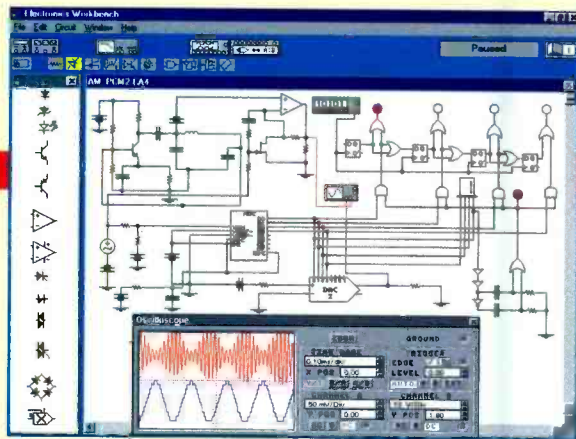

True Mixed-Mode Power

Connect any analog or digital device to any other device without limit. Only Electronics Workbench offers this professional power for under \$2,000.

Real-World Digital

Real-world TTL and CMOS, complete with propagation delays and fanout. Unique at this price.

32-Bit Speed

Integrated SPICE analog and native-mode digital simulation in full 32-bit. Unique at this price.

Real-World Results

Unlimited supply of over 200 components and ICs and 350 real-world models — all perform as real devices.

Electronics Workbench®

\$299

*30-DAY MONEY-BACK GUARANTEE

VERSION 4.1 FOR WINDOWS 95/NT/3.1, DOS AND MACINTOSH.

Ask about our Engineer's Pack with thousands of additional models and more. Version 4.0 users call for your free upgrade.

800-263-5552



Fax: 416-977-1818 Internet: <http://www.interactiv.com>
CompuServe: 71333,3435/BBS: 416-977-3540/E-mail: ewb@interactiv.com

INTERACTIVE IMAGE TECHNOLOGIES LTD., 908 Niagara Falls Boulevard, #068, North Tonawanda, New York 14120-2060/Telephone 416-977-5550
TRADEMARKS ARE PROPERTY OF THEIR RESPECTIVE HOLDERS. OFFER IS IN U.S. DOLLARS AND VALID ONLY IN THE UNITED STATES AND CANADA. ALL ORDERS SUBJECT TO \$15 SHIPPING AND HANDLING CHARGE

Australia: 2-519-3933 • Belgium: 2-384-73-09 • Brazil: 11-453-5588 • Canada: 416-977-5550 • Chile: 2-236-0300 • Cyprus: 9-641-801 • Czech Republic: 4-823-454 • Denmark: 33-25-0109 • Finland: 0-297-5033
France: 1-49-08-90-00 • Germany: 711-62-7740 • Greece: 1-524-9981 • Hungary: 1-215-0082 • India: 11-578-7055 • Indonesia: 21-470-0815 • Israel: 3-647-5613 • Italy: 11-437-5549 • Japan: 3-5395-2126
Malaysia: 3-774-2189 • Mexico: 5-593-5260 • Netherlands: 10-450-4949 • New Zealand: 9-267-1756 • Norway: 22-16-70-45 • Philippines: 973-27-0118 • Portugal: 1-814-6609 • Singapore: 777-2303 • Slovenia: 61-317-830
South Africa: 331-6-8309 • South Korea: 2-3452-9757 • Spain: 1-383-8335 • Sweden: 8-740-5500 • Taiwan: 2-366-0080 • Thailand: 2-398-6952 • UAE: 4-453505 • UK: 203-23-3216 • USA: 416-977-5550

CIRCLE 13 ON FREE INFORMATION CARD

Popular Electronics®

DECEMBER 1996

Vol. 13, No. 12



A GERNSBACK
PUBLICATION

C O V E R S T O R Y

23 A Holiday Gift Guide

Let us help you find the right electronic gifts for everyone on your shopping list. There's something in this guide that's sure to match just about every budget and interest—*Teri Scaduto and Christopher Scott*

C O N S T R U C T I O N

32 Build the Light Animator

If you want to add some motion and excitement to your Holiday lighting this year, this is the project for you. This circuit will control up to eight strings of lights, letting you create unique animated displays that will make your house the talk of the neighborhood—*Rodrick Seely*

43 Build the Color-Blind Illusion

Here's a neat little "magic" trick that will fool just about anyone. It's an electronic version of the old three-card Monte con game that will keep your friends puzzled for hours. Like those who witness any good illusion, those in your "audience" won't be able to believe their eyes—*Rick Duker*

F E A T U R E S

39 High-Tech Electronic Building Security

What can technology do to prevent terrorism and crime? You'll find some answers to that and other questions here as we explore how electronics help provide public safety by detecting guns, explosives, and bad guys before they get a chance to enter a building—*Bill Siuru*



Page 23



Page 32



Page 39

POPULAR ELECTRONICS (ISSN 1042-170-X) Published monthly by Gernsback Publications, Inc. 500 B-County Boulevard, Farmingdale, NY 11735. Second-Class postage paid at Farmingdale, NY and at additional mailing offices. One-year, twelve issues, subscription rate U.S. and possessions \$21.95, Canada \$28.84 (includes G.S.T. Canadian Goods and Services Tax Registration No. R125166280), all other countries \$29.45. Subscription orders payable in U.S. funds only, International Postal Money Order or check drawn on a U.S. bank. U.S. single copy price \$3.50. Copyright 1996 by Gernsback Publications, Inc. All rights reserved. Hands-on Electronics and Gizmo trademarks are registered in U.S. and Canada by Gernsback Publications, Inc. Popular Electronics trademark is registered in U.S. and Canada by Electronics Technology Today, Inc. and is licensed to Gernsback Publications, Inc. Printed in U.S.A.

Postmaster: Please send address changes to Popular Electronics, Subscription Dept., P.O. Box 338, Mount Morris, IL 61054-9932

A stamped self-addressed envelope must accompany all submitted manuscripts and/or artwork or photographs if their return is desired should they be rejected. We disclaim any responsibility for the loss or damage of manuscripts and/or artwork or photographs while in our possession or otherwise.

As a service to readers, Popular Electronics publishes available plans or information relating to newsworthy products, techniques, and scientific and technological developments. Because of possible variances in the quality and condition of materials and workmanship used by readers, Popular Electronics disclaims any responsibility for the safe and proper functioning of reader-built projects based upon or from plans or information published in this magazine.

PRODUCT REVIEWS

16 Product Test Report

Hitachi VT-FX613A Hi-Fi VCR

COLUMNS

8 Multimedia Watch

Checking your Blood Pressure via PC—*Marc Spiwak*

12 Net Watch

Holiday Shopping Spots—*Dan Karagiannis*

48 Computer Bits

Hypertext Wrap-Up—*Jeff Holtzman*

51 Antique Radio

Antique Radio on the Internet—*Marc Ellis*

54 Think Tank

Block Diagrams and Readers' Requests—*John Yacono*

58 DX Listening

Far East Broadcasting Company—*Don Jensen*

60 Ham Radio

An Old Friend Revisited—*Joseph J. Carr*

62 Circuit Circus

More Crystal Sets—*Charles D. Rakes*

66 Scanner Scene

Eavesdropper's Delight—*Marc Saxon*

DEPARTMENTS

4 Editorial

6 Letters

21 New Products

68 Electronics Library

71 Popular Electronics Market Center

102 Advertiser's Index

102A Free Information Card

Larry Steckler, BHF, CET,
editor-in-chief and publisher

EDITORIAL DEPARTMENT

Dan Karagiannis, editor

Teri Scaduto, assistant editor

Evelyn Rose, editorial assistant

Joseph J. Carr, K4IPV,
contributing editor

Marc Ellis, contributing editor

Jeffrey K. Holtzman,
contributing editor

Don Jensen, contributing editor

Charles D. Rakes,
contributing editor

Marc Saxon, contributing editor

Marc Spiwak, contributing editor

John Yacono, contributing editor

PRODUCTION DEPARTMENT

Ruby M. Yee, production director

Ken Coren,
desktop production director

Lisa Baynon, desktop production

Kathy Campbell,
production assistant

ART DEPARTMENT

Andre Duzant, art director

Russell C. Truelson, illustrator

CIRCULATION DEPARTMENT

Jacqueline P. Cheeseboro,
circulation director

Theresa Lombardo,
circulation assistant

Michele Torrillo,
POPULAR ELECTRONICS bookstore

**BUSINESS AND EDITORIAL
OFFICES**

Gernsback Publications, Inc.
500 Bi-County Blvd.
Farmingdale, NY 11735
1-516-293-3000
FAX: 1-516-293-3115

Web: <http://www.gernsback.com>
President: **Larry Steckler**

**SUBSCRIPTION
CUSTOMER SERVICE/
ORDER ENTRY**

1-800-827-0383
7:30 AM - 8:30 PM EST

**Advertising Sales Offices
listed on page 102**

Composition by Mates Graphics

Cover by Loewy Design
Cover Illustration by Scott Pallack



Since some of the equipment and circuitry described in POPULAR ELECTRONICS may relate to or be covered by U.S. patents, POPULAR ELECTRONICS disclaims any liability for the infringement of such patents by the making, using, or selling of such equipment or circuitry, and suggests that anyone interested in such projects consult a patent attorney.

Connect with Barnes & Noble.

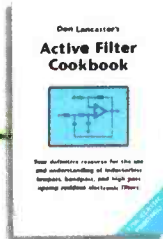

Don Lancaster's Active Filter Cookbook
by Don Lancaster
Here's one of the bestselling active filter books of all time. Microcomputer pioneer Don Lancaster explains everything you need to know to build active lowpass, bandpass and highpass filters. (Synergetics Press)
Price \$29.95

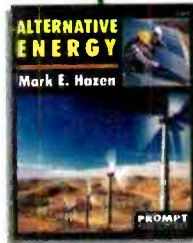

Alternative Energy
by Mark E. Hazen
A thorough introduction to the subject of energy, this informative book not only addresses transducers and the five most common sources of energy, but also explores solar, geothermal and nuclear energy. (Prompt)
Price \$18.95



The Howard W. Sams Troubleshooting & Repair Guide to TV
Perfect for instructors or anyone trying to learn TV repair, this fully illustrated, up-to-date guide includes all makes of TVs. You'll find coverage of common TV symptoms and helpful timesaving features. (Prompt)
Price \$29.95

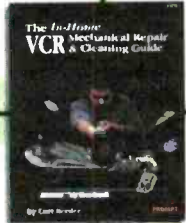

The In-Home VCR Mechanical Repair & Cleaning Guide
by Curt Reeder
Need help maintaining your VCR? Clearly written chapters on repairing and cleaning will teach you tricks and secrets for keeping your VCR in tip-top shape. (Prompt)
Price \$19.95

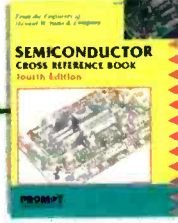

Semiconductor Cross Reference Book, Fourth Edition
Engineers and technicians will find revised and updated information on all major types of semiconductors—including BJTs, ICs, SCRs and LEDs—as well as more than 490,000 part, type and other identifying numbers. (Prompt)
Price \$24.95

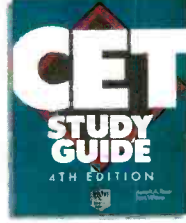

CET Study Guide, 4th Edition
by Joseph A. Risse and Sam Wilson
An essential resource for those preparing to take a Certified Electronics Technician (CET) exam, this guide reviews three-terminal amplifying components, digital and linear circuits and more, and provides three helpful practice exams. (McGraw-Hill)
Price \$19.95

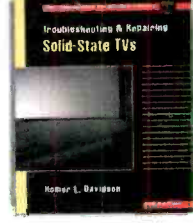

Troubleshooting & Repairing Solid-State TVs, 3rd Edition
by Homer L. Davidson
Detailed illustrations and photographs as well as complete, up-to-date information make it simple for technicians and electronic hobbyists to solve any TV problem quickly and easily. (McGraw-Hill)
Price \$24.95



Electronics, 2nd Edition: A Self-Teaching Guide
by Harry Kybett
Learn the basics of electricity and electronic components. Using the easy-to-follow chapters, various examples and self quizzes, you can master the simple concepts as well as more advanced circuits—all at your own pace. (Wiley)
Price \$19.95

Barnes & Noble

Booksellers Since 1873

CIRCLE 163 ON FREE INFORMATION CARD

EARN YOUR B.S. DEGREE IN COMPUTERS OR ELECTRONICS



By Studying at Home

Grantham College of Engineering, now in our 46th year, is highly experienced in "distance education"—teaching by correspondence—through printed materials, computer materials, fax, modem, and phone.

No commuting to class. Study at your own pace, while continuing on your present job. Learn from easy-to-understand but complete and thorough lesson materials, with additional help from our instructors.

Grantham offers three separate distance-education programs, leading to the following accredited degrees;

(1) The B.S.E.T. with Major Emphasis in Electronics.

(2) The B.S.E.T. with Major Emphasis in Computers.

(3) The B.S.C.S. — the Bachelor of Science in Computer Science.

An important part of being prepared to *move up* is holding the right college degree, and the absolutely necessary part is knowing your field. Grantham can help you both ways—to learn more and to earn your degree in the process.

Write or phone for our free catalog. Toll free, 1-800-955-2527, or see mailing address below.

Accredited by
the Accrediting Commission of the
Distance Education and
Training Council

GRANTHAM
College of Engineering
Grantham College Road
Slidell, LA 70460

Editorial

Here Come the Holidays

The wheel of the year has spun around once again, and the Holiday season is upon us. It's a time for being with loved ones, sharing gifts, and for enjoying light and warmth in the dark, cold nights of winter. In keeping with the spirit of this magical time of year, **Popular Electronics** would like to offer some ways to make the season a bit more enjoyable.

First there's our Holiday Gift Guide. After all, before we can get to those relaxing days around the end of the year, there are quite a lot of shopping days to get through! This Guide should help you find just the right electronic present for each loved one on your list. Whoever's been nice and not naughty will really appreciate the goodies in these pages. The story begins on page 23.

Then, for those who like to keep their soldering irons warm, we have a project that's sure to brighten up the Holidays. Called the Light Animator, it's a circuit that can control up to eight strings of lights, making them appear to "move." This allows you to make some great looking displays. Create a waving Santa, shooting stars, or whatever else you think will enhance the look of your home, and bring some cheer to your block. The story begins on page 32.

Also, to help with your shopping needs, this month's *Net Watch* focuses on a couple of hot spots on the Web where you can do your Holiday gift buying. If you'd prefer not to put up with long lines in stores (and sometimes even in parking lots), you should check out this column, which begins on page 12.

On behalf of everyone at **Popular Electronics**, I'd like to wish you and yours a very happy Holiday season.

Dan Karagiannis
Editor

CircuitMaker[®]

The Virtual Electronics Lab[™]

The screenshot displays the CircuitMaker software interface. On the left is a vertical toolbar with icons for various functions. The main workspace is divided into several panes:

- Schematic Diagram:** Shows an analog circuit with components like resistors (R1-R6), capacitors (C1, C2), and operational amplifiers (UA741, UA742).
- DC Analysis (4):** A graph showing a linear relationship between input and output voltage.
- Transient Analysis (2):** A graph showing two periodic waveforms, one blue and one red.
- AC Analysis (5):** A graph showing the magnitude of the transfer function versus frequency.

 On the right side, there is a smaller window titled 'Count down to launch' showing a rocket launch sequence, and another window showing an 'Alarm' circuit diagram.

New For
Windows 95/NT
VERSION 4
Enhanced For
Windows 3.1x

Professional Schematic Layout

CircuitMaker's schematic capabilities are unmatched and include many advanced editing features not found in similar programs. These powerful features minimize the time and task associated with drawing a schematic and insure a professional looking final product. Printout and export options are numerous and results are of the highest quality. But that's what people have come to expect from CircuitMaker.

Unlimited, Indestructible Devices

CircuitMaker ships with over 1500 devices. That's more (at no additional cost) than any competing product. If you need a device that is not included, CircuitMaker provides industry standard SPICE import and a powerful macro capability. These indestructible devices accurately emulate actual devices and enable the user to try all those "what if" scenarios with no risk and at no additional cost.

Accurate Simulation & Advanced Analysis

CircuitMaker features analog, digital and mixed-mode simulation. Obviously, simulation is of no value if the results are not accurate. CircuitMaker's simulation engine is based on Berkeley SPICE3, which is renowned for its accuracy. That's why we can factually state that CircuitMaker provides its user with the most accurate simulation available. Furthermore, CircuitMaker provides a wealth of analysis capabilities not found in other products in its class. No other product offers this much simulation muscle at such a reasonable price.

Printed Circuit Board Output

CircuitMaker's PCB output capability helps you complete your design cycle, by generating a netlist that can be imported into any compatible PCB program. This is not a costly "add-on module", it comes standard with every copy of CircuitMaker. MicroCode Engineering also offers TraxMaker, a professional level, PCB layout and autorouting program for just \$299. Used in conjunction with CircuitMaker, TraxMaker completes a powerful end-to-end circuit design system.

Advanced Schematic Capture
Digital, Mixed-Mode Simulation
Full SPICE Compatibility
SPICE Export/Import
PCB Export
Retail Price

	Advanced Schematic Capture	Digital, Mixed-Mode Simulation	Full SPICE Compatibility	SPICE Export/Import	PCB Export	Retail Price
CircuitMaker	YES	YES	YES	YES	YES	\$299
Electronics Workbench version 4	YES	NO	YES	NO	NO	\$299
Electronics Workbench Engineer's Pack	YES	NO	YES	NO	YES	\$599

"CircuitMaker Shocks The Competition, With An Unbeatable Bottom-line"

Total Customer Satisfaction

At MicroCode Engineering we are committed to total customer satisfaction. When you purchase CircuitMaker you have the confidence of knowing that a trained staff of professionals is available to serve you after the sale. Our free unlimited customer service is second to none! Whether you have general or technical questions they will be answered promptly by a knowledgeable representative.

FREE Functional Demo

A free functional demo is available on the Internet at <http://www.microcode.com>, on CompuServe (GO MICROCODE) and on America Online by doing a file search for CircuitMaker.

Call now to order or
request additional information
800-419-4242



LETTERS

The Naming Game

A MISNAMED CIRCUIT

The circuit described as a clamping circuit (*Circuit Circus*, **Popular Electronics**, June 1996) is not a clamping circuit. It is a shunt clipper.

The circuit clips off the signal above or below a certain level (in this case, at the cut-in voltage of the diode because it is unbiased) by effectively shorting out the output. In general, the peak-to-peak voltage of the signal is reduced.

In the case of a clamping circuit, the average or DC level is shifted, but the peak-to-peak voltage stays about the same. A clamping circuit has a capacitor in addition to the diode.

S.B.D.

Teaneck, NJ

THINK TANK ALARM CIRCUIT

There are some errors in my Think Tank alarm circuit in the September 1996 issue. See Fig. 5 on page 67 of that issue. Switch S12 should allow you to switch R14 to ground, not +12V. Also, switches S5 through S7 should be labeled as "normally closed," and switches S9 through S11 should be labeled "normally open."

Here's an extra suggestion for the circuit: At a remote location where the alarm siren may not be heard, the relay's +12V line could be used to trigger an automatic phone dialer, available at RadioShack. Some of the alarm switches could also be wired to temperature sensors to warn of too high or low a reading at a site.

Thanks.—Roger W. Hamel

HAVES & NEEDS

I'm searching for an SN 74185 AN IC that is no longer being manufactured. It is an essential component in an electronic scoreboard that I am maintaining.

I only need one. I'd be delighted to pay shipping and handling costs as well as a reasonable price for a functional chip.

Many thanks.

RICHARD J. SCHEICH
20220 Beaufait
Harper Woods, MI 48225

I have been in electronics for more than 50 years, and a subscriber to Gernsback publications as well.

Now I am trying to locate an RCA part #158770 42-pin IC for an RCA Model PJR-500-SR TV made in 1984. The chip is labeled NEC 8351E6/D1705C-520.

I will pay the cost of the chip as well as shipping. Please help!

Thanks.

HOLLAND BOST
310 Deer Haven Drive
China Grove, NC 28023

I have a DeForest DT-600 crystal set without the box, and I'm wondering if anyone might have one. I also need a case for a World War I crystal set, Signal Corp BC-14A. I will pay a fair price.

Thank you.

GALEN FEIGHT
3104 S.E. 20th
Portland, OR 97202

I repair my own household appliances, but I've been having trouble fixing my TV because I don't have the schematic diagram of it. The TV set I own is a Zenith System-3 model 14-1167-8.

I'd be very grateful if any readers would send me a copy of the diagram.

I'd gladly pay for all costs.

MIGUEL A. TORRES
1308 Bayview Circle
Ft. Lauderdale, FL 33326-3336

We have enjoyed **Popular Electronics** over the years, and we hope some fellow readers might be able to help us out.

We deal in old televisions and need a source of short-run, custom-built flybacks. We're also seeking someone who rebuilds electrostatic CRTs.

Can anyone possibly supply leads?

Thank you.

HARRY POSTER
VINTAGE TV's AND RADIOS
P.O. BOX 1883
South Hackensack, NJ 07606

I have enjoyed reading **Popular Electronics** for many years now and hope you will continue its winning format. Please don't become another computer magazine!

I need help with the following items. I'm seeking a manual for a Tektronix 549 storage oscilloscope and operating instructions for the storage function. I also need schematics for a Model 6050A power supply from Power Designs Inc. (Westbury, NY), and a Data Pulse 101 pulse generator made by Systron Donner Corp. of Culver City, California.

I also have a couple of items that might be of interest to other readers. I have a 1973 booklet written by Don Lancaster (TV Typewriter) that I will send to someone if \$1.50 in postage is included. And I have for sale the 1821A time-base and sweep delay generator with 1804A four-channel vertical amplifier plug-in for Hewlett-Packard oscilloscopes models HP 180 or 181 or OS-189/USM 281. Anyone interested can write to me for the price.

Thank you very much.

CRAIG KENDRICK SELLEN
RR-1 58-B BOX 1038
Waymart, PA 18472-1038

KEEP IN TOUCH

Now there are more ways than ever to contact us at **Popular Electronics**.

You can write to:

Letters
Popular Electronics
500 Bi-County Blvd.
Farmingdale, NY 11735

Or you can send e-mail to:

peeditor@gernsback.com

And don't forget to visit to our Web site at:

<http://www.gernsback.com>

Convert any electrical outlet into a high-speed Internet gateway...

The Wireless Modem Jack, from Phonex Corporation, turns an outlet into a phone jack, letting you connect your modem in every room of your home!

by Mark Peters

Although we both have full-time jobs, my wife and I enjoy having a home office. Whether it's balancing the checkbook, bringing work home or "surfing" the Internet, we spend an hour or two on our computer each evening.

The dilemma. In our new house, there were only three jacks in the house—one in the downstairs bedroom, one in the kitchen and a third in the master bedroom upstairs. We wanted our office in one of the upstairs bedrooms, but obviously not our bedroom. We discussed our options—run a phone line ourselves from one jack through the walls and ceiling, pay the phone company to install a jack or put our office in the downstairs bedroom. None of those scenarios were acceptable, but what choice did we have?

The solution. Phonex Corporation is proud to unveil the answer to this dilemma. It's called the Wireless Modem Jack—an amazing device that turns any electrical outlet into a phone jack instantly.

Easy installation. In less than five minutes, you'll have your Wireless Modem Jack completely installed. Plug the transmitter (the unit with two jacks on the right side) into an electrical outlet that's close to a phone jack. Then connect it, with the enclosed six-foot phone line, to that jack. Then simply plug your telephone into the transmitter's second port, and the Wireless Phone Jack is ready to transmit. Now just plug the receiver

(the unit with just one jack on the side) into any electrical outlet in your home, plug your modem in it and bingo! You've just converted an electrical outlet to a phone jack.

Complete freedom. The Wireless Modem Jack gives you the true "freedom" you've wanted when it comes to your home office equipment. No more are you constrained by the location of traditional phone jacks in your home. No more expensive phone company visits. No more miles of phone line woven around the inside and outside of your home. The Wireless Modem Jack lets you turn an outlet in any room in your home into a modem gateway in a few minutes.

High-speed access. The Wireless Modem Jack can support a 28,800-baud modem, perfect for surfing the Internet. You didn't settle for a bottom-of-the-line modem, so why would you want a wireless jack device that couldn't support it? The Wireless Modem

PLUG YOUR MODEM INTO ANY OUTLET...

1 Connect the transmitter by plugging it into a phone jack and an outlet. Plug your phone into the transmitter.

2 Adding a receiver is easy! Plug it into an outlet and connect your modem. Now you can fax or access the Internet from any room in your home! (For fax modem applications, you must manually receive faxes.)

HOW THE WIRELESS MODEM JACK CAN SET YOU FREE

With all the advancements that are being made in terms of the portability of your personal computer equipment, why should you be tied down to a phone jack? Unlike electrical outlets, phone jacks are scarce in most homes. That's where the Wireless Modem Jack comes in. Just plug the transmitter into a phone jack and an outlet. Then plug a receiver

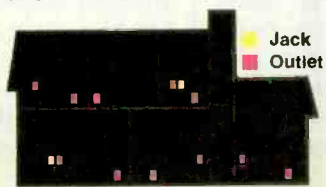

into any outlet into your home and it instantly becomes a phone jack! Plug it into your modem, and with its 28,800-baud capabilities, you'll be "surfing" with the same speed and clarity as if you were plugged into a standard jack.

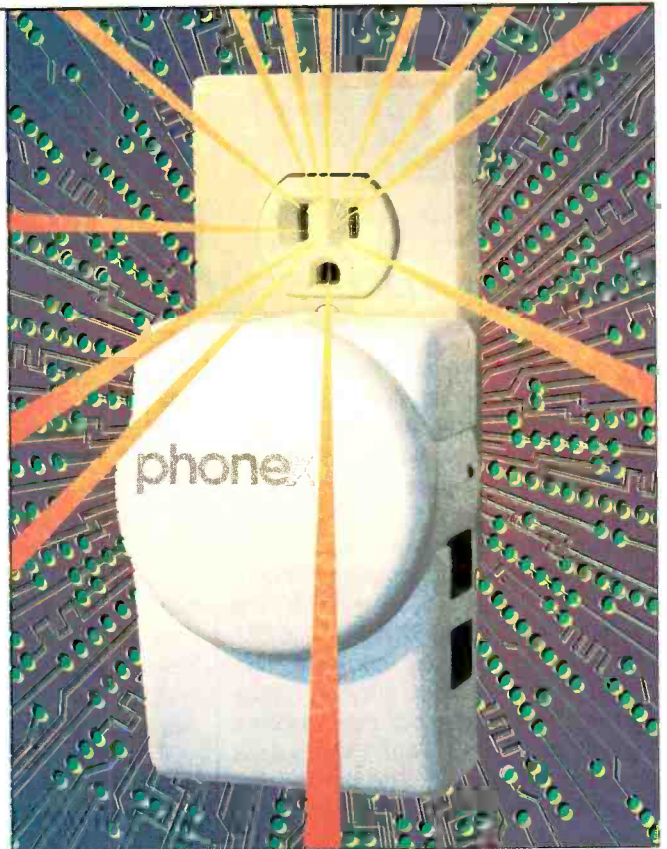

Jack is virtually "invisible" in terms of the speed and clarity of your data transmissions—it works so well you'll forget your modem isn't hard-wired to a traditional jack!

Risk-free. If you'd like the convenience of being able to connect your modem and computer in any room of your home, the Wireless

Modem Jack is the answer.

Try it for yourself!

Of course, it comes

with Comtrad's 90-day risk-free

trial as well as a one-year manufacturer's warranty.

If you are not satisfied, just return it for a full refund,

"No Questions Asked."



The Wireless Modem Jack system consists of a transmitter (left), a receiver (right) and a six-foot phone cord. That's all you need to put your modem in any room of your home!

Wireless Modem Jack system . \$99 \$9 S&H
System includes one transmitter and one receiver.

Mention promotional code 1981-PL-6677.

For fastest service, call toll-free 24 hours a day

800-992-2966



To order by mail, send check or money order for the total amount including S&H. To charge it, enclose account number and exp. date.

Virginia residents only—please add 4.5% sales tax.

comtrad industries
2820 Waterford Lake Dr., Suite 102
Midlothian, Virginia 23113

MULTIMEDIA WATCH

Checking your Blood Pressure via PC

BY MARC SPIWAK
TECHNICAL EDITOR
WINDOWS MAGAZINE

I find that more and more unusual devices make use of personal computers—that is, they use the smarts of a PC to control something. I've seen TV and radio tuners, appliance timers, construction toys, electronic test equipment, and more, that all require a computer to control things or to record data. The latest such gadget I've played with is called *DynaPulse 200M*. Made by Pulse Metric, Inc., it's a computer-controlled blood-pressure monitoring system that not only displays results on your PC, but it also keeps track of the records. The device connects to a PC or Mac computer.

beats. When the heart pushes blood out, the pressure increases, and the systolic, or maximum blood pressure is achieved. When the heart relaxes, the pressure in the artery decreases, and the diastolic, or minimum pressure is reached. When stating blood pressure, systolic blood pressure is given first followed by the diastolic blood pressure—or systolic/diastolic in mmHg. Normal blood pressure typically has a systolic from about 130 to 139 and a diastolic from 85 to 89.

The inflatable arm cuff included with DynaPulse, just like the one your doctor uses, presses on the artery in your arm

DynaPulse lets you immediately get to measuring blood pressure or you can enter new users into a database. Each new user gets their own password and set of records. The software prompts you to wrap the cuff around your arm, tighten the air valve on the bulb, start pumping, stop pumping and wait, and then to loosen the valve and release the air. The process takes about 30 seconds. Results appear on-screen and can be saved or printed.

A clinical DynaPulse version (\$499) is designed for hypertension screening in clinical environments with the ability to store a virtually unlimited patient database and other special features. An educational version (\$295) comes complete with curriculum and lab material. A home version (\$179) can keep track of up to six people. Any application that requires measuring blood pressure can be simplified greatly by using DynaPulse, and it's another really neat techno-gadget you can add to your collection.

NEW STUFF

I've got two new discs this month from Books That Work, both intended to help you keep your home looking beautiful, inside and out. The *Home Improvement Encyclopedia* is loaded with tips and tricks to help you keep up with the repairs and maintenance that are necessary when you own any home. The disc contains information on installing lighting, building paths, wiring outlets, choosing paint, installing phone jacks, building decks, repairing broken windows, fixing leaky roofs, "oiling" squeaky floors, and a whole lot more.

Once you're done sprucing up the inside of your house (does anyone ever actually reach this point?), and when the weather warms up, *Garden Encyclopedia 2.0* is ready to help you landscape your property. This latest update tells you everything you need to know about the needs of different plants, trees, shrubs, vines, flowers,

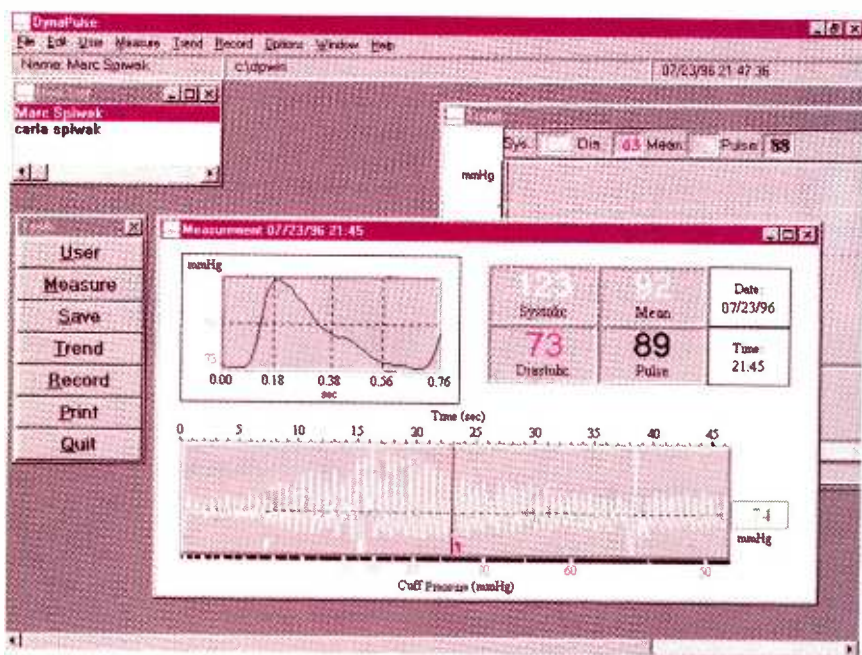

The DynaPulse 200M is a computer-controlled blood-pressure monitoring system that displays results on your PC and keeps track of the records.

The kit comes with an inflatable, adult-sized cuff and inflation bulb that plugs into the side of the DynaPulse unit, which connects to the computer via a serial cable. I tested DynaPulse on a PC running Windows 95 and in minutes I was taking readings, printing charts, and storing records.

The pressure of the blood flowing through the arteries varies as the heart

to the point where blood stops flowing. At some point as pressure is released, blood starts flowing again. At this point the blood flow causes variations in pressure that DynaPulse can detect. The point where blood starts to flow is measured as the high pressure point (systolic). As pressure is released, the turbulence ceases and the lower pressure point (diastolic) is measured.

FLUKE®

Some
things
come
and go.

Others
last a
lifetime.



20 Series

70 Series

80 Series

Introducing The Fluke Lifetime Limited Warranty For Multimeters.

Some things you buy on a whim. And regret later. But now we have something you'll never regret: genuine Fluke Digital Multimeters, backed by our new lifetime limited warranty.

Every member of our rugged and reliable Fluke 20, 70, and 80 Series DMMs now comes with our new lifetime warranty. That's a lifetime longer than standard warranties on the other bargain-basement meters.

Which is reassuring. As is knowing that you've already purchased the DMM known for its unsurpassed

quality, reliability, accuracy, and ruggedness.

Every Fluke multimeter is built in the United States, under a quality system certified to meet ISO 9001 requirements. They're easy to use, with faster response times that give you readings in seconds, and at a glance.

It's no wonder millions of professionals have chosen Fluke DMMs as the only name they trust.

For more information on the DMMs that last a lifetime, call Fluke today at 1-800-44-FLUKE. Or visit our website at www.fluke.com. It's one move you won't live to regret.

YOU CAN'T CHANGE IT...

but you can gauge it,
test it, measure it,
monitor it, record it,
project it, extrapolate
it, computerize it...

with the
Weather Wizard III
from
DAVIS INSTRUMENTS



1-800-678-3669

CIRCLE 162 ON FREE INFORMATION CARD

and more. It tells you how to select the right plants for your geographic location and how to care for them so they will be around for years to come. It even helps you design gardens and floral arrangements.

I recently received the *1996 Edition of the Guinness Multimedia Disc of Records* from Grolier Interactive. This latest version has been spruced up with a new appearance and pumped up with new records, facts, photos, and more. What's the oldest DNA, most expensive teddy bear, fastest land animal, or smallest airplane? Answers to those questions and thousands more can be found on this CD-ROM. There's over 15,000 records, 1200 photographs, 60 short movies, and a lot more to discover.

Children's software and multimedia are one and the same thing. That's because children's software is usually chock full of multimedia, or at least it should be. Children love pictures, cartoons, music, funny characters, puzzles, and more, just like the rest of us. Multimedia has also provided new ways of telling *timeless* children's stories. *The Sleeping Beauty* on CD-ROM, from Memorex Software, puts a

multimedia spin on this classic. As modern as the delivery method is, however, the story is brought to life with colorful drawings reminiscent of late 19th-century children's books. Kids can absorb the story while at the same time improving their reading and vocabulary skills. They also get to see definitions of highlighted words, watch animations and hear sound effects, sit back and relax and take in the animated "movie" version of the story, and even solve puzzles that relate to the story. To top it all off, you only have to shell out \$14.99 for this disc.

If you're interested in ancient civilizations, then you might want to check out Sumeria's new CD-ROM, *Exploring the Lost Maya*. This title focuses on the period from 2000 BC to 1500 AD in Mayan culture. It covers history, evolution, culture, and the demise of the Mayans, in 37 sites in four countries. Interactive maps, timelines, narrations, slide shows, video, and photography complete the score. This hybrid Mac/Windows disc sells for \$49.95.

I've talked about a lot of CD-ROMs over the years that let you play golf on your PC. Some of these simulations are so real that it's almost like playing the real game. However, this month I've got a new CD-ROM title that is intended for people who prefer to play the real game. *Golf Digest's Best Places to Play* from Creative Multimedia provides golfers with essential information on over 14,000 golf courses across the U.S., Canada, and the Caribbean. Courses are reviewed by readers of *Golf Digest*, so you can take their word for it as to which are the best courses to play on. The disc also lets you search for the best courses to play on according to value. Get tour dates, trivia, and more, for only \$29.95.

I don't use Windows NT all that often, but I'm learning more and more about it all the time. At some point I think we'll all be running some form of NT, but let's worry about that when the time comes. In the meantime, if you've already invested in NT and would like some tools to enhance your investment, then consider Symantec's Norton NT Tools. The software works with workstation or server installations and provides assistance for detecting and eliminating viruses, managing files, monitoring information, and more. You can get these tools for \$49.95.

I haven't taken a look at *CoreDRAW*

WHERE TO GET IT

Books That Work

2595 E. Bayshore Road
Palo Alto, CA 94303

CIRCLE 60 ON FREE
INFORMATION CARD

Corel Corporation

The Corel Building
1600 Carling Avenue
Ottawa, Ontario, Canada K1Z 8R7

CIRCLE 61 ON FREE
INFORMATION CARD

Creative Multimedia

225 SW Broadway, Suite 600
Portland, OR 97205

CIRCLE 62 ON FREE
INFORMATION CARD

Grolier Interactive, Inc.

90 Sherman Turnpike
Danbury, CT 06816

CIRCLE 63 ON FREE
INFORMATION CARD

Memorex Software

18000 Studebaker Road, Suite 200
Cerritos, CA 90703

CIRCLE 64 ON FREE
INFORMATION CARD

Pulse Metric, Inc.

6190 Cornerstone Court East, Suite 103
San Diego, CA 92121

CIRCLE 65 ON FREE
INFORMATION CARD

Sumeria, Inc.

329 Bryant Street, Suite 3D
San Francisco, CA 94107

CIRCLE 66 ON FREE
INFORMATION CARD

Symantec Corporation

10201 Torre Avenue
Cupertino, CA 95014

CIRCLE 67 ON FREE
INFORMATION CARD

in quite some time. Well, *CorelDRAW 6* is the latest update to this awesome suite of do-everything software, and it's designed for Windows 95. This package contains everything you need to produce text documents, drawings, desktop publishing, video editing, morphing, and plenty more. Software written for Windows 95 always runs better than older versions for Win 3.1x, and this Corel update is no exception. The *CorelDRAW 6* package includes *CorelDRAW 6*, *Corel Photo-Paint 6*, *CorelDREAM 3D 6*, *Corel Motion 3D 6*, and *Corel Presents 6*, all of which allow you to do nearly anything that's considered to be productive. Unfortunately the price for this all-inclusive suite is a hefty MSRP of \$695. But add up the features and it becomes a relative bargain. ■

If You're Getting Bad Reception, the Answer Is Clear.



Before imageLock

Your TV picture can sparkle without double images, shadows or ghosts.

There's nothing more frustrating. You're curled up on the couch with your favorite snack as you turn on a great show or movie...only to be met with a blurry, distorted picture. You can fiddle and fuss with the controls, wiggle the antenna... but the problem won't go away. Now, there's finally something you can do about it: **imageLock™**, the simple solution to the oldest of TV reception problems – ghosting.

imageLock is Emmy® Award-Winning Technology.



In 1995, **imageLock** technology won an Emmy® Award for its effectiveness in restoring picture clarity. Now you can put this award-winning technology to work in your own home to improve the quality of almost everything you watch on TV.



imageLock
television ghost canceling reception system

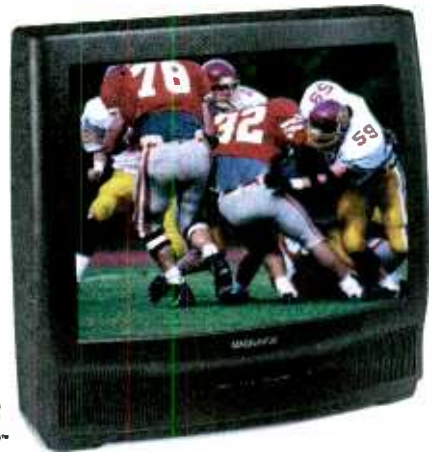

After imageLock

Easy to install and use.

Easy to follow instructions will come with your shipment showing you how to hook **imageLock** to your TV through your VCR. Plus, you'll have a toll-free hotline to call with any questions or problems. Magnavox is committed to helping you every step of the way.

Once **imageLock** is installed, you will see an end to blurring, ghosting, color distortions and most other reception problems forever...or your money back.

**AVAILABLE EXCLUSIVELY
FACTORY DIRECT FROM
MAGNAVOX**

Your satisfaction guaranteed.

There may be reception problems in your area that **imageLock** cannot overcome. If that proves to be the case, simply return it within 30 days for a full refund, including shipping and handling. But chances are excellent that **imageLock** can give you the clear, clean picture you've longed for. You're invited to put **imageLock** to the test for 30 days without risk or obligation.

imageLock solves bad reception from antenna and cable.

Yes, even cable subscribers can experience poor reception, as some of you well know. But **imageLock** is designed to decode the Ghost Cancellation Reference (GCR) signal sent by broadcast and cable networks throughout the U.S. This eliminates signal contamination from cable and antenna by digitally restoring your picture to optimum clarity. So put this advanced Emmy® Award-winning technology to use in your own home. The result will be the sharper, clearer picture you've always wanted. And we back this promise up with our no questions asked 30 day return policy. Your satisfaction is always completely guaranteed.



CALL NOW TO ORDER:

1-800-446-7860

Six Easy Payments of \$32.95 Ext. 101

Plus \$7.95 Shipping and Handling and any applicable tax. VISA and MasterCard accepted.

MAGNAVOX
Smart. Very smart.™

Performance may vary according to broadcasting and ghosting conditions. Requires transmission of the GCR signal by broadcast and cable networks. Television images are simulated.

NET WATCH

Holiday Shopping Spots

BY DAN KARAGIANNIS

Christmas is fast approaching. And we all know what that means: Lines, lines, and more lines at the stores.

However, if you're connected to the Net, you just might be able to avoid that ruckuss this year. Instead of running around with your arms full of packages, and your shopping list clenched between your teeth, try sitting at your computer and taking care of all your gift buying with only a key-

check out at the Holidays. Especially if that place is The Entertainment Connection (TEC).

This easy-to-navigate "virtual" megastore and service allows you to custom design your shopping experience, depending on the musical or movie preferences of those on your list (or depending on what you like, if you're shopping for yourself). Such customization is not necessary, of course, but be warned: The inventory

To personalize your account, you can enter Your Journeys and let TEC know the names of your favorite musical artists. That way on subsequent visits or through e-mail you can be notified when something new comes out by your favorites.

But when it comes to Holiday shopping, you'll be most pleased with TEC's powerful search feature, which appears at the bottom of every page you enter, after you access your account. That lets you perform keyword searches for anything the store. In the music category, you can enter an album or song title, or an artist's name. To look for a movie, search by actor, film title, director, or even character name. You can also search for books and clothing featuring your favorite musicians.

If there are any special imports or other unique types of merchandise available by a certain artist, you'll learn about it once you execute a search. For example, while searching for one of my favorite bands, Amu let me know they had a rare import available from Japan. He added that it was a "hot" release, and even had some sweat on his red brow to help make his point.

Each search generates several other choices as well. If you find an artist in TEC, a list of all that artist's releases will be presented, including compilations they appeared on. Any videos, clothing, or books relating to that artist will be presented as well. And if you feel like reading more about what you're buying, text from the *All Music* and *All Movie Guides* is available.

Want to listen before you buy? Well, TEC has RealAudio clips available of the top-100 albums. I've covered RealAudio before in this column; it's a free program that lets you listen to audio as you download it. There are 30-second tracks of all the top-100 albums, which should give you a good idea what each song sounds like before you shell out your money. Most record stores you visit in person won't let you hear samples of more than a dozen CDs.

Finally, I saved the best feature for last. Ever notice how, once you finish



Welcome to The Entertainment Connection, where little Amu will help you find all the music and videos you're looking for.

board and mouse below your fingers. We'll look at two sites this month that let you do just that.

So fire up your Web browser, and have your credit card or checkbook handy. It's shopping time...

THE ENTERTAINMENT CONNECTION

Music and movies make great gifts for people of all ages. Whether you want to get your main squeeze the new CD by The Cure, or your little daughter the latest video from Disney, a store that stocks both audio and video prerecorded media is a convenient place to

you have to search from is enormous, to say the least; well over 250,000 cassettes, CDs, videos, and music-related books and clothes are available.

When you first log on, you'll be asked to set up a free account, and choose a password. Then, you'll meet Amu, your personal shopping assistant. Depending on where you move through the site, Amu will remember your preferences, suggest specials or new releases, and even take you to favorite areas of TEC. The greatest thing about Amu is that he is helpful and present at each step you take, without getting on your nerves.

Introducing...

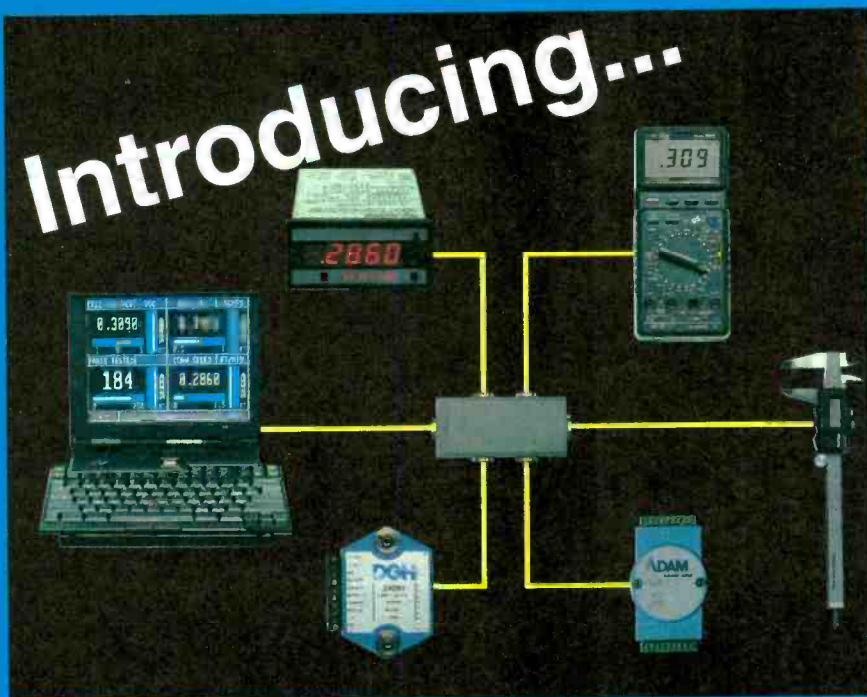

MeterBOSS Test & Measurement Software for your PC

*Build test and
measurement systems
from conventional
off-the-shelf
instruments quickly
and inexpensively.*

Only \$249

The MeterBOSS PC software combines conventional measuring devices and power supplies into a versatile, expandable test and measurement system. The readings from serial port-equipped multimeters, signal conditioners, panel meters and scales can be recorded and/or used as controls for the self-contained logic sequencer. The sequencer can operate low-cost serial port equipped power supplies, relays and I/O modules to perform user designed application specific tests. MeterBOSS can automatically run test sequences, log data, monitor processes, linearize data, and create new meters from other meters. It is truly a low-cost alternative to IEE 488 systems and it does not require programming.

Typical Applications:

- Product Performance Tests
- Statistical Quality Control
- Durability Testing
- Prototype Evaluation
- Incoming Inspection
- Quality Assurance
- Spurious Event Capture
- Process Monitoring
- Power Consumption Analysis
- ISO 9000 Testing
- Lab Data Collection



YOUR FIRST MeterBOSS PERIPHERAL FREE!

*Start your own expandable, low-cost test and measurement system today!
One that is powerful, versatile and can use most measuring devices.*

For a limited time, buy MeterBOSS software at the regular price of \$249, and receive **ABSOLUTELY FREE** a Metex True RMS handheld multimeter with PC serial communications interface (a \$149.00 value). Includes case, test leads, thermocouple and RS-232 cable.

It's all you need to get an application running with MeterBOSS!

FREE



Order Toll Free: 1-888-METER-SW



Teramar Group, Inc. 211 Teramar Way, El Paso, TX 79922 • (915) 833-0300 • Fax: (915) 833-0571
e-mail: 75777.3347@compuserve.com

Visit our home page at <http://www.meterboss.com> and download demo software

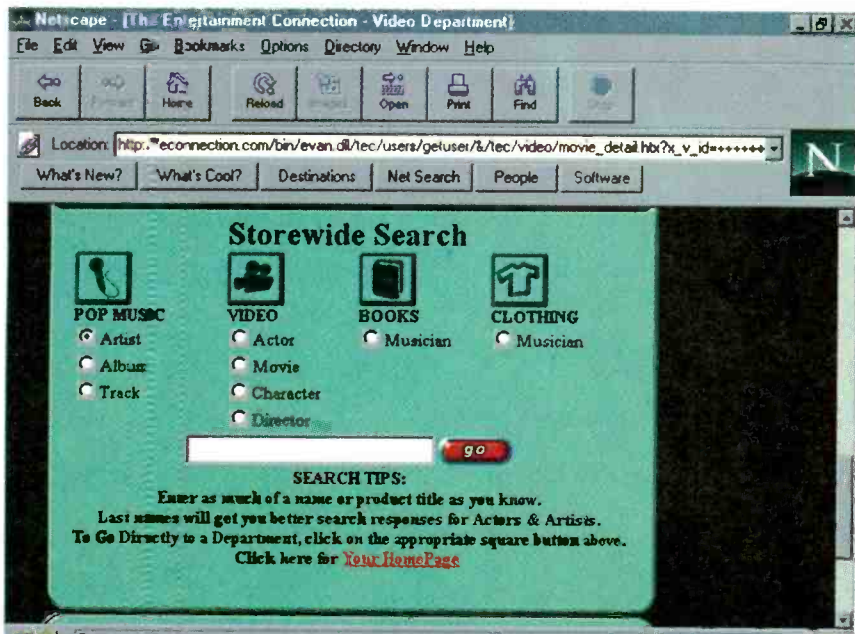

At the bottom of every page on The Entertainment Connection, you'll find a powerful, keyword search engine.

shopping, it's often difficult to actually wrap and get all those gifts to their recipients before the Holidays? That's especially difficult with relatives who live out of town. There are always gift-wrapping stands and the Post Office; however, that's just asking for more lines and frustration. TEC has the solution to that problem.

In your personal account you can set up an address book for sending gifts. At the time of your purchase, you can have the present wrapped and

shipped with a personal note. That will save you time and money.

Before we move on, you might be wondering: How are the prices? To answer that I first have to explain two things: First, shipping is \$2.95 for the first item, plus \$0.50 for each additional item up to a maximum shipping charge of \$5.95. Second, merchandise prices are about the same or less than found in most stores. So if you buy more than one item, you won't really be spending any extra money

for the shop-from-home convenience you're getting.

CYBERSHOP ONLINE

Go to any mall around the Holidays and you're sure to find the longest lines in the big department stores. That's because most people find the large selection of merchandise available to be quite convenient. Get Mom a blender, Dad a VCR, etc. Now, do it all at CyberShop Online.

The first thing you'll notice about this site is how attractive it really is. Frames and graphics provide a nice appearance, but best of all are the crisp images of the products located in each of the store's departments. And there are quite a few departments to visit.

Choose from Bed & Bath, Beauty & Fitness, Children, The Dining Room, Electronics, Furniture & Home, Gourmet Food, Jewelry & Watches, The Kitchen, Office & Travel, Outdoor Living & Sports, and Personal Gifts. Each department has many subcategories to choose from; so many in fact, that there isn't even room here to list them!

Some of the subcategories in Electronics, for example, are TVs, VCRs, Word Processors, Audio, etc. Just what you'd expect to find in Macy's or another department store. Click on any product picture under one of the categories, and a larger image of the product along with a detailed description will appear on your screen. Of course, that includes ordering information.

Like many other online shops, the CyberShop gives you a virtual shopping basket that you can put your merchandise into. Then, when you're ready, you can arrange to buy all of it at once.

Prices at CyberShop are pretty much on par with those of other department stores. In other words, I've found some of the items are cheaper at the site, and some are a few dollars more.

You can send e-mail to me at peeditor@gernsback.com, or send snail-mail to **Net Watch, Popular Electronics**, 500 Bi-County Blvd., Farmingdale, NY 11735. Also visit our Web site : <http://www.gernsback.com>. ■

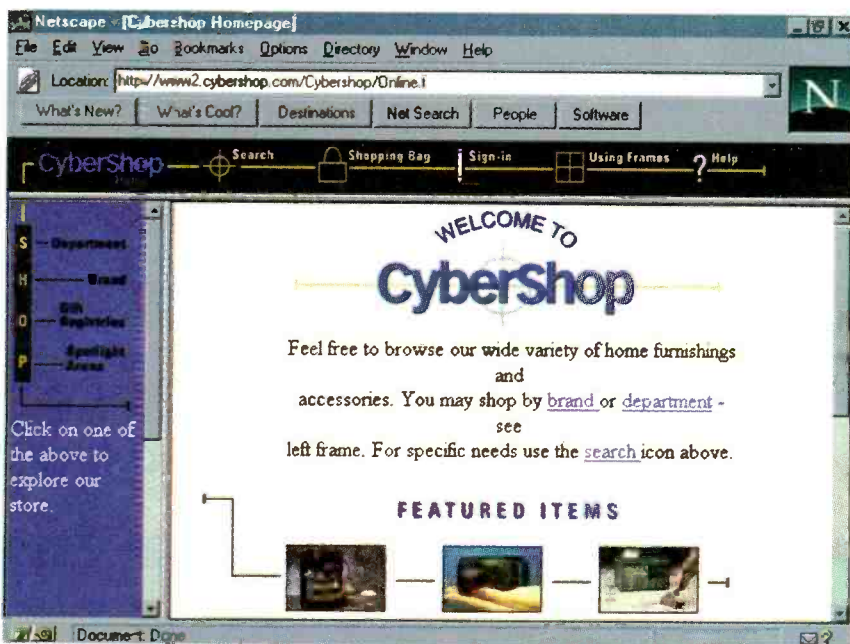

Instead of braving the malls and department stores this Holiday, enjoy the large selection of products found at the CyberShop Online.

HOT SITES

The Entertainment Connection
<http://www.econnection.com>

CyberShop Online
<http://www2.cybershop.com/Cybershop/Online.fl>

Why pay for cellular phone service if you only want it for emergency use?

The SOS phone offers a 24-hour call center to connect you with your emergency roadside service, 911 service or family members in the event of an emergency.



Press the Tow button and your emergency road service will be dispatched to tow your automobile.

To tell you the truth, I am not interested in owning a cellular phone...except for use in an emergency. What would I do if my car broke down on the interstate or ran out of gas on some deserted back road? How would I get help? Like most women, I have the safety of my children to consider.

Last month, I inquired about cellular phone service. I was surprised to find out how expensive it was, even for the most basic calling plans! I just couldn't justify spending that much for something I may never need. Then a good friend told about a product she thought would solve my problem. It's the SOS Phone—a cellular phone service designed exclusively for emergency use!

What does it do? With the touch of a button, the SOS Phone will connect me to a roadside emergency service, a 911 service or a trained SOS operator, 24 hours a day. If I ever need help, I know it's just a phone call away.

Emergency assistance. By pressing the "tow" button, I'll be connected with my emergency roadside service provider. Or, if I don't have one, the SOS operator can recommend one to me and dispatch them immediately.



The 911 button will connect you to 911 police or other emergency services, and the call is absolutely free!

The "911" button will connect me to the 911 emergency service in my area—best of all, the call is absolutely free!

Personalized service. Each SOS Phone has a serial number that is recorded at the Call Center, so each time I use my phone, the operators will know that it is me calling, and will greet me by name. Plus, my SOS Emergency Record will appear instantly on the computer screen and the operator will connect me with the person or emergency service I need.

Not just for emergencies. If I just want to call home to tell

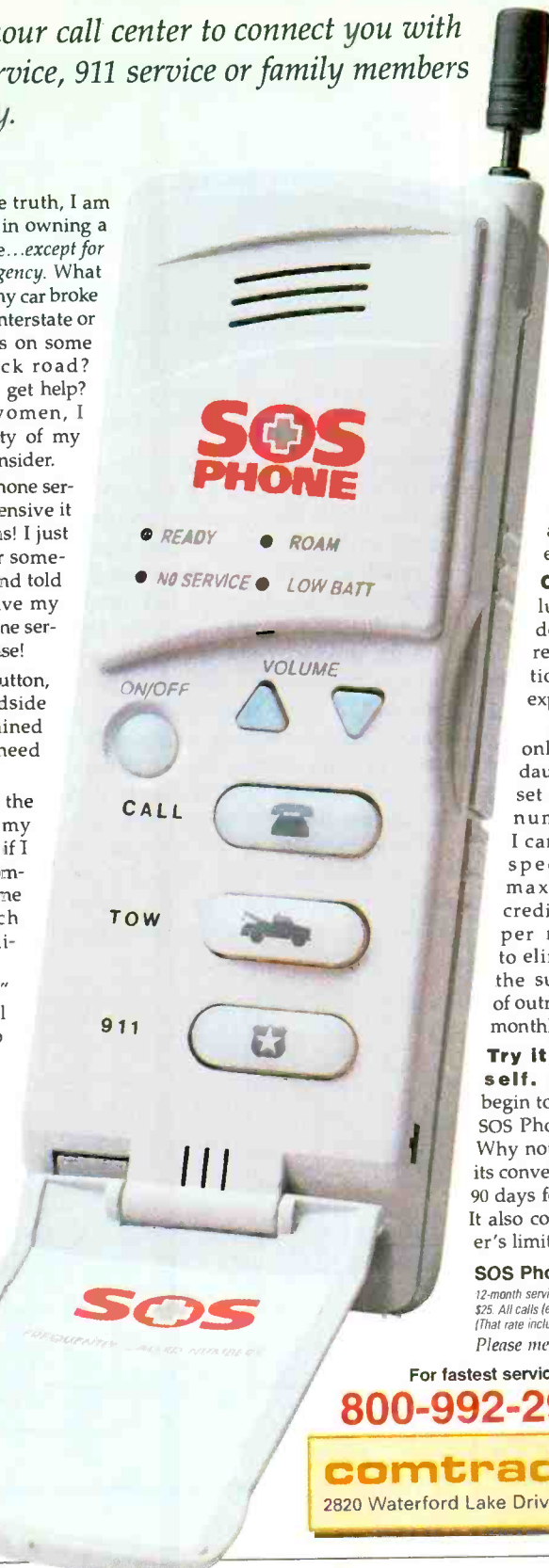

my husband that the kids and I are running late, I can! By pressing the "agent" button, I'll reach an operator. When I ask the operator to call home, I'll be connected automatically. And because the Call Center has my list of 10 most-used phone numbers, I don't even have to recite the number!

Great for teens. The SOS Phone is also a great thing to have around for my stepdaughter. I can rest assured that she'll always be able to get in touch with us (or an emergency service) if she needs to.

Cost control. Unlike ordinary cellular phone plans, the SOS Phone doesn't have any minimum usage requirements or any other stipulations that could change the price I expect to pay each month.

Plus, without my password, the only non-emergency calls my stepdaughter can make are to our 10 preset phone numbers. I can even specify a maximum credit limit per month to eliminate the surprise of outrageous monthly bills!



Use the Agent button to talk to an SOS operator or be connected to someone on your preset list of numbers.

Try it yourself. I can't begin to tell you how much confidence the SOS Phone has given me and my family. Why not try it yourself? If you don't enjoy its convenience and security, return it within 90 days for a "No Questions Asked" refund. It also comes with a three-year manufacturer's limited repair or replacement warranty.

SOS Phone \$14.95/month \$12 S&H
12-month service contract required for this price. One-time activation fee of \$25. All calls (except to 911) are billed to your credit card at \$1.45 per minute. (That rate includes all local, long-distance, cellular and roaming fees.)
 Please mention promotional code 1782-PL-6675.

For fastest service call toll-free 24 hours a day

800-992-2966    

comtradindustries

2820 Waterford Lake Drive, Suite 102 Midlothian, VA 23113

PRODUCT TEST REPORT

Hitachi VT-FX613A Hi-Fi VCR

BY STEPHEN A. BOOTH

It tips the scales at just about eight pounds. However, like many boxers in the lower weight classes, Hitachi's VT-FX613A gives you your money's worth in performance.

In fact, a year ago, a Hi-Fi VCR with this combination of features and top-rank electrical measurements carried a price tag of \$550—and the one we tested here didn't even have an illuminated remote control! The curious thing is that the VT-FX613A isn't even the top-shelf model in Hitachi's line. But all it lacks, compared to the company's high-end UltraVision VCRs (such as the VT-UX617A, \$399), is Commercial Advance (to bypass recorded commercials) and DSS compatibility (remote control over DSS satellite receivers, to perform unattended recording).

FEATURES

The VT-FX613A is the most loaded VCR in Hitachi's new High-5 lineup. These VCRs are characterized by a so-called "efficient chassis" design. Among other things, this means some controls perform multiple functions. For example, the up/down channel selector buttons on the front panel that let you go through the 181-channel tuner (that's in the U.S.; in Canada the tuner has 178 channels) also control manual tape-tracking during video playback.

Additionally, having 20 percent fewer parts than other VCRs, the High-5 design outboards many functions—they're activated via the infrared remote control instead of front-panel buttons and switches. Consequently, you'll program the VCR for unattended timer-recording through the remote. But if you're rushing to tape a show that's about to begin, and don't have time to use the on-screen programming (in English, French, and Spanish), a convenient (if tiny) Instant Record button on the front panel is good for up to four hours, in 30-minute increments.

Hitach's zapper is a delight to use in a darkened room, thanks to green-16 backlighted buttons for TV and tuner



The Hitachi VT-FX613A performs on par with top-of-the-line VCRs, only lacking commercial advance and remote control of DSS receivers.

controls and red-glowing ones for VCR transport functions. It also sports a shuttle dial, duplicated on the front panel, for forward/reverse tape search at variable speeds, as well as single-frame advance. Although this model lacks the Commercial Advance feature for automatically fast-forwarding through commercials that have been recorded, it does have a Video Skip feature. This advances one-minute's worth of tape before resuming play. The tape counter is in real time, and can display the tape-remaining time.

Other features of the VT-FX613A include Gemstar's VCR Plus+ C3, for easy timer-programming via codes printed in TV-schedule guides. This

version also controls outboard cable-boxes. If you're taping in the EP mode, Hitachi says the 19-micron recording heads and Dynamic Picture Enhancement circuitry in this deck will record better images than you'd expect from the slow-speed mode.

The VT-FX613A also has automatic clock setting, if a station in your area is transmitting the time via the Vertical Blanking Interval in its signal, as well as a one-hour battery backup. Auto Blue Screen displays a blue field on the TV and mutes the audio for channels where there is no signal, or where the broadcast day has ended. Among other conveniences, the VCR has front panel A/V inputs, for dubbing from a

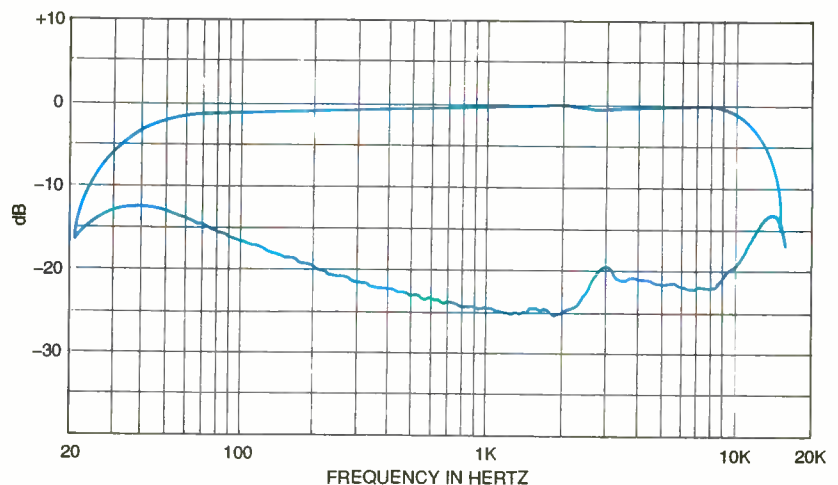

Fig. 1. As this frequency response trace shows, the VT-FX613A has consistent 20 dB of separation from 200 Hz through 9 kHz.

It's Not Just Training...

"I needed a refresher in fundamentals and a piece of paper that said I had a degree. CIE gave me both."

Louis P. Briant
Senior Engineer
Sentel Corp.

"CIE allowed me to use my G.I. Bill benefits and independent study allowed me to continue my studies while deployed."

Charles Hopper
Electronics Senior Chief
U. S. Navy

"The fact that I intended to continue pursuing my Associate Degree with CIE was a key factor in being considered for my current position."

Annamarie Webster
Project Engineer -
Instrumentation
Katchikan Pulp

"My associates at work recommended CIE... The lessons were structured so they were easy to comprehend."

Vincent R. Buescher
Communications Technician
AT&T

"I reenrolled and received my A.A.S. degree from CIE because of the good experiences I had in one of CIE's career courses."

Maurice M. Henthorn, Jr.
Electronic Technician
The Denver Post

Independent study from CIE will give you the skills you need to win your own independence in a successful career.

At CIE, we pride ourselves in keeping pace with the latest developing technologies. In turn, this assures our students that upon graduation they can mesh seamlessly into a variety of exciting and rewarding technology-based careers.

Back in the 1930's, we specialized in teaching radio and television sciences. Today, it's computer technology, programming, robotics, broadcast engineering, information systems management, and the electronics behind it all.

But some things have not changed, like the desire of CIE's faculty and staff to see their graduates succeed.

That is why at CIE we teach not only the hands-on, practical aspects of electronics technology, but also delve into the "why" behind today's technology. Why does it work the way it does?

The insights to be gained from such a broad, rich and comprehensive

education at CIE matches or exceeds those gained through traditional commuter institutes while providing an education schedule to match your commitments and lifestyle.

Our patented learning program is specifically tailored for independent study and backed up by a caring team of professional educators who are at your call whenever you need their help.

At CIE, we'll match our training with your background and career goals and help you decide which of the many career courses that we offer suits you best. We offer an Associate Degree Program and through our affiliation with World College a Bachelor Degree



Computer Programming



Electronics Technician

Program.

If you have the sincerity, the smarts and the desire, CIE can make it happen. CIE is already the institute of choice for many Fortune 1000 companies. Why shouldn't you be next?

...It's an Education.



1776 East 17th Street
Cleveland, OH 44114
(216) 781-9400 • 1-800-243-6446

YES! Please send me more information on:

- CIE's Associate Degree Program
- CIE's Career Courses
- World College's Bachelor Degree Program

Name _____

Address _____

City _____ State _____ Zip _____

Phone: _____

Check for G.I. Bill Active Duty Veteran

AH 84

TABLE 1—TEST RESULTS

The following test results were furnished by the Advanced Product Evaluation Laboratory, an independent testing facility located in Bethel, CT.

Brand: Hitachi
Model: VT-FX613A VHS Hi-Fi VCR
Price: \$299.95

VIDEO MEASUREMENTS (SP MODE)

Frequency Response: -1.34 dB @ 2.0 MHz
 -15.0 dB @ 3.0 MHz

Signal-to-Noise Ratios:**Luminance Level:**

@ 100 IRE 44.0 dB
 @ 50 IRE 43.8 dB
 @ 10 IRE 42.9 dB
 Chroma AM 48.2 dB
 Chroma PM 42.5 dB

AUDIO MEASUREMENTS (HI-FI RECORDING)

0-dB Reference Level: (1 kHz)
 Output: 2.31 volts
 THD: 0.76%
 Flutter (DIN):
 Average: 0.021%
 Peak: 0.024%
 Signal-to-Noise Ratio: 83.8 dB
 Frequency Response (-3 dB): 20 Hz to 20 kHz
 Record/Play THD (@ -10 dB):
 @ 100 Hz 0.23%
 @ 1 kHz 0.27%
 @ 5 kHz 0.35%

AUDIO MEASUREMENTS (CONVENTIONAL RECORDING)

0-dB Reference Level: (1 kHz)
 Output: 0.36 volts
 THD: 1.87%
 Flutter (DIN):
 Average 0.38%
 Peak 0.40%
 Signal-to-Noise Ratio: 50.5 dB
 Frequency Response (-3 dB): 155 Hz to 11.5 kHz
 Record/Play THD (@ -10 dB):
 @ 100 Hz 0.58%
 @ 1 kHz 0.42%

MTS STEREO TV DECODER MEASUREMENTS**(Stereo Mode/Left Channel)**

Signal-to-Noise Ratio:
 (re 100% modulation) 60.5 dB
 THD (@ 1 kHz, -20 dB) 0.38%
 Frequency Response*: 36 Hz to 11.2 kHz
 Separation*: 24.2 dB

*Measured using real-world reception conditions of -20dB relative to 100% signal modulation.

(Mono Mode)

Signal-to-Noise Ratio:
 (re 100% modulation) 61.7 dB
 THD (@ 1 kHz, -20 dB) 0.53%
 Frequency Response:
 (re 100% modulation) 36 Hz to 3.0 kHz

(S.A.P. Mode)

Signal-to-Noise Ratio:
 (re 100% modulation) 69.5 dB
 THD (@ 1 kHz, -20 dB) 0.94%
 Frequency Response:
 (re 100% modulation) 540 Hz to 2.4 kHz

ADDITIONAL DATA

Fast Forward Time (T-120 tape): 2 min. 02 sec.
 Fast Rewind Time (T-120 tape): 2 min. 00 sec.
 Power Requirements: 19 watts
 Weight: 8 lbs.
 Dimensions (inches): 3-5/8 × 14-15/16 × 11

camcorder or another VCR. Fast forward and rewind are speedy—about two minutes for a T-120 cassette.

TEST RESULTS

Superb video and audio: That's the verdict from the test-bench at the Advanced Product Evaluation Laboratory (APEL), an independent testing facility in Bethel, Connecticut.

As you can see from the numbers in Table 1, video frequency response is fine at 2 MHz, and still plenty sharp at the 3-MHz point—this VCR delivers the 240 lines of horizontal resolution available from the conventional VHS format. The fine resolution does not come at the expense of video noise: Signal-to-noise ratio for Luminance is quite good—44 dB at the 100 and 50 IRE luminance levels. For color (red field chroma) the numbers are excellent: 48.2 dB for AM.

Audio performance is on par with the video—especially in the VT-FX613A's MTS Broadcast Stereo decoder. Signal-to-noise ratio in stereo (60.5 dB) put it in the top class of VCRs. More important, though, is frequency response and channel separation in the stereo mode.

Here, Hitachi's deck scores 24.2 dB of separation (at the 1-kHz point). Frequency response is flat over a broad range—36 Hz to 11.2 kHz. What's impressive, as shown in the frequency response trace (see Fig. 1), is the consistent 20 dB of separation from 200 Hz through 9 kHz. Accordingly, you'll get pleasing results if you're running this VCR's audio through a home-theater system with Dolby Surround decoding.

The MTS decoder posts just average numbers in the Monaural and SAP modes. Signal-to-noise ratios are just dandy, but over the very restricted bandwidth we've come to expect in VCRs over the past few years.

In Hi-Fi Stereo recording, the VCR's measurements are good, though not the best APEL has seen. Frequency response runs the usual 20 Hz through 20 kHz, and S/N ratio is 83.8 dB at the 1 kHz measuring point—no less than you should expect, but the lab has measured 90 dB in some decks. The VT-FX613A is exceptional in mono recording: S/N ratio is 50.5 dB, and frequency response is broad: 155 Hz to 11.5 kHz. Distortion levels in all modes are insignificant. Bottom line: This is a very quiet deck, electrically and mechanically.

NEW PRODUCTS

DIGITAL VOICE RECORDER

No larger than a credit card and only 1/2-inch thick, Machina's Cardcorder 600 digital voice recorder uses microchip technology instead of tape to store up to 10 minutes of memos, dictation, telephone numbers, and appointments. Flash memory safely stores the recordings until they are erased, even if the batteries are removed or run out. Even if you accidentally delete a memo, it can be recovered.



Four channels allow related recordings to be filed and labeled by name for easy retrieval. Thumb-operated buttons make it easy to instantly go forward or backward, and repeat or delete recordings selectively. The Cardcorder 600 can fast-forward at double speed for quick memo review, or slow to half speed for detailed listening, without any change in voice pitch. Recording automatically pauses during silences to maximize recording time. Digital volume control allows you to set the playback level for quiet or loud environments.

A backlit LCD readout tracks all memos by number, length, and channel, and always shows the amount of available memory. All memos are referenced with a time/date stamp that is displayed during playback. Other clock functions include an alarm that you can set to sound a soft tone that builds in volume or your own pre-selected voice message.

The Cardcorder 600, including batteries and a leather carrying case, has

a suggested retail price of \$120. For further information, contact Machina, Inc., 21 South Park, San Francisco, CA 94107; Tel. 800-223-4340; Fax: 415-243-4359.

CIRCLE 80 ON FREE INFORMATION CARD

SATELLITE RADIO RECEIVER

The same satellites that carry hundreds of channels of television to American homes also carry audio and data channels that cannot be received by home satellite receivers. Tuning SCPC, or single channel per carrier, on satellite is like tuning a whole new world of short-wave broadcasts, but without the noise and fading. Many international broadcasters use SCPC to reach remote sites. SCPC signals carry hundreds of audio program services, including syndicated radio shows, network feeds, and sporting events.



SatScan Electronics' SCPC Explorer provides professional-quality audio reception of SCPC and FM signals from C- and Ku-band satellites. The receiver tunes the entire satellite band and provides a direct digital readout of the tuned frequency. A special software algorithm provides digital automatic frequency control to compensate for drift. A 100-channel memory comes preloaded with many favorite stations, such as BBC and NPR.

The SCPC Explorer is a super-heterodyne receiver using a digital synthesizer to tune to and demodulate SCPC signals provided at the output of a block downconverter. The Explorer can also be used as a stand-alone UHF receiver for the reception of wide-band FM modulated signals. The audio output is designed to be connected to the input of a stereo sound system.

The SCPC Explorer costs \$479. For more information, contact SatScan Electronics Corporation, P.O. Box

1109, Sultan, WA 98294-1109; Tel. 360-793-7533; Fax: 360-793-0359; e-mail: info@satscan.com; Home page: <http://satscan.com>.

CIRCLE 81 ON FREE INFORMATION CARD

IMPROVED MOUSE PAD

3M's Precise Mousing Surface is a super-thin mouse pad designed to improve computer-mouse—and computer-user—performance. Based on the company's patented microreplication technology, the pad's surface allows users to maintain accurate contact between the mouse, the pad, and the software, making mouse movements faster and more precise. Microreplication is used to create microscopic, precisely shaped, three-dimensional structures on surfaces such as plastic film. A magnified view of the mouse pad's surface reveals rows of peaks and valleys. The design allows the mouse's trackball to roll over the peaks while hand oil, dust, and dirt fall into the valleys. That keeps the trackball clean and rolling smoothly.

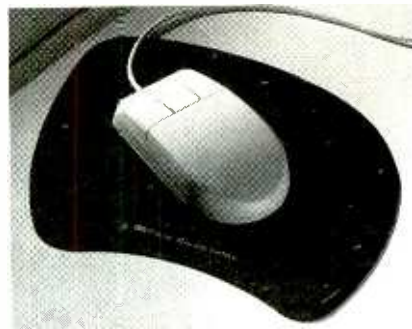

The thin, flat pad also has a special shape, based on 3M hand/motion studies, that allows the user's hand to remain in a natural, relaxed position when moving the mouse. That provides maximum comfort and gives users the ability to finely control cursor placement.

The 3M Precise Mousing Surface has a suggested retail price of \$15. For more information, contact 3M Consumer Stationery Division, 530 Fifth Avenue, New York, NY 10036; Tel. 800-3M-HELPS; e-mail: innovation@mmm.com; Web: <http://mmm.com>.

CIRCLE 82 ON FREE INFORMATION CARD



If this satellite deal won't get you off the couch, check your pulse.

Been thinking about satellite TV? Come to RadioShack. Now for as little as a dollar a day, you can own an RCA®-brand DSS system with programming. Up to 200 channels on USSB® and DIRECTV®. Or subscribe to PRIMESTAR®, with equipment and programming, also for as little as a buck a day. You can have up to 95 channels with no equipment to buy. If access to tons of movies, pay-per-view, music and sports with digital picture and sound gets your heart racing, come on in. For a store near you, call **1-800-THE SHACK**™.



RadioShack™

You've got questions.
We've got answers.®

RCA-brand system and programming sold separately. PRIMESTAR system and programming included in monthly payments. Price and equipment may vary. Installation cost not included. Some restrictions apply. Broadcast networks are only available to customers in those limited areas not served by local affiliates. Blackout and other restrictions may apply.

CIRCLE 14 ON FREE INFORMATION CARD

Holiday Gift Guide

BY TERI SCADUTO & CHRISTOPHER SCOTT



You'll find something for everyone on your list on the next few pages, starting here with audio/video gifts that you might want to include in your own letter to Santa.

SURROUND YOURSELF WITH SOUND

Looking for a "totally immersive home theater experience" without the fuss and expense of a multi-speaker surround-sound system? The *Spatializer HTMS-2510* turns an ordinary TV, stereo, and speaker pair into a true home theater by providing the same 3-D surround-sound technology used in some of Hollywood's blockbusters. Spatializer's 3-D stereo technology, used with any stereo source and just two speakers, makes music sound as if it is coming from all around the listener, and sound effects as if they are coming from precise positions far outside the speaker boundaries. Because there's no need to mess with additional speakers, amplifiers, decoders, complex adjustments, or specially encoded broadcasts or tapes, it's a great way to create the home-theater experience in your bedroom. The self-contained system has a suggested retail price of \$249.95.

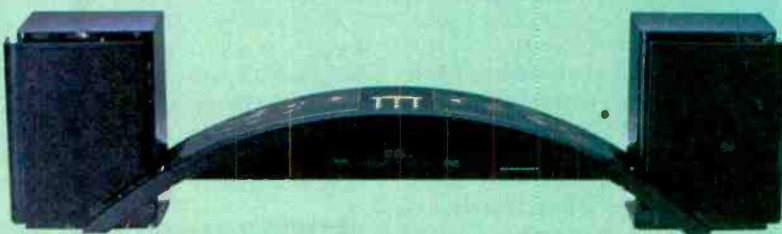

AUDIO ARCH DE TRIOMPHE

For those who want their music to look as good as it sounds, Marantz offers the Arch integrated music system. Merging form and function, the arch-shaped central section houses an AM/FM stereo tuner and a six-disc CD changer that's hidden behind a motorized door. A discreet fluorescent display indicates program status or, when in standby mode, the time of day. Two bi-amplified speakers can be placed directly beside the central section, or placed elsewhere in the room. Each speaker is powered by its own 30-watt amplifier, and contains a five-inch high-compliance woofer and a 3/4-inch soft dome tweeter in a ported enclosure. A "dual-personality" remote control groups basic functions on one side and more advanced functions on the other. One external audio source can be accommodated. Available in your choice of walnut veneer or faux black marble finishes, the Arch has a suggested retail price of \$1599.99.

TOUCH-PAD HOME THEATER

Is technophobia keeping your family from installing a sophisticated home-theater system? Kenwood's Stage 3 KC-Z1 tuner/preamplifier will change that. Based on what the company calls "Human Touch Technology," the KC-Z1's handheld touch-pad controller allows you to operate an entire home-theater system through icons, menus, and prompts displayed on its LCD screen. The touch pad uses RF signals to communicate with the tuner/amplifier, which then sends infrared commands to IR-controlled system components. The touch pad can save and recall each family member's personal preferences and automatically adjust the system's audio and video characteristics, activate specific components, and adjust the volume level accordingly. Once it "learns" the components that each person tends to adjust most, the touch pad puts those components at the top of the personalized menu. The tuner not only features Dolby Pro-Logic and the Dolby AC-3 digital surround system, but also meets Home THX standards. It accepts six video inputs, five analog audio inputs, four digital audio inputs, and an AC-3 RF input. A two-channel stereo preamp output can supply audio to amplifiers and speaker systems in other rooms. The KC-Z1 has a suggested retail price of \$2800.





ALL THE WORLD'S A STAGE

... and your family will think the New York Philharmonic (or Hootie and the Blowfish) is playing on their living-room stage—if it's equipped with the *Bose Lifestyle 901* music system. Using Bose's helical voice coil (HVC) driver and Acoustic Matrix enclosure, the system's speakers come close to recreating the sound of a live concert.

The injection-molded plastic enclosure ports each of the HVC drivers into a separate chamber, which, in turn, is ported through one of three reactive air columns. The Lifestyle 901 system is controlled by a music center that features a six-disc magazine CD changer, an AM/FM tuner with 30 presets, four audio/video inputs, and full two-zone listening capability. Bose's signature RF remote control works through walls and around corners, without aiming. Integrated signal processing provides deep, well-defined bass at all listening levels by compensating for the ear's decreased sensitivity at low volumes. The Lifestyle 901's electronics are tucked out of sight in the left speaker pedestal, with one simple connection to the right accessory speaker, so there's no unsightly clutter of bulky components. The Lifestyle 901 costs about \$4200.

Put a new PC under the tree, or treat your family and friends (or yourself) to new software or peripherals!



DESTINATION: THE LIVING ROOM

So long, home office! *Gateway 2000's Destination PC* is destined for use in the living room or family room. Billed as a multimedia theater system, it combines all the benefits of a full-feature multimedia PC with the impact of a large-screen (31-inch) television. Use it to watch TV, play games, run multimedia applications, or surf the Web—all from the comfort of your favorite armchair. Computer and television functions can be controlled from 10 to 15 feet away through a touch-pad-equipped wireless keyboard and a wireless "Field-Mouse" remote control/mouse. The Destination's big screen will also make an impact on corporate and educational presentations. Configured for consumers (with a 120-MHz Pentium processor, 16-Megabyte DRAM, 1.2-gigabyte hard disk, 1.44 floppy drive, 6X CD-ROM, 28.8 fax modem, PCI VGA graphics adapter with integrated TV tuner, hi-fi audio adapter, the wireless keyboard and FieldMouse, Windows 95, and a special software bundle that includes an electronic TV program guide), the Destination PC costs less than \$4000.



FREEDOM TO MOVE

Give the gift of gaming freedom with *Vivitar's WJ2000* wireless joystick. Designed for use with PC games, the joystick uses microcontrollers and a patented "sensing technology" to determine its position relative to game action. Its unique, one-piece design (there's no need to hold onto a base unit in your other hand) also eliminates all moving parts and any need for recalibration. Gamers are freed from tangled cords and the hand strain associated with hours of game playing. Switchable analog and digital modes accommodate different players' style and sensitivity of hand movement. The joystick has a range of 12 feet, is powered by three "AAA" batteries, and can be used with any PC game. The suggested retail price is \$129.99.



KEYING FREEDOM

Keyboards are also cutting the cord. These two wireless keyboards from *Key Tronic* each has an added bonus: The *Model LT WLS Tpad* includes a wireless touchpad, while the *LT WLS Tball* has a wireless trackball built in. Aimed at power users and graphics professionals, the Wireless Touchpad keyboard features 500-counts-per-inch resolution and "trigger-edge tracking," which allows you to drag to the pad edge and hold to scroll—without tipping or running out of space. You can even use the pad surface instead of mouse buttons to make your selections by tapping, double-tapping, and dragging. On the wireless trackball keyboard, the trackball is conveniently located below the space bar, where it can be used without lifting your hands

A PURPLE PC?

Sony's first entries into the multimedia PC market stand out from the crowd at first sight, thanks to their lavender-and-gray color scheme and VAIO signature mark. VAIO, which stands for Video Audio Integrated Operation, represents Sony's intention that PCs be integrated into the home audio/video environment. A 3-D graphic user interface called VAIO Space, which complements Windows 95, allows users to access video, audio, and communications capabilities and provides a menu of application programs. The *PCV-70* and *PCV-90* are mini-tower-systems. Future Sony PC peripherals will match and be stackable, like stereo components. The 166-MHz Pentium *PCV-70* (16 megabytes of RAM, and a 2.1 gigabyte hard drive) and 200-MHz Pentium *PCV-90* (32 megabytes RAM, and a 2.5-gigabyte hard drive) each feature a 28.8 DSVD modem, MPEG decoding, an 8X CD-ROM drive, and a comprehensive software bundle. The visually pleasing computers are competitively priced between \$2000 and \$3000.

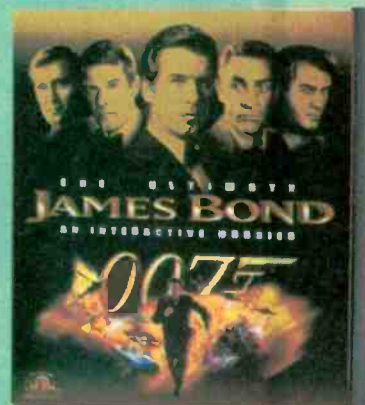



movies, and profiles the five actors who portrayed Bond. The Ultimate James Bond costs \$44.95.

LAPTOP FOR KIDS

Tired of surrendering your PC when your kids need to do their homework? Looking for a way to keep soda and peanut-butter-and-jelly sandwiches out of your keyboard? Why not buy the kids their own laptop—the *ComQuest Plus* from *Team Concepts*. Aimed at kids 9 and older, the lightweight, portable, battery-operated electronic learning aid has word processing, memory, a full-size keyboard, icon- and menu-driven activity selection, great sound effects, and a mouse. Its PC Link accessory (\$39.99) allows children to upload files onto the family PC and print out the homework they did on the laptop. Kids can write letters and stories, and even add graphics, on the *ComQuest Plus*. Besides graphics, the software includes 38 multi-level and multi-player activities. A save-and-store feature gives kids the option of keeping documents in their own laptop. There's also a perpetual calendar and scheduler; an address book; a world time clock and world atlas; metric conversion; and word, strate-

gy, logic, math, and trivia games. The *ComQuest Plus* has a suggested retail price of \$149.99.

SECRET AGENT MAN

The name is Bond—*The Ultimate James Bond: An Interactive Dossier*. The name of the game is getting to know the ultimate secret agent, inside and out. *MGM Interactive's CD-ROM* lets you explore eight different categories of James Bond's movie life through actual film clips, trivia, photos, and some never-before-seen material. The "Gadgets" section, for instance, highlights his arsenal of unusual espionage tools, including a ski-pole rifle, fake fingerprints, and the combination buzz-saw/magnetic Rolex that Bond used to unzip a woman's dress in *Live and Let Die*. The "Women" section reveals the likes, dislikes, and hidden agendas of all the "Bond Girls." You can also explore the high-tech vehicles, evil villains, and exotic locales. The CD-ROM includes clips from all 17 "007"



gym, logic, math, and trivia games. The *ComQuest Plus* has a suggested retail price of \$149.99.

JUST CRUISIN' ALONG

Fisher-Price teamed up with Compaq to bring kids the *Wonder Tools Cruiser*, a brightly colored "dash board"—complete with steering wheel, throttle, horn, and "radio stations"—that allows children to navigate through specially created software adventures. By replacing the point-and-click motions of a standard mouse—which can be troublesome for young users—the *Cruiser* gives kids real control of the multimedia environment. The steering wheel is used to drive through each adventure; the throttle changes the speed; the joystick selects things and moves them; and the horn clears obstacles from the child's path. "Spruce Squirrel's Hiccup Mix-up," a program that lets kids explore the worlds of land, sea, and space, is included in the \$150 suggested retail price.

ON-SCREEN IN-LINE SKATING LESSONS

If you're buying your kids in-line skates this year, you just might want to splurge

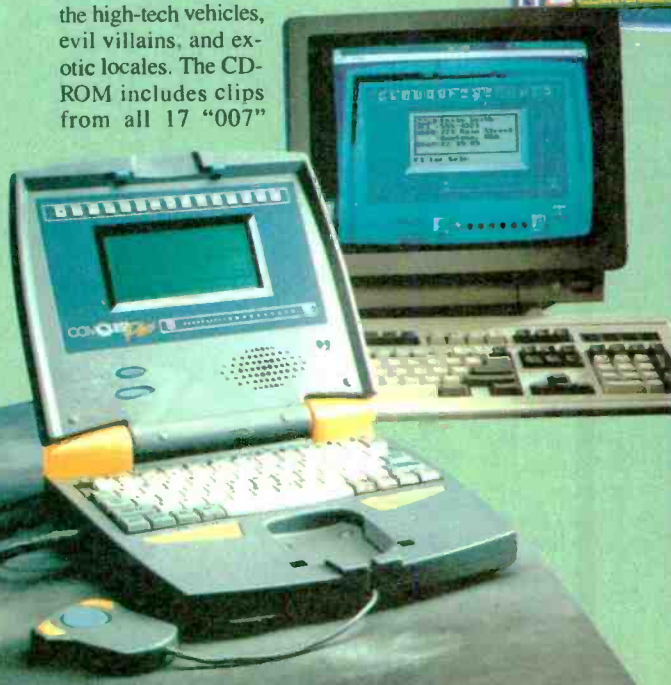

for *L3 Interactive's Real-Line CD-ROM*, hosted by, and featuring performances by, world-class skaters. Other top skaters are shown demonstrating and teaching step-by-step tricks and tips on everything from the most basic moves to radical maneuvers like skating down steps. The action-packed skating footage is accompanied by music by top alternative-rock bands (none of whom, we hate to admit, the aging baby boomers here at Gizmo have ever heard of). The CD-ROM uses the "Learning Cube" graphic user interface, which allows users to move through lessons and access many animated rows and blocks by selecting icon panels on a colorful, swirling cube. *Real-Line* has a street price of \$34.95.

GIVE 'EM GOOSEBUMPS

R.L. Stine's best-selling book series has gone interactive in *Goosebumps: Escape from Horrorland*, a Windows 95-based CD-ROM aimed at kids aged 8 and up. *DreamWorks Interactive's* disk combines detailed, miniature 3-D sets with live-action, big-star video. Jeff Goldblum stars as Count Dracula, and Isabella Rossellini portrays Lady Cadaver, in this interactive sequel to the hit novel *One Day at Horrorland*. Players are thrust into the Horrorland "scream park" at night, and creepy characters from the book come to life. Non-linear action, thousands of hot spots, and 16 levels of arcade-style fun allow players to explore Horrorland in any order they choose. *Goosebumps* is available at a not-too-scary suggested price of xxx.

CHITTY CHITTY BANG BANG PACKAGE

MGM Interactive's Chitty Chitty Bang Bang's Adventure in Tinker Town CD-ROM for both Windows 95 PCs and Macs comes bundled with a free, full-length videocassette of the film *Chitty Chitty Bang Bang*, starring Dick Van Dyke. The CD-ROM takes kids into an enchanting world where they use animated tools to fix and explore colorful, larger-than-life versions of common household appliances—and learn how



the world around them functions while they're at it. The game also challenges children to solve 15 puzzles designed to help them develop oral comprehension, science, safety, and memory skills. Three levels of difficulty accommodate different age groups. The CD-ROM and video have an estimated street price of \$29.95.

Digital Video's time has come, and here are a few ways to make it come your way for the holidays!

YOU BETTER SHOP AROUND

If a *Digital Satellite System* topped your list last year—as it did ours—but Santa didn't come through, perhaps he was simply being frugal. Anyone who waited to



casting are expected to begin subsidizing equipment suppliers, as well as sending buyers a rebate. That should bring the price of basic DSS hardware down to the \$199 level by the time you read this. With the purchase of \$300 of subscription programming, you can now buy a DSS system for \$199. How low can they go? Keep watching! Along with lower prices, expect advanced features on newer DSS systems.

Toshiba's Model TSS-222, pictured here, offers the StarSight on-screen program guide and a dish with dual LNBS, making it easy to add a second receiver for multiroom DSS viewing. Its suggested retail price (before any subsidies or rebates have gone into effect) was \$699.

BE THE FIRST ONE ON YOUR BLOCK

... to bring home a new DVD player. Many of the biggest names in consumer-electronics are backing the new DVD format and, as we go to press, are hoping to have their products on the shelves in time for Christmas 1996, along with hundreds of DVD titles from major Hollywood studios. DVD delivers better



buy a DSS system now has more brands to choose from, and often at greatly reduced prices. With DSS systems available from several major manufacturers, and competition from relative newcomer DBS systems like EchoStar and AlphaStar, the price wars are in full swing. As we go to press (in late summer), AT&T has been offering its long-distance customers complete DSS systems for just \$399 (if they promise to stick with the phone service, that is). EchoStar is offering its satellite dish and receiver for just \$199 to customers who pay \$300 for a year's subscription to programming. To keep DSS prices in line with those of the competition, DSS program suppliers DirecTV and U.S. Satellite Broad-



resolution and color purity than laserdiscs or even professional studio masters, and supports six-channel discrete Dolby Digital Surround Sound as well as Dolby Pro Logic and high-fidelity stereo. With a much larger storage capacity than that of current CDs or CD-ROMs, a single DVD disc can easily accommodate just about any full-length film. The DVD format offers a few other bonuses: users have a choice of viewing options (4:3, letterboxed, or 16:9); movie producers can present soundtracks in as many as eight different languages, and up to 32 distinct subtitles; more than one story line can be included on a single disc, allowing different endings or R- and PG-rated versions; and a parental-control feature automatically shows the edited version selected by parents. DVD is not just for video—it will be used in a broad range of computer-based multimedia applications as well. Finally, your new DVD player will play all current audio CDs. *Toshiba's SD-3006*, pictured here, is expected to carry a suggested retail price of \$699.

PHOTO SCANNER

Put this year's holiday photos—and some shots from graduation ceremonies, vacations, and other family events—in next year's Christmas letter, with *Polaroid's PhotoPad* digital photo scanner. It scans any 35mm or Polaroid photo, up to 46 inches in size, into any PC document. Once the photo is placed on the scanner, it requires only one step and takes less than a minute to scan an image. The digitized image can be dragged and dropped into place in documents created in many popular word-processing and presentation programs, including Microsoft Word, WordPerfect, Microsoft Works, and Microsoft Powerpoint. Won't your friends and relatives be impressed when they receive your annual greeting, complete with photos, via e-mail or the Internet? The PhotoPad digital scanner, complete with easy-to-use software, has a suggested retail price of \$299.



DIGITAL DARKROOM

Give the photography buff on your list a complete, plug-and-play home digital darkroom. *Fargo Electronics' FotoFUN!* digital color photo printer combines all the hardware and software needed to create photo-lab quality color prints up to 46 inches in size, using your Macintosh, Amiga, or Windows PC. Color-matching software automatically adjusts the color of an image according to pre-configured printer and default system profiles. With optional accessory kits, FotoFUN can be used to create color-photo postcards, coffee mugs, and labels. A print film kit, including ribbon and paper for 36 prints, is included in the average purchase price of \$499.

MULTIMEDIA SNAPSHOTS

Put your photographs on video or publish them on the Internet, with *Casio's QV-30* digital camera. The camera stores up to 96 images in flash memory. You can view them instantly on its 2.5-inch, high-resolution, active-matrix color LCD. Or have your subjects star in multimedia presentations, by transferring the images to a Windows or Macintosh computer, or outputting them to a TV or VCR. All the necessary



connectors and cables are included. So is Adobe PhotoDeluxe software, which makes it easy to modify and personalize your photos. The camera features a two-position lens: 46mm for wide-angle, and 105mm for telephoto shots. The LCD replaces the standard viewfinder, making it easy to compose pictures without missing out on any of the action. You can view either one, four, or nine images on a single screen, and consecutive images can automatically be displayed one-by-one on a TV. The QV-30 has a suggested retail price of \$999.

Anyone who travels frequently on business trips will surely appreciate receiving any of the gadgets on this page!

BUSINESS-CARD READER

How do you organize those stacks of business cards that are spilling out of your pockets and briefcase after a few days at a trade show or convention? *Seiko's Smart Business Card Reader* scans individual business cards and stores the images into its own full-featured database, or into many other popular





contact-management data-base programs. The reader features a 400-dot-per-inch resolution in an 8-bit gray scale (256 shades of gray). You can wait until you get back to your office, or take the 7- X 2.75-inch device along to scan on the road, and leave all those business cards in the hotel room wastebasket. Business cards in either landscape or portrait formats are scanned at up to four cards per minute. The built-in software recognizes the card data and inserts it into the appropriate fields in about 15 seconds. You can then view a complete image of the card on a PC monitor, or view and verify the contacts in database or list format. You can add notes to the cards and search for contacts based on those notes,

tures a Bell Laboratories-patented authentication feature, or "A-Key," designed to reduce cellular phone fraud. The new A-Key method is expected to be much more effective than the current practice of transmitting an equipment serial number before each call. Thieves with cellular scanning devices can intercept a standard phone's serial number and then program it into other cell phones, which then charge all their calls to your account.

That's why, in areas with high cell-phone fraud rates, customers are required to enter a personal identification number (PIN) before every call. No PIN will be required with A-Key-equipped cell phones. The AT&T 3740 has on-screen instructions for its sophisticated calling features, which include caller ID, short-message service, and voice-mail indicator, where those services are offered by the cellular service provider. It also has one-button dialing of up to nine numbers, a 60-number alphanumeric memory, 70-minute talk time, 10-hour standby time, a call log, and preprogrammed insertion of a calling card number. Contact your local AT&T dealer for the costs of the 3740 and cellular service.

COMMUNICATIONS DOUBLE PLAY

How many people on your list rely on both cell phones and pagers? Consider giv-

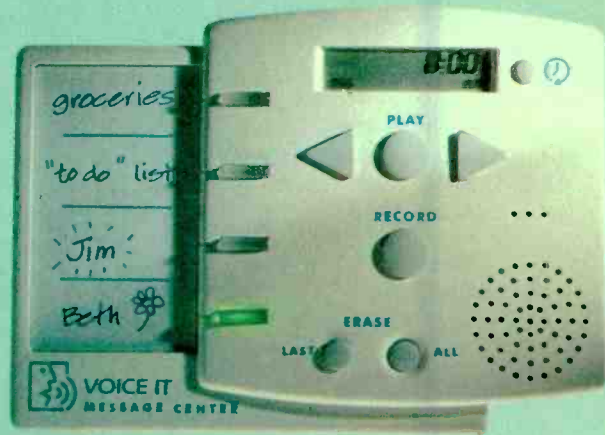

ing them *Motorola's RSVP*, a full-featured numeric pager that's built-into a cellular telephone battery. Although they are both powered by the same source, the pager and the phone function independently. The user can be paged even when talking on the phone. By keeping the telephone off and giving out the pager number only, RSVP can be used as a call-screening device as well. RSVP has a suggested retail price of \$259.

WATCH IT!

Lighten someone's briefcase load by giving them the *Timex Data Link*—a wrist-watch that doubles as an electronic organizer. Don't be scared off by the thought of entering data on a watch-sized keypad. Built-in software (created by Microsoft and Timex) lets you input appointments, phone numbers, important dates, and to-do lists



easily calling up everyone to whom you promised to send more information on your company's products. Cards can be saved in user-defined categories, sorted by a field or multiple fields, and printed as an address book, phone book, or labels. The Smart Business Card Reader has a street price of about \$200.

FRAUD-PREVENTION CELL PHONE

AT&T's Model 3740 cellular phone fea-



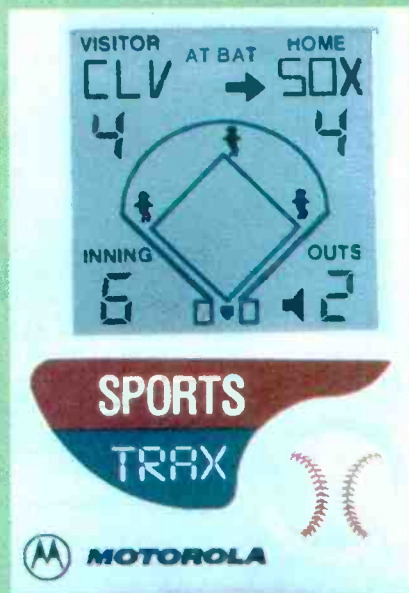

on your PC, and download the data to the watch in seconds, without any cables or connectors. The watch's sensor reads flashing bars of light on the monitor. The Data Link watch requires Windows 3.1 or better, and is fully integrated with Microsoft Schedule+ for Windows 95, which is now part of Microsoft Office for Windows 95. Up to 150 entries can be entered, then read on a 31-character scrolling message line. Watch functions include a stopwatch, count-down timers, and Timex's "Indiglo" night light. The Data Link 150 costs about \$139.

LAPTOP PRIVACY

Anyone who uses a laptop on an airplane or in other crowded public places knows how annoying it is to have the stranger in the next seat read whatever's on screen. *GlareGuard's Traveler 2000* notebook privacy filter makes it virtually impossible for anyone not seated directly in front of the screen to read what's displayed. A film coating restricts the viewing angle by diffusing the image. The Traveler 2000 also has a multi-layer, anti-reflective coating



that reduces glare by 95%, while increasing contrast, maintaining resolution, and reducing eye strain. The lightweight filter fits any notebook computer with a diagonal screen measurement of up to 10.4 inches. Its suggested retail price of \$69.99 includes a protective carrying pouch.

PERSONAL TRAVEL PLANNER

For the frequent traveler on your list, consider the *Triplink* from *Ultradata Systems Inc.*, a pocket-sized "travel computer" that can replace the stacks of maps, guidebooks, auto-club handouts, and phonebooks used for planning business or pleasure trips. The Triplink system consists of a CD-ROM disc and the portable travel computer. The traveler plans the trip at home or in the office using the included CD-ROM and a desktop PC. The personalized trip and route information is then downloaded into the handheld travel computer, where it is available instantly at the traveler's fingertips. The user enters the starting point and destination, including any planned stops along the way—"New York to Orlando, via Washington, D.C." for instance. To personalize the trip, he can choose from the fastest, most scenic, or shortest route and can enter more than one point of interest to stop at along the way. The Triplink CD-ROM

then calculates the route, directions, and mileage; provides information about services; and lists facts about the cities along the route. The traveler can find out where the nearest McDonald's or 24-hour copy center is located, get directions to his or her hotel, and see emergency phone numbers and resources. Triplink also provides detailed information and directions for more than 80 major U.S. and Canadian cities, including lodging, dining, tourist attractions, convention centers, sports arenas, and such services as gas stations and pharmacies. Triplink has a suggested retail price of \$139.95.

There's always someone on your list who has you totally stumped. Here's a sampling of some interesting and unusual products that just might suit an otherwise hard-to-fit person.

FAMILY MESSAGE CENTER

Instead of buying a bunch of small gifts for every member of a busy family, why not try to simplify their hectic lives with the *Family Message Center* from *Voice It Worldwide*. Four separate digital channels allow spoken messages and reminders to be grouped by name or message category. For instance, whoever drinks the last of the milk can just say "milk" into the grocery list category. An indicator light flashes when new messages are waiting, and a clock and display panel show when they were recorded. The Family Message Center, which can be mounted on a wall, or placed on the refrigerator to replace all those scribbled reminders held by magnets, has a suggested retail price of \$119.

PRIVATE COOKING LESSONS

Does your family eat out or order in all the time because no one knows how to prepare a decent meal? For those who are truly desperate for some home cooking, consider the *Kitchen Coach* from *Jericho Promotions*. The Kitchen Coach is an integrated TV, CD player, and "dedicated computer brain." When you insert one of its special video CDs, it guides you, step-by-step and in real time, through the process of cooking. You can choose the

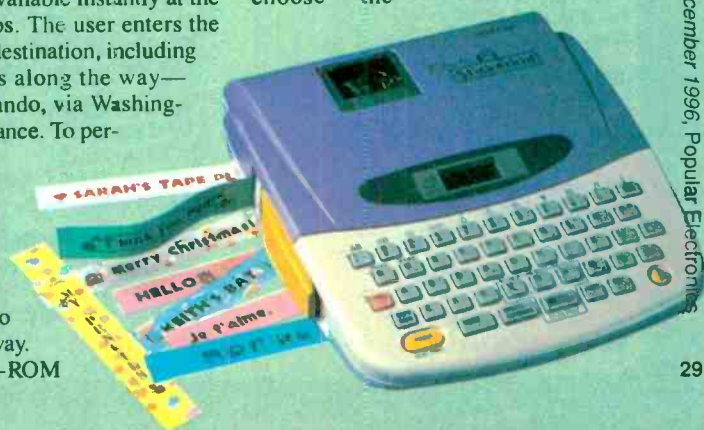

MANUFACTURERS

AT&T Consumer Products

5 Wood Hollow Road
Parsippany, NJ 07054
Tel. 800-232-5179

Bose Corporation

The Mountain
Framingham, MA 01701-9168
Tel. 800-444-BOSE

Brother International Corporation

200 Cottontail Lane
Somerset, NJ 08875
Tel. 908-356-8880

Casio, Inc.

570 Mt. Pleasant Ave.
Dover, NJ 07801
Tel. 201-361-5400

Compaq Computer Corporation

P.O. Box 692000
Houston, TX 77269-2000
Tel. 713-514-0484

County Line Limited

4543 Taylor Lane
Warrensville Heights, OH 44128
Tel. 216-765-1234

DreamWorks Interactive

640 North Sepulveda Blvd.
Los Angeles, CA 90049
Tel. 310-234-7000

Fargo Electronics, Inc.

7901 Flying Cloud Drive
Eden Prairie, MN 55344
Tel. 800-327-4622
Web: <http://www.fargo.com>

Fuji Photo Film U.S.A. Inc.

555 Taxter Road
Elmsford, NY 10523
Web: <http://www.fujifilm.com>

Gateway 2000

610 Gateway Drive
P.O. Box 2000
North Sioux City, SD 57049-2000
Tel. 800-846-5253
Web: <http://www.gw2k.com/destination>

Glare/Guard Division

Optical Coating Laboratory
2789 Northpoint Parkway
Santa Rosa, CA 95407-7397
Tel. 800-545-6254

ITT Night Vision

7635 Plantation Road
Department P
Roanoke, VA 24019
Tel. 800-448-8678
Web: <http://www.ittnv.com>

Jericho Promotions, Inc.

924 Broadway
New York, NY 10010-6007
Tel. 212-260-3744

Kenwood USA Corp.

P.O. Box 2745
Long Beach, CA 90801

Key Tronic Corporation

P.O. Box 1468
Spokane, WA 99214-0687
Tel. 800-262-6006

L3 Interactive

3000 West Olympic Blvd.
Santa Monica, CA 90404
Tel. 800-644-CUBE
Web: <http://www.learningcube.com>

Marantz America, Inc.

440 Medinah Road
Roselle, IL 60172
Tel. 708-307-3100
Fax: 708-307-2687

MGM Interactive

2500 Broadway Street
Santa Monica, CA 90404-3061
Web: <http://www.mgmua.com>

Motorola

Paging Products Group
3301 Quantum Blvd.
Boynton Beach, FL 33426-8292
Tel. 800-724-3638

Polaroid Corporation

575 Technology Square
Cambridge, MA 02139
Tel. 800-343-5000

Seiko Instruments USA, Inc.

1130 Ringwood Court
San Jose, CA 95131
Tel. 408-922-5900

Sony Electronics

1 Sony Drive
Park Ridge, NJ 07656
Tel. 201-930-1000

Spatializer Audio Laboratories, Inc.

20700 Ventura Blvd., Suite 134
Woodland Hills, CA 91364
Tel. 818-227-3370
e-mail: info@spatializer.com
Web: <http://www.spatializer.com>

Team Concepts North America, Ltd.

1101 San Antonio Road, Suite 414
Mountain View, CA 94043
Tel. 800-486-0898

Timex Data Link

P.O. Box 310
Middlebury, CT 06762-0310
Tel. 800-367-8463

Toshiba America Consumer Products, Inc.

82 Totowa Road
Wayne, NJ 07470
Web: <http://www.toshiba.com>

Ultradata Systems Inc.

9375 Dielman Industrial Drive
St. Louis, MO 63132
Tel. 800-759-8486
Web: <http://www.ultradatasystems.com>

Vivitar Corporation

1280 Rancho Conejo Blvd.
P.O. Box 2559
Newbury Park, CA 91319-2559
Tel. 805-498-7008

Voice It Worldwide, Inc.

2643 Midpoint Drive, Suite A
Fort Collins, CO 80525
Tel. 1-800-876-4699, ext. 45
Web: <http://www.voiceit.com>

type and speed of the lesson using a water- and grease-proof remote control that also allows you to switch from "coach" mode to regular television programming while the turkey roasts. Six video CDs are included: *Stocking Up*, *Chef's Secrets*, *Classic Accompaniments*, *Essential Gourmet Techniques*, *Meals in Minutes*, and *Low-Fat Healthful Cooking*. Future CDs will include ethnic menus, barbecuing and grilling, and choosing wines. You'll have to forego a lot of restaurant meals, however, to cover the Kitchen Coach's hefty retail price of about \$950.

NIGHT EYES

Campers, star-gazers, nighttime boaters, and wildlife buffs—as well as those who'd like to be able to spot a possible burglar without turning on all the lights—would love to get *ITT's Night Quest 100 Night Vision viewer*. Using the same technology used by the U.S. military and police forces, it allows users to survey the area they can't see with the naked eye as a clear "picture" in near-daylight conditions. At the heart of the Night Quest 100 is a three-component image-intensifier tube that multiplies thousands of times the minute amounts of ambient light (from stars, the moon, or artificial lights) collected by an objective lens. The weather-resistant viewer offers a 52-degree field of view. Weighing in at just 10 ounces, the compact viewer won't add much weight to a backpack. The Night Quest 100 has a suggested retail price of less than \$800.

ELECTRONIC BIRD-FEEDER

Is one of the 63 million Americans who enjoys bird watching and bird feeding on your holiday gift list? The perfect gift for that person is the *WingSong* bird feeder from *County Line Limited*. The Colonial-style feeder has a patented wireless microphone and transmitter located under its roof. A portable receiver/speaker placed inside the bird watcher's house allows the song of every bird that comes to feed to be heard. A large overhanging roof keeps birdseed dry, windows on all six sides makes it easy to see the level of seed, and two perch sizes accommodate both large and small birds. The *WingSong (Model BF3)* bird feeder can be yours to give for less than \$100.

POCKET-SIZED PLAY-BY-PLAY

Baseball fans can easily follow their favorite team with the *SportsTrax* wireless sports newswire monitor from *Motorola*. The pocket-sized devices display continuous, commercial-free game updates originating from the game-side press box, in real time. They allow the user to keep track of a game at a glance, without neglecting work or family obligations. *SportsTrax* displays the current score, the inning, the team

at bat, and the number of outs—and a graphic of a baseball diamond shows the positions of the base runners. Audible alerts let the user know when an inning is ending, a run is scored, a home run is hit, a game is starting, or a rally is taking place. About the size of a pager, SportsTrax can be used anywhere in the country, allowing fans to monitor their home teams while traveling. The retail price of \$199 includes the device and complete coverage of three seasons of regular games, and playoffs, and the World Series. A basketball version is also available, although the NBA has initiated a lawsuit to block the unit's distribution.

STICKER MAKER

Kids love those stickers they sell in stores—imagine how much more they'll like stickers they design and make by themselves. *Brother International's Stickerkid* lets kids create personalized stickers for school projects, dressing up gifts, or making customized labels for personal items. The purple, handheld device offers many of the features found on its adult counterpart, the Brother P-Touch labeler. A typewriter-style keyboard is used to enter letters, more than 300 built-in symbols, and framing styles. Stickers are viewed on the device's LCD and printed out onto adhesive-backed, "crack-n-peel" style tapes, available in six colors and four patterns. Stickerkid offers seven fonts, five type-styles, ribbon pattern-making capabilities, and a special code function for encoding and decoding "secret" messages. Stickerkid is quite affordable, costing less than \$100.

STATE-OF-THE-ART CAMERAS

Cameras are perennial favorite holiday gifts, and the new Advanced Photo System (APS) cameras make good gifts even for those who already own a camera. APS cameras provide photographers with a choice of three print formats: the standard 46 inches, a slightly larger 47 inches, or a 410-inch panoramic shot. When the film is developed, a proof sheet is included, making it easy to order reprints in the format the picture was shot in, or either of the other two formats. *Fujifilm's* line of *Endeavor* APS cameras include one for every price range. The basic *Endeavor 10*, with a 23mm fixed-focus lens and built-in flash, has a suggested retail price of \$69.95. The top-of-the-line *Endeavor 400SL*, a 4X zoom single-lens reflex camera aimed at pleasing advanced amateur photographers, features TTL autofocus and light measurement, stop-action and portrait modes, multi-programmed flash, red-eye reduction, night-portrait mode, and data input (date and time, title, print quantity, format selection, and shooting data). The top-of-the-line camera has a suggested retail price of \$849.95.

Wavetek. The Way Value Is Measured.

For the best values in digital multimeters everyone is turning to the Wavetek XT Series. Each of these full-function DMMs measures voltage, current, resistance, and also a set of additional electrical or electronic properties you work with every day. Inductance. Capacitance. Frequency.

Temperature. There is an XT Series DMM right for you.

With oversized character displays, these DMMs are as easy to read as they are to use. All have fully fused current inputs and input warning beepers to protect you and the meter. Each comes with safety test

leads and are approved to IEC1010-1 safety standards.

Our commitment to reliability and high-quality is backed by the industry's only "No Hassle" warranty

program. If your XT Series meter requires

warranty service, your local dealer

replaces it immediately. Call today

for full details and the names of your

local Wavetek distributors. You'll find that when it comes to Wavetek

performance and price, nothing else measures up.

Wavetek Corporation
9145 Balboa Avenue, San Diego, CA 92123
(800) 854 2708



27XT
A unique combination of DMM and component checking in a single meter.

- Inductance
- Capacitance
- Logic
- Frequency

Accessories include current clamps, RF & HV probes, temperature converters, holsters, boots and carrying cases.

23XT

- Electronic and electrical test functions for general duty and HVAC/R, building or plant maintenance.
- VAC Safety Testers
- Temperature
- Capacitance
- Logic

25XT

- A full G-meter in a DMM, and more! Ideal for AM, cell-phone & antenna matching, component inspection.
- Full Capacitance 0.1pF to 20mF
- Capacitance Zoning & Test Slots

28XT

- A thermometer + DMM for HVAC/R, building or plant maintenance.
- Temperature
- Capacitance
- Frequency
- Max-Hold

85XT

- A precision True-RMS reading DMM, ideal for equipment like copiers.
- 4 1/2 digit Accuracy
- True-RMS
- Frequency
- Duty Cycle

LCR55

- Full-function LCR, extra test features for "best-buy" in a component tester.
- Inductance
- Capacitance
- Resistance
- Transistor
- Dual Diode

CIRCLE 159 ON FREE INFORMATION CARD

BUILD THE **LIGHT ANIMATOR**

Add some excitement to your holiday lighting this Christmas.

BY RODRICK SEELY



Here's a fun project for the holidays that will dazzle your friends and neighbors: it's called the *Light Animator*. With this ultimate lighting accessory, your home or yard can rival that of the Griswold family from the movie *National Lampoon's Christmas Vacation*.

What do we mean? Well, by plugging strings of lights into the Light Animator and arranging them into shapes and patterns, you can create such animated effects as waving Santas, flying reindeer, or shooting stars! That's possible because the Light Animator is a chaser, or sequencer, which controls up to eight outputs. Each output can drive multiple light strings to create many interesting effects.

The unit features an LED display, adjustable rate control, a mode-selector switch, and a position-selector switch. The position switch selects from 3 to 8 steps in the animation sequence, and the mode switch selects between "bounce" mode and "cycle" mode. Bounce mode flashes the light strings back and forth, and cycle mode flashes the lights in one direction. Now let's look at how that's accomplished.

Circuit Description. The schematic for the Light Animator is shown in Fig. 1. That circuit consists of a 5-volt power supply, an oscillator, some control logic, and eight triac-based power-control circuits (only one is shown; the others are identical).

Power for the circuit is taken from a 117-volt AC outlet. That source passes through a 3-ampere fuse and is used

in two different ways by the circuit. For one, transformer T1 steps the power down to a 6-volt AC source, which is rectified by bridge rectifier BR1 and filtered by capacitor C3. The voltage is then regulated by IC5 to provide a stable 5-volt supply. As for the other use of the power, the hot and neutral lines from the outlet are also fed to AC-sockets SO1-SO8, which are in the eight power-control circuits.

A 555 timer, IC1, is configured as an oscillator, which controls the sequence rate. The oscillator's frequency is determined by the formula:

$$f = 1.44 / (R1 + R3 + 2R2) \times C$$

The frequency range with the values shown is about 1.3 Hz to 14.1 Hz. Potentiometer R3 can be changed to set the maximum speed.

The heart of the circuit's logic control is IC3, a binary up/down counter. Switch S1 is used to select the circuit's mode. In cycle mode, IC3 is operated as an up-counter that is reset after it has counted up to the last position in the sequence. In bounce mode, IC3 counts up to the last position in the sequence, then counts back down. The clock pulses from the oscillator are steered to the up- and down-counting pins of IC3 by quad NAND gate IC2. A flip-flop is formed by IC2-c and IC2-d that toggles IC3 between up and down counting in bounce mode. In cycle mode, IC2 controls the up counting and reset inputs of IC3.

The binary outputs of IC3 are decoded by IC4, which is a 3- to 8-line binary decoder. The last six outputs of

the decoder are connected to rotary-switch S2, which is used to select the number of positions or steps in the sequence. Those decoder outputs are also used to drive the eight power-control circuits, which actually manipulate the light strings. Because IC3 is a 4-bit up/down counter, a 4- to 16-line decoder (*i.e.* a 74LS154) could be used to provide 16 positions instead of 8 in the circuit. Of course, a rotary switch with more positions would also have to be used with the Light Animator.

Each of the eight power-control circuits consists of an MOC3040 opto-isolator (IC6-IC13), a Q4004L3 triac (TR1-TR8), and a red display LED (LED1-LED8). The opto-isolators provide isolation, triac-driving circuitry, and zero-crossing detection. The zero-crossing feature protects the light bulbs by ensuring that each triac will turn on at the instant when the AC voltage is at zero volts, rather than at the AC peak voltage.

Note that the arrows with numbers in them, which are connected to the decoder's eight outputs, match the arrows in each power-control circuit. Only one circuit is shown, and therefore only arrow 1 is drawn solid, but in each consecutive circuit, the arrows connect at the same point (*i.e.* arrow 2 in circuit 2, etc.). The same holds true for the open circle connections to resistor R5 and the +5-volt source. Match each open circle with the open circle in the corresponding power-control circuit (*i.e.*, circle 1 goes with circle 1 in circuit 1, etc.).

Fig. 1. The Light Animator circuit, shown here, consists of a 5-volt power supply, an oscillator, some control logic, and eight triac-based power-control circuits (only one is shown; the others are identical).

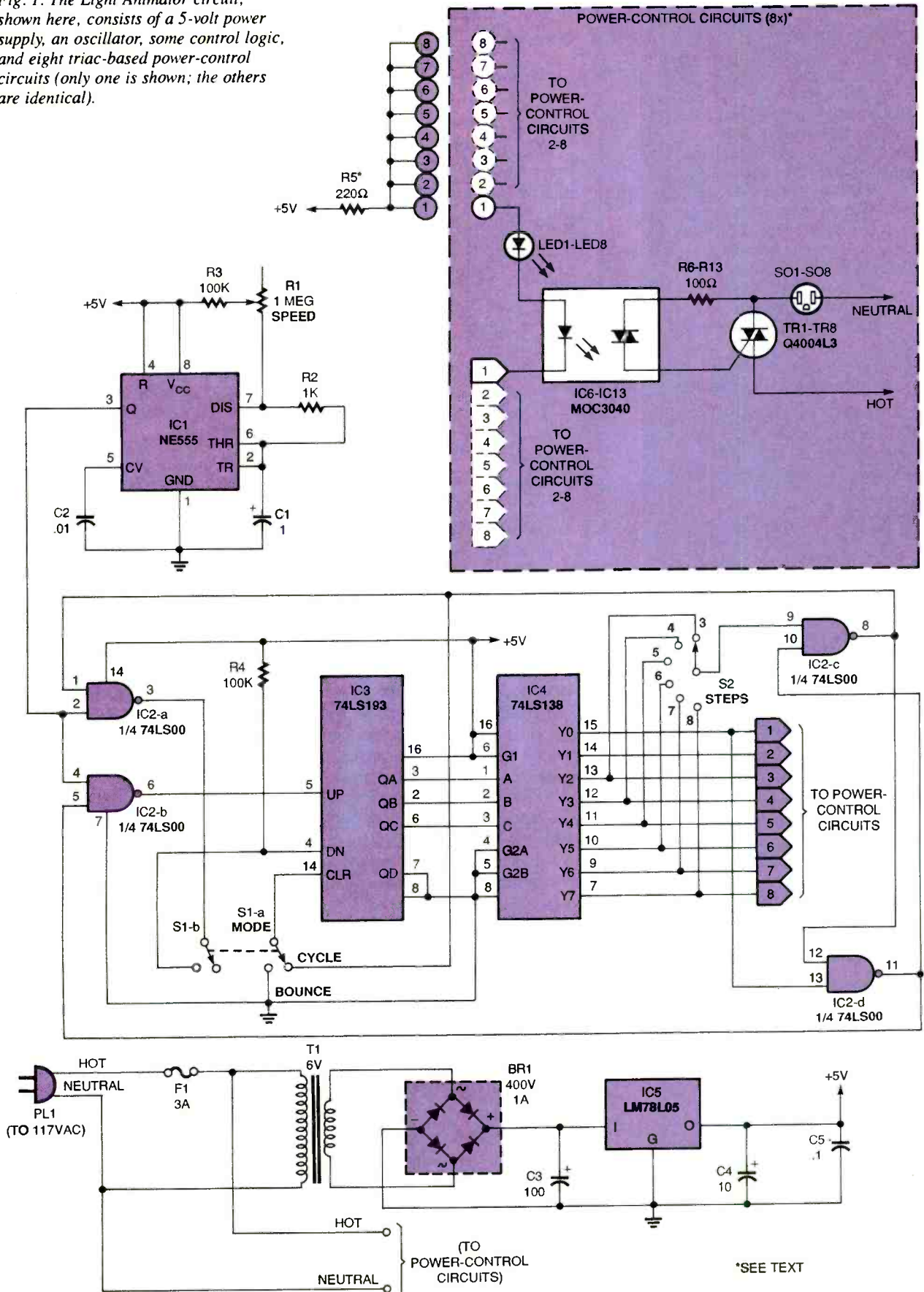

PARTS LIST

SEMICONDUCTORS

- IC1—NE555 timer, integrated circuit
 IC2—74LS00 quad NAND gate, integrated circuit
 IC3—74LS193 binary 4-bit up/down counter, integrated circuit
 IC4—74LS138 binary 3- to 8-line decoder, integrated circuit
 IC5—LM78L05 5-volt regulator, integrated circuit
 IC6-IC13—MOC3040 opto-isolator triac driver, with zero-crossing, integrated circuit
 TR1—TR8—Q4004L3, 400-volt, 4-amp isolated tab triac
 LED1-LED8—Light-emitting diode, red
 BR1—Full-wave bridge rectifier, 400-volt, 1-amp (DB104 or equivalent)

RESISTORS

- (All fixed resistors are 1/4-watt, 5% units, unless otherwise noted.)
 R1—1-megohm linear potentiometer, PC-mount
 R2—1000-ohm
 R3, R4—100,000-ohm
 R5—220-ohm, 1/2-watt
 R6-R13—100-ohm

CAPACITORS

- C1—1- μ F, 16-WVDC, electrolytic
 C2—0.01- μ F, Mylar
 C3—100- μ F, 16-WVDC, electrolytic
 C4—10- μ F, 16-WVDC, electrolytic
 C5—0.1- μ F, Mylar

ADDITIONAL PARTS AND MATERIALS

- T1—117- to 6-VAC transformer
 F1—3-ampere fuse
 S1—2PDT toggle switch, PC-mount
 S2—DP6T rotary switch, PC-mount (only one section used, see text)
 SO1-SO8—AC socket, two-terminal
 PL1—AC plug, two-terminal
 Printed-circuit materials, enclosure, spacers, knobs, fuse holder, AC line cord, strain-relief grommet, wire, solder, hardware, etc.

Note: The following items are available from Lynn-Eren Electronics (17093 SW Lynnly Way, Sherwood, OR 97140; Tel: 503-625-2205; Web: <http://www.teleport.com/~lynneren>): complete kit of parts including all electronic components, an etched, drilled and plated-through PC-board, and a pre-drilled enclosure with screen-printed front panel—\$129; PC-board—\$20; enclosure—\$45. Please add 5% shipping and handling. Check or money order, VISA and MasterCard are accepted. Oregon residents please add appropriate sales tax.

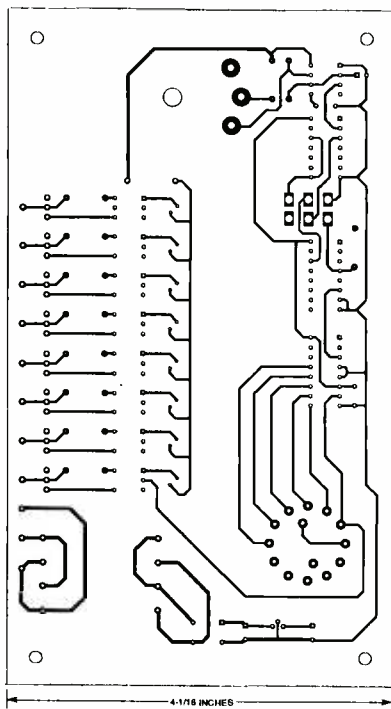

Fig. 2. This is the solder side of the Light Animator PC board, reduced by 50%.

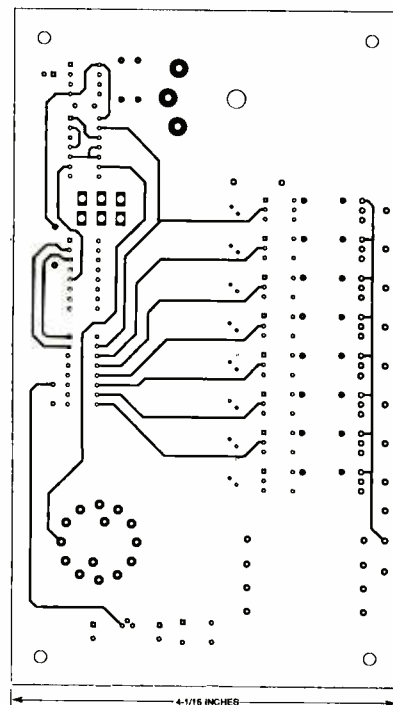

Fig. 3. Here's a 50% reduction of the component side of the double-sized PC board.

Construction. The author's prototype for the Light Animator was built on a double-sided printed-circuit board. Doing the same will ensure ease of assembly, and reduce the chance of wiring mistakes. You can make your own PC board from the solder- and component-side patterns shown in Figs. 2 and 3, respectively (they are shown at 50% of their original size). Or, you can purchase an etched and drilled board from the source mentioned in the Parts List.

The circuit board is designed for a PC-mounted transformer and potentiometer, as well as board-mounted switches. That eliminates a lot of messy wiring. If those parts are not available, however, you can of course use chassis-mounted components and insulated wires.

If you're building the unit on a PC board, use the parts-placement diagram shown in Fig. 4 as a guide. Note that some components have connections on both sides of the circuit board, so both connections need to be soldered on those parts. Begin by installing sockets for IC1-IC4 and IC6-IC13. Note that for opto-isolators IC7-IC13 you will need to bend pin 5 on each socket away as there is no mounting hole for it.

Solder all the fixed resistors and capacitors to the board next, being careful to orient the polarized capacitors correctly. Install the bridge rectifier, making sure it is oriented properly as well.

Mount the potentiometer and two switches next, as shown. Note that in the case of S2, the board was designed for a two-pole, six-position rotary switch; only one pole is actually used, however. The board was designed that way because two-pole rotary switches are much easier to obtain.

Solder short, insulated wires to the board to facilitate connections to the sockets, fuse, and AC cord, as shown in the parts-placement diagram. Note that transformer T1 mounts on the solder side of the board. Install that part at this time.

Continue with assembly by soldering the eight LEDs to the board. Because the PC-board will be mounted directly to the front panel of the enclosure using 1/2-inch spacers, make sure the bases of the LEDs stand about 3/8-inch off the board. That way the lenses will reach the front panel. Solder the eight triacs to the board, next. Then insert the opto-isolators into their sockets. You will have to bend the tri-

5 BOOKS FOR ONLY \$4.95

WHEN YOU JOIN THE

Electronics Book Club®

VALUES TO \$182.80

The leading source of information for electronics hobbyists for over 30 years!



0350787-XX \$44.95
Counts as 2/Hardcover



0376581-XX \$39.50
Counts as 2/Hardcover

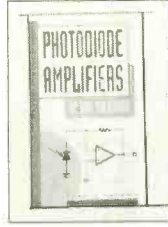

024247X \$49.00

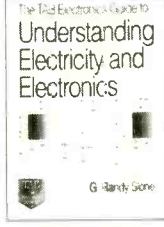

0542157 \$26.95
Hardcover

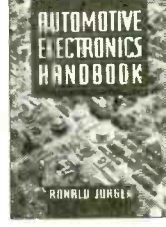

0331898-XX \$89.50
Counts as 2



1570519 \$17.95



0156786-XX \$24.95
Counts as 2



575472 \$27.95

COMPUTER
TECHNICIAN'S
HANDBOOK
3rd Edition

0487375 \$24.95



9119350-XX \$49.95
Counts as 2

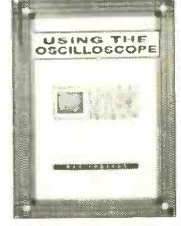

5872625-XX \$30.00
Counts as 2/Hardcover



036432X \$29.95
Hardcover

5871599-XX \$74.00
Counts as 2



1574875 \$19.95



5865314-XX \$59.95
Counts as 2

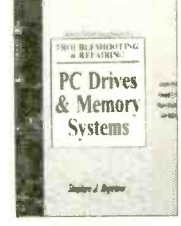

0053146 \$24.95



9122264-XX \$39.95
Counts as 2



0052387 \$28.95
Hardcover



0304068 \$15.95

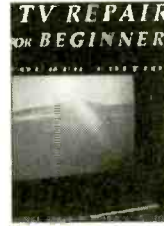

073092X \$19.95



155016X-XX \$34.95
Counts as 2

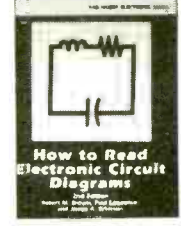

1554637 \$16.95

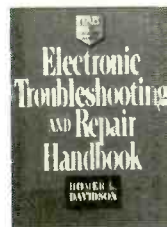

015676-XX \$69.00
Counts as 2/Hardcover



0717753 \$19.95



1577564 \$22.95

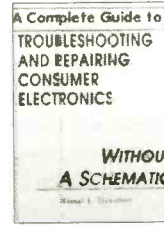

0156492 \$34.95
Hardcover



0303932 \$17.95

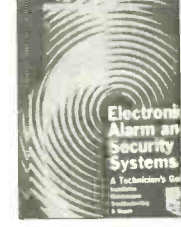

0305285 \$39.95

As a member of the ELECTRONICS BOOK CLUB®...you'll enjoy receiving Club bulletins every 3-4 weeks containing exciting offers on the latest books in the field at savings of up to 50% off the regular publishers' prices. If you want the Main selection, do nothing and it will be shipped automatically. If you want another book, or no book at all, simply return the reply form to us by the date specified. You'll have at least 10 days to decide. If you ever receive a book you don't want due to late delivery of the bulletin, you can return it at our expense. Your only obligation is to purchase 3 more books during the next 12 months, after which you may cancel your membership at any time. And you'll be eligible for FREE BOOKS through our Bonus Book Program.

A shipping/handling charge and sales tax will be added to all orders. All books are softcover unless otherwise noted. If you select a book that counts as 2 choices, write the book number in one box and XX in the next. (Publishers' Prices Shown) ©1996 EBC

PE1296

If card is missing, write to: Electronics Book Club®, A Division of the McGraw-Hill Companies, P.O. Box 549, Blacklick, OH 43004-9918

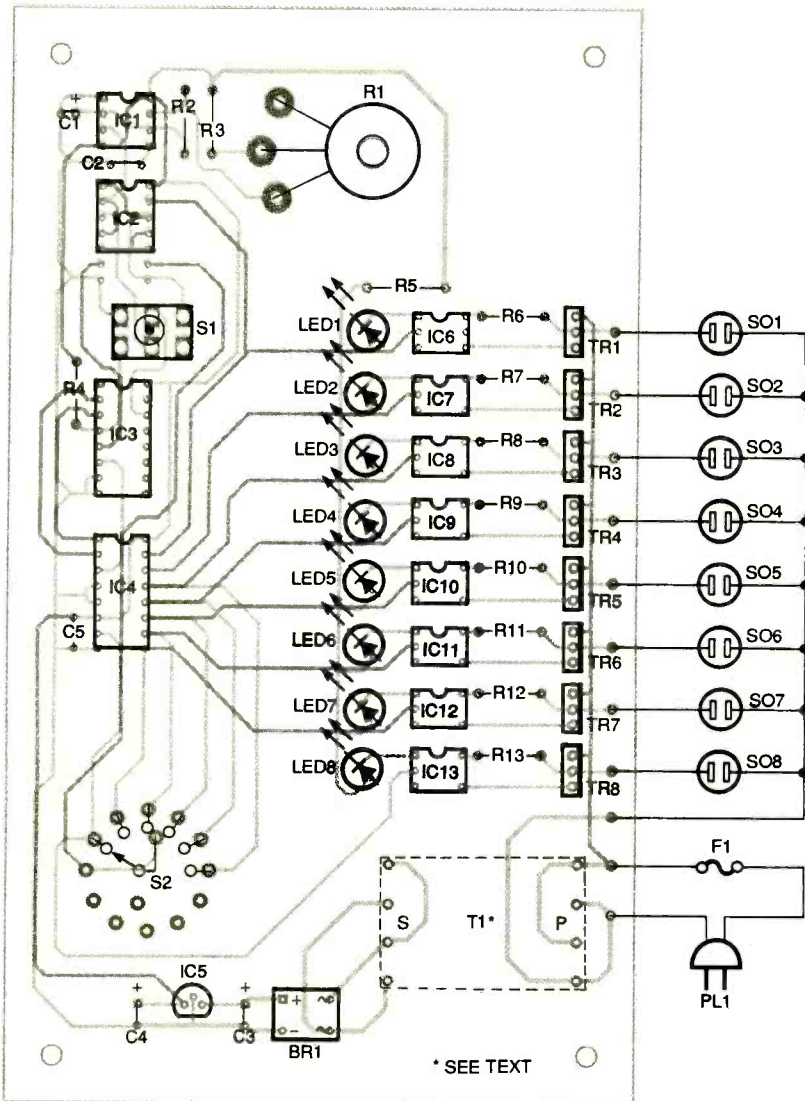

Fig. 4. Use this parts-placement diagram as a guide when building the Light Animator. Note that transformer T1 mounts onto the solder side of the board.

acs over so that they stand less than 1/2-inch off the board. The heat sinks of the triacs will then partially cover the opto-isolators, which is why the isolators have to be inserted before you bend over the triacs. Make sure the LEDs and triacs are all oriented correctly.

Install IC5 next, as shown in the diagram. Then, to complete on-board assembly, insert IC1-IC4 into their sockets.

Once all the PC-board components are installed and you've double-checked the wiring, install sockets SO1-SO8 and a fuse holder to the enclosure you selected for the Light Animator. Run an AC line cord through a grommet into the case, as well (attach PL1 to the other end of the cord). Then wire those parts to the leads you

soldered to the board. Use the parts-placement as a guide to make sure you make the correct connections. Note that you will need to connect all the neutral sides of the sockets together with a wire. **The AC sockets, fuse holder, and line cord must be wired correctly to prevent electric shock and fire hazard.**

You will now need to prepare the front panel of the Light Animator case. To do that you will need to drill holes to accommodate the potentiometer, switches, and LEDs. As you would do with any other project, measure the distance between the components that require holes and mark those points on the inside of the case cover. Then use a drill bit of the correct size for each different part. You'll probably need to use a 5/16-inch bit for R1's hole,

a 1/4-inch bit for S1, a 3/8-inch bit for S2, and a 3/16-inch bit for the holes for the LEDs. Once the panel is complete, make sure it matches up with the board, but do not assemble the case yet.

Testing and Final Assembly. Clear an area for testing, and arrange the PC-board so it does not touch any of the high-voltage components in the chassis. Plug in the unit and verify the operation of the LED display, speed control, and switches. **Be careful not to touch the circuit board while the unit is plugged in.** Unplug the unit before final assembly or troubleshooting. If the unit does not function properly, check the orientation of all polarized components, and make sure the parts are soldered on both sides of the PC-board where necessary.

With the unit unplugged, mount the PC-board to the front panel using 1/2-inch spacers. A guide for drilling the front panel is shown in Fig.4. The front panel and PC-board assembly can then be mounted in the case. After the unit is fully assembled, the outputs can be tested with a lamp or light string.

Installation and Use. Because the Light Animator operates on 117-volts AC, extreme care must be taken to avoid the risk of electric shock. Set up the unit only in an area where it will stay dry.

Multiple light strings can be connected to each output, but the maximum safe current capacity of the power-control circuits is about 3 amperes, or 350 watts. The fuse rating of 3 amperes should definitely not be exceeded.

Some unique animation effects can be achieved by arranging light strings into shapes and figures on wood or wire forms. Trees and fences also make good forms for creating lighting displays and effects. Holiday greetings can even be set in motion by forming letters with separate light strings.

Experiment with the two modes of the Light Animator and its various speed settings to find what works best for your own applications. In no time at all, you'll be creating stunning displays and brightening up the holidays in your neighborhood! ■

HIGH-TECH BUILDING SECURITY

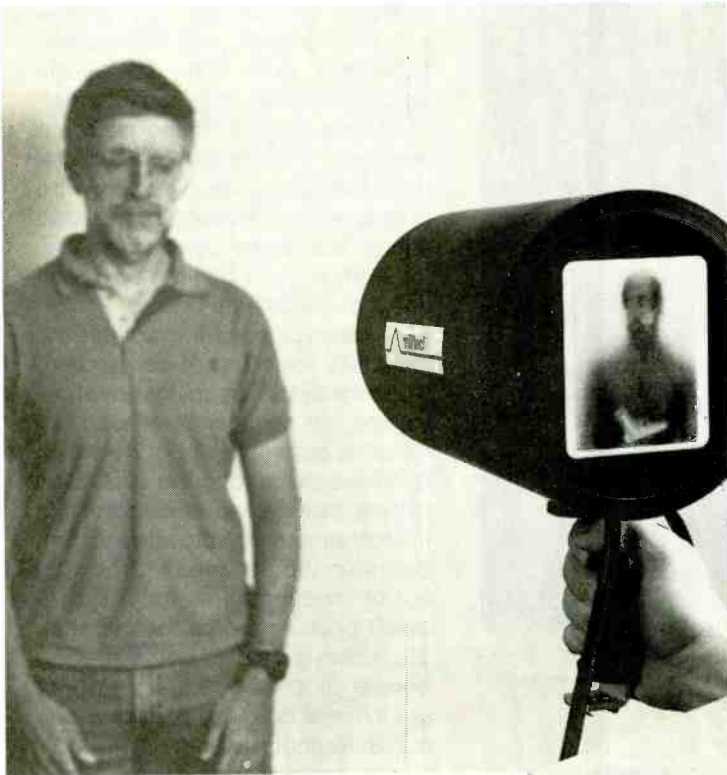

A look at how electronics can help provide public safety by detecting guns, explosives, and bad guys before they enter a building.



BY BILL SIURU

Hardly a week goes by without someone entering a courthouse, police station, post office, school, or other public building armed with a weapon and evil intentions. Less frequent, though even more dangerous, are threats of bombings like those that occurred in Oklahoma City, at the World Trade Center in New York City, and at the 1996 Olympics in Atlanta.

Many government facilities, especially courthouses, have metal detectors to screen individuals for weapons as they enter. Most of these detectors use active electromagnetic (EM) induction techniques to sense metal objects. While they detect the presence of metal, they provide no information on the massiveness of metal objects or their location on a person. Therefore, these detectors cannot discriminate between a concealed weapon, an intricate bomb, and a pocketful of coins. Many false alarms are generated and each event has to be resolved by atten-

dants. These searches make the total detection process very labor intensive and quite costly. Also, there is the loss of time and annoyance suffered by honest people who have to wait on lines.

The U.S. Department of Justice is responding to the growing terrorist threat with its two-million dollar plus "Concealed Weapons Detection Initiative." The Millitech Corporation, Raytheon Company, and Idaho National Engineering Laboratory were commissioned to develop three different technologies for detecting and identifying concealed weapons.

Passive Imaging. Millitech is using millimeter-wave, passive-imaging technology. All objects naturally emit a broad spectrum of electromagnetic radiation. The human body is an especially good emitter at millimeter wavelengths, whereas metal objects

are very poor emitters. The emission properties of plastics, ceramics, plastic explosives, and powdered drugs lie between metals and flesh.

The technique can theoretically detect not only metal guns and knives, but also plastic explosives, ceramic knives, powdered or liquid drugs in vials or plastic bags, tape recorders, explosive detonators and other contraband that is easy to conceal on a person. These harmful items can be found even when concealed under multiple layers of clothing (see Fig. 1). However, while passive-imaging detection can detect powders, solids, and liquids, it cannot determine their chemical composition.

Passive-imaging detection is a promising candidate since reasonably sized sensors can provide adequate resolution, and because of the high transparency of virtually all clothing in the millimeter wave

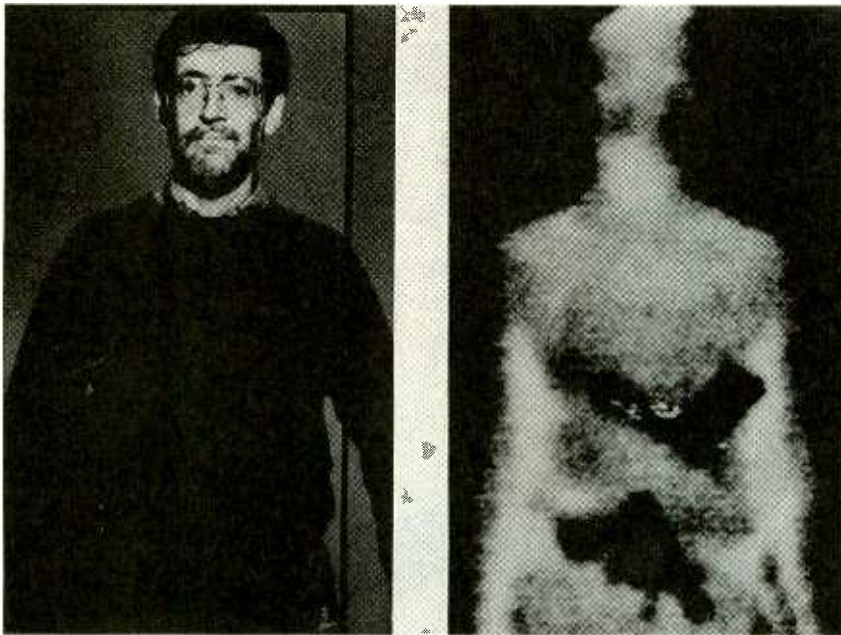

Fig. 1. The image on the left is transformed by passive magnetic-field sampling technology into the transparent view on the right. You can see the two hidden weapons as dark silhouettes in his chest area.

lengths, and the extraordinarily high emissivity of human flesh compared to the vast majority of other materials. While the passive-imaging devices literally see through clothing, the display need not reveal intimate anatomical details. Additionally, to ensure individual privacy and protection from unreasonable search implications, actual images of people being observed need only be displayed if a suspicious item is detected by an automatic image analyzer. Most people could be cleared without operator intervention or without any image being displayed.

The passive-imaging detection system could be used with another sensor, like a walk-through metal detector. Then if a suspicious item sets off the metal-detector alarm, passive-imaging detection could be used for more detailed scrutiny.

The passive-imaging technique relies solely on existing natural emissions from objects. Thus the person under inspection, system operator, or others in the vicinity of imaging system are not subjected to any man-made electromagnetic fields or other radiation sources. Passive imaging eliminates health and safety concerns that are associated with x-ray or other types of active electromagnetic sensors.

Passive imaging is quite adaptable,

so a variety of camera systems can be designed for different applications. Currently, a proof-of-concept camera with a 300mm aperture and a monitoring console for fixed entrance-way surveillance is being developed by Millitech to demonstrate the technology. Also being considered are a hand-held camera with a video screen; a totally portable, battery-powered camera; and a stand-off camera system that can be used from a police car.

A great feature of portable detectors is that they allow for remote "frisking." Police officers could use the system when they don't want to heighten tensions by direct physical contact with a suspect. They could remotely examine a suspicious person for concealed weapons as he or she leaves a vehicle. Officers could also perform a remote "pat-down" without the fear of being pricked by a contaminated hypodermic needle.

Low-Frequency EM. Raytheon's concealed-weapons detection system uses low-frequency electromagnetic radiation. While EM-based, the Raytheon system does not require people to walk through a portal equipped with the EM sensor. Therefore, the hardware can be installed unobtrusively so people would not be aware that they are under sur-

veillance. The subject is illuminated with a low-intensity, electromagnetic "Heaviside" pulse. Then the re-radiated (reflected) energy from any metal objects carried by the person is measured. The intensity and the time decay of this radiation can then be characterized. Resulting re-radiated energy "signatures" can be identified, for example, as a gun or non-threatening metal objects.

Raytheon plans to demonstrate the feasibility for discreet concealed-weapons detection. Raytheon will determine the occurrence of such parameters as probability of detection and false-alarm rate. The evaluation of these parameters will establish that the technology can provide sufficient discrimination to meet "probable cause" requirements for a subsequent physical search for weapons. The system is ideal for both screening people at large gatherings and for use in small buildings like stores and banks. Raytheon also plans to show that technology can be used for portable and "standoff" weapon-detection devices.

Magnetic Gradiometers. The Idaho National Engineering Laboratory (INEL) is using its extensive experience with magnetic gradiometers in its weapons-detection system. Extremely sensitive magnetometers can passively sample the earth's magnetic field to detect and measure local aberrations in the magnetic field produced by ferromagnetic objects. For instance, INEL's Rapid Geophysical Surveyor (RGS) technology uses flux-gate gradiometers to locate buried ferromagnetic wastes and buried structures like underground storage tanks. Likewise small aberrations produced by metal guns and knives can be sensed by extremely sensitive, commercially available magnetometers.

Compared to EM detection now used, which is generally sensitive to the size of the object, magnetic-based sensing tends to be sensitive to the mass of the object. Thus magnetic sensing can detect and locate heavy, compact objects such as handguns. The technique requires "target recognition software," which includes simple algorithms to compare actual magnetometer measurements against a catalog of electronic sig-

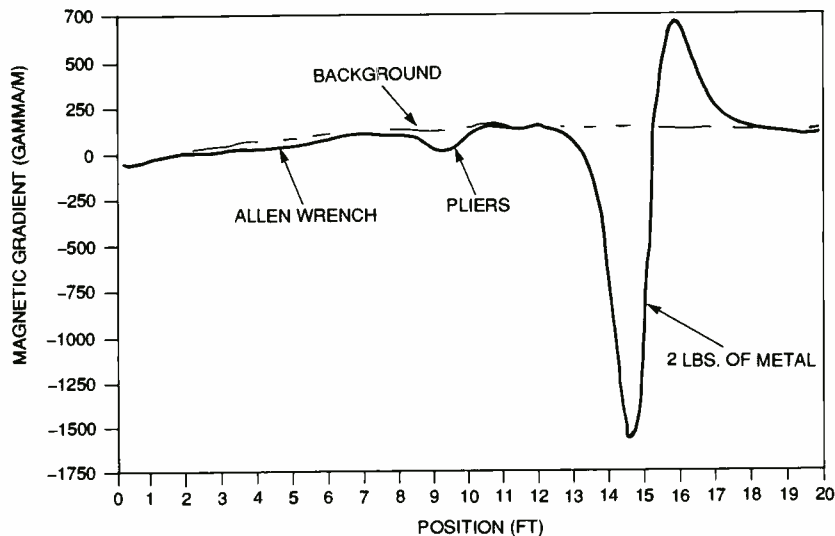

Fig. 2. Extremely sensitive magnetometers can distinguish between various size and mass. Here's a charted magnetic gradient from a sensor that was exposed to a small, stainless-steel allen hex wrench; a heavy pair of carbon-steel pliers; and two pounds of carbon steel used to simulate the size and mass of a large handgun. They were all hidden on a person.

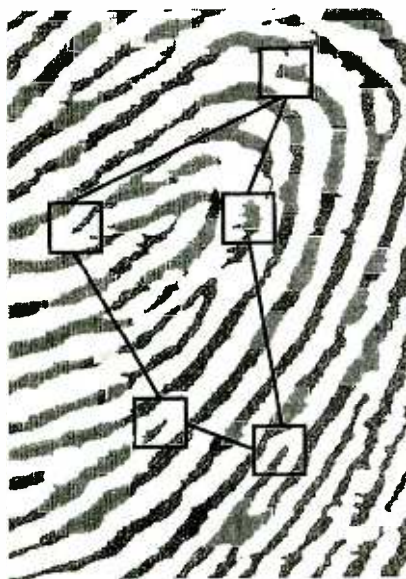

Fig. 3. With digital technology, a number of points where two fingerprint ridges meet are digitized and then analyzed based on factors such as ridge crossings, and distance and direction from each other.

natures or magnetic profiles of known objects. An important part of INEL's effort is developing these signatures for weapons as well as items such as keys, change, etc. In very rare situations, weapons made from aluminum, copper or ceramics would escape detection.

Typically, a series of magnetic gradiometers would be incorporated into a magnetic weapons-detection

scanner that looks much like the EM scanners now used in courthouses and airports. Or the system could be more inconspicuous by installing it in a doorway or hallway. Measurements from all the sensors provide a top-to-bottom magnetic profile of a person that could be displayed on a computer screen (see Fig. 2). Because false alarms are greatly reduced, scanners located at all entrances to a courthouse could be monitored by a single operator to reduce personnel costs.

Detecting Explosives. A simple method to detect explosives has eluded scientists for over thirty years. Vapor detection of explosives is difficult because of the explosive's extremely low vapor pressures and bulk detection is not sensitive to trace amounts of explosives. Also, vapor detection typically requires large, expensive instruments. The dramatic increase in car-, human-, and letter-bomb incidents involving both terrorists and deranged individuals demands real-time, low-cost, portable detection equipment. This equipment must be simple to use, very accurate and sensitive to *micro-tiny* amounts of explosives.

Scientists at the Los Alamos National Laboratory have developed a new technique for detecting explosives that could meet these requirements. The technique relies on two proper-

ties of explosives: their "stickiness" and their unique burn traits. While only demonstrated in prototype apparatus so far, the technique could be incorporated into portable devices for screening packages, mail, luggage, vehicles, or people for explosive residues. The most logical of them seems to be a vacuum cleaner-like device to pick up minute samples.

Because of the explosive's stickiness, surfaces contacting explosives during storage, handling, or device fabrication become contaminated with explosive residues. The presence of explosives remains on human hands even after several washings. Also, surfaces are contaminated through contact with explosive ingredients. For instance, individuals were tied directly to the World Trade Center bombing through the large amount of ammonium nitrate (AN) residue found on rental-car documents. They handled the AN and redeposited traces on to paper. Reportedly, a suspect in the Oklahoma City bombing had significant amounts of explosives PETN (pentaerythritol tetranitrate) and AN residues on his clothes and inside his vehicle.

There are two characteristics that result in significantly different burn rates for explosive and non-explosive materials. Because of their high oxygen content resulting from a pre-mix of fuel and oxidant, and simple, rapid-combustion kinetics, explosives burn very rapidly. In contrast, most common non-explosive materials require atmospheric oxygen for combustion and/or have complex combustion kinetics so they burn more slowly. Burning an explosive results in a high-intensity, short-duration emission. For non-explosives, the emission is a low-intensity, low-duration burn. Some explosives may emit a characteristic emission spectrum that may be used for identification.

To demonstrate a technique, explosive residue was collected and burned in a light-tight enclosure. The light flash from the tiny burning specks of explosive produced unique optical signatures that were detected with a photomultiplier tube and recorded on an oscilloscope for analysis. Numerous substances were tested: gun powder, pyrotechnic powder, match heads, paper, sugar, engine oil, hair, and dust. In the analysis, the ratio of

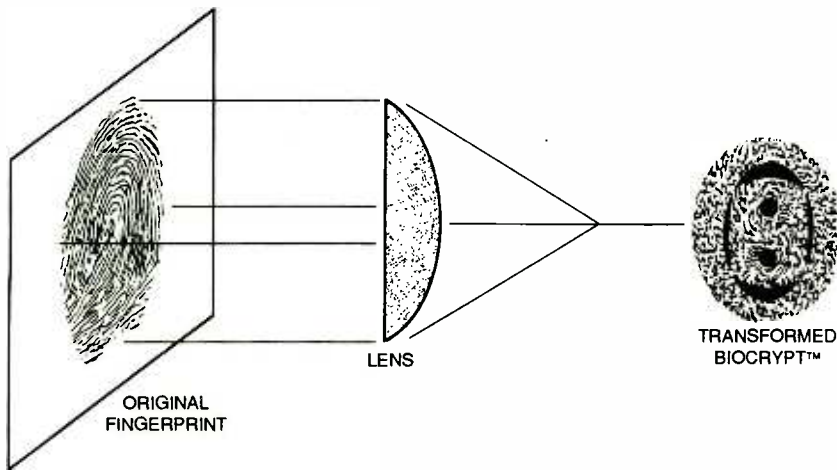

Fig. 4. The only way to match an individual with a Biocrypt is to turn his or her fingerprint into a Biocrypt and compare the two.

the emission brightness to the time duration was nearly six orders greater for gunpowder than non-explosive materials, indicating a potential identification parameter for a quantitative evaluation of the emissions. Sugar, hair, some paper samples, and a majority of dust particles did not produce any visible emissions. These results indicate that gunpowder, and possible other explosives, can be uniquely detected and differentiated from non-explosive material due to their rapid, high-intensity burn traits.

Fingerprints. Because they provide virtually absolute positive identification, and are impossible to forge, fingerprints are the key technique for biometric verification systems. Biometric verification, forecasted to become a multi-billion business by the end of the decade, is already used for controlling access into public buildings and prisons, and across national borders. The technique is even used to ensure the right person picks up the right child at day-care centers.

Mytec Technologies, Inc. has developed a fingerprint-verification system that overcomes limitations found with most other systems, while assuring absolute privacy. Its Zebra Recognition system uses optical computing versus digital processing employed in other fingerprint-verification systems.

In digital-based techniques, comparisons for verification are based on a selected number of points where two fingerprint ridges meet (see Fig. 3). Those points are digitized and analyzed on the basis of characteristics such as ridge crossings, and distance

and direction from each other. The problem is in choosing the same points every time the fingerprint is read for verification. Therefore, the technique can be inaccurate or refuse verification if there are dirt particles, scratches, or cuts on the fingerprint.

In contrast, with the Zebra optical approach, the entire fingerprint is used for verification so there is no problem if a few points of the fingerprint are destroyed by a cut or covered with dirt. Compared to digital processing, which takes a finite amount of time, optical computing processes fingerprint information at the speed of light. That means verification is completed in a fraction of

a second.

Another important feature of Mytec's system is the Biocrypt, short for "biometric encryption," process that assures absolute privacy. This overcomes the public's fear that fingerprints of ordinary citizens might be mixed up with those of criminals or allow the government to amass central files on individuals.

With Mytec's proprietary process, each individual fingerprint is transformed into a Biocrypt (see Fig. 4). This Biocrypt is stored in the system—not a digital record, image, or template of the actual fingerprint. In the Biocrypt there is no visual resemblance to the original fingerprint. Instead, the Biocrypt is a unique, random-appearing pattern that cannot be retrieved as an original fingerprint or identified as belonging to a particular individual.

Biometric encryption is similar to the encryption technology used in secure-data transmissions and thus it's extremely difficult, if not impossible, to decipher a stored Biocrypt or restore it to an image of the original print. The only way the Biocrypt can be used is in comparison with another Biocrypt made from a live fingerprint of a person. If the Biocrypts match, the same person made both Biocrypts.

When used as an access-verification system, fingerprints of authorized users are "biocrypted" and stored in the system's memory. When access is required by someone, he or she places a finger over the lens on the Zebra True Recognition terminal. The Biocrypts are compared and access is either permitted or denied depending upon the match.

One local terminal can store thousands of Biocrypts or the terminal can be interfaced with a PC or another computer to store an unlimited number of Biocrypts. The Zebra True Recognition system is a stand-alone unit that does not require additional hardware, software or separate power supply.

The system is especially valuable when used with a "smart" card for identification for welfare services, medical records, or financial transactions. An optical card can hold a person's complete medical records without difficulty. For instance, the Cannon Optical Card can hold three megabytes of information. In this

(Continued on page 46)

FOR MORE INFORMATION

Idaho National Engineering Laboratory
P.O. Box 1625
Idaho Falls, ID 83415

Los Alamos National Laboratory
Nonproliferation and International
Security Division MS D466
Los Alamos, NM 87545

Militech Corporation
South Deerfield Research Park
P.O. Box 109
South Deerfield, MA 01373

Mytec Technologies Inc.
10 Gateway Blvd., Suite 430
Don Mills, Ontario
Canada M3C 3A1

National Institute of Justice
Technology Development
633 Indiana Ave., N.W.
Washington, DC 20531

Raytheon Company
1847 West Main Road
Portsmouth, RI 02871

BUILD THE COLOR-BLIND ILLUSION

*Here's a neat little
electronic magic trick
that will fool just about anyone.*

BY RICK DUKER

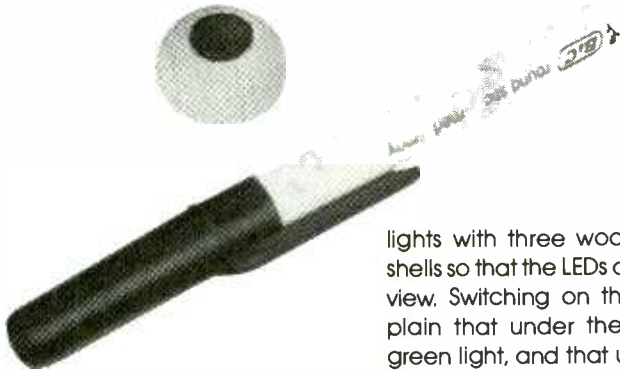
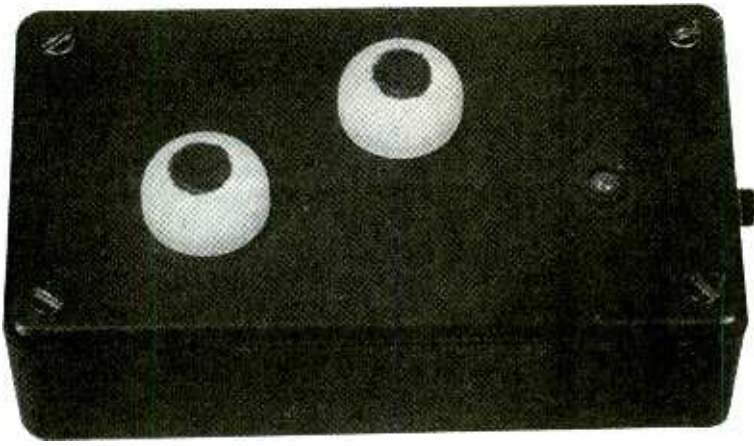

People enjoy magic. You might have noticed the large audiences that illusionists such as David Copperfield attract; that only proves that fact. But have you ever considered performing a magic trick yourself?

If you're an electronics hobbyist (as most of our readers are), you might want to consider using your abilities to create an electronic illusion of your own. The Color-Blind Illusion described in this article is just such a project. The portable unit lets you perform a trick at a moment's notice, because you can carry it with you wherever you go.

The Trick. The Color-Blind Illusion is a modern version of the famous three-shell game and the three-card Monte trick. Many unsuspecting people in the past were swindled out of their money because they thought they could outsmart the swindler. We hope you have fun fooling, but not swindling, your friends with this electronic version of the trick.

Here's how the trick is performed. You display a black box with three unit lights (LEDs) on top. Then you cover the

lights with three wooden covers or shells so that the LEDs are hidden from view. Switching on the unit, you explain that under the first shell is a green light, and that under the other two shells are red lights. You have the spectator lift each shell in turn to confirm this fact. The audience is then asked to remember where the green light is.

Using a ball-point pen as a pointer you instruct the spectator to uncover the green light. Much to their surprise the light is now red and from this point on the green light continues to be elusive. Only you know under which shell the green light is. Finally, you explain to your audience that they could all be color blind or that maybe there was never a green light. Your friends lift away all three covers to reveal that all three lights are red, and now they believe the green light was an optical illusion.

Circuit Description. The circuit for the Illusion is shown in Fig. 1. At the heart of the circuit is IC1, a type 4093 quad NAND Schmitt-trigger inverter. Triggers IC1-a, IC1-b, and IC1-d along with R2-R7 and C4-C6 form debounce networks for magnetic switches S1, S2, and S3.

In its normal state, each magnetic switch is an open circuit that causes each NAND gate Schmitt-trigger inverter to be at a logic high. With a mag-

net held close to a switch, it closes and the inverters switch to a logic low. As the magnet is moved away from the switch, the inverters toggle high, clocking (triggering to the next steady-state condition) sections of IC2 and IC3, which are dual, D-type, flip-flop circuits. The three flip-flop circuits are IC2-a, IC2-b, and IC3-a; IC3-b is not used. Section IC1-c, along with R1, C3, and D1, is used as a set/reset network for the flip-flop circuits.

Capacitors C1 and C2 filter the power supply. Switch S4 is a slide-type, on/off switch. When power is first applied to the circuit, there is a short delay before the output of IC1-c goes low to set the D-type flip flops. The delay ensures that the Q outputs of each flip-flop in IC2 and IC3 begin at a logic high.

The light-emitting diodes used in the circuit are dual color—green and red. When the unit is first turned on, LED2 and LED3 are red, and LED1 glows green. Resistors R8-R10 limit the LED's currents. Each time a flip flop is clocked by the opening of a magnetic switch, the Q and \bar{Q} outputs reverse logic states. That reverses the polarity of the dual color light-emitting diode, changing its color from green to red or from red to green. The circuit is wired so that S1 toggles LED2, S2 toggles LED3, and S3 toggles LED1.

Construction. The author's prototype for the Illusion was built on a printed-circuit board. If you'd like to do the same, you can either use the

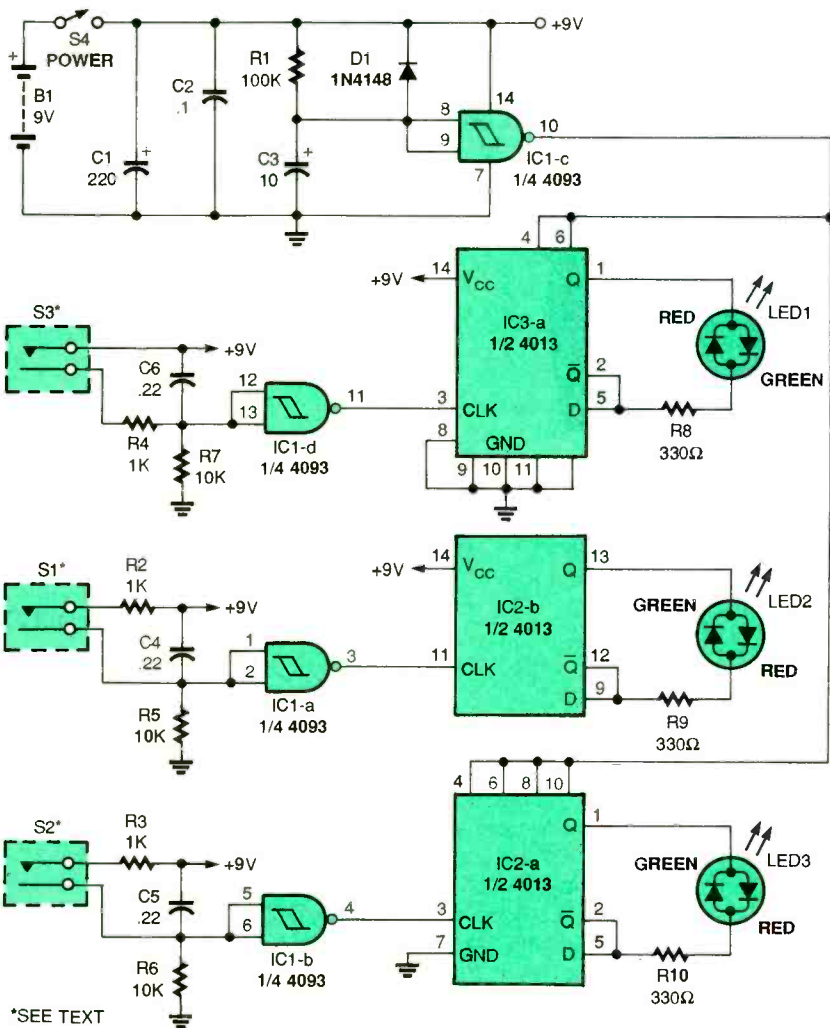

Fig. 1. Here's the schematic for the Color-Blind Illusion. The colors of the LEDs are changed by three magnetic switches (S1-S3) and three flip-flop sections of IC2 and IC3.

foil pattern shown in Fig. 2 to etch your own, or you can order a board from the source mentioned in the Parts List.

If you're building the unit on a PC board, use the parts-placement diagram shown in Fig. 3 as a guide. Begin assembly by mounting sockets for the ICs, noting correct orientation. Install all capacitors, making sure that C1 and C3 are properly oriented. Then solder D1 and all resistors vertically on the board.

Attach wire leads to switch S4 and connect the ends to the PC board. Trim the battery-clip leads to a 2-inch length, then connect them to the PC board. Solder 3-inch leads to each LED lead, close to the base. Trim the excess leads and insulate the solder joint. Next, attach each of these leads to the PC board, noting correct polarity (the R's on the parts-placement indicate which side of the tri-color LED is

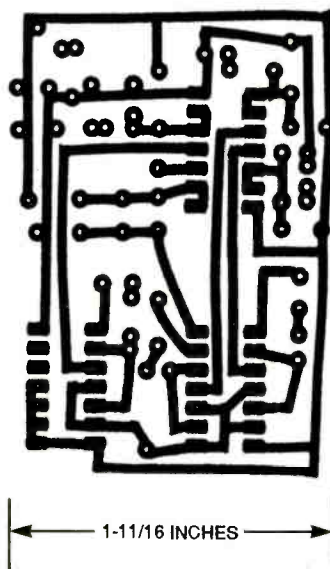

Fig. 2. If you'd like to etch your own PC board for the Illusion, use this full-size template.

PARTS LIST FOR THE COLOR-BLIND ILLUSION

SEMICONDUCTORS

IC1—4093 quad NAND Schmitt-trigger, integrated circuit
 IC2, IC3—4013 dual flip-flop, integrated circuit
 D1—1N4148 switching silicon diode
 LED1-LED3—Tri-color light-emitting diode, red and green elements

RESISTORS

(All resistors are 1/4-watt, 5% units.)
 R1—100,000-ohm
 R2-R4—1000-ohm
 R5-R7—10,000-ohm
 R8-R10—330-ohm

CAPACITORS

C1—220- μ F, 16-WVDC, electrolytic
 C2—0.1- μ F, ceramic-disc
 C3—10- μ F, 16-WVDC, electrolytic
 C4-C6—0.22- μ F, ceramic-disc

ADDITIONAL PARTS AND MATERIALS

S1-S3—SPST miniature magnetic switch (normally open)
 S4—SPST switch
 B1—9-volt alkaline battery
 Printed-circuit materials, plastic enclosure (4- \times 2 $\frac{1}{2}$ - \times 1-inch, or similar), 1/4-inch-diameter cylindrical magnet, ball-point pen (Bic Round Stic, or similar), LED holders (3), foam tape, wooden half-sphere covers (see text), wire, solder, hardware, etc.

Note: The following are available from Quantum Research (17919 77 Ave., Edmonton, Alberta, Canada T5T 2S1): etched and drilled PC board—\$10.00 plus \$3.00 shipping and handling; kit of parts and PC board (no battery)—\$44.50 plus \$5.00 shipping and handling; and assembled and tested unit—\$59.50 plus \$6.00 shipping and handling S & H. All prices quoted in U.S. funds.

red). The lead on the flat end of the LED lens is the anode of the green LED and the cathode of the red LED. Connect that lead of LED1 to pin 1 of IC3. The same leads of LED2 and LED3 connect to pins 1 and 13 of IC. The other leads are connected as shown to R8, R9, and R10.

Clip the leads of the magnetic switches to approximately 2-inches long and strip the ends. Attach each pair of leads to the board; the switches are unpolarized.

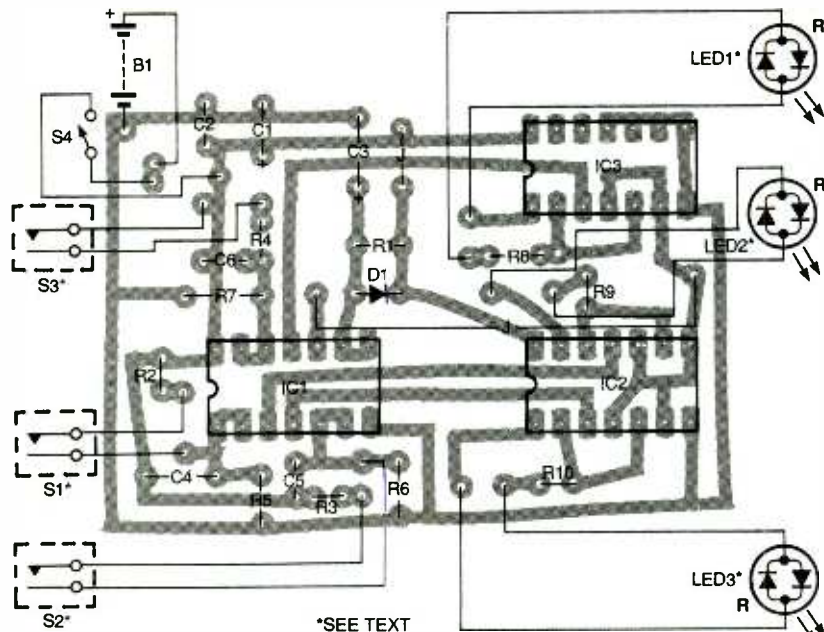

Fig. 3. This parts-placement diagram should make assembling the board simple. Note the "R's" that indicate which sides of LED1-LED3 are red.

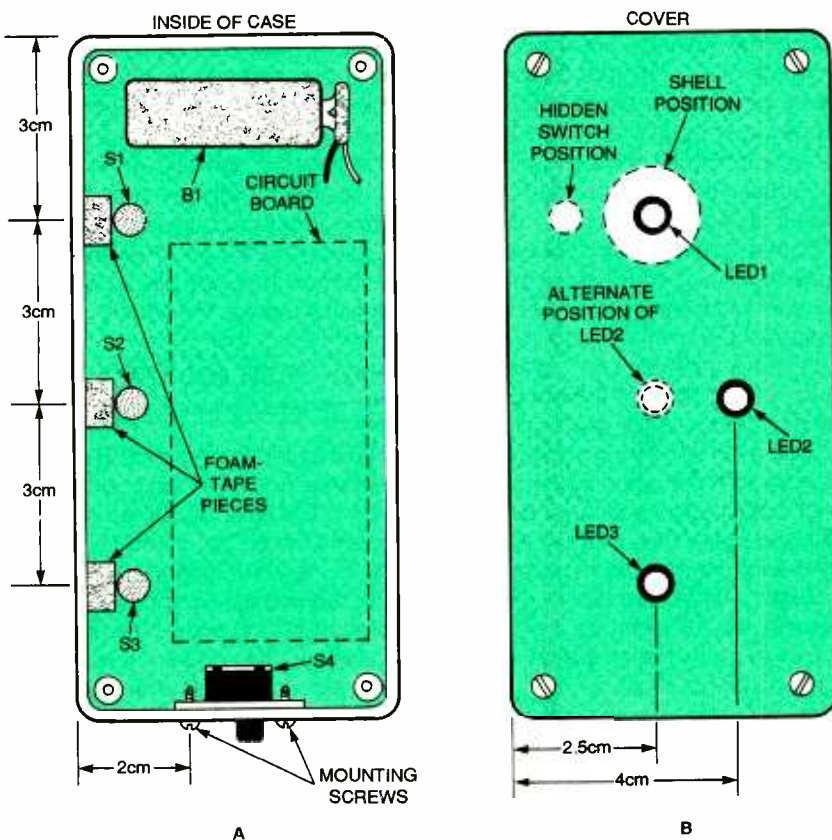

Fig. 4. The inside (A) and cover (B) views of the case shown here indicate where to mount all the off-board components.

Finally, insert the three ICs into their sockets, noting proper orientation. The board is now ready to be mounted.

Prepare an appropriate plastic en-

closure by drilling holes for switch S4 at one end (see Fig. 4A). To prepare the case cover, drill three 1/4-inch holes to accommodate LED holders (see Fig. 4B). Install S4 from the inside and allow

the slider to protrude through the connecting holes. You may need to enlarge this opening slightly for the slider to move freely. Secure the switch with two mounting screws.

Position the PC board in the enclosure. Cut three 1-inch pieces of foam tape and stick them to the insides of the case where the magnetic switches will be positioned (see Fig. 4A). Remove the front backing of the tape and secure each switch to its piece of tape. The tops of the switches should protrude slightly from the top level of the case to bring them as close to the cover as possible.

Install LED1-LED3 using mounting grommets. Install a fresh 9-volt alkaline battery into the clip holder. Put the cover in place and fasten it with the four corner screws.

Now you have to build the three wood covers and the magic pen. The covers in the author's prototype are wooden half spheres with a hollow inside to allow space for the LED. Wooden units like that give the project some old-fashioned charm; however, any hollow object of suitable size can be used.

The magnet that controls the switches in the unit is concealed in the end of a ball-point pen that is used as a pointer. Here's how to make the "gimmicked" pen: Obtain a 1/4-inch-diameter cylindrical magnet. That should fit in many pens, including Bic "Round Stic" pens, one of which was used in the prototype. Make sure the pen you use has an inside diameter of at least 1/4-inch diameter.

Remove the ball-point tube assembly and discard it. Apply some adhesive to the side of the magnet, then insert it into the pen body until it is flush with the opening. Paint the exposed end of the magnet the same color as the opposite end of the pen body. Now push the pen cap onto the end opposite the magnet. The pen now appears as an ordinary pen except it is capped in reverse. This fact should go unnoticed.

Checkout. To test the device for correct operation, turn it on and note LED1 is green, while LED2 and LED3 are red. Place the end of the pen with the magnet near the first magnetic switch and then remove it. LED2 should change color to green. Now bring the pen near the second switch and then

remove it. This time LED3 should change color to green. Repeat this move with switch 3 and note LED1 changes to red. If you now repeat the entire above procedure, all the light-emitting diodes should return to their original colors.

With all the shells in place, resting the pen on the enclosure over the position of a magnetic switch is how you point to the specific LED cover. As you remove the pen to point at the next cover, the LED color will change. Practice this move until you can do it smoothly and without hesitation. When required to point to a cover without changing the LED color, keep the pen higher above the enclosure or lightly tap the cover itself.

Presentation. To present the Color-Blind Illusion to spectators, place the unit in front of you and position the shells. Switch on the power and casually remove the pen from your pocket. Here is a basic routine that you should master before developing your own



Here's the inside of the Color-Blind Illusion. Note the placement of the magnetic switches.

routines. Practice the routine until it becomes second nature to do it. Only then are you ready to show someone the illusion. Performing a trick well and never revealing its secret are the two most important rules in magic.

Explain to your audience that there are three lights, one under each shell. Say that "Two of the lights are red, and one light is green." Point at each cover in turn, asking the spectator to uncover each light as you do so. This will reveal that light one is green, light two is red and light three is red. It is important to use the pen as a pointer consistently whether or not you use it to activate a hidden switch. You do not want to draw special attention to the use of the pen, otherwise it could make your audience suspicious.

Explain that this is a simple memory game; say something like "All you have to do is remember where the green light is." Point the pen behind shell 3 (which changes the color of light 1) and ask the spectator if the green light was there. They will answer no. Point behind shell 2 (which changes the color of light 3) and ask the spectator if the green light was there. They will again answer no.

Then ask the spectator to uncover light 1. They will be amazed to see that light 1 is now red instead of green. Instruct the spectator to uncover light 3. When that is done it will reveal that this is the new position of the green

light. Say, "It is easy to mix up light 1 and light 3. Don't worry, I'm sure you won't let that happen again."

Then go on to say, "How about we mix things up a bit." Have the spectator exchange shell 3 with shell 2. Point to each shell but do not do a color change. Now point behind shell 2 (this changes the color of light 3 to red) and say to the spectator(s), "Now please exchange shell 2 with shell 1." Point to shell 1 but do not effect a color change. After this exchange light 1 is red, light 2 is red, and light 3 is red as well. At this point ask the spectator, "Have you been following the green light? I'm sure you know where it is this time. Can you please point to the green light's position?"

Because all the lights are red, the spectator cannot win. Allow the spectator to lift the shell where he or she believes the green light to be. Say, "Sorry you missed the green light again. My guess is that the green light is here." Indicate the shell of your choice, then immediately point behind the preceding shell, changing the light you chose to green. Say to the spectator, "Please lift this last shell." The light will be red. Then ask the spectator to lift the shell that you chose. It will of course be green.

As your audience will learn, the magician or illusionist always wins. Just don't give away the secret! ■

HIGH-TECH SECURITY

(Continued from page 42)

compressed form, both Old and New Testaments of the Bible plus all the comedies and tragedies of Shakespeare could be stored on a single card. The individual's fingerprint transformed into a Biocrypt would also be placed on the card. "Enrollment" requires less than 30 seconds to read the fingerprint and store the necessary information on a card.

With the fingerprint and information on the card and not stored anywhere else, the only way anyone can access the information is if the individual is there with his or her fingerprint. The user's fingerprint is the only "key" that can open the gateway to the information stored on the card. People can carry out their transactions in a "blind manner," without any way to electronically trace a person's activities. That ensures total privacy. ■

ATTENTION! ELECTRONICS TECHNICIANS

EARN YOUR
**B.S.E.E.
DEGREE**



THROUGH HOME STUDY

Our Highly Effective Advanced-Placement Program for experienced Electronic Technicians grants credit for previous Schooling and Professional Experience, and can greatly reduce the time required to complete the program and reach graduation. No residence schooling required for qualified Electronic Technicians. Through our Special Program you can pull all of the loose ends of your electronics background together and earn your B.S.E.E. Degree. Upgrade your status and pay to the engineering level. Advance rapidly! Many finish in 12 months or less! Students and graduates in all 50 states and throughout the world! Established Over 50 Years! Write or call for free Descriptive Literature. (601) 371-1351

COOK'S INSTITUTE
OF ELECTRONICS ENGINEERING



4251 CYPRESS DRIVE
JACKSON, MISSISSIPPI 39212

Hobbyist's Paperback Budget Books



□ **BP80/98—Popular Electronic Circuits-Books 1 and 2...\$11.90.** Contains a wide range of circuits which are accompanied by text giving a brief introduction, circuit description and special notes on construction and setting-up that may be necessary.

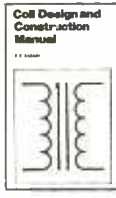

□ **#160—Coil Design and Construction Manual...\$5.95.** A complete book for the home builder on how to make RF, IF, audio and power chokes and transformers. Practically every possible type is discussed and calculations are explained in detail.



□ **BP271—How to Expand, Modernize and Repair PC's and Compatibles...\$7.75.** All the practical information you are likely to need to upgrade your PC and compatible. Also contains useful information and illustrations to help you with repairs.



□ **BP276—Shortwave Superhet Receiver Construction...\$6.95.** Provides construction details, including coil winding, of a number of advanced-design receivers which should have performance levels at least equal to commercial sets of similar complexity.



□ **#223—50 Projects Using IC CA3130...\$5.00.** One of the more practical and useful operational amplifiers (opamp), the CA3130 integrated circuit chip is the heart of several easy-to-assemble projects covered in the book. The projects are divided into five categories: audio projects, RF projects, test equipment, household projects and a catch-all miscellaneous group. Ideal for all skill levels.



□ **BP122—Audio Amplifier Construction...\$5.75.** Practical designs are featured and include circuit diagram and description, Veroboard or printed-circuit board layout and construction notes. The text is divided into two parts. The first deals with many types of preamplifiers. The second covers power amplifiers from a simple low-power battery type to a 100-watt DC-coupled amplifier using four MOSFETs in the output stage.



□ **BP107—30 Solderless Breadboard Projects-Book 1...\$5.95.** Each project is designed to be built on a "Verobloc" breadboard and is presented with a brief circuit description, circuit diagram, component layout diagram and components list. Notes on construction and applications are provided. Wherever possible, the components are common to several projects to keep project costs down.



□ **BP266—Electronic Modules and Systems for Beginners...\$7.25.** Shows the reader how to build a number of simple analog and digital circuit modules, all suitable for battery operation, and all based on only 1 or 2 transistors or ICs.



□ **BP329—Electronic Music Learning Projects...\$6.25.** A beginner's book that will assist you in assembling such projects as the Elexylophone, Gildaphone, Melody Ranger, Cordmaker, Appealing Handbells, Electronic Sol-Fa, Tune-up Box and more.



□ **BP319—Making MS-DOS Work for You...\$6.50.** What you need to know first, comes first, however the text is written in a circular style so that the reader can start anywhere in the text. This book is relevant to all versions of both MS-DOS and PC-DOS.



□ **BP303—Understanding PC Software...\$6.95.** Covers main types of PC software, giving details of typical uses, the basics of how they are used and their limitations. Each chapter covers popular software and programs of a similar type.



□ **BP105 Aerial (Antenna) Projects...\$5.50.** In this book the author has considered practical antenna designs, including active, loop and ferrite antennas which perform well and are relatively simple and inexpensive to build. The complex theory and mathematics of antenna design have been avoided. Also included are construction details of a number of antenna accessories including a pre-selector, attenuator and filters.



□ **BP33—Electronic Calculator Users Handbook...\$5.75.** The book eliminates the mysteries of the calculator and offers unique ideas for the simplest to most complex calculators. Covers the basic functions plus trigonometric, hyperbolic, logarithms, square roots and powers. Included are formulas and data for VAT, discounts, and mark up, currency conversion, interest, binary and octal numbers, and much more!



□ **BP125—25 Simple Amateur Band Antennas...\$5.50.** Plans to build antennas that are simple and inexpensive to construct and perform well. From the simple dipole to beam, triangle and even mini-rhombic types made from four TV masts and about 400 feet of wire. After the antenna discussion you will find a complete set of dimension tables that will help you "tune" an antenna on a particular frequency.



□ **BP263—A Concise Introduction to dBASE...\$6.95.** The most popular data-base program, dBASE, is difficult to master without help. This book helps you spend your time using dBase, not setting it up. A user's guide that covers all the basics up to dBase IV.



□ **PCP104—Electronics—Build and Learn...\$9.95.** Construction details are given to build a circuit demonstrator that is used throughout the book to introduce common electronic components and how these components are built up to useful circuits.



□ **BP302—A Concise Users Guide to Lotus 1-2-3 Release 3.1...\$6.25.** Written to help existing spreadsheet users upgrade to 1-2-3 Release 3.1, which has the ability to work 3-dimensionally with both multiple worksheets and files.

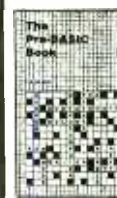

□ **BP146—The Pre-BASIC Book...\$6.95.** Another book on BASIC but with a difference. It concentrates on introducing technique by looking in depth at the most frequently used and more easily understood computer instructions.

Just What the Project Builder Is Looking For!

- | | | | |
|--|---------|---|--------|
| □ #160—Coil Design and Construction Manual | \$5.95 | □ 1596T—24 Silicon-Controlled Rectifier Projects..... | \$9.95 |
| □ #219—Solid State Novelty Projects | \$4.95 | □ BP58—50 Circuits Using 7400 Series ICs | \$5.50 |
| □ #222—Solids State Shortwave Receivers for Beginners..... | \$5.50 | □ BP69—Electronic Games..... | \$5.50 |
| □ #223—50 Projects Using IC CA3130..... | \$5.00 | □ BP71—Electronic House Projects | \$5.00 |
| □ #225—Practical Introduction to Digital ICs..... | \$5.25 | □ BP84—Digital IC Projects..... | \$5.50 |
| □ PCP111—Electronic Test Equipment Handbook..... | \$13.95 | □ BP93—Electronic Timer Projects..... | \$5.50 |

ELECTRONIC TECHNOLOGY TODAY INC.
P.O. BOX 240, Massapequa, NY 11762-0240

Name _____
Address _____
City _____ State _____ Zip _____
PE5 Allow 6-8 weeks for delivery

SHIPPING CHARGES IN USA AND CANADA
\$0.01 to \$5.00\$2.00
\$5.01 to \$10.00\$3.00
\$10.01 to 20.00\$4.00
\$20.01 to 30.00\$5.00
\$30.01 to 40.00\$6.00
\$40.01 to 50.00\$7.00
\$50.01 and above\$8.50

SORRY No orders accepted outside of USA & Canada

Total price of merchandise \$ _____
Shipping (see chart) \$ _____
Subtotal \$ _____
Sales Tax (NYS only) \$ _____
Total Enclosed \$ _____

Number of books ordered

All payments must be in U.S. funds!

COMPUTER BITS

Hypertext Wrap-Up

BY JEFF HOLTZMAN

We've been talking for several months now about hypertext as implemented by the Windows Help system and by the Web. I want to wrap up that discussion, and talk about some hot new products.

WINHELP IS DEAD

Most engineers, including software engineers, hate few things worse than doing documentation. One thing Windows programmers hate worse than doing documentation is doing help files. As we have discussed here in bloody detail, creating help files is a complex activity akin to programming in hexadecimal machine language.

The good news is that WinHelp is dead, or at least dying. Taking its place is HTML and browser technology. It won't happen right away, and many software packages will probably continue to support WinHelp for the next year or two. But Microsoft has publicly stated that it is evolving its whole user-interface paradigm to browser technology, and that the help compiler and related tools will receive no more updates. In addition, the help systems of all major MS apps are moving to HTML.

This is all good news because it means that instead of the quirky, non-visual tools that have traditionally dominated the WinHelp market, we'll now see more tools like Microsoft's own FrontPage. Big market (*i.e.*, the Web) attracts big vendors with lots of creativity and R&D budget to push the tool envelope. We benefit. Enough said.

QUICKVIEW PLUS

If you use Windows 95, you've probably seen QuickView, a mini-app you can pop up from the Explorer to quickly view the contents of disk files. The problem with QuickView is that it's not very quick, and it offers only limited views of your files. However, the company that wrote QuickView, Chicago-based Inso Corporation, has introduced QuickView Plus, which greatly enhances the Win95 version.

HTML), spreadsheets, databases, graphics, presentations, compressed files (ZIP etc.), and executable files. Coverage is very good, but there are some lapses. For example, the program can display Access 2 databases, but not the more recent Access 7 format. QVP can also integrate itself with several Win95 shells, including Norton Navigator and MicroHelp's PowerDesk. In fact, I consider PowerDesk (with its enhanced Explorer) and QVP my only indispensable Win95 utilities. Highly recommended.

BURNING CDs

Nowhere is the rapid evolution of technology in the computer industry more apparent than with optical storage. Just two or three years ago, CD-ROM recorders (CD-R) cost ten to twenty times what they do now. It's not hard to find units for under \$800, and there are predictions that there will be \$500 units soon. At least one vendor (Gateway 2000) is already selling a machine that includes a CD-R as part of its base configuration.

One high-quality unit, the Deltis CD-R2, is manufactured by Olympus Image Systems, Inc. The CD-R2 is a

double-speed device with a 1-MB buffer. It can record in most CD formats, including CD-ROM, audio CD, Photo CD, CD-I, and more. The review unit came with a 16-bit ISA Future Domain SCSI controller, which I had no trouble integrating into my test system, even though that system already contained an Adaptec SCSI controller. In fact, setting up the hardware was completely uneventful. However, the documentation is a bit rag-tag, with several different manuals for the various hardware and software components, and little to tie it all together.

A copy of CD Mastering software called Gear comes with the unit. It provides a compact user interface for specifying what to record and how to record it. While some packages emphasize ease of use, Gear's strength is the variety of formats and configurations it supports. In short, Gear plus the CD-R2 can write any standard format: ISO-9660, CD-ROM Mixed Mode, CD XA, CD Plus, Mac Hybrid and HFS, CD Digital Audio, and MMCD. It also supports CD-I, CDTV, Photo CD, and just about any other predefined or custom format in existence in the following ways: single-session,



Deltis CD-R2 from Olympus delivers double-speed CD-R burning at an attractive price.

Fifteen years of microelectronic research makes conventional antennas a thing of the past!

This little box uses your home's electrical wiring to give non-subscribers, cable subscribers and satellite users better TV reception!

by David Evans

Technology corner

1. Why don't conventional antennas work as well as the Spectrum?

Bandwidth of TV Signal



When TV signals are tuned at the TV channel's center frequency, optimum tuning has been achieved.

Other antennas can't offer center frequency tuning like the Spectrum Antenna can. They only offer such tuning up to the edge of the center frequency. As a result your TV picture remains snowy.

2. How does Spectrum use a home's electrical wiring as an antenna?

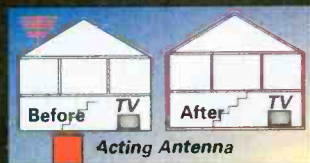

Believe it or not, the Spectrum Antenna simply "activates" the giant antenna that already exists in your home. Essentially, it uses all of the wiring throughout your home's walls and ceilings to make an antenna as large as your house for unbelievably clear reception of local broadcasting.

3. Spectrum antenna features

Parallel 75 ohm resistance
For minimum loss of signal

Signal search control
For selecting multiple antenna configurations

Polarized three-prong plug for grounding
For optimum signal grounding to eliminate noise and static

Resonant fine tuner control
For dialing in crisp clear TV/stereo reception, eliminates ghosting

Dual AC outlets with built-in surge protection
For plugging in additional TV/stereo equipment guarding against damage and electrical surges



Until recently, the only convenient way to guarantee great TV reception was to have cable installed or place an antenna on top of your TV. But who wants to pay a monthly cable fee just to get clear reception, or have rabbit-ear antennas that just don't work on all stations? Some people just aren't interested in subscribing to cable. Or they may live in an area where they can't get cable and TV-top antennas aren't powerful enough. And what about those people who have cable or satellite systems but still can't get certain local stations in clearly?

Now, thanks to fifteen years of microelectronics research, a new device has been developed that is so advanced, it actually makes conventional antennas a thing of the past. It's called the Spectrum Universal Antenna/Tuner.

Advanced technology.

Just imagine watching TV and seeing a picture so clear that you'd almost swear you were there live. Just plug the Spectrum Antenna into a standard AC outlet and plug your TV into the Spectrum. You can remove the unsightly clutter of traditional TV-top devices gathering more dust than television signals. Get ready for great reception. Your TV will suddenly display a sharp, focused picture thanks to its advanced design "Signal Search" and "Fine Tuner" controls.

Uses your home's electrical wiring. The Spectrum Antenna is a highly sophisticated electronic device that connects into a standard wall outlet. The outlet interfaces the Spectrum Antenna with the huge antenna that is your home wiring network. It takes the electrical wiring in your house or apartment and turns it into a multi-tunable, giant TV reception station which will improve your TV's overall tuning capability. The results are incredible. Just think how much power runs through your home's AC wiring system—all that power will be used to receive your local broadcasting signals.

How it works. Broadcast TV signals are sent out from the local broadcast station (ABC, CBS, NBC, etc.). They interface with your home's AC power line system, a huge aerial antenna network of wiring as large as your home itself. When the Spectrum Antenna interfaces with the AC line, the signal is sent to its signal



processing circuit. It then processes and separates the signal into 12 of the best antenna configurations. These specially processed signals route themselves into 12 separate circuits. The Spectrum Antenna includes a 12-position rotary tapping switch, the "Signal Switch" control, which gathers twelve of the best antenna configurations.

Who can use Spectrum?

• **Cable users-You have cable but you can't get certain local stations in clearly.**

• **Non-cable users-You don't have cable and want the stations to come in more clearly**

• **Satellite users-You have a digital satellite system but can't get local stations in clearly**

The "Signal Search" offers varying antenna configurations for the user to select from the best signals of all those being sent. The signal then passes through the Spectrum Antenna's special "Fine Tuner" circuit for producing crisp, clear reception.

Risk-free offer. The Spectrum Universal Antenna/Tuner comes with our exclusive 90-day risk-free home trial and a 90-day manufacturer's warranty. Try it, and if you're

not satisfied, return it for a full "No Questions Asked" refund.

Limited time offer! We realize that most people have more than one TV in their home. We are offering a special discount on additional Spectrum Antennas so you get great reception on all your TVs!

Spectrum Antenna™.....\$39 \$4 S&H
Additional antennas just.....\$34 S&H free

Please mention promotional code 1492-PL-6674.
For fastest service, call toll-free 24 hours day

800-992-2966



COMRAD INDUSTRIES
2820 Waterford Lake Drive, Suite 106
Midlothian, Virginia 23113

VENDOR INFORMATION

Inso Corporation
401 North Wabash
Suite 600
Chicago, IL 60611

**CIRCLE 83 ON FREE
INFORMATION CARD**

MicroHelp, Inc.
4311 J.V.L. Industrial Park NE
Marietta, GA 30066

**CIRCLE 84 ON FREE
INFORMATION CARD**

Olympus Image Systems, Inc.
Two Corporate Center Drive
Melville, NY 11747-3157

**CIRCLE 85 ON FREE
INFORMATION CARD**

multi-session, multi-volume, incremental (packet) write, track-at-once, and disk-at-once.

You can copy tracks from audio CDs and create your own greatest hits disc. You can also build combined audio/data CD-ROMs. By creating a custom image file, you can literally create your own format. Gear also supports batch processing for low-volume production runs, although at \$7 to \$8

apiece, CD-R blanks are still relatively expensive.

In general, burning a CD-R is more involved than copying files to floppies, because there are precise timing and data-throughput requirements. Basically, once recording starts, it better not stop except when planned. Otherwise, the disc becomes an expensive Frisbee. The combination of the 1-MB buffer and Gear's intelligent buffering scheme allowed me to create discs with no problem under Windows 95 on a relatively slow system (a 60-MHz Pentium VLB with 24 MB of RAM and a 3-GB hard drive).

Since I completed my tests, the company has released an updated version, CD-R2x4, which provides a faster CD-R mechanism, a different software package, and which costs \$100 less. The mechanism now reads at quad speed, although it still writes at only double speed.

Instead of industrial-strength Gear, the CD-R2x4 includes Corel's CD-Creator, a package renowned for its ease of use. The package also includes a new technology created by Sony, called CD-RFS (CD Recordable

File System). CD-RFS takes advantage of the incremental-write capability of the CD-R writer and lets the user write CD-R discs just like magnetic media. Copying files can be as simple as drag-and-drop from the Win95 Explorer, although maximum disk utilization requires a more planned approach.

The only question at this point is what kind of life the CD and CD-R are going to have, with DVD just around the corner. ■



1 see. So a computer virus ate your answer to question number three.

IN STOCK

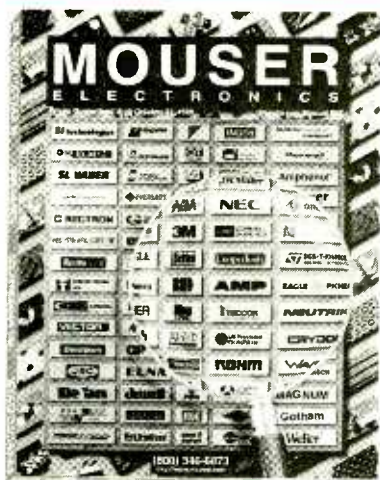

Call for your **FREE** 332 page catalog **TODAY!**

- 67,092 Products
- 126 Manufacturers
- All Orders Ship Same Day
- No Minimum Order

MOUSER
ELECTRONICS

800-992-9943
FAX: 817-483-0931

<http://www.mouser.com>
sales@mouser.com

958 North Main St., Mansfield TX 76063

CIRCLE 164 ON FREE INFORMATION CARD

SURVEILLANCE NEW

& COUNTERSURVEILLANCE Electronic Devices

Discreet audio & video systems
• High performance recording devices
• Voice encryption devices
• Personal protection • Bug detection
• How-to books from the Spytech™ library...and more!

CALL TOLL-FREE:
1-888-SPY-TECH
(1-888-779-8324) 24 hrs a day
7 days a week

Exclusive Spytech™ Catalogue — over 100 pages of the latest security & surveillance products in the world. See it for yourself!

\$29.95 incl. S/H plus post. taxes
James Bond shops here!



ANTIQUA RADIO CLASSIFIED

Free Sample!

Antique Radio's
Largest Circulation Monthly
Articles, Ads & Classifieds.

6-Month Trial: \$18.95. 1-Yr: \$36.95 (\$53.95-1st Class).
A.R.C., P.O. Box 802-L16, Carlisle, MA 01741
Phone:(508) 371-0512 VISA/MC Fax:(508) 371-7129

BREAST CANCER BEGINS EVEN SMALLER THAN THIS. THAT'S WHY YOU NEED A YEARLY MAMMOGRAM, ESPECIALLY AS YOU GET OLDER. MAMMOGRAMS CAN DETECT LUMPS TOO SMALL FOR YOU TO FEEL AND EARLY DETECTION MAY SAVE YOUR LIFE, SO CALL 1-800-ACS 2345.

GET A MAMMOGRAM. EARLY DETECTION IS THE BEST PROTECTION.



BUY BONDS

ANTIQUE Radio

Antique Radio on the Internet

BY MARC ELLIS

As often happens during the summer months (yes, I am writing my December column in midsummer!), I haven't been at my workbench much recently. Yard work and other outside maintenance, radio meets, vacation trips, and other activities claim time that might otherwise be used for delving into antique-radio circuitry.

That's why I didn't get enough done on our current restoration project (a *Knight Star Roamer*, rescued from an ignominious end in a landfill by a friend of mine) to devote a column to it this month. Instead, I'm going to discuss a topic that I've wanted to touch on for some time: antique-radio resources on the Internet. To say that there is a gold mine of information for new and advanced collectors is putting it mildly indeed!

If you have already been on line and started to explore the Internet, you probably won't find much new information here this month. But if you've been thinking of getting in and need to be pushed, cajoled, encouraged, or otherwise motivated to make that fateful connection between your computer and the modular telephone jack in your den, read on!

INTERNET PROVIDERS

Now let me say at the outset that I'm not really billing myself as a computer guru. If you come across something by a **Popular Electronics** computer columnist or other *bona fide* author in this field that contradicts something here, take it seriously! All I'm going to do is share my own very personal experiences with you.

To get started on the Internet, you are going to need a provider (someone who gives you access to the Net through a dial-up number). There are several different types of services available through providers, and a complete discussion of them certainly doesn't belong in this column. But I've had some experience with two of the common "extremes."

One extreme gives you an e-mail address, access to the Internet, and

perhaps some basic third-party software. You're then left on your own to log onto the Net facilities that are of interest to you. You'll find providers of this kind operating both on a local and a national level. Prices seem to be coming down all the time, and most offer at least two pricing structures. You can order unlimited (untimed) service for a flat monthly fee. My provider, for instance, charges \$30, but recently cut it to \$25 for customers willing to pay automatically by credit card. Or you can opt to get a given number of hours (usually 5) for a flat fee per month (usually in the neighborhood of \$10). Additional time is metered and charged for at an hourly rate; \$2.50-\$2.75 per hour is typical.

The other type of provider, usually national, offers an integrated software package that includes proprietary menus for accessing various Internet facilities. Special services unique to the provider—such as on-line news, stock quotations, encyclopedias, and "chat rooms" where you can meet other subscribers to the service—are also offered. America Online (AOL) is

the provider I am familiar with, but services such as Prodigy and CompuServe must be similar. AOL does not offer an untimed service rate at this time. Right now the fee is \$9.95 a month for five hours, with additional hours costing extra. A new flat rate for a larger number of hours has recently been announced.

The AOL type of service is perhaps more user friendly and is typically used by families. An interesting feature is that different family members can have different e-mail addresses at no extra charge—thus ensuring mutual privacy.

HARDWARE REQUIREMENTS

I use a local provider of the "you're on your own" type, and first got started with a very minimal computer (a 16-MHz 386 SX with 8 MB of memory and a 14.4-Kbps modem). I was (and still am) running Windows 3.1. With that setup, I got reasonably satisfactory results, although access times to various services were a bit slow.

When I opened up an AOL account for a member of my family who need-

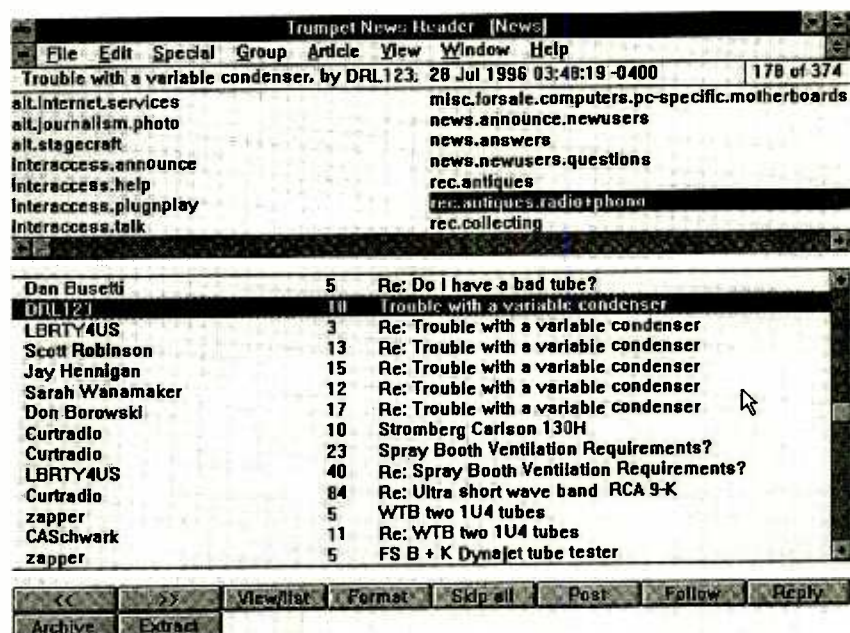

Fig. 1. The main menu for the news reader I'm using at the moment. Groups subscribed to are shown in the top third of the screen, with postings to the "rec.antiques.radio+phono" group listed below.

ed it, that setup proved to be quite unsatisfactory. The AOL log-on menu took *several minutes* to appear on the screen and, once logged on, access to many of the features required an impossibly long wait. Around that time, I had the opportunity to upgrade the motherboard to a 120-MHz 486 DX. Even though I'm still using my original ISA-bus controller and graphics cards, access speeds are *dramatically* faster and quite reasonable.

Bottom line: If you now have a 386 computer, don't hesitate to try it on the Net. But if you are buying a PC for Internet access, I certainly would recommend that you get nothing less than the fastest 486 DX you can find (with at least 8-MB of memory). 486 PCs are becoming available at closeout prices now that the hardcore folks have changed to Pentium-based PCs. As for modems, don't try to make it with anything less than a 14.4. If you are buying now, spend the extra money and get a 28.8. Prices on these are also coming down all the time.

INTERNET NEWSGROUPS

Okay, so you have Internet access. Now how do you tap into the rich vein of antique-radio lore that I promised? Perhaps the most obvious route is through the newsgroups. Newsgroups are international discussion groups, devoted to specific topics, where people with common interests can exchange ideas. The newsgroups are accessed through a piece of software called a "news reader."

A newsgroup is like a bulletin board: You don't talk "live" on it. Instead, you electronically post your question, comment on someone else's post, or answer someone else's question. To make a post, you simply click on a convenient "post" button. Replying to someone else's post is done similarly, via a "reply" button. Sometimes the questions, comments, answers, and comments on answers go on for weeks, forming what is called a "message thread" devoted to a single topic.

Figure 1 is a screen captured from my news-reader software. Some of the newsgroups that I "subscribe" to are shown in the top third of the screen (above the horizontal scroll bar). Several of them are just administrative question-and-answer groups set up by my provider; others reflect various special interests. The group highlight-

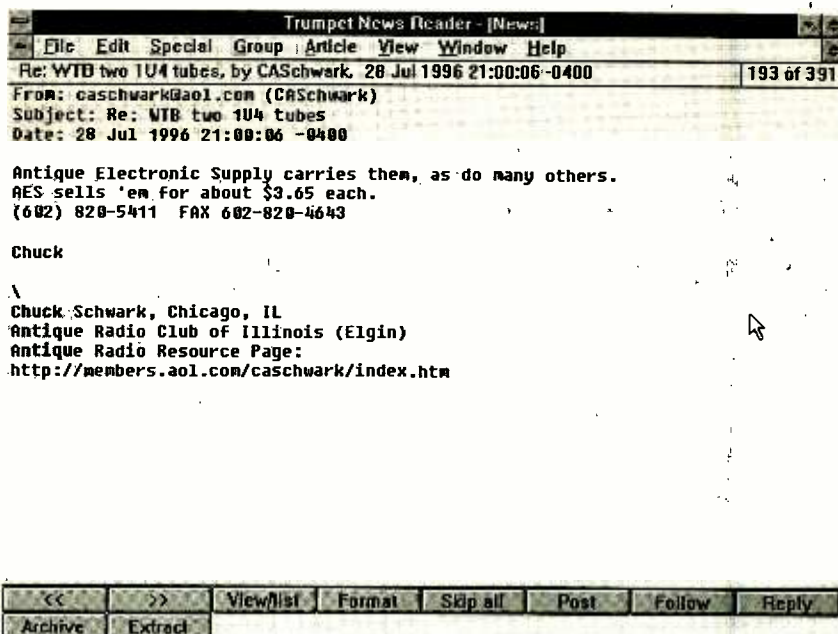

Fig. 2. A typical newsgroup message. This one, whose title appears near the bottom of the postings list shown in Fig. 1, responds to the previous post of a person looking for 1U4 tubes.

ed by the black bar (rec.antiques.radio+phono) is of interest to us here.

This group is one of the most popular of those dealing with antique radio, and the lower two-thirds of the screen shows some of the typical posts to it. Of course, you are seeing just the menu containing the titles of the postings. To read an actual message, you would click the mouse on the title desired—whereupon the title menu would disappear and the message would fill the screen.

Note the message thread starting near the top of the screen. The person identified as DRL123 (highlighted by the black bar) was having trouble with a sticking variable capacitor (I know this because I read the post) and was seeking advice on how to correct it. Below his post are responses from five different people. If I were to log on tomorrow, I might find responses to the responses!

Near the bottom of the tube is a post from "Zapper," who wants to buy a couple of 1U4 tubes. Below that is a response, which happens to be from my friend Chuck Schwark, suggesting a source. I'm showing the text of Chuck's response in Fig. 2 so that you can see what an actual newsgroup message looks like.

Note that at the very bottom of his message, Chuck has the address of his "Antique Radio Resource Page." That is Chuck's personal "home page"

on the World-Wide Web. I had intended to cover the Web in this column, but I'm fast running out of space. It looks as if this Internet orientation is going to need a "Part 2!"

Getting back to the newsgroups for a moment, you are probably wondering how to discover and identify groups that you'd like to join (or "subscribe to," as it is called). Well, I'd certainly like to suggest that you subscribe to rec.antiques.radio+phono right away, and begin reading posts there. Once you begin monitoring those posts, you will get leads to other groups that might interest you.

However, there is another, more direct, way to look for newsgroups. Most news readers have a "search" function that allows you to look for newsgroup names that contain certain key words or strings (for example, "antiques," "collectibles," "antique radios," etc.). After you activate such a search, all the names that match the list of newsgroups carried by your provider will come up on your screen. Just click on the ones you want to subscribe to.

Incidentally, the term "subscribe" is a bit of a misnomer because there is no cost involved. Just click on the ones you want and, from then on (unless you "unsubscribe" at some point), the names of those groups will appear on your list of possible selections every

continued on page 67

Give a Friend a Year of Electronics Fun this Christmas...



Does fighting the crowds at Christmas short-circuit your holiday fun? Don't blow a fuse this year...for the friend who shares your love of project-oriented electronics — or a youngster who may need only a spark to ignite a life-long interest — give a gift subscription to Popular Electronics.

Popular Electronics readers get the know how they need to build exciting, educational, and useful projects like these...a professional-quality home-security system...an autoranging frequency counter...a nine-band shortwave receiver...a radio-controlled car...a telephone scrambler...an aviation receiver...and even a robot!

PLUS...Gizmo, our honest and straight-shooting review of the latest consumer-electronics gear...Market Center, featuring mail-order merchants that are ready to help you in all your hobby activities...articles and columns covering every aspect of the electronics hobby — including antique radio, shortwave listening, ham radio, computers, scanners, circuit design, and more!

SAVE MONEY...A great gift to receive, Popular Electronics is also a great gift for *you* to give! The Special Holiday Rate saves you \$25.05* off the newsstand price on each gift. You can save another \$25.05* when you start or extend your own subscription at the same time. It's our "thank-you" for sharing Popular Electronics with a friend at Christmas.

Send no money, unless you prefer. We'll be glad to bill you in January, 1997. Just take a brief moment to go over your gift list and make sure you haven't forgotten anyone who might appreciate the many benefits of Popular Electronics. Then write the names on the attached Gift Certificate and mail it back in the postage-paid reply envelope...we'll take it from there!

Your friends will receive a handsome gift announcement card signed with your name just before Christmas. And all through the new year they'll remember and appreciate your thoughtful gift! So don't blow a fuse...take it easy and enjoy the holidays. Give Christmas gifts of Popular Electronics!

Popular Electronics[®]

*Basic sub rate—1 yr/\$21.95

Think Tank

Block Diagrams and Readers' Requests

BY JOHN J. YACONO
TECHNICAL EDITOR
WINDOWS MAGAZINE

We've been discussing components for so long that I thought it'd be nice to take a break and talk about methods of design. Using block

more complete explanation, see *Think Tank*, September through November, 1992.) Note I listed the pins for each of the 558's sections for reference. Pins

circuit detail in a "black box" like the one in Fig. 1B, and you've got a monostable block ready to go. Because there's only one reset input per four 558 sections, only one output of four monostable timer blocks will show a reset input.

In Fig. 2A, we've shoved a generic AC-load block into a schematic to make it more flexible. This demonstrates how a block can be mixed with discrete components. In Fig. 2B we've taken all of Fig. 2A and turned it into a single AC-load controller block. That means the AC-load controller block contains the AC-load block, demonstrating how blocks can be nested. Now let's see how they can be used to answer some of our readers' letters.

ALTERNATING-OUTPUT CIRCUIT

Could you provide a schematic for a dual 110-VAC, 400-watt output circuit. These outputs would alternate between on and off. I would need to be able to adjust alternating time between these two outputs for two to five seconds. I would prefer to use SCRs or TRIACs to control the AC output, and I'd like to power the control circuit from 110 VAC.

—Don Witchelhouse, Woodhaven, MI
Well, I'll leave the parts values

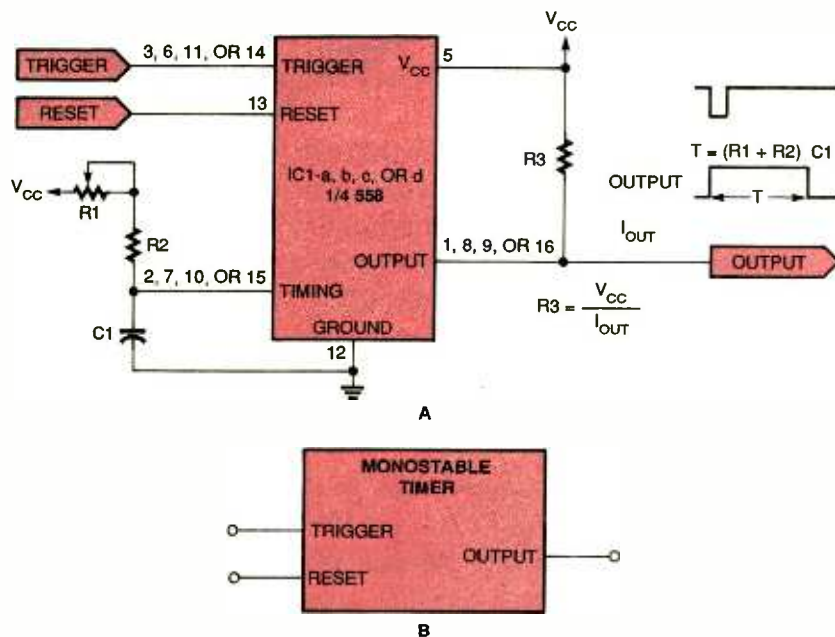

Fig. 1. Here's a monostable timer based on one section of a 558 quad timer (A). Note how it can be converted into a block diagram (B).

diagrams is a surefire way to design and troubleshoot circuits quickly. If you make your documentation clear and keep it well organized, you can quickly design new circuits using blocks from your repertoire.

For troubleshooting, checking a circuit block by block can quickly lead you to the failed section. Using blocks also eliminates duplicated effort at the drafting table, and reduces the burden of having to organize your documentation.

That said, let me demonstrate with a couple of blocks. Figure 1A shows a monostable timer based on one section of a 558 quad timer. To summarize the circuit's operation, if a falling edge is detected by the trigger input, the output goes high for a period determined by R1, R2, and C1 as shown. (For a

5, 12, and 13 are shared by all the sections. I've labeled points where the circuit will connect to other circuits—the inputs and outputs—with descriptive names. Then you just obscure the cir-

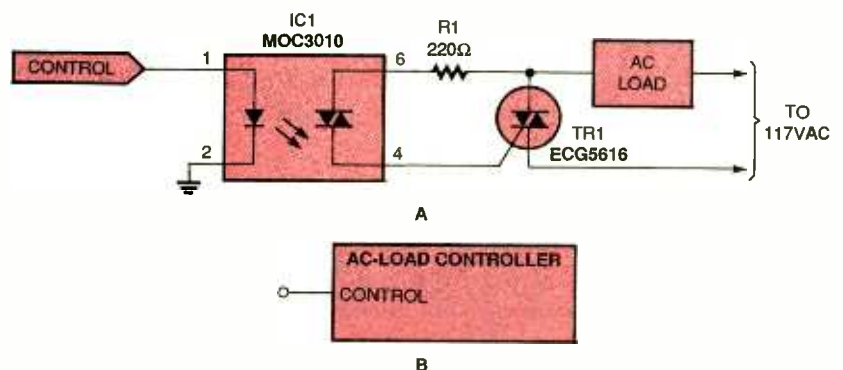

Fig. 2. This opto-coupler-based circuit (A) can be turned into a single AC-load controller block (B).

DATA-BOOK SOURCES

Advanced Micro Devices, Inc.
One AMD Place
Sunnyvale, CA 94088

Allegro Micro Systems, Inc.
115 N. Cutoff
Worcester, MA 01615

Cypress Semiconductor Corp.
3901 North First St.
San Jose, CA 95134

GEC Plessey Semiconductors
1500 Green Hills Rd.
Scotts Valley, CA 95066

GoldStar Technology, Inc.
3003 N. First St.
San Jose, CA 95134

Harris Corp.
Semiconductor Sector
P.O. Box 883
Melbourne, FL 32902-0883

Hitachi America, Ltd.
2000 Sierra Point Parkway
Brisbane, CA 94005

Ideal Semiconductor
P.O. Box 442
Liberty Lake, WA 99019

Integrated Device Technology, Inc.
2975 Stender Way
Santa Clara, CA 95054-3090

Lansdale Semiconductor, Inc.
2929 South 48th St., Ste. #2
Tempe, AZ 85282

Maxim Integrated Products
120 San Gabriel Dr
Sunnyvale, CA 94086

Micrel
1849 Fortune Dr
San Jose, CA 95131

Mitsubishi Electronics America
1050 East Arques Ave
Sunnyvale, CA 94086

Motorola Semiconductor Products
2100 East Elliot
Tempe, AZ 85284

National Semiconductor Corp.
2900 Semiconductor Dr.
Santa Clara, CA 95052

NJR Corp.
Div. of New Japan Radio Co. Ltd.
340-B East Middlefield Rd.
Mountain View, CA 94043

**Panasonic Industrial Co.
Matsushita Electric Corp.
of America**
1616 McCandless Dr.
Milpitas, CA 95035

Performance Semiconductor Corp.
610 E. Weddell Dr.
Sunnyvale, CA 94089

Philips Semiconductors
811 East Arques Ave.
Sunnyvale, CA 94088-3409

Quality Semiconductor
851 Martin Ave.
Santa Clara, CA 95050

Rochester Electronics, Inc.
10 Malcolm Hoyt Dr.
Newburyport, MA 01950

Rockwell International
4311 Jamboree Rd.
Box C
Newport Beach, CA 92658-8902

Samsung Semiconductor, Inc.
3655 North First St.
San Jose, CA 95134

Sharp Electronics Corp.
5700 N.W. Pacific Rim Blvd.
Camas, WA 98607

Siliconix, Inc.
2201 Laurelwood Rd.
Santa Clara, CA 95056

STC Components
Maidstone Rd.
Sidcup, Kent, United Kingdom
DA14 5HT

Teledyne Electronic Technologies
1274 Terra Bella Ave.
Mountain View, CA 94043

Texas Instruments, Inc.
P.O. Box 655303
Dallas, TX 75265

**Toshiba America Electronic
Components, Inc.**
9775 Toledo Way
Irvine, CA 92718

Universal Semiconductor, Inc.
1925 Zanker Rd.
San Jose, CA 95112

VTC, Inc.
2800 E. Old Shakopee Rd.
Bloomington, MN 55425

briefly explains what you want. Don't discuss your technical savvy, personal experiences, or hobby interests. If you are a part of the electronics industry, use company letterhead for impact.

PARTS SOURCES

On pages 29 and 30 of the February 1995 **Popular Electronics**, in the article on the "Low-RF Switch" you mention a Soldering-Iron Controller that supposedly appeared on page 53 of the May 1994 issue. I could not find that article on that page, but I want to build a controller like the one you mention (see Fig. 6). The soldering-iron controller I use is causing interference.

Also, would you please state where I can find a 25-ohm potentiometer and IC1, the TL783? (I can not find a re-

placement for IC1 in the *ECG Master Replacement Guide* or in the *SK Solid-State Replacement Guide*.) And, can I use a higher amperage diode than the 1N4001, and what is the wattage of R1 and R2?

I have been a subscriber for a long time.

—John Baird, Granite City, IL

Sorry about that misprint. The article was actually in the May 1992, issue.

I got the 25-ohm potentiometer from RadioShack. Chances are, if they no longer carry them, you'll find them at Digi-Key. Call them at 1-800-DIGI-KEY for their hefty catalog or to check for parts availability.

The potentiometers typically used as crossover components so audio-parts dealers are another good bet. The TL783 (for which I know of no

replacement) is available from Active Electronics. Give them a ring at 1-800-677-8899.

Using a diode specified for higher amperage won't gain you anything. The TL783 can only handle low-current loads, and the fixed resistor in the circuit programs IC1 for a maximum current of about 0.25 amperes.

As built, the fixed resistor was a 1/4-watt unit; the potentiometer was a 5-watt unit.

HELP!

I have been looking through some old issues of **Popular Electronics** and came across a circuit on page 27 of the July 1990 issue that I would like to build (see Fig. 7). The only trouble is I'm an old vacuum-tube man dating back to the days when almost anything

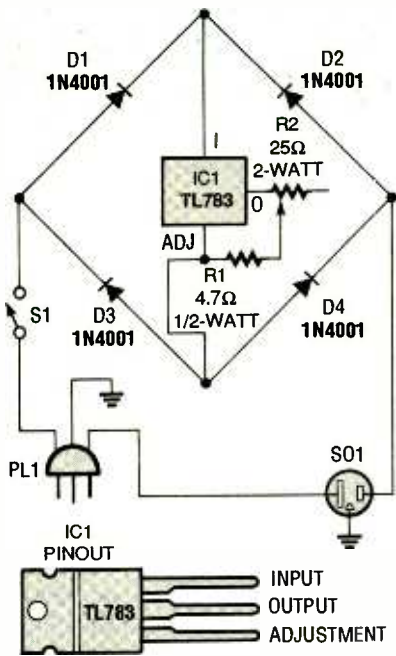

Fig. 6. Here's the elusive Soldering-Iron Controller that ran in the May 1992 (not 1994) issue of this magazine.

could be found in one of the catalogs from Allied Radio or Lafayette.

Where do I get the 555s? Can I use any kind of LED? Is this an 8-ohm speaker? Will I need an amplifier with this circuit or is it loud enough to be used as a car alarm?

Along with this circuit I need a small mechanical timer switch that is normally closed but which can be opened for thirty to sixty seconds. I have seen these advertised, but I need a source for this and the other parts.

—David B. Holzinger, Houston, TX

Never fear, the 555 timer is a very popular part that can be purchased from almost any large IC retailer you're likely to find advertising in this magazine. They're definitely available off the shelf at RadioShack.

About LEDs, almost any LED will work in a typical circuit requiring one, as almost all can handle about the same amount of current. The exceptions to the rule are few and far between. The speaker is indeed an 8-ohm unit, which is the magazine's default when we don't specify a rating, and yes, you'll definitely need an amplifier to use the circuit as a car alarm.

I haven't come across the switching circuit you need, but requesting catalogs from our advertisers is a good start to your hunt for that and the other parts.

MIXED REACTIONS

I need to make an audio mixer and I don't care if it's mono or stereo. My problem, though it may seem simple, is that every mixer I have tried to make buzzes uncontrollably (especially when "jiggled" or when parts are touched), and for some reason, I still can hear faint audio coming out even when I turn off the main mixer section. I even get "buzzy" signals and that faint trace of my inputs even if I turn them off individually. Should I try using integrated circuits, such as op-amps to mix audio signals? Up to now I've tried circuits that are 98% passive.

As a beginner, I could use some extra advice. For one thing, why are my circuits so touchy? I even put them in entirely plastic cases, but they still buzz when I touch anything metal. What kind of mounting techniques should I use?

One more thing, (this is a pretty big one, so I'll understand if you don't have the time to answer this). I really have a hard time understanding negative voltage. I know circuits use negative voltage, so I figure I'll get used to making negative supplies for those circuits. However, I would just like to be able to understand it. The books that I have read (Forrest Mimms) didn't explain negative volt-

age, so I still am in quite a state of curiosity.

I know this is a really tall order, but I have faith. If it makes you great people any more helpful, I would just like you to know that after I read one issue of **Popular Electronics**, I bought a subscription for two years, and when that runs out I will buy another two years. **Popular Electronics** is the only magazine I need. I find the other magazines just not as helpful and interesting as this one. God bless you all!

—Jon Hildenstein, Omana, NE

After looking at the rough schematic you sent in, the solution is quite clear. You're grounding the center of the RCA jacks, using the outer conductor for the signal path. Because the standard audio equipment your mixer connects between is wired just the opposite way, the audio signal is traveling through your mixer's ground path as it passes through the mixer, not the desired signal path. If you connect the jacks properly and use a metal enclosure, you can shield out the hum you hear.

There's not really much to say about negative supply voltages. Just as a positive supply pulls electrons up from ground through circuitry, electrons travel from a negative supply

continued on page 59

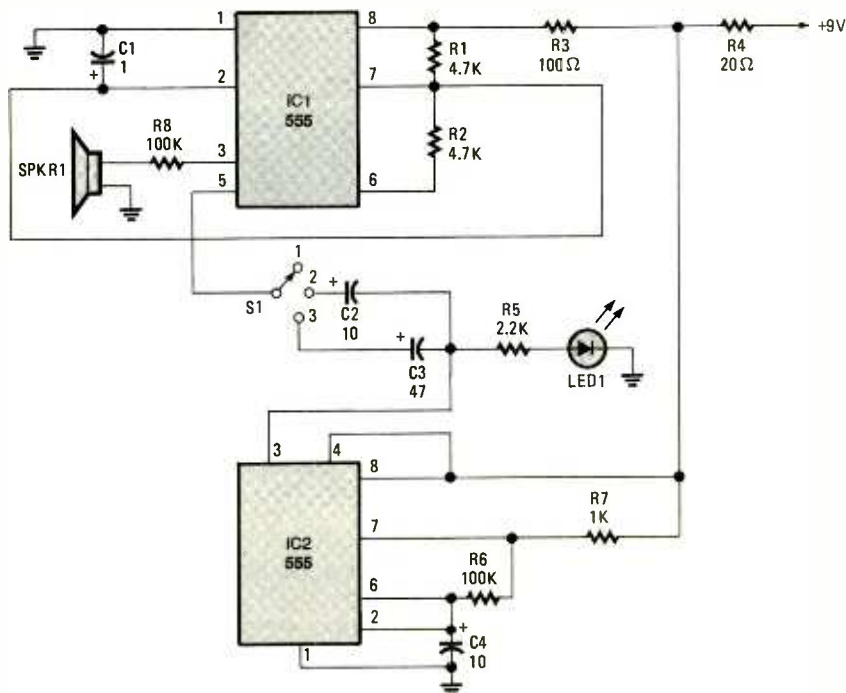

Fig. 7. To use this 555-based oscillator for any real volume, you'll need an amplifier.

DX LISTENING

Far East Broadcasting Company

BY DON JENSEN

The Far East Broadcasting Co. dates back a half century to the end of World War II, when American GIs were returning from combat in the Pacific Theater. Among them were John Broger and Bob Bowman, who felt called to establish a religious ministry via radio. Their target was China.

By March 1946, the two men were in Shanghai, trying to get their programs broadcast over local radio stations. It took nearly a year to get the first one on the air. Soon, though, it became apparent that the civil strife tearing China apart would doom that effort. Eventually, the Nationalist government retreated to Taiwan, and China had a Communist regime headed by Mao.

brand new nation was willing to let the broadcaster establish its headquarters in Manila.

The first broadcasts over a local AM radio station, then called KZAS, went on the air from Manila on June 4, 1948. Shortwave broadcasts to China began in 1949, and have since expanded to cover most of Southeast Asia, as well as Russia. Since these early years, FEBC operations have expanded to include local AM and FM stations in Manila, and ten regional outlets throughout the Philippine provinces. There are six shortwave transmitters in the Philippines. Three 50-kilowatt units and a 100-kilowatt transmitter are located at Bocaue, and

although it also serves Asiatic Russia and Japan. Later, another powerful medium-wave companion station was set up at Incheon, outside the Korean capital of Seoul.

FEBC developed another shortwave site on the island of Saipan in the early 1980s. The station, called KFBS, has four 100-kilowatt transmitters serving Russia, China and other targets in Southeast Asia. An associated operation, the Far East Broadcasting Associates, or FEBA, transmits to Africa on shortwave from the Seychelles, an island group in the Indian Ocean.

The Far East Broadcasting Co. says it broadcasts in an astonishing 151 languages and dialects—from Arabic and Akha, a Chinese tongue, to Vietnamese and an African dialect called Yao.

FEBC can be heard on shortwave in North America, although its signals, beamed to listeners elsewhere in the world, don't exactly boom in. It is scheduled in English on 11,635 kHz from 0930-1100 UTC; 11,995 kHz from 1300-1600 UTC; and 15,450 kHz from 0000-0200 UTC, all from Philippines transmitter sites. KFBS on Saipan has English scheduled on 9,465 kHz at 1830-1900 UTC. FEBA's English broadcasts from Seychelles are aired on 9,810 kHz from 1500-1600 UTC; 12,090 kHz from 1500-1545 UTC; and 15,555 kHz from 0500-0545 UTC.

PUTTING OUT FIRES

When I see what is happening in the world of international broadcasting today, I'm reminded of the small rural volunteer fire department in the community where I once lived. They would arrive at the scene of a prairie fire, its flames swiftly racing across a field of dry grass.

It was hot, hard work, but the firefighters usually managed to halt the onrush of the grass fire. With the danger seemingly over, they set about extinguishing the final patches of fire, beating out the last small flames with shovels. But just as they finished, a



Here's a photo of the Far East Broadcasting Company's transmitter building at Iba, in the Philippine province of Zambales. If you'd like to check out other views of the station, visit FEBC's website at <http://www.febc.org/febchom.html>.

Broger searched Asia for a more congenial home for FEBC. The Philippines, at the time developing its independence from the United States, as a

there is a pair of 100 kw'ers located at Iba.

In 1972, FEBC established a high-power medium-wave station on the South Korean island of Cheju, which has become the mainstay of this religious broadcaster's coverage of China,

CREDITS—Brian Alexander, PA; Rich D'Angelo, PA; David Clark, ONT; Bob Fraser, MA; Charles Rippel, VA; North American SW Association.

puff of wind would reignite smoldering embers a bit further down the fire line.

So they rushed to the new site and, again, beat out the rekindled fire. Only by that time, another hot spot had flared up. Time and again, just when they thought it was out, the fire popped up again, somewhere else.

As funding for broadcasting worldwide gets tighter and tighter, shortwave listeners have responded to one alarm after another as this or that shortwave service announces it will have to cut back programming or shut down entirely because its government has axed the budget.

Earlier this year it was the popular Radio Canada International whose broadcasting life was on the line. It was touch and go, but in the end, funding somehow was found. A good bit of the credit goes to SWLs in North America and elsewhere, who bombarded the Canadian government with fervent pleas to "Save RCI."

That fire was beaten back! But the flames have rekindled elsewhere. This time it is Radio Australia that is in peril.

How serious is the threat? At this writing we know only that the Australian newspaper, the Melbourne Herald-Sun has reported that the international broadcaster faces closure because the government considers shortwave broadcasting outmoded and not worth the expenditure of tax money.

So it's time, once again, to put on the fire helmets and boots, grab the shovels, and try to stamp out another blaze. If the RCI situation taught us anything, it was that letters help. Tell Radio Australia that you don't want to lose their SW service. Give the station some useful "ammunition" for its budget battle with the Australian government.

Radio Australia's address is GPO Box 428G, Melbourne, Australia 3001. Or you can send your comments via e-mail—raust3@ozemail.com.au. Radio Australia also has a New York Bureau; you can reach them at 1 Rockefeller Plaza, Suite 1700, New York, NY 10020 (Tel. 212-332-2540; Fax: 212-332-2546).

PROGRAM NOTES

I've mentioned before Richard Cuff's excellent "Easy Listening" column, which appears regularly in the monthly Journal of the North American SW Association. It is a great guide to

some of the better programs heard on SW stations around the world.

If you think that you might be interested in joining NASWA to read its excellent Journal regularly, you can get membership information by sending a stamped, self-addressed envelope to NASWA, 45 Wildflower Road, Levittown, PA 19057.

In a recent column, Cuff observes that Radio Sweden offers "a quick take on news and events in Scandinavia" on its 60 Degrees North program. It is a weekday half-hour program about Sweden and its neighboring Nordic countries.

On Friday, the program features a week-in-review wrap-up, Richard notes. Tuesday it includes *Sportscan*, a feature focusing on sports relevant to Swedes. On Wednesdays, you'll find included in the program a business and economics feature called *Money Matters*.

Richard says he finds Radio Sweden's morning transmissions at 1230 and 1330 UTC transmissions "easy listening." At this writing, the former broadcast is heard on 13,740 and 15,240 kHz; the latter transmission on 9,835, 11,650 and 15,245 kHz.

Or, if you prefer to try for Radio Sweden during the evening hours, look to 6,065 kHz at 0030 UTC; 7,120, 7,290 and 9,435 kHz at 0130 UTC; 7,290 kHz at 0230 UTC or 7,115 kHz at 0330 UTC.

DOWN THE DIAL

Here are some listening targets to try for:

BANGLADESH—9,548 kHz. Radio Bangladesh has been heard in English, signing on at 1227 UTC with a tuning signal and identifications, news, and subcontinental-type music.

BRAZIL—15,265 kHz. Radio Nacional do Brasil is reported in English with a program covering Brazilian current events.

MONGOLIA—12,085 kHz. Radio Ulanbaatar has English scheduled at 1200 UTC, but interference then makes reception nearly impossible. Try a half hour earlier, at 1130 UTC, when it is transmitting in Japanese.

TAHITI—15,167 kHz. RFO Tahiti is heard on this frequency during the late night hours. Rumor has it that this longtime exotic SW voice may leave the air forever. Try it now.

TURKEY—9,655 kHz. Voice of Turkey

was noted in English at 2230 UTC with a program called *The Veiled World*, which is actually the music of the sultans. ■

THINK TANK

(continued from page 57)

through components to ground. Same concept only the direction of the current flow might seem to be a bit confusing.

A BARKING LOT?

The item "One Good Turn" in *Think Tank*, March 1992, brings to mind a project I've been planning to build. I live in a place where people have a nasty habit of backing their vehicles into pedestrians: I would like to assemble a back-up warning system, the same as big trucks, with an audible warning system, but adding a strobe light so people will not only hear, but also see the vehicle.

Parking lots are terrible with backing-up collisions, so I'm asking if you could help with this project: a simple system, with an independent horn and flashing strobe, to mount on the rear bumper (underneath), but using the existing electrical system. Your help would be greatly appreciated in this matter.

Thanks.

—Charles Lucas, Wilmington, NC

If you're not interested in reinventing the wheel, RadioShack sells an annunciator/bulb assembly that replaces one of your back-up bulbs that lights when you're in reverse. They also have a 12-volt-powered outdoor strobe for alarm systems (No. 49-527) that you could run in parallel with the other back-up light.

Frankly, though, I advise against using a strobe on a vehicle. At night, it can briefly impair the vision of other drivers or the pedestrians you're concerned about, making conditions much more hazardous than if you were simply to look around a lot (no pun intended).

That closes this month's column Remember, if you'd like to receive a book, contribute schematics and text for working circuits to *Think Tank*, Popular Electronics, 500 Bi-County Blvd., Farmingdale, NY 11735. Send enough quality items to fill a column, and you'll get a kit and MCL1010 chip, too. ■

HAM Radio

An Old Friend Revisited

JOSEPH J. CARR, K4IPV

A long time ago, in a neighborhood not so far away, I learned a bit about radio. Ham radio, in fact. My income was from a paper route, and one of my customers had this odd antenna mounted on the side of his house. Fascinated, I asked the boyish question of Mac Parker: "What's that?" He showed me his ham rig and I was hooked for a lifetime.

Mac had the mentor's heart and took me and several other youngsters and adults under his wing. Mac taught us Morse code, along with a bit about radio theory and good operating practices. He also gave me my first copy of a book that has been a friend down the years: *The ARRL Handbook for Radio Amateurs* (ARRL, 225 Main Street, Newington, CT, 06111-1494; ISBN 0-87259-173-5, ARRL Order No. 1735, 1158 pages, \$38; e-mail: info@arrl.org).

The Handbook comes out annually. Although there is not any radical difference from one year to the next (nor should there be: E still equals $I \times R$ after all), over time changes follow changes in amateur-radio technology. What does change from year to year is the construction projects. If you are interested in building ham projects, especially things like linear amplifiers, receivers, and ham-station accessories, then the Handbook is a primary source of both detailed plans and ideas.

In the 1996 Handbook (shown in Fig. 1), which I just bought, there are topics that weren't even dreamed of only a few years ago. I buy a new one every year, principally because it's a research reference for me. Most of my old copies are well-worn and dog-eared because of the use they have had over the years. Others buy a new edition every four or five years. I recommend buying it a little more often because of changes in radio technology that almost overrun us (perhaps every two or three years).

One nice thing about recent editions is that they provide printed-circuit patterns for the projects that require them.

All the patterns are placed at the back

of the book so they can be removed without major damage to the book, or be easily photocopied. Of course, if you are not very keen about making your own printed-circuit boards, then FAR Circuits (18N640 Field Court, Dundee, IL, 60118) will provide them for you. Write to FAR for their price list of project boards. By the way, FAR also makes boards for magazine projects and will also do your own designs if you prefer.

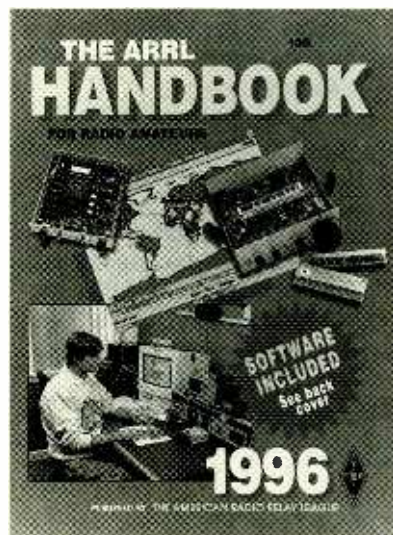

Fig. 1. This is the 1996 edition of the ARRL Handbook for Radio Amateurs. By the time you see this, the 1997 edition should be available.

There are several new features in this year's Handbook. I find the layout is improved over past editions (the topics seem better grouped). There are chapters on safety practices, real-world component characteristics (which often differ from theoretical components), and even a chapter on radio mathematics. The math chapter is useful for people who need to know the type of math needed for radio and general electronics calculations, but don't have the inclination to take a full-up math course.

A feature found in most recent editions is instructions and information that makes it possible for you to design your own high-pass, low-pass, band-

pass, and notch filters, even if you are not a math whiz. Basically, if you can do division on a calculator you can design the types of filters that ham operators often need.

A feature that was new in 1996 (and will probably be continued when the 1997 edition comes out) is a software diskette for IBM-PC compatible DOS computers. It contains programs on pi-network design, slow-scan TV, shortened dipole design, a true-north aid, solenoid filter design, and active-filter (e.g. audio filter) design.

If you were to visit my basement library you would see ARRL Handbooks on the shelves dating back to 1959 (the one Mac Parker gave me for passing my Novice test).

UHHHH...YOU'RE KIDDING, OF COURSE

I get some interesting mail from time to time. One that landed in my e-mail box was from a newcomer to the hobby who was thinking about using about 100 feet of white 75-ohm coaxial cable that someone gave him to hook up a scanner receiver to a rooftop antenna. A local expert told him that coaxial cable with white insulation has higher loss than black coax because it has a lower resistance to solar ultraviolet radiation. Someone is sucking wind, I'm afraid. Although I've seen white coax weather to a pukey color, it's not less effective radio-wise. After all, white cable has been used for TV antennas for decades. Indeed, my local cable company uses white cable from the drop box, all around the house, to the service entrance (I see fine on my TV).

However, there might be a real reason to be wary of TV-type coaxial cable. Television cable usually has an aluminum-foil outer conductor, rather than braided wire. The foil does not take solder very well. So it is restricted to uses where a crimp-on connector can be used instead of solder. If you have crimp-on connectors, and intend to use it solely for reception (not transmitting), then the TV-type coaxial cable should

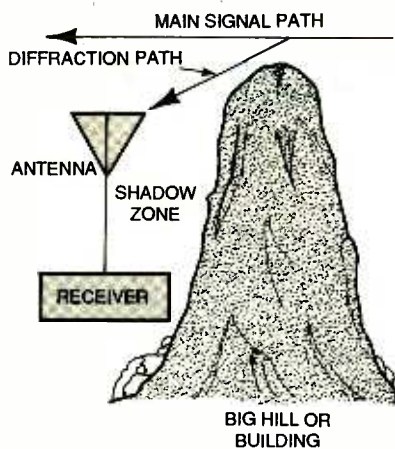

Fig. 2. Diffraction over a hill can sometimes make VHF/UHF reception possible in what you would normally think is a blackout area.

work fine. If your receiver doesn't mind 75-ohm coax (it won't), then use it with confidence. I don't recommend it for transmitting, however, even at low power levels.

OVER-THE-HILL REPEATER HITS

Another question that I received in my e-mail box concerned reception of the local 2-meter repeater when there is a large hill in the way. The only thing I can recommend that will definitely work is to go to the top of the hill and install a remote-controlled transceiver of your own. Hardly practical for most of us. Yet some people do, in fact, "see" through hills on VHF and UHF frequencies.

Take a look at Fig. 2. This is a sectioned view of the landscape. Suppose you are down in the valley, or somehow manage to get a QTH on the wrong side of some mountain or big honkin' hill. The direct signal passes over the mountain into the wild blue yonder. The receiver antenna in Fig. 2 is in the shadow zone because of that hill.

The only way to get the main signal path, either receiving or transmitting, is to stick an antenna into the path. Unfortunately, that means a remote station on top the hill or one heckuva tower mount for your antenna. In some rare cases, the VHF/UHF signal will diffract (*i.e.* the path bends a small amount) as it comes over the crest of the hill at an angle that can be picked up by your valley-imprisoned receiver.

I've heard from some hams in nearby West Virginia that such things happen rather regularly. In most cases,

they can hear a repeater, but cannot key it up because the diffraction doesn't necessarily work as well both ways. Also, many years ago I was in the TV business, and antennas was one job I seemed to get a lot. I've seen odd reception situations in the TV business that could only be explained by diffraction phenomenon.

Another case is a bit more practical for most of us. Figure 3 shows a situation where a big hill, building or other obstacle stands between you and the VHF or UHF repeater. Normally, one does not expect to see much signal on the shadow side of the hill. But in some cases, the signal will be 5-by-9 even in the shadow. The reason is that there is some other object or hill that causes a reflection of the original signal. It is this "multipath" signal that you pick up. In this case, the transmit and receive paths are probably the same, so by aiming your antenna at the reflecting object, you can work the repeater on the other side.

I learned about this trick back in my TV days. My area is rather hilly, so there are many spots where a hill shadows the TV transmitters. An old antenna guy named Jack showed me how to aim the antenna at a water tower, opposite hill, high-rise building or other structure. Often, the reflected signal was a lot stronger than the direct signal. We also used that tactic to eliminate ghosts. Sometimes, with

the multipath signal stronger, the antenna would work better against the reflected signal than the direct signal.

Sometimes, the reflector idea is used artificially. Microwave operators have used it in mountainous areas for years. I've seen the technique used with amateur-radio equipment, commercial land-mobile communications gear, and television receivers. In those cases, a billboard-size aluminum passive reflector is erected on the top of a mountain. Because the thing is just a big hunk of plywood (or several pieces), some 2 x 4 lumber and a lot of aluminum foil (or sheet aluminum), it uses no power, does not need a transmitter or receiver, but works nonetheless. The idea is to install the reflector so that it reflects the signal down in the valley. And because it's a reflector arrangement, it will take your signal out of the valley as well.

I've seen two non-commercial applications of the passive reflector. One was in southwestern Virginia where a friend of mine installed one to bounce television signals into his valley. Recently he used a TVRO satellite dish (and probably has the newer 18-inch style TV disk by now). In the mountain states, the TVRO dish is called the "state flower" from all the dishes seen in those valleys.

The other installation that I personally saw was in Arizona a few dozen

continued on page 64

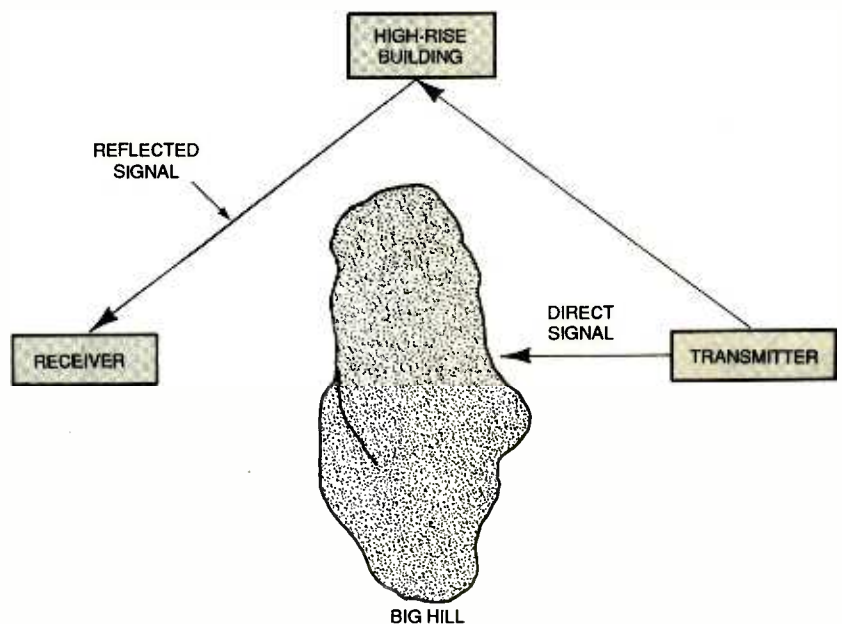

Fig. 3. A passive reflector often makes two-way communication possible where natural geography does not cooperate.

CIRCUIT CIRCUS

More Crystal Sets

BY CHARLES D. RAKES

If you tuned in last month you'll remember that we were deep into crystal-radio circuits that our grandpas would have built. I don't know about you, but working with these primitive receiver circuits brought back many pleasant memories of times past.

Long before becoming a teenager, I can remember building numerous crystal sets and one tubers from parts taken from Dad's stash of old radios stored in stacks in our attic (those radios would now be considered classics of the twenties). I would snip out beautiful green coils wound on bakelite forms and remove large brass tuning capacitors as well as other components that would tie together on the end of a wooden orange crate. No AC, no batteries, just pure radio magic.

The saga continues this visit with more simple receiver circuits. We'll add an active device or two, a DC power source, and see what improvement these modern devices bring to crystal radio.

Our first two items are add-on amplifier circuits for the crystal radios covered in last month's column. Let's get to them:

HEADPHONE AMPLIFIER

The amplifier circuit shown in Fig. 1 will increase the volume of a weak or distant station to a useful level for headphone listening. Power for the circuit can be provided by a 5- to 9-volt DC source.

Amplification is provided by a

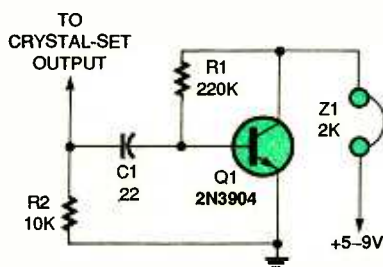

Fig. 1. This simple circuit should make it easier to hear in headphones those faint stations that your crystal set is receiving.

PARTS LIST FOR THE HEADPHONE AMPLIFIER (Fig. 1)

Q1—2N3904 NPN transistor
R1—220,000-ohms, $\frac{1}{4}$ -watt, 5% resistor
R2—10,000-ohm, $\frac{1}{4}$ -watt, 5% resistor
C1—0.22- μ F, Mylar or similar capacitor
Z1—2000-ohm headphones
Power source, wire, solder, etc.

2N3904 NPN transistor, Q1. For Z1, use 2000-ohm headphones.

drive an 8-ohm speaker. With an LM386 amplifier (IC1) connected as shown, the IC's gain is set at 50. The gain can be increased to 200 by removing R3 and connecting the positive side of C4 directly to pin 1.

If a gain of 50 or 200 turns out to be too high, then the gain can be reduced to a minimum figure of 20 by removing C4, C6, and R3. The combined gain of Q1 and IC1 is several thousand, so keep all of

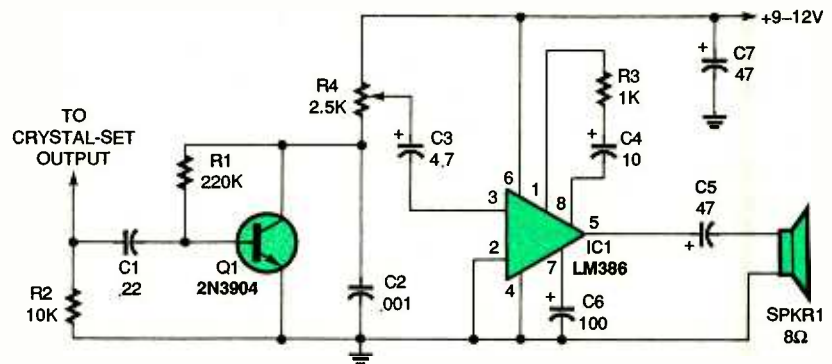

Fig. 2. If you'd like to hear your crystal set at a comfortable room-filling volume, hook it up to this amplifier.

PARTS LIST FOR THE SPEAKER AMPLIFIER (Fig. 2)

RESISTORS

(All fixed resistors are $\frac{1}{4}$ -watt, 5% units.)

R1—220,000-ohm
R2—10,000-ohm
R3—1000-ohm
R4—2500-ohm potentiometer

CAPACITORS

C1—0.22- μ F, Mylar or similar
C2—0.001- μ F, ceramic-disc
C3—4.7- μ F, 16-WVDC, electrolytic
C4—10- μ F, 16-WVDC, electrolytic
C5, C7—47- μ F, 16-WVDC, electrolytic
C6—100- μ F, 16-WVDC, electrolytic

ADDITIONAL PARTS AND MATERIALS

IC1—LM386 audio power amplifier, integrated circuit
Q1—2N3904 NPN transistor
SPKR1—8-ohm speaker
Power source, IC socket, wire, solder, etc.

SPEAKER AMPLIFIER

Our second amplifier, shown in Fig. 2, will increase the audio signal of a crystal set to a level that is sufficient to

your leads short and neat. Potentiometer R4 is used to control the volume.

TAPPED COIL

Figure 3 shows a winding diagram for a coil that will be used in the rest of the receiver circuits this month. You can cut the coil form from a 2- $\frac{1}{2}$ -inch-diameter piece of PVC pipe. Make it 3 inches long. If this material is not readily available, any similar diameter and length of plastic tubing will do. Other sources for the coil form can be pill bottles, plastic drinking glasses, and discarded toys.

Wind 50 close turns of 19- or 20-gauge enamel-covered copper wire on the plastic form. Bring out a tap at the 10th and 20th turns, and your coil is ready to use.

RF AMPLIFIER RECEIVER

There are two easy methods that can be used to increase the output of

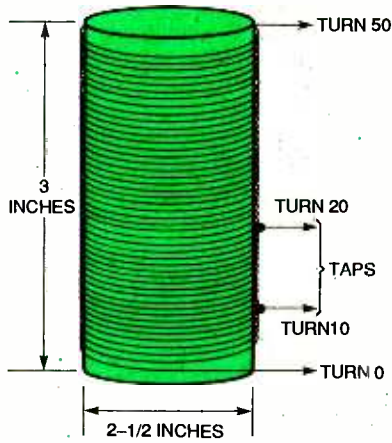

Fig. 3. This 50-turn coil, which is used in the receivers in this month's column, has taps at the 10th and 20th turns.

PARTS AND MATERIALS LIST FOR THE TAPPED COIL (Fig. 3)

- 2-1/2-inch PVC pipe, 3-inch length (see text)
- 19- or 20-gauge enamel copper wire

a crystal radio. One method is to add an audio amplifier, like those shown in Figs. 1 and 2, at the detector's output. Another way is to add a radio-frequency (RF) amplifier in front of the detector circuit, as shown in Fig. 4.

The desired radio-frequency signal is selected by tuning C5, which may be any 365-pF, or larger-value, tuning capacitor. Older AM broadcast receivers are a good source for salvaging these type of capacitors. Also you might want to check out your local hamfest, where often you will find a good selection of variable capacitors and many other useful components just looking for a new home.

Capacitor C6, a 5- to 50-pF unit, helps in matching the antenna to the tuned circuit and optimizing the circuit's sensitivity and selectivity. Adjusting C6 to its maximum capacitance will yield maximum sensitivity in the circuit. And when C6 is adjusted to a workable minimum setting, the selectivity will be at its best. As in any receiver, there's always a compromise between sensitivity and selectivity.

The RF signal is tapped off at the 10th turn up from ground on L1, and is fed to the base of Q1. That transistor amplifies the RF signal, which drives the dual diode-detector circuit. The detected audio drives the headphones (Z1).

The antenna I used with this single-

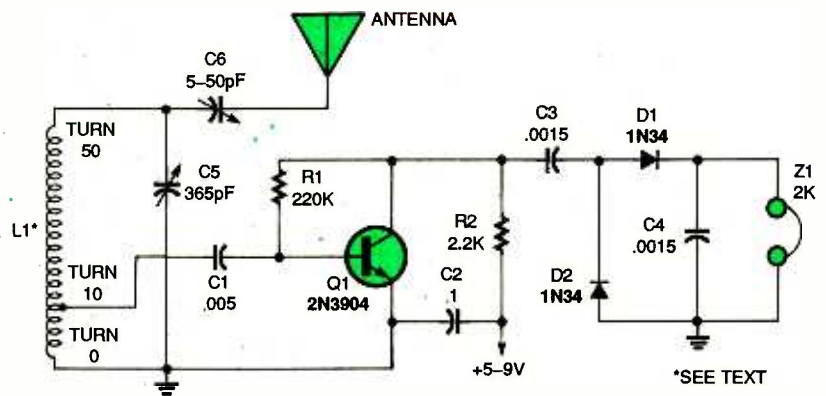

Fig. 4. Here's a receiver that contains an RF amplifier. The desired radio-frequency signal can be selected by tuning C5.

PARTS LIST FOR THE RF AMPLIFIER RECEIVER (Fig. 4)

CAPACITORS

- C1—0.005- μ F, ceramic-disc
- C2—0.1- μ F, ceramic-disc
- C3, C4—0.0015- μ F, ceramic-disc
- C5—365-pF, or similar-value, variable tuning capacitor
- C6—5-50-pF, or similar-value, variable tuning capacitor

ADDITIONAL PARTS AND MATERIALS

- Q1—2N3904 NPN transistor
- D1, D2—1N34 germanium diode
- R1—220,000-ohm, 1/4-watt, 5% resistor
- R2—2200-ohm, 1/4-watt, 5% resistor
- L1—50-turn coil (see Fig. 3)
- Z1—2000-ohm headphones
- Antenna, power source, wire, solder, etc.

That certainly isn't an ideal ground system either. But even with these two major deficiencies, the simple little receiver performed well. Try the circuit; the cost is small and the excitement is contagious.

IMPROVED RF AMPLIFIER RECEIVER

Now on to the next receiver circuit (see Fig. 5), which uses an RF amplifier in front of a diode detector, and an audio amplifier behind it. This RF-amplifier circuit is very similar to the one used in the previous receiver, with two exceptions: First, a 2.5-mH RF choke (L2) replaces Q1's load resistor. Second, an RF-gain-control potentiometer, R4, is added.

The RF choke improves the amplifier's efficiency and gain at the AM broadcast frequencies. With the circuit's added RF and AF amplification, R4 serves as the receiver's volume control.

Once you build the receiver, hook up an antenna and ground. Set C7 to about half of its maximum capacitance

transistor receiver consisted of about 25 feet of 26-gauge copper wire that I ran across the ceiling. That's not exactly an ideal antenna for my location, however, as I'm over 100 miles from any powerful AM transmitter. My ground circuit consisted of a single ground-rod setting in dry rocky soil.

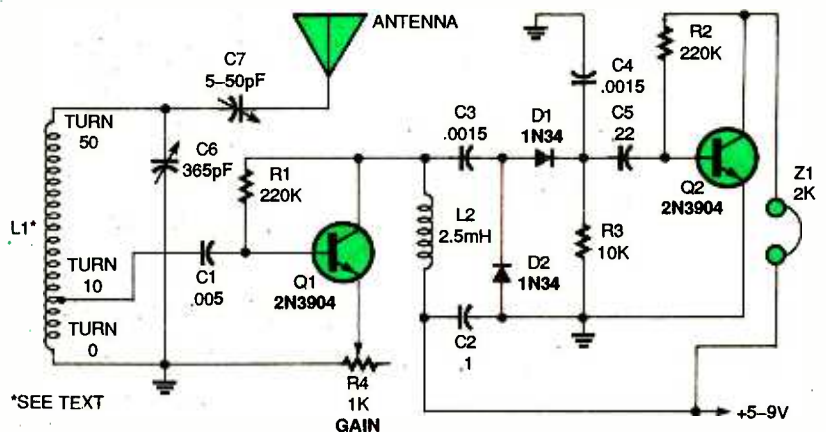

Fig. 5. This receiver allows you to select the gain of its RF amplifier by adjusting R4.

PARTS LIST FOR THE IMPROVED RF AMPLIFIER RECEIVER (Fig. 5)

RESISTORS

(All fixed resistors are $\frac{1}{4}$ -watt, 5% units.)
 R1—220,000-ohm
 R3—10,000-ohm
 R4—1000-ohm potentiometer

CAPACITORS

C1—0.005- μ F, ceramic-disc
 C2—0.1- μ F, ceramic-disc
 C3, C4—0.0015- μ F, Mylar
 C5—0.22- μ F, Mylar
 C6—365-pF variable tuning capacitor
 C7—5-50-pF variable tuning capacitor

ADDITIONAL PARTS AND MATERIALS

Q1, Q2—2N3904 NPN transistor
 D1, D2—1N34 germanium diode
 L1—50-turn coil (see Fig. 3)
 L2—2.5-mH RF choke
 Z1—2000-ohm headphones
 Antenna, power source, wire, solder, etc.

and R1 to its maximum resistance; then apply power. Rotate C6 until a station is heard and adjust R4 for a pleasant listening level. If more than one station is received at the same time, re-adjust C7 for less capacitance; that should help the circuit's selectivity.

If a strong local station overloads the receiver, a trap might be necessary in the antenna circuit. You'll find two easy-to-build trap circuits following our next receiver circuit.

SOLID-STATE REGENERATIVE RECEIVER

Our last receiver circuit, shown in Fig. 6, is a solid-state version of Major E.H. Armstrong's famous regenerative receiver. At its time in radio history, the regenerative receiver reigned supreme and remained so until the Major came out with his superheterodyne receiver circuit. The basic superheterodyne design is the one used in just about all of the commercial radios that are built today.

You will need to modify the coil shown in Fig. 3 to use it with the regenerative receiver. Here's how to do that: Place a single layer of electrical tape around the bottom winding of the coil (L1); wind 6 turns of 19- or 20-gauge wire over the taped winding, leaving 4-inch pig tails. Tape the winding in place. Then connect the modified coil to the receiver circuit as shown in Fig. 6.

The two 2N3904 transistors are

connected in a Darlington high-input-impedance circuit configuration to reduce loading of the tuned circuit. Both C3 and C4 perform the same duties as in the previous two receiver circuits.

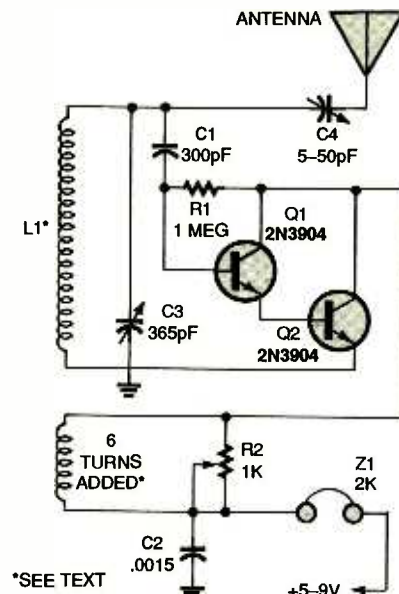

Fig. 6. Here's a solid-state version of a well-known regenerative receiver. You will need to modify coil L1 to use it with this circuit.

PARTS LIST FOR THE SOLID-STATE REGENERATIVE RECEIVER (Fig. 6)

CAPACITORS

C1—300-pF, ceramic-disc
 C2—0.0015- μ F, Mylar
 C3—365-pF variable tuning capacitor
 C4—5-50-pF variable tuning capacitor

ADDITIONAL PARTS AND MATERIALS

Q1, Q2—2N3904 NPN transistor
 R1—1-megohm, $\frac{1}{4}$ -watt, 5% resistor
 R2—1000-ohm potentiometer
 L1—Modified coil (see text and Fig. 3)
 Z1—2000-ohm headphones
 Antenna, power source, wire, solder, etc.

Potentiometer R2 controls the positive RF feedback. When used like this, a potentiometer is more commonly known as the regeneration control, which also determines the receiver's audio output.

If the receiver seems dead, and only weak signals are heard, try reversing the leads on the 6-turn feedback coil. That might be all that's necessary to do the trick.

RF FILTERS

The two RF-filter circuits shown in Fig. 7 can help reduce the interference

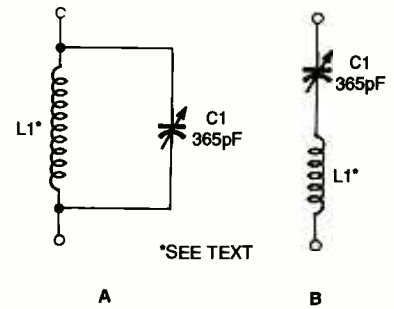

Fig. 7. These parallel-tuned (A) and series-tuned (B) filter circuits can help reduce the interference from nearby or powerful AM stations. Tune C1 to accomplish that.

PARTS LIST FOR THE RF FILTERS (Fig. 7)

C1—365-pF variable tuning capacitor
 L1—50-turn coil (see Fig. 3)
 Wire, solder, etc.

from nearby or powerful AM stations. They are slightly different, but work in similar ways.

The parallel-tuned filter circuit, shown in Fig. 7A, connects in series with an antenna and receiver circuit. Tune C1 to reduce or remove the interfering station.

The series-tuned filter circuit, shown in Fig. 7B, also connects in series to the antenna and ground circuit. You can tune C1 in this filter as well to reduce or remove the interfering station.

That's all our time for now. Until next month, try at least one of these simple receivers. I'm certain you'll enjoy them as much as I do.

May your radio only receive good news. ■

HAM RADIO

(continued from page 61)

miles east of Tucson where an amateur radio club erected a 20-foot-high, 40-foot-long passive reflector on a mountaintop so they could work repeaters in desert towns on the other side. I didn't get up to it, but was told that it was relatively cheap to build (about \$300), and is used by 2-meter operators all over the area. Heck, I bet even the rattlesnakes like it...it does, after all, provide them with shade for part of the day.

I can be reached by snail mail at P.O. Box 1099, Falls Church, VA, 22041, or by e-mail at carrjj@aol.com. ■

The Four-Year Electronics Degree Program That Really Hits Home!

Bring The Technology Home With A Bachelor Of Electronics Engineering Degree. No Hassles. No High Cost!



Now's the time to prepare for a profitable career.

We've lowered the cost of higher education.

It's true! You can earn a four-year Bachelor of Electronics Engineering Technology degree today ... and prepare yourself for a high-paying electronics career ... without quitting your job or ever leaving your home. Because World College, an affiliate of the Cleveland Institute of Electronics, offers you the total flexibility of independent study programs proven effective for people like you who truly want to succeed! World College independent study lessons help you build valuable skills

**Mail/Fax Today
or Call
1-800-696-7532**

step-by-step, and expert instructors are personally available to you with a toll-free call. What a way to earn an education!

A world of opportunity.

Where is your career headed? With a four-year bachelor's degree from World College, you call the shots, choosing from incredible, high-paying opportunities in electronics, telecommunications, computer, electrical power, and many other growing fields.

World College gives you the skills, the knowledge, the power to take advantage of your best opportunity in electronics. And you can do it all at your own pace!

Without leaving home.

World College continually works to provide its students with the most advanced education tools. From the latest equipment and reference books to breakthrough computer-simulated experiments, students are exposed to the latest technological advancements.

All the equipment, parts, and software you need are included in your affordable tuition, including more than 300 hands-on lab experiments you can complete in your home.

Choose your own pace.

Earn your bachelor's degree on your time — and at your pace — because you pay tuition to World College only as you complete the upper-level semesters close to graduation. The faster you make it through, the less you pay. So you have an incentive to make your future happen quickly — yet the freedom to choose your own pace!

Send today for your FREE course catalog — and give yourself that future you've always wanted — with an electronics degree education from World College.



Take charge of your future in electronics.

Four Powerful Reasons To Connect With World College Today:

- 1. Earn your four-year degree!**
- 2. Self-paced training!**
- 3. Independent study in your home!**
- 4. Expert instruction!**

Give Me The Power!

Send me a FREE World College course catalog today!



(Please Print Neatly)

Name _____

Address _____

City _____

State, Zip _____

Phone (____) _____

Age _____

**For faster service, call
1-800-696-7532,
or call
1-804-464-4600.**

**Or fax this coupon to
1-804-464-3687.**



Lake Shores Plaza
5193 Drive, Suite 113
Virginia Beach, VA 23455-2500



Affiliated with
Cleveland Institute of Electronics
WAH34

SCANNER SCENE

Eavesdropper's Delight

BY MARC SAXON

For those who want to be able to eavesdrop on virtually everything, Icom offers its brand-new IC-R8500 super-wide-band all-mode receiver. Think of it as a professional-grade combination VHF/UHF scanner merged with a highly versatile communications receiver. And it's available at an affordable price.

Here's the deal. You get continuous coverage from 100 kHz to 2000 MHz (no gaps). The IC-R8500 can tune in NFM, WFM, AM-W, AM-N, SSB, CW, RTTY, and (with optional narrow filter) CW-N. There are 1000 memory channels and 20 scan-edge channels. The memory channels are set up in 20

panel keyboard or rotary tuning knob. There are selectable tuning steps of 10, 50, or 100 Hz; 1, 2.5, 5, 9, 10, 12.5, 20, 25, and 100 kHz; and 1 MHz.

Additional features include high-frequency stability even when receiving in the GHz range, a noise blanker that eliminates pulse-type noise in the SSB/AM modes, three separate antenna connectors, S-meter, and center indicator for tuning convenience. Options include the UT-102 voice synthesizer, the TV-R7100 TV-receive adapter, and the CR-293 high-stability crystal unit.

What do you think? For more information, please contact your nearest

462.6875, 462.7125, 467.5625, 467.5875, 467.6125, 467.6375, 467.6625, 467.6875, and 467.7125 MHz. CTCSS tone-code squelch is permitted, although repeaters are not.

Transceivers will certainly be plentiful, with many manufacturers offering them for less than \$200. There could be some rather interesting chatter on those channels if you're within range.

HOBBY NEWS

We were taken by surprise upon recently receiving a postcard from the Radio Communications Monitoring Association (RCMA) of Silverado, California, advising members that it was suspending operations. After more than 20 years on the scene, the RCMA now says that its membership rolls have thinned out to the point where it has become impractical to continue bringing out their excellent *Scanner Journal*. A definite loss to the scanning hobby.

However, there's good news, too! A few weeks ago, we were sent a copy of an all-new, bi-monthly newsletter for scanner users, and it looked quite good to us. It's called *The Scanner Club*, and is published and edited by Les Mattson, founder of the well-remembered *North East Scanner News*. The issue we saw had 67 pages with coverage of all aspects of the hobby, with columns and features for all areas of the U.S.

The yearly membership (subscription) to *The Scanner Club* is \$24.95 for six issues. Make checks payable to Les Mattson at The Scanner Club, P.O. Box 62, Gibbstown, NJ 08027. If you want more information, the club's phone number is 609-423-1603, and Les Mattson's e-mail address is less-can@aol.com.

Let's also remind you of *Radio Monitors Newsletter of Maryland*, P.O. Box 394, Hampstead, MD 21074-0394. Their e-mail address is RBscan@aol.com. There's plenty of good frequencies and information in this monthly publication.



Icom's IC-R8500 combines a top-of-the-line VHF/UHF scanner with a versatile communications receiver (and at a reasonable price, too!)

banks of 40 each, with 100 channels reserved for automatic memory write scan and another 100 for skip scan. Each memory channel can store frequency, mode, tuning steps, and RF ATT information. You can also store up to five characters of your own alphanumeric information into each memory bank, and eight in each memory channel, for quick reference.

Scanning functions include programmed scan, memory scan, priority scan, selected mode memory scan, auto memory write scan, and selected number memory scan. Scanning speed is 20 channels per second in programmed scan mode and 10 channels per second in memory scan.

Icom dealer or Icom America, Inc. (2380 116th Avenue N.E., Bellevue, WA 98004; Tel. 206-454-8155).

ALL IN THE FAMILY

RadioShack came up with the idea for a new radio service and presented it to the FCC. After kicking the concept around for a while, the FCC has decided to approve the Family Radio Service, thus providing us with yet one more type of station to monitor!

Now that it has been approved, the Family Radio Service (FRS) offers the very short-range use of unlicensed half-watt special transceivers by families and groups. There are 14 frequencies allocated to FRS: 462.5625, 462.5875, 462.6125, 462.6375, 462.6625,

CTCSS TONES

The *Scanner Club* newsletter offered a number of what it described as "typical federal CTCSS tones." That is, CTCSS tones (or, as some refer to them, "PL tones") that seem to be preferred by specific federal agencies. Because many scanner owners can get readouts of those tones, let's check out some of them here in an effort to get you an ID on any difficult stations.

For instance, the FCC uses a CTCSS of 173.8 Hz; the Department of Energy uses 77.0 Hz; Commerce has 127.3 Hz; and the DEA has 156.7 Hz. Immigration and the Customs Service use 100.0 Hz, while the FBI and HHS both use 167.9 Hz. The Secret Service uses 103.5 Hz.

The Scanner Club also reminds us of those ten medical channels that are now so heavily used between ambulances and hospitals. Channels Med 9 and 10, which are 462.95 and 462.975 MHz, are the calling channels, where communications are established and a working channel (Med 1 through Med 8) is assigned. Channel Med 1 is 463.000, Med 2 is 463.025, Med 3 is 463.050, Med 4 is 463.075, Med 5 is 462.100, Med 6 is 463.25, Med 7 is 163.150, and Med 8 is 463.175 MHz. The working channels may be used for voice communications, as well as for sending EKGs or other digitized data from the ambulances to the hospital staff.

Keep in touch with us here at *Scanner Scene*! Please send along your frequencies, questions, suggestions, and opinions. We are always on the alert for input from our readers. Our address is *Scanner Scene*, **Popular Electronics**, 500 Bi-County Blvd., Farmingdale, NY 11735. ■

ANTIQUE RADIO

(continued from page 52)

time you activate your news reader.

Before leaving the subject of newsgroups, a few ground rules should be mentioned. The culture of most groups requires you to behave in a reasonably intelligent and considerate manner. If you post something thoughtless, or if you "flame" (insult) a member of the group, you might hear from the group moderator or become, yourself, the target of multiple flames.

Many groups strongly discourage overtly commercial postings (although private buy, sell, or trade ads are usual-



Fig. 3. Here are about half of the postings (see text) in a typical Boatanchors mailing-list digest.

ly acceptable). Naive questions asked by newcomers (or "newbies") sometimes draw testy responses. To avoid the latter, see if the group has posted an FAQ (list of answers to frequently asked questions). Most groups have FAQs and post them at regular intervals. If you don't see one, post a message asking when you can get it. And when it does become available, print it out—or save it to a file—so that you can study it at your leisure.

MAILING LISTS

Mailing lists are similar in concept to newsgroups, but a lot less public. Postings to a mailing list, or replies to the posts of others, are made by sending them to a special e-mail address. The list owner or manager, in turn, blanket-forwards all postings to the e-mail addresses of all list subscribers—perhaps after editing or organizing the message in some manner.

It's not as easy to locate mailing lists as it is to find newsgroups, although "lists of lists" have been compiled. One way to access them is to search the World-Wide Web (to be covered next time). To join a list, you have to have the e-mail address of the owner/manager so that you can request information on how to become a member. There may or may not be a membership fee.

One well-known list of definite interest to antique-radio hobbyists is known as "Boatanchors." Quoting from the

Boatanchors new-subscriber welcome message: "This mailing list is devoted to a discussion of vintage communications equipment, which we fondly refer to as 'Boatanchors,' and closely related subjects. The central theme is vintage amateur-radio equipment using vacuum-tube (firebottle) technology, but we have been known to drift into discussions of such things as entertainment boatanchors, antennas, telegraph keys, classic electronic/radio books, and radio history."

To join Boatanchors, there is a small annual fee (\$12). You may elect to receive each new posting as it arrives or, instead, choose the "digest" option. In digest mode, the list manager holds your e-mail until the accumulating group of new postings reaches a certain size. It is then forwarded to you, accompanied by a "header" listing the titles of the posts, so that you can skip directly to the items you'd like to read immediately.

Part of the header of a sample digest sent to me by the list owner/manager is included here as Figure 3. It shows about half of the titles in the group. For information on joining Boatanchors, e-mail listown@jackatak.the-porch.com.

And speaking of message threads, it looks as if this Internet orientation will have to be continued next time, when we will examine the amazing resources waiting for you on the World-Wide Web! ■

ELECTRONICS LIBRARY

AUTO AUDIO: Choosing, Installing & Maintaining Car Stereo Systems

by Andrew Yoder

Regardless of your level of expertise, or your budget, this book will help you put together a great-sounding car stereo system. It helps consumers minimize the confusion they experience when confronted by the dizzying array of available components, and avoid paying a premium for professional advice. The book arms you with the information you need to make intelligent choices without spending a small fortune.

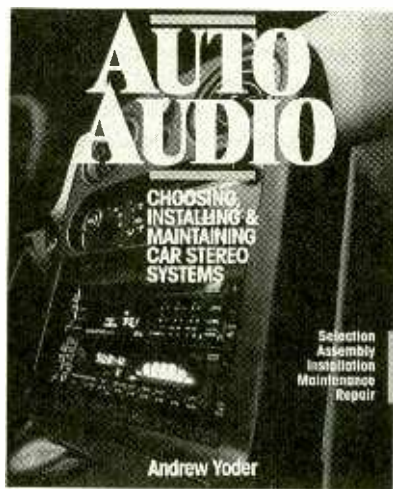

The book is filled with practical advice on how to select and install car-stereo systems, as well as how to keep them trouble-free and sounding great. It presents all the information you'll need in terms that a lay person can understand. The book begins with a detailed discussion of how to choose an audio system that meets your demands, followed by helpful advice on where to shop, including the names and addresses of equipment sources. There are complete chapters on amplifiers; speakers and speaker enclosures, filters and crossovers; antennas; wire, cabling, connectors, and transmission systems; installations; and maintenance and repair. Also covered are some less-common car-audio components, such as MiniDisc players, and

the radio display system (RDS), and shortwave receivers.

Auto Audio: Choosing, Installing & Maintaining Car Stereo Systems costs \$24.95 and is published by McGraw-Hill, Inc., 1221 Avenue of the Americas, New York, NY 10020; Tel. 800-2-MCGRAW.

**CIRCLE 90 ON FREE
INFORMATION CARD**

THE ARRL EXTRA CLASS LICENSE MANUAL

edited by Larry D. Wolfgang, WR1B

Even though there are some juicy DX stations and a lot of contest stations in the bands reserved exclusively for Extra class users, many amateurs put off taking the Extra class exam because they don't think they can understand the theory, or master 20-word-per-minute code. If you're willing to make the commitment to study and practice, however, you can do it, and this book can help.



The book teaches you everything needed to pass the Element 4B written exam. It provides clear explanations of the theory you'll need, along with the complete and up-to-date question pool. This edition features the revised question pool as released by the Volunteer Examiner Coordinators' Question Pool Committee for use beginning July 1, 1996. The question-pool answer key is printed next to the questions for easy reference. The book also clearly ex-

plains all the FCC rules you'll need to know for the exam, and recommends Morse-code study materials.

The ARRL Extra Class License Manual For the Radio Amateur costs \$12 and is published by The American Radio Relay League, 225 Main Street, Newington, CT 06111-1494; Tel. 860-594-0200; Fax: 860-594-0303; e-mail: pubsales@arrl.org; Web: <http://www.arrl.org/>.

**CIRCLE 91 ON FREE
INFORMATION CARD**

COMPUTER-AIDED STUDY GUIDES

from Ameco Corporation

You can use your IBM-compatible PC to prepare for the FCC Ham Radio license written exams with Ameco's FCC Test Packages. All possible exam questions are presented word-for-word as they will appear on the actual exams. The software includes a friendly interface, mouse support, and full-time online help. Sample VEC tests can be viewed on-screen or printed out. There are colorful graphs and all required schematic diagrams, quizzes on every topic, and complete explanations for every question. An Ameco FCC Test manual is included as part of every Test Package.



Ameco Test Packages for No-Code Technician Class, Technician Class, General Class, Novice Class, Advanced Class, and Extra Class exams are priced starting at \$24.95 and are published by Ameco Corporation, 224 East Second Street, Mineola, NY 11501; Tel. 516-741-5030; Fax: 516-741-5031.

**CIRCLE 92 ON FREE
INFORMATION CARD**

Market Center TM

Paperback Books

GREAT BOOKS AT BUDGET PRICES

100 RADIO HOOKUPS
—#7—\$3.00

First published in May, 1923 this popular booklet went into reprint editions nine times. It is packed with circuits, theory, antenna installation and tips on consumer radio receivers that were popular in the early 1920's. Antique radio buffs and those inquisitive about the early days of radio will find this booklet an exciting, invaluable and excellent reference into the minds of early-day radio listeners. Sorry, we cannot honor the original 25-cent cover price.

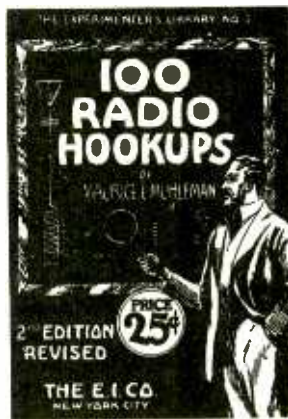

INTERNATIONAL RADIO STATIONS GUIDE—BP255
—\$9.95

Provides the casual listener, amateur radio DXer and the professional radio monitor with an essential reference work designed as a guide for listening to the complex radio bands. Includes coverage on Listening to Shortwave Radio, ITU Country Codes, Worldwide Radio Stations, European Long Wave and Medium Wave Stations, Broadcasts in English and more.

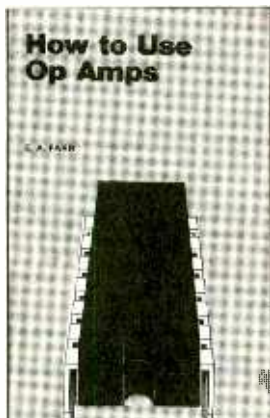

HOW TO USE OP AMPS
—BP88—\$5.95

The engineer's best friend is the op amp. This basic building block is found in many circuits, analog and digital alike. The op amp finds many useful purposes such as: oscillators, inverters, isolators, high- and low-filters, notch and band-pass filters, noise generator, power supplies, audio, MIDI, and much more. Prepared as a designer's guide, some limited math is used, however engineers and hobbyists alike find it a useful text for their design needs.



WIRELESS & ELECTRICAL CYCLOPEDIA
—ETT1—\$5.75

A slice of history. This early electronics catalog was issued in 1918. It consists of 176 pages that document the early history of electricity, radio and electronics. It was the "bible" of the electrical experimenter of the period. Take a look at history and see how far we have come. And by the way, don't try to order any of the radio parts and receivers shown, it's very unlikely that it will be available.

ELECTRONIC TECHNOLOGY TODAY INC.
P.O. BOX 240, Massapequa, NY 11762-0240

Name _____
Address _____
City _____ State _____ Zip _____

SHIPPING CHARGES IN USA AND CANADA

\$0.01 to \$5.00	\$2.00
\$5.01 to \$10.00	\$3.00
\$10.01 to \$20.00	\$4.00
\$20.01 to \$30.00	\$5.00
\$30.01 to \$40.00	\$6.00
\$40.01 to \$50.00	\$7.00
\$50.01 and above	\$8.50

SORRY No orders accepted outside of USA & Canada

Number of books ordered

Total price of merchandise	\$ _____
Shipping (see chart)	\$ _____
Subtotal	\$ _____
Sales Tax (NYS only)	\$ _____
Total Enclosed	\$ _____

All payments must be in U.S. funds!

ET01

SEE US
NOW AT
<http://www.cir.com>

**CIRCUIT
SPECIALISTS
INC.**

**Check Out
What
We
Have
To Offer:**

Fantastic DMM Offer!!!

Don't let the price fool you. This meter is a digital multimeter designed for engineers and hobbyists. Equipped with 5 functions and 19 ranges. Each test position is quickly and easily selected with a simple turn of the FUNCTION/RANGE selector rotary

switch. **Rubber Boot Included**

General
Display: 3-1/2 Digit LCD, 21mm Figure Height with Automatic Polarity
Overrange Indication: 3 Least Significant Digits Blank

Temperature for Guaranteed Accuracy:
23°C±5°C RH<75%

Temperature Ranges:
Operating: 0°C to 40°C (32°F to 104°F)
Storage: -10°C to 50°C (14°F to 122°F)

Power: 9V Alkaline or Carbon-Zinc Battery (NEDA1604)

Low Battery Indication: BAT on Left of LCD Display

Dimensions: 188mm long x 87mm wide x 33mm thick
Net Weight: 400g

DC Voltage (DCV)
Range: Resolution: Accuracy:
200mV 100µV
2000mV 1mV ±(1%rdg+2dgt)
20V 10mV
200V 100mV
1000V 1V
Maximum Allowable Input: 1000V DC or Peak AC.

DC Current (DCA)
Range: Resolution: Accuracy:
200µA 100nA
200mA 10µA ±(1.2%rdg+2dgt)
2000µA 1mA
10A 10mA ±(1.2%rdg+2dgt)
Overload Protection: mA Input. 2A/250V fuse.

AC Voltage (ACV)
Range: Resolution: Accuracy:
200V 100mV ±(1.2%rdg+10dgt)
750V 1V
Frequency Range: 45Hz-450Hz
Maximum Allowable Input: 750V rms
Response: Average Responding. Calibrated in rms of a Sine Wave.



**Our
Best
Offer
Ever
on a**

**High
Quality
Full Sized
DMM**

\$19.00
any qty

Resistance (Ω)
Range: Resolution: Accuracy:
200Ω 100mΩ
2000Ω 1Ω
20KΩ 10Ω ±(1.2%rdg+2dgt)
200KΩ 100Ω
2000KΩ 1KΩ
20MΩ 10KΩ ±(2%rdg+10dgt)
Maximum Open Circuit Voltage: 2.8V

Diode Test
Measures forward voltage drop of a semiconductor junction in mV test current of 1.5mA Max.

hFE Test
Measures transistor hFE.

CAT NO	DESCRIPTION	PRICE
9300G	Rugged High Quality DMM with Rubber Boot	\$19.00

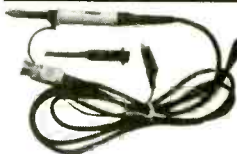

Switchable Scope Probe Sets

(Selectable X1/Ref/X10) These high quality scope probe sets are for oscilloscopes up to 60MHz (model HP 9060) or 150MHz (model HP9150). Both sets include a handy storage pouch and include an IC test-hook adapter for

the probe. The BNC connector rotates to avoid cable tangle or kink. Cable length is 1.4 meters.

CAT NO	DESCRIPTION	PRICE EACH		
		1	10	100
HP-9060	Scope Probe Set DC~60MHz	\$16.49	\$14.49	\$11.58
HP-9150	Scope Probe Set DC~150MHz	24.95	21.95	18.62



Positive Photo Resist Pre-Sensitized Printed Circuit Boards

These pre-sensitized printed circuit boards are ideal for small production runs. They provide high resolution and excellent line width control. High sensitive positive resist coated on 1oz. copper foil allows you to go direct from your computer plot or art work layout. No need to reverse art.

Single-Sided, 1oz. Copper Foil on Paper Phenolic Substrate

CAT NO	DESCRIPTION	PRICE EACH		
		1	10	50
PP101	100mm x 150mm/3.91" x 5.91"	\$2.55	\$1.90	\$1.70
PP114	114mm x 185mm/4.6" x 6.6"	2.98	2.45	1.98
PP152	150mm x 250mm/5.91" x 9.84"	5.40	3.98	3.60
PP153	150mm x 300mm/5.91" x 11.81"	6.15	4.48	4.10

Single-Sided, 1oz. Copper Foil on Fiberglass Substrate

CAT NO	DESCRIPTION	PRICE EACH		
		1	10	50
GS101	100mm x 150mm/3.91" x 5.91"	\$ 3.90	\$2.98	\$2.60
GS114	114mm x 185mm/4.6" x 6.6"	4.80	3.49	3.20
GS152	150mm x 250mm/5.91" x 9.84"	8.69	5.98	5.78
GS153	150mm x 300mm/5.91" x 11.81"	10.20	7.20	6.80

Double-Sided, 1oz. Copper Foil on Fiberglass Substrate

CAT NO	DESCRIPTION	PRICE EACH		
		1	10	50
GD101	100mm x 150mm/3.91" x 5.91"	\$ 5.07	\$3.68	\$3.38
GD114	114mm x 185mm/4.6" x 6.6"	5.95	4.29	3.99
GD152	150mm x 250mm/5.91" x 9.84"	10.47	7.39	6.98
GD153	150mm x 300mm/5.91" x 11.81"	11.95	8.69	8.30

Etching Chemicals/Ferric Chloride

A dry concentrate that mixes with water to make 1 pint of etchant, enough to etch 400 sq. inches of 1oz board.

CAT NO	DESCRIPTION	PRICE EACH	
		1	5
ER-3	Makes 1 pint	\$3.50	\$2.75



Developer This product is used as the developer on our positive photo-resist printed circuit boards. Includes instructions. 50 gram package, mixes with water.

CAT NO	DESCRIPTION	PRICE EACH		
		1	10	25
POSDEV	Positive Developer	\$.95	\$.80	\$.50



Etching Tank This handy etching system will handle PC boards up to 8" x 9", two at a time. Ideal for etching your PCB's! System includes an air pump for etchant agitation, a thermostatically controlled heater for keeping etchant at optimum temperature and a tank that holds 1.35 gallons of etchant. A tight fitting lid is also supplied to prevent evaporation when system is not being used. Typical etching time is reduced to 4 minutes on 1oz. copper board!

REDUCES ETCHING TIME!

CAT NO	DESCRIPTION	PRICE	
		12-700	Etch Tank System
			\$37.95

Desoldering Pumps

These powerful plastic body desoldering pumps are designed for easy one hand operation for fast, efficient desoldering. Double O-ring piston seals for maximum suction.

CAT NO	DESCRIPTION	PRICE EACH		
		1	5	10
08-366S	Large Desoldering Pump	\$15.89	\$13.49	\$11.95
08-366E	Regular Desoldering Pump	10.89	8.59	7.39
08-366TIP	Replacement Tip	1.95	1.95	1.95

SEE OUR ON-LINE CATALOG AT
<http://www.cir.com>

Electronic Soldering System Here's the ideal solution when **Temperature Control** is required. Easy to use slide control allows user to set system from 300°F to 840°F. Voltage to iron from control unit is 24V Iron heating power is 48W. Replaceable 5.3mm tip is standard. Replacement irons and tips are available.

CAT NO	DESCRIPTION	PRICE EACH	
		1	5
SL10	Temp Controlled Soldering Iron	\$56.00	\$50.00
SL24V	Spare 24V Soldering Iron	10.50	7.50



Electronic Soldering System with LED Display

Deluxe temperature controlled system with LED display for maximum accuracy. Temperature is adjustable from 160°-480°C (320°-900°F). Iron heating power is 48 Watts. Runs on 24V from controller unit. Replacement irons and tips are available. Tip size is 5.3mm.

CAT NO	DESCRIPTION	PRICE EACH	
		1	5
SL30	Deluxe Soldering System w/LED	\$86.00	\$75.00
SL24V	Spare 24V Soldering Iron for SL10 or SL30	10.50	7.50



Replacement Tips for SL10/SL30

We now offer a variety of replacement tips for the SL10/SL30 soldering stations.

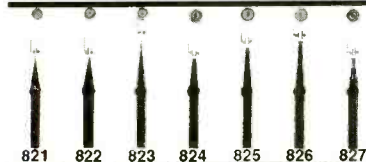

CAT NO	DESCRIPTION	PRICE EACH		CAT NO	DESCRIPTION	PRICE EACH	
		1	5			1	5
821	1/32" Pencil Tip	\$1.39	\$1.19	825	1/8" Chisel Tip	\$1.49	\$1.29
822	1/32" Pencil Tip	1.39	1.19	826	3/64" Chisel Tip	1.49	1.29
823	1/64" Pencil Tip	1.39	1.19	827	3/64" Pencil Tip	1.59	1.39
824	1/16" Chisel Tip	1.49	1.29				

Ball Bearing 12V DC Fans



These High Quality Fans feature Ball Bearings and Brushless DC Motors. All of them are designed to meet UL, CSA & VDE Standards. Design these fans into power supplies, computers or other equipment requiring additional air flows for heat removal. These fans are regular Circuit Specialists stock items — they are not surplus.

CAT NO	DESCRIPTION	PRICE EACH			
		1	10	25	100
CSD 4010-12		\$ 9.88	\$ 6.38	\$5.48	\$4.87
CSD 6025-12		9.38	5.91	5.41	4.71
CSD 8025-12		8.88	5.85	5.19	4.49
CSD 9225-12		8.95	6.14	5.29	4.59
CSD 1225-12		11.45	8.96	7.82	6.85

INDUSTRY BEST PRICING!

Specifications

CAT NO	DIMENSIONS (MM)	RATED VOLTAGE (V)	START VOLTAGE (V)	INPUT CURRENT (A)	AIR FLOW (CFM)	STATIC PRESSURE (INCH-H ₂ O)	SPEED (RPM)	NOISE LEVEL (dB)	WEIGHT (g)
CSD 4010-12	40x40x10mm	12	7	0.06	5.1	0.19	5,500	26	20
CSD 6025-12	60x60x25mm	12	5	0.13	13.7	0.165	4,500	28	65
CSD 8025-12	80x80x25mm	12	5	0.16	37.8	0.177	3,000	31	80
CSD 9225-12	92x92x25mm	12	5	0.32	42	0.18	2,800	37	95
CSD 1225-12	120x120x25mm	12	5	0.35	62	0.180	2,500	42	135

SOLDER • SOLDER • SOLDER • SOLDER • SOLDER • SOLDER • SOLDER • SOLDER

We stock high quality 60/40 (Sn%/Pb%), .031" and 63/37, .031" diameter. This is prime JIS certified solder that we maintain as a regular stock item (It is not "Left-overs, Rejects or Surplus") and you can buy it from us at a fraction of the price that you are used to.



Tired of Paying Inflated Prices for Solder?

CAT NO	DESCRIPTION	PRICE EACH		
		1	10	25
RH60-1	1-lb. Spool, .031", 60/40	\$ 6.90	\$ 5.96	\$ 5.30
RH63-1	1-lb. Spool, .031", 63/37	6.95	6.10	5.41
RH60-4	4.4-lb. Spool, .031", 60/40	24.00	21.90	17.92
RH60-TUBE	6-oz. Tube, .031", 60/40	.99	.89	.79

CCD Camera - IR Responsive As Low As \$109!!

This black and white monochrome CCD Camera is totally contained on a PCB (70mm x 46mm). The lens is the tallest component on the board (27mm high from the back of the PCB) and it works with light as low as 0.1 lux. It is IR Responsive for use in total darkness. It comes with six IR LED's on board. It connects to any standard monitor, AUX or video input on a VCR or through a video modulator to a TV. Works with a REGULATED 12V power supply (11V-13V). Hooks up by connecting three wires: red to 12V, black to ground (power & video) and brown to video signal output.

CAT NO	DESCRIPTION	PRICE EACH	
		1	5
CA-H34A	PCB Mounted IRCCD Camera	\$125.00	\$109.00

SEE OUR ON-LINE CATALOG AT <http://www.cir.com>

CIRCUIT SPECIALISTS, INC. SINCE 1971

**800-811-5203
602-464-2485
602-464-5824(FAX)**

WE ACCEPT:



RECEIVE OUR LATEST 132 PAGE CATALOG!

It's chock full of all types of electronic equipment and supplies. We've got I.C.'s, capacitors, resistors, pots, inductors, test equipment, breadboarding supplies, PC supplies, industrial computers, data acquisition products, personal computers and computer parts, plus much, much more. FAX us your name and address or call **800-811-5203, ext. 5**, to leave a message on our catalog request line.



AMAZING ELECTRONIC & SCIENTIFIC DEVICES

Lasers, Tesla, Ions, Anti-Gravity, Magnetics & More!

Plans • Ready-to-Use • Easy-to-Build Kits

Laser Ray Gun
Handheld, battery operated. Produces an intense burst of light capable of burning holes.
LAGUN2 Plans \$20.00
LAGUN2K Kit / Plans Price on Req



250KV Tesla Coil
10-14" of Explosive Bolts of Lightning!
• Transmit Wireless Energy
• Ion Motors
• Anti-Gravity
• Strange and bizarre pyrotechnical effects
• Many other experiments shown in detail
• Award winning science project!

BTC3 Plans \$15.00
BTC3K Kit/Plans with coil \$299.50
BTC30 Assbl'd Ready to Use \$399.50
BTC4 Plans, 500KV unit \$20.00



ATTENTION: Experimenters & Researchers!
Anti-Gravity, Rail & Coil Guns, Mass Warping, Levitation Research, Exploding Water, Propulsion Drivers, Lattice Snapping, EMP etc. Loss-less Energy Charger with triggered spark switch. • Adjustable 500 to 3KV out
• Charges up to 25KJ • Programmable Output
HEP1 Plans \$15.00
HEP1K Kit/Plans with 500J \$399.50
HEP10 Lab Assembled - to your spec's.
Write, call or fax for price & delivery



HEP10
...shown connected to potential rail gun system

Visible Beam Gas Lasers
Millions degree temp equiv. Illuminates low level clouds
• Light Shows
• Window Listener
• Optical Projects
• 12/115V
• Science Project

LAS1KM 1 mw, low cost Kit \$69.50
LGU6K 2-3mw Kit \$119.50
HNE70 5-7mw, ready to use \$299.50



Gravity Generator
Levitate an object!
Great science fair project!

GRA1 Plans \$15.00
GRA1K Power Supply Kit/Plans \$99.50
GRA10 Assbl'd Kit/Plans \$149.50
Includes text book on Anti-Gravity theory!



Solid State Tesla Coil

• Generate fiery electrical plasma discharge
• Powers light and objects without contact
• Experiment with electrical and mechanical fields. TCL5 Plans \$8.00
TCL5K Kit/Plans 12VDC \$49.50



Pioneer a Futuristic Weapon!
Electric Gun - prototype designed in our lab - Join the research!
• Ballistic Velocities
• Handheld • Battery Operated
• Labelled as DANGEROUS Product
Experiment now before it is classified as a firearm! EGUN1 Plans \$20.00
(Must be 21 for purchase of hardware)



Ion Ray Gun
Project Energy!
Star Wars technology demonstrates weapons potential. IOG7K Kit/Plans \$99.50



4000 Volts 10ma High Voltage Module - Ready to use - for many projects from hoverboards to pyrotechnics.
MINMAX4 While they last! \$19.50

"Talking" Plasma Globe
Spectacular color. Pulsates to music, sounds! 8-9", with intensity and sound controls. PLASMA1 Ready to Use \$79.50



Electronic Hypnotizer *Caution Required*
Control their minds! Programmable audible and visual stimuli induces hypnotic trances. HYP2K Kit with Book \$39.95
EH2 Hypnosis Book & Plans \$14.95



We can design and build high voltage systems - to your specs!
Call or fax us with your requirements!

TACTICAL ELECTRONICS

Cybernetic Ear!
Enhances normal hearing 3-4 times!
Adjustable volume control, fits easily into either ear. Many, many uses.
Ready to Use!
CYBEREAR \$19.95



Telephone Line Grabber Infinity Transmitter
Use any Tone phone to monitor a premises, access other calls or control up to 8 devices! TELCON3K Plans/Kit \$99.50
TELCON30 Ready to Use \$149.50



Long Range Microphone
24" dish focuses signals to an ultra-high gain amplifier.
PM5K Kit/Plans \$149.50

Parabolic dish to BUG Mother Nature and more!

• Optional wireless module transmits captured sounds to an FM radio.
WMSK Kit for Wireless Option \$29.50



Phasor Sonic Blast Pistol
Rids areas of unwanted pests. Trains and conditions wild and domestic animals. Great for barns, attics, cellars, gardens.
PPP1K Kit/Plans \$39.50



3 Mi Telephone Xmitter
• Tune-able 80-130 Mhz • Undetectable
• Only transmits when phone is used
VWPM7K Kit/Plans \$39.50

3 Mi Voice Transmitter
• Ultra-Sensitive Mike
• Crystal Clear
• Tunes 80-130 MHz.
FMV1K Kit/Plans \$39.50



FireBall Gun
Shoots flaming ball - two shot capacity. Great for special effects and remote fire starting. CAUTION REQUIRED!
FIREBALL Plans (dangerous product) . \$10.00



Shocker Force Field/Vehicle Electrifier
Make hand and shock balls, shock wands and electrify objects. Great payback for those wiseguys!
SHK1K Easy to Assemble Kit \$19.50



Extended Play Telephone Taping System
• Tapes Phone Conversation • Extends Tape X4 • Check Local Laws before using!
TAP30X Ready to Use \$84.50



Invisible Pain Field Intruder Deterrent
System detects intrusions and turns on a sonic field of pain, causing disorientation, acute paranoia, nausea and more. The perpetrator - man or animal - soon vacates! Protects 4 individual areas up to 5000 sq ft. Non hazardous when used as instructed.
PPG4K Kit/Plans \$129.50
PPG40 Ready to Use \$199.50



See In Total DARKNESS!
• High Quality IR Night Vision Scope with IR illuminator.
SD10 Ready to Use \$199.50



Electric Charge Gun
Life is Precious - PROTECT IT!
Stuns & immobilizes attackers 15 feet away! Check your state laws for legality. More knockdown power than most handguns. No permanent injury. ID coded.
ECG1 Data
(Creditable to purch) \$10.00
ECG10 Charge Gun, Ready to Use, includes FREE Stun Gun! \$249.50
STUN GUNS - sold separately:
STUN100 100,000 Volts \$34.50
STUN200 200,000 Volts \$49.50



3 Mi Tracker Transmitter
• Tunable Output
• Uses FM Radio
• Excellent Signal Beacon
HOD1K Kit/Plans \$39.50



MIND CONTROL!
Places subjects under your control. Programmable audible & visual stimuli with biofeedback. Induces strange & bizarre hallucinations without drugs. Caution - not FDA approved.
MIND2 Plans \$15.00
MIND2K Kit and Plans \$49.50
MIND20 Assembled Unit \$69.50



FANTASTIC BRIGHTNESS!
High Quality Laser Pointer
LAPN64 15mw equiv, 2000' \$39.50
LAPN61 50mw equiv, 4000' \$84.50



Window Bounce Laser Listener
Aim at window and listen to sounds from reflected light. CAUTION - Not for illegal use. LWB3 Plans \$10.00
LWB3K Kit/Plans (req's vid tripod) \$149.50



1000' Potato Cannon
Not a Toy! Uses electronic or piezo ignition. CAUTION REQUIRED!
POT1 Plans (dangerous product) \$10.00



VISIT US ON THE WEB!
<http://www.amazing1.com>

INFORMATION UNLIMITED

Dept PEM-6, Box 716, Amherst, NH 03031
Phone: 603-673-4730 FAX: 603-672-5406
MC, VISA, COD, Checks accepted Please add \$5.00 S & H

CATALOG!
FREE with Order or send \$1 P&H

24 Hour Phone
800-221-1705
Orders Only Please!

DALBANI

UNIQUE REALTIME
OSCILLOSCOPE
BUILT-IN FUNCTION
GENERATOR



Manuf # OS-9020G
20MHz 2-CH
DUAL TRACE

Order N° 50-820



1 MHz FUNCTION
GENERATOR

Features

- Wider than specified frequency response • High deflection factor of 1mV/div. • Wide dynamic range up to 30MHz without waveform distortion • Algebraic sum of CH1 and CH2 • Low drift with compensation circuit • Superb trigger sensitivity • Maximum sweep rate of video signals with internal TV sync. separator • Jitterless trigger circuitry • CH1 signal output terminal available • Variable trigger hold-off • High precision X-Y phase difference measurement up to 50kHz • Built-in function generator with BNC output of 50Ω and TTL • Three kinds of waveform are available with 50Ω output • Flat output waveform frequency up to 1MHz

Specifications:

- Vertical deflection:** • Bandwidth :DC coupled (DC to 20MHz normal), AC coupled : (10Hz to 20MHz normal) • Deflection factor: 5mV/div to 5V/div in 10 calibrated steps of 1-2-5 sequence • Rise time: 17.5nS or less
- Horizontal deflection:** • Time Base A: 0.2μs to 0.2S/div in 19 calibrated steps. 1-2-5 sequence • Uncalibrated continuous control between steps of at least 1: 2.5.



CODE PE96
PLEASE MENTION
WHEN ORDERING

Items are subject to availability.
Prices are subject to change without
any prior notice.

**FLYBACK
TRANSFORMERS**



\$12.50

Replaces
GOLDSTAR 154-074R
ORDER N° 63-0189

TUN-O-WASH®
ORDER N° 30-0100

\$7.50

(CFC Free)

Fast drying electronics
grade cleaner for tuners,
controls and PC boards.

TUN-O-WASH is excellent cleaner and
degreaser for tuners, controllers and PC boards.

- Designed for cleaning and degreasing consumer electronics • Cleans in one step, no rinsing required • Contains no ozone depleting compounds • CFC and HCFC free
- Not for use on energized equipment
- 12.5 Oz aerosol (12 cans per case)



DIGITAL MULTIMETERS
NEW! Digital

- Overload protect 1000VDC or peak AC on all other ranges
- Input impedance 10M Ohm on all ranges • Base accuracy range ± 0.5 % to ± 1.0 % • Resistance 200Ω, 2K, 20K, 200K, 2M, 20M
- Audible continuity response lower than 50Ω • DC Voltage 200mV, 2V, 20V, 200V; 1000V AC Voltage 200mV, 2V, 20V, 200V, 700V

ORDER N° 50-815

DALCO



\$19.95



**\$20 MINIMUM ORDER
CALL NOW FOR YOUR
232 PAGE FREE CATALOG
1-800-325-2264**

HOT PRICES ON POPULAR SEMI'S

Order N°	Brand	Min	Price
BU-208	TESLA	10	\$1.49
BU-208/O	TOSHIBA	1	4.50
2N-3055	TESLA	10	0.60
2N-3773	TESLA	5	1.20
2SD-1398	SANYO	10	1.49
2SD-1650	SANYO	5	1.69
STRD-1005	SANKEN	1	4.15
STR-30130	SANKEN	1	2.66
STRS-6301	SANKEN	1	8.50
TA-7777N	TOSHIBA	1	6.96
TDA-2005	SGS	5	1.49



**COLOR CODED
LEADS HEAVY DUTY**
ORDER N° 56-500

\$2.82

- 11" Long Wire Lead
- Insulated 1 1/2" Alligator Clips
- 20 Gauge Wire Size • 10 Leads
- BLACK, GREEN, RED, YELLOW, WHITE



SOLDER WICK

- Solder Remover
- Length 5 Feet

85¢

Min. 2 pcs.



VCR ALIGNMENT TOOL KIT
ORDER # 50-888

\$24.99

The most popular

- VCR Head puller
- Retaining ring remover
- Spring hook
- Micro screwdriver
- Hex key set • Fitted vinyl • Soft zippered case
- Dimensions: 9 1/2" (W) X 12 1/4" (L)
- 7 Assorted head & guide aligners
- 3 Reverseable screwdrivers (Small-Flat-Philips)



LOGIC Probe

ORDER N° 51-1015

- Length: 8 inches
- Range: 4.5 To 15 VDC
- Includes Test Leads • Compatible With TTL, DTL, RTL, HTL, CMOS, NMOS Logic

\$8.99



SOLDER ROLL

- 1 LB Spool
- 370 deg F melting point
- Fastest solder
- Alloy 60/40, tin lead, non corrosive flux, Diam. 1.2mm

ORDER N° 51-1005

\$3.95



**TEMPERATURE CONTROLLED
SOLDERING STATION**

\$64.00

- Adjustable Temp.: 300°F - 790°F - 150°C - 480°C
- Grounded Tip for Soldering : Static Sensitive Devices, Heater Aid.
- Led Power Temperature Indicator
- Overheat Protection W/ Temperature Control
- Auxiliary Grounded Terminal
- Comes in digital LED display
- 48 Watts soldering iron

ORDER N° 51-1035



Universal Audio/video Remote
ORDER N° 82-1055

- Controls basic functions of TV, VCR, cable box, and CD or laser player • Ergonomic design! Main buttons are in line with natural thumb motion • Two-minute memory allows time to replace batteries without re-programming • Programming reminder sticker inside battery compartment • Sleep time for 60, 30, or 15 minutes (according to your TV) • Set key recessed to prevent accidental deprogramming • Spanish instruction included. • Requires four AAA Batteries (not included)



MAGNAVOX
Smart. Very smart

\$9.95

- Cable (11 brands)
- VCR (68 brands)
- TV (77 brands)
- Compact disc and Laser Disc (94 brands)

ALFA ELECTRONICS

HIGH QUALITY TEST EQUIPMENT
BEST PRICE



DMM 89 \$179.00
Most Advanced DMM
All Purpose & Communication
-80.7 to 81.4 dBm with 4Ω-1200Ω
20 reference impedances
True RMS
Frequency counter: 0.01Hz-10MHz
Capacitance: 1pF-50,000μF
Measure AC volt to 20kHz
5000 counts, 0.1% accuracy
Auto/manual range, fast bar graph
Min/Max/Ave/DH/Relative/Zoom
Auto power off
Input warning
Splash proof
Volt, amp, ohm, logic, diode, continuity
Ruggedized case
Rubber holster included



DMM A91 \$49.95
NOW \$45.00
Plus Free Case
Solar Cell Powered Large Display
Diode, Continuity
Volt, Amp, Ohm
Data Hold
Auto power off
7 functions, 19 ranges
3.5 Digit, 0.6% accuracy
Auto/Manual ranging
Energy saver
Student & hobbyist's favor



DMM 20 \$74.95
Inductance: 1μH-40H
Capacitance: 1pF-200μF
Frequency: 1Hz-20MHz
Volt, amp, ohm, diode,
20 Amp AC/DC current
Transistor HFE
Continuity, duty %
Peak hold/Max
Ruggedized case
Rubber holster \$8.00
Full line of DMMs,
economy, compact,
ruggedized, solar cell,
automotive, heavy
duty, industrial,
starts from \$19.95

Fluke Multimeter
Fluke 12 \$84.95
Holster C-10 \$10
Fluke 70 II \$75.95
Fluke 73 II \$97.50
Fluke 75 II \$129
Holster C-70 \$16
Fluke 77 II \$155
Fluke 79 II \$175
Fluke 29 II \$175
Fluke 76 \$175
Fluke 87 \$287
Fluke 867 \$1199
Fluke 97
Scope Meter \$1785
Fluke 105
Scope Meter \$2799



LCR Meter 131D \$229.95
Most Advanced LCR
Dual display: L/Q or C/D
Inductance: 0.1μH-1000H
Capacitance: 0.1pF-10,000μF
Impedance: 1mΩ-10MΩ
0.7% basic accuracy
Auto/manual range
Dissipation factor & Q factor
Serial & parallel mode
Relative mode for comparison
and to remove parasitics
Statistics, tolerance,
Best for design, incoming
testing & production
SMD and chip component
test probe \$25.00



LCR Meter 814 \$189.95
Best Resolution LCR
Inductance: 0.1μH-200H
Capacitance: 0.1pF-20,000μF
Resistance: 1mΩ-20MΩ
1% basic accuracy
Dissipation factor indicates leakage
in capacitor and Q factor in inductor
Zero adjustment to reduce parasitics
Best for high frequency RF
SMD and chip component test probe
\$25.00
LIMITED QUANTITY SPECIAL
DIGITAL LCR 680 \$74.95
0.1pF, 1μH, 10mΩ resolution

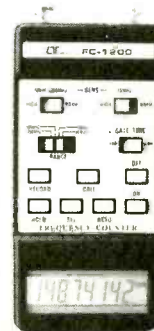

Frequency Counter FC-1200 \$129.95
Frequency: 0.1Hz-1.25GHz
Display: 8 digit LCD
Period: 0.1μs-0.1s
Records Max/Min/Average
Data hold, relative mode
Telescoping antenna \$8.00
Deluxe case \$5.00
Also Available:
AC/DC clamp meter, Light meter,
Thermometer, pH meter, High
voltage probe, Digital caliper,
Anemometer, Electronic scale,
Force gauge, Tachometer
Stroboscope, Humidity & EMF
adapter, Sound level meter,
Frequency counter, SWR/field
strength/power meter, Dip meter

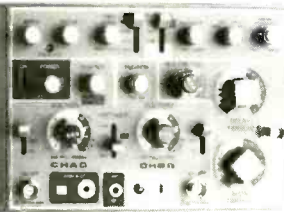

20 MHz Oscilloscope with Delay Sweep PS-205 \$429.95
Dual Trace, Component test, 6" CRT, X-Y Operation, TV Sync, Z-Modulation, CH2 Output, Graticule Illum, 2 probes each has x1, x10 switch. Best price with delay sweep.
PS-200 20 MHz DUAL TRACE \$339.95
PS-400 40 MHz DUAL TRACE \$494.95
PS-405 40 MHz DELAY SWEEP \$569.95
PS-805 60 MHz DELAY SWEEP \$769.95
PS-1000 100 MHz DUAL TRACE \$999.95
Scope Probe: 60MHz x1, x10 \$15, 100MHz x1, x10 \$22, 250MHz x1, x10 \$29, 250MHz x100 \$39

Digital Storage Scope DS-303 30MHz, 20M Sample/sec \$849.95
DS-303P with RS-232 interface \$1,049.95
Switchable between digital and analog modes
2 K word per channel storage
8 bit vertical resolution (25 Level/div)
Expanded Timebase 10ms/div - 0.5 s/div
Refresh, Roll, Save all, Save CH2, Pre-Trig
Plotter control

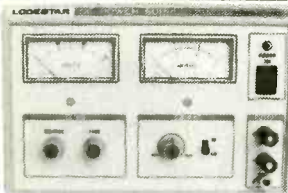

DC Power Supply PS-303 \$159.00
0-30 VDC, 0-3A output
Constant voltage & constant current mode
0.02% + 2mV line regulation
0.02% + 3mV load regulation
1 mVrms noise and ripple
Short circuit and overload protected
PS-8200 with digital voltmeter \$179.00
Also available: 30V/5A, 60V/3A, 60V/5A, 16V/10A, 30V/10A

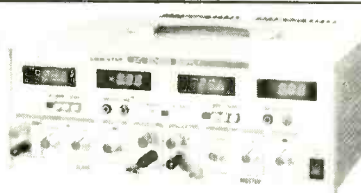

DC Power Supply Triple Output PS-8202 \$499.95
Two 0-30 VDC, 0-3A outputs
One fixed 5VDC, 3A output
Capable of independent or tracking operation
Constant voltage and constant current mode
Four digital meters for volt and current display
Excellent regulation and low ripple
Short circuit and overload protected
Also available: 30V/5A triple output \$549.95
Dual tracking 30V/3A, 30V/5A, 60V/3A, 60V/5A

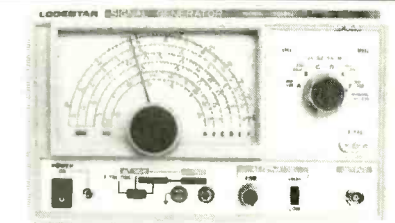

RF SIGNAL GENERATOR SG-4160B \$124.95
100 kHz-150MHz sinewave in 6 ranges
RF Output 100mVrms to 35 MHz
Internal 1kHz, External 50Hz-20kHz
AM modulation
Audio output 1 kHz, 1 Vrms

AUDIO GENERATOR AG-2601A \$124.95
10Hz - 1MHz in 5 ranges
Output: 0-8Vrms sinewave
0-10Vp-p squarewave
Synchronization: ±3% of oscillation frequency per Vrms
Output distortion:
0.05% 500Hz - 50kHz
0.5% 50Hz - 500kHz
Output impedance: 600 ohm

FUNCTION GENERATOR FG-2100A \$169.95
0.2 Hz - 2 MHz in 7 ranges
Sine, square, triangle, pulse and ramp
Output 5mV-20Vp-p
1% distortion, DC offset ± 10V
VCF: 0-10V control frequency to 1000:1

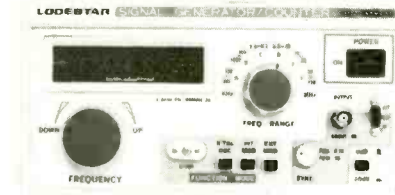

RF SIGNAL GEN./COUNTER SG-4162 AD \$229.95
Generates RF signal same as SG-4160B
6 digit frequency counter 1Hz - 150 MHz for internal and external source Sensitivity <50mV

AUDIO GEN./COUNTER AG-2603AD \$229.95
Generates audio signal same as AG-2601A
6 digit frequency counter 1Hz-150MHz for internal and external sources Sensitivity <50mV

FUNCTION GEN./COUNTER FG-2102AD \$229.95
Generates signal same as FG-2100A
Frequency counter 4 digits
Feature TTL and CMOS output
SWEEP FUNCTION GEN./COUNTER \$329.95
0.5Hz to 5 MHz in 7 ranges
Sweep: Linear 10:1/Log 10:1 20ms to 2s
AM Modulation
Gated Burst, Voltage Control Generator
Generator Control Voltage & 6 digit counter
1Hz-10MHz for internal & external sources

ALFA ELECTRONICS
741 Alexander Rd., Princeton, NJ 08540

(800) 526-2532/(609) 520-2002 15 DAY MONEY BACK GUARANTEE 1 YEAR WARRANTY
FAX:(609) 520-2007 CALL OR WRITE FOR FREE CATALOG
Visa, Master Card, American Express, COD, Purchase Order Welcome

CIRCLE 26 ON FREE INFORMATION CARD

New and Pre-Owned Test Equipment

Substantial **SAVINGS** on New & Pre-Owned B+K Precision, Fluke, Hewlett-Packard, Goldstar, Leader, Tektronix, and more ...

 **Goldstar**

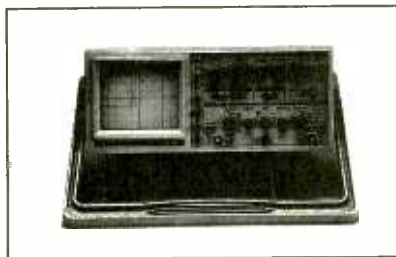

Model OS-9100P → **\$999.00**

Full 100 MHz Bandwidth!

- Dual-Channel, High Sensitivity
- TV Synchronization Trigger
- Calibrated Delayed Sweep
- Includes Two Probes, 2 Year Warranty

FREE SHIPPING!

ON ALL GOLDSTAR EQUIPMENT ANYWHERE IN THE U.S.

Excluding AK & HI

PROFESSIONAL QUALITY DIGITAL STORAGE OSCILLOSCOPES AT AFFORDABLE PRICES!

Bandwidth	20 MHz	40 MHz	60 MHz
Model	OS-3020	OS-3040	OS-3060
SALE Price	\$1,199.00	\$1,599.00	\$1,899.00

- Transmit and Receive Data with Standard RS-232C Interface
- Includes FREE Comprehensive Communication Software
- Waveform Save, Calculation, and Print
- Dual Channel, Delayed Sweep, TV Synchronization Trigger
- 20 MS/s Sampling Rate, Two Save Memories
- Switch Between Analog and Digital Modes
- CRT Readout Including Measurement Cursors
- Includes Two Probes, 2 Year Warranty

LOWEST PRICES EVER!

NEW FLUKE MULTIMETERS & TEKTRONIX OSCILLOSCOPES

The Industry Standard in Multimeters

Model 79 II.....\$172.00
Model 87\$285.00

**NEW! TEKTRONIX TDS SERIES
SUPER SALE!**

Pre-Owned Oscilloscope Specials

B + K Precision 1476 10 MHz \$229.00
Great Starter Scope!

Tektronix 465 100 MHz \$599.00
Tektronix 465B 100 MHz \$699.00
Tektronix 475 200 MHz \$799.00
Tektronix 475A 250 MHz \$899.00

- The Industry Standard of Oscilloscopes
- Dual Channel, Calibrated Delayed Sweep
- Professionally Refurbished
- Aligned & Calibrated to Original Specifications
- 6 Month Warranty - The Longest Available!

 **BK PRECISION**
MAXTEC INTERNATIONAL CORP.

20 MHz Sweep/Function Generator
Model 4040 \$499.00

- 0.2 Hz to 20 MHz, 5 digit LED Display
- AM & FM Internal or External Modulation
- Sine, Square, Triangle, TTL, CMOS Outputs
- Burst Operation
- External 30 MHz Frequency Counter

NEW!

Fotronic Corporation offers the ultimate value in high quality test equipment. Our factory-trained technicians completely refurbish, align, and calibrate all Pre-Owned equipment to the original manufactures specifications. All New equipment shipped from Fotronic goes through a performance test and burn-in. This service is unmatched anywhere. Whether the equipment you choose is New or Pre-Owned our rigorous quality control assures that the product that you purchase will be the best possible. Don't Settle for Second Best! Call today to discuss your test equipment requirements.

Full line of Oscilloscopes, RF, Video & Audio Test Equipment, Power Supplies, Meters, Probes and Accessories.



Availability of Equipment Subject to Prior Sale
Prices Subject to Change Without Notice
Warranty Details Available Upon Request

TOLL FREE 1-800-99-METER

On the Web!

1-800-996-3837

<http://www.fotronic.com>

 **FOTRONIC CORPORATION**
P.O. BOX 708
Medford, MA 02155

(617) 665-1400

FAX (617) 665-0780

E-Mail afoti@fotronic.com

Example!

The PRIMER 8085 Based Microprocessor Training and Control System shows you how to program by example. Program examples take you from writing simple programs to controlling motors. This trainer can be used stand alone via the keypad and display or connected to a PC with the optional upgrade (\$49.95). The Upgrade includes: an RS232 serial port, a serial cable, 32K of battery backed RAM and Assembler/Terminal software.



EXPERIMENTS USING THE PRIMER INCLUDE:

- Measuring Temperature
- Using a Photocell to Detect Light Levels
- Making a Waveform Generator
- Constructing a Capacitance Meter
- Motor Speed Control Using Back EMF
- Interfacing and Controlling Stepper Motors
- Scanning Keypads and Writing to LCD/LED Displays
- Using the Primer as an EPROM Programmer

The PRIMER is only \$119.95 in kit form. The PRIMER Assembled & Tested is \$169.95. Please add \$5.00 for shipping within the U.S. Picture shown with upgrade option and optional heavy-duty keypad (\$29.95) installed.

ENAC, inc.

P.O. BOX 2042, CARBONDALE, IL 62902
618-529-4525 Fax 457-0110 BBS 529-5708

1985 - 1996
OVER
10
YEARS
OF SERVICE

Low Cost CAD Software for the IBM PC and Compatibles Now In Windows™

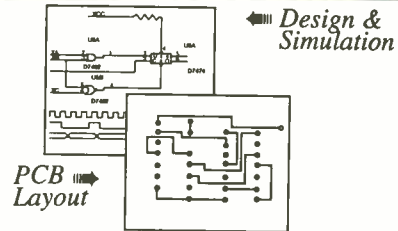

- Easy to use schematic entry program (SuperCAD) for circuit diagrams, only \$149. Includes netlisting, bill of materials, extensive parts libraries, More parts, and automatic wiring available in enhanced CAD package (SuperCAD+) for only \$249.
- Powerful, event-driven digital simulator (SuperSIM) allows you to check logic circuitry quickly before actually wiring it up. Works directly within the SuperCAD editor from a pulldown menu and displays results in "logic analyzer" display window. Starting at \$149 this is the lowest cost simulator on the market. Support for PALs, a larger library, and a separate interactive logic viewer are available in full-featured SuperSIM+ for only \$399. Library parts include TTL, CMOS and ECL devices.
- Circuit board artwork editor and autorouter programs (SuperPCB), starting at \$149. Produce high quality artwork directly on dot matrix or laser printers. You can do boards up to 16 layers including surface mount. Includes Gerber and Excellon file output. Autorouter accepts netlists and placement data directly from the SuperCAD schematic editor.
- Low cost combination packages with schematics and PCB design: 2-layer for \$399, 16-layer for \$649.
- DOS version available.

Write or call for free demo disks:

MENTAL AUTOMATION, INC.

5415 - 136th Place S.E.

Belleveue, WA 98006

(206) 641-2141 • BBS (206) 641-2846

<http://www.mentala.com>

**K
A
B
L
E
W
O
R
K
S**

Zenith ST 1000's \$25.00

Screened
&
Cleaned

Also:
SA-8580
SA-8550
SA-8590
DPBB-7
DPV-5
DPV-7
Basics
Pioneers
& more!

All converters unmodified

800-899-5000

Radiotelephone - Radiotelegraph

FCC Commercial License

Why Take Chances?

Discover how easy it is to pass the exams. Study with the most current materials available. Our Homestudy Guides, Audio, Video or PC "Q&A" pools make it so fast, easy and inexpensive. No college or experience needed. The new commercial FCC exams have been revised, covering updated Aviation, Marine, Radar, Microwave, New Rules & Regs, Digital Circuitry & more. We feature the Popular "Complete Electronic Career Guide" 1000's of satisfied customers **Guarantee to pass or money back.** Send for **FREE DETAILS** or call **1-800-800-7588**

WPT Publications
4701 N.E. 47th Street
Vancouver, WA 98661

Name _____

Address _____

City _____ St. _____ Zip _____

1-800-800-7588

WE HAVE IT ALL! Surveillance

Infinity Transmitters
FM Wireless Transmitter Kits
Vehicle Tracking Systems
Bug Detectors
Caller I.D.
Wired Mikes
Telephone Register with Printer
Long-play Recorders
Shotgun Mikes
Telephone Recording Adapters
Alcohol Testers
Telephone Scramblers
Hidden Video Cameras
Telephone Tap Detectors
Drug Testers
MUCH, MUCH, MUCH MORE.

Our 27th Year!

Small catalog FREE.
Larger catalog send \$5.
Mail Order only.

Visa, MasterCard and C.O.D. accepted.

Inquire for dealers' prices.

A.M.C. SALES, INC.

193 Vaquero Dr. • Boulder, CO 80303
Mon.-Fri. 8 a.m.-5 p.m. Mtn. Time

800-926-2488

(303) 499-5405 • Fax (303) 494-4924

RAINBOW KITS

LOOK FOR OUR
FULL CATALOG
ON OUR WEBB PAGE:
www.rainbowkits.com

THE SUPER SENSITIVE BIONIC EAR

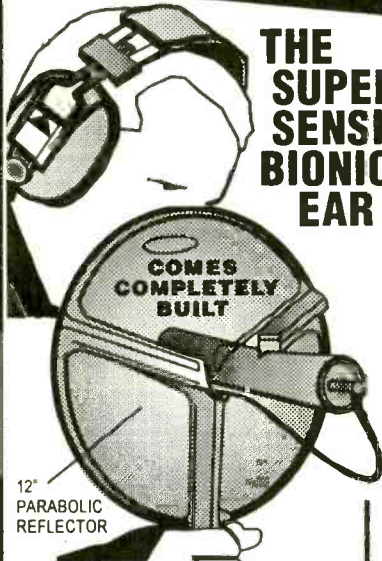

12" PARABOLIC REFLECTOR

COMES COMPLETELY BUILT

- Complete with
- Professional headset
 - Ultra sensitive microphone
 - 12" parabolic reflector.

- Individual volume controls for each ear.
- Auto Safety Circuit shuts sound off at 95 decibels for your ear protection.
- On/Off & master volume control
- The Bionic Ear increases sound by up to 30 decibel.
- Hear & pinpoint sounds of wild birds and animals, great for hunters, Search & Rescue teams, sports events and Law Enforcement.
- Hear mere whispers at incredible distances.
- Record those sounds with your own recorder.

BE-1 BUILT \$149⁹⁵

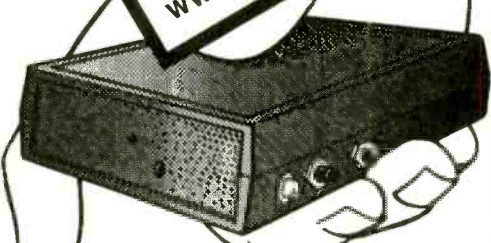

The "ZAPPER II"

With it's new and improved design it will not only test your radar detector... BUT it's tuned to the amateur radio band .

- While your out on American highways personally test yours and your fellow travelers radar detectors.

The "ZAPPER II" is a 10.450 GHz to 10.550 Transmitter

KIT \$39⁹⁵ BUILT \$49⁹⁵

TV NOTCH FILTERS FOR CHANNELS 2 thru 22 ONLY

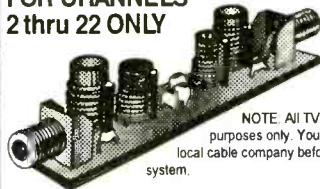

system.

DF-222

Our TV filters eliminate unwanted TV channels or interference that alters both sound and video with a beep beep beep. Works on cable channels 2 thru 22) only.

NOTE: All TV Filter Kits are sold for educational purposes only. You must obtain permission from your local cable company before using these filters on your cable system.

KIT \$14.95

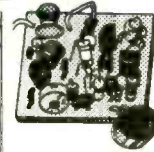

WIRELESS FM MICROPHONE

Small but mighty this little jewel will out perform most units many times its price. It really stomps out a signal. The WM-2 kit is a buffered wireless mike that operates from 80MHz to 120MHz FM, the frequency of any broadcast FM radio. Includes a mini-electret mike. 6 to 12v DC. SIZE: 1.25" x 1" WM-2 KIT \$14.95



STROBE LIGHT

Do you need an attention getter, warning light, or flashing light for model airplanes? Then this kit is for you. Use it as an emergency light for your auto, radio tower, even use it on your bicycle. Has a variable flash rate. Power requirement 6 or 12v DC. Size 3.5"x1.9"

ST-1 KIT \$11.95



SUPER SNOOPER BIG EAR

Listen through walls, hear conversations across the room. Add a parabolic reflector and hear blocks away. The BIG EAR can be hidden about anywhere. Makes an ultra sensitive intercom. Can be used as a 1.5W AMP. We supply a mini-electret mike in the kit. Power requirement 6 to 12v DC. SIZE: 1.75"x1"

AA-1 BUILT \$29.95 KIT \$10.95



MICRO-MINIATURE WIRELESS MIKE

So small you could hide this one on some real bugs! It's the smallest we've ever seen. With it's super sensitive mike it transmits a whisper or a room of conversation to an FM radio, tunable from 88 to 108MHz FM. With a proper antenna it transmits about 1/2 mile. The kit is made with surface mounted parts, we have already mounted these parts. You install the leaded parts. Power requirement 6 to 12v DC. Size .35"x.9"

MMWM5 KIT \$34.95

Record every number dialed on your phone

Okay. Caller ID's tell you what number is calling you. But what about the calls made from your phone? Now, return from work or vacation and know the answer. The new DTMF Recorder electronically logs and saves every number dialed. This is the same high-tech magic used by detectives and government spies. Now yours. Does your wife or husband make expensive long-distance calls and then deny it? Does your son or daughter call that low-life you forbade them to talk to? Now know.

- Decodes digits 0 thru 9, #, *, A, B, C, on a 2 line 16 character LCD display.
- Clicks into your phone or extension in seconds, with no special wiring or hassles, or jack it to the incoming service panel in your garage.
- Records all numbers dialed, including local numbers that don't appear on your bill.
- Records credit card numbers entered through your phone key-pad.
- Records Voice mailbox, answering machines, and modem access numbers.
- Records Cellular or repeater phone numbers heard over your phone. Even hook to a scanner, and learn scores of emergency phone numbers. Also decodes tones stored on a tape recorder. Never before has such sophisticated gear been available to the public. And not at this price.

Power requirement 9v DC. SIZE: 3.5" x 4" x 1" BLACK ANODIZED ALUMINUM CABINET

DIS-1 KIT \$119⁹⁵ BUILT \$159⁹⁵



Read the code from any INFRARED Device

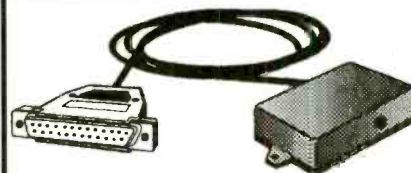

- Complete with Software for any 80386 or 80486 base machine, with DOS 3.3 or higher.
- Sampled data can be saved to disk for instant comparison & analysis.
- Zoom in on and view any 8 millisecond portion.

TIR-1 KIT \$89.95



To Order Call 317-291-7262

We accept Visa or Mastercard orders

Please add sufficient postage
First lb \$5.00 Canada \$7.00
Additional LB. Add \$1.00



ELECTRONIC RAINBOW INC.
6227 Coffman Rd. Indianapolis, IN 46268
FAX 317-291-7269
INTERNET: www.rainbowkits.com

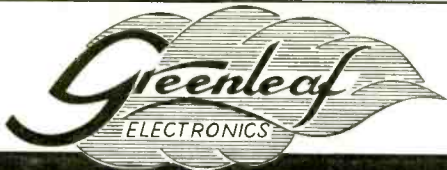

CABLE TV Converters & Descramblers

Compatible with
**Jerrold, Scientific Atlanta,
Pioneer, Oak, & Hamlin
Equipment**

BRAND NEW!

6-MONTH GUARANTEE

LOWEST PRICES

Volume Control & Parental Lockout Available

Greenleaf Electronics

1-800-742-2567

NO ILLINOIS SALES

It is not the intent of Greenleaf Electronics to defraud any pay television operator and we will not assist any company or individual in doing the same.

CABLE BOX DISCOUNT

We'll Meet or Beat The Competition!

ORIGINAL EQUIPMENT, DESCRAMBLERS,
CONVERTERS, SUPER-Q

***** Same day Shipping! *****

Have make and model number used in your area
REPLACEMENT FOR MOST SYSTEMS

\$\$ SAVE BIG BUCKS\$\$

DON'T WAIT CALL TOLL FREE

1-888-561-4796

VOID WHERE PROHIBITED

Anyone implying theft will be denied assistance.

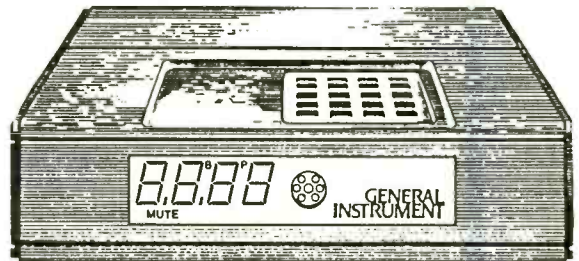

❖ ATTENTION CABLE VIEWERS ❖

CABLE VIEWERS...get back to your BASIC Cable Needs

Call 800-577-8775

For information regarding all of your **BASIC** cable needs.

5 GOOD REASONS TO BUY OUR FAR SUPERIOR PRODUCT

- ❖ **PRICE**
- ❖ **EFFICIENT SALES AND SERVICE**
- ❖ **WE SPECIALIZE IN 5, 10 LOT PRICING**
- ❖ **ALL FUNCTIONS (COMPATIBLE WITH ALL MAJOR BRANDS)**
- ❖ **ANY SIZE ORDER FILLED WITH SAME DAY SHIPPING**

We handle **NEW** equipment **ONLY** - Don't trust last year's **OBSOLETE** and **UNSOLD** stock!
COMPETITIVE PRICING—DEALERS WELCOME

HOURS: Monday-Saturday 9-5 C.S.T.

It is not the intent of B.E.S.W. to defraud any pay television operator and we will not assist any company or individual in doing the same. Refer to sales personnel for specifications.

**BASIC
ELECTRICAL
SUPPLY &
WAREHOUSING
CORPORATION**

P.O. Box 8180 ■ Bartlett, IL 60103 ■ 800-577-8775

I DOUBLED MY INCOME...

WORK ONLY HALF THE HOURS!

I covered a lot of miles driving a cab for 13 years... but I sure didn't get anywhere! I mean the hours were long. The pay was short. My boss pushed, pushed, pushed all the time. In the meantime bills were piling up. Medical bills. House repairs. Charge cards. Just the everyday things. I was not just behind the wheel, I was behind the eight ball.

That's when I saw a magazine article that talked about the hottest big money-making career opportunities of the 90's. The one that interested me the most pertained to the **NEW explosive SATELLITE DISH/TV/ELECTRONICS field.**

I mailed the coupon for the FREE information kit they offered. I liked what I saw when the information packet came in the mail. What really caught my eye, however, was the idea I could gain all the knowledge I needed to make a success of this business studying in my spare time at home. **Foley-Belsaw's modern, practical hands on course combines simple step-by-step lessons with easy-to-follow video cassette guidance.** No special experience, education or electronics background is necessary. Just average mechanical aptitude to follow simple A-B-C repair procedures that are clearly outlined for you.

I decided to get in on the action... and just look at me now! Now I'm really in the driver's seat. I'm doing what I want to do. I'm my own boss. I set my own hours. I'm making more money than my wife and I ever dreamed possible. **Would you believe I'm making twice what I made driving a cab...and I work only half as many hours.**

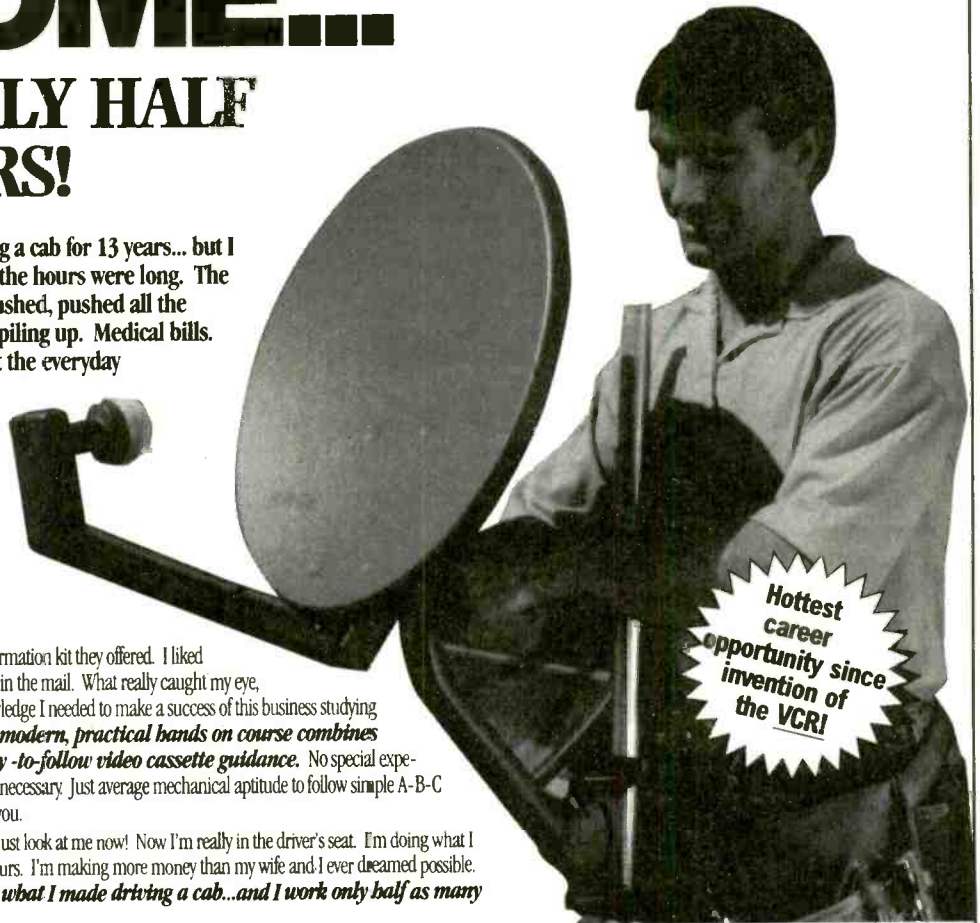

Hottest career opportunity since invention of the VCR!

Get in the FAST LANE on the New "INFORMATION SUPERHIGHWAY" Everyone's Talking About!

It's exciting! It's gigantic! The technology of tomorrow is here today! You've been reading and hearing about the amazing INFORMATION SUPERHIGHWAY. **It's so NEW that few technicians are equipped to service this fast emerging field!** **Foley-Belsaw gives you SATELLITE DISH technology (including New MINI-DISH)...** along with the electronics expertise you need to make BIG MONEY servicing TVs and other electronics equipment.

Be Your Own Boss!

It's quick and easy to become an expert at home in your spare time. Earn really BIG money adjusting, installing and repairing Satellite Dish Systems, TVs, Amplifiers, CD Players, AM/FM Tuners, Home Entertainment Centers. Every home, every business, every office in your area desperately needs your expertise!

Your Timing Couldn't Be Better!

Never before and probably never again will you have a ground-floor opportunity like this to get into a

booming business of your own, make really big money, be your own boss and enjoy financial freedom and security. The fact you're reading this message shows you're smart enough to realize this!

Learn In Spare Time At Home!

It's easy to learn in your spare time at home. And when you complete the course you will receive Foley-Belsaw's official diploma acknowledging your accomplishment.

Send Coupon Today for FREE Kit. No Obligation.

Don't miss out on this once-in-a-lifetime opportunity. Send in the coupon NOW. Get all the facts and study them in the privacy of your own home. There's absolutely no obligation and no salesman will call on you. So don't delay. Mail the coupon today.

"Took in over \$3,200 in the past 10 days!"
H.H., Denver, CO

"Doubled my income within 6 weeks."
R.B., Bakersfield, CA

Mail for FREE Information Package

Foley-Belsaw Institute
6301 Equitable Road
Kansas City, MO 64120-1395



Please Check Only ONE of the Following:

- | | |
|---|---|
| <input type="checkbox"/> Satellite Dish, Dept. 31334 | <input type="checkbox"/> Locksmithing, Dept. 12873 |
| <input type="checkbox"/> Computer Repair, Dept. 64459 | <input type="checkbox"/> Small Engine Repair, Dept. 52748 |
| <input type="checkbox"/> Gunsmithing, Dept. 92364 | <input type="checkbox"/> Woodworking, Dept. 43620 |
| <input type="checkbox"/> PC Programming, Dept. 35292 | <input type="checkbox"/> Upholstery, Dept. 81289 |
| <input type="checkbox"/> VCR Repair, Dept. 62562 | <input type="checkbox"/> Saw & Tool Sharpening, Dept. 21688 |
| <input type="checkbox"/> Vinyl Repair, Dept. 71222 | |

Name _____

Address _____

City _____

State _____ Zip _____

Call Toll-FREE **1-800-487-2100**

Electronic Training Videos



Learn electronics quickly and easily with UCANDO's computer-animated training videos. Students can learn at their own pace and professionals will find the UCANDO videos to be a valuable source of reference material. If these videos aren't the best learning tools you've ever seen, return them within 30 days for a

complete refund. These videos are being used by Tech-Schools, CET's, Military Branches, Ham Operators, Industries, and more, across the United States and around the world. Order today and see how UCANDO is ...

"Changing The Way The World Learns Electronics."

VCR Maintenance & Repair ... \$29.95 All others ... \$44.95 each
 • Intro to VCR Repair • Direct Current • Alternating Current • Semiconductors • Power Supplies • Amplifiers • Oscillators • Digital 1 • Digital 2 • Digital 3 • Digital 4 • Digital 5 • Digital 6 • AM Radio • FM Radio Part 1 • FM Radio Part 2 • TV Part 1 "Intro to TV" • TV Part 2 "The Front End" • TV Part 3 "Audio" • Fiber Optics • Laser Technology •

SAVE!!! 6 videos for only \$240 or 12 videos for only \$450



1-800-678-6113

or mail check or money order to:

UCANDO Videos

P.O. Box 928

Greenville, OH 45331



FREE Shipping ... FREE Catalog

CIRCLE 136 ON FREE INFORMATION CARD

COUNTERSURVEILLANCE EQUIPMENT

AI 6600 PHONE TAP DETECTOR

- DETECTS:
- Radio Frequency Taps
 - Series and Parallel Taps
 - Line Impedance Taps
 - Extension Phone Listeners



\$149.95

AI 2100 VIBRATING TRANSMITTER DETECTOR

- DETECTS:
- Body Wires
 - FM Wireless Mics
 - AM Transmitters
 - UHF Transmitters



\$189.95

AI 5500 COMPLETE SAFETY SYSTEM

- DETECTS:
- All Phone Taps and Extension Phone Listeners
 - All Body Wires, Wireless Mics, AM/FM and UHF Transmitters



- DEFEATS:
- All Body Wires, Transmitters and Distance Microphones with its built-in white noise generator

\$379.95

We also sell audio & video transmitters, body armor, covert cameras, night vision products, recording devices, tape recorder & video detectors, and much, much more...

Request Our 36-Page Catalog for \$5.00, Receive \$10.00 OFF First Order (FREE WITH ANY PURCHASE)



AMERICAN INNOVATIONS, INC.

119 ROCKLAND CENTER ~ SUITE 315 • NANUET, NY 10954

VOICE: (914) 735-6127 • FAX: (914) 735-3560

HTTP://WWW.SPYSITE.COM • E-MAIL: WEBMASTER@SPYSITE.COM



Model mA-2000

- * measures DC & AC currents from 0 to 2000mA with resolution as low as 0.1mA
- * basic DC accuracy of 1% of reading
- * true RMS measurement
- * frequency range DC to 100 kHz
- * built-in 3.5 digit display
- * BNC analog output for connection to oscilloscope or recorder
- * simple clamp-on operation
- * supplied with hard carrying case



Regular \$448.00 Sale \$424.95

PRINT™
 Products International



800-638-2020



Test Instruments, Equipment, Tools & Supplies For Electronic Production, Maintenance & Service
 8931 Brookville Road, Silver Spring, MD, 20910 * 800-638-2020 * Fax 800-545-0058

CIRCLE 45 ON FREE INFORMATION CARD

AMERICAN RELIANCE

AMREL Offers Lowest Prices & Best Warranties on DC Power Supplies ANYWHERE!

3 YEAR WARRANTY



3 YEAR WARRANTY



AMREL Offers Superior Analog Power Supplies Starting as Low as \$149.00

- Low Output noise rating less than 0.3mV.
- Line/load regulation rated at low 0.01% + 1mV.
- Transient response time of 50µ Sec.
- Overload protection, and Output enable/disable.
- Coarse and fine voltage/current adjustment.
- Auto series/parallel operations for triple output supplies.

AMREL Offers Features And Prices on Digital Power Supplies That The Competition Can't Beat!

- Microprocessor controlled.
- User friendly keypad data entry.
- Low output noise rating less than 1mV.
- Line/Load regulation rated less than 2mV.
- Output enable/disable and Power off memory.
- Optional RS-232 interface capability.

Model	LPS-101	LPS-102	LPS-103	LPS-104	LPS-105	LPS-106	LPS-301	LPS-302	LPS-303	LPS-304	LPS-305
Rating	30V/1A	30V/2A	30V/3A	+30V/1A -30V/1A 3-6.5V/3A	+30V/3A -30V/3A 3-6.5V/3A	60V/1A	15V/2A(H) 30V/1A(L)	15V/4A(H) 30V/2A(L)	30V/3A	+30V/1A -30V/1A 5V/2A	+30V/2.5A -30V/2.5A 3.3-5V/3A
List Price	\$195	\$225	\$295	\$395	\$495	\$245	\$249	\$299	\$369	\$399	\$599
Sale Price	\$149	\$179	\$199	\$375	\$469	\$219	\$199	\$285	\$350	\$379	\$569

PRINT



Products International Inc.

8931 Brookville Road • Silver Spring, Maryland 20910 • Fax: 800-545-0058 •

Call: **1-800-638-2020**



CIRCLE 46 ON FREE INFORMATION CARD

CONTROL MEASURE INPUT

RELAYS • LIGHTS • MOTORS
TEMPERATURE • PRESSURE • LIGHT LEVELS • HUMIDITY
SWITCH POSITIONS • THERMOSTATS • LIQUID LEVELS

MODEL 30 \$79



- PLUGS INTO PC BUS
- 24 LINES DIGITAL I/O
- 8 CHANNEL 8 BIT A/D IN
- 12 BIT COUNTER
- UP TO 14K SAMP/SEC

MODEL 45 \$189



- RS-232 INTERFACE
- 8 DIGITAL I/O
- 8 ANALOG INPUTS
- 2 ANALOG OUTPUTS
- 2 COUNTERS-24 BIT

MODEL 100 \$279



- 12 BIT 100 KHZ A/D
- 4 ANALOG OUTPUTS
- 3 TIMER COUNTERS
- 24 DIGITAL I/O

MODEL 60 \$179



- 8 2-AMP RELAYS
- 16 DIGITAL I/O
- 1 8-BIT ANALOG INPUT

MODEL 40 \$99



- RS-232 INTERFACE
- 28 LINES DIGITAL I/O
- 8 ANALOG INPUTS
- PWM OUTPUT
- OPTIONAL 12 BIT A/D

MODEL 70 \$239



- RS-232 INTERFACE
- 18 BIT A/D
- 5.5 DIGIT
- UP TO 60 SAMP/SEC

NEED A CUSTOM PCB? TRY US.
PRAIRIE DIGITAL, INC.
PHONE 608-643-8599 • FAX 608-643-6754
846 SEVENTEENTH STREET • PRAIRIE DU SAC, WISCONSIN 53578

CIRCLE 47 ON FREE INFORMATION CARD

AT LAST! DC-20 MHz SYNTHESIZED PERFORMANCE FOR ONLY \$795!

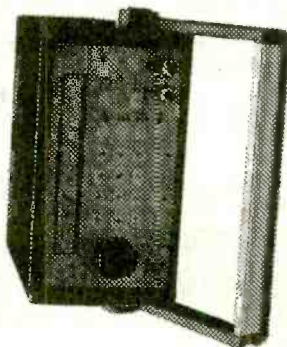

- DC-20 MHz, .1 Hz resolution, DC offset
- Linear/Log Sweep
- Internal/External AM
- Internal/External FM
- Internal/External PM
- Internal/External SSB
- Internal/External BPSK
- Dualtone Generation
- Internal/External FSK
- Burst
- DTMF Generation
- DTMF Detection
- Power Level Measmt

\$795
Quantity 1
Made in U.S.A.

The SG-100 gives you .1 Hz synthesized precision and a wide diversity of modulation functions all of which can be performed using an internally generated or externally applied signal. You also get signal analysis functions that are just not offered on any other signal source such as DTMF Detection and Power Level Measurement. And because you can download new instrument functions to Flash memory, you can ensure that your SG-100 will never become obsolete.

The SG-100 is available NOW and is ready to turn your engineering bench into a real powerhouse!



Telulex Inc.
2455 Old Middlefield Way S, Mountain View, Ca. 94043 (415) 938-0240
Fax: (415) 938-0241 <http://www.telulex.com> email: sales@telulex.com
C.O.D. P.O.

December 1996, Popular Electronics

CIRCLE 150 ON FREE INFORMATION CARD

CALL TOLL FREE
(800) 292-7711 orders only
Se Habla Español

C&S SALES
EXCELLENCE IN SERVICE

CALL OR WRITE FOR
A FREE 60 PAGE
CATALOG!
(800) 445-3201

XK-550 Digital / Analog Trainer

Elenco's advanced designed Digital / Analog Trainer is specially designed for school projects. It is built on a single PC board for maximum reliability. It includes 5 built-in power supplies, a function generator with continuously sine, triangular and square wave forms. 1560 tie point breadboard area.

XK-550
Assembled and Tested
\$169.95

XK-550K - Kit
\$139.95

Tools and meter shown optional



TK-3000
\$89.95

Tools Included:

- SR-2 - Deluxe Soldering Iron
- SH-1 - Soldering Iron Stand
- ST-1 - Diagonal Pliers
- ST-2 - Long Nose Pliers
- ST-30 - Deluxe Wire Stripper
- SE-1 - Solder Ease Kit
- ND-3 - 3 pc. Nut Driver Set
- TL-8 - Precision Screw Drivers
- ST-5 - Screw Driver Slotted 3/16"
- ST-6 - Screw Driver #1 Phillips
- ET-10 - IC Puller
- SP-2 - Solder Pump
- ST-20 - Safety Goggles
- ST-9 - Pocket Screw Driver
- ST-4 - Solder Tube
- SW-3 - Solder Wick



A professional technician service tool kit in a metal reinforced tool case with heavy-duty handle and locks. A removable pallet handles most of the tools listed with more room for tools and parts in the lower half.

GF-8026 w/ Frequency

- Linear and Log Sweep
- .02Hz to 2MHz
- Counter Range 1Hz to 10MHz
- 4 Digit Display

\$225



MX-9300 Four Functions in One

- One instrument with four test and measuring systems:
 1.3GHz Frequency Counter • 2MHz Sweep Function Generator
 Digital Multimeter • Digital Triple Power Supply
 (0-30V @ 3A, 15V @ 1A, 5V @ 2A)

\$479.95



Model XP-581

- 4 Fully Regulated DC Power Supplies in One Unit**
 4 DC voltages: 3 fixed - +5V @ 3A, +12V @ 1A, -12V @ 1A
 1 Variable - 2.5 - 20V @ 2A

\$85



Auto Ranging Hand-Held DMM w/ Bar Graph Model EDM-163

\$99.95

7 Functions with data hold
 Compares to Fluke Model 77II

Digital Multimeter Model M-1700

\$39.95

11 functions including freq to 20MHz, cap to 20µF. Meets UL-1244 safety specs.



Fluke Multimeters

70 Series	80 Series
Model 701I \$69.95	Model 83 \$235.00
Model 731I \$97.50	Model 85 \$269.00
Model 751I \$135.00	Model 87 \$289.00
Model 771I \$154.95	
Model 791I \$175.00	

B&K Precision Multimeters

Model 391 \$159.00	Model 388A \$99.00
Model 390 \$139.00	Model 2707 \$79.00
Model 389 \$109.00	Model 2860A \$85.00

Kit Corner

over 100 kits available

PT-223K
\$15.95

Phone kit with training course.



Fiber Optics Technology with training course Model FO-30K

\$19.95



Model AM/FM-108K Transistor Radio Kit

with training course

\$29.95

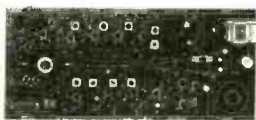

M-1005K Compact Multimeter Kit

\$19.95
 6 Functions & Transistor Test



Model M-6100 Programmable DMM

Includes **FREE** Computer Interface and **FREE** Software

- Analog Bar Graph
- Large 3 3/4" LCD Display
- Menu Driven
- Triple Display
- RS-232 Interface
- True RMS
- 9 Basic Functions including cap. & freq.
- Auto Power Off
- Easy-to-use

\$125



WE WILL NOT BE UNDERSOLD

C&S SALES, INC.

UPS SHIPPING: 48 STATES 5%
 OTHERS CALL FOR DETAILS
 IL Residents add 8% Sales Tax

150 W. CARPENTER AVENUE
 WHEELING, IL 60090
 FAX: (847) 520-9904 (847) 541-0710
http://www.elenco.com/cs_sales/



15 DAY MONEY BACK GUARANTEE

FULL FACTORY WARRANTY

PRICES SUBJECT TO CHANGE WITHOUT NOTICE

**FREE PROBES
WITH ALL
SCOPES**

OSCILLOSCOPES

Lowest Prices of the Year!

**CALL OR WRITE FOR
A FREE 60 PAGE
CATALOG!
(800) 445-3201**

B&K Precision Scopes

60MHz ANALOG WITH DIGITAL STORAGE

Model 2560
• Cursors and readouts
• RS-232 port
• 20MS/s real time sampling
• 1GHz equivalent time sampling (at 0.1µs/div.)
• Prints via RS-232 port to any HP-GL plotter
\$1995



20MHz ANALOG WITH DIGITAL STORAGE

Model 2522A
• 20MHz analog bandwidth
• 20MS/s sampling rate
• 2K memory per channel
• 300MHz equivalent time sampling
• Pre-trigger capture
\$869.95



100MHz THREE-TRACE

Model 2190A
• 1mV/division sensitivity
• Sweeps to 5ns/division
• Dual time base
• Signal delay line
• 300MHz equivalent time sampling
• 15KV accelerating voltage
\$1379.95



60MHz DUAL-TRACE

Model 2160A
• 1mV/division sensitivity
• Sweeps to 5ns/division
• Dual time base
• Signal delay line
• V mode-displays two signals unrelated in frequency
• Component tester
\$949.95



40MHz DUAL-TRACE

Model 1541C
• 1mV/division sensitivity
• Video sync separator
• Z-axis input
• Single sweep
• V mode displays two signals unrelated in frequency
• Component tester
\$695



60MHz, CURSORS & READOUTS, DUAL TIME BASE

Model 2260
• Cursors and readouts
• 1mV/div sensitivity
• 23 calibrated ranges - main time base
• 19 calibrated ranges - delayed time base
• Signal delay time
• V mode - displays 2 signals unrelated in frequency
• Component tester
• 2 axis input
• Single sweep
\$1225



20MHz DUAL-TRACE

Model 2120 - 2 Year Warranty

Special \$389.95

Model 2125 with delayed sweep

\$539.95



• 1mV/division sensitivity
• AUTO/NORM triggered sweep operation
• AC, TVM, TVM and line coupling
• Calibrated 10 step time-base with x10 magnifier
• Compact low-profile design

Quality Scopes by Elenco



60MHz

DS-603 \$1350

- Analog / Digital Storage
- 20MS/s Sampling Rate

S-1360 \$749

- Analog with Delayed Sweep



40MHz

S-1345 \$569

- Analog with Delayed Sweep

S-1340 \$475

- Analog

25/30MHz

DS-303 \$1095

- Analog / Digital Storage

S-1330 \$439

- 25MHz Analog
- Delayed Sweep

S-1325 \$325

- 25MHz Analog

**2 Year
Warranty**

OSCILLOSCOPE SELECTION CHART

ANALOG Model		Bandwidth MHz	Sensitivity (max) mV/div	No. of Channels	Sweep Rate Max ns/div	Delayed Sweep	Video Sync	Component Tester	Beam Find	Time Base
S-1360	60	1mV/div	2	10ns/div	Yes	Yes	Yes	Yes	2	
S-1345	40	1mV/div	2	10ns/div	Yes	Yes	No	No	1	
S-1340	40	1mV/div	2	10ns/div	No	Yes	Yes	Yes	2	
S-1330	25	1mV/div	2	10ns/div	Yes	Yes	Yes	Yes	2	
S-1325	25	1mV/div	2	10ns/div	No	Yes	No	No	1	

DIGITAL STORAGE Model		Bandwidth MHz	Analog Sen (max) mV/div	No. of Channels	Sampling Rate	Memory Channel	Internally Backed Up	Pretrigger %	Output
DS-303	30	1mV/div	2	20MS/S	2K	Yes	0, 25, 50, 75	RS232	
DS-603	60	1mV/div	2	20MS/S	2K	Yes	0, 25, 50, 75	RS232	

Affordable Spectrum Analyzers by B&K

500MHz Series

Model 2615 - \$1595
Model 2620 w/ tracking generator - \$1895

1.05GHz Series

Model 2625 - \$2395
Model 2630 w/ tracking generator - \$2995



HITACHI SCOPES Inventory Reduction Sale Lowest Prices of the Decade!

V-209 - 20MHz Battery Operated Was \$1505, NOW \$1095 Save \$410

V-695 - 60MHz w/ Cursors Was \$1815, NOW \$1395 Save \$420

V-422 - 40MHz Was \$965, NOW \$765 Save \$200

V-1065A - 100MHz w/ Cursors Was \$2139, NOW \$1565 Save \$574

V-525 - 10MHz w/ Cursors Was \$1355, NOW \$955 Save \$400

V-1560 - 100MHz Was \$1790, NOW \$1490 Save \$300

V-552 - 50MHz Was \$1195, NOW \$850 Save \$345

V-1565 - 100MHz w/ Cursors Was \$1960, NOW \$1595 Save \$365

V-555 - 50MHz w/ Cursors Was \$1375, NOW \$975 Save \$400

V-252 - 20MHz **\$419**

Fluke Scopemeters



91 \$1225
92B \$1445
96B \$1695
97 \$1795
97A \$2945
99B \$2095

Call or write for complete specs.

WE WILL NOT BE UNDERSOLD

C&S SALES, INC.

150 W. CARPENTER AVENUE
WHEELING, IL 60090

FAX: (847) 520-9904 (847) 541-0710

http://www.elenco.com/cs_sales/

CIRCLE 32 ON FREE INFORMATION CARD

UPS SHIPPING: 48 STATES 5%
OTHERS CALL FOR DETAILS
IL Residents Add 8% Tax



**15 DAY MONEY BACK
GUARANTEE**

FULL FACTORY WARRANTY

PRICES SUBJECT TO CHANGE WITHOUT NOTICE

ALL ELECTRONICS

C O R P O R A T I O N

QUALITY PARTS

FAST SHIPPING

DISCOUNT PRICING

CALL, WRITE, FAX
or E-MAIL For A
Free 64 Page
CATALOG.
Outside the U.S.A.
send \$2.00 postage.

SET OF 12, SPDT NUMBERED LIGHTED SWITCHES

Twelve push-on/push-off switches (only 6 pictured). Each switch has a 0.6" square yellow lens with a 0.25" high black numeral 1 through 12. They are lighted by a 28 volt, #85 wedge base incandescent lamp which can be easily replaced if a different voltage is desired.

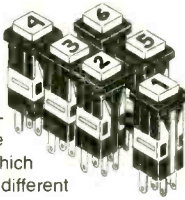

CAT #PBL-12 **\$15⁰⁰** per set of 12

SPECIAL! REDUCED PRICE 12 POSITION BARRIER STRIP



20 amp, single row, pc mount barrier strip with screw-clamp terminals. Just slip wire under clamp and tighten it down. 12 terminals on 0.375" centers. Black thermoplastic strip is 4.56" X 0.61". Barriers between screws are 0.63" high. Large quantities available.

CAT #TER-124
65¢ each
100 for \$50.00
1000 for \$300.00

"HI-8" VIDEO CASSETTE (USED)

SONY Hi-8 Top quality, metal particle 120 minute video cassettes. Used for a short time, then bulk-erased. Each cassette has its own plastic storage box. Satisfaction Guaranteed.

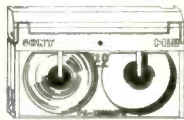

\$3⁰⁰ each

CAT # VCU-8

10 for \$28.00 • 100 for \$250.00

2 WAY CROSSOVER

JBL # 70561

No specs available on this two way crossover made for JBL speakers. 2.38" square black plastic backplate has color-coded spring lever terminals and fits a 1.95" diameter hole. Crossover is attached to backplate and extends 3.17" behind mounting plate. Color coded wire leads.

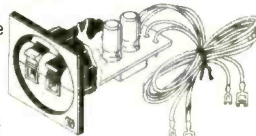

CAT # LX-70561 **\$3⁵⁰** each

LARGE HEATSINK

Extruded aluminum heatsink for high heat dissipation. Ideal for semiconductors or thermoelectric coolers. 6.75" X 5" X 2.27" high. Flat on one side with some small predrilled holes. 18 cooling fins.

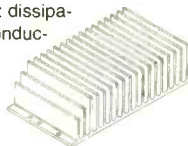

\$10⁰⁰ each

CAT # HS-19

ULTRA-BRIGHT LED



Rohm # SLA-580MT-E49 T-1 3/4 GREEN, water clear in off state. 500+ mcd @ 2.1 v, 16ma. **2 for \$1⁰⁰**

100 for \$40.00 • 1000 for \$300.00

SPECIAL PRICING! 12 VDC MINI-FAN

Sunon # KD1206PTS1 12Vdc, 2.2 W fan. 60mm X 60mm X 25mm. Black plastic housing. Five blade impeller. 18" pigtail leads. White Supply Lasts!

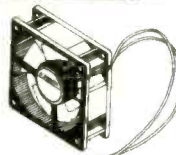

\$4⁰⁰ each

CAT# CF-35
10 for \$35.00

THERMOELECTRIC COOLER PELTIER JUNCTIONS



NEW LOWER PRICING

These incredible miniature solid state heat pumps raise or lower temperature in a small area almost instantly. Utilizing the Peltier effect these modules perform the same cooling or heating functions as freon based refrigerators but they do it with no moving parts, and are very reliable. Current applied to the device will produce heat on one side and cold on the other side, up to 68° C difference between the two sides. Modules can be mounted in parallel to increase the heat transfer effect or can be stacked to achieve high differential temperatures. 127 thermocouples per device. Operates on 3-12 Vdc. Requires a heatsink to prevent overheating.

1.18" (30 mm) square
X 0.15" (3.8 mm) thick.
\$17⁰⁰ each CAT# PJT-1
5 for \$75.00

1.57" (40 mm) square
X 0.15" (3.8 mm) thick.
\$26⁰⁰ each CAT# PJT-2
5 for \$110.00

Quantity Pricing Available!

12 Vdc 1 AMP WALL TRANSFORMER



2.1 mm co-ax plug center positive.

CAT# DCTX-1212
\$6⁰⁰ each

ORDER TOLL FREE

1-800-826-5432

MAIL ORDERS TO:
ALL ELECTRONICS CORP.
P.O. BOX 567
VAN NUYS, CA 91408-0567

FAX (818) 781-2653 • INFO (818) 904-0524
INTERNET <http://www.allcorp.com/>
E-MAIL allcorp@allcorp.com

NO MINIMUM ORDER • All Orders Can Be Charged to Visa, Mastercard, American Express or Discover • Checks and Money Orders Accepted by Mail • Orders Delivered in the State of California must include California State Sales Tax • NO C.O.D • Shipping and Handling \$5.00 for the 48 Continental United States - ALL OTHERS including Alaska, Hawaii, P.R. and Canada Must Pay Full Shipping • Quantities Limited • Prices Subject to change without notice.

MANUFACTURERS - We Purchase EXCESS INVENTORIES... Call, Write, E-MAIL or Fax YOUR LIST.



Skyvision, Inc.
1048 N. Frontier Dr. Fergus Falls, MN. 56537

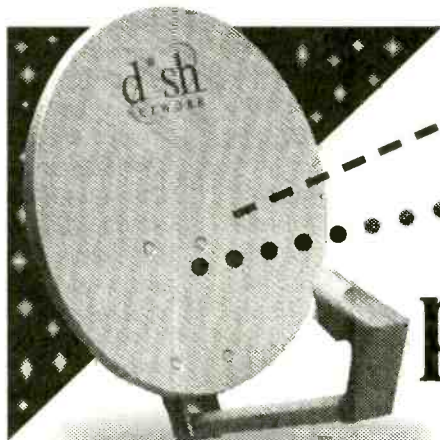

Small dish, **BIG** programming!

PLUS:

- ▼ Multi-room TV viewing options & accessories
- ▼ Mobile systems for RV's & vacation homes

AND MORE!

800-500-9264

 **Skyvision®**
www.skyvision.com

40 of America's Most Popular TV Channels includes DISNEY

- ▼ Makes cable & other 18" dish options obsolete.
- ▼ The HOTTEST digital programming available!

CALL NOW TO LEARN MORE!

DISH NETWORK

The Best Television Comes on a DISHSM

DISH Network is a registered Service Mark of EchoStar Comm. Corp.

FREE DISCOUNT BUYER'S GUIDE

KEEP YOUR SYSTEM RUNNING STRONG!

MOST COMPLETE SELECTION OF:

- ✓ System Upgrades
- ✓ Parts & Accessories
- ✓ Tune-up Tools & Kits
- ✓ Complete Systems
- ✓ Technical Support Hotline
- ✓ Discount SKYPAC™ Programming

GET YOUR FREE ISSUE NOW!

800-334-6455

NEED A REPAIR ITEM FAST? WE'LL GET IT OUT TODAY!

 **Skyvision®**
www.skyvision.com



GIANT! SPY ELECTRONICS CATALOG



ENTHUSIAST'S

Just Like In The Movies!

Fiber-optics • IR Detectors • UV Powder
Covert TV Cameras • Phone Transmitters
Laser/Parabolic Mic's • Nightvision • Wrist Watch
Cameras • Time Lapse VCR's • Surveillance-Counter
Surveillance • Homing Xmitters • Fiberscopes • Police
Electronics • Micro-TV's • Phone Bug's • TV Xmitters
Transmitter • Books/Video's and Much, Much More!

SECRET

EVIDENCE LOCATER

Just whistle your secret code and it whistles back

\$7.77+2.00 S&H



CATALOG **Rush!** \$5.00 to CLASSOCIATES
2801PE Shelterwood, Arlington, TX 76016

Timid about getting on the... World Wide Web?

You've heard about the *Information Superhighway* and all the hype that goes with it! Sort of makes you feel timid about getting on the Web. Put your fears aside! A new book, *The Internet and World Wide Web Explained*, eliminates all the mystery and presents clear, concise information to build your confidence. The jargon used is explained in simple English. Once the tech-talk is understood, and with an hour or two of Web time under your belt, your friends will believe you are an Internet guru!

To order Book #403 send \$6.95 plus \$3.00 for shipping in the U.S. and Canada only to Electronics Technology Today Inc., P.O. Box 240, Massapequa Park, NY 11762-0240. Payment in U.S. funds by U.S. bank check or International Money Order. Please allow 6-8 weeks for delivery.

WINDOWS 95 —One Step at a Time

Don't know what to do when confronted with Microsoft's Windows 95 screen? Then you need a copy of *Windows 95—One Step at a Time*. Develop your expertise with the straight-forward presentation of the frequently-used features that make Windows 95 so valuable to the PC user.

To order Book BP399 send \$6.95 plus \$3.00 for shipping in the U.S. and Canada only to Electronics Technology Today Inc., P.O. Box 240, Massapequa Park, NY 11762-0240. Payment in U.S. funds by U.S. bank check or International Money Order. Please allow 6-8 weeks for delivery.



Weeder Technologies

Electronic KITS!
from
\$29 to \$55

FREE
CATALOG!



Pro-Kit™

PO Box 421, Batavia, OH 45103

weedtech@iglou.com

513-752-0279

Home Automation

Connects between a TW523 and an RS-232 serial port. Use your PC or Mac to receive and transmit all X-10 commands. Create your own program to control your home automation system, turning on/off any device plugged into an electrical outlet with response to time/date, other X-10 transmissions or any other computer input stimuli.

Caller ID / RS-232

Connects between a telephone wall jack and an RS-232 serial port. Decodes the caller ID data sent over the phone line and sends it to your PC or Mac, in a pre-formatted ASCII character string. Create your own program to log the name, number, date, and time of all incoming calls.

Telephone Call Restrictor

Connects to telephone wall jack. Disables all phones on the line if attempting to either: dial a number that has been stored in memory "Block" mode or, dial a number that has not been stored in memory "Allow" mode. Use touch-tone phone to enter telephone numbers into memory, and choose mode. Program from any phone on the line using your password.

50 MHz Frequency Counter

Reads frequency from 1Hz to 50MHz and displays up to 7 digits on a 16x1 character LCD display. Auto-range feature provides floating decimal point and automatically affixes the correct suffix (Hz, KHz, or MHz). Microcontroller based provides for very small parts count, only 2"x3" big.

Telephone Scrambler

Scrambles your voice before sending it over the telephone line. Prevent eavesdropping from an extension or tap. Connects between your telephone and wall jack. No modifications are required to your telephone. Full duplex operation.

IR Remote Control Receiver

Learns and records the data patterns emitted by standard Infrared remote controls used by TVs, VCRs, Stereos, etc. Lets you control all your electronic projects with your TV remote. Seven individual I/O pins can be assigned to any button on your remote, and can be configured for either "toggle" or "momentary" action.

Caller Block

Connects between your telephone and its wall jack. Prevents your telephone from ringing unless the calling party is one which you've entered into memory using your touch-tone phone. Can also be set to allow all callers "except" those which you've entered into memory.

DTMF Decoder/Logger

Keep track of all numbers dialed or entered from any phone on your line. Connects to your telephone wall jack. Decodes all 16 touch-tones and displays them on an LCD display. Holds the last 240 digits in a non-volatile memory. Scroll through and view all telephone numbers dialed, credit card numbers entered, etc.



PUT YOUR PC TO WORK

THIS IS THE DREAM MACHINE YOU'VE BEEN WAITING FOR

2.5, 3, & 4 AXIS CNC/DNC
DESKTOP MANUFACTURING UNITS

STARTING AT
\$495.00

FREE
CAD/CAM
SOFTWARE

- AUTOMATICALLY PROTOTYPE PC BOARDS & MACHINE 3D PARTS FROM CAD
- CARVE, ROUTE, MILL, & DRILL WOOD, PLASTICS, & LIGHT METALS
- FREE POWERFUL 3D CAD/CAM SOFTWARE WITH EACH UNIT
- INEXPENSIVE CNC KITS AND ASSEMBLED CNC UNITS
- NOW OVER 20 DIFFERENT MODEL-OPTIONS
- EXPEDITE & SUPER-EXPEDITE AVAILABLE

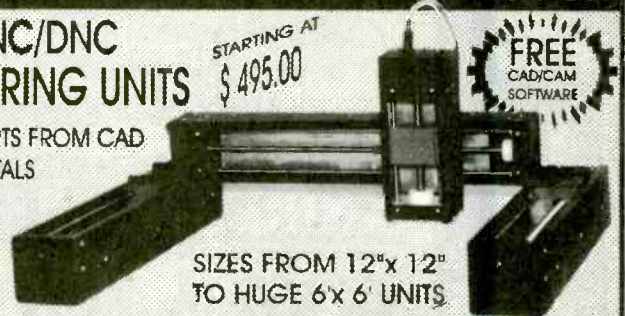

SIZES FROM 12"x 12"
TO HUGE 6'x 6' UNITS

ORDER NOW! 501-839-8293 U.S. CYBERLAB, INC., 14786 SLATE GAP ROAD, WEST FORK, AR 72774

CALL NOW FOR INSTANT SPECS 501-839-8293 24 HR. FAX-BACK SERVICE

EPROM+ PROGRAMMING SYSTEM USES PARALLEL PORT

EPROMS (24,28,32 & 40 PIN*)+27C AND 25XX
1702*,2708,TMS2716*,32,32A,64,64A,128,128A
256,512,513,011,010,101,1001,1000,1024,210,020
2001,220,2048,4001/2,040,080,240,4096,68764/66
FLASH EPROMS 28F256, 28F512, 28F010
28F020,29C257,29C010,29C040,29F010,29F040
EEPROMS & NVRAMS (18,24 & 28 PIN+CX)
2210, 2212, 2804, 2816, 2816A, 2817, 2864, 2865
28256, 28C010, DS1220, DS1225, DS1230
SERIAL EPROMS* (8 & 14 PIN PLUS CX)
ER1400,M58657, 2401,02,04,08,16,32,65, 2444
59C11,80011A,9306,46,56,66,8572,82,92,168/9XX
BIPOLAR PROMS* (16 THROUGH 24 PINS)
74SXXX AND 82SXXX FAMILY
MICROCONTROLLERS* 8741, 42, 48, 49, 8751
C51, 52, C52, 87C5XXX, 87C75X, 89C5X, 68705
68HC705, 68HC711E9, PIC16CXX, TMS7742
*ADAPTER REQUIRED - DIAGRAMS INCLUDED

SOFTWARE READ,VERIFY,PROGRAM,COPY
DISK FILE LOAD/SAVE, CHECKSUM, FULL
SCREEN BUFFER EDITOR W/20 COMMANDS
READS HEX, S-RECORD AND BINARY FILES
FAST-DEVICES PROGRAM IN UNDER 20 SEC
RUGGED (9" X6" X3") ENCLOSURE W/HANDLE
MADE IN USA - 1 YEAR WARRANTY

ANDROMEDA RESEARCH, P.O. BOX 222, MILFORD, OH 45150
(513) 831-9708 FAX (513) 831-7562



SYSTEM INCLUDES:
PROGRAMMING UNIT
PRINTER PORT CABLE
POWER PACK, MANUAL
AND SOFTWARE.

\$289

ADD \$5.00 SHIPPING
\$5.00 C.O.D.
VISA/MASTERCARD

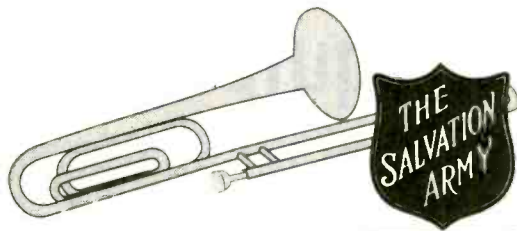

Your ticket to a secure retirement.



Save for retirement with U.S. Savings Bonds. For more information, ask your employer or bank, or write:

U.S. Savings Bonds.
Washington, DC 20226.

For a recorded message of current rate information, call
1-800-4US BOND • 1-800-487-2663



A public service of this magazine

Learn MICROCONTROLLERS EMBEDDED SYSTEMS and PROGRAMMING...

...with the AES learning system/
embedded control system.
Extensive manuals guide you
through your development
project. All programming and
hardware details explained.
Complete schematics. Learn to
program the LCD, keypad digital,
analog, and serial I/O. for your applications.

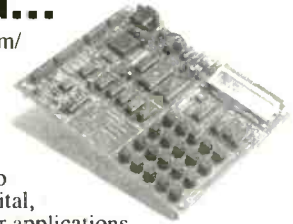

**THREE MODELS AVAILABLE. Choose from an
Intel 8051, Intel 8088, or Motorola 68HC11
based system. All models come with:**

- 32K Byte ROM, 32K Byte RAM • 2 by 16 Liquid Crystal Display • 4 by 5 Keypad • Digital, Analog, and Serial I/O • Interrupts, timers, chip-selects • 26 pin expansion connector • Built-in Logic Probe • Power Supply (can also be battery operated) • Powerful ROM MONITOR to help you program • Connects to your PC for programming or data logging (cable included) • Assembly, BASIC, and C programming (varies with model) • Program disks with Cross Assembler and many, well documented, program examples • User's Manuals: cover all details (over 500 pages) • Completely assembled and ready to use • Source code for all drivers and MONITOR • Optional Text Book

Everything you need. From \$279.
Money Back Guarantee

Call for Free Info Pack, or see
WEB at <http://www.aesmicro.com>
714-550-8094, FAX 714-550-9941



Call 1-800-730-3232

AES 970 W. 17TH STREET, SANTA ANA, CA 92706, USA

PROGRAMMERS OVER 50 MODELS

ADVANTECH EETOOLS NEEDHAMS DATA I/O ICE TECHNOLOGY HILO SYSTEM GENERAL CHROMA MODULAR CIRCUIT TECHNOLOGY XELITEK



PROMAX EMP 20 MEGAMAX MEGAMAX4 SIMM/SIP TESTER EMUPA

CALL ADVANTECH LABTOOL	629 EETOOLS SIMMAX
689 ICE TECH MICROLV	795 CHROMA SIMM/SIP
669 EETOOLS ALLMAX +	350 MOD-MCT-EMUPA/R
429 EETOOLS PROMAX	279 MOD-MCT-EMUP/R
439 EETOOLS MEGAMAX	49 EPROM 1G TO 512K
539 EETOOLS MEGAMAX4	79 EPROM 1G TO 1MEG
429 XELITEK SUPERPRO II	99 EPROM 4G TO 1MEG
529 XELITEK SUPERPRO II P	199 EPROM 16G TO 1 MEG
269 XELITEK SUPERPRO L	99 EPROM 1G TO 8MEG
179 XELITEK ROMMASTER II	129 EPROM 4G TO 8MEG
479 MOD-MCT-EMUPA	250 EPROM 8G TO 8MEG



LABTOOL48 MACROMASTER SUPERPRO ALLMAX PLUS ROMMASTER2

General Device Instruments

Sales 408-241-7376 Fax 241-6375 BBS 983-1234

Web www.generaldevice.com E-Mail icdevice@best.com

The Pocket Programmer

\$129.95



The portable programmer that uses the printer port of your PC instead of an internal card.

Easy to use software that programs E(E)prom, Flash & Dallas Ram. 27(C)/28(C)(F)/29(C)(F)/25 series from 16K to 8 Megabit with a 32 pin socket. Adapters available for MCU's 874X, 875X, Pic, 40-Pin X 16 & Serial Eprom's, PLCC, 5-Gang and Eprom Emulator to 32K X 8.

Same Name, Address & Phone # for 13 Years.... Isn't it Amazing ?

Intronics, Inc.

Box 13723 / 612 Newton St.

Edwardsville, KS 66113 Add \$4.75 COD

Tel. (913) 422-2094 Add \$4.00 Shipping

Fax (913) 441-1623 Visa / Master Charge

Be a PC repair expert!

Approved home study. Learn to troubleshoot, repair, install, upgrade, and service computers.
Free literature: 800-223-4542

Name _____ Age _____
Address _____ Phone (____) _____
City/State _____ Zip _____
School of PC Repair, DEPT JJP341, PCDI
6065 Roswell Road, Atlanta, Georgia 30328



Learn computer programming!

Hands-on home study. Learn career-level programming in Visual Basic for Windows. Earn good money!
Free career literature: 800-223-4542

Name _____ Age _____
Address _____ Phone (____) _____
City/State _____ Zip _____
The School of Computer Training, Dept. CPP341
PCDI, 6065 Roswell Road, Atlanta, Georgia 30328



Quality you can afford.

#72-2035 ...Reg. \$149

only **\$129**



#72-2040 ...Reg. \$179

only **\$159**



TENMA® Test Equipment

Compact, rugged, and autoranging, this line of high-performance DMMs are perfect for troubleshooting electronic circuitry, adjusting and calibrating products and testing components. The "High Tech Series" offer performance and 5,000 count for greater resolution and repeatability. So whether you are solving problems in the field, at home, or at the workbench, Tenma digital multimeters give you all the measurement capability you need for today's technology.

Why should you buy Tenma DMMs?

- Best price/performance
- One year warranty
- Large LCD Displays
- 5000 Count
- Feature packed
- Reliability

The complete Tenma line can be found at MCM Electronics. MCM stocks over 30,000 items...serving every need of the electronics repair industry. Test equipment, semiconductors, audio/video parts, tools, computer parts and more. Request your FREE catalog today!

Prices effective from October 17 through November 30, 1996



FREE Catalog

20th
Anniversary
1996

Authorized

Panasonic
Quasar/Technics
Original Parts Distributor

REA 
Premier
Distributor

To order a FREE catalog, Call...

1-800-543-4330



MCM ELECTRONICS®
650 CONGRESS PARK DR.
CENTERVILLE, OH 45459-4072
A PREMIER Company

Fast delivery from distribution centers near Reno, NV and Dayton, OH.

CODE:POP35

CIRCLE 140 ON FREE INFORMATION CARD

ELECTRONIC KITS! VOICE CHANGERS! AND MORE!

PRICES SUBJECT TO CHANGE WITHOUT NOTICE



TOLL FREE ORDER LINE: 1-800-336-7389
FAX LINE: 1-602-731-4748
TECH SUPPORT NUMBER: 1-602-894-0992

XANDI ELECTRONICS, INC.
MANUFACTURER OF HIGH QUALITY KITS

143.775 MHz CRYSTAL CONTROLLED TRANSMITTER KITS

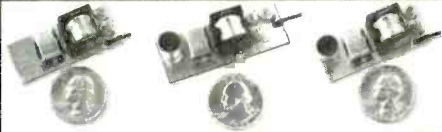

XTR300EZ \$79.95
XTL3000EZ \$99.95
XTL1000EZ \$69.95

XTR300 TRACKING TRANSMITTER KIT
Transmits continuous beep-beep-beep
Ideal for locating lost or stolen items
Range up to 1/2 mile

XTL3000 LONG RANGE TRANSMITTER KIT
Sensitive built in microphone
Range up to 1 mile
Custom frequencies available

XTL1000 TRANSMITTER KIT
Sensitive built in microphone
Range up to 1/2 mile
Custom frequencies available

CRYSTAL TRANSMITTER KITS

- Ultra-miniature surface mount construction.
- E-Z kit approach makes assembly a snap.
- Miniature battery and holder mounted directly to the circuit board.
- Transmit to any scanner type receiver

BUG DETECTOR

XBD500
\$149.95

- Professional quality.
- Not a kit, ready to use.
- Covers 1 to 2,000MHz.
- Uses new Microwave Integrated Circuit amplifier.
- Adjustable sensitivity.
- Audio jack for privacy ear phone.



Any intercepted signal causes an audio tone that increases from a low pitched growl to a high pitched squeal as the signal strength increases.

88-108 MHz FM RECEIVER

XMR2000
\$29.95

- Worlds smallest FM radio.
- As small as a hearing aid.
- Weighs less than 1/4 oz.
- Digital touch tuning.
- Ideal for use with our 88-108MHz FM transmitters



88-108 MHz FM TRANSMITTER KITS



XST 500EZ \$49.95
XWB 1000EZ \$46.95
XFM 100C \$21.95



XSP 250EZ \$34.95
XTR 100C \$29.95
XTT 100C \$19.95

XST 500 Voice transmitter. Range up to 1 mile. Supersensitive mic. Uses 9 volt battery. Uses surface mount components.

XWB 1000 Voice transmitter. Range up to 1/2 mile. Includes mic and battery on circuit board. Uses surface mount components.

XFM 100 Voice transmitter. Range up to 1 mile. 9 v battery and leaded components.

XSP 250 Super-miniature telephone transmitter. Range 1/4 mile. Powered by phone line. Uses surface mount component.

XTR 100 Tracking transmitter. Range up to 1 mile. Uses 9 volt battery. Transmits a BEEP - BEEP - BEEP tone

XTT 100 Telephone transmitter. Range up to 1 mile. Uses 9 volt battery.



XPC 400 TV CAMERA
400 LINES OF RES
● Use any TV or VCR with a video input connector.
● Includes power cube.
● About half the size of a pack of cigarettes.
● See entire room through pin sized hole.
Assembled \$269.95



XVS100 TV TRANSMITTER
● Use with XPC400, VCR, Camcorder, etc.
● Power cube included.
● Uses the UHF TV band.
● Transmits video and audio.
● Up to 100 foot range.
E-Z Kit \$29.95

PHONE VOICE CHANGER

16 levels of digital voice changing. Sound tougher, older or younger, female or male. Powered by 4 AA batteries. (Batteries not included).

Works with regular or multi-line phones. Connects between handset and phone. Note will not work with cordless or handset type telephones.



T-2001 Assembled
\$69.95



XLB-9 \$8.95 9V LITHIUM BATTERY

Worlds most powerful 9V battery! Twice the life of alkaline batteries.

XLB-3 \$3.95 3V CAMERA BATTERY

Small 3V Lithium battery. For use with XTL3000, XTL1000, XTR300, and XWB1000.



PROJECT BOX \$14.95

Ideal project box to give your kits that professional look. Available custom drilled for the following kits: XFS108, XPS1000, XLC900, and XVA250.

XANDI ADVANCED HOBBY KITS



XPS 1000C
\$55.95

TELEPHONE SNOOP KIT

- Dial home from anywhere and hear inside your home.
- TouchTone coded for secure operation.
- Stop burglars and intruders.
- Reliable 24 hour protection.



XLC 900C
\$49.95

SCANNER CONVERTER KIT(800-950MHZ)

- Uninterrupted coverage of the 800 to 950 MHz band!
- Works with any 400-550MHz scanner.
- Gain: 6 dB typical.
- Noise figure: 3 dB typical.

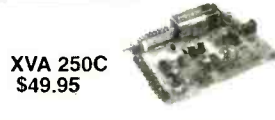

XVA 250C
\$49.95

VOICE-STRESS ANALYZER KIT

- See at a glance if your being lied to!
- Subject need not be present. Works with voices from recordings, TV or radio.
- Has built-in microphone.
- Easy to use LED display output.

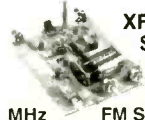

XFS 108C
\$39.95

88-108 MHz FM STEREO TRANSMITTER KIT

- Separate level control for both left and right channels.
- Output level circuit with test points for quick and easy tuning.
- Transmit from any stereo audio source to most any FM stereo receiver.

Serving the public since 1981
XANDI ELECTRONICS, INC.
1270 E Broadway Rd. # 113
Tempe AZ 85282

WE ACCEPT CHECK, VISA, MC, MO, COD
SHIPPING & HANDLING EXTRA



SEND \$2.00 FOR COMPLETE CATALOG REFUNDABLE ON FIRST ORDER

SEND MAIL ORDERS TO:
XANDI ELECTRONICS
BOX 25647
TEMPE, AZ 85285-5647

CIRCLE 134 ON FREE INFORMATION CARD

EARN MORE MONEY!

Be an FCC LICENSED ELECTRONIC TECHNICIAN!



No costly school. No commuting to class. The Original Home-Study course prepares you for the "FCC Commercial Radiotelephone License." This valuable license is your professional "ticket" to thousands of exciting jobs in Communications, Radio-TV, Microwave, Maritime, Radar, Avionics and more...even start your own business! You don't need a college degree to qualify, but you do need an FCC License.

No Need to Quit Your Job or Go To School

This proven course is easy, fast and low cost! **GUARANTEED PASS**—You get your FCC License or money refunded. **Send for FREE facts now. MAIL COUPON TODAY!**

Or, Call 1-800-932-4268 Ext. 240

COMMAND PRODUCTIONS

FCC LICENSE TRAINING, Dept. 240
P.O. Box 2824, San Francisco, CA 94126
Please rush FREE details immediately!

NAME _____
ADDRESS _____
CITY _____ STATE _____ ZIP _____

WORLD'S SMALLEST

Wireless Video Transmitters

Used by hundreds of hobbyists and professionals alike in R/C models, Robots, Surveillance Video, movie Special Effects, and Law Enforcement.

"... previously, I used expensive wireless units from Pelco, MVP, and Supercircuits. Nothing approaches the VidLinks in power, picture quality, size, and value. Thank you." *R. Leslie, CCTV Installer, NY.*
"The best... Incredible color, resolution... very easy to use... cool." *P. Davis, Movie Props, CA.*

Actual Size!!!



Live Remote Video From \$99.00

- Full 100 mW RF Power. Range 500ft. to 1/2mile •
- Crystal Controlled •
- High-Resolution Full Color/ B&W video •
- Fully epoxy encased- no exposed components •
- Fully assembled- only two wires to attach •
- MONEY BACK GUARANTEE. •

VidLink 100: 100mW Power- upto 1/4 Mile
\$199.00 New! High-Power!

VidLink 15: 15mW Power- upto 150 Feet
\$99.00 New! Low Price- Same Size!

Covert Camera: 1 1/4" sq. Pinhole Lens
\$169.00 Pro Grade Japanese Quality!

*** Audio Module Now Available. Call. ***
Check/MO, COD +\$5.00, S&H \$5.50

AEGIS RESEARCH

#671-1225 E. Sunset Dr.
Bellingham, WA
98226-3529 USA

1-604-224-0416

Visit our virtual catalog on the INTERNET at:
<http://www.lynx.bc.ca/virtualspy>

TOP SECRET

CONSUMERTRONICS
P.O. Drawer 537
Alamogordo, NM 88311

Fax: (505)434-0234
Phone: (505) 439-1776
Tech & Customer Services
(505)439-9551 (8AM-6PM, Mon-Sat)
For orders or prospective orders only!

Web Site

users.aol.com/wizguru/hl-tech.html

10% Off orders \$100+ **15% Off over \$200+**
Add \$5 total S/H (US, Canada). All items in stock. Postal M.O. is fastest. VISA, MC OK. COD (\$49-\$999), add \$8. New Catalog (200+ offers) \$2 w/ order, \$5 w/o (no CC), \$19/foreign. *Sold for educational purposes only.*

*Software supports all IBM-PC systems

OFF-THE-SHELF HARDWARE

Van Eck Systems*Data Card Reader/Writers* ATM3*Security/Surveillance*RF/EM/UV/Wave/Radar/Ultrasonic/IR/Light/Sound Detectors/Receivers/Xmitters/Jammers/Blasters*Neurophone/Rife/Hieronymus/Resonant Crystal Radionics* EM Lab/Weaponry/Countermeasures*ESS Infinity Devices *Voice Disguisers* Lineman's Handsets * Bug/Tap Detector/Blaster *Phone Color Boxes *DTMF Decoders *Carjack/Kidnap Follower *Bumper Beeper/Child Finder *Panic Button*Shriek Module*TENS*Subliminal Mixer/Amp (Ultrasonic & Infrasonic) * Electronic Downders*Hidden Presence Detectors *Hearing Assistor*Vortex Generator*6th Sense Communicator*Noise Cancel. System*Levitating - many more! See our **New Catalog!**

SPECIAL PROJECTS

We design/build/repair/modify/maintain/consult on any device/system/process/project - electronic/computer/mechanical/optical (eg: phone/auto/security/radionics/lab/energy/HVEM/RF/radar/ultrasonic/IR/UV/commo/consumer) for business/personal/invention needs. Describe & include \$30 pre-engineering fee (no obligation). Time & cost estimates 7-10 days. Confidentiality guaranteed.

CELLPHONE MODS

See our Catalog for our infamous cellphone modification guide (\$69) - detailed, comprehensive, covers all makes - 10 times more info than competitor's "guide". (Do Special Projects for up-to-date hardware/software). **Free Data Search:** As a special service to our C&CP customers, we will perform one FREE search of our massive cellphone database if requested within 30 days of your purchase of C&CP. Data now on cellphones is so great, we can fit in C&CP only that in greatest demand. Search results not guaranteed. Request by mail (don't fax); include a #10 SASE.

PAGER (BEEPER) MANUAL

Describes in detail how Pagers work, different types and uses, frequencies, advantages over and uses with cellphones, and tips and tricks. And how Pagers are hacked and countermeasures. Includes the plans for your own **Personal Pocket Paging System** (transmitter and receiver). \$49.

HACKING FAX MACHINES

Describes in detail how Fax machines are hacked and countermeasures. Includes Fax protocols, comms parameters, compression, commands, spy switch. And insights into designing Fax interception devices and modifying existing Faxes into Stealth Faxes. \$49.

VOICE MAIL HACKING

How Voice Mail box systems are used and the ways they are hacked. Includes ASPEN, MESSAGE CENTER, BIX, GENESIS, EZ, SYDNEY, PHONE MAIL, AUDIX, CINDY, CENTAGRAM, SPERRY LINK, RSVP, etc. A must for users, sysops, security types! \$29.

PBX HACKING

PBXs are hacked to the tune of \$ Billion/syr! While "VOICE MAIL HACKING" details how VMSs are hacked - including VMS methods for hacking PBXs themselves - "PBX HACKING" addresses ALL issues relating to PBX hacking, including countermeasures! Can you afford a \$90,000 phone fraud loss (avg. loss of hacked PBXs)? As described in Forbes. \$29.

BEYOND VAN ECK PHREAKING

Eavesdropping on TV and computer video signals using an ordinary TV described in detail. Includes security industry reports. Range up to 1 KM. Plans include our and original Top Secret Van Eck designs! \$29.

STOPPING POWER METERS

As reported on CBS' "60 Minutes": How certain devices can slow down - even stop - watt-hour meters - while loads draw full power! Device simply plugs into one outlet and normal loads into other outlets. Also describes meter creep, overload droop, etc. Plans \$29. **Loops MANUAL:** External magnetic ways (applied to the meter itself) to slow down and stop watt-hour meters while drawing full loads. Plans \$25. **KW-HR METERS:** How watt-hour meters work, calibration, error modes (many), ANSI Standards, etc. Demand and Polyphase Meters. Experimental results to slow and stop meters by others. \$25. 2nd, \$47. All 3, Only \$69!

PHREAKING CALLER ID & ANI

Details on how they work and dozens of ways of defeating Caller ID, ANI, *69, *57, and Call Blocking & *67. Describes Caller ID, Orange, Bolge, Cheese and CF Boxes, ESS, SS7, E-911, various CLASS services, CNA, NON PUB DA, CAMA, DNR, 800-ECR, Diverters, Extenders, Centrax - more. \$29.

COMPUTER PHREAKING

Describes in detail how computers penetrate each other, and how VIRUSES, TROJAN HORSES, WORMS, etc are implemented. Dozens of computer crime and abuse methods and countermeasures. Includes disk filled with hacker text files and utilities, and the legendary FLUSHOT+ protection system (Ed. Choice, PC Magazine). BBS advice, password defeats, glossary - much more! Manual + Disks* \$39.

BEYOND PHONE COLOR BOXES

Dozens phone color boxes described - many circuits. Plus Call Forwarding, Centering, Phreak History Glossary, Diverters, Extenders, Loops, REMOBS, Bridging Heads & Cans, Opticom, 3rd Party and many other non-box methods - more. \$39.

HACKING ANSWERING MACHINES

How answering machines are hacked to listen to - even erase - messages, and to convert them into mini-VMSs. And countermeasures - protect yourself from snoops, stalkers, burglars and pranksters! \$29.

AUTOMATIC TELLER MACHINES

ATM crimes, abuses, vulnerabilities and defeats exposed! 100+ methods detailed, include: Physical, Reg. E, cipher, PIN compromise, card counterfeiting, magnetic stripe, false front, TEMPEST, Van Eck, tapping, spoofing, inside job, super-cool, vibration, pulse, high voltage - others. Case histories, law, countermeasures, detailed security checklist, labeled internal photos, figures. Recent \$350,000 ATM crime spree still unsolved! \$39.

CREDIT CARD SCAMS

Cardholders, merchants, banks suffer \$ billions in losses annually because of credit card fraud. Describes every known means of credit card fraud and scams. Protect yourself! \$29.

CONS & SCAMS

Cons and related swindles fleece victims of \$100+ Billion per year! The most comprehensive survival manual on cons & scams of all kinds - from the classic to hi-tech. Details on 100s and many variations. And countermeasures. Protect yourself! \$39.

INTERNET CONS & SCAMS

Internet scams and related frauds fake in \$2+ Billion annually! Most are done anonymously and with little fear of prosecution (hard to prove or find perpetrators). Described in detail. Includes countermeasures. \$29.

THE HACKER FILES

Compilation of 100s of the best articles written (in ASCII) by top hackers & phreakers. Covers every major topic in hackerdom! 3 HD Disks* \$59.

MIND CONTROL

Concern and fear increases over EM and ultrasonic mind (and body) control technologies - especially implants! Unfortunately, there is much more disinformation published than facts. Some victims are controlled and exploited by armchair "experts" and so-called victims' groups! \$39. Visit our site at: users.aol.com/wizguru/mindcontrol.html

UNDER ATTACK!

Electromagnetic Interference and Electronic Weapon Attacks cause: Cancer, birth defects, and profound psychological and physiological disorders! Destructive to people, plants, equipment! Includes ACTUAL CASES OF EM ATTACKS (we investigated!) Includes how to verify and pinpoint EM/EL and electronic attack sources, and effective countermeasures. \$29. **EM BRAIN-BLASTER:** Tutorial and plans for powerful ELECTROMAGNETIC WEAPONS and LAB DEVICES. Optimum circuits, freqs, waveforms, duty cycles, intensities. Thorough. \$29. Both Only \$49!

HIGH VOLTAGE DEVICES

Plans: Stun Gun, Taser, Prod, Cam, Blaster, Flasher, Zapper, Audio/RF/Radar Jammer, Fence Charger, Plasma & Van de Graaff Gens, Jacob's Ladder, Golger Counter, Ozone Gen., Fish Stunner, Plant Stim., Kirlian, more! All plans for only \$29.

CABLE T.V. EQUIPMENT

Friendly, Knowledgeable Service



ORDERS CALL:
1-800-361-4586

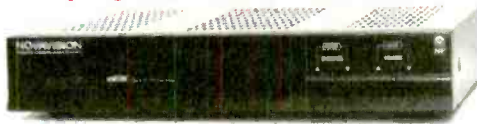

- All Equipment New
- Convertors & Descramblers
- 30 Day Money Back Guarantee
- 6 Month Warranty
- Visa, MC, C.O.D. Welcome

KDE ELECTRONICS, INC.

P.O. Box 1494

Addison, IL 60101

Info. 630-889-0281 HRS: Mon-Fri, 9-6 CST
Fax 630-889-0283 Sat, 9-3 CST



Are you overpaying . . .
. . . your cable company?

You are if . . . 
. . . you are leasing their equipment.

- Forest Electronics, Inc. offers a complete line of New Cable Decoders and Converters that are fully Compatible with your cable system.
- All systems come with: Remote Control, & Parental Guidance Feature. Volume Control is also available.
- All Equipment is fully guaranteed & comes with a 30 day money back option.

For More Information Call Us 24 Hours a Day At:

800-332-1996

FAX: 708-860-9048

New Surveillance Devices!

Smoke Alarm and Table Clock Video Cameras



Ultra miniature video cameras hidden in smoke alarm or alarm clock - your choice. Wide field of view and super .1 lux low light sensitivity! Undetectable!

SC-600 High quality B/W with 420 lines of resolution for ultra sharp images. Direct output of video and audio. **\$219.95 ea.**
Best price on surveillance cameras anywhere!

Telephone Transmitter Kit hidden in dual modular adaptor Transmits both sides of conversation to any FM radio up to 1/4 mile. "SnapKit" technology. Uses phone line for power and antennal Goes completely unnoticed. **MA-100 \$25.95**

THR-12 12 Hour Telephone Recorder High quality cassette deck plugs directly into telephone jack! Records up to 12 hours of conversations on a single cassette. Recording starts and stops automatically when phone is used! **Visa/MC (214)255-7490**

Seymour-Radix Inc. Box 166055-E Irving, TX 75016
Now you can visit us on the internet at <http://www.why.net/home/sr/>

SURVEILLANCE

The Latest High Tech Professional Electronic Devices

Our latest catalog offers a **HUGE** selection of surveillance, privacy devices including: hidden video equipment, electronic kits, telephone recording systems, touch tone decoders, scanners, telephone tap detectors, bug detectors, voice disguisers, telephone scramblers, locksmithing tools, and more. **Catalog \$5.00.**

SPY OUTLET

P.O. Box 337, Buffalo, NY 14226
(716) 691-3476 / (716) 695-8660

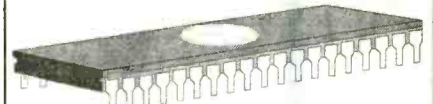

CABLE CONVERTER DIAGNOSTIC TEST CHIP

LOAD FULL ACTIVATION OF CABLE CONVERTER

WE STOCK A COMPLETE LINE OF CHIPS, TOOLS, WIRELESS QUICK INSTALL TEST BOARDS AND DIAGNOSTIC CUBES FOR ALL CONVERTERS!

*****ANYONE IMPLYING ILLEGAL USE WILL BE *** DENIED SALE. WE SELL PRODUCTS ONLY!! TO TECHNICIANS OR CABLE REPAIR FACILITIES!!**

#1 IN CUSTOMER SERVICE & TECH. SUPPORT!

***ALL ORDERS SHIP WITHIN 24HRS. UPS! FED-X.**

***PRIORITY NEXT DAY SHIPPING AVAILABLE!**

***SALE= BUY 5 TEST BOARDS AND GET 1 FREE.**

MONDAY THRU FRIDAY - 8AM-7PM EST.

HTTP://WWW.AMERICANINTERNET.COM/GOCABLE

VISA MasterCard VISUAL

COMMUNICATIONS INC. FOR ORDERS 1-800-GO-CABLE CATALOG & TECH. SUPPORT 717-620-4363 EST. 1976

MORE for LESS... Always!

Best Values for Performance, Features and Dependability

DM5050C, 42 Range DMM + CAPACITANCE METER

- Digital Multimeter
 - Resistance - Up to 2,000 MΩ
- Capacitance Meter, Extended Range
 - Up to 20,000μF (9 Range)
 - Zero Adjust Knob
 - Test Leads and Built-in Socket
 - Check Motor Starting & Running Capacitance
- Triggering Lamp

DM5100, 45 Range WIDE RANGE, ELEVEN FUNCTION

- Auto Power Off, Data & Peak Hold
- Measures Wider Range
 - Frequency - Up to 20 MHz
 - Capacitance - Up to 200 μF
 - Resistance - Up to 200 MΩ
 - Current - Up to 20 A AC/DC
- Logic - TTL
- TRhFE

± 0.25% Basic DCV Accuracy
1.5" Big LCD Display
3 1/2 Digit Manual AC/DC Volt & Amp
Resistance, Diode Continuity Buzzer
Alligator Clip Test Leads
Double Insulated Jack
Deluxe Holster
● Lead Holders
● Velcro Hanger
Tilt Stand



\$89

- Prices start at \$44.95, measuring AC/DC 10 Amp. & Volt, Resistance, more and including protective Holster
- Lots more High Standard Test Instruments available All in One Instrument, Oscilloscope, Power Supply, Function Generator, Freq. Counter, Multimeter, Capacitance, Engine Analyzer, Clamp-On, Electrical Tester and More.
- See your local distributors or Call for Catalog

Bel MERIT SOLUTIONS FOR THE TEST INSTRUMENT

26242 Dimension Dr., Suite 110
Lake Forest, CA 92630
(714) 586-3700 • FAX: (714) 586-3399

\$139* Laser LightShow

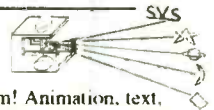

Draw with a laser beam! Animation, text, music & more! Includes galvos, mirrors, servo amp, demo software disk, analog and digital computer interface. Use an inexpensive pen pointer or high power gas laser.



Computerized Motors \$39*

Includes: 2 Stepper motors, 2 DC motors, computer interface, training manual, & demo software disk. Expandable! Up to 12 motors, up to 3 amps per phase.

Now with 4 Axis Linear Interpolation

* Add \$6 for shipping. Computer with parallel printer port & cable, assembly, power supply, & laser are required

FREE FLYER

Voice 510-582-6602 Fax 510-582-6603

SVS

1273 Industrial Pky West Bldg. 460
PO Box 55125 Hayward CA 94545-0125



Strange Books!

Unusual, detailed how-to books, manuals, references, old & new, for experimenters, builders, and mad scientists on high voltage, Tesla, crystal sets, very early radio and television, vacuum tube gear, plastics, chemistry, lasers, more! Repair cameras! Make neon signs! Make whiskey! Hydrogen fuel! A solar cell! A windmill! Electric bicycle! Highest quality! Guaranteed! Big illustrated catalog! Write!

Lindsay's Technical Books

PO Box 538-WJ2, Bradley IL 60915
fax: 815/935-5477 • lindsay@keynet.net

TAKE A BITE OUT OF YOUR CABLE BILL !!!

CABLE BOXES & DESCRAMBLERS



1(800) 72-BOXES

OSCILLOSCOPES

from \$169 !!!

ATC O-Scope uses printer port to turn PC-AT into Digital Storage Oscilloscope, Spectrum Analyzer, Freq. Counter, Logger, DVM. DC-500KHz

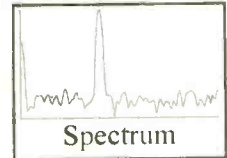
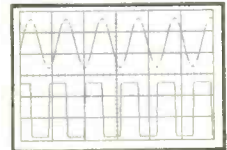

- Print, log to disk, or export data
- Accepts standard scope probes
- Uses standard printer port
- Small and portable
- Works with laptops
- Same day shipping
- Made in U.S.A.
- Single channel units from \$169
- Dual channel units from \$349

Options:

- Probe sets
- Automotive probes
- Battery packs

Order yours today.

800 980 9806

MC/Visa/Amex

Allison Technology Corporation

8343 Carvel, Houston, TX 77036 USA

PH: 713 777 0401, FAX: 713 777 4746, BBS: 713 777 4746

<http://www.atcweb.com>

CABLE DIRECT

CONVERTERS
DESCRAMBLERS
VIDEO STABILIZERS
FILTERS



100%
MONEY BACK
GUARANTEE!

30 DAY
FREE
TRIAL!

FREE Cable TV Catalog.



Now you can tune-in your favorite cable TV programming and SAVE \$100'S - EVEN \$1000'S on premium CABLE TV EQUIPMENT.

MODERN ELECTRONICS

1-800-906-6664

2125 S. 156TH CIRCLE • OMAHA, NE 68130

New! Surveillance, & PIC microcontroller, project kits.

Most kits use surface mount technology. Among the kits are an ultra small wireless FM mic, and our new phone transmitter SLeach™. All kits include our exclusive surface mount soldering guide. Many kits under \$20, call!

Pager Decoder Interface for your PC, Only \$19.95 + S+H
includes shareware software.

We carry the TDA2005 20W Power Amplifier IC. Great for auto alarm projects!

Order 1-800-417-6689

Mon. - Fri. 9AM-5PM ET.
Visa, MC, Money Order's
IEC, P O Box 52347, Knoxville, TN 37950-2347

Sorry, no refund for used kits. Do not use these devices without authorization from your local officials.

Prices subject to change. No TN sales. This ad quotes cash discount pricing. Returns are subject to a restocking fee.

©1996 IEC

CABLE TV DESCRAMBLERS



WE CARRY A FULL LINE OF PREMIUM CONVERTERS AND DESCRAMBLERS

- Scientific Atlanta™ Compatible
- Jerrold™ Compatible
- Tocom™ Compatible
- Zenith™ Compatible
- Pioneer™ Compatible
- Oak™ Compatible

SATISFACTION GUARANTEED OR YOUR MONEY BACK!
BEST PRICES FREE CATALOG

Please have the MAKE & MODEL # of your full premium service cable box ready when you call!

ALLSTAR ELECTRONICS

800-782-7214

HCURS: 9-6 M-F 10-3 Sat EST

It is not the intent of Allstar Electronics to defraud any pay TV operator. Anyone implying theft of service will be denied assistance. All brand names are registered trademarks of their respective owners & are used for reference only. 110-64 Queens Blvd., #465, Forest Hills, NY 11375. NO NYS SALES!

DEALERS!

Zenith

(as is/refurb)

ST-1000-165 \$40/\$70
 ST-1000-288 \$60/\$90
 ST-1600-288 \$80/\$110
 (Screened & Cleaned)

RFT

1 unit \$80
 10+ \$55
 100+ \$47.50

Super PIO-Q

(w/filter)
 1 unit \$85
 10+ \$68

Remotes

\$6.00

Test chips

\$3.50

(702)895-9120
(800)478-0334(pgr)

WHOLESALE PRICES STARTING AS LOW AS \$99.00 CABLE TV DESCRAMBLERS CONVERTERS FILTERS · VIDEO STABILIZERS



1 Year Warranty on All Products.
 Affordable Extended Warranty.
FREE CATALOG!

30 Day
**FREE
 TRIAL**

Call the Cable Professionals 24 Hours A Day!

Orion Electronics
1-800-379-3976
[HTTP://WWW.ORION-ELECTRONICS.COM](http://www.orion-electronics.com)

C.O.D.
 VISA
 MasterCard
 Discover

Quality Microwave TV Systems
 WIRELESS CABLE · ITFS · MMDS
 ATV · INTERNATIONAL · S-BAND
 Amplifiers · Antennas · Books · Components
 Filters · Systems · Video Products
 • RF Frequency 1990 - 2700 MHz
 • Cable Ready - VHF - UHF Outputs
 • SASE For "FREE" Catalog or Send \$1

PHILLIPS-TECH ELECTRONICS
 PO Box 8533 • Scottsdale, AZ 85252

ORDER LINE 800-880-MMDS
FAX LINE 602-947-7799
 VISA • MC • Amx • Disc • C.O.D.'s • Qty Pricing
FREE SHIPPING

CHALLENGER SYSTEM
 33-Channel 52db+ Gain
 Complete Grid \$285
 Five Year Warranty
FREE SHIPPING

CIRCLE 145 ON FREE INFORMATION CARD

"FULL VIEWING" CABLE BOXES

FREE
 Converter Box Catalog
 Open Every Day!

**LOWER YOUR CABLE
 BILL NOW!**
CHANNEL SURFERS
1-800-447-7634

TRANSISTORS + Free
CD - Book
 E-MAIL: METZA@INFOBOARD.COM

PROFESSIONAL TRANSISTORS C.O.D.
 M.E.T.

CD-Rom
MORE THAN 27,000 TRANSISTORS Only \$33

Reference Table - Comparison Table
 20 Technical data and drawings for each transistor.

BUGGED??

EAVESDROPPING is unbelievably widespread! Electronic Devices with amazing capabilities can be monitoring your telephone and room conversations RIGHT NOW! Are you sure you're safe? **FREE CATALOG tells you fast!** Includes Free Bonus details on fantastic opportunities now open in Counter-Surveillance field. Exciting, immensely interesting and EXTREMELY profitable (up to \$250/hr) full/part-time income. Call Now!
1-800-732-5000

BE A LOCKSMITH!

Home study. Learn locksmithing for a great career, or to start your own at-home business.
FREE LITERATURE: 800-223-4542

Name _____ Age _____
 Address _____ Phone _____
 City _____ State _____ Zip _____

The School of Locksmithing, Dept. LMP341
 PCDI, 6065 Roswell Rd., Atlanta, GA 30328

WORK AT HOME!

BE AN ELECTRICIAN!

Home study. Maintain and install electrical systems, wiring, utilities, phones, and more.
FREE LITERATURE: 800-223-4542

Name _____ Age _____
 Address _____ Phone _____
 City/State _____ Zip _____

The Electrician School, PCDI, DEPT TEP341
 6065 Roswell Road, Atlanta, Georgia 30328

Parts Express

Parts Express is dedicated to becoming your source for TV and VCR service related parts. We have taken this commitment to heart and added over 1,000 new original Japanese semiconductors and literally hundreds of new VCR parts including original Zenith, Sanyo, Fisher, Goldstar, Hitachi, Panasonic, JVC, RCA and much much more!

Call now for a **FREE 228 page** catalog packed with over 2,600 new items.
 Source Code: POM

CALL TOLL FREE
1-800-338-0531

Parts Express 340 E. Cargill St. Dept. 11111 Ohio 45402-1251
 Phone: 513-222-0173 Fax: 513-222-4644

CIRCLE 147 ON FREE INFORMATION CARD

Prototype it..... FAST!

with ProtoQuick 8051 or 28

- Complete single board computers
- 120 pin DIP package and 80 pin DIP
- 12 sq. in. plated through proto area
- PCB20 C serial port or DB25 option
- 30 pins in EPROM w/ source code
- Assembly ready to run - 5v only
- MS-DOS data assembler included

ProtoQuick 28 and 8051
\$99.00 each

Run prototype applications or experimental hardware from the serial port - WITHOUT PROGRAMMING!

Software Science
 3786 Foundation Road
 Channahon, IL 61414 USA
 (513) 561-2060

Remote Automotive Engine Starters

Warm up your car in the winter. Cool it off in the summer.
 Real Time clock based. Programs like a VCR. The engine starts at the times you set, up to 4 start times per day. Also set the run time, day and time.

SmartStart MCS-100
 Start and stop the engine, and honk the horn with a 2 channel key chain transmitter up to 300 ft. away.

TouchStart MCS-200

Plans and parts list only... \$14.00 each + \$3 S&H.
 Send check or M.O. to: Modern Circuit Solutions Corporation
 P.O. Box 212 Cedarburg, WI 53012-212

FREE ALARM SYSTEM

TOP QUALITY, U.L. LISTED WIRELESS SYSTEM
 PROTECT YOUR FAMILY AND POSSESSIONS
 INSTALL IT YOURSELF AND SAVE
 MONITORING AGREEMENT REQUIRED
 FREE INFORMATION EASY TO INSTALL

FORT KNOX SECURITY SYSTEMS, INC.
800-388-5669 WWW.FORTKNOX.COM

Many Electronics inc

RFT, FTG, PIO-Supers,
 Filters, FTG KIT's
800-716-3561 9-7 est

CONVERTERS & DESCRAMBLERS

TARGET ELECTRONICS
(800) 995-1749

We sell Test Chips!
 MC, VISA, AE, C.O.D

DEALERS WELCOME!

Don't rent own!
Cable TV Descramblers
 We'll beat Any Price!

- Same Day Shipping!
- 30 Day Money Back Guarantee!
- Credit Cards/C.O.D.

Have make and model number of equipment used in your area

REPLACEMENTS FOR MOST SYSTEMS
 CALL TOLL FREE

CABLE DISCOUNT
1-800-684-9135

NO NEW JERSEY SALES!
 Anyone implying theft of service will be denied assistance.

HOME AUTOMATION

World's Largest Selection!

Widest Selection of
X-10 Devices Available

Hundreds of hard-to-find automation, X-10 and wireless control products. Computer interfaces, software, development tools, lighting control, telephone systems, security systems, surveillance cameras, infra-red audio/video control, HVAC, pet care automation, wiring supplies, books and videos and much more!

Packed with Pictures & Diagrams



HOME AUTOMATION SYSTEMS, INC.

Questions: 714-708-0610 Fax: 714-708-0614
 e-mail: catalog@smarhome.com
 http://www.smarhome.com/smarhome

Lowest Prices Guaranteed!

24 Hours **Call 800-SMART-HOME 800-762-7846**

THERE'S NO REASON TO KEEP CABLE
 YOU MAY ALREADY BE APPROVED
 FOR THIS EXCITING OFFER

WE WILL SHIP TO YOUR DOOR

\$18

A NEW 2nd GENERATION

- RCA 18" Satellite System •
- RCA Installation JKII •
- RCA Surge Suppressor •

This Offer also includes
ONE FREE MONTH of USSB
 Entertainment Plus, Viewing Guide

PER MONTH
 *programming additional

Financing by GE Capital, Resolving Credit. Free installation, shipping & handling. Programming not included. One month DIRECTV TV Total Choice Package required.

CALL TODAY WHILE SUPPLIES LAST. OPERATORS ARE STANDING BY.

(888) 711-DISH
 (3 4 7 4)

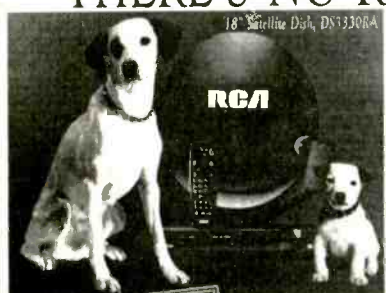

ACT NOW & GET A \$100 REBATE FROM RCA



DSS
 DIGITAL SATELLITE SYSTEM

CABLE TV CONVERTERS

Equipment & Accessories
Wholesalers Welcome

Call C&D ELECTRONICS
1-800-310-1153 M-F 10a-8p

BROADCAST TRANSMITTER

The FMS2 studio quality transmitter is FULLY crystal controlled and programmable to any FM broadcast frequency.

Unit features: ALC, 2:1 compressor, audio buffer / amplifier, pre-emphasis, roll off filter, stereo generator, digital PLL tuning, 75 MHz-125MHz bandwidth, 500mW power output and a special introductory price of only \$295.00 US

SCHEMATICS FOR UNIT: \$27 CATALOG 800-504-1178
 FAX POLL INFO 416-243-1067 TEL LINE 416-243-2260



Plant Trees for America

Ten free Colorado blue spruces, or other conifers selected to grow in your area will be given to each person who joins the Arbor Day Foundation.

To become a member and to receive your free trees, send a \$10 membership contribution to Ten Blue Spruces, National Arbor Day Foundation, 100 Arbor Avenue, Nebraska City, NE 68410.

Join today, and plant your Trees for America!



-SPY, INC.

ELECTRONIC SURVEILLANCE & PRIVACY ASSURANCE DEVICES
 Cell & Home Phone Scramblers, Covert Video Cameras, State of the Art Electronic Devices

"YOU NEVER KNOW WHO'S WATCHING OR LISTENING"

For a Full Catalog Send \$5 Check or M.O. to:
T-SPY, Inc., PO Box 1707PE Amherst, NY 14226
 or call (716) 874-1707

CABLE TV DESCRAMBLERS

Never rent again! Save \$100's on premium Cable TV Descramblers & Converters compatible with Jerrold, Scientific Atlanta, Zenith, Pioneer, Tocom and More! Get your best prices and call us last! Please have the MAKE & MODEL # of your area's cable box ready.
GUARANTEED TO WORK IN YOUR AREA!
 1 year warranty and 30 day money back guarantee!
Allstar Electronics 1-800-782-7214

CABLE TV CHANNELS

EQUIPMENT GUARANTEED

SAVE \$'000's

The Nationwide source for cable TV equipment.

BUY WHERE THE DEALERS BUY!

FREE TV Cable Descramblers, Converters and Magic Box Catalog. Open Every Day!

Your VCR TAPES CAN PLAY AS CLEAR AS DAY!

FREE UNJAM NOW WITH Video Decoder!

- Copy any rental/bought tape
- Power Cord and RC Plug included

2 Year Warranty

CALL NOW!

Member Better Business Bureau

MEGA ELECTRONICS!

1-800-676-6342 VISA • MC • COD

FREE 30 DAY TRIAL!

ENGINEERS, RESEARCHERS HOBBYISTS: EXCITING NEW PRODUCTS!!

Oscilloscope Probes: from \$99.95
100 MHz DIFFERENTIAL PROBE (3 ranges)
100 MHz ACTIVE PROBE (2 ranges)

4 1/2 Digit LED Panel Meter \$59.95

Electromagnetic Radiation Monitor \$79.95

Handheld Radiation Survey Meter \$149.95

250 kV Tesla Coil (complete 12V kit) \$149.95

Low cost high voltage power supplies, coaxial cables, connectors and much more. *We stand behind our products with a 1 year warranty.*

Call for our free catalogue

Synergex Scientific

1-800-366-5147

Toronto, Canada All prices in U.S. dollars

OWN A MACHINE SHOP

The Smithy
3-in-1
lathe-mill-
drill
gives
you all 3



basic machine tools in one easy-to-use benchtop machine. Save time & money. For home or business.

Call for your FREE Info Pak & instructional video.

1-800-345-6342

Ask for
Operator PE12

FREE
Machining
Basics video

Smithy

Dept. PE12
PO Box 1517
Ann Arbor, MI
48106-1517

It could be a best seller.

But it's free.

You can't buy the Consumer Information Catalog anywhere. You can send for it, free! It's your guide to more than 200 free or low-cost government publications about getting federal benefits, finding jobs, staying healthy, and more. The information is priceless. Send your name and address to:

**Consumer
Information Center
Department BEST
Pueblo, CO 81009**

1-800-USA-NAVY.

World Wide Web:

<http://www.navyjobs.com>

Sound Activated Christmas Tree Kit

Twenty-Five Red, Green And Yellow LED's Flash & Sparkle Randomly When Activated By Any Sound, Voice, Music Or Ambient Room Noise.

Christmas Sale!

Complete Kit
With Stand
C-F606-E
\$21.90

Assembled
With Battery
C-S606-E
\$26.90

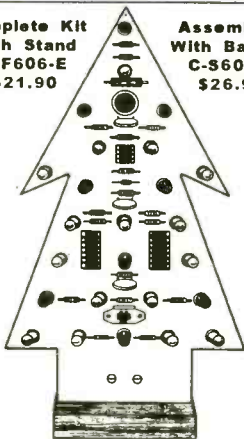

Green Solder Masked Board Size
Printed Circuit Board 4.5" x 8.5"

Visa/MC, Check Or Money Order

1-800-892-8000



Please Add \$4.50 For S&H
Calif. Add 8.25% Sales Tax



Cal West Supply, Inc. 31320 Via Colinas #105
Westlake Village, CA 91362



Free Catalog

If you are not getting this catalog you are missing out on some of the best deals in electronics today! We have thousands of items ranging from unique, hard-to-find parts to standard production components. Call, write, or fax today to start your free subscription to the most unique catalog in the industry, filled with super values on surplus electronic and hobbyist type items. If you have a friend who would like to receive our catalog, send us their name and address and we will gladly forward them a complementary 100 page catalog.

Why pay more? Call today.



340 East First Street Fax Order Line
Dayton, Ohio 45402 1-800-344-6324

Order Toll-Free 1-800-344-4465

CIRCLE 149 ON FREE INFORMATION CARD

Trees Make a World of Difference™

Find out how trees can make a world of difference for you, and your neighborhood. For your free brochure write: Trees For America, The National Arbor Day Foundation, Nebraska City, NE 68410.

The National
Arbor Day Foundation

NEW 18" Dish System
 Save 30-50% on Programming.
 Compare to Cable and other 18" Dishes!
 Call Now!
 800-500-9264
Skyrison, Inc.
 1038 Frouder Dr. Fargo, ND 58107
 The Best Television Comes on a DISH™
 See full page ad in The Market Center

!!! BROADCAST FARTHER !!!
 The model 220 is a 80-110MHz RF amplifier that connects to mono or stereo FM transmitters and produces a powerful 2-15 watt signal which could broadcast up to 5 miles or more! Requires 50-150 mW drive.
 Step by step plans complete with part source information and antenna designs... ONLY \$14 PLUS \$2 S&H NO C.O.D.'s
Progressive Concepts
 BOX 586 STREAMWOOD, IL 60107
 (630)736-9822 FAX (630)736-0353

CABLE TV CONVERTERS
 Equipment & Accessories
 Wholesalers Welcome
 Call C&D ELECTRONICS
 1-800-310-1153 M-F 10a-8p

Discover DC Electronics

17-Module Course -- Only \$49.95

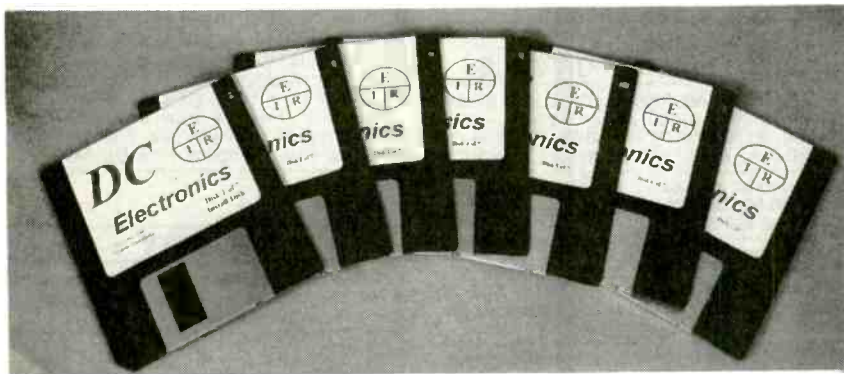

Contains everything you ever needed to know about DC electronics. Whether you are a professional working in electronics and you want a review of the basics, or a student or hobbyist new to this field and need a good self-paced course, this is the perfect way to get started.

The course starts with basics and assumes you know nothing about electronics. It teaches the required math, how to use a scientific calculator, and the metric notation system. Each module has been written by an electronics instructor, and will directly from a floppy or from a menu-driven system on your hard drive. Every module includes a review, summary, quiz, and a final exam that can be printed out. Important points are animated to make the explanation clear.

System requirements: IBM Compatible, 512K RAM, VGA Color, Hard Drive and DOS 3.2 or newer.



Here are the Modules

- | | |
|---|--------------------------------------|
| 1. Atoms and Electrons | 10. Series / Parallel Circuits |
| 2. Volts / Current / Resistance | 11. Voltage Dividers |
| 3. Numbers greater than one
Scientific - metric notation | 12. Kirchhoff's Law |
| 4. Numbers less than one
Scientific - metric notation | 13. Advanced DC Circuit Analysis |
| 5. Resistor Color Codes | 14. Capacitors / RC Time Constants |
| 6. Using Calculators | 15. Introduction to Magnetism |
| 7. Ohms Law and Power | 16. Inductors and L/R Time Constants |
| 8. Series Circuits | 17. Volt/Ohm/Current Meters |
| 9. Parallel Circuits | |

Clagg Inc. P.O. Box 4099, Farmingdale, NY 11735

Send me my course, today! Charge me the special introductory price!

Name _____ \$49.95 + \$4.95 shipping

Address _____

Address _____

City _____ State _____

Zip _____

Payment Enclosed \$ _____

Check Money Order Credit Card

New York residents add local sales taxes. Canadians add \$6

per order. Credit card orders by phone or fax. Automated

telephone orders 516-293-3751. Fax 516-293-3115.

Allow 4 to 6 weeks for delivery.

Credit Card Info

MC Visa

Card # _____

Exp Date _____

Signature _____

Converters & Descramblers

Call 1-800-715-6789

30 Day Money Back Guarantee

FREE Catalog



...It's Full of Stars

- Panasonic®
- Jerrold®
- Pioneer®
- Zenith®
- Scientific Atlanta®

ALL MAJOR CREDIT CARDS ACCEPTED

13492 Research Blvd • Suite 120-113 • Austin, TX 78750

Debco is a Kit Builders Paradise

Electronic Kits - Plans - Parts - Computers - Amateur Radio



Call Debco today for your FREE copy of

The Electronic Experimenter's Journal

1 800 423 - 4499

Debco Electronics 4025 Edwards Rd. Cincinnati, OH 45209

IMPROVE YOUR IMAGE!

WITH OUR VIDEO STABILIZERS

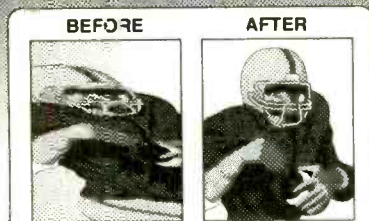

The clearest picture possible playing back movies. **GUARANTEE** to eliminate copy protection.

- No Rolls/Jitters/Flickers/Fading
- Works on all TV's, VCR's Beta & Cable
- Gold Video Connectors & Cables Included
- 2 Year Warranty
- Money Back Guarantee

VISION ELECTRONICS

1-800-562-2252

2125 S. 156TH CIRCLE • OMAHA, NE 68130

MONDO • TRONICS •

ROBOT STORE

* KITS *

Your

* BOOKS *

Mailorder

* PARTS *

Source

* VIDEOS *

For

* MODELS *

Robots!

* MORE! *

(REQUEST OUR FREE CATALOG)

www.robotstore.com

800-374-5764

Or write to us:

524 San Anselmo Ave #107-121
San Anselmo CA 94960

Phone 415-455-9330

Fax 415-455-9333

Email info@mondo.com

CLASSIFIED

MISCELLANEOUS ELECTRONICS FOR SALE

THE Case Against Patents. Thoroughly tested and proven alternatives that work in the real world. \$28.50. **SYNERGETICS PRESS**, Box 809-C, Thatcher, AZ 85552. (520) 428-4073. Visa/MC.

57 Electronic Journals. How to get free subscriptions. \$5.00. **CABLETRONICS**, Box 30502PE, Bethesda, MD 20824.

POOR reception on your A.M. radio? Our signal booster will help. Guaranteed! Send \$2.00 for details (refundable with order). **FALA ELECTRONICS**, PO Box 1376, Dept. 4, Milwaukee, WI 53201.

"PERSONAL Computer Data Acquisition and Control Made Absolutely Simple." Valued, respected training manual. Digital engineer tells how: Measure/control the physical world. Remote or local. **Easy! Order today!** \$5.00. **CYBER**, Box 53743, Lubbock, TX 79453.

SILENT sam, patented turn signal reminder for all vehicles. Doesn't bug you. Beeps only if you forget to cancel. \$22.00. Free flyer. Toll free 1 (800) 398-5605.

DO-It-Yourself Remote car starter. Save\$\$\$. 800# support. Manufacturer's lifetime warranty. **Free bonus** if you order today. Only \$109.99. Free shipping. Send chk/moneyorder to, **M. AL**, Dept-PEN, 20815 Brooklawn, Dearborn Hts., MI 48127-2614.

HEWLETT-Packard equipment - Wave analyzer, audio signal generator and others. Very reasonable. Phone (818) 786-0989. Fax (818) 908-1497.

PLANS-KITS-SCHEMATICS

TRANSISTOR Data Tables — Given are the basic electronic parameters for the worlds popular transistors in one volume. A must for servicemen, hobbyists and engineers. Order "Transistor Data Tables" (BP401) for only \$9.95 (price includes shipping) from **ELECTRONIC TECHNOLOGY TODAY, INC.**, PO Box 240, Massapequa Park, NY 11762-0240. USA and Canada only. US funds.

CRYSTAL Set Handbook — Visit antiquity by building the radios your grandfather built. Assemble a "Quaker Oats" rig, wind coils that work and make it look like the 1920s! Only \$10.95 plus \$4.00 for shipping and handling. **CLAGGK INC.**, PO Box 4099, Farmingdale, NY 11735. US funds only! USA and Canada — no foreign orders.

HEATH COMPANY is selling photocopies of most Heathkit manuals. Only authorized source for copyright manuals. Phone: (616) 925-5899, 8-4 ET.

AWESOME Kits: Voice changer, levitator, laser, gas sensor and more! Catalog \$1.00. **LNS TECHNOLOGIES**, 20993 Foothill Blvd., Suite 307P, Hayward, CA 94541.

HOME automation via phone. No expensive computers. Furnace, air conditioner, on remotely. Plans, \$10.95. **AMR CTR.**, PO Box 1176, Waltham, MA 02254-1176.

NEURAL Network. Study and build this fascinating learning synthetic brain. Details: **THINK-2** 2-89 Emma, Guelph, ON, N1E 1V1.

HACKERS catalog. **Hard-To-Find** kits and assembled equipment (**Red box, spy, cable** etc.). **Low prices.** \$1.00. **SMITH-05**, Box 371, Cedar Grove, NJ 07009.

ELECTRONIC Project Kits. www.qkits.com. 1 (888) GO-4-KITS, 292 Queen St., Kingston, ON., K7K 1B8. **QUALITY KITS.**

CARL'S Electronics - The Cable Hacker's Guide, electronic plans and kits, and much more. Come check us out at <http://www.ultranet.com/~carlton>, or call for more information (508) 534-3228.

MONITORS made simple. Learn to repair computer monitors! Case studies, illustrations, parts sources, manufacturers included! 136 pages, soft-cover. \$19.95 + \$2.50 shipping. Order today! Send check or money order to **PIKES PEAK PRESS**, 321 W. Henrietta Ave., P.O. Box 1801, Woodland Park, CO 80866. (719) 687-1499.

SECURITY

ELECTRONIC sales of security systems for home, apartment, or business, will send information, call (812) 295-4240.

REPAIRS-SERVICES

COMPUTER repairs only \$59.95!! Parts extra! Sales, service, upgrades and more. **BEACH RADIO**, Quincy, MA. (617) 823-2985 or (617) 928-0626.

TEST EQUIPMENT

TECHNICIANS: Electronic component tester for use with oscilloscope. Satisfaction guaranteed. \$29.95 plus S&H. Info.: **ELECTROHM**, 529 Brentwood, Lawrence, KS, 66049. Fax: (913) 832-2481.

BUSINESS OPPORTUNITIES

START your own technical venture! Don Lancaster's newly updated **Incredible Secret Money Machine II** tells how. We now have autographed copies of the Guru's underground classic for \$18.50. **SYNERGETICS PRESS**, Box 809-C, Thatcher, AZ 85552. (520) 428-4073. Visa/MC.

INVENTIONS, ideas, new products! Presentation to industry/exhibition at national innovation exposition. Patent services. 1 (800)-288-IDEA.

PERSONAL computer owners earn thousands part time. Free report. 100 best ways. **C.A.P.A.F.**, PO Box 12068, Hauppauge, NY 11788.

TELEVISION pays! Join us marketing the fastest selling, most advanced digital minidish satellite home entertainment system. Discount prices, you profit! Not MLM. No startup fees. Free information: (800) 899-9707, 8am-10pm Pacific.

EDUCATION

LEARN IBM PC Assembly Language. Disk \$5.00, Book \$18.00. **ZIPFAST**, Box 12236, Lexington, KY 40581-2238.

WINDOWS 95 Kickoff — Staring at Windows 95 and not knowing what to do? Then get your personal copy of "Windows 95-One Step at a Time" (BP399). Only \$9.95 (price includes shipping) from **ELECTRONIC TECHNOLOGY TODAY, INC.**, PO Box 240, Massapequa Park, NY 11762-0240. USA and Canada only. US funds.

FCC/CET software. General Radiotelephone, CET preparation. Five 3.5 inch diskettes. Q/A format: interactive, comprehensive. **EGA/VGA.** Complete program, \$35.00. **TUTOR-TECH**, 170 Locksunat Way, #2, Sunnyvale, CA 94087. (408) 481-9543.

ELECTRONICS, languages, more! US Military courses. Free catalog. **FTP**, Box 1218P, GlenLake, MN 55345.

THE Revelation of Electricity: If you have not read this 23-page report, you probably do not really understand the basic electric circuit. \$15.00. Michigan residents add .90 cents sales tax. **REALITY PRESS**, Dept. D, Box 15756, Ann Arbor, MI 48106-5756.

CLASSIFIED

CABLE TV

ATTN. CABLE box owners! Order your ID signal stopper now. Send \$23.00 to **R.R. ENTERPRISE**, Box 3532, Easton, PA 18043.

CABLE descrambling, new secret manual. Build your own descramblers for cable and subscription TV. Instructions, schematics for **SSAVI**, gated sync, sinewave, some free methods (HBO, Cinemax, Showtime, UHF, Adult) \$12.95, \$2.00 postage. **CABLETRONICS**, Box 30502PE, Bethesda, MD 20824.

CABLE TV equipment & accessories. Wholesalers welcome! 30 day moneyback guarantee! Free catalog! **PROFORMANCE ELECTRONICS, INC.**, 1 (800) 815-1512.

CABLE descrambler! Anyone can build in seven steps with **Radio Shack** parts. Plans/kits from \$5.00. plus free bonus. 1 (800) 818-3103.

DESCRAMBLE cable using simple circuit. E-Z to follow instructions \$10.00. Complete kit with free "Bullet Stopper". \$20.00. 1 (800) 522-8053.

CABLE TV Test Chips for Jerrrod, Tocom, Pioneer, Scientific Atlanta, etc... **Quick Installation!** New Multi-Mode modules available. Prices from \$5.00 each. 1 (800) 766-9025.

CABLE "Bullet Terminator/I.D. Blocker". Electronically shields yourself and your box. Factory direct. Lifetime guarantee. \$14.95. 1 (800) 820-9024.

CABLE TV notch filters. Request our free brochure by calling our voicemail at 1 (800) 433-6319 or write to **STAR CIRCUITS**, PO Box 94917, Las Vegas, NV 89193. Visit our web site at <http://ourworld.compuserve.com/homepages/starcircuits>

CABLE TV descramblers. One piece units. Pioneer 6310's, Scientific Atlanta 8580's, DPV7's and others. Lowest prices. Money back guarantee. Houston, TX (713) 691-4610.

CABLE converters and test modules. Money back guarantee. Extremely competitive. Wholesale pricing. Catalog. Credit cards. 1 (888) 443-9185.

CABLE box discount, original equipment, descramblers, converters, Super-Q, quantity discount, call now. We'll meet or beat the competition. **TC TRONICS**, 1 (718) 349-6506.

CABLE TV, descramblers, converters. Quantity discounts. 30 day free trial. Competitive prices. Call now! 1 (800) 322-0921 **REGAL SALES, INC.**

8580 Compatible 150, any test chip or master file 25. Call (908) 370-0160. 24 hours. Satisfaction guaranteed.

DESCRAMBLE cable with simple circuit added to Radio Shack RF modulator and using VCR as tuner, instructions \$10.00. **TELCOM**, PO Box 832P12, Brusly, LA 70719.

DESCRAMBLE cable using any VCR as a cable box. RF parts available at Radio Shack. Send \$5.00 cash or money order only and a SASE to **ADVANCE**, 1209 Chartiens Ave., McKees Rocks, PA 15136.

BULLET Zapper and "I.D. Killer" Modules! Includes free descrambler plans! **VISA/MC/AMEX/COD: \$10.00.** (3/\$22.00). (912) 937-5485 ext. 5. **BEL-LABS.**

SATELLITE EQUIPMENT

VIDEOCYEPHER II descrambling manual. Schematics, video and audio. Explains **DES, EPROM, CloneMaster, Pay-per-view** (HBO, Cinemax, Showtime, Adult, etc.) \$16.95, \$2.00 postage. Schematics for Videocypher Plus, \$20.00. Schematics for Videocypher 032, \$15.00. Collection of Software to copy and alter EPROM codes, \$25.00. **VCII Plus EPROM**, binary and source code, \$30.00. **CABLETRONICS**, Box 30502PE, Bethesda, MD 20824.

SATELLITE Radio Book and Guide. New book covers all audio services, SCPC, subcarriers, FM Squared, facsimile, press services, weather services. Simple how-to-receive instructions. \$16.95 plus \$3.00 Priority Mail. **UNIVERSAL ELECTRONICS**, 4555 Groves Road, #12, Columbus, OH 43232. (614) 866-4605.

OBTAINING Sound for your **VCII** and **VCII Plus** is easy. No codes needed. Also **DSS Test Card** information. **Details: 1 (800) 211-5635.**

IMPROVE your satellite picture. **Focus Maximizer** is a diagnostic tool that optimizes feedhorn spacings. \$26.50. Free brochure. **WATERSHED ELECTRONIC DEVELOPMENT** (800) 756-7854.

KU-BAND satellite universal 3' dish 0.9dB LNBF remote receiver. Free software \$249.00. **smaller@wny.com. PME** (716) 691-5618.

SOUND for Videocypher-II and plus without codes. Free details. **SASE. NASSIRIAN**, Box 382-P, Rio Linda, CA 95673.

FIRE your cable company! Get all the channels for less with your own digital satellite home entertainment system. Free information: (800) 899-9707, 8am-10pm Pacific.

KU Satellite systems from \$349.50 complete. Legally intercepts network feeds. Sports and news galore! No monthly charge. Free brochure. (520) 624-3907.

COMPUTER SOFTWARE

ZSORT. Sort huge files fast. Disk \$5.00. Manual \$10.00. Box 12238, Lexington, KY 40581-2238.

COMPONENTS

RESISTORS 20 for \$1.00. **LEDS** 4 for \$1.00. Catalog \$1.00. **ZIPFAST**, Box 12238, Lexington, KY 40581-2238.

CRYSTALS: 2Way/pager/scanner/micro-processor, delivery/performance guaranteed. Prototype/productions runs welcome. **VELCO ELECTRONICS**, (716) 924-2073.

AUDIO-VIDEO-LASERS

VIDEO stabilizer. Eliminates all the latest copyguards on rented videotapes. 30 day moneyback. AC powered. \$45.95 + \$6.00 S&H. **STAR DEVELOPMENT**, Box 92457, Milwaukee, WI. 53202 (414) 860-1471.

CELLULAR TELEPHONES

No second line charge! Enjoy convenience of multiple phones on one number. 1 (800) 227-8290. **ohlnd@aol.com**

Picture the Seven
Dwarfs without
a forest.

Only You Can Prevent Forest Fires.



USA Forest Service and your State Forester.

**Create Your Own
Virtual Worlds
and Share Them with
10 Million People!**

- Learn How to Build Your Own Virtual Reality "Virtual Worlds" Quickly and Easily!
- Explore your Virtual Worlds on Your PC or put them on the Internet for Others to Explore!
- Explore your Worlds with your PC monitor and keyboard, or with Greater Immersion using Low-cost Homebrew Virtual Reality Equipment!

Convert this \$69 Mattel Powerglove into a VR Glove! Save \$Thousands! We show you how, and where you can buy Powergloves!



VR Goggles with head tracking cost over \$4,000 only a few years ago. Now they're under \$500! And 3-D VR Shutter Glasses are under \$100! Now Immersive VR is affordable!

"A Smorgasborg of info on VR!" -Sid Mirzad
"I love it! At under \$5 per book, don't miss out on this Incredible Value!" - Pam Eitert

Desktop VR contains a complete primer on using VR on your PC, plus: • Where to get low cost HMD's (head mounted displays) & other equip • The famous Mattel Powerglove hack (converting a \$69 Powerglove for use with VR) • Powerglove sources • Listings of virtual world building software • Comprehensive listings of HMD compatibility with popular games & software • Plus much more! • 36 pp.

VRML Primer explains VRML (Internet's "VR Modeling Language"), plus: • Building virtual worlds on the Internet • Virtual world authoring software & where to get it • Great VR worlds to visit on the Internet • Putting your virtual world on the Internet • More! • 32 pp.

Special Report: Virtual Reality an Exploding Technology Exclusive report on the explosion of VR in medical, amusement, consumer & other arenas • News blurbs on market entry by heavyweights & Fortune 500's • The VR marketplace • 28 pp.

VR InfoMania Time saving valuable resources including Listings of Internet websites devoted to VR • Listings of VR books • Listings of VR magazine articles & research papers • Listings of Internet FTP download sites & VR-related newsgroups • Article listings from back issues of VR magazines • Where to go to experience real VR • Reviews of popular VR books • Glossary of VR terms • Great VR applications • The future of virtual sex • Plus Much More! • 88 pp.

FREE DOUBLE BONUS!

FREE! **VR Resource Directory** is your guide to over 600 companies involved with VR products, software, P&D & consulting, plus professional trade organizations, clubs, more! 80 pp. Yours absolutely **FREE!**

FREE! **VR Cartoons** featuring dozens of funny cartoons about VR! Yours absolutely **FREE!** Limited printing, don't miss out! Order today!

Under \$5 Per Publication! **You Get All 6 Publications! ONLY \$49!** Call residents add sales tax **OVER 1/3 OFF! ONLY \$29!** Plus \$3.95 S&H **Special Introductory Price! Includes All 6 Publications!** 3 Day Delivery \$7.95 FedEx Overnight Air \$19.95

30-Day 100% Satisfaction Money-Back Guarantee!
24 HOUR TOLL FREE ORDER LINE 1-800-951-7100
FAX ORDERS 619-485-8968

Send Check or Money Order to: Virtual Reality Publishing 1644e Bernardo Center Drive, Suite 378, San Diego CA 92128

*Some shipping on orders received before 4 pm EST. Personal check orders need 2 weeks for credit card. No COD orders. All orders must be paid in US funds. Call for int'l S&H charges. We participate in the BBB Case Program through the Better Business Bureau of San Diego.

ORDER TODAY... HAVE IT TOMORROW!"

ADVERTISING INDEX

Popular Electronics does not assume any responsibility for errors that may appear in the index below.

Free Information Number	Page	Free Information Number	Page
—	Aegis Research, Canada92	—	Lindsay Publications94
—	AES89	—	Magnavox (Phillips)11
26	Alfa Electronics76	140	MCM90
28	All Electronics86	—	Mega Electronics97
—	Allison Technology95	149	Mendelson's98
—	Allstar Electronics95	—	Mental Automation78
—	AMC Sales78	157	MicroCode Engineering5
—	American Innovations82	—	Millennium Enterprises99
—	Andromeda Research89	—	Modern Electronics95
163	Barnes & Noble3	—	Mondo-tronics100
—	Basic Electrical Supply80	164	Mouser Electronics50
30	Bel-Merit94	—	NRI Schools69
32	C&S Sales, Inc.84	43	OptoelectronicsCV4
—	Cable Discount97	—	Orion Electronics96
—	Cal West Supply98	156	ParallaxCV3
—	Circuit Specialists72	147	Parts Express96
—	Cleveland Institute of Electronics .19	47	Prairie Digital Inc.83
—	Command Productions92	46	Print83
—	Comtrad Industries7, 15, 49	45	Print82
—	Consumertronics93	—	Quality Entertainment95
—	Cook's Institute46	14	Radio Shack22
—	DC Electronics99	—	Silicon Valley Surplus94
139	Dalbani75	—	Skyvision Inc.87
162	Davis Instruments10	—	Smithy Company98
—	Desert Cable96	—	Spytech50
148	Electronic Rainbow79	—	Synergex Scientific98
—	Electronic Technology Today .47, 71	—	Tab Books37
—	EMAC78	—	T.C. Tronics97
158	Fluke Corp.9	—	Tecma Maquila Services13
—	Foley-Belsaw81	150	Telulex83
—	Forest Electronics93	—	The Satellite Center98
—	Fotronic Corporation77	136	UCANDO Videos82
—	General Device Instruments89	—	US Cyberlab88
—	Grantham College of Engineering .4	—	Virtual Reality Publishing101
—	Greenleaf Electronics Inc.80	—	Vision Electronics99
—	Home Automation Systems97	—	Visual Communications94
—	I.E.C.95	159	Wavetek Corp.31
—	Information Unlimited74	—	Weeder Technologies88
13	Interactive Image Technologies CV2	—	World College (Div. of C.I.E.)65
—	Intronics, Inc.89	—	WPT Publications78
—	Kableworks78	134	Xandi Electronics91
—	KDE Electronics93		

ADVERTISING SALES OFFICES

Gernsback Publications, Inc.
 500 Bi-County Blvd.
 Farmingdale, NY 11735-3931
 1-(516) 293-3000
 Fax 1-(516) 293-3115

Larry Steckler, EHF/CET
 President (ext. 201)

Christina Estrada
 Assistant to the President (ext. 209)

For Advertising ONLY
 1-516-293-3000
 Fax 1-516-293-3115

Larry Steckler
 publisher

Arline Fishman
 advertising director (ext. 206)

Michele Torriolo
 advertising assistant (ext. 211)

Adria Coren
 credit manager (ext. 208)

**Subscription/
 Customer Service/
 Order Entry**
 1-800-827-0383
 7:30 AM - 8:30 PM EST

ADVERTISING SALES OFFICES EAST/SOUTHEAST

Stanley Levitan
 Eastern Sales
 1 Overlook Ave.
 Great Neck, NY 11021-3750
 1-516-487-9357, 1-516-293-3000
 Fax 1-516-487-8402

MIDWEST/Texas/Arkansas/ Oklahoma, Colorado, Arizona

Ralph Bergen
 Midwest Sales
 One Northfield Plaza, Suite 300
 Northfield, IL 60093-1214
 1-847-559-0555
 Fax 1-847-559-0562
 bergenrj@aol.com

PACIFIC COAST/Mountain States

Anita Bartman
 Hutch Looney & Assoc., Inc.
 6310 San Vicente Blvd.
 Suite 360
 Los Angeles, CA 90048-5426
 1-213-931-3444 (ext. 227)
 Fax 1-213-931-7309

BASIC STAMP[®] COMPUTERS

Tiny computers run PBASIC[™] programs

BASIC Stamps are component-sized computers that run PBASIC programs. They have 8 or 16 I/O lines, which can be used for a variety of digital and analog purposes. And their PBASIC language is both familiar and extensive; the language includes FOR...NEXT, IF...THEN, and GOTO, as well as XOUT, SHIFTOUT, DTMFOUT, and other special commands.

We've been making BASIC Stamps for several years, and we've accumulated some interesting photos along the way. In this ad, we thought it might be fun to show some of these photos.



Marvin Green and his students in Hillsboro, Oregon, use BASIC Stamps to make small robots.



John McLean uses BASIC Stamps to gather data in Lechugutulla Cave (America's deepest cave, located in Carlsbad Caverns National Park).



Charles Walsh and his students in Great Falls, Montana, use BASIC Stamps in robotics projects.



Although it may be difficult to see here, that's a BS1-IC next to the white wires.

Issac Kirtz and John Bishop use BASIC Stamps in artificial hands at the Bloorview MacMillan Centre in Toronto, Canada.

BS1-IC Module [™] **\$34**
 8 I/O lines
 80 instructions max.
 2000 instructions/sec.
 2400 baud serial I/O
 14-pin SIP module



FaxBack #6002

I/O instructions for pushbuttons, potentiometers, pulse measurement, PWM, serial I/O, sound, etc.

Programming Package **\$99**

Contains programming materials needed to program BASIC Stamps; includes cables, PC software, manuals, and free tech. support.

Carrier Boards **\$15-\$20**

Provide small prototyping area, 9-volt battery clips, and programming connector. Not absolutely necessary, but recommended to make programming easy.

BS2-IC Module [™] **\$49**
 16 I/O lines
 500 instructions max.
 4000 instructions/sec.
 50k baud serial I/O
 24-pin DIP module

Same I/O instructions as BS1, plus touch-tones, frequency generation, pulse counting, serial shift registers, X-10 powerline control, etc. I/O functions common to both modules have a higher resolution on the BS2-IC, due to its faster clock speed.

Data Collection Board **\$179**

This nifty board from Scott Edwards Electronics provides everything you need to use the BS2-IC as a data logger. Includes ample prototyping area, two 12-bit analog inputs, a real-time clock, and 32K bytes of EEPROM storage. BS2-IC module not included.



PARALLAX

3805 Atherton Road, #102 • Rocklin, CA 95765 • USA • (916) 624-8333 • Fax: 624-8003 • FaxBack: 624-1869 • BBS: 624-7101
 E-mail: info@parallaxinc.com • Ftp: ftp.parallaxinc.com • World-wide-web: http://www.parallaxinc.com

Australia +61 39720 5344, +61 67 722 777 • Austria +49 241 918 908 • Belgium +32 41 77 51 51 • Bulgaria +359 2 72 77 50 • Brazil +55 11 453 5588, +55 11 801 0045 • Canada (514) 336-9426 • Czech Republic +42 49 5813 252 • Egypt +202 267 0147 • Finland +358 31 266 1885 • France +33 20 52 98 52 • Germany +49 241 918 900 • Greece +30 1 902 0115 • Hong Kong +852 2720 0255 • Hungary +36 1163 2879 • India +91 422 232 561 • Ireland +44 1 977 683 665 • Israel +972 3 498 543 • Japan +81 3 3251 1779 • Netherlands +31 1045 04949 • New Zealand +61 39720 5344 (PICs), +61 67 722 777 (Stamps) • Poland +48 34 648 882 • Slovak Republic +42 7 583 2574 • Sweden +46 705 76 14 54, +46 431 41 00 88 • Switzerland +49 241 918 900 • Taiwan +886 2 647 1978 • United Kingdom +44 1 977 683 665 • United States (800) 344-4539 (Digi-Key), (800) 831-4242 (Jameco), (800) 538-5000 (JDR)

PBASIC, BS1-IC, and BS2-IC are trademarks and BASIC Stamp & the Parallax logo are registered trademarks of Parallax, Inc. Prices do not include shipping and applicable sales tax • Features and prices subject to change without notice. • Prices are U.S. prices only; prices in other countries may vary.

0796PESR

CIRCLE 156 ON FREE INFORMATION CARD

**NEW
Xplorer**

It's a receiver
a counter, a recorder, a decoder...



U.S. Patent No. 5,471,402

•Two-Line LCD display, first line displays frequency. Second line switches between either CTCSS, DCS, DTMF, Signal Strength, or Numerical Deviation.

The New Xplorer Test Receiver. Ideal for any two-way communications testing or monitoring. The Xplorer is a value packed performer integrating the functions of a CTCSS, DCS, and DTMF Decoder, Frequency Recorder, Nearfield Receiver and more into one hand-held unit. No more guessing when programming a frequency for monitoring-the Xplorer captures nearfield frequencies off the air from 30MHz - 2GHz in less than 1 second. The New Xplorer; providing the power of handheld portability with state of the art functionality and performance.

NMEA-0183 GPS Interface. Connect your GPS to the Xplorer for Mapping applications. (GPS and Mapping Software not included)



•Built-in Speaker. All frequencies received are demodulated for instant monitoring.

and the last instrument you will ever **NEED.**

Features & Specifications

- Frequency Lock Out, Manual Skip, and Auto or Manual Hold
- Internal Speaker, Audio Earphone/Headphone Jack
- Built-in PC Interface, PC Connection Cable and Download Software included
- Relative ten segment Signal Strength Bargraph
- Optimum Maximized Sensitivity for increased nearfield distance reception
- Tape Control Output with Tape Recorder Pause control relay and DTMF Encoder for audio data recording
- High speed FM Communications Nearfield Receiver, sweeps 30MHz - 2GHz in less than 1 second
- Two line LCD displays Frequency and either CTCSS, DCS, DTMF, Deviation or Signal Strength
- NMEA-0183 GPS Interface provides tagging data with location for mapping applications
- Frequency Recording Memory Register logs 500 frequencies with Time, Date, Number of Hits and Latitude/Longitude. (Latitude & Longitude coordinates are only displayed in memory when used with GPS)
- Real-Time Clock/Calendar with lithium battery back-up
- Built-in Rapid Charge NiCad Batteries with 5 hour discharge time and Power Supply included
- Numerical Deviation Display with 1-10kHz and 10-100kHz ranges
- Telescoping Whip full range Antenna included



•Easy touch control pad. F1 & F2 keys control all Xplorer functions. Hold, Skip, Store and Lockout all enabled through the keypad.

Introductory Price \$899

FACTORY DIRECT ORDER LINE 800-327-5912

OPTOELECTRONICS®

5821 NE 14th Avenue • Ft Lauderdale, FL • 33334 • Tel: 954-771-2050 • Fax: 954-771-2052
Visa • MasterCard • C.O.D.

Prices and Specifications are subject to change without notice or obligation
Contact Optoelectronics for mapping software available
CIRCLE 43 ON FREE INFORMATION CARD

Check Out Our Web Site:
www.optoelectronics.com