

A Buyers' Guide To Surplus Sources

February 1996

Popular Electronics®

Build a Vacuum-Tube Amplifier

Get audiophile sound at a hobbyist price

Super Surplus Sources

Find great bargains on new and used electronics parts and equipment

Build a Wireless DC Voltage Probe

The easy way to measure voltages in hard-to-reach places

Build a Vacuum-Tube Transmitter

A great project for the novice ham

Ghost Voices

Our readers talk back!

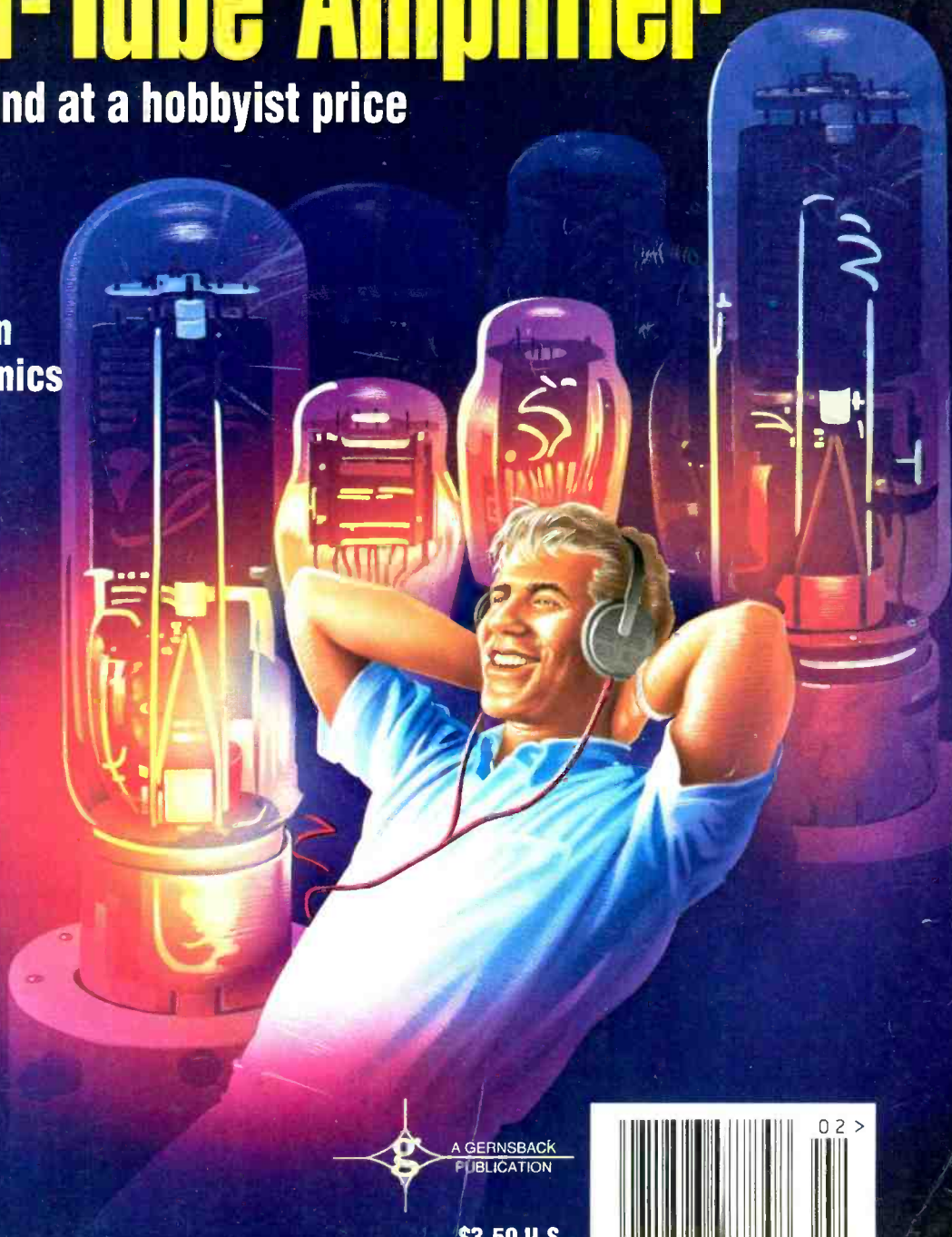

A GERNSBACK PUBLICATION

\$3.50 U.S.
\$3.95 CAN.



Electronics Workbench^{Version 4.1}

NEW
WINDOWS 95/NT
32 BIT VERSION

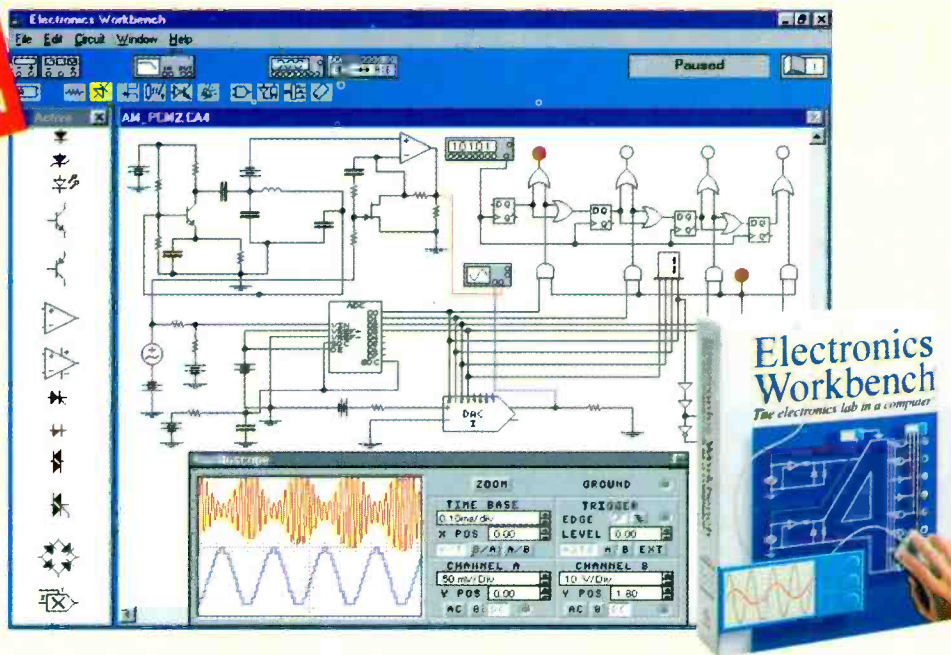

Design and Verify Circuits Faster

Join over 20,000 customers using the affordable mixed-signal simulator

Design faster with Electronics Workbench.

Mix the analog and digital components and ICs in any combination. And with a click of the mouse, try 'what if' scenarios and fine tune your designs. The built-in SPICE simulator gives you real-world waveforms.

All without programming or netlist syntax errors.

And in minutes. Not hours or days.

You'll be up and running sooner. And create better designs faster with Electronics Workbench. We guarantee it!

Electronics Workbench: \$299

- Click & drag schematic capture
- Mixed analog/digital SPICE simulator
- Instant Bode plots and scrollable waveforms
- 50 analog components with 350 models
- 140 digital components and ICs in TTL and CMOS
- Windows 95/NT/3.1, DOS and Macintosh versions
- Free unlimited technical support
- 30-day money-back guarantee

Engineer's Pack: \$599

- Electronics Workbench
- 2,450 models
- Import/Export SPICE netlists
- Export to PCB packages

To discover more about *the* affordable mixed-signal simulator, call us today at:

800-263-5552

Fax: 416-977-1818

Internet: <http://www.interactiv.com>

INTERACTIVE IMAGE TECHNOLOGIES LTD.

908 Niagara Falls Blvd. #068, North Tonawanda, NY 14120-2060

Telephone: 416-977-5550

BBS: 416-977-3540

CompuServe: 71.333.3435

E-mail: ewb@interactiv.com

Australia: 25193933 • Brazil: 11-455-5888 • Cyprus: 262-1088 • Czech Republic: 42-4823454 • Denmark: 33-250109 • Finland: 0-297-5033 • France: 14-908-9000 • Germany: 711-62-7740 • Greece: 1524-9981 • Hungary: 1-215-0082 • India: 11-544-1343
Indonesia: 21-470-0815 • Israel: 3-647-5613 • Italy: 11-437-5549 • Japan: 3-3382-3136 • Malaysia: 3-774-2189 • Mexico: 5-993-5260 • Netherlands: 18031-7666 • New Zealand: 9-267-1756 • Norway: 22-16-7045 • Philippines: 973-27-0118 • Portugal: 181-46609
Singapore: 777-2205 • Slovenia: 01-317-830 • South Africa: 331-68309 • South Korea: 2-222-2431 • Spain: 1-383-8335 • Sri Lanka: 1-865-970 • Sweden: 8740-5500 • Taiwan: 886-2-366-0080 • Thailand: 662-398-6952 • UAE: 4453595 • UK: 203-23-3216



INTERACTIVE

Trademarks are property of their respective holders. Offer is in U.S. dollars and valid only in the United States and Canada. All orders subject to \$15 shipping and handling charge.

CIRCLE 13 ON FREE INFORMATION CARD

Popular Electronics®

FEBRUARY 1996

Vol. 13, No. 2

A GERNSBACK
PUBLICATION

COVER STORY

38 Build a Single-Ended, Vacuum-Tube, Hi-Fi Amplifier

This great-sounding, all-triode, hi-fi amplifier features a design favored by many audiophiles, but can be built at a more "hobbyist-friendly" cost—*Larry Lisle*

CONSTRUCTION

31 Build a Vacuum-Tube Transmitter

This 40-meter, crystal-controlled, CW transmitter is just perfect for the novice ham—*Larry Lisle*

33 Build a Wireless DC Volt Probe

Use it to measure voltages under your car's hood, or in other hard-to-reach places where test leads can be a real nuisance—*Skip Campisi*

FEATURES

41 Pyrometers for the Workbench

Thanks to reduced prices, these heat-sensing tools are now practical for the troubleshooting professional or the serious hobbyist—*Bill Siuru*

44 Super Surplus Sources

Where to get great bargains on new and used equipment and parts, and where to find old, obscure manuals, via mail order and in cyberspace—*Karl T. Thurber*

56 Restoring a Vintage Radio

Collecting old radios is fun, especially if you can return them to their former glory—*L.G. Robertson*

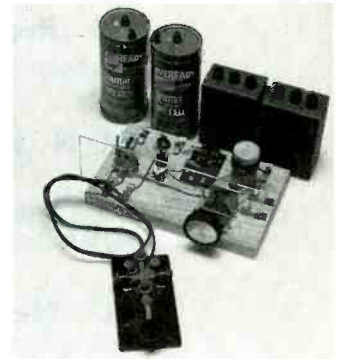

Page 31

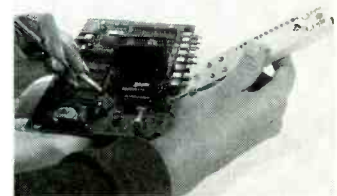

Page 33

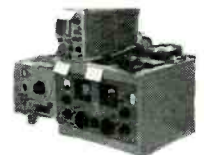

Page 44

POPULAR ELECTRONICS (ISSN 1042-170-X) Published monthly by Gernsback Publications, Inc. 500 Bi-County Boulevard, Farmingdale, NY 11735. Second-Class postage paid at Farmingdale, NY and at additional mailing offices. One-year, twelve issues, subscription rate U.S. and possessions \$21.95, Canada \$28.84 (includes G.S.T. Canadian Goods and Services Tax Registration No. R125166280), all other countries \$29.45. Subscription orders payable in U.S. funds only. International Postal Money Order or check drawn on a U.S. bank. U.S. single copy price \$3.50. Copyright 1995 by Gernsback Publications, Inc. All rights reserved. Hands-on Electronics and Gizmo trademarks are registered in U.S. and Canada by Gernsback Publications, Inc. Popular Electronics trademark is registered in U.S. and Canada by Electronics Technology Today, Inc. and is licensed to Gernsback Publications, Inc. Printed in U.S.A.

Postmaster: Please send address changes to Popular Electronics, Subscription Dept., P.O. Box 338, Mount Morris, IL 61054-9932

A stamped self-addressed envelope must accompany all submitted manuscripts and/or artwork or photographs if their return is desired should they be rejected. We disclaim any responsibility for the loss or damage of manuscripts and/or artwork or photographs while in our possession or otherwise.

As a service to readers, Popular Electronics publishes available plans or information relating to newsworthy products, techniques, and scientific and technological developments. Because of possible variances in the quality and condition of materials and workmanship used by readers, Popular Electronics disclaims any responsibility for the safe and proper functioning of reader-built projects based upon or from plans or information published in this magazine.

P R O D U C T R E V I E W S

22 Hands-On-Report
Philips Fun with Electronics CD-ROM and Experimenter's Lab

24 Product Test Report
Panasonic CT-27SF31S Color TV

C O L U M N S

12 Multimedia Watch
My Windows95 upgrade—*Marc Spiwak*

20 Net Watch
Internet phone—*Dan Karagiannis*

27 Circuit Circus
Let's make some noise!—*Charles D. Rakes*

63 Antique Radio
The ham-receiver project continues—*Marc Ellis*

65 Computer Bits
Cleaning up, part two—*Jeff Holtzman*

67 Think Tank
Weather circuits—*John Yacono*

70 DX Listening
Watch your intervals—*Don Jensen*

72 Ham Radio
Ham-radio accessories—*Joseph J. Carr*

74 Scanner Scene
Disaster scanning—*Marc Saxon*

D E P A R T M E N T S

- 3 Editorial**
- 4 Letters**
- 8 New Products**
- 58 1995 Annual Index**
- 70A Free Information Card**
- 79 Electronics Library**
- 81 Popular Electronics Market Center**
- 118 Advertiser's Index**

Larry Steckler, EHF, CET,
editor-in-chief and publisher

EDITORIAL DEPARTMENT

- Carl Laron**, editor
- Dan Karagiannis**, associate editor
- Teri Scaduto**, assistant editor
- Evelyn Rose**, editorial assistant
- Joseph J. Carr, K4IPV**,
contributing editor
- Marc Ellis**, contributing editor
- Jeffrey K. Holtzman**,
contributing editor
- Don Jensen**, contributing editor
- Charles D. Rakes**,
contributing editor
- Marc Saxon**, contributing editor
- Marc Spiwak**, contributing editor
- John Yacono**, contributing editor

PRODUCTION DEPARTMENT

- Ruby M. Yee**, production director
- Kathy Campbell**,
production assistant

ART DEPARTMENT

- Andre Duzant**, art director
- Russell C. Truelson**, illustrator

Jacqueline P. Cheeseboro,
circulation director

Michele Torrillo,
POPULAR ELECTRONICS bookstore

**BUSINESS AND EDITORIAL
OFFICES**

Gernsback Publications, Inc.
500 Bi-County Blvd.
Farmingdale, NY 11735
1-516-293-3000
FAX: 1-516-293-3115
President: **Larry Steckler**

**SUBSCRIPTION
CUSTOMER SERVICE/
ORDER ENTRY**

1-800-827-0383
7:30 AM - 8:30 PM EST

**Advertising Sales Offices
listed on page 118**

Composition by Mates Graphics

Cover by Laewy Design
Cover illustration by John Edwards



Since some of the equipment and circuitry described in POPULAR ELECTRONICS may relate to or be covered by U.S. patents, POPULAR ELECTRONICS disclaims any liability for the infringement of such patents by the making, using, or selling of such equipment or circuitry, and suggests that anyone interested in such projects consult a patent attorney.

EDITORIAL

A TIME OF CHANGE

Regular readers of **Popular Electronics** might notice that a few things are different in this issue. Those are but a portent of things to come as we enter into a period of change for this magazine.

First, and foremost, you might note that there is no Gizmo in this issue. If you are a fan of that section, don't worry: It will return next month, and will continue to appear on a bi-monthly basis.

Why the change? Survey after survey tells us that one of the chief reasons most of you read this magazine is our projects. By making Gizmo bi-monthly, we can squeeze a few extra projects and other articles into the issues when it does not appear. By the way, that change might not be permanent, so if you feel strongly about it one way or another, write and let us know.

The other change has to do with the symbols and component designations we use in our articles. We've begun to make several changes that will bring them more into line with what is more commonly used in industry today. The changes are subtle and should not cause too much confusion, but because both the old and new symbols and designations will be used for awhile, and might appear in different stories in the same issue, I thought I should mention the change in case anyone wonders what's going on.

What else is going on? Next month will begin the introduction of a new look for some sections of the magazine. Beyond that, well, I don't want to tip my hand yet, so you'll have to just wait and see!

One thing I will promise, however, is that the basic content and mission of **Popular Electronics** will NOT change. We will continue to bring you, our readers, the most complete coverage possible of every aspect of the electronics hobby.



Carl Laron
Editor

EARN YOUR B.S. DEGREE IN COMPUTERS OR ELECTRONICS



By Studying at Home

Grantham College of Engineering, now in our 45th year, is highly experienced in "distance education"—teaching by correspondence—through printed materials, computer materials, fax, modem, and phone.

No commuting to class. Study at your own pace, while continuing on your present job. Learn from easy-to-understand but complete and thorough lesson materials, with additional help from our instructors.

Grantham offers three separate distance-education programs, leading to the following accredited degrees:

- (1) The B.S.E.T. with Major Emphasis in Electronics.
- (2) The B.S.E.T. with Major Emphasis in Computers.
- (3) The B.S.C.S. — the Bachelor of Science in Computer Science.

An important part of being prepared to *move up* is holding the right college degree, and the absolutely necessary part is knowing your field. Grantham can help you both ways—to learn more and to earn your degree in the process.

Write or phone for our free catalog. Toll free, 1-800-955-2527, or see mailing address below.

Accredited by
the Accrediting Commission of the
Distance Education and
Training Council

GRANTHAM
College of Engineering
Grantham College Road
Slidell, LA 70460

LETTERS

Ghost Voices: The Readers Talk Back!

OUR READERS WRITE

Our publishing of the recent article, "Ghost Voices" (Popular Electronics, October 1995), has resulted in quite a bit of mail from our readers. Unfortunately, due to space limitations, we are unable to print all of the letters we received. The following is what we consider to be a fair sampling of expressed viewpoints.

—Editor

SPEAKING OUT ON GHOST VOICES

I read with interest the article "Ghost Voices". The "voices of the dead" theme is simply an example of the phenomenon known to engineers as audio rectification, wherein broadband radio frequency energy impinging on an unintentional "antenna" is demodulated by accidental nonlinearities. That results in a mishmash of audio signals being heard simultaneously. Occasionally, a few words might be heard clearly through the garbled mess.

Fifty years ago, I was playing with crystal sets. Once I disconnected the tank circuit so that my entire installation consisted of an antenna wire running the length of my basement, a connection of that antenna to a crystal detector and high-impedance headphones, and a connection to a water-pipe ground. As you might have expected, I heard a mixture of perhaps a half-dozen broadcast-band AM stations, all simultaneously. I learned then that a tank circuit is needed to select one of the many signals picked up by the antenna.

A similar thing occurred with the equipment described in the referenced article. The very short antenna is extremely broadband, so it will receive a very wide range of broadcasts. Being excessively short, it will have almost negligible gain. However, if the diode or transistor detector is followed by a high-gain audio amplifier, the

expected mix of simultaneous audio will be heard, usually sounding like noise with an occasional word or two being readily identified.

R.E.
Littleton, CO

Talk about serendipity! The day before I saw the October issue of **Popular Electronics**, with its "Ghost Voices" cover story, I had decided to sell my old reel-to-reel TEAC tape recorder. I also had a dozen reels of audio tapes that I planned to include with the recorder. In checking through the tapes, I found three labeled, "Mystery Voices, 1979." That was the year I had read *Breakthrough* and experimented with the electronic voice phenomenon (EVP).

I used my TEAC recorder connected to the FM output of a radio tuned to the white noise between stations. After spending many evenings recording and hearing nothing but white noise, I decided to try just one more time. I sat listening to the white noise and watching the meters holding steady as it was being recorded. I had just decided to give up when I saw the needles make four distinct jumps. When I played the tape back, I could hear a voice buried under the white noise. The voice contained a four-word message that seemed to directly respond to my thinking of discontinuing the experiment.

Although I did continue for a few more months, and did get some additional results, other life events began demanding my time and attention. I put the tapes on a shelf and forgot about them until I was preparing to sell the old recorder. After listening to them again, I found myself wishing I could find some updated material, if any existed, on EVP. I had no idea how soon my wish would come true.

The next day I agreed to go grocery shopping with my wife.

Knowing that I get impatient walking up and down the aisles, she insisted that I wait for her at the store's magazine rack, where **Popular Electronics** practically leaped out at me. Finding the tapes and your article has rekindled my interest in electronic voice phenomena.

I have had broadcast engineers, ham-radio operators, and pilots listen to my tapes. In each case, while they didn't agree on what was being said, they did agree that the voices were not from broadcast, a ham radio, or a passing plane. And, although cellular and cordless phones might now have to be considered, they did not exist in 1979 when I recorded the voices.

So what's the bottom line? I think that the EVP is something that can't be explained away. Are the voices from the dead? Maybe. Are they from a different dimension in space and time? That's possible. Or could it be, as a psychologist friend of mine claims, that the voices are "simply the result of my intense desire to hear voices, and because of that desire I created a mental electronic imprint on the tape resulting in recorded voices on tape." It didn't seem to bother him that because I did not have a microphone connected to the recorder, that alone would be an amazing electronic feat, worthy of serious exploration.

If any of your readers are seriously interested in exploring this strange phenomenon, I would welcome their letters. I would also be happy to send them a copy of my tapes, along with a copy of a radio interview with William Blattey, author of *The Exorcist*, in which he talks about his experiences with the electronic voice phenomenon.

RICHARD SZUMSKI
3356 Mortar Court
Placerville, CA 95667

What could you *possibly* have been thinking with your cover

CircuitMaker®

The Complete, Low Cost, Circuit Design System

Professional Schematic Layout

CircuitMaker's schematic capabilities are unmatched and include many advanced editing features not found in similar programs. These powerful features minimize the time and task associated with drawing a schematic and insure a professional looking final product. Printout and export options are numerous and results are of the highest quality. But that's what people have come to expect from CircuitMaker.

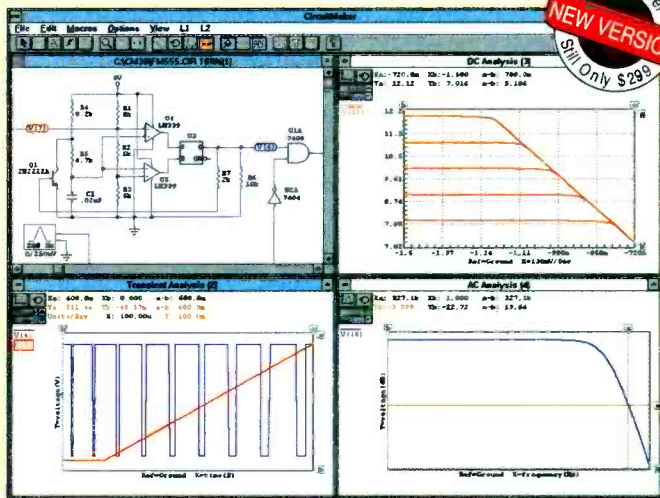

Total Customer Satisfaction

At MicroCode Engineering we are committed to total customer satisfaction. When you purchase CircuitMaker you have the confidence of knowing that a trained staff of professionals is available to serve you after the sale. Our free unlimited customer service is second to none! Whether you have general or technical questions they will be answered promptly by a knowledgeable representative.

FREE Functional Demo

A free functional demo is available on the Internet (<http://www.microcode.com>), on CompuServe (GO MICROCODE) and on America Online (keyword search: CircuitMaker). A demo can be purchased directly from MicroCode Eng. for \$10.

Printed Circuit Board Netlist Output

The PCB output capability helps you complete your design cycle, by generating a netlist that can be imported into any compatible PCB program. This is not a costly "add-on" product. It comes standard with every copy of CircuitMaker.

PCB Program

MicroCode Engineering also offers a CircuitMaker compatible, professional level, PCB layout and autorouting program for just \$299. Used in conjunction with CircuitMaker, Autotrax completes a powerful end-to-end circuit design system. Call for details.

Analog, Digital and Mixed-Mode Simulation

CircuitMaker's SPICE3 based analog simulation is fast and accurate. SPICE sub circuits for all base level digital devices provides advanced mixed-mode simulation capability. Digital simulation is live and highly interactive. This powerful simulation trio is tightly integrated into one package and will confirm your circuit designs with accuracy and ease.

Comprehensive Device Library

Version 3 features a state-of-the-art device browser which greatly simplifies the task of organizing and selecting devices. With its newly expanded device library, CircuitMaker now ships with more devices (at no additional cost) than any competing product. If you need a device that isn't provided, CircuitMaker provides industry standard SPICE import and a powerful Macro capability to enable you to create new devices. CircuitMaker provides you with the tools to get the job done right.

Professional Schematic Capture
 Digital, Analog, and Mixed-Mode Simulation
 1000+ Devices/Models
 SPICE Export/Import
 PCB Export
 Retail Price

CircuitMaker	YES	YES	YES	YES	YES	YES	Retail Price
Electronics Workbench version 4	YES	NO	YES	NO	NO	NO	\$299
Electronics Workbench Engineer's Pack	YES	NO	YES	YES	YES	YES	\$599

"CircuitMaker Shorts The Competition Out, With An Unbeatable Bottom-line"

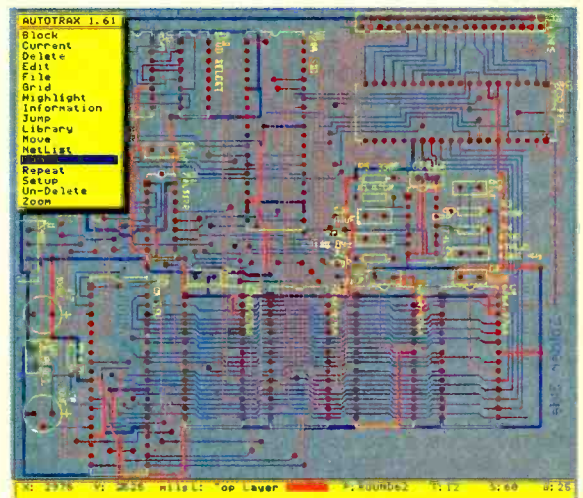

MicroCode Engineering
 573 W. 1830 N. Suite 4
 Orem, UT 84057 USA
 Phone (801) 226-4470
 FAX (801) 226-6532

To order or request additional information call 800-419-4242

Competitive upgrades are available for \$149. Call for details. CircuitMaker is a registered trademark of MicroCode Engineering. All other trademarks are the property of their owners.



CIRCLE 177 ON FREE INFORMATION CARD

story, "Ghost Voices?" And Hal-
loween is *not* an excuse.

I've been reading **Popular Electronics** steadily (except for its brief hiatus) since I was ten years old. It was a serious educational influence on me early on, and inspired many of my career interests.

I'm sure that there are still plenty of kids like me who read your magazine. To expose them to such shop-worn pseudoscience—not even new or imaginative pseudoscience!—seems irresponsible, especially since you didn't include so much as a sidebar about alternative explanations, such as the tendency of human perception to assign "meaning" to white noise.

I suspect your mailbags are bulging with similar complaints. This is indeed a low point for the same magazine that, two decades ago, used its cover to introduce America's young technologists to the personal computer.

M.R.

San Francisco, CA

I was fascinated by the article, "Ghost Voices." At first glance, I wondered whether **Popular Electronics** was lowering itself to the point of tabloid journalism. But after reading the complete article, I realized that you were taking the subject very seriously.

I have some suggestions for improving some of the methods that you described.

First, I would use an open-reel deck, which can monitor off the tape while recording. That should be done so that the participants can hear any voices as the recording is being made, not after the fact. I would place headphones on all the participants in the experiment in order to let them hear any faint voices, and also to prevent any feedback from a microphone.

Second, in the case of using only a microphone to receive the voices, I would choose a mic that was ultra-sensitive, and possibly even apply extra stages of amplification between the microphone and the mic input on the recorder to boost the volume of the faint voices.

Third, in the case of the radio method, I wonder what would

happen if you used an FM transmitter whose output is connected to the input of the recorder. I'd like to see what happens if you install an inductor made of extremely fine wire that can be used as a tuning coil, modulating the transmitter frequency if its turns are expanded and contracted by the slightest air pressure. If a faint voice were to disturb it, then a frequency shift should be able to be amplified and detected. That is, of course, assuming that air pressure would have a bearing on the experiment. I am assuming so because the article stated that a microphone alone can be used. And, of course, a microphone works on air pressure.

Finally, in the case of using radio frequencies, why can't a transmitter be used without any modifications to it just to create a dead silence out of the radio due to an unmodulated carrier? That would eliminate interstation noise, which could obscure faint voices.

What I'd really like to know is: Do you think that any of my ideas has a ghost of a chance?
R.J.M
Austin, TX

I just finished reading "Ghost Voices" and felt compelled to comment to fellow readers who might consider exploring this mystery.

We, as electronics technicians and engineers and hobbyists, are different from others because. I believe, we are curious about physical phenomena. We seek to know more and more about the physical nature of our universe. We are students of the physical world. The article provides us with a means to delve into another aspect of our universe, namely the spiritual.

The fact is, we are not in our element if we do that. I am writing to warn you against it. Do not communicate with the dead, for it is written in Deuteronomy 18:10-12:

"There shall not be found among you anyone that ... useth divination, or an observer of times, or an enchanter, or a witch, or a charmer, or a conjurer of familiar spirits, or a wizard, or a necromancer. For

all that do these things are an abomination unto the Lord ..."

If anyone feels they must persist, please follow this advice offered in 1 John 4:1-3:

"Believe not every spirit, but try the spirits whether they are of God: because many false prophets are gone out into the world. Hereby know ye the Spirit of God: Every spirit that confesseth that Jesus Christ is come in the flesh is of God. And every spirit that confesseth not that Jesus Christ is come in the flesh is not of God: and this is that spirit of antichrist, whereof ye have heard that it should come, and even now already is it in the world."

I pray that everyone heed these words in their pursuit of knowledge.

R.W. CET

Lee's Summit, MO

ADVERTISING CORRECTION

A full-page ad for our books, *Communications Licensing and Certification Examinations*, and *Practice Tests for Communications Licensing and Certification Examinations* recently ran in **Popular Electronics**.

As often happens with new books, a few errors crept into these two. Errata sheets are available to any readers who have purchased one or both books. Anyone interested can send a stamped, self-addressed envelope to the address below.

We offer our sincere apologies.
SAM WILSON AND
JOE RISSE
P.O. Box 2077
Melbourne, FL 32902-2077

DEFENDING HACKERS

I am extremely dismayed at the stereotypes of hackers presented in a review of the book *Protection and Security on the Information Superhighway* (*Electronics Library, Popular Electronics*, August, 1995). Kevin Mitnick was not charged with the crimes you mentioned. Hackers and phreakers do not destroy computer systems and use credit-card numbers for fun or personal profit as you stated. If you do that you are a criminal.

Hackers have helped expose

the fact that your personal information might be stored on insecure computers that can be accessed by anyone. Hackers have revealed various scandals done by phone companies. In fact, many hackers have paved the way to what your magazine is all about.

The hacker community does not appreciate the media's false stereotypes. I expected that an electronics magazine such as **Popular Electronics** would better understand the computer- and phone-related issues so as not to judge hackers as "cyberthugs." I was wrong.

R.H.

East Meadow, NY

HAVES & NEEDS

Help! I'm in need of the schematic page from the user manual for a Radio Shack APM-200 Audio Peak and RMS Power Meter, #42-2102. If you could send the whole manual, or a copy of it, that would be fine, too.

I'll reimburse the postage and copying costs. Thank you!

KEN SIMMONS

29101 38th Avenue South
Auburn, WA 98001-1447

I have a Realistic (Tandy) Clarinette-120 stereo system, cat. no. 13-1224, for which I need a replacement AC power transformer. Neither Tandy nor their parts supplier can provide a replacement.

As an alternative to a replacement transformer, I can use information on the transformer secondary voltage and current ratings. There is only one secondary winding.

I will appreciate any help!
ED CARTOTTO
641 West Hillsdale Blvd.
San Mateo, CA 94403

I have enjoyed reading **Popular Electronics** for many years and hope you will continue its winning format.

I'm writing in hopes that another reader will be able to supply a copy of the operator's manual for Rockwell's AIM 65 microcomputer. I would gladly pay any photocopying expense.
DOUG W. IVERSON
10415 83rd Street
Edmonton, Alberta
Canada T6A 3P2

The Four-Year Electronics Degree Program That Really Hits Home!

Bring The Technology Home With A Bachelor Of Electronics Engineering Degree. No Hassles. No High Cost!



Now's the time to prepare for a profitable career.

We've lowered the cost of higher education.

It's true! You can earn a four-year Bachelor of Electronics Engineering Technology degree today ... and prepare yourself for a high-paying electronics career ... without quitting your job or ever leaving your home. Because World College, an affiliate of the Cleveland Institute of Electronics, offers you the total flexibility of independent study programs proven effective for people like you who truly want to succeed! World College independent study lessons help you build valuable skills

**Mail/Fax Today
or Call
1-800-696-7532**

step-by-step, and expert instructors are personally available to you with a toll-free call. What a way to earn an education!

A world of opportunity.

Where is your career headed? With a four-year bachelor's degree from World College, you call the shots, choosing from incredible, high-paying opportunities in electronics, telecommunications, computer, electrical power, and many other growing fields.

World College gives you the skills, the knowledge, the power to take advantage of your best opportunity in electronics. And you can do it all at your own pace!

Without leaving home.

World College continually works to provide its students with the most advanced education tools. From the latest equipment and reference books to breakthrough computer-simulated experiments, students are exposed to the latest technological advancements.

All the equipment, parts, and software you need are included in your affordable tuition, including more than 300 hands-on lab experiments you can complete in your home.

Choose your own pace.

Earn your bachelor's degree on your time — and at your pace — because you pay tuition to World College only as you complete the upper-level semesters close to graduation. The faster you make it through, the less you pay. So you have an incentive to make your future happen quickly — yet the freedom to choose your own pace!

Send today for your FREE course catalog — and give yourself that future you've always wanted — with an electronics degree education from World College.



Take charge of your future in electronics.

Four Powerful Reasons To Connect With World College Today:

- 1. Earn your four-year degree!**
- 2. Self-paced training!**
- 3. Independent study in your home!**
- 4. Expert instruction!**

Give Me The Power!

Send me a FREE World College course catalog today!



(Please Print Neatly)

Name _____

Address _____

City _____

State, Zip _____

Phone (____) _____

Age _____

**For faster service, call
1-800-696-7532,
or call
1-804-464-4600.**

**Or fax this coupon to
1-804-464-3687.**



Lake Shores Plaza
5193 Drive, Suite 113
Virginia Beach, VA 23455-2500



Affiliated with
Cleveland Institute of Electronics
WAH24

NEW PRODUCTS

Interactive TV Program Listings

Radio Shack's VideoGuide set-top box adds a new dimension to channel surfing and makes VCR programming easier. The interactive program system provides an on-screen guide with seven days worth of program information, including times, channels, and detailed show descriptions. To view a program, you just select it from the on-screen guide using the VideoGuide remote. To record a program, you just select it and press another button on the remote, and the VCR is ready to record that show. "Smart-sorting" allows you to arrange the program grid to suit your personal viewing habits.



VideoGuide services are linked directly to the set-top receiver by BellSouth's MobileComm wireless paging network. A monthly subscription starts at less than one dollar a week.

Besides the on-screen guide and one-touch recording, the VideoGuide provides regional, national, and international news and weather through the Associated Press, United Press International, and other news sources. Up-to-the-minute sports scores and detailed summaries of completed games and games in progress are also offered.

The VideoGuide set-top re-

ceiver costs \$99.99 at Radio Shack stores nationwide. For more information, contact Radio Shack, 700 One Tandy Center, Fort Worth, TX 76102; Tel. 817-390-3300; Fax: 817-878-6508.

CIRCLE 50 ON FREE INFORMATION CARD

PCMCIA DIAGNOSTIC CARD AND EXTENDER CARD

Accurite Technologies' PC ReportCard makes easy work of developing and troubleshooting software or hardware on a PC card. By using the PC ReportCard in conjunction with the PC ExtenderCard, all the PC Card I/O and memory access cycles are displayed on a series of LEDs, allowing you to make a quick and convenient diagnosis of the card's hardware or software without using expensive test equipment.

Aimed at engineers involved in designing and developing PC cards and technicians who debug PC cards during the manufacturing process, the PC ReportCard is a passive device that monitors PC-card activity without any special software. Its external trigger signal can easily be connected to an oscilloscope or logic analyzer to aid with the capture of all the timing cycles. It also contains a general-purpose logic probe that can be used to look at bus signals or signals on the PC card.

The PC ExtenderCard includes a four-layer printed-circuit board with extensive use of grounding to minimize noise and maximize the integrity of the various signals. That allows for an extended length, providing adequate clearance for commonly used PC-card sockets. Test points for each of the 68 pins of the bus are clearly labeled. The PC ExtenderCard also includes 16 DIP switches that allow breaking of key signals to the PC card to isolate problems. The three power sources have a convenient point



for a current meter. Push buttons are provided to interrupt card detect 1 and 2, which simulates the wear and tear on the card's sockets and pins. A second socket provides direct access to all bus signals of the computer's PC card slot, accepting adapter cards for logic analyzers of the PC ReportCard.

The PC ReportCard and the PC ExtenderCard cost \$229 each, or \$425 for both if purchased together. For more information, contact Accurite Technologies Inc., 231 Charcot Avenue, San Jose, CA 95131-1107; Tel. 408-433-1980; Fax: 408-433-1716.

CIRCLE 51 ON FREE INFORMATION CARD

ECONOMICAL D/A CONVERTER

According to AMC/Weltronics, anyone with an older CD player, portable CD player with digital output, or a laserdisc player used as the basis of a home-theater system can improve the sound quality of CDs and laserdiscs with the DAC 8 digital-to-analog (D/A) converter. The DAC 8 features four switched inputs, a tape loop for digital recording, and EIA-standard output. It supports up to 18-bit input data.

Using high-grade components on a double-sided PC board, the DAC 8 offers low-



Get 3 PROFESSIONAL BOOKS for only \$9.95

When you join the **ELECTRONICS ENGINEERS' BOOK CLUB**® Values to \$157.00

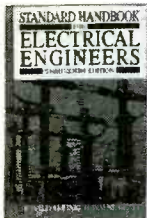

0209847-XXX \$110.50
Counts as 3



0039615 \$45.00

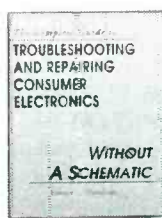

0156492 \$34.95

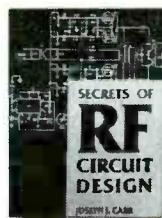

0100926 \$24.95
Softcover



0709645-XX \$70.00
Counts as 2

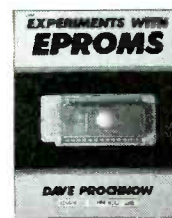

156490X \$18.95
Softcover



1556206 \$49.50

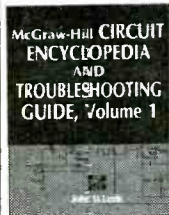

0376034-XX \$59.50
Counts as 2



031716X-XX \$52.00
Counts as 2



0494347 \$52.00



0209820-XXX \$105.50
Counts as 3

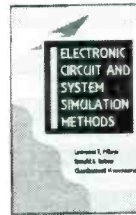

0501696 \$55.00



012616X-XX \$79.50
Counts as 2

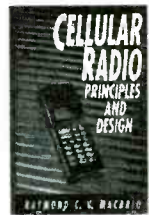

0443017 \$50.00

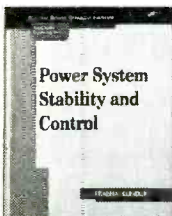

035958X-XX \$95.00
Counts as 2



0628432-XX \$60.00
Counts as 2

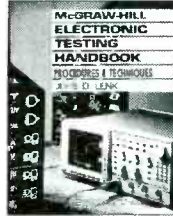

0376026 \$45.00



1575472 \$26.95
Softcover

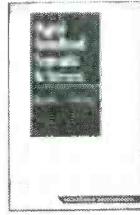

037336X \$50.00



0042144 \$39.00



0375054 \$39.50



023986X \$21.95
Softcover

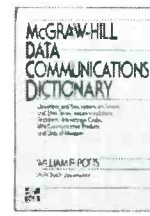

0031541 \$34.50

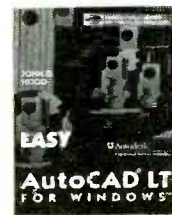

0297894 \$45.00



002671B \$50.00



0404348-XX \$49.50
Counts as 2

As a member of the Electronics Engineers' Book Club...

...you'll enjoy receiving Club bulletins every 3-4 weeks containing exciting offers on the latest books in the field at savings of up to 50% off the regular publishers' prices. If you want the Main selection, do nothing and it will be shipped automatically. If you want another book, or no book at all, simply return the reply form to us by the date specified. You'll have at least 10 days to decide. If you ever receive a book you don't want due to late delivery of the bulletin, you can return it at our expense. And you'll be eligible for FREE BOOKS through the Bonus Book Program. Your only obligation is to purchase 3 more books during the next 2 years, after which you may cancel your membership at any time. ©1996 EEBC

All books are hardcover unless otherwise noted. Publishers' prices shown. A shipping/handling charge & sales tax will be added to all orders. If you select a book that counts as 2 choices, write the book number in one box and XX in the next. If you select a counts as 3 choice, write the book number in one box and XXX in the next 2 boxes.

If coupon is missing, write to: **Electronics Engineers' Book Club**®
A Division of the McGraw-Hill Companies, PO Box 549, Blacklick, OH 43004-9918

ELECTRONICS ENGINEERS' BOOK CLUB®

A Division of The McGraw-Hill Companies
PO Box 549, Blacklick, OH 43004-9918

YES! Rush me the following title(s), billing me just \$9.95 (plus shipping/handling & sales tax). Enroll me as a member of the *Electronics Engineers' Book Club* according to the terms outlined in this ad. If not satisfied, I may return the book(s) within 10 days for a full refund and my membership will be cancelled. I agree to purchase just 3 more selections at regular Club prices during the next 2 years and may resign anytime thereafter.

Code #'s of my book(s) for \$9.95

--	--	--

If you select a book that counts as 2 choices, write the book number in one box and XX in the next. If you select a Counts as 3 choice, write the book number in one box and XXX in the next two boxes

Name _____

Address/Apt. # _____

City/State/Zip _____

Phone _____

Offer valid for new members only, subject to acceptance by EEBC. Canada must remit in U.S. funds drawn on U.S. banks. Applicants outside the U.S. and Canada will receive special ordering instructions. A shipping/handling charge & sales tax will be added to all orders. PPIF296

noise, high-resolution, digital-to-analog conversion using Philips' latest bit-stream DAC with continuous calibration up to 18 bits. Automatic detection and lock for 32K, 44.1K, and 48K digital signals are provided. The unit's output provides an optimum signal level for Dolby Pro Logic circuits, eliminating input overload.

The DAC 8 D/A converter costs \$199.95. For additional information, contact AMC/Weltronics, P.O. Box 80584, San Marino, CA 91108; Tel. 818-799-6396; Fax: 818-799-6396.

CIRCLE 52 ON FREE INFORMATION CARD

DIGITAL MULTITESTERS

Four additions to Wavetek's XL Series of handheld digital multimeters include two autoranging models, one extended function unit, and one capacitance/resistance meter. In addition to the standard DMM functions—voltage, current, diode test, and continuity—each meter in the XL series offers specialized functions.



The autoranging *DM30XL* and *DM35XL* offer special features such as a 3200-count display, bar graph, data hold (which freezes the reading on the display for later viewing), an auto-off feature to preserve battery life, a diode tester, and continuity beeper. Both models measure resistance to 30 megohms and AC/DC voltage to 600 volts.

The pocket-sized *DM16XL* includes a dependable frequency counter that measures frequencies to 15 MHz. It reliably tests capacitance, transistor gain, and logic, and measures resistance to 20 megohms.

The *CR50* is a full-range ca-

pacitance and resistance meter with zero adjust to eliminate the effects of the test leads. It features seven resistance ranges—20 ohms to 20 megohms with a 0.01 resolution—and nine capacitance ranges—200 pF to 20 mF with 0.1-pF resolution. As an added value, the *CR50* offers continuity and diode tests.

All XL-series meters come with safety test leads that are shrouded with plastic to eliminate the risk of shock. The *DM30XL* and *DM35XL* feature an incorrect input warning, which sounds a beeper for incorrect test-lead placement. Each meter comes with a manual, alligator clips, a battery, and an extra fuse.

The *DM30XL* costs \$79.95, the *DM35XL* and *DM16XL* each cost \$99.95, and the *CR50* costs \$69.95. For further information, contact Wavetek Corporation, Instruments Division, 9045 Balboa Avenue, San Diego, CA 92123; Tel. 619-279-2200;

Fax: 619-565-9558.

CIRCLE 53 ON FREE INFORMATION CARD

POCKET-SIZED FREQUENCY COUNTER

The *CUB 3300* frequency counter from *Optoelectronics* is designed for use in traditional lab settings as well as in field service, counter surveillance, police work, military situations, private investigations, two-way radio, and ham radio. Aimed at novice users and experienced technicians alike, it is simple to operate, yet is sophisticated and accurate.

The *CUB* features a digital filter that reduces false counts, and an auto capture mode that acts like an intelligent auto hold button. It allows a frequency to remain displayed as long as you want it to, with no chance of being overridden by surrounding RF. Other features include eight selectable gate times, a 9-digit LCD readout, 1- to 250-MHz direct-count capability for high resolution, maximized sensitivity for picking up radio transmissions, a 10-MHz timebase, extended (10-hour) battery life, and direct and pre-scaled ranges. Its frequency range is 1 MHz to 2.8 GHz.

The *CUB 3000* frequency counter costs \$149. For additional information, contact *Optoelectronics, Inc.*, 5821 NE 14th Avenue, Ft. Lauderdale, FL 33334; Tel. 1-800-327-5912 or 305-771-2050;

Fax: 305-771-2052.

CIRCLE 54 ON FREE INFORMATION CARD

PORTABLE SURROUND-SOUND SYSTEM

Audio-Technica's CS2000 can give your multimedia business presentations the same great sound that you've come to expect from your home-theater system. The system includes a powered subwoofer; powered left, center, right, and rear speakers (the rear channel information is transmitted via the 900-MHz UHF band); a Dolby Pro Logic decoder; and remote control. The "plug-and-play" transportable home-theater system can also be carried along to a vacation house, or between rooms at home.

The *CS2000* was designed for portability and easy setup. The subwoofer module contains its own amplifier plus amplifiers for the three front speakers, the Dolby Pro Logic decoder, and the wireless transmitter for the rear channel.



speakers slide into locking grooves on the top of subwoofer module. Once the satellite speakers are locked into place, you can lift the 38-pound package by its built-in handle holds and move it where desired.

One audio cable connects the subwoofer module to either the line-level or headphone audio output of your computer or VCR. Arrange the speakers, plug the subwoofer and rear speakers into AC sockets, and the system is ready to use.

The *CS2000* costs \$599.95. For further information, contact *Audio-Technica U.S., Inc.*, 1221

Commerce Drive, Stow, OH 44224-1760; Tel. 216-686-2600; Fax: 216-688-3752; e-mail: cs2000@atus.com.

CIRCLE 55 ON FREE INFORMATION CARD

LOW-COST OSCILLOSCOPE

Leader Instruments' Model LS 1020 is a 20-MHz dual-trace oscilloscope designed to meet general-purpose bench and field needs. It features a maximum sensitivity in both channels of 0.5-mV per division and a maximum, calibrated sweep speed of 50-nanoseconds per division. The scope provides sharp, bright traces. It uses switch-selected scale illumination, which is a necessity for oscilloscope photography.

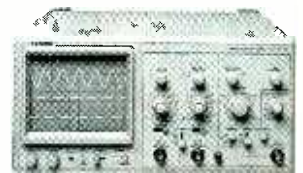

Vertical mode selection offers CH1, CH2, chop, alt, and ADD (subtract with CH2 inverted). H-timebase selections range from 0.2-ms/div to 0.1-μs/div in 20 steps with continuous sweep speed control. A ×10 magnifier shortens the time base by a factor of ten to yield a maximum observable speed of 10 ns/div.

Trigger coupling includes AC, RF reject, DC, TVH, and V settings. The trigger source selector sets source triggering to CH1, CH2, Alt (alternate trigger for stable display of asynchronous signals, power line, and external). Auto triggering is standard, with continuous control of trigger level and variable hold-off to view complex pulse trains. XY operation is standard with 1-MHz X-axis bandwidth and less than 3° phase difference between X and Y at 100 kHz. Other features include channel-1 output and Z-axis modulation.

The *LS 1020* general-purpose oscilloscope costs \$525. For more information, contact *Leader Instruments Corporation*, 380 Oser Avenue, Hauppauge, NY 11788; Tel. 800-645-5104, or (in NY) 516-231-6900.

CIRCLE 56 ON FREE INFORMATION CARD



New microprocessor puts the brain of a \$50,000 car under your hood...

Breakthrough remote control lets you start your car, turn on its headlights, sound a panic alarm and unlock the doors and trunk...from up to 400 feet away.

by Charles Anton

How many times have you had to bundle up and brave freezing weather to start your car? Or sit in a sticky car and touch a blistering-hot steering wheel to get your car started? What else can you do besides shiver while a defroster blows cold air in your face or roast in the scorching heat of your car?

A better way. The new AutoCommand keychain transmitter gives you the power to start your car from the comfort of your home or office. Simply press a button to start warming up or cooling off your car from up to 400 feet away. You can turn on the heater, air conditioner or defroster without leaving your seat.

The powerful microprocessor brain learns your car's starting pattern. It adjusts the starting routine based on the outside temperature,

Why AutoCommand is better...

- **Range.** Most remotes only work up to 100 feet away. AutoCommand gives you a range of up to 400 feet.
- **Self-diagnostics.** The unique feedback lights on AutoCommand confirm proper wire connections during and after installation, just like a car's on-board computer.
- **Total security and convenience.** AutoCommand gives your car the capability of remote car starting, keyless entry, panic alarm and car security. It also has built-in low temperature and low battery voltage start options.

battery voltage and the amount of time since your car was last run to guarantee starting every time.

Give your car a brain.

AutoCommand gives your car the same features as luxury cars, and even some they don't have, by adding this microprocessor brain. In addition to remote car starting, your car will have features such as keyless entry and built-in car security.

You can call for help or scare someone away with the panic alarm; locate your car with CarFinder; and have your car automatically turn on its headlights when it gets dark or turn them off 20 seconds after leaving your car. You can even leave your car running with the doors locked and no key in the ignition. If you forget your car is running, it will automatically shut off after 10 or 15 minutes, you choose.

Intelligent benefits. With AutoCommand, your car can't be driven until a key is put into the ignition. The AutoCommand immediately cuts off the engine if your vehicle's hood is raised, brake pedal is pressed or the vehicle is shifted out of gear without the key in the ignition, preventing theft or tampering.

AutoCommand also monitors your car while you are away. The built-in Vacation Control Option will automatically start and run your car for 10 minutes every four to six hours when the temperature drops below zero. On hot summer days, AutoCommand will also start your car when the interior reaches 140 degrees. If your battery drops below 11 volts, AutoCommand will start your car to recharge it.

Try it risk-free. At Comrad, we back all our products with a risk-free home trial. Try AutoCommand in your car and if you're not completely satisfied with its value and performance, return it within 90 days for a full refund, "No Questions Asked."

AutoCommand is also backed by a two-year manufacturer's limited warranty. Most orders are processed within 72 hours and shipped UPS.

UPGRADE OPTIONS.

You can replace your existing garage door remote control with the Garage Door Remote Control replacement system. This system can be added to any garage door that has an existing electrical garage lift unit. It will share the same transmitter as the AutoCommand, eliminating extra keychain remotes! You can also add the Shock Sensor option to the built-in car security system. It detects any impact on your car, giving you added protection.



The keychain transmitter works with all the available features.

Exclusive \$50 installation discount

AutoCommand comes with an installation video and has patented self-diagnostic feedback lights which confirm wire connections step-by-step during installation. But for those who prefer to have AutoCommand professionally installed, we offer a \$50 installation discount. Use the money for professional installation, or install it yourself and keep the money. Either way, AutoCommand makes it easy and affordable to add luxury car features to your automobile.

AutoCommand	\$249	\$14 S&H
with installation discount	\$299	\$14 S&H
AutoCommand Upgrade Features			
Garage Door Opener	\$79	\$8 S&H
add Shock Sensor to alarm	\$49	\$4 S&H

AUTOCOMMAND FEATURES

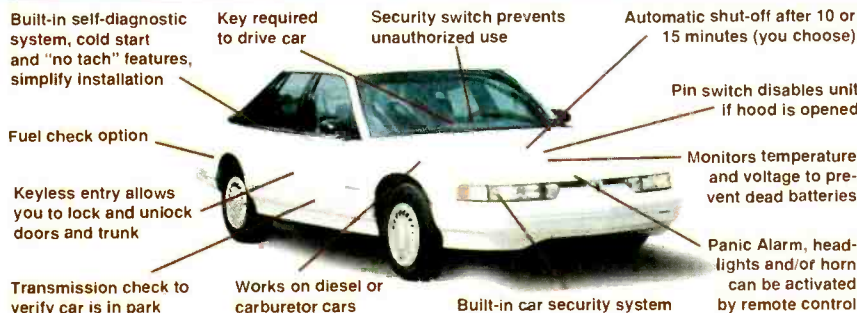

Please mention promotional code 691-PL-6646
For fastest service call toll-free 24 hours a day
800-992-2966



To order by mail, send check or money order for the total amount including S&H (VA residents add 4.5% sales tax.) Or charge it to your credit card, enclosing your account number and expiration date.

COMRAD INDUSTRIES

2820 Waterford Lake Drive, Suite 106
Midlothian, Virginia 23113

MULTIMEDIA WATCH

By Marc Spiwak
Technical Editor
Windows Magazine

Upgrading to Windows 95



Here's my new Windows 95 desktop. While I had problems during the install procedure, the effort was worth it.

I recently upgraded my home computer (a DX2/50) to Windows 95. While I'm happy with the results, I wasn't too happy during the upgrade process. Windows 95 offers many great improvements for someone who really knows how to use and configure computers. And that person shouldn't have too much trouble performing the upgrade. But the guy who needs help with that kind of stuff should wait for help, because the upgrade going can get rough.

Although I had access to the beta versions, I avoided upgrading my home computer to Windows 95 before the product's official release. It was hard enough to get many CD-ROMs to run on that system using "good old" Windows 3.11. So to be fair to software manufacturers and myself, I figured I ought to wait for the official release of Windows 95 before I installed it.

The main benefit to upgrading to Windows 95 is that once it's properly loaded, you end up with a more stable, more integrated machine.

WHAT TO EXPECT

Windows 95 requires an awful lot of hard-disk space. If you're stuck with, say, only a 100-megabyte hard disk, forget about upgrading—Windows 95 can easily gobble up half of it depending on the configuration you choose. I have two hard drives in my computer: C: is 200 megabytes and D: is 540 megabytes. Neither of them is compressed. The C: drive pretty much contains my operating system and programs I have used for a long time—Winword for example. The D: drive is where I have been stashing all the multimedia stuff in recent years.

My C: drive was nearly full, so before I began the upgrade process I deleted anything I really didn't want from it and moved anything I didn't immediately need over to D:. That left me with about 20 megabytes free on C: and I figured that installing Windows 95 over Windows 3.11 wouldn't require more space than that. But it turned out that I was wrong. It also turns out that if you have the free disk space, then you should install Windows 95 in a new directory leaving your old Windows intact. I just didn't want to install Windows 95 on a different drive for the sake of efficiency.

I backed up all the im-

portant system files before starting, but the install software also gave me a chance to back them up. It also recommended that I back up several other files, so I did. Just to be safe I let Windows back up all the files it wanted to.

The first time I tried to install Windows 95, it told me to disable a Norton antivirus TSR before it could install itself. I had to "REMO out" all references to the TSR in my startup files before I could continue. The next time around Windows informed me that I would need another 25 megabytes free on C: for any upgrade or else it would have to go on D:. Now I had to move all my screen saver stuff to D: along with all my .WAV files and some other assorted stuff.

The next try was going OK until Windows told me I should close any applications that were running by pressing ALT-TAB. I didn't think any were running but I tried it anyway—that crashed the computer! The next go around informed me that the previous attempt was unsuccessful (oh really!) and that I should take certain precautions during the next try (making a startup diskette, for example) to allow for a safe recovery in the future—as if I wouldn't take the precautions without Windows' recommendation.

The next stumbling block came when Windows told me that for the install option I selected ("Typical"), I would need even more

What's better than speed reading? *Speed Learning.*

Speed Learning has replaced speed reading. It's a whole new way to read and learn. It's easy to learn...lasts a lifetime... applies to everything you read. It may be the most productive course you've ever taken.

Do you have too much to read and too little time to read it? Do you mentally pronounce each word as you read? Do you frequently have to go back and reread words, or whole paragraphs, you just finished reading? Do you have trouble concentrating? Do you quickly forget most of what you read?

If you answer "Yes" to any of these questions — then here at last is the practical help you've been waiting for. Whether you read for business or pleasure, school or college, you will build exceptional skills from this major breakthrough in effective reading, created by Dr. Russell Stauffer at the University of Delaware.

**Not just "speed reading" — but
speed reading — thinking —
understanding — remembering —
and — learning**

The new *Speed Learning Program* shows you, step-by-proven step, how to increase your reading skill and speed, so you understand more, remember more and use more of everything you read. The typical remark from over one million people taking the *Speed Learning program* is, "Why didn't someone teach me this a long time ago." They were no longer held back by their lack of skills and poor reading habits. They could read almost as fast as they could think.

What makes Speed Learning so successful?

The new *Speed Learning Program* does not offer you a rehash of the usual eye-exercises, timing devices, and costly gadgets you've probably heard about in connection with speed reading courses, or even tried and found ineffective.

In just a few spare minutes a day of easy reading and exciting listening, you discover an entirely new way to read and think — a radical departure from anything you have ever seen or heard about. *Speed Learning* is the largest selling self-study reading program in the world. Successful with Fortune 500 corporations, colleges, government agencies and accredited by 18 professional societies. Research shows that reading is 95% *thinking* and only 5% eye movement. Yet most of today's speed reading programs spend their time teaching you rapid eye movement (5% of the problem), and ignore the most important part, (95%) *thinking*. In brief, *Speed Learning gives you what speed reading can't*.

Imagine the new freedom you'll have when you learn how to dash through all types of reading material at least twice as fast as you do now, and with greater comprehension. Think of being able to get on top of the avalanche of newspapers, magazines and correspondence you have to read...finishing a stimulating book and retaining facts and details



FOR FASTER SHIPMENT CALL 1-800-729-7323 OR FAX 1-609-273-7766

more clearly, and with greater accuracy, than ever before.

Listen — and learn — at your own pace

This is a practical, easy-to-learn program that will work for you — no matter how slow a reader you think you are now. The *Speed Learning Program* is scientifically planned to get you started quickly...to help you in spare minutes a day. It brings you a "teacher-on-cassettes" who guides you, instructs, and encourages, explaining material as you read. Interesting items taken from *Time Magazine*, *Business Week*, *Wall Street Journal*, *Money*, *Reader's Digest*, *N.Y. Times* and many others, make the program stimulating, easy and fun...and so much more effective.

Executives, students, professional people, men and women in all walks of life from 15 to 70 have benefited from this program. *Speed Learning* is a fully accredited course...costing only 1/4 the price of less effective speed reading classroom courses. Now you can examine the same easy, practical and proven methods at home...in your spare time...without risking a penny.

Examine Speed Learning RISK FREE for 15 days

You will be thrilled at how quickly this program will begin to develop new thinking and reading skills. After listening to just one cassette and reading the preface, you will quickly see how you can achieve increases in both the speed at which you read, and in the amount you understand and remember.

You must be delighted with what you see, or you pay nothing. Examine this remark-

able program for 15 days. If, at the end of that time you are not convinced that you would like to master *Speed Learning*, simply return the program for a prompt refund. (See the coupon for low price and convenient credit terms.)

RISK-FREE ORDER FORM

YES! I want to try *Speed Learning* for 15 days without risk. Enclosed is the first of 4 monthly payments of \$32.25*. If I'm not completely satisfied, I may return it for a prompt refund.

SAVE 8.00! I prefer to pay the \$129.00 now, and save the \$8.00 shipping & handling charge. I may still return the program for a full refund.

Method of payment: (Federal Tax Deductible)

Check or money order payable to Learn Incorporated

Charge to: Visa MC Am Ex Discover

Card # _____ Exp. _____

Signature _____

Phone (_____) _____

Name _____

Address _____

City _____ State _____ Zip _____

*Plus \$8.00 shipping and handling. U.S. funds only. For New Jersey residents, sales tax will be added.

learn
INCORPORATED

Dept. LEC-01, 113 Gaither Drive,
Mt. Laurel, NJ 08054-9987

free space on C:. As it turned out, Windows 95 needed more disk space to perform the install procedure than it actually ended up using once it was installed. I guess it needs the extra space for various temporary files during the install procedure—or at least it thinks it needs the space!

Disk-space issues aside, Windows 95 installed and ran—not without problems, but at least it was running. Windows 95 boots straight into Windows—DOS is gone for the most part. The first time it runs it configures startup files and hardware to run with the new operating system. During a fairly lengthy procedure, Windows 95 examines and automatically configures the hardware. My hardware was all nearly four years old, none of it plug-n-play, and Windows 95 properly identified all of it. A sound-card problem during bootup (it sounded like an IRQ conflict) seemed to clear itself up—at first.

Windows 95 was now up and running, but all of my Norton desktop groups were gone. Instead I was left with an ancient set of icons for which most of the software was long gone. Fortunately I was able to customize Windows 95 with shortcuts (look them up in Help) to mimic my old Norton desktop.

You can easily customize Windows 95 however you like, and all the controls are more integrated. For example, there's a master volume control on the main button bar. Another example is that if you want to change your desktop settings (wallpaper, colors, resolution, etc.), all you have to do is click on the desktop with the right mouse button and adjust its properties. Everything has properties (files, functions,

desktop items, etc.), and they are all accessed and changed in the same convenient manner. And if you can't figure out what to do, you can launch programs and get to control panels through the help box.

Another benefit I received is that my old computer can perform new tricks when it comes to scrolling through menus and image files, and when playing .AVI files. That boost in performance is due to the new 32-bit applets included with Windows 95. My old apps probably run a bit slower, although it's not apparent.

TROUBLE UP AHEAD

Just when I was getting into the new features, the apparent IRQ problem with the sound card reappeared. All I could get in the way of audio was stuttering, and .AVI files wouldn't play with the broken audio. A reboot would only generate stuttering audio right at startup—something was obviously "permanently" screwed up. After a few nights of tinkering, it was time to talk to others who had a little more experience with the idiosyncracies of the new operating system.

Because the card appeared to work fine at first, then later failed, the general consensus was that Windows 95 first matched the old Win 3.11 settings and everything worked properly. Later on it automatically made some changes that messed up the sound card. The trick would be to see how Windows would set up the sound card initially, when it would work properly, and then manually make those settings permanent. To do that a "make settings automatically" box in the

Windows Device Manager would have to be unchecked when the sound card was working properly, the settings changed, and then changed back. If you uncheck the automatic check box without changing anything, Windows 95 automatically rechecks it for you! How's that for automatic?

Of course, that meant uninstalling and reinstalling Windows 95. The Windows 95 uninstall procedure was uneventful, except when it came time to run the old Windows 3.11. It seems that the old swap file was gone and Windows wouldn't run. The way around that was to disable everything that took up memory (drivers, hundreds of fonts, and so on) so that Windows would run without a swap file. That way we could get back Windows 3.11 so that we could re-begin the reinstall procedure. Believe it or not, it worked, and Windows 3.11 was back. The reinstall procedure went OK except for

hard-disk space problems again because I had put some stuff back on C:. After some fiddling with the sound-card settings as described, it seemed to be working. But the sound demon soon reappeared.

It was time to take another approach. Again turning for help, it was suggested that I jot down the settings of all my peripherals before I begin the upgrade (too late for me, of course, although I was able to look them up in my old setup files) and then set everything manually from within Windows 95 to match those settings. Then, disable everything in CONFIG.SYS (which is still used in Windows 95) and re-enable just enough of it to get everything to work.

That seems to have somewhat—but not completely—solved the problem. My Windows 95 setup is much better now and the sound glitch crops up only on occasion. A reboot clears up the problem, so now it only gets screwed up temporarily instead of permanently. I'll get the bugs "completely" ironed out yet—maybe I don't have quite enough of CONFIG.SYS disabled! But more than likely, I'll replace the "ancient" system before that happens.

GO FOR IT

I won't say that you shouldn't upgrade to Windows 95, because it really is kind of neat. Once it's set up properly you'll enjoy the greater stability of the new operating system. For example, even when my computer is suffering from the sound-card problem, I can still do whatever else I want. It's not that I like having problems with my sound card, but just that it demonstrates Win 95's true multitasking capabilities.

VENDOR INFORMATION

Activision Los Angeles

11601 Wilshire Boulevard, Suite 1000
Los Angeles, CA 90025

**CIRCLE 57 ON FREE
INFORMATION CARD**

Creative Multimedia

513 NW 13th Avenue, Suite 400
Portland, OR 97209

**CIRCLE 58 ON FREE
INFORMATION CARD**

Electronic Arts

1450 Fashion Island Blvd.
San Mateo, CA 94404

**CIRCLE 59 ON FREE
INFORMATION CARD**

Insight Software

8405 Pershing Drive, Suite 400
Playa Del Rey, CA 90293

**CIRCLE 60 ON FREE
INFORMATION CARD**

LucasArts Entertainment Company

P.O. Box 10307
San Rafael, CA 94912

**CIRCLE 61 ON FREE
INFORMATION CARD**



Breakthrough device creates a wall of silent noise that drives away annoying animal pests...

Now you can use ultrasonic power to repel annoying dogs, cats and many wild animals—without harming them.

by Charles Anton

Be honest. Even if you like animals, you don't want strange animals in your yard. You know what I'm talking about: dogs that dig holes and foul your lawn or cats that trample flowers and sleep on your car.

Common problem. If you live in a rural area, you've probably had trouble with raccoons, skunks or possums. If you live in the southwest, you may even have had problems with armadillos.

Until now, there weren't many options. You wouldn't want to harm a stray animal, and an animal control agency may take days to respond, if they do.

Modern solution. Fortunately, modern technology has provided an answer: the new Yard Gard. It uses high-frequency sound waves to force unwanted animals to leave the area. Yard Gard eliminates the need for repellents, trapping or physical attacks. Pests learn to avoid the areas Yard Gard watches over.

Proven powerful and effective...

In the past, people relied on traps or poisons to get rid of pests. But environmental awareness has increased the demand for clean, non-lethal pest control methods. Safe and humane, Yard Gard is the perfect solution.

Humane. Yard Gard causes no harm to animals. By creating a wall of high-frequency sound, it forces them to leave the area and create new habitual routes. While the sound is very annoying to animals, it is virtually unobtrusive to people.

Non-toxic. Chemicals used to eliminate pests can be dangerous to neighborhood pets or humans. Yard Gard poses no health risk when used properly.

Nature-friendly. Poisons and pesticides can pollute soil and water sources. Yard Gard deters pests with sound so it causes no damage to the environment.



Ultrasonic power. Yard Gard's electronic ultrasonic generator broadcasts powerful "high frequency noises" that repels four-legged yard pests, yet is generally unobtrusive to people. *

Tones are harmless, but animals find the sounds unpleasant, so they flee.

Why it works. Small animals depend on their acute hearing for survival. They can hear in the 18 to 25.5 kilohertz range which is beyond the range of most humans. When critical hearing frequencies are disrupted by strong pulses, animals feel threatened and leave the noisy area. Yard Gard takes advantage of this fact to protect your yard from pests.

Break their habits. Animals are creatures of habit. They establish a territory and generally follow the same travel routes. Yard Gard forces animals to change their patterns and establish new ones. They soon modify their habitual routes to avoid Yard Gard zones. Once that has happened,

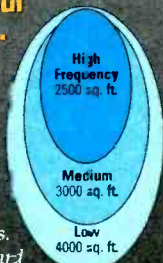

they'll no longer be a irritating problem.

Just plug it in. Yard Gard plugs into any standard household outlet. Electricity consumption is very low and costs only about 25¢ a month to operate.

Yard Gard is designed for outdoor operation in all types of weather. You can use your Yard Gard all year round.

Three settings. Yard Gard has three frequency settings. At its lowest frequency setting, one Yard Gard covers an oval area of approximately 4,000 square feet—the size of an average city lot. Additional units can be added to accommodate especially large yards.

Optional motion sensor. The Yard Gard's optional motion sensor turns the unit on when pests approach, increasing the surprise factor and effectiveness. An optional 50 feet extension cord allows you to place Yard Gard in remote areas that don't have electricity.

Keep the birds. Do you love to watch and feed birds in your yard? If you have problems with cats chasing birds away or killing them, Yard Gard is the answer. Birds are not affected by high frequency sound waves, but cats hate them.

Try it risk-free. For a limited time, you can get the new Yard Gard at the introductory price of just \$99. Call today to take advantage of this special factory-direct pricing. Yard Gard is backed by Comtrad's exclusive risk-free home trial. Try it and if you're not completely satisfied, return it within 90 days for a full "No Questions Asked" refund. Yard Gard is also backed by a two-year manufacturer's warranty. Most orders are processed within 72 hours and shipped UPS.

*People that are more sensitive to high frequency sounds may hear the Yard Gard.

- Yard Gard \$99 \$12 S&H
- Motion Sensor \$39 \$4 S&H
- Extension Cord \$19 \$3 S&H

Please mention promotional code 503-PL-6644.

For fastest service call toll-free 24 hours a day

800-992-2966



To order by mail, send check or money order for the total amount including S&H (VA residents add 4.5% sales tax.) Or charge it to your credit card by enclosing your account number and expiration date.

COMTRAD INDUSTRIES

2820 Waterford Lake Drive, Suite 106
Midlothian, Virginia 23113

Are animals turning your yard into a zoo?



Do cats think your garden is a litter box?



Do you have problems with unusual animals?



Mount Yard Gard to a fence or porch railing, or place it on a post.

Another simple example of that is how you can resize a window as the information in it is being updated. Supposedly when one application crashes—even though that shouldn't happen!—the operating system and all other applications should remain intact. I haven't had anything crash yet, but I'll keep you posted.

If you want to give Windows 95 a try, I recommend the following: First clean up your hard drive(s). Get rid of any software you don't use. You can always put it back, but now's a good time to give your computer a fresh, clean start. You should have 50 to 60 megabytes free before you begin the upgrade to avoid hassles down the road. Back up all of your system files and maybe even your whole hard disk if you have the equipment and the initiative. I didn't really risk losing anything important, as all of my work is always backed up. So I didn't bother backing up anything but my system files (AUTOEXEC.BAT, CONFIG.SYS, WIN.INI, and SYSTEM.INI). Other files are sometimes important, but those four are the ones you should really be concerned with. Now is also a good time to defragment your hard drives if you haven't done it in a while.

I highly recommend installing from the CD-ROM version of Windows 95, which avoids a lot of diskette swapping. There's also lots of extra goodies on the CD. If you have the hard-disk space, it's convenient to copy the entire Windows 95 subdirectory from the CD-ROM to your hard drive and install it from there. Then all the install stuff will always be there if you need it, and reinstalls or loading new parts of the system are much quicker. And with any luck, you'll have less trouble

getting Windows 95 up and running than I did.

NEW STUFF

It's Activision's big month this month—not that they or I am celebrating anything. It's just that I have received a large number of new Activision CD-ROMs over the past couple of months and so I figured I would mention all of them at once.

To begin with, *MechWarrior 2* is a really neat combat-simulation game that straps you into a highly destructive robot that you customize yourself. Multiple players can stomp around destroying everything in their path. About 50 different missions take place on different worlds with various terrains and environments. An instant action mode lets you customize missions and jump right into game play. A career mode lets you join a clan and advance in rank through competition. *MechWarrior* has a suggested retail price of \$59.95.

Paparazzi! Tales of Tinseltown turns you into a tabloid photographer in search of candid celebrity shots. But to find those celebrities you have to do a little sleuthing to figure out where they will show up next. The player interacts with over two hours of video and more than 60 characters. Only the most strategic photographers will get the best shots. *Paparazzi* has a suggested retail price of \$49.95.

Many readers probably remember the old *Pitfall* game where you had to swing from vines, jump over pits, hop on logs, and avoid crocodiles. Activision's new *Pitfall: The Mayan Adventure* features Harry Jr., the son of *Pitfall* Harry from the original game. In much more real-

istic settings than the original game, Harry Jr. is trying to rescue his father from the spirit of an evil Mayan warrior. The new *Pitfall*, written for Windows 95, has a suggested retail price of \$49.95.

The *Atari 2600 Action Pack 2* is the second title in a four-volume series that lets people re-play their favorite old Atari games in Windows. Fifteen best-selling titles are featured: Atlantis, Barnstorming, Dolphin, Dragster, Enduro, Ice Hockey, Keystone Kapers, Laser Blast, Megamania, Oink!, Plague Attack, River Raid II, Skiing, Stampede, and Tennis.

Activision's *Infocom Classics* features five volumes of classic text adventures revisited. The *Mystery Collection* contains *Deadline*, *Suspect*, *The Lurking Horror*, *Witness*, *Moonmist*, and *Sherlock*. The *Comedy Collection* features *Ballyhoo*, *Bureaucracy*, *Hollywood*, and *Nord and Bert Couldn't Make Head or Tail of it*. The *Sci-Fi Collection* includes *The Hitchhiker's Guide to the Galaxy*, *A Mind Forever Voyaging*, *Starcross*, *Stationfall*, and *Suspended*. The *Adventure Collection* features *Border Zone*, *Cutthroats*, *Infidel*, *Plundered Hearts*, and *Trinity*. Last but not least, *The Fantasy Collection* includes *Enchanter*, *Seastalker*, *Sorcerer*, *Spellbreaker*, and *Wishbringer*.

LucasArts has a new archive of its own for sale, but this one is actually one box

containing six separate discs that you would normally have to buy individually, and all for only \$29.95. *The LucasArts Archive Vol. 1* includes *Indiana Jones and the Fate of Atlantis*, *Day of the Tentacle*, *Sam & Max Hit the Road*, *Rebel Assault*, *Star Wars Screen Entertainment*, and *LucasArts Super Sampler*.

Available through Electronic Arts, *Bloodwings: Pumpkinhead's Revenge* pits you against the tormented spirit of Pumpkinhead who is seeking vengeance among the living. The game is based on the cult-classic horror movie series, *Pumpkinhead*. It has a retail price of \$54.95.

Pure Motivation from Insight Software is a combination screen saver, quote of the day inspirational guide, and affirmation generator, all designed to motivate you to do something new and different. It sells for \$24.95.

I've got two new titles from Creative Multimedia this month: *Air & Space Smithsonian Dreams of Flight* is a guide to the history of flight as seen through the eyes of pilots, inventors, and ordinary people, and it sells for about \$29.99. *The Blockbuster Video Guide to Movies and Videos* includes over 21,000 reviews of films, videos, and made-for-TV movies. Also contained are over 5000 photos and 40 video clips. It sells for \$19.95 at Blockbuster Video stores and elsewhere. ■

ANTIQUE RADIO CLASSIFIED

Free Sample!

Antique Radio's
Largest Circulation Monthly.
Articles, Ads & Classifieds.



6-Month Trial: \$17.95. 1-Yr: \$34.95 (\$51.95-1st Class).
A.R.C., P.O. Box 802-L14, Carlisle, MA 01741
Phone:(508) 371-0512 VISA/MC Fax:(508) 371-7129

Be a high-paid computer service technician

Train With NRI — America's #1 Choice in Computer Training

Only NRI gets you inside a powerful full-featured 486DX4/100 MHz computer system you keep — giving you the hands-on experience you need to work with, troubleshoot, and repair today's most widely used computers and peripherals. There's no more affordable way to start a money-making career, even a profitable business of your own, as a computer service technician.

Rely on the original — NRI

Over a decade ago, NRI pioneered at-home training in computer servicing. Today, NRI offers the *only* computer servicing course with real-world experiments using state-of-the-art computer equipment and professional diagnostic tools.

There's no doubt about it: Working "hands-on" with all the most sought-after technology gives you practical skills and lasting confidence. Performing key tests and demonstrations, you're able to see for yourself how things work, what can go wrong, and how you can fix it.

Train with and keep the most advanced computer in home study today

NRI's unique training has you explore a top-notch computer system and its peripherals, beginning with the revolutionary 486DX4 100 MHz central processing unit (CPU).

You get to know your computer's 8 meg RAM, 128K cache memory, 540 meg hard drive, and 14,400 baud fax/modem. Then you gain an appreciation for the brilliant display of your Super VGA color monitor, the drama of your quad-speed CD-ROM drive and 16-bit sound card, as well as the cutting-edge technology of Windows 95.

Plus, you learn how to use Ultra-X professional diagnostic hardware and software to pinpoint problems on any IBM-compatible machine.

No experience needed, NRI builds it in

Studies show that jobs for computer service technicians will be up by 38% in the next 10 years. Even if you've never worked with

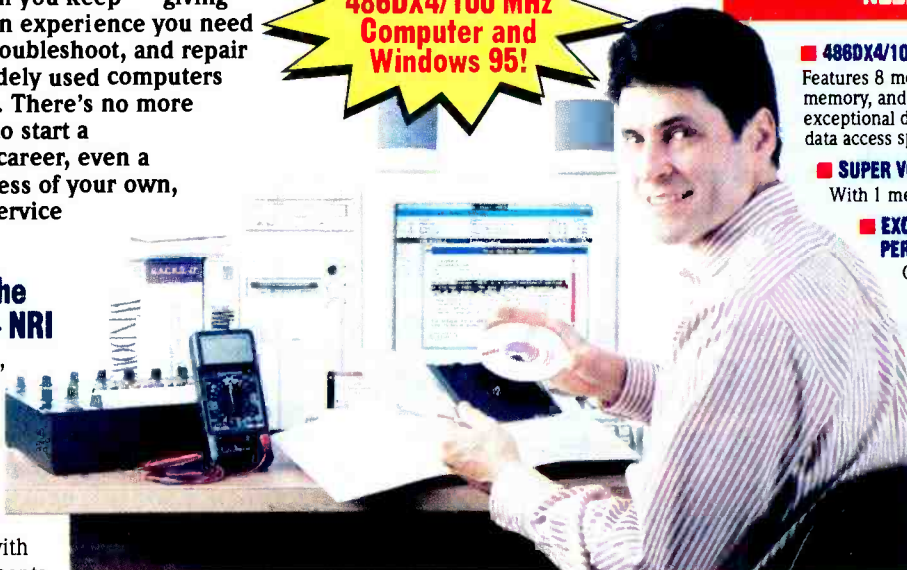

computers before, NRI's interactive training builds such a solid foundation of know-how and practical experience that tomorrow's jobs can be yours.

Right from the start, hands-on experiments reinforce concepts presented in NRI's bite-sized lessons. And because your work is reviewed by your personal instructor, you know for certain that you can apply theory to real-world demands.

FREE NRI catalog tells more

Send today for your free, full-color catalog. If the coupon is missing, write to: NRI Schools, 4401 Connecticut Avenue, NW, Washington, DC 20008. Or . . .

YOU GET EVERYTHING YOU NEED FOR SUCCESS

■ 486DX4/100 MHZ COMPUTER

Features 8 meg RAM, 128K cache memory, and 540 meg hard drive for exceptional data storage capacity and data access speed

■ SUPER VGA COLOR MONITOR

With 1 meg video memory

■ EXCITING MULTIMEDIA PERIPHERALS

Quad-speed CD-ROM drive, 16-bit sound card, and speakers

■ FAX/MODEM

14,400 baud for fast communications, plus ten free hours of *America Online*

■ ULTRA-X DIAGNOSTIC PACKAGE

R.A.C.E.R. II plug-in card and QuickTech-PRO software to help you detect problems on

virtually all IBM-compatible machines, even if computer is 5% operational

■ NRI DISCOVERY LAB

Complete breadboarding system to design and modify circuits, diagnose and repair faults

■ DIGITAL MULTIMETER

Professional, hand-held test instrument for quick and easy measurements

■ WINDOWS 95

Time-saving operating system that's taken the computer world by storm!

R.A.C.E.R. and QuickTech-PRO are registered trademarks of Ultra-X, Inc. Windows 95 is a trademark of the Microsoft Corporation.

CALL NOW!

1-800-321-4634, Ext. 0000

SEND TODAY FOR FREE NRI CATALOG!

NRI Schools 4401 Connecticut Avenue, NW, Washington, DC 20008

Check one **FREE** career catalog only

MICROCOMPUTER SERVICING

- Computer Programming Networking with Windows NT
 TV/Video/Audio Servicing Bookkeeping and Accounting
 Desktop Publishing Visual Programming in C++
with PageMaker

OR GET YOUR DEGREE!

- Associate Degree in Accounting
 Associate Degree in Business Management

Name (please print)

Age

Address

City

State

Zip

A Division of The McGraw-Hill Companies

Accredited Member, Distance Education and Training Council

0018-0296

would support that mode of communication.

In addition to providing demo software, the VocalTec site also offers a lot of useful information that will help you make your decision as to whether Internet Phone is right for you. Of course the best way to find that out is to download the free software and give it a try. But here are a few points to keep in mind:

Internet Phone works through the IRC network. Similar to IRC, the program provides you with a list of online users and topics of conversation when you connect. You can simply select a user from the list and call him or her, or create your own topic and wait for others to contact you.

Now, that raises the question about privacy. VocalTec addresses that concern in detail: "Internet Phone provides you with 'private topics' that only you and your family, friends or business associates can use. These topics are 'unlisted,' and can be accessed only by the users who know about them. In this way you can conduct your conversations quietly, without getting calls from all the other online users. When you only use private topics, your name does not appear on the global list of online users. Only users who know where to look can reach you."

Another concern some users might have is that of multitasking. In other words, do you have to devote your computer to nothing but waiting for an Internet Phone call? Definitely not, you can do other work and keep the program minimized. Then if someone calls, you can "answer" it.

As you can see, you really have nothing to lose by giving the program a try. Visit VocalTec's easy-to-use

site and prepare for a new experience in communication.

A CIRCUIT COOKBOOK

And now, let's not forget who the primary readers of this column are—electronics hobbyists! To keep all of you with a hunger for technical knowledge satisfied, we'll now turn our attention to a really great electronics site with numerous circuit diagrams, descriptions, and FAQs, and computer programs.

The site, called the "Circuit Cookbook," is actually a page that links you to FTP files. That link allows you to just type in the address given in the "Hot Links" box while using your browser, and explore the FTP files with an interface, instead of being launched into meaningless directories, which is what happens when you normally access FTP sites.

The first thing you'll notice when you access the site is the list of readme files. Those are meant to introduce the types of formats that files are posted in, and to show you how you can contribute to the archive with any circuits or tips you might have. Once you familiarize yourself with the site, which should take all of two minutes, you can take advantage of the wealth of information found there.

Scrolling down past the readme files, you'll find a list of file subjects that can each be selected and linked to. Those are: Audio, Computers, Digital, Frequently Asked Questions, Integrated Circuits, Miscellaneous, Optics, Power, RF Information, Software, SPICE Files, Telecommunications, Video, and Wave Shaping.

As you'll find out either by entering those subject directories, or by reading the readme files, the posted

HOT LINKS

VocalTec Internet Phone
<http://www.vocaltec.com>

Circuit Cookbook WWW Page
<http://ftp.ee.ualberta.ca/pub/cookbook/index.html>

programs, schematics, and electronics documents appear in various formats, including several for IBM-compatible and Unix formats. IBM users should be happy to find that there are also instructions for converting the Unix files for use (and there are some good ones here). A quick note to IBM users: The .GIF schematics are really the best way to go; they're clear and easy to read.

We obviously can't explore in this column what each of the subject directories contain (that's what

your Net connection is for!). But here's a sample of what you can expect:

The first directory, Audio, contains schematics of simple through advanced projects, including a guitar-project subdirectory. Circuits include a 100-watt RMS amplifier, guitar distortion box, and guitar "crybaby." You'll also find a Windows speaker-design program that helps you generate enclosures and crossovers.

The Program directory is another interesting grouping of files. As my reference to the speaker-design program just showed, not all the software found in this FTP site is grouped in the Program directory, but a large number of useful programs are. In addition to the PC-board-design pro-
(Continued on page 26)

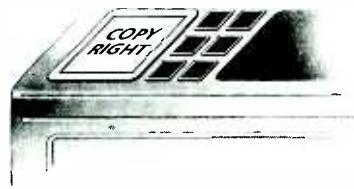

THE MOST
**AN IMPORTANT PART
OF YOUR PHOTOCOPIER
ISN'T PART OF
YOUR PHOTOCOPIER**

Having a machine may not permit you to photocopy books, journals, newsletters and magazines.

The Copyright Clearance Center CAN.

Contact us to find out
how you too can COPY RIGHT!SM

COPYRIGHT CLEARANCE CENTER

222 Rosewood Drive, Danvers, MA 01923 □ Tel. (508) 744-3350 □ Fax (508) 741-2318

© 1993 Copyright Clearance Center

A Hands-on Electronics REPORT

Philips Fun with Electronics CD-ROM and Experimenter's Lab

In the old days, the only way to learn was with books, a blackboard, and a good teacher. Modern technology introduced records, tapes, slides, video, and more lively entertainment to the classroom, whether it be at school or at home. Now, thanks to the advent of multimedia, learning has never been more fun.

A picture says a thousand words, and video maybe more. From the old "please advance the frame at the sound of the beep" classroom film strips, to more-modern multimedia learning aids, any narrated picture show really helps make learning more effective and more fun. As a matter of fact, it is more effective because it is more fun.

Multimedia has opened up a whole new area in the learning arena. People can now study with the aid of sound, pictures, and video, and with the ability to skip around the media from place to place instantaneously—try that with an audio cassette or video tape!

The electronics field has its many learning aids as well, including breadboards, trainers, and kits that are de-

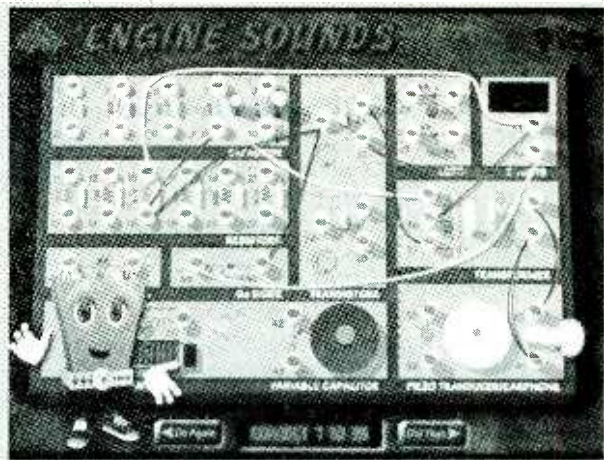

CIRCLE 119 ON FREE INFORMATION CARD

Children, and the young-at-heart, will have fun learning about electronics with this multimedia learning lab.

signed to make it easier to learn. But until recently, if you were the owner of a multimedia home computer, there was very little you could do with it to help you or your kids learn about electronics. But all that has changed with the introduction of *CyberCrafts: Hands-on-Learning* series Fun with Electronics combination CD-ROM and experimenter's lab from Philips Media Home & Family Entertainment (for Mac and PC-compatible computers—a CD-i version should be available in January 1996).

The animated multimedia CD-ROM is geared toward kids ages 8 and up with its entertaining characters based on electronic components. But any adult into multimedia and wanting to learn about electronics might also enjoy this program. It takes a light-hearted approach to teaching the basics of electronics, and the funny characters make it easy to remember what each component does.

The Fun with Electronics package includes a colorful work bench and a storage box containing over 100 electronic components. Step-by-step instructions, both in a printed manual and on CD-ROM, guide the user through 25 exciting experiments including sirens, radios, metal detectors, and more. Fun with Electronics is priced at \$44.99.

Fun With Electronics. The first step in having fun with electronics is to as-

semble the work bench. The work bench consists of a sturdy, flat cardboard box colorfully printed on the outside with pre-punched holes on top for mounting the electronic components. Component locations and necessary values are clearly labeled.

A divided, plastic storage box comes loaded with various components and breadboard springs that screw into the pre-punched holes in the box cover. Components include various resistors and capacitors, a diode, LEDs, transistors, a variable capacitor and tuning wheel, a wire-wound antenna, an earphone, a piezoelectric transducer, a 9-volt battery connector, and a transformer. Insulated jumper leads in different lengths are also included.

Component leads pass through small holes in the work-bench cover and wrap around the bottom ends of the breadboard springs. Once all the component leads are connected to springs on the underside, circuits can be made quickly and easily by connecting wire jumpers from spring to spring on the top side. Building the workbench gives the user a hands-on feel for the components themselves. The multimedia fun comes next.

The CD-ROM program installed and ran with no hassles. The program also runs fast. There are no long waits after you press a button, and the program does not crash or lock up from pressing one too quickly. New icons

appear in Windows after the software is installed. One of them controls on-line assembly instructions for the workbench should you prefer them over the printed instructions. The other icon controls the project's software.

The software is hosted by Mr. Battery, an animated 9-volt battery with hands and a snap connector for a hat. He always tips his hat to remind you to remove the connector when necessary. Pressing an overview button guides the user through the different parts of the software. The overview recommends that you start with the Basics, then Meet the Stars, then go Behind the Scenes, and then start picking Projects to build.

The Basics is an animated movie that explains how electricity works, from atoms and their proton-neutron-electron activity, to insulators and conductors, to oscillators (in which it is explained that "an oscillator is not a cross between an ocelot and an alligator"), to schematics.

Meet the Stars is an animated presentation that looks like a TV game show with a panel of electronic component stars. You'll be introduced to the "Transistor sisters," "Mr. Piezo Transducer" from Italy, whose hat vibrates; a sun-worshipping photocell girl; and "Officer Diode," who only allows current to flow one way. There are plenty of other funny characters, too. An electronic quiz show asks questions about the different components and you have to point to the right one.

Behind the Scenes is a multimedia tutorial on how common, everyday things work. Items include a light bulb, telephone, television, radio, microwave oven, tape recorder, metal detector, bar-code scanner, electric guitar, light switch, and vending machine. Pressing different parts of each machine illustrates what each part does.

The 25 projects are divided into three categories of varying difficulty. The "no sweat" category includes step-by-step instructions on how to build an engine-sound circuit, a light fader, a traffic light, a burglar alarm, a light-activated switch, a conductance checker, an electronic rooster, and an electronic tag game. The "mind benders" category includes sirens and lights, a touch switch, a light organ, an electronic

(Continued on page 102)



Raise your standard to Wavetek.

Why choose between paying more for a brand name or getting more functions for your money? Get the best of both worlds with **Wavetek**.

Worldwide Service. Support whenever and wherever you need it.

Tech-preferred Features. The XL meters have the largest displays, auto-off, data hold, manual and autoranging models in pocket-size convenience.

Quality. Less than 0.5% warranty returns assures continuous reliability.

Selection. Over 35 different **Wavetek** DMMs to meet any measurement need.

User Safety. Conservative voltage ratings, fused inputs, warning beepers, shrouded test leads, and designs that meet worldwide agency approvals.

Total Value. Eight XL Series meters from \$29.95 to \$99.95 to meet any requirement.

You don't need to pay more.
You can't afford to settle for less...

For the name and location of the Wavetek dealer near you, call
1-800-854-2708
(outside the U.S., call 619-279-2200)

WAVETEK

Wavetek Corporation
9045 Balboa Avenue,
San Diego, CA 92123

©Wavetek Corp., 1995. Wavetek and the Wavetek logo are registered trademarks of the Wavetek Corporation

PRODUCT TEST REPORTS

By Stephen A. Booth

Panasonic CT-27SF31S 27-Inch Color TV



CIRCLE 120 ON FREE INFORMATION CARD

The Panasonic CT-27SF31S 27-inch "SuperFlat" color TV.

Every once in a while, a TV comes along that sets itself apart from the crowd. One such set is the *Panasonic CT-27SF32S* 27-inch "SuperFlat" TV. In addition to its wonderful picture tube, which shows 30% less curvature than garden-variety CRTs, this set comes loaded with frills and features—and a sticker price—that guarantees you won't mistake it for "light-and-play" sets of the same size.

FEATURES

SuperFlat is Panasonic's version of the dark-glass, high-contrast, reduced-curvature tubes that most TV makers now incorporate in their premium receivers. Besides better off-axis viewing, the benefits of the new geometry include less optical-distortion and, especially in the corners, reduced color distortion caused by mis-registration of the electron beam. The more-planar screens also cut the amount of glare from reflected ambient light, which otherwise would rob contrast.

What you see in the 27-inch screen of this Panasonic set is a pretty picture—as many as two of them if you use the picture-in-picture (PIP) function. The PIP can be located in any corner of the screen, or swapped with the main picture. The input isn't limited to an external video source, because the CT-27SF31 has two tuners built-in. Whatever the source, though, audio accompanies only the video on the main screen.

Virtually every feature and setting for the CT-27SF31S is operated through Panasonic's "Easicon" on-screen menu, which is about as intuitive as any I've seen. It's all point-and-click via the unit's universal remote control, whose spacious layout has large buttons and cursor-like keypads, which, alas, isn't illuminated (one of the set's very few shortcom-

ings—the only other ones of note are the lack of front-panel audio/video jacks for a camcorder and no headphone jack anywhere).

Noteworthy features within the Easicon menu include AI (Artificial Intelligence) Picture and Audio, and user-selectable White Balance that lets you alter the color temperature of the video. Those features, unlike many buzzword items in consumer electronics, do actually make a demonstrable difference in what you see and hear.

AI Picture monitors flesh-tone accuracy and brightness, color-edge distortion, and color noise. It's a dynamic, on-the-fly system well-suited to the vagaries among cable, broadcast, and external-video signals. You'll find noise-reduction to be its strong suit when you're the one-thousandth renter of that hit-movie tape.

AI Sound is another multi-function feature that really works. One of its functions is to apply corrective equalization to soundtracks that have lost or picked up something along the way (like the bass and noise, respectively, on those rental tapes). Better still, AI Sound maintains the volume level between programming and commercials—no more waking the dead when that late-night pitch comes on. It does the same for channel-to-channel level differences, or differences between external sources.

Happily, so does its performance. Based on subjective appraisal and laboratory bench-tests, this is one outstanding example of TV technology.

Like most TVs, the CT-27SF31S comes with its color temperature preset to compete on the retail showfloor. APEL measured that "Standard" mode at 12,000°K—very typical for out-of-the-box performance, but rather feverish to videophiles who want the perfectly-cinematic 6500°K written into the NTSC standard.

Fortunately, the White Balance can be adjusted through the Easicon menu. Besides Standard, there's a Warm setting (10,000°K) that is the closest to NTSC this TV gets, and a Cool setting (15,900°K) that will positively delight retailers (or football fans who like to simulate the stadium experience by viewing TV outdoors). The difference among those settings is evident on the CT-27SF31S. For the record, when dealing with °K (de-

grees Kelvin), the higher the temperature the cooler (icy-blue whites) the picture seems. Lower temperatures mean "warm" in the sense of sunshine-dappled yellow on a snowscape.

One final note on the Easicon menu. You can take Parental Lockout (of taboo channels) for granted these days, but a sign of the times has got to be "Game Lockout." That feature cuts off the Channel-3 or -4 video inputs where videogame consoles (among other sources) tend to be installed. Presumably, the idea is to get Johnny and Susie to read "Great Expectations" when they'd rather be plucking out livers in a friendly game of "Mortal Kombat."

PERFORMANCE

As usual, this piece of gear went on the rack at

the Advanced Product Evaluation Laboratory, an independent testing facility in Bethel, Connecticut.

Whatever color temperature you choose, the CT-27SF31S will be plenty bright—APEL measured maximum usable luminance at 75 foot-lamberts. And with horizontal resolution clocked at 560 lines, it'll handle the sharpest input sources you can feed it—laserdisc, direct-broadcast satellite, high-band camcorders, and even the new Digital Video Cassette home-moviemakers (which yield some 500 lines of resolution). Meanwhile, color quality (saturation and hue) referenced to the standard Macbeth chart was excellent.

In geometry class the CT-27SF31S scores high, but not a perfect 100%—few TVs do. Its shortfalls from

perfection in overscan, convergence, interlace and transient response are negligible, in the sense that test-equipment is faster than the eye. Meanwhile, the tuner in this TV is exceptionally good. Under worst-case conditions, reception showed minimal snow.

Audio quality ought to complement video this good, and in the CT-27SF31S it does. Performance from the MTS broadcast stereo decoder is no less than you should expect in a TV of this caliber—though no one would complain about getting more channel-separation than the 20.4 dB measured by APEL. It's a typical reading for TVs, though VCRs usually have greater separation, and extends across a broad frequency range from 23 Hz to 10.1 kHz. Signal-to-noise ratio (59.7 dB) is

SCANNER USERS • COMMUNICATIONS PROFESSIONALS

Finally, a better frequency book than Police Call!

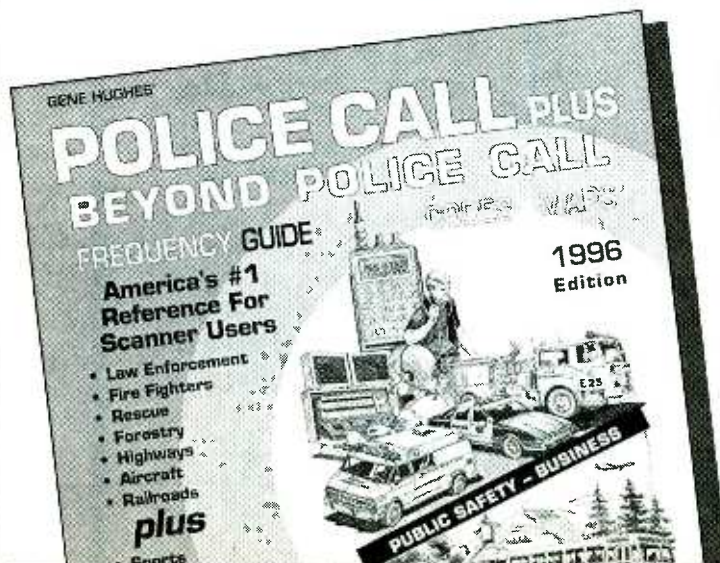

POLICE CALL PLUS

1996 EDITION

Now includes **BEYOND POLICE CALL** non-public safety frequencies

- Completely revised. Current through October 1995.
- 16,000 Codes and Signals.
- FCC and Federal Frequency Allocations 25-941 MHz.
- Illustrated Listener's Guide Book.

GOT A SCANNER? GET POLICE CALL PLUS.

At your scanner dealer and all Radio Shack stores.

More People Have Bought **POLICE CALL** Than All Other Frequency Guides (VHF/UHF) Combined.

TABLE 1—TEST RESULTS

Brand:	Panasonic
Model:	CT-27SF31S
Price:	\$950
VIDEO MEASUREMENTS:	
Maximum usable luminance	75 foot-lamberts
Horizontal resolution	560 lines
Convergence (center)	0.0%
Convergence (corners)	0.2%
Overscan (horizontal)	1.0%
Overscan (vertical)	0.0%
Interlace	60/40
Transient response	Slight ringing
Color temperature (standard)	12,000°K
Color temperature (warm)	10,000°K
Color temperature (cool)	15,900°K
Color quality	Excellent
Reception (100 µV/M)	Very good

AUDIO MEASUREMENTS:

Audio Out	
0-dB reference level (@ 1 kHz, 3.00% THD)	2.85 volts
Signal-to-noise ratio	69.1 dB
Total harmonic distortion (1 kHz)	0.08%
Frequency response	20 Hz–20 kHz

MTS STEREO TV DECODER MEASUREMENTS:

Stereo Mode/Left Channel	
Signal-to-noise ratio (re 100% modulation)	59.7 dB
THD (@ 1 KHz, -20 dB)	0.36%
Frequency response*	23 Hz–10.1 kHz
Separation*	20.4 dB

S.A.P. Mode	
Signal-to-noise ratio (re 100% modulation)	69.0 dB
THD (@ 1 kHz, -20 dB)	0.66%
Frequency response (re 100% modulation)	20 Hz–6.0 kHz

Mono Mode	
Signal-to-noise ratio (re 100% modulation)	60.5 dB
THD (@ 1 KHz, -20 dB)	0.47%
Frequency response (re 100% modulation)	20 Hz–5.8 kHz

ADDITIONAL DATA:	
Picture size	27-inch (diagonal)
Loudspeakers (2)	5 x 3.5 inch oval
Power requirements	145 watts
Dimensions (HxWxD, inches)	21.25 x 26.5 x 19

*Frequency response and stereo separation for Multichannel TV Sound broadcasts are measured using real-world reception conditions of -20 dB relative to 100% signal modulation.

excellent, and distortion (0.36%) is inaudible.

Those measurements, in conjunction with the TV's very-clean audio-output section, mean you'll get satisfying results if you connect the CT-27SF31S to an out-board stereo system, possibly one with Dolby Surround decoding. Test results for monaural reception and for the monaural, SAP (Second Audio Program) channel were equally good: wide frequency response, low noise, and negligible distortion.

Even with retail discounts, the CT-27SF31S (\$950 list) doesn't come cheap for a 27-inch TV. But its features and performance won't disappoint.

For more information on the Panasonic CT-27SF31S, contact the manufacturer at the address that follows, or circle no. 120 on the Free Information Card. ■

VENDOR INFORMATION

Matsushita Consumer Electronics Company
One Panasonic Way
Secaucus, NJ 07094

NET WATCH

(Continued from page 21)

grams you might expect to find here, there are also quite a few useful shareware programs that can aid in the math behind electronics design (such as determining what value components to use, etc.).

A final word on the site before we leave off. There is a disclaimer basically stating that the circuits can't all be tested before they are posted. Some might not work, but according to the disclaimer, many do seem to. So, if you find a circuit that doesn't work, or that could be better, follow the readme-file instructions and make a contribution to the site. It can only make the archive a better resource for all of us.

Until next time, enjoy your

Net explorations. If you have any questions or comments, or perhaps a neat site you'd like to see covered in future columns, you can e-mail me at oeeditor@aol.com, or send snail-mail to *Net Watch*, **Popular Electronics**, 500 Bi-County Blvd., Farmingdale, NY 11735. ■



EVERY LITTLE
BIT
HELPS



CABLE TV CONVERTERS/DESCRAMBLERS!

- **Novavision 5600, 5700, 5800**
5-lot @ \$195.00 ea.
- **M-80**
10-lot @ \$49.00 ea.
- **TNT Original Digital Dynamite**
10-lot @ \$45.00 ea.
- **PIO TRIPLE-MODE Add On**
10-lot @ \$55.00 ea.

CALL FOR MANY OTHER POPULAR MODELS!!

ALL EQUIPMENT AVAILABLE IN STOCK!
FAST DELIVERIES! WE SHIP WITHIN 24 HOURS!
30 DAY GUARANTEE / 1 YEAR WARRANTY



1-800-818-2282

8 a.m. to 5 p.m. CST, Monday - Friday

PROtech
DISTRIBUTORS, INC.

13 S. Randall Road #507, Algonquin, IL 60102

NOTE: Converters and Descramblers must be used according to The Federal Cable Television Consumer Protection and Competition Act of 1992

NO ILLINOIS ORDERS ACCEPTED

CIRCUIT CIRCUS

By Charles D. Rakes

Let's Make Some Noise!

While the cover date on this magazine may say February, it will be in your hands well before January. So let's dedicate this visit to some electronic noise makers that could liven up your New Year celebrations.

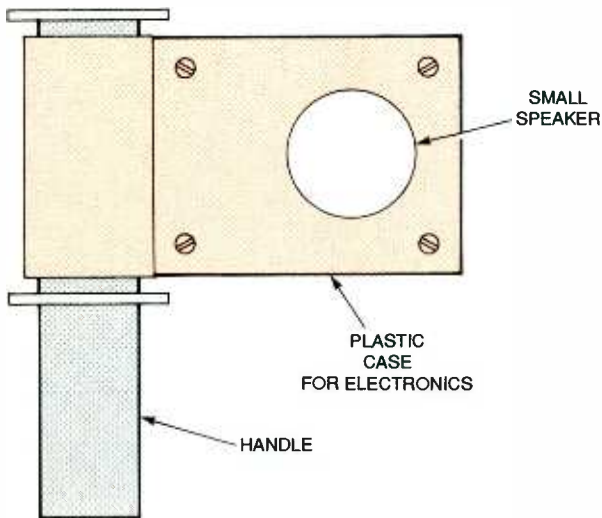

Fig. 1. Does this look familiar? It is the case for an electronic version of a noise maker that has been around for a long time.

ELECTRONIC NOISE MAKER

A long time ago, kids used to play with an ear-hurting, hand-cranked noise maker that produced a rat-a-tat sound. Our first entry is an electronic version of that device. Take a look at the sketch in Fig. 1 and see if it doesn't look a little familiar. No matter if it doesn't, we'll explain as we proceed.

Figure 2A shows a length of wood dowel rod, about 6-inches long, with a cut out made to hold a small magnet. The cut-out should be made deep enough so that, when in place, the magnet's outside surface will be flush with the dowel's

outer surface. A section of plastic pipe, sized so that it slides smoothly over the dowel rod, serves as both a holder for six reed switches (see Fig. 2B) and a place to mount the plastic case shown in Fig. 1.

Two fiber or plastic washers keep the plastic pipe in place but free enough to turn around the dowel rod. The small plastic case should be attached to the plastic pipe with a good plastic glue. One that actually melts the two joining surfaces would be the best choice.

Now let's look at the circuitry itself, which is shown in Fig. 3. The noise maker's circuit is about as straightforward as you can get. A single unijunction transistor, Q1, generates the different tones, and a general-purpose NPN transistor, Q2,

raises the level to drive a small speaker. The six reed switches, S1-S6, are mounted around the outside of the plastic pipe as shown in Fig. 1B. As the pipe turns over the magnet, the reed switches open and close, tying a different-valued resistor to the oscillator's frequency-control circuitry. It's also possible for two reed switches to be closed at the same time. When that happens, the output tone will be much higher in frequency than when one at a time is activated.

The oscillator's frequency range could be lowered by increasing the value of C1, and raised by decreasing C1's value. To operate just grab the noise maker by the dowel rod and give it a twist to start the plastic case turning.

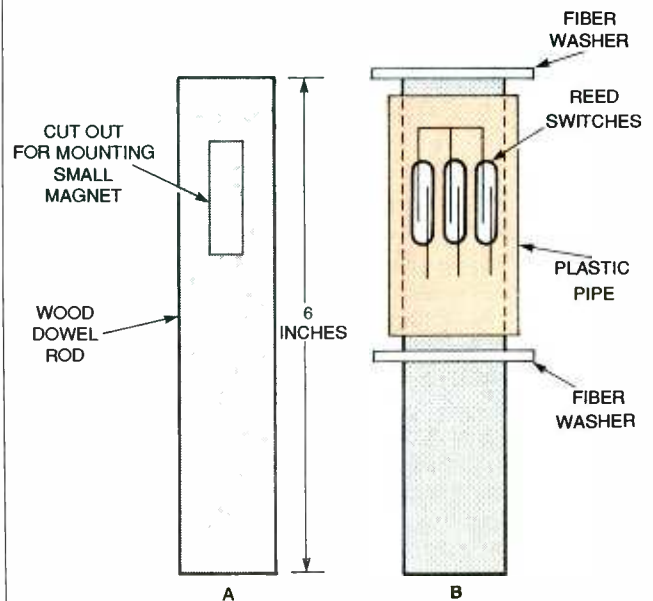

Fig. 2. Here's the handle for the noise maker. The location of a cut out for a small magnet is shown in A; the positioning of a plastic pipe on which the switches and the case with rest of the circuitry mount is shown in B. The fiber washers keep the plastic pipe in place but free enough to turn around the dowel.

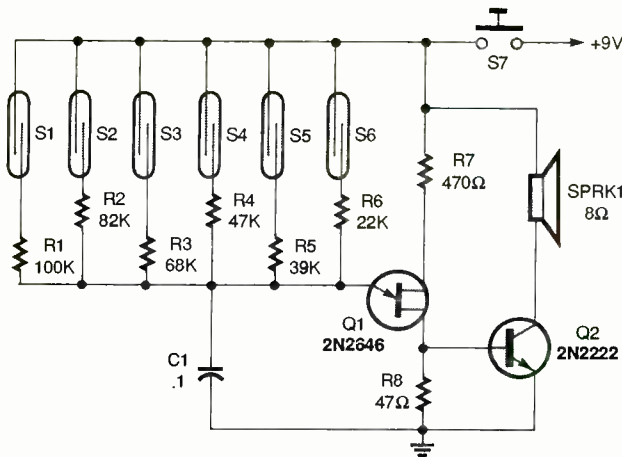

Fig. 3. Here's the circuitry for the noise maker. As it swings around the handle, the magnet activates the reed switches, constantly changing the frequency of the audio oscillator.

PARTS LIST FOR THE ELECTRONIC NOISE MAKER (Fig. 3)

RESISTORS

(All fixed resistors are 1/4-watt, 5% units.)

- R1—100,000-ohm
- R2—82,000-ohm
- R3—68,000-ohm
- R4—47,000-ohm
- R5—39,000-ohm
- R6—22,000-ohm
- R7—470-ohm
- R8—47-ohm

ADDITIONAL PARTS AND MATERIALS

- Q1—2N2646 unijunction transistor
- Q2—2N2222 NPN transistor
- C1—0.1- μ F ceramic-disc capacitor
- S1-S6—Reed switch
- S7—SPST normally-open pushbutton switch
- SPKR1—8-ohm speaker
- Magnet, wood dowel, plastic pipe, fiber washers, plastic case, perfboard, wire, hardware, etc.

A WAILING WITCH

Our next noise maker, see Fig. 4, is an electronic "wailing witch." After you play with the circuit awhile, you might find a more fitting moniker for it—feel free to name it what you like.

Whatever you call it, here's how the circuit works. Two unijunction transistors, Q1 and Q2, are connected in a dual oscillator circuit. Transistor Q1 is connected in a very-low-frequency relaxation oscillator circuit with C1, R1, R5, and R9. Transistor Q2 is connected in a similar os-

illator circuit that operates at a much higher audio frequency. That oscillator's frequency is set by R6, R10, and C2. Resistor R7, a 1-megohm potentiometer, sets the mixing level of the two oscillators. By adjusting R5, R7, and R6, many strange sounds are created.

AN ELECTRONIC TROMBONE

Our next circuit, see Fig. 5, is a short-stroke electronic trombone. The heart of the trombone is R3, a slide potentiometer. Two gates of a quad two-input NAND gate,

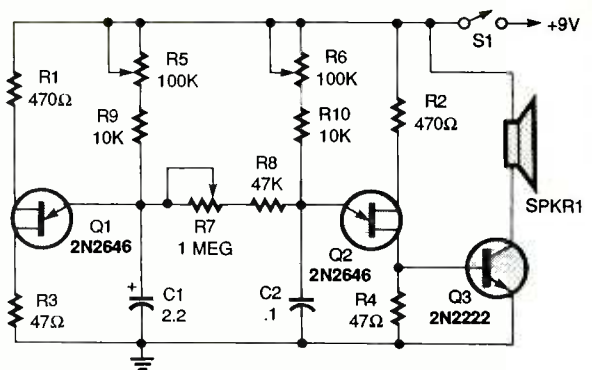

Fig. 4. Here's a "wailing witch" that you can build. After you've heard the racket it can produce for a while, you might come up with a different name for it!

PARTS LIST FOR THE WAILING WITCH (Fig. 4)

RESISTORS

(All fixed resistors are 1/4-watt, 5% units.)

- R1, R2—470-ohm
- R3, R4—47-ohm
- R5, R6—100,000-ohm, potentiometer
- R7—1-megohm, potentiometer
- R8—47,000-ohm
- R9, R10—10,000-ohm

ADDITIONAL PARTS AND MATERIALS

- Q1, Q2—2N2646 unijunction transistor
- Q3—2N2222 NPN transistor
- C1—2.2- μ F, 35-WVDC, electrolytic capacitor
- C2—0.1- μ F, ceramic-disc capacitor
- S1—SPST toggle switch
- SPKR1—8-ohm speaker
- Perfboard, case, wire, solder, etc.

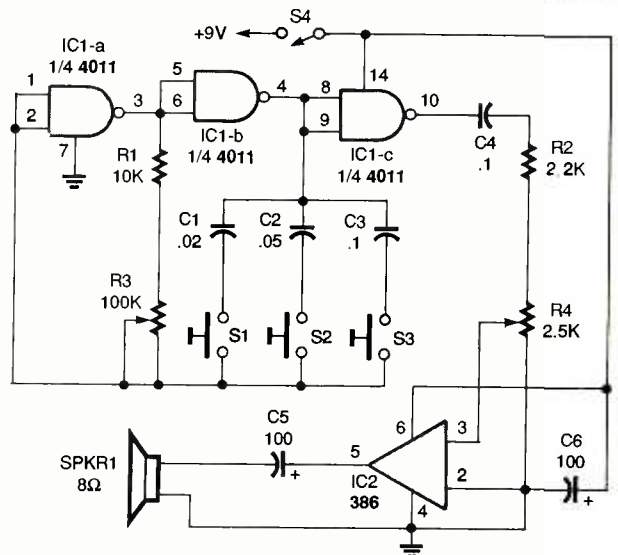

Fig. 5. The slide potentiometer, R3, in this electronic noise maker acts much like the slide of a trombone.

IC1-a and IC1-b, make up a simple audio-oscillator circuit with R1, R3, C1, C2, and C3 setting the oscillator's frequency. The oscillator's

output is buffered by IC1-c, which also supplies the drive signal for the power amplifier, IC2. The trom-

(Continued on page 77)



Breakthrough device repels pests... without chemicals or traps!

The new Transonic ESP generates ultrasonic and sonic noises to drive away annoying pests electronically.

by Thomas R. Buchanan



Ticks that torment your pet.
Crickets that chirp incessantly. Bees and wasps that build nests under your eaves.
Spiders that spin webs endlessly.
Are you waging a constant battle to

get rid of household pests? If you're like me, you don't like using poisons or traps, especially if you have small children. Until now, there weren't other options. Fortunately, now there is a solution.

Drive them away. Now, thanks to modern technology, there's a better way to get rid of household pests—the Transonic ESP. This remarkable new electronic device uses high-frequency sound waves to repel common pests. Best of all, the Transonic ESP doesn't trap or kill them—it drives them away. Pests are forced to flee the area to get away from the annoying and confusing sound waves. Therefore, there are no dead bodies or unsightly messes to clean up.

Tired of battling pests?



Fleas and ticks. Famous for causing skin discomfort, these pests also spread disease and parasites.



Spiders. Eliminate webs draped across your furniture and in the corners of your living room.



Bats. Dark places invite bats to roost. They can make a mess of your attic or storage building.



Squirrels. Gnawing squirrels in your walls or attic can cause structural and electrical damage.



Mice and rats. Well-known carriers of disease, rodents can be hard to get rid of once they have infested your home or office.



The Transonic ESP covers an area of up to 5,000 square feet.

Ultrasonic/sonic repellent. The key to the Transonic ESP is a patented electronic sound generator which broadcasts powerful ultrasonic and sonic noises in the five to 50 KHz range. These frequencies and pulse sequences are extremely uncomfortable to insects and small rodents. Pests are forced to leave or die.

Why it works. Most wild creatures depend on their acute hearing abilities for survival. They rely on hearing mechanisms for communicating with each other, for establishing territorial boundaries and for locating available food sources.

When critical hearing frequencies are disrupted by high-frequency pulses, insects and small rodents feel threatened and confused. They are forced to leave. Remaining in the area causes apathy and immobility.

Just plug it in. The Transonic ESP comes with its own transformer which plugs into any standard outlet. To operate, simply press the appropriate button on the front panel. You

Are poisons and traps endangering more than just household pests?

Traps. In addition to the trouble of setting up a trap and the danger of accidentally stepping into it, you also face the unpleasant task of disposing of the animal once it is caught.

Foggers. Using a fogger is both time-consuming and inconvenient. You must cover up all of your belongings in order to shield them from the chemicals. You also must wait several hours for the fumes to disperse before re-entering the area.

Pest sprays. Exposing your carpet and furniture to chemicals can be potentially dangerous, especially if you have young children who are still crawling. Plus, chemical sprays are difficult to apply in a way that eliminates all the pests, especially the hidden ones.



can repel fleas, ticks, spiders, bats, mice, rats or squirrels, depending upon the sound frequency you select. (For optimum performance, follow proper pest control practices.)

Optional motion sensor. The Transonic ESP's optional motion sensor turns the unit on when pests approach, increasing the surprise factor and effectiveness. An optional 50 foot extension cord allows you to place the Transonic ESP unit in remote areas that don't have electricity, like the attic.



The versatile Transonic ESP is perfect for home, barn or storage shed.

Factory-direct offer. The Transonic ESP is an extremely cost-effective way to control pests. And through this special factory-direct offer, it's even more affordable. In order to introduce this product to the public, we're offering a \$25 discount off the retail price. Right now, you can purchase the new Transonic ESP for only \$99.

Risk-free. The Transonic ESP is backed by our exclusive 90-day risk-free home trial. Try it in your home, garage, barn—anywhere. If you're not completely satisfied, just return it for a full "No Questions Asked" refund. The Transonic ESP is also backed by a two-year manufacturer's warranty. Most orders are processed within 72 hours and shipped UPS.

Transonic ESP ~~\$124~~ \$12 S&H
With special factory-direct offer **\$99**
 Motion Sensor \$39 S4 S&H
 Extension Cord \$19 S3 S&H
 Please mention promotional code 534-PL-6645.

For fastest service, call toll-free 24 hours a day

800-992-2966



To order by mail, send check or money order for the total amount including S&H (VA residents add 4.5% sales tax.) Or charge it to your credit card by enclosing your account number and expiration date.

COMTRAD INDUSTRIES

2820 Waterford Lake Drive, Suite 106
Midlothian, Virginia 23113

RETAILERS THAT SELL OUR MAGAZINE MONTHLY

Alaska

Frigid North Co.
1207 W. 36th Avenue
Anchorage, AK 99503

Alabama

Radio Distributing Supply
121 East Broad Street
Gadsden, AL 35903

Arizona

Dalis Electronics
2829 E. McDowell Road
Phoenix, AZ 85008

California

California Electronics
221 N. Johnson Ave.
El Cajon, CA 90202

Signal Electronics
22307 Ocean Avenue
Torrance, CA 90505

Ford Electronics
8431 Commonwealth Avenue
Buena Park, CA 90621

All Electronics
14928 Oxnard Street
Van Nuys, CA 91411

Gateway Electronics of CA
9222 Chesapeake Drive
San Diego, CA 92123

Mac's Electronics
191 South "E" Street
San Bernardino, CA 92401

Electronics Warehouse
2691 Main Street
Riverside, CA 92501

Orvac Electronics
1645 E Orangethorpe Ave.
Fullerton, CA 92631

Sav-On Electronics
13225 Harbor Blvd.
Garden Grove, CA 92643

Marvac Dow Electronics
980 S. A Street
Oxnard, CA 93030

Kandarian Electronics
1101 19th Street
Bakersfield, CA 93301

Whitcomm Electronics
105 W. Dakota #106
Clovis, CA 93612

Marvac Dow Electronics
265-B Reservation Road
Marina, CA 93933

Minuteman Electronics
37111 Post St., Suite 1
Fremont, CA 94536

HCS Electronics
6819 S. Redwood Drive
Cotati, CA 94931

Halted Specialties Co.
3500 Ryder Street
Santa Clara, CA 95051

JDR Micro Devices
2233 Branham Lane
San Jose, CA 95124

Metro Electronics
1831 J Street
Sacramento, CA 95814

The Radio Place, Inc.
5675-A Power Inn Road
Sacramento, CA 95824

HSC Electronics
4837 Amber Lane
Sacramento, CA 95841

Colorado

Gateway Electronics of CO
2525 Federal Blvd.
Denver, CO 80211

Centennial Electronics
2324 E. Bijou
Colorado Sps., CO 80909

Connecticut

Signal Electronics Supply
589 New Park Avenue
W. Hartford, CT 06110

Cables & Connectors
2198 Berlin Turnpike
Newington, CT 06111

Electronic Service Prod.
437 Washington Avenue
North Haven, CT 06473

Georgia

Norman's Electronics, Inc.
3653 Clairmont Road
Chamblee, GA 30341

Idaho

The Current Source
5159 Glenwood
Boise, ID 83714

Illinois

Tri State Elex
200 W. Northwest Hwy.
Mt. Prospect, IL 60056

Maryland

Mark Elec. Supply Inc.
5015 Herzel Place
Beltsville, MD 20705

Massachusetts

U-Do-It Electronics
40 Franklin Street
Needham, MA 02194

Michigan

Purchase Radio Supply
327 East Hoover Avenue
Ann Arbor, MI 48104

The Elec. Connection
37387 Ford Road
Westland, MI 48185

Minnesota

Acme Electronics
224 Washington Avenue N.
Minneapolis, MN 55401

Missouri

Gateway Electronics Of MO
8123-25 Page Blvd.
St. Louis, MO 63130

New Jersey

Lashen Electronics Inc.
21 Broadway
Denville, NJ 07834

New York

Sylvan Wellington Co.
269 Canal Street
New York, NY 10013

R&E Electronics
4991 Rt. 209
Accord, NY 12404

Unicorn Electronics
Valley Plaza
Johnson City, NY 13790

Ohio

Philcap Electronic Suppliers
275 E. Market Street
Akron, OH 44308

Oregon

Norvac Electronics
7940 SW Nimbus Avenue
Beaverton, OR 97005

Portland Radio Supply
234 S.E. Grand Avenue
Portland, OR 97214

Texas

Tanner Electronics
1301 W. Beltline
Carrollton, TX 75006

Mouser Electronics
2401 Hwy. 287 N
Mansfield, TX 76063

Electronic Parts Outlet
17318 Highway 3
Webster, TX 77598

Washington

Amateur Radio Supply Co.
5963 Corson Ave., Ste 140
Seattle, WA 98108

Wyoming

Chris Supply
2007 S. Douglas Hwy., Ste. C
Gillette, WY 82716

**If you'd like to sell our magazine in your store,
please circle 180 on Free Information Card.**

Send simple transmissions
in the 40-meter amateur band.

BUILD A VACUUM- TUBE Transmitter

BY LARRY LISLE



made. Even though the unit outputs in the 1- to 2-watt range, that should be strong enough to establish plenty of contacts, provided that conditions are right, and that the unit is used with skill and patience.

Circuit Description. The schematic for the Transmitter is shown in Fig. 1. In the circuit, power is shown supplied by a 3-volt battery, B1, and a 135-volt battery, B2. The latter battery, B2, can be replaced by a power-supply circuit that we'll get to in a moment. Switch S1 is used to turn the circuit on or off.

The heart of the circuit is a 3A5 tube, V1. Both sections of V1 are connected in parallel in a conventional Miller oscillator. Resistor R1 sets the bias for the tube; the value of R1 might seem low to some because it is only 4700 ohms, but keep in mind that V1 is a transmitting triode operating at class C.

A 2.5-mH, RF-choke coil, L3, is needed to keep the radio frequency where it belongs. Capacitor C1 and inductor L1 resonate at the frequency of a 40-meter (7–7.3 MHz) amateur crystal, XTAL1. Inductor L2 couples RF energy to an attached antenna; C2 is a bypass capacitor.

Switch S2 is a telegraph-type key-switch. That's used to generate the content of any transmissions you make.

As mentioned earlier, you can eliminate the need for battery B2 by build-

ing a simple power supply. It's schematic is shown in Fig. 2.

Transformer T1 provides isolation from the power line. The isolated AC voltage is rectified by diode D1 and filtered by capacitor C1.

Construction. The author's prototype for the Transmitter was built on a 9- x 5½-inch wood baseboard.

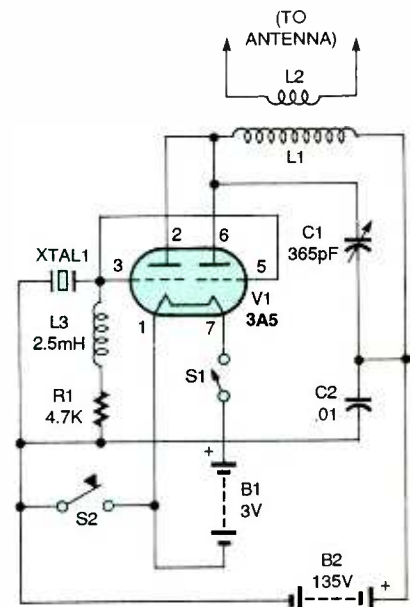

Fig. 1. This is the schematic for the Vacuum-Tube Transmitter. At the heart of the circuit is V1, a 3A5 tube with two sections that was designed for battery-powered transmitters.

If you're a licensed radio amateur, or you're just interested in how tube transmitters work, here's a little ham-radio transmitter that can provide you with hours of fun on 40 meters. The *Vacuum-Tube Transmitter* described in this article is an easy-to-build unit, with a fairly low parts count, that is an ideal project even for someone who's never built a transmitter before.

The Transmitter is a low-power (QRP) one-tube unit based around a type-3A5, twin-triode vacuum tube. The 3A5 was one of the few tubes actually designed to operate on battery power, and was widely used in portable and emergency transmitters in World-War II. Battery power is somewhat safer for a newcomer to tube voltages, and is actually practical with low-cost military surplus batteries. For those who wish to not bother with the hassle of replacing batteries, an optional power-supply circuit is also included.

Before we get to the actual circuit itself, a brief mention of the power output of the Transmitter should be

PARTS LIST FOR THE BATTERY-TUBE TRANSMITTER

- R1—4700-ohm, 1-watt, 5% resistor
- C1—365-pF, variable capacitor
- C2—0.01- μ F, ceramic-disc capacitor
- L1—See text
- L2—See text
- L3—2.5-mH, radio-frequency choke coil
- V1—3A5 vacuum tube
- XTAL1—40-meter amateur crystal (see text)
- S1—SPST knife switch
- S2—Key-switch, telegraph type
- B1—3-volt battery (two 1.5-volt D-type batteries in series)
- B2—135-volt battery (three 45-volt batteries in series; see text)
- Wood baseboard (9 × 5½ inches), Plexiglas (9 × 4½ inches), Fahnestock clips, 7-pin miniature tube socket, socket for XTAL1, knob for C1, screws, wire, solder, hardware, etc.

Note: The following is available from Antique Electronic Supply (6221 S. Maple Ave., Tempe, AZ 85283; Tel. 602-820-5411): a kit of parts for the Battery-Tube Transmitter, including everything except XTAL1, (K-PE-BT KIT)—\$99.95 (contact Antique Electronic Supply for shipping cost). Arizona residents please add appropriate sales tax.

Fahnestock clips and tube sockets were used to mount the components.

Begin by mounting an octal tube socket (using wood screws) to hold crystal XTAL1. Then insert the crystal you want to use. Remember that you are "rock bound" with the Transmitter. That is, the crystal frequency you select is the only one you will be able to transmit on. Be sure to choose a frequency that's appropriate to your license class and in the CW-portion of the band. You might find it helpful to monitor the frequencies you have in mind before finalizing your decision.

For the preceding reasons, no crystal is supplied with the Transmitter kit available from the source mentioned in the Parts List (the octal socket is supplied, however). If you can't locate and buy the crystal locally, you can order one from either CW Crystals (570 N. Buffalo Street, Marshfield, MO 65706) or from International Crystal Mfg. Co., Inc. (10 N. Lee Street, Oklahoma City, OK 73102).

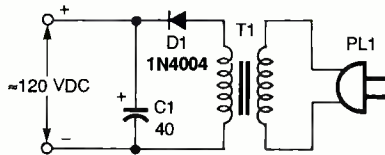

Fig. 2. Here's a simple circuit that can be used instead of batteries to power the Transmitter.

Next mount a 7-pin, miniature tube socket for V1, and insert the tube. Go on to wire R1, C2, and the choke coil. The variable capacitor, C1, is the type used in tube broadcast radios. Mount it towards the edge of the baseboard by passing machine screws through the board from below.

Attach S2, the key-switch, to the Transmitter using insulated wires. Keep S2 off-board, for safest operation.

Inductor-coil L1 should be made on a 1¼-inch-diameter piece of wood dowel rod. Wind 13 turns of 22-gauge enameled wire and space them so that the coil is 1-inch long. To make L2, wind two turns of wire over L1. Wire the coils into the circuit at this time, and connect Fahnestock clips so that you can attach an antenna later.

The last step in assembling the Transmitter is to wire the power connections. For starters, you will have to wire B1 (two 1.5-volt D cells in series) into the circuit. Then, you have to come to a decision about the other

PARTS LIST FOR THE OPTIONAL POWER SUPPLY

- D1—1N4004 silicon rectifier diode
- C1—40- μ F, 250-WVDC, electrolytic capacitor
- T1—Power transformer, 117-volt primary, 117- to 125-volt secondary
- PL1—Two-terminal AC plug
- Wood baseboard (5½ × 6 inches), Fahnestock clips, power cord, clamp, wire, solder, hardware, etc.

power source. If you would like to use B2, a 135-volt battery, just wire it into the circuit at this time, and you're almost done (note that B2 is made of three 45-volt batteries in series; use military-surplus types SZ-283 or SZ-284, which are included in the kit, or Eveready No. 455). If you would like to use the optional power supply shown in Fig. 2, just wire Fahnestock clips to the Transmitter for positive and negative connections to the supply. Whatever

power source you use, though, make sure to position power connections as far away from C1 as possible.

Cut a 9- × 4½-inch Plexiglas panel, and prepare to attach it to the edge of the baseboard where C1 is. Cut a hole for the shaft of C1 to protrude through, and drill holes to fasten the panel with screws. When the panel is attached, it will protect you from the voltages present in the unit.

If you would like to use the optional power supply, you will need another

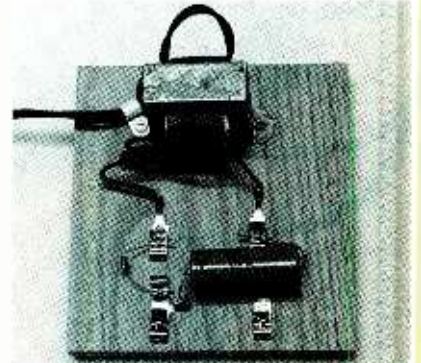

Building this optional power supply will cost just a few dollars, but over time can save you much more than that in the cost of batteries.

wood baseboard, this one measuring approximately 5½ × 6 inches. Begin by mounting the transformer at one end of the board. Then go on to wire diode D1 and capacitor C1. Finally, attach a power cord and plug to the transformer, using a clamp to prevent strain on the cord.

Do not touch any of the components on the power supply when power is applied. Never touch C1 without first discharging it.

Using the Transmitter. Connect an antenna to the Transmitter, and then make sure all power connections are made as well. Before you proceed, you might want to use a good output indicator. If you don't have one, try using a number-49 pilot light in series with one of the antenna leads.

Tune your receiver to the Transmitter crystal frequency. Then close S1 and key the Transmitter using S2. Adjust C1 until a signal is heard in the receiver and the pilot light or output indicator shows that the greatest amount of power is flowing to the antenna. If necessary, you might want to try more or fewer turns on L2 to match the rig to your antenna system. ■

BUILD A WIRELESS DC VOLT PROBE

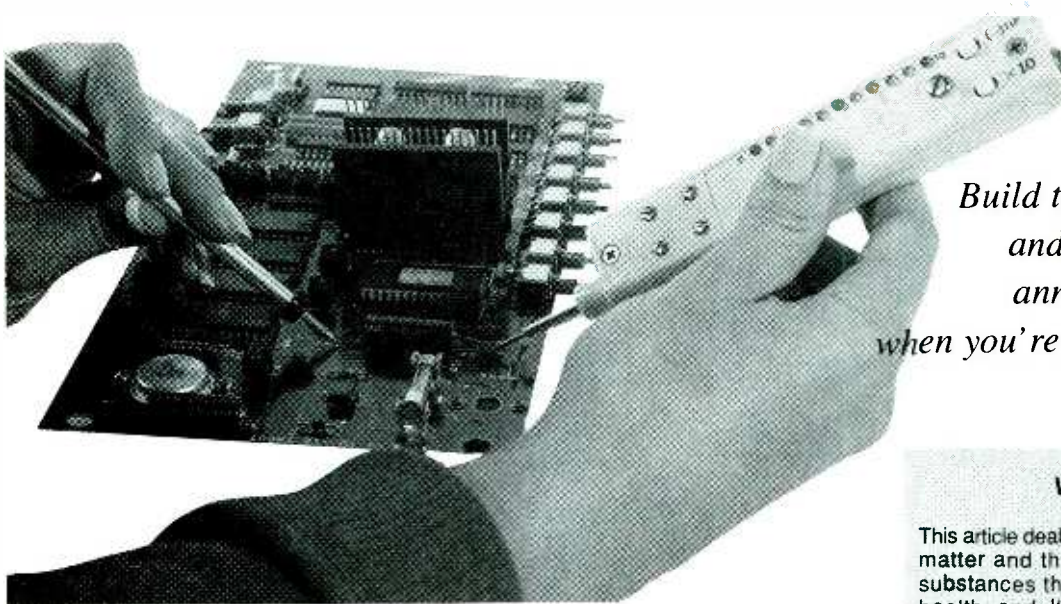

Build this handy probe and eliminate those annoying test-leads when you're in a tight spot.

BY SKIP CAMPISI

WARNING!!

This article deals with and involves subject matter and the use of materials and substances that may be hazardous to health and life. Do not attempt to implement or use the information contained herein unless you are experienced and skilled with respect to such subject matter, materials and substances. Neither the publisher nor the author make any representations as for the completeness or the accuracy of the information contained herein and disclaim any liability for damages or injuries, whether caused by or arising from the lack of completeness, inaccuracies of the information, misrepresentations of the directions, misapplication of the information or otherwise.

Have you ever leaned over a hot, running, car engine, and watched your expensive multi-meter slide towards disaster as you attempted to get your test leads on the correct terminals? Or, perhaps you hate reaching into a piece of equipment with test leads and having to look over your shoulder at what the reading is.

The *Wireless DC Volt Probe* described in this article can eliminate those types of problems and more, as it does not use any interconnecting cables or wires between the probes or an external display. Rather, your own body becomes part of the signal path!

As you might suspect, including a human body in the signal path creates some unusual design problems, not the least of which is user safety. Therefore, heed the following **warning**: Although an effort has been made to fully protect the user to a peak voltage of ± 250 -volts DC, this instrument is *not* intended for use above 100-volts DC, or on any AC earth-ground-referenced equipment!

We'll see in a moment, how other design challenges were met as well. Those include the DC resistance of, and 60-Hz pickup by, your body (and the Hi-Z input circuit), which must be

dealt with, and there is a possibility of radio-frequency interference (RFI) that should be prevented.

Circuit Description. The schematic for the DC Volt Meter is shown in Fig. 1. Power for the circuit is provided by two 1.5-volt N-type cells, B1 and B2, which are wired in series.

For the circuit to work, it must be completed or closed. That is accomplished when the passive probe is held in one hand and the active probe is held in the other, and the points of the two probes are placed across two points in a circuit under test. The resistor labeled R_{body} is simply the resistance of the user's body.

For R_{body} to be "swamped out," or kept from interfering with the reading, extremely high input-circuit impedances are used in the circuit. All of the people tested by the author for this project indicated a body resistance from hand-to-hand in the range of 200,000 to 500,000 ohms. Therefore, an input impedance of 50 megohms, resistor R3, was added. That resistor also provides an adequate safety isolation feature.

The reduction of RFI and 60-Hz pickup is accomplished by the use of a symmetrical difference amplifier (IC1) at the input; the inherent common-mode-rejection takes care of most of

the AC-related problems. The amplifier used for IC1 is a TLC271 CMOS op-amp. Switch S1 is used to select polarity.

Note that 50 megohms of resistance are present at both of IC1's differential inputs (R3 at one input, and the combined series resistance of R1 and R2 at the other). That allows full protection for the TLC271's inputs. The user is placed in series with the 100-megohm loop containing a 10-megohm resistor (R1) as the protective device in the passive-probe section.

Capacitors C1 to C4 provide additional filtering of residual AC noise, and allow IC2, an LM3914 bar-graph-display driver, to step up sequentially. Switch S2 selects between two selectable input ranges: $\times 1$, where each step equals 1 volt, and $\times 10$, where each step equals 10 volts. The display

PARTS LIST FOR THE WIRELESS DC VOLT PROBE

SEMICONDUCTORS

IC1—TLC271 CMOS op-amp, integrated circuit
 IC2—LM3914 display driver, integrated circuit
 LED1, LED6, LED11—Light-emitting diode, T1 case, low-current, red
 LED2—LED5, LED7—LED10—Light-emitting diode, T1 case, low-current, green

RESISTORS

(All fixed resistors are 1/4-watt, 5% units.)

R1—10-megohm
 R2—40-megohm (see text)
 R3—50-megohm (see text)
 R4, R7—560,000-ohm
 R5, R6—5.1-megohm
 R8—680-ohm
 R9—1000-ohm, mini trimmer potentiometer
 R10, R11—10,000-ohm
 R12—390-ohm

CAPACITORS

C1, C4—0.33- μ F, ceramic-disc
 C2, C3—0.033- μ F, ceramic-disc
 C5—1.0- μ F, tantalum
 C6—0.1- μ F, ceramic-disc

ADDITIONAL PARTS AND MATERIALS

S1, S2—DPDT, subminiature toggle or latching pushbutton switch
 S3—SPDT, subminiature toggle switch
 B1, B2—1.5-volt, N-type cells
 Perforated board, N-cell holders, five inches of 1/4-inch-diameter aluminum tubing, insulated "tip" jack, 0.08-inch (2-mm) probe tip, 0.75- x 3.75- x 0.020-inch aluminum sheet, logic-probe-type plastic enclosure with probe tip (see text), 3/8-inch plastic or metal standoff/spacer, IC sockets, heat-shrink tubing, wire, solder, hardware, etc.

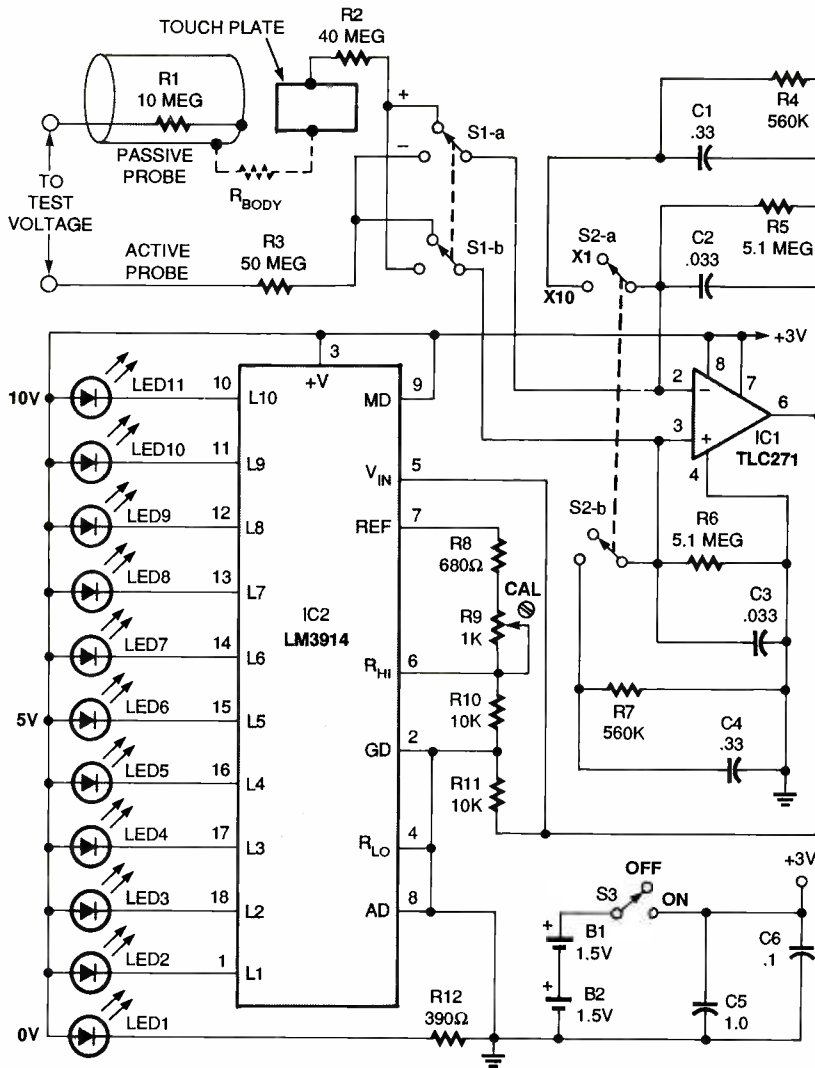

Fig. 1. This is the schematic for the DC Volt Probe. The passive probe is held in one hand and the active probe is held in the other, and the points of the two probes are placed across two points in a circuit under test.

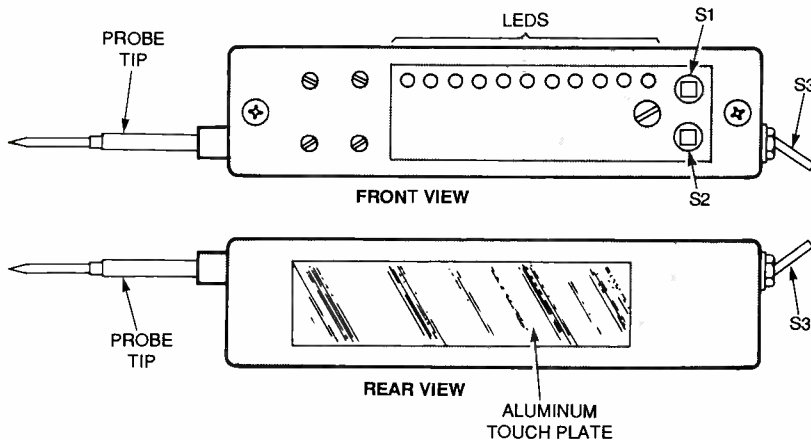

Fig. 2. Here's an illustration of the front and back of the prototype active probe, showing how the author placed the LEDs and switches.

is made up of LED1—LED11; LED2 through LED11 indicate each step, and LED1, the zero-volt indicator, is also the power-on indicator.

Construction. The author's prototype for the DC Volt Probe was built on a 1- x 2 1/2-inch perforated board and mounted in a case available

from Kelvin Electronics (10 Hub Drive, Melville, NY 11747; Tel. 800-535-8469) as part number 430068. The details of building this project are based on the assumption that you are using the Kelvin logic-probe case; however, any suitable plastic enclosure can be used along with any type of circuit board that you prefer. The other parts specified for the project are readily available from a number of hobbyist sources.

(Continued on page 78)

Just like these Fully Trained Electronics Professionals



"Thanks to CIE I have tripled my previous salary, and I am now in a challenging and rewarding new field where only the sky is the limit."
Daniel Wade Reynolds
Industrial Electrician
Ore-Ida Foods



"CIE was recommended to me by my boss. It was appealing since I could study at my own pace at home and during business travel."
Dan Parks
Marketing Manager/Consumer Products
Analog Devices, Inc.



"I loved the flexibility CIE offered. It was the only way I could continue both school and my demanding job."
Britt A. Hanks
Director of Engineering
Petroleum Helicopters, Inc.



"I liked the way the school was set up with laboratory assignments to enforce conceptual learning. The thing which impressed me the most about CIE's curriculum is the way they show application for all the theory that is presented."
Daniel N. Parkman
Missile Electro-Mechanical Technician
U.S. Air Force



"Completing the course gave me the ability to efficiently troubleshoot modern microprocessor based audio and video systems and enjoy a sense of job security."
Tony Reynolds
Service Manager/Technician
Threshold Audio & Video

Graduate with an Associate Degree from CIE!

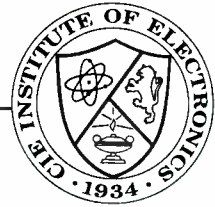

CIE is the best educational value you can receive if you want to learn about electronics, and earn a good income with that knowledge. CIE's reputation as the world leader in home study electronics is based solely on the success of our graduates. And we've earned our reputation with an unconditional commitment to provide our students with the very best electronics training.

Just ask any of the 150,000-plus graduates of the Cleveland Institute of Electronics who are working in high-paying positions with aerospace, computer, medical, automotive and communications firms throughout the world. They'll tell you success didn't come easy...but it did come...thanks to their CIE training. And today, a career in electronics offers more rewards than ever before.

CIE'S COMMITTED TO BEING THE BEST...IN ONE AREA...ELECTRONICS.

CIE isn't another everything-to-everyone school. CIE teaches only one subject and we believe we're the best at what we do. Also, CIE is accredited by the National Home Study Council. And with more than 1,000 graduates each year, we're the largest home study school specializing exclusively in electronics. CIE has been training career-minded students for nearly sixty years and we're the best at our subject...
ELECTRONICS... IT'S THE ONLY SUBJECT WE TEACH!

CIE PROVIDES A LEARNING METHOD SO GOOD IT'S PATENTED.

CIE's AUTO-PRO-GRAMMED® lessons are a proven learning method for building valuable electronics

career skills. Each lesson is designed to take you step-by-step and principle-by-principle. And while all of CIE's lessons are designed for independent study, CIE's instructors are personally available to assist you with just a toll free call. The result is practical training... the kind of experience you can put to work in today's marketplace.

LEARN BY DOING...WITH STATE-OF-THE-ART EQUIPMENT AND TRAINING.

CIE pioneered the first Electronics Laboratory

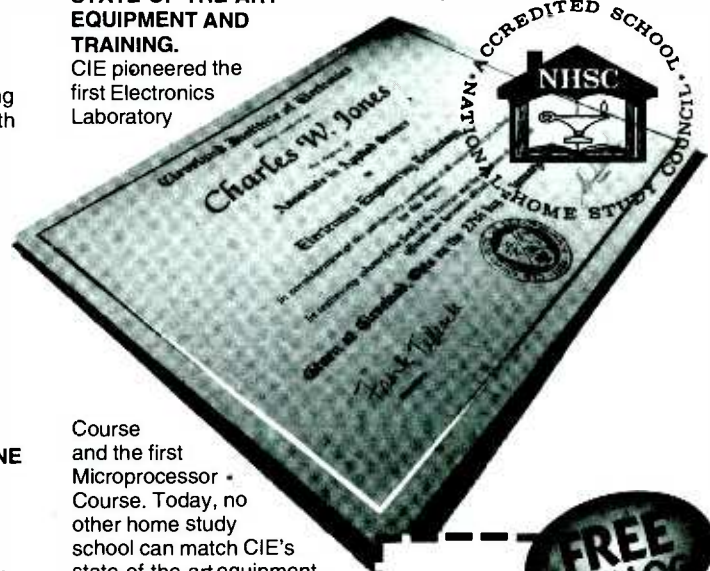

Course and the first Microprocessor - Course. Today, no other home study school can match CIE's state-of-the-art equipment and training. And all your laboratory equipment, books and lessons are included in your tuition. It's all yours to use while you study and for on-the-job after you graduate.

PERSONALIZED TRAINING...TO MATCH YOUR BACKGROUND.

While some of our students have a working knowledge of electronics others are just starting out. That's why CIE has developed twelve career courses and an A.A.S. Degree program to choose from. So, even if you're not sure which electronics career is best for you, CIE can get you started with core lessons applicable to all areas in

electronics. And every CIE Course earns credit towards the completion of your Associate in Applied Science Degree. So you can work toward your degree in stages or as fast as you wish. In fact, CIE is the only school that actually rewards you for fast study, which can save you money.



YES!

I want to get started. Send me my CIE course catalog including details about the Associate Degree Program. (For your convenience, CIE will have a representative contact you - there is no obligation.)

Please Print Clearly

Name _____

Address _____

City _____

State _____ Zip _____ Age _____

Phone No. _____

Check box for G.I. Bill Benefits.

Veteran

Active Duty

AH74

Cleveland Institute of Electronics, Inc.
1776 East 17th Street
Cleveland, OH 44114

A School of Thousands.
A Class of One. Since 1934.

Send for CIE's FREE Course Catalog and See How We Can Help Your Career Too!

BUILD A SINGLE-ENDED HI-FI AMPLIFIER

BY LARRY LISLE

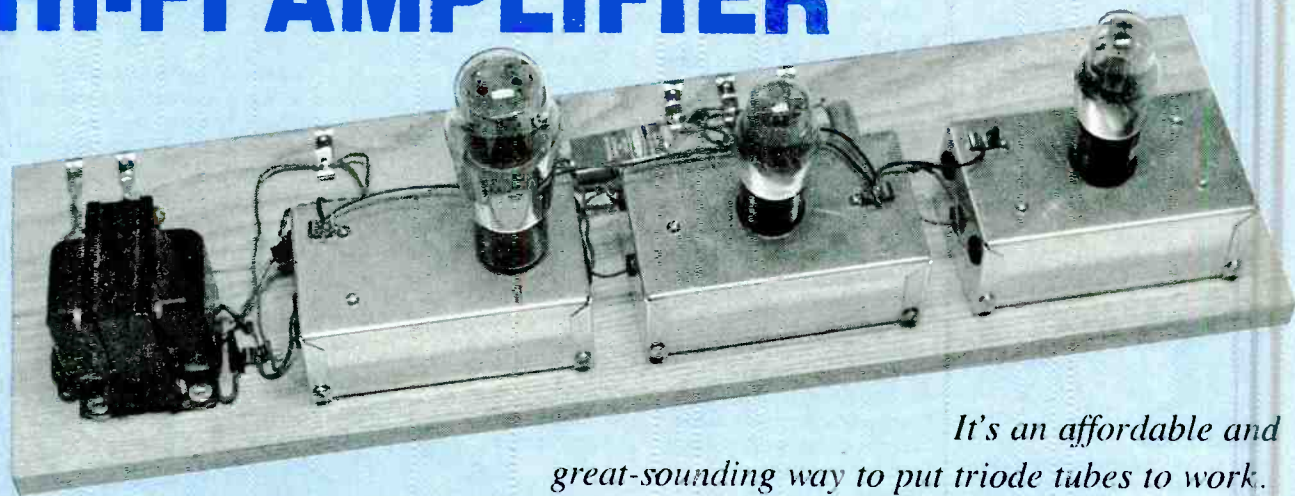

It's an affordable and great-sounding way to put triode tubes to work.

Many of the tubes produced today go into pricey, single-ended (not push-pull) hi-fi amplifiers. Now, not everyone wants to shell out the big bucks for a tube amp. So, if you'd like to own a great-sounding, all-triode, single-ended amp for a lot less than most audiophiles are paying, you can build the *Single-Ended Hi-Fi Amplifier* described in this article.

Why Single-Ended Amps? Many audiophiles are convinced that amplifiers using directly heated triodes in a single-ended configuration sound better than anything else. Those individuals attribute the audio superiority of such amps to the presence of small amounts of second-harmonic distortion and the (usual) absence of negative feedback (which supposedly makes the sound more natural).

A lot of ink has been shed on whether single-ended amps are really all that much better. If you would like to learn more about that debate, you might want to check out some of the references in the "Suggested Reading" box. But the purpose of this article is to show you how to build an amp for yourself, and that's exactly what we'll get to next.

One of the best features of the Sin-

gle-Ended Amplifier is how easy it is to build; the parts-count is low and the circuitry is simple and straightforward. Some audiophiles might throw up their hands in protest because exotic parts and wire often found in high-end equipment were not used. While those amplifiers are most likely worth every penny they cost, the Single-Ended Amplifier is something that the average person could afford to build and be happy with afterwards. Most of the benefits of single-ended tech-

nology can be gained in a relatively simple manner with ordinary, good-quality parts.

Circuit Description. The schematic for the Amplifier is shown in Fig. 1. For quiet listening, an input of about 0.05 volt or less should be used. The circuit as shown will handle up to about 0.5 volt; above that, distortion will be present.

The input stage amplifies the signal voltage about seven times, and the

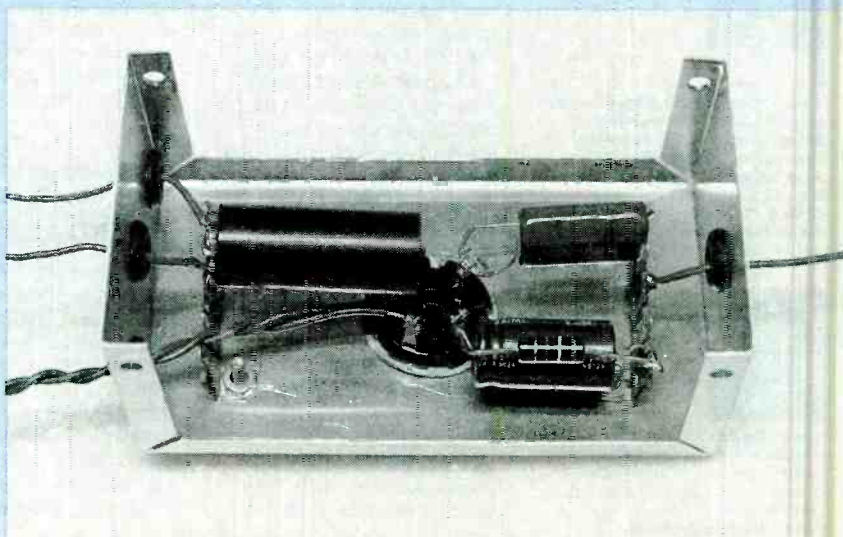

Here's an internal view of one of the Amplifier stages. Building each stage separately in an aluminum case helps reduce hum.

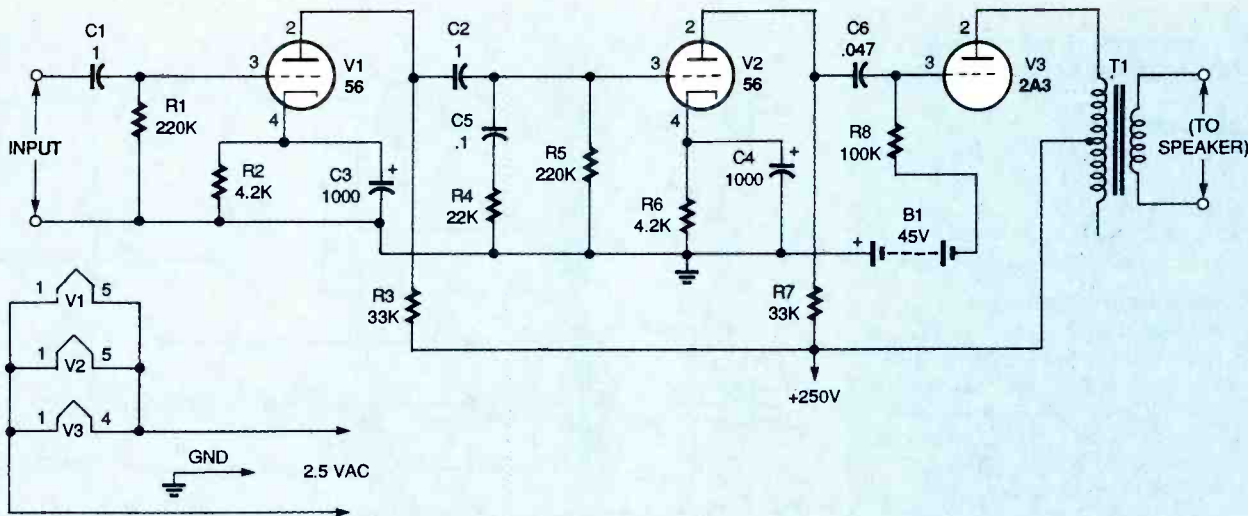

Fig. 1. This is the schematic of the Amplifier circuit; the single-ended design, and use of triodes, contributes to a great sound.

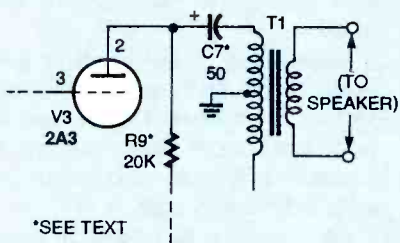

Fig. 2. Here's an alternate output section for the amplifier that keeps DC out of the primary winding of the transformer.

second stage amplifies the voltage about ten times. Both stages use type-56 triodes (V1 and V2).

The output stage uses a type-2A3 tube, V3. Battery bias seems to work well on output tubes, and for that reason two 22.5-volt batteries wired in series (B1) were used to provide 45 volts on the grid of V3.

In this circuit (and other single-ended amplifiers), direct current flows in the primary of the output transformer (T1). Transformers designed for single-ended use have an air-gap in the core to keep it from saturating, which would diminish the low-frequency response.

If you don't use a single-ended-style transformer for T1, an ordinary push-pull transformer (which can be bought at a more reasonable price) can be made to work with some restrictions. First of all, if you use a push-pull transformer with the Amplifier circuit shown in Fig. 1, you will have to live with a moderate roll-off below 60 Hz.

One way to make a push-pull transformer work better with the Amplifier is

PARTS LIST FOR THE SINGLE-ENDED HI-FI AMPLIFIER

RESISTORS

(All resistors are 1-watt, 5% units, except where noted.)

- R1, R5—220,000-ohm
- R2, R6—4200-ohm
- R3, R7—33,000-ohm
- R4—22,000-ohm
- R8—100,000-ohm
- R9—20,000-ohm, 10-watt (optional, see text)

CAPACITORS

- C1, C2—1-μF, ceramic-disc
- C3, C4—1000-μF, 50-WVDC, electrolytic
- C5—0.1-μF, ceramic-disc
- C6—0.047-μF, ceramic-disc
- C7—50-μF, 450-WVDC, electrolytic (optional, see text)

ADDITIONAL PARTS AND MATERIALS

- V1, V2—56 vacuum tube
- V3—2A3 vacuum tube
- T1—8000-ohm to speaker, hi-fi output transformer (Antique Electronic Supply PT-1608 or PT-S142A, or equivalent)
- B1—45-volt battery (two 22.5-volt batteries in series; Eveready 412 or equivalent)
- Baseboard (approximately 24 × 7½ inches), rubber mounting feet, three aluminum project boxes (5 × 3 × 2 inches), tube sockets (one 4-pin, two 5-pin), Fahnestock clips, screws, wire, solder, hardware, etc.

to use the circuit modification shown in Fig. 2. That change keeps DC out of the primary at some sacrifice in power. With the modification, the Amplifier will be flat (within 1 db) from 20 to 20,000 Hz. (As we'll see in a moment, the modified circuit requires that a higher-voltage transformer be used in the power-supply circuit.)

Note that in both Figs. 1 and 2, transformer T1 is shown connected from one end of the primary to the center tap. That was done because it is assumed the transformer used will have a primary impedance of about 8000 ohms. The recommended load for a 2A3 tube (V3) is 2500 ohms for maximum output, but increasing the impedance lowers the distortion while only slightly decreasing the power. For that reason, using the center tap will get the best sound without too much of a power loss.

You probably noticed that in addition to B1, the Amplifier circuit runs on additional 2.5- and 250-volt DC sources (the latter value is 350-volts DC in the case of the modified circuit). The power supply shown in Fig. 3 is a conventional, tube-type, full-wave rectifier circuit with a capacitor-choke-capacitor filter made up of C1, L1, and C2. The 5U4G tube rectifier, V1, was used instead of a solid-state rectifier to prevent radiating hash noise.

If you're using the modification shown in Fig. 2, the high-voltage secondary of transformer T1 in Fig. 3 should be about 350-0-350 volts. If you use the unmodified Amplifier circuit, a 250-0-250-volt transformer can be

PARTS LIST FOR THE AMPLIFIER POWER SUPPLY

RESISTORS

(All fixed resistors are 10-watt, 5% units.)

R1—2500-ohm

R2—50,000-ohm

R3—50-ohm, 2-watt potentiometer

ADDITIONAL PARTS AND MATERIALS

C1—50- μ F, 450-WVDC, electrolytic

C2—40- μ F, 450-WVDC, electrolytic

V1—5U4G or 5U4G-B vacuum tube

L1—8-H or greater, 90-mA or greater

filter choke (Antique Electronic Supply PT-C-7X or equivalent)

T1, T2—Power transformer,

350-0-350 volts at 70 mA (see

text), 5 volts at 3 A, and 2.5 volts

at 4.5 A (Antique Electronic Supply

PT-143 or equivalent)

PL1, PL2—3-conductor AC plug

Baseboard (approximately 24 x 10

inches), rubber mounting feet,

octal tube socket, power cord,

cable clamps, Fahnestock clips,

screws, wire, solder, hardware,

etc.

Note: The following is available from Antique Electronic Supply (6221 S. Maple Ave., Tempe, AZ 85283; Tel. 602-820-5411): a complete kit of parts for the Amplifier (K-PE-SE-A KIT)—\$109.95; a partial kit of parts for the power supply, baseboard not included (K-PE-SE-P KIT)—\$89.95. Please contact Antique Electronics Supply for shipping and handling information. Arizona residents please add appropriate sales tax.

used for T1, and R1 can be omitted.

The 2.5-volt source is supplied by transformer 2. As shown in Fig. 3, potentiometer R3 can be adjusted for minimum hum.

Construction. Like any tube project, sometimes the most difficult part of building it is to first get the components. If you find you can't locate the tubes or transformers on your own, you might want to order the amplifier and power supply kits that are available from the source that is mentioned in the Parts List.

The Amplifier could be built on a common aluminum or steel chassis, but if there turns out to be a hum problem from the magnetic fields of the transformers or other causes, you

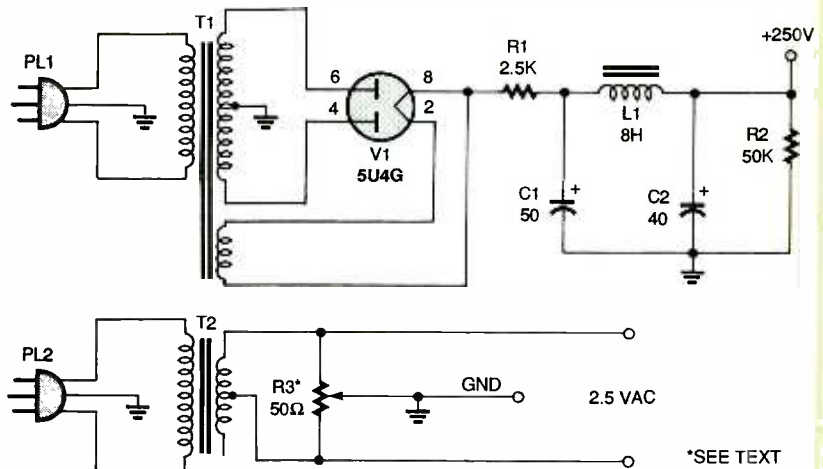

Fig. 3. This is the power-supply circuit for the Amplifier. A 5U4G tube rectifier was used instead of a solid-state one to reduce hash radiation.

might have to do a complete rebuild to solve it. A recommended alternative is to build each stage in a separate project box; that way you can tinker with one stage without disturbing the rest.

Building the project is therefore simple. Begin by wiring each stage into its respective project box, using Fahnestock clips. The filament wiring should be twisted to cancel the AC fields around the wires. When the stages are assembled, simply mount them on a wood baseboard, and connect them together.

Mount resistor R1 and capacitor C1 to the baseboard, and wire them to the circuit ground. Next install the output transformer. If you like, you could wire Fahnestock clips for the audio output terminals, or you could attach a connector that will match a particular speaker.

When all connections are made, wire Fahnestock clips for the 2.5- and 250-volt power connections shown in Fig. 1. Then complete the assembly by

connecting the two 22.5-volt batteries.

Building the power supply is even easier. Begin by mounting the tube rectifier in a socket at the center of a wood baseboard. Go on to install the capacitors, resistors, and choke coil, using Fahnestock clips.

Next, wire the two transformers on one end of the baseboard. Connect potentiometer R2 to T2. Attach the power cords and plugs to the transformers, and secure the cords to the baseboard with clamps.

Note that the voltage present in the power supply is dangerous. Don't touch any components on the Amplifier or power supply when power is applied, and discharge all capacitors before touching anything after it's unplugged. For safety reasons you should consider enclosing the power supply in some way when it is finished.

Using the Amp. Connect a speaker to the Amplifier. Then make all the power and ground connections between the Amplifier and power supply. If you follow the input-signal requirements mentioned earlier, you should get a great sound out of your unit.

It goes without saying, of course, that this is a mono amp. For stereo applications, two units will have to be used.

As this project shows, single-ended amplifiers are easy and fun to build, and are a real pleasure to listen to. Once you hear one, you're sure to be hooked. ■

SUGGESTED READING

The Absolute Sound (P.O. Box 360, Sea Cliff, NY 11579; Tel. 800-222-3201) Issue 96 had an interesting article in semi-technical language on tubes and single-ended amps.

Glass Audio (P.O. Box 176, Peterborough, NH 03458; Tel. 603-924-9464). Features articles on tube amps of all types.

Sound Practices (P.O. Box 180562, Austin, TX 78718; Tel. 512-339-6229). Another publication that contains articles on tube amps.

These affordable, temperature-measuring devices can be used in a wide variety of troubleshooting applications.

BY BILL SIURU

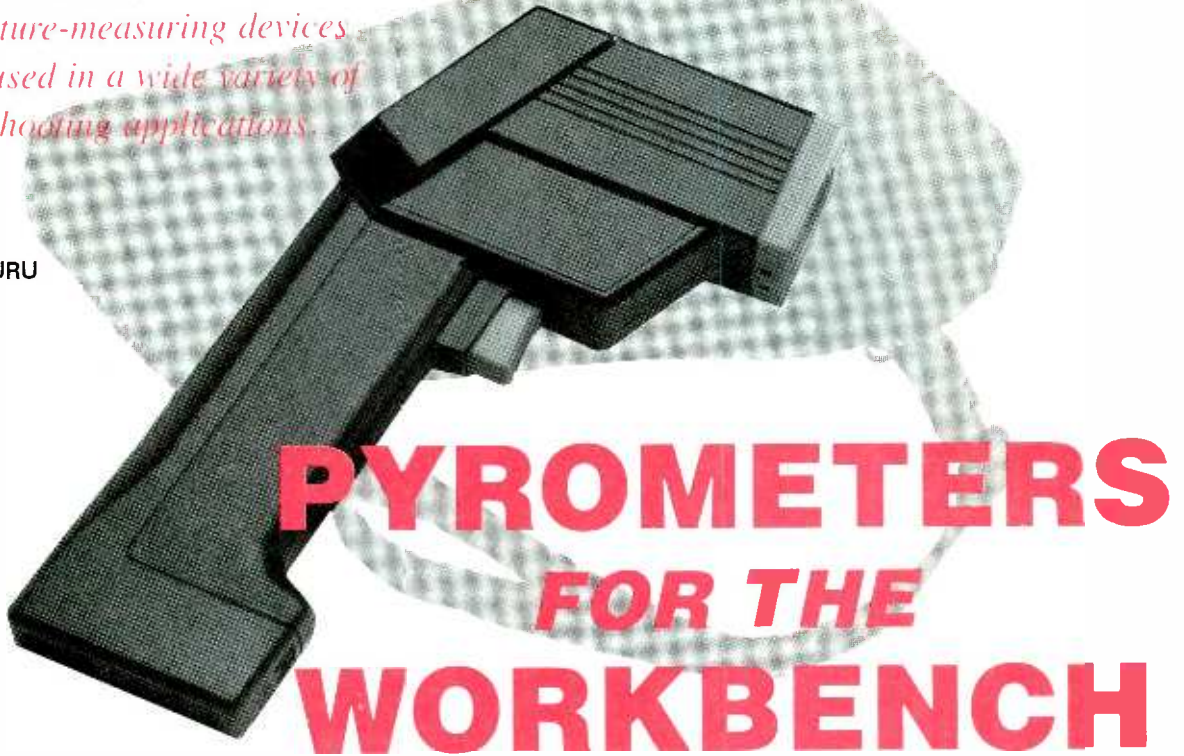

PYROMETERS FOR THE WORKBENCH

Temperature measurements often provide valuable information when troubleshooting problems around the home, workbench, or garage. For instance, faults in electrical connections and bad bearings in motors often result in excessive temperatures, whereas too-low temperatures come with malfunctioning ovens and furnaces. Problems in engines, drive trains, brakes, cooling systems, air-conditioning, and so forth often include abnormal temperatures. However, measuring temperatures beyond touching and finding the item "too hot" or "too cold" has not been very easy until now.

Portable, hand-held, non-contact pyrometers, developed for industrial applications and "discovered" by professional racers for measuring tire and track temperatures, are now priced low enough that they are good investments for serious home mechanics and electronics hobbyists. Besides prices that now run from \$200 to \$350, the latest pyrometers are also quite user friendly. In most cases, just aim, pull the trigger, and read the temperature.

What's a Pyrometer. Pyrometers, also called infrared (IR) non-contact

thermometers, measure the infrared radiation emitted from an object and, in less than a second, calculate the object's temperature from that measurement. The heart of the unit is a thermopile detector whose voltage output is directly proportional to the amount of emitted infrared radiation detected; the unit's optics focus the infrared radiation on that detector (See Fig. 1). The voltage output is converted to Celsius and Fahrenheit temperature readings that are shown on a digital display.

Virtually every object absorbs heat energy and then emits that energy as IR radiation that is proportional to its temperature. To complicate things a bit, radiation can also be reflected (bounces off an object) or transmitted (travels through an object). Only a perfect "black-body" neither reflects nor transmits energy. The electronic circuitry and physical construction of today's non-contact pyrometers automatically reduce the influence of reflected and transmitted infrared radiation. Thus, for most diagnostic applications, reflected and transmitted IR energy do not influence the accuracy of temperature measurements enough to affect the results of a diagnosis.

Unfortunately, "most" applications does not mean "all" applications. One troublesome application is when the pyrometer is used to measure the temperature of shiny, polished, or unoxidized metal surfaces made of aluminum or stainless steel. In such cases you will have to do a bit more than point the instrument and take a reading; you now will have to compensate for reflected and transmitted radiation. The amount of compensation is called the "emissivity factor." That factor corrects for the difference in reflected and transmitted radiation for the test material and a perfect "emitter" (a black body). If you plan to use the non-contact pyrometer to measure shiny surfaces, be sure that any pyrometer you purchase includes an emissivity-compensation feature.

To determine the proper emissivity factor setting for a material, you will need some black friction tape or black paint, both nearly perfect radiators with emissivity factors of 0.95 (they radiate 95% of their thermal energy). Put the tape or paint on the shiny surface and take two measurements. First, after adjusting the pyrometer's emissivity factor to 0.95, measure the temperature of the surface with the tape or paint. Then point

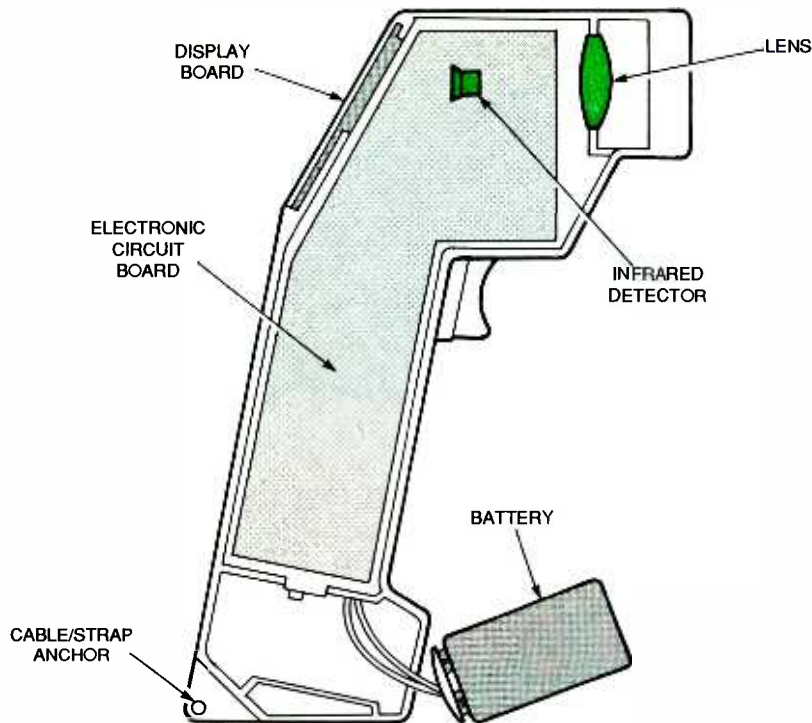

Fig. 1. Using a special optical system, a non-contact pyrometer focuses and filters infrared radiation onto its thermopile infrared detector.

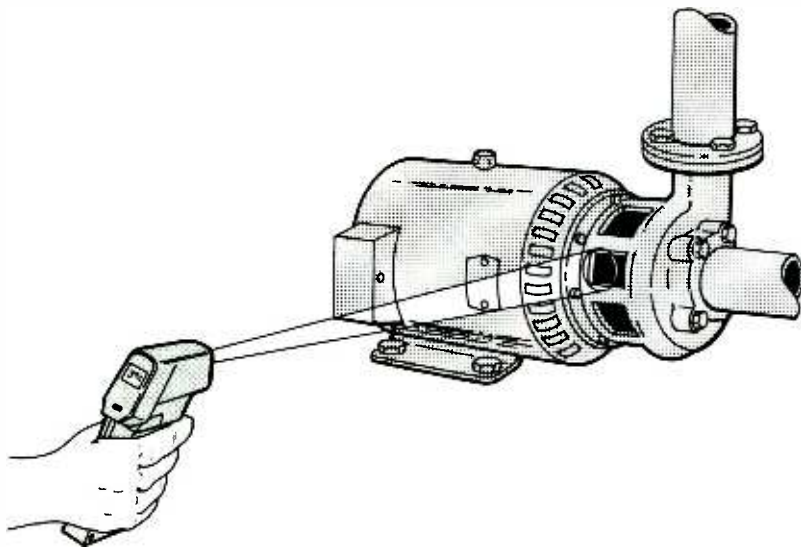

Fig. 2. You can detect a misfiring cylinder by measuring the exhaust manifold nearest to the cylinder head's exhaust ports. Look for a lower temperature.

the pyrometer at the bare surface and adjust the emissivity setting until the temperature reading matches the temperature measured previously. So the calibration procedure does not have to be repeated, record the emission factor displayed because it can be used on all similar materials.

Using a Pyrometer. There are many diagnostic jobs that can be per-

formed using a non-contact pyrometer. Because it reads temperatures visibly without physical contact, it can be used in hard-to-reach locations or where moving parts are a hazard. Not having to touch an object eliminates the possibility of burns or shocks, as well as the possibility of contaminating the object or affecting its operation. Here are just some sample applications; over time, you will probably discover many more.

Troubleshooting Electrical Problems. A non-contact pyrometer can locate high resistance in connections by measuring the temperature of electrical connectors while current is flowing. A higher-than-normal temperature indicates excessive resistance. Likewise, the device can help locate high current or high resistance in fuse holders. Point the pyrometer at a fuse holder while current flows: Higher-than-normal temperatures indicate a worn fuse link, a poor fuse-holder connection, or a short circuit.

Pyrometers really shine when it comes to testing the electronics in an automobile. You can check out automotive wiring harnesses, especially at the connectors and electrical components. There, a higher-than-normal temperature indicates a short circuit or a component in the circuit that is drawing too much current.

One specific automotive application is finding broken grids in the rear-window defoggers now found in most cars. Turn the defogger on and scan the entire defogger with the pyrometer. Move the pyrometer over each grid and watch the temperature. It should increase uniformly right over a grid. If it does not, the grid line is broken and current cannot flow through it to heat the tiny wire. That technique is the easiest way to verify that a defogger is operating properly; otherwise you would have to somehow fog the window to determine if an even pattern is produced.

There are, of course, many non-automotive uses for a pyrometer. For example, it can be used to check the accuracy of temperature controls in ovens, clothes dryers, refrigerators, freezers, etc. After the appliance is at operating temperature, open the door and quickly take a temperature measurement. You can then compare the temperatures read against the control setting or manufacturer's settings.

Troubleshooting Mechanical Devices. Once again, a pyrometer really excels at diagnosing mechanical problems in automobiles. For example, on cars suspected of braking problems, measure the drum or rotor temperature immediately after the vehicle has been driven and stopped in a straight line. Compare the temperature of all four brakes. Front

brakes usually will have higher temperatures than rear ones, but they should have nearly the same temperature on the left and right side. Significant, right/left bias temperatures indicate uneven braking caused by sticking caliper pistons, adjusters, etc.

The pyrometer can also be used to identify drive train—driveshafts, transmissions, differentials, etc.—problems, again with abnormal temperatures indicating trouble. For instance, measure axle bearings and compare left and right-side readings; they should be about the same, unless one is bad.

It is sometimes hard to isolate which cylinder is misfiring in a rough running engine without using an engine analyzer. However, it can be done easily and quickly with a non-contact pyrometer (see Fig. 2). Measure and compare the temperatures of the exhaust manifold for each cylinder. Lower temperatures indicate poor combustion or a misfire. On some vehicles, the front section of the exhaust manifold might normally by design run a little cooler than the rear, but not usually at the low temperature associated with a misfire. For best results, take readings from cold engines at startup before heat is distributed pretty uniformly over the whole manifold. The pyrometer is especially effective in finding misfiring or dead cylinders in a diesel engine.

If you suspect the coolant temperature gauge in the instrument cluster reads too hot or too cold, measure the block temperature near the temperature sensor after the engine has run for awhile. The temperature readings of the gauge and pyrometer should agree. However, that measurement only works with gauges that have numerical markings, or you can otherwise interpret the tick marks.

If an engine overheats and no coolant leaks are found, you can use the pyrometer to find other possible causes. For instance, scan the entire front and back of the radiator—a job that is easier on older cars with lots of space under the hood—with the pyrometer. Look for abrupt differences in temperatures indicating that the radiator core is plugged at that point obstructing coolant flow.

With a pyrometer, some automobile thermostats can be checked without removing them from their engines. When a thermostat opens, the

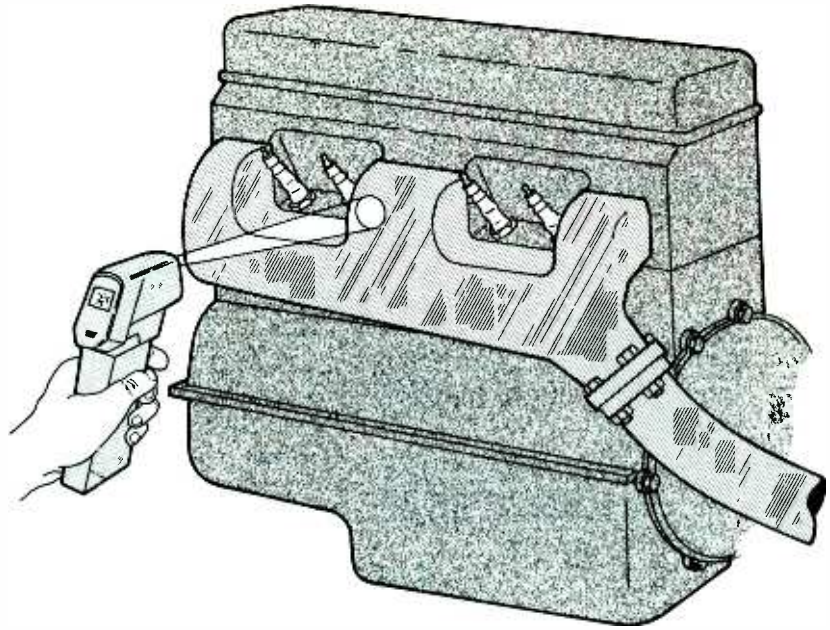

Fig. 3. A worn bearing in a motor, pump, etc. will give off excessive heat. That heat can be spotted easily by a pyrometer.

temperature drops drastically, about 15°C (25°F). Start the engine and read the pyrometer as the engine warms up. Compare the temperature when it opens to the manufacturer's specifications. When performing that test, take your measurements from the surfaces at the radiator inlet or thermostat outlet because hose temperatures can be up to 15°C lower than the actual coolant temperature.

As you might expect, a pyrometer is a particularly useful tool for checking out a malfunctioning heater. For instance, you can check for coolant circulation through the heater core. Measure the temperatures of the inlet and outlet heater-core hoses—if there is a large difference, suspect a restricted heater core.

Pyrometers can also be used to troubleshoot non-automotive mechanical devices. One such applica-

tion would be to find bad bearings in motors, pumps, compressors, etc. (see Fig. 3). Excessive temperatures in bearing locations usually indicate a bad bearing that needs replacement. Make sure the item is running long enough for a suspected bad bearing to heat up.

Those who service air-conditioning or heating systems also would find a non-contact pyrometer invaluable. For example, one easy way to see if a system is not working correctly is to measure the temperatures in the system's outlets or vents. If higher-than-manufacturer's-specification temperatures are measured, you know something is malfunctioning. Likewise, too low a temperature indicates a problem in a furnace or space heater. For those types of measurements, do not point the pyrometer directly into the air flow; measure the vent openings from an angle. Of course, you will need manufacturer's temperatures settings to compare against.

As you can see, in situations where heat can pinpoint a problem in an electronic or mechanical system, it is hard to beat a pyrometer for quick troubleshooting tasks. Now that pyrometer prices have come down to where they are practical for the troubleshooting professional or a serious hobbyist, isn't it time you added one to your arsenal of test gear? ■



Battery-powered portable pyrometers are compact enough to fit in a toolbox.

SUPER SURPLUS SOURCES

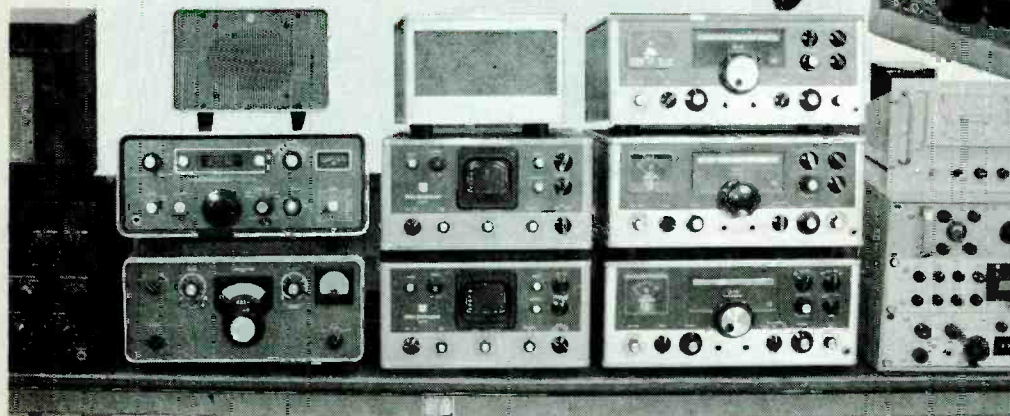

How to find and make use of the bustling electronics surplus market.

BY KARL T. THURBER, JR.

Do you love a bargain? Most people do, electronics hobbyists included. If you fit into that latter category, and chances are good that you do, then you most likely would like a good bargain when buying electronic equipment or parts. And the best way to get a good bargain is by buying surplus.

Most dictionaries define "surplus" as an amount or a quantity that is more than, or in excess of, what is needed. That is a very broad definition, one which might be more expansive than most hobbyists envision, so let's refine it. In the 1940s and 1950s, if you mentioned surplus to a radio hobbyist, the word would have conjured up visions of stacks of World-War-II-vintage GI gear, ready to be purchased for a dime on the dollar. That concept of "war surplus" is perhaps the classic meaning of the word from a hobbyist's viewpoint, but times truly have changed.

In the 1990s, hobbyists consider "surplus" as most anything that's clearance or bargain-priced and related to radio, electronics, and computers (including software, CD-ROMs, hardware, and the like), whether of commercial, industrial, government, or military origin. That includes equipment and components from over-

produced, overrun, distressed, or overstocked inventories.

But where do you get all those goodies? That's exactly what we'll answer in the pages that follow. So read on, and prepare to save some money on your next electronics spending spree.

Traditional Surplus Sources.

Finding electronic components for your next construction project at affordable prices is no longer as simple as a Saturday trip to the nearest Radio Row, a trip hobbyists might well have taken in the 1940s and 1950s (for more information on those hobbyist sources of yesteryear, see the article "Remembering Radio Row" in the January 1996 issue of **Popular Electronics**). Now, if your local franchise outlet can't supply what you need, what do you do?

In that case you use mail-order. The fact is that many local radio jobbers, distributors, parts houses, and wholesalers don't carry much of interest to the radio amateur, electronics buff, or computer user. So, when ordering specialty parts and accessories, it's prudent and convenient to look to mail-order houses for items that you can't obtain locally.

The two routes to parts-procure-

ment success are: First, have a good supply of mail-order catalogs, flyers, and parts and equipment lists in your personal library. And, second, take advantage of a variety of marketplace publications to help meet your needs.

Most mail-order companies publish their own catalog or flyer; no home electronics library is complete without a representative selection of them. With a good variety to peruse, if you can't find what you're searching for in one supplier's catalog or flyer, you can simply try another. Many of the larger catalogs are splendid reference resources, whether or not you actually order from them.

We located a number of firms that specialize in surplus electronics, computers, and software (see the "Names and Numbers" box). Many of them publish catalogs, flyers, and price lists, though sometimes irregularly. Check out their publications, or call them for availability. Here are a few sources we've chosen to highlight:

American Science and Surplus: Some firms still carry the "classic" war surplus parts and equipment. American Science and Surplus, in Skokie, IL, has been one such resource since 1937. It's a very active mail-order organization that has a great deal of

ELECTRONIC AUCTION®

The Electronic Marketplace for Wholesale Inventory

voice: (206) 487 3700 / fax: (206) 487 3632 / fax-on-demand: (213) 483 9999

e-mail: info@auction.net

Welcome to the ELECTRONIC AUCTION Internet site.

What is the Electronic Auction? How do I sell through the Electronic Auction? How do I buy through the Electronic Auction?....and be sure to read this disclaimer.

ELECTRONIC AUCTION : Wholesale liquidation (inventory lists, etc.).

(This is a popular ftp site. If you can't get on, keep trying...or try our mail server: info@auction.net)

Fig. 1. The Electronic Auction bills itself as "the electronic marketplace for wholesale inventory." It moves wholesale overstock and surplus merchandise and equipment, including electronics, computers, software, CDs, videos game, hardware, office supplies, and the like. Look for it at the URL <http://www.auction.net/index.html>.

surplus parts and equipment available, including some that date back 50 years or more to the war years.

Fair Radio Sales: Another mail-order firm that carries on with "classic" radio surplus is Fair Radio Sales. The company has been in business since 1947 with the motto that it sells "the world's finest electronic surplus." Most of its 36-page catalog is devoted to military and government radio surplus, and it's a real gem.

Halted Specialties Co: The Santa Clara, CA firm specializes in "new," surplus electronics equipment, as well as new and used test equipment. The mail-order firm also operates three walk-in stores in the southern California area.

R&D Electronics: R&D Electronics stocks a wide variety of surplus electronics equipment and components. It does a booming mail-order business and also operates a surplus emporium, Electronic Surplus, Inc. In business since 1948, R&D Electronics has about 40,000 square feet of space devoted mostly to surplus stuff. No catalog is available, but R&D maintains a mailing list.

Surplus Sales of Nebraska: With its motto of "where the hard-to-find parts are found and on hand," Surplus Sales of Nebraska publishes a catalog full of capacitors, switches, filters, re-

lays, insulators, cables, connectors, and sundry other goodies of interest to radio amateurs and electronics hobbyists. The firm also stocks manuals for Collins amateur gear (we'll deal with manual-supply resources later on).

Surplus Software: Surplus Software is a clearinghouse for publishers and distributors with overstocked, overproduced, or distressed software inventories. The firm offers many current-version, previous-version, and promotional packages. While you might wonder why someone would want an older, perhaps obsolete version of a software package, remember that many software publishers allow owners of previous versions the option of inexpensively upgrading to the current releases. Their newsprint catalog runs about 40 pages.

Tucker Surplus Store: The Tucker Surplus Store is an adjunct to Tucker Electronics Co. The firm has a broad selection (96,000+ new and used items) and offers repair and reconditioning facilities. Tucker specializes in vacuum-tube test equipment and also handles some used amateur gear.

Publications of Interest. The contemporary surplus market isn't limited

to military and government materials: there's abundant civilian surplus being advertised in radio, electronics, computer, and amateur-radio magazines. Several radio, electronics, and computer-marketplace publications have excellent component and/or surplus sections you can peruse.

Gernsback Publications: Good component and surplus sources include the magazine you're reading, **Popular Electronics**, and its sister Gernsback publication, *Electronics Now*. Both have large sections ("Market Center" in **Popular Electronics**, for example) devoted to procuring new and used equipment, parts, and components by mail-order. Check them out.

Other Resources: Other good surplus resources include the classified advertising sections of the major amateur-radio magazines, such as *QST*, *73 Amateur Radio Today*, *Amateur Radio Trader*, and *CQ*. Several of those magazines have at times published radio surplus handbooks and conversion guides. To my knowledge such vintage publications all are out of print. However, a few surplus-oriented books are available (see the "Suggested Reading" box for more information).



Though the firm quit making kits in the early 1990s, Heath's transmitters, transceivers, and receivers are still found at hamfests and swap meets. Take special care in purchasing used equipment built from kits, though; inspect the quality of the builder's assembly and soldering techniques before purchase.

For computers, computer peripherals, accessories, and software, *Computer Shopper* is difficult for direct buyers to beat. Each issue runs around 775-800 pages and is crammed with display and classified ads. Vendors and equipment are well-indexed.

The American Computer Exchange: There's an old expression that goes, "the best day to sell your old computer is yesterday and the best day to buy your next one is tomorrow." Since 1988, *The American Computer Exchange* has acted as a computer broker, matching buyers and sellers of used microcomputer equipment. The Exchange serves individual and corporate buyers and sellers, resellers, liquidators, and retailers. It also offers consulting services, listings, and appraisals. In addition, over 130 trade magazines use the Exchange's "Am-CoEx Index of Used Computer Prices" as benchmarks of current used computer prices.

Hamfests: Modern-Day Resources. Not all shopping has to be done by mail, however. Hamfests—amateur radio conventions or get-togethers—are popular activities, and well worth a bargain hunter's time. The main activity at most hamfests is the flea-market or swap-meet area where people buy, sell, and swap used radio equipment, parts, and components. Increasingly, computer shows are held in conjunction with many hamfests, and surplus computer hardware and software is seen side-by-side with radio equipment in the flea-market areas.

A hamfest is a grand meeting of radio amateurs and radio enthusiasts, and the name covers a variety of affairs. There are some small events that are strictly radio flea markets, swap meets, and auctions; some of the smaller ones attract but a few hundred visitors. Larger events can attract many thousands and have hundreds of exhibit booths and swap tables. Let's look at the range of them, beginning at the bottom.

The simpler hamfests often include an auction, a bid table (where the bidding is written rather than verbal), and "tailgaters," people who sell from their car trunks in the parking lot or "bone yard." Older, tube-type equipment (including gear euphemistically known as "boat anchors" or "white elephants") abounds in the bone yard and on the auction block.

But the main activity at such hamfests is really the swapping, selling, and buying of radio and electronic parts and equipment. Because of the numerous bargains, a shrewd shop-

USENET NEWSGROUPS

```
rec.radio.amateur.equipment
rec.radio.amateur.homebrew
rec.radio.amateur.miscellaneous
rec.radio.info
rec.radio.scanner
rec.radio.shortwave
rec.radio.swap
rpi.union.electronics
sci.electronics
sci.electronics.repair
tnn.radio.amateur
uk.radio.amateur
```

per often can equip his or her radio shack and workbench at a rock-bottom cost.

Now, the medium-size regional affairs are a cross between less-formal local swap meets and more-formal conventions. Many hamfest activities are featured, with swapping competing for attendees' attention with technical seminars and radio- and computer-equipment displays by manufacturers and dealers.

Moving up the scale, we come to the top hamfest ranks—the major amateur expos and conventions. Those often are affiliated with the American Radio Relay League (ARRL), which is a national association of radio amateurs. ARRL conventions are conducted on division and state levels, and a national convention is held

yearly on a rotating basis—in 1996 it will be held September 13–15 in Peoria, IL.

And then there's Dayton. The Dayton HamVention, in a class by itself, is a huge, three-day affair held in the spring. It's by far the largest hamfest in the country. Some 35,000 to 40,000 hobbyists annually rummage through the Hara Arena and Exhibition Center's gigantic outdoor flea market, countless exhibit booths and meeting rooms, and dozens of interesting forums.

It's often said, with some truth, that if you can't find what you need at Dayton, you won't find it *anywhere*. Whether you're looking for a receiver, transmitter, transceiver, satellite station, packet gear, kit, UHF and microwave gear, computer hardware and software, or most anything else that's vaguely electronic, whether new or used or surplus, Dayton's the place to find it. In 1996 it's set for May 18–19.

Finding a Hamfest Near You. There are several ways you can find hamfests. The simplest is to ask the members of a local radio club. If you're not a member, listen to the chit-chat on local amateur FM repeaters. Another option is to check the postings of hamfests often found in radio stores. Also, check the hamfest and special-

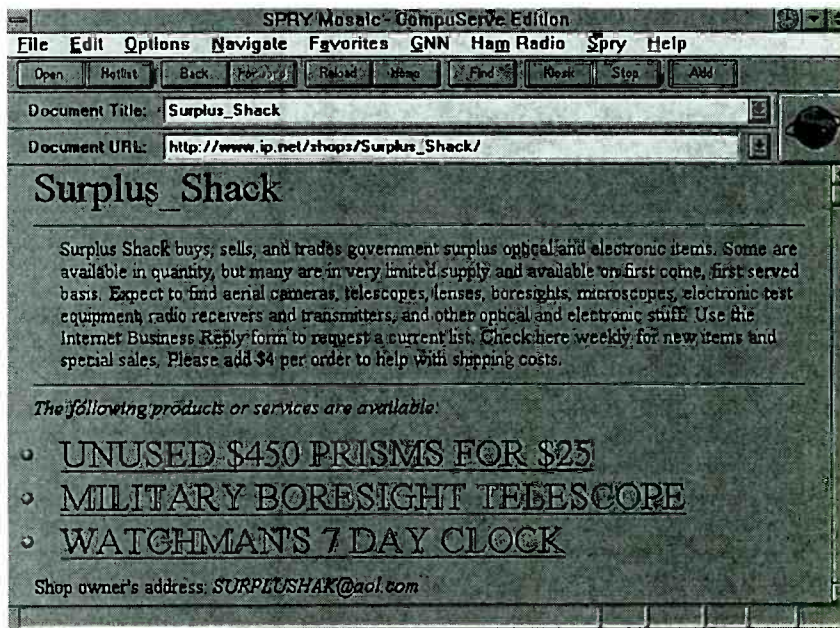

Fig. 2. Surplus—Shack buys, sells, and trades government-surplus optical and electronic items. Expect to find electronic test equipment, radio receivers and transmitters, and a variety of other optical and electronic stuff. Most equipment is offered on a first-come, first-served basis. Check out the URL <http://www/ip.net/shops/Surplus-Shack/>.

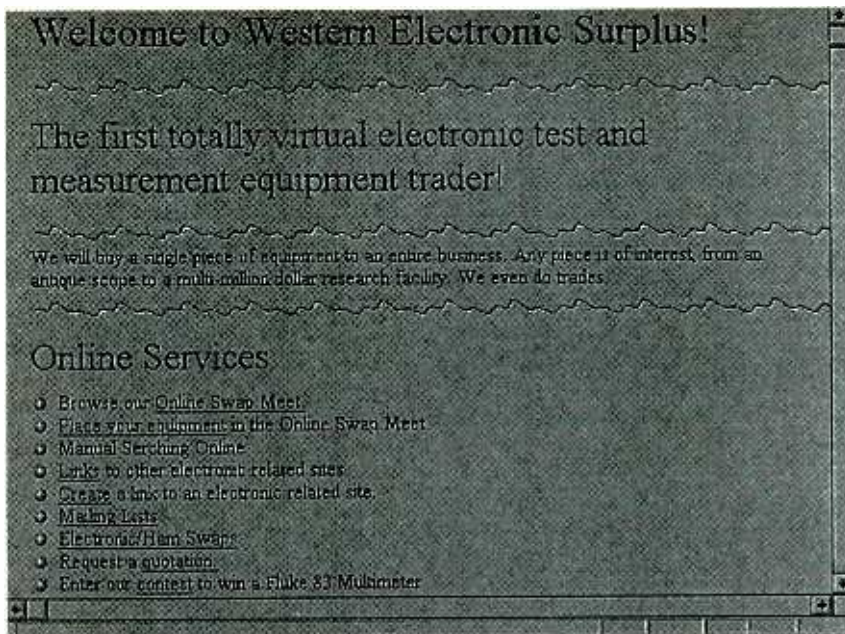

Fig. 3. *Western Electronic Surplus* claims to be "the first totally virtual electronic test and measurement equipment trader." It sponsors a variety of online services related to buying, selling, and trading surplus electronic and amateur radio equipment. The URL is <http://www.westes.com/>.

event calendars in *CQ*, *73 Amateur Radio Today*, and *QST*. For a listing of some of the more major events, see the "1996 Flea Markets and Hamfests" box.

Your modem-equipped PC can also help you find a hamfest. If you have an America Online (AOL) account, check the Ham Radio Club (Keyword: HAM or HAM RADIO) and ARRL areas (found in the Ham Radio Club). Those on Compuserve can check the HamNet Forum (GO HAMNET). You can also find ARRL hamfest lists, as well as a great deal of other radio-related information, on the ARRL Information Service; check out their BBS at 203-666-0578.

Another hi-tech way to access the ARRL's automated information server is by Internet "anonymous FTP" (file-transfer protocol). Access the oak.oakland.edu FTP site; the ARRL information files are found in the "pub/hamradio/arrl/infoserver" directories.

Surfing the Net for Surplus. The Internet is rapidly becoming an important resource to the electronics and computer hobbyist. Many electronics and computer manufacturers and surplus dealers have World-Wide Web pages or maintain other presences on the Net. However, finding exactly what you need can be confusing, frustrating, and even intimidat-

ing. To help alleviate that, we'll survey a few relevant links you'll want to hook up with and check out.

For better or worse, the Net is rapidly becoming a sort of universal marketing vehicle for all types of goods and services. Many business firms, individuals, and organizations have created Web "home pages" as "virtual storefronts" or "online stores" ready to accept your dollars.

Commercial Web pages typically include the firm's logo, as it would appear in a catalog or magazine advertisement. Customers visiting such a site simply point and click on the page to select ("go to") any of the choices listed. Those choices often include lists or profiles of products or services offered, as well as purchase information. The advantages of online marketing have not been lost on surplus firms, and several computer and electronics traders have online Web presences.

The Web pages you'll find offering surplus goods typically have the usual hypertext links, serving as on- and off-ramps as well as links to other Web sites. You'll also find e-mail addresses, searchable catalogs and listings, mail-server capabilities, instructions on using the online services, order forms, and the like as part of the total Web package. Those real-time features are eminently suited to the tran-

sitory and fast-moving, "here today but gone tomorrow" characteristics of all types of surplus stuff.

Here are a few Web pages featuring surplus that might be of some interest. Note that some are strictly online entities and don't publicize their physical addresses and telephone numbers; if that information is available, it's listed in the "Names and Numbers" box.

Defense Re-utilization and Marketing Service (DRMS): This federal government agency sells surplus Department of Defense (DOD) property to the public. There are bargains galore, and current DOD drawdowns and inventory likely will mean more surplus items coming to market. The site has a searchable online catalog for excess government property. Look for it at the following uniform resource locator (URL) <http://www.drms.dla.mil/index.html>. (Note: a free pamphlet, "How to Buy Surplus Personal Property from the Department of Defense" is available from DRMS or the Superintendent of Documents at the U. S. Government Printing Office.)

Electronics and Computers Surplus City: ECSC buys and sells surplus, excess and discontinued new and used electronic parts, assemblies, and systems, to the public and at wholesale. This self-proclaimed "super surplus store" operates the EIO (Electronics Information Online) WWW Server that lets you access inventory information. They're at <http://www.eio.com>. You also can call their BBS at 310-217-8021.

The Electronic Auction: The Electronic Auction bills itself as "the electronic marketplace for wholesale inventory." Acting as an information service and not being directly involved in transactions, the Auction moves overstock electronics and computer merchandise and equipment. Anyone who buys or sells in wholesale quantity can participate through online auctions, inventory listings, or advertising. Marketing services, a sample distribution center, and online trading services are available. The page is found at the URL <http://www.auction.net/index.html> (see Fig. 1). More information is available through their automated mail server at info@auction.net or via e-mail at admin@auction.net. There's also an FTP site at [ftp.auction.net](ftp://ftp.auction.net).

SUGGESTED READING

Power UP! by Dave Strom. This book helps solve the problem of conveniently using military surplus equipment that requires hard-to-find, expensive, or unavailable military batteries for power. Strom shows you how to make commercial battery adapters for many popular units. The book is \$14.95 plus \$4 shipping and handling from CRB Research Books.

Understanding & Repairing CB Radios by Lou Franklin, K6NH. This is a 380-page technical reference that includes circuit descriptions and a troubleshooting guide for most CB radios. It's \$29.95 plus \$3.50 shipping from CBC International.

The Zenith Trans-Oceanic: The Royalty of Radios by Professors John H. Bryant and Harold N. Cones. This is the definitive book on the Zenith radio classics. The authors present a wealth of authoritative information concerning those fascinating radios, their collection, preservation, and restoration. The book is \$24.95 plus \$2 shipping and handling from The Radio Professors.

Communications Receivers, third edition, by Ray Moore. If you're looking for detailed information on commercial and military-surplus communications receivers from the vacuum-tube era, 1932-1981, this book's for you. It covers about 400 receivers (over 700 with variations) from 68 major manufacturers, as well as military-surplus receivers such as the BC-312, BC-348, and BC-454. The 125-page book is \$19.95 plus \$2.50 shipping and handling from RSM Communications. A companion transmitter guide is planned. ■

JEM Computers: This Cambridge, MA firm functions as a sort of retail factory outlet that purports to offer good values in personal computers, selling surplus PCs, peripherals, and accessories at very low prices. Look for them at the URL <http://www.tiac.net/biz/bargains/>.

Surplus—Shack: Surplus—Shack buys, sells, and trades surplus optical and electronic items. Expect to find test equipment, radio receivers and transmitters, and optical and electronic stuff at attractive prices on a first-come, first-served basis. You can fill in an online "business reply form" to request a current listing; new items and sales are posted weekly. Their URL is <http://www.ip.net/shops/Surplus—Shack/> (see Fig. 2).

Team America: Team America, located in southern California, buys excess and obsolete inventories. They purchase computer hardware, disk

drives, and peripherals. Test equipment and electronic component parts are also available from the company. Check out the URL <http://www.vir.com/JAM/team.html>.

Western Electronic Surplus: Western Electronic Surplus claims to be "the first totally virtual electronic test and measurement equipment trader." It sponsors a variety of online services related to buying, selling, and trading surplus electronics and amateur radio equipment. Look for them at the URL <http://www.westes.com/> (see Fig. 3). They also sponsor the Online Swap Meet (URL <http://www.westes.com/Ads/Ads.html>) and the Electronic/Ham Swap Meet listings (see Fig. 4). The latter is at the URL <http://www.westes.com/swap—meets/swap—meets.html>.

Zeke's General Store: Zeke's General Store, in Central, AZ, takes pride in being a "mom and pop" retail operation that sells a mixture of practically anything and everything, including computers, graphic arts materials, and electronic equipment. Zeke and Ellen are at the URL <http://www.zekes.com/>.

Other Online Resources. Besides the Web sites we looked at, there are other online surplus resources you can access easily. Here are several:

USENET Newsgroups: Today the commercial action on the Net is on the Web, but there are also considerable surplus electronic and computer resources you'll find in the USENET newsgroups. Those are a series of discussion groups that focus on specific subjects; they're the Internet equivalent of online service and BES forums. There are over 10,000 such discussion groups on the Net; a number of them have to do with electronics and computers.

You might find the discussions and information postings on the several science, radio, and amateur radio newsgroups that deal with electronic-project building and related topics to be useful. Some of the more promising newsgroups are listed in the "USENET Newsgroups" box.

AOL Ham Radio Club and CompuServe HamNet Forum: Check out the Ham Radio Club (Keyword: HAM or HAM RADIO) and ARRL areas (found in the Ham Radio Club) on AOL, or in the HamNet Forum (GO HAMNET) on CompuServe. The CompuServe HamNet Forum has swap shop and vintage gear areas in which messages can be exchanged and software files downloaded. A HamNet Internet Web page is also at URL <http://www.webcom.com/sjl/HamNet—Companion>.

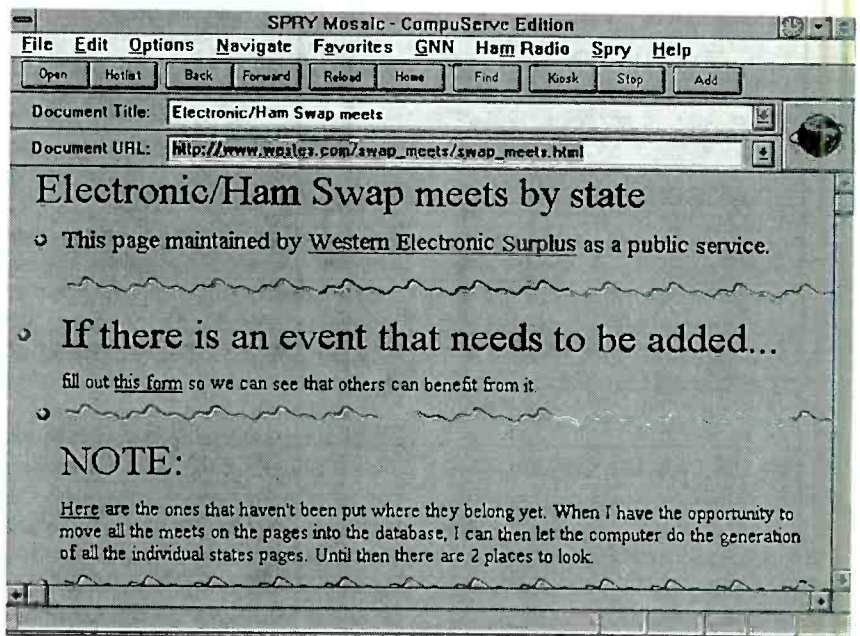

Fig. 4. The Electronic/Ham Swap Meets Web Page lists events by state so they can be easily found online. There's also an online form you can use to add events yourself. The page is sponsored by Western Electronic Surplus as a public service. It's found at the URL <http://www.westes.com/swap—meets/swap—meets.html>.

NAMES AND NUMBERS

All Electronics

P.O. Box 567
Van Nuys, CA 91408
Tel. 800-826-5432

Altex Electronics, Inc.

11342 I-35 North
San Antonio, TX 78233
Tel. 800-531-5369

73 Amateur Radio Today

70 Route 220N
Peterborough, NH 03458
Tel. 800-677-8838

Amateur Radio Trader

P.O. Box 3729
Crossville, TN 38557
Tel. 800-774-2623

The American Computer Exchange

Northside Tower
6065 Roswell Rd. N.E.
Atlanta, GA 30328
Tel. 800-786-0717

American Design Components

P.O. Box 220
Fairview, NJ 07022
Tel. 800-776-3700

American Radio Relay League (QST Magazine)

225 Main St.
Newington, CT 06111
Tel. 203-666-1541

American Science and Surplus

3605 Howard St.
Skokie, IL 60076
Tel. 708-982-0870

Antique Audio

41560 Schoolcraft
Plymouth, MI 48170

Antique Electronic Supply

6221 S. Maple Ave.
Tempe, AZ 85283
Tel. 602-820-5411

Ardco Electronics

P.O. Box 95
Berwyn, IL 60402

A.R.E. Surplus

15272 East State Route 12
Findlay, OH 45840
Tel. 419-387-7771

Artsci, Inc.

P.O. Box 1428
Burbank, CA 91507
Tel. 818-843-4080

B.G. Micro, Inc.

P.O. Box 280298
Dallas, TX 75228
Tel. 800-276-2206

Bigelow Electronics

P.O. Box 125
186 E. Jefferson St.
Bluffton, OH 45817-0125
Tel. 419-358-7851

Brock Publications

P.O. Box 5004
Oceanside, CA 92052
Tel. 619-757-0372

Cardwell Condenser Corporation

80 East Montauk Highway
Lindenhurst, NY 11757
Tel. 516-957-7200

CBC International

Box 31500
Phoenix, AZ 85046

Center for Legislative Archives

National Archives
Washington, DC 20408
Tel. 202-501-5350

C & H Sales

P.O. Box 5356
Pasadena, CA 91107
Tel. 800-325-9465

Circuit Specialists, Inc.

P.O. Box 3047
Scottsdale, AZ 85271-3047
Tel. 800-528-1417

CQ Communications, Inc.

76 N. Broadway
Hicksville, NY 11801
Tel. 800-853-9797

CRB Research Books, Inc.

P.O. Box 56
Commack, NY 11725
Tel. 800-656-0056

C & S Sales, Inc.

1245 Rosewood
Deerfield, IL 60015
Tel. 800-292-7711

Dalco Electronics

275 Pioneer Blvd.
Springboro, OH 45066
Tel. 800-445-5342

Danbar Sales Co.

14455 North 79th St., Unit #C
Scottsdale, AZ 85260
Tel. 602-483-6202

Davilyn Corp.

1340E Saticoy St.
North Hollywood, CA 91605-3475
Tel. 800-235-6222

Dayton HamVention

P.O. Box 964
Dayton, OH 45401-0964

DBA National Radio Company

229 Marginal St.
Chelsea, MA 02150
Tel. 617-884-8100

Debec Electronics

4025 Edwards Rd.
Cincinnati, OH 45209
Tel. 800-423-4499

Defense Reutilization and Marketing Service (DRMS)

National Sales Office
2163 Airways Blvd
Memphis, TN 38114-5210
Tel. 800-222-3767

Digi-Key

P.O. Box 677
Thief River Falls, MN 56701
Tel. 800-344-4539

Edlie Electronics

2700 Hempstead Turnpike
Levittown, NY 11756-1443
Tel. 800-645-4722

Eico Electronics Instrument Co, Inc.

363 Merrick Rd.
Lynbrook, NY 11563
Tel. 516-599-5744

Electronic Goldmine

P.O. Box 5408
Scottsdale, AZ 85261
Tel. 602-451-7454

Electronics & Computers Surplus City

1490 W. Artesia Blvd.
Gardena, CA 90248
Tel. 800-543-0540

Fair Radio Sales Co., Inc.

P.O. Box 1105
Lima, OH 45802
Tel. 419-227-6573

Gateway Electronics, Inc.

8123 Page Blvd.
St. Louis, MO 63130
Tel. 800-669-5810

Gernsback Publications, Inc.

500 Bi-County Blvd.
Farmingdale, NY 11735
Tel. 516-293-3000

Halted Specialties Co.

3500 Ryder St.
Santa Clara, CA 95051
Tel. 800-442-5833

Herbach and Rademan

18 Canal St.
Bristol, PA 19007
Tel. 215-788-5583

Hi-Manuals

P.O. Box 802
Council Bluffs, IA 51502

Hosfelt Electronics

2700 Sunset Blvd.
Steubenville, OH 43952
Tel. 800-524-6464

Howard W. Sams & Co.

2647 Waterfront Parkway East Dr.
Suite 300
Indianapolis, IN 46214-2041
Tel. 800-428-7267

HSC Electronic Supply

4837 Amber Lane
Sacramento, CA 95841
Tel. 916-338-2545

International Components Corporation

105 Maxess Rd.
Melville, NY 11747
Tel. 800-645-9154

Jameco Electronic Components

1355 Shoreway Rd.
Belmont, CA 94002
Tel. 800-831-4242

JEM Computers, Inc.

35 Spinelli Pl.
Cambridge, MA 02138
Tel. 617-497-2500

Marlin P. Jones & Associates

P.O. Box 12685
Lake Park, FL 33403-0685
Tel. 407-848-8236

The Manual Man

P. A. "Pete" Markavage
27 Walling St.
Sayreville, NJ 08872
Tel. 908-238-8964

MCM Electronics

650 Congress Park Dr.
Centerville, OH 45459-4072
Tel. 800-543-4330

MECI

340 East First St.
Dayton, OH 45402
Tel. 800-344-4465

Mendelson Electronics, Inc.

340 E. First St.
Dayton, OH 45402
Tel. 800-422-3525

John J. Meshna, Inc.

19 Allerton St.
Lynn, MA 01904
Tel. 800-637-4627

NAMES AND NUMBERS (continued)

Mouser Electronics

2401 Highway 287 North
Mansfield, TX 76063
Tel. 800-992-9943

Musty Manuals

645 Wheeling Rd.
Wheeling, IL 60090
Tel. 708-634-6467

National Cable Brokers

1801 W. Jefferson St.
Plymouth, IN 46563
Tel. 219-935-4128

Nuova Fonte del Surplus

Via Tarò
7 - Loc. Gorzano, 41050
Torre Maina, Modena, Italy
Tel. 0039-536-940253

Oatley Electronics

5 Lansdowne Parade
Oatley, Sydney
N.S.W., Australia 2223
Tel. 011 61 2 579 4985

Parts Express

340 E. First St.
Dayton, OH 45402
Tel. 800-338-0531

Pioneer Supply Co., Inc.

3524 Charlotte St.
Pittsburgh, PA 15201
Tel. 412-678-2300

Puett Electronics

P.O. Box 28572
Dallas, TX 75228
Tel. 214-321-0927

The Radio Professors

P.O. Box 592
Stillwater, OK 74076

R&D Electronics

5363 Broadway Ave.
Cleveland, OH 44127
Tel. 800-642-1123

Richardson Electronics, Ltd.

P.O. Box 393
LaFox, IL 60147-0393
Tel. 800-348-5580

RSM Communications

P.O. Box 1046
Key Largo, FL 33037-1046
Tel. 305-853-0379

Servo Systems

115 Main Rd.
Montville, NJ 07045-0097
Tel. 800-922-1103

Slep Electronics Company

P.O. Box 100
Otto, NC 28763-0100
Tel. 704-524-7519

Steinmetz Electronics

7519 Maplewood Ave.
Hammond, IN 46324
Tel. 219-931-9316

Superintendent of Documents

U. S. Government Printing Office
Washington, DC 20402

Surplus A1

P.O. Box 215
Hunlock Creek, PA 18621

Surplus Center

P.O. Box 82209
Lincoln, NE 68501
Tel. 800-488-3407

Surplus Sales of Nebraska

1502 Jones St.
Omaha, NE 68102-3112
Tel. 402-346-4750

Surplus Software Incorporated

489 North 8th St.
Hood River, OR 97031
Tel. 800-753-7877

Surplus Traders

P.O. Box 276
Alburt, VT 05440
Tel. 514-739-9328

Team America

16104 Corvello St.
Van Nuys, CA 91406
Tel. 818-787-1920

Timeline, Inc.

23605 Tejo Ave.
Torrance, CA 90505
Tel. 800-872-8878

Tucker Electronics Co.

P.O. Box 551419
Dallas, TX 75355-1419
Tel. 800-527-4642

Unicorn Electronics

10010 Canoga Ave., Unit B-8
Chatsworth, CA 91311
Tel. 800-824-3432

Universal Radio, Inc.

6830 Americana Pkwy.
Reynoldsburg, OH 43068
Tel. 800-431-3939

U.S. Army Military History Institute

Carlisle Barracks, PA 17013-5008
Tel. 717-245-3611

Varian Associates, Inc.

301 Industrial Way
San Carlos, CA 94070-2682
Tel. 800-432-4432

W7FG Vintage Manuals

3300 Wayside Dr.
Bartlesville, OK 74006
Tel. 918-333-7893

Western Nebraska Electronics

P.O. Box 1
Potter, NE 69156
Tel. 308-879-4552

Zeke's General Store

5000 The Old West Highway
Central, AZ 85531-0373
Tel. 520-428-1117

service is by anonymous FTP on the Net. If you have FTP access, access the oak.oakland.edu FTP site; you'll find the ARRL information files in the "pub/hamradio/arrl/infoserver" directories.

You can also have the ARRL's automated server (info@arrl.org) e-mail you the text files you desire once you have in hand the index.txt file that provides a complete listing of available files and file descriptions. Still another way to access the service is through the ARRL's BBS at 203-666-0578.

CompuServe and America Online Classifieds: Both online services have classified advertising sections you might wish to peruse for electronic and computer surplus equipment, parts, and components. It might, however, take some digging in a variety of ad classifications to find what you're looking for.

On CompuServe, GO CLASSIFIEDS; on AOL, use the keyword: CLASSIFIEDS. You'll find that AOL, in particular, has a wide variety of appropriate classifications and offers several "trading boards." AOL also lets you access several major daily newspapers' classified advertisements.

PCBUILD: PCBUILD is an Internet mailing list for the do-it-yourselfer; it offers you tips on building your own PC, upgrading, and buying inexpensive hardware. The Internet list address is at pcbuild@scvm.trenton.edu; the subscription address is list-serv@scvm.trenton.edu. (If you're unfamiliar with Internet LISTSERV procedures, view the LISTSERV Guide for General Users at the Web URL <http://www.earn.net/lug/notice.html>.)

PC Catalog: Peed Corporation's PC Catalog Online is a timesaving, Internet gopher resource. It contains more than 2000 PC products and nearly 200 companies that sell micro-computer, software, peripheral, and new technology products direct. This gopher (a popular Net tool that lets you search databases and presents you with a hierarchical distributed database of text documents) is updated weekly. It has price information, new-technology announcements, shoppers' checklists, and other items of interest. The gopher address is pccatalog.peed.com. The catalog also is on the Web at <http://www.peed.com/pccatalog.html>. You can e-mail the company at market@pccatalog.peed.com.

ARRL Information Service: The ARRL has several downloadable text files that deal with surplus topics and project-building and parts-procurement information. One is a list of mail-order electronics companies that sell electronic components in small quantities, compiled by John Woods,

WB7EEL. Classifications include new components, surplus electronics, specialty components, kits, and other categories. You can also access this and a variety of other amateur-radio and electronics-related information on the ARRL Information Service. Probably the easiest way to access the



The main activity at radio swap meets was, and still is, the swapping, selling, and buying of radio and electronic parts and equipment. Here are several shoppers and buyers performing those very acts.

Locating Manuals. So let's assume you buy some equipment from the sources mentioned so far. You'll find it difficult to repair and maintain that electronic equipment without operating or service manuals and schematic diagrams. Unfortunately, many manufacturers of older equipment are defunct, or the manuals are out-of-print. Nevertheless, there is a good chance that documentation still exists somewhere for almost any gear you're likely to encounter.

Prevention is the best medicine. Manufacturers, even the top brand names, might go out of business someday. Keep that in mind the next time you purchase equipment. Obtaining a manual might take a little extra effort initially, but you'll be making a very worthwhile investment in the future well-being of your equipment. Let's look at the different types of manuals and service documentation available to you:

Owner's or Operating Manuals: These are the least useful for the would-be repairer of equipment. An owner's manual is furnished at the time of purchase and is primarily an operating manual. Such manuals usually do not contain a schematic, and service data is often minimal.

Manufacturer's Service Manuals: Service manuals are usually sold separately. They contain important repair,

service, and alignment data. Most manufacturers offer service manuals, but they might not always have them available for obsolete equipment.

Other Manufacturer's Documentation: Besides owner's (operating) and service manuals, you might encounter other types of documentation. That could include combination assembly/operating and operating/service manuals, as well as charts, schematics, bulletins, and various technical specification sheets. For documentation, contact the manufacturer directly. If it's out of business, or if it no longer supplies the manual you need, you have other options (we'll deal with those later on in the "Possible Sources of Manuals" section).

Third-Party Service Documentation: Such documentation is published by companies other than the original manufacturer and is available in various forms from basic schematics to complete service manuals. That type of documentation offers a wealth of information on antique radio receivers and modern, consumer-electronics equipment, but amateur-radio equipment usually isn't covered.

Howard W. Sams & Company Photofacts: Sams began publishing *Photofacts* in 1946 to cover most consumer-electronics items. They offer *Photofacts* for TV sets; antique, ham,

and CB radios; VCRs; computers; and other electronic equipment. Although they don't include modern amateur equipment, you'll find service data for some classic shortwave receivers made by Hammarlund, Hallicrafters, and several others. *Photofacts* are numbered. To obtain the correct one, you must find the equipment in the *Annual Index*, which is \$5.95 plus \$1 shipping and handling, or \$12.95 for a disk-based version. You can order *Photofacts* through distributors, by mail, or by phone. Sams also offers a photocopy service for various manufacturer's manuals, *Rider's* data, and other manuals.

John F. Rider Perpetual Troubleshooters' Manuals: *Rider's* was first published in 1930. New volumes were published about one per year until the last one, volume 23, was issued in 1953. *Rider's* manuals are indexed by a system similar to *Photofacts*. Several index volumes were published.

Tip: If you think a *Photofact* or *Rider's* document might be available, based on the age and type of equipment involved, first check with your local library. Many larger libraries have them and will let you photocopy them.

Vacuum-Tube Data: The most common tube manuals are the ones published by RCA, especially in the case of receiving tubes. Manuals were also published for transmitting, special-purpose, and industrial tubes. The manuals first appeared in the 1930s and frequently were updated. Once common, they are now hard to find. Sylvania also published a comparable series.

As for tubes themselves, they're becoming very scarce and expensive, and are offered by just a few specialized dealers (they're still found at hamfests). Data for EIMAC tubes, frequently found in amateur amplifiers and other high-power RF applications, are available from Varian Associates. Transmitting tube data can also be found in the *ARRL Handbook*; look in the "Component Data" chapter of the most recent edition you can find.

Possible Sources of Manuals. Luckily, a seeker of documentation for a surplus item has a few options. For starters, there are a number of third-party resources that can furnish you with originals or reproductions of

manuals (we'll get to some of those in a moment). Further, some military equipment manuals can still be obtained from the government.

Hamfest flea markets and swap meets can also be good sources, as well. If you're having a particularly difficult time, however, it might be easier to try a classified advertisement in the hobbyist publication that most closely deals with your area of interest (**Popular Electronics** also publishes "Haves and Needs" sections in the "Letters" column).

Here are some possible sources of manuals and other documentation, listed in alphabetical order:

Antique Audio: This firm has older factory manuals for RCA, Zenith, and others. Most *Rider's*, *Photofacts*, *Transistor Service Manuals*, and *Beitman's* volumes are available.

Antique Electronic Supply: This company supplies pre-1960 service manuals for many electronic products and receivers. They offer reprints of older service manuals, tube manuals, a tube-substitution guidebook, and a catalog of radio parts and books.

Ardco Electronics: Most Hallicrafters service manuals for amateur/SWL equipment are available from Ardco Electronics. Specify the model numbers you're interested in when inquiring.

Artsci: Artsci specializes in reference publications for the amateur radio, SWL, and scanner communities. Those publications include *Lost Users Manuals* (\$19.95), which offers over 150 pages of condensed charts, drawings, radio programming information, and operating instructions for most ICOM, Kenwood, Yaesu, Alinco, and Uniden mobile radios, handi-talkies (HTs), and scanners.

Brock Publications: Most manuals for amateur equipment sold by Swan, Cubic Communications, Atlas, Astro, and Siltronix, are available from this resource.

Cardwell Condenser Corporation: Manuals for Hammarlund equipment, along with some components for their receivers and transmitters, are available from this source.

DAR Electronics: For manuals for National Radio Company communications receivers, contact DAR Electronics, DBA National Radio Company.

Eico Electronics Instrument Co,

1996 FLEA MARKETS AND HAMFESTS

Here's a chronological sampling of some of the flea market and hamfest events—large and small—you'll find across the U.S.A. in 1996. Check with your local radio club and the various amateur radio magazines' monthly hamfest calendars and special events listings to confirm these advance dates. Many of these events are ARRL-sanctioned.

January 28—Glen Burnie, MD: Maryland Mobileers ARC
February 3-4—Miami, FL: Southern Florida Section Convention
February 10—Pensacola, FL: Pensacola Area Hamfest Association
February 16-18—Orlando, FL: Florida State Convention
February 24-25—Cincinnati, OH: Great Lakes Division Convention
March 8-10—Norfolk, NE: Nebraska State Convention
April 12-13—Lawton, OK: Oklahoma State Convention
April 13—Spokane, WA: Inland NW Hamfest Association
April 13-14—Atlanta, GA: Georgia State Convention
April 13-14—Birmingham, AL: Alabama Section Convention (BirminghamHamfest)
May 18-19—Dayton, OH: Dayton Hamvention
May 31-June 2—Rochester, NY: Atlantic Division/New York State Convention
June 14-15—Albany, GA: Albany GA Amateur Radio Club
August 17-18—Huntsville, AL: Huntsville Hamfest
September 13-15—Peoria, IL: ARRL National Convention
October 5-6—Boxboro, MA: New England Division Convention
October 11-13—Mesa, AZ: Southwestern Division Convention
November 9—West Monroe, LA: Twin City Ham Club
November 16-17—Ft. Wayne, IN: Indiana State Convention
November 23-24—Tampa, FL: Southeastern Division Convention



Amateur radio hamfests are a big source of vintage communications equipment. Here a prospective buyer examines a classic, incredibly rugged, early 1960s Technical Material Corporation GPR-92 all-band HF communications receiver at a hamfest.

Inc.: Eico has manuals for the last 25 years of its product lines. Those mostly are for test equipment, but there are also some for amateur radio and audio equipment.

Fair Radio Sales, Inc.: Manuals for a variety of surplus equipment, some Tektronix manuals, and vacuum-tube data are available from this Ohio radio-surplus dealer.

Hi-Manuals: Manuals for most ham gear made from 1935-1970 are available from Hi-Manuals. A catalog, which is required to order manuals, is \$3. Tube data on RCA receiving and transmitting tubes also is available.

The Manual Man: P.A. "Pete" Markavage, "The Manual Man," offers vintage manuals for radio and audio equipment. His catalog shows a broad selection of operating, service, and assembly manuals, along with some charts, schematics, bulletins, technical specifications, and other equipment documentation.

Musty Manuals: Musty Manuals offers an extensive collection of owner's manuals, service and maintenance manuals, and other technical information on both early and late-model radio equipment, including amateur gear. A catalog is available.

National Archives: Photocopies of U.S. Army technical manuals for radio equipment from 1940 to 1949 are available from the Center for Legislative Archives of the National Archives. Requesting documents requires you to know the Army technical-manual number and to fill out a microfilm order form; a booklet describing how to determine the manual number is available.

Puett Electronics: This firm offers schematic diagrams for practically every radio receiver ever manufactured.

Slep Electronics: Slep Electronics offers manuals for commercial and military-surplus test equipment, commercial and military-surplus radios, antique radios, and equipment manuals.

Steinmetz Electronics: This firm offers *Rider's* and *Beitman's* manuals, plus older manufacturer's manuals.

Surplus AI: Surplus AI offers military technical manuals and has over 20,000 in stock. A nominal refundable charge is made for a current listing of available manuals.

(Continued on page 78)

5 BOOKS FOR ONLY \$4.95

WHEN YOU JOIN THE

Electronics Book Club®

VALUES TO \$199.30

The leading source of information for electronics hobbyists for over 30 years!



0350787 \$44.95 Hardcover

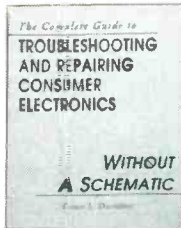

0156492 \$34.95 Hardcover

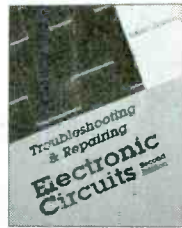

573119 \$19.95

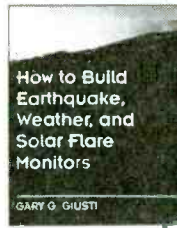

0252092 \$19.95



0156294-XX \$34.95 Counts as 2/Hardcover

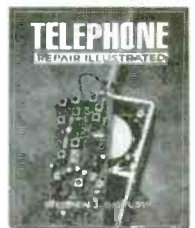

0052387 \$28.95 Hardcover

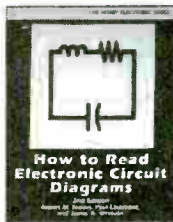

1554637 \$15.95

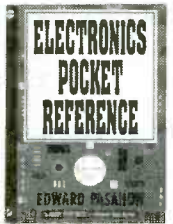

0487375 \$24.95



155014X \$34.95 Hardcover

0102740 \$12.95

0376581 \$39.50 Hardcover

0054088-XX \$42.95 Counts as 2/Hardcover

1575472 \$26.95

1570519 \$17.95

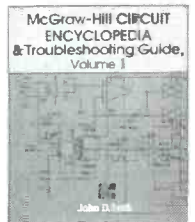

0376034-XX \$59.50 Counts as 2/Hardcover



5869284-XX \$46.00 Counts as 2/Hardcover



0156778 \$44.95 Hardcover

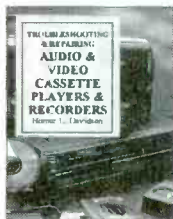

1077564 \$19.95



0112738-XX \$45.00 Counts as 2/Hardcover



073092X \$19.95

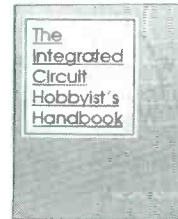

5871491 \$19.95

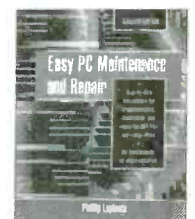

036432X \$27.95 Hardcover

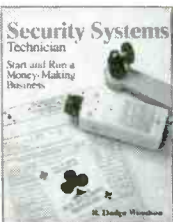

0717753 \$19.95

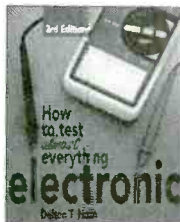

0304068 \$15.95

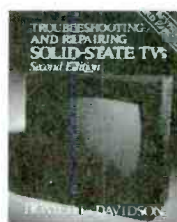

1576769-XX \$36.95 Counts as 2/Hardcover



0707618 \$19.95

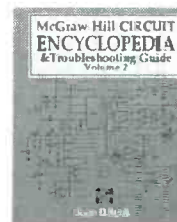

0376107-XX \$59.50 Counts as 2/Hardcover

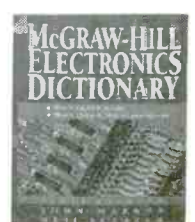

0404348-XX \$49.50 Counts as 2/Hardcover

As a member of the ELECTRONICS BOOK CLUB . . . you'll enjoy receiving Club bulletins every 3-4 weeks containing exciting offers on the latest books in the field at savings of up to 50% off the regular publishers' prices. If you want the Main selection, do nothing and it will be shipped automatically. If you want another book, or no book at all, simply return the reply form to us by the date specified. You'll have at least 10 days to decide. If you ever receive a book you don't want due to late delivery of the bulletin, you can return it at our expense. Your only obligation is to purchase 3 more books during the next 12 months, after which you may cancel your membership at any time. And you'll be eligible for FREE BOOKS through our Bonus Book Program.

A shipping/handling charge and sales tax will be added to all orders. All books are softcover unless otherwise noted. If you select a book that counts as 2 choices, write the book number in one box and XX in the next. (Publishers' Prices Shown) ©1996 EBC PE296

If card is missing, write to: Electronics Book Club, A Division of The McGraw-Hill Companies, P.O. Box 549, Blacklick, OH 43004-9918

When you live in an apartment like I do, having a weakness for console radios from the 30's and 40's can cause problems. Still, when I saw that 1941 Silvertone console lying out there in the front yard of a small antique shop, I just couldn't let it die. Perhaps, I thought, I can leave the apartment to my radios, and go live in the car! Well, with these and similar thoughts in mind I stopped in, dickered a bit, and brought the behemoth home in the back of my tiny car. I'm sure my neighbors had consigned my sanity to the nether regions when they saw me haul yet another one up the stairs. The project had begun; 80 hours of fun was under way.

The First Steps. A simple cleaning was the first thing to be done. The set was so absolutely filthy that bringing it indoors was out of the question. Furthermore, it was evident that several interesting creatures had taken up residence in the cabinet over time. Fortunately, all had either died or moved. It's worth nothing that taking an old radio inside can be hazardous—one old set I took apart came complete with a very live Black Widow spider who was not at all happy about being disturbed, so be cautious. Cleaning the cabinet out made me feel a bit like an archaeologist.

I like to know right off the bat if I've got a good or bad chassis. By that I mean whether or not the thing can be restored at all. It's been my experience that few chassis are total losses. Still, a real bad one pops up from time to time, and I really didn't want to spend weeks restoring a cabinet to find that the radio was not repairable.

There are many that think even a poorly functioning antique radio is valuable. However, I still think it's a crime to spend hours and hours on restoring a cabinet and then shove it in a corner and merely look at it. It makes about as much sense as paying six figures for a

Restoring a Vintage



Radio

BY L.G. ROBERTSON

Collecting antique radios is a fun hobby, especially if you can return your finds to their former glory. This article describes one such restoration project.

classic car and then keeping it all locked up in a warehouse. All my sets work, and to original specifications, too.

The electrical part of the project was rather straightforward. I suppose my having played with radios for the past 25 years probably had something to do with it, but I must say that luck played a great part, too. Most of the set's vital components (IF cans, tuning condensers, coils, and dial-string parts) were present and intact. However, all the fixed capacitors and nearly all the resistors had to be replaced.

However, the first "start-up" was not without problems. The set was a bit grumpy, I guess, after being awakened from a 30-year snooze. Some "motorboating" occurred, but was cured with a thorough cleaning of the tube sockets—poor connections were responsible. Details like that help me appreciate the fact that these sets came from an era when radio was as much an art as a science.

There was also a problem with fungus (the set is from Seattle): It formed a short in the transformer, causing the rectifier to glow cherry red the first few times the set was switched on (and quickly off!). The problem vanished

after the third start-up, never to reappear. It seems that the fungus burned through, breaking the short circuit. Now that the unit was working I moved on to the more laborious stuff.

Rolling Up My Sleeves. The chassis was thoroughly rusted and pitted. It was only after many hours of sanding with medium, fine, and crocus-grade emery cloth that the bright metal emerged. Fifty years of rust is a formidable opponent. **Don't** use Naval Jelly no matter how tempting it might be. If it should drip, it will ruin wiring. Sorry, but good old-fashioned elbow grease works best for this step.

For sheer "fun" in chassis work, though, stringing the dial cord system

takes first place. If you're at a loss about how to get admitted to the violent ward of your local mental hospital, by all means try this. Imagine trying to juggle crystal stemware while your hands are enmeshed in the children's game of "Cat's Cradle," and you'll get the idea.

The dial in the set was the real heart-breaker. All the gold leaf on the dial needed to be replaced; little of the old stuff survived. When the set was first obtained, the gold was flaking and peeling at some points, but held as fast as iron where it was not. As there was some very slight difference between the old gold and the new material, it was decided to eliminate what remained of the old gilt entirely. That was rather tricky, as I didn't want to disturb some white silkscreened markings on the dial. A solution of 85% witch hazel and 15% alcohol was used to soften up the old gold leaf without ruining the white silkscreening. Fine manicure tools and some dental picks were also used.

The new material I used was Maimeri brand "Pale Gold #904" gold-leaf powder from Italy. That was then mixed



This is the set before restoration. The cabinet has been thoroughly bashed, scratched and scarred. Fortunately, all the pieces were there, and, wonder of wonders, the speaker did not need re-coning. The chassis has been removed for rust removal.

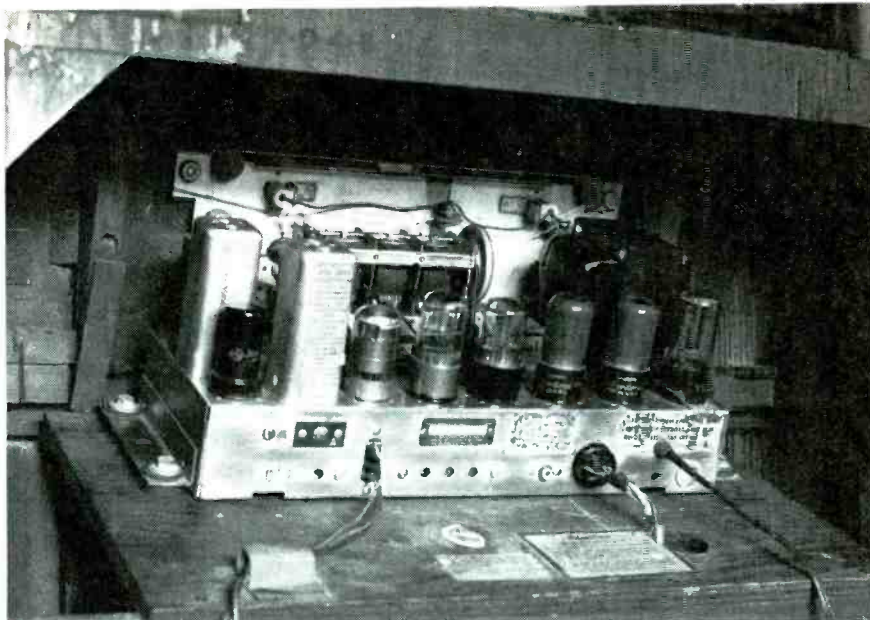

Here's the chassis, after extensive rust removal. Note the original Svetlone tubes; they were still good after nearly fifty years.

with a polymer/acrylic medium, and applied to clear adhesive tape that I cut to fit in the tracks where the old gilt had lain.

Stripping the cabinet provided me with yet another experience with products containing Toluene, and again I hated it. Still, the chemical stripper did a very good job. Incidentally, the ventilation advisories on the can are not to be taken lightly!

Once fully into the finish stripping, I found it necessary to use small brushes to get into the various crevices and crannies. It was well worth the effort. Once down to the wood, a beautiful deep-red stain was revealed that had nothing whatsoever to do with the color of the finish! Someone had used a one-step varnish/stain sometime in the past. (Utter heresy!) The red stain was matched very closely using present-day stain, and applied very lightly indeed, just enough to even things out all over. It was wiped up five minutes after application.

The cabinet was finished by hand rubbing nine coats of satin spar varnish, with 24-48 hours between coats. In between coats, sanding was done with 000 steel wool, as even fine sandpaper seemed to be too coarse for the stain and the Mahogany and Walnut wood veneers used in the unit. Before all this, however, some veneer did have to be replaced as it was damaged beyond repair. Fortunately, present-day materials make that easy. Some veneer even



This is the complete rear view. The ten-inch speaker and huge magnet assembly below provide impressive sound indeed.

comes with adhesive backing!

Radio restoration is a very interesting sideroad of the radio avocation, and the number of collectors grows daily. If you're interested in some good tips and reading, try "A Flick of The Switch," by Morgan McMahon, or "Antique Radios: Restoration and Price Guide," by David and Betty Johnson. Both are available from Antique Electronic Supply (6221 S. Maple Ave., Tempe, AZ 85283).

And so, to paraphrase John Bunyan, "I pieced it back together until at last it came to be; For length and breadth the bigness which you see." ■

Abbreviations: (AR)Antique Radio, (C)Construction, (CB)Computer Bits, (CC)Circuit Circus, (D)Department, (DX)DX Listening, (ED)Editorial, (G)Gizmo, (HOR)Hands-On Report, (HR)Ham Radio, (LET)Letter, (MW)Multimedia Watch, (NW)Net Watch, (PTR)Product Test Report, (SS)Scanner Scene, (TT)Think Tank

#

12-VDC and Continuity Tester (Yacono)(TT) **Aug 28**
 12-Volt Power Supply (Rakes)(CC) **Jun 76**
 25-MHz Frequency Counter, Build a (Bolles)(C) **Feb 53**
 40-Meter Loop Antenna (Rakes)(CC) **Nov 79**

A

A K Peters Mobile Robot Kit (HOR) **Jun 26**
 A + H International's BeeperKid Child Monitoring System (Scaduto & O'Brian)(G) **Jul 14**
 A D Converter, Build an Eight-Channel (Barbarelli)(C) **Jun 45,(LET)Sep 4**
 A V Preamp Tuner, Carver CT-27V (Scaduto & O'Brian)(G) **Apr 19**
 Apex Software's Columbia Dictionary of Quotations (Holtzman)(CB) **Jan 68**
 AC Circuits, Analyzing (Tarchinski) **Dec 55**
 AC Fuse Alert Circuit (Rakes)(CC) **Feb 70**
 Add a Switch to your Serial Port (Spiwak)(C) **May 60**
 Advanced Digital Systems Radio Rock-II RDS (Scaduto & O'Brian)(G) **Nov 19**
 Advanced Recorder/Player (Rakes)(CC) **Jul 78**
 Aircraft Receiver (Yacono)(TT) **Sep 28**
All About
 Crystal-Oscillator Circuits (Carr) **Aug 61**
 Current Crowbar Circuits (Kallangile) **Apr 59, (LET)Jul 4**
 MMIC Amplifiers (Carr) **Dec 41**
 AM Broadcast Band Preselector, Build a (Carr)(C) **Apr 58**
 Amplifier, Headphone, for Your Guitar (Seely)(C) **Mar 33**
 Analyzing AC Circuits (Tarchinski) **Dec 55**
 Answering Some Questions (Yacono)(TT) **Feb 28**
 Answering-Machine Message Stopper, Build an (Piller)(C) **Sep 57,(LET)Nov 4**

ANTENNA

Antenna Safety for Hams and SWLs (Thurber) **May 37**
 DX Beam-Aimer Program, A (Biechman) **Jan 40,(LET)Apr 4,(LET)May 4**
 Limited-Space Antennas for SWLs (Thurber)(C) **Jun 61**
 Simple Antenna for 800-MHz, A (Williams)(C) **Nov 60**
 Some Antenna Topics (Carr)(HR) **Mar 78**

ANTIQUÉ RADIO (D)(Ellis)

Building a Starter Ham Receiver —1930 Style **Oct 66**
 From the Mallbag **Dec 69**
 Mallbag Time Again! **Mar 64**
 Minerva Gets a Re-Capping, The **Jun 69**
 Minerva Restoration Begins, The **May 64**
 Minerva Tropicmaster: A Postwar Puzzle **Apr 64**
 Putting Minerva Back Together **Jul 69**
 Scrounging Parts for the 1930 Ham Receiver **Nov 70**
 Tel-OhMike Wrap-Up **Jan 64**
 This 'n That **Feb 64**
 Time to Read the Mail **Aug 67**
 Tropicmaster Gets an Alignment, The **Sep 66**
 Apple's Newton (Scaduto and O'Brian)(G) **Jan 9**
 Are We Alone? (Laron)(ED) **Dec 3**
 askSam 2.0 (Holtzman)(CB) **Jun 74**
 Assorted Circuits (Rakes)(CC) **Jun 76**
 Astronomy, Radio (Thurber) **Oct 72**
 At Home With Home Theater (Scaduto & O'Brian)(G) **Apr 9**
 Atlantic Technology System 250 Home-Theater Speaker System (Scaduto & O'Brian)(G) **Apr 20**

Audible IR Detector (Rakes)(CC) **Jun 76**
 Audible Level, Build an (Cartwright)(C) **Apr 53**
AUDIO (See also RADIO)
 At Home With Home Theater (Scaduto & O'Brian)(G) **Apr 9**
 Atlantic Technology System 250 Home-Theater Speaker System (Scaduto & O'Brian)(G) **Apr 20**
 Build Your Own FM Transmitter (Biechman)(C) **Feb 33**
 California Audio Labs DX-1 CD Player (Scaduto and O'Brian)(G) **Jan 18**
 Canon S-35 Loudspeakers (Scaduto and O'Brian)(G) **Jan 16**
 Carver AV-405 Power Amplifier (Scaduto & O'Brian)(G) **Apr 19**
 Designing Loudspeaker Crossovers (Hoffman) **Jul 37,(LET)Dec 4**
 Desper Products Spatializer EMR 4.0 Audio Processor (Scaduto & O'Brian)(G) **Mar 18**
 Frequency Response Tester (Constan)(C) **Mar 51**
 Guitar Preamp-Distortion Box (Willimott)(C) **Aug 43,(LET)Dec 4**
 Headphone Amplifier for Your Guitar (Seely)(C) **Mar 33**
 Oldsmobile Aurora with Bose Audio System (Scaduto and O'Brian)(G) **Jan 14**
 Poor Man's Transmitter (Cicon)(C) **Nov 43**
 Sharp WO-CH800 Portable Music System with 5-Disc CD Changer (Scaduto & O'Brian)(G) **Mar 17**
 Sound-Level Meter (Panosh)(C) **Nov 56**
 Subwoofer, Build this (Hoffman)(C) **Jul 43,(LET)Oct 4**
 Truth About Speaker Cables, The (Hoffman) **Jul 46**
 Vacuum-Tube Audio Amplifier, Build a (Lisle)(C) **Jan 53,(LET)Jun 4**

AUTOMOTIVE

Auto Stethoscope, Build the (Hansen)(C) **Apr 46**
 Automotive Electronics for the 21st Century (Siuru) **Jun 43**
 Car-Audio Supply (Yacono)(TT) **Jun 29**
 Fog Detection and Warning Systems (Siuru) **Sep 62**
 Handing-Control Systems (Siuru) **Feb 37**
 Oldsmobile Aurora with Bose Audio System (Scaduto and O'Brian)(G) **Jan 14**
 Radar Speed Gun, Build a (Spiwak)(C) **Jun 37**
 Shortwave Converter for your Car, Build a (Williams)(C) **Sep 41,(LET)Nov 4**
 Silent Sam Turn-Signal Reminder (HOR) **Apr 24,(LET)Oct 4**

B

Backup Software, Filesafe First (Scaduto & O'Brian)(G) **Jun 12**
 Balanced View, A (Laron)(ED) **Jun 3**
 Bananas Were Green: The Early Days of Color TV (Rybak) **Jul 55**
 Banishing "Nightmare" Signals (Saxon)(SS) **Aug 83**
 Bar-Graph Display (Yacono)(TT) **Dec 74**
 Battery Charger (Yacono)(TT) **Jun 29,Jul 30**
 BeeperKid Child Monitoring System, A + H International (Scaduto & O'Brian)(G) **Jul 14**
 Bike Alarm (Rakes)(CC) **Feb 70**
 Bookman Electronic Books, Franklin Electronics (Scaduto & O'Brian)(G) **Oct 14**
 Bose Audio System in Oldsmobile Aurora (Scaduto and O'Brian)(G) **Jan 14**
 Brother International HL-630 Laser Printer (Scaduto & O'Brian)(G) **Sep 16**
BUILD A/AN/THE/THIS (See CONSTRUCTION)
 Build Your Own FM Transmitter (Biechman)(C) **Feb 33**
 Building a Starter Ham Receiver —1930 Style (Ellis)(AR) **Oct 66**
 Building Receivers with the NE-602 (Carr)(HR) **Apr 78**
 Burglar Alarm (Rakes)(CC) **Apr 68**

Buried Bytes: A History of the Personal Computer (Thurber) **Apr 36**
 Buy or Upgrade? (Holtzman)(CB) **Jan 68,Feb 68**
 Bye-Bye Cable (Laron) **Feb 3**

C

California Audio Labs DX-1 CD Player (Scaduto and O'Brian)(G) **Jan 18**
 Camcorder, Sony CCD-TRV30 (Booth)(PTR) **Oct 30**
 Can't Find It? Just ask Sam (Holtzman)(CB) **Jun 74**
Canon
 Innova Book 200LS Notebook Computer (Scaduto & O'Brian)(G) **Oct 10**
 S-35 Loudspeakers (Scaduto and O'Brian)(G) **Jan 16**
Carver
 AV-405 Power Amplifier (Scaduto & O'Brian)(G) **Apr 19**
 CT-27V AV Preamp Tuner (Scaduto & O'Brian)(G) **Apr 19**
 CD-i Multiplayer with Digital Video Cartridge, Magnavox CDI450 (Scaduto & O'Brian)(G) **Mar 9**
 CD-Player, California Audio Labs DX-1 (Scaduto and O'Brian)(G) **Jan 18**
 CD-ROM Drive, Media Vision Reno Portable (HOR) **Jul 28**
 Central Point Software XTree Gold 4.0 (Scaduto & O'Brian)(G) **Jun 18**
 Chirrup, Build the (Panosh)(C) **Sep 59**
 Christmas Tree, Electronic (Clifton)(C) **Dec 39**
CIRCUIT CIRCUS (D)(Rakes) **Jan 71,Feb 70,Mar 70, Apr 68,May 69,Jun 76, Jul 78,Aug 74,Sep 73, Oct 76,Nov 79,Dec 77**
 Assorted Circuits **Jun 76**
 Circuit Grab Bag, A **Feb 70**
 Controller Circuits **Mar 70**
 Ham-Radio Circuits **Nov 79**
 Handy Hobbyist Circuits **Sep 73**
 More ISD1000A Circuits **Aug 74**
 More Motorcycle Circuits **May 69**
 More Ultrasonic Circuits **Jan 71,(LET)Apr 4**
 Motorcycle Circuits **Apr 68**
 One-Transistor Circuits **Dec 77**
 Some LED Fun **Oct 76**
 Voice Recording and Playback **Jul 78**
 Circuit Grab Bag, A (Rakes)(CC) **Feb 70**
 Circuits of Yore (Yacono)(TT) **Oct 72**
 Club of Clubs, The (Jensen)(DX) **Nov 82**
 Code-Practice Oscillator (Rakes)(CC) **Nov 75**
 Color TV, The Early Days of (Rybak) **Jul 55**
 Color Video Printer, Sharp GZ-P15U (Scaduto & O'Brian)(G) **Sep 11**
 Columbia Dictionary of Quotations, AAPEX Software (Holtzman)(CB) **Jan 68**
 Command Communications ComShare 750 (Holtzman)(CB) **Nov 74**
 Command Your Telephone System (Holtzman)(CB) **Nov 74**
 Compaq Presario CDS 520 PC (Scaduto & O'Brian)(G) **Mar 15**
 Component Tester (Yacono)(TT) **Aug 28**
COMPUTER (See also COMPUTER BITS)
 Add a Switch to your Serial Port (Spiwak)(C) **May 68**
 Apple's Newton (Scaduto and O'Brian)(G) **Jan 9**
 Brother International HL-630 Laser Printer (Scaduto & O'Brian)(G) **Sep 16**
 Build an Eight-Channel A D Converter (Barbarelli)(C) **Jun 45,(LET)Sep 4**
 Build the "Faux-Fax" Scanner (Black)(C) **Oct 59**
 Buried Bytes: A History of the Personal Computer (Thurber) **Apr 36**
 Canon Innova Book 200LS Notebook Computer (Scaduto & O'Brian)(G) **Oct 10**
 Central Point Software

XTree Gold 4.0 (Scaduto & O'Brian)(G) Jun 18
 Compaq Presario CDS 520 Mar 15
 PC (Scaduto & O'Brian)(G) Oct 27
 Data Depot MiniPOST Post-Code Reader (HOR) Aug 65
 Delta-Wye Conversion Program, The (Tarchinski) Jul 37,(LET)Dec 4
 Designing Loudspeaker Crossovers (Hoffman) Sep 14
 Digital Vision ComputerEyes1024 Video Frame Grabber (Scaduto & O'Brian)(G) Apr 4,(LET)May 4
 DX Beam-Aimer Program, A (Blechman) Mar 49
Exploring the Imagination (Roach) Nov 46
Internet (Thurber)
Filesafe
 First Backup Software (Scaduto & O'Brian)(G) Jun 12
 Sidecar II Tape Backup System (Scaduto & O'Brian)(G) Jun 12
 TD-700 II Tape Backup System (Scaduto & O'Brian)(G) Jun 12
 Graffiti Handwriting-Recognition Software (Scaduto & O'Brian)(G) Feb 16
 Hauppauge Computer Works Win:TV-Prism (Scaduto & O'Brian)(G) Sep 9
 Idea Generator Plus (Holtzman)(CB) May 67
 Interlink Electronics RemotePoint Cordless Mouse (Scaduto & O'Brian)(G) Aug 18
 Kantek Spectrum Ring Mouse Pointing Device (Scaduto & O'Brian)(G) Aug 16
 Media Vision Reno Portable CD-ROM Drive (HOR) Jul 28
 MEI Micro Premium RMS 150 + Removable Mass Storage System (HOR) Feb 23
 Microsoft Bob (Scaduto & O'Brian)(G) Aug 11
NEC
 Multisync XV17 Computer Monitor (Booth)(PTR) Nov 32
 Ready Multimedia Computer (Scaduto & O'Brian)(G) Aug 9
 SIM-EQ: The Simultaneous Equation Program (Tarchinski) Mar 46
 Sony PIC-1000 Magic Link Personal Communicator (Scaduto & O'Brian)(G) Oct 9
 Survival Guide for PC Owners, A (Thurber) Feb 46
 Upgrading and Maintaining Your Personal Computer (Spiwak) Apr 49,Jun 47,Aug 57
 WinNET Plus Internet Access Software (Scaduto & O'Brian)(G) Jul 16
COMPUTER BITS (D)(Holtzman) Jan 68, Feb 68, Mar 68 Apr 67, May 67, Jun 74 Jul 74, Aug 72, Sep 72 Oct 64, Nov 74, Dec 72
 Buy or Upgrade? Feb 68
 Buy or Upgrade? Part II Jun 74
 Can't Find It? Just askSam Nov 74
 Command Your Telephone System Disk and File Utilities Sep 72
 Emergency Disk Aug 72
 Going Online Dec 72
 Inspiration May 67
 Methods, Attributes, and Messages Apr 67
 Objects Mar 68
 Soldering Irons and Cyber Circuits Jul 74
 System Resource Management Oct 64
 Constant-Current Source (Rakes)(CC) Dec 77
CONSTRUCTION
 Add a Switch to your Serial Port (Spiwak) May 60
Build A/An/The This
 25-MHz Frequency Counter (Bolles) Feb 53
 "Faux-Fax" Scanner (Black) Oct 59
 "g" Machine (Caristi) May 46
 "Galviamp" (Carr) Jul 63
 Answering-Machine Message Stopper (Pitler) Sep 57,(LET) Nov 4
 Audible Level (Cartwright) Apr 53
 Auto Stethoscope (Hansen) Apr 46
 Chirrup (Panosh) Sep 59
 DTMF Decoder/Logger (Weeder) Sep 37
 Eight-Channel A/D Converter (Bartorello) Jun 45,(LET)Sep 4
 Electronic Oracle (Rawlinson) Sep 47
 Electronic Xmas Tree (Clifton) Dec 39
 Equatorial Camera Mount (Iovine) Oct 54
 Flash-Battery Tester (Bailey) Nov 64
 Frequency Response Tester (Constan) Mar 51
 Guitar Preamp/Distortion Box (Willmott) Aug 43,(LET)Dec 4
 Headphone Amplifier for Your Guitar (Seely) Mar 33
 Magic Eye (Lisle) Dec 67
 Novel Nightlight (Lisle) Mar 37
 Oscilloscope Calibrator (Hansen) Aug 45
 Pathfinder (Stroud) Oct 50
 PK Tester (Duarte) May 57
 Poor Man's Transmitter (Cicon) Nov 43
 Preselector for the AM Broadcast Band (Carr) Apr 56
 Radar Speed Gun (Spiwak) Jun 37
 Scanner Converter (Spiwak) Nov 39
 Shortwave Converter for your Car (Williams) Sep 41,(LET)Nov 4
 Sound-Level Meter (Panosh) Nov 56
 Space Wings (Spiwak) Sep 53
 Sprinkler Guardian (Schopp) Apr 33,(LET)Oct 4
 Subwoofer (Hoffman) Jul 43,(LET)Oct 4
 Sun-Tracking Circuit (Wright) Jun 54
 Telephone-Line Simulator (Black)

Telephone-Wiring Tester (Zguris) Jul 60
 TV Transmitter (Spiwak) Aug 37
 Vacuum-Tube Audio Amplifier (Lisle) Jan 53,(LET)Jun 4
 Variometer Radio (Lisle) May 55
 Vocal Sound-Effects Generator (Williams) Oct 48
 WWW Receiver (McKean) Jan 49
 Build Your Own FM Transmitter (Blechman) Feb 33
 Expanded Resistance Ranges for Your DMM (Stiles) Dec 64
 Limited-Space Antennas for SWL's (Thurber) Jun 61
 Make Your Own RF Transformers (Carr) Nov 67
 Simple Antenna for 800-MHz, A (Williams) Nov 60
 Contestant Lock-Out Circuit (Yacono)(TT) Dec 74
 Controller Circuits (Rakes)(CC) Mar 70
 Cordless Mouse, Interlink Electronics RemotePoint (Scaduto & O'Brian)(G) Aug 18
 Crossing-Gate Flasher (Yacono)(TT) Mar 28
CRYPTOLOGY
 Security in the Information Age (Howard) May 33
 Crystal-Coupling Circuit (Yacono)(TT) Aug 28
 Crystal-Oscillator Circuits, All About (Carr) Aug 61
 Current Crowbar Circuits, All About (Kaliangile) Apr 59,(LET)Jul 4
D
 Data Depot MiniPOST Post-Code Reader (HOR) Oct 27
 Dayton Hamvention (Spiwak)(MW) Sep 24
 DBS Alternative, A (Laron)(ED) Jul 3
 DC Fuse Alert (Rakes)(CC) Feb 70
 DC Level Indicator (Rakes)(CC) Oct 76
 DC Power Supply for Hams, A (Carr)(HR) Nov 84
 Deep-Space Scanning (Saxon)(SS) Apr 80
 Delayed Turn-Signal Monitor (Rakes)(CC) Feb 70
 Delta-Wye Conversion Program, The (Tarchinski) Aug 65
 Designing Loudspeaker Crossovers (Hoffman) Jul 37,(LET)Dec 4
 Desper Products Spatializer EMR 4.0 Audio Processor (Scaduto & O'Brian)(G) Mar 18
 DH Laser Drive (Yacono)(TT) Dec 74
 Digital Vision ComputerEyes1024 Video Frame Grabber (Scaduto & O'Brian)(G) Sep 14
 Digital Analog Trainer, Elenco (HOR) Mar 24
 Disk and File Utilities (Holtzman)(CB) Sep 72
 DTMF Decoder/Logger, Build a (Weeder)(C) Sep 37
 Dual-Deck VCR, Goldstar VH8 8mm/VHS (Scaduto & O'Brian)(G) Jun 9
 Dual-Tone Generator (Yacono)(TT) May 29
 DX Beam-Aimer Program, A (Blechman) Jan 40,(LET)Apr 4,(LET)May 4
DX LISTENING (D)(Jensen) Jan 75, Feb 76, Mar 76 Apr 74, May 74, Jun 81 Jul 82, Aug 79, Sep 78 Oct 80, Nov 82, Dec 80
 DX Listening Club of Clubs, The Jun 82
 End of an Era, The Jul 82
 Fun in the Summertime Jul 82
 Helping Beginners Jan 75
 Popular-Priced Shortwave Receivers Feb 76
 Radio from Eastern Europe Sep 78
 Radio Still Reigns Oct 80
 Russian Radio Revolution, A Aug 79
 Shortwave from Austria Apr 74
 Shortwave from South Africa Mar 76
 Voice from the North, A May 74
 Voice of Terror, The Dec 80
 Dynamic Receiver Specifications (Carr)(HR) Aug 81
E
 Echoes, Long-Delayed: Fact or Fancy? (Thurber) Aug 54
EDITORIAL (D)(Laron) Jan 3, Feb 3, Mar 3, Apr 3, May 3, Jun 3, Jul 3, Aug 3, Sep 3, Oct 3, Nov 3, Dec 3
 Are We Alone? Dec 3
 Balanced View, A Jun 3
 Bye-Bye Cable, A Feb 3
 DBS Alternative, A Jul 3
 Getting Connected, A Aug 3
 Hello DSS Mar 3
 Hobbyists and SMT Jan 3
 Security in the Information Age May 3
 Upgrading Your Personal Computer Apr 3
 Voices from Beyond Oct 3
 Warm Up Your Soldering Iron Sep 4
 Watching the Net Nov 3
 Electric Firefly (Yacono)(TT) Dec 74
Electronic
 Bartender's Guide, Franklin Electronics (Scaduto & O'Brian)(G) Feb 18
 Locks (Yacono)(TT) Apr 29
 Oracle, Build the (Rawlinson)(C) Sep 47
 Xmas Tree, Build This (Clifton)(C) Dec 39

ELECTRONICS LIBRARY Jan 84, Feb 82, Mar 84, Apr 82 May 84, Jun 87, Jul 88, Aug 85 Sep 84, Oct 86, Nov 88, Dec 86
 Electronics on a Budget (Adams) Sep 49
Elenco
 FG-500K Function Generator Kit (HOR) May 24
 LP-525K Logic-Probe Kit (HOR) Aug 26
 Telephone Line Analyzer (HOR) Jan 24
 XK-525 Digital-Analog Trainer (HOR) Mar 24
 Emergency Disk (Holtzman)(CC) Aug 72
 End of an Era, The (Jensen)(DX) Jun 81
 Equatorial Camera Mount, Build an (Iovine)(C) Oct 54
 Expanded Resistance Ranges for Your DMM (Stiles)(C) Dec 64
Exploring the Imagination (Roach) Mar 49
 Internet (Thurber) Nov 46
 Extch Indoor/Outdoor Temperature Alarm (HOR) Nov 30
 Extraterrestrial Intelligence, The Search for (Thurber) Dec 46
F
 Fan Actuator (Yacono)(TT) Jan 28
 Fast-Food Frequencies (Saxon)(SS) Jun 85
 "Faux-Fax" Scanner, Build the (Black)(C) Oct 59
 Field-Strength Meter (Rakes)(CC) Nov 79
Filesafe
 First Backup Software (Scaduto & O'Brian)(G) Jun 12
 Sidecar II Tape Backup System (Scaduto & O'Brian)(G) Jun 12
 TD-700 II Tape Backup System (Scaduto & O'Brian)(G) Jun 12
 Flash Unit (Yacono)(TT) Nov 76
 Flash-Battery Tester, Build a (Bailey)(C) Nov 64
 Flashy Brake Light (Rakes)(CC) May 69
 FM Transmitter, Build Your Own (Blechman)(C) Feb 33
 Fog Detection and Warning Systems (Siuru) Sep 62
 Four-Output Controller (Rakes)(CC) Mar 70
Franklin Electronics
 Bookman Electronic Books (Scaduto & O'Brian)(G) Oct 14
 Electronic Bartender's Guide (Scaduto & O'Brian)(G) Feb 18
 Parker's Electronic Wine Guide (Scaduto & O'Brian)(G) Feb 18
 Freeze Sensor (Yacono)(TT) Jan 28
Frequency
 -Based Lock (Yacono)(TT) Apr 29
 Counter, 25-MHz, Build a (Bolles)(C) Feb 53
 Response Tester, Build a (Constan)(C) Mar 51
 From the Mailbag (Ellis)(AR) Dec 69
 Fun in the Summer/Time (Jensen)(DX) Jul 82
 Fun With Random-Dot Images (Spiwak) Jul 49
 Function Generator Kit, Elenco FG-500K (HOR) May 24
G
 "g" Machine, Build the (Caristi)(C) May 46
 "Galviamp," Build the (Carr)(C) Jul 63
 Game Controllers, and More (Spiwak)(MW) Jun 23
 Game with a Mission, A (Constan)(MW) Nov 23
 GE KitchenVision TVCR (Scaduto & O'Brian)(G) Feb 14
 Getting Connected (Laron)(ED) Aug 3
 Getting Started In Surface-Mount Technology (Reis) Mar 39
 Ghost Voices: Exploring the Mysteries of Electronic Voice Phenomena (Konstantinos) Oct 37
GIZMO (D)(Scaduto & O'Brian) Jan 9, Feb 9 Mar 9, Apr 9, May 9, Jun 9 Jul 9, Aug 9, Sep 9, Oct 9 Nov 9, Dec 9
 Advanced Digital Systems Radio Rock-It RDS Nov 19
 Apple's Newton Jan 9
 At Home With Home Theater Apr 9
 Atlantic Technology System 250 Home Theater Speaker System Apr 20
 BeeperKid Child Monitoring System Jul 14
 A + H International Sep 16
 Brother International HL-630 Laser Printer Jan 18
 California Audio Labs DX-1 CD Player Jul 3
 Canon Innova Book 200LS Notebook Computer Oct 10
 S-35 Loudspeakers Jan 16
Carver
 AV-405 Power Amplifier Apr 19
 CT-27V A/V Preamp/Tuner Apr 19
 Central Point Software XTree Gold 4.0 Jun 18
 Compaq Presario CDS 520 PC Mar 15
 Desper Products Spatializer EMR 4.0 Audio Processor Mar 18
 Digital Vision ComputerEyes1024 Video Frame Grabber Sep 14
Filesafe
 First Backup Software Jun 12
 Sidecar II Tape Backup System Jun 12
 TD-700 II Tape Backup System Jun 12

Franklin Electronics					
Bookman Electronic Books	Oct 14				
Electronic Bartenders Guide	Feb 18				
Parker's Electronic Wine Guide	Feb 18				
GE KitchenVision TVCR	Feb 14				
Gizmo's Holiday Gift Guide	Dec 9				
Goldstar VHS 8mm VHS Dual-Deck VCR	Jun 9				
Graffiti Handwriting-Recognition Software	Feb 16				
Hauppauge Computer Works Win-TV-Prism Interlink Electronics RemotePoint Cordless Mouse	Sep 9				
Kantek Spectrum Ring Mouse Pointing Device with Digital Video Cartridge	Aug 18				
Magnavox CD1450 CD-i Multiplayer	Mar 9				
Microsoft Bob	Aug 11				
NEC Ready Multimedia Computer	Aug 9				
Oldsmobile Aurora with Bose Audio System	Jan 14				
Oregon Scientific BA-213 Desktop Weather Forecaster	Aug 15				
Primestar Digital Direct Broadcast Satellite Service	Jul 9				
Quasar LD510 Laserdisc Player	Jun 17				
Radio Shack Personal Emergency Phone Dialer	Jun 19				
Reel-Talk RT-101 Radio Recorder	Jun 10				
Samsung 4-Head Hi-Fi VCR with StarSight Capability	Nov 16				
Sharp					
GZ-P15U Color Video Printer	Sep 11				
WQ-CH800 Portable Music System with 5-Disc CD Changer	Mar 17				
Showtime in Las Vegas	May 9				
Sony PIC-1000 Magic Link Personal Communicator	Oct 9				
StarSight					
Interactive On-Screen Program Guide	Nov 9				
Model CB1500 Receiver	Nov 11				
Samsung 4-Head Hi-Fi VCR with StarSight Capability	Nov 16				
Unisar First Sounds Prenatal Listening Device	Jun 14				
Vidikron Crystal One LCD Projector	Apr 18				
WinNET Plus Internet Access Software	Jul 16				
Zenith ZS8000LE Satellite TV Receiver	Feb 9				
GMR5, Tuning in to (Saxon)(SS)	Nov 86				
Going Online (Holtzman)(CB)	Dec 72				
Goldstar VHS 8mm VHS Dual-Deck VCR (Scaduto & O'Brian)(G)	Jun 9				
Good, The Bad, and The Scrambled, The (Saxon) (SS)	Oct 84				
Graffiti Handwriting-Recognition Software (Scaduto & O'Brian)(G)	Feb 16				
Great Straight Key, A (Carr)(HR)	Dec 82				
Guitar Preamp Distortion Box (Willmott)(C)	Aug 43,(LET)Dec 4				
	H				
HAM RADIO (D)(Carr)	Jan 77, Feb 78, Mar 78				
	Apr 78, May 76, Jun 83, Jul 84				
	Aug 81, Sep 80, Oct 82, Nov 84, Dec 82				
Building Receivers with the NE-602	Apr 78				
DC Power Supply for Hams, A	Nov 84				
Dynamic Receiver Specifications	Aug 81				
Great Straight Key, A	Dec 82				
Monitoring SIDs	Feb 78				
NE-602 Input and Output Circuits	May 76				
NE-602 Oscillator Circuits	Jun 83				
Receiver Selectivity	Jul 84				
Shop Stuff	Oct 82				
Some Antenna Topics	Mar 78				
Some Receiver Accessories	Sep 80				
Step Attenuator Project, A	Jan 77				
Ham-Radio Circuits (Rakes)(CC)	Nov 79				
Handing-Control Systems (Sluru)	Feb 37				
HANDS-ON REPORT (D)	Jan 24, Feb 23, Mar 24				
	Apr 24, May 24, Jun 26, Jul 28				
	Aug 26, Sep 26, Oct 27, Nov 30, Dec 30				
A K Peters Mobile Robot Kit	Jun 26				
Data Depot MiniPOST Post-Code Reader	Oct 27				
Elenco					
FG-500K Function Generator Kit	May 24				
LP-525K Logic-Probe Kit	Aug 26				
Telephone Line Analyzer	Jan 24				
XK-525 Digital/Analog Trainer	Mar 24				
Extch Indoor/Outdoor Temperature Alarm	Nov 30				
Heathkit ID-5001 Advanced Weather Computer	Sep 26				
Media Vision Reno Portable CD-ROM Drive	Jul 28				
MEI Micro Premium RMS 150+ Removable Mass Storage System	Feb 23				
Silent Sam Turn-Signal Reminder	Apr 24,(LET)Oct 4				
VersaTimer Programmable Power Scheduler	Dec 30				
Handwriting-Recognition Software, Graffiti (Scaduto & O'Brian)(G)	Feb 16				
Handy Hobbyist Circuits (Rakes)(CC)	Sep 73				
Hauppauge Computer Works Win-TV-Prism (Scaduto & O'Brian)(G)	Sep 9				
Headlight Monitor (Rakes)(CC)	Apr 68				
Headphone Amplifier for Your Guitar, Build a (Seely)(C)	Mar 33				
Heathkit ID-5001 Advanced Weather Computer (HOR)	Sep 26				
Helio DSS (Laron)(ED)	Mar 3				
Helping Beginners (Jensen)(DX)	Jan 75				
High-Voltage Projects (Yacono)(TT)	Nov 76				
HISTORY					
Bananas Were Green: The Early Days of Color TV (Rybak)	Jul 55				
Buried Bytes: A History of the Personal Computer (Thurber)	Apr 36				
Looking Back at the Reflex Radio (Rutland)	Aug 40				
Hobbyist's Guide to Surface-Mount Technology, A (Reis)	Jan 45				
Hobbyists and SMT (Laron)(ED)	Jan 3				
Holiday Gift Idea, A (Saxon)(SS)	Dec 84				
HOME THEATER					
At Home With (Scaduto & O'Brian)(G)	Apr 9				
Speaker System, Atlantic Technology System 250 (Scaduto & O'Brian)(G)	Apr 20				
	I				
IdeaFisher (Holtzman)(CB)	May 67				
ImaginNation Network, The (Roach)	Mar 49				
Impedance Converter (Rakes)(CC)	Sep 73				
Impedance-Matching Circuit (Rakes)(CC)	Dec 77				
Improved Headlight Monitor (Rakes)(CC)	Apr 68				
Improved Horn (Rakes)(CC)	May 69				
Inspiration (Holtzman)(CB)	May 67				
Instant Publishing on CD-ROM (Spiwak)(MW)	Feb 6				
Interlink Electronics RemotePoint Cordless Mouse (Scaduto & O'Brian)(G)	Aug 18				
Internet, Exploring the (Thurber)	Nov 46				
IR Detector (Rakes)(CC)	Jun 76				
	J				
Jack Lock (Yacono)(TT)	Apr 29				
	K				
Kantek Spectrum Ring Mouse Pointing Device (Scaduto & O'Brian)(G)	Aug 16				
Kids Like Multimedia, Too (Spiwak)(MW)	Aug 24				
KIT BUILDING					
A K Peters Mobile Robot Kit (HOR)	Jun 26				
Elenco					
FG-500K Function Generator Kit (HOR)	May 24				
LP-525K Logic-Probe Kit (HOR)	Aug 26				
Telephone Line Analyzer (HOR)	Jan 24				
XK-525 Digital/Analog Trainer (HOR)	Mar 24				
Heathkit ID-5001 Advanced Weather Computer (HOR)	Sep 26				
Silent Sam Turn-Signal Reminder (HOR)	Apr 24,(LET)Oct 4				
	L				
Lamp-Life Extender (Rakes)(CC)	Sep 73				
Laser Printer, Brother International HL-630 (Scaduto & O'Brian)(G)	Sep 16				
Laser Pulser (Yacono)(TT)	Nov 76				
Laserdisc Player, Quasar LD510 (Scaduto & O'Brian)(G)	Jun 17				
LCD Projector, Vidikron Crystal One (Scaduto & O'Brian)(G)	Apr 18				
Learn How to Service VCRs (Splwak)	Feb 58				
LED					
Constant-Current Source (Rakes)(CC)	Oct 76				
Flasher (Rakes)(CC)	Oct 76				
-Off Circuit (Rakes)(CC)	Dec 77				
-On Driver (Rakes)(CC)	Dec 77				
Pilot Lamp (Rakes)(CC)	Oct 76				
LETTERS (D)	Jan 4, Feb 4, Mar 4				
	Apr 4, May 4, Jun 4, Jul 4, Aug 4				
	Sep 4, Oct 4, Nov 4, Dec 4				
Light Add-on (Yacono)(TT)	Feb 28				
Limited-Space Antennas for SWLs (Thurber)(C)	Jun 61				
Locks, Electronic (Yacono)(TT)	Apr 29				
Logic-Probe Kit, Elenco LP-525K (HOR)	Aug 26				
Long-Delayed Echoes: Fact or Fancy? (Thurber)	Aug 54				
Looking Back at the Reflex Radio (Rutland)	Aug 40				
Loudspeaker Crossovers, Designing (Hoffman)	Jul 37,(LET)Dec 4				
Low-Ohms Tester Expanded Resistance Ranges for Your DMM (Stiles)(C)	Dec 64				
Low-RF Switch (Yacono)(TT)	Feb 28, Jul 30				
	M				
Magic Eye, Build the (Lis)(C)	Dec 67				
Magic Link Personal Communicator, Sony PIC-1000 (Scaduto & O'Brian)(G)	Oct 9				
Magnavox CD1450 CD-i Multiplayer with Digital Video Cartridge (Scaduto & O'Brian)(G)	Mar 9				
Malibag Time Again! (Ellis)(AR)	Mar 64				
Make Your Own RF Transformers (Carr)(C)	Nov 67				
Making Square Waves at Home (Carr)	Mar 57,(LET)Jul 4				
Media Vision Reno Portable CD-ROM Drive (HOR)	Jul 28				
Megohm Tester Expanded Resistance Ranges for Your DMM (Stiles)(C)	Dec 64				
MEI Micro Premium RMS 150+ Removable Mass Storage System (HOR)	Feb 23				
Message-Start Locator (Rakes)(CC)	Jul 78				
Methods, Attributes, and Messages (Holtzman)(CB)	Apr 67				
Microsoft Bob (Scaduto & O'Brian)(G)	Aug 11				
Minerva					
Gets a Re-Capping, The (Ellis)(AR)	Jun 68				
Restoration Begins, The (Ellis)(AR) Tropicmaster:	May 64				
A Postwar Puzzle (Ellis)(AR)	Apr 64				
Miniature Amp (Yacono)(TT)	Oct 72				
MMIC Amplifiers, All About (Carr)	Dec 41				
Mobile Robot Kit, A K Peters (HOR)	Jun 26				
Model-Railroad Circuits (Yacono)(TT)	Mar 28				
Model-Railroad Sounder (Yacono)(TT)	Mar 28				
Monitoring					
"Bumper Bleepers" (Saxon)(SS)	Feb 80				
Beeper Messages (Saxon)(SS)	Sep 82				
SID's (Carr)(HR)	Feb 78				
VIP Military Aircraft (Saxon)(SS)	Jan 82				
More					
ISD100CA Circuits (Rakes)(CC)	Aug 74				
Motorcycle Circuits (Rakes)(CC)	May 69				
Readers' Comments (Yacono)(TT)	Jul 30				
Ultrasonic Circuits (Rakes)(CC)	Jan 71,(LET)Apr 4				
Motion Detector (Rakes)(CC)	Jan 71				
Motor-Speed Control (Yacono)(TT)	Sep 28				
Motorcycle Circuits (Rakes)(CC)	Apr 68				
Motorcycle Circuits, More (Rakes)(CC)	May 69				
MULTIMEDIA (See also MULTIMEDIA WATCH)					
Computer, NEC Ready (Scaduto & O'Brian)(G)	Aug 9				
Magnavox CD1450 CD-i Multiplayer with Digital Video Cartridge (Scaduto & O'Brian)(G)	Mar 9				
MULTIMEDIA WATCH (D)(Spiwak)	Jan 6, Feb 6				
	Mar 6, Apr 6, May 6, Jun 23, Jul 24				
	Aug 24, Sep 24, Oct 24, Nov 23, Dec 23				
Game Controllers, and More	Jun 23				
Game with a Mission, A	Nov 23				
Instant Publishing on CD-ROM	Feb 6				
Kids Like Multimedia, Too	Aug 24				
Multimedia Monitor, A	Mar 6				
New Multimedia Keyboard, A	Dec 23				
Report from Dayton	Sep 24				
Slide-Show Software	Oct 24				
This and That	Jan 6				
Tiny Multimedia Toys	Apr 6				
Virtual Guitar, A	May 6				
Worth the Wait	Jul 24				
Music Online (Karagiannis)(NW)	Dec 26				
	N				
NE-602					
Input and Output Circuits (Carr)(HR)	May 76				
Oscillator Circuits (Carr)(HR)	Jun 83				
NEC					
Multisync XV17 Computer Monitor (Booth)(PTR)	Nov 32				
Ready Multimedia Computer (Scaduto & O'Brian)(G)	Aug 9				
Neon Christmas Lights (Rakes)(CC)	Jun 76				
NET WATCH (D)(Karagiannis)	Nov 28, Dec 26				
Music Online	Dec 26				
World of Information, A	Nov 28				
New Multimedia Keyboard, A (Spiwak)(MW)	Dec 23				
NEW PRODUCTS (D)	Jan 86, Feb 84, Mar 88				
	Apr 85, May 87				
	Jun 6, Jul 6, Aug 6, Sep 6				
	Oct 6, Nov 6, Dec 6				
Newton Messagepad 110 (Scaduto and O'Brian)(G)	Jan 9				
Nightlight, Build a Novel (Lis)(C)	Mar 37				
Norton Commander, Symantec (Holtzman)(CB)	Sep 72				
Notebook Computer, Canon Innova Book 200LS (Scaduto & O'Brian)(G)	Oct 10				
	O				
Objects (Holtzman)(CB)	Mar 68				
Oldsmobile Aurora with Bose Audio System (Scaduto and O'Brian)(G)	Jan 14				
On-Screen Interactive Program Guide, StarSight (Scaduto & O'Brian)(G)	Nov 9				
One-Transistor Circuits (Rakes)(CC)	Dec 77				
Optoelectronics					
OptoScout 455 Interface System (Saxon)(SS)	Mar 82				
Scout (Saxon)(SS)	Aug 83				

Oregon Scientific BA-213 Desktop
Weather Forecaster (Scaduto & O'Brian)(G) Aug 15
Oscilloscope Calibrator, Build the (Hansen)(C) Aug 45

P

PAR Electronics VHF/DN153
Dual-Stage Filter (Saxon)(SS) Aug 83
Parker's Electronic Wine Guide,
Franklin (Scaduto & O'Brian)(G) Feb 18
Pathfinder, Build the (Stroud)(C) Oct 50
PC (See also COMPUTER)
Compaq Presario
CDS 520 (Scaduto & O'Brian)(G) Mar 15
Owners, A Survival Guide for (Thurber) Feb 46
-Powerful Scanning (Saxon)(SS) Mar 82
Upgrading and Maintaining (Spiwak) Apr 49, Aug 47
Personal Emergency Phone Dialer,
Radio Shack (Scaduto & O'Brian)(G) Jul 19

PHOTOGRAPHY

Build a Flash-Battery Tester (Bailey)(C) Nov 64
Build an Equatorial Camera Mount (Iovine)(C) Oct 54
Picture-Frame Audio (Rakes)(CC) Jul 78
PK Tester, Build the (Duarte)(C) May 57
Plug-n-Play System Resource
Management (Holtzman)(CB) Oct 64
Pocket Stroboscope (Yacono)(TT) Nov 76
Poor-Man's Transmitter, Build the (Cicon)(C) Nov 43
Popular-Priced Shortwave
Receivers (Jensen)(DX) Feb 76

Portable Music System with 5-Disc CD Changer,
Sharp WQ-CH800 (Scaduto & O'Brian)(G) Mar 17
Post-Code Reader, Data Depot MiniPOST (HOR) Oct 27
Power Amplifier,
Carver AV-405 (Scaduto & O'Brian)(G) Apr 19
Practical Peripherals
Fax-Me Cartridge (Holtzman)(CB) Nov 74
Precision Current Source (Yacono)(TT) May 29
Precision Voltage Source (Yacono)(TT) Aug 28
Prenatal Listening Device, Unisar
First Sounds (Scaduto & O'Brian)(G) Jun 14
Primestar Digital Direct Broadcast Satellite
Service (Scaduto & O'Brian)(G) Jul 9

PRODUCT TEST REPORTS (D)(Booth)

NEC Multisync XV17 Computer Monitor Nov 32, Dec 32
Samsung VR8905 Hi-Fi VCR Nov 32
Sony CCD-TRV30 Camcorder Dec 32
Programmable Power Scheduler,
VersaTimer (HOR) Dec 30
Proximity Sensor (Rakes)(CC) Jan 71
Psychokinesis Tester (Duarte)(C) May 57
Putting Minerva Back Together (Ellis)(AR) Jul 68

Q

QRP Tuning Monitor (Rakes)(CC) Nov 79
Quasar LD510
Laserdisc Player (Scaduto & O'Brian)(G) Jun 17

R

Radar Speed Gun, Build a (Spiwak)(C) Jun 37
Radiating Circuits (Yacono)(TT) Dec 74
RADIO (See also DX LISTENING, HAM RADIO, SCANNER SCENE)
Build a the
Magic Eye (Lisle)(C) Dec 67
Preselector for the AM
Broadcast Band (Carr)(C) Apr 56
Scanner Converter (Spiwak)(C) Nov 39
Shortwave Converter
for your Car (Williams)(C) Sep 41, (LET) Nov 4
Variometer Radio (Lisle)(C) May 55
VWV Receiver (McKean)(C) Jan 49
Build Your Own FM Transmitter (Blechman)(C) Feb 33
Limited-Space Antennas
for SWLs (Thurber)(C) Jun 61
Long-Delayed Echoes:
Fact or Fancy? (Thurber) Aug 54
Looking Back at the Reflex Radio (Rutland) Aug 40
Make Your Own RF Transformers (Carr)(C) Nov 67
Radio Astronomy (Thurber) Oct 42
Radio Recorder,
Reel-Talk RT-101 (Scaduto & O'Brian)(G) Jun 10
Radio Rock-II RDS (Scaduto & O'Brian)(G) Nov 19
Reflex Radio, Looking Back at (Rutland) Aug 40
Simple Antenna for 800-MHz,
A (Williams)(C) Nov 60
Radio Astronomy (Thurber) Oct 42
Radio from Eastern Europe (Jensen)(DX) Sep 78
Radio Shack
Handheld GMRS Receiver (Saxon)(SS) Nov 86
Personal Emergency Phone
Dialer (Scaduto & O'Brian)(G) Jul 19
PRO-2035 (Saxon)(SS) May 82
PRO-26 Handheld Scanner (Saxon)(SS) Dec 84
PRO-62 Handheld Scanner (Saxon)(SS) Jun 85

Radio Still Reigns (Jensen)(DX) Oct 80
Rain Detector (Rakes)(CC) Feb 70
Ramsey SS-70 Analog
Scrambler/Descrambler (Saxon)(SS) Oct 84
Random-Dot Images, Fun With (Spiwak) Jul 49
Random-Number Generator (Yacono)(TT) Sep 28
Readers' Observations (Yacono)(TT) Jun 29
Receiver Selectivity (Carr)(HR) Jul 84
Reel-Talk RT-101 Radio
Recorder (Scaduto & O'Brian)(G) Jun 10
Reflex Radio, Looking Back at (Rutland) Aug 40
Regulated Power Supply (Yacono)(TT) May 29
Relay Driver (Rakes)(CC) Dec 77
Removable Mass Storage System,
MEI Micro Premium RMS 150 + (HOR) Feb 23
Report from Dayton (Spiwak)(MW) Sep 24
Revamped Nightlight (Yacono)(TT) Oct 72
Revised Lock (Yacono)(TT) Oct 72
RF Transformers, Make Your Own (Carr)(C) Nov 67
Ring wave Pointing Device,
Kantek Spectrum (Scaduto & O'Brian)(G) Aug 16

ROBOTICS

A K Peters Mobile Robot Kit (HOR) Jun 26
Russian Radio Revolution, A (Jensen)(DX) Aug 79
Russians (and Others) Are Coming!,
The (Saxon)(SS) May 82

S

Samsung
4-Head Hi-Fi VCR with
StarSight Capability (Scaduto & O'Brian)(G) Nov 16
VR8905 Hi-Fi VCR (Booth)(PTR) Dec 32
SATELLITE TV
Primestar Digital Direct Broadcast Satellite
Service (Scaduto & O'Brian)(G) Jul 9
Zenith ZS8000LE IAD (Scaduto & O'Brian)(G) Feb 9
Scanner Converter, Build the (Spiwak)(C) Nov 39
SCANNER SCENE (D)(Saxon) Jan 82, Feb 88, Mar 82
Apr 80, May 82, Jun 85, Jul 86
Aug 83, Sep 82, Oct 84, Nov 86, Dec 84
Banishing "Nightmare" Signals Aug 83
Deep-Space Scanning Apr 80
Fast-Food Frequencies Jun 85
Good, The Bad, and The Scrambled, The Oct 84
Holiday Gift Idea, A Dec 84
Monitoring "Bumper Beepers" Feb 80
Monitoring Beeper Messages Sep 82
Monitoring VIP Military Aircraft Jan 82
PC-Powerful Scanning Mar 82
Russians (and Others) Are Coming!,
The (Saxon)(SS) May 82
Tuning in to GMRS Nov 86
Up In the Air Jul 86

Scrounging Parts for the 1930
Ham Receiver (Ellis)(AR) Nov 70
Search for Extraterrestrial Intelligence,
The (Thurber) Dec 46
Security in the Information Age
(Howard) May 33
(Laron)(ED) May 3

Semiconductor Lights (Rakes)(CC) Jun 76
Sensor Foil Patterns (Yacono)(TT) Jun 29
Serial Port, Add a Switch to
your (Spiwak)(C) May 60

Sharp
GZ-P15U Color
Video Printer (Scaduto & O'Brian)(G) Sep 11
WQ-CH800 Portable Music System with
5-Disc CD Changer (Scaduto & O'Brian)(G) Mar 17
Shop Equipment (Yacono)(TT) May 29
Shop Stuff (Carr) Oct 82
Short Detector (Rakes)(CC) Sep 73

Shortwave
Converter for your Car
(Williams)(C) Sep 41, (LET) Nov 4
from Austria (Jensen)(DX) Mar 76
from South Africa (Jensen)(DX) Apr 74
Showtime in Las Vegas (Scaduto & O'Brian)(G) May 9

Silent Sam Turn-Signal
Reminder (HOR) Apr 24, (LET) Oct 4
SIM-EQ: The Simultaneous Equation
Program (Tarchinski) Mar 46

Simple
Antenna for 800-MHz, A (Williams)(C) Nov 60
Antenna Tuner (Rakes)(CC) Nov 79
Audio Amplifier (Rakes)(CC) Dec 77
FM Transmitter (Rakes)(CC) Feb 70
Horn (Rakes)(CC) May 69
Recorder/Player (Rakes)(CC) Jul 78
Simplified Digital Lock (Yacono)(TT) Apr 29
Simultaneous Equation Program:
SIM-EQ (Tarchinski) Mar 46
Slide-Show Software (Spiwak)(MW) Oct 24
Smart Turn Signal (Rakes)(CC) May 69
Soldering Irons and Cyber
Circuits (Holtzman)(CB) Jul 74
Soldering-Iron Standby (Rakes)(CC) Sep 73

Some
Antenna Topics (Carr)(HR) Mar 78
Assorted Circuits (Yacono)(TT) Sep 28
LED Fun (Rakes)(CC) Oct 76
Receiver Accessories (Carr)(HR) Sep 80

Sony

CCD-TRV30 Camcorder (Booth)(PTR) Oct 30
PIC-1000 Magic Link Personal
Communicator (Scaduto & O'Brian)(G) Oct 9

Sound

-Activated Player (Rakes)(CC) Jul 78
-Effects Generator, Vocal (Williams)(C) Oct 48
-Level Meter, Build a (Panosh)(C) Nov 56
Space Wings, Build the (Spiwak)(C) Sep 53
Spatializer EMR 4.0 Audio Processor,
Desper Products (Scaduto & O'Brian)(G) Mar 18
Speaker Cables, The Truth About (Hofman) Jul 46
Spectrum Analyzer, Using a (Clarke) Oct 62
Sprinkler Guardian,
Build The (Schopp)(C) Apr 33, (LET) Oct 4
Square Waves, Making,
at Home (Carr) Mar 57, (LET) Jul 4

StarSight

-Capable VCR, Samsung
VR8905 (Scaduto & O'Brian)(G) Nov 16
CB1500 Receiver (Scaduto & O'Brian)(G) Nov 11
Interactive On-Screen Program
Guide (Scaduto & O'Brian)(G) Nov 9
VR8905 Hi-Fi VCR with, Samsung
(Booth) (PTR) Dec 32
Step Attenuator Project, A (Carr)(HR) Jan 77
Subwoofer, Build a (Hoffman)(C) Jul 43, (LET) Oct 4
Sun-Tracking Circuit, Build a (Wright)(C) Jun 54
Surface-Mount Technology
A Hobbyist's Guide to (Reis) Jan 45
Getting Started in (Reis) Mar 39
Survival Guide for PC Owners, A (Thurber) Feb 46
Symantec's Norton Commander (Holtzman)(CB) Sep 72
System Resource Management (Holtzman)(CB) Oct 64

T

Tamper Alarm (Rakes)(CC) Sep 73

Tape Backup System

Filesafe
Sidecar II (Scaduto & O'Brian)(G) Jun 12
TD-700 (Scaduto & O'Brian)(G) Jun 12
Tel-Ohmike Wrap-Up (Ellis)(AR) Jan 64

TELEPHONE

Answering-Machine Message
Stopper (Piller)(C) Sep 57, (LET) Nov 4
DTMF Decoder/Logger (Weeder)(C) Sep 37
Radio Shack Personal Emergency Phone
Dialer (Scaduto & O'Brian)(G) Jul 19
Telephone
Line Analyzer, Elenco (HOR) Jan 24
-Line Simulator, Build a (Black)(C) Jan 31
System, Command Your (Holtzman)(CB) Nov 74
-Wiring Tester, Build This (Zguris)(C) Jul 60

Temperature

Alarm, Extch Indoor/Outdoor (HOR) Nov 30
-Controlled Circuits (Yacono)(TT) Jan 28
Ten-Step Timer (Rakes)(CC) Mar 70

TEST EQUIPMENT

25-MHz Frequency Counter (Bolles)(C) Feb 53
Build the
"Galviamp" (Carr)(C) Jul 63
Auto Stethoscope (Hansen)(C) Apr 46
Oscilloscope Calibrator (Hansen)(C) Aug 45

Elenco

FG-500K Function Generator Kit (HOR) May 24
LP-525K Logic-Probe Kit (HOR) Aug 26
Telephone Line Analyzer (HOR) Jan 24

Expanded Resistance Ranges

for Your DMM (Stiles)(C) Dec 64
Frequency Response Tester (Constan)(C) Mar 51
Using a Spectrum Analyzer (Clarke) Oct 62
Workbench Equipment (Yacono)(TT) Aug 28

THD Adapter (Yacono)(TT)

Jul 30

Thermostat Circuit (Yacono)(TT)

Jan 28

THINK TANK (D)(Yacono)

Jan 28, Feb 28, Mar 28

Apr 29, May 29, Jun 29, Jul 30

Aug 28, Sep 28, Oct 72, Nov 76, Dec 74

Feb 28

Oct 72

Apr 29

Nov 76

Mar 28

Jul 30

Dec 74

Jul 29

May 29

Sep 28

Jan 28

Aug 28

Feb 64

Jan 6

Aug 74

Aug 67

Aug 74

Apr 6

Tone Encoder (Rakes)(CC)	Aug 74
Tone Generator (Rakes)(CC)	Aug 74
Touch Control (Rakes)(CC)	Sep 73
Touch Switch (Yacono)(TT)	Sep 28
Track Control Signal (Yacono)(TT)	Mar 28
Traffic-Light Controller (Rakes)(CC)	Jun 76
Transmitter, Poor Man's (Cicon)(C)	Nov 43
Tri-Color Display (Yacono)(TT)	Sep 28
Trident TR-1200 Handheld Scanner (Saxon)(SS)	Apr 80
Tropicmaster Gets an Alignment. The (Ellis)(AR)	Sep 66
Truth About Speaker Cables, The (Hoffman)	Jul 46
Tune-Up Aid (Rakes)(CC)	Apr 68
Tuned Circuits and Resonance (Coxwell)	May 51
Tuning in to GMRS (Saxon)(SS)	Nov 86
Turn-Signal	
Monitor Circuit (Rakes)(CC)	Feb 70
Reminder, Silent Sam (HOR)	Apr 24,(LET)Oct 4
System Motorcycle Circuits (Rakes)(CC)	Apr 68
TV Transmitter, Build a (Spiwak)(C)	Aug 37
TVCR, GE KitchenVision (Scaduto & O'Brian)(G)	Feb 14
Two	
-Function Controller (Rakes)(CC)	Mar 70
-Volt Reference (Rakes)(CC)	Sep 73
-Way Intercom (Rakes)(CC)	Apr 68
U	
Ultrasonic	
Circuits, More (Rakes)(CC)	Jan 71,(LET)Apr 4
Tester (Yacono)(TT)	May 29
Transceiver (Rakes)(CC)	Jan 71
Uniden BearTracker BCT-7 Scanner (Saxon)(SS)	Jul 86
Unisar First Sounds Prenatal Listening Device (Scaduto & O'Brian)(G)	Jun 14
Universal M-400 Decoder (Saxon)(SS)	Sep 62
Up in the Air (Saxon)(SS)	Jul 86
Upgrading and Maintaining Your Personal Computer (Spiwak)	Apr 49,Jun 57,Aug 47
Upgrading Your Personal Computer (Laron)(ED)	Apr 3
Using a Spectrum Analyzer (Clarke)	Oct 62

V	
Vacuum-Tube Audio Amplifier, Build a (Lisle)(C)	Jan 53,(LET)Jun 4
Variometer Radio, Build a (Lisle)(C)	May 55
VCR's, Learn How to Service (Spiwak)	Feb 58
VCR, Samsung VR8905 Hi-Fi (Booth)(PTR)	Dec 32
VersaTimer Programmable Power Scheduler (HOR)	Dec 30
VIDEO	
At Home With	
Home Theater (Scaduto & O'Brian)(G)	Apr 9
Bananas Were Green: The Early Days of Color TV (Rybak)	Jul 55
Build a TV Transmitter (Spiwak)(C)	Aug 37
Digital Vision ComputerEyes.1024	
Video Frame Grabber (Scaduto & O'Brian)(G)	Sep 14
GE KitchenVision TVCR (Scaduto & O'Brian)(G)	Feb 14
Goldstar VH8 8mm VHS Dual-Deck VCR (Scaduto & O'Brian)(G)	Jun 9
Hauptpage Computer Works	
Win TV-Prism (Scaduto & O'Brian)(G)	Sep 9
Learn How to Service VCR's (Spiwak)	Feb 58
Magnavox CDi450 CD-i Multiplayer with Digital Video Cartridge (Scaduto & O'Brian)(G)	Mar 9
NEC Multisync XV17	
Computer Monitor (Booth)(PTR)	Nov 32
Quasar LD510 Laserdisc Player (Scaduto & O'Brian)(G)	Jun 17
Samsung	
4-Head Hi-Fi VCR with StarSight Capability (Scaduto & O'Brian)(G)	Nov 16
VR8905 Hi-Fi VCR with StarSight (Booth)(PTR)	Dec 32
Sharp GZ-P15U Color Video Printer (Scaduto & O'Brian)(G)	Sep 11
Sony CCD-TRV30 Camcorder (Booth)(PTR)	Oct 30
StarSight	
-Capable VCR, Samsung VR8905 (Scaduto & O'Brian)(G)	Nov 16
CB1500 Receiver (Scaduto & O'Brian)(G)	Nov 11
Interactive On-Screen Program Guide (Scaduto & O'Brian)(G)	Nov 9
Samsung VR8905 Hi-Fi VCR with. (Booth)(PTR)	Dec 32
TV Transmitter,	
Build a (Spiwak)(C)	Aug 37
Vidikon Crystal One LCD Projector (Scaduto & O'Brian)(G)	Apr 18

Zenith ZS8000LE Satellite IRD (Scaduto & O'Brian)(G)	Feb 9
Vidikon Crystal One LCD Projector (Scaduto & O'Brian)(G)	Apr 18
Virtual Guitar, A (Spiwak)(MW)	May 6
Vocal Sound-Effects Generator (Williams)(C)	Oct 18
Voice	
from the North, A (Jensen)(DX)	May 74
of Terror, The (Jensen)(DX)	Dec 80
Recording and Playback (Rakes)(CC)	Jul 78
Voices from Beyond (Laron)(ED)	Oct 3
Voltage Regulator (Rakes)(CC)	Dec 77
W	
Walkman Amp (Yacono)(TT)	Oct 72
Warm Up Your Soldering Iron (Laron)(ED)	Sep 4
Watching the Net (Laron)(ED)	Nov 3
Weather	
Computer, Advanced, Heathkit ID-5001 (HOR)	Sep 26
Forecaster, Oregon Scientific BA-213 (Scaduto & O'Brian)(G)	Aug 18
Win/TV-Prism, Hauptpage Computer Works (Scaduto & O'Brian)(G)	Sep 9
WinNET PlusInternet Access Software (Scaduto & O'Brian)(G)	Jul 16
Winter Consumer Electronics Show (Scaduto & O'Brian)(G)	May 9
Workbench Equipment (Yacono)(TT)	Aug 28
World of Information, A (Karagiannis)(NW)	Nov 28
Worth the Wait (Spiwak)(MW)	Ju 24
WWV Receiver, Build a (McKean)(C)	Jan 49
X	
XTree Gold 4.0. Central Point Software (Scaduto & O'Brian)(G)	Jun 8
Z	
Zenith ZS8000LE Satellite IRD (Scaduto & O'Brian)(G)	Feb 9

FACTCARDS

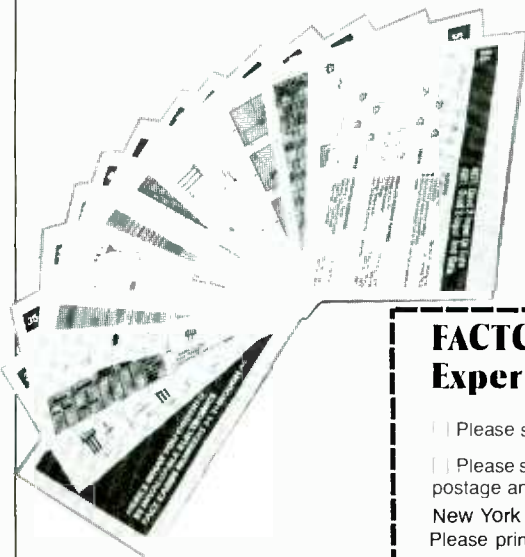

Jampacked with information at your fingertips

■ ALL YOU NEED to know about electronics from transistor packaging to substitution and replacement guides. FACTCARDS numbers 34 through 66 are now available. These beautifully-printed cards measure a full three-by-five inches and are printed in two colors. They cover a wide range of subjects from Triac circuit/replacement guides to flip-flops, Schmitt triggers, Thyristor circuits, Opto-Isolator/Coupler selection and replacement. All are clearly explained with typical circuit applications.

■ WANT TO EXPAND your knowledge of electronics? Do it the easy way

by studying the Electronics Fact Cards. Do you travel to and from your job each day? Drop a handful of cards in your pocket before you leave, and the bus becomes a schoolroom! At home, you can build some of the projects and not only have fun building and using them, but learn how they work at the same time.

■ YOU'LL BE AMAZED both at how rapidly you learn with these cards, and how easy it is to understand. These new cards are available right now. Don't miss out. Send your check or money order today.

FACTCARDS—Facts at your fingertips for Experimenters and Project Builders!

|| Please send one copy of FACTCARDS at \$3.50. Shipping \$1.00 (U.S. and Canada only).
 || Please send _____ copies of FACTCARDS. Total cost is sum of copy price and First Class postage and handling cost multiplied by number of card sets ordered.
 New York residents add sales tax to total cost of each order.
 Please print Allow 6-8 weeks for the material to arrive.

Detach and mail today:
 CLAGGK Inc.
 P.O. Box 4099
 Farmingdale, NY 11735

All Payment must be in U.S. Funds!

(Name) _____
 (Street Address) _____
 (City) _____ (State) _____ (Zip) _____

BS168

ANTIQUE RADIO

By Marc Ellis

The 1930's Ham Receiver: Construction Continues

I hadn't intended for our "1930's Ham Receiver" project to be in work for quite this long. Part of the problem has been my extremely busy summer. Perhaps unwisely, I signed up to give talks at both of the major antique radio meets: Elgin (Antique Radio Club of Illinois) in early August and Rochester (Antique Wireless Association) in early September. Because the two talks were totally different, quite a bit of preparation was required.

"run of the show," except on the last half-day. Many vendors pulled out early rather than trying to cope with the intermittent showers that finally did loom up on the horizon.

The inside activities included the usual feast of interesting talks and exhibits—not to mention those all-important auctions. And, in keeping with the conference theme; "100 Years of Radio," the program for the Grand Banquet included a slide presentation by the charming and distinguished Gioia Marconi Braga—daughter of Guglielmo himself!

COIL CONSTRUCTION

This month's work session began with construction of the coil. The original pictorial diagram of that unit is shown in Fig. 1. Note that the upper portion can be shorted out, via a clip lead, to provide coverage on a second band.

With all coil turns active, the set is designed to cover the 160-meter ham band (indicated as "Band A" on the diagram). With the shorting clip attached at the designated spot, the set tunes to 80 meters (indicated as "Band B" on the diagram).

It was my original intention to redesign that coil so that it would cover 80 and 40 meters, rather than 160 and 80 meters—figuring that there would be more stations to hear that way. Referring to some coil tables, I first checked to see that the 80-meter tap (as originally designed) was in the correct spot.

HISTORY OF THE RECEIVER PROJECT

For those who might be just joining us, this project began in the October 1995 issue—when we discussed the background and theory of a starter ham receiver of the 1930s as recommended by contemporary ARRL (Amateur Radio Relay League) publications. Construction of the two-tube (regenerative detector plus audio amplifier) short-wave set officially began with a parts-scrounging session covered in the following issue.

There was no progress on the set in the next (December, 1995) issue, which was devoted to reader mail. But last month (January, 1996), the front panel and baseboard were assembled and stained, and the front-panel controls were mounted. We also arrived at a layout for the parts to be mounted on the baseboard. Now, let's see what this month brings!

Based on the inductances required for 160- and 80-meter coverage with the 100-pF tuning capacitor used, the 15-turn (above ground) location for the 80-meter tap is in the correct proportional relationship to the 42-turn location of the 160-meter tap. However, using the same methods of calculation, a 40-meter tap would be only four turns above ground on the coil.

I was concerned that a different coil geometry—one requiring many more turns than four to reach 40 meters—might be required for efficient operation on that frequency. It also occurred to me that I might

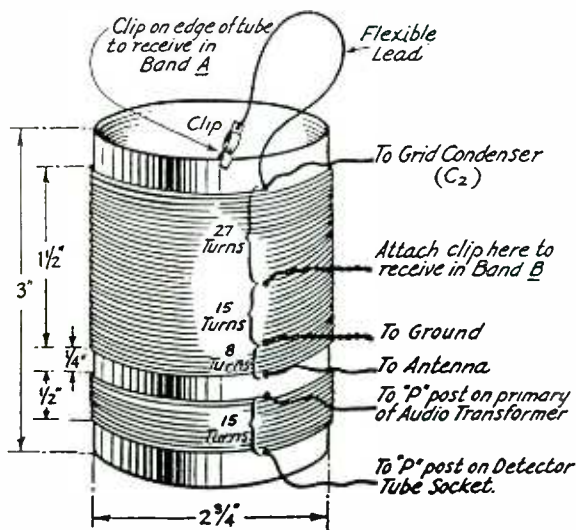

Fig. 1. Here's the pictorial diagram of the coil assembly from the original construction article. See text for the locations of extra "experimental" taps.

I thoroughly enjoyed the experience, but it certainly did limit my project-building time!

By the way, the Rochester meet was not troubled by the rainy weather that put such a damper on the Elgin flea market (see last month's column). For the most part, conditions were clear and sunny—though a bit windy at times. Trading was brisk throughout the

also have to lose some turns from the tickler coil (bottom winding on the diagram) as well as from the antenna-ground section of the coil for proper operation at the higher frequency range.

Not being sure how to arrive at the necessary design in a definitive manner, I decided to wind a 160-/80-meter coil more-or-less as described in the original construction article. That way, I'd be reasonably sure of having a coil that worked. However, I would add *extra* taps—at locations determined by educated guesses—that might make 40-meter operation possible.

If things worked out, I'd have a coil that would permit 160-, 80-, and 40-meter operation. If not, I could ignore the experimental taps and at least be able to receive on 160 and 80 meters as originally intended.

To that end, I placed an extra tap about half-way up from the bottom (7 turns) of the 15-turn tickler. I also placed one half-way between the antenna and ground taps (at four turns up from the antenna tap). I located the last extra tap four turns up from the ground tap, at the location calculated to be correct to tune 40 meters. Using temporary clip leads instead of permanent connections, I'll be able to experiment with different tap configurations to see which (if any) might make it possible to receive on 40 meters.

By the way, for a schematic representation of the original coil, see the October 1995 issue—where you will find the schematic of the complete receiver. However, for some reason, the 80-meter tap ("Band B" on the pictorial diagram) is not shown on the sche-

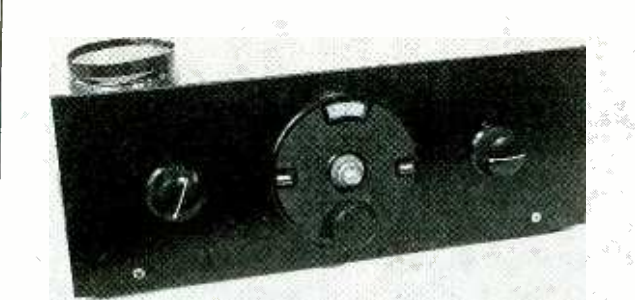

Here's a front view of the receiver with all parts in place. Filament rheostat and regeneration control are at left and right, respectively, of tuning dial.

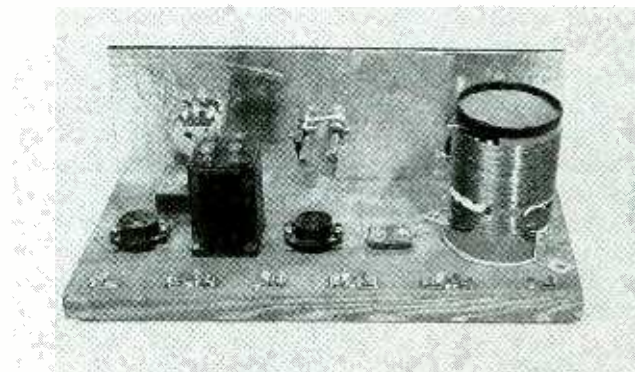

This rear view of the set shows the arrangement of parts on breadboard.

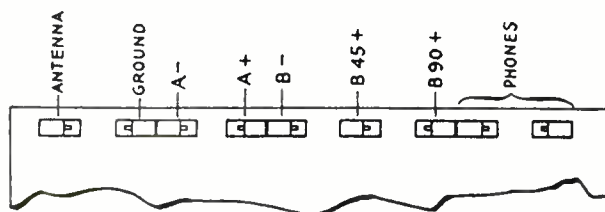

Fig. 2. This is the layout and function of Fahnestock-clip connection points.

matic. Perhaps that extra band was an afterthought.

My version of the coil was wound with some 20-gauge, enamel-covered wire that I had on hand, instead of with the 22-gauge double-cotton-covered (DCC) wire specified in the original construction article. I figured that even though my wire was heavier, its enamel insulation would be thinner than DCC and the resulting coil would be physically quite similar to what was intended.

That did indeed turn out to be the case with the tickler coil, which came out

very close to the 1/2-inch height specified on the diagram. The main coil wasn't too far off either. Specified at 1 1/2 inches, it measured out at about 1 3/4 inches. It'll be quite interesting to see what frequency ranges the coil will actually tune when the receiver is completed.

FIRST AID FOR OLD PARTS

Though I had all of the other parts for the set already in hand, a few of them needed some help before they would be usable. As mentioned in an earlier column, the vintage

1- μ F bypass capacitor tested out at only a fraction of its rated value. But it required only the bending of a couple of tabs to release the connection strip, with its attached capacitor, so that they could be slid out of the case.

The old capacitor was then removed from the strip and a new 1- μ F orange drop installed in its place. That assembly was then slid back into the case and reinstalled.

The standard 15-ohm filament rheostat, which I'm using as a substitute for the exotic "Lynch Equalizer" filament voltage control originally specified, also needed some attention. On the rheostat, contact with the resistance element and wiper arm is made via nut and bolt assemblies that also serve to secure the solder lugs used to make electrical connections to the unit. Both of those assemblies were quite loose, and also quite tarnished.

Removing both nut-and-bolt sets and their associated lugs, I steel-wooled all of the surfaces intended to be in electrical contact with each other or with metal parts in the rheostat itself. The latter were also steel-wooled until they were made bright. Now the unit was reassembled, using a screwdriver and nutdriver to draw up the screws and nuts so that all parts were in firm contact.

A little contact cleaner/lubricant sprayed on the wiper arm and resistance element—followed by vigorous working of the control—completed the job. And while I had the can in my hand, I also sprayed and worked all bearing surfaces in the tuning capacitor to make sure that the moving parts of the very tarnished unit would

(Continued on page 76)

COMPUTER BITS

By Jeff Holtzman

Cleaning Up, Part Two

Last month, I sent out a cry of frustration over DOS's antiquated file system. The frustration arose as part of a project that would: 1) Upgrade a system to Win95, but 2) Simultaneously retain the ability to run Win3.11 and all the 16-bit apps on it. In particular, to support existing clients, I need to run Windows for Workgroups, Microsoft Office Pro 4.3, 16-bit programming tools such as Vi-

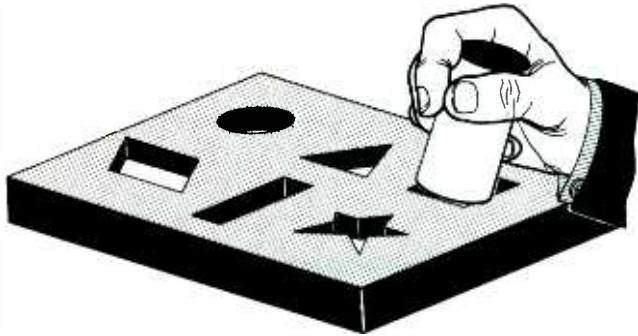

Getting the same set of applications to run under several different operating systems on the same PC can turn out to be as hard as fitting a round peg into a square hole.

sual Basic 3.0 and Visual C + 1.5, and assorted other 16-bit tools and applications. But to support clients who are making the transition to Win95, I also need to run Win95, along with an upgraded complement of productivity and programming tools.

I also have several constraints. For one, due to economics, the purchase of a new machine must wait several months. Second, I don't want to waste time (and disk space) re-installing scads of software so that the necessary tools will work in both environments. Third, I don't want to waste existing resources. Fourth, I would prefer not to use disk compression. And

finally, I would prefer not to add another hard disk.

I started off with a 90%-full, 1-GB hard disk; after housecleaning, I ended up with an 80%-full, 1-GB hard disk. What galled me was that of that 80%, approximately 20% was simply wasted, because of the stupid, brain-dead, idiotic way DOS allocates disk space. Twenty percent might not seem like much, but it translates to 150 MB!

The problem is that the larger the hard disk, the larger the minimum amount of space that can be allocated at once. That minimum chunk is variously known as a cluster or an allocation unit. Cluster size ranges from 2K for 128-MB and smaller drives, to 64K for 4-GB drives.

A 1-GB drive has 16K clusters. So on a 1-GB drive, every file that has fewer than 16,384 bytes will nonetheless swallow up a 16K chunk of disk space. In addition, it's not just small files that are affected. Any file larger than a single cluster can still waste as many as (ClusterSize-1) bytes. For example, a file containing 32,769 (16,384 + 16,384 + 1) bytes requires three clusters. The first two clusters will be full. The last cluster will use one byte and waste the other 16,383. By reducing cluster size, wasted space can be reduced, but maximum drive size must also be reduced.

OPTIONS

In some ways, adding a new disk makes the most sense. All my systems are based on the SCSI standard. On the machine in

question, there are currently three hard drives plus a CD-ROM. In a SCSI system, every device must have a unique ID, ranging from zero to seven. Some time ago, I ran a ribbon cable through the machine. At one end is an eight-position DIP switch. At the other are small female header blocks that plug onto the SCSI ID jumpers. That way, I can change SCSI IDs whenever I need or want to.

In practice, that setup allows me to change the boot drive without opening the case, removing the drives, and reconfiguring the jumpers. In the past, I used that setup to test versions of OS/2, Win95 betas, etc. As far as running different operating systems on one machine, the setup works great. But that does not mean that there have not been problems.

One is that simply shuffling the drives around affects the "bootability" of the drives. For example, the last time I installed a Win95 beta on one of the subsidiary drives, it disabled the ability of the main (Win3.1) drive to boot. A few terrifying minutes with FDISK and SYS restored bootability, but, needless to say, that experience left a rather bad taste in my mouth.

Another problem concerns application programs. The little pests get used to living in one spot (e.g., C:\MSOFFICE\WINWORD), and usually don't take kindly to suddenly being uprooted and plunked down somewhere else (i.e., D:\MSOFFICE\WINWORD). On the other hand, the Uninstall application that was dis-

cussed here last time, Remove-IT, is supposed to be able to help in that type of situation. Hmmm . . .

Another possibility would be to install all the applications on a drive that always appeared at the same drive letter, regardless of which physical drive (and OS) actually booted the machine. For example, if all the apps ran from a drive that always had SCSI ID 1, and the other drives with their different operating systems swapped through SCSI ID 0—that might work.

That might work—but getting a specific drive to appear at a specific letter is trickier than it might first appear. When booting, DOS allocates drive letters according to both physical ID and partition type. Under DOS (and Windows), a hard disk can have as many as four partitions. There are

several types of partitions, including primary partitions, extended partitions, and partitions for other operating systems. Primary partitions are bootable, and are allocated before extended partitions.

Using those capabilities, we might then get all the applications and data into an extended partition on one drive. The extended partition would be allocated after all the physical drives and DOS partitions. So, assuming only the one extended partition, regardless which drive was set as the boot drive, the extended partition would always appear at the same drive letter. Does it really need to be that complicated?

In a similar fashion, we might be able to use disk-compression software to force the apps and data to

appear at specific drive letters. I have used compression on and off for years, typically toward the end of a machine's life, when hardware upgrades are no longer cost effective, but the machine is not really quite ready to be put out to pasture yet either.

I have other concerns as well. Win95 has new, more powerful compression software than previous DOS versions. The new software allows larger compressed drive sizes (2 GB), and better compression. However, using the new features would practically guarantee incompatibility with any other operating system (except Windows NT 3.5 or greater).

Next month, with luck, I hope to have this issue resolved once and for all. I'll let you know how everything turns out. ■



One tree can make
3,000,000 matches.



One match can burn
3,000,000 trees.



A Public Service of This Magazine
© The Advertising Council

NOW Find the Right Part for Your VCR!

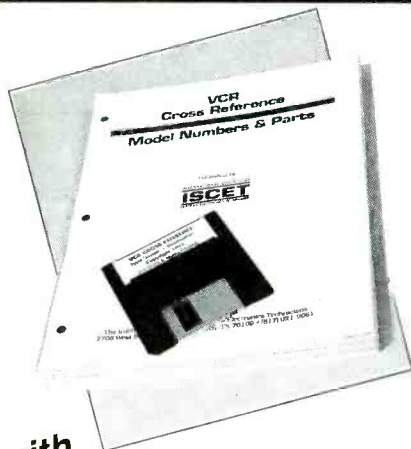

with
the

IS CET VCR CROSS REFERENCE

NEW! The Fifth Edition is contained on a diskette for IBM PC AT/XT compatibles, DOS 2.1 or higher. The disk software allows technicians to search by manufacturer for model numbers and description of part numbers. A parts editing sequence gives an on-screen view of all substitutes for parts entered. With the diskette, the technician can update files by adding model and parts

The 119-page Fifth Edition of the VCR Cross Reference contains both model and part number cross references. Over 1300 new parts and 360 new models have been added.

VCR's are made in a few factories from which hundreds of different brand names and model numbers identify cosmetically-changed identical and near-identical manufactured units. Interchangeable parts are very common. An exact replacement part may be available only a few minutes away from you even though the original brand-name supplier is out of stock. Also, you may be able to cannibalize scrap units at no cost.

crosses of future models. The Fifth Edition can be printed on pages completely from the diskette.

The IS CET VCR Cross Reference, Fifth Edition, is on 8½ × 11-in., pre-punched pages and sell for **\$38.00**. The 3½ inch diskette sells for **\$69.95** and you can view listings from a monitor or printed page.

**Only \$38.00 for pages
\$69.95 diskette**

Clagck Inc.
VCR CROSS REFERENCE OFFER
P.O. Box 4099
Farmingdale, New York 11735

Name _____
Business _____
Address _____
City _____
State _____ Zip _____
Phone _____

Enclosed **\$38.00** for the IS CET VCR Cross Reference, Fifth Edition.

Enclosed **\$69.95** for the diskette containing the IS CET VCR Cross Reference, Ver. 6.0. Please specify:

5¼ Diskettes (2) 3½ Diskette (1)

Include \$3.00 for shipping each Cross Reference (Pages or Diskette)

The total amount of my order is \$ _____

Check enclosed—do not send cash.

Visa MasterCard Exp. Date ____/____/____

Signature _____

New York State residents must add applicable local sales tax to total.

CB03

THINK TANK

By John J. Yacono
Technical Editor
Windows Magazine

Weather Circuits

This month's circuits deal with wind and rain, while the tutorial continues the overview of capacitor types and properties. But first, I'd like to remind everyone about our current contest: send in enough quality circuits to fill a column, and get a kit, a 1967 MCL1010 and a book. Submissions with too few qualifying circuits will be printed one at a time, with the author getting a different book for each circuit printed.

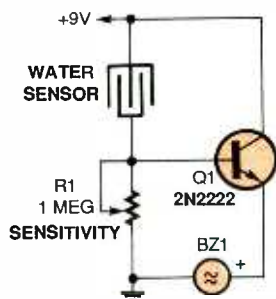

Fig. 1. Don't let rain water destroy your basement. Build this circuit to alert you to flooding, or with some modification, make it start a pump when trouble strikes.

Also, before we get on with this month's tutorial, I'd like to bring up the fact that in a tutorial a couple of months ago, I used the word "electrolytic" in place of the word "dielectric." While electrolytics have dielectric properties, I was speaking of all dielectrics at that point in the series. Thanks to reader Keith Kundane for pointing out the slip up. And now, let's move on.

One old capacitor type that endures today is the paper capacitor, then considered a "film-type" capacitor. Shortly after its

introduction it was improved upon by the addition of oil. The result was a capacitor capable of withstanding high voltages. Thus they are typically used in heavy-duty applications, and sometimes built in large-form factors to store large amounts of charge. Those capacitors make their home in industrial applications.

Another variant, called the "metalized-paper" capacitor, has a zinc or aluminum coating on the paper. The capacitors are also good for high-current, high-voltage use, but the dielectric is prone to breakdown, losing its insulating property if the voltage gets too high too quickly. That makes metalized-paper capacitors poor at handling sudden surges. Those units can be best used in high-current, high-voltage, large-value applications where the conditions are predictable, space is not at a premium, and cost-per-microfarad is an important concern.

Both paper and metalized-paper capacitors are usually made of two long strips of metal foil surrounding a long strip of the dielectric. That "sandwich" is rolled up tightly, and electrodes are added to the plates. The roll is placed in a cylindrical case of metal, plastic, or, less often, paper.

RAIN DETECTOR

This simple circuit (see Fig. 1) can save your house from a water-inundation. Also, it can save your electric equipment from water damage. When rain drops fall on the water sensor, a

small current flows, turning on Q1 and the buzzer. Alternatively, you could replace the buzzer with a relay to drive a pump. The water sensor can be made from an etched circuit board. —

Enrique A. Compan,
Monterrey, N.L. Mexico

Short and sweet. By the way, if you substitute a Darlingtion pair for the single transistor, the circuit becomes a very sensitive touch sensor.

ANEMOMETER

Here's a really simple and inexpensive anemometer I have been using for years (see Fig. 2). You can use any small DC motor for MOT1. Meter M1 can be any milli-amp or microamp meter with markings from 0 to 50 or 100. You can easily find the parts, including the 1000-ohm, 15-turn potentiometer, at Radio Shack and other hobbyist sources.

A three-paddle wheel for the motor can be made with golf-ball-sized "wiffle" balls. Cut two of them in half, and bolt three of the halves to a PVC hub, using 6-32 machine screws. Calibrate the circuit by holding it out of a car window while someone drives steadily be-

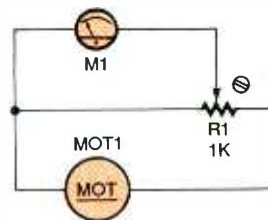

Fig. 2. Perhaps the world's simplest anemometer, you'll spend more time working on the wind cups than the circuit. A trip in a car is needed to calibrate the unit, however.

tween 20 and 30 miles per hour on a still day. —

Lawrence Fiedler, Garden Grove, CA

Thanks; the circuit's so simple that the mechanics are the only real job. Placing the motor in an enclosed and water-proofed container is necessary for protection against the rain.

ADVANCED WATER DETECTOR

I've looked through several years of electronics magazines for articles about detecting the presence or absence of water, but I have never seen mention of two ICs specifically designed to detect water: the LM1830 and ULN2429. They sell for under \$2.00 a piece, are very easy to use, and have at least one very distinct feature: the probes receive a very small oscillating (AC) signal. That is preferable to using a DC signal, which would electroplate the probes.

I have included a circuit that I've been using on my boat since 1983 to detect and pump out the bilge (see Fig. 3). The heart of the circuit is the LM1830 fluid detector. It contains all the circuitry needed to sense fluid levels and activate an external device (relay, etc.). The IC generates an AC signal that is passed through two probes in the fluid. The IC's detector circuit senses the presence or absence of fluid by comparing the resistance between the probes with its internal reference resistance. When the probes detect the presence of water, the LM1830 will trigger Q1, and that in turn will trigger IC2 (an LM555), which starts a timing period. The output from pin 3 of IC2 closes the relay and the bilge pump is activated for the duration of the timing period. The tim-

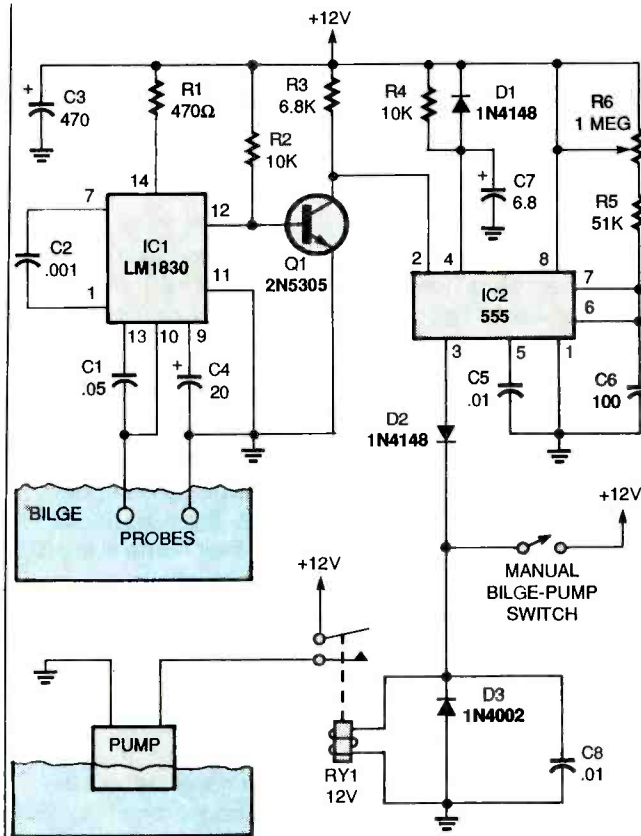

Fig. 3. Useful for chronic basement flooding or a boat bilge, this circuit detects the presence of water and activates a pump.

ing period is adjustable, using R6, a 1-megohm potentiometer. For the values shown, and depending on the setting of R6, the timing period is about 5–120 seconds. Components R4, D1, and C7 are tied to pin 4 of IC2 to hold the timer at reset when power is first applied.

A few notes on the circuit's use: Mount the probes at about 1/3 the total height of bilge. The probes should be cleaned periodically. Although my circuit hasn't failed in eight years, I would advise the use of a manual bilge-pump switch as an alternate means for operating the pump. The circuit draws about 12 mA in stand-by mode.

The advantage of using the type of bilge-pump switch I've described here is that most bilge pumps use a float-type switch, which will cycle the pump on and

off due to the sloshing action of the water in the bilge. My application will keep the pump on and eliminate the cycling of the pump. —

Dick Foster, Middleburg Heights, OH

Well, you're certainly using the right chips for the right job. Something worth considering is using the manual switch as a bypass for the relay contacts, instead of activating the relay with it. That way, if on a fluke the relay refuses to work properly, the manual switch can still save the day.

WIND VANE

I have a rather complete hobbyist machine shop as well as a pretty good electronics bench and so was able to come up with a digital weathervane. The tedious part of this project was building a suitable transducer that was

weatherproof and could be mounted on the roof.

To make the weathervane, I needed a 360° variable resistance that could be controlled by a wind vane attached to the shaft of the resistance element. I solved that by etching a disk composed of 36 segments (like pie slices). All but one of the gaps between the slices is bridged by a 22,000-ohm resistor to form the stator of a giant variable resistor. The slices across the one unbridged gap are the clockwise and counter clockwise terminals. I made a housing of two 2-inch, PVC-pipe caps threaded into each other, installed bushings, a shaft (a threaded rod), a wiper, a moisture shield, etc. and mounted it on a 1/2-inch galvanized pipe that could easily be installed on my rooftop.

Now let's look at the circuit (see Fig. 4). There, IC1-a and IC1-b form an astable oscillator in which IC1-a produces a positive pulse-width proportional to the resistance of the segmented potentiometer, R1. The negative pulse width, determined by IC1-b, is fixed. The third section, IC1-c, is triggered by the falling edge of IC1-b. Its pulse width is set by potentiometer R7 so that it is exactly equal to the width of the IC1-a's pulse when the vane is at zero resistance. Potentiometer R8 and IC1-d make up the frequency-reference.

An astable oscillator formed out of IC1-d and its surrounding components provide a clock signal to IC2, a 555 timer IC. The reset pulse from IC1-c starts the count at zero, and the latch pulse from IC1-a freezes the instantaneous reading in the timer. So U2 counts for the time be-

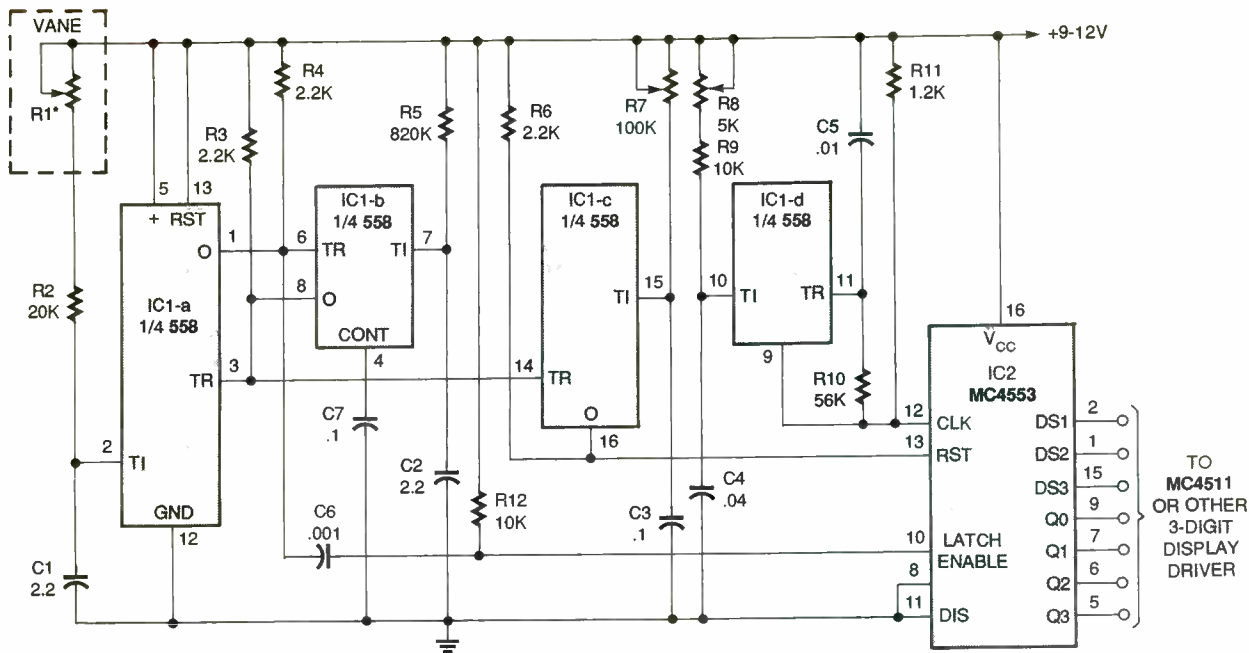

Fig. 4. The electronic weather vane relies on a home-brew transducer and a latching counter to display wind direction.

tween the falling edge of IC1-a and the falling edge of IC1-c, which is determined by the position of the vane. The timer can feed its digital output to the 3-digit display circuit of your choosing (such as an MC4511 display driver).

To adjust the circuit, rotate R1 (the transducer) to its zero-resistance position (North) and adjust R7 until the readout is zero. Second, rotate R1 to its maximum resistance position and ad-

just R8 until the readout is 350. That will give, theoretically, readings between zero and 350 in 10-degree increments as the vane is rotated.

Some people don't understand the concept of a digital readout in degrees magnetic because they are more familiar with N, S, E, W etc. But, I have found that once they understand that the wind direction is always given for the direction from which the wind is blowing

and that there are 360° in a full circle, with 0° being N, 90° as E, 180° as S, and 270° as W, they accept it readily.

The circuit could be adapted to form an antenna rotator indicator. Or it can be used almost anywhere rotational motion or position is measured. —

Sidney E. Buck,
Key Largo, FL

That's a very interesting circuit. The concept behind your design could be used to test the output of RC

receivers. The readout could display the degrees of rotation the receiver should move a servo when provided an RF signal.

That wraps up another month. Until next time, be sure to submit your work to **Think Tank, Popular Electronics**, 500 Bi-County Blvd., Farmingdale, NY 11735. If you send in enough circuits, you could have a whole column dedicated to your work as well as a kit, an MCL1010, and a book. ■

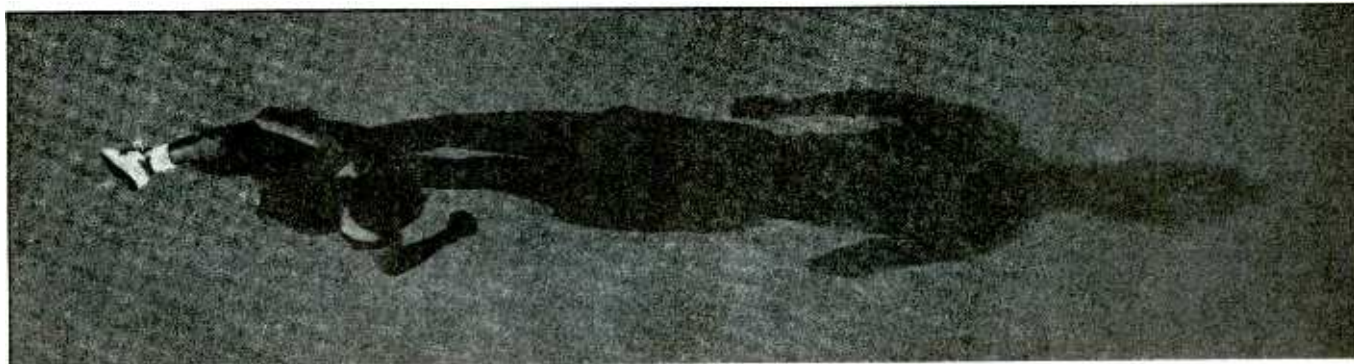

SEE WHAT TAKES SHAPE. EXERCISE.

American Heart Association 

© 1992, American Heart Association

DX LISTENING

By Don Jensen

Watch your Intervals



Cuba's Radio Rebelde, noted after 0100 UTC on 5,025 kHz, is a great source for hot Latin rhythms.

The easiest way to identify a shortwave station, naturally, is to listen to the announcements, at least if the programs are in English. But it's not the only way. SWLs also can tell what they're tuning by noting their individual and unique tuning or "interval signals."

That brings us to a question from DX-Listening reader Robert Farley of Portsmouth, VA:

ated as IS by shortwave listeners—are unique identifiers. They could be a few bars of melody, horns, drumbeats, chimes, or electronic tones. One southern African station even uses a brief recorded segment of barnyard sounds, including cows mooing and roosters crowing, as its IS.

An interval signal can be heard before a station's sign on or preceding each scheduled transmission. It might be heard between programs at "station-break" times. Each broadcaster's IS is unique and can help you identify the station even when it is programming in an unknown language.

The *Voice of America*, for example, uses the musical signature, "Yankee Doodle" as its interval signal. South Africa's external service, *Channel Africa*, features the call of a native bird, the *Bokmakierie*, combined with a few bars of a folk melody played on the guitar.

Vatican Radio uses a segment of church melody, "Christus Vincit," played on the bell-like celeste, with orchestra. Also using a celeste IS, though the tune is an old Dutch folk song, is *Radio Nederland*.

Transmissions from *Radio Portugal* begin and end with a gong time signal and the national anthem, "A Portuguesa." And on the *British Broadcasting Corporation's* World Service you'll hear its famed Bow Bells IS before the start of programs each hour.

The list of shortwave interval signals is long and varied. Make note of them. They might help you identify

a station when it's not broadcasting in English.

MORE MAIL

"I read an item in a European shortwave-club bulletin," writes a reader, "about a clandestine shortwave station that supposedly is run on coconut oil. Don't use my name, please. I don't want to seem gullible if this is just some sort of hoax."

I saw the same item, Ms. "A. Nonymous." It referred to the broadcasts of *Radio Free Bougainville*. As WW2-vintage ex-Marines know, Bougainville is a tropical Pacific isle, the scene of bloody fighting back in 1943. Now, more than a half-century later, again there's trouble in paradise.

For several years, the world's least-known civil war has been waged between separatist islanders and the government of Papua New Guinea, of which Bougainville is a remote part. The dissidents, indeed, have established their own makeshift clandestine shortwave station that broadcasts their views.

Radio Free Bougainville is on the air on 3,850 kHz around 0900 to 1100 UTC. Though feeble at best, its signal has been heard in the U.S. on a few rare occasions.

The rest of the story, though, I can't confirm. A French source reports that the SW transmitter is powered by a coconut-oil-fueled generator. Supposedly it takes the oil of 40 coconuts per hour of broadcasting. I'm even more dubious about the further claim that PNG sol-

"When listening to the RAI, the Italian Radio and Television service broadcasting from Rome, I've noted bird chirping at the start of the transmission. Is that what is known as an interval signal?"

Yes, indeed, Rome has used a distinctive bird call IS for as long as I can recall.

Interval signals—abbrevi-

diers have executed four people caught harvesting coconuts for the station.

THE LAW AND YOU

Back in the chilliest days of the Cold War Era, some SWLs worried if they would get in trouble by monitoring and sending reception reports to Communist stations like Radio Moscow and Radio Peking. The answer, of course, was no. SWLing ordinary shortwave programming, no matter its country of origin was, and is, perfectly legal. But in this day of scanners and cordless telephones, the general issue of monitoring radio signals is a bit more complex.

Art Sanchez, Miami, FL, offers this tip: "A friend of mine belongs to one of the SWL clubs and showed me a copy of the ANARC Guide to U.S. Monitoring Laws written by Frank Terranella. Since I also have a scanner as well as a SW receiver, I found it interesting and helpful. Maybe others will also."

Good suggestion, Art. ANARC stands for the Association of North American Radio Clubs, the umbrella organization linking most of the major listening clubs in the United States and Canada. Terranella, ANARC's legal counsel, has written this 39-page guide through the Electronic Communications Privacy Act (ECPA) of 1986, which covers the legal aspects of monitoring and scanning.

It's available for \$7.50 from ANARC, 2216 Burkey

Drive, Wyomissing, PA 19610.

ON THE ROAD AGAIN

"I commute to work," writes B.C. Eckert, Fayetteville, NC, "about 50 minutes each way. As an avid SWL, I hate to waste this time. I'd prefer listening to, say, a BBC news broadcast rather than the same old 'same-old' on my AM car radio. I've tried using my SW portable but it doesn't bring in much in the car. Any suggestions?"

I think your answer is to install a converter, B.C. One manufacturer, MFJ Enterprises, has a neat little unit, the MFJ-306 World Band Mobile Shortwave Converter, for under \$80. It's a small box, about the size of an index card and just an inch-and-a-half deep, that installs between your car radio and its antenna. It covers the popular SW bands, 49, 31, 25, and 19 meters, converting those signals for reception on the car radio's AM band.

You probably should not expect performance to equal your SW receiver at home. And because you're using your car radio's tuning, you might have to guess a bit at the SW frequencies. But a converter should provide decent reception of the major international broadcasters you want to hear as you drive to and from work. For more information, you can contact MFJ Enterprises, P.O. Box 494, Mississippi State, MS 39762, or call 601-323-5869.

Another alternative, if you are comfortable with a soldering iron, is to build the single-band converter described in "Build a Shortwave Converter for your Car" in the September 1995 issue of **Popular Electronics**.

Your suggestions and comments about SWLing

are always welcome. The address is DX Listening,

Popular Electronics, 500 Bi-County Blvd., Farmingdale, NY 11735.

DOWN THE DIAL

February is usually a great month for DXing, particularly on the lower SW frequencies. Here are some targets to keep you tuning. Times are listed in 24-hour Universal Coordinated Time (UTC).

ALGERIA—15,160 kHz. *Radio Algiers International* is now heard on this frequency, in English, from 1800 to 1900, and 2000 to 2100 UTC.

AUSTRALIA—17,750 kHz. *Radio Australia* from Melbourne is on this frequency, and simulcast on three or four other channels, in English at 0300 UTC.

BOSNIA-HERCEGOVINA—7,108 kHz. *Radio Bosnia-Herzegovina* has been heard at 0200 UTC with a 5-pip

time signal, station identification, and folk music.

COLOMBIA—5,075 kHz. *CARACOL Bogota* has been noted around 0800 UTC with a late-night music program and taped Spanish announcements.

CUBA—5,025 kHz. *Radio Rebelde* noted after 0100 UTC with an excellent program of salsa music.

INDONESIA—9,535 kHz. *Radio Republik Indonesia*, broadcasting in Indonesian, is logged on this frequency at 1030 UTC with western popular music, then interval signal, identification, and the 1100-UTC news from the capital, Jakarta.

MOROCCO—17,595 kHz. *Radio Morocco's* English programming is audible on Sundays when Radio Cairo signs off at 1432 UTC.

YUGOSLAVIA—11,870 kHz. *Radio Yugoslavia* from Belgrade airs an hour-long English program starting at 0400 UTC. ■

*CREDITS: Brian Alexander, PA; Skip Campisi, NJ; Bruce Conti, NH; Mark Humenyk, ONT; Marie Lamb, NY; William McGuire, MD; Denis Pasqual, PA; Ed Rausch, NJ; North American SW Association, 45 Wildflower Road, Levittown, PA 19057.

ATTENTION!
ELECTRONICS
TECHNICIANS



EARN YOUR
B.S.E.E.
DEGREE

THROUGH HOME STUDY

Our Highly Effective Advanced-Placement Program for experienced Electronic Technicians grants credit for previous Schooling and Professional Experience, and can greatly reduce the time required to complete the program and reach graduation. No residence schooling required for qualified Electronic Technicians. Through our Special Program you can pull all of the loose ends of your electronics background together and earn your B.S.E.E. Degree. Upgrade your status and pay to the engineering level. Advance rapidly! Many finish in 12 months or less! Students and graduates in all 50 states and throughout the world! Established Over 50 Years! Write or call for free Descriptive Literature. (601) 371-1351

COOK'S INSTITUTE
OF ELECTRONICS ENGINEERING

CI 4251 CYPRESS DRIVE
JACKSON, MISSISSIPPI 39212

CIRCLE 179 ON FREE INFORMATION CARD

HAM RADIO

By Joseph J. Carr, K4IPV

Some Ham-Radio Accessories

There are a number of devices that a ham can use to enhance his or her hobby, dress up the shack, or use in the workshop. Over the decades that I've been hamming, my shack and workshop have accumulated a lot of different things . . . some useful, some very useful, and some that make me wish I'd saved my money. This month, let's look at some ham accessories that I consider essential, or at least very useful.



An antenna-resistance bridge like this one can make it easier to check the performance of your antenna.

ANTENNA-RESISTANCE BRIDGE

Hams use antennas, and antennas sometimes need adjusting, troubleshooting, or fixing. There are a

number of ways to adjust an antenna, but in the main, the resonant frequency is changed by changing the length of the radiating elements. And how do you know when the correct length is found? There are several different approaches, but the two main methods involve measuring the VSWR or feedpoint impedance (especially the resistive component of impedance). The VSWR approach is usually taken care of for most hams because most of us own at least one RF power meter or VSWR meter, even if it is only the one built into our rig.

The other approach is to measure the feedpoint impedance using a device known as an antenna-impedance meter or an antenna-resistance bridge. At resonance, most antennas offer a resistive impedance that will have a low value (e.g. 3 to 37 ohms for a vertical, or 75 ohms for a correctly installed dipole). On a dipole, for example, the impedance will vary from the minimum of 75 ohms at resonance, to several-thousand ohms at frequencies that are very removed from resonance.

If you use an antenna-resistance bridge you can find the resonant point by varying the frequency until the dip in resistance is found. Some models have a built-in signal generator. Others use a digital frequency readout, and a resistance readout. At least one new model graphs the VSWR over a 500-kHz range.

An antenna-resistance bridge can be used to find

out a whole lot about an antenna that either doesn't work as intended when it is installed, or that has suddenly stopped working correctly (indicated perhaps by a sudden increase in VSWR).

ANTENNA COAXIAL SWITCH

Many hams use two or more antennas at their station; for example, a multi-band trap vertical and either a horizontal dipole or some kind of directional beam antenna. Switching between them can be a problem if you have to stretch behind the rig and unscrew coaxial connectors one-by-one. In other cases, hams might connect an antenna to the rig to operate, and a 50-ohm dummy load to either test the rig, or to find the correct settings for an antenna-tuning unit. Again, the problem of switch-over presents itself.

Ordinary switches don't work well at radio frequencies, and most will not handle either the voltages or the power levels typically found in amateur-radio transmitters. A regular switch, even if it can withstand the power/voltage problem, will interrupt the impedance of the system causing a VSWR problem. The answer is to use a coaxial switch. Those switches are specially designed to withstand high power and voltage levels, and present as constant an impedance as possible to the rig. I own about five simple two-antenna switches, and one that is an eight-antenna model. Those switches are distributed be-



Step attenuators have many applications including calibrating a receiver's S-meter, comparing two signal levels, or reducing the signal level to a receiver to prevent overload and a host of other ills.

tween my station and workshop. I need several antennas because I develop circuits, receivers, and test antennas for this column and my other writing . . . the switches make it a lot easier.

One use for an antenna switch is to make comparisons between antennas. Getting a handle on things like gain and directivity are difficult for the amateur, but it is quite easy to make comparisons by observing distant signals using both antennas. Switching between the two antennas will provide some measure of their relative effectiveness.

PRECISION STEP ATTENUATOR

An attenuator is a circuit or device that reduces the level of a signal by a certain amount. Proper attenuators for use in RF circuits have input and output impedances of 50 ohms (except for TV, in which case 75 ohms is the standard), and reduce the signal by a fixed, precise amount.

Attenuators can be used for quite a lot of different applications. For example, calibrating a receiver's S-meter; comparing two signal levels; or reducing the signal level to a receiver to prevent overload, intermodulation distortion, or a host of other ills.

They can also be used to provide precision levels from relatively cheap signal generators. Normally, such generators are roughly calibrated, at best. But if you know the signal level at some standard output-level setting, then you can reduce that level with precision using a step attenuator.



If you work on AC-powered circuits, an isolation transformer like this one is a necessary accessory for your workbench.

One step attenuator that I am familiar with uses eight different attenuator stages, each of which can be either in or out of the circuit, depending on the switch setting. The ranges of that particular attenuator are: 1, 2, 3, 5, 10, and 20 dB (three 20 dB stages are provided); that's more than 80 dB of attenuation with a 1-dB minimum step.

Note: in RF circuits it is common to use the power level to represent signal lev-

els. The unit is the dBm, which is power dB (10 LOG (P1/P2)), relative to 1 milliwatt dissipated in a 50-ohm load. If you know the dBm level at the input of the attenuator, then it is relatively easy to calculate the output level in dBm. But to find the dBm level at the input you might have to measure the voltage level with an RF voltmeter or an oscilloscope.

Most low-cost meters/scopes will measure the peak or peak-to-peak value of the voltage, but to calculate the power level you need the rms value. Divide the peak value by 1.414, or the peak-to-peak by 2.828, in order to find the rms voltage. The power level in milliwatts (mW) is found from $V^2/50$, when V is in millivolts, or $(V^2 \times$

$1000)/50$ when V is in volts. If you can only measure the voltage, then the signal level in dBm is found from either:

$$\text{dBm} = 10 \log ((V^2/50)/0.001)$$

when V is in volts, or:

$$\text{dBm} = 10 \log (V/50)$$

ISOLATION TRANSFORMER

In my opinion, an isola-

tion transformer is one of the most necessary accessories on a ham or any other electronics workbench. Safety is an essential issue when working on electronics circuits. The 117-volt AC power line can be a real killer! And some hams also use 220 VAC for high-power linear amplifiers, and that is even deadlier. On my workbench I always use an isolation transformer for the greatest possible safety.

The reason for that is that the power system in this country is grounded. That is, the power transformer feeding your house has a center-tapped secondary that is grounded, and two hot lines carrying 117-volts each (out of phase with each other), which is distributed to the circuits in your house. If you accidentally touch one of those 117-volt hot lines while grounded, you will complete a circuit and the result will be a serious, and potentially lethal, shock.

That's where an isolation transformer comes in. That unit is a 1:1 ratio transformer for 117 VAC-to-117 VAC conversions, and 2:1 for 220 VAC-to-117 VAC conversions. The isolation transformer lifts the ground connection, making a "floating" electrical system for the workbench. Instead of a hot wire and a neutral, the 117 VAC is obtained from a pair of floating lines from the unit's 117-VAC secondary. That is a much safer set up.

That's all for this month. I can be contacted at P.O. Box 1099, Falls Church, VA, 22041, or by e-mail at carrij@aol.com. The e-mail address is new, and readers are encouraged to use it for suggestions, questions, comments, and criticisms. I will endeavor to answer questions, but please keep them reasonable! ■

SCANNER SCENE

By Marc Saxon

Disaster Scanning



Radio Shack's PRO-2040 is more than just another pretty face—the versatile desktop scanner offers 100 memory channels, two scanning speeds, and three search speeds.

Scanners keep getting better looking with each new model, and *Radio Shack's PRO-2040* desktop is an eye-catching example. Forget about decorative styling to fit unobtrusively into your room—this one has the macho look that the gutsy PRO-2040 deserves.

The PRO-2040 gives you 100 memory channels set up in 10 bands of 10 channels each. An additional 10 monitor memories allow you to temporarily store worthwhile frequencies discovered during band searches. Frequency coverage is 29–54 MHz, 137–174 MHz, 406–512 MHz, 806–956 MHz, and the 108–136-MHz aeronautics band. The cellular bands

are permanently locked out and cannot be restored internally. There is a direct-access key to the NOAA weather band.

This unit has several versatile features, such as allowing the user to select from two scanning speeds, either 12 channels per second or 73 channels per second. There are no less than three selectable search speeds—50 channels per second, 100 channels per second, and (in 5-kHz steps) 300 channels per second. A data-skip feature allows the unit to ignore data signals (such as pager tones) during searches. You can even select up to 50 specific channels for the scanner to skip during a search so that you can avoid unwanted frequencies.

The IF frequencies are 10.8 MHz and 450 MHz. Selectivity at -6 dB is ± 11 kHz, and at -50 dB it is ± 15 kHz. Sensitivity is rated at 0.5 μ V below 54 MHz and between 406 and 512 MHz; it's rated at 0.7 μ V from 137 to 174 MHz, and 1.0 μ V above 806 MHz.

Power requirements are 117 VAC. The stored channels will remain in the scanner's memory for up to three days during a power loss.

Take a look at the PRO-2040 at your local Radio Shack store. It's a rather interesting new addition to the scanner market.

DOOMSDAY SCANNING

Sophisticated and extensive contingency

arrangements exist for the emergency operation of our government in the event of certain disasters or crises that make it risky, unsafe, or somehow impossible to conduct the government from existing facilities. You might imagine that enemy attack, or the imminent threat of one, could temporarily create such a situation. So could natural disasters, as well as some other major events.

At such times, your scanner would be humming with a myriad of communications. Let's hope that never happens. But, remember, those systems and the staffs that operate them must be maintained at a level of instant readiness. That means that the communications associated with those systems can be monitored at almost any time, and numerous active frequencies have been reported by scanner owners. They're worthy of keeping on tap.

The Federal Emergency Management Agency (FEMA) plays an important role in the government's contingency-operations planning. The agency has dozens of frequencies, but nationally, the following seem to be among the more important ones in the VHF-FM range: 138.225, 141.725, 166.225, 168.35, 169.60, 169.875, and 170.20 MHz.

The National Emergency Airborne Command Post (NEACP) is an E-4B aircraft outfitted as a "Doomsday Plane." At a time of threat

or attack, the craft can serve as a flying headquarters for governmental and military leaders. There are extensive communication facilities aboard.

The NEACP facility most often reported by scanner owners has been the one classified as *Nightwatch*. It is a duplex air/ground link that sometimes uses WFM mode. Much of the traffic has been sent in clear voice, although data transmissions have been noted as well. It has also been monitored with wide-band (± 50 -kHz) Frequency Division Multiplex containing AM, LSB, and USB voice traffic.

The downlink frequencies for NEACP's *Nightwatch* are: 246.95, 305.55, 322.75, 326.0, 336.8, 345.5, 366.0, 382.35, 390.0, and 397.05 MHz. Several different VIP ("SAM") military aircraft, as well as FEMA stations, have been reported, in addition to Air Force One.

The Joint Emergency Evacuation Plan (JEEP) is a FEMA operation. Under that plan, in the event of an emergency, threat, or attack, certain government and military personnel would be evacuated by helicopter from Washington, D.C. to support sites in Maryland, Virginia, and Pennsylvania that have been reserved for that purpose.

JEEP's primary frequency is 293.5 MHz, while the secondary is 287.6 MHz; 268.0 MHz is also used. JEEP's code name is "Wheelhouse."

By the way, FEMA's Urban Search and Rescue Task Force Teams operate in several dozen cities coast-to-coast. They swing into action in the aftermath of hurricanes, earthquakes, tornadoes, floods, and other major disasters. Although they work in

conjunction with local and state agencies, the teams have their own special frequencies. Among them are 163.10, 164.8625, 165.6625, 168.35, 408.40, 408.5125, 409.4875, 410.4875, 410.5125, 413.2125, 416.0375, 416.8125, 416.9375, 417.5875, 417.6625, 418.05, 418.075, and 418.575 MHz.

WHITHER 220 MHZ?

A few years ago, the FCC accused the ham radio service of underusing its 220- to 225-MHz frequency band. That resulted in the 220- to 222-MHz portion of the ham band being reallocated for other uses so that the chunk of spectrum could attain increased usage. It was a hollow gesture. Today, if you scan from 220 to 222 MHz, you will notice that those frequencies are very quiet. The FCC recently has been working overtime to pump life into them. That's good news for scanner owners.

The FCC foresees the band as primarily used for public-safety radio, emergency medical services, and subscriber-based services such as paging and dispatching.

JOIN IN

For those of you who continue to request the names of worthwhile scanner organizations, here are two whose monthly membership publications brim over with news and frequencies. The Radio Communications Monitoring Association, Inc. can be reached at P.O. Box 542, Silverado, CA 92676. A one-year membership is \$24 (\$30 in Canada). A one-year subscription to "The Radio Monitors Newsletter of Maryland" (P.O. Box 394, Hampstead, MD 21074-0394) costs \$15. A sample issue is \$1. ■

This could be a best seller.

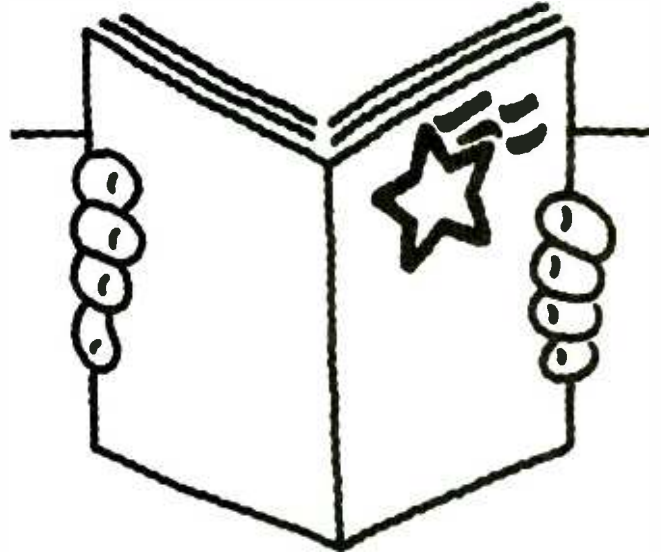

But it's free.

You can't buy the Consumer Information Catalog anywhere. But you can send for it, free! It's your guide to more than 200 free or low-cost government publications about getting federal benefits, finding jobs, staying healthy, buying a home, educating your children, saving and investing, and more.

Send today for your latest free Consumer Information Catalog. The Catalog is free. The information is priceless.

Send your name and address to:

**Consumer Information Center
Department BEST
Pueblo, Colorado 81009**

ANTIQUE RADIO

(Continued from page 64)

make good electrical contact.

Those cleaning and polishing activities might seem quite simplistic to you. And, indeed, they're hardly rocket science. Yet one can't underestimate the importance of housekeeping when dealing with antique parts and/or sets. A very large percentage of problems with simple battery sets of that kind comes from poor electrical contact caused by loose and dirty connections.

As long as I had the tuning capacitor and filament rheostat off of the front panel, I also removed the last remaining control (the regeneration control) and unscrewed the panel from the baseboard. I'd been dissatisfied with the

appearance of that panel, which had been simply treated with varnish stain. Now I could go ahead and spray it with gloss enamel as originally planned.

After receiving several coats, the panel's appearance resembled that of the Bakelite or hard rubber material that would probably have been originally used. I like it much better now.

FINAL PARTS ASSEMBLY

Reinstalling the front panel and front-panel controls, I arranged the baseboard-mounted components pretty much as shown in the original ARRL photograph (see October 1995 issue) and fastened them in place with wood screws. The coil assembly was screwed down using a pair of hardware-store angle irons attached to the coil

form with machine screws and nuts.

The nine Fahnestock clips required for connections to antenna, ground, power, and headset were screwed down along the rear edge of the baseboard as specified in the original construction article (see Fig. 2). Note that pairs of clips that connect to the same circuit point (i.e. Ground and A-, A+ and B-, +B90 and phones) are mounted back-to-back under the same screw.

That's about all of the work I had time for this month, but the set is now ready to wire up and test. Hopefully, I'll be able to report on that next time.

Until then, I'd enjoy hearing from you. Send your comments and questions to me c/o *Antique Radio*, **Popular Electronics**, 500 Bi-County Blvd., Farmingdale, NY 11735. ■



“Whenever tax season rolls around I feel like _____ing, because I know the IRS offers so many ways to help me.”

Free booklets and forms, a volunteer assistance network (VITA), and recorded telephone tax tips. With all these ways the IRS helps people with their taxes, you think people would think of the IRS as a big ol' fuzzy teddy bear. Well, maybe that's a bit optimistic. But really, call 1-800-TAX-1040 if you need any help.



A public service message

CIRCUIT CIRCUS

(Continued from page 28)

bone's output level is set by R4.

A slide handle made of plastic or wood should be attached to the slider of R3, and the complete circuit enclosed in a small plastic cabinet with the three pushbutton switches, S1-S3, mounted in a convenient location for playing. The actual arrangement is up to you, but if you use your imagination, you could create a masterpiece.

Making irritating noise with the electronic trombone is easy. Just press one or more of the tone-control switches, S1-S3, and work the slide.

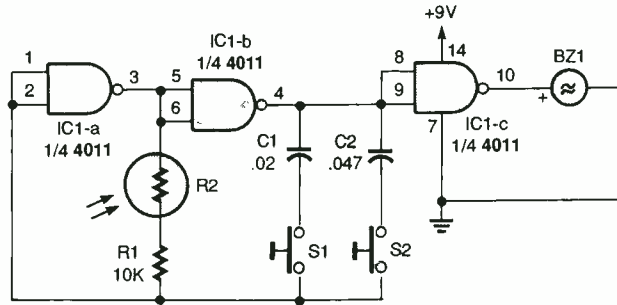

Fig. 6. Point the photocell, R2, at a light source and this circuit will produce a tone; wave it around, and it will produce a melody.

Fig. 6, is easy to use: Just aim the wand at a light source and listen to the tone; move it around and you could create a melody.

Two gates, IC1-a and IC1-b, of a quad two-input NAND gate are connected in a audio-oscillator circuit with R1; the photocell, R2; C1; and C2 setting the tone

BZ1. When the photocell is aimed at a light source, its resistance drops and the oscillator's output tone increases in frequency. When either of tone switches S1 or S2 is pressed, the frequency range goes up. Pressing S2 shifts the oscillator into its highest frequency range. Only one tone switch may

be pressed at a time; if both switches are pressed simultaneously, the output stops.

Building the magic wand is an easy evening project. The complete circuit, with the exception of the photocell, could be built on perboard and housed in a small plastic case. A 3- to 5-inch length of opaque plastic tubing, just large enough in diameter for the photocell to slide in, will serve as the wand. Place the photocell in one end of the tube, facing out the full length of the tube. Make the back of the tube light proof and seal it with silicon rubber.

Looks like that's enough racket for one visit. Happy New Years to one and all. ■

PARTS LIST FOR THE ELECTRONIC TROMBONE (Fig. 5)

RESISTORS

(All fixed resistors are 1/4-watt, 5% units.)

- R1—10,000-ohm
- R2—2200-ohm
- R3—100,000-ohm, slide potentiometer
- R4—2500-ohm, potentiometer

CAPACITORS

- C1—0.02- μ F, Mylar or similar
- C2—0.05- μ F, Mylar or similar
- C3, C4—0.1- μ F, Mylar or similar
- C5, C6—100- μ F, 35-WVDC, electrolytic

ADDITIONAL PARTS AND MATERIALS

- IC1—4011 quad NAND gate, integrated circuit
- IC2—386 audio power amp, integrated circuit
- S1-S3—SPST normally-open pushbutton switch
- S4—SPST toggle switch
- SPKR1—8-ohm speaker
- Perfboard, case, handle for R3 slider (see text), wire, solder, etc.

PARTS LIST FOR THE MAGIC WAND (Fig. 6)

- IC1—4011 quad NAND gate, integrated circuit
- R1—10,000-ohm, 1/4-watt, 5% resistor
- R2—Photoconductive cell, Mouser #338-54C679 or similar
- C1—0.02- μ F, Mylar or similar capacitor
- C2—0.047- μ F, Mylar or similar capacitor
- S1, S2—SPST normally closed pushbutton switch
- BZ1—Small piezo speaker
- Perfboard, plastic tubing, case, wire, solder, hardware, etc.

A MAGIC WAND

Our next noise producer is a light-activated magic wand. The circuit, shown in

frequency. A third gate of IC1, IC1-c, acts as a buffer to the oscillator and a driver for a small piezo speaker,



Coil Design and Construction Manual

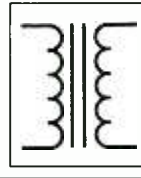

YOU CAN WIND YOUR OWN COILS?

There's no trick to it except knowing what you are doing. In a unique, 106-page book you can become expert in winding RF, IF, audio and power coils, chokes and transformers. Practically every type of coil is discussed and necessary calculations are given

with the mathematical data simplified for use by anyone. Get your copy today!

Mail coupon to:

Electronics Technology Today, Inc.
P.O. Box 240 • Massapequa Park, NY 11762-0240

Please send me my copy of *Coil Design and Construction Manual* (BP160). I enclose a check or money order for \$8.45 to cover the book's cost and shipping-and-handling expenses. NY state residents must add local sales tax.

Name _____

Address _____

City _____ State _____ ZIP _____

All orders must be paid in U.S. funds only. Sorry, no orders accepted outside of USA and Canada. Please allow 6-8 weeks for delivery.

DC VOLT PROBE

(Continued from page 34)

While the arrangement of components on perfboard is not critical, a few common-sense guidelines should be followed. For example, begin assembly on your board by mounting the 11 LEDs. You can use the drawing of the prototype shown in Fig. 2 to get an idea of how those should be arranged. Next mount switches S1 and S2 flush to the edge and centered on the board, spaced about a half-inch apart.

Before going any further with circuit-board assembly, drill clearance holes for the switches and LEDs. Drill 1/8-inch holes for the latter, so that you can accommodate the T1 LED cases. Once you're sure the switches and LEDs match up with their drilled holes, you can go on with assembly.

Install sockets for IC1 and IC2 on the board. Then mount the resistors and capacitors, fitting the board occasionally into the case to check for clearance. In the author's prototype, R2, the 40-megohm resistor, was assembled from four 10-megohm resistors connected in series. Also, for R3, the 50-megohm resistor, the author used five 10-megohm resistors connected in series. You might want to cover them with heat-shrink tubing before installing them onto the board, just in case one of the leads causes a short with another component.

Attach a short lead to the circuit for the "touch-plate" connection indicated in Fig. 1. Drop a 0.1-inch-diameter \times 1/4-inch-long compression spring on the lead, and solder the joint.

Notice that the rear side of the Kelvin case has a depression in it. That's where you will install the touch plate. But first, drill a clearance hole in that depression so that the compression-spring lead protrudes through when the halves are assembled. Then cut a 3/4- \times 3 3/4-inch piece of aluminum "flashing" with shears and use silicone sealant to affix it in the depression. The touch plate must cover the spring hole.

Next, install the N-type battery holder in the front half of the case near the probe tip. Mount power-switch S3 at the rear of the case with its leads running at the side up to the battery holder. Install the ICs in their sockets,

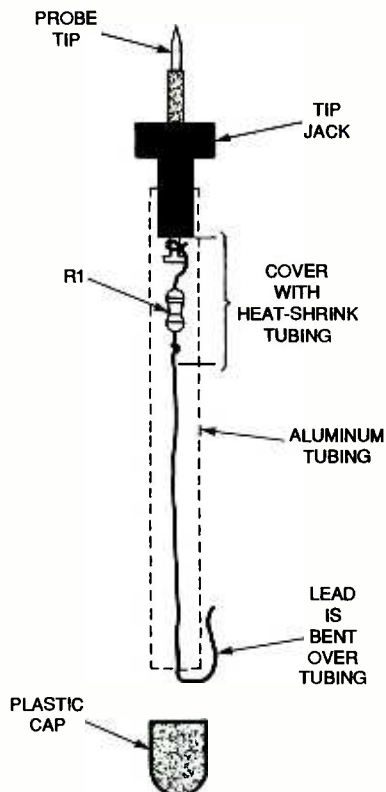

Fig. 3. This is how the passive probe is assembled. Note that the wire lead is bent over the end of the tube and covered with a plastic cap to establish an electrical connection.

connect the power leads and a lead to the probe tip, and install the batteries. Turn on the power and adjust potentiometer R9 for a reading of 1.0 volt at pin 6 of IC2 (use a DMM to determine that). Finally, mount the board and secure it.

With the active probe complete, you can begin assembling the passive probe. Solder one end of R1, the 10-megohm resistor, to an insulated "tip" jack (see Fig. 3) and extend the other lead with a 5-inch length of 24-gauge wire. Cover the joints and R1 with heat-shrink tubing, then slide the assembly into a 5-inch length of thin-wall, 1/4-inch-diameter, aluminum tubing. Press the jack into the end of the tube; you might have to sand down the threads on the jack for a nice fit.

Next, wrap the protruding lead from R1 around the end of the tube and secure it with a plastic cap. Make a probe tip from 0.08-inch (2-mm) diameter steel (a nail will work) and insert it into the jack. That completes your passive probe.

Checkout and Use. Turn on the

power and LED1, the zero-volt indicator, should light up. Grasp the active probe so that your fingers rest on the touch plate, and grasp the passive probe with your other hand. Apply the probe tips to a 1.5-volt cell and note that LED1 and LED2 are lit. Pushing in S1 will give you a negative tip polarity. If you find the unit doesn't work as described, double-check your wiring.

Apply the probes to a 9-volt battery and note the sequential lighting of the display until LED1 through LED10 are lit. Then push in S2 for a \times 10 scale, apply the probes to two series-connected, 9-volt batteries, and note that LED1, LED2, and possibly LED3 are lit. Over-voltage will not harm either scale, but please heed the warnings already given! ■

SUPER SURPLUS SOURCES

(Continued from page 52)

U.S. Army Military History Institute: Technical manuals for obsolete military radio equipment could be obtained from the U.S. Army Military History Institute. In some cases, if duplicates are on hand, you can photocopy manuals or borrow them.

Universal Radio, Inc.: The firm publishes a 100+ page communications catalog that features about a dozen books that offer guidance on classic radio repair and restoration, radio collectibles, servicing, and related topics. The catalog is free.

W7FG Vintage Manuals: W7FG provides manuals and also offers repair and restoration work for most vintage to present-day radio gear. A list is available for an SASE.

Western Nebraska Electronics: This firm reportedly offers a complete collection of Collins manuals as well as a good selection of parts for Collins communications equipment.

Conclusion. Radio, electronic, and computer surplus—who says you can't find it in the 1990s? As we've seen, there are a number of sources out there for both surplus and the documentation that goes with it. We hope that this guide to available surplus helps you out in your search for the right part or piece of equipment. Good bargain hunting! ■

ELECTRONICS LIBRARY

Danny Goodman's Windows 95 Handbook

by Danny Goodman

Designed to be as colorful and appealing as Windows 95 itself, this book features four-color, two-page spreads that are accessible and easy to navigate. Each spread includes a Windows 95-like menu bar that shows the section, chapter, and page number; and color-coded information that separately addresses the concerns of new, average, and advanced users. Within the text, cross references set in bold face to resemble hypertext link topics through the book. Illustrations and screen shots show how Windows 95 actually looks, and icons and mini-screens provide detailed close-ups of screen elements. Highlighted words help users quickly locate the information they need.

The book is divided into four color-coded sections: Hardware, Software, Troubleshooting, and Glossary/Index. All aspects of

using Windows 95 are covered, including installation and setup, file management with the Desktop and Windows Explorer, optimizing memory and hard-disk space, using shortcuts to access frequently used documents, installing hardware and software easily using Wizards, and using and mixing applications efficiently. The glossary and index are combined to help users find fast answers to their questions.

Danny Goodman's Windows 95 Handbook costs \$30 and is published by Random House Electronic Publishing, division of Random House, Inc., 201 East 50th Street, New York, NY 10022; Tel. 410-848-1900, ext. 3000; on CompuServe: GO RANDOM.

CIRCLE 101 ON FREE INFORMATION CARD

THE FCC RULE BOOK Complete Guide to the FCC Regulations Governing Amateur Radio

edited by Norm Bliss, WA1CCQ

The 10th Edition of this handy reference has been revised and updated to include all of the exciting changes in Amateur Radio rules and regulations. It covers changes in licensing, describing the six separate classes of Amateur Radio licenses now available—Technician Plus is now a separate class—and providing all the details you need on the first new Club Station licenses to be issued since 1979. The book also explains how you can begin operating with your new privileges as soon as they are granted by the FCC, *before* you receive your actual license in the mail. Other new rules include "vanity call signs," allowing hams to request their own call signs; and the approval of automatic digital operation in

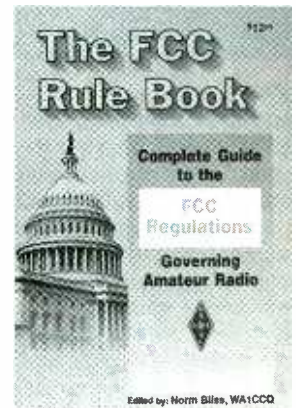

certain parts of the HF bands.

As in previous editions, this book contains the complete text of the rules and regulations, along with easy-to-understand explanations of Part 97. Appendices have also been expanded with the addition of more original material, and now include the FCC's Internet addresses as well as fax and BBS numbers.

The FCC Rule Book, 10th Edition costs \$12 and is published by The American Radio Relay League, 225 Main Street, Newington, CT 06111; Tel. 203-666-1541; Fax: 203-665-7531.

CIRCLE 102 ON FREE INFORMATION CARD

C AND UNIX: Tools for Software Design

by Marten L. Barrett and Clifford H. Wagner

This book shows readers how to combine the efficiency of C with the productivity of UNIX to create more powerful computer programs. It is written for experienced programmers, as well as those with a background in mathematics, engineering, and science.

The book introduces five principles to guide readers through a complete course in programming. First, an emphasis on

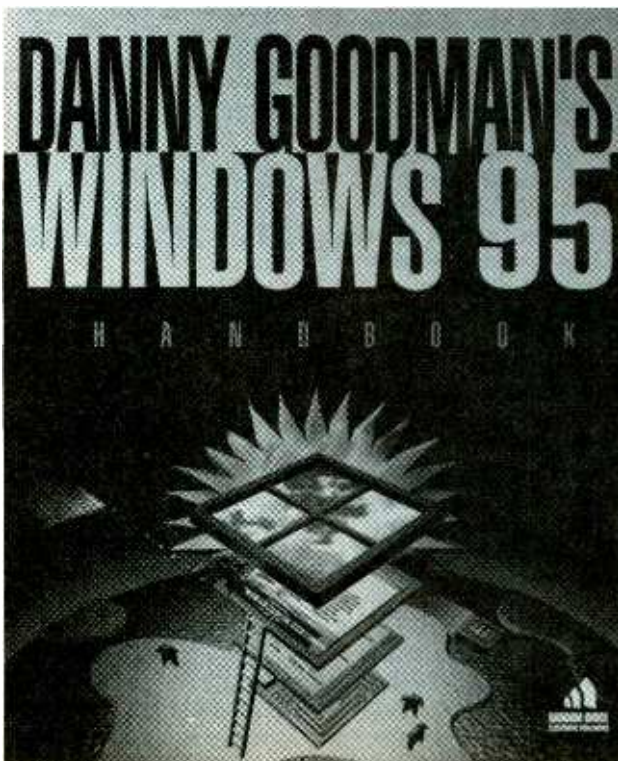

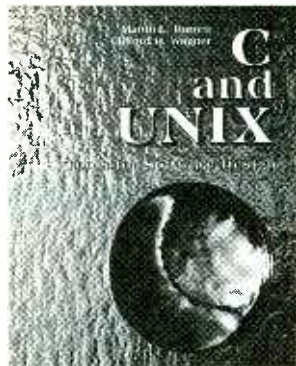

software design via program and data structure design, the design of tables, data encapsulation, and the use of abstract data types solidifies all aspects of the design process. Second, the development of C and UNIX simultaneously, yet independently of one another, allows designers to develop skills in both languages, or focus on them individually. Chapter summaries, review problems, and many practical programming problems allow readers to tie several different concepts together in a coherent scheme. A focus on basic principles provides the groundwork for understanding data structures, analysis of algorithms, numerical analysis, computer graphics, and compiler design.

Finally, extensive examples covering scientific problems, applied mathematics, and floating-point arithmetic broaden the spectrum of computer science and programming. Problems feature the ideal gas law, the accuracy of summations, root finding, the future value of an annuity, simulation, time series smoothing, image processing, integrals, descriptive statistics, fuzzy sets, and sparse arrays.

C and UNIX: Tools for Software Design costs \$46.95 and is published by John Wiley & Sons, Inc., 605 Third Avenue, New York, NY 10158-0012; Tel. 800-CALL-WILEY.

CIRCLE 103 ON FREE INFORMATION CARD

ELECTRONIC TESTING AND PROTOTYPING EQUIPMENT CATALOG

from *Global Specialties*

This 45-page catalog features dozens of high-quality electronic testing instruments, prototyping equipment, and sol-

derless breadboarding products. Product categories include power supplies, generators, counters, powered breadboards, project kits, breadboarding accessories, meters, logic-analysis equipment, benchtop and portable enclosures, and data-acquisition cards. Each product offering is accompanied by a photograph, complete specifications, and description of its features. Instrument-selection guides make it easier for users to choose the right power supply, generator, or counter.

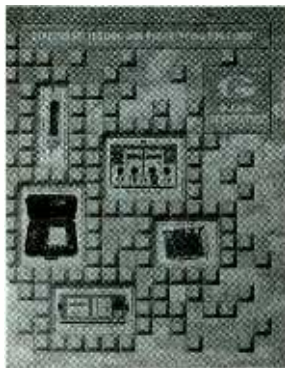

The Electronic Testing and Prototyping Equipment Catalog is free upon request from *Global Specialties*, 70 Fulton Terrace, New Haven, CT 06512; Tel. 800-572-1028; Fax: 203-468-0060.

CIRCLE 104 ON FREE INFORMATION CARD

NET TECH: Your Guide to Tech Support, Product News, and Software Resources on the Info Highway

by Kelly Maloni, Ben Greenman, and Jeff Hearn

As you might expect, the biggest topic of interest on the Internet is computers, and this book maps the wealth of online computer information and support resources. It helps you find the right online technical staff to solve your problems. It puts you in touch with fellow brand-name users. It helps you find people who can solve your "unsolvable" computer problems. And it directs you to valuable, free software resources. More than 3500 computer-related Web sites, chat areas, and software and file archives, are listed and described.



Net Tech shows readers how to find computer magazines, industry gossip, product introductions, help forums, and the latest software, online. It covers Windows 95, multimedia, shopping, and more. It helps readers avoid waiting on hold for telephone help by pointing the way to online support for virtually every PC, modem, printer, and software manufacturer.

Readers seeking specific information can look for it in the book's index, where every subject and site in the book is listed alphabetically. Otherwise, they can browse through the book's six sections. "Booting Up" is a collection of cross-platform sites, from online computer primers to online computer stores. "The Big Two" lists and describes hundreds of sites with resources for Apple and IBM hardware and software, while "The Rest of the Field" covers other platforms and operating systems. "A Small Matter" is devoted to online resources for microcomputers: portables, PDAs, palmtops, and calculators. A variety of applications, including word processors, spreadsheets, and desktop publishing, are covered in "PC Power." "Creativity in Cyberspace" includes sections on graphics, sound, multimedia, and hypermedia. "The Cutting Edge" highlights the latest news in computing, and "Getting Wired" offers the basics of Internet connection and navigation. Every entry includes a name, description, and address, with updates available instantly online.

Net Tech costs \$19 and is co-published by Michael Wolff & Company, Inc., 1633 Broadway, 27th Floor, New York, NY 10019, Tel. 212-841-1572, e-mail: editors@ypn.com; and Random

House Electronic Publishing, a division of Random House, Inc., 201 East 50th Street, New York, NY 10022, Tel. 800-793-BOOK.

CIRCLE 105 ON FREE INFORMATION CARD

OPERATIONAL AMPLIFIER CIRCUITS: Analysis and Design

by John C.C. Nelson

This book provides the non-specialist with the tools needed to make use of readily available, integrated-circuit operational amplifiers for a broad range of applications. The widespread availability of op-amps in the form of low-cost ICs makes possible a modular approach to analog electronic circuit design. In many cases, a single op-amp, in conjunction with a small number of passive components, might be all that is required to perform a particular function. Interconnection of several such subsystems allows the required configuration to be assembled with a minimum of design effort.



Because the book uses a simple, consistent notation throughout its pages, the only background required is that of basic circuit analysis. A range of computer programs illustrate the text, providing rapid determination of component values and assistance in designing circuits for practical applications.

Operational Amplifier Circuits: Analysis and Design costs \$22.95 and is published by Butterworth-Heinemann, 313 Washington Street, Newton, MA 02158-1626; Tel. 617-928-2500; Fax: 617-933-6333.

CIRCLE 106 ON FREE INFORMATION CARD

Market Center TM

Paperback Books

GREAT BOOKS AT BUDGET PRICES

100 RADIO HOOKUPS
—#7—\$3.00

First published in May, 1923 this popular booklet went into reprint editions nine times. It is packed with circuits, theory, antenna installation and tips on consumer radio receivers that were popular in the early 1920's. Antique radio buffs and those inquisitive about the early days of radio will find this booklet an exciting, invaluable and excellent reference into the minds of early-day radio listeners. Sorry, we cannot honor the original 25-cent cover price.

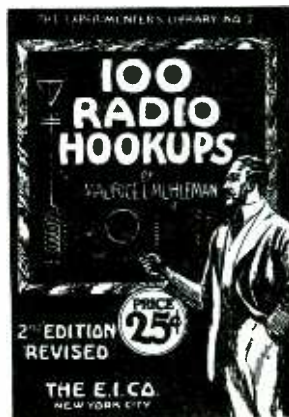

INTERNATIONAL RADIO STATIONS GUIDE—BP255
—\$9.95

Provides the casual listener, amateur radio DXer and the professional radio monitor with an essential reference work designed as a guide for listening to the complex radio bands. Includes coverage on Listening to Shortwave Radio, ITU Country Codes, Worldwide Radio Stations, European Long Wave and Medium Wave Stations, Broadcasts in English and more.



HOW TO USE OP AMPS
—BP88—\$5.95

The engineer's best friend is the op amp. This basic building block is found in many circuits, analog and digital alike. The op amp finds many useful purposes such as: oscillators, inverters, isolators, high- and low-filters, notch and band-pass filters, noise generator, power supplies, audio, MIDI, and much more. Prepared as a designer's guide, some limited math is used, however engineers and hobbyists alike find it a useful text for their design needs.



WIRELESS & ELECTRICAL CYCLOPEDIA
—ETT1—\$5.75

A slice of history. This early electronics catalog was issued in 1918. It consists of 176 pages that document the early history of electricity, radio and electronics. It was the "bible" of the electrical experimenter of the period. Take a look at history and see how far we have come. And by the way, don't try to order any of the radio parts and receivers shown, it's very unlikely that it will be available.

ELECTRONIC TECHNOLOGY TODAY INC.
P.O. BOX 240, Massapequa, NY 11762-0240

Name _____
Address _____
City _____ State _____ Zip _____

SHIPPING CHARGES IN USA AND CANADA

\$0.01 to \$5.00\$2.00
\$5.01 to \$10.00\$3.00
\$10.01 to \$20.00\$4.00
\$20.01 to \$30.00\$5.00
\$30.01 to \$40.00\$6.00
\$40.01 to \$50.00\$7.00
\$50.01 and above\$8.50

SORRY No orders accepted outside of USA & Canada

Number of books ordered

Total price of merchandise \$ _____
Shipping (see chart) \$ _____
Subtotal \$ _____
Sales Tax (NYS only) \$ _____
Total Enclosed \$ _____

All payments must be in U.S. funds!

ET01

New and Pre-Owned Test Equipment

Substantial **SAVINGS** on New & Pre-Owned B+K Precision, Fluke, Hewlett-Packard, Goldstar, Leader, Tektronix, and more ...

LG Precision New Oscilloscope Specials

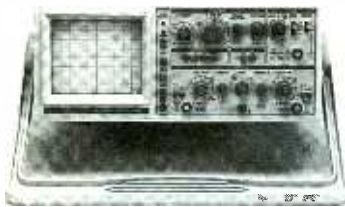

FREE SHIPPING!
ON ALL LG PRECISION EQUIPMENT
ANYWHERE IN THE U.S.
Excluding AK & HI

Model OS-9100P → **\$999.00**

Full 100 MHz Bandwidth! **SUPER SALE!**

- Dual-Channel, High Sensitivity
- TV Synchronization Trigger
- Calibrated Delayed Sweep
- Includes Two Probes, 2 Year Warranty

Professional Quality Digital Storage Oscilloscopes at Affordable Prices!

- Transmit and Receive Data with Standard RS-232C Interface
- Includes FREE Comprehensive Communication Software
- Waveform Save, Calculation, and Print
- Dual Channel, Delayed Sweep, TV Synchronization Trigger
- 20 MS/s Sampling Rate, Two Save Memories
- Switch Between Analog and Digital Modes
- CRT Readout Including Measurement Cursors

Bandwidth	20 MHz	40 MHz	60 MHz
Model	OS-3020	OS-3040	OS-3060
SALE Price	\$1,199.00	\$1,599.00	\$1,899.00

Pre-Owned Oscilloscope Specials

Tektronix 465	100 MHz	\$589.00
Tektronix 465B	100 MHz	\$689.00
Tektronix 475	200 MHz	\$749.00
Tektronix 475A	250 MHz	\$849.00

- Professionally Refurbished
- Calibrated to Original Specifications
- Dual Channel, Calibrated Delayed Sweep
- 90 Day Warranty



Professional Computer Monitor Pattern Generator

Model 1280 \$429.00 **NEW!**

- Tests CGA, EGA, VGA, SVGA, and MAC II Monitors
- Outputs Interface to DB 9, HD 15, DB 15 and BNC
- Interlaced or Non-Interlaced
- Color Bars, Raster, and Crosshatch Patterns

20 MHz Sweep/Function Generator

Model 4040 \$499.00 **NEW!**

- 0.2 Hz to 20 MHz, 5 digit LED Display
- AM & FM Internal or External Modulation
- Sine, Square, Triangle, TTL, CMOS Outputs
- Burst Operation
- External 30 MHz Frequency Counter

Don't Leave Your Computer Unprotected!

Fairstone Uninterruptible Power System..... Reliable Blackout, Brownout, Spike and Surge Protection.

VA Rating	500	600	750
Model	P500	P600	P750
SALE Price	\$239.00	\$269.00	\$329.00

- Sleek Good Looks and Small Footprint Design
 - Cold Start Function, LCD Status Display
- Automatic Monitoring and Shutdown Software for Windows with cable Only \$79.00

Full line of Oscilloscopes, RF, Video & Audio Test Equipment,
Power Supplies, Meters, Probes and Accessories.



TOLL FREE 1-800-99-METER

1-800-996-3837

Availability of Equipment Subject to Prior Sale
Prices Subject to Change Without Notice

FOTRONIC
CORPORATION
P.O. BOX 708
Medford, MA 02155
(617) 665-1400
FAX (617) 665-0780

DALBANI

the ultimate saving source

For over then ten years, **DALBANI CORP.** was, and still the ultimate saving source . **DALBANI CORP.** is a national and International distributor of quality electronic parts and components servicing the wholesale, retail and manufacturing industry.

Since finding the parts you need should not be a major task, **DALBANI CORP.** maintains a huge stock of the most popular parts that are hard to find. Our service, low prices and quality reflects our commitments to our customers.

DALBANI CORP. keeps customers informed of the latest new items, that gets to our warehouse, thru publications. The multilingual sales dept. coupled with the state of the art computerized order processing, enable us to offer prompt and efficient service to benefit the customer.

We, offer many shipping options. Company checks, COD's, Cash and major credit cards are accepted. There is a \$20.00 minimum order.

We meet our customer needs



For a free 192 catalog please call
TOLL FREE 1-800-DALBANI



Oscilloscopes



**Digital
Multimeter**

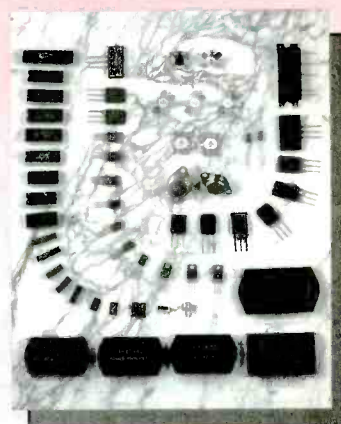

**Large Line Of
Semiconductors**



VCR Heads Replacements



**Soldering
Equipments and Tools**



4225 NW 72nd. Miami, Florida 33166

Telephone : (305) 716-1016 or Fax : (305) 594-6588

Business Hours : monday thru Friday 9:00 am to 7:00 pm eastern time

CIRCLE 167 ON FREE INFORMATION CARD

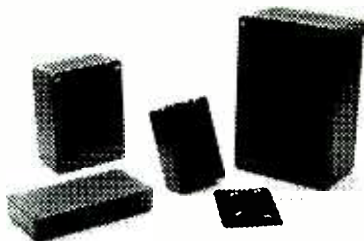

PLASTIC SPEEDY BOXES

Slotted walls to accept PCBs. ABS black plastic. Screws included. Will not crack or split when drilled or punched.

PB114A (1" x 3" x 2")	\$2.20
PB114B (0.8" x 4.25" x 2.188")	2.50
PB114C (1.563" x 3.875" x 2.938")	3.00
PB114D (2.313" x 5.875" x 3.938")	5.00

5 1/4" DISKETTE BOX

Holds up to 100 5 1/4" disks or CD-ROMs in antistatic box with security lock and key, and built-in handle for easy carrying. Materials made of 3mm plastic.

DS510 \$4.95 each

RECYCLED HARD DRIVES

Seagate ST-225 - 20MB, MFM, 5 1/4", half-height.
94C033 \$19.95 each

Quantum Q540 - 36 Meg MFM, 5 1/4" full-height.
94C025 \$29.95 each

SUPERPRO II PROGRAMMER

40-pin universal programmer for PALs, GALs, FLASH, E(E)PROMs, and Microcontrollers. 24/28/32/40 pin E(E)PROMs, CMOS EPROMs and FLASH EPROMs, 1M 2M 4M & 8Mbit. Bipolar PROMs. PAL, EPLD, EEPLD, GAL, MACH, MAX, PEEL, FPGA, IFL, FPL, etc. Microcontrollers from Atmel, Hitachi, Intel 87nn, Microchip PIC, Motorola, NEC, NSC, Signetics 87Cnnn. WSI, Zilog, etc. Also functions as an IC tester for CMOS/TTL Logic and DIP DRAM/SRAM. Device updates available via BBS or mail. Wide range of adapters available for DIP, PGA, PLCC, SOIC, QFP, SOP, etc.

95Z018 \$ 449.00

ECOHEAT™ HEAT GUN

economical, lightweight, multi-use heat gun with 2 heat settings (500° and 1000°F), 3-position slide switch, built-in hand guard, 3-wire grounded cord, thermo-plastic case. UL listed, 120VAC.
EC-100 \$32.95 each



MINI CLAMP-ON TABLE VISE

This handy little gem will clamp onto tables and benches up to 1" thick. Two screw holes are provided so it can be permanently attached. The jaws are 1 1/4" wide and will clamp workpieces up to 1" thick.

843MV \$8.75 each

FM WIRELESS MIKE KIT

Powerful two-stage, wireless mike kit transmits over half mile (up to 1Km in the open). Tunable to the upper part of FM broadcast band. Circuit requires the ability to tweak RF circuits by stretching or compressing coils. With mike and 9V battery clip. Operates from 6-12VDC. 2.75" x 0.625" x 0.5". Sold for educational purposes only.

Kit 32 \$10.95 each

SHAPE-MEMORY LINEAR ACTUATOR

This actuator incorporates a helical spring made of a nickel-titanium alloy that enables the actuator to perform a unique set of electromechanical functions. Activated by either temperature or electricity, it provides linear actuation in minimal space without gears or converters, and exerts one-pound force throughout its stroke. Shape-memory actuation starts and stops gently, minimizing vibration. There are no magnetic materials, and the unit is resistant to corrosion, jams and overloads. Applications include robotics, doors, valves, toys, shutters, security devices, and manipulators. Spec sheets included.

Nominal Specifications: Operating voltage: 1V, 5A Electrical resistance: 0.2 Ohms. Pull in cycle: 2 sec. Relax cycle: 8 sec. Max. cycle rate: 6 cpm. De-energized length: 100mm. Energized length: 75mm. Diameter: 9mm. Stroke: 20mm. Self-activating temperature: 165°F

95T001 \$7.95 each

TV DEMODULATOR BOARD

Takes channel 3, 4 or 5 signal and demodulates the audio. Comes with info and schematics, and additional schematics to build add-on video demodulator board.

92A028 \$14.95 each

Send \$2.00 U.S. (\$4.00 foreign) for our new catalog. Refundable on first order.

LASER POINTER

This solid-state laser emits a red light up to 5mW at 670nm that will produce a spot on objects up to 100 ft. away. Use as a pointer/instructional aide, tease your cat, or use as a sight for your peashooter. Buy two so you and a friend can have lightsaber battles on foggy nights. Runs on two AAA cells and comes in a hard, protective case. Batteries included.
94L007 \$49.95 each

MINIATURE C-BAND LNB

Low-noise block converter. Better than 40°K noise temperature. Spec sheet included.
94G001 \$49.95 each

MULTIMEDIA SPEAKERS

8 Ohms impedance without amplification. Baffled box for better bass. Frequency response ±6dB, 120 Hz to 14 KHz. Use two in parallel for sound enhancement. Applications include multimedia (plugs into internal PC speaker jack), ham radio (visor mount), etc. Measures only 3 1/2" x 4 1/2" x 1 1/2".
95V017 \$1.00 each

BRIDGE RECTIFIER

300V @ 1A. Mopar P/N PBDF103. Large quantities available.
93S029 45¢ each - 25 for \$9.95

STEPPER MOTOR DRIVER IC

UCN5804-B. Drives a unipolar stepper in one of three operating modes: single phase, two phase or half step. Up to 12.5 Amps per phase. Step and direction input. Drive with a 555 oscillator, parallel port, etc. Build your own robot turntable for model trains, anything that requires precision positioning.

93I002 \$4.50 each

• Above, packaged with 5V stepper motor (92M010) and schematics.

93I003 \$9.95 each

HANDI-VAC®

This tool is a must for servicing surface mount boards. Vacuum is used to lift and hold components during assembly or replacement. The vacuum bulb is treated with Staticide, the probes are metal, and the vacuum cups are electrically conductive to prevent charge generation. The Handi-Vac® comes with four vacuum cups and probes.
HV-Kit \$9.95

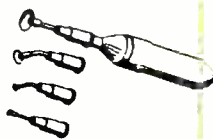

VISA, MC, Amex cards accepted. Prices good for 60 days from date of publication. California residents add sales tax. Shipping additional on all orders.

ALLTRONICS

2300 Zanker Road - San Jose, CA 95131
(408) 943-9773 - Fax (408) 943-9776

On-Line Ordering
(408) 943-0622

14400 Baud • N-8-1 • 24 Hrs.

Catalog by E-Mail:
info@alltronics.com



CIRCLE 27 ON FREE INFORMATION CARD

Robot Kits Kits Kits!!!

Sonic Rover Robot #3-174 \$27.95

A great, low-priced kit. Runs forward until it bumps object or hears loud noise, reverses, turns 90° & resumes. Molded body, red/green LED, great 48 page manual. Requires soldering. *An excellent first robot.* Two AA NiCads INCLUDED!



IR Light Sensing Robot #3-216 \$68.95

Clever infrared sensors system lets this robot wander around & avoids objects - even solve mazes! Dual motors, rubber tires, preassembled gears & circuit board. *No Soldering Required!* Three AA NiCads INCLUDED!



Wall Hugging Mouse Robot #3-215 \$29.95

Classic robot design escapes mazes using the "Left Hand Rule". Two motors & sensing switch guide it along walls and around corners. Preassembled gear box, plastic base & body. *No Soldering Required!* One C NiCad INCLUDED!



Cats watch out!

Mobile Robots Brains & Brawn Kit #3-148 \$489.00

Serious research robot platform from MIT. Develop programs in C or assembly. Includes 68HC11 CPU, memory, sensors, wheels, motors, chassis, software. Companion to Mobile Robots book (3-098). *NOTE: Indicate PC or Mac Interface.*

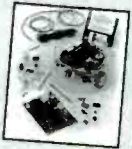

Accessory Kits!

Power Shovel/Dozer #3-211 \$39.95

An excellent full function robot base! Wire controlled left, right, forward, reverse, plus scoop up & down. Kit has extra track & other useful parts. Two D size NiCads INCLUDED!



Electric Piston Deluxe 5-Pack #3-137 \$39.95

Incredible mini cylinders lift 1 pound! Just 10 cm long, shorten 23 mm with 1V, 5A. Cycles up to 6 times/min. Has five pistons, high current battery & full plans for 4 unique projects.



Solar Car Kit #3-217 \$59.95

Run on the sun! High efficiency solar panel (0.5V, 1200 mAh), special high torque motor & adjustable gearing. Clean design!



Batteries & Chargers



Earth Friendly - Wallet Friendly

High quality nickel-cadmium cells replace hundreds of disposables! Save money! reduce waste! Keep your robots rolling!

AA, 1.25V, 650 mAh	#3-269	\$2.95
C, 1.25V, 1400 mAh	#3-270	\$3.95
D, 1.25V, 1400 mAh	#3-271	\$3.95
9V, 7.2V, 100 mAh	#3-272	\$7.95

Special

Charger, Quad AA #3-277 \$14.95

Charge 1 or 2 pair of AA or one 9V cell. Ideal for all kits above. *BONUS - Includes 4 AA NiCads!*



8 at a time!

Charger, 8 Position #3-276 \$29.95

Fully charge up to 4 pairs of AAA, AA, C, D or up to four 9Vs - in just 4 hours!



MONDO • TRONICS Robot Store

Robot Builder's Bonanza #3-114 \$18.95

Practical, ready-to-use circuits, devices, mechanisms, sources, tools, vision, grippers, navigation & more! 336 pgs.



Gadgeteer's Goldmine #3-129 \$21.95

Unique high-tech projects & hard-to-find info. Robots, high voltage Tesla & Van de Graaff generators, Kirlian photos, lasers & much more! 400+ pgs.

Mobile Robots #3-098 \$39.95

From MIT a complete guide to designing & building robots: hardware, software, sensors, motors, "subsumption" software. 300+ pgs. A must for all roboticists.



Sensors for Mobile Robots #3-145 \$59.95

Whoa! Everything about sensors: tactile, proximity, range, acoustic, laser, radar, microwave, path following, dead reckoning, compasses, gyros. Fun & intelligent!

507 Mechanical Movements #3-173 \$9.95

Reprinted from 1893 - when steam was king! Here are 100's of cams, clutches, linkages, latches, ratchets & more! *Don't reinvent the past - use it!* 120 pg. High powered!



The Robot Zoo #3-149 \$19.95

A big, imaginative & fun book about animals that work like robots, or maybe they're robots that work like animals? 50 pages. *For kids of all ages.*



Isaac Asimov's Ultimate Robot CD-ROM #3-95

Mac #3-135 or Windows #3-138

An incredible interactive collection of robot info. movie clips, demos & more. 100's of pictures, 50+ Asimov stories, animate on-screen robots. "Must have" resource all robot makers. *BONUS 12 pg "Explorer's Guide" FREE!*



Controlling the World With Your PC #3-165 \$35.00

Convert ordinary serial & parallel ports into object-detecting, motor-spinning monsters! 2 circuits AND software in BASIC, C and Pascal! 256 pages, with PC disk.



PIC Source Book #3-202 \$39.95

Program PIC processors the easy way! Proven code to duplicate 30 BASIC functions - serial I/O, analog input, sound, 16-bit math, more. Adaptable to other processors! 104 pgs, w/PC disk.



Order Toll Free!

24-hour Voice Order Line - VISA MasterCard

Request our FREE Robot Store Catalog!

Mondo-tronics

524 San Anselmo Ave. #107-99
San Anselmo, CA 94960
Questions: 415-455-9330
Fax: 415-455-9333
Email: info@mondo.com
Web: www.RobotStore.com

To Order:
Send check, MO
or credit card info.
All orders add
\$5.00 P & H.
Call. orders also
add sales tax.

International Orders Welcome! First Class P&H: \$12.00

Robotic Lawn Mower



'WeeEater' VIP

Robotic Solar Mower

#3-224 \$1,999.00

An astounding advance in robots & lawn maintenance. Sun powered, whisper quiet, safe emission free! Range limited by buried wire boundary. Handles 1,450 m² (17,000 ft²) up 30° slope. Frees you for other work (or to build robots!)

'Video, Robotic Solar Mower #3-223 \$4.95

See the Robotic Solar Mower in action! Shows robot in operation, blades, setup, even a time lapse sequence of the mower in action, 5 minutes, color VHS \$4.95 only.



Robot Movies

We found all our favorites & more! VHS-NTSC format (all U.S. systems.) Ratings in parenthesis.

Video Special Offers!

Buy any 5, take \$10 off your total.
Buy any 10, take \$25 off your total.

• Classic Robot Films

Metropolis - 1926 (nr)	#3-235	\$29.95
Frankenstein - Restored (nr)	#3-250	\$19.95
Forbidden Planet - 1956 (G)	#3-233	\$19.95
Day the Earth Stood Still (nr)	#3-251	\$19.95
2001: A Space Odyssey (G)	#3-144	\$19.95
Silent Running (PG)	#3-243	\$19.95

• Comedy Robot Films

Dark Star (G)	#3-231	\$19.95
Sleeper (PG)	#3-244	\$19.95
Young Frankenstein (PG)	#3-252	\$19.95

• Adventure Robot Films

Batteries Not Included (PG)	#3-255	\$19.95
D.A.R.Y.L. (PG)	#3-258	\$19.95
Short Circuit (PG)	#3-241	\$19.95
Short Circuit II (PG)	#3-242	\$19.95
Runaway (PG-13)	#3-240	\$19.95

• Action Robot Films

Alien (R)	#3-226	\$19.95
Aliens (R)	#3-227	\$19.95
Alien III (R)	#3-228	\$19.95
Blade Runner - Director's Cut (R)	#3-256	\$19.95
Battlestar Galactica (PG)	#3-229	\$19.95
Logan's Run (PG)	#3-234	\$19.95
RoboCop (R)	#3-237	\$19.95
RoboCop II (R)	#3-238	\$19.95
RoboCop III (PG-13)	#3-239	\$19.95
Terminator (R)	#3-246	\$19.95
Terminator II (R)	#3-247	\$19.95
THX-1138 (PG)	#3-268	\$19.95
Westworld (PG)	#3-248	\$19.95

• The Star Wars Trilogy

Star Wars (A New Hope) (PG)	#3-245	\$19.95
Empire Strikes Back (PG)	#3-232	\$19.95
Return of the Jedi (PG)	#3-236	\$19.95

Mondo Robot Video Library #3-267 \$499.00
Get all 30 films & Save 18% - Over 50 hours of movies!!!

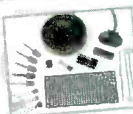

PICProto Demo Kit #3-130 \$34.95

Discover PIC computer power. Quick & easy kit makes a variable speed metronome, PC board, speaker, parts & programmed PIC 16C54!

Muscle Wires Project Book & Deluxe Kit #3-168 \$59.95

Create direct linear action with Muscle Wires. They contract up to 5% when powered! For robots, models & anything needing strong all-electric motion. 128 page book, full plans for BORS, a motorless walking robot & 14 others. One meter each 50, 100 & 150 µm dia Muscle Wires. Got





CABLE TV

Universal Descrambler
NEW PRODUCT



UNIVERSAL 5000

\$199.95

Our fully assembled product is factory tested and **GUARANTEED** to work on your system.

MODEL 4000 KIT

\$ 79.95

The 4000 KIT comes with all the electronic parts and our Cad designed PC board. We provide parts list, full schmatic, wiring diagram and tutorial.

MODEL 4000A Enclosure

\$ 44.95

The 4000A Enc. Package will provide the hobbyist, who has our 4000 Kit, a custom enclosure, AC adaptor and finish accessories to enclose their kit.

MODEL 4000 And 5000 Features

- The latest in Video Amplification Technology.
- New clocking circuits to stabilize color and picture performance.
- The most advanced picture locking circuitry.
- Inverted Video Option is available.
- NO CONVERTER BOX is necessary.

The Halcyon Group **1-800-664-6999**

* THE BEST * 8085 MICROPROCESSOR TRAINING SYSTEM JUST GOT BETTER

Are you interested in Single Board Computers and Microprocessor-based systems? If the answer is yes and you want to know more about these fascinating subjects the PRIMER Trainer is the place to start. The PRIMER teaches more and is easier to use than other comparably priced trainers. The over 100 page Self Instruction manual takes you from binary number systems to processing interrupts. At the end of the manual are working examples of using a photocell, a temperature sensor, making a waveform generator, a programmable timer with alarm, and a new motor speed control lab using back EMF. The PRIMER comes with everything you need

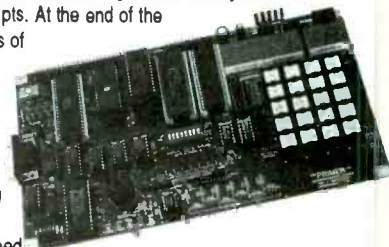

to start programming in machine language. Continue on to program in Assembler, Forth or BASIC with optional upgrade and software. Upgrade includes: RS232 serial port, a serial cable and, 32K of battery backed RAM. Picture shown with upgrade option and optional heavy-duty keypad installed.

THE PRIMER IS ONLY \$119.95 QUANTITY 1 IN KIT FORM. THE PRIMER ASSEMBLED & TESTED BY EMAC IS \$169.95. ORDER NOW AND RECEIVE ONE FREE POWER SUPPLY WHEN YOU MENTION THIS AD. PLEASE ADD \$5.00 FOR SHIPPING WITHIN THE U.S.

EMAC, inc.

618-529-4525 FAX: 457-0110 BBS: 529-5708
P.O. BOX 2042 CARBONDALE, IL 62902

ELECTRONIC MARVELS

4 NEW PRODUCTS

NEW! MICROPROCESSOR CONTROLLED VOICE RECORDERS WITH MSM

Powerful microprocessor controlled MSM (MENU/SUB-MENU) system allows you to record, play, loop, fast forward, delete, lock, auto-play (1sec. - 1hour), and externally trip selected messages. Great for announcements, product displays, vending machines, amusement & action parks, museums, etc.

MICRO-1.4

\$69.95

- 60 & 90 second versions available
- Small size 1.837" x 1.025"
- Up to 255 messages
- Auto-play timer (1second to 1 hour)
- 5-6.5 volt DC supply
- On board pushbuttons or external control
- External trip pins for the first 4 messages in memory
- PTT to turn on external devices (high or low active)
- Built in microphone
- Fully assembled not a kit
- 50 milliwatt output into a 16 ohm speaker
- No battery back-up needed (stores memory for 100 years without power)
- High quality (exact) sound reproduction
- Manual, ribbon cable, and connector included
- Cascadeable for more time



HPVFC

\$129.95

PROFESSIONAL CRYSTAL CONTROLLED TRANSMITTER

Great for Fox-hunting, tracking, wireless modems, etc...

- Superior design
- RF output 100-800 MWs approximately
- 9-10 volt DC power supply
- Small size 1.920" x .536"
- True FM modulation
- Tested up to 18 miles
- Super sensitive microphone
- 3 stage audio amplifier
- 3 stage RF amplifier
- 5 stage low pass filter
- Very low harmonic spurs
- Easy assembly, only 5 solder connections
- Receive on any scanner or VHF receiver
- Line level audio input 1-2 volts P-P
- Solid crystal controlled oscillator



VFC400 VHF FM VOICE TRANSMITTER KIT

ONLY **\$99.95**

- Same features as HPVFC plus
- RF output 50-400 milliwatts approx.
- Small size 1.50" x .560"
- 3-6.5 volt DC supply

- 3 standard frequencies available
- Tested up to 5 miles



MICRO TX2000 KIT

ONLY **\$39.95**

- Smallest 120 MW FM Voice/Phone Transmitter
- Small size 1-1/16" x 21/32"
- 28-110mhz on any broadcast receiver
- Rock solid tuning. Doesn't drift
- 5 min. assembly. Hear a whisper up to 2 miles
- SMT parts pre-assembled
- Includes TXMTR, Mic, Antenna, Battery Clip, Tuning Tool, and Instructions

SCRAM-3

\$69.95

AUDIO INVERSION SCRAMBLER

- Talk in privacy over any audio path speaker, mic, etc.
- Small size 1.747" x .897"
- Full duplex scramble/de-scramble
- 7-13.8 volt DC power supply
- Excellent audio quality
- Scramble/bypass feature
- 1/2 watt audio amplifier
- All surface mount components are pre-assembled
- Includes full documentation



MICRO-3

\$129.95

Same features as Micro-1.4 but available in 2 & 3 minute versions

PLUS:

- Small size 1.910" x 2.272"
- 7-13.8 volt DC regulated input
- Variable line level audio input
- External trip pins for first 8 messages in memory
- 2 external PTT's
- 3 status LEDs
- Cascadeable for more time
- MANY MORE FEATURES

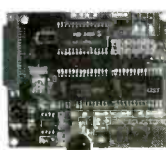

AGRELO ENGINEERING

1145 CATALYN STREET, SCHENECTADY, NY 12303
Order (800)588-4300 Tech (518)381-1057

BBS/Fax (518)381-1058

Check us out on the Web

<http://home.nyuvisoft.com/agrelo/pe.htm>



ORDER BY PHONE/MAIL/BBS IN U.S.A. ADD \$6 FOR S&H
Low OEM pricing available

C.O.D. CHARGES APPLY
NYS RESIDENTS ADD SALES TAX

Prices and specifications subject to change without notice.

CUSTOM ENGINEERING AVAILABLE - CONTACT US FOR QUOTES.

NOW MAKE AN EXTRA \$600 PART TIME WEEKENDS -- UP TO \$2,000 A WEEK FULL TIME IN Explosive SATELLITE DISH TV/ELECTRONICS FIELD!

Hottest Career Opportunity Since Invention of the VCR!

See How Fast The Money Rolls In!

Part time: *Here's what you can earn
over a typical weekend:*

Install 2 Satellite dish systems at \$200	= \$400
Repair 4 TV's at \$50 each	= \$200
Total Weekend Income	= \$600

Full time: *Working just five days a week
you could easily earn:*

Install 5 Satellite dish systems at \$200	= \$1,000
Repair 10 TV's, average \$50 each	= \$500
Clean and adjust 10 CD players, average \$35 each	= \$350
Service 2 Home entertainment centers at \$75	= \$150
Total Weekly Income	= \$2,000

**In addition you can make big extra profits
on other supplies you furnish!**

Get in **THE FAST LANE** on the NEW "INFORMATION SUPERHIGHWAY" Everyone's Talking About!

It's exciting! It's gigantic! The technology of tomorrow is here today! You've been reading and hearing about the amazing Information Superhighway. It's so new that few technicians are equipped to service

this fast emerging field! Foley-Belsaw gives you Satellite dish technology (including new mini-dish) along with the electronic expertise you need to make big money servicing TVs and other electronic equipment.

Be your own boss! It's quick and easy to become an expert at home in your spare time. Earn really BIG money adjusting, installing and repairing • **Satellite dish systems** • **TV's** • **Amplifiers** • **CD players** • **AM/FM tuners** • **Home entertainment centers**. Every home, every business, every office in your area desperately needs your expertise!

Your timing just couldn't be better! Never before and probably never again will you have a ground-floor opportunity like this to get into a booming business of your own, make really big money starting right away, be your own boss and enjoy financial freedom and security. The fact you're reading this message shows you're smart enough to realize this!

Satellite dish/TV/Electronics is easy

to learn in your spare time at home. This modern, practical hands-on course combines simple step-by-step lessons with easy-to-follow video cassette guidance. No special experience or electronics background is necessary. Just average mechanical aptitude and the ability to follow simple A-B-C repair procedures that are clearly outlined for you.

And when you complete the course you will receive Foley-Belsaw's official diploma attesting to your expertise.

**30-DAY
NO RISK TRIAL**
Send for details



Send coupon today for FREE Fact Kit. No obligation.

Don't miss out on this once-in-a-lifetime opportunity. Send in the coupon NOW. Get all the facts and study them in the privacy of your own home. There's absolutely no obligation and no salesman will call on you. So don't delay. Mail the coupon today!

MAIL TODAY FOR FREE INFORMATION PACKAGE

Foley-Belsaw Institute
6301 Equitable Road
Kansas City, MO 64120-1395



Since 1926

- YES!** Without obligation send free information kit so I can learn how to become a professional Satellite Dish/TV/Electronics Specialist, in order to earn high extra income. Dept. 31200
- VCR Repair**-Unlimited profits in this growing field. Dept. 62426
- Interested in an exciting, money making career in **Computer Repair, Maintenance and Upgrade?** Dept. 64323
- Personal Computer Programming**-Learn fast at low cost for big earnings. Dept. 35148

Name _____

Address _____

City _____ State _____ Zip _____

Call toll-free 1-800-487-2100

ALL ELECTRONICS CORP.

QUALITY PARTS • DISCOUNT PRICES • FAST SERVICE

COMMUNICATION HEADSET w/ ANTENNA



Headband with electret microphone, dynamic earphone and antenna. Mouthpiece position and headband are adjustable. Cable is 3' long with 6 wire termination. These are new units that appear to have been removed from walkie-talkie radios.

CAT# PHN-8
\$5⁰⁰ each

10 for \$45.00

CANVAS CASE

Good-looking, well constructed 7.5" X 6" X 1.95" canvas carrying case with zipper on three sides. Webbed nylon hand strap and ample foam padding inside. Probably designed for transporting memory storage media. The black foam padding inside can easily be reconfigured to accommodate photographic, audio or video components. The removal of one large chunk of foam gives you a well padded interior volume of 5.9" x 4.3" x 0.75". All black with red and white embroidered "K-stor" (tm) logo on front.

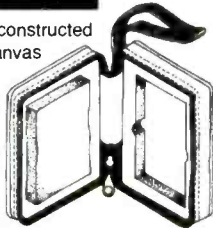

\$3⁷⁵ each

CAT# CSE-3
 10 for \$35.00

C-30 AUDIO CASSETTE



Brand-new, good-quality 30 minute (15 min. per side) audio cassettes. Excellent for demos or instruction tapes.

Manufactured without record-prevent knockout tabs, so the indentations must be taped over before use.

CAT # C-30 **3 for \$1⁰⁰**

100 for \$30.00 • 500 for \$125.00

RECHARGEABLE GEL CELL 12 VOLTS 3 A/H



Maintenance free, rechargeable gel cell battery. An excellent back-up power source for alarms, communications equipment, lighting or computers. Can be used in any position and can be trickle charged for long periods of time. 5.3" X 2.63" X 2.39"

CAT# S12-3
\$15⁰⁰ each

case of 10 - \$120.00

HEAVY DUTY HEAT SINK

Black anodized aluminum heatsink for heavy-duty heat dissipation. 15 cooling fins. Three threaded brass inserts embedded in ends of heatsink to facilitate mounting. 10.75" X 4.82" X 1.43".



CAT# HS-18

\$9⁷⁵ each

MINIATURE BLACK & WHITE CAMERA w/ AUDIO

High-resolution, ultra-compact pc board CCD camera. 1.58" X 1.79" X 0.84".



Equipped with pinhole lens which can view objects from 2" to infinity in extremely low light (.5 Lux @ F 1.6). Infrared sensitive - works in total darkness with an infrared light source. Auto-iris for automatic light compensation. Includes electret mike, audio board and 20" audio output cable with RCA plug. 18" shielded cable with RCA plug for video output. 20" cable with co-ax DC power plug (2.1mm center positive) 12vdc @ 150 ma. operation.

CAT# VC-200PA **\$169⁰⁰** each

INTERNET USERS!

Visit Our Web Site..
<http://www.allcorp.com/allcorp/>

MULTI-MEDIA ELECTRET MIKE & HOLDER



This is a very cool looking microphone, originally designed for use with a "Media-Vision" multi-media package. It has an electret element, so it requires a little voltage to operate.

The overall size of the mike is 1.5" high and 0.64" thick including the pocket clip on the back. Also included is a little plastic holder with an adhesive backing which allows the mike to be stored or used while attached to a computer or automobile dashboard. 7' cable with stereo 3.5mm plug. Beige mike, holder and cord.

CAT# MIKE-25

\$3⁵⁰ each

LARGE QUANTITY AVAILABLE!

9 FOOT DUAL AUDIO CABLE



9' shielded dual audio cable with color coded (red and yellow) RCA style pin plugs either end. Black cable.

\$1⁰⁰ each

CAT# DCB-108

10 for \$8.50 • 100 for \$75.00
 1000 for \$500.00

12 Vdc GEAR MOTOR

Denso Brand 40 RPM @ 12.6 Vdc @ 600 ma. (no load). Right-angle drive gearhead motor originally designed for automotive applications where lots of torque is required. 6.68" long X 3.5" X 1.62" thick. Three mounting holes on 1.9" and 2.6" centers.

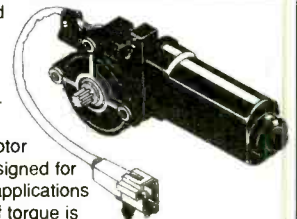

\$17⁵⁰ each

CAT# DCM-64

MANUFACTURERS - We Purchase EXCESS INVENTORIES... Call, Write or Fax YOUR LIST.

CALL, WRITE or FAX For A Free 64 Page CATALOG.

Outside the U.S.A. send \$2.00 postage.

ORDER TOLL FREE **1-800-826-5432**

MAIL ORDERS TO:
 ALL ELECTRONICS CORP.
 P.O. BOX 567
 VAN NUYS, CA 91408-0567

E-MAIL allcorp@allcorp.com
 FAX (818) 781-2653
 INFO (818) 904-0524

NO MINIMUM ORDER • All Orders Can Be Charged to Visa, Mastercard or Discover • Checks and Money Orders Accepted by Mail • Orders Delivered in the State of California must include California State Sales Tax • NO C.O.D. • Shipping and Handling \$5.00 for the 48 Continental United States - ALL OTHERS including Alaska, Hawaii, P.R. and Canada Must Pay Full Shipping • Quantities Limited • Prices Subject to change without notice.



CIRCLE 28 ON FREE INFORMATION CARD

COMING SOON!
http://www.csi.com/

CIRCUIT SPECIALISTS INC.

Check Out What We Have To Offer:

680MB TAPE BACKUP

Only \$119

INCLUDES

- Internal Tape 700 Drive
- Complete Documentation
- Cables and Mounting Hardware
- Easy-to-Use DOS & Windows Software
- Uses QIC-3010 (3M3000XL \$34.90)



Teac Tape 700 \$119

MULTI-FUNCTION DIGITAL & ANALOG I/O MULTI-LAB PACKAGE

The ACL-711S is a low cost, but fully integrated package designed for applications of general lab and industrial automation. It contains:

- **8 Single-Ended A/D Inputs**
 - Resolution: 12 bits
 - Input Range: -5V to +5V
 - Trigger Mode: Software trigger only
- **One Analog Output (D/A)**
 - Resolution: 12 bits
 - Output Range: 0 to +5V or 0 to +10V
- **16 Digital Inputs**



- **16 Digital Outputs**
- **ACLD-711S** Wiring terminal board (furnished with ACL-711S)
- **Utility Software Disk** Driver routines for BASIC and Quick-BASIC, demo and example programs

ACL-711S \$199

24-BIT COLOR FLATBED SCANNER

- High-Speed 3-Pass Scanner
- Long Lasting Cold Cathode Technology (10,000Hrs)
- Up to 2400x2400dpi (300x600 hardware)
- Intelligent LCD Panel
- TWAIN Compliant
- Includes: PhotoStacker, WordLinx OCR & Media-House Multimedia Document Manager Software
- Includes SCSI Interface Card



A6ADF Optional 50pg Doc Feeder

\$359

A6TK Optional Transparency Kit

\$259

DIGITAL PANEL METERS

- 200mV Full Scale Input Sensitivity
- Single 9 Volt DC Operation
- Decimal Point Selectable
- Auto Polarity Indication
- High Input Impedance (>100M ohm)



AS LOW AS \$5.25 EACH

CAT NO	DESCRIPTION	PRICE EACH				
		1	10	25	100	250
PM-128	3-1/2 Digit LCD Panel Meter	\$ 9.90	\$ 7.09	\$ 6.40	\$ 5.86	\$ 5.25
PM-129	3-1/2 Digit LED Panel Meter	11.49	9.54	8.67	7.95	6.95
PM-328	4-1/2 Digit LCD Panel Meter	19.88	16.40	14.90	13.66	11.93

This very easy to use tool is a "must have" if you need to straighten the pins on your IC's. Made from anti-static material, this tool is suitable for IC's from 8 to 20 pins (narrow side) and 24-48 pins (wide side). A grounding terminal is also built-in to the tool allowing for easy grounding when using this tool at a fixed location.



CAT NO	PRICE EACH		
	1	10	100
ICS-01	\$7.18	\$6.44	\$4.89

PC218902 (AT-BUS)



- Board Length: 13-1/8" (333mm)
- Board Width: 4-5/16" (110mm)
- Double Sided, 3-Hole Solder Pads and Power Buses
- Space Reserved for: Header, 32x2, 0.1" Spacing and Pin Grid Array

CAT NO	PRICE EACH	
	1	5
PC218902	\$25.66	\$20.25

PC218904 (AT-BUS)



- Board Length: 13-1/8" (333mm)
- Board Width: 4-5/16" (110mm)
- Double Sided, Pad-Per-Hole and Power Buses
- Space Reserved for: 1 D-Type Connector, 25-pin

CAT NO	PRICE EACH	
	1	5
PC218904	\$25.42	\$20.06

PC218903 (XT-BUS)

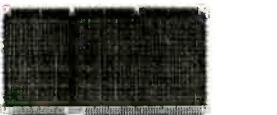

- Board Length: 13-1/8" (333mm)
- Board Width: 4-5/16" (110mm)
- Double Sided, Pad-Per-Hole and Power Buses
- Space Reserved for 1 D-Type Connector, 25-Pin

CAT NO	PRICE EACH	
	1	5
PC218903	\$23.51	\$18.63

PC232904 (Multi-BUS)



- Board Length: 12" (305mm)
- Board Width: 6-3/4" (171mm)
- Double Sided, Pad-Per-Hole and Power Buses
- Space Reserved for 1 Header, 100x2, 0.1" Spacing

CAT NO	PRICE EACH	
	1	5
PC232904	\$38.40	\$29.80

PC207905 (STD-BUS)

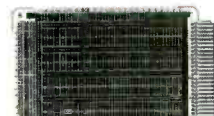

- Board Length: 6-1/2" (165mm)
- Board Width: 4-7/16" (113mm)
- Double Sided, 3-hole Solder Pads, Ground Plane and Power Bus
- Space Reserved for 1 Header, 34x3, 0.1" Spacing

CAT NO	PRICE EACH	
	1	5
PC207905	\$13.66	\$11.25

PC412902 (VME-BUS)



- Board Length: 6-5/16" (160mm)
- Board Width: 3-15/16" (100mm)
- Single Sided, Pad-Per-Hole and Power Buses
- Space Reserved for 1 D-Type Connector, 25-Pin

CAT NO	PRICE EACH	
	1	5
PC412902	\$7.06	\$6.00

RECEIVE OUR LATEST 132 PAGE CATALOG!

It's chock full of all types of electronic equipment and supplies. We've got I.C.'s, capacitors, resistors, pots, inductors, test equipment, breadboarding supplies, PC supplies, industrial computers, data acquisition products, personal computers and computer parts, plus much, much more. FAX us your name and address or call 800-811-5203, ext. 5, to leave a message on our catalog request line.



CIRCUIT SPECIALISTS, SINCE 1971

800-811-5203
602-464-2485
602-464-5824(FAX)

WE ACCEPT:



February 1996, Popular Electronics

AMAZING Electronic and Scientific Products

Mystery Levitating Device!

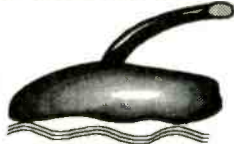

Remember *War of the Worlds*? Objects float in air and move to the touch. Defies gravity, amazing gift, conversation piece, magic trick or great science project.

ANT1K Easy to Assemble Kit / Plans \$19.50

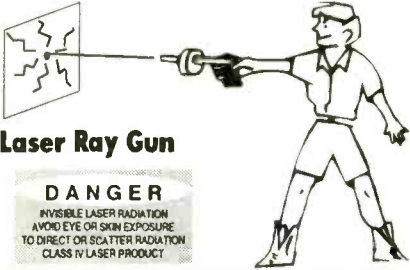

Laser Ray Gun

DANGER
INVISIBLE LASER RADIATION
AVOID EYE OR SKIN EXPOSURE
TO DIRECT OR SCATTERED RADIATION
CLASS IV LASER PRODUCT

Advanced project produces a burst of light energy capable of burning holes in most materials. Hand-held device uses rechargeable batteries. 500 joules of flash energy excite either a neodymium glass, yag or other suitable 3" laser rod. This is a dangerous CLASS IV project (individual parts/assemblies available). LAGUN1 Plans \$20.00
LAGUN1K Kit / Plans Price on Request

Extended Play Telephone Recording System



READY TO USE! Automatically controls and records on our X-4 extended play recorder, taping both sides of a telephone conversation. Intended for order entry verification. Check your local laws as some states may require an alerting beeper. TAP20X Ready to Use System \$129.50



Shocker Force Field / Vehicle Electrifier

Neat little device allows you to make hand and shock balls, shock wands and electrify objects, charge capacitors. Great payback for those wise guys who have wronged you!

SHK1K Easy to Assemble Electronic Kit \$29.50



Electric Charge Gun

All New Technology!



Stuns/immobilizes attackers up to 15 feet away!
*Legal in most state (not in NY, NJ, MA, WI) * More knock-down power than most handguns * No permanent injury * ID coded * Free 80KV stun gun with every purchase.
ECG1 Data Packet, Creditable toward purchase \$10.00
ECG10 Charge Gun, Ready to Use, w/Free 80KV Gun \$249.50

Homing / Tracking Transmitter

Beeper device, 3 mile range.
HOD1 Plans \$10.00 HOD1K Kit / Plans \$49.50

Listen Through Walls, Floors

Highly sensitive stethoscope mike.
STETH1 Plans \$8.00 STETH1K Kit/Plans \$44.50

Infinity Transmitter ++



Telephone Line Grabber / Room Monitor / Controller

All New - The Ultimate in Home/Office Security & Safety! Simple to use! Call your home or office, push a secret tone on your telephone keypad to access: • On premises sounds and voices • Ongoing phone conversation w/break-in capability • Up to 10 external electrical functions, lights, TV, alarms, coffee pots, heater, etc. CAUTION! Check legality with your state's attorney general's office before use for monitoring of voices.

TELECON1K Kit, includes PC board \$149.50
TELECON10 Ready to Use \$199.50

Visible Beam Laser

Easy to build, RED Beam, visible for miles. Use for light shows, window bounce holography, cloud illumination and much more! LAS1KM Kit w/1mw Laser Tube, Class II \$69.50
LAS3KM Kit w/2.5mw Laser Tube, Class IIIA \$99.50

Life is Precious - PROTECT IT!

Hard hitting, crackling, sizzling HIGH VOLTAGE plasma! Stuns and immobilizes most attackers
STUN200 Ready to Use, 200,000V \$69.50
STUN120 Smaller Unit, 120,000V \$39.50

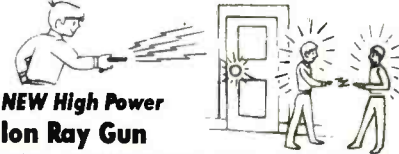

NEW High Power Ion Ray Gun

Projects charged ions that induce shocks in people and objects without any connection! Great science project as well as a high tech party prank. IOG7 Plans \$15.00
IOG7K Kit/Plans \$99.50

Invisible Pain Field Generator

Shirt pocket size electronic device produces time variant complex shock waves of intense directional acoustic energy, capable of warding off aggressive animals, etc.
IPG7 Plans \$8.00 IPG7K Kit/Plans \$49.50
IPG70 Assembled \$74.50

1000 Ft++ Potato Cannon

NOT A TOY. Uses electronic or piezo ignition. CAUTION REQUIRED!
POT1 Plans \$10.00
(Dangerous Product)

FireBall Gun

Shoots flaming ball - two shot capacity
Great for special effects and remote fire starting. CAUTION REQUIRED!
FIREBALL Plans (Dangerous Product) \$10.00

TV & FM Joker / Jammer



Shirt pocket device allows you to totally control and remotely disrupt TV or radio reception. Great gag to play on family or friends. Discretion required.
EJK1KM Easy to Assemble Electronic Kit \$24.50

ATTENTION: High Voltage Fans!

4,000 volts in the palm of your hand! Experiment with anti-gravity, hovercraft, ion guns, force fields, plasma guns, shock devices, wireless energy and electrical pyrotechnics. Input: 9-14VDC.
MINIMAX4 Ready to Use \$19.50



"Laser Bounce" Listener System

NEW - Latest Technology! Allows you to hear sounds from a premises without gaining access. Aim at room window and listen to sounds from within via reflected laser light. Not for illegal use. Requires video tripods.
LWB3K 5mw Laser and Receiver Kit \$149.50
LWB30 Ready to Use \$199.50

5mw Visible Red Pocket Laser

Utilizes our touch power control!
VRL5KM Kit / Plans \$74.50

Put's subjects under control using highly effective electronic stimuli. Intended for parties and entertainment but must be used with caution. Includes valuable text book reference and plans.
EH2 Plans and Text Book \$19.50

Automotive

NEON

Easy-to-Install 4-Tube Kit for Cars, Trucks, Vans! Available in Pink, Purple, Blue or Green - please specify color when ordering.
RG4K (Specify Color) \$129.50
Flash-To-Music Option for above kit FMU1 \$29.50
License Frame Kit (Specify Color) LIC1K \$24.50

3 Mi FM Wireless Microphone

Subminiature! Crystal clear, ultra sensitive pickup transmits voices and sounds to FM radio. Excellent for security, monitoring of children or invalids. Become the neighborhood disk jockey!
FMV1 Plans \$7.00 FMV1K Kit and Plans \$39.50

Telephone Transmitter - 3 Mi

Automatically transmits both sides of a telephone conversation to an FM radio. • Tunable Frequency • Undetectable on Phone • Easy to Build and Use • Up to 3 Mile Range • Only transmits during phone use. VWPM7 Plans \$7.00
VWPM7K Kit/Plans \$39.50

CATALOG
With many more items!
Free with Order or send \$1 P&H

Order by Mail or by 24 Hour Orders-Only Phone
800-221-1705

Dept PEM-19, Box 716, Amherst, NH 03031
Phone: 603-673-4730 FAX: 603-672-5406
MC, VISA, COD, Checks accepted Please add \$5.00 Shipping & Handling

INFORMATION UNLIMITED

Are Cable Companies Sucking You Dry?



**FREE
Catalog!**

**All Major
Brands!**

Take a Bite out of High Rental Fees
with your own

Converters & Descramblers



Everquest • Panasonic • Jerrold • Zenith • Pioneer • Scientific Atlanta • Oak • Eagle • Hamlin • Tocom



Order
Toll-Free **1 800 624-1150**

Call today for a FREE catalog!



M.D. Electronics



875 S. 72 Street • Omaha, NE 68114

© JERROLD, STARCOM, PANASONIC, ZENITH, PIONEER, OAK, SCIENTIFIC ATLANTA, EAGLE, HAMLIN, and TOCOM are all registered trademarks. All references to the above mentioned equipment is for identification purposes only. We are in no way implying that any of the products in this advertisement are original equipment. M.D. Electronics is in no way affiliated with the above mentioned companies or corporations.

ALFA ELECTRONICS

HIGH QUALITY TEST EQUIPMENT
BEST PRICE



DMM 89 \$199.95

Most Advanced DMM
All Purpose & Communication
-80.7 to 81.4 dBm with 4Ω-1200Ω
20 reference impedances
True RMS
Frequency counter: 0.01Hz-10MHz
Capacitance: 1pF-50,000μF
Measure AC volt to 20kHz
5000 counts, 0.1% accuracy
Auto/manual range, fast bar graph
Min/Max/Ave/DH/Relative/Zoom
Auto power off
Input warning
Splash proof
Volt, amp, ohm, logic, diode, continuity
Ruggedized case
Rubber holster included



DMM 2360 \$119.95

DMM+LCR Meter
Very Versatile DMM
Inductance: 1μH-40H
Capacitance: 1pF-40μF
Frequency: 1Hz - 4MHz
Temperature: -40-302°F
TTL Logic Test: 20MHz
Diode, Continuity
Volt, Amp, Ohm
3899 count display
Peak Hold
Auto power off
Ruggedized case.
Temperature probe included
Rubber Holster \$8.00



DMM 20 \$74.95

Inductance: 1μH-40H
Capacitance: 1pF-200μF
Frequency: 1Hz-20MHz
Volt, amp, ohm, diode,
20 Amp AC/DC current
Transistor HFE
Continuity, duty %
Peak hold/Max
Ruggedized case
Rubber holster \$8.00

Full line of DMMs,
economy, compact,
ruggedized, solar cell,
automotive, heavy
duty, industrial,
starts from \$15.95

Fluke Multimeter
Fluke 12 \$84.95
Holster C-10 \$10
Fluke 70 II \$75.95
Fluke 73 II \$97.50
Fluke 75 II \$129
Holster C-70 \$16
Fluke 77 II \$155
Fluke 79 II \$175
Fluke 29 II \$175

Fluke 76 \$175
Fluke 87 \$287
Fluke 867 \$1199

Fluke 97
Scope Meter \$1785



LCR Meter 131D \$229.95

Most Advanced LCR
Dual display: L/Q or C/D
Inductance: 0.1μH-1000H
Capacitance: 0.1pF-10,000μF
Impedance: 1mΩ-10MΩ
0.7% basic accuracy
Auto/manual range
Dissipation factor & Q factor
Serial & parallel mode
Relative mode for comparison
and to remove parasitics
Statistics, tolerance,
Best for design, incoming
testing & production
SMD and chip component
test probe \$25.00



LCR Meter 814 \$189.95

Best Resolution LCR
Inductance: 0.1μH-200H
Capacitance: 0.1pF-20,000μF
Resistance: 1mΩ-20MΩ
1% basic accuracy
Dissipation factor indicates leakage
in capacitor and Q factor in inductor
Zero adjustment to reduce parasitics
Best for high frequency RF
SMD and chip component test probe
\$25.00

LIMITED QUANTITY SPECIAL
DIGITAL LCR 680 \$74.95
0.1pF, 1μH, 10mΩ resolution

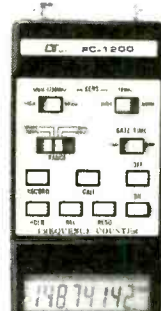

Frequency Counter FC-1200 \$129.95

Frequency: 0.1Hz-1.25GHz
Display: 8 digit LCD
Period: 0.1μs-0.1s
Records Max/Min/Average
Data hold, relative mode
Telescoping antenna \$8.00
Deluxe case \$5.00

Also Available:
AC/DC clamp meter, Light meter,
Thermometer, pH meter, High
voltage probe, Digital caliper,
Anemometer, Electronic scale,
Force gauge, Tachometer,
Stroboscope, Humidity & EMF
adapter, Sound level meter,
Frequency counter, SWR/field
strength/power meter, Dip meter

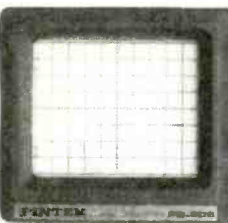

20 MHz Oscilloscope with Delay Sweep PS-205 \$429.95
Dual Trace, Component test, 8" CRT, X-Y Operation, TV Sync, Z-Modulation, CH2 Output, Graticule Illum, 2 probes each has x1, x10 switch. Best price with delay sweep.
PS-200 20 MHz DUAL TRACE \$339.95
PS-400 40 MHz DUAL TRACE \$494.95
PS-405 40 MHz DELAY SWEEP \$589.95
PS-605 60 MHz DELAY SWEEP \$769.95
Scope Probe: 60MHz x1, x10 \$15, 100MHz x1, x10 \$22
250MHz x1, x10 \$28, 250MHz x100 \$39

Digital Storage Scope DS-303 30MHz, 20M Sample/sec \$849.96
DS-303P with RS-232 interface \$1,049.96
Switchable between digital and analog modes
2 K word per channel storage
8 bit vertical resolution (25 Level/div)
Expanded Timebase 10ms/div - 0.5 s/div
Refresh, Roll, Save all, Save LCD, Pre-Trig
Plotter control

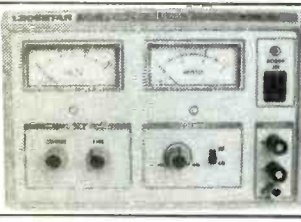

DC Power Supply PS-303 \$159.00
0-30 VDC, 0-3A output
Constant voltage & constant current mode
0.02% + 2mV line regulation
0.02% + 3mV load regulation
1 mVrms noise and ripple
Short circuit and overload protected
PS-8200 with digital voltmeter: \$179.00
Also available: 30V/5A, 60V/3A, 60V/5A
16V/10A, 30V/10A



DC Power Supply Triple Output PS-8202 \$499.95
Two 0-30 VDC, 0-3A outputs
One fixed 5VDC, 3A output
Capable of independent or tracking operation
Constant voltage and constant current mode
Four digital meters for volt and current display
Excellent regulation and low ripple
Short circuit and overload protected
Also available: 30V/5A triple output \$549.95
Dual tracking 30V/3A, 30V/5A, 60V/3A, 60V/5A

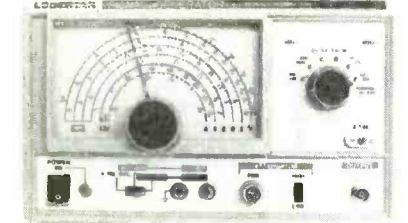

RF SIGNAL GENERATOR SG-4160B \$124.95
100 kHz-150MHz sinewave in 6 ranges
RF Output 100mVrms to 35 MHz
Internal 1kHz, External 50Hz-20kHz
AM modulation
Audio output 1 kHz, 1 Vrms

AUDIO GENERATOR AG-2601A \$124.95
10Hz - 1MHz in 5 ranges
Output: 0-8Vrms sinewave
0-10Vp-p squarewave
Synchronization: ±3% of oscillation frequency per Vrms
Output distortion:
0.05% 500Hz - 50kHz
0.5% 50Hz - 500kHz
Output impedance: 600 ohm

FUNCTION GENERATOR FG-2100A \$169.95
0.2 Hz - 2 MHz in 7 ranges
Sine, square, triangle, pulse and ramp
Output: 5mV-20Vp-p
1% distortion, DC offset ± 10V
VCF: 0-10V control frequency to 1000:1

FUNCTION GEN/COUNTER FG-2102AD \$229.95
Generates signal same as FG-2100A
Frequency counter 4 digits
Feature TTL and CMOS output

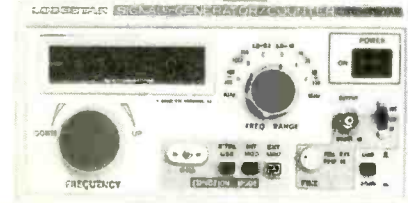

RF SIGNAL GEN./COUNTER SG-4162 AD \$229.95
Generates RF signal same as SG-4160B
8 digit frequency counter 1Hz - 150 MHz for internal and external source Sensitivity <50mV

AUDIO GEN./COUNTER AG-2603AD \$229.95
Generates audio signal same as AG-2601A
8 digit frequency counter 1Hz-150MHz for internal and external sources Sensitivity <50mV

SWEEP FUNCTION GEN./COUNTER \$329.95
0.5Hz to 5 MHz in 7 ranges
Sweep: Linear 10:1/Log 10:1 20ms to 2s
AM Modulation
Gated Burst, Voltage Control Generator
Generator Control Voltage & 6 digit counter
1Hz-10MHz for internal & external sources

ALFA ELECTRONICS
741 Alexander Rd., Princeton, NJ 08540

(800) 526-2532/(609) 520-2002 15 DAY MONEY BACK GUARANTEE. 1 YEAR WARRANTY
FAX: (609) 520-2007 CALL OR WRITE FOR FREE CATALOG AND BEST OFFER.
Visa, Master Card, American Express, COD, Purchase Order Welcome

CIRCLE 26 ON FREE INFORMATION CARD

HAPPY HOLIDAY SPECIALS... from the NEW EEB!!

25th

SCANNERS

AOR	AR2700	\$399.95
AOR	AR8000	\$599.95
AOR	AR3000A	\$1029
AOR	SDU5000	\$995.95
AOR	AR5000	\$CALL
Bearcat	BCT7	\$169.95
	BC120XLT	\$179.95
	SC150Y/B	\$169.95
	BC220XLT	\$224.95
	BC890XLT	\$229.95
	BC3000XLT	\$369.95
	BC9000XLT	\$369.95
Radio Shack	PRO26	\$339.95
	PRO46	\$179.95
	PRO60	\$299.95
	PRO2039	\$229.95
	PRO2040	\$219.95
	PRO2042	\$429.95*

JOIN THE OPTO/AOR REVOLUTION!!! The Hottest Thing in Scanners in the Last 20 yrs.

Save up to
28%

- OPTO Electronics and AOR are revolutionizing the scanner world. The new Scout 40 version 3.1 and the AOR AR2700/AR8000 scanners gives you the *Intercept* power in your hands, that just a few years ago could only be a dream. Imagine having your scanner hop on a signal the instant someone presses the mic button. The Scout will *Reaction Tune* your AOR scanner in a blink of an eye to any locally generated signal.
- Scout/AOR system allows easy listening to communications at: Air shows, Car races, Sporting events, Accident scenes, Airports, Railroad, Theme Parks, Marinas, anywhere radios are use.
- Scout/AOR is a must for; Law enforcement, News service, TV/ Radio news crew, Swat teams, FBI, DEA, Border patrol, Whenever hearing what's going around you can be a matter survival.
- Here is what you need to start truly enjoying your scanner hobby; (1) Scout 40 (2) Scanner AR2700 or AR8000 (3) EEB modification to scanner including interconnect cable (CB-RT)



Shown with DB32 Antenna Optional \$29.95

EEB special package deal Save up to 28%
Scout 40, EEB mod w/cable and AR2700 (\$839.95) or AR8000 (\$1039). One year warranty on system included. Optional extended 3 year total system warranty \$79.95

PORTABLE SHORTWAVE

GRUNDIG	YB305	\$129.95*
	YB400	\$179.95
	SAT700	\$459.95
SANGEAN	ATS202	\$89.95
	ATS303	\$89.95
	ATS606	\$149.95*
	ATS818	\$147.95
SONY	ICF30	\$104.95
	ICF33	\$159.95
	ICF55	\$344.95
	ICF77	\$469.95
	ICFSW100	\$349.95
	ICF2010	\$344.95
	ICF7600G	\$179.95

!!REMEMBER!!

The AR8000 is the **only** portable on today's market that has true USB/LSB/SSB with 50 Hz steps.
Listen to easy to tune true SSB.

AR2700 & AR8000 are cellular block per FCC.
Unblocked units available to qualified users.

• AR2700	list \$499.95	EEB \$399.95
• AR8000	list \$799.95	EEB \$599.95
• Mods & system check		EEB \$50
• Cable CB-RT		EEB \$20
• Scout 40	list \$449.95	EEB \$399.95

CYBER SCAN AOR AR5000

The new AOR AR5000 is on it's way. At this writing (mid Sept) details are sketchy. *Internet* is buzzing and here are some of the tentative specs.

- 10KHz-2600 MHz • 1000 memories • All mode AM/FMN/ FMW/LSB/USB/CW • IF band width 3 to 200KHz (7 filters) • 12VDC computer control 10.7 MHz IF output

Watch our next ad for more detailed information
Price in the \$2000 class



TABLE TOP RECEIVERS

AOR	AR3030	\$599.95 ^{sp}
DRAKE	R8A	\$1069
ICOM	R71A	\$CALL*
	R7100	\$CALL*
	R100	\$CALL*
JRC	NRD535DB	\$1699
Kenwood	R5000	\$1069
LOWE	HF150	\$569.95
	HF225E	\$959.95
	HR250	\$CALL*
WJ	HF1000	\$3799

CB RADIO

COBRA	29LTDWX	\$129.95
	HH40	\$99.95
	HH70	\$109.95
	93LTD	\$129.95
	148FGTL	\$249.95
	2010GTL	\$399.95
UNIDEN	PRO340	\$69.95
	PRO501XL	\$39.94
	PRO501AXL	\$79.95
	PRO538W	\$74.95

(* Lower Price (sp) Special Limited Qty)

Night Vision

Imagine seeing in the dark. This state of the art scope allows you to observe by starlight, superior optics produce brilliant images. Ideal for hunting, neighborhood watch, security, wildlife, law enforcement and star gazing. (You'll see 1000s more stars)



- NV100 List \$449 **EEB \$339.95**
- NV100-1 w/Illuminator List \$499 **EEB \$379.95**
- NV100C compact List \$349 **EEB \$299.95**
- NV100C-1 w/Illuminator **EEB \$329.95**

GPS Global Positioning System

It's sweeping the industry and now prices start under \$200. Perfect gift for the Hunter, Camper, Boater, Outdoorsmen and fun for all! Know your location and altitude to within 300ft anywhere in the world. We carry all major GPS brands.



Magellen GPS2000 Only \$199.95

GE SUPERADIO III

Puts the fun back into AM Dx'ing

At last there is an AM/FM radio built for the radio aficionado. Has extra large ferrite rod antenna, R.F. amp stage, 4 I.F. stages, wide/narrow filter, 2 speakers, bass & tremble. All adds up to superior reception! It's also great on FM too!



New lower price this issue only;

From 11-15 to 1-15-96... \$54.95

CATALOG 1996

- SW
- Scanner
- Amateur
- Books
- Comm/Govt.

All new expanded 1996 catalog. Hundreds of new items, you should have a copy by now...if not...get one!



323 Mill St.
Vienna, VA. 22180
FAX: 703-938 3350

Orders: 800 368 3270
INFO/Metro: 703 938 3350
BBS: 703 938 3781
Internet: eeb@access.digex.net

- We'll match anyone's deal
- Prices subject to change
- Prices do not include freight
- Returns subject to 20% restock fee
- Sorry no COD's



ERPOM UV ERASER

The ERA-08 EPROM Eraser can hold up to eight devices on its anti-static, conductive foam lined tray. A built-in timer (1-60 min.) provides proper exposure and correct intensity levels, assuring a long life for EPROM's and other erasable devices. A 9V AC adapter is included with the unit.



#M12ERA-08 \$98.95

DIGITAL VOICE MODULE

The DVM-58D has variable length message capabilities and can store up to 16 individual messages for immediate playback. Use it to add real voice prompting or instruction to any project, via the m.c. input. Standard 1Mb DRAM on-board (32 sec. @ 32K bps) with options to expand up to 16Mb (8 min. @ 32K bps). ADM recording with selectable 16/32/44K bps sampling rates and very low power consumption.



#M105858 \$89.95
1Mb DRAM \$5.15
4Mb DRAM \$21.95

RF TRANSMITTER + ENCODER MODULES

The TX-99 interfaces with the TX-01 as the RF carrier module. 300 MHz AM with a typical range of 50' - 100' line-of-sight. (Key-chain transmitter is also available, model TX-99K \$15.95)

#M109903 \$5.95

The TX-01 Motherboard can encode a 12-bit address code with 4096 possible code combinations or can be used to encode an 8-bit address code with a 4-bit data code.

#M10001 \$9.95

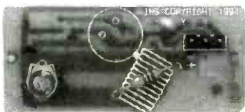

RF RECEIVER + DECODER MODULES

The RE-99 interfaces with the RE-01 as the RF carrier's receiver module and requires only a few solder connections to mate the two. 300 MHz AM.

#M109904 \$6.95

The RE-01 Motherboard will decode a 12-bit address or 8-bit address with 4-bits of data, depending on which of the two included IC's is installed into the board.

#M10001D \$14.95



PC INTERFACE CARD PROTECTOR

The Data Genie P-300 is a device that allows quick and easy installation of add-on cards or prototype circuits for testing externally on your PC without having to turn off the computer. Maintains complete protection for your motherboard via the built-in protection circuitry & current limit fuses. Adds 3 expansion slots.



#M12P300 \$349.95

PIR DETECTOR

The Medusa Passive Infrared Detector has been tested at 20V/m over the frequency range 20 to 1000 MHz, proving that the unit has ultra-high RFI protection and reliability. With N.C contacts including tamper, plus selectable pulse counts of 1, 3 or 5, Medusa makes for confident installations.

Detects ambient body heat and movement to trigger your connected security system, announcement buzzer, or warning device.



#M113300 \$24.95
3+ at \$19.95 each.

LASER POINTER

The Infiniter Laser Pointer is lightweight, durable and can project a beam over 150' to enhance any demonstration or presentation. It even works well on overhead projection screens and can be used in conference rooms, exhibition hall, construction sites, museums, etc.



(2-"AAA" Batteries not included)

#M160012 \$49.95

MELODY DEMO KIT

The HT-38DPB Demo Board comes complete with a preassembled playback board, battery holder and ten Holtek melody IC's. Great for experimenting or adding a musical melody to a project.

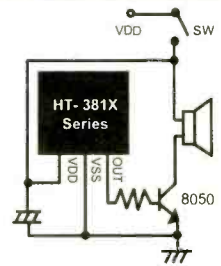

Included melodies:

Karinka-Happy Birthday-It's A Small World-Home Sweet Home-Yankee Doodle-Rock-A-Bye Baby-Are You Sleeping?-Song Of Joy-My Little Tricycle-When The Saints Go Marching In

#M14HT38DPB \$16.95

\$25 min. order or \$5 process fee.

ORDER BY MAIL:

ELECTRONICS 123
17921 ROWLAND ST.
INDUSTRY, CA 91748

24 hr. Product Information
Fax-On-Demand
818-964-8490
Call from your fax machine.

S&H Charges Continental US, up to 3 lbs:

UPSGround \$7.00
UPS 3-Day \$8.00
UPS Blue \$10.00
UPS Red (Next Day) \$20.00
COD's Add: \$4.75

Calif. Orders Add: 8.25% Sales Tax

CANADA S&H Charges, up to 3 lbs:

US Postal, First Class \$10.00
Prepayment by credit card required.
Sorry No COD orders to Canada
(INTERNATIONAL S&H rates: Call/Fax for quote.)

All specifications and pricing are subject to change without notice.

STOP LOOKING! YOU'VE FOUND WHAT YOU NEED!

For over 15 years, MCM Electronics[®] has been a leading supplier to the service industry. Vast selection, rapid delivery and competitive prices have made us a household name in repair shops across the nation and beyond.

Perhaps this is why we also supply tens of thousands of hobbyists, enthusiasts and educators. Whether you are designing, repairing, modifying or learning, MCM has over 21,000 items to meet your needs. We are THE source for tools, test equipment, amateur radio accessories, reference material, semiconductors, resistors, capacitors, speakers, PA equipment and much more.



Authorized Original
Parts Distributor
Panasonic
Quasar
Technics



Stop looking and call for your FREE Catalog today...

1-800-543-4330



MCM ELECTRONICS[®]
650 CONGRESS PARK DR.
CENTERVILLE, OH 45459-4072
A PREMIER Company

**CODE:
POP27**

**FAST DELIVERY
FROM DISTRIBUTION
FACILITIES IN RENO, NV
AND DAYTON, OH!**

CIRCLE 165 ON FREE INFORMATION CARD

Tube & General Purpose Projects

NEW

HIGH
QUALITY
CHASSIS
FOR NEW
TUBE
PROJECTS!



LC SERIES

FIELD REMOVABLE TOP AND BOTTOM 0.080" ANODIZED ALUMINUM PANELS. FRONT & REAR PANELS 0.063" GOLD ANODIZED ALUMINUM. OTHER PARTS BLACK ANODIZED. VENTED CAGES & OAK ENDS AVAILABLE.

MODEL	W x D x H (in)	PRICE \$
LC-1	100 x 100 x 50	45.00 47.50
LC-2	150 x 100 x 50	60.00 62.50
LC-3	200 x 100 x 50	85.00 87.50
LC-4	300 x 100 x 50	95.00 97.50
LC-5	150 x 150 x 75	50.00 54.00
LC-6	200 x 150 x 75	55.00 59.00
LC-7	300 x 150 x 75	60.00 64.00
LC-8	400 x 150 x 75	65.00 69.00
LC-9	200 x 200 x 75	60.00 64.00
LC-10	250 x 200 x 75	65.00 69.00
LC-11	300 x 200 x 75	70.00 74.00
LC-12	426 x 200 x 75	75.00 79.00
LC-13	250 x 250 x 100	70.00 75.00
LC-14	300 x 250 x 100	75.00 81.00
LC-15	350 x 250 x 100	80.00 86.00
LC-16	425 x 250 x 100	85.00 91.00

GREAT LITTLE BOXES FOR LOW COST CONSTRUCTION. DESIGNED TO GET THE JOB DONE WITHOUT THE FRILLS!



MINI PROJECT BOX

ALTHOUGH NOT DESIGNED FOR TUBE CONSTRUCTION, THESE ARE VERY USEFUL IN LABS. DESIGNED WITH SIX 0.040" FLAT RAW ALUMINUM PANELS AND MICRO EXTRUSION.

Mini Project Boxes

MODEL	W x D x H (in)	PRICE \$
MPB-1	1.2 x 2.1	1.95 2.25
MPB-2	1.4 x 1.1	2.40 2.75
MPB-3	1.6 x 1.1	2.85 3.25
MPB-4	1.5 x 2.4 x 1.5	2.05 2.25
MPB-5	1.5 x 4.1 x 1.5	2.55 2.85
MPB-6	1.5 x 6 x 1.5	3.00 3.60
MPB-7	1.5 x 2 x 3	2.25 2.65
MPB-8	1.5 x 4 x 3	2.75 3.15
MPB-9	1.5 x 6 x 3	4.20 4.80
MPB-10	1.5 x 2 x 5	2.50 3.00
MPB-11	1.5 x 4 x 5	2.95 3.45
MPB-12	1.5 x 6 x 5	4.25 5.05
MPB-13	2.2 x 2 x 2	2.20 2.60
MPB-14	2.4 x 2 x 2	2.65 3.15
MPB-15	2.6 x 2 x 2	3.10 3.60
MPB-16	2.8 x 2 x 2	3.55 4.05
MPB-17	3.2 x 2 x 2	3.95 4.55
MPB-18	3.4 x 2 x 2	4.25 4.85
MPB-19	3.8 x 2 x 2	4.75 5.35
MPB-20	4.2 x 2 x 2	5.20 5.75
MPB-21	4.6 x 2 x 2	5.70 6.25
MPB-22	4.8 x 2 x 2	6.10 6.80

PERFORATED OR PLEXIGLASS PANELS ALSO AVAILABLE.

Metal Cabinets

MODEL	W x D x H (in)	PRICE \$
MC-1A	4.3 x 3.2	12.00 14.00
MC-2A	6.3 x 3.2	14.00 16.00
MC-3A	8.3 x 3.2	16.00 18.00
MC-4A	4.3 x 3.2	14.00 16.00
MC-5A	6.3 x 3.2	16.00 18.00
MC-6A	8.3 x 3.2	18.00 20.00
MC-7A	4.7 x 3.4	18.00 18.00
MC-8A	6.7 x 3.4	20.00 22.00
MC-9A	8.7 x 3.4	22.00 24.00
MC-10A	6.5 x 7.1 x 1.75	32.00 34.50
MC-11A	8.5 x 10.1 x 1.75	36.00 38.50
MC-12A	8.5 x 17.1 x 1.75	36.00 38.50
MC-13A	8.5 x 3 x 3.5	33.50 36.00
MC-14A	8.5 x 10 x 3.5	35.50 38.00
MC-15A	8.5 x 14 x 3.5	37.50 40.00
MC-16A	17.1 x 1.75	34.50 38.00
MC-17A	17.1 x 10 x 1.75	36.75 40.25
MC-18A	17.1 x 17 x 1.75	42.75 46.25
MC-19A	17.1 x 3.5	38.75 40.25
MC-20A	17.1 x 10 x 3.5	38.25 42.75
MC-21A	17.1 x 14 x 3.5	45.25 48.75

EXTRA PAIR FRONT/REAR PANELS 5.00 7.50



SESCOM ALSO STOCKS ALL KINDS OF USEFUL PARTS FOR CONSTRUCTION, INCLUDING CONNECTORS, SCREWS, METERS, TOOLS, ETC.

RACKEM 'N' STACKEM Table Top Racks

MODEL	HEIGHT IN	PRICE \$
RBB-8-18	8	70.00 80.00
RBB-8-15	15	75.00 85.00
RBB-18-19	10	70.00 80.00
RBB-18-18	18	70.00 80.00

CLEAR/BLACK OR FOR GOLD.



PICTURED WITH OPTIONAL RE-1 RACK EARS

RACKEM 'N' STACKEM BOXES

MODEL	W x D x H (in)	PRICE \$
RBB-2	7.5 x 3 x 1.5	25.00 30.00
RBB-3	7.5 x 3 x 1.5	31.25 36.25
RBB-4	7.5 x 3 x 1.5	38.00 43.00
RBB-5	7.5 x 3 x 1.5	45.00 50.00
RBB-6	7.5 x 3 x 1.5	51.50 56.50
RBB-7	7.5 x 3 x 1.5	58.25 63.25

ASSORTED MOUNTING ACCESSORIES ALSO AVAILABLE.

ALL BOXES ARE SHIPPED FLAT FOR EASY FABRICATION

UNLESS OTHERWISE NOTED, BOXES HAVE FLAT PANELS CONSTRUCTED OF 0.063" ANODIZED ALUMINUM (SIDES ARE 0.125"). FRONT AND REAR PANELS ARE CLEAR. BALANCE OF BOX IS BLACK. BLACK OR GOLD FRONT & REAR AVAILABLE FOR AN ADDITIONAL \$5.00.

Audio Transformers for Tube Construction

MODEL	PRI	SEC	CASE	USE	PRICE \$
AT-1	150	60K	A	MIC INPUT	40.50 42.50
AT-2	15K	15K	A	LINE INPUT	40.50 42.50
AT-3	15K	600	B	LINE OUTPUT	46.75 48.50

MODEL	W x D x H (in)	PRICE \$
IRU5	19 x 8 x 1.75	36.00 44.00
IRU10	19 x 7 x 1.75	36.50 46.50
IRU15	19 x 10 x 1.75	38.75 50.00
IRU12	19 x 12 x 1.75	42.75 56.00
IRU15	19 x 15 x 1.75	45.75 58.00
IRU17	19 x 17 x 1.75	48.75 60.00
IRU5	19 x 5 x 3.5	36.50 46.50
IRU7	19 x 7 x 3.5	38.75 50.75
IRU10	19 x 10 x 3.5	41.25 53.00
IRU12	19 x 12 x 3.5	45.25 58.25
IRU15	19 x 15 x 3.5	48.25 63.50
IRU17	19 x 17 x 3.5	51.25 65.50
IRU12	19 x 12 x 5.25	51.00 63.00
IRU15	19 x 15 x 5.25	54.00 68.25
IRU17	19 x 17 x 5.25	57.00 70.50
IRU17	19 x 17 x 5.25	60.00 72.50

EXTRA PAIR FRONT/REAR PANELS 7.50 9.00

Tube Outputs

MODEL	W x D x H (in)	PRICE \$
OT-1	5K 8 B	EL84 9 WATT 9.00 11.00
OT-2	8K 4 B 16 B	EL84 10 WATT 12.00 16.00
OT-3	4K 8 16 B	EL84 20 WATT 18.00 24.00

ULTRA LINEAR DESIGN. OUTPUT TRANSFORMERS DESIGNED FOR SIMPLE OUTPUT STAGES, AND FEATURE FREQUENCY RESPONSE OF 20-40-15K Hz.

Power Supply

MODEL	W x D x H (in)	PRICE \$
PT-1	125V 6V3 250MA 2A	9.00 11.00
PT-2	250V 300 5V 6V3 2A	18.00 24.00
PT-3	300V 300 5V 6V3 2A	10W 20.00 26.00
PT-4	400V 400 5V 6V3 2A	20W 24.00 30.00

180MA 3A 4A AMP

Pots

PART #	Ω	TYPE	PRICE \$
APOT-1	100K	S LIN	2.75 3.00
APOT-2	100K	S LOG	2.75 3.00
APOT-3	100K	D LIN	4.50 6.00
APOT-4	100K	D LOG	4.50 6.00
APOT-5	470K	S LIN	2.75 3.00
APOT-6	470K	D LIN	2.75 3.00
APOT-7	1M	S LIN	2.75 3.00
APOT-8	1M	D LIN	2.75 3.00
APOT-9	1M	D LOG	5.50 8.00
APOT-10	1M	D LOG	5.50 8.00
APOT-11	100K	D	6.50 7.00

(FOR BALANCING)

MOUNTING HOLES: 10mm (3/8") DIA. BLACK SHEETS 6mm (1/8") DIA. BLACK MATTE KNIFE-EDGE (1/8") DIA. x 14mm (1/2") SUPPLIED.

8 = SINGLE D = DUAL

Mounting Holes

3/8" THROUGH BUSHING

CASE STYLE A

CASE STYLE B

MOUNTING HOLES

GENERAL PURPOSE SOCKET TYPES. FULL MOUNTING DETAILS INCLUDED IN CATALOG TB-1. S = SOLDER P = PC MOUNT

FOR MORE INFO REQUEST CATALOG TB-1

MENTION AD AND TAKE 5% OFF YOUR FIRST ORDER!

WRITE OR FAX FOR OTHER CATALOGS: AUDIO SOLUTIONS, CONSTRUCTOR'S HARDWARE, AUDIO SIPS and AUDIO TRANSFORMERS

SESCOM, INC.
2100 WARD DRIVE
HENDERSON, NV
89015 U.S.A.

ORDER TODAY
ALL PRICES INCLUDE WORLDWIDE SHIPPING!
A IS USA, CANADA & MEXICO, B IS REST OF WORLD

HOURS
Monday thru Friday
8 am 'til 4 pm (PST)

ORDERS (800) 634-3457 ■ FAX (800) 551-2749
OFFICE (702) 565-3400 ■ FAX (702) 565-4828
TECH LINE (702) 565-3993 M-Th 8 am to 4 pm (PST)
SESCOM, INC. is not responsible for inadvertent typographical errors. Prices and specifications are subject to change without notice.

CALL TOLL FREE
1-800-292-7711
1-800-445-3201 (Can)

C&S SALES

EXCELLENCE IN SERVICE

**WRITE FOR
FREE CATALOG**



Line Tracker
MV-963
\$52.95
(Infra-red Sensor)
The robot follows
a black line
on white paper
Preassembled PCB



Dual-Display
LCR Meter
w/ Stat Functions
B+K Model 878
\$239.95
Auto/manual range
Many features
with Q factor
High Accuracy

Electronic Tool Kit Model TK-1000
A professional organizer tool kit at affordable prices. No student should be without this unique tool kit that holds all the tools you need.
Including:
Diagonal Cutter
Long Nose Pliers
6" Wire Stripper
Solder 60/40
6" Screwdriver
6" Phillips Driver
Safety Goggles
IC Puller
3pc Nut Drivers
Iron 25W
Iron Stand
Solder Wick
Desoldering Pump
5 pc Solder Ease Kit
6pc Precision Screwdrivers
\$39.95



Robotic Arm
Y-01
\$49.95
(Wired Control)
Movement grabs
& releases,
lifts & lowers,
pivots from side to side



Stereo Cassette Player
Kit
Model
TR-18K
\$16.95
Headphones
Included



Digital
Multimeter
EDM-83B
\$175.00
Almost every
feature available
Bargain of
the decade



Elenco
LCR + DMM
LCM-1950
\$79
12 Functions
Freq to 4MHz
Inductance
Capacitance



Digital
Capacitance
Meter
CM-1555
\$49.95
Measures capacitors
from .1pf to 20,000pf



Digital
LCR Meter
LCR-680
\$79.95
3-1/2 Digit
LCD Display
Inductance
1uH to 20MΩ



Function Generator
GF-8026
\$239
Int/Ext
Operation
Sine, Square, Triangle, Pulse
Ramp, .2 to 2MHz, Freq Ctr



3-3/4 Digit Multimeter
BK-390
\$139.00
0.1% DCV accy
Analog bar graph
Auto/manual ranging
Capacitance meas
Temperature probe



Digital
Multimeter Kit
w/ Training Course
M-2665K
\$49.95
Full function 34 ranges
Ideal school project
M-2661 (Assembled) **\$55.00**



Frequency Counter
F-1225
\$225.00
8 Digit LED display
Wide meas range
High sensitivity
Data hold function
Input impedance 1MΩ or 50Ω
10:1 input attenuation function

Fluke Multimeters
(All Models Available Call)
Scopemeters **70 Series**
Model 97 \$1,795 Model 7011 \$69.95
10 Series Model 7311 \$97.50
Model 10 \$62.95 Model 7711 \$149
Model 12 \$84.95 Model 7911 \$175
20 Series **80 Series**
Model 2911 \$175 Model 87 \$289



Triple Power
Supply
XP-620
By Elenco
\$75.00
3 fully regulated supplies; 1.5-15V @ 1A, -1.5 to -15V @ 1A or 3-30V @ 1A & 5V @ 3A Kit XP-620K **\$49.95**



Quad Power
Supply
XP-581
By Elenco
\$79.95
Four supplies in one unit; 2-20V @ 2.5A, 5V @ 3A, -5V @ .5A and 12V @ 1A. All regulated and short protected



High Current DC
Power Supply
BK-1686 **\$169.95**
3 to 14 VDC Output
12A @ 13.8V
For servicing high
power car stereos,
camcorders, ham radios, etc.
Connect 2 or more in parallel



Wide Band
Signal
Generators
SG-9000
\$124.95
RF Frequency 100K-450MHz
AM modulation of 1KHz Variable
SG-9500 150MHz **\$239.00**



Telephone Kit
PT-223K
\$14.95
Available
Assembled
PT-223
\$15.95

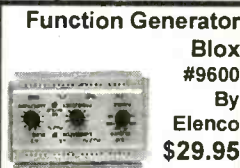

Function Generator
Blox
#9600
By
Elenco
\$29.95
Kit **\$28.95**
Sine, Triangle, Square Wave

Learn to Build & Program
Computers with this Kit

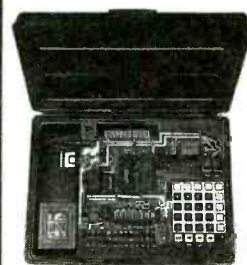

MM-8000
By Elenco
\$129.00
From scratch you build a complete system. Our Micro-Master trainer teaches you to write into RAMs, ROMs and run a 8085 microprocessor, which uses similar machine language as IBM PC.

Digital/Analog Trainer
Complete Mini-Lab For Building,
Testing, Prototyping Analog and Digital



By Elenco
in U.S.A.
XK-550
\$169.95
Kit
XK-550K
\$139.95

AM/FM Transistor
Radio Kit
with Training Course
Model AM/FM 108
\$29.95
14 Transistor, 5 Diodes
Easy to build because
schematic is printed on the PCB
Makes a great school project
Model AM-550 AM Only **\$17.95**



Telephone Line
Analyzer
Kit TT-400K **\$19.95**
Assembled TT-400 **\$26.95**

WE WILL NOT BE UNDERSOLD
UPS SHIPPING: 48 STATES 5%
IL RES 7.5% TAX (\$3 min \$10 max)
OTHERS CALL

C&S SALES INC.

150 WEST CARPENTER AVENUE, WHEELING, IL 60090
FAX: 708-520-0085 (708) 541-0710



15 DAY MONEY BACK
GUARANTEE
FULL FACTORY WARRANTY
PRICES SUBJECT TO CHANGE WITHOUT NOTICE

CIRCLE 32 ON FREE INFORMATION CARD

**FREE PROBES
WITH ALL
SCOPES**

**ELENCO ♦ HITACHI ♦ B+K
SCOPES
AT GUARANTEED LOWEST PRICES**

**WRITE FOR
FREE
CATALOG**

**QUALITY - ELENCO OSCILLOSCOPES
2-YEAR WARRANTY**

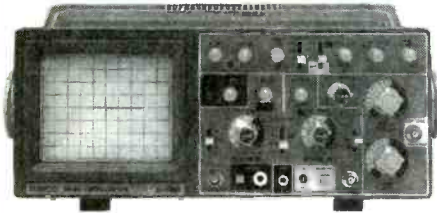

60MHz

S-1360 \$775

Delayed Sweep

S-1365 \$849

Cursor Readout

- ♦ Voltage, Time
- ♦ Frequency differences displayed on CRT



40MHz

S-1340 \$495

2- Channel

S-1345 \$575

Delayed Sweep

- ♦ Beam Find
- ♦ Component Tester



25MHz

S-1325 \$325

2- Channel

S-1330 \$449

Delayed Sweep

- ♦ Beam Find
- ♦ Component Tester

Dependable Equipment at Affordable Prices

B+K 20MHz

2 Channel

Model 2120 \$389.00



Delayed Sweep

Model 2125 \$539.95

40MHz DUAL -TRACE

Model 1541B

\$749.95

- 1mV/div sensitivity
- Video sync separators
- Z axis input
- Single sweep
- V mode-displays 2 signals unrelated in frequency

60MHz DUAL-TRACE

Model 2160

\$949.95

- 1mV/div sensitivity
- Sweep to 5ns/div
- Dual time base
- Signal delay line
- Component tester
- V mode-displays 2 signals unrelated in frequency

100MHz THREE-TRACE

Model 2190

\$1,379.95

- 1mV/div sensitivity
- Sweeps to 2ns/div
- Dual time base
- Signal delay line
- 19kV accelerating voltage
- Calibrated delay time multiplier

**20MHz ANALOG with
DIGITAL STORAGE**

Model 2522A

\$869.95

- 20MHz analog bandwidth
- 20MS/s sampling rate
- 2k memory per channel
- 20MHz equivalent time sampling

HITACHI POPULAR SERIES

V-212 - 20MHz, 2 Channel	\$449.00
V-222 - 20MHz, DC Offset	\$695.00
V-422 - 40MHz, Dual Trace	\$849.00
V-522 - 50MHz, Dual Trace	\$975.00
V-523 - 50MHz, Delayed Sweep	\$995.00
V-525 - 50MHz, w/ Cursor	\$1,069.00

HITACHI COMPACT SERIES SCOPES

V-660 - 60MHz, Dual Trace	\$1,375.00
V-665A - 60MHz, DT, w/cursor	\$1,449.00
V-1060 - 100MHz, Dual Trace	\$1,549.00
V-1065A - 100MHz, DT, w/cursor	\$1,695.00
V-1085 - 100MHz, QT, w/cursor	\$2,125.00
VC-6045A - 100MHz, Digital Stor	CALL
VC-6025A - 50MHz, Digital Stor	CALL

**Elenco DS-203 20MHz, 10MS/s
Digital Storage Oscilloscope**



\$749

2K Word Per Channel • Plotter Output
8 Bit Vert. Resolution • 2048 Pts Hor.
Resolution • Much More.....

FLUKE SCOPEMETERS

A handheld instrument that combines a 50MHz, 25MS/s dual channel digital storage oscilloscope with feature-packed 3000 count digital multimeter.



Model 95 - \$1,225

Model 95 - \$1,549

Model 97 - \$1,795

- Autoset, automatically sets voltage, time & trigger
- Multimeter display;
- 3-2/3 digits (>3000 counts)
- True RMS volts; AC or AC+DC up to 600V

C&S SALES INC.

150 WEST CARPENTER AVENUE, WHEELING, IL 60090
FAX: 708-520-0085 (708) 541-0710

CALL TOLL FREE

1-800-292-7711

1-800-445-3201 (Can)



**15 DAY MONEY BACK GUARANTEE
FULL FACTORY WARRANTY
ALL PRODUCTS ARE FACTORY NEW**

PRICES SUBJECT TO CHANGE WITHOUT NOTICE

CIRCLE 32 ON FREE INFORMATION CARD

EARN MORE MONEY!

Be an FCC LICENSED ELECTRONIC TECHNICIAN!



Earn up to \$60 an hour and more!

Learn at home in spare time. No previous experience needed!

No costly school. No commuting to class. The Original Home-Study course prepares you for the "FCC Commercial Radiotelephone License." This valuable license is your professional "ticket" to thousands of exciting jobs in Communications, Radio-TV, Microwave, Maritime, Radar, Avionics and more...even start your own business! You don't need a college degree to qualify, but you do need an FCC License.

No Need to Quit Your Job or Go To School
This proven course is easy, fast and low cost! **GUARANTEED PASS**—You get your FCC License or money refunded. **Send for FREE facts now. MAIL COUPON TODAY!**

Or, Call 1-800-932-4268 Ext. 240

COMMAND PRODUCTIONS
FCC LICENSE TRAINING, Dept. 240
P.O. Box 2824, San Francisco, CA 94126
Please rush FREE details immediately!

NAME _____
ADDRESS _____
CITY _____ STATE _____ ZIP _____

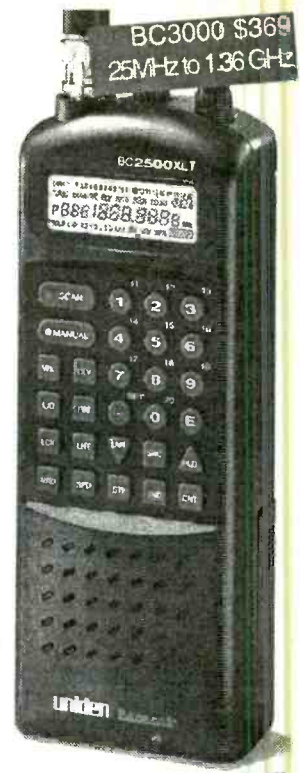

Toll Free, 24 Hours! For orders, dial 800 445 7717. For Fax Facts Instant catalog sheet service, dial 317 849 8683. Computer BBS 317-579-2045. Fax: 317 849 8794.

Email: ACESCAN@aol.com. Mastercard, Visa, Checks, Approved P.C.'s & COD (add \$5.50) & AMEX, Discover. Prices, specs and availability subject to change. Ground shipping and handling charge \$6.95, 10707 E. 106th St. Fishers, IN 46038

ACE COMMUNICATIONS

CIRCLE 25 ON FREE INFORMATION CARD.

BLACK FEATHER ELECTRONICS

VIDEO CLARIFIER

ELIMINATES ADVERSE EFFECTS OF VIDEO COPY-GUARDS!



State-of-the-art circuitry restores original (master) quality to all video tapes. Allows for flawless viewing of all pre-recorded video's whether rented, purchased or produced at home (even copy-protected tapes), for your personal home use. Unique auto Sync Boost feature eliminates horizontal instability and restores tapes to broadcast quality. Noise Reduction Circuit filters out the "snow" and other annoying interference. Compatible with all VCRs and T.V.s. Includes AC adapter.

CAT #VC-1 **\$49.95** each

ULTRA-MINI FM RADIO

WOW! SOUNDS GREAT!

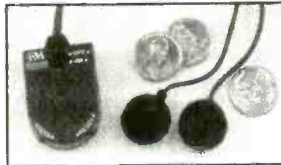

Fit an entire orchestra in the palm of your hand and still

have room for the concert tickets with this Mini FM Radio that has an incredible sound. Features on/off button, seek button and reset button. Includes battery. If this isn't the world's smallest, it's close to it. But the sharp, clear sound that comes out will make you think you have a jam box. Black.



CAT #FM-1 **\$10.95** each

3 1/2 DIGIT PANEL METER

This meter has many useful applications such as Voltmeter, Thermometer, Db Meter, Watt Meter, Current Meter, Capacitance Meter, Lux Meter and LCR



Meter. Features include: 200mV full scale input sensitivity, single 9VDC operation and decimal point selectable. In addition, it has 13mm figure height, automatic polarity indication, guaranteed zero reading for 0 volt input and high input impedance (>100M ohms). Specifications: Max input 199.9mV DC-Max. Display: 1999 counts (3-1/2 digits). Measuring method: Dual slope integration A-D converter system, plus many other features.

CAT #PM-1 **\$9.95** each

STEPPER MOTOR CONTROLLER KIT

This kit allows you to adjust the speed and direction of a stepper motor. You can move the motor in one step increments or rotate it at a constant speed. There are a set of visual indicators that show the sequence of motor. Includes stepper motor, pc board, parts and instructions.

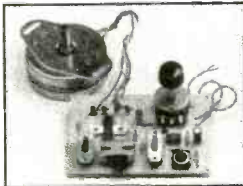

(19Vdc power source not incl.)

CAT #SMK-1 **\$35.00** each

LASER POINTER

5mW LASER POINTER!

Make a point with your laser pointer. Pointers are the most effective way to demonstrate your drawings, schematics, presentation, and charts. Just press and point! The beam shoots out across the room and puts a red dot on the wall up to 350 feet away. Operates on 2AAA batteries (included). wt. 2.3oz, wavelength 670nm/5mW output. Measures: .5" diameter x 5.75" L



CAT #LP-1 **\$39.99** each

SUPER VHS VIDEO TAPES

SUPER VHS PRO VIDEO TAPES

Name brand S-VHS tapes, T-120. These tapes were used for a brief period, then bulk erased. The record tabs have been broken out, so you will need to cover the notch with a bit of tape, but they are a great deal at a fraction of the "New" price!



CAT #S-VHS **\$3.00** each - 10 for **\$28.00**

FM WIRELESS MIKE KIT

POWERFUL

2 stage, wireless mike kit transmits over .5 mile (up to 1 Km in the open) Tunable to the upper part of FM broadcast band. Circuit does require the ability to "tweak" RF circuits by stretching or compressing coils. With mike and 9V battery clip. Operates from 6-12V DC. 2.75" x .625" x .5" WT .06



CAT #FM-32 **\$10.95** each

9V DC FM TRANSMITTER KIT

POWERFUL

FM transmitter. Transmits over 100 meters in building and over 500 meters outside using .25 or .5 wavelength of wire. Transmits to the upper part of FM broadcast band (100-108MHz). Circuit requires the ability to "tweak" RF circuits. Operates on 9V DC. 1.75" x .75" x .375" WT .05



CAT #FM-18 **\$9.95** each

CAMCORDER VIDEO TAPES

HI-8 120 MINUTE VIDEO CASSETTE TAPES (used)

They were recorded on once and played only a few times. Made by a major brand name manufacturer. Professional series metal tapes. Includes plastic jewel box.



NOTE: Other tapes available.
CAT #CCT-1 **\$3.00** each
10 or more - **2.80** each

EMERGENCY LIGHT

THE AMAZING EMERGENCY LIGHT!

Never ever needs batteries! This waterproof unit is powered by pumping the handle—this action moves a flywheel which activates a dynamo. The dynamo produces a DC voltage and current that powers the light. Great for the car, home and boat. Never be without a light when the power goes out due to earthquakes, floods or other disasters. Operates when completely submerged in water. The dynamo can be stripped out for experimentation.

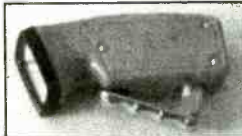

CAT # EL-1
\$7.95 each

TELEPHONE TRANSMITTER KIT

JUST LIFT THE HANDSET!

Phone line powered and activated when handset is lifted. Uses phone wires for antenna. Transmits over short distance (100ft) to the lower part of FM broadcast band (90-95MHz). Circuit does not require the ability to "tweak" RF circuits. WT .06

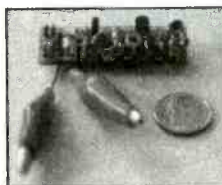

CAT #FM-16
\$9.95 each

STROBE KIT

This kit allows you to vary the rate of strobe flashes 60 to 120 flashes per minute. Operating voltage is adjustable depending on how you wire the kit. It will work on 4.5, 6 and 12 VDC. Includes pc board, parts and instructions.

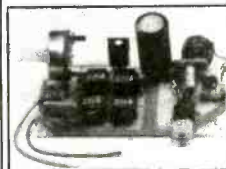

CAT #SLK-1 **\$7.50** each



Black Feather ELECTRONICS

Electronic Components, Supplies, Parts & Kits

645 Temple Avenue #7 Long Beach CA 90814

Local Phone Number (310) 434-5641

Hours: Monday - Friday
9 a.m. to 5 p.m. (Pacific Time)

California residence must include sales tax by county: 7.25% or 7.5% or 7.75% or 8.25% or 8.5%

Check, Money Order, VISA or MasterCard.

Shipping in USA > \$4.00

NO C.O.D.S. - Do not send cash.

CALL TOLL FREE!
1-800-526-3717

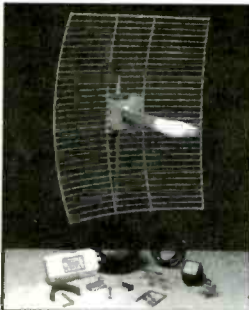

Quality Microwave TV Systems

**WIRELESS CABLE - ITFS - MMDS
ATV - INTERNATIONAL - S-BAND**
Amplifiers • Antennas • Books • Components
Filters • Systems • Video Products

- RF Frequency 1990 - 2700 MHz
- Cable Ready - VHF - UHF Outputs
- SASE For "FREE" Catalog or Send \$1

PHILLIPS-TECH ELECTRONICS

PO Box 8533 • Scottsdale, AZ 85252

ORDER LINE 800-880-MMDS

CATALOG / INFO 602-947-7700

FAX LINE 602-947-7799

Visa • M/C • Amx • Disc • COD's • Qty Pricing

CHALLENGER SYSTEM
33-Channel 52dB+ Gain
Complete Grid \$265
Five Year Warranty
FREE SHIPPING

CIRCLE 164 ON FREE INFORMATION CARD

MORE for LESS... Always!

Best Values for Performance, Features and Dependability

DM5050C, 42 Range DMM + CAPACITANCE METER

- Digital Multimeter
 - Resistance - Up to 2,000 M Ω
- Capacitance Meter, Extended Range
 - Up to 20,000 μ F (9 Range)
 - Zero Adjust Knob
 - Test Leads and Built-in Socket
 - Check Motor Starting & Running Capacitance
- Triggering Lamp

DM5100, 45 Range WIDE RANGE, ELEVEN FUNCTION

- Auto Power Off, Data & Peak Hold
- Measures Wider Range
 - Frequency - Up to 20 MHz
 - Capacitance - Up to 200 μ F
 - Resistance - Up to 200 M Ω
 - Current - Up to 20 A AC/DC
- Logic - TTL
- TRhFE

- ± 0.25% Basic DCV Accuracy
- 1.5" Big LCD Display
- 3 1/2 Digit Manual AC/DC Volt & Amp Resistance, Diode Continuity Beeper
- Alligator Clip Test Leads
- Double Insulated Jack
- Deluxe Holster
 - Lead Holders
 - Velcro Hanger
- Tilt Stand



\$89



- Prices start at \$44.95, measuring AC/DC 10 Amp. & Volt, Resistance, more and including protective Holster
- Lots of more High Standard Test Instruments available
All in One Instrument, Oscilloscope, Power Supply, Function Generator, Freq. Counter, Multimeter, Capacitance, Engine Analyzer, Clamp-On, Electrical Tester and More.
- See your local distributors or Call for Catalog

Bel MERIT
SOLUTIONS FOR THE TEST INSTRUMENT

26242 Dimension Dr., Suite 110
Lake Forest, CA 92630
(714) 586-3700 • FAX: (714) 586-3399

CIRCLE 30 ON FREE INFORMATION CARD

Professional Desoldering Made Easy & Affordable



Try Our

Unique, All in the Handle, with
Built-in Diaphragm Pump for
Superior Suction & Efficiency
Variable Temperature Control
Quick Replacement Filter
SMD Removal Capability - ESD Safe
Ergonomic Design for Comfort
One Year Parts & Labor Warranty

DEN-ON SC7000
Desoldering Tool
for a 15 Day

FREE TRIAL

Regular Price \$499.00

Our Price
\$439.00

We MEET or BEAT Advertized Prices

1-800-394-1984
or Fax (316) 744-1994

Purchase in advance and receive a
30 DAY MONEY BACK GUARANTEE

HOWARD
HEI ELECTRONIC
INSTRUMENTS Inc
6222 N. Oliver Wichita, KS 67220
Evaluated in Electronics Now, Jan. 1994

AMREL Offers Lowest Prices & Best Warranties on DC Power Supplies ANYWHERE!

3 YEAR WARRANTY



AMREL Offers Superior Analog Power Supplies Starting as Low as \$149.00

- Low Output noise rating less than 0.3mV.
- Line/load regulation rated at low 0.01% + 1mV.
- Transient response time of 50µ Sec.
- Overload protection, and Output enable/disable.
- Coarse and fine voltage/current adjustment.
- Auto series/parallel operations for triple output supplies.

3 YEAR WARRANTY



AMREL Offers Features And Prices on Digital Power Supplies That The Competition Can't Beat!

- Microprocessor controlled.
- User friendly keypad data entry.
- Low output noise rating less than 1mV.
- Line/Load regulation rated less than 2mV.
- Output enable/disable and Power off memory.
- Optional RS-232 interface capability.

Model	LPS-101	LPS-102	LPS-103	LPS-104	LPS-105	LPS-106	LPS-301	LPS-302	LPS-303	LPS-304	LPS-305
Rating	30V/1A	30V/2A	30V/3A	+30V/1A -30V/1A 3-6.5V/3A	+30V/3A -30V/3A 3-6.5V/3A	60V/1A	15V/2A(H) 30V/1A(L)	15V/4A(H) 30V/2A(L)	30V/3A	+30V/1A -30V/1A 5V/2A	+30V/2.5A -30V/2.5A 3.3-5V/3A
List Price	\$195	\$225	\$295	\$375	\$495	\$245	\$249	\$299	\$369	\$399	\$599
Sale Price	\$149	\$179	\$199	\$275	\$469	\$219	\$199	\$285	\$350	\$379	\$569

PRINT
Products International Inc.



Call: 1-800-638-2020



8931 Brookville Road • Silver Spring, Maryland 20910 • Fax: 800-545-0058

CIRCLE 46 ON FREE INFORMATION CARD

VOICE CHANGERS! ELECTRONIC KITS AND MORE!

ELECTRONIC
KITS!

WE ACCEPT VISA, MC, MO, COD
SHIPPING & HANDLING EXTRA



BUY WITH CONFIDENCE FROM XANDI

- 30-DAY REFUND POLICY
- TECH SUPPORT NUMBER (602-894-0992)

- Powerful 2 stage audio amplifier.
- Tunes 88-108 MHz.
- Up to 1 mile range.
- Requires 9V battery. (Not incl.)
- Sensitive, picks up sounds at the level of a whisper.



SUPER-MINIATURE FM TRANSMITTER
Super small FM transmitter. Use with any FM broadcast receiver. Easy to assemble, all chip (SMT) parts are pre-assembled to the circuit board.

XST500 E-Z Kit \$44.95

- Sensitive audio amplifier, picks up sounds at the level of a whisper.
- Tunes 88-108 MHz.
- Up to 1/2 mile range.
- Miniature photo battery mounts right on circuit board. (Included)



MICRO-MINIATURE FM TRANSMITTER
Including the battery, this is the Worlds smallest FM transmitter. Use with any FM broadcast receiver. Easy to assemble, uses pre-assembled circuit board.

XWB1000 E-Z KIT \$46.95

- Up to 1/2 mile range.
- Miniature photo battery mounts right on circuit board.
- Transmits at 143 MHz.
- Amazing audio sensitivity, picks up sounds at the level of a whisper.



CRYSTAL CONTROLLED FM TRANSMITTER
Including the battery, this is the Worlds smallest crystal controlled FM transmitter. Transmits to any scanner type receiver. Easy to assemble, uses pre-assembled circuit board.

XTL1000 E-Z KIT \$69.95

- Smallest Phone transmitter anywhere!
- Tunes 88-108 MHz.
- Up to 1/4 mile range.
- Attach to phone line anywhere in house.
- No battery required, powered by phone line.



SUPER-MINIATURE PHONE TRANSMITTER
Worlds smallest FM phone transmitter. Use with any FM broadcast receiver. Easy to assemble, all chip components are pre-assembled to the circuit board.

XSP250 E-Z Kit \$28.95

- Dial your phone from anywhere and listen to the sounds inside your home.
- Two digit Touch Tone code for secure operation.



TELEPHONE SNOOP

The latest in home or office security. Call home from anywhere, enter a two digit security code, and hear the sounds in your home. Automatically turns on without ringing the phone, verifies code, then activates for one and a half minutes.

XPS-CASE KIT \$13.95

XPS1000 C KIT \$55.95

- Digital voice changing: male to female, female to male, adult to child, child to adult.
- Anonymity on any call.
- Button for normal operation.
- 16 levels of voice masking.



VOICE CHANGING TELEPHONE
STOP THOSE ANNOYING TELEPHONE CALLS!
Sound older and tougher when you want to. Not a kit. Fully assembled. Single phone operation only.

TRANSITION 2000 \$89.95

- Transmits a continuous beeping tone.
- Adjustable from 88 to 108 MHz.
- Up to 1 mile range.
- Works with any FM broadcast receiver.



TRACKING TRANSMITTER

Only 0.7 by 2.4 inches, the XTR100 operates at voltages of 3 to 18 Volts and is ideal for use in locating lost model rockets, bicycles, automobiles, games of hide and seek, and contests.

XTR100 C Kit \$29.95

- Digital voice changing: male to female, female to male, adult to child, child to adult.
- Use with any modular phone.
- 16 levels of voice masking.
- Connects between handset and phone.



VOICE CHANGING ACCESSORY
STOP THOSE ANNOYING TELEPHONE CALLS!
Sound older and tougher when you want to. Not a kit. Fully assembled. Use with single or multi-line phones.

TRANSITION 2001 \$59.95

- Covers 1 to 2,000 MHz.
- Compact hand held unit.
- Uses sensitive microwave transistor amplifier.
- Includes miniature loud speaker for audio indication of detected signals.



SUPER SENSITIVE BUG DETECTOR

When the XBD200 intercepts a signal in the 1 to 2,000 MHz range, it emits a growl that increases to a high pitched squeal as the signal strength increases.

XBD200 C Kit \$39.95

- Uninterrupted coverage of 800 to 950 MHz.
- Works with any scanner that can receive 400 to 550 MHz.



800-950 MHz SCANNER CONVERTER KIT
If your scanner can receive 400-550 MHz, just add the XLC900 for uninterrupted 800-950 MHz coverage. It converts all 800-950 MHz signals down to 400-550 MHz so your scanner can receive them! Add our custom case kit for that "Professional" look.

XLC-CASE KIT \$13.95

XLC900 C KIT \$49.95

- Use with any FM broadcast receiver.
- Hear every sound in an entire house!
- Up to 1 mile range.
- Powerful 2 stage audio amplifier.



MINIATURE FM TRANSMITTER

The XFM100 has a super sensitive microphone and is capable of picking up sounds at the level of a whisper and transmitting them to any FM broadcast receiver.

XFM100 C Kit \$21.95

- Transmit high quality stereo to any FM stereo receiver.
- Built-in output level monitor for quick and easy tuning.
- Ideal for use with personal CD player.



FM STEREO TRANSMITTER
Transmit full-bodied Hi Fi stereo to any FM stereo receiver. Separate left and right inputs and gain controls. Includes an output booster stage for greater range.

XFS-CASE KIT \$13.95

XFS108 C KIT \$39.95

XANDI ELECTRONICS, INC.
Serving the public since 1981
1270 E Broadway Rd. # 113, Tempe AZ 85282

TOLL FREE ORDER LINE: 1-800-336-7389
FAX LINE: 1-602-731-4748
ASK FOR FREE CATAG OF OUR PRODUCTS

SEND MAIL XANDI ELECTRONICS
ORDERS TO: BOX 25647
TEMPE, AZ 85285-5647

CIRCLE 134 ON FREE INFORMATION CARD

CABLE TV DESCRAMBLERS



WE CARRY A FULL LINE OF PREMIUM CONVERTERS AND DESCRAMBLERS

- Scientific Atlanta™ Compatible
- Jerrold™ Compatible
- Tocom™ Compatible
- Zenith™ Compatible
- Pioneer™ Compatible
- Oak™ Compatible

**SATISFACTION GUARANTEED
OR YOUR MONEY BACK!**

BEST PRICES FREE CATALOG

Please have the MAKE & MODEL # of your full premium service cable box ready when you call!

ALLSTAR ELECTRONICS

800-782-7214

HOURS: 9-6 M-F 10-3 Sat EST

It is not the intent of Allstar Electronics to defraud any pay TV operator. Anyone implying theft of service will be denied assistance. All brand names are registered trademarks of their respective owners & are used for reference only. 110-64 Queens Blvd., #465, Forest Hills, NY 11375. NO NYS SALES!

Parts Express™



Parts Express is proud to announce that we now stock the NTE line of replacement semiconductors. NTE has been

supplying the electronics industry with top notch replacement parts for over 15 years. All NTE products meet or exceed industry specifications and offer an exclusive 2 year manufacturer warranty.

We also offer a complete line of parts for the service repair industry. Test equipment, loudspeakers, video and audio heads, magnetrons, belts, idler assemblies, tools, soldering equipment, just to name some of the 12,000 items we stock. Ask about our new dealer program for resellers. Call toll free for a copy of our FREE 212 page catalog. Source Code: POM



**CALL TOLL FREE
1-800-338-0531**

Parts Express 340 E First St. Dayton, Ohio 45402-1257
Phone: 513-222-0173 Fax: 513-222-4644

\$139* Laser LightShow



Draw with a laser beam! Animation, text, music & more! Includes galvos, servo amp, oscillators, software listing, analog & digital computer interfaces. Call for details



Computerized Motors \$39*

Includes: 2 Stepper motors, computer interface, 32 page training manual, & software listing. Expandable system! Up to 12 motors, up to 3 amps per phase. Call for details

* Add \$6 for shipping. Computer with parallel printer port. Assembly, Power supply, & Laser are required

Call or fax for **FREE FLYER**

SVS

Light &
Motion
in kit form

1273 Industrial Pkwy. West Bldg. 460
PO Box 55125
Hayward CA 94545-0125

Voice **510-582-6602**
Fax **510-582-6603**

The Pocket Programmer

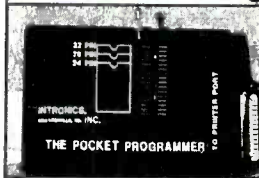

\$129.95

The portable programmer that uses the printer port of your PC instead of a internal card.

Easy to use software that programs E(Eprom, Flash & Dallas Ram. 27(C)/28(C)(F)/29(C)(F)/25 series from 16K to 8 Megabit with a 32 pin socket. Adapters available for MCU's 874X, 875X, Pic, 40-Pin X 16 & Serial Eprom's, PLCC, 5-Gang and Eprom Emulator to 32K X 8.

**Same Name, Address & Phone # for
13 Years.... Isn't it Amazing ?**

Intronics, Inc.

Box 13723 / 612 Newton St.

Edwardsville, KS 66113 Add \$4.75 COD

Tel. (913) 422-2094 Add \$4.00 Shipping

Fax (913) 441-1623 Visa / Master Charge

PROGRAMMERS

1349 DATA I/O CHIPLABS 4800

799 DATA I/O CHIPLABS 3200

579 EETOOLS ALLMAX

249 XELTEK SUPERPRO (R)

599 LOGICAL DEVICES 3000

599 ADVANTECH PC-UPROG

269 SUNSHINE UNIVERSAL

449 TUP-300 HILO SYSTEMS

449 JDR MCT-EMUP

539 TUP-400 HILO

429 NEEDHAMS EMP-20

679 NEEDHAMS SA-20

139 EETOOLS 1 GANG

199 EETOOLS 4 GANG

49 SUNSHINE 1 GANG

99 SUNSHINE 4 GANG

169 SUNSHINE 8 GANG

349 SUNSHINE 16 GANG

GENERAL DEVICE INSTRUMENTS

(408) 241-7376 Fax 241-6375 BBS 983-1234

HANDS-ON REPORT

(Continued from page 23)

timer, an electronic candle, a strength detector, a Morse-code oscillator, and a metronome. "Brain fryers" include a musical organ, a sound-activated switch, an intercom, a crystal radio, a transistor radio, an electronic thermometer, a metal detector, and more.

Many of the projects are quite clever. The strength detector measures physical strength by varying the pitch of an oscillator with the changing conductance between skin and aluminum foil balls as they are squeezed. The electronic thermometer uses a capacitor as a sensor to control the pitch of an oscillator according to temperature. The metal detector uses an oscillator/transmitter that you build and an AM radio that you supply to indicate when metal is near the oscillator.

Fun with Electronics certainly is a lot of fun for kids. If you are into electronics and want to introduce your children to the hobby, it could be the perfect way to start. It's entertaining, inexpensive, and very effective in teaching the basics of electronics. Finally, while they might not appreciate some of the cuter touches, grown-up beginners in electronics could also benefit from the effectiveness of multimedia as a learning aid.

For more information on the Philips CD-ROM and experimenter's lab, contact Philips directly at the address that follows, or circle no. 119 on the Free Information Card.

VENDOR INFORMATION

**Philips Media Home and
Family Entertainment**
10960 Wilshire Blvd.
Los Angeles, CA 90024



"So that's why you gave the neighbors cellular phones for Christmas."



Are you overpaying . . .
. . . your cable company?

You are if . . .
. . . you are leasing their equipment.

- Forest Electronics, Inc. offers a complete line of New Cable Decoders and Converters that are fully Compatible with your cable system.
- All systems come with: Remote Control, & Parental Guidance Feature. Volume Control is also available.
- All Equipment is fully guaranteed & comes with a 30 day money back option.

For More Information Call Us 24 Hours a Day At:

800-332-1996

FAX: 708-860-9048

Tap into a World of...

FREE ELECTRICITY

Our 150+ page Self-Reliance Catalog IS JUST LOADED WITH DC to AC ENERGY INDEPENDENCE ...

We offer:

- Solar, Wind & Hydroelectric energy systems. True Sine Wave DC to AC Inverters.
- Electric Boat & Car kits.
- Portable power packs.
- Solar Lighting & Cooling systems. Solar Pool Heaters.
- Solar Battery chargers. Solar Books & Toys. DC Appliances.
- Active & Passive Solar Air & Water Heating Systems.
- Composting Toilets. Hydroponic, Fish-Farming, Solarium & Greenhouse Systems. Water Testing, Treatment, & Pumping Systems.
- Emergency Food & H₂O Kits. High Efficiency AC/DC Refrigeration + More...



A LOT OF INFORMATION FOR ONLY \$6.75 ...

SEND CHECK or MO TO:

Self-Reliance Company Inc.

P.O. Box 306, Florissant, MO 63032

Tel: (954) 974-6864
 Fax: (954) 974-6818

Gateway Products Corp.

Please mail orders to:
 P. O. Box: 93-6397
 Margate, FL 33093

Popular I.C.s LM324 ... 45¢ LM339 ... 45¢ LM358 ... 45¢ NE555 ... 40¢ LM556 ... 50¢ LM741 ... 40¢ Deal U3: 12 pcs total, (2pcs of each) ... \$5.00	Transistors PN2222A ... 7¢ PN2907A ... 7¢ 2N3904 ... 7¢ 2N3906 ... 7¢ 2N4401 ... 7¢ 2N4403 ... 7¢ Deal N8: 60 pcs total, (10pcs of ea.) ... \$3.50	Semiconductors 74LS174 ... 40¢ 74LS244 ... 45¢ 74LS245 ... 45¢ 74LS374 ... 45¢ LM388N ... 45¢ MC1488 ... 45¢	DIODES 1N914 ... 3¢ 1N4148 ... 3¢ 1N4001 ... 1A/50V ... 3¢ 1N4004 ... 1A/400V ... 4¢ 1N4007 ... 1A/1kV ... 5¢ Deal P7: 50 pcs total, (10pcs of ea.) ... \$2.00	RADIAL LYTICS 1uF/50V ... 6¢ 2.2uF/50V ... 6¢ 3.3uF/50V ... 6¢ 4.7uF/50V ... 6¢ 10uF/50V ... 7¢ 22uF/50V ... 8¢ 33uF/50V ... 9¢ 47uF/50V ... 10¢ Deal A2: 40 pcs total, (5pcs of each) ... \$3.00	Ceramic Disc (All caps rated 50V) 10pF ... 6¢ 22pF ... 6¢ 27pF ... 6¢ 33pF ... 6¢ 47pF ... 6¢ 100pF ... 6¢ 150pF ... 6¢ 220pF ... 6¢ Deal R4: 40 pcs total, (5pcs of each) ... \$2.50	Toggle Switches Miniature size 1/4" Panel hole on-on ... SPDT ... 55¢ on-off-on ... SPDT ... 65¢ on-on ... DPDT ... 75¢ on-off-on ... DPDT ... 85¢ Deal S3: 8 pcs total, (2pcs of each) ... \$5.00
Popular CMOS CD4001B ... 30¢ CD4011B ... 30¢ CD4013B ... 40¢ CD4017B ... 50¢ CD4028B ... 40¢ CD4050B ... 40¢ CD4068B ... 40¢ CD4069B ... 40¢ Deal V8: 16 pcs total, (2pcs of each) ... \$5.00	More Transistors MPSA05 ... 15¢ MPSA13 ... 15¢ MPSA27 ... 15¢ MPSA42 ... 15¢ MPSA56 ... 15¢ MPSA92 ... 15¢ Deal Q2: 30 pcs total, (5 pcs of ea.) ... \$4.00	V. Regulators LM317T ... 70¢ 7805 ... 50¢ 7808 ... 50¢ 7812 ... 50¢ 7815 ... 50¢ 7818 ... 50¢ 7824 ... 50¢ 7905 ... 50¢ 7908 ... 50¢ 7912 ... 50¢ 7915 ... 50¢ 79L05 ... 40¢ 79L12 ... 40¢	Power Diodes 1N5401 ... 3A/100V ... 6¢ 1N5404 ... 3A/400V ... 9¢ 1N5408 ... 3A/1kV ... 10¢ 6A10 ... 6A/100V ... 24¢ 6A100 ... 6A/1kV ... 32¢ Deal H8: 25 pcs total, (5pcs of ea.) ... \$3.00	RADIAL LYTICS 10uF/25V ... 6¢ 22uF/25V ... 6¢ 33uF/25V ... 6¢ 47uF/25V ... 7¢ 100uF/25V ... 8¢ 220uF/25V ... 9¢ 330uF/25V ... 14¢ 470uF/25V ... 17¢ Deal A7: 40 pcs total, (5pcs of each) ... \$4.00	Ceramic Disc (All caps rated 50V) 270pF ... 6¢ 330pF ... 6¢ 470pF ... 6¢ .001uF ... 6¢ .001uF ... 6¢ .022uF ... 6¢ .047uF ... 6¢ 1uF ... 8¢ Deal R7: 40 pcs total, (5pcs of each) ... \$2.50	DEAL W2... \$2.50 120 pcs total (20 pcs of each: 10, 47, 100, 470, 1k, 4.7k. All 1/4W 5%
DEAL M3... \$5.00 7805 7812 7905 7912 12 pcs total (3pcs of each)	More Transistors 2N2222A ... 30¢ 2N4124 ... 13¢ 2N4128 ... 13¢ 2N5401 ... 16¢ MPSH10 ... 15¢ 2N3055 ... 65¢ TIP31C ... 55¢ TIP32C ... 55¢ TIP117 ... 55¢ TIP120 ... 60¢ TIP125 ... 65¢	Digital Meter only \$32 Tests: AC Volt DC Volt AC Amp DC Amp Transist Resistor Diode • Audible Cont. tester. • Probes included. • Res: 200 to 20M. • Curr: 200uA to 20A. • Volts: 200mV to 1kV.	1W Zener Diodes 1N4728A ... 3.3V ... 10¢ 1N4733A ... 5.1V ... 10¢ 1N4739A ... 9.1V ... 10¢ 1N4742A ... 12V ... 10¢ 1N4744A ... 15V ... 10¢ 1N4748A ... 18V ... 10¢ Deal Z5: 30 pcs total, (5pcs of ea.) ... \$2.00	1A SCHOTTKY 1N5817 ... 1A/20V ... 20¢ 1N5818 ... 1A/30V ... 23¢ 1N5819 ... 1A/40V ... 24¢ Deal Y6: 9 pcs total, (3pcs of each) ... \$2.00	DEAL W5... \$2.50 100 pcs total (20 pcs of each: 10K, 47K, 100K, 470K, 1M. All 1/4W 5%	
5mm (T1 3/4) Diffused LEDs Red ... 8¢ Green ... 10¢ Yellow ... 12¢ Deal L3: 30 pcs total, (10pcs of ea.) ... \$2.50	3mm (T1) Diff. LEDs Red ... 8¢ Green ... 10¢ Yellow ... 12¢ Deal L6: 30 pcs total, (10pcs of ea.) ... \$2.50	Germanium Diodes 1N34A ... 14¢ 1N60 ... 14¢ 1N270 ... 28¢ Deal G5: 18 pcs total, (6pcs of ea.) ... \$2.50	3A SCHOTTKY 1N5820 ... 3A/20V ... 32¢ 1N5821 ... 3A/30V ... 36¢ 1N5822 ... 3A/40V ... 40¢ Deal Y9: 9 pcs total, (3pcs of each) ... \$3.00	Mono Caps ... 8¢ ea .01uF/50V 047uF/50V .022uF/50V 1uF/50V Deal B5: 40 pcs total, (10pcs of ea.) ... \$2.50	400V BRIDGES 1Amp 4Amp 1.5Amp DF04M ... DIP ... 40¢ W04M ... Round ... 35¢ KBL04 ... In-line ... 90¢ Deal X8: 6pcs total, (2pcs of each) ... \$3.00	
Tantalum Caps 1uF/35V ... 18¢ 2.2uF/35V ... 22¢ 10uF/35V ... 50¢ Deal T6: 15 pcs total, (5pcs of each) ... \$3.50	SOLDER ROLL SN63/37 .031" dia 1 Lb Roll \$7.80					

\$10.00 minimum order. We accept VISA, MC, MO, Check, No-CODs. Please add \$5.00 for shipping & handling (foreign addresses: \$8.50). Florida addresses add 6% sales tax. Hours: Mon-Fri: 9AM to 5PM, Sat: 9AM to 12PM (EST). All new premium parts. Send for free Catalog.

February 1996, Popular Electronics

CABLE TV DESCRAMBLER KITS

Universal-New Product

This Product includes all the Parts, PC Board, Complete Schematic with Functional Guide. Generates Sync for most Video Applications.

\$79.95

Tri-Mode Descrambler

This product includes all the parts PC Board and AC Adaptor. NO Enclosure included.

\$59.95

SB-3 Descrambler

This Product includes all the Parts, PC Board and AC Adaptor. Enclosure is not included.

\$44.95



Call Toll Free 1-800-886-8699

M & G Electronics, P.O. Box 3310, No. Attleboro Mass. 02761



Anyone implying theft of Cable service will be denied assistance.

NO MASSACHUSETTS SALES!

PUT YOUR PC TO WORK!

THIS IS THE MACHINE YOU'VE BEEN WAITING FOR!

Imagine using your computer to turn 3D CAD drawings into actual working parts! Machine and drill printed circuits directly from blank material. Fabricate intricate mechanical components from raw plastic or aluminum. Route wood to make signs or "digitally" carve three dimensional art objects AND MORE! Sound interesting? You bet it is and with your creativity the sky's the limit! The NEURACTOR CNC-4+, 5, 6, & 7 Desktop Manufacturing Systems may be just the edge you need! Utilizing patent pending technology the NEURACTOR CNC kits provide you with machining resolution of .001". All mechanical components are pre-fabricated, pre-machined, plated and painted. The CNC-4+ machines an area approximately 18"x18"x4.6" and includes four 83 oz/in CY-MOTORS. The CNC-5, 6, & 7 (appx. 42"x42"x4.6", 66"x42"x4.6" and 66"x66"x4.6" respectively) include four 125 oz/in CY-MOTORS.



MICRO MACHINING

Interface card, 5 amp power supply, 10 pitch steel lead screws, 4 proprietary Slide Block actuator mechanisms, 4 aluminum linear actuator channels, polished steel guide-rods, toolholder bracket, hardware, etc., are included with each unit. (You provide Dremel(tm) Tool or flex-shaft router and work surface.) It's a complete kit! All you do is put it together, calibrate it and TURN IT LOOSE! IF THAT'S NOT EXCITING ENOUGH, WE'RE THROWING IN A FREE, FULL-FEATURED 3D CAD/CAM SOFTWARE PACKAGE WITH EACH UNIT! CNC-4+ is \$695 + 29.95 S/H, CNC-5 is \$895 + 69.95 S/H, CNC-6 is \$995 + 79.95 S/H, CNC-7 is \$1195 + \$89.95 S/H. We also have MICRO-DRILLS, FLEX-SHAFTS, MILLS, ETCHERS, CHEMICALS, BLANK BOARDS, ETC. CNC units sold in USA and Canada only, no exports! At these prices, demand is high so please allow 4 weeks minimum for delivery. CALL NOW!

U.S. CYBERLAB, 14786 Slate Gap Rd., West Fork, AR 72774 (501) 839-8293

IMAGINE THE POWER!

WITH FREE 3D CAD SOFTWARE!

starting at **\$695!**

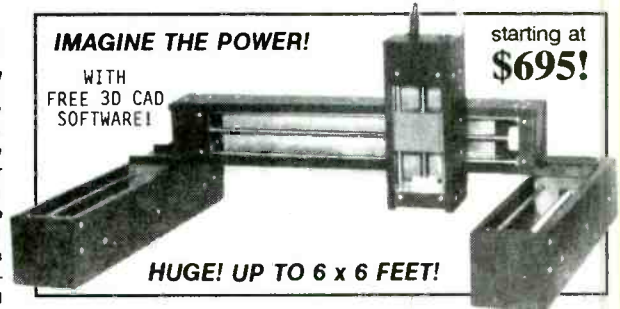

HUGE! UP TO 6 x 6 FEET!

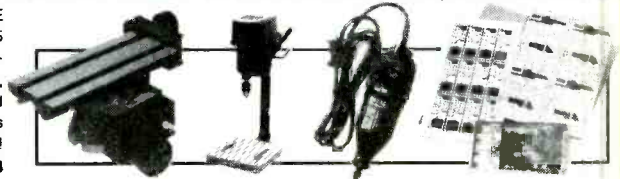

Weeder Technologies

Ask for our **FREE** catalog of other exciting kits, Call 513-752-0279

Pro-Kit™

P.O. Box 421, Batavia, OH 45103

Educational Kits for the Serious Hobbyist

Home Automation

Connects between a TW523 and an RS-232 serial port. Use your computer to receive and transmit all X-10 commands. Create your own program to control your home automation system, turning on/off any device plugged into an electrical outlet with response to time/date, or another X-10 transmission. \$38.50

Caller ID / RS-232

Connects between a telephone wall jack and an RS-232 serial port. Decodes the caller ID data sent over the phone line and sends it to your computer in a pre-formatted ASCII character string. Create your own program to log the name, number, date, time of all incoming calls. \$34.50

Telephone Call Restrictor

Connects to telephone wall jack. Disables all phones on the line if attempting to either: dial a number that has been stored in memory "Block Mode" or, dial a number that has not been stored in memory "Allow Mode". Use touch-tone phone to enter telephone numbers into memory, and choose mode. Program from any phone on the line using your password. \$35.00

50 MHz Frequency Counter

Reads frequency from 1Hz to 50MHz and displays it on a 16x1 character LCD display. Auto-range feature provides floating decimal point and automatically affixes the correct suffix (Hz, KHz, or MHz). Microcontroller based, very few additional components. \$46.50

Telephone Scrambler

Scrambles your voice before sending it over the telephone line, and descrambles it on the other end. Connects between your telephone and wall jack. No modifications are required to your telephone. Full duplex operation. \$43.00

IR Remote Control Receiver

Learns and records the data patterns emitted by standard infrared remote controls used by TVs, VCRs, Stereos, etc. Lets you control all your electronic projects with your TV remote. Seven individual I/O pins can be assigned to any button on your remote, and can be configured for either "toggle" or "momentary" action. \$32.00

Vocal Filter

An audio device which can be used with a home component stereo system, to filter out the main vocal sound track from standard stereo recordings (CD, tape, record or FM), leaving the background music to sing along with. Produce your own karaoke tapes. \$39.00

DTMF Decoder/Logger

Keep track of all numbers dialed or entered from any phone on your line. Connects to your telephone wall jack. Decodes all 16 touch-tones and displays them on an LCD display. Holds the last 240 digits in a nonvolatile memory. Scroll through and view all telephone numbers dialed, credit card numbers entered, etc. \$54.50

RAINBOW KITS

FM STEREO TRANSMITTER

Own your own FM radio station. Any stereo signal you plug into the FMST-100 will be transmitted to any FM radio tuneable from 76 to 108MHz FM. Transmit a wireless link through an auditorium, from your car to your camper, listen to your CD's while mowing the lawn, Play music on one channel sing on the other. Clarity is excellent, approx. 40dB stereo separation. Length of antenna determines the distance of transmission. Complete with stereo input level controls & crystal for stereo separation. 9v battery operation. SIZE: 1.5" x 2.5" x 3"

FMST-100 kit \$29.95 / Cabinet \$8.95

PHONE TRANSMITTER

Small but mighty, it fits anywhere. Phone line powered, never needs batteries. Transmits both sides of a phone conversation loud and clear, wireless, to any FM radio at great distances. Variable tunes from 70MHz to 130MHz FM. You can also use it as a speaker phone. SIZE: 1.25" x .6"

TEL-B1 kit \$12.95 BUILT \$29.95

SUPER SNOOPER BIG EAR

Listen through walls, hear conversations across the room. Add a parabolic reflector and hear blocks away. The BIG EAR can be hidden about anywhere. Makes an ultra sensitive intercom. Can be used as a 1.5W AMP. We supply a mini-electret mike in the kit. Power requirement 6 to 12v DC. SIZE: 1.75" x 1"

AA-1 kit \$10.95 BUILT \$29.95

WIRELESS FM MICROPHONE

Small but mighty this little jewel will out perform most units many times its price. It really stomps out a signal.

The WM-1 kit is a buffered wireless mike that operates from 80MHz to 120MHz FM, the frequency of any broadcast FM radio. Includes a mini-electret mike. 6 to 12v DC. SIZE: 1.25" x 1"

WM-1 kit \$14.95

DC VOLTAGE MONITOR

If battery status is important, you need this kit. This kit uses 7 LEDs to monitor 12v DC in 1v, 1/2v, or 1/4v steps. Monitor 8v or 5v in 1/4v steps. Great for boats, motor homes, model planes or race car ni-cads. All parts and instructions are included. SIZE: 1.3" x 2.7".

VM-1 kit \$7.95

The 10GHz Transmitter is back...

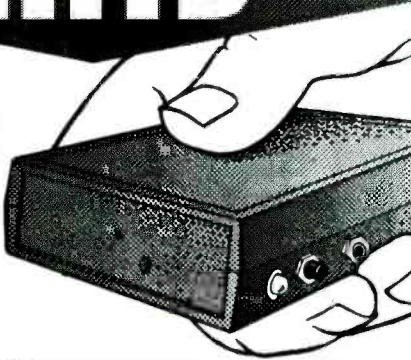

The "ZAPPER II"

With it's new and improved design it will not only test your radar detector... BUT it's tuned to the amateur radio band.

- While your out on American highways personally test yours and your fellow travelers radar detectors.

The "ZAPPER II" is a 10.450 GHz to 10.550 CW oscillator. It has a code key jack installed for those who want to send Morse code.

BUILT \$49.95 KIT \$39.95

TV NOTCH

FOR CHANNELS 2 thru 22 ONLY

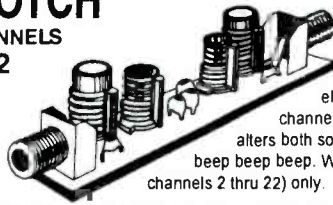

channels 2 thru 22) only.

NOTE: All TV Filter Kits are sold for educational purposes only. You must obtain permission from your local cable company before using these filters on your cable system.

DF-222

KIT \$14.95

FILTERS

Our TV filters eliminate unwanted TV channels or interference that alters both sound and video with a beep beep beep. Works on cable

This Manual contains schematics, parts lists & P.C. board layouts for many of the Rainbow Kits. Use your own parts to construct our kits.

KIT BOOK

\$14.95 \$9.95 with the purchase of any kit.

Please add sufficient postage First lb \$5.00 Canada \$7.00 Additional LB. Add \$1.00 US FUNDS ONLY We will accept telephone orders for Visa or Mastercard



To Order Call 317-291-7262



ELECTRONIC RAINBOW INC

6254 LaPas Trail • Indianapolis, IN 46268 FAX 317-291-7269

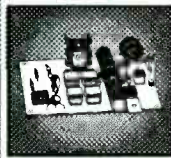

STROBE LIGHT

Do you need an attention getter, warning light, or flashing light for model airplanes?

Then this kit is for you. Use it as an emergency light for your auto, radio tower, even use it on your bicycle. Has a variable flash rate. Power requirement 6 or 12v DC. Size 3.5"x1.9"

ST-1

KIT \$9.95

MICRO-LIGHT

Visible Over 1 Mile.

This is truly an indestructible flash light.

- Comes in red or yellow light.
- Bulb will not burn out.
- Uses a 5 year shelf life lithium battery.
- Case made of tough ABS.

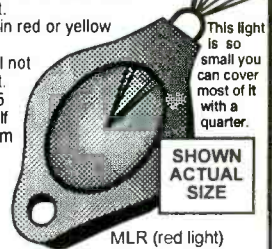

This light is so small you can cover most of it with a quarter.

SHOWN ACTUAL SIZE

MLR (red light) MLY (yellow light) CHOICE \$9.95



4.0 mW Laser Diode

Great for making a gun sight, use as a transit, makes a super experimenters project.

The beam is visible with a wavelength of 670 nm. Size of beam is 6mm at 5 meters. Power requirement 3 volts DC at 85mA. Size: 10.5mm x 18.5mm

LDM-5 New Low Price \$59.95

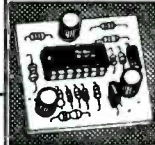

VOICE ACTIVATED SWITCH

This VOX circuit can be used to operate a tape recorder, ham radio, CB radio, or turn on an alarm. The VOX-1 kit has 100MA of output that operates a relay, light, motor, ? What could you do with a sound activated switch? Power requirement 7.5 TO 18vDC. SIZE: .15" x 1.3"

VOX-1

KIT \$6.95



WIDE BAND PREAMP

The ideal preamp for scanners, hand held radios, frequency counters. Amplifies low level

(weak) signals. If the signal is extremely low 2 amps can be used in series. 1MHz to 2.5GHz @ 2.8dB NF. 1dB compression = +0 dBm. Gain: 1MHz=20dB to 2.5GHz=6dB. Power requirement 12v DC @ 6Ma. SIZE: 1.2" x .8"

WBA-6

KIT \$19.95

CIRCLE 137 ON FREE INFORMATION CARD

Electronics Paperback Books

How to Use Op Amps



BP88—How to Use Op Amps...\$5.95. A designer's guide that covers operational amplifiers. Serving as both a source book of circuits and a reference book for design calculations. The text is non-mathematical and easy to understand by most readers.

30 Solderless Breadboard Projects

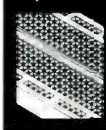

BP113—30 Solderless Breadboard Projects-Book 2...\$5.95. Companion to BP107. Presented in exactly the same style using "Verobloc" breadboards. All the breadboard projects in this book are based on CMOS logic integrated circuits.

An Introduction to Computer Communications

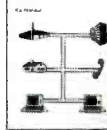

BP177—Introduction to Computer Communications...\$5.95. Details on types of modems and their suitability for specific application, plus details of connecting various computers to modems, and modems to the telephone system.

Electronic Board Games



BP350—Electronic Board Games...\$6.00. Twenty novel electronic board games that you can build from the plans in this book. Some games are motor racing, searching for buried treasure or for gold in Fort Knox, — there is something for you to build and enjoy!

Beginners Guide To Digital Techniques



BP61—Beginners Guide to Digital Techniques...\$5.00. Covers the basics of digital techniques—decimal, binary, octal and hexadecimal numbering systems are covered plus insights on weighted and non-weighted binary-coded-decimal codes and alphanumeric codes. The basic building blocks of circuit logic, the common AND, OR, NAND, NOR and EXCLUSIVE-OR gates and bi-stables are thoroughly covered.

A Beginners Guide to Modern Electronic Components



BP285—A Beginners Guide to Modern Electronics Components...\$6.50. It is easy for newcomers to electronics to become confused. There are a great many different types of components available often with numerous variations of each type. This book presents the reader with a vast amount of invaluable parts information to enable the right component to be selected every time for repairs and projects.

PRACTICAL MIDI HANDBOOK



PCP103—Practical MIDI Handbook...\$9.95. The Musical Instrument Digital Interface (MIDI) is surrounded by a great deal of misunderstanding. This book is aimed at musicians and technicians who want to explore the vast capabilities of MIDI. It covers MIDI-based equipment you can use: keyboards, drum machines, sequencers, effects units, mixers, drum pads guitars. There is also a section on computer music.

Electronic Music and MIDI Projects



PCP119—Electronic Music and MIDI Projects...\$14.95. Save cash by building the MIDI gadgets you need. Want a MIDI Thru box, program change pedal, Metronome, analog echo unit? Over 16 practical and very useful music and MIDI projects.

How to Design and Make Your Own PCB's



BP121—How to Design and Make Your Own PCB's...\$5.75. Simple methods for copying printed-circuit board designs from magazines and books on to copper. Covers all aspects of simple PCB construction as comprehensively as possible.

IC 555 Projects



BP44—IC 555 Projects...\$5.95. Every so often a device appears that is so useful that one wonders how life went on before without it. The 555 timer integrated-circuit chip is one such device. Included are basic and general circuits used by most hobbyists.

DATA BOOK

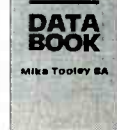

PCP109—Everyday Electronics Data Book...\$10.00. An invaluable source of electronic information—the text contains sections that deal with the underlying theory of electronic circuits and a wide range of practical electronic uses for everyone.

Antennas for VHF and UHF



BP301—Antennas for VHF and UHF...\$6.00. From installing a TV or FM antenna to setting up a multi-antenna array for shortwave listening or amateur radio, this book explains the basics of VHF and UHF antenna operation and installation. The text describes in easy-to-understand terms the essential information about how antennas work, the advantages of different antenna types, and how to get the best performance.

Loudspeakers for Musicians



BP297—Loudspeakers for Musicians...\$6.25. Contains all the information that a working musician needs to know about loudspeakers; the different types, how they work, the most suitable for different instruments, for cabaret work, and for vocals. It gives tips on constructing cabinets, wiring up, available fittings, finishing and how to connect multi-speaker arrays, etc. Includes ten enclosure designs with plans.

ELECTRONIC POWER SUPPLY



PCP110—Electronic Power Supply Handbook...\$10.95. All types of power supplies used for electronics purposes are covered in detail, starting with cells and batteries and extending by way of rectified supplies and linear stabilizers to modern switch-mode systems, IC switch-mode regulators, DC-converters and inverters. The devices, their operating principles and typical circuits, are dealt with in detail.

From Atoms to Amperes



BP254—From Atoms to Amperes...\$6.50. Explains in crystal-clear terms the fundamentals behind the whole of electricity and electronics. Really helps you to understand the basis of the complex subject perhaps for the first time ever.

Practical Digital Electronics Handbook



PCP101—Practical Digital Electronics Handbook...\$9.95. An introduction to digital circuits, logic gates, bi-stables, timers, microprocessors, memory and I/O devices. A special feature of the book is the section on digital test gear projects.

An Introduction to the Electromagnetic Wave

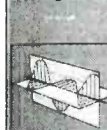

BP315—Introduction to the Electromagnetic Wave...\$5.95. A fundamental and easy-to-understand approach to a complicated theory topic. The beginner requires no more than elementary mathematics and basic knowledge of electronics.

Essential Theory for the Electronics Hobbyist



#228—Essential Theory for the Hobbyist...\$5.25. Supplies to the hobbyist background knowledge tailored to the specific requirements of the hobbyist. Relevant material is presented in a readable manner with minimum mathematics.

TEST EQUIPMENT SPECIALS

- BP239—Getting the Most from Your Multimeter...\$5.95**
Covers analog and digital gear, component and gear testing.
- BP267—How to Use Oscilloscopes & Other Testing Equipment...\$6.95**
Get with the next step to proficient troubleshooting.
- PCP111—Electronic Test Equipment Handbook...\$13.95**
The all-purpose, all-pro handbook that covers basics to in-circuit testing.

SUBSTITUTION GUIDES FOR HOBBYISTS

- BP85—International Transistor Equivalents Guide...\$7.50**
The ultimate guide to replacing foreign and domestic transistors.
- BP108—International Diode Equivalents Guide...\$5.95**
Rectifiers, Zeners, LEDs, OCIs, diacs, triacs...all hobby types.
- BP140—Digital Equivalents and Pin Connectors...\$12.50**
A master reference for builders who design projects.

ELECTRONIC TECHNOLOGY TODAY INC.
P.O. BOX 240, Massapequa, NY 11762-0240

Name _____
Address _____
City _____ State _____ Zip _____
PE6

SHIPPING CHARGES IN USA AND CANADA	
\$0.01 to \$5.00	\$2.00
\$5.01 to \$10.00	\$3.00
\$10.01 to 20.00	\$4.00
\$20.01 to 30.00	\$5.00
\$30.01 to 40.00	\$6.00
\$40.01 to 50.00	\$7.00
\$50.01 and above	\$8.50

SORRY No orders accepted outside of USA & Canada

Total price of merchandise	\$ _____
Shipping (see chart)	\$ _____
Subtotal	\$ _____
Sales Tax (NYS only)	\$ _____
Total Enclosed	\$ _____

Number of books ordered

All payments must be in U.S. funds!

CONTROL RELAYS • LIGHTS • MOTORS MEASURE TEMPERATURE • PRESSURE • LIGHT LEVELS • HUMIDITY INPUT SWITCH POSITIONS • THERMOSTATS • LIQUID LEVELS

MODEL 30 \$79



- PLUGS INTO PC BUS
- 24 LINES DIGITAL I/O
- 8 CHANNEL
- 8 BIT A/D IN
- 12 BIT COUNTER
- UP TO 14K SMP/SEC

MODEL 45 \$189



- RS-232 INTERFACE
- 8 DIGITAL I/O
- 8 ANALOG INPUTS
- 2 ANALOG OUTPUTS
- 2 COUNTERS-24 BIT

MODEL 100 \$279



- 12 BIT 100 KHZ A/D
- 4 ANALOG OUTPUTS
- 3 TIMER COUNTERS
- 24 DIGITAL I/O

MODEL 150-02 \$179



- RS-232 INTERFACE
- TRMS, 20 AMPS
- 12 BIT A/D
- OPTO-ISOLATED
- COMPLETE DMM

MODEL 40 \$99



- RS-232 INTERFACE
- 28 LINES DIGITAL I/O
- 8 ANALOG INPUTS
- PWM OUTPUT

MODEL 70 \$239



- RS-232 INTERFACE
- 18 BIT A/D
- 5.5 DIGIT
- UP TO 60 SMP/SEC

Prairie Digital, Inc.

PHONE 608-643-8599 • FAX 608-643-6754
846 SEVENTEENTH STREET • PRAIRIE DU SAC, WISCONSIN 53578

CIRCLE 47 ON FREE INFORMATION CARD

SHOW TIME CABLE

Your Cable
Connection
To The Stars!



Order your **FREE**
catalog today!
1-800-643-4258



STARGATE SST

- Converters & Descramblers
- All Makes & Models
- Quantity Discounts
- 30-day Money Back Guarantee
- Best Warranties

Show Time Cable
643 N 98th St STE 260
Omaha, NE 68114

COD • MasterCard • Visa • Amex • Discover

❖ ATTENTION CABLE VIEWERS ❖

CABLE VIEWERS... get back to your **BASIC** Cable Needs

Call 800-577-8775

For information regarding all of your **BASIC** cable needs.



- 5 GOOD REASONS TO BUY OUR FAR SUPERIOR PRODUCT
- ❖ PRICE
 - ❖ EFFICIENT SALES AND SERVICE
 - ❖ WE SPECIALIZE IN 5, 10 LOT PRICING
 - ❖ ALL FUNCTIONS (COMPATIBLE WITH ALL MAJOR BRANDS)
 - ❖ **ANY SIZE ORDER FILLED WITH SAME DAY SHIPPING**

We handle **NEW** equipment **ONLY** - Don't trust last year's **OBSOLETE** and **UNSOLD** stock!
COMPETITIVE PRICING—DEALERS WELCOME

HOURS: Monday-Saturday 9-5 C.S.T.

It is not the intent of B.E.S.W. to defraud any pay television operator and we will not assist any company or individual in doing the same.
*Refer to sales personnel for specifications.

BASIC ELECTRICAL SUPPLY & WAREHOUSING CORPORATION

P.O. Box 8180 ■ Bartlett, IL 60103 ■ 800-577-8775

HOME AUTOMATION

Largest Selection of HOME AUTOMATION products in the World!

Browse us on the WEB!

<http://www.techmall.com/smarthome>

Hundreds of hard-to-find automation, X10, and wireless control products. Computer control of your home, security systems, surveillance cameras, infra red audio/video control, HVAC, pet care automation, wiring supplies, and much more!

HOME AUTOMATION SYSTEMS, INC.

151 Kalmus Drive, Ste L4, Costa Mesa, CA 92626
Questions 714-708-0610 FAX 714-708-0614

800-SMART-HOME

Call 24hrs for FREE
64 page Color Catalog Over 500
unique products!

HOME AUTOMATION
SYSTEMS, INC.



FREE

EPROM+ PROGRAMMING SYSTEM USES PARALLEL PORT

EPROMS (24,28,32 & 40 PIN)*+27C AND 25XX
1702*,2708,TMS2716*,32,32A,64,64A,128,128A
256,512,513,011,010,101,1001,1000,1024,210,020
2001,220,2048,4001/2,040,080,240,4096,68764/66
FLASH EPROMS 28F256, 28F512, 28F010
28F020,29C257,29C010,29C040,29F010,29F040
EEPROMS & NVRAMS (18,24 & 28 PIN+CXX)
2210, 2212, 2804, 2816, 2816A, 2817, 2864, 2865
28256, 28C010, DS1220, DS1225, DS1230
SERIAL EEPROMS* (8 & 14 PIN PLUS CXX)
ER1400,M58657, 2401,02,04,08,16,32,65, 2444
59C11,80011A,9306,46,56,66,8572,82,92,1689XX
BIPOLAR PROMS* (16 THROUGH 24 PINS)
74SXXX AND 82SXXX FAMILY
MICROCONTROLLERS* 8741, 42, 48, 49, 8751
C51, 52, C52, 87C5XXX, 87C75X, 89C5X, 68705
68HC705, 68HC711E9, PIC16CXX, TMS7742
*ADAPTER REQUIRED - DIAGRAMS INCLUDED
SOFTWARE - READ, VERIFY, PROGRAM, COPY
DISK FILE LOAD/SAVE, CHECKSUM, FULL
SCREEN BUFFER EDITOR W/20 COMMANDS
READS HEX, S-RECORD AND BINARY FILES
FAST-DEVICES PROGRAM IN UNDER 20 SEC
RUGGED (9"X6"X3")ENCLOSURE W/HANDLE
MADE IN USA - 1 YEAR WARRANTY



SYSTEM INCLUDES:
PROGRAMMING UNIT
PRINTER PORT CABLE
POWER PACK, MANUAL
AND SOFTWARE.

\$289

ADD \$5.00 SHIPPING
\$5.00 C.O.D.
VISA/MASTERCARD

ANDROMEDA RESEARCH, P.O. BOX 222, MILFORD, OH 45150
(513) 831-9708 FAX (513) 831-7562

CABLE TV CONVERTERS

Equipment & Accessories
Wholesalers Welcome

Call VISION TIME PRODUCTS

1-800-310-1153 M-F 8a-8p
NO TENN SALES

Invest a stamp...Save a bundle

For the price of a stamp, you can get the latest edition of the federal government's free
Consumer Information Catalog. It lists more than 200 free or low-cost publications on federal
benefits, jobs, health, housing, education, cars, and more.

So stamp out ignorance with our free Catalog. Send your name and address to:
Consumer Information Center, Department SB, Pueblo, Colorado 81009

LEARN COMPUTERS!

Home study: become an expert on the personal computer for home or business use.
Free literature: 800-223-4542

Name _____ Age _____
Address _____ Phone (____) _____
City/State _____ Zip _____

School of Computer Training, Dept. KKB341
6065 Roswell Road, PCDI, Atlanta, GA 30328



CABLE TV Converters & Descramblers

Compatible with

**Jerrold, Scientific Atlanta,
Pioneer, Oak, & Hamlin
Equipment**

BRAND NEW!

6-MONTH GUARANTEE

LOWEST PRICES

Volume Control & Parental Lockout Available

Greenleaf Electronics

1-800-742-2567

NO ILLINOIS SALES

It is not the intent of Greenleaf Electronics to defraud any pay television operator
and we will not assist any company or individual in doing the same.

!!! BROADCAST FARTHER !!!

The model 1525 is a 75-110MHz RF amplifier that connects to mono or
stereo FM transmitters and produces a powerful 15-20 watt signal which
could broadcast up to 5 miles or more! Requires 75-250 mW drive.

Step by step plans complete with part source information and antenna designs... **ONLY \$14 PLUS \$2 S&H**
NO C.O.D.'s

Progressive Concepts
1434 N. MILLS AVE., SUITE A
CLAREMONT, CA 91711 (909) 626-4969 (909) 626-4FAX

Satellite-TV

SAVE 40% - 60%

800-334-6455
218-739-5231 Int'l
218-739-4879 Fax

Skyvision®

1048 FRONTIER DRIVE • FERGUS FALLS, MN 56537

**FREE
Buyer's
Guide**

Learn how to repair VCRs!

Home study. Learn low-overhead, high-profit repairs step
by step. Start a great career or open your own business.

Free career literature: 800-223-4542

Name _____ Age _____
Address _____ Phone (____) _____
City/State _____ Zip _____
The School of VCR Repair, DEPT VRB341
PCDI, 6065 Roswell Rd., Atlanta, GA 30328



There's No Easier Way to TROUBLESHOOT AND REPAIR Your Electronics!



It's easy, fast and rewarding to do it yourself with the Electronics Repair Manual!

- TVs VCRs
- Hi-Fi Stereo Amplifiers
- Turntables
- Speakers
- Shortwave Radios
- Camcorders
- Tape Decks
- CD Players
- Walkmans
- AM & FM Receivers
- PC Systems
- Automobile Sound Systems
- PC Peripherals
- Telephone Systems
- Fax Machines
- Electronic Home Appliances

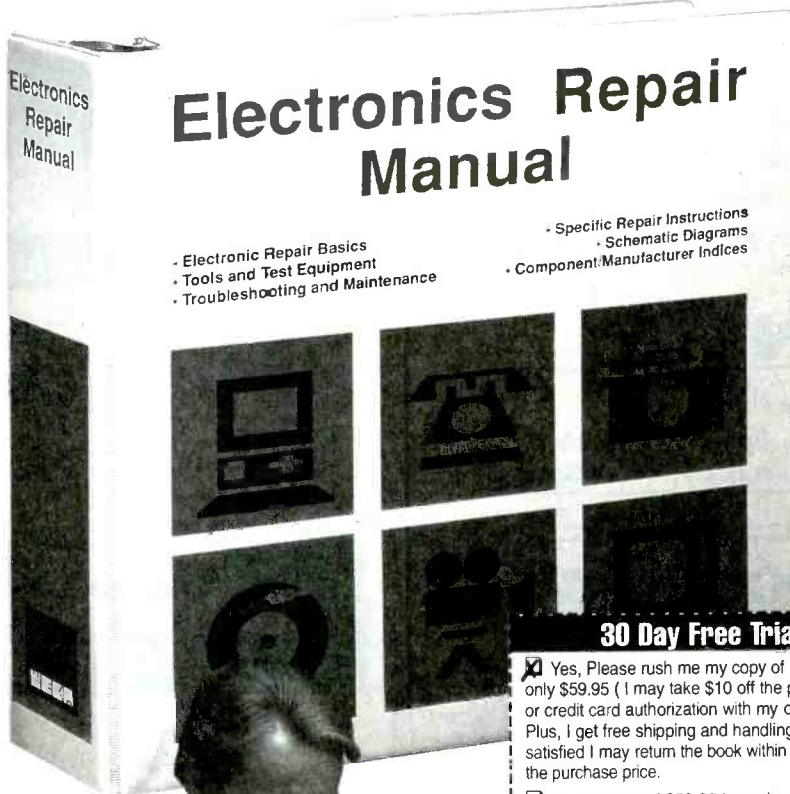

- 900-PAGE, MODULAR FORMAT MANUAL
- TROUBLE ANALYSIS FLOWCHARTS
- SCHEMATIC DIAGRAMS
- HANDS-ON, DETAILED, TROUBLESHOOTING INSTRUCTIONS
- "HOW TO" PRIMER FOR TEST EQUIPMENT SUCH AS OSCILLOSCOPES, FREQUENCY COUNTERS, AND VIDEO ANALYZERS
- SAFETY PRECAUTION CHECKLISTS
- COMPREHENSIVE REPLACEMENT PARTS LISTS
- PREVENTIVE MAINTENANCE TECHNIQUES
- DIRECTORY OF MANUFACTURERS

Electronics Repair Manual

- Electronic Repair Basics
- Tools and Test Equipment
- Troubleshooting and Maintenance

- Specific Repair Instructions
- Schematic Diagrams
- Component/Manufacturer Indices

30 Day Free Trial Order Form

Yes, Please rush me my copy of Electronics Repair Manual for only \$59.95 (I may take \$10 off the price when I enclose my check or credit card authorization with my order within the next 30 days. Plus, I get free shipping and handling!) I understand that if I am not satisfied I may return the book within 30 days for a full 100% refund of the purchase price.

My payment of \$59.95 is enclosed (\$49.95 when ordering with-in the next 30 days.)

Check enclosed.

Optional express delivery (available in U.S. only). Enclose an additional \$10.00 and we'll guarantee delivery within 5 business days from receipt of your order (prepaid orders only).

Credit card no.

Expiration Date Daytime phone no.

Signature

Bill me later for \$59.95 plus \$6.50 shipping and handling, subject to credit approval. Signature and phone number required to process your order. P.O. Box addresses must be prepaid.

Mr./Mrs./Ms. _____

Company _____

Address _____

City _____ State _____ Zip _____

Shipping and handling to Canada, \$10 (U.S. currency); Overseas, \$15 (foreign orders must be prepaid); CT residents add 6% sales tax. Supplements will be sent 4-5 times a year on a fully-guaranteed, 30-day trial basis. They may be cancelled at any time.

MAIL TO: WEKA Publishing, Inc. 82070
1077 Bridgeport Avenue, Shelton, Connecticut 06484

1-800-222-WEKA FAX: 1-203-944-3663

Keep Your Skills Up-to-Date!

The Electronics Repair Manual will be a valuable reference for years to come. Supplements, each containing 140 pages, add new repair projects, valuable insights into new technologies, diagnostic and repair techniques, and more schematic diagrams into your manual. Just \$35 each plus shipping and handling. Supplements are sent 4-5 times a year and are fully guaranteed. Return any supplements you don't want within 30-days and owe nothing. Cancel anytime.

INSTEK Test & Measuring Instruments

20 MHZ, 2-Channel, OSCILLOSCOPE

- model #OS-622B
- 20MHz, Dual Channel
- High Sensitivity 1mV/DIV
- TV Synchronization
- Z axis input
- ALT Triggering Function
- Hold Off Function
- Trigger Level Lock Function
- CH 1 Output
- Includes Probes (x1, x10)
- 2 Year Warranty



Regular \$499.00 Sale \$389.95



800-638-2020



Test Instruments, Equipment, Tools & Supplies For Electronic Production, Maintenance & Service
8931 Brookville Road, Silver Spring, MD, 20910 * 800-638-2020 * Fax 800-545-0058

CIRCLE 130 ON FREE INFORMATION CARD

Electronic Training Videos



Learn electronics quickly and easily with UCANDO's computer-animated training videos. Students can learn at their own pace and professionals will find the UCANDO videos to be a valuable source of reference material. If these videos aren't the best learning tools you've ever seen, return them within 30 days for a

complete refund. These videos are being used by Tech-Schools, CET's, Military Branches, Ham Operators, Industries, and more, across the United States and around the world. Order today and see how UCANDO is ...

"Changing The Way The World Learns Electronics."

VCR Maintenance & Repair ... \$29.95 All others ... \$44.95 each
• Intro to VCR Repair • Direct Current • Alternating Current • Semiconductors • Power Supplies • Amplifiers • Oscillators • Digital 1 • Digital 2 • Digital 3 • Digital 4 • Digital 5 • Digital 6 • AM Radio • FM Radio Part 1 • FM Radio Part 2 • TV Part 1 'Intro to TV' • TV Part 2 'The Front End' • TV Part 3 'Audio' • Fiber Optics • Laser Technology •

SAVE!!! 6 videos for only \$240 or 12 videos for only \$450



1-800-678-6113

or mail check or money order to:

UCANDO Videos
P.O. Box 928
Greenville, OH 45331



FREE Shipping ... FREE Catalog

CIRCLE 136 ON FREE INFORMATION CARD

PROFESSIONAL COUNTERSURVEILLANCE EQUIPMENT

AI 6600 Phone Tap Detector

Detects:

- Radio Frequency Taps
- Series and Parallel Taps
- Line Impedance Taps
- Extension Phone Listeners

\$149.95



AI 2100 VIBRATING TRANSMITTER DETECTOR

Detects:

- Body Wires
- FM Wireless Mics
- AM Transmitters
- UHF Transmitters



AI 5500 COMPLETE SAFETY SYSTEM

Detects:

- All Phone Taps and Extension Phone Listeners
- All Body-Wires, Wireless Mics, AM, FM and UHF Transmitters

Detects:

- All Body Wires, Transmitters and Distance Microphones with its built in white noise signal breaker

\$379.95



We sell a variety of covert cameras, transmitters, night vision equipment, video transmitters, time lapse recorders, remote video monitoring systems, body armour, and much more...

Request Our Full Catalog for \$5.00, Receive \$10.00 OFF First Order (FREE WITH ANY PURCHASE)

AMERICAN INNOVATIONS, INC.
119 Rockland Center Suite 315 Nanuet, N.Y. 10954
914-735-6127 • Fax 914-735-3560



IMPROVE YOUR IMAGE!

WITH OUR VIDEO STABILIZERS

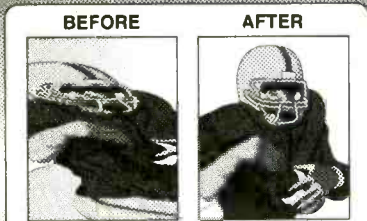

SUPER VHS MODEL AVAILABLE!
The clearest picture possible playing back movies. **GUARANTEE** to eliminate copy protection.

- No Rolls/Jitters/Flickers/Fading
- Works on all TV's, VCR's Beta & Cable
- Gold Video Connectors & Cables Included
- 2 Year Warranty
- Money Back Guarantee



VISION ELECTRONICS

1-800-562-2252

2125 S. 156TH CIRCLE • OMAHA, NE 68130

CABLE TV DESCRAMBLERS

Best Wholesale Prices in the U.S.A.!

	10-19	20-49	50+
<i>For Jerrold Systems</i>			
FX TB	89	59	50
Stealth	79	59	50
<i>For Scientific Atlanta Systems</i>			
M80	85	65	55
<i>For Pioneer Systems</i>			
PIO Plus	89	79	69
<i>Everquest Converters</i>			
Stargate Elite Non-Parental	72	63	54
Stargate Elite Parental	76	69	59

1-800-818-9688

MD Electronics

875 S. 72nd St. • Omaha, NE 68114

Learn MICROCONTROLLERS EMBEDDED SYSTEMS and PROGRAMMING with the New AES-10

The AES-10... a complete learning system, a complete embedded control system. Extensive manuals guide you through your 8051 development project. Assembly, BASIC, and C programmable. All hardware details, complete schematics. Learn to program the LCD, keypad, digital and analog I/Os. The entire board is software reconfigurable for your applications. Everything you need, nothing extra required.

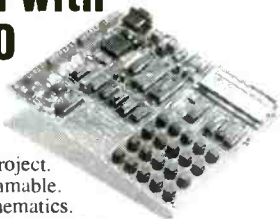

80C32 Computer/Microcontroller board with:

- 32K Byte ROM • 32K Byte RAM • 2 by 16 Liquid Crystal Display • 4 by 5 Keypad • Two serial ports • 5 interrupt sources • 3 timers • A/D, D/A, PWM and digital I/O • Built in Logic Probe • Power supply (can also be battery operated) • Extended Intel BASIC and AES Monitor in ROM • RS-232 cable to connect to PC for programming • 8051/52 DOS Cross Assembler • Program disks with well documented examples • User's Manual, Language Manual, and Text (over 400 pages).

AES-10 \$285 Complete
Money Back Guarantee

Free Info Pack, M/C Visa
714 - 550-8094
Fax 714 - 550-9941

AES

Advanced Educational Systems

970 W. 17th St., Santa Ana, California. 92706 USA

CALL 1 - 800 - 730-3232

Low Cost CAD Software
for the IBM PC and Compatibles
Now In Windows™

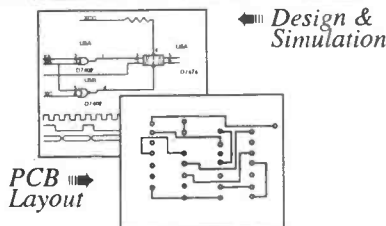

- Easy to use schematic entry program (SuperCAD) for circuit diagrams, only \$149. Includes netlisting, bill of materials, extensive parts libraries, More parts, and automatic wiring available in enhanced CAD package (SuperCAD+) for only \$249.
- Powerful, event-driven digital simulator (SuperSIM) allows you to check logic circuitry quickly before actually wiring it up. Works directly within the SuperCAD editor from a pulldown menu and displays results in "logic analyzer" display window. Starting at \$149 this is the lowest cost simulator on the market. Support for PALs, a larger library, and a separate interactive logic viewer are available in full-featured SuperSIM+ for only \$399. Library parts include TTL, CMOS and ECL devices.
- Circuit board artwork editor and autorouter programs (SuperPCB), starting at \$149. Produce high quality artwork directly on dot matrix or laser printers. You can do boards up to 16 layers including surface mount. Includes Gerber and Excellon file output. Autorouter accepts netlists and placement data directly from the SuperCAD schematic editor.
- Low cost combination packages with schematics and PCB design: 2-layer for \$399, 16-layer for \$649.
- DOS version available.

Write or call for free demo disks:
MENTAL AUTOMATION, INC.
5415 - 136th Place S.E.
Bellevue, WA 98006
(206) 641-2141
BBS (206) 641-2846

USE POPULAR ELECTRONICS CLASSIFIEDS

READ BY BUYERS OF ELECTRONIC EQUIPMENT ACCESSORIES AND PARTS

INSTRUCTIONS FOR PLACING YOUR AD!

HOW TO WRITE YOUR AD

TYPE or **PRINT** your classified ad copy **CLEARLY** (not in all capitals) using the form below. If you wish to place more than one ad, use a separate sheet for each additional one (a photo copy of this form will work as well). Place a category number in the space at the top of the order form (special categories are available). If you do not specify a category, we will place your ad under miscellaneous or whatever section we deem most appropriate.

We cannot bill for classified ads. **PAYMENT IN FULL MUST ACCOMPANY YOUR ORDER.** We do permit repeat ads or multiple ads in the same issue, but, in all cases, full payment must accompany your order.

WHAT WE DO

The first word and company name of each ad are set in bold caps at no extra charge. No special positioning, centering, dots, extra space, etc. can be accommodated.

RATES

Our classified ad rate is \$1.75 per word. Minimum charge is \$26.25 per ad per insertion (15 words). Any words that you want set in bold are each .40 extra. Indicate bold words by underlining. Words normally written in all caps and accepted abbreviations are not charged anything additional. State abbreviations must be post office 2-letter abbreviations. A phone number is one word.

If you use a **Box number** you must include your permanent address and phone number for our files. **ADS SUBMITTED WITHOUT THIS INFORMATION WILL NOT BE ACCEPTED.**

For firms or individuals offering Commercial products or Services. **Minimum 15 Words.** 5% discount for same ad in 6 issues within one year; 10% discount for same ad in 12 issues. **Boldface** (not available as all caps), add .40 per word additional. **Entire ad in boldface**, add 20%. **Tint screen behind entire ad**, add 25%. **Tint screen plus all boldface ad**, add 45%. **Expanded type ad**, add \$2.25 per word.

General Information: A copy of your ad must be in our hands by the 13th of the fourth month preceding the date of issue (i.e. Sept issue copy must be received by May 13th). When normal closing date falls on Saturday, Sunday or Holiday, issue closes on preceding work day. Send for the classified brochure.

DEADLINES

Ads not received by our closing date will run in the next issue. For example, ads received by November 13 will appear in the March issue that is on sale January 17. **POPULAR ELECTRONICS** is published monthly. No cancellations permitted after the closing date. No copy changes can be made after we have typeset your ad. **NO REFUNDS**, advertising credit only. No phone orders.

CONTENT

All classified advertising in **POPULAR ELECTRONICS** is limited to electronics items only. All ads are subject to the publishers approval. **WE RESERVE THE RIGHT TO REJECT OR EDIT ALL ADS.**

AD RATES: \$1.75 per word. Minimum \$26.25

Send you ad payments to:

POPULAR ELECTRONICS 500 Bi-County Blvd, Farmingdale, NY 11735-3931

CATEGORIES

100 -- Antique Electronics	270 -- Computer Equipment Wanted	450 -- Ham Gear Wanted	630 -- Repairs-Services
130 -- Audio-Video Lasers	300 -- Computer Hardware	480 -- Miscellaneous Electronics For Sale	660 -- Satellite Equipment
160 -- Business Opportunities	330 -- Computer Software	510 -- Miscellaneous Electronics Wanted	690 -- Security
190 -- Cable TV	360 -- Education	540 -- Music & Accessories	710 -- Telephone
210 -- CB-Scanners	390 -- FAX	570 -- Plans-Kits-Schematics	720 -- Test Equipment
240 -- Components	420 -- Ham Gear For Sale	600 -- Publications	730 -- Wanted

CLASSIFIED AD COPY ORDER FORM

Place this ad in Category # _____ Special Category \$20.00 Additional _____

1 - \$26.25	2 - \$26.25	3 - \$26.25	4 - \$26.25	29 - \$50.75	30 - \$52.50	31 - \$54.25	32 - \$56.00
5 - \$26.25	6 - \$26.25	7 - \$26.25	8 - \$26.25	33 - \$57.75	34 - \$59.50	35 - \$61.25	36 - \$63.00
9 - \$26.25	10 - \$26.25	11 - \$26.25	12 - \$26.25	37 - \$64.75	38 - \$66.50	39 - \$68.25	40 - \$70.00
13 - \$26.25	14 - \$26.25	15 - \$26.25	16 - \$28.00	Total words _____		\$1.75 per word = \$ _____	
17 - \$29.75	18 - \$31.50	19 - \$33.25	20 - \$35.00	Bold Face _____		\$0.40 per word = \$ _____	
21 - \$36.75	22 - \$38.50	23 - \$40.25	24 - \$42.00	Special Heading _____		\$20.00 = \$ _____	
25 - \$43.75	26 - \$45.50	27 - \$47.25	28 - \$49.00	Other _____		= \$ _____	

Total classified ad payment \$ _____ enclosed **TOTAL COST OF AD** \$ _____

Check Mastercard Visa Card # _____ Expiration Date ___/___/___

Signature _____

Name _____ Phone _____

Address _____ City State Zip _____

TOP SECRET

CONSUMERTRONICS
2011 Crescent Dr., P.O. Drawer 837
Alamogordo, NM 88310

Voice: (505) 439-1776, 439-8551
8AM - 7PM MST, Mon - Sat

Fax: (505) 434-0284, 434-1778 (orders only, if you get voice, enter *#11 #11 any time), 24-hr

Free Tech Support: (relates directly to your order or prospective order): **Tues. & Thurs. only.**

10% Off on orders \$100+ 15% Off over \$200+ Add \$5 total SH (US, Canada). All items in stock. **VISA, MC Card OK.** No CODs or "bill me's". New Catalog (200+ offers) \$2 w/order, \$5 wb (check or MO). **No dealers.** Since 1971. As seen on CBS "60 Minutes", "Forbes", etc. By John Williams - former Lockheed Senior Engineer, NMSU CS Professor, DOD Electronic Weapons Engineer, NIH Health Physicist. **Wanted:** • MAC Int. PCAs (or better), peripherals, new surplus electronic parts, test equipment - buy, trade. • All software supports all IBM-PC compatible x86 systems (8088 - Pentium).

Off-The-Shelf HARDWARE

Van Eck Systems • Data Card Reader/Writers • ATM3 • RF/EM/IR/Wave/Radar/Ultrasonic/IR/Light/Sound Detectors/Receivers/Xmitters/Jammers/Blasters • Security/Surveillance • EM Lab/Weaponry/Countermeasures • Neurophones/Rife/Hieronymus/Resonant Crystal Radionics • Voice Disguisers • ESS Infinity Devices • Phone Color Boxes • DTMF Decoders • Lineman's Handsets • Bug/Tap Detector/Blaster • Bumper Beeper/Child Finder • Panic Button • Carjack/Kidnap Follower • Hidden Presence Detectors • Hearing Assistor • Shriek Module • TENS • Subliminal Mixer/Amp • Vortex Generator • 6th Sense Communicator • Noise Cancel. System • Electronic Dowsing • Laser • Levitator - more! See our New Catalog!

SPECIAL PROJECTS

We design/build/obtain/repair/modify/maintain/consult on any device/system/process/project - electronic/computer/mechanical/optical (ex: phone/auto/security/radionic/lab/energy/HV/EM/RF/Radar/ultrasonic/IR/UV/commo/consumer) for business/personal/invention needs. Describe & include \$30 pre-engineering fee (no obligation). Time & cost estimates 7-10 days. Confidentiality guaranteed.

CELLPHONE MODS

See our Catalog for our infamous cellphone modification guide (\$69) - detailed, comprehensive, covers all makes - 10 times more info than competitor's "guide"! (Do Special Projects (above) to get up-to-date hardware/software).

VOICE MAIL HACKING

How Voice Mail Box (VMB) systems are used and the specific ways they are hacked. Includes ASPEN, MESSAGE CENTER, BIX, GENESIS, EZ, SYDNEY, PHONE MAIL, AUDIX, CINDY, CENTAGRAM, SPERRY LINK, RSPV, etc. Absolutely required for all users, sysops and security personnel! \$29.

PBX HACKING

1,000s of PBXs are hacked to the tune of \$ Billions/yr! While "VOICE MAIL HACKING" details how VMSs are hacked for "spun" and profit - including VMS methods for hacking PBXs themselves - "PBX HACKING" addresses ALL issues relating to PBX hacking, including countermeasures! Can your business or agency afford a \$90,000 phone fraud loss (the average loss due to hacked PBXs)? As described in Forbes Magazine. \$29

PHREAKING CALLER ID & ANI

Details on how they work and dozens of effective ways of defeating Caller ID, ANI, *69, *57, and Call Blocking and *67. Also describes Caller ID, Orange, Belge, Cheese and CF Boxes, ESS, SS7, E-911, various CLASS services, CNA, NON PUB DA, CAMA, DNR, 800-ECR, Diverters, Extenders, Centrex - more. \$29.

Beyond PHONE COLOR BOXES

Dozens phone color boxes described - many circuits. Plus Call Forwarding, Conferencing, Phreak History, Glossary, Diverters, Extenders, Loops, REMOBS, Bridging Heads & Cans, Optocom, 3rd Party and many other non-box methods - more. \$39.

ROBOFONE AUTODIALER

Powerful, versatile, menu-driven "Wargames" autodialer lets you dial any quantity (up to 10K) or mix of local/long distance numbers in any order, over any length of time, whether busy or answered (your choice) and log the times, commands and results to monitor, printer and/or disk. Quick-dial directory up to 600 numbers. BUSY redial options. Direct modem command and control. All Result Codes, including VOICE and RINGING. Optional shell to terminal program upon CONNECT. Exit to menu or DOS (for batching). Manual + Disk* \$29.

By an ORDER of the MAGNITUDE

The most comprehensive, hard-hitting, hi-tech survival book ever written! Topics include electronics, computers, energy, weapons, concealment, revenge, alarms, etc. to survive today's dangerous world. We all face increasingly financially and physically brutal times! Field-expertise use of technology in various threat and conflict environments and scenarios. \$49. **Bold for educational purposes only!**

COMPUTER PHREAKING

Describes in detail how computers penetrate each other, and how VIRUSES, TROJAN HORSES, WORMS, etc. are implemented. Dozens of computer crime and abuse methods and countermeasures. Includes disk filled with hacker text files and utilities, and the legendary FLUSHOT+ protection system (Ed. Choice, PC Magazine), BBS advice, password defeats, glossary - much more! Manual + Disk* \$39.

The HACKER FILES

Compilation of 100s of the best articles written (in ASCII) by top hackers & phreakers. Covers every major topic in hackerdom! 3 HD Disks* \$39.

Beyond VAN ECK PHREAKING

Eavesdropping on TV and computer video signals using an ordinary TV described in detail. Includes security industry reports. Range up to 1 KM. Plans include both the Consumertronics and the original Top Secret Van Eck designs! \$29.

STOPPING POWER METERS

As reported on CBS "60 Minutes": How certain devices can slow down - even stop - watt-hour meters - while loads draw full power! Device simply plugs into one outlet and normal loads into other outlets. Also describes meter creep, overload droop, etc. Plans \$29. **I.G. MANUAL:** External magnetic ways (applied to the meter itself) to slow down and stop watt-hour meters while drawing full loads. Plans. \$19. **KW-HR METERS:** How watt-hour meters work, calibration, error modes (many), ANSI Standards, etc. Demand and Polyphase Meters. Experimental results to slow and stop meters by others. \$19. Any 2, \$38. All 3, \$59.

AUTOMATIC TELLER MACHINES

ATM crimes, abuses, vulnerabilities and details exposed! 100+ methods detailed. Include: Physical, Reg. E. cipher, PIN compromise, card counterfeiting, magnetic stripe, false front, TEMPEST, Van Eck, tapping, spoofing, inside job, super-cool, vibration, pulse, high voltage - others. Case histories, law, countermeasures, detailed security checklist, labeled internal photos, figures. ATMs contain up to \$250,000 in cash! Recent \$350,000 ATM crime spree still unsolved! \$39.

CREDIT CARD SCAMS

Cardholders, merchants, banks suffer \$ Billions in losses annually because of credit card fraud. Describes every known means of credit card fraud and scams. Protect yourself! \$29.

CONS. SCAMS & SWINDLES

Cons & scams and related swindles fleece Americans of \$100+ Billion per year! The most comprehensive survival manual on cons & scams of all kinds - from the classic to hi-tech. Details on 100s and many variations. And countermeasures. Protect yourself! \$39.

STEALTH TECHNOLOGY

Police radar is fascinating! It also has error rates of 10-20%! Every known error mode - stealth method and material used to minimize radar reflections - tactic and strategy to fight unjust radar tickets (that cost you \$100s in insurance and risk cancellation) - methods to detect and jam signals - fully described! \$29.

SECRET & SURVIVAL RADIO

Optimum survival and security radio equipment, methods, freq allocations and voice/data scrambling/encoding. Includes small receivers/transmitters, telemetry, antenna optimizations, remote monitoring and control, security, surveillance, and ultrasonic, fiber-optic and infrared commo. 70+ circuit plans, tables. \$29.

HIGH VOLTAGE DEVICES

HV devices plans: Slon Gun, Laser, Prod, Cano, Paster, Flasher, Zapper, Audio/RF/Radar/Jammer, Fence Charger, Plasma Arc, Van de Graaf Generator, Jacob's Ladder, Galger Counter, Ozone Gun, Fish Stunner, Plant Stim, Kirlian, more! All plans for only \$29.

UNDER ATTACK!

Electromagnetic Interference and Electronic Weapon Attacks cause Cancer, birth defects, and profound psychological, neurological, cardiovascular and immune system disorders! Destructive to people, animals, plants, equipment! Includes ACTUAL CASES OF EM ATTACKS (we investigated)! Includes how to verify and pinpoint EMI and electronic attack sources, and effective countermeasures. \$29. **EM BRAINBLASTER!** Tutorial and plans for powerful ELECTROMAGNETIC WEAPONS and LAB DEVICES. Optimum circuits, freqs, waveforms, duty cycles, intensities. Thorough. \$29. Both \$49.

RADIONICS MANUAL

Exciting electrical, electronic, electromagnetic therapeutic, diagnostic & preventive devices (mostly experimental). History, descriptions, plans (dozens), availabilities of Radionics Devices from early to modern. While drugs cost \$100s, electricity costs pennies! \$29. **HEAL YOURSELF!** Plans for 3 major electronic therapeutic devices of types approved by FDA. \$19. Both \$39.

CRYPTANALYSIS TECHNIQUES

Five powerful menu-driven crypto programs (in COM and BAS source code) to analyze, decrypt "secure" ciphertexts. Worked-out examples. Recommended by prestigious "Computers & Security." Manual + Disk* \$29.

ROCKET'S RED GLARE

How to design and build solid-propellant amateur and survival rockets. Emphasis on formulation, manufacture, installation of propellants, motors, igniters, etc. Includes list of commonly available materials, and the design of launch pads and test beds and their electronics. \$29. **FIREWORKS:** How firecrackers (M-80s, blockbusters, cherry bombs), small rockets, volcanos, fountains, sparklers and safety fuses are made and colored. Simple, cheap, common ingredients. \$9. Both \$36.

ULTIMATE SUCCESS MANUAL

Underpaid, overworked, harassed or bullied? Victim of office politics? Stuck in a dead-end job? Can't find a good job? Expect to be laid off, fired or transferred soon? The ultimate no-holds-barred, looking-alter-#1 Machiavellian techniques to find, obtain, optimize and keep top jobs, pay and benefits. The Rules of the Game for a Game without Rules! From resume to CEO. \$29.

CABLE T.V. EQUIPMENT

Friendly, Knowledgeable Service



ORDERS CALL:
1-800-361-4586



- All Equipment New
- Convertors & Descramblers
- 30 Day Money Back Guarantee
- 6 Month Warranty
- Visa, MC, C.O.D. Welcome

KDE ELECTRONICS, INC.

P.O. Box 1494

Addison, IL 60101

Info. 708-889-0281 HRS: Mon-Fri, 9-6 CST

Fax 708-889-0283

Sat, 9-3 CST

DIGITAL STORAGE OSCILLOSCOPE

\$189.

The O-SCOPE is a pocket-size module that plugs into a PC's printer port and turns it into a DSO, Spectrum Analyzer, Freq. Counter, DVM and Data Logger. Accepts standard probes.

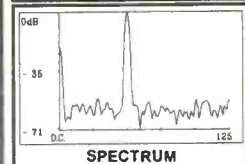
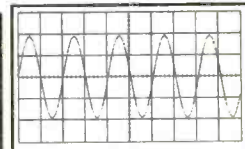

Includes software & instructions. Made in U.S.A.
Inquiries and Orders Accepted at: **1-800-980-9806**
Same-day shipping.

ALLISON TECHNOLOGY CORP.

Technical Phone: 713-777-0401

8343 Carvel

FAX: 713-777-4746

Houston, TX. 77036

BBS: 713-777-4753

U. S. A.

CABLE DIRECT

CONVERTERS
DESCRAMBLERS
VIDEO STABILIZERS
FILTERS



100%
MONEY BACK
GUARANTEE!

30 DAY
FREE
TRIAL!

FREE Cable TV Catalog.



Now you can tune-in your favorite cable TV programming and **SAVE \$100'S - EVEN \$1000'S** on premium CABLE TV EQUIPMENT.

MODERN ELECTRONICS

1-800-906-6664

2125 S. 156TH CIRCLE • OMAHA, NE 68130

Radiotelephone - Radiotelegraph

FCC Commercial License

Why Take Chances?

Discover how easy it is to pass the exams. Study with the most current materials available. Our **Homestudy Guides**, Audio, Video or PC "Q&A" pools make it so fast, easy and inexpensive. No college or experience needed. The new commercial FCC exams have been revised, covering updated Aviation, Marine, Radar, Microwave, New Rules & Regs, Digital Circuitry & more. We feature the Popular "Complete Electronic Career Guide" 1000's of satisfied customers

Guarantee to pass or money back. Send for **FREE DETAILS** or call **1-800-800-7588**

WPT Publications
4701 N.E. 47th Street
Vancouver, WA 98661

Name _____

Address _____

City _____ St. _____ Zip _____

1-800-800-7588

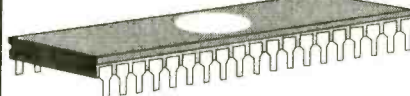

CABLE CONVERTER DIAGNOSTIC TEST CHIP

LOAD FULL ACTIVATION OF CABLE CONVERTER

WE STOCK A COMPLETE LINE OF CHIPS, TOOLS, WIRELESS QUICK INSTALL TEST BOARDS AND DIAGNOSTIC CUBES FOR ALL CONVERTERS!

****NEW EXCLUSIVE PIONEER CUBES & BOARD****

RESETS E-1 THRU E-8 INSTANTLY, ALL MODELS!!

WHOLESALE PRICING-DEALERS WANTED, CALL.

#1 IN CUSTOMER SERVICE & TECH. SUPPORT!

*ALL ORDERS SHIP WITHIN 24HRS, UPS/ FED-X.

*PRIORITY NEXT DAY SHIPPING AVAILABLE!

*SALE- BUY 5 BOARDS GET 1 FREE TILL JAN 96.

*LOWEST PRICE & SUPERIOR PRODUCT GUAR!!

*FRIENDLY COURTEOUS SERVICE. WE'RE PRO'S

VISAL COMMUNICATIONS INC.

FOR ORDERS 1-800-GO-CABLE

CATALOG & TECH. SUPPORT 717-620-4363 EST. 1977

Surveillance Devices!

MS-25
Micro Spec
Telephone
Transmitter Kit

Tiny - 1/3 the size of a dime! Professional quality Crystal clear reception on any FM radio up to 1/4 mile. "SnapKit" technology for easy assembly!

Also available: Tiny room transmitter with the highest power available, and with the most sensitivity of any unit offered - MD250 \$44.95



\$29.95 Guaranteed to be smaller than any other transmitters offered anywhere!

Telephone Transmitter Kit hidden in dual modular adaptor Transmits both sides of conversation to any FM radio up to 1/4 mile. "SnapKit" technology. Uses phone line for power and antenna! Goes completely unnoticed. MA-100 \$25.95



High quality cassette deck plugs directly into telephone jack! Records up to 12 hours of conversations on a single cassette. Recording starts and stops automatically when phone is used!

THR-12 12 Hour Telephone Recorder \$99.95 free shipping! Visa/MC (214) 255-7490 Seymour-Radix Inc. Box 166055-E Irving TX 75016

Prototype it..... FAST!

with ProtoQuick 8051 or Z8

- Complete single board computers
- Up to 32K EPROM and 8K RAM
- 12.5K in 200 pin through hole array
- RS232 C serial port w/ DB25 conn.
- Up to 8K EPROM w/ source code assembled, ready to run. \$5. only
- MS-DOS cross assembler included

ProtoQuick Z8 and 8051 **\$99.00** each

Software: Science 3755 Roundbottom Road Cincinnati, OH 45244 USA (513) 561-2060

Run prototype applications or experimental hardware from the serial port - WITHOUT PROGRAMMING!

TESLA COILS VAN de GRAAFF GENERATORS

Create Lightning Bolts
10 Feet Long!

Build powerful, professional apparatus.
Plans & Experiments

TABLE TOP TESLA COIL creates 2-ft. lightning bolts (38 pp., 19 illus.) . . . \$12.95

GIANT TESLA COIL creates 10-ft. lightning bolts (62 pp., 48 illus.) . . . \$24.95

VAN de GRAAFF Generators 400 kV to 1.2 million V. (48 pp., 46 illus.) . . . \$14.95

SUMMIT Design 7635 Marquette
Dallas, TX 75225

PE MARKET CENTER CLASSIFIEDS

MISCELLANEOUS ELECTRONICS FOR SALE

THE Case Against Patents. Thoroughly tested and proven alternatives that work in the real world. \$28.50. SYNERGETICS PRESS, Box 809-C, Thatcher, AZ 85552. (520) 428-4073. Visa/MC.

CABLE descramblers and test turn-on kits available for most makes and models. No catalog, no 800 number equals your lowest prices. Call others, then compare our prices! We pay cash for unwanted cable boxes. No Florida sales. (305) 425-0751.

57 Electronic Journals. How to get free subscriptions. \$5.00. CABLETRONICS, Box 30502PE, Bethesda, MD 20824.

CABLE TV descrambler! Anybody can build with seven parts from Radio Shack. Plans \$8.00. 1 (800) 818-9103.

PRINTED circuit boards — etched, drilled, tin plated. Single sided \$1.25/sq. inch. CHELCO ELECTRONICS, 61 Water Street, Mayville, NY 14757. 1 (800) 388-8521. Fax 1 (716) 753-322C.

BUILD Electronic Surveillance Devices! Secrets revealed! Download phone bug plan from BBS! Free information! TECHNOTES, Box 388-PE, Tehachapi, CA 93581-0388. BBS/Fax (805) 823-1549.

F&M Electronics — inwall speakers, intercoms, central vac systems. For the do it yourselfer. Free catalog 1 (800) 699-1484.

PLANS-KITS-SCHEMATICS

FIBER-Optic projects — Swing into the new technology by assembling tried and true projects recently published. "Practical Fiber-Optic Projects" only \$9.95 (price includes shipping) ELECTRONICS TECHNOLOGY TODAY, Inc., PO Box 240, Massapequa Park, NY 11762-0240.

ALL- in-one catalog. AM/FM/ham/spy, transmitters, amplifiers, receivers. Voice scramblers/disguisers, audio, TV, Tesla coils, plans, "secret" books, kits, imports, exports and more. Start your own licensed or unlicensed radio station. 60 full pages for \$1.00. PAN-COM INTERNATIONAL, PO Box 130-H1, Paradise, CA 95967.

FIBER optic educational experiments kit. Includes: Tutorial, w/experiments, 40ft fiber assortment, + cutting tool. \$19.95 + S/H (609) 468-1660.

CRYSTAL Set Handbook — Visit antiquity by building the radios your grandfather built. Assemble a "Quaker Oats" rig, wind coils that work and make it look like the 1920s! Only \$10.95 plus \$4.00 for shipping and handling. CLAGGK INC., PO Box 4099, Farmingdale, NY 11735. US funds only! USA and Canada — no foreign orders.

HEATH COMPANY is selling photocopies of most Heathkit manuals. Only authorized source for copyright manuals. Phone: (616) 925-5899, 8-4 ET.

UNIVERSAL remote control systems infrared, RF, miniature transmitters, receivers. Items for novice, technician or educator. Combine your home and vehicle control. Automate anything. Free catalog. INVENTIVE SOLUTIONS, PO Box 8, Stratford, NY 13470.

FASCINATING Electronic devices! Tazer! Dazer! Super spy microphone! Vocal truth detector! Universal IC tester! Radar and laser jammer! Surveillance! Countermeasures! Ultrasonic! Tesla! High voltage! More! Plans and kits catalog \$2.00. QUANTUM RESEARCH, 17919-77th Avenue, Edmonton, Alberta, T5T 2S1.

PE MARKET CENTER CLASSIFIEDS

GREEN Thumb alert — Electronics enters the garden! New exciting book points out how gardeners can build simple gadgets to promote success where the elements work against you. Some of the projects are: over/under temperature monitoring, dusk/dawn switching, automatic plant watering, warming cables, etc. "Electronic Projects for the Garden" only \$9.95 (price includes shipping) **ELECTRONICS TECHNOLOGY TODAY, Inc.**, PO Box 240, Massapequa Park, NY 11762-0240.

DATA Acquisition System Plans for a 16 channel, 8 bit DAC system. Includes QBasic software and Visual Basic driver. Send \$24.95 to **DESIGN TECH**, PO Box 1502, Welch Ave. Station, Ames, IA 50014. (515) 296-1652. Fax (515) 296-1648.

STEPPER Motor Controller Plans for controller that drives up to 32 bi-phase stepper motors from parallel printer port. Includes QBasic software and Visual Basic driver. Send \$24.95 to **DESIGN TECH**, PO Box 1502, Welch Ave. Station, Ames, IA 50014. (515) 296-1652. Fax (515) 296-1648.

PERSONAL Guitar Practice Amp w/stereo input and distortion effect built in. Buy parts at Radio Shack. Complete plans \$3.00. **LJD ELECTRONICS**, Box 685, Norton, MA 02766-0685.

COMPUTER HARDWARE

FREE catalog. Amiga, C64/128, IBM. Chips, ICs, parts, quality electronics. **JSP, SSF, CA** 94083-5060. 24hrs. (415) 871-5158.

SECURITY

SURVEILLANCE Privacy security protection. Catalog \$5.00. **SPY EMPORIUM**, 6065 Hillcroft 414, Houston, TX 77081. (713) 774-1000.

ELECTRONIC sales of security systems for home, apartment, or business, will send information, call **(812) 295-4240**.

SECURITY Systems Devices of all types. Control panels, motions, sirens, CCTV, more. Install it yourself and save. **Special package** 6 zone control, keypad. Fully programmable for monitoring, back-up. Battery, siren & contacts, **only \$179.00**. Catalog with order 1 (800) 335-2296. Fax (519) 541-1277. check/Visa **A-1**, 940 Murphy Rd. #3, Sarnia, Ontario, Canada.

REPAIRS-SERVICES

COMPUTER and video monitor repairs for the business, sending equipment out, pc board fabrication, call **(812) 295-4240**.

BUSINESS OPPORTUNITIES

START your own technical venture! Don Lancaster's newly updated **Incredible Secret Money Machine II** tells how. We now have autographed copies of the Guru's underground classic for \$18.50. **SYNERGETICS PRESS**, Box 809-C, Thatcher, AZ 85552. (520) 428-4073. Visa/MC.

MAKE \$75,000 to \$250,000 YEARLY. Repairing all kinds IBM monitors. Successful home based business, anywhere. Telephone required. Details: USA \$3.00 cash (no checks). Dealerships: Canada-all foreign countries: \$85.00 for application-brochure. **RANDALL DISPLAY**, Box 2168H, Van Nuys, CA 91404.

GREAT extra income! Assemble craft products at home. Easy/fun! Program guaranteed! Call 1(800) 377-6000, ex 7930.

Save Big \$ and watch what you want!

Cable TV Descramblers

Converters * Filters * Accessories

30 day Free Trial - NO RISK!
Unbeatable wholesale prices!
Affordable extended warranty
1 Year Warranty on all products

Free
Catalog

Call the cable professionals!

Credit Cards Welcome!

1-800-379-3976

We'll beat anyone's price!



Prices starting
as low as \$99!

SURVEILLANCE

The Latest High Tech Professional Electronic Devices
Our latest catalog offers a HUGE selection of surveillance, privacy devices including: hidden video equipment, electronic kits, telephone recording systems, touch tone decoders, scanners, telephone tap detectors, bug detectors, voice disguisers, telephone scramblers, locksmithing tools, and more. **Catalog \$5.00.**

SPY OUTLET

P.O. Box 337, Buffalo, NY 14226
(716) 691-3476/(716) 695-8660

Nabi's Technical Acronym Reference Book

For Electronics, Electrical Engineering, Computer Science, Data Communications, HAM Radio, and others

Nabi's Technical Acronym Reference Book is a compilation of 2,000 acronyms for Electronics, Electrical Engineering, Computer Science, Data Communications, HAM Radio and others. You do not have to second-guess those acronyms or abbreviations any more.

Now, you can get your own copy of the *Nabi's Acronym Reference Book* for only US \$11.98 (includes S&H) in US and Canada.

Send money order or your check of (US) \$11.89 to:

Nabi's Byte P.O. Box 5006 Salem, OR 97304

Allow 8-10 weeks for delivery

Debcos is a Kit Builders Paradise

Electronic Kits - Plans - Parts - Computers - Amateur Radio



Call Debcos today for your **FREE** copy of



The Electronic Experimenter's Journal

1 800 423 - 4499

Debcos Electronics 4025 Edwards Rd. Cincinnati, OH 45209

BE AN ELECTRICIAN!

Home study. Maintain and install electrical systems, wiring, utilities, phones, and more.

FREE LITERATURE: 800-223-4542

Name _____ Age _____

Address _____ Phone () _____

City/State _____ Zip _____

The Electrician School, PCDI, DEPT TEB341
6065 Roswell Road, Atlanta, Georgia 30328



New!
Pocket Cube™ with Filter
Wireless cable box tester
for authorized cable
technicians.

Smallest cube on the market
just under 1" x 2"!
Simply clip it onto a 9V
battery for 10sec!

Works on J***** models
D*5, D*V5, D*7, D*V7, D*BB, C*T.

Only \$69.⁹⁵!

(plus \$8 S&H)

30 Day Warranty!
Quantity discounts available.
Dealers Welcome!

Test chips available for
J***** and SA8600.

Order Toll Free
1-300-417-6689

Mon-Fri, 9AM-10PM EST.

If busy please keep trying.

VISA, MC, MO & COD

IEC, P O Box 52347, Knoxville, TN 37950-2347

Pocket Cube is a test generator ONLY.

Do not use these devices without authorization
from your local cable company.

No TN sales.

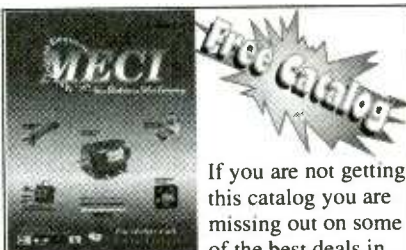

If you are not getting this catalog you are missing out on some of the best deals in electronics today! We have thousands of items ranging from unique, hard-to-find parts to standard production components. Call, write, or fax today to start your free subscription to the most unique catalog in the industry, filled with super values on surplus electronic and hobbyist type items. If you have a friend who would like to receive our catalog, send us their name and address and we will gladly forward them a complementary 100 page catalog.

Why pay more? Call today.



340 East First Street Fax Order Line
Dayton, Ohio 45404 1-800-344-6324

Order Toll-Free
1-800-344-4465

CIRCLE 149 ON FREE INFORMATION CARD

CABLE TV CHANNELS

EQUIPMENT Direct!
GUARANTEED

SAVE \$1000's
The Nationwide source for cable TV equipment.
"BUY WHERE THE DEALERS BUY."

FREE TV Cable Descramblers, Converters and Magic Box Catalog. Open Every Day!

FREE 30 DAY TRIAL

YOUR VCR TAPES CAN PLAY AS CLEAR AS DAY! Eliminates copy protection on any tape.

UNJAM NOW WITH Video Decoder

- Copy any rental/bought tape
- Power Cord and RC Plugs Included

2 Year Warranty
CALL NOW!
Member Better Business Bureau
MEGA ELECTRONICS
1-800-676-6342 VISA • MC • COD

FREE 30 Day Trial!

AMERICAN HEART ASSOCIATION MEMORIALS & TRIBUTES

1-800-AHA-USA1
American Heart Association

CABLE TV DESCRAMBLERS

Never rent again! Save \$100's on premium Cable TV Descramblers & Converters compatible with Jerrold, Scientific Atlanta, Zenith, Pioneer, Tocom and More! Get your best prices and call us last! Please have the MAKE & MODEL # of your area's cable box ready. **GUARANTEED TO WORK IN YOUR AREA!** 1 year warranty and 30 day money back guarantee!
Alistair Electronics 1-800-782-7214

Get your copy of the CRYSTAL SET HANDBOOK



Go back to antiquity and build the radios that your grandfather built. Build the "Quaker Oats" type rig. Wind coils that work and make it look like the 1920's! Only \$10.95 plus \$4.00 for shipping and handling. Claggg Inc., P.O. Box 4099, Farmingdale, NY 11735. USA Funds ONLY! USA and Canada—no foreign orders. Allow 6-8 weeks for delivery. MA01

CABLE TV EQUIPMENT

We carry a complete line of all major brands including test chips and all accessories

BELOW WHOLESALE PRICES • QUANTITY DISCOUNTS
30 DAY MONEYBACK GUAR. • 1 YR. WARRANTY
YEARS OF CUSTOMER SATISFACTION
C & C ELECTRONICS
CALL NOW 1-800-995-1749
Immed. Delivery from Giant Stock! Sorry no Florida Sales.

CRYSTAL CONTROLLED SURVEILLANCE

VHF & UHF PROFESSIONAL ENCASED PARTIALLY ASSEMBLED TRANSMITTER KITS
Countersurveillance. Also Tunable 70 to 305 MHz Kits. We Design & Manufacture Our Equipment. Custom Design.
FOR CATALOG SEND \$2.00 TO:
SHEFFIELD ELECTRONICS CO., P.O. Box 377940-B
Chicago, IL 60637-7940. Tel. (312) 324-2196

BUGGED??

EAVESDROPPING is unbelievably widespread! Electronic Devices with amazing capabilities can be monitoring your telephone and room conversations **RIGHT NOW!** Are you sure you're safe? **FREE CATALOG** tells you fast! Includes Free Bonus details on fantastic opportunities now open in Counter-Surveillance field. Exciting, immensely interesting and **EXTREMELY** profitable (up to \$250/hr) full/part-time income. Call Now! **1-800-732-5000**

BUY BONDS

SURVEILLANCE

FM TRANSMITTERS MINI (KITS)

- 3-VOLT FM XMTR, up to 300 ft. indoors, 1500 ft. outdoors
- PHONE XMTR, range to 500 ft., uses phone-line power
- Sound-Activated XMTR, range to 500 ft.
- 2-STAGE XMTR, 9-Volt, very powerful

All above require simple soldering at 2 to 4 places. **\$29.95** ea.**

TELE FM WIRELESS MONITORING SYSTEM. (Kit) **\$99.00***

TELE CALL FORWARDER. Transfers incoming calls. **\$99.00***

CALLER ID. Registers incoming number. **\$99.00***

TEL REGISTER WITH PRINTER. Records dialed number, duration, and prints record. **\$139.00***

12-HOUR LONG-PLAY RECORDER. Modified Panasonic. Records 6 hrs. on each side of 120 tape (supplied). Compatible with VOX and Tel Rec Adapter. **\$119.00***

VOX VOICE-ACTIVATED SWITCH. Makes recorder self-activating with voices or other sounds. **\$28.50****

TELE RECORDING ADAPTER. Records incoming and outgoing calls. **\$28.50****

TELEPHONE SCRAMBLERS. Over 4,000 separate codes. **\$199.00***

VOICE CHANGER. Changes man's voice to lady's and vice versa. **\$49.00***

For Shipping & Handling add *\$5.00 and **\$2.00 per item. Colo. residents add sales tax. Mail Order, VISA, M/C, COD's o.k. Inquire for dealer prices. Free catalog.

MUCH, MUCH MORE — OUR 25TH YEAR!

TOLL FREE 1-800-926-2488

A.M.C. SALES, INC.

193 Vaquero Dr., Boulder, CO 80303
Tel: (303) 499-5405, Fax: (303) 494-4924
Mon.-Fri. 8 a.m.-5 p.m. Mtn. Time

CIRCLE 140 ON FREE INFORMATION CARD

Be a PC repair expert!

Approved home study. Learn to troubleshoot, repair, install, upgrade, and service computers.

Free literature: 800-223-4542

Name _____ Age _____

Address _____ Phone (____) _____

City/State _____ Zip _____

School of PC Repair, DEPT. JUB341, PCDI
8065 Roswell Road, Atlanta, Georgia 30328



Cable Test Aids

Orders Only **1-800-615-9221** Information **407-998-7883**

Test Chips that fully activate Jerrold, Tocom, Zenith, SA, Pioneer and more. Quick-Board installation! Prices from \$5 to \$49.95 ea. **MC SPECIALTIES** 1 Year Warranty!
No FL Sales. Not for use in cable co. owned equip. For test or repair only.

PE MARKET CENTER CLASSIFIEDS

SIGN of The Times Start your own profitable alarm company with **monthly recurring revenues**: Further info. Send details to: **A1, 940 Murphy Rd. #3, Sarnia, Ontario N7S-5C4 Canada.**

EASY work! Excellent pay! Assemble products at home. Call toll free **1(800) 467-5566 ext. 5192.**

EARN money with a revolutionary new high-tech secret! Free details **PARKSIDE PRESS, Dept. 1A, 7527 Berwick Drive, Westland, MI 48185-1414.**

SMALL Business "Government" loans available nationwide! It's easy when you know how — call **NIC: 1 (800) 226-3601, BF 7930.**

EDUCATION

LEARN PC Assembly Language. Disk \$5.00, Book \$18.00. **ZIPFAST, Box 12238, Lexington, KY 40581-2238.**

KNOWLEDGE CARDS. Tables. Formulas. Fun and educational. Package \$2.00. Box 12238, Lexington, KY 40581-2238.

ESP, Bioelectricity, microwave hearing, comprehensive booklist.... \$1.00; \$2.00 foreign. **RESEARCH ASSOCIATES, PO Box 3583, Boynton Beach, FL 33424-3583.**

PUBLICATIONS

DATA Acquisition Handbook, Contains enough information that reader will be able to design and build working DAC systems. Includes theory/hardware, software examples. Send \$14.95 to **DESIGN TECH, PO Box 1502, Welch Ave. Station, Ames, IA 50014. (515) 296-1652 Fax (515) 296-1648.**

WANTED

UNASSEMBLED EICO, Knight, Heathkits complete with manuals. Call or fax **KEN, (707) 545-8300, Fax (707) 545-3930.**

INVENTORS

FREE invention package: Davison & Associates offers customized development, patenting, and licensing of new product and ideas. Proven results: **1 (800) 677-6382.**

RESOURCE GUIDE

HOME Automation: Who manufactures the home automation products you want? Home theatre, security, automatic drapes, 30 categories, hundreds of manufacturers, distributors and wholesalers, over 1000 products! The '95-'96 Resource Guide will get you started and save you money. Just published by **ELECTRONIC HOUSE MAGAZINE, special \$19.95. 1 (800) 375-8015.**

CABLE TV

"BULLET Buster." Protect your cable box against the infamous cable "bullet." The "Bullet" Buster acts as an electronic shield. Installs in-line in seconds. Don't wait until it's too late! **\$19.95 + \$3.00 S&H. Visa/MC/Amex. ELECTROMAN, Box 24474, New Orleans, LA 70184. (504) 482-3017.**

PE MARKET CENTER CLASSIFIEDS

CABLE—safe. Guarantee cable privacy. The one way valve for your cable TV signal. Cable signals come in, but they don't go out! \$29.95, + \$3.00 S&H. Visa/MC/Amex. **ELECTROMAN**, Box 24474, New Orleans, LA 70184. (504) 482-3017.

CABLE unscrambled. Everything you want to know about cable, but are afraid to ask. \$10.00. Visa/MC/Amex. **ELECTROMAN**, Box 24474, New Orleans, LA 70184. (504) 482-3017.

"DESCRAMBLER Schematics Revealed." A powerful guide to descrambling schemes. \$10.00. Visa/MC/Amex. **ELECTROMAN**, Box 24474, New Orleans, LA 70184. (504) 482-3017.

UNIVERSAL descrambler. Unscramble signals using your VCR as the tuner. Works with virtually any system, this is the only one you need. Declare cable box independence! \$129.95 + \$5.00 S&H. Visa/MC/Amex. **ELECTROMAN**, Box 24474, New Orleans, LA 70184. (504) 482-3017.

"BASEBAND Video Explained". Discover what a Baseband Signal is and how it's constructed. Learn the advantages of doing things the "Baseband" Way. \$10.00. Visa/MC/Amex. **ELECTROMAN**, Box 24474, New Orleans, LA 70184. (504) 482-3017.

ATTN. Cable box owners. Get your Bullet and ID stopper before its too late. Send \$20.50 to **R.R. ENTERPRISE**, Box 3532, Easton, PA 18043.

CABLE descrambling, new secret manual. Build your own descramblers for cable and subscription TV. Instructions, schematics for **SSAVI**, gated sync, sinewave, some free methods (HBO; Cinemax, Showtime, UHF, Adult) \$12.95, \$2.00 postage. **CABLETRONICS**, Box 30502PE, Bethesda, MD 20824.

SECRET cable descramblers! Build your own descrambler for less than \$12.00 in seven easy steps! **Radio Shack** parts list and free descrambling methods that cost nothing to try, included. Send \$10.00 to: **INFORMATION FACTORY**, PO Box 669, Seabrook, Texas 77586. For Visa/MC, CODs, (713) 922-3512 any time!

DESCRAMBLE cable with simple circuit added to Radio Shack RF modulator and using VCR as tuner. Instructions \$10.00. **TELCOM**, PO Box 832P1, Brusly, LA 70719.

CABLE TV equipment & accessories. Wholesale prices! 30 day moneyback guarantee! Free catalog! **PERFORMANCE ELECTRONICS, INC.**, 1 (800) 815-1512.

CABLE descrambler! Build with 7 **Radio Shack** parts costing \$12.00. Instructions \$8.00: **F.A.S.T.**, Box 369-EP1, Pt. Salerno, FL 34992-0369.

REVOLUTIONARY technology does all boxes — for free catalog please call **MEGA 1 (800) 676-6342.**

CABLE TV test chips for Jerrold, Tocom, Pioneer, Scientific Atlanta, etc... **Quick installation!** New multi-mode modules available. Prices from \$5.00 each. **1 (800) 788-9025.**

E2 Clearer for 6300-6750 \$30.00. Clears E2 & puts unit into full ser. mode without serial # or writer. **Test Aids** Jerrold, Pioneer & SA \$15.00. **Zenith & Tocom** \$13.00. **Diagnostic Transmitters** Jerrold \$105.00. SA & Pioneer E2 programmable \$130.00. **Pioneer Writer** \$25.00. **Audio Boards** \$25.00, **Filters** \$20.00. **Remotes** \$10.00. **(718) 241-2560** 8am-11am est.

CABLE Box privacy and protection guaranteed with our bullet and snooper protector. Send \$19.95 to **T.V. DAVIS**, PO Box 5763, Hialeah, FLA. 33014-1763. **(305) 434-7039.**

SATELLITE EQUIPMENT

VIDEOCYEPHER II descrambling manual. Schematics, video and audio. Explains **DES, EPROM**, CloneMaster, Pay-per-view (HBO, Cinemax, Showtime, Adult, etc.) \$16.95, \$2.00 postage. Schematics for **VideoCypher II Plus**, \$20.00. Schematics for **VideoCypher II 032**, \$15.00. Software to copy and alter EPROM codes, \$25.00. **VCI Plus EPROM**, binary and source code, \$30.00. **CABLETRONICS**, Box 30502PE, Bethesda, MD 20824.

BUY BONDS

IMPROVE Satellite picture quality. Focus Maximizer™ is a diagnostic tool that quickly optimizes dish to feedhorn spacings. Works with Chaparral style feedhorns, \$29.50 delivered. Free brochure on request. EMAIL: **Water Elec-@aol.com**. **WATERSHED ELECTRONIC DEVELOPMENT**, Visa/MC orders: 1 (800) 756-7854.

SATELLITE Radio Book and Guide. New book covers all audio services, SCPC, subcarriers, FM squared, facsimile, press services, weather services. Simple how-to-receive instructions. \$16.95 plus \$3.00 Priority Mail. **UNIVERSAL ELECTRONICS**, 4555 Groves Road, #12, Columbus, OH 43232. (614) 866-4605.

DSS How its done. 150 channels received direct with small dish system. Send \$14.95 + \$2.00 postage. **CABLETRONICS**, Box 30503PE, Bethesda, MD 20824.

MISCELLANEOUS ELECTRONICS WANTED

TOP dollar for gold plated IC's boards, electronic scrap. **RON**, (817) 838-3611 TX area.

Imagine Little Red Riding Hood without a forest.

Only You Can Prevent Forest Fires.



USA Forest Service and your State Forester.

Step into Motion with Visual Stepper

- Stepper motor controller card
- Controls 2 bi-phase stepper motors using PC parallel printer port
- With additional cards controls up to 32 stepper motors
- Precision velocity control (velocity is controlled with on board timing chips)

Applications

Automation, robotic, mechanical control

Includes

- controller card
- 2 bi-phase stepper motors
- power supply
- 1/2 rack size box that can be used on table or rack. (rack is sold separately)
- Windows based **Visual Stepper** control software, Qbasic program examples.
- \$249

16 Channel 8 bit Data Acquisition and Control System

- 16 A/D inputs
- 1 D/A output

Includes

- DAC control board
- I/O module board
- mounting accessories, cable
- Windows based data acquisition & control software
 - real time strip charting
 - Data to disk
 - sophisticated FormulaOne spreadsheet
 - Dynamic data exchange (DDE) to Excel
 - Software programmable gain

- Driver for Visual Basic
- Qbasic program examples
- S 299

MidWest I/O Design Co. is a new company!

We are committed to building low cost, well engineered tools. We are so confident that you will like our products that we will offer a 30 day money back guarantee if you are not satisfied for any reason. In addition, we offer a full 6 month warranty on all products that we sell. Please call for our complete catalog.

MidWest I/O Design Co.
P.O. Box 1502 Welch Ave. Sta.
Ames, IA 50014-150
Phone (515)-296-1648
Fax (515)-296-1652

ADVERTISING INDEX

POPULAR ELECTRONICS magazine does not assume any responsibility for errors that may appear in the index below.

Free Information No.	Page	Free Information No.	Page
25	Ace Communications	—	Information Unlimited
—	Agrelo Engineering	13	Interactive Image Technologies CV2
26	Alfa Electronics	—	Intronics
28	All Electronics	—	KDE Electronics
—	Allen Engineering	—	Learn, Inc.
—	Allison Technology	—	M&G Electronics
—	Allstar Electronics	165	MCM Electronics
27	Alltronics	—	MD Electronics
140	AMC Sales	—	Mega Electronics
—	American Innovations	149	Mendelsohn's
—	Andromeda Research	—	Mental Automation
—	Basic Electrical Supply	177	MicroCode Engineering
30	Bel Merit	—	MidWest I/O Design Co.
—	Black Feather	—	Ming Engineering
32	C&S Sales	—	Modern Electronics
—	Circuit Specialties	—	Mondo-tronics
—	CLAGGK, Inc.	—	NRI Schools
—	Cleveland Inst. of Electronics	43	Optoelectronics
—	Command Productions	176	Parallax
—	Comtrad Industries	148	Parts Express
—	Consumertronics	164	Phillips Tech
170	Cook's Institute of Elec. Eng.	47	Prairie Digital Inc.
—	Copyright Clearance Center	46	Print
167	Dalbani	130	Print
—	Electronic Equipment Bank	—	Protech Dist. Inc.
137	Electronic Rainbow	—	Self-Reliance Co. Inc.
—	Electronics Tech. Today	—	Sescom Inc.
—	Electronics Tech. Today	—	Show Time
—	EMAC	—	Silicon Valley Surplus
—	Foley-Belsaw	—	Summit Design Group
—	Forest Electronics	—	Tab Books
—	Fotronic Corporation	136	UCANDO Videos
—	Gateway Products	—	US Cyberlab
—	General Device Instruments	—	Vision Electronics
—	Grantham College of Engineering	—	Visual Communications
—	Greenleaf Electronics Inc.	178	Wavetek Corp.
—	Halcyon Group	—	Weeder Technologies
—	Hollins Radio Data	—	Weka Publishing
—	Home Automation Systems	—	World College (Div. of C.I.E.)
—	Howard Electronics	—	WPT Publications
—	I.E.C.	134	Xandi Electronics

ADVERTISING SALES OFFICE

Gernsback Publications, Inc.
500 Bi-County Blvd.
Farmingdale, NY 11735-3931
1-(516) 293-3000

Larry Steckler, EHF/CET
 President

Christina Estrada
 Assistant to the President

For Advertising ONLY
1-516-293-3000
Fax 1-516-293-3115

Larry Steckler
 publisher

Arline Fishman
 advertising director

Michele Torriolo
 advertising assistant

Adria Coren
 credit manager

**Subscription/
 Customer Service/
 Order Entry**
 1-800-827-0383
 7:30 AM - 8:30 PM EST

ADVERTISING SALES OFFICES EAST/SOUTHEAST

Stanley Levitan
 Eastern Sales
 1 Overlook Ave.
 Great Neck, NY 11021-3750
 1-516-487-9357, 1-516-293-3000
 Fax 1-516-487-8402

MIDWEST/Texas/Arkansas/ Oklahoma, Colorado, Arizona

Ralph Bergen
 Midwest Sales
 One Northfield Plaza, Suite 300
 Northfield, IL 60093-1214
 1-708-446-1444
 Fax 1-708-559-0562

PACIFIC COAST/Mountain States

Anita Bartman
 Hutch Looney & Assoc., Inc.
 6310 San Vicente Blvd.
 Suite 360
 Los Angeles, CA 90048-5426
 1-213-931-3444
 Fax 1-213-931-7309

BASIC STAMP® II

BASIC-programmable computer in a 24-pin DIP

The BASIC Stamp II is a complete BASIC-programmable computer in a 24-pin DIP package. It has 16 I/O lines, which can be used for a variety of digital and analog purposes. The Stamp's BASIC language includes familiar instructions, such as FOR...NEXT, IF...THEN, and GOTO, as well as special instructions for DTMF tone generation, X-10 powerline control, tachometer applications, and serial communications (up to 50k baud!).

The BASIC Stamp Programming Package contains everything you need to program BASIC Stamp modules using your PC. The package includes our editor software, programming cables, manuals, application notes, and free technical support. The package is available for \$99; Stamps must be purchased separately.



DTMFOUT

Generates DTMF tones with just one I/O pin, two capacitors, and a speaker. Another related instruction, **FREQOUT**, generates one or two tones simultaneously. Each tone is programmable in 1-Hz increments from 0-Hz to 32767-Hz.

** Carrier board provides battery clips, prototyping area, reset button, and programming connector.*

Attention Sacramento-area computer nerds: we're looking for 1 or 2 customer tech helpers. A perfect set of abilities would include digital logic, PIC assembly language, and BASIC. If you're a fellow nerd and you're interested, please call.

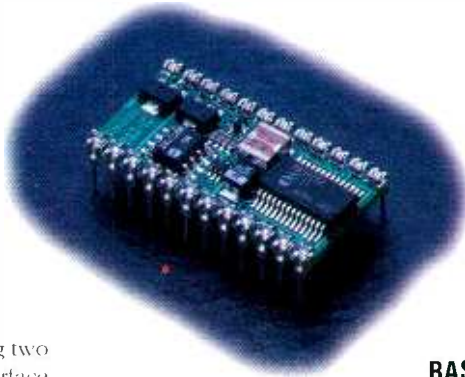
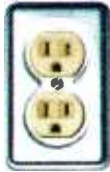

BS2-IC Module
(FaxBack #6002)

XOUT

Generates X-10 powerline control signals using two I/O pins and an inexpensive TTL-to-AC interface module (X-10 part #PL513 or #TW523). Signals are received by small modules that control lights and appliances. Receiver modules are available from Parallax, Radio Shack, and other convenient sources.

BASIC Stamp II Module (BS2-IC)

16 general-purpose I/O lines
2048-byte program space (600 instructions)
20-MHz clock (50k baud serial, etc.)
\$49, \$69 with optional carrier board *

74HC595

OUT1	1	16	VCC
OUT2	2	15	OUT0
OUT3	3	14	SERIN
OUT4	4	13	OE
OUT5	5	12	RCLK
OUT6	6	11	SCLK
OUT7	7	10	SCLR
GND	8	9	OUT7

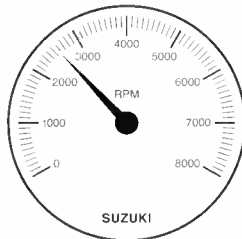

SHIFTOUT

Uses two I/O pins to control common serial-to-parallel shift registers.

COUNT

Counts cycles on a pin. Makes tachometer applications simple.

"Robo-Cat"

Guy Gustavson of Maple Grove, Minnesota, turned in a very interesting Stamp application. His cat, Kesha, developed Heptic Lipodosis, or "fatty liver." The treatment called for tube feeding every three hours. Guy couldn't be home all day, so he combined a BASIC Stamp, electric pump, some switches, and various other parts. Instead of a 100ml feeding every three hours, Kesha received a continuous feeding, which seemed to work even better. Now, Kesha is doing fine. If his experience could be of any help, Guy would like to hear from you. Please send any email to bigfoot@winternet.com.



3805 Atherton Road, #102 • Rocklin, CA 95765 • USA • (916) 624-8333 • Fax: 624-8003 • FaxBack: 624-1869 • BBS: 624-7101
E-mail: info@parallaxinc.com • Ftp: ftp.parallaxinc.com • World-wide-web: http://www.parallaxinc.com

Australia +61 3 720 5344 (PIC tools), +61 67 722 777 (Stamps) • Austria +49 241 15 4071 • Belgium +32 41 77 51 51 • Brazil +55 11 453 5588 • Canada (514) 336-9426 • Czech Republic +42 49 5813 252 • France +33 20 52 98 52
Germany +49 241 15 4071 • Greece +30 1 902 0115 • Hong Kong +852 2720 0255 • Hungary +36 1163 2879 • India +91 422 232 561 • Israel +972 3 498 543 • Japan +81 3 3251 1779 • Netherlands +31 1803 17666 • Poland +48 34
648 882 • South Africa +27 11 907 8475 • South Korea +82 2 849 8567 • Sweden +46 223 228 67 • Switzerland +49 241 15 4071 • Taiwan +886 2 647 1978 • United Kingdom +44 1 977 683 665 • United States (800) 344-4539

Stamp, BASIC Stamp, and the Parallax logo are registered trademarks of Parallax, Inc.
Prices do not include shipping and applicable sales tax • Features and prices subject to change without notice. • Prices are U.S. prices only; prices in other countries may vary.

0895PE

CIRCLE 176 ON FREE INFORMATION CARD



Are You Listening?

CATCH **THE** Action

WITH **an** INTERCEPTOR!

NEW DISCOUNTED PRICE!

R10 INTERCEPTOR

If searching out RF signals is your thing, then the R10 Interceptor is the answer. The R10 searches out nearfield signals and locks on in less than a second. It provides a shield of protection that no RF signal can penetrate without being detected. Unlike scanners and receivers that must be tuned to a specific frequency or scanned through a fixed frequency range, the INTERCEPTOR will provide an exciting new dimension in recreational monitoring with near instant response to strong signals. Communications monitoring hobbyists will be able to take the R10 on cruise ships, to military bases, theme parks, zoos, airports, to space shuttle launches, parades, sporting events, car races and anywhere two way FM communications is used. •Check Deviation with 10K or 100K range •Check Relative signal strength •Continuous 30MHz-2GHz coverage in less than 1 second •Built in Speaker •Thumb wheel volume and squelch control •Supplied with telescoping whip antenna, Internal NiCad battery pack, and an AC charger.

R20 INTERCEPTOR

The R20 is a compact RF signal strength detector with a 10 segment bargraph display. There is also an audio output from the detector for monitoring AM communications. The audio output is useful for room sweeps where in close proximity to a transmitter a quieting effect can be heard due to detector saturation. •The 10 segment LED bargraph responds to all RF signals with nominal 3dB increments •Pocket sized with built in telescoping whip antenna •9 volt battery operation •Monitor Aircraft, CB, AM Broadcast transmissions •Check Microwave oven leakage •Wide .5MHz-2.5GHz range



R20 \$119.00



R10 \$299.00

OPTOELECTRONICS

5821 N.E. 14th Avenue • Ft. Lauderdale, FL 33334

Contact Factory for shipping prices. Visa, MasterCard, & C.O.D. (Cash or Money Order Only)

All prices and specifications are subject to change without notice or obligation

MADE IN THE U.S.A.

ORDER LINE: 800-327-5912 TEL. 305-771-2050 FAX 305-771-2052

CIRCLE 43 ON FREE INFORMATION CARD

www.americanradiohistory.com