

MIXED-MODE SIMULATION

Design & Verify Faster with Electronics Workbench®

**New
Version 4**

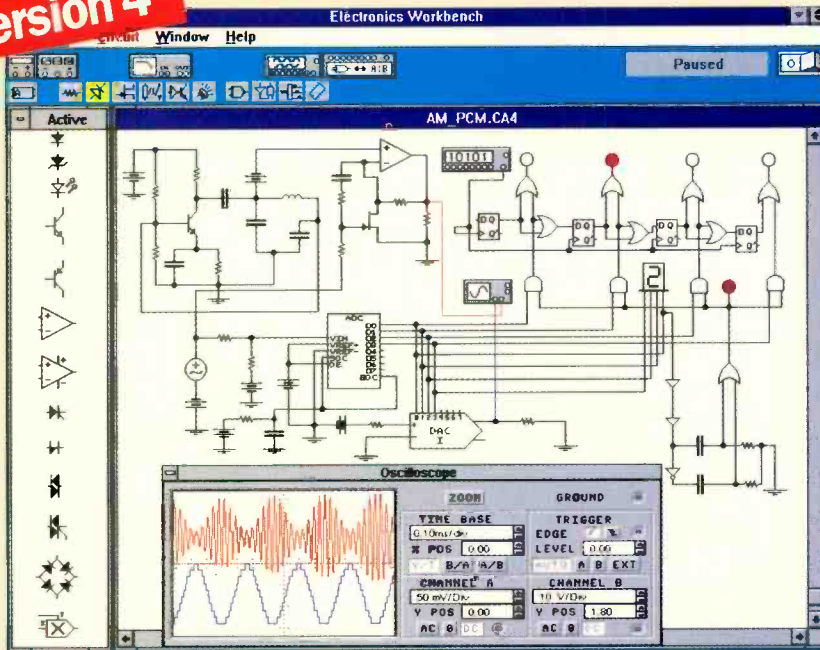

True mixed-mode simulation: Simultaneous AM transmission, digitization and pulse-code modulation of a signal.

Analog, Digital & Mixed Circuits

Electronics Workbench® Version 4 is a fully integrated schematic capture, simulator and graphical waveform generator. It is simple to mix analog and digital parts in any combination.

Design and Verify Circuits... Fast!

Electronics Workbench's simple, direct interface helps you build circuits in a fraction of the time. Try 'what if' scenarios and fine tune your designs painlessly.

Electronics Workbench delivers the power you need to design and verify analog, digital and true mixed mode circuits. Over 20,000 customers have already put Electronics Workbench to the test. The result: Better designs... Faster. And over 90% would recommend it to their colleagues. Electronics Workbench will save you time and money. We guarantee it.*

Call Now: 800-263-5552

*30 day money-back guarantee
Free unlimited technical support

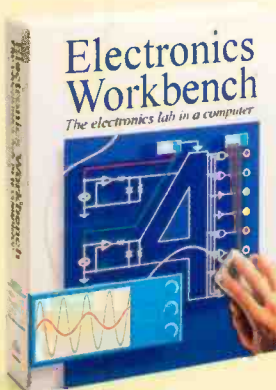

Electronics Workbench \$299

- Includes:
- Schematic capture
 - Simulator
 - Graphical waveform generator
 - 350 models
- + 15 S/H

Engineer's Pack \$599

- Includes:
- Electronics Workbench
 - 2,000 Extra Models
 - Export/Import to/from SPICE
 - Export to PCB packages
- + 15 S/H

Yes, I'm interested in
Electronics Workbench.

Name: _____

Title: _____

Organization: _____

Address: _____

Phone: _____

I prefer to be contacted by e-mail/fax/at:

9EA1FP4

INTERACTIVE IMAGE
TECHNOLOGIES LTD.
908 Niagara Falls Blvd. #068,
North Tonawanda, NY 14120-2060
Telephone: 416-977-5550
FAX: 416-977-1818
E-mail: ewb@interactiv.com
CompuServe: 71333,3435
BBS: 416-977-3540



Trademarks are property of their respective holders. Offer is in U.S. dollars and valid only in the United States and Canada.

Australia: 25193933 • Brazil: 11-4535588 • Cyprus: 2621068 • Czech Republic: 19224908 • Denmark: 33250109 • Finland: 02975083 • France: 149089000 • Germany: 711627740 • Greece: 15249981 • Hungary: 12150082
India: 11-5441343 • Indonesia: 21-4721730 • Israel: 36475613 • Italy: 11-4375549 • Japan: 333823136 • Malaysia: 37742189 • Mexico: 5995260 • Netherlands: 180317666 • New Zealand: 92651756 • Norway: 22167045
Portugal: 181-46609 • Singapore: 7772302 • Slovenia: 61317880 • South Africa: 33168809 • South Korea: 222223431 • Spain: 15533234 • Sri Lanka: 1859970 • Sweden: 405900 • Thailand: 6623986952 • UAE: 453505 • UK: 28-23-2216

CIRCLE 169 ON FREE INFORMATION CARD

C O N S T R U C T I O N

37 Build a DTMF Decoder/Logger

Keep a running record of your telephone use, or capture, decode, and record telephone tones that are broadcast over the radio—
Terry J. Weeder

41 Build a Shortwave Converter for your Car

Add shortwave reception to any digital or analog car radio—
Lyle Russell Williams, KC5KBG

47 Build the Electronic Oracle

Be the life of the party with this tricky little novelty circuit that treats its owner especially well—
Keith Rawlinson

53 Build the Space Wings

A whimsical project that demonstrates the special properties of an amazing wire—
Marc Spiwak

57 Build an Answering-Machine Message Stopper

Stop your answering machine's outgoing message from any phone in the house—
Brian Pfliler

59 Build the Chirrup

Have your own "Cricket on the Hearth"—
Richard Panosh

F E A T U R E S

49 Electronics on a Budget

A little work and ingenuity can let a hobbyist have fun on even the most meager of bankrolls—
John Adams

62 Fog Detection and Warning Systems

How technology is being used to prevent those devastating high-way pile-ups—
Bill Siuru



Page 37



Page 41



Page 53

POPULAR ELECTRONICS (ISSN 1042-170-X) Published monthly by Gernsback Publications, Inc. 500-B Bi-County Boulevard, Farmingdale, NY 11735. Second-Class postage paid at Farmingdale, NY and at additional mailing offices. One-year, twelve issues, subscription rate U.S. and possessions \$21.95, Canada \$28.84 (includes G.S.T. Canadian Goods and Services Tax Registration No. R125166280), all other countries \$29.45. Subscription orders payable in U.S. funds only, International Postal Money Order or check drawn on a U.S. bank. U.S. single copy price \$3.50. Copyright 1995 by Gernsback Publications, Inc. All rights reserved. Hands-on Electronics and Gizmo trademarks are registered in U.S. and Canada by Gernsback Publications, Inc. Popular Electronics trademark is registered in U.S. and Canada by Electronics Technology Today, Inc. and is licensed to Gernsback Publications, Inc. Printed in U.S.A.

Postmaster: Please send address changes to Popular Electronics, Subscription Dept., P.O. Box 338, Mount Morris, IL 61054-9932

A stamped self-addressed envelope must accompany all submitted manuscripts and/or artwork or photographs if their return is desired should they be rejected. We disclaim any responsibility for the loss or damage of manuscripts and/or artwork or photographs while in our possession or otherwise.

As a service to readers, Popular Electronics publishes available plans or information relating to newsworthy products, techniques, and scientific and technological developments. Because of possible variances in the quality and condition of materials and workmanship used by readers, Popular Electronics disclaims any responsibility for the safe and proper functioning of reader-built projects based upon or from plans or information published in this magazine.

P R O D U C T R E V I E W S

9 Gizmo

Sharp Color Video Printer, Brother Laser Printer, Digital Vision Video Frame Grabber, Hauppauge Computer Works TV Card, and more

26 Hands-On-Report

Heathkit ID-5001 Advanced Weather Computer

C O L U M N S

24 Multimedia Watch

Report from Dayton—*Marc Spiwak*

28 Think Tank

Some assorted circuits—*John Yacono*

66 Antique Radio

Finishing up the Minerva Tropicmaster—*Marc Ellis*

72 Computer Bits

Disk and file utilities—*Jeff Holtzman*

73 Circuit Circus

Handy hobbyist circuits—*Charles D. Rakes*

78 DX Listening

Radio from Eastern Europe—*Don Jensen*

80 Ham Radio

Some receiver accessories—*Joseph J. Carr*

82 Scanner Scene

Monitoring beeper messages—*Marc Saxon*

D E P A R T M E N T S

3 Editorial

4 Letters

6 New Products

76 Electronics Market Place

84 Electronics Library

95 Popular Electronics Market Center

126 Advertiser's Index

127 Free Information Card

Larry Steckler, BHF, CET
editor-in-chief and publisher

EDITORIAL DEPARTMENT

Carl Laron, editor
Dan Karagiannis, associate editor
Teri Scaduto, assistant editor
Evelyn Rose, editorial assistant
Marc Spiwak, editorial associate
Joseph J. Carr, K4IPV, contributing editor
Marc Ellis, contributing editor
Jeffrey K. Holtzman, contributing editor
Don Jensen, contributing editor
Charles D. Rakes, contributing editor
Marc Saxon, contributing editor
John Yacono, contributing editor

PRODUCTION DEPARTMENT

Ruby M. Yee, production director
Karen S. Brown, production manager
Kathy Campbell, production assistant

ART DEPARTMENT

Andre Duzant, art director
Russell C. Truelson, illustrator

Jacqueline P. Cheeseboro, circulation director

Michele Torrillo, POPULAR ELECTRONICS bookstore

BUSINESS AND EDITORIAL OFFICES

Gemsback Publications, Inc.
500-B Bi-County Blvd.
Farmingdale, NY 11735
1-516-293-3000
FAX: 1-516-293-3115
President: **Larry Steckler**

SUBSCRIPTION CUSTOMER SERVICE/ORDER ENTRY

1-800-827-0383
7:30 AM - 8:30 PM EST

Advertising Sales Offices listed on page 126

Composition by Mates Graphics

Cover by Loewy Design
Illustration by Chris Gould



Since some of the equipment and circuitry described in POPULAR ELECTRONICS may relate to or be covered by U.S. patents, POPULAR ELECTRONICS disclaims any liability for the infringement of such patents by the making, using, or selling of such equipment or circuitry, and suggests that anyone interested in such projects consult a patent attorney.

EDITORIAL

WARM UP YOUR SOLDERING IRON

While our mission here at **Popular Electronics** has always been to present a balanced view of the electronics hobby, when all is said and done, project building remains at the heart of what makes us what we are. It is also what makes us valuable to you, our readers. After all, according to recent surveys, over 85% of you build at least one project a year, and almost half of you build more than four.

It's not surprising then that our annual "Project-Builders' Special" is one of our most popular issues each year. Well, it is that time again, and we think we've lined up one of the best we've ever done.

Consider, for instance, our DTMF Decoder/Logger. That handy project can help you keep tabs on your telephone usage. It automatically decodes the tones used by tone-dialed telephones, and keeps a running log of the last 20 numbers dialed. It is also great for radio work: Just hook it up to the speaker terminals of any radio. The story begins on page 37.

If you are a shortwave enthusiast that misses the action and excitement of foreign broadcasts while on the road, our Shortwave Converter might be just what you are looking for. It is inexpensive, easy-to-build, and will work with any digital or analog AM radio. The story begins on page 41.

Do you want to be the life of the party? Well, you just might be if you build the Electronic Oracle. It divines the answers to anyone's most personal questions. Of course, because it is yours, it treats you especially well! The story begins on page 47.

And there is much more, including an Answering-Machine Message Stopper that lets you cut off the outgoing message from any phone in the house, and the Chirrup, which brings you the peaceful song of the cricket. So, get out your tools, warm up your soldering iron, and have some great project-building fun!



Carl Laron
Editor

The professional weather station for people curious about the weather.



Haven't you always wanted a weather station? The Weather Monitor II makes a state-of-the-art weather monitoring system affordable enough for home use!

FEATURES INCLUDE:

- Inside & Outside Temps
- Wind Speed & Direction
- Barometer
- Time & Date
- Inside Humidity
- Wind Chill
- Alarms
- Highs & Lows
- Rainfall Option
- Instant Metric Conversions
- Outside Hum. & Dew Point Option
- Optional PC Interface

Order today:

1-800-678-3669

M-F 7 a.m. to 5:30 p.m. Pacific Time • PE657E
FAX 1-510-670-0589 • M/C and VISA
One-year warranty • 30-day money-back guarantee

DAVIS INSTRUMENTS

3465 Diablo Ave., Hayward, CA 94546

CIRCLE 160 ON FREE INFORMATION CARD

Earn \$1000

A Week While You Learn High Paying VCR Repair.

Earn While You Learn . . .
Secrets Revealed . . .



Train at Home

If you are able to work with small hand tools and possess average mechanical ability, you could earn top dollar part time or full

time. Our learn by doing method teaches you how to work on VCR's without boring unnecessary electronic basics.

For Free Information Package Send Coupon to:
Foley-Belsaw Institute, 6301 Equitable Road,
Kansas City, MO 64120

Check VCR or another High Paying Career Field	(Check One Box Only)
	<input type="checkbox"/> VCR Repair, Dept. 62355
	<input type="checkbox"/> Computer Repair, Dept. 64252
	<input type="checkbox"/> TV/Satellite Dish, Dept. 31133
	<input type="checkbox"/> Advance VCR Repair, Dept. 65047
	<input type="checkbox"/> Camcorder Repair, Dept. 66057
	<input type="checkbox"/> Fax Repair, Dept. 67057
	<input type="checkbox"/> Printer Repair, Dept. 68056
	<input type="checkbox"/> Computer Programming, Dept. 35081
	Since 1926

Name _____
Address _____
City _____
State _____ Zip _____

CIRCLE 13 ON FREE INFORMATION CARD

THAT DOES NOT COMPUTE

Due to a printing problem, some errors appeared in the program listing in "Build an Eight-Channel A/D Converter" (Popular Electronics, June 1995). The program lines in Listing 1 here should be substituted for the ones that appear in the article. Also, if you have a modem, you could download the entire program from the Gernsback BBS (516-293-2283) and save yourself some typing.—Editor

errors. First, transistors Q1 and Q2 are numbered correctly in both the schematic and the Parts List, but disagree with the text. In the article, Q1 should read Q2, and vice versa.

Second, on page 56, the last sentence in the second paragraph should read: "If you would

(ground) lead of the Tracker and the battery."

Finally, the Calibration section contains a typographical error that says you should turn "R4's resistance up 1" turn. That should read "1/2 turn." I hope that clears up any confusion.—
Jack Wright

LISTING 1

```
52 FOR i = 1 TO 8: LOCATE 12, i * 8 + 2: PRINT USING "CH #"; i; : NEXT
62 OUT add, activech + 0: REM: Set CS* low, CLK low.
63 OUT add, activech + 1: OUT add, activech + 0: REM: Pulse Clk Hi/low, keep CS* low
```

TRICKY TRACKER

My article, "Build a Sun-Tracking Circuit," which appeared in the June 1995 issue of Popular Electronics, contained a few

like some indication as to whether the battery is charging, connect a meter with a shunt across its terminals in series to the circuit between the negative

TIGHTER INFORMATION SECURITY

I read with interest Craig Howard's article, "Security in the Information Age" in the May 1995 issue of Popular Electronics. I think such discussion is helpful and necessary as we build toward the Information Superhighway. However, I think a few additional words are in order.

All forms of attack on the DES require that it be used in the Electronic Code Book Method. Using the Cipher Feedback Method or the Cipher Block Chaining method causes the statistical properties of the plaintext to be diffused across the entire cipher text.

Pretty Good Privacy offers no security at all. It is notoriously susceptible to standard cryptographic statistical attacks. The source code has gone around the world on bulletin boards. It is impossible to put any level of trust in software that is obtained that way. Covert channels are easily installed in such software. The installer can then read all of the communications being transmitted. You might as well use a Clipper chip with Leaf installed. At least then, only the government can read your mail.

The RSA system is interesting. The government gave Rivest, Shamir, and Adelman a

patent on an algorithm. I think I will apply for one on the exclusive-OR operation. You can bet that they installed a secret solution before the government gave them the patent.

Covert channels can easily be installed. Let's say that the transmission key for a message is 1234. The installer simply modifies the output routine to put in a one-millisecond delay after the first, second, fourth, seventh, and eleventh characters. The first person to receive the message can read the key. The beauty of the system is that subsequent transmissions of the message will strip the delays, so the fact that it was done is concealed. There are so many ways in which covert channels can be installed that it is almost impossible to guard against them or detect them. The blinking cursor on your screen or its refresh rate might be giving you away.

If you want real security you must use techniques that offer you a high level of trust. You need to get your security software from someone who has the reputation of a Swiss bank. It must be incorruptible and not subject to government pressures. Then you must take great care to control access to the software.

J.E.H.
Palm Coast, FL

HAVES & NEEDS

Last summer, I bought a Heathkit HERO 2000 robot that was both broken and without documentation. I know I can repair the mechanical problem, but I need schematics and other information on the electronics and programming. If any readers have a HERO and would contact me, I sure would like to talk with them. Also, I'd like to know if there are any HERO users groups out there? Thanks in advance for any help anyone can give me!

TOM CRONICK
2010 West 8th Street
Odessa, TX 79763



Jerrold Compatible
DP5, DPV5...as low as \$5.00
DP7, DPV7 ..as low as \$7.00
R2, V5, CFT modules from \$15.00
Scientific Atlanta
Quick-Boards for:
8550, 8570, 8580, 8590, 8600
all as low as \$14.75

ALSO AVAILABLE FOR TOCOM, PIONEER AND ZENITH

1-800-639-6369

CIRCLE 16 ON FREE INFORMATION CARD

CircuitMaker[®]

The Ultimate Circuit Design Tool

But don't take our word for it

"BRAVO! Incredible graphics, flexibility and selection of components. I regret having wasted time and money on your competitors product."
Owen Bordelon, Lunar Technology Corp.

"I have played with CircuitMaker all weekend and haven't found a single problem. I was able to produce usable work 1 hour after setup!"
Joseph Bouche, Amherst College

"Very Intuitive!"
Mike Grover, STS Production

"This is an incredible product."
Michael Boberski, Vanderbilt Univ.

"CircuitMaker really shines in the simulation phase..."
Macworld Computer Magazine



Comprehensive Device Library

Version 3 features a new, state-of-the-art device browser which greatly simplifies the task of organizing and selecting devices. With its newly expanded device library, CircuitMaker now ships with more devices (at no additional cost) than any competing product. If you need a device that isn't provided, CircuitMaker provides industry standard SPICE import and a powerful Macro capability to enable you to create new devices. CircuitMaker provides you with the tools to get the job done right.

Printed Circuit Board Netlist Output

The new PCB output capability helps you complete your design cycle, by generating a netlist that can be imported into any compatible PCB program. This is not a costly "add-on" product. It comes standard with every copy of CircuitMaker.

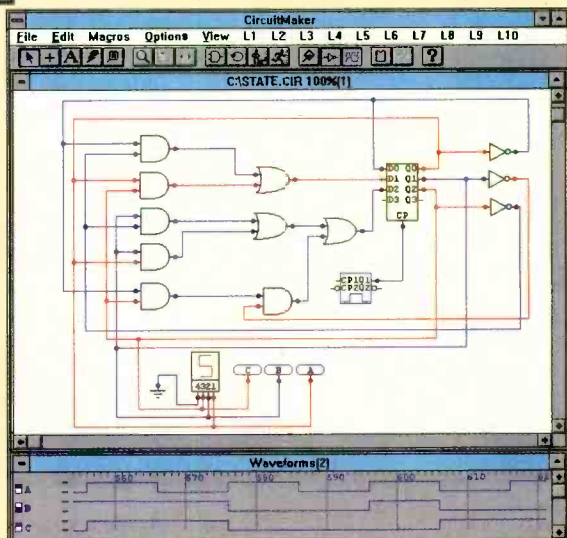
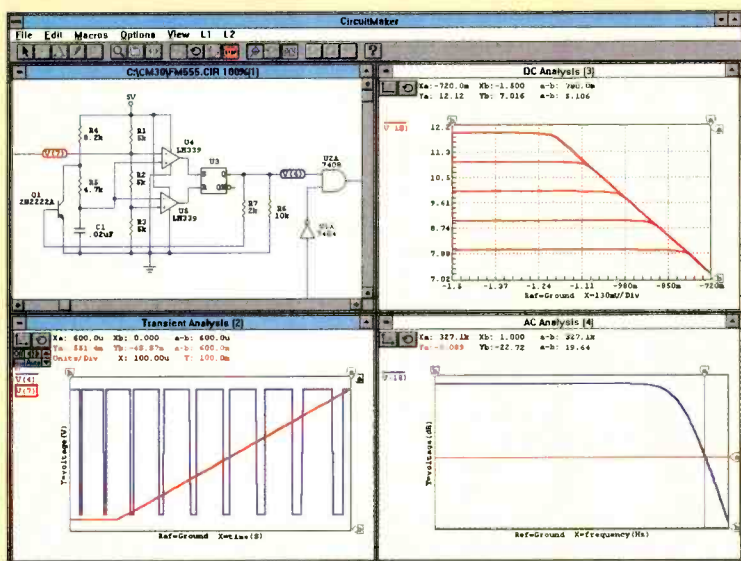

Professional Schematic Layout

This easy to use layout tool is unmatched. It includes many advanced schematic editing features not found in similar programs. These powerful features minimize the time and task associated with drawing a schematic and insure a professional looking final product. Printout and export options are numerous and results are of the highest quality. But that's what people have come to expect from CircuitMaker.

Analog, Digital and Mixed-Mode Simulation

CircuitMaker's SPICE3 based analog simulator provides fast and accurate simulation. New SPICE sub circuits allow mixed-mode simulation with all base level digital devices. Digital simulation is live and highly interactive. This powerful simulation trio is tightly integrated into one package and will confirm your circuit designs with accuracy and ease.

MicroCode Engineering
573 W. 1830 N. Suite 4
Orem, UT 84057 USA
Phone (801) 226-4470
FAX (801) 226-6532

To order or request additional information call 800-419-4242



CIRCLE 42 ON FREE INFORMATION CARD

A demo version is available on major on-line services or for \$10 direct. Competitive upgrades are available for \$149. Call for details. CircuitMaker is a registered trademark of MicroCode

NEW PRODUCTS

True-RMS Multimeter

According to *Fluke*, its *Model 76* is the first handheld, true-RMS digital multimeter in its price range to meet the requirements of IEC-1010 standards for use in Overvoltage Category III locations. As a Category III instrument, it is designed to withstand up to 600 volts AC or DC continuously between any terminal and earth ground, with impulse protection up to 6000 volts.

To ensure accuracy in the presence of electromagnetic interference, the *Model 76* meets the generic standard for the CE-



mark electromagnetic compatibility (EMC) requirements. It also is certified or has pending certification for approval from UL, CSA, CE, and TUV.

The *Model 76* offers guaranteed true-RMS response to the growing number of distorted

(non-sinusoidal) signals found in today's power and electronic environments. (Average-responding multimeters are accurate only when measuring undistorted sine waves.) The *Model 76* has a rated crest factor—the ability to measure severely distorted signals, such as those with a high harmonic content—of three at full scale.

The 3½-digit, 4000-count multimeter offers measurement modes including true-RMS AC voltage and current, DC voltage and current, resistance, frequency, capacitance, continuity, and diode test. With a basic DC-voltage accuracy of 0.3% and AC-voltage accuracy of 1.5%, the *Model 76* is an effective all-around troubleshooting tool, especially in environments where harmonics are a problem.

Other features include autoranging, automatic "Touch-Hold" mode, and "Smoothing." With autoranging, the user chooses the measurement function and lets the meter select the range with the greatest accuracy and resolution. (Manual mode is also available.) In the Touch-Hold mode, the meter automatically captures and holds a reading in memory, allowing the user to concentrate on touching the right test point, thus reducing the risk of shock or component damage. The user can view unstable signals on the fast-moving analog bar graph. The Smoothing function provides a stable digital reading of those signals.

The *Model 76* handheld digital multimeter costs \$199. For more information, contact Fluke Corporation, P. O. Box 9090, Everett, WA 98206; Tel. 800-44-FLUKE.

CIRCLE 101 ON FREE INFORMATION CARD

CORDLESS PHONE

Cobra's CP-720 cordless phone is aimed at those who want the convenience and freedom of a cordless phone but don't want to give up the clarity and privacy of corded phones. It features

Cobra's patented, built-in "Intenna" handset and base antennas, which free users from the worry of breaking or bending an antenna, or knocking into things with it. The phone also features "Private Call," a scrambling system that allows users to talk in confidence. For audio



performance similar to that of high-quality corded phones, the *CP-720* also features "Clear Call Plus" as well as automatic 10-channel scanning to minimize transmission noise and help avoid interference from other cordless phones. Those two technologies cut down on the fuzzy signals and static that can interfere with many cordless-phone conversations.

Convenience features include a special duplex answering system that allows users to page and talk between the handset and base locations; a built-in speaker phone with volume controls on both the base and the handset; 32-number-memory direct access, and automatic redial. The unit is hearing-aid compatible and comes in ivory or black.

The *CP-720* cordless phone costs \$149.95. For additional information, contact *Cobra Electronics Corporation*, 6500 West Cortland Street, Chicago, IL 60635; Tel. 312-889-8870; Fax: 312-794-1930.

CIRCLE 102 ON FREE INFORMATION CARD

ON-LINE WORD PROCESSOR

The *WP7800J* from *Brother In-*

ternational is the first word processor to bring consumers the benefits of on-line capability. Equipped with a 2400-baud modem, and including a free month of basic service on CompuServe, the word processor allows users to access news, sports, stock quotes, weather, bulletin boards, movie and restaurant reviews, travel information, and e-mail. For those customers who are interested in accessing CompuServe's extended services, a \$15 credit is also included.

The WP7800J also facilitates desktop publishing. It features a two-disk set of 1100 graphic-art images. Also available is an optional hand-held image scanner to insert illustrations and photographs into documents.

The 14-inch, super-flat screen features pull-down windows. The windowing software allows even first-time users to easily create multi-column newsletters, spreadsheets, and reports. Different type sizes, styles, fonts, and symbols can be combined, and bar graphs and pie charts can be created and inserted on a page with written text. For professional-looking print outs, the unit features a built-in ink-jet printer.



A standard 3.5-inch, 1.44-MB floppy-disk drive provides MS-DOS file compatibility with personal computers, allowing ASCII and Lotus 1-2-3 WK 1 files to be transferred to and from PCs. The word processor also includes spreadsheet software, a pop-up calculator, a "word-spell" corrector dictionary, and a thesaurus.

The WP7800J word processor has a suggested retail price of less than \$600. For more information, contact Brother International Corporation, 200 Cottontail Lane, Somerset, NJ 08875-6714; Tel. 908-356-8880; Fax: 908-356-4085.

CIRCLE 103 ON FREE INFORMATION CARD

Measure It All!

The DMM/LCR Meter/ Frequency Counter. All in One.

Troubleshoot down to the component level — any component! Verify poorly marked parts, test for tolerances and damage. Wavetek's new DM27XT is not only a full-function DMM, but also includes complete inductance, capacitance, and frequency measurement capabilities.

- **Wide LCR range:**
10 Ω to 2000 MΩ
10 pF to 2000 μF
100 pF to 20 H
- **Autoranging frequency meter** 10 Hz to 20 MHz
- **Ac and dc current to 20 A**
- **Logic test, diode test, max reading hold, continuity beeper, input warning beeper, fused input protection, battery saver**

Consolidate your test bench with one meter that does it all — Wavetek's high-performing, full-function XT Series DMM. It's all in one compact, rugged, field-ready package with a big 0.7-inch, 3 1/2-digit display. Insulated probes and alligator clip leads are included, and there is a huge selection of accessories, including current, rf and HV probes, temperature converters, holsters, and cases. Ask for Wavetek DMMs. They're the meters to pick when you have things to fix.



\$119⁹⁵

Other XT Series DMMs from \$89.95

U.S.A.: (619)279-2200
Europe: (44)243) 531323
Asia Pacific: (852)865-1903

©1993 Wavetek Corporation

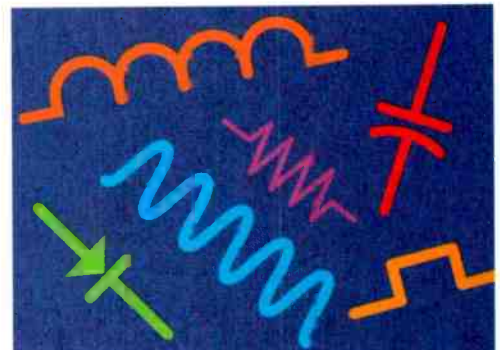

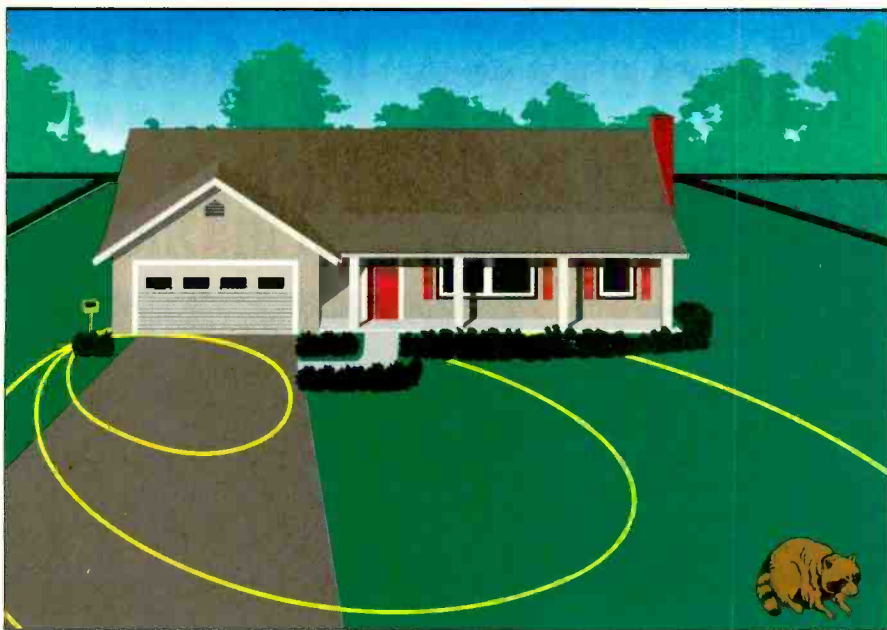

How ultrasonic power can safely deter unwelcome animals from your yard...

Yard Gard creates a wall of silent noise that drives away annoying dogs, cats and many wild animals without harming them.

by Charles Anton

Be honest. Even if you're an animal lover, you don't want strange animals in your yard.

You know what I'm talking about... dogs that dig holes and foul your lawn, cats that trample your flowers and sleep on your car. If you live in a rural area, you've probably had trouble with uninvited visitors like raccoons, possums, rabbits, or armadillos.

Until now, there weren't many options. After all, you wouldn't want to harm a stray animal, and your animal control agency may take days to respond, if they ever do.

High-tech solution.

Fortunately, modern technology has provided an answer: the new Yard Gard. It uses high frequency sound waves to force unwanted animals to leave the area.

Yard Gard eliminates the need for repellents, trapping or physical attacks. Pests learn to avoid the areas Yard Gard protects.

Ultrasonic Power. Yard Gard's electronic ultrasonic generator broadcasts powerful "silent noise" that repels four-legged yard pests, yet is generally unobtrusive to people. Tones are harmless but animals find the sounds so unpleasant that they flee.

Why it works. Small animals depend on their acute hearing for survival. They can hear in the 18 to 25.5 kilohertz range which is beyond the range of most humans. When critical hearing frequencies are disrupted by strong pulses, animals feel threatened and leave the noisy area. Yard Gard takes advantage of this fact to protect your yard from pests.

Break their habits.

Animals are creatures of habit. They establish a territory and generally follow the same travel routes. Yard Gard forces animals to change their patterns and establish new ones. They soon modify their habitual routes to avoid Yard Gard zones.

Cruelty-free pest control that works...

In the past, people relied on poisons or violent means to get rid of unwanted animal pests. Recent environmental awareness has increased the demand for clean, non-lethal methods of pest control. Safe and humane, Yard Gard is the modern solution for pest control.

Humane. Yard Gard causes no harm to animals. By creating a wall of high frequency sound, it forces them to leave the area and create new habitual routes. While the sound is very annoying to animals, it is virtually unobtrusive to people.

Nature friendly. Poisons and pesticides can pollute soil and water sources. Yard Gard deters pests with sound so it causes no damage to the environment.

Non-toxic. Chemicals used to eliminate pests can be dangerous to humans or neighborhood pets. Yard Gard poses no health risk when used as directed.



Just plug it in. Are animals turning your yard into a zoo?

Yard Gard's transformer plugs into any standard household outlet. Electricity consumption is very low and costs only about 25¢ a month to operate.

Yard Gard is designed for outdoor operation in all types of weather. You can use your Yard Gard all year.

Mount your Yard Gard on a wall, post, or fence or place it on a flat surface. Yard Gard is essentially maintenance-free and requires only a minimum of care.

Three settings. Yard Gard has three frequency settings. At its lowest frequency setting, one Yard Gard covers an oval area of approximately 4,000 square feet the size of an average city lot. Additional units can be added to especially large yards.

Keep the birds.

Do you love to watch and feed birds in your yard? If you have problems with cats chasing birds away or killing them, Yard Gard is the answer. Birds are not affected by the high frequency sound waves. They can't hear it, but cats can't stand it.

Risk-free offer. For a limited time, you can get the new Yard Gard at the introductory price of just \$99. Call today to take advantage of this special factory direct pricing. All Comtrad products are backed by our "No Questions Asked" money-back guarantee. If you're not satisfied with the Yard Gard, simply return it within 30 days for a full refund. Yard Gard is also backed by a two year manufacturers warranty.

Yard Gard.....\$99 \$12 S&H

Please mention promotional code 502-PL-6630

For fastest service call toll-free 24 hours a day

800-992-2966



To order by mail, send check or money order for the total amount including S&H (VA residents add 4.5% sales tax.) Or charge it to your credit card, enclose your account number and expiration date

COMTRAD INDUSTRIES

2820 Waterford Lake Drive Suite 106
Midlothian, Virginia 23113



Do dogs like your yard better than their own?



Are rabbits eating as much from your garden as you are?



Do you have problems with unusual animals?



Do neighborhood cats think your garden is a litter box?

GIZMO®

Now Appearing on Your PC

WIN/TV-PRISM. Manufactured by:
**Hauppauge Computer Works, Inc., 91
Cabot Court, Hauppauge, NY 11788. Tel.
516-434-1600. Price: \$249.**

A funny thing is happening to multimedia personal computers—they are becoming as addictive as television. Children coming home from school are flipping on their PCs and playing *Myst* instead of flipping on the tube and watching MTV.

TV-program directors don't have to worry, however. Now kids can play *Myst* and watch their favorite music videos at the same time—and on the same PC. Expansion cards such as *Win/TV-Prism* from *Hauppauge Computer Works* are what make it possible.

Of course *Win/TV* can be used for more than giving Junior a way to watch his favorite shows while he plays games on his PC. It's an ideal way for business people to keep up with the latest news without leaving their desks, and it's very helpful for creating winning multimedia presentations on the desktop.

The *Win/TV-Prism* is a 16-bit ISA (industry standard architecture) I/O board. It works with most VGA or SVGA video adapters that provide a VGA feature connector. It does require that the display mode be set to either 640×480 or 800×600 pixels. Because all of the image processing takes place on the Prism card, its performance is not affected by the performance of the computer in which it is installed. Likewise, the board will not affect the computing performance.

Software supplied with the card requires Microsoft Windows 3.1 or Windows 95. The software doesn't eat up a lot of disk space—it requires under 360 kilobytes.

Installing the board is rather straightforward. If you're lucky, you won't have to change any jumper settings, and you can plug it into a slot, connect a cable between



it and your VGA card's feature connector, and button up the computer. Alternatively, if you know how the boards in your computer are configured, you can select the proper I/O port address, memory base address, and the IRQ level. For most people, the installation will be somewhat of a trial-and-error process. However, the default selections of *Win/TV* were chosen to avoid conflicts.

The rear panel of the card has five input and output jacks. An "F" connector is provided for an antenna or cable input to the card's TV tuner. *Win/TV* can also accept line-level audio and video—a special 5-pin DIN connector is provided for that. An adapter cable that converts the DIN connector to a pair of RCA-type female phono jacks is provided with the card. A line-level mono 1/8-inch phone jack is provided for audio output. It connects to either a sound card or a pair of amplified speakers.

Two other jacks on the card put *Win/TV* into your display loop. The card intercepts the VGA signal coming from the VGA card, merges its own video signal with that from the VGA card, and then sends the

resulting video out to the monitor. One 9-pin DIN-type connector accepts the output from your VGA card. (A short cable provided with the card converts the 15-pin D-type connector of your VGA card to a 9-pin DIN plug.) The second connector is a standard 15-pin D-type VGA video connector that provides the output signal for your computer monitor.

After the hardware is set up, the software can be installed. It follows standard Windows convention for installation. The first choice presented is for the selection of one of eight languages. *Win/TV*'s international capability is indicated by the choices: Danish, German, U.S. English, Castilian Spanish, French, Italian, Dutch, and Swedish.

The second setup choice is for the selection of the disk drive and directory where the software is to be installed. The third selects the type of board. *Win/TV* comes in three "flavors" to support standards around the world. The first, which we installed, supports NTSC (as used in North America, Japan, and Taiwan) and PAL-N and PAL-M (as used in South America). The second board type supports PAL-BG,

which is used in Central and West Europe, Africa, and Australia. The third supports PAL I, used in the United Kingdom and South Africa.

The next installation option asks whether the Teletext software application should be installed. Teletext is not commonly broadcast in the U.S., and our board did not include the Teletext hardware option.

The final software installation option is the Win/TV MCI overlay driver, which allows the card to be controlled from other multimedia applications such as Gold Disk's VideoDirectory and Astound, or any other program that uses an MCI-compatible video overlay device. A VisualBasic or C++ programmer's toolkit is available for multimedia authors.

Once the cables are hooked up and the software is installed, running Win/TV is just a simple matter of double-clicking on its icon. A window pops up on the screen, displaying either TV snow or a video image.

Win/TV has many of the features that you would expect to see on a modern TV set. For example, the tuner can be programmed to automatically skip channels that are unused in your area. Selecting Configure/Channels brings up the Setup Channels dialog box. From there, you can select the RF region (US, US-Cable, Japan, etc.) and video format, and tune manually through the channels, adding them to the preferred-channels list.

Clicking the Scan button causes the Win/TV to automatically scan the entire cable or broadcast band to search for active channels. The names it assigns to the channels are generic—USA-2, USA-4, etc. Those names can be customized, however, to include the call letters, network affiliation, or any other identifier up to 13 characters.

The Configure/Color menu option also brings up a dialog box that allows you to set the color saturation, hue, contrast, and brightness. A Default button is provided to return to the factory settings.

Win/TV can run in either 640 × 480 or 800 × 600 display modes. The Configure/Display menu option lets you compensate for misalignment that might occur when video modes are switched. A palette Skew setting aligns an overlaid image—such as the cursor or a pull-down menu—with the chroma key in the video window. If not properly aligned, a magenta shadow will appear on overlaid images.

Chroma keying or color keying is the technique on which the Win/TV is based.

Gizmo is published by Gernsback Publications, Inc., 500-B Bi-County Blvd., Farmingdale, NY 11735. Senior Writers: Chris F. O'Brian and Teri Scaduto. Copyright 1995 by Gernsback Publications, Inc. Gizmo is a registered trademark. All rights reserved.



The toolbar provides quick access to the most commonly used functions including channel changing, volume, and freeze-frame.

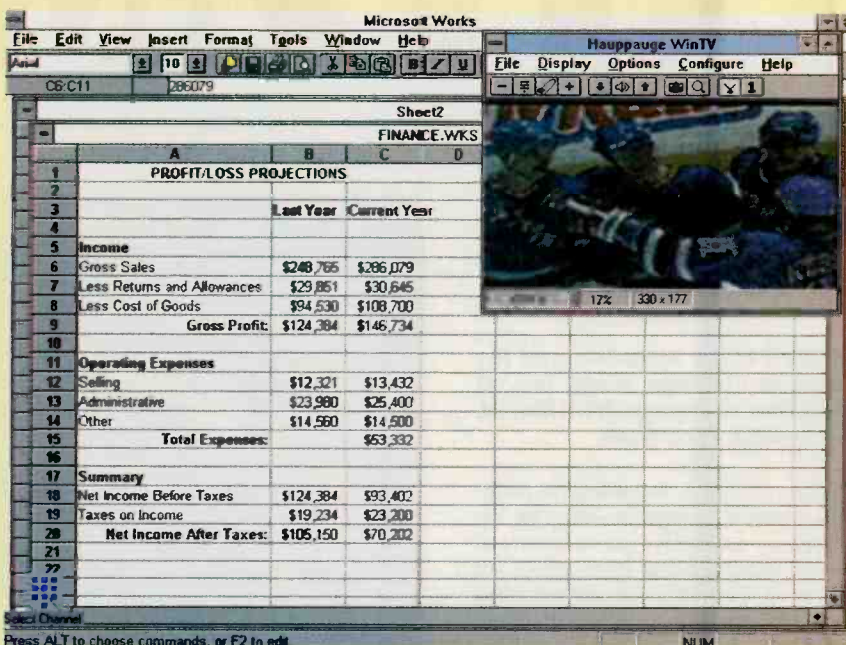

The Win/TV window can be placed anywhere on the screen. The image can be distorted from the normal aspect ratio for even more convenient placement.

You are probably familiar with chroma keying from watching weather forecasts on TV. The weatherman does not stand in front of a map. Instead he stands in front of a blank, usually greenish, screen. The maps are then keyed so that they replace the greenish color in the resulting video.

The Win/TV board converts the TV broadcast YUV color into the RGB signals used by VGA cards; the RGB video image is stored in the on-board frame buffer. That image is then scaled to the correct size and sent to the chroma-key circuit, which combines the scaled video image with the output of your VGA card. The combined image is then displayed on your monitor.

The Configure/Display menu also provides three other settings. The first sets the vertical sync either less than or greater than 72 Hz to activate special circuitry on the board necessary for using high-res VGA cards in the 800 × 600 mode. The second setting selects between interlace or non-interlace modes of your VGA card. (The Auto selection allows Win/TV to automatically detect the VGA card's mode.) The third selection for high/true color mode is to set the card for either 1 × or 2/3 × clock, which might allow the card to work in high-resolution (1024 × 768) mode.

Once the mundane settings are out of

the way, you can start having fun with the Win/TV.

A number of software-settable features allow you to customize the display for the way that you work. For example, one setting from the Options menu allows you to set the Win/TV display so that it is always on top of your other applications. Thus, you can be working on, for example, an application in its full-screen mode and still have the TV image off to the side so that you can see it. Home-office workers might want to use that feature to keep an eye on a baby's nursery while they worked, or to keep tabs on the hockey game during a late night's work.

Win/TV has two main display modes: with and without its title bar. Without its title bar, of course, the display can take up less room on the screen. A toolbar, which provides such controls as channel-changing, volume, and zoom buttons, can be displayed in both modes.

Flipping between the two modes is as simple as clicking the secondary mouse button. The screen size and position are saved with the mode information, so you can quickly change from a small display up out of the way in the corner to a full-screen display. That can be useful, for example, if your baby starts fussing in the nursery or when your team scores a goal.

The keyboard can also be used to control various functions when Win/TV is the active window. The page-up and -down keys control the volume, and the plus and minus keys act as channel changers. Function key F10 snaps the control up to the menu bar. A frame of video can be printed, frozen on screen, and copied to or from the Windows clipboard with the Control key in conjunction with the P, F, C, and V keys.

Win/TV can be forced to always display its TV window with the 4×3 aspect ratio of NTSC video. Optionally, video can be shown in odd aspect ratios. That is a convenience in fitting the video window alongside or on top of your work. Again, the ability to flip back and forth between two displays with the click of the secondary mouse button, adds to the convenience and practicality.

If desired, annunciators can be displayed on top of the video window. They can be timed so that they automatically disappear after about ten seconds, or they can be displayed continuously. They can also be configured with or without an opaque background color.

Another feature that “comes along for free” with the digital Win/TV is a “channel surf” mode that quickly scans through TV channels and the external video source and displays 16 thumbnail images on the screen.

Video frames can be captured and stored in several formats and resolutions, including TIFF, TGA, PCX, BMP, and GIF. The resolutions that can be stored depends on the chosen format. TIFF and BMP files can be stored in 8-bit black-and-white, and both 8- and 24-bit color. PCX and GIF files can be stored in 8-bit black-and-white and color. TGA files can be stored only in 24-bit color.

The image can be saved with different qualities and sizes. The size of the image can be set to the current window size, the maximum capture resolution, or scaled to a user-chosen size. The Window size setting will scale the number of captured pixels to equal the width, in pixels, of the current window size. It will drop lines to equal the number of lines in the current window size. The user-specified image size will scale the video image by dropping video pixels and video lines to fit the

specified image size.

Two Quality options, called Best Save and Viewable Freeze, control the quality of the captured image. The Best Save option gives the highest quality saves by storing all video pixels that the board digitizes. Win/TV can also store a “clip” of video—16 consecutive frames of video are stored in thumbnail fashion.

We have one minor complaint about the Win/TV Prism and one relatively major one. First, the VGA loop connector could become dislodged too easily, resulting in the loss of display. Hauppauge is aware of the problem and is currently shipping a modified connector that eliminates it. We noticed a more important problem in the 800×600-resolution mode—intermittent flickering. We were unable to determine what caused the flickering, or how to remove it, and it never showed up in 640×480 mode.

Win/TV can turn a standard multimedia PC into something truly special. It might not be an essential peripheral for all PC users, but we found it to be easy to become accustomed to, and we didn't want to take it out of our machine. ■

Video Snapshots

MODEL GZ-P15U COLOR VIDEO PRINTER. Manufactured by Sharp Corporation, Sharp Plaza, Mahwah, NJ 07430-2135; Tel. 201-529-8661. Price: \$999.95.

How many times have you shot a roll of film at some important event—your child's birthday party or ball game, a wedding or family reunion—and *thought* you had captured 24 or 36 “Kodak moments,” only to discover that in virtually every picture someone had moved, or blinked, or simply looked posed and unnatural? Photographs can make wonderful mementos, but unless the photographer is skilled and the subjects are cooperative, they don't truly capture the spirit of an occasion.

Videotape, on the other hand, does capture every moment as it happens. That's one reason why camcorders are replacing still cameras as the recording medium of choice at family events and vacations. But there's still a demand for hard-copy prints that keeps many folks juggling still and video cameras at family functions.

When it comes to sharing recorded memories, videotapes present some problems. First, not many people are interested in seeing every moment replayed as it happened, and not many amateur videographers have the ability or the equipment needed to make short, snappy



edited tapes. And, after the wedding or christening, you can't just stick a videotape in the card with the thank-you note as you would a photograph. You can't frame a videotape and display it proudly on the living room wall. Or can you?

You can if you have the *GZ-P15U* video printer from Sharp. The compact device connects to video equipment, including camcorders, TVs, and VCRs, and makes color prints of single frames from any videotape or broadcast program.

The GZ-P15U uses what's known as a dye-sublimation process to produce images. A microprocessor translates video images into heat levels, and a thermal head generates heat levels corresponding to the original image. The amount of heat applied to a transfer film determines the amount of ink that soaks into the paper, so that different heat levels produce different gradations. Precise control over the volume of ink allows a wide range of gradations to be printed, improving the quality



In its 4-image mode, the GZ-P15U prints four images on a single sheet. A 16-image mode is also available.

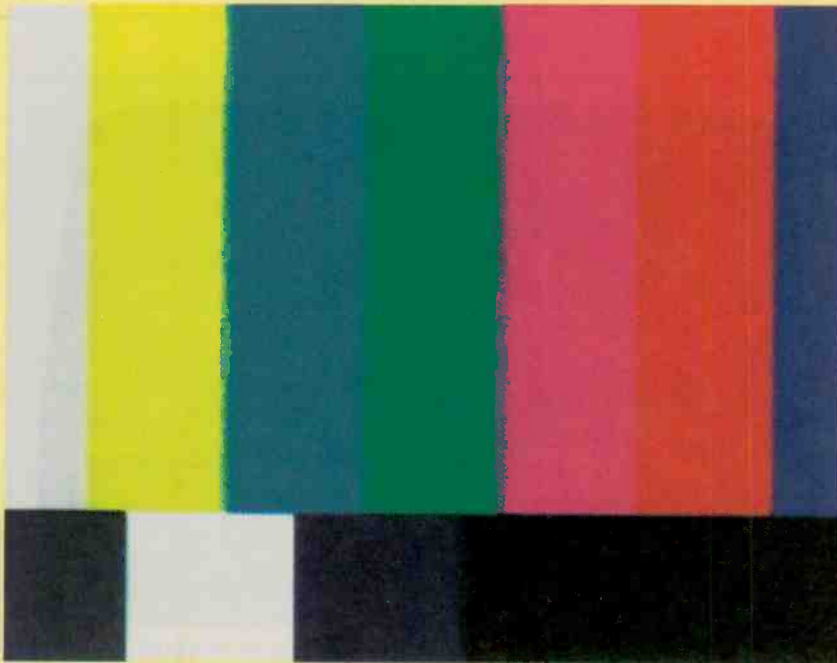

This image of a video test pattern, taken from a laserdisc, shows the video printer's true capability.

of the image. From the three primary colors (yellow, magenta, and cyan) used by the cartridge-type printer, 16.7-million colors with 256 brightness levels can be generated. The result is photo-quality pictures printed on paper, adhesive-backed labels, postcards, and even fabric transfers.

An ultra-thin printer mechanism allowed Sharp to keep the video printer compact, lightweight, and portable; it

measures approximately $10 \times 2\frac{1}{2} \times 11\frac{1}{4}$ inches and weighs just four pounds. Sharp suggests taking the unit along on vacations for printing your own custom postcards on the road, but we prefer to pack as lightly as possible and would probably wait until we got home to print out any vacation stills.

The video printer's top panel contains status indicators and most of the controls. At the front are two slide switches (for selecting print modes and stabilization

mode) and a slot for inserting video print sheets (which we will refer to as paper). Rear-panel connectors include video input and output jacks, the jack for the included wired remote control, and the power-cord socket. An S-Video input terminal is found on the left side, along with a second video-input jack. The right side of the video printer offers access to the ink-cassette compartment, along with the PAPER EJECT button.

Two types of ink cassettes and video print sheets are available—one for printing on paper, the other for printing on adhesive-backed stickers. You can't mix and match; the video printer won't accept the standard video print sheet if the adhesive sheet ink cartridge is installed.

Setup is easy. The video printer is connected between the video source and the monitor, using the video in and out jacks and the supplied cables. The ink cartridge slides into the opening on the left side of the unit; you'll hear a click when it's firmly in place.

For basic printing of a single frame of video off a videotape, you first locate the picture you want and then start playing the tape a little before that frame occurs. When you reach the desired picture, a press of the MEMORY button stores it and freezes the image on the monitor. Pressing the DISPLAY button allows you to toggle between the live video and the image stored in memory. Insert the paper into the front-panel slot, and press PRINT. A soft musical "fanfare" lets you know the paper was inserted correctly and accepted by the video printer. It takes less than a minute and a half for your print to be generated.

The picture image is about $3\frac{1}{4} \times 4\frac{1}{8}$ inches, printed on glossy paper measuring about 4×6 inches. Quality is ensured through the video printer's use of such features as full-frame memory, which allows videos to be stored as a full-frame unit ($\frac{1}{60} \times 2$ scans); the five-axis Select Field Interpolation function, which smoothes out jagged lines; and Digital Image Processing, which includes adaptable digital color correction, digital edge enhancement, and digital noise reduction.

In the long run, however, the quality of the print depends on the quality of the original video. Our first attempts, using an old, homemade tape, resulted in prints in which the colors were somewhat washed out. The fault was with the original tape; it couldn't be blamed on the video printer. Prints of a laserdisc test pattern, on the other hand, demonstrated the true potential of the GZ-P15U. The image was clear, edges were crisp, and colors were true.

Sharp recommends storing the prints in photo albums with cellophane or nylon sheets for longest life. The company advises against using tape or rubber bands on the prints (which might cause discolora-

TECHNOLOGY UPDATE

500 miles from nowhere, it'll give you a cold drink or a warm burger...

NASA space flights inspired this portable fridge that outperforms conventional fridges, replaces the ice chest and alternates as a food warmer.

By Charles Anton

Recognize the ice cooler in this picture? Surprisingly enough, there isn't one. What you see instead is a Koolatron, an invention that replaces the traditional ice cooler, and its many limitations, with a technology even more sophisticated than your home fridge. And far better suited to travel.

What's more, the innocent looking box before you is not only a refrigerator, it's also a food warmer.

NASA inspired portable refrigerator.

Because of space travel's tough demands, scientists had to find something more dependable and less bulky than traditional refrigeration coils and compressors. Their research led them to discover a miraculous solid state component called the thermo-electric module.

Aside from a small fan, this electronic fridge has no moving parts to wear out or break down. It's not affected by tilting, jarring or vibration (situations that cause home fridges to fail). The governing module, no bigger than a matchbook, actually delivers the cooling power of a 10 pound block of ice.

From satellites to station wagons. Thermo-electric temperature control has now been proven with more than 25 years of use in some of the most rigorous space and laboratory applications. And Koolatron is the first manufacturer to make this technology available to families, fishermen, boaters, campers and hunters—in fact anyone on the move.

Home refrigeration has come a long way since the days of the ice box and the block of ice. But when we travel, we go back to the sloppy ice cooler with its soggy and sometimes

spoiled food. No more! Now for the price of a good cooler and one or two seasons of buying ice, (or about five family restaurant meals), all the advantages of home cooling are available for you electronically and conveniently.

Think about your last trip. You just got away nicely on your long-awaited vacation.

You're cruising comfortably in your car along a busy interstate with only a few rest stops or restaurants. You guessed it... the kids want to stop for a snack. But your Koolatron is stocked with fruit, sandwiches, cold drinks, fried chicken... fresh and cold. Everybody helps themselves and you have saved valuable vacation time and another expensive restaurant bill.

Hot or cold. With the switch of a plug, the Koolatron becomes a food warmer for a casserole, burger or baby's bottle. It can go up to 125 degrees.

And because there are no temperamental compressors or gasses, the Koolatron works perfectly under all circumstances, even

upside down. Empty, the large model weighs only 12 pounds and the smaller one weighs just seven. Full, the large model holds up to 40 12-oz. cans and the smaller one holds six.

Just load it up and plug it in. On motor trips, plug your Koolatron into your cigarette lighter; it will use less power than a tail light. If you decide to carry it to a picnic place or a fishing hole, the Koolatron will hold its cooling capacity for 24 hours. If you leave it plugged into your battery with the engine off, it consumes only three amps of power.

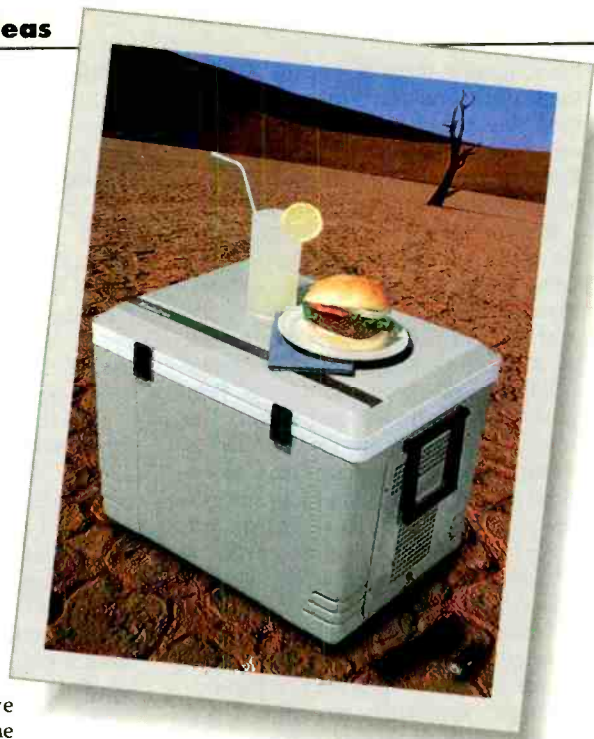

The refrigerator from outer space.

The secret of the Koolatron Cooler/Warmer is a miniature thermo-electric module that effectively replaces bulky piping coils, loud motors and compressors used in conventional refrigeration units. In the cool mode, the Koolatron reduces the outside temperature by 40 degrees F. At the switch of a plug, it becomes a food warmer, going up to 125 degrees.

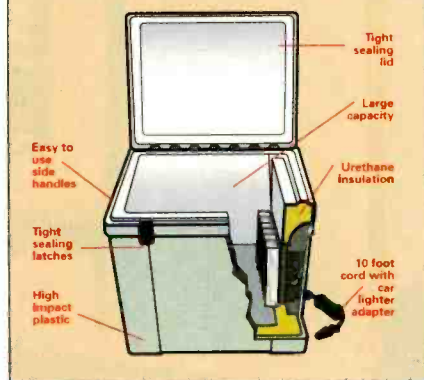

Limited time offer.

Because Comtrad is bringing this offer to you directly, you save the cost of middlemen and retail mark-ups. For a limited time only, you can get this advanced, portable Koolatron refrigerator at the introductory price of \$99. Call today to take advantage of this special promotional pricing. Most orders are processed within 72 hours.

Try it risk free.

We guarantee your satisfaction with any product from Comtrad Industries. With the Koolatron you get our complete "No Questions Asked" 30 day money-back guarantee. Plus you get a full one year manufacturer's limited warranty. If you are not satisfied for any reason, just return the product for a complete refund.

Koolatron (P24A) holds 30 quarts.....\$99 \$16 S&H
Koolatron (P9) holds 7 quarts.....\$79 \$8 S&H
Optional AC Adapter (AC 10).....\$49 \$6 S&H

Please mention promotional code 025-PL-6629.

For fastest service call toll-free 24 hours a day

800-992-2966



To order by mail send check or money order for the total amount including S&H (VA residents add 4.5% sales tax). Or charge it to your credit card by enclosing your account number and expiration date.

COMTRAD INDUSTRIES

2820 Waterford Lake Drive Suite 106
Midlothian, Virginia 23113



The versatile Koolatron is available in two sizes. The P24A holds 30 quarts and the smaller P9 holds seven quarts. An optional AC adaptor lets you use them in your rec room, patio or motel room. They plug into any regular outlet.

tion), leaving them in a stack for any length of time, or placing two printed surfaces against each other. We couldn't put our prints through the test of time, but a Sharp spokesman told us that with proper handling, aging shouldn't result in fading.

Besides doing basic photo-like prints, the video printer has a few tricks up its sleeve. It's possible to create photo "collages" of either 4 or 16 frames on one page. In each mode, you can use the top-panel LOCATION SELECT button to arrange the images in the order you'd prefer. Four frames result in wallet-sized photos. The manual suggests using that arrangement to print photographic index tabs on adhesive sheets of print paper. With 16 images in a 3½ x 5-inch area, each picture is too small to see well, although it does provide a convenient, all-in-one view of a special event or vacation.

You can also print a smaller picture, ¼ of the print size, over a full-size picture—sort of a video-print picture-in-picture. You might, for instance, insert over a panoramic view of the Grand Canyon a close-up of the family posing on the rim.

The high-speed strobe function, in which 16 consecutive frames of a single scene are printed on one sheet, is activated

by sliding the front-panel switch to its strobe position. That mode is particularly useful for filming sports sequences—a golf swing or a tennis serve, for instance. You might also want to capture and print your child's first steps using the strobe mode.

The GZ-P15U also offers a stabilization mode. If the frame you like is unsteady, selecting that mode steadies the picture. For the best possible resolution, however, the stabilization switch should be left in the off position.

The wired remote control contains just three buttons: MEMORY, PRINT, and DISPLAY. But once you've selected the print mode, those are really all you need to select and print the frames you want from the comfort of your favorite chair or sofa.

Although you can print frames right off standard TV programming, using a videotape or laserdisc as the source gives you more control. (We're not sure what images you'd want to print from a laserdisc, although we suppose teens might want to print out still pictures of favorite movie stars or bands.) You can easily move around the tape or disc using the fast-forward and reverse controls to find the precise frames you want to print. And, if you

don't press the MEMORY button fast enough to catch it the first time around, you can simply rewind a bit and try again until you get it right.

The beauty of making still shots from a videotape is the sheer number of possible photos available. There are 30 frames in every second of taped video, giving you 20 potentially good pictures to print. If someone blinked, wait a split second until her eyes are open, and then print the image. You can easily capture just the expression you wanted, or the right angle, or lighting, by waiting for the best possible video frame. And there's often a spontaneity to videotape (at least, after it's been rolling for a while) that still photos lack.

The GZ-P15U is easy and fun to use. The pictures it prints are good quality, and there's a bit of the magic of Polaroid as you wait those 80 seconds for the image to emerge. In fact, we have only one complaint—its price. Sharp bills the video printer as a consumer item, but \$999 is a bit steep for most of the consumers we know.

Still, the GZ-P15U does take the uncertainty out of photography. With the video printer, what you see is what you get—and we liked what we got. ■

Grab It While You Can

COMPUTEREYES/1024 VIDEO FRAME GRABBER. From Digital Vision, Inc., 270 Bridge Street, Dedham, MA 02026. Tel. 617-329-5400. Price: \$599.95

Computers have always done an admirable job crunching numbers and processing words. Today, the ability to handle graphics and images are at least as important.

Many PC users are creating wonderful electronic and printed documents on their PCs. However, the major difficulty that they are facing is obtaining photographic images with adequate quality. You don't have to look very far to see what we're talking about. We see plenty of catalogs and advertisements that are put together without the benefit of an unlimited budget. Grainy, low-resolution photographs are the rule. You can tell they were scanned and printed at too low a resolution. Worse yet are newsletters put together on a budget.

Although printing and production costs can get out of sight pretty quickly, there's no longer any excuse for not producing top-notch images even if you have to print at a resolution of 300 dots per inch (DPI). New video-frame grabbers like the *Com-*



CIRCLE 62 ON FREE INFORMATION CARD

puterEyes/1024 from Digital Vision allow you to capture exactly the image you want from any video source.

Of course, you'll need a video camera or camcorder, but you can do away with a 35-mm still camera and the problems that it brings to the table, including film and developing costs, and the job of re-shooting something after you find that you just don't like the pictures you took. You can also do away with the image scanner, or digital camera, and their high costs.

For color work, the production expenses get even higher as you have to scan the print or negative and separate it into the four colors—cyan, yellow, magenta, and black (CMYK)—used in the commercial printing process.

Video frame grabbers are also excellent tools for incorporating photographic images in desktop presentations, or in electronically published documents as found on the Internet's World Wide Web. They offer a benefit over traditional photography if for no other reason than they get the image onto your PC with fewer interim, resolution-robbing steps.

ComputerEyes/1024 is a 16-bit ISA bus board that can be installed in an AT-class or better IBM-compatible personal computer with a hard-disk drive, a 3½-inch floppy-disk drive, and at least 640 kilobytes of RAM. It requires MS-DOS 2.1 or higher, or Microsoft Windows 3.1 or higher (to run the Windows version of the software). A VGA or MCGA video adapter capable of displaying at least 640 × 480 at 256 colors is required, as is a video camera, camcorder, VCR, videodisc player, or any other video source that can provide a standard composite, S-Video, or RGB signal.

Hardware installation can be performed in one of two ways, depending on how hard you want to work. The easy way is called the "compatibility mode." It's a quick, easy, relatively conflict-free procedure that provides standard I/O register operation, and no interrupt or DMA channel settings are necessary. The hard way is the "performance mode," which sets the board for memory-mapped I/O.

The quality of captured images is the same in either mode. However, the speed of the video in the preview window and the speed of movie capture is faster when the board is installed in its performance mode. The board is more difficult to install in that mode because it is more likely to conflict with other boards in your computer or with memory managers. However, if you are comfortable working with such details, you should find that installation will go smoothly.

Three other connectors are located on the card's rear panel. First is a standard RCA-type phono jack for a composite-video input. Second is a 4-pin mini DIN con-

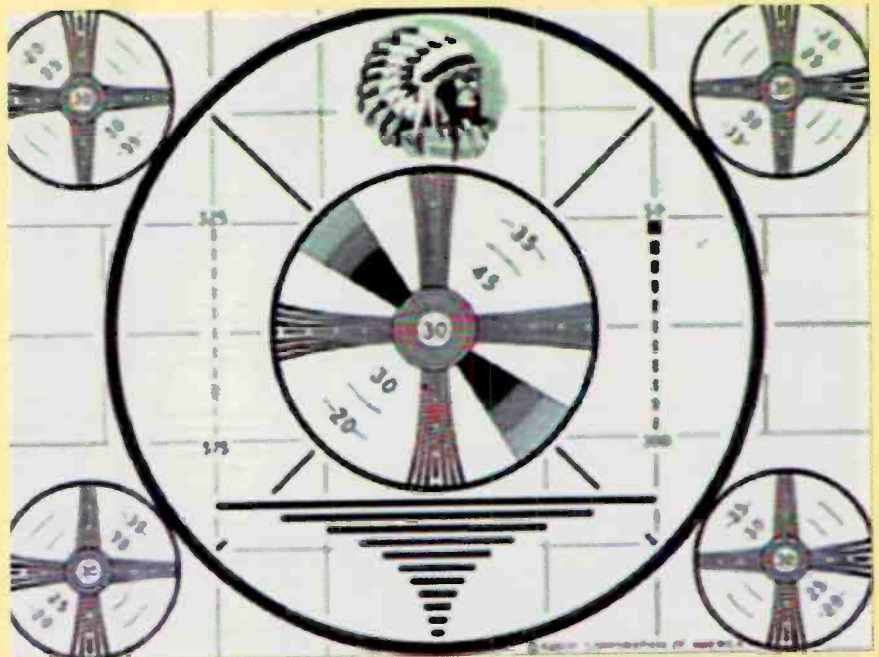

The main claim to fame of the ComputerEyes/1024 is its excellent resolution.

nect for S-video input, and third is a 9-pin D-type connector for RGB video input. ComputerEyes does not require a VGA feature connector, which further helps to eliminate installation problems.

Software is provided for both the DOS and Windows environments. Both single images and animations can be captured with either version of the software. We applaud Digital Vision's decision to support both Windows and DOS. It allows less powerful machines to capture high-quality images even if they can't run Windows. We spent most of our time with the Windows software.

When that software is launched, a preview window is opened. It shows either the video at the configured input connector, or a blank window with a warning that no video is detected.

The preview window can be resized, but the larger you make it, the worse the video looks. The pixels grow larger, and the frame rate decreases. However, the quality of the image in the preview window does not affect the quality of the captured image. ComputerEyes stores a frame of video every 1/30 of a second in on-board memory. It transfers an image to your display at a speed that is determined by your computer, and the settings you have selected for the preview window.

Images can be captured by clicking on the Capture toolbar button or by simply hitting the F2 function key. Once the image is captured, it can be manipulated with one of the seven Edit-menu commands before it is saved to disk.

Choosing Smooth filters out harsh edges in the images. It can be selected multiple times to multiply the effect.

Choosing Sharpen does the opposite, enhancing the edges in images. It, too, can be selected multiple times. The Flip and Mirror selections allow the image to be flipped vertically or mirrored horizontally. The Invert selection in the Edit menu creates a black-and-white or color negative of the image. The Motion Filter selection in the Edit menu allows you to reduce the distortion caused by a moving object in a video image by eliminating the moving portions of one of the two fields that make up a frame of video. A Reverse Fields command can also help reduce image distortion.

ComputerEyes/1024 supports several file formats including Windows Bitmap (BMP), CompuServe GIF (GIF), PC Paintbrush (PCX), Tagged Image File Format (TIFF), and JPEG Compressed (JPG). The DOS software adds Targa (TGA), ComputerEyes (CE), Splash (SS), and Deluxe Paint (LBM).

To capture moving video, the program CineMaker is included with the board. A Video For Windows driver is also included with ComputerEyes/1024 so that animations can be captured with third-party software such as Macromedia Action! CineMaker can store animations in ComputerEyes Snip (SNP), Autodesk Animator Flic (FLI), and IBM Linkway (MOO).

The software provided with ComputerEyes allows for basic image enhancement so that the captured image can be manipulated to fit most of your requirements. However, for more demanding tasks—and for printing—an image-editing program is required.

(Continued on page 18)



CIRCLE 63 ON FREE INFORMATION CARD

Straight Shooter

HL-630 LASER PRINTER. Manufactured by Brother International Corporation, 200 Cottontail Lane, Somerset, NJ 08875-6714; Tel. 908-356-8880. Price: \$499.

Whoever predicted that the advent of computers heralded the end of paper documents was sadly mistaken. Now it seems that we have at least three copies of everything: on disk, on paper, and on back-up disk—and there's often a Xerox "back-up" of the paper version as well.

The paper glut is here to stay, at least for the foreseeable future. That makes the printer a vital part of any computer system.

There are three basic choices when selecting a printer. Dot-matrix printers have the virtue of being cheap; unfortunately, their print quality proves the adage "You get what you pay for," and their noise level can be deafening. Ink-jet printers have good quality output at a reasonable price, but they are terribly slow. Laser printers offer high quality, quick speed, and quiet operation, but until recently they were priced out of many people's range.

Despite their high price tags, sales of laser printers have been rising—particularly for the lower-priced, slower (up to 6 pages per minute) models. Sales of low-speed laser printers are expected to increase by at least 50% over the next five years, driven largely by the rapidly grow-

ing SOHO (small office/home office) market. Falling prices are also spurring momentum in the laser-printer market.

In fact, it's now possible to buy a laser printer for about the same price as an ink-jet unit. Case in point: The *HL-630 Laser Printer* from *Brother International* has a street price of just \$399. Yet it doesn't skimp on either features or quality. It offers all the basics—6-page-per-minute (ppm) output, 300 dot-per-inch (dpi) resolution, 200-sheet paper-feeder tray. Then it adds some features you'd expect to see on higher-priced machines—automatic interface switching, optimized Windows 3.1 driver, 45 fonts, high-speed bi-directional parallel port, power-saver mode. Finally, it throws in Brother's proprietary "Straight Paper Path" technology.

Most printers require the paper to pass through a convoluted maze of rollers inside the machine. The Straight Paper Path design (found exclusively on Brother's HL-600 Series printers, of which the HL-630 represents the low end) feeds the paper through the shortest, straightest possible path (see Fig. 1). Paper curling is reduced, and you're much less likely to find your printing halted due to a jammed page in some unseen area of the paper path or have a label pop off its release liner.

The shortest path between two points is a straight line, so it's to be expected that the straight path will result in faster output. And because the paper isn't twisted or bent as it travels through, the printer is able to efficiently handle envelopes, a wide range of paper sizes, and even the thicker

paper stock used in many custom print jobs. The HL-630 can be used to print tri-fold brochures, business cards, invitations, and other formats. Less obvious, but important over the life of a machine, is the fact that fewer moving parts should mean better reliability and less maintenance.

The simpler paper-moving design also translates into a smaller footprint. The HL-630 measures a slim 14.4 × 14.3 × 7.2 inches. The paper-feeder tray, which stands almost upright at the back of the unit, adds another foot in height. (The manual paper feeder is a slot in the front of the automatic paper-feeder tray. A sliding paper guide securely holds paper sizes ranging from business cards to legal size.) The paper output tray adds about four inches when it is folded down from the front of the printer; when you're not using the printer, the tray can be flipped back to free up desk space.

The "control panel" is almost non-existent. It consists of four LEDs and two buttons. The READY lamp lights when the unit is on-line, blinks at one-second intervals when it's off-line, and blinks every half second during warm up. The DATA lamp flashes when the printer is receiving data from the computer and remains lighted while print data remains in the printer's memory. The MANUAL LED blinks to prompt the user to insert paper when the printer is in the manual mode. A flashing ALARM lamp indicates a printer error.

The SELECT/RESET switch can be used to stop printing in progress. A second press of the button restarts printing, reprinting the entire interrupted page. Holding down the SELECT/RESET button until all four LEDs are lit resets the printer; it restores all the default settings, puts the unit into sleep mode, and clears all data from its memory. The FF/CONT(TEST) has three functions: form feed and continue are both used in manual print mode, and test is used for printing test sample pages. The two buttons can also be used to reprint the last printed page without sending it again from your computer. First press SELECT to turn the printer off-line, then press FF/CONT to reprint the last page. Pressing FF/CONT more than once creates multiple copies of that page.

Noticeably missing from the front panel is an on/off switch. That can be a bit disconcerting—particularly for those who tend to use new products before reading the manual. Instead of on and off modes, the HL-630 is either "asleep" (in Power Saver Mode) or active (in standby mode, receiving data, or actually printing). Pressing either of the front-panel buttons activates the printer, but that's not necessary. The machine wakes itself up automatically when it receives data. When no data is received for a certain period of time (the



1-6-94 8:07 p.m.
Situation: Mother and two children in mall parking lot

The first alarm system designed to protect you as well as your car...

Revolutionary new vehicle security system is the first of its kind to focus on the safety of the vehicle driver as well as the vehicle itself.

By Charles Anton

Do you wonder why car alarms have countless features to protect your car, but nothing to protect you? After all, what's more important your car or the safety of you and your family?

Now there is a car alarm that will protect you and your family. It is the first of its kind to focus on the safety of the vehicle owner as well as the vehicle itself.

Protect yourself. It all begins with the panic button. Imagine you're walking to your car at night and a person approaches. Pushing the panic button on your transmitter lets your car come alive with a shrieking siren and flashing headlights. While the panic alarms of other vehicle security systems have a range of 100 feet, the Smart Alarm's panic alarm lets you call for help or scare away potential attackers from up to 400 feet!

Exclusive feature. Unlike other car alarm systems that begin and end their focus on per-

sonal protection with the panic alarm, that's just the beginning of the Smart Alarm. In addition to the panic alarm, the Smart Alarm also has a car finder feature. You'll never again have to wander around a dark and dangerous parking lot searching for your car. You will be able to know where your car is from anywhere within 400 feet by flashing its lights and briefly sounding the siren. You can activate and deactivate your car's headlights by remote control to light your way in a dark driveway or parking lot.

Carjacking. The Smart Alarm also addresses a growing hazard for today's motorists—carjacking. It's alarming how often drivers are hurt in their cars because they refuse to give them up to carjackers. Because of its anti-carjacking device, the Smart Alarm allows you to safely retain your car when confronted by a carjacker. This is made possible by a delayed panic alarm.

What makes Smart Alarm better?

- **Range.** Most car alarm features only work up to 100 feet away—all Smart Alarm features work up to 400 feet away.
- **Panic button.** Smart Alarm lets you call for help or scare away potential troublemakers by controlling a piercing alarm and your car's headlights.
- **Car finder.** Your car will be able to let you know where it is by flashing its lights and briefly sounding the siren.
- **Carjacking.** Its delayed panic alarm allows you to safely prevent theft of your car when confronted by a carjacker.
- **Easy installation.** Other car alarms are complicated or cost hundreds of dollars to install. Smart Alarm is inexpensive, and you can install it in just minutes.



Smart Alarm is the first car alarm that will protect you and your family.

Easy installation. Installing the Smart Alarm requires no fumbling with wires. Special Plug-In Connectors let you install the Smart Alarm without a single wire-cutter! Simply unplug the headlight connector, plug in the Smart Alarm connector, and then plug the headlight connector to the Smart Alarm. Connect the Smart Alarm to the battery cable with the special clip. In minutes, you and your car can enjoy complete 24-hour protection. Away from your car, you'll feel safer knowing that your car is protected! Near your car, you'll feel safer knowing that you are protected!

All you do is give up your car and activate the delayed panic alarm. When the assailant has reached a safe distance and is no longer a threat to you, a deafening 120dB siren and flashing lights will force him to flee your car, letting you recover it safely.

Vehicle protection. Smart Alarm's current sensor triggers the siren if the trunk or any of the doors are opened while the alarm is armed. To supplement the current sensor, a shock sensor triggers the siren when it detects a blow to your car. Together, these sensors provide your car with blanket protection.

An adjustable shock sensor prevents the siren from being triggered, eliminating false alarms. You can also adjust the shock sensor and the siren with your remote control at any time you choose. The siren's tone and volume can be adjusted to six separate tones. As a result, you'll never confuse it with any other alarm. You can also customize the siren, making it louder in noisy neighborhoods and quieter in more peaceful neighborhoods.

Risk-free home trial. With the Smart Alarm, you get a complete "No Questions Asked" 30-day money-back guarantee. If it's not everything we say, just return it for a full refund. The Smart Alarm is also backed by a two-year warranty. Your order will be shipped UPS in seven to ten working days.

The Smart Alarm Car Alarm..... \$99 \$9 S&H

Please mention promotional code 483-PL6631
For fastest service call toll-free 24 hours a day

800-992-2966



To order by mail, send check or money order for the total amount including S&H (VA residents add 4.5% sales tax.) Or charge it to your credit card, enclosing your account number and expiration date.

CONTRAD INDUSTRIES

2820 Waterford Lake Drive Suite 106
Midlothian, Virginia 23113

factory default "time out" is 15 minutes, but you can set it anywhere from 1 to 99 minutes), the printer goes into its sleep mode. The lamps go off, but the fan stays on until the printer engine is cooled down.

When sleeping—in Power Save Mode—the HL-630 consumes 10 watts of power or less, compared with 60 watts in standby mode and as much as 480 watts during printing. The HL-630 complies with the Environmental Protection Agency's Energy Star program, exceeding specifications for printers rated at less than 15 ppm, which require less than 30-watts power consumption in energy-saving mode. The Power Save mode benefits the user as well as the environment. The printer is quieter when in its sleep mode (silent, once the fan goes off), and using less power means lower electric bills and less heat generated.

The HL-630's penny-pinching features don't stop at its low street price and Energy Star compliance. It offers two print modes: Economy, which produces lighter print, and Normal. According to Brother, the Economy mode can cut per-page printing cost to less than 2 cents and increase toner yield by up to 50%. The printer also uses a separate drum unit and toner cartridge, which cuts down on replacement costs. The DR-100 drum, which has a life expectancy of 17,000 pages, has a suggested retail price of \$189.95, and the toner cartridge (*Microfine TN-100HL*), which needs to be replaced after approximately 3000 pages, costs \$39.95.

On the minus side, installing two separate pieces is somewhat trickier than dealing with an all-in-one unit. The situation isn't helped much by the manual. The illustrations depicting proper installation procedure bear little resemblance to the actual pieces, and the scanty text didn't clarify matters.

Even the paper feeder tray was somewhat difficult to install. It seemed that the metal paper-support rack was cut just a bit off size, making it hard to insert in its proper position.

Once the physical side of the setup procedure is complete, however, the rest is quite easy. The HL-630 offers an optimized Windows 3.1 print driver, which is installed using standard Windows conventions. It offers 21 resident bit map fonts and 24 True Type-compatible scalable fonts. On the inside, the printer features a powerful 16-MHz microprocessor, and a high-speed, bi-directional parallel port. Standard RAM is 512K, expandable to 2MB by adding user installable 1- or 1.5-MB memory modules. The printer can also be used with DOS. It comes with Hewlett Packard LaserJetIIP (PCL4), Epson FX-850, and IBM Proprinter emulations, ensuring compatibility with major PC computer platforms and popular software application packages.

At the heart of the printer controller and driver is a proprietary advanced data-compression algorithm that increases the HL-630's ability to move more data at a faster rate—according to Brother, up to 44% faster than its competitors in its ability to process and print files of similar types and sizes. The algorithm also affects memory requirements by reducing the data required for printing. By using existing memory more efficiently, the printer is able to handle more data before more memory is required.

Brother's "IntelliPrint" technology allows the printer to take over several operations that normally require some type of user intervention. For instance, Auto Emulation Switching allows the printer to automatically sense and adjust to the data stream being sent by the personal computer. In other words, you don't have to man-

ually switch the printer between its Epson and HP emulation modes when you print from different applications. The printer does it automatically. Auto Interface Switching automatically determines whether the data is coming over the printer's parallel port or the optional serial port. When you have the settings adjusted to your liking, you can generate a Setting Status Page—a one-page printout itemizing all the settings. A Lock-Up Settings feature allows you to lock in those settings to prevent other users from changing them. The Power Saver Mode, discussed above, also falls under the IntelliPrint umbrella.

How does all that technology affect everyday use? The HL-630 is a fine performer for most home-office/small business demands. It's small, easy to use, quiet, and quick. The Straight Paper Path allows you to print on heavier stock, so you can easily print business cards, invitations, or brochures that previously would have required a trip to the print shop. The type quality is sharp and clear when printing text. The printer has some trouble with graphics—there are some dark, fuzzy areas, and a lack of distinction between gray shades. For most SOHO uses, however, its graphics reproduction capabilities should be adequate.

The HL-630's super-low price might be its primary attraction to those in the market for a printer. But its wealth of features will hook them in—and keep them very happy. ■

FRAME GRABBER

(Continued from page 15)

One of the strengths of ComputerEyes/1024 is its versatility. Many users will appreciate the Compatibility mode, which allows an easy way for non-technical users to capture video frames. As for users who require higher-performance operation, they will be able to obtain it with a little more work. Windows users will be able to capture AVI files or other formats provided by their software, while DOS users will still be able to capture video for their needs.

ComputerEyes' claim to fame is its high resolution, capturing 1024 samples per line—better than any image you can capture with your camcorder or VCR. It is designed to take advantage of RGB equipment rated at 600 or 700+ lines, or black-and-white video rated at 900+ lines.

Although the ComputerEyes/1024 is not the fastest animation-capture card on the market, it can capture motion AVI files at 30 frames per second at sizes up to 340 x 240. That competent performance is overshadowed by its superb still-frame capture capability. ■

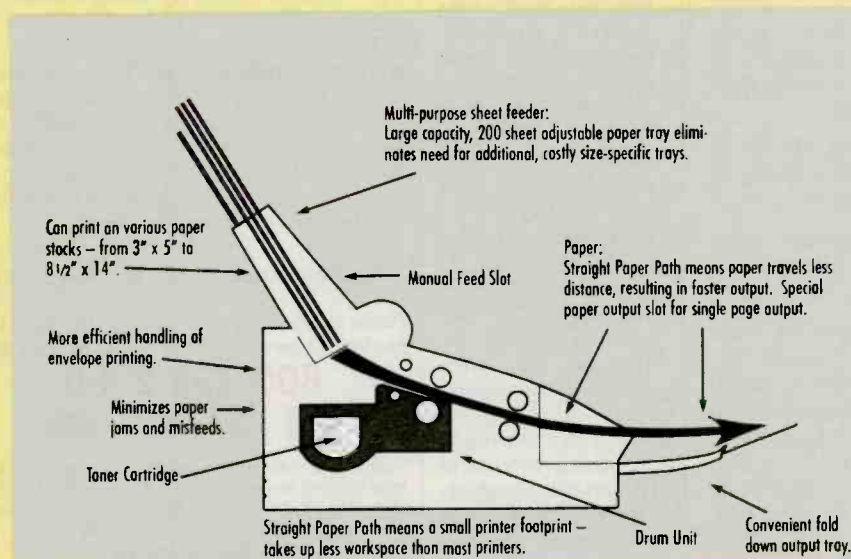

Fig. 1. Brother's Straight Path Paper Technology.

GIZMO NEWS

Blow to Primestar as RCA Ships Millionth DSS System

The Federal Communications Commission (FCC) dealt a major blow to Primestar Partners, which had planned to launch a high-power direct-broadcast satellite (DBS) service next year to compete with the DSS digital satellite system.

Primestar currently uses the medium-power Satcom K1 Ku-band satellite to beam about 70 channels of programming to dishes roughly three feet in diameter. Last fall, Tempo, a subsidiary of Tele-Communication Inc., reached a deal to buy Advanced Communications Corp. and the 27 channels that Advanced owned at the 110-degree DBS orbital slot—a prime location for delivering programming to the continental U.S.

The FCC, however, stripped Advanced of its slot, saying that the company—after more than a decade—did not provide and was not close to providing DBS service. Although Advanced had requested that its license be transferred to Tempo, the FCC did not rule on that request, saying that Advanced now has nothing to transfer.

Primestar “intends to support any and all efforts to appeal this decision and seek its reversal,” the company said in a statement. “By delaying enhanced competition in high-power DBS for at least three years, this decision—if it stands—will de-

prive consumers of expanded financial, programming, and service options provided by a competitive marketplace.”

Most industry observers expect that the decision, if it stands, will help DirecTv and USSB, the two program providers for DSS, strengthen their places in the market. At the end of April, the two companies had a total of 583,000 subscribers, according to the industry publication *Satellite Business News*. Primestar, by contrast, had 371,000.

EchoStar Communications, which controls 22 channels at the 119-degree slot, is hoping to launch its first DBS satellite by the end of the year, and its second satellite in mid-1996. However, that would still leave EchoStar with five fewer channels than its competitors, DirecTv/USSB.

Thomson, meanwhile, shipped its millionth DSS receiver just ten months after it introduced the hardware. Under the terms of a licensing agreement, that milestone gave Sony the right to enter the DSS hardware market. The two companies will share the market until October, when additional manufacturers will be allowed to enter.

Sony introduced two units, both more expensive than RCA's. The basic unit will be priced at \$749, with the step-up dual-LNB model priced at \$849. A more advanced model will carry a \$949 price. The

receivers feature an improved menu system and a “signal seeker” LED on the LNB that indicates when a signal is received, making installation easier.

“Mega” Disk for PC

Compaq, 3M, and MKE have announced a joint effort to develop a super-high-density floppy disk. The new 3.5-inch diskette will boast a capacity of 120 megabytes, about 80 times that of today's standard 3.5-inch diskette. In addition, the disks will perform five times faster than today's disks, according to the companies, who refused to divulge any technical information regarding the advancement in capacity.

Compaq expects to ship computers with the new drives by the end of the year. As the developers see it, the primary benefits of the disks are the reduction in time and trouble for hard-drive backup, and the lower price of software distribution. Also, the disks “will allow PC users to stay organized by consolidating all their files onto a single floppy disk and conserve hard-drive space. Literally years of information, from school papers to financial records, can be stored simply and efficiently in one place.”

Disc Wars

Two competing digital videodisc (DVD) formats are threatening an all-out format war. The two formats are the Multi-Media Compact Disc (MMCD), developed by Sony and Philips, and the Super Density (SD) DVD proposed by an alliance of 17 electronics and entertainment companies led by Toshiba and Time Warner.

Five leading computer-industry members—IBM, Apple, Compaq, Hewlett-Packard, and Microsoft—unveiled a wish-list of nine requirements they would like to see in the new format. They are:

- There should be a single standard for high-density discs.
- The system should include backward-read compatibility with existing CDs.
- It should have forward compatibility with future read/write and write-once discs.
- The system should have a single file system for all kinds of discs.
- Discs should be inexpensive.
- They should not require a caddy or cartridge.
- The system should offer reliable storage and retrieval for read-only, read/write, and write-once discs.
- It should have high on-line capacity.



Sony's SAS-BS1 DSS receiver is expected to be a big hit in the pre-Christmas selling season.

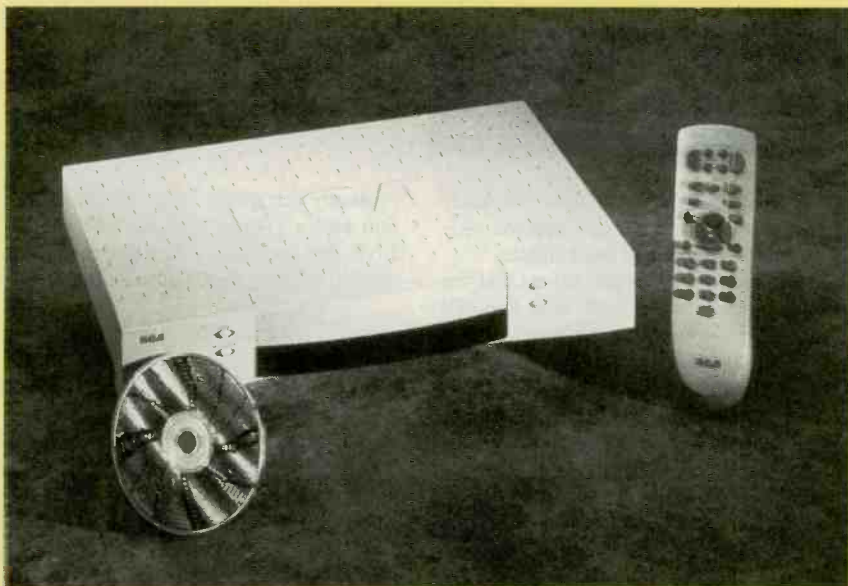

SD DVD players could be on the market as early as next summer with prices starting at around \$500. An RCA player is shown here.

- The performance should be high for both sequential and non-sequential data.

Both the Sony/Philips and the Toshiba/Time Warner camps insisted that they can meet all nine requirements.

The SD and MMCD formats are based on 5-inch discs. The MMCD provides a storage capacity of 7.4 gigabytes on a dual-layer disc. The SD DVD originally offered a storage capacity of 5 gigabytes per side, or 10 gigabytes on a double-sided disc. Now, however, Matsushita has announced the development of a single sided, dual-layer SD DVD with a 9-gigabyte capacity. The family of SD discs now includes a single-sided 5-gigabyte disc, a two-sided 10-gigabyte disc, a single-sided 9-gigabyte disc, and a two-sided 18-gigabyte disc.

The development of a single-sided disc was considered very important for acceptance in the computer industry, where reading all the data from one side of the disc is preferred. Matsushita also announced the development of a laser pickup that supports both the super-density and standard CD formats without the need to switch focus settings. It could conceivably also be used to read both layers of a dual-layer SD DVD at the same time.

CD-E

In other disc news, ten major computer hardware and media manufacturers announced their intent to develop a new CD-Erasable format for data applications.

The format was proposed by Philips Electronics and supported by IBM, Ricoh,

Hewlett-Packard, Mitsubishi, Mitsumi, Matsushita, Sony, 3M, and Olympus. It will support existing CD platforms, and allow computer users to read and write CD-Recordable (CD-R) discs. It will also allow users to write, read, and rewrite CD-E discs, and read all CD-ROM discs.

According to a Philips spokesperson, CD-E is seen as the next logical extension to CD-R and to the existing CD format as it is being used in the computer world. CD-R serves the small-office environment for file exchange and archiving. CD-E can also serve as a cost-effective backup in business-critical applications, while saving users' investment in CD-R discs and current CD-ROM software.

Current CD-ROM drives cannot read the new CD-E discs. However, new CD-ROM drives will need only a minor modification "which all current CD-ROM drive manufacturers can easily implement," according to Philips.

Power Program

Customers of Southern California Edison in Palm Springs and Orange County will soon be able to tune in to a new television station, the Edison Energy Channel. No, it won't be for public-service safety messages or for promotions for new rate increases. Instead, viewers will be able to get information about their home's energy use through a new, interactive information service called the Advanced Energy Management System or AEMS.

Customers will be linked to Edison through SCENET, Edison's own fiber-optic network, combined with either cable-television lines, wireless communications, or telephone lines.

Initially, AEMS will show customers energy-use profiles for five major appliances—such as an air conditioner, refrigerator, and swimming-pool pump—on their TV sets. Customers will be able to track energy profiles on a daily, weekly, or monthly basis. They'll also be able to see what their costs would be under various rates that Edison offers. Edison plans to use the information to test new residential rates. Customers might also be able to receive a customized on-screen bill that shows how each of the monitored appliances contributes to their total electric bill.

Components of the system include a CEBus (Consumer-Electronics Bus) card, which is the central controller that uses power-line communication with other CEBus devices and sends data to and from Edison. A TV/Video interface will process and convert digital information into TV signals. A touch pad will provide a supplemental customer interface to the TV used to display appliance operational status. An appliance/CEBus interface module is required for each monitored appliance for data collection.



Here is Sony's prototype DVD player.

ELECTRONICS WISH LIST

Colorful Special-Effects Generator

The V-6301 special-effects generator from *Ambico* (46-23 Crane Street, Long Island City, NY 11101) allows home-video hobbyists to easily add substantial color and excitement to their videotapes. It provides fade capability in eight different colors, making available more than 50 different wipe patterns. The wide range of choices lets even novice editors create professional-looking home video productions. Microprocessor control endows the unit with a level of automation that simplifies use. Up to eight single fades and wipes can be stored in memory for instant recall, and entire sequences of fades and wipes can be programmed for repetition at the touch of a button. Users can choose the precise angle of a fade, from vertical to horizontal and any angle in between. Wipe-pattern edges can be varied from a soft halo to hard and crisp. A built-in demo program illustrates the special effects generators' capabilities. Price: \$259.99.

CIRCLE 64 ON FREE INFORMATION CARD



Ambico Special Effects Generator

S-VHS Camcorder

Aimed specifically at events videographers, the AG-456U two-hour, S-VHS camera/recorder from *Panasonic Broadcast & Television Systems Company* (One Panasonic Way, 2A-2, Secaucus, NJ 07094) offers a variety of advanced recording and playback functions and versatile special effects. Videographers can use the 12x power zoom to record closeups with a continuously variable zoom speed, or zoom in manually for greater artistic control. The built-in VITC recording/reset gives each frame its own address during shooting, for highly precise VITC editing when teamed with Panasonic's AG-DS850 S-VHS editing recorder and AG-DS849 S-VHS player. For easy editing, you could pair it with the AG-1970 S-VHS Hi-Fi VCR and AG-A96 multi-event controller. The camcorder's amorphous video head maintains a signal-to-noise ratio of more than 45 dB. The unit is equipped with one linear audio and two hi-fi channels and a stereo zoom microphone. The AG-456U's 1/3-inch (360,000-pixel) CCD offers high performance in light levels as low as one lux (in digital gain up mode). Special digital effects include digital strobe, still, tracer, wipe, and mix. Price: \$2495.

CIRCLE 65 ON FREE INFORMATION CARD



Panasonic S-VHS Camcorder

Indoor/Outdoor Speaker

With its "infinitely positionable" gimbal mounting system and stylish contemporary design, the *Project One* loudspeaker from *AudioSource* (1327 North Carolan Avenue, Burlingame, CA 94010) ensures optimum speaker placement and maximum sound enjoyment in any home environment. The sturdy three-legged bracket system allows the speaker to be mounted on any horizontal or vertical surface, and a unique pivot system allows it to be angled in any direction, independent of how the bracket meets the wall. The result is a sonic image that can be aimed precisely. An offset front baffle ensures proper time/phase alignment for correct imaging. The bass driver's four-inch polypropylene cone is matched with its massive magnet to produce deep, well-defined low-frequency imaging. The soft-dome polycarbonate tweeter offers smooth highs. The speakers are magnetically shielded to allow placement near PCs or televisions. Price: \$229/pair.

CIRCLE 66 ON FREE INFORMATION CARD

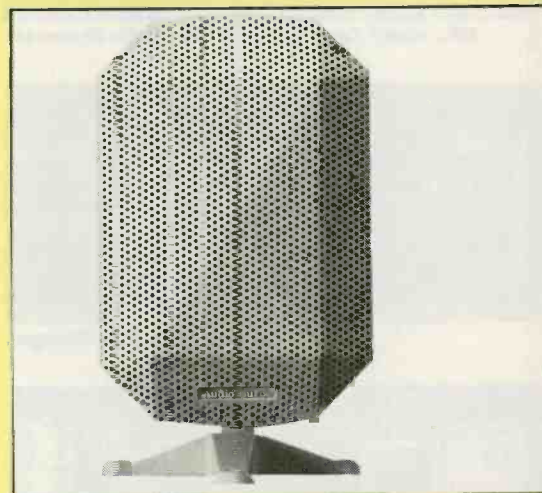

AudioSource Indoor/Outdoor Speakers

Elite Laserdisc Player

Pioneer Electronics' (2265 East 220th Street, Long Beach, CA 90810-1639) *CLD-53 Elite* laserdisc player uses a "gamma-turn" mechanism to reverse play from side A to side B within eight seconds, for quiet, seamless presentation. The company's Legato Link Conversion system extends high-frequency analog audio output beyond the conventional 20 kHz, so that frequencies contained in the original music are recovered in full. The unit's digital video processing system includes a digital timebase correction, digital drop-out compensation, and a feed-forward digital phase-locked loop, all on a single chip. Together, those technologies offer a high (51-dB) signal-to-noise ratio for a picture that is crisp and noise-free. A digital comb filter prevents color bleeding and dot crawl and improves luminance and chrominance separation. Price: \$850.

CIRCLE 67 ON FREE INFORMATION CARD



Pioneer Elite Laserdisc Player

ELECTRONICS WISH LIST



XLO THX-Certified Cables

High(-end) Wire Act

You might think that all wires are basically the same, but Lucasfilm Ltd. begs to differ. That company has granted *XLO Electric Company's* (9480 Utica Avenue, Suite 612, Rancho Cucamonga, CA 91730) XLO/VDO cables THX certification. To qualify for THX licensing, the cables had to meet or exceed Lucasfilm's performance requirements, with product testing conducted by Lucasfilm personnel. The cables are also recognized by Dolby Laboratories as being compatible with all Dolby and other home-theater surround-sound coding systems. Included in the XLO/VDO line are power cords, antenna wires, and audio and video speaker wire and interconnects. Prices: range from \$1.65 to \$7 a foot for speaker wire; \$49 per meter for video and audio interconnects.

CIRCLE 68 ON FREE INFORMATION CARD

World-Band Mobile Shortwave Converter

You can explore the world as you drive to work with the *MFJ-306 World Band Explorer* from *MFJ Enterprises, Inc.* (P. O. Box 494, Mississippi State, MS 39762), which turns your AM car radio into a world-band shortwave receiver. The converter allows you to monitor the entire 19-, 25-, 31-, and 49-meter international shortwave broadcast bands, providing exciting listening from stations around the world. The MFJ-306 is easy to install and to use: Push a button to select a band and then tune into world-band stations. The converter works on all car radios, even new, digital models. In fact, a built-in clarifier knob lets you tune in world-band stations that would otherwise be lost between standard AM stations on newer digital radios. A pushbutton allows you to switch between world-band and your radio's standard AM/FM modes. Price: \$79.95.

CIRCLE 69 ON FREE INFORMATION CARD



MFJ World Band Explorer Car Radio Converter

Compact Compact-Disc Changer

According to *Sanyo* (21350 Lassen Street, Chatsworth, CA 91311-2329), its *MAX-9000* is the world's smallest 10-disc CD changer. Measuring in at a petite 9.75 x 6.25 x 3.125 inches, the changer can be installed in many car glove compartments, under the seat, or built into some consoles. It fits virtually any angle of installation with horizontal, vertical, and 0-90° mounting capability. It offers fast CD access time and, to withstand rough roads, features an anti-shock suspension mechanism. Other features include 8x oversampling, a 1-bit twin D/A converter, a changer controller with a large LCD readout, and an FM modulator. The product is also available as the *AX-900* for use with Sanyo receiver/CD changer controllers. Price: MAX-9000, \$569.99; AX-900, \$499.99.

CIRCLE 70 ON FREE INFORMATION CARD



Sanyo 10-Disc CC Changer

Modular Cabinet System

The *Insight Collection* modular home-entertainment system from *CWD* (P. O. Box 8, 54 Concord Street, North Reading, MA 01864-0008) includes 12 different-sized cabinets that provide consumers with an almost unlimited number of ways to arrange their home-theater furniture while retaining a custom appearance. The cabinets feature distinctive crown moldings, solid wood and wood veneers, and fine furniture finishes. They range in size from 24(W) x 30(H) x 19 inches to 47 1/4 x 42 x 20 inches. All are designed to suit different entertainment and lifestyle functions. Offered in the collection are a cocktail bar cabinet with lighting, wine rack, and hanging glass holders; a display cabinet with lighting, glass shelves, and mirrored back; television cabinets built to accommodate specific screen sizes up to large rear-projection sets; storage cabinets for tapes and CDs; speaker modules with fabric grilles in the doors; and audio/video modules with adjustable shelves for housing components. Prices: \$225 to \$1000.

CIRCLE 71 ON FREE INFORMATION CARD



22 CWD Modular Home-Entertainment Cabinets



A Shocking Offer!

Now you don't have to be enrolled at CIE to receive our introductory Electronic and Electricity Lesson Modules. This program is available for a limited time to non-students for the shockingly low price of only \$99.50.

With CIE's patented AUTO-PROGRAMMED method of learning you will quickly learn and then master the basics of electronics and electricity and then move on to... DC/AC circuit theories, fundamentals of bi-polar junction transistors (BJT), field effect transistors (FET), wiring, diagram and schematic readings, component identification, soldering techniques... and much, much, more. This introductory offer includes the first 39 lessons in CIE's Associate in Applied Science in Electronic Engineering Technology Degree.

Your commitment to CIE ends with your payment, but CIE's commitment to your success just begins when you receive your lessons, exams, binder and equip-

ment. This special introductory price includes all the benefits and assistance CIE normally extends to its full time students. You'll be entitled to unlimited access to CIE's faculty and staff to assist you in your studies via a toll free 800 number six days a week, 24-hour turnaround on grading your submitted exams, CIE bookstore privileges, a patented learning method, reference library, access to CIE's electronic bulletin board and a free issue of CIE's school newspaper The Electron.

And best of all, when you decide to continue your electronics education in any of CIE's programs you'll receive full academic credit for successful lessons submitted and a \$100.00 Tuition Credit Certificate.

All this knowledge and support will put you on the road to understanding digital electronics, automotive and industrial electronics, microprocessing principals, computer systems, telecommunications and much, much, more.



All This For Only!

\$99.50

- \$100.00 Tuition Credit
- Academic Credit
- Free issue of The Electron
- Build your personal burglar alarm
- Toll Free Instructor Assistance
- 24-hour grading
- CIE bookstore privileges

- 39 theory and hands-on training lessons and exams.
- Patented learning method
- CIE electronic bulletin board privileges

Yes! Send me CIE's Introductory Electronic and Electricity Lessons and Equipment. A7333

Name: _____

Street: _____ Apt#: _____

City: _____

State: _____ Zip: _____

Age: _____ Phone: (____) _____



BOOKSTORE
1776 East 17th Street
Cleveland, Ohio 44114

Total Merchandise: _____ \$99.50

Ohio Residents add 7% Sales Tax: _____

California Residents add 6 1/2% Sales Tax: _____

Total This Order: _____

Shipping and Handling Charge: _____ \$5.00

Method of Payment/Amount Enclosed: _____ \$

Personal Check or Money Order

Master Card Visa Discover

Card Expiration Date: _____

Signature: _____



CHARGE BY PHONE!
9 AM to 4:30 PM Eastern Time;
1-800-321-2155 ext. 7333

MULTIMEDIA WATCH

MARC SPIWAK

Report from Dayton

I just got back from the Hamvention in Dayton, Ohio. I'm not a ham hobbyist, mind you, but in addition to this column, I do a lot of different things for Gernsback Publications. On occasion, that includes attending the various electronics shows around the country.

For anyone who has never been to the Dayton Hamvention, you should know that it's the biggest ham-radio show in the world, and people from all over converged there. Over the three days (April 27–29,



Firebird's 17 programmable buttons can be used as traditional joystick buttons, to activate single- or multiple-keystroke game commands, or to send strings of keystrokes. The unit also features an 8-button jet-style joystick handle, throttle control, and elevator trim control.

1995) the attendance was estimated at about 40,000, making it sort of a "techie Woodstock." There were thousands of booths offering parts, tools, broken stuff, new stuff, obsolete stuff, and more.

It was my first trip to the

show, and I expected to see mostly ham-radio equipment and related supplies.

What surprised me was that, by my estimate, 30 to 40 percent of everything for sale at the show was computer-related. Parts of the indoor exhibits resembled PC Expo more than a ham convention. On sale were whole computers and hard, floppy, and CD-ROM drives. One could purchase motherboards, memory, power supplies, fancy cases, monitors, expansion cards, and just about anything else computer-related that anyone could possibly think of.

Most booths that were selling hardware were also selling software. And anyone selling software also displayed huge assortments of CD-ROMs, both new titles and older ones that you won't find on store shelves anymore. On the first day of the show the prices weren't much better than what you might pay for mail-order, but the prices seemed to creep down as the weekend progressed—or at least the dealers were more willing to do a little bargaining!

Outside, in the "flea-market" section, it seemed that many of the dealers were simply hobbyists who gathered up all of their old projects, parts, broken appliances, old software, obsolete computers, and anything else they didn't want anymore, threw them in their car, and drove off for a weekend of fun and profit. Judging by the smiles I saw, they had both.

NEW PC VIDEO TECHNOLOGY

I recently met with some representatives from the Weitek Corporation, long-time specialists in computer video. Weitek's new unified memory architecture will soon provide high-performance video to PCs without requiring a separate video card containing exotic specialty memory.

The new video systems will be built into motherboards, and make use of the standard motherboard DRAM, using only as much of it as is needed for a particular display task, while leaving the rest of it available for system use. Normally, one or two megabytes of separate, special-purpose (fast and expensive) memory is exclusively dedicated to the video system, but much of it is never used, especially at lower resolutions. But regardless of how much or how often the memory is used, the user has already paid for it. The goal of the new architecture is to lower prices for end users, while at the same time providing high-performance, 64-bit graphics when it is needed.

Weitek's W464 and W564 Unified System/Display Controllers (US/DC) will integrate PCI core logic with a 64-bit GUI accelerator. The W464 chipset implements full PCI core logic for all popular 486 processors and incorporates Weitek's fourth-generation 64-bit DRAM-based GUI accelerator. The W464 chipset will add only two 208-pin devices to a

typical PCI motherboard while eliminating the need for a separate add-on card. The W564 chipset incorporates full PCI support for all Pentium-class processors and also supports the Enhanced IDE (EIDE) local bus.

Years ago I would have objected to having video hardware built into the motherboard. After all, the idea of having expansion slots was to have the ability to upgrade and enhance a system with newer and more powerful cards. But the truth is, most users stick with the hardware that came with their system. My 486 DX2/50 is only about three years old, yet it's pretty much obsolete. It contains a non-local bus, ISA motherboard, and a video accelerator that sold for around \$500 by itself when the system was new. Unfortunately that was about as good as ISA video cards got before motherboards went local bus.

I've also got a one-year-old 486 SX/25 that I occasionally use as a test system, especially when software refuses to run on the 486 DX2/50 (in addition to being obsolete, the older video card gives some multimedia software fits). That system features a Cirrus Logic local-bus video-accelerator chip and two megabytes of dedicated video memory built into the motherboard. Just about everything I've tried runs fine on it, and the video is just about as fast as with the older, non-local bus video card. So I guess that high-performance PCI video built right into a motherboard will certainly provide adequate performance for the life of the machine.

The big advantage to the Weitek approach is cost. Even though today I can buy a hot Pentium system

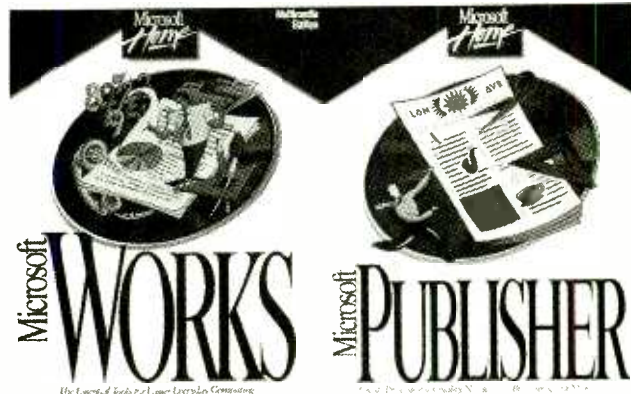

Microsoft's Publisher 2.0 and Works on CD-ROM both offer users a lot of function for not a lot of money.

for about \$1000 less than I paid for the DX2/50, that is still too much for many potential buyers. Eliminating the need for separate, and expensive, video memory will shave a bit more off that price, while only marginally, if at all, affecting performance. It could be the wave of the future for moderate-priced PCs.

NEW STUFF

I've got two new products from Advanced Gravis this month, one that aids in controlling games and another that enhances the sound. Back in March I reported on the *Phoenix* flight control system that combined a high-quality joystick, a throttle and rudder controller, and 24 programmable buttons all in one unit. Gravis' new *Firebird* is basically a trimmed down version of the *Phoenix*, with a smaller, more user-friendly size and a lower price.

Instead of 24 programmable buttons, *Firebird* contains 17 of them, along with an 8-button jet-style joystick handle, throttle control, and elevator-trim control. The 17 programmable buttons can be used as traditional joystick buttons, to activate single- or multiple-keystroke game commands, or to send strings of keystrokes from a

single button. Up to 106 keystrokes can be assigned to a button and stored in the *Firebird*'s memory. That allows a string of characters, such as a popular cheat code for a game, to be activated by pushing a single button. In addition, separate commands can be assigned to the pressing and releasing of a button. So it's possible, for example, to become "invisible" by pressing a button and reappear by releasing it.

Another neat *Firebird* feature is the mouse-controlled setup software. Users can point to a button and type in a command for it. That drag-and-drop programming is very easy once you get the hang of it.

The *Firebird* is able to perform so many functions because it connects to both the joystick port and the keyboard connector. A *Firebird* connector plugs into your PC's keyboard connector, and your keyboard plugs into the other end of the *Firebird* connector. The *Firebird* should sell for around \$69.95.

Gravis is not only known for neat game controllers, but for sound cards as well, notably the Gravis *UltraSound*. The *UltraSound* is a wavetable sound card, meaning that it produces sound using bits of digitally recorded samples of actual

WHERE TO GET IT

Activision, Inc.
11601 Wilshire Blvd., Suite 1000
Los Angeles, CA 90025
CIRCLE 50 ON FREE INFORMATION CARD

Advanced Gravis
#101-3750 North Fraser Way
Burnaby, B.C., Canada V5J 5E9
CIRCLE 51 ON FREE INFORMATION CARD

E-Media
1517 20th Street
Santa Monica, CA 90404
CIRCLE 52 ON FREE INFORMATION CARD

LucasArts
P.O. Box 10307
San Rafael, CA 94912
CIRCLE 53 ON FREE INFORMATION CARD

Microsoft Corporation
One Microsoft Way
Redmond, WA 98052
CIRCLE 54 ON FREE INFORMATION CARD

Synergy Interactive Corporation
333 S. Hope St., Suite 2500
Los Angeles, CA 90071
CIRCLE 55 ON FREE INFORMATION CARD

Weitek Corporation
1060 E. Arques
Sunnyvale, CA 94086
CIRCLE 56 ON FREE INFORMATION CARD

instruments. Many people are stuck with older FM-synthesis sound cards that just don't sound as good as wavetable. Many have been able to upgrade to wavetable sound by adding a wavetable upgrade card to their existing FM synthesis card, but that usually requires special connectors or adapters.

The new Gravis *UltraSound ACE* is a wavetable upgrade that does not require any special connectors or adapters, and it works with any 8- or 16-bit sound card. The card plugs into an expansion slot and works alongside the existing sound card. In addition to 32-voice wavetable synthesis, it also offers 16-bit multichannel digital audio, (Continued on page 83)



HEATHKIT ID-5001 ADVANCED WEATHER COMPUTER



CIRCLE 119 ON FREE INFORMATION CARD

A serious weather forecasting system for the serious amateur meteorologist.

Weather affects us all in different ways. For some folks, rainy weather means good crops. But too much rain can mean ruined crops. Snow just means a slow, treacherous trip to work for most people, while others make good overtime money plowing the stuff away.

One thing is for sure, though, everybody is interested in what the weather will bring, albeit we all have different reasons. While bad weather is, for the most part, to be avoided, we all look forward to good weather. Countless camping, fishing, and skiing trips have been ruined by poor weather planning, or perhaps poor forecasting.

Surprisingly, in this modern age of gadgetry, one thing few people own is their own weather computer. It's true that one is never too far from a weather report of some kind, but the report might not be local enough or recent enough to be helpful. And if one is planning on a career in meteorology, there's very little to be learned from watching the weather report on TV.

If it's the weather that you're inter-

ested in, whether it be past, present, or perhaps even future, you need a weather computer. A weather computer ideally can display all important weather parameters, make weather calculations for you, and store important information and statistics to help you monitor and predict weather conditions. But where do you get a weather computer?

A Weather Computer. If you have more than just a passing interest in weather, and are willing to make a sizable investment in monitoring it, the *Heathkit ID-5001 Advanced Weather Computer* from the Heath Company could be just for you. That high-tech instrument has a fluorescent backlit LCD that constantly displays outdoor wind speed and direction, temperature, barometric pressure, and humidity, as well as indoor temperature and humidity, and the time and date. When it rains, the amount of rainfall is also displayed. And if the unit thinks that bad weather is approaching based on conditions, it can warn you with visual and/or audible signals.

All of that's just for starters, though. The unit can also display dew-point temperature, fog potential, wind chill, and more. Up/down arrows indicate the direction and rate-of-change of temperature and humidity. A keypad lets you recall peak wind gusts, including direction and time of occurrence. The value and time of temperature, barometric pressure, and humidity highs and lows can also be recalled. By observing changes in the past 24 hours, weather trends can be determined. The Heathkit Advanced Weather Computer can easily meet the demands of a professional meteorologist, yet is available at a price affordable to non-professionals. The unit costs less than the average PC.

What You Get. The weather computer does not come cheap. As a fully assembled unit, it will set you back \$1295. Included in that price are indoor/outdoor humidity sensors, the rain-gauge sensor, an RS-232 computer interface, software, a technical manual, and the wind-boom assembly. However, when we learned that

the weather computer is also available as a kit—the last great Heathkit kit—for a savings of nearly \$400, we though it might be worth checking out, and that our readers might be especially interested.

In kit form, the Advanced Weather Computer comes with the same features as the fully assembled unit for \$899.95. And if you want or need them, you'll only have to add \$29.95 for the technical manual, \$59.95 for the PC software, and \$22.95 for 100 feet of 8-conductor boom cable. We ordered one of these kits from Heathkit to find out exactly what's involved in building one.

The Kit. The kit and all of its accessories arrive in a few different cartons, some of them larger than you might imagine. After all, the finished unit measures about 6 by 16 by 9 inches. Its internals consist of several PC boards that interconnect and work as a team. All of the boards must be built from scratch with the exception of a display-driver board that would be too difficult for most people to build. That is the only part that comes pre-assembled.

When we said that this is Heathkit's last great kit, we meant it. For anyone that has to work days for a living, there's enough work involved in building this kit to keep the most confident builder busy for at least a week, and that's rushing it. Everything, including various sensors, must be built, tested, and calibrated before the weather computer is of any use. And when it's finished, it's another day's work installing the outdoor sensors.

While the instructions are perfectly clear, we don't recommend the kit for beginners—it's too much work, and some of the work is complicated. But we don't imagine that anyone would make that kind of investment without being 100-percent serious. Though we do think the kit might be perfect for a supervised science class to build in teams; afterwards, the completed computer can be used to study weather.

The first step in building the kit is to assemble the display board. That involves mounting various parts, including a very delicate 6-by-9-inch LCD, to a PC board. Two long conductive rubber strips pass signals to the LCD from the board. Assembling that delicate

piece can make even the most seasoned builder nervous. The display board plugs into a slot on the pre-assembled display-driver board.

The power-supply board is assembled next. That board powers both the digital and analog circuitry, as well as the small fluorescent tube that mounts behind the LCD. The power-supply board ends up mounted to the chassis base. Heat sinks rising off two power regulators on that board are bolted to the steel fluorescent lamp housing. That arrangement distributes heat evenly throughout the chassis and adds strength to the entire assembly.

Next comes the main board, onto which literally hundreds of parts are soldered. That board contains the CPU and EPROM among other things. Among the "other things" is a semiconductor pressure transducer that can sense barometric pressure.

Once all of the individual pieces are assembled, they all go together in the chassis. Lots of wiring is involved in that step, and it is the most tedious part of the job. Many color-coded wires must be stripped, tinned, bundled, and soldered to various boards and connectors. Small ferrite beads must be placed over many of the leads. Special attention must be paid to wiring the AC line-cord and power transformer that mounts to the bottom of the chassis. Errors here can be disastrous. While the wiring job is the most tedious, it is here that the builder begins to get that home-stretch feeling, a feeling you don't really get with those "one-nighter" kits.

When the wiring is complete, the unit really should be thoroughly "buzzed out" according to instructions, and it is here that the builder is most tempted to simply plug it in and see if it works. But you should resist the temptation; a few hours invested in making sure there are no problems can eliminate days of repair or rebuild time as well as added expense.

When it looks like all of the soldering is done, the builder will realize that the humidity sensors must be assembled and calibrated, and that takes at least another two nights. Four small boards for the wind boom must also be built before they can be installed in the boom housings. The boom consists of wind-vane and wind-cup assemblies

(Continued on page 87)

EARN YOUR B.S. DEGREE IN COMPUTERS OR ELECTRONICS



By Studying at Home

Grantham College of Engineering, now in our 45th year, is highly experienced in "distance education"—teaching by correspondence—through printed materials, computer materials, fax, modem, and phone.

No commuting to class. Study at your own pace, while continuing on your present job. Learn from easy-to-understand but complete and thorough lesson materials, with additional help from our instructors.

Our Engineering Technology B.S. Degree Program is available in either of two options:

- (1) The B.S.E.T. with Major Emphasis in Electronics, OR
- (2) The B.S.E.T. with Major Emphasis in Computers.

Our Computer Science B.S. Degree Program leads to the B.S.C.S.—the Bachelor of Science in Computer Science.

An important part of being prepared to *move up* is holding the right college degree, and the absolutely necessary part is knowing your field. Grantham can help you both ways—to learn more and to earn your degree in the process.

Write or phone for our free catalog. Toll free, 1-800-955-2527, or see mailing address below.

Accredited by
the Accrediting Commission of the
Distance Education and
Training Council

GRANTHAM
College of Engineering
Grantham College Road
Slidell, LA 70460

THINK TANK

By John J. Yacono,
Technical Editor,
Windows Magazine

Some Assorted Circuits

This month's letters present a mix of circuits that don't fit a clearly defined category, but deserve attention nonetheless.

However, before we get to them, we'll start examining the next component in our tutorial series: the capacitor.

As we discussed very early on in this series, charges affect one another at a distance, being attracted toward each other if their polarity is different, or repelled if their polarity is the same. We can use that behavior to cause charges to bunch up in a plate of metal in the simple experiment shown in Fig. 1. There, each terminal of a battery is connected to a metal plate by a wire, although one connection passes through a switch. The two

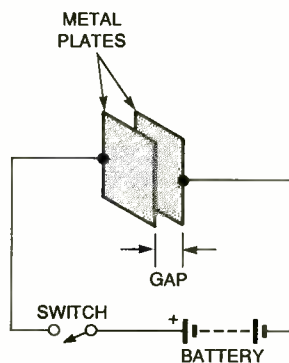

Fig. 1. This simple experiment illustrates how a capacitor works.

plates are parallel to one another with a small air gap between them, forming what is essentially a capacitor.

When the switch is closed, electrons in the top plate will be attracted toward the battery's positive terminal. That will leave the top plate with a net positive charge. However, the bat-

tery's negative terminal provides electrons to the other plate making that plate negative. Up to a point, the electrons are satisfied being squeezed together on the lower plate, so long as they can stare lovingly across the gap at the positive plate, which they are attracted to but cannot reach.

Eventually, though, the density of electrons in the bottom plate is great enough to deter additional occupants, and current stops flowing. That's because the electrons in the bottom plate are much closer to one another than they are to the positively charged plate.

Consider what would happen if we then disconnected the battery, flipped it upside down, and reconnected it. Encouraged by the battery and overpopulation, electrons would leave the crowded lower plate and race toward the top plate. The current would continue until the upper plate was as chock-full of electrons as the lower plate used to be. The current would then cease as before. That demonstrates two important characteristics of capacitors: DC (direct-current) blocking and AC (alternating-current) conductance. If a capacitor is connected to a DC source, current flows briefly and halts; the DC current is blocked. If a capacitor is connected to a current source of alternating polarity, the current is permitted to flow back and forth. With that out of the way, let's check out this month's letters.

TRI-COLOR DISPLAY

Because you said you liked tri-color LED circuits, I am enclosing a *true* tri-color circuit for you to peruse (see Fig. 2). The purpose of the circuit is to sequentially light three-terminal LEDs on a small sign for a model railroad, but I'm sure readers can come up with different applications.

Capacitor C2 is connected to the resets of the three 4015 shift registers, U2-U4. When the circuit is first turned on, C2 automatically sets all the outputs to 0, thus inputting a 1 through U1-b, a section of a 4093 NAND Schmitt trigger, to the A input (pin 7) of U2. The circuit is clocked by U1-a, which is connected as an oscillator, while U1-a inverts the 0s to 1s until the first 1 is recirculated to the output of the last shift register, U4. Then the 1s become 0s and they recirculate. That all repeats as U1-a clocks the shift registers.

What all that does is as follows: When the first 1 is received at the first output of U2, the LED segment connected to it lights (that segment is labeled as "R" (red) in the schematic). As U1-a clocks the shift register, the LEDs connected to the other outputs sequentially light up red. After ten clock cycles, the clock skips two, and then continues lighting up the green segments of the LEDs, giving a yellowish-orange tint to them. After all the LEDs are lit, the shift register starts turning off the red LED segments. That leaves the green segments on—the third color from the LEDs. The oscillator continues to clock the green

Take this GIANT CIRCUIT LIBRARY for only \$14.95

when you join the *Electronics Engineers' Book Club*®

THE ENCYCLOPEDIA OF ELECTRONIC CIRCUITS —Vols. 1-4 by Rudolf F. Graf

Hundreds of circuit ideas alphabetically arranged — from Alarm circuits to Zero crossing detector circuits!

"... includes schematics for the latest electronics circuits from industry leaders..."

—Popular Electronics

Turn to this comprehensive circuit library for hundreds of project ideas . . . valuable troubleshooting and repair tips . . . and concise pinout diagrams and schematics. In each volume you'll find more than 700 electronic and integrated circuits and 100+ circuit categories right at your fingertips to give you ideas you can use on the job or at your workbench.

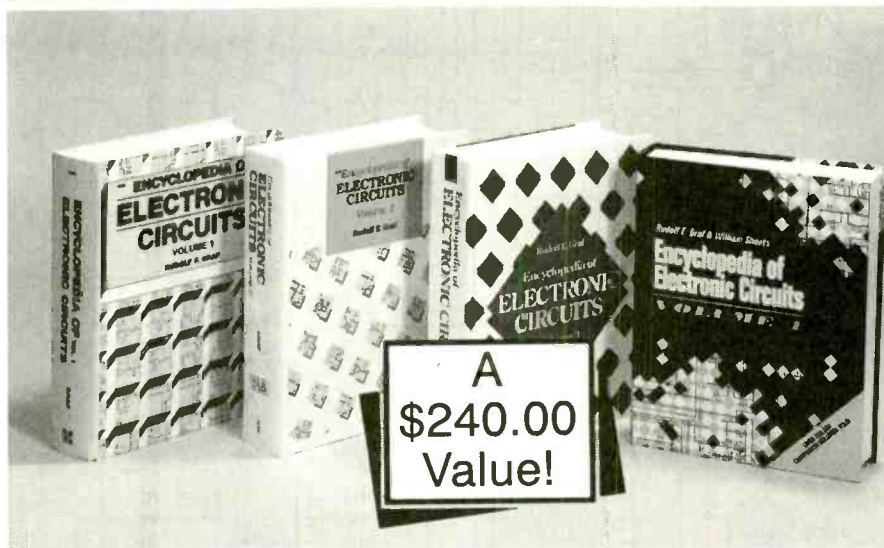

3,088 total pages 4,490 total illustrations

Book No. 5861488 Hardcover

As a member of the Electronics Engineers' Book Club . . .

. . . you'll enjoy receiving Club bulletins every 3-4 weeks containing exciting offers on the latest books in the field at savings of up to 50% off of regular publishers' prices. If you want the Main Selection, do nothing and it will be shipped automatically. If you want another book, or no book at all, simply return the reply form to us by the date specified. You'll have at least 10 days to decide. If you ever receive a book you don't want due to late delivery of the bulletin, you can return it at our expense. And you'll be eligible for **FREE BOOKS** through the Bonus Book Plan. Your only obligation is to purchase 3 more books during the next 2 years, after which you may cancel your membership at any time.

Publisher's price shown. ©1995 EEBC

ELECTRONICS ENGINEERS' BOOK CLUB

A Division of McGraw-Hill, Inc.,
P.O. Box 549, Blacklick, OH 43004-9918

YES! Please send me *The Encyclopedia of Electronic Circuits—Vols. 1-4* (5861488), billing me \$14.95 plus shipping/handling & tax. Enroll me as a member of the **Electronics Engineers' Book Club** according to the terms outlined in this ad. If not satisfied, I may return the books within 10 days and have my membership cancelled.

Name _____
Address _____
City _____
State _____
Zip _____ Phone _____

Valid for new members only, subject to acceptance by EEBC. Canada must remit in U.S. funds drawn on U.S. banks. Applicants outside the U.S. and Canada will receive special ordering instructions. A shipping/handling charge & sales tax will be added to all orders. PPIF995

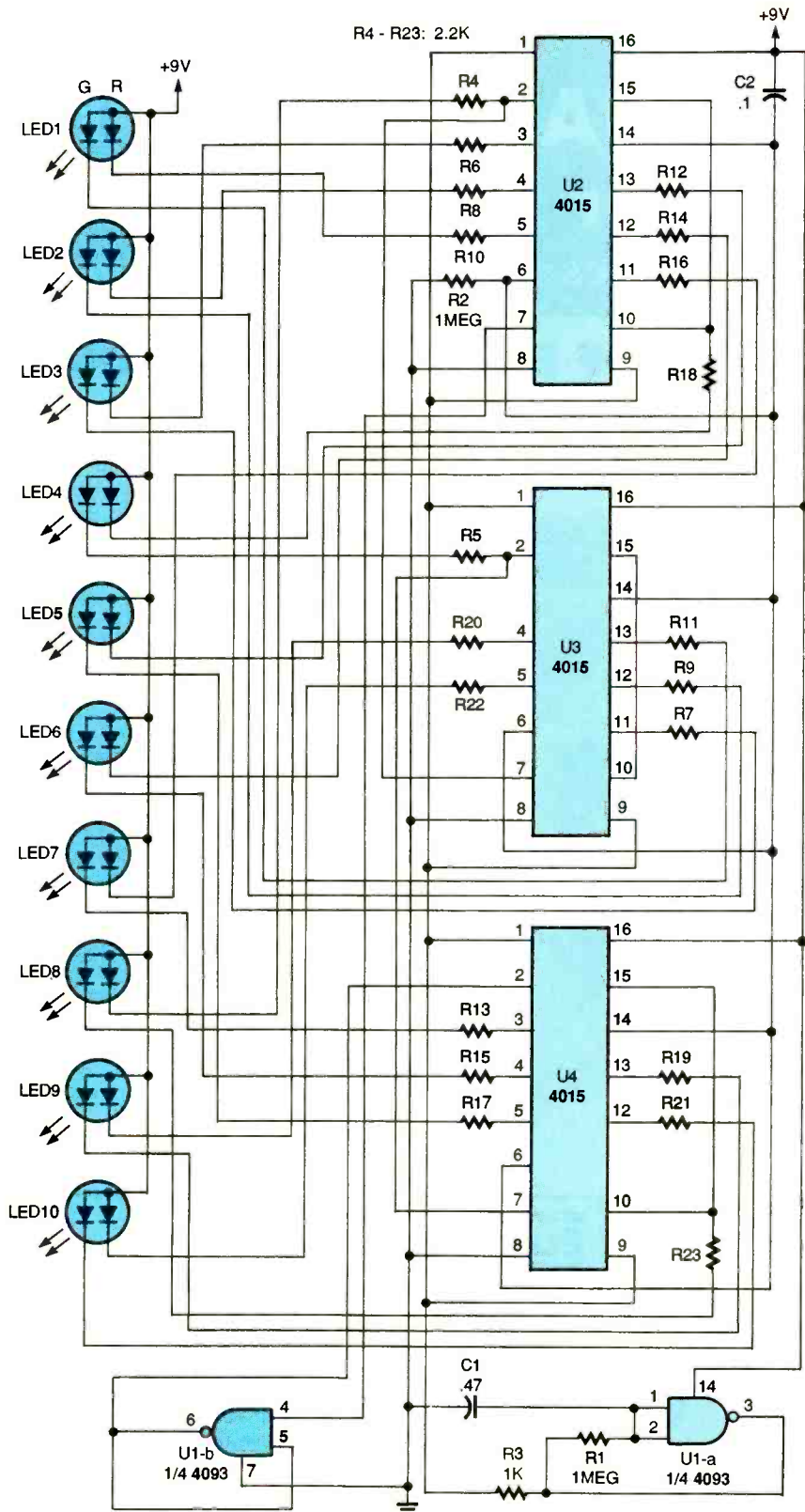

Fig. 2. With this circuit you can have tri-color LEDs change colors from red to yellow to green to off.

LEDs off, leaving the sign dark.

After completing that cycle, the operation repeats,

giving the effect of a sign that goes from red to yellow to green to dark. The circuit is drawn for ten LEDs, but

any number can be accommodated by adding more 4015's and resistors in similar configurations.

I hope you like this circuit. I thought it a truly novel application of tri-color LEDs.

—Brian F. King, Groton, CT
 What's cool is how expandable the circuit is. Frankly, I couldn't have done a better job myself. Note: for easy comprehension, the resistors for the red LED segments are denoted with even numbers. Green segments have odd-numbered resistors.

TOUCH SWITCH

Here is an interesting touch switch (see Fig. 3). This circuit has two high-gain transistors. Operation occurs when the ambient 60-Hz AC field is impressed on the touch-plate during the finger contact. The signal turns on Q1, causing Q2 to energize the relay. Capacitors

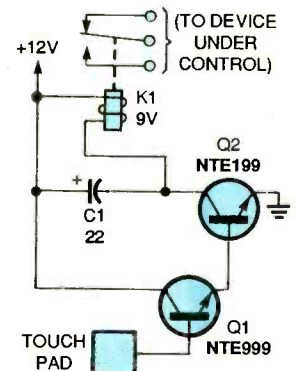

Fig. 3. Build this circuit if you want a really simple touch switch.

for C1 is used to prevent the relay from oscillating. Is this the simplest touch switch with the fewest parts?

—Roger Yabrudy, New York, NY

That's certainly the simplest touch switch I've seen. I did something similar once, but didn't use the capacitor. I probably got lucky and unknowingly selected a relay with a high-impedance coil. Your circuit is definitely more stable, but putting a kickback diode across relay K1's coil would be a good idea.

AIRCRAFT RECEIVER

If you have a scanner like mine, which does not cover the 225- to 400-MHz high aircraft band, and like me, you live near a military or commercial airport whose tower or repeaters use that band, you might be interested in the simple little regenerative receiver that I built (see Fig. 4). The circuit monitors transmissions of the Air Force planes and tower in my area. Tuning-coil L2 can be wound with 2 turns of No. 22 wire on a 5/32-inch drill bit. Our local

capacitor of 1 pF or less to the emitter of the 2N918. On my prototype, it worked well without signal overload by connecting the antenna directly to the cathode of the 1N82 diode. Other high-frequency transistors can be used but might require different resistance in the regeneration circuit.

The output of this circuit must go to an audio amplifier. If you'd rather buy one than build one, I have found that Radio Shack's mini-amp (catalog No. 277-1008) works well.

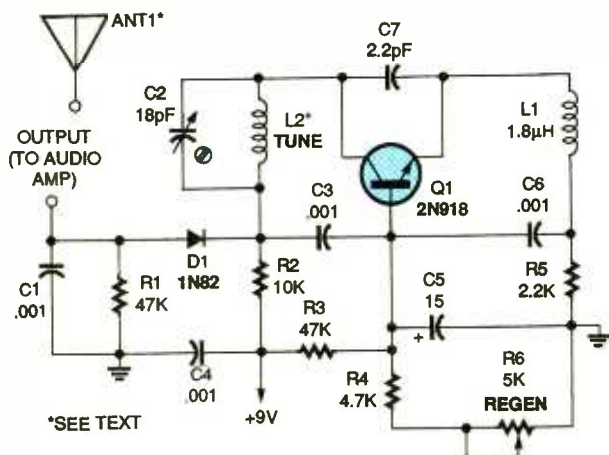

Fig. 4. Listen to frequencies in the high aircraft band with this simple receiver. The antenna can be connected to the circuit in a couple of ways (see text) to vary reception.

Air Force base's control-tower frequency is 289.6 MHz, but by modifying L2, other frequencies in the band can be covered.

This circuit is well behaved at those frequencies, as long as a good component layout is used. The component leads must be kept short and neat, especially the leads of the transistor. The lengths should not exceed 3/16 of an inch.

Audio could be tapped off the tuning coil with a 5-µF or so electrolytic capacitor, but the 1N82 diode circuit seems to produce less signal loss. The RF signal from ANT1, an approximately 18-inch antenna, can be introduced through a small

—William Stratton,
Columbus, MS

I can't believe it takes so few components to build such a receiver. You could probably fit the whole thing inside the amplifier you mentioned.

RANDOM-NUMBER GENERATOR

Have you ever wondered how a computer is able to generate random numbers? This circuit (see Fig. 5) is designed to simulate—in a simple way—a random-number generator similar to those found in computer systems. Its function is to produce a specified number of pseudo-random, four-bit patterns (I say

53,226

ELECTRONIC COMPONENTS

Whether you order 1 part or all 53,226...MOUSER stocks and...ships same day!!

CALL... (800) 992-9943

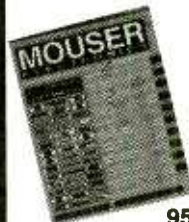

for your
FREE
CATALOG

958 North Main St.
Mansfield, TX 76063

MOUSER
ELECTRONICS
Sales & Stocking Locations Nationwide

CIRCLE 14 ON FREE INFORMATION CARD

ATTENTION! ELECTRONICS TECHNICIANS

EARN YOUR
**B.S.E.E.
DEGREE**

THROUGH HOME STUDY

Our New and Highly Effective Advanced-Placement Program for experienced Electronic Technicians grants credit for previous Schooling and Professional Experience, and can greatly reduce the time required to complete Program and reach graduation. No residence schooling required for qualified Electronic Technicians. Through this Special Program you can pull all of the loose ends of your electronics background together and earn your B.S.E.E. Degree. Upgrade your status and pay to the Engineering Level. Advance Rapidly! Many finish in 12 months or less. Students and graduates in all 50 States and throughout the World. Established Over 40 Years! Write for free Descriptive Literature.

COOK'S INSTITUTE
OF ELECTRONICS ENGINEERING

CIE 4251 CYPRESS DRIVE
JACKSON, MISSISSIPPI 39212

CIRCLE 15 ON FREE INFORMATION CARD

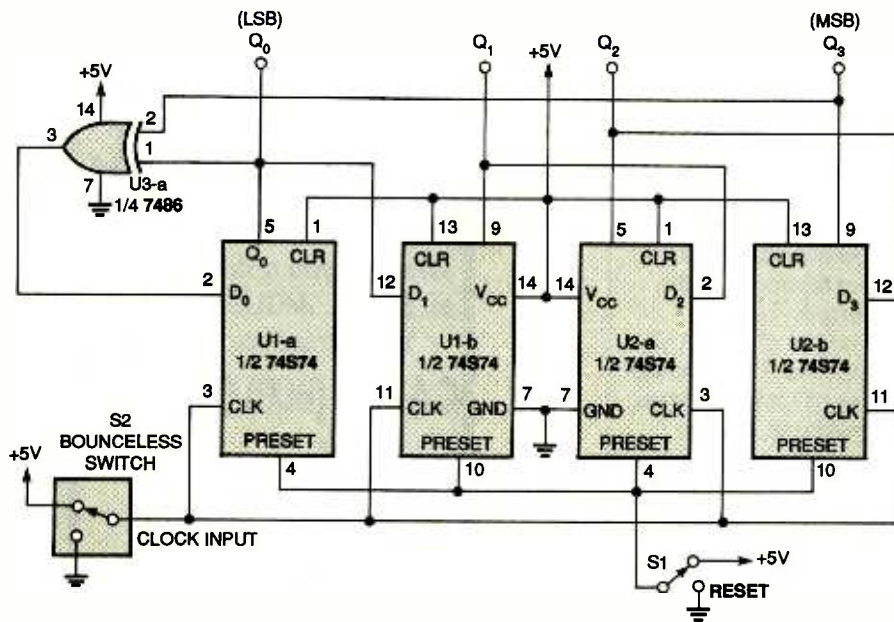

Fig. 5. This circuit generates pseudo-random numbers—in other words, the numbers eventually repeat.

pseudo-random because the same sequence of bit patterns will eventually repeat themselves). I have not included a specific application for this circuit's use, but it could be readily modified by hobbyists and experimenters—especially by those designing types of electronic games and toys.

The 74S74 flip-flops shown in the circuit are arranged to form a four-bit shift register. Binary data enters the D_0 input on U1-a and is sequentially shifted

to each output (Q_0 , Q_1 , Q_2 , Q_3) with each clock pulse. The data input to the shift register comes from the output of U3-a, one gate of a 7486. That exclusive-or gate compares two of the output bits from the shift register. If the two bits are the same, then the output of U3-a is 0 volts (or low). If the two bits are different, then the output of U3 is +5 volts (or high).

Therefore, U3-a acts as a type of logical-feedback network that changes the

data at D_0 , which in turn changes the outputs of the flip-flops. The effect of that network is to create a pseudo-random sequence of bits at the outputs of U1 and U2.

If Q_1 is considered the least-significant bit (LSB) and Q_4 the most-significant bit (MSB), then the resulting bit pattern at the outputs of U1 and U2 for each applied clock pulse could be converted into a decimal equivalent. The output bit sequence I found for the

arrangement shown is (in decimal notation): 15, 14, 13, 10, 5, 11, 6, 12, 9, 2, 4, 8, 1, 3, 7, and 15 (the sequence then repeats). Note that every number from 1 to 15 is used.

Different sequences can be obtained by connecting the input gates of U3-a to different outputs of U1 and U2—the length of the sequence might change by doing that. Also, extra flip-flops can be added to the arrangement (in the same way U2 is connected to U1) to increase both the numeric span and the maximum length of the sequence.

As soon as power is applied to the circuit, push S1 momentarily to reset U1 and U2. All four outputs should be high at that point. Outputs Q_1 , Q_2 , Q_3 , and Q_4 could be connected through resistors to LEDs so that the results can be shown visually. The clock input can be controlled manually using a bounceless switch (S2) or by using a square pulse train from a function generator (not to exceed 5-volts maximum in this case). Other types of flip-flops can be used to get the same results.

Perhaps this circuit will give others some ideas in how they might be able to put a bit of unpredictability into their projects.

—Thomas Edmonds, Barrington, NH

This would be a great start toward building a digital-dice game. All you'd need is a two-digit binary-to-decimal display circuit and two more flip-flop sections. Each digit driver would receive input from three flip-flops and each digit display would represent the outcome of a single die. If a digit reads "7" or "8" you could do a turn over, or reset the

(Continued on page 88)

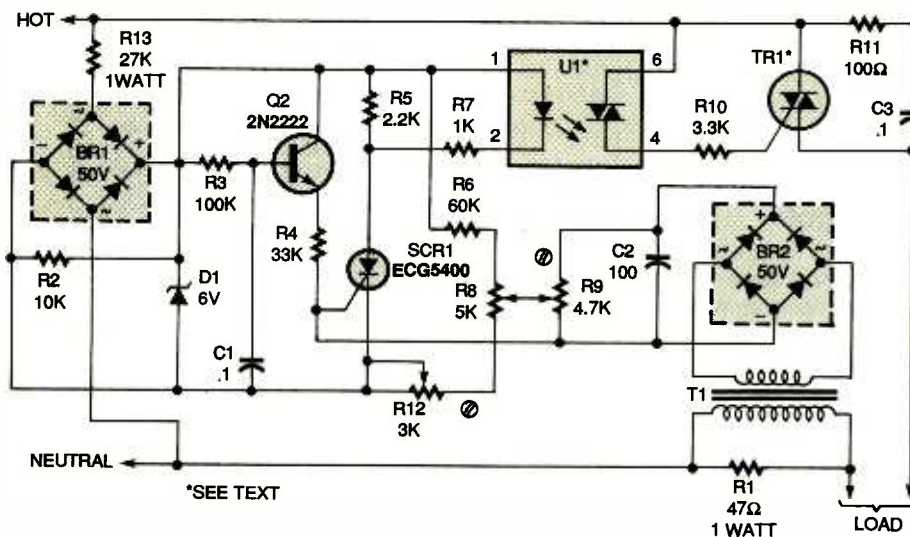

Fig. 6. Control fans and other AC motors with this motor-speed control.

Just like these Fully Trained Electronics Professionals



"Thanks to CIE I have tripled my previous salary, and I am now in a challenging and rewarding new field where only the sky is the limit."
Daniel Wade Reynolds
Industrial Electrician
Ore-Ida Foods



"CIE was recommended to me by my boss. It was appealing since I could study at my own pace at home and during business travel."
Dan Parks
Marketing Manager/Consumer Products
Analog Devices, Inc.



"I loved the flexibility CIE offered. It was the only way I could continue both school and my demanding job."
Britt A. Hanks
Director of Engineering
Petroleum Helicopters, Inc.



"I liked the way the school was set up with laboratory assignments to enforce conceptual learning. The thing which impressed me the most about CIE's curriculum is the way they show application for all the theory that is presented."
Daniel N. Parkman
Missile Electro-Mechanical Technician
U.S. Air Force



"Completing the course gave me the ability to efficiently troubleshoot modern microprocessor based audio and video systems and enjoy a sense of job security."
Tony Reynolds
Service Manager/Technician
Threshold Audio & Video

Graduate with an Associate Degree from CIE!

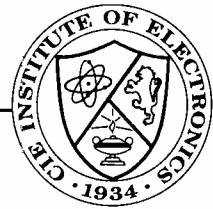

CIE is the best educational value you can receive if you want to learn about electronics, and earn a good income with that knowledge. CIE's reputation as the world leader in home study electronics is based solely on the success of our graduates. And we've earned our reputation with an unconditional commitment to provide our students with the very best electronics training.

Just ask any of the 150,000-plus graduates of the Cleveland Institute of Electronics who are working in high-paying positions with aerospace, computer, medical, automotive and communications firms throughout the world. They'll tell you success didn't come easy...but it did come...thanks to their CIE training. And today, a career in electronics offers more rewards than ever before.

CIE'S COMMITTED TO BEING THE BEST...IN ONE AREA...ELECTRONICS.

CIE isn't another be-everything-to-everyone school. CIE teaches only one subject and we believe we're the best at what we do. Also, CIE is accredited by the National Home Study Council. And with more than 1,000 graduates each year, we're the largest home study school specializing exclusively in electronics. CIE has been training career-minded students for nearly sixty years and we're the best at our subject...
ELECTRONICS... IT'S THE ONLY SUBJECT WE TEACH!

CIE PROVIDES A LEARNING METHOD SO GOOD IT'S PATENTED.

CIE's AUTO-PROGRAMMED® lessons are a proven learning method for building valuable electronics

career skills. Each lesson is designed to take you step-by-step and principle-by-principle. And while all of CIE's lessons are designed for independent study, CIE's instructors are personally available to assist you with just a toll free call. The result is practical training... the kind of experience you can put to work in today's marketplace.

LEARN BY DOING...WITH STATE-OF-THE-ART EQUIPMENT AND TRAINING.

CIE pioneered the first Electronics Laboratory

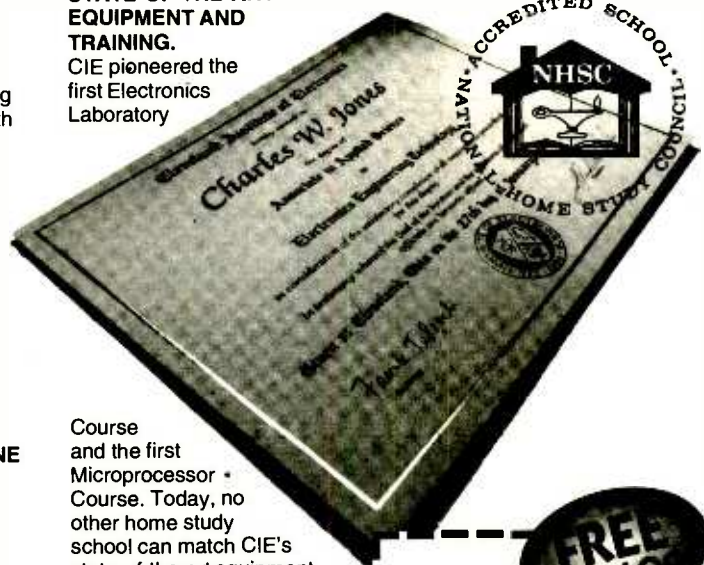

Course and the first Microprocessor - Course. Today, no other home study school can match CIE's state-of-the-art equipment and training. And all your laboratory equipment, books and lessons are included in your tuition. It's all yours to use while you study and for on-the-job after you graduate.

PERSONALIZED TRAINING...TO MATCH YOUR BACKGROUND.

While some of our students have a working knowledge of electronics others are just starting out. That's why CIE has developed twelve career courses and an A.A.S. Degree program to choose from. So, even if you're not sure which electronics career is best for you, CIE can get you started with core lessons applicable to all areas in

electronics. And every CIE Course earns credit towards the completion of your Associate in Applied Science Degree. So you can work toward your degree in stages or as fast as you wish. In fact, CIE is the only school that actually rewards you for fast study, which can save you money.



YES!

I want to get started. Send me my CIE course catalog including details about the Associate Degree Program. (For your convenience, CIE will have a representative contact you - there is no obligation.)

Please Print Clearly

Name _____

Address _____

City _____

State _____ Zip _____ Age _____

Phone No. _____

Check box for G.I. Bill Benefits.

Veteran
 Active Duty **AH69**

Cleveland Institute of Electronics, Inc.
 1776 East 17th Street
 Cleveland, OH 44114

*A School of Thousands.
 A Class of One. Since 1934.*

Send for CIE's FREE Course Catalog and See How We Can Help Your Career Too!

RETAILERS THAT SELL OUR MAGAZINE MONTHLY

Alaska

Frigid North Co.
1207 W. 36th Avenue
Anchorage, AK 99503

Alabama

Radio Distributing Supply
121 East Broad Street
Gadsden, AL 35903

Arizona

Dalis Electronics
2829 E. McDowell Road
Phoenix, AZ 85008

California

California Electronics
221 N. Johnson Ave.
El Cajon, CA 90202

Signal Electronics
22307 Ocean Avenue
Torrance, CA 90505

Ford Electronics
8431 Commonwealth Avenue
Buena Park, CA 90621

All Electronics
14928 Oxnard Street
Van Nuys, CA 91411

Gateway Electronics of CA
9222 Chesapeake Drive
San Diego, CA 92123

Mac's Electronics
191 South "E" Street
San Bernardino, CA 92401

Electronics Warehouse
2691 Main Street
Riverside, CA 92501

Orvac Electronics
1645 E Orangethorpe Ave.
Fullerton, CA 92631

Sav-On Electronics
13225 Harbor Blvd.
Garden Grove, CA 92643

Marvac Dow Electronics
980 S. A Street
Oxnard, CA 93030

Kandarian Electronics
1101 19th Street
Bakersfield, CA 93301

Whitcomm Electronics
105 W. Dakota #106
Clovia, CA 93612

Marvac Dow Electronics
265-B Reservation Road
Marina, CA 93933

Minuteman Electronics
37111 Post St., Suite 1
Fremont, CA 94536

HCS Electronics
6819 S. Redwood Drive
Cotati, CA 94931

Halted Specialties Co.
3500 Ryder Street
Santa Clara, CA 95051

JDR Micro Devices
2233 Branham Lane
San Jose, CA 95124

Metro Electronics
1831 J Street
Sacramento, CA 95814

The Radio Place, Inc.
5675-A Power Inn Road
Sacramento, CA 95824

HSC Electronics
4837 Amber Lane
Sacramento, CA 95841

Colorado

Gateway Electronics of CO
2525 Federal Blvd.
Denver, CO 80211

Centennial Electronics
2324 E. Bijou
Colorado Sps., CO 80909

Connecticut

Signal Electronics Supply
589 New Park Avenue
W. Hartford, CT 06110

Electronic Service Prod.
437 Washington Avenue
North Haven, CT 06473

Georgia

Norman's Electronics, Inc.
3653 Clairmont Road
Chamblee, GA 30341

Idaho

The Current Source
5159 Glenwood
Boise, ID 83714

Illinois

Tri State Elex
200 W. Northwest Hwy.
Mt. Prospect, IL 60056

Maryland

Mark Elec. Supply Inc.
5015 Herzel Place
Beltsville, MD 20705

Massachusetts

U-Do-It Electronics
40 Franklin Street
Needham, MA 02194

Michigan

Purchase Radio Supply
327 East Hoover Avenue
Ann Arbor, MI 48104

The Elec. Connection
37387 Ford Road
Westland, MI 48185

Minnesota

Acme Electronics
224 Washington Avenue N.
Minneapolis, MN 55401

Missouri

Gateway Electronics Of MO
8123-25 Page Blvd.
St. Louis, MO 63130

New Jersey

Lashen Electronics Inc.
21 Broadway
Denville, NJ 07834

New York

Computrs
7 Great Jones Street
New York, NY 10012

Sylvan Wellington Co.
269 Canal Street
New York, NY 10013

Unicorn Electronics
Valley Plaza
Johnson City, NY 13790

Ohio

Philcap Electronic Suppliers
275 E. Market Street
Akron, OH 44308

Oregon

Norvac Electronics
7940 SW Nimbus Avenue
Beaverton, OR 97005

Portland Radio Supply
234 S.E. Grand Avenue
Portland, OR 97214

Texas

Tanner Electronics
1301 W. Beltline
Carrollton, TX 75006

Mouser Electronics
2401 Hwy. 287 N
Mansfield, TX 76063

Electronic Parts Outlet
17318 Highway 3
Webster, TX 77598

Virginia

Elec. Equipment Bank
323 Mill Street, N.E.
Vienna, VA 22180

Cain Electronics Co.
1530 Ingleside Road
Norfolk, VA 23502

Washington

Amateur Radio Supply Co.
5963 Corson Ave., Ste 140
Seattle, WA 98108

Wisconsin

Appleton Electronic Dist.
205 W. Wis Avenue
Appleton, WI 54911

Wyoming

Chris Supply
2007 S. Douglas Hwy., Ste. C
Gillette, WY 82716

If you'd like to sell our magazine in your store,
please circle 180 on Free Information Card.

Build a DTMF Decoder/Logger

If you've ever wanted to keep a running log of all the activity on your phone line, then the *DTMF Decoder/Logger* described in this article is for you. It can decode all 16 DTMF tones that are used by standard, touch-tone telephones, and automatically log the numbers. The Decoder can also be wired directly to the speaker terminals of any radio receiver to decode repeater codes, control codes, or any other touch tones that are broadcast.

The Decoder's nonvolatile memory will continually hold the last 240 characters entered, which can then be viewed on a 16-character LCD display by using a pair of pushbutton switches to scroll through the contents of memory. A "space" is automatically inserted between groups of numbers that are received more than ten seconds apart for ease of viewing.

Circuit Description. The schematic diagram for the DTMF Decoder/Logger is shown in Fig. 1. The circuit is powered by a 9-volt battery, B1; a 78L05 regulator, U4, drops the voltage to the 5 volts required for the circuit. To stabilize the operation of the regulator, capacitors C9 and C10 are used.

Capacitors C1 and C2, and transformer T1, isolate the circuit from the phone line and couple the DTMF tones to pin 7 of U1. That MC145436 DTMF receiver converts the tones generated by your phone into 4-bit TTL-level data.

The circuit is protected from high-voltage spikes on the line by MOV1, a metal-oxide varistor. Zener diodes D1 and D2 clamp the ringer voltages.

At the heart of the circuit is microcontroller U2, a PIC16C55. That microcontroller receives the 4-bit DTMF identification data from U1's output pins, converts it to ASCII characters, then stores that information in the



Keep track of phone numbers that were called from your phone, or "catch" the tones you hear in broadcasts.

BY TERRY J. WEEDER

93LC56 EEPROM, U3. Microcontroller U2 also monitors switches S2 through S4, and manages the LCD display module, DISP1. (The microcontroller, EEPROM, and display module will all be looked at more closely later.)

In order to scan the switches for activity, U2 sets bit 3 of port A (pin 9) low to provide a corresponding low through R1 on any switch that is closed. When bit 3 is set high, U1 is enabled (that occurs when you check for a DTMF tone). The 3.58-MHz crystal, XTAL1, generates the clock pulse that is shared by both U1 and U2. Trimmer potentiometer R6 is used to adjust the contrast of the LCD display.

The Microcontroller and EEPROM. The PIC16C55 is an 8-bit CMOS microcontroller (manufactured by Microchip) that has two 8-bit I/O ports, one 4-bit I/O port, 512 × 12 bits of on-chip EPROM for storing the operating program, and 32 × 8 bits of data RAM. Each pin of each I/O port can be configured individually as either an input or output through software commands.

The instruction set for the PIC consists of 33 single-word operations, most of which require one cycle (four clock pulses) for execution. Those instructions that force a program branch require two cycles.

One of the other ICs used in the Decoder, U3, is also manufactured by Microchip. That chip is a 93LC56 2K serial EEPROM. In our application, four pins of the 93LC56 interface with three pins of U2: the chip select (cs) pin of U3 connects to pin 6 of U2, the clock (clk) pin of U3 connects to pin 7 of U2, and both the data in (di) and data out (do) pins of U3 connect to pin 8 of U2. Because the di and do pins share the same line, R7 limits current flow during those transition times between read and write when there are conflicting logic levels.

Microcontroller U2 communicates with the 93LC56 by placing a high on the CS pin. Data is then transferred serially to and from the 93LC56 on the positive transition of the clk pin. Each read or write function is preceded by a start bit, an opcode (that identifies the function to be performed), then an 8-bit address, followed by the 8 bits of data that is being written to, or read from that address. Immediately preceding and following all write operations, the microcontroller sends instructions to the 93LC56 that enables/disables the write function, protecting the data thereafter.

LCD Display Module. The component used for DISP1 is a 1-line, 16-character, LCD module. It has its own built-in controller designed to display both numbers and letters by receiving the standard ASCII code equivalent on its 8-bit port. Data, including the ASCII codes, are sent to the display via port C (pins 18–25) of microcontroller U2. The last three bits of U2's port B (pins 15–17) are used as control lines for the display.

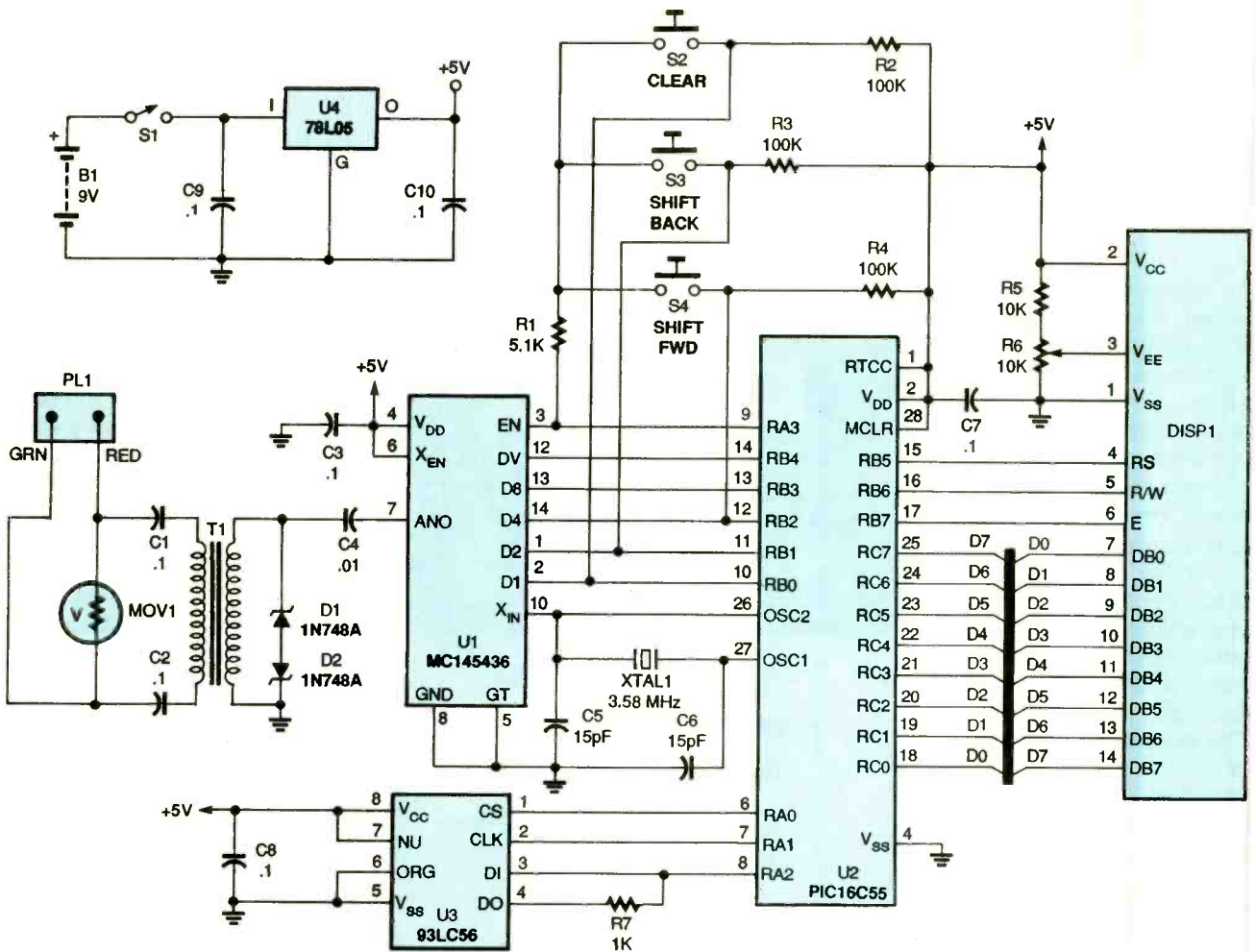

Fig. 1. Here's the schematic for the DTMF Decoder/Logger. The preprogrammed microcontroller, U2, monitors switches S2-S4, takes the decoded DTMF data from U1, and stores the data in U3, the EEPROM. Microcontroller U2 also manages the LCD display module, DISP1, which allows viewing of the DTMF digits stored in U3.

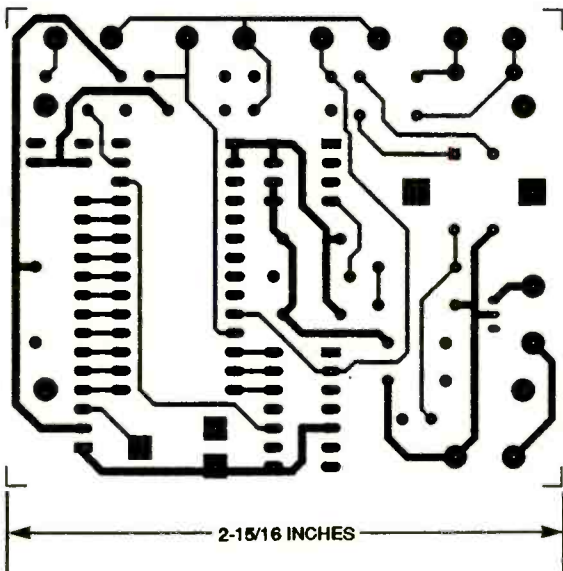

Fig. 2. This is the full-size template for the solder side of the double-sided circuit board.

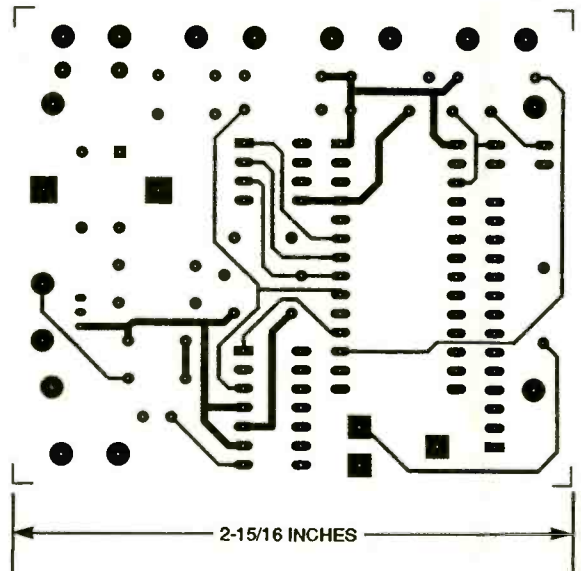

Fig. 3. Here's the component side of the DTMF Decoder/Logger's PC board.

PARTS LIST FOR THE DTMF DECODER/LOGGER

SEMICONDUCTORS

- U1—MCI45436 DTMF receiver, integrated circuit
 U2—PIC16C55 (preprogrammed) 8-bit microcontroller, integrated circuit
 U3—93LC56 serial EEPROM, integrated circuit
 U4—78L05 5-volt regulator, integrated circuit
 DISP1—16 × 1-character LCD module (Optrex DMC16117 or equivalent)
 D1, D2—1N748A 3.9-volt Zener diode
 MOV1—130 VRMS, metal-oxide varistor

RESISTORS

(All fixed resistors are ¼-watt, 5% units.)

- R1—5100-ohm
 R2—R4—100,000-ohm
 R5—10,000-ohm
 R6—10,000-ohm, trimmer potentiometer
 R7—1000-ohm

CAPACITORS

- C1—C3, C7—C10—0.1-µF, Mylar
 C4—0.01-µF, Mylar
 C5, C6—15-pF, ceramic-disc

ADDITIONAL PARTS AND MATERIALS

- T1—600-ohm primary, 600-ohm secondary, audio transformer
 XTAL1—3.58-MHz, TV colorburst crystal
 PL1—Modular telephone plug
 S1—SPST toggle switch
 S2—S4—SPST pushbutton switch, momentary contact, normally open
 B1—9-volt battery
 Printed-circuit materials, project enclosure, IC sockets, battery snap with leads, ribbon cable, telephone cable, RTV adhesive, wire, solder, hardware, etc.

Note: The following items are available from Weeder Technologies (P.O. Box 421, Batavia, OH 45103; Tel. 513-752-0279): Double-sided etched and drilled PC board (WTTDL-B)—\$9.50; all board-mounted components, including a pre-programmed PIC16C55 (WTTDL-C)—\$26.50; LCD display module (DISP16X1)—\$18.50; pre-programmed PIC16C55 (PIC-TDL)—\$18.00. All orders must include an additional \$3.50 for shipping and handling. Ohio residents please add 6% sales tax.

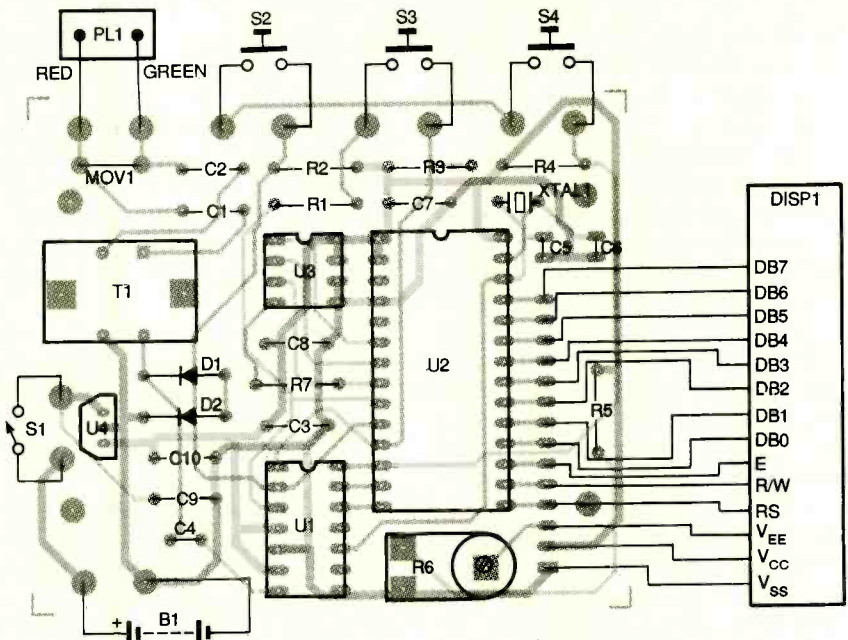

Fig. 4. Use this parts-placement diagram when mounting components to the component side of the PC board. Ribbon cable can be used to connect the display module to the main board.

The process of writing a character to the display consists of first placing the character's 8-bit address, or location, on port C, thereby setting the correct status on the control lines while strobing the enable line. Then, the actual ASCII character code is placed on port C, while again strobing the enable line with the correct status on the control lines. The microprocessor then changes port C to an input, sets the status lines to read the busy flag from DISP1, and strobbs the enable line until the busy flag indicates that DISP1's internal operation has finished writing the character to the screen. All of those operations take less than 100 microseconds to complete.

The Program. For the microcontroller to perform all the functions described in this article, it needs to be programmed with the DTMF Decoder/Logger firmware. A PIC16C55 microcontroller pre-programmed with the firmware is available from the source mentioned in the Parts List. For those who have the equipment and wish to program their own microcontroller, the source and object code files for the PIC16C55 are available on the **Popular Electronics** bulletin board (516-293-2283).

Here's how the PIC16C55 microcontroller works when programmed

with the firmware. Upon power-up, the microcontroller sends a series of commands to the LCD module to initialize it; a logo is then printed across the display and remains there for a few seconds before clearing. The microcontroller goes on to read the 93LC56 EEPROM and determines whether any characters have been previously stored there, and if so, the microcontroller sets the EEPROM address pointer to the end of memory. If the 93LC56 is found to be blank, the microcontroller branches to a subroutine that writes a space (in ASCII format) to all locations in the EEPROM and then sets the EEPROM address pointer to the beginning.

The PIC16C55 constantly monitors switches S2—S4 and the DTMF receiver, U1. When a high is detected on the data-valid (dv) pin of U1 (indicating that a valid DTMF tone pair is sensed and decoded at U1's output), the PIC reads that decoded value through port B, converts it to its ASCII character equivalent, and stores it in the next available memory location in the EEPROM, using port A. Starting from the EEPROM address pointer, U2 reads the next 16 characters from the EEPROM and writes them across the display from left to right. Because the DTMF digit was placed in the next available memory location and all unused areas of memory were initially

set to spaces, the character appears at the leftmost position of the display with all other locations showing a blank space.

Each additional DTMF digit that is received is stored in a subsequent memory location, and the display is again rewritten starting from the EEPROM address pointer that has not been changed. That causes each new character to be shown immediately to the right of the last one. When more than 16 characters have been received, the EEPROM address pointer increments prior to a display rewrite. As a result, when reading the EEPROM and writing the characters to the display, it appears that all characters have shifted to the left and that they continue to do so as each new digit is received.

If a time period of more than 10 seconds elapses between the reception of DTMF tones, the microcontroller inserts a space in memory, and sets the address pointer to the end. When the next group of DTMF tones are received, the screen appears to be cleared, and the new characters start printing on the left-hand side of the display as if the DTMF Decode/Logger was just powered up or cleared.

When the microcontroller detects a

high from any one of pushbutton switches S2–S4, one of the following occurs:

Switch S2 (CLEAR) is Pressed: The microcontroller writes a space to all locations in the EEPROM, sets the address pointer to the beginning of memory, then writes the next 16 characters in the EEPROM to the display.

Switch S3 (SHIFT BACK) is Pressed: The microcontroller decrements the address pointer, then writes the next 16 characters in the EEPROM to the display. That action is continuously repeated while the switch is held down.

Switch S4 (SHIFT FWD) is Pressed: The microcontroller increments the address pointer, then writes the next 16 characters in the EEPROM to the display. That action is repeated for as long as the switch is held down.

Construction. The author's prototype for the DTMF Decoder/Logger was built on a double-sided printed-circuit board measuring just 2½ × 3 inches. A pre-etched and drilled PC board can be obtained from the source mentioned in the Parts List, or you could make your own using the templates shown in Fig. 2 and Fig. 3. Of course, the circuit can also be built

on a perforated board, using point-to-point wiring. But if you do use a PC board, the parts-placement diagram shown in Fig. 4 should make building the board a lot easier.

Identify the component side of the board (it has the pattern shown in Fig. 3), and start by soldering in IC sockets for U1, U2, and U3 (but don't insert the ICs yet). Mount U4 directly to the board, being very careful to avoid solder bridges between the pads, which are very close together.

Next, mount the resistors, capacitors, and diodes, paying attention to the orientation of the latter. When soldering crystal XTAL1, leave a small space between the bottom of the crystal and the PC board. There is a chance that the metal case of the crystal could short the two solder pads together if it is mounted flush against the board. Next, install transformer T1 and varistor MOV1.

Use a piece of 14-conductor ribbon cable to connect the display module, DISP1, to the board. If you can't find that type of cable, 25-conductor ribbon cable, which is readily available from Radio Shack (catalog no. 278-772), will work fine. Simply peel off the 11 excess wires. Separate the conductors on each end of the cable by a length of about 1 inch to make it easier to solder to the PC board and the display module. On the PC board, the pad for pin 1 is rectangular instead of oval; be sure to match that pad with the pad labeled "1" on the display module.

Switches S1–S4 are mounted on the enclosure. Cut eight 6-inch pieces of insulated hook-up wire and twist them into pairs. You will use those wires to connect the switches to the board. Solder a battery snap to the terminals as shown in Fig. 4, making sure that the red wire goes to the "+" terminal and the black wire goes to the "-" one.

Solder the red and green leads of a phone cord to their appropriate connection points on the board, and attach the other ends of those leads to the proper positions in a modular plug. If you're not sure of how to do so, use a modular plug that comes with a phone cord already attached. The yellow and black leads are not used and can be cut off.

After soldering all components and wires to the PC board, carefully check

(Continued on page 92)

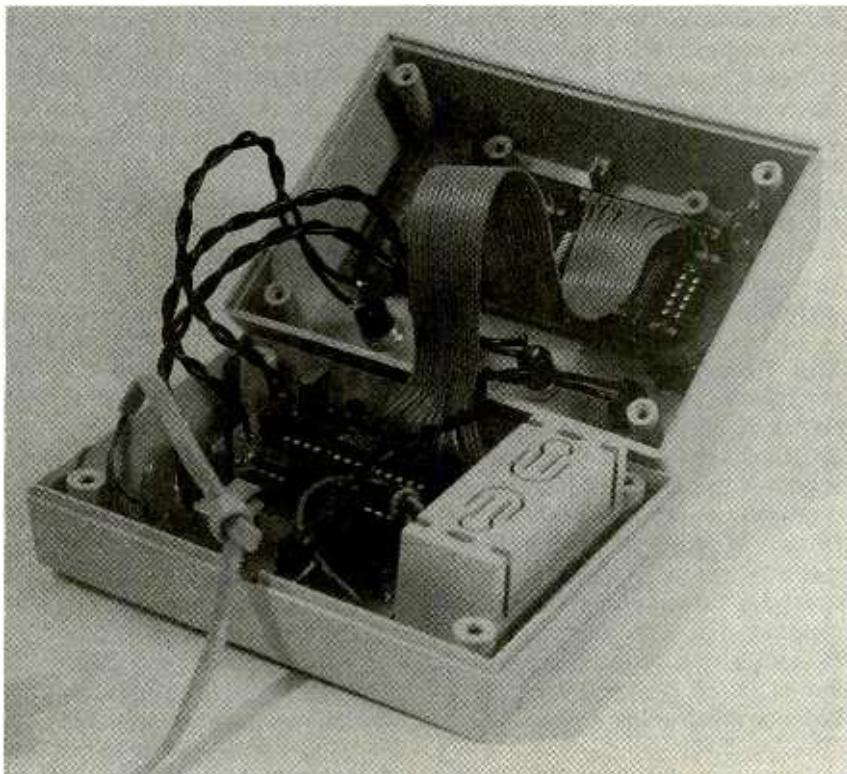

This internal view shows how the display module and main PC board are connected. Ribbon cable keeps the assembly neat.

Most of us have to spend a good deal of time in our automobiles. During those periods, AM/FM car radios can provide entertainment from local stations; however, some of us would like to be able to get a world-wide assortment of programming. That's where shortwave radio comes in.

Now, there are several ways to get shortwave reception in your car. Two European companies, for instance, offer digital automobile radios with AM/FM/shortwave reception (usually 530 kHz to 30 MHz continuous on AM). The cost of those receivers, however, is in the \$350 to \$1000 range! A cheaper option is to use a portable shortwave radio in your car, but those are not shielded, are difficult to mount in a convenient location, and really aren't loud enough to fill a car with sound and overcome road noise.

That's why we're introducing the *Shortwave Converter*; it provides an inexpensive way to receive shortwave stations on an existing automobile radio set to the AM band. The Converter is a circuit that is connected in series between the automobile antenna and the radio. Shortwave stations are heard over the existing power amplifier and speaker system, so audio power is not a problem.

The Shortwave Converter is built for a single international shortwave band. Multi-band versions are possible, but the circuit complexity would be greatly increased. To have the Converter operate over a wide band, as is popular in simple shortwave superhets, is not practical.

Combining the Converter and an AM radio results in a dual-conversion receiver with an image rejection that is usually better than that of a common, single-conversion shortwave superhet with an IF of about 455 kHz. When the Converter is used, an international band is spread out over a considerable proportion of the tuning-capacitor rotation instead of being compressed into a tiny section, as is the case with analog shortwave superhets.

Commercial or Homemade? There are some commercially available shortwave converters, but they do not have tuning capabilities of their own. A problem would arise when using one of those converters with modern,

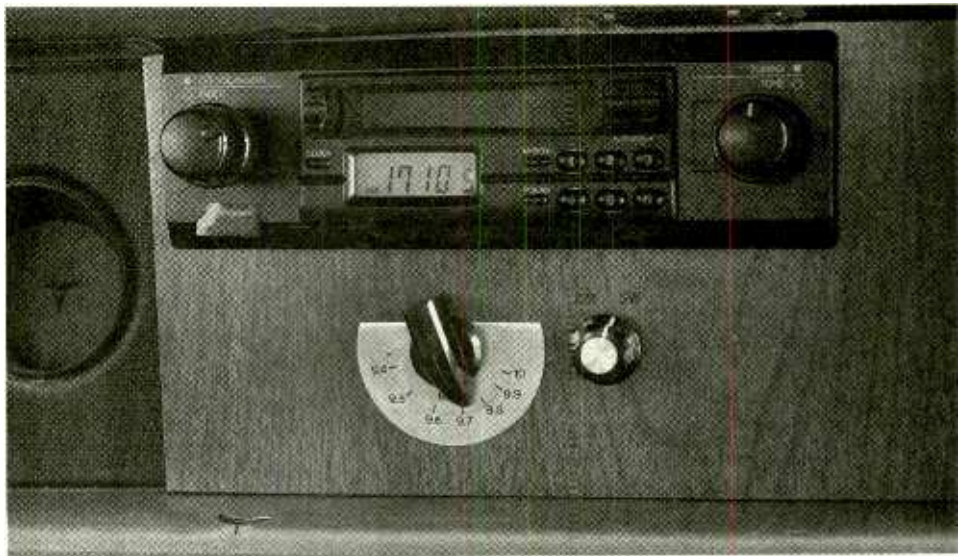

Build a Shortwave Converter for your Car

BY LYLE RUSSELL WILLIAMS, KC5KBG

Let your digital or analog car radio tune in the shortwave band.

digital automobile radios that tune in 10-kHz steps on the AM band. That 10-kHz-step tuning method works fine for AM because all domestic stations are broadcast at precise 10-kHz intervals. On shortwave, however, stations are supposed to broadcast at 5 kHz intervals (and many stations transmit off frequency).

It is also desirable to be able to tune to one side of a station's frequency in order to avoid interference on the other side. A digital AM receiver used with a commercial converter would completely skip over some stations and not be able to tune optimally for many others. The Converter described in this article overcomes that problem and can be used with digital as well as analog receivers.

The Converter allows for minute adjustments in frequency to minimize interference. It has a dial that lets you set the actual shortwave frequency being received instead of settling for

a medium-wave frequency. Because of the unit's overall superb performance, image frequencies are rarely, if ever, audible. The author's prototype of the Shortwave Converter has been operated over a wide range of temperatures and no frequency drift has been observed. Overall bandwidth depends partly upon the automobile receiver, but is usually around 5 kHz. Strong stations come in surprisingly clear.

Because a single international band for the Converter had to be chosen, the 31-meter band was selected. That band officially extends from 9.5 to 9.9 MHz, making it (unofficially) the widest of international bands. Because there are numerous out-of-band broadcasters, the Converter needs to tune from 9.35 MHz to 10 MHz (incidentally, there is a WWV station at 10-MHz, which could make checking your calibration of the unit easy).

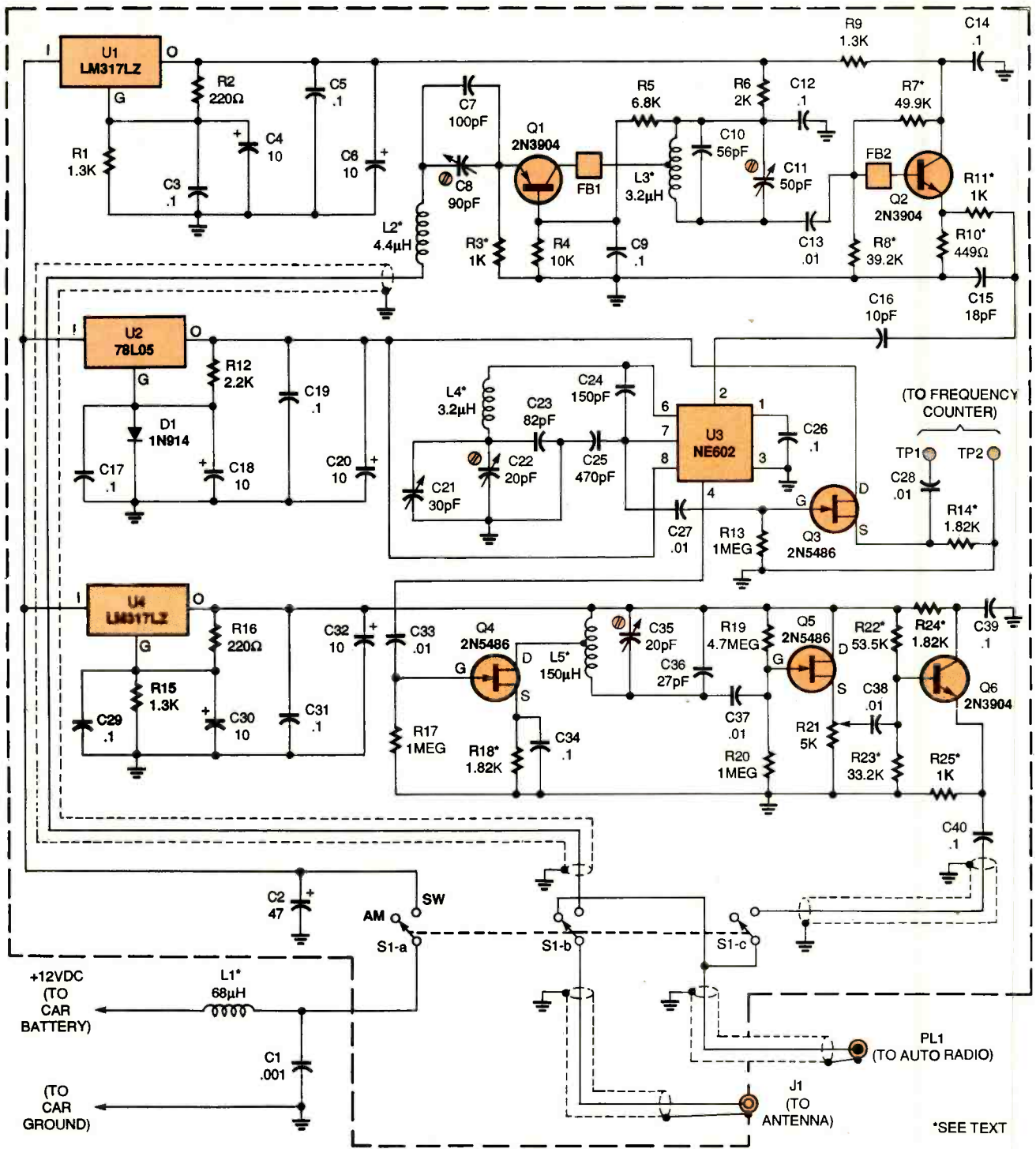

Fig. 1. This Shortwave Converter lets you listen to either AM or SW with a flick of switch S1. And because of tuning-capacitor C21, you can tune in any shortwave station, not just ones that are broadcast in 10-kHz increments.

In the early evening, it is not unusual to be able to receive as many as six English-language stations on that band as well as numerous foreign-language stations. During the daytime, the author can receive good-quality signals from stations that are each about 1000 miles away. But keep in mind that shortwave recep-

tion conditions change radically over time.

In a conventional shortwave converter, when the unit is on, the car-antenna signal is fed to the internal bandpass filter, which passes the entire shortwave band of interest (9.35 to 10 MHz for the 31 meter band). A crystal-controlled local oscillator (which is

fixed at a single frequency, usually 8.5 MHz) and mixer convert the band of shortwave frequencies to a band of medium-wave frequencies (often 850 to 1500 kHz for 31 meters). The output bandpass or lowpass filter removes the unwanted mixer products and passes the signal to an analog broadcast-band receiver.

In the Shortwave Converter described in this article, the local oscillator is made variable and the output is made narrowband on a single frequency—1710 kHz. If your automobile receiver doesn't receive the new AM frequency of 1710 kHz, then 1610 kHz can be used (that difference in output frequency can be accommodated during the calibration procedure discussed later). The tuning capacitor for the local oscillator is fitted with a dial and knob that is accessible to the driver.

Circuit Description. The circuit diagram for the Converter is shown in Fig. 1. Power for the circuit is taken from the car battery and is dropped to the proper voltages for three sections of the circuit by three separate regulator ICs: U1, U2, and U4.

Inductor L2 and capacitors C7 and

C8 act as the circuit's antenna tuner. The tuned signal is fed to an input bandpass filter composed of L3, C10, and C11. An NE602 oscillator IC, U3, is used as a combined mixer and oscillator. That configuration is known as a "series-tuned Colpitts" or "Clapp" oscillator, and is among the most temperature-stable variable oscillators.

The 1710-kHz output filter mentioned earlier consists of L5, C35, and C36. Each of the filters in the circuit was limited to a single LC section in order to simplify as much as possible the alignment of the Converter. Transistor Q3 is a frequency-counter buffer that is used only during alignment.

The gain of the Converter is sufficient to overload the input of some receivers. Potentiometer R21 can be used to decrease the output level and prevent overload; but more on that later.

Construction. To prevent stray capacitance and ensure the best-sounding reception, you should build the Shortwave Converter on a printed-circuit board. If you'd like to etch your own, you can use the full-size pattern shown in Fig. 2. Or you could order an etched and drilled board from the source given in the Parts List. The PC board was designed to fit in the bottom of a standard 5¼- x 3- x 2½-inch metal Minibox, but any metal enclosure that is large enough can be used.

If you do build the Converter on a PC board, use the parts-placement diagram in Fig. 3 as a guide. When mounting the components, note the orientation of the transistors, voltage regulators, the DIP IC, and the electrolytic capacitors. Before inserting transistors Q1 and Q2, place a ferrite bead on the collector of Q1 and on the base of Q2. Electrically, ferrite beads are insulators, so you don't have to worry about shorting the transistor leads.

Note that several of the resistors are metal-film types. The behavior of those is more predictable at RF frequencies, and they only cost a few cents more than carbon resistors. If a source of metal-film resistors cannot be located, they are available from the source given in the Parts List as part of a kit. The silver mica capacitors are also included in that kit, but can be replaced with NPO ceramics if desired.

For C21, the author used a simple, direct-drive tuning capacitor with a pointer knob for his prototype. Tuning was not excessively difficult using that unit, however, a reduction-drive tuning capacitor would be better (in fact, one is supplied in the kit).

The board was originally designed to accommodate LM317LH regulators for use as U1 and U4. However, the more commonly available LM317LZ regulators were used instead, and they have a different pin configuration. Note that the parts-placement diagram shows how to orient the parts and where each pin should be inserted.

Install all board-mounted parts and jumper wires except for capacitor C8 and jumper-wires JU2 and JU4 in the PC board. Those three parts will be added later.

Turning to the inductors, toroidal

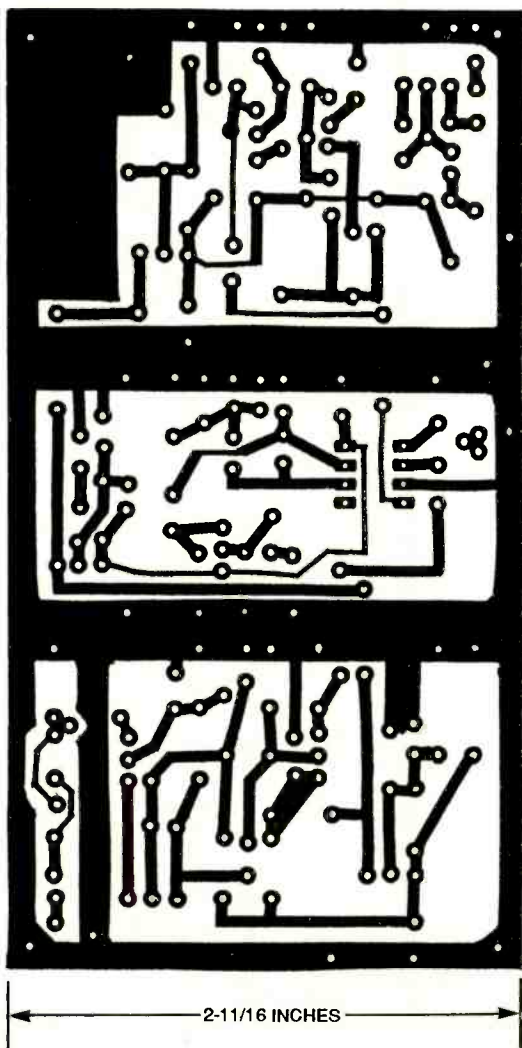

Fig. 2. Building the Converter on a PC board is strongly recommended. You can use this full-size pattern to make your own board.

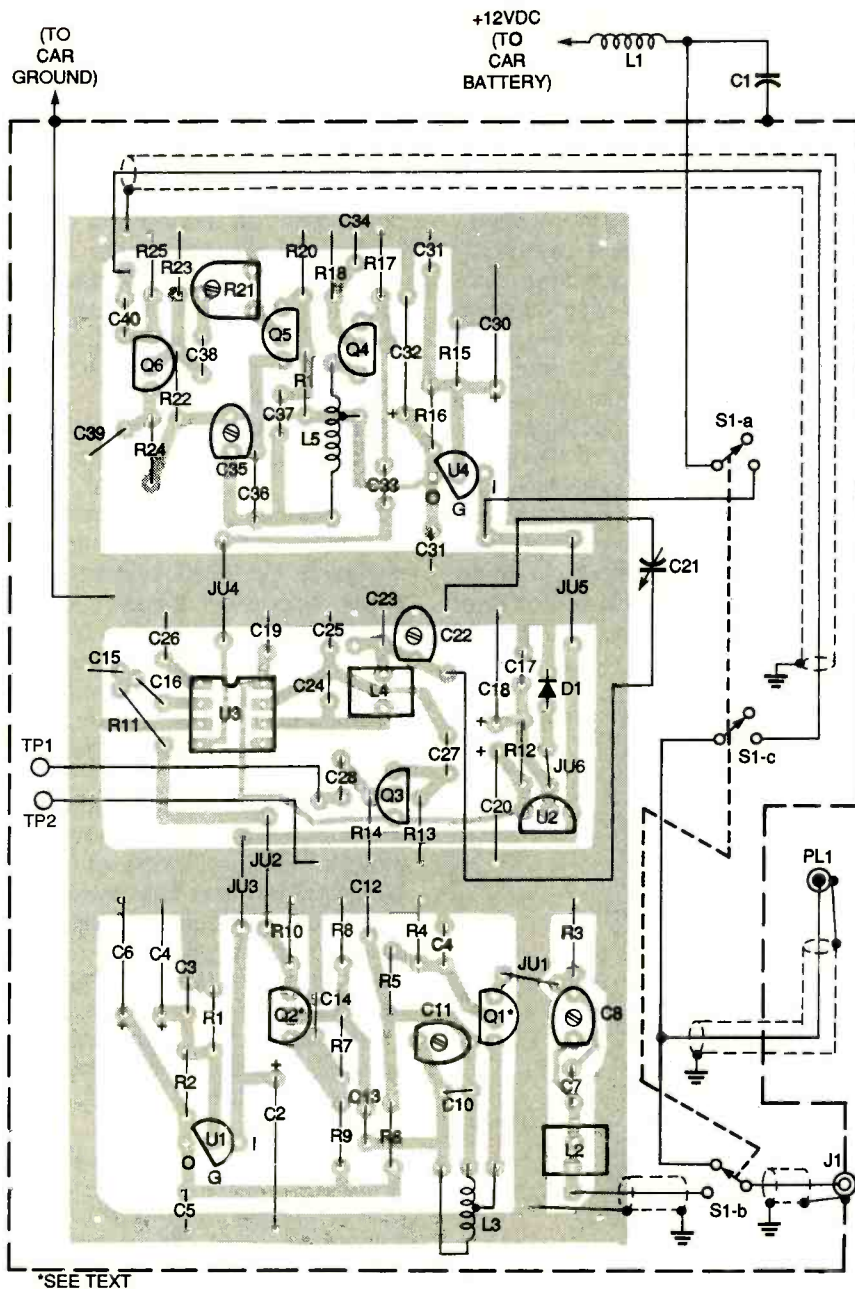

Fig. 3. When mounting the components on the PC board, and doing the off-board wiring, you might want to use this parts-placement diagram as a guide to make things simpler.

units were used where possible because they have inexpensive cores, exhibit a high Q, and are fairly easy to wind. Noise-suppression inductor L1 will carry a current of 15 mA and have a self-resonant frequency of 13 MHz or greater. The author's prototype used a 68- μ H unit (J.W. Miller 9250-683), but an 18- μ H coil (Mouser 43LS185) will work as well. Inductors L2-L5 require winding on the part of the builder (unless, of course, the kit, which contains all inductors, is purchased).

For those who wish to wind L2-L5 on

their own, use the following guidelines: Coils L2-L4 can each be wound using an Amidon Associates T-30-2 (red) powdered iron toroidal core and 30-gauge enameled magnet wire. Inductor L2 is a 4.4- μ H unit that is made by winding 32 turns on the core. Coils L3 and L4 each have a total inductance of 3.2 μ H, and are made by winding 27 turns on the respective cores. A tap is made on L3 four turns from one end.

Finally, inductor L5 is a 150- μ H unit (J. W. Miller 73F154AF) with 13 turns of

30-gauge magnet wire added at one end. Make sure that the added turns are in the same direction as the existing turns, and check that the total inductance of both windings is greater than the original inductor was by itself (the total should be about 180 μ H). As an alternative, you can wind 56 turns of 30-gauge magnet wire on an Amidon FT-50-43 ferrite toroidal core. Tap the winding eleven turns from one end. The latter coil is larger and doesn't fit the PC board as well, but has about twice the Q (which is desirable).

After the board-mounted inductors are installed on the PC board, they should be covered with a drop of silicone glass sealer. That product is available in automobile supply stores. The sealer will immobilize the windings on the inductors and help protect the inductors from the mechanical shock that the Converter will experience inside an automobile.

Calibration. There are several ways to calibrate the Converter. The general idea is to tune the input filter and antenna tuner to a center frequency of 9.675 MHz, tune the output filter to 1710 kHz (or 1610 kHz), and set the oscillator so that the Converter will cover the range of 9.35 to 10 MHz. What follows is a description of the method and equipment used by the author.

You will need the following equipment to calibrate your Converter: a signal generator that will produce the frequency range of 9.35 to 10 MHz and the fixed frequency of 1710 kHz (or 1610 kHz); a receiver (preferably battery operated), with an external antenna input jack and an S meter, that will receive 9.675 MHz and 1710 kHz; and a plug that matches the re-

TABLE 1

CONVERTER-DIAL MARKING (MHz)	LOCAL-OSCILLATOR FREQUENCY FOR 1710 KHz AM	LOCAL-OSCILLATOR FREQUENCY FOR 1610 KHz AM
9.35	11.060	10.960
9.4	11.110	11.010
9.5	11.210	11.110
9.6	11.310	11.210
9.7	11.410	11.310
9.8	11.510	11.410
9.9	11.610	11.510
10.0	11.710	11.610

PARTS LIST FOR THE SHORTWAVE CONVERTER

SEMICONDUCTORS

U1, U4—LM317LZ variable voltage regulator, integrated circuit
 U2—78L05 5-volt regulator, integrated circuit
 U3—NE602 balanced-modulator oscillator, integrated circuit
 Q1, Q2, Q6—2N3904 general-purpose NPN transistor
 Q3—Q5—2N5486 VHF JFET transistor (can substitute an MPF102 or MPF107)
 D1—1N914 general-purpose silicon diode

RESISTORS

(All fixed resistors are 1/4-watt, 5% carbon units, unless otherwise noted.)

R1, R9, R15—1300-ohm
 R2, R16—220-ohm
 R3, R11, R25—1000-ohm, metal-film, 1%
 R4—10,000-ohm
 R5—6800-ohm
 R6—2000-ohm
 R7—49,900-ohm, metal-film, 1%
 R8—39,200-ohm, metal-film, 1%
 R10—449-ohm, metal-film, 1%
 R12—2200-ohm
 R13, R17, R20—1-megohm
 R14, R18, R24—1820-ohm, metal-film, 1%
 R19—4.7-megohm
 R21—5000-ohm miniature potentiometer, board mounted (Radio Shack 271-283 or equivalent)
 R22—53,500-ohm, metal-film, 1%
 R23—33,200-ohm, metal-film, 1%

CAPACITORS

C1—0.001- μ F standoff or feed-through type
 C2—47- μ F, 16-WVDC, electrolytic
 C3, C5, C9, C12, C14, C17, C19, C26, C29, C31, C34, C39, C40—0.1- μ F, ceramic-disc
 C4, C6, C18, C20, C30, C32—10- μ F, 16-WVDC, electrolytic
 C7—100-pF, silver-mica
 C8—8- to 90-pF, ceramic-trimmer
 C13, C27, C28, C33, C37, C38—0.01- μ F, ceramic-disc

C10—56-pF, silver-mica
 C11—9- to 50-pF, ceramic-trimmer
 C15—18-pF, ceramic-disc
 C16—10-pF ceramic-disc
 C21—2.3- to 30-pF, air-variable capacitor, panel-mounting, direct or reduction-drive
 C22, C35—3.5- to 20-pF, ceramic-trimmer
 C23—82-pF, silver-mica
 C24—150-pF, silver-mica
 C25—470-pF, silver-mica
 C36—27-pF, silver-mica

ADDITIONAL PARTS AND MATERIALS

L1—68- μ H (see text)
 L2—4.4- μ H (see text)
 L3—3.2- μ H, tapped (see text)
 L4—3.2- μ H (see text)
 L5—150- μ H (see text)
 FB1, FB2—Ferrite bead (Amidon Associates FB-43-101 or equivalent)
 J1—Coaxial jack
 PL1—Coaxial plug
 S1—3PDT switch, bushing mounted
 Printed-circuit materials, aluminum project enclosure (Radio Shack 270-238 or equivalent), coaxial cable, two knobs, dial pointer (if using reduction drive), 2 1/8-inch-diameter aluminum dial, standoff insulator, 20-gauge solid buss wire (for jumpers and test points), wire, solder, hardware, etc.

Note: The following is available from Dan's Small Parts and Kits (1935 S. 3rd W. #1, Missoula, MT 59801; Tel./Fax: 406-543-2872): PC board—\$11 plus \$1.50 postage and handling; complete kit including PC board, all components, 6:1 reduction-drive tuning capacitor, and undrilled enclosure (excluding wire, cable, plugs, jacks, hardware, knobs, dial, and dial pointer)—\$49.95 plus \$3.75 postage and handling. Check or money orders only, or please call for COD rates. Montana residents, please add any appropriate sales tax.

ceiver's jack. You'll also need a frequency counter, a plastic alignment screwdriver, some coax cable, two 0.001- μ F capacitors, and two 9-volt batteries with clips.

Connect the 9-volt batteries in series, attach the positive lead to the input pad near U4, and the negative lead to ground on the PC board. The

voltage regulators on the board will reduce the resulting 18 volts to the proper levels.

Set the output of the signal generator to 9.675 MHz and apply the signal to the emitter of Q1 (at the pad for capacitor JU1) through a 0.001- μ F capacitor. Attach a 0.001- μ F capacitor from the emitter of Q2 (at the pad for

jumper JU2) to the center wire of a coax cable, and attach the shield to board ground. Then connect the proper plug to the other end of the coax cable and plug it into the antenna jack of the receiver. Set the receiver to 9.675 MHz, and set the output of the signal generator as low as possible for an adequate reading on the receiver. Tune capacitor C11 for a maximum reading on the S meter. That calibrates the input filter.

Leave the coax cable connected to the emitter of Q2. Disconnect the signal generator and the blocking capacitor at the emitter of Q1, and install capacitor C8 on the board. Then, attach an automobile antenna jack to the input side of L2, and connect the jack housing with a short wire to the PC-board ground.

Take the board along with the 9-volt batteries and the receiver inside the automobile. Plug the cable from Q2 into the antenna jack of the portable receiver, then plug the cable from automobile antenna into the automobile antenna jack on the board. Extend the automobile antenna to full length and place the signal generator just outside the car near the antenna. Tune the signal generator to 9.675 MHz and attach a short wire antenna if necessary, but do not physically connect the signal generator to the automobile. Tune the receiver to 9.675 MHz. Adjust C8 on the converter for a maximum indication on the S meter of the receiver. That calibrates the antenna tuner for the antenna in your car.

Bring the board and other equipment back indoors. Disconnect the receiver coax cable from the emitter of Q2 and connect it to the pad at the output end of capacitor C40 with the shield to board ground. Set the signal generator to 1710 kHz (or 1610 kHz as required) and apply a signal at the gate of Q4 through capacitor C33 (use the pad for jumper JU4). Tune the receiver to 1710 kHz (or 1610 kHz) and plug the coax cable into its antenna jack. Set the output of the signal generator as low as will allow adequate output, and tune C35 for maximum output (if you are tuning to 1610 kHz, you might have to increase the value of C36). That completes the calibration of the output filter. Install jumpers JU2 and JU4 before you go on to the next step.

Leave the receiver connected to C40 and tuned to 1710 kHz (or 1610 kHz). Attach tuning-capacitor C21 to the board using short wires, and connect a 4-foot wire antenna to the center terminal of the automobile jack installed at L2. You should now be able to tune in shortwave stations with the Converter that will be heard on the receiver. Tune the signal generator to a frequency near 9.675 MHz; the Converter should pick up the signal without any physical connection (add a short wire antenna to the signal generator if necessary).

Using the signal generator, adjust C22 so that tuning-capacitor C21 covers the frequency range of 9.35 to 10 MHz. If you are using a 1610-kHz output and C22 doesn't have enough capacitance, there is a place on the

closure in the proper places to accommodate mounting screws for the board, the off-board components, and the cable. Then, install the printed-circuit board, C21, the switch, output cable, automobile antenna jack, C1, standoff, etc. in the enclosure, making sure to check your off-board wiring (again, use Fig. 3 as a guide).

Add a 12-volt power wire to the standoff at the input of L1 and a ground wire from PC board ground. Drill two holes and extend short wires from the output of buffer Q3 through the holes to the outside. Attach a dial and pointer knob to C21. Align the knob so that it points to the left at a maximum capacitance of C21.

The dial has to be individually calibrated for each Converter con-

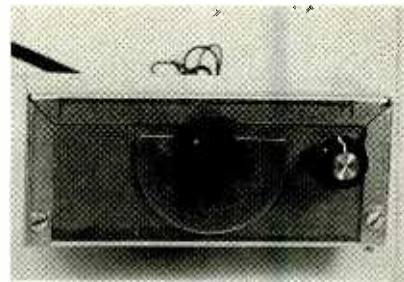

Here's the finished converter prior to installation in an automobile. The tuning capacitor's dial is homemade and will vary by the band of interest.

Table 1 next to the marks. When all the wax transfers are placed, spray the dial with clear acrylic lacquer. Insulate the leads from Q3 and tape them against the box for future use.

Installation in the automobile is accomplished by drilling two holes with the appropriate spacing at a convenient location in the automobile panel. The Converter is placed behind the panel with the switch and capacitor threaded bushings protruding. Place the dial over the capacitor bushing and secure the box to the panel by putting a second pair of nuts on the bushings (note the dial alignment while tightening the nuts). Install knobs on the switch and capacitor shafts.

Some reduction-drive tuning capacitors mount to the panel with three screws instead of a threaded bushing. With that type of tuning capacitor, the Converter will have to be secured to the automobile panel with a screw on the capacitor side and with the switch bushing on the other. The dial will have to be attached to the automobile panel with small, self-tapping screws.

Connect the power wire to the same 12-volt source that is used by the automobile radio and connect the ground wire to the automobile chassis ground at any convenient place. Plug PL1 into the automobile radio and plug the automobile antenna into jack J1. Turn on the automobile radio and set it to 1710 kHz (or 1610 kHz) AM. Turn switch S1 on the Converter to sw and tune in a shortwave station with C21. You are now set to enjoy a type of radio programming that very few people can get in their cars.

Incidentally, if you wish to contact the author directly with any questions or comments, send e-mail to: lrwilliams@nopc.jaxx.com

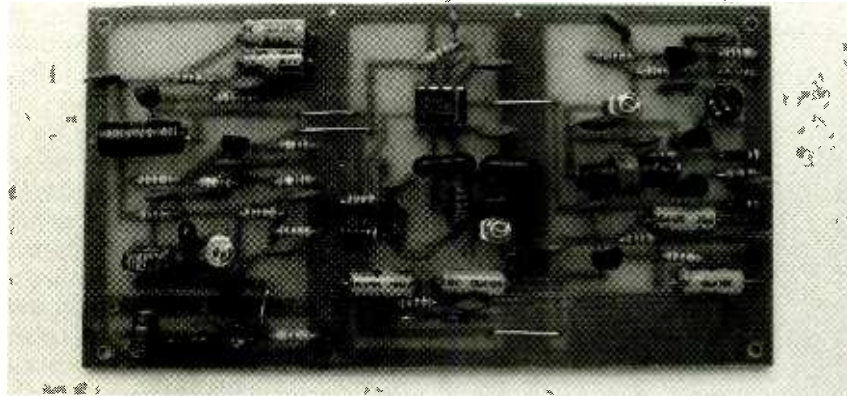

Here's the completed PC board. Building the project in this fashion minimizes stray capacitance and ensures the best performance.

printed-circuit board where an additional capacitor can be added in parallel with C22. That completes the calibration of the oscillator section.

As mentioned earlier, the gain of the Converter could overload the input of some receivers. Potentiometer R21 is used to adjust that. The potentiometer operates backward, in that the maximum output is at the full counter-clockwise position. When the Converter is installed in an automobile, R21 should be adjusted so that the AM receiver is not overloaded. With the author's radio, best results were obtained with R21 adjusted near the minimum output position (near full clockwise).

Final Assembly and Installation.

Remove the cable and automobile antenna jack from the printed-circuit board. Drill holes in the project en-

closed because the variable capacitor and the tuning components L4, C22, C23, C24, and C25 will vary somewhat from those used in the author's prototype. In that unit, a 2½-inch diameter, standard dial plate was used as a base. The dial plate was cut to a semicircular shape because a complete circle was not needed.

Attach a frequency counter to the buffer leads from Q3 and apply 12-volt power to the Converter. Use Table 1 as a guide when calibrating the dial. Rotate C21 until the frequency specified in the second or third column of Table 1 is indicated on the counter, and mark the dial with a pencil at the place indicated by the pointer knob. When all the marks are made, remove the dial from C21. Use wax transfers to cover the pencil marks and place the appropriate frequency number from the first column of

An oracle is one who possesses and imparts great wisdom and insight, usually with the help of supernatural powers. Those types of oracles, while great for people who lived near Delphi in ancient Greece, are not very easy to come by in the modern world. For that reason, we're presenting the *Electronic Oracle* in this article. It will provide you and others with answers to questions of universal—or just marginal—importance, through electronic means.

The Electronic Oracle started out as a simple, innocent party game that gave random yes or no answers to the participants' questions, using a green or red LED, respectively. Using it always resulted in much fun and laughter; however, it wasn't long before the device developed a very interesting twist. It seemed as though every time its creator asked a question, the Oracle gave whichever response would be the most embarrassing for him. That just didn't seem quite fair, so the device was modified to allow its creator, or anyone knowing the secret, to cheat! Therefore, if you build the Oracle, you can get whichever answer you prefer, while everyone else gets only a random response. Sound like fun? Then read on.

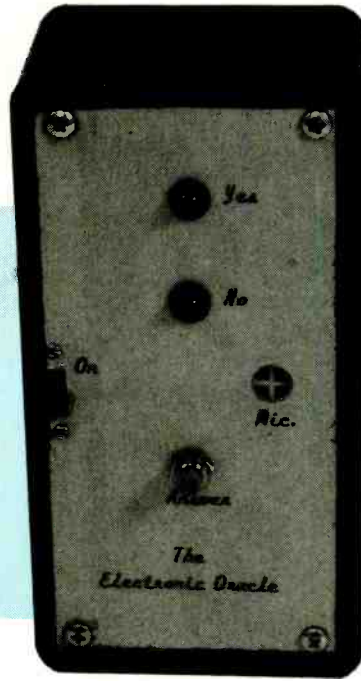

Build the Electronic Oracle

BY KEITH RAWLINSON

Others can use it to get random answers to yes or no questions, but only you know the secret that makes the unit answer exactly how you want it to.

Circuit Description. The schematic diagram for the Oracle is shown in Fig. 1. Switch S1 is used to turn the circuit on

or off. The circuit is powered by a single 9-volt battery, B1.

Integrated circuit U1, a standard 555 timer, is configured as an astable oscillator with a running frequency of approximately 4.8 kHz. That frequency is set by the values of R1, R2, and C3, and could vary slightly depending on the tolerance of those components.

The 555 timer provides clock pulses for U2, which is a 4013 dual data-type flip-flop. One of the flip-flop sections of that IC, U2-b, is constantly being clocked via pin 11; the other section, U2-a, is only clocked when pushbutton S2 is pressed. The reason for that unusual clocking scheme will become apparent in a moment.

When pushbutton S2 is pressed, U2-a is clocked via pin 3. That causes U2-a's Q output at pin 1 and Q output at pin 2 to alternate between high and low with the clock pulses (when Q is high, Q is low, and vice versa). Because the YES and NO LEDs (LED1 and LED2, respectively) have their anodes connected to those pins, whichever of those outputs is high at the time S2 is released is the LED that will light, resulting in each LED having a 50% chance of lighting. Resistor R7 limits current to the LEDs.

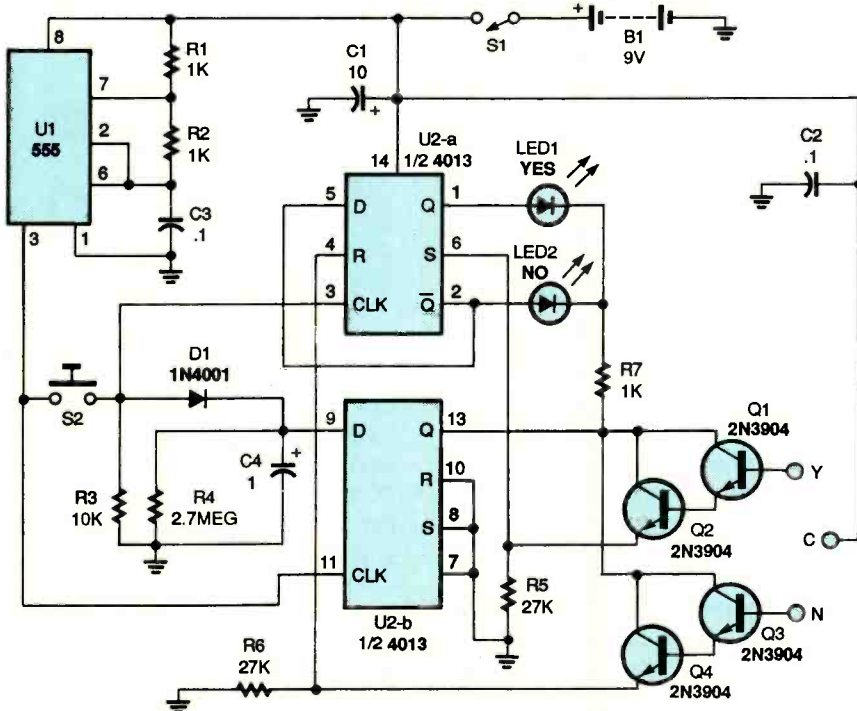

Fig. 1. This is the schematic diagram for the Electronic Oracle. Output pins 1 and 2 of U2-a alternate between high and low. Because LED1 and LED2 have their anodes connected to those pins, whichever of the outputs is high at the time S2 is released will light the LED connected to it.

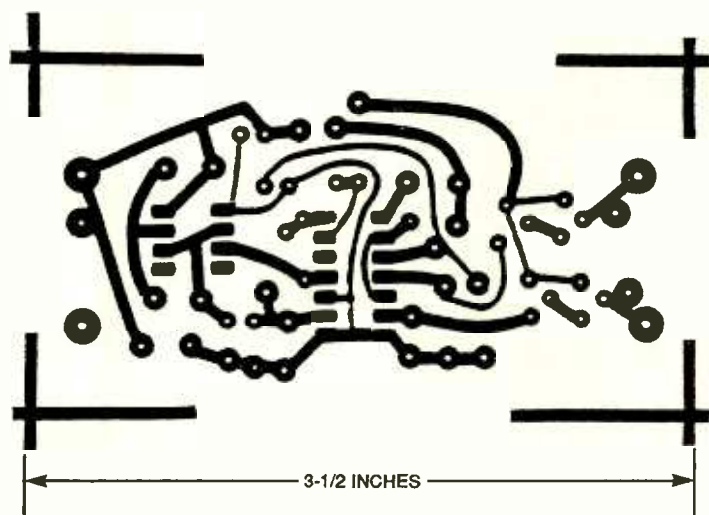

Fig. 2. If you would like to build the Oracle on a PC board, use this foil pattern to etch your own.

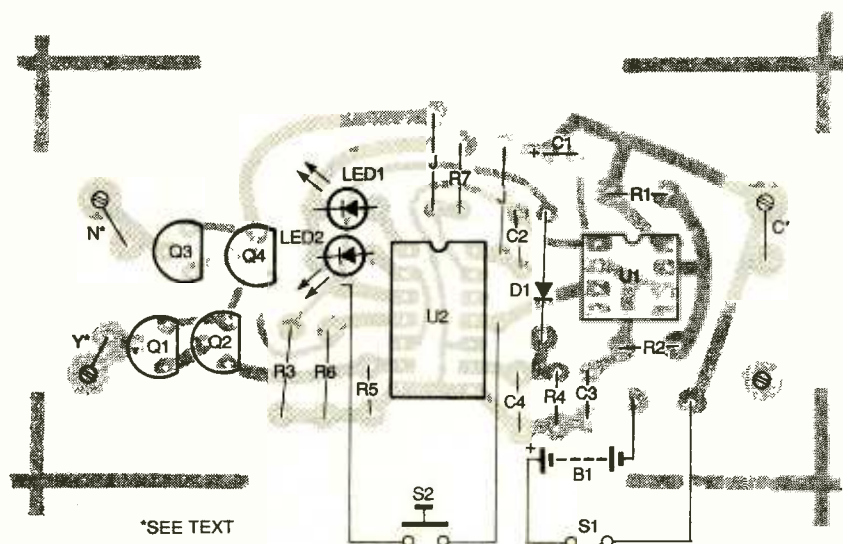

Fig. 3. This parts-placement diagram shows the electrical connections of the three cheat points (C, Y, and N).

Now, if that were all there was to the clocking scheme, one of the LEDs would light the instant you released S2. However, that seemed rather abrupt and uninteresting, so a delay was added for a bit of drama and suspense.

The delay is accomplished through U2-b. In addition to clocking U2-a, pressing S2 also charges C4 through D1. As long as C4 is adequately charged, a logic high is applied to the data (D) input of U2-b through pin 9. The output of U2-b at pin 13 will follow the logic level at pin 9 each time the flip-flop is clocked. Because that is constantly happening while the circuit is on, pin 13 will go high as soon as S2 is pressed, and remain so until about one-and-a-half seconds later when C4 has discharged back to a

logic low through R4. As long as pin 13 is high, neither LED can be forward biased, thus, both remain off until C4 has had time to discharge.

The circuitry that allows you to cheat is made up of transistors Q1 through Q4, and resistors R5 and R6. If you want a "yes" response, use your finger to bridge point C (common) to point Y (yes). A very small current then passes through your finger to the base of Q1, and is amplified by the Darlington pair made up of Q1 and Q2. The amplified signal then applies a logic high to pin 6 of U2-a. A high at pin 6 "sets" pin 1 of U2-a to a logic high, which lights LED1 (the green "yes" LED) a short time after S2 is released.

Similarly, bridging points C and N (no) with your finger applies current to

transistors Q3 and Q4. That places a logic high on pin 4 of U2-a, which resets the flip-flop and causes pin 2, which is connected to LED2, to go high. Because the transistors derive their positive voltage from pin 13 of U2-b, cheating can only take place during the time that the LEDs are both off. That lessens the chance of the "secret" being discovered accidentally by someone else.

PARTS LIST FOR THE ELECTRONIC ORACLE

SEMICONDUCTORS

- U1—555 timer, integrated circuit
- U2—4013 dual data flip-flop, integrated circuit
- Q1-Q4—2N3904 NPN transistor
- D1—1N4001 silicon rectifier diode
- LED1—Light-emitting diode, green
- LED2—Light-emitting diode, red

RESISTORS

- (All resistors are 1/4-watt, 5% units.)
- R1, R2—1000-ohm
 - R3—10,000-ohm
 - R4—2.7-megohm
 - R5, R6—27,000-ohm
 - R7—1000-ohm

CAPACITORS

- C1—10- μ F, 16-WVDC, electrolytic
- C2, C3—0.1- μ F, ceramic-disc
- C4—1.0- μ F, 16-WVDC, electrolytic

ADDITIONAL PARTS AND MATERIALS

- S1—SPST switch
- S2—Pushbutton switch, momentary contact, normally open
- B1—9-volt battery
- Printed-circuit materials, project enclosure, IC sockets, lugs, machine screws and nuts, wire, solder, hardware, etc.

Construction. The layout used for the circuit is not critical, so you could use any standard project-building method to build the Oracle. For those who would like to build the circuit on a PC board, however, a full-size foil pattern is shown in Fig. 2. If you do make your own board, use the parts-placement diagram shown in Fig. 3 as a guide when mounting the components.

First mount an IC socket for each of the two chips. Then install all the resistors; note that R1, R2, R4, R5, and R7 are all mounted upright on the PC board. Next you should install the ca-

(Continued on page 90)

Electronics

Sometimes there is a stigma attached to the words "cheap or frugal." Maybe a better expression would be a "smart shopper." In any event, words matter little when you have a hobby that is dear to you, but only a limited budget on which to support it.

Electronics is no exception. Fortunately, there are many ways to save money in electronics, yet still achieve the desired results. Let's take a look at how you could support your hobby on a budget.

Where to Save. Take a look at Fig. 1 to get an idea of the areas in which a hobbyist could economize. You'll notice five main areas in which to find tremendous savings if you are willing to search for deals.

Test Equipment. On the top of the list of important items to speed your projects along, and the first place to save, is in the area of test equipment. That does not mean you should not stock your workbench with the tools you need; instead you should work at getting what you need at the least possible cost. Here's how to go about it:

The best way to save your pennies is to visit garage sales in your neighborhood. I was completely surprised at some of the test equipment and old gadgets I found just in a 2-mile radius of my home. Many of the devices might not operate but do contain parts that would normally run you hundreds of dollars in electronics stores if you purchased them new. Look for items that might contain reusable parts such as socketed ICs, induction coils, transistors, capacitors, voltage regulators, amplifiers, etc. After performing electronics surgery for a while you'll get a feeling for what devices contain what parts.

The best place to look isn't always in Yard Sale ads that list specific items you might need. The solution is to wander around one Saturday and see if you could find the elusive computer monitor propping up a couch or the frequency counter that's buried under an 8-track deck. That way, you're sure to pick it up cheap; just

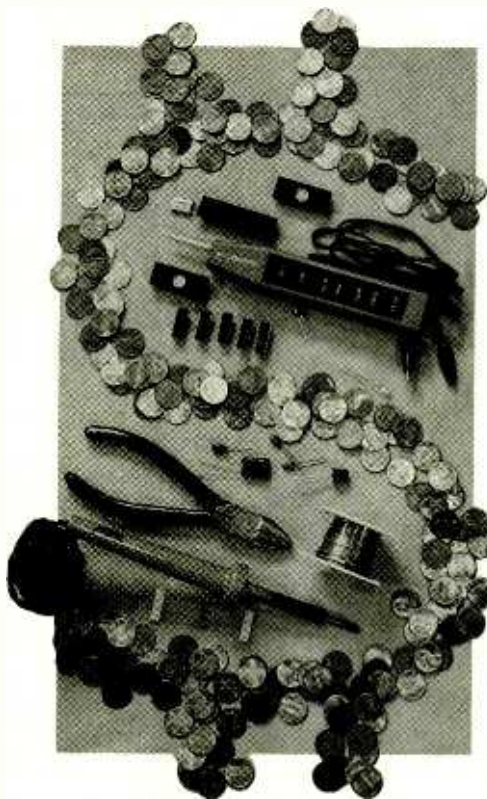

on a Budget

Here are some simple techniques to make your hobby dollars go much farther.

BY JOHN ADAMS

don't let-on to any value it might contain.

What about test gear that is rarely if ever found in a garage or yard sale, such as an oscilloscope? Believe it or not, often the best place to find a deal on an oscilloscope or other piece of test gear is to go to electronic repair shops and simply ask them if they have an old unit that they might want to sell you.

Talk to the head technician, as he or she is the one likely to say "We should

get rid of this old 20-MHz model as we now have a 100-MHz unit with Auto Setting and a hundred-and-twenty bells and whistles." It also helps to tell them you are starting out in electronics and that you are desperately in need of cheap equipment to learn on.

As an example of how little you might have to pay for a simple scope, I once bought a 15-MHz dual-trace portable unit for \$40 (and I'm not even a good haggler). It had been sitting on a shelf for five years and was only used twice in that period.

Another way to save on test equipment is simply to build it yourself either from scratch or from kits offered by companies. I still use my father's original multimeter that he built as a project for school 20 years ago.

Electronics magazines, such as this one, are geared to help the smart shopper. They frequently publish articles on building simple test equipment. One word of advice about that—it is usually a good idea to get a pre-etched board if one is available. However, unless some components are particularly difficult to find, don't be afraid to scrounge up your own parts.

Tools and Accessories. My grandfather used to tell me "always use the right tool for the right job." I remember receiving an hour lecture after trying to cut a wire with a pair of scissors. I now have nine different kinds of wire cutters. The lesson here is: Always have a large variety of tools to use while assembling your projects. However, you should practice your thriftiness while searching for new tools for the right job.

Swapmeets are my favorite place to pick up tools. Most have a tool-bin booth located somewhere in their mazes. Pliers, soldering guns, solder, electrical tape, etc., could be found for extremely low prices. You might also find kits that contain hard-to-find tools that are useful in electronics. Those could include dentistry or surgical items (clamps, scalpels, mirrors, drill bits, etc.).

Pawn shops sometimes have a



Fig. 1. By being resourceful, you could save money in virtually all important areas of your electronics hobby.

"miscellaneous tool bin" where you could locate all sorts of tools and weird gadgets. You will also, on occasion, see oscilloscopes and DMMs for sale. Beware of items that are not clearly priced and left to the whim of the dealer, though.

Parts. Recycling is the key word in these days of "earth consciousness," so why not follow along. Electronics components are very durable, and in most cases could be used over and over again. There is always a healthy supply of broken gadgets that contain good ICs, capacitors, coils, motors, and hundreds of other dodads to keep yourself supplied. All it takes is a little desoldering to get to them. You'll be helping the environ-

ment as well as saving big bucks.

If you walked into an electronics retailer and bought two 10- μ F capacitors, it could easily run you as much as \$1. For that dollar, you could have gone to a yard sale and bought an old radio that contained several of the capacitors and a hundred other parts to boot. You might need to take a few screws out and do some desoldering, but who cares when you're saving money.

The best place to find devices to gut for parts are yard sales and thrift stores. Another option when looking for old parts is to go to TV/VCR repair shops and ask them if they have any "throw aways." I have picked up \$500 VCRs that are loaded with parts, for

free. Just use the same method mentioned earlier; tell them you are studying VCR repair and need help. You might have to pull the entire recorder apart to get the parts you need, but there will always be a healthy selection of resistors, capacitors, motors, LED displays, etc.

If auctions are held in your area, frequent them while building up a parts base. Old TVs, computers, and who knows what else, could be obtained for pennies on the dollar. Try to find the equipment that is not functioning and make a "lot bid" (several items together) if it's not sold by the end of the auction.

Switches (particularly pushbuttons) and LEDs offer the greatest savings using those resources. I once bought an old videogame system that had a huge selection of pushbutton switches, a power supply, socketed ICs, and a good case enclosure with keypads for the scant price of \$1.50! The unit's power switch alone costs that much in a store.

Try as you might, however, scrounging won't always turn up all the parts you need. When that happens, it's time to use the old postal system. In the back of this magazine are several parts houses that sell surplus or bulk parts at unbelievably low prices. Keep a look out for firms that offer reasonable or free shipping with a minimum order and stock up. Even if you have to buy new or in single quantities, mail order is usually less expensive than buying from local, non-hobbyist-friendly distributors.

Books and Magazines. It has always been my opinion that the most valuable tool man has is the written word, whether writing it himself or reading the views of others. The subject of electronics is no exception.

Electronics books are not always expensive to obtain. Of course, the cheapest way to obtain what you're looking for is to borrow them from your local library. I have found countless electronic books at our five local libraries, some that I have not been able to find anywhere else. University libraries are even better. And don't forget the occasional "book sale" that almost every library holds to raise funds. In addition to disposing of old stock, many of those sales feature books and magazines that were do-

(Continued on page 94)

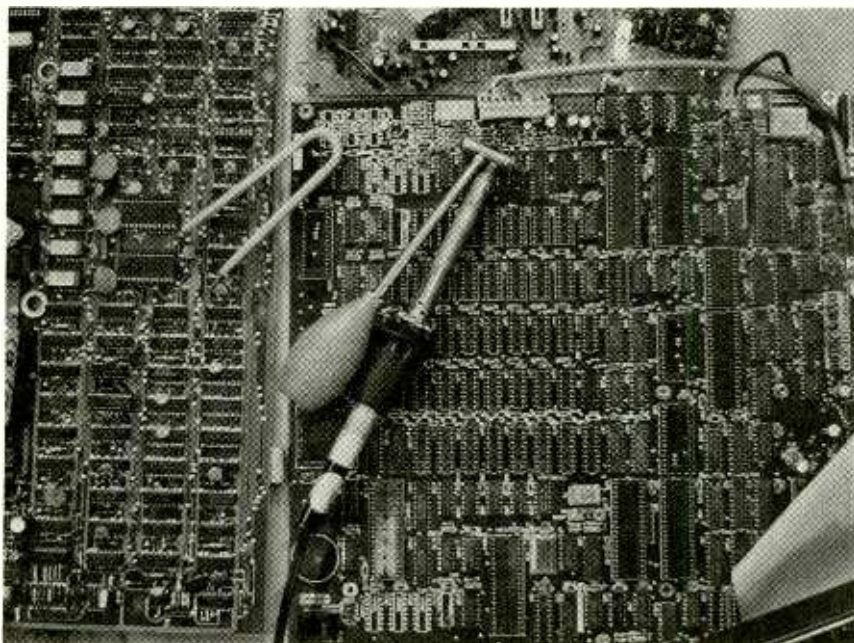

Old PC boards could yield dozens or even hundreds of reusable parts. All you need to get at them is a desoldering tool and a chip puller.



One of the most common questions asked about any home-made project is "what does it do?" That's because a gadget's function is often not that apparent. But in the case of *Space Wings*, what the project does is quite apparent; it's how it does it that is more of a puzzle—especially to the technically inclined person.

The average person might not even think of asking how a pair of shiny silver wings, perched atop a small circuit board, flap up and down. But the person who understands how basic electronics and short lengths of wire work might be very curious as to what makes *Space Wings* go.

Space Wings is a 555-timer-based circuit powered by two AA batteries. The circuit board stands on end, and a Y-shaped, plastic wing base extends off the top of the board. Mounted on that wing base are a pair of silver, triangular, polyester wings. A hair-thin piece of wire is attached to the top

BY MARC SPIWAK

A whimsical device that demonstrates an amazing type of wire.

corners of the board by a pair of screws and nuts, and the wire spans across the center of the Y-shaped base like a main cable on a suspension bridge. That forms the fulcrum of the lever that raises and lowers the wings. But how does a short, hair-thin piece of wire bolted to two corners of the board raise and lower the wings? It would apparently have to change its length. Guess what—it does!

Muscle Wire. Muscle Wire is in a class of metals known as Shape Memory Alloys, or SMA's. The crystal structure of an SMA changes shape at

different temperatures. Muscle Wire can be stretched at a relatively low temperature. When heated, it will contract back to its original length with quite a pull, more or less so depending on the gauge of the wire.

Another property of SMA metals is known as the Shaped Memory Effect (SME). That refers to the fact that memory alloys can be fabricated into a shape that will be "remembered" by the metal. If deformed, the part will "magically" return to its original shape when heated.

The most common type of memory alloy is called Nitinol (pronounced: "night in all"). The main components of Nitinol are nickel and titanium. Mondo-tronics' Muscle Wire is the trademark name for their brand of Nitinol wire. Nitinol wire is easily heated with electricity, turning electricity into silent motion.

Nitinol is made by melting together nickel and titanium and casting them into an ingot. The ingot is then rolled

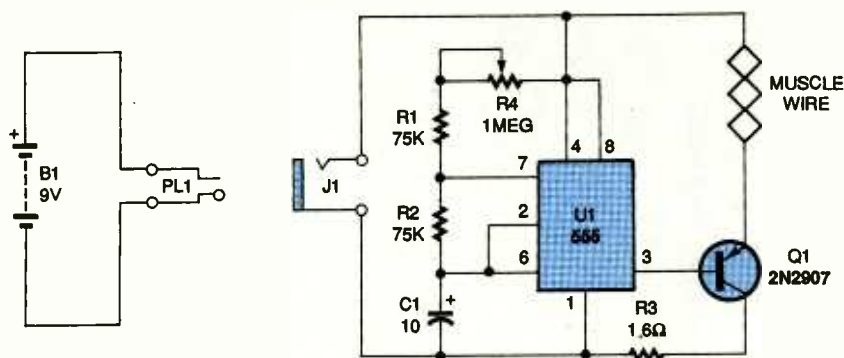

Fig. 1. This schematic shows how simple the Space Wings circuit is. A 555 timer and potentiometer R4 control the rate at which the Muscle Wire flexes.

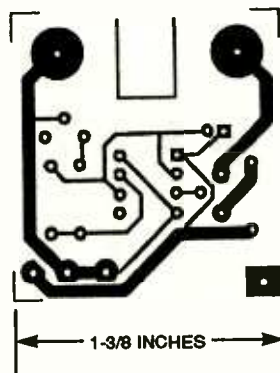

Fig. 2. This foil pattern can be used to make your own PC board.

and formed into bars and wire. Machining the metal is very difficult and expensive because of how it reacts to heat. Shapes are formed at low temperatures, clamped, and heated to above the transformation temperature to anneal the metal. That shape will then be "remembered."

Muscle Wire is available in diameters from 25 to 250 micrometers (μm). Thicker wire exerts more force, although it also requires more power to heat and takes longer to cool. Nitinol alloys can exert as much as 40 tons per square inch.

Nitinol wire can contract up to 10% of its length. To do that, it must be heated to between 100- and 130-degrees Celsius (it should not be overheated). If properly handled, a wire can have an operating life of more than 1,000,000 cycles. Even though the wire can be heated directly with low-voltage electricity, that leads to uneven heating. A better way to heat the wire is with pulse-width modulation, which leads to better control of motion and more-even heating.

The applications for memory alloys

are limitless, including: shower heads that shut off at a certain temperature, virtually unbreakable eyeglass frames, tight-fitting hydraulic-line couplings, medical and dental use, heat engines, and more. Space Wings uses Muscle Wire only to flap its wings, but Muscle Wire and memory alloys in general can certainly be put to use in more-critical applications, perhaps by some readers of this magazine. Who knows what future applications await the use of memory alloys? But in the mean time, Space Wings is an excellent demonstration of how SMA's work.

Circuit Description. The schematic for the Space Wings circuit is shown in Fig. 1. Resistors R1 and R2, potentiometer R4, and capacitor C1 set the rate and duty cycle of U1 (a 555 timer). The

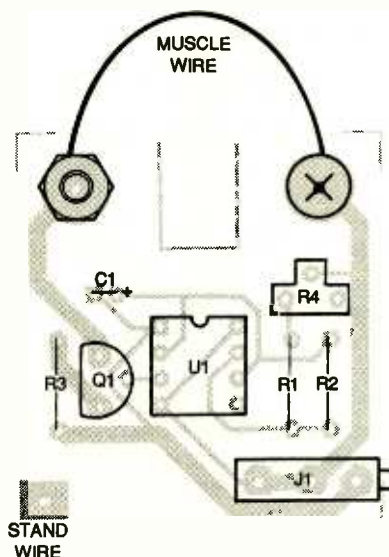

Fig. 3. Use this parts-placement diagram as a guide when mounting the components. A stiff piece of wire is used as a stand (see text).

output at pin 3 of U1 controls the rate at which current passing through the Muscle Wire turns on and off, and transistor Q1 actually switches that current on and off. Resistor R3 limits current through the wire to protect it from overheating.

Potentiometer R4 varies the rate at which the wings flap, but there are other ways to alter the wing's speed. Decreasing C1's value will make the wings beat faster overall, and different resistor-values will change the duty cycle's on and off times.

When current passes through the wire, its resistance of about 2 ohms causes it to heat to over 212-degrees Fahrenheit. Because of the wire's small mass, however, it never feels hot to the touch. When the wire is heated, its length decreases by 3 to 5 percent. When current through the wire stops, the wire cools off and returns to its original length as gravity pulls the wings back down.

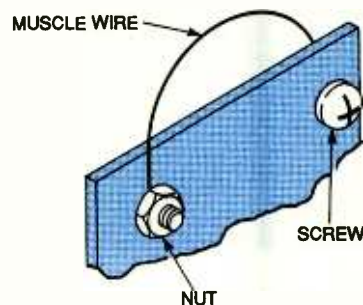

Fig. 4. The Muscle Wire must be held in place against the circuit board by the nuts only, and the two nuts should be on opposite sides of the board as shown.

Construction. Aside from the Muscle Wire itself and the wing base, you might be able to find everything you need to build Space Wings in your spare-parts box. However, for people who don't want to waste their time making a PC board or messing around with bits of plastic and tape, Space Wings is available as a complete kit from the source mentioned in the Parts List. People who do want to make their own PC board can do so from the foil pattern shown in Fig. 2, and they can purchase only the wing base and Muscle Wire from the same source.

A parts-placement diagram is shown in Fig. 3. Install the components on the board, paying careful attention to the polarity of the capacitor,

PARTS LIST FOR THE SPACE WINGS

SEMICONDUCTORS

U1—555 timer, integrated circuit
Q1—2N2907 PNP transistor

RESISTORS

(All fixed resistors are 1/4-watt, 5% units.)

R1, R2—75,000-ohm

R3—1.6-ohm

R4—1-megohm potentiometer, PC-mount

ADDITIONAL PARTS AND MATERIALS

C1—10- μ F, electrolytic capacitor

J1—2.5-mm mini jack

PL1—2.5-mm mini plug

Muscle Wire (Flexinol 100 HT, 90°C), printed-circuit materials, 8-pin IC socket, two 4-40 by 1/4-inch pan-head screws and nuts, paper clip (for use as stand wire), two AA batteries and holder with power leads, wing-base strip (see text), 3/4- x 4 1/2-inch polyester wing sheet (or other similar material), solder, hardware, etc.

Note: The following items are available from Mondo-tronics, Inc. (524 San Anselmo Ave., #107-05, San Anselmo, CA 94960; Tel. 415-455-9330, Fax: 415-455-9333): Complete Space Wings Kit (everything except batteries)—\$19.95 + \$5.00 S&H (\$6.00 S&H to Canada., \$10.00 S&H International); Muscle Wire and wing base only—\$10.00 plus SASE; 1 meter of Flexinol 100 HT Muscle Wire—\$17.95 + \$5.00 S&H. California residents add appropriate sales tax.

transistor, and IC. Install a socket for U1, and insert the IC when the board is complete. Insert a straightened paper clip or a piece of stiff wire in the hole marked "Stand Wire" with equal lengths protruding through both sides of the board and solder it in position. Bend both sides of the wire so that it supports the board vertically.

Jack J1 is a 2.5-millimeter mini jack. Connect a matching 2.5-millimeter mini plug to a battery holder that holds two AA cells, making the tip of the plug positive. Inspect the board carefully for errors before continuing.

Install the two screws and nuts in opposite directions in the top-corners holes in the board as shown in Fig. 4. Insert the Muscle Wire behind the nuts

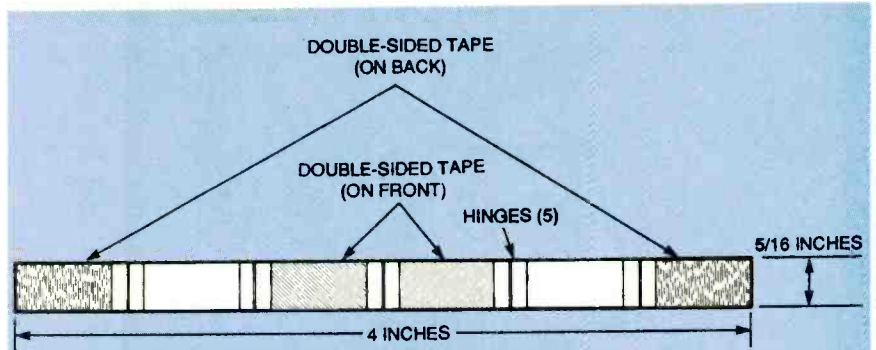

Fig. 5. The wing base is fabricated as shown here. But you might want to consider purchasing one instead of making your own (see text).

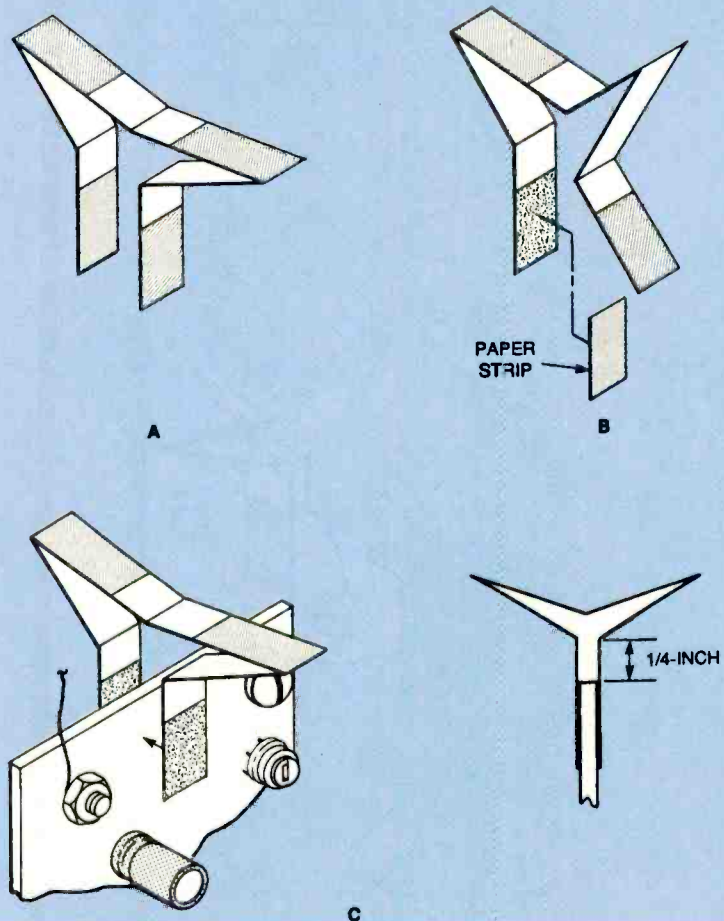

Fig. 6. Bend the wing base into a Y shape (A) with the lower double-sided tape on the inside and remove the paper strip (B). Adhere the wing base to the end of the board (C) with the arms of the base splitting off about 1/4-inch above the board.

from one side of the board to the other as shown and temporarily tighten the screws to secure the wire. Note that, for obvious reasons, the Muscle Wire can not be soldered.

At this point the circuit can be tested. Set potentiometer R4 to mid position. Apply power by plugging in the battery holder and observe the Muscle Wire; it should alternately kink up and relax, as if it were alive.

Next the wing base must be adhered to the board so that it forms a Y shape. The wing base is a strip of clear plastic—similar to the kind that a stiff blister pack is made of—with five flexible joints along its length. Tape forms the flexible joints, and double-sided tape holds the wing base to the PC board and the wings to the wing base. Figure 5 shows details. However, read on before making your own.

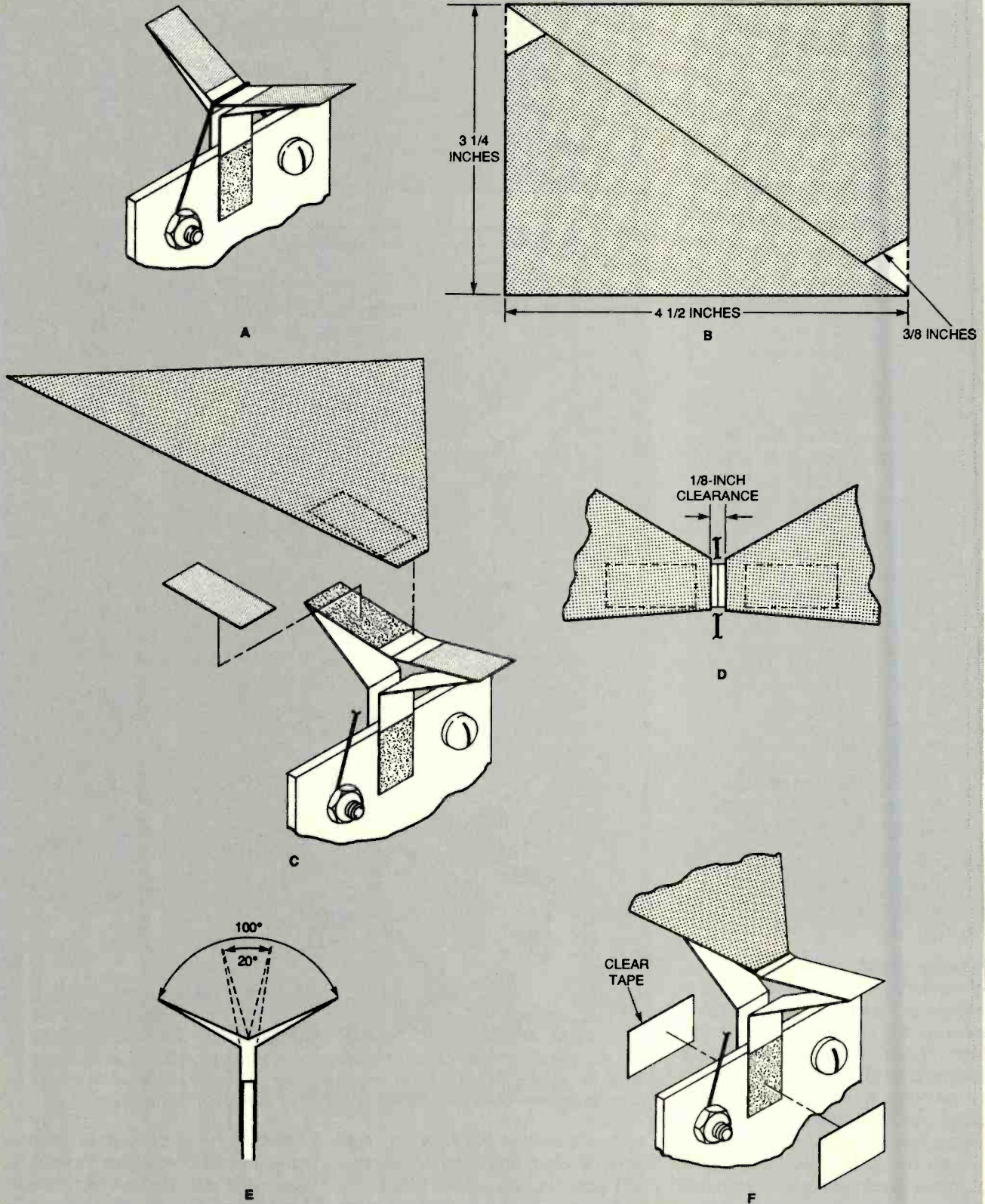

Fig. 7. Attach the Muscle Wire so that the Y-shape is seen "standing up" (A). Cut the wing sheet diagonally and clip the corners (B); mount them to the wing base (C) leaving 1/8-inch clearance between the base and the wings (D). The wings should nearly close up and open to about 100 degrees (E). Secure the wing base to the board with clear tape (F).

The wing base that comes with the kit is more specialized than it might appear at first glance. The orange

tape that allows its joints to flex is made of a special material called polyimide that allows repeated flex-

ing and heating without damage. And the double-sided tape is ex-
(Continued on page 94)

Are you tired of shouting over your answering machine's outgoing message when it answers the phone before you do? If you are, then the *Answering-Machine Message Stopper* described in this article is the solution you've been searching for.

The Message Stopper connects between your present answering machine and any convenient modular phone jack. When any extension telephone on the same line rings, and the answering machine answers the phone first, you can easily stop the outgoing message and reset the machine for the next call simply by pressing a key on the tone-dialed telephone's keypad (note that the circuit will not work with pulse-dialed equipment). That causes the Message Stopper to silence the answering machine immediately, and allows the conversation to proceed without any further interference.

Circuit Description. The schematic diagram for the Message Stopper is shown in Fig. 1. Power for the circuit is supplied by a 12-volt source. The output of that source is fed to the junction of K2 and D1. That output is also dropped to 5 volts through a voltage-regulator stage made up of transistor Q3, resistor R13, and Zener diode D2, and fed to the balance of the circuit.

Plug PL1 connects to the telephone line. The *tip* and *ring* conductors of that plug are connected in series to line-sense relay K1, line-disconnect relay K2, and finally to plug PL2, which connects to the answering machine. Integrated circuit U1, a CM8870 DTMF receiver, monitors the phone line for the presence of DTMF signals. That chip contains an internal op-amp stage that allows it to be interfaced to the phone line using only a pair of capacitors (C1 and C2), and a few resistors. The voltage gain of the internal amplifier is determined by the ratio of R5/R1, and is unity in this circuit.

Resistors R3 and R4 bias the inputs of U1 to approximately $\frac{1}{2} V_{cc}$. When a connected answering machine answers the line, and a DTMF signal is detected by U1, the output at pin 16 of U1 goes high. That causes capacitor C3 to begin discharging through resistor R6. After C3 has discharged, the output at pin 15 goes high. The amount of time that a DTMF tone pair

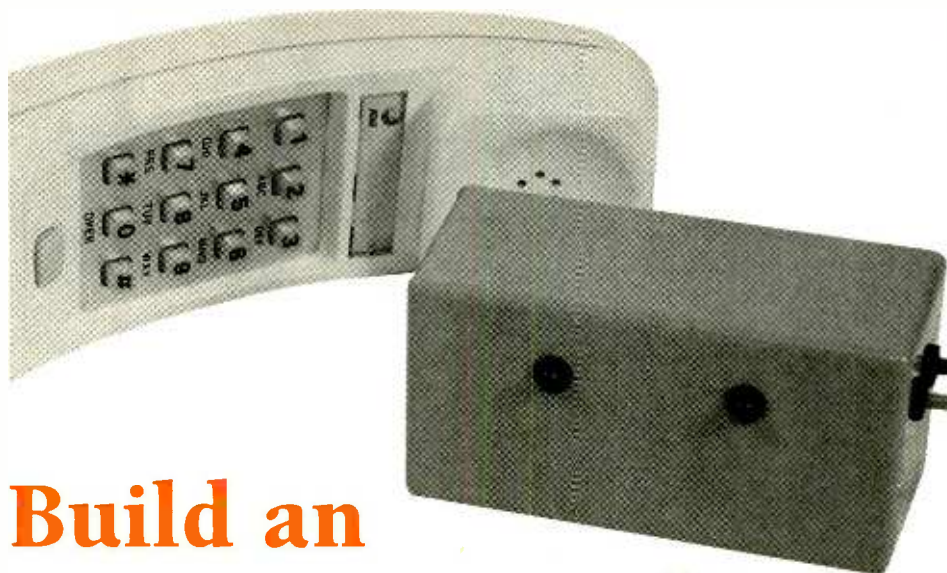

Build an Answering-Machine Message Stopper

BY BRIAN PLILER

Get your old answering machine to stop recording when you pick up the phone.

must be present before pin 15 goes high is approximately $\frac{1}{3}$ of a second, and is determined by the following formula:

$$t = 0.67RC$$

where t is the time in seconds, R is the value of R6 in ohms, and C is the value of C3 in farads.

As soon as the output of pin 15 goes high, transistor Q1 is turned on, lighting LED1 and triggering the 555 timer, U2, which is configured as a monostable multivibrator, into operation via capacitor C4. However, U2 can only receive power if the answering machine answers the line. That is accomplished by the relay contacts within line-sense relay K1, because they will close when the line current through the coils exceed 20 mA, thereby applying +5 volts to pin 4 of U2.

Once U2 is triggered, pin 3 goes high for approximately 5 seconds. As a result, LED2 illuminates, and transistor Q2 switches on. Relay K2 then switches on, disconnecting the answering machine from the phone line

for approximately 5 seconds. That should give the typical answering machine more than sufficient time to detect the line disconnection, and force it to reset for the next call. However, the length of the time period can be altered by changing the values of R10 or C5, as shown in the formula:

$$t = RC$$

where t is the time in seconds, R is the value of R10 in ohms, and C is the value of C5 in farads.

Construction. The author's prototype was assembled on a small section of perforated board using point-to-point wiring. If you would like to etch a printed-circuit board for the project instead, you can use the pattern shown in Fig. 2. For those who do build the project on a PC board, a parts-placement diagram is provided in Fig. 3.

Begin by installing the two jumpers. Then proceed to mount resistors R5 and R12 vertically, and the other resistors horizontally. Install IC sockets for U1 and U2, as they make testing of the

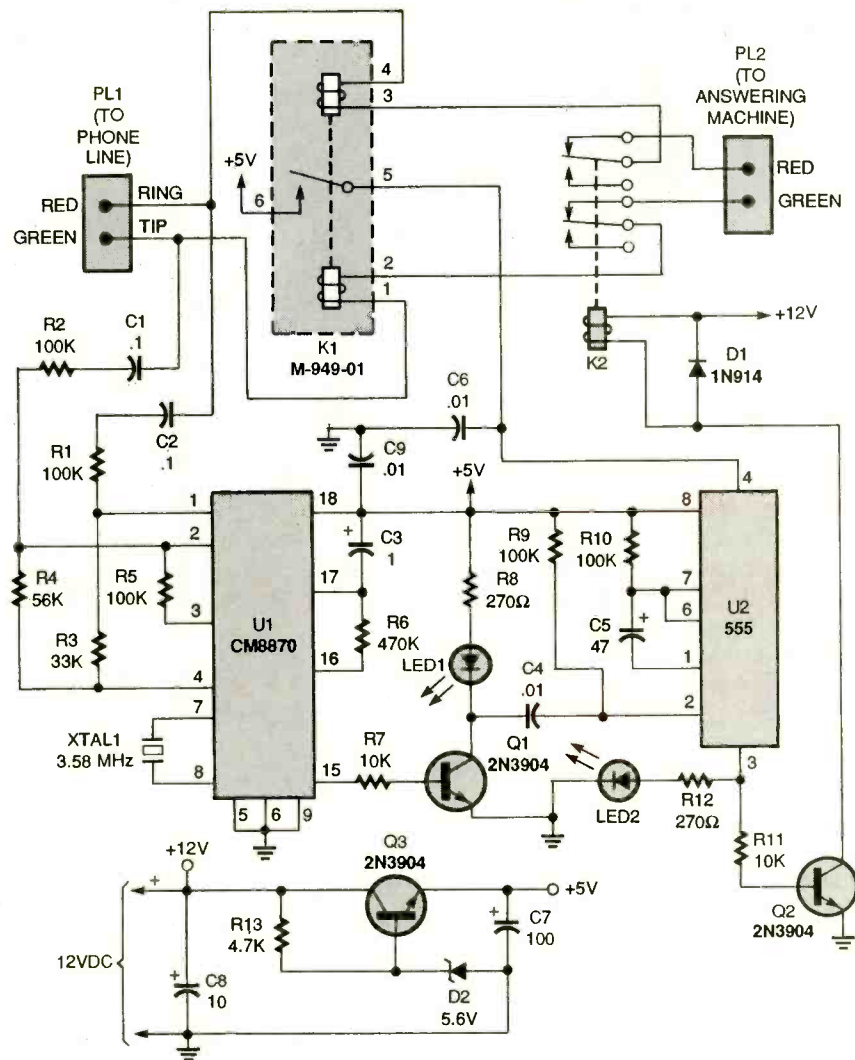

Fig. 1. This circuit lets you pick up your phone, press any button, and stop your answering machine. The CM8870 DTMF receiver, U1, detects whether a button was pressed.

PARTS LIST FOR THE ANSWERING-MACHINE MESSAGE STOPPER

SEMICONDUCTORS

U1—CM8870 DTMF receiver, integrated circuit
 U2—555 timer, integrated circuit
 Q1—Q3—2N3904 general-purpose NPN transistor
 D1—1N914 general-purpose silicon diode
 D2—5.6-volt, 400-mw Zener diode
 LED1, LED2—Jumbo light-emitting diode, red

RESISTORS

(All resistors are 1/4-watt, 5% units.)
 R1, R2, R5, R9, R10—100,000-ohm
 R3—33,000-ohm
 R4—56,000-ohm
 R6—470,000-ohm
 R7, R11—10,000-ohm
 R8, R12—270-ohm
 R13—4700-ohm

CAPACITORS

C1, C2—0.1-µF, polyester
 C3—1-µF, 50-WVDC, electrolytic
 C4, C6, C9—0.01-µF, polyester
 C5—47-µF, 10-WVDC, electrolytic
 C7—100-µF, 10-WVDC, electrolytic
 C8—10-µF, 10-WVDC, electrolytic

ADDITIONAL PARTS AND MATERIALS

K1—M-949-01 line-sense relay (Teltone, see text)
 K2—DPDT DIP relay, 12-volt coil, PC mount (ITT# RZ-12C or similar)
 PL1, PL2—Modular plug
 Printed-circuit materials, enclosure, IC sockets, 12-volt power supply, telephone cable, wire, solder, hardware, etc.

project and IC replacement easier. Go on to install the capacitors, diodes, and transistors.

Next, mount the two relays. The Teltone M-949-01 line-sense relay is manufactured by Teltone Corporation (22121 20th Ave. SE, Bothell, WA 98021-4408; Tel. 800-426-3926). If you cannot find that part at your local hobbyist source, call Teltone for information on the distributor closest to you.

After all of those components have been installed on the board, double-check your work, paying particular attention to the orientation of the diodes and the electrolytic capacitors. Before installing U1 and U2 in their respective sockets, apply 12-volts DC to the voltage-regulation section of the circuit (the author's prototype uses an ordinary 12-volt-DC wall adapter). Confirm that +5 volts is present at the emitter of transistor Q3 and at the appropriate IC socket pins. Using a temporary jumper wire, connect one end to a +5-volt point, and connect the opposite end to pin 15 of the socket for U1. LED1 should stay lit as long as the jumper is connected.

Remove the jumper from pin 15 and connect it instead to pin 3 of the socket for U2. That should light LED2 and activate relay K2. With the temporary jumper wire and power removed, install the ICs into their respective sockets. Then connect appropriate lengths of telephone cable to the two plugs and to the correct points on the board. Finally, mount the completed circuit board into a suitable enclosure.

Installation and Use. Disconnect your answering machine from the phone line. Insert modular-plug PL1 of the project into the phone jack, and insert modular-plug PL2 into the phone-line input jack on the answering machine (a double-female adapter might be needed for that connection if you have an answering machine with a cord that is not removable). Then, apply power to the project and have someone call your phone number.

After your answering machine answers the line, pick up any extension telephone and press any key on the telephone's DTMF keypad. The answering machine should be silenced

(Continued on page 93)

Many people like listening to a cricket's song. Some believe it induces a feeling of well-being that can aid in getting a better night's sleep. Others like to have a natural sound in their homes during the winter months, possibly to prevent cabin fever. And a few hold to the belief that the song can bring good luck to a person. If you'd like to bring the song of a cricket into your home, but not the insect itself, build the *Chirrup* described in this article. It's a compact, realistic-sounding device that can easily be built in an evening.

Cricket Folklore. Due to the cricket's long relationship with humans, much folklore surrounds the creature. In Europe, legend has it that if a cricket abandons a house, those living there can expect the coming of bad luck. Moving to the east, we find that the Chinese kept crickets that were selectively bred for musical sounds in bamboo cages, while others were bred specifically for fighting. Wagers were placed on those fighting crickets for entertainment.

Popular fiction has also contributed to the popularity of the cricket in the past couple of centuries. Most notably, Charles Dickens immortalized the cricket in his story "The Cricket on the Hearth," which was written in three "chirps" instead of chapters. More recently, everyone of course remembers the lovable Walt Disney character, Jiminy Cricket.

One final bit of cricket lore surrounds the fact that crickets are cold blooded and seek warm places to live. For that reason, the insects are known to many as "poor men's thermometers." Supposedly, if you count the number of chirps a cricket makes in 15 seconds and add 39 to that number, the result is the approximate temperature in degrees Fahrenheit.

Cricket Song. While crickets have no sound-producing organs, they do interact and communicate with each other through sounds they make by rubbing their forewings together (it seems those wings evolved just for the production of sound). One wing has a serrated ridge, called the "file," which is dragged across the opposite wing's "scraper." That excites a clear area on the left wing, causing it to resonate.

The sound produced as a result of

Build the

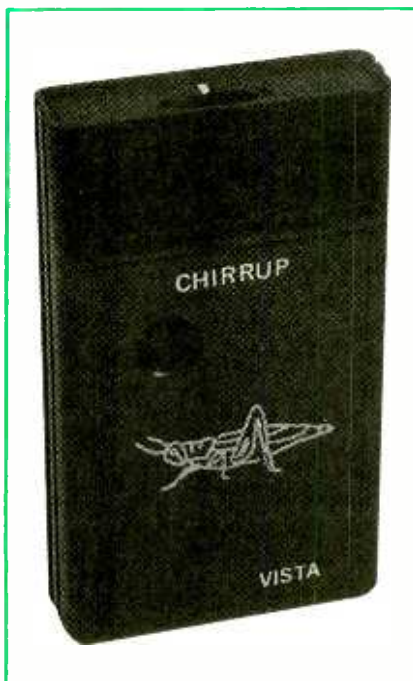

Chirrup

Let the summer song of the cricket bring you good luck and peace of mind all year long.

BY RICHARD PANOSH

that seemingly simple process, however, is anything but simple. The natural resonant frequency of a cricket wing is near 2 kHz, and is excited by the file to produce a nearly 100% amplitude modulation of the carrier, which contains about seven beats within a duration of 0.22 seconds. After producing the chirp, the wings reset in about 0.35 seconds to begin the next chirp. A complex waveform is generated due to the intermittent impulse of the file and its subsequent damping. Superimposed on that waveform is the pulse frequency dur-

ing the time the wings are reset. In addition, some distortion of the resonant frequency of the wing is produced by the appendage's complex structure.

The cricket's song is an insect version of the "siren's love call" from mythology. However, unlike the alluring female sirens, it is the male cricket that calls the wandering female to his lair with his song. In fact, the sound of the song itself is sufficient to excite the female. The female (and male) cricket hears with auditory organs that are located on the front legs just below the knee; each organ is highly directional (similar to a directional microphone). Those sound receptors are very sensitive to ultrasonic sounds and can respond to frequencies as high as 100 kHz.

Circuit Description. The schematic for the Chirrup is shown in Fig. 1. Power is supplied from a 9-volt battery, B1; current drain is a little under 2 mA, so an alkaline battery should last over 250 hours. Switch S1, the power switch, is part of potentiometer R10, which also acts as a volume control.

A duty cycle is generated by op-amp U1-a, which is configured as a pulse generator. Diode D1 establishes a fast charging rate that generates a 0.22-second period, which matches the duration of a cricket's seven-beat chirp. The discharge rate is established by R2 to generate a reset time of 0.35 seconds, which is the exact reset time of a cricket's wing.

One half of an ICM7556 CMOS timer, U2-a, is used to simulate the amplitude modulation of a chirp (do not substitute another bipolar timer IC, because it will adversely affect the timing and also increase power consumption). The pulse output of the chip is not directly used, but rather the alternate charge and discharge voltage across C2. During the charge time, diodes D2-D4 are reverse biased. The timer then operates in a conventional manner, charging C2 through R6 and R7 to 2/3 of the supply voltage.

During the discharge time, when the output goes low, the control voltage at pin 3 of U2-a is pulled down by diodes D2 through D4. Because the lower comparator threshold voltage is internally biased to 1/2 the control voltage, the lower trip point has been

PARTS LIST FOR THE CHIRRUP

SEMICONDUCTORS

U1—LM358 dual op-amp, integrated circuit
 U2—ICM7556 dual CMOS timer, integrated circuit
 Q1—2N4401 NPN transistor
 Q2—2N4403 PNP transistor
 D1—D4—1N4148 general-purpose silicon diode

RESISTORS

(All fixed resistors are 1/4-watt, 5% units.)
 R1—470,000-ohm
 R2—560,000-ohm
 R3—R5, R11, R13—100,000-ohm
 R6—8200-ohm
 R7, R14—10,000-ohm
 R8, R9—36,000-ohm
 R10—10,000-ohm audio-taper potentiometer with switch (Mouser 31TV401 or equivalent)
 R12—47,000-ohm

CAPACITORS

C1, C2, C7—1- μ F, 16-WVDC, electrolytic
 C3, C8—10- μ F, 16-WVDC, electrolytic
 C4, C5—0.01- μ F, ceramic-disc
 C6—0.1- μ F, ceramic-disc

ADDITIONAL PARTS AND MATERIALS

BZ1—Piezo element (Radio Shack 273-073 or equivalent)
 S1—SPDT switch (part of R10)
 B1—9-volt battery
 Printed-circuit materials, project enclosure, battery snap with leads, IC sockets for U1 and U2, machine screws and nuts, water-soluble flux, wire, solder, hardware, etc.

Note: The following items are available from Vista (P.O. Box 1425, Bolingbrook, IL 60440; Tel. 708-378-5534): double-sided PC board (CHIRRUP-BRD)—\$10.00; kit of all parts including prepunched case with silk screen and battery (CHIRRUP-KIT)—\$38.00; fully assembled Chirrup with battery (CHIRRUP-ASSEM)—\$48.00. Add \$5.00 shipping and handling on all orders. Illinois residents please add appropriate sales tax. Check, money order, and credit cards are accepted. For fast check verification, please provide street address (no P.O. box), telephone number, and driver's license number with state of issue.

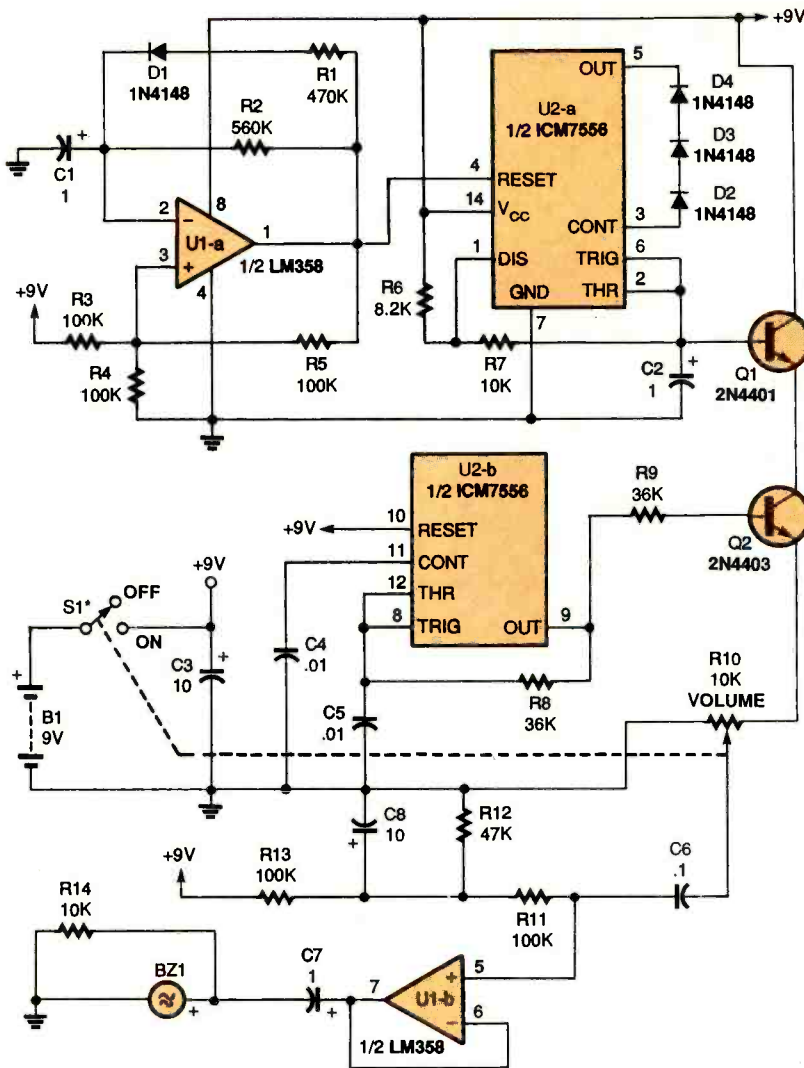

Fig. 1. This circuit matches the 0.22-second period of a cricket's seven-beat chirp, and the 0.35-second time of a cricket's wing. Potentiometer R10 is used as both a power switch (S1) and a volume control.

modified to 1/2 the voltage drop across the three diodes (about 1 volt). The longer discharge time that results is offset by resistors R6 and R7, which cause the first charge time to be very close to the subsequent timing cycles.

The lower voltage across C2 is just below the cutoff voltage of transistors Q1 and Q2, thereby ensuring that both transistors will be turned off at the very bottom of each discharge cycle. The cut-off time has been established to allow the piezoelectric element, BZ1, to ring down to zero in order to achieve 100% amplitude modulation. The resulting voltage across C2 produces the amplitude modulation envelope and is buffered by Q1.

Timer U2-b is configured as a conventional pulse generator with a symmetrical duty cycle and an output

frequency of 2 kHz. The output of U2-b is used to switch Q2 on and off, which produces a voltage across volume-control R10 that has the magnitude of the instantaneous voltage across C2 with a 2-kHz sampling rate. A portion of that voltage is applied to U1-b, which is configured as a unity-gain, non-inverting buffer that drives the piezo element, BZ1. A suitable piezo device is Radio Shack catalog no. 273-073, which has a center frequency of 500 to 2500 Hz. That piezo element comes in a Helmholtz resonator cavity that attenuates higher-frequency components of the square-wave to produce a sinewave, which more closely resembles the sound produced by a cricket.

Construction. To make the unit por-

table, the author's prototype was built on a double-sided printed-circuit

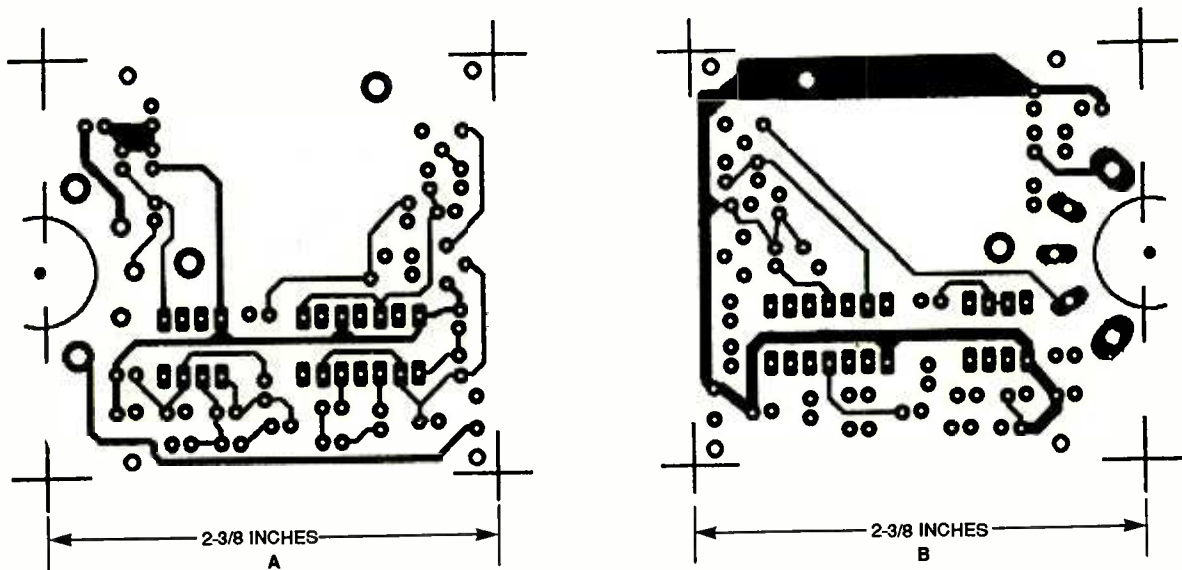

Fig. 2. The template for the solder side of the board is shown in A; the component side of the board is shown in B.

board. However, any standard project-building method can be used. If you do want to build the circuit on the PC board, you can either etch your own using the solder- and component-side foil patterns shown in Figs. 2A and 2B, respectively, or you could order the board from the source mentioned in the Parts List. Use the parts-placement diagram shown in Fig. 3 as a guide if you do use the printed-circuit board.

Mount potentiometer R10 so that its terminals are on the component side of the circuit board, with the knob shaft facing upward. Next, mount IC sockets for U1 and U2, being careful to observe the proper orientation. Working outward from the center of the board, install the resistors standing upright, followed by the capacitors. Double-check the orientation of the electrolytic capacitors. Then install the diodes and transistors, and insert the ICs.

Cut the battery-snap connector leads to a length of approximately 2½ inches, and solder them to the board. The leads should be positioned along the side of the board and routed to the battery compartment in a way that allows a little slack when installing batteries. A little silicone rubber can also be applied at the connection point to reduce the strain.

To prevent foreign material from entering the piezo element housing, clean the residual flux off the board before installing the unit. Trim the leads of element BZ1 to a 1 inch length and solder them to the appropriate

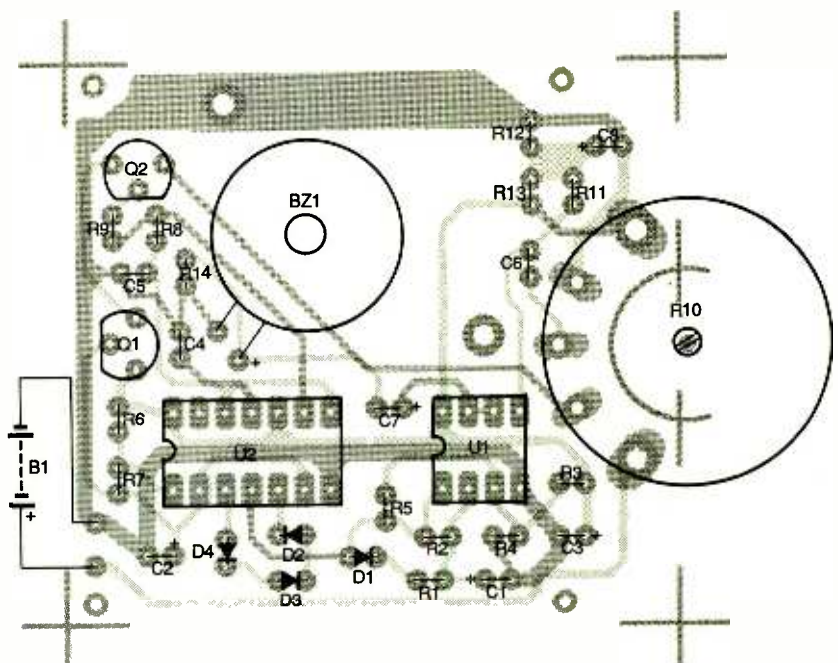

Fig. 3. When mounting components to the double-sided board, use this parts-placement diagram as a guide.

points (again, see Fig. 3). The piezo element can be glued to the board or secured with machine screws and nuts. Be careful how you mount it though, as placing the element near structures that obscure the opening can alter its audio characteristics. For best results, speaker cloth or acoustically transparent speaker foam can be used in front of BZ1 to cover a sound hole on the enclosure's surface.

The author's prototype board was placed in a Serpac M6-style case, which is available as part of a kit from the source mentioned in the Parts List.

Of course, any case that the board fits in can be used. How you mount the board depends on the case you use; for the Serpac case, four plastic mounting posts are provided (a bit of ⅛-inch-thick foam tape will keep the board firmly held between the two halves of that case).

When your Chirrup is assembled, connect a fresh 9-volt battery to the snap, and turn on the power by turning potentiometer R10 (which closes the built-in switch, S1). Then sit back and enjoy your very own "Cricket on the Hearth."

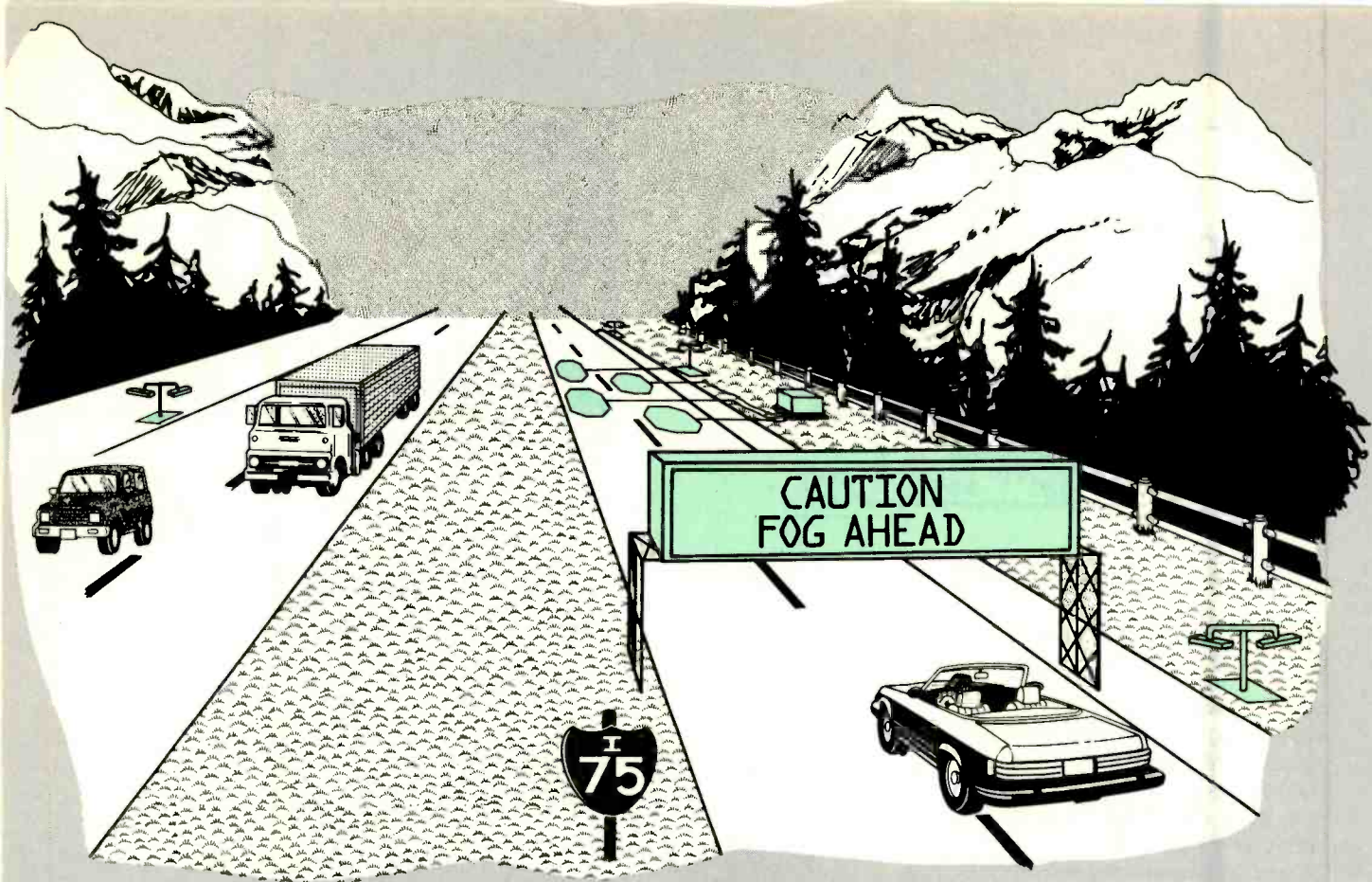

You have probably read about the 20-, 50-, or even 100-vehicle pileups that happen when cars and trucks drive into a dense fog bank and run into other vehicles that are stopped or have already collided. Perhaps you have even been cruising down a stretch of highway when you suddenly found that you could not see beyond your hood ornament because of dense fog that "appeared out of nowhere." Well, that might soon be a thing of the past if a couple of "smart" highway projects now underway in the U.S. are successful. Those projects are aimed at demonstrating electronic equipment and techniques for detecting and warning drivers of suddenly deteriorating visibility.

A Fog-Warning System. A section of I-75 south of Adel, Georgia and north of the Georgia/Florida border is an excellent example of a location where visibility could go from clear to near-zero within a few minutes. That 35-mile stretch of interstate is noted for its killer fog. In that region, dense fog develops rapidly and without

FOG DETECTION AND WARNING SYSTEMS

See how technology is working to keep us safe even under some of the most unpredictable and dangerous driving conditions.

BY BILL SIURU

warning in ponds and bogs. The fog moves from those very low-lying swampy areas to the nearby highway, suddenly reducing visibility. Sometimes the fog is so bad, the interstate has to be closed and traffic re-routed. The situation is usually worse between midnight and dawn, and is sometimes aggravated by smoke from agricultural burning.

A fully-automated fog-detection and warning system (shown in Fig. 1), being developed jointly by the Georgia Department of Transportation and the Georgia Tech Research Institute, will be installed to improve the driving safety on that heavily traveled portion of Interstate 75. The system will use a network of fog sensors, five sets of highway-embedded speed-monitoring loops (to monitor traffic speed and volume), and several other types of weather instruments. Information from those devices is sent via buried fiber-optic cable to a central computer.

When the system detects a visibility problem, it automatically notifies authorities by telephone and simultaneously posts warnings on four variable-message signs (VMS) along a 12-mile section of the highway. Two of the signs, which are 36-foot wide and 9-foot high, are installed over the traffic lanes. Two smaller signs, each measuring 16-foot wide by 9-foot high, are located on the shoulder of the road. The latter could include warnings to reduce speed or even provide detour instructions should the highway have to be closed. The signs could also be turned on manually by the Cook County Sheriff's office in Adel.

The system uses commercially available optical fog sensors. The sensors consist of an optical transmitter and receiver aligned so they are aimed slightly off a mutual line-of-sight by a small angle. When there is no fog and visibility is good, the light from the transmitter just misses the receiver. When fog is present, the water droplets scatter the light beam so that some light will reach the receiver. According to Dr. Gary Gimmetstad, the project director, "The receiver measures the amount of projected light which is scattered by fog particles. The denser the fog, the more light will be scattered and measured by the receiver." The system is intercon-

nected by single-mode fiber-optic cable that is buried along the highway. Development of the system should be complete by sometime in early 1997.

The Tennessee System. The Georgia system is not the only fog-warning system; in fact, it is not even the first. In 1993, a fog-detection system was installed farther north on Interstate 75, some 30 miles north of Chattanooga, Tennessee. Among other things, that fog-prone area includes inter-

changes with State Routes 163 and 308, and the crossing of the Hiwassee River. The system's Central Control Center (CCC) is located at the Highway Patrol offices in Tiftonia, which is located just west of Chattanooga.

In that system, two weather stations continually monitor the conditions in the fog-prone area, plus eight miles on either side of the area. Eight fog sensors, or visimeters, are used to measure the visibility range. Also 44 radar-based vehicle-flow detectors attached to breakaway poles on the

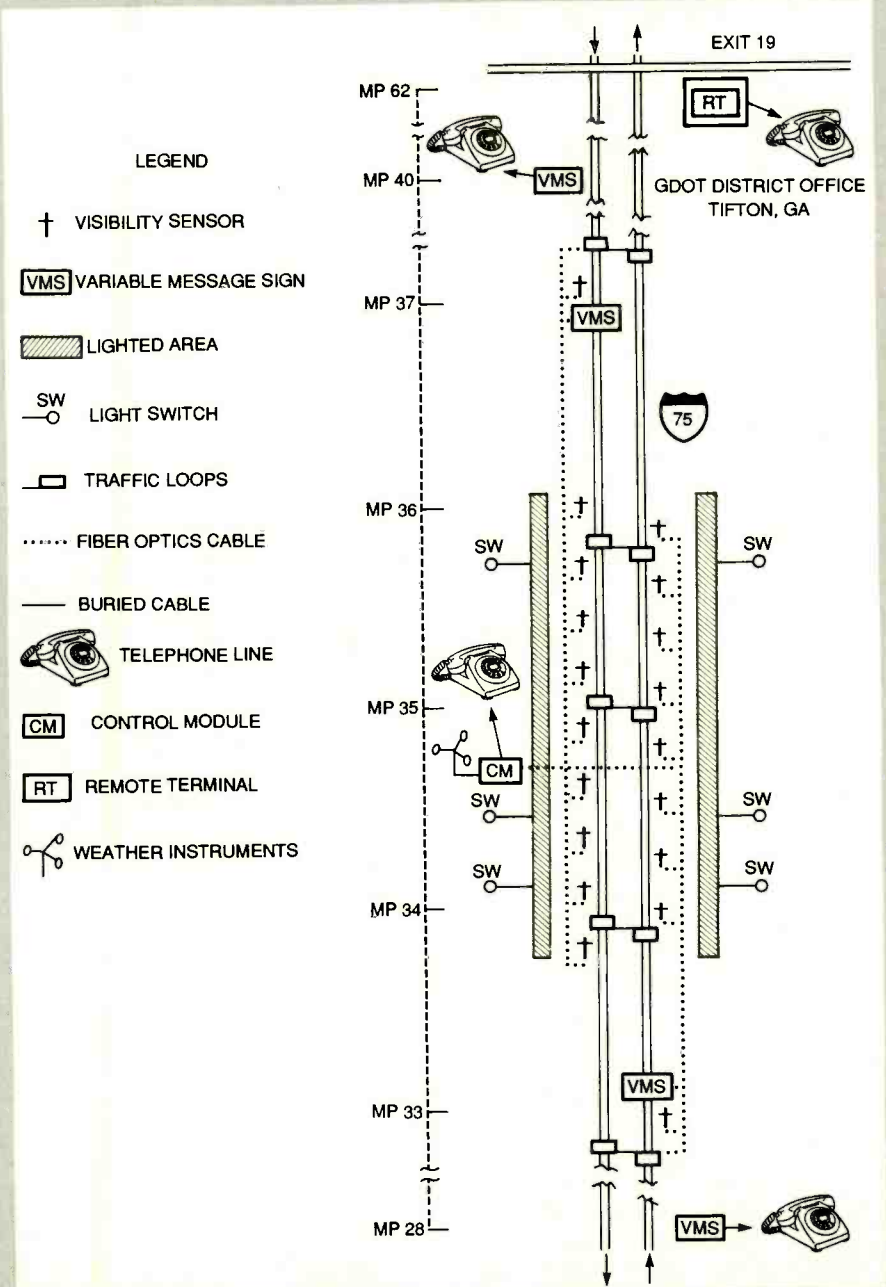

Fig. 1. The fog-warning system in Georgia will use a network of fog sensors, five sets of highway-embedded speed-monitoring loops (to monitor traffic speed and volume), and several other types of weather instruments to warn drivers of reduced visibility.

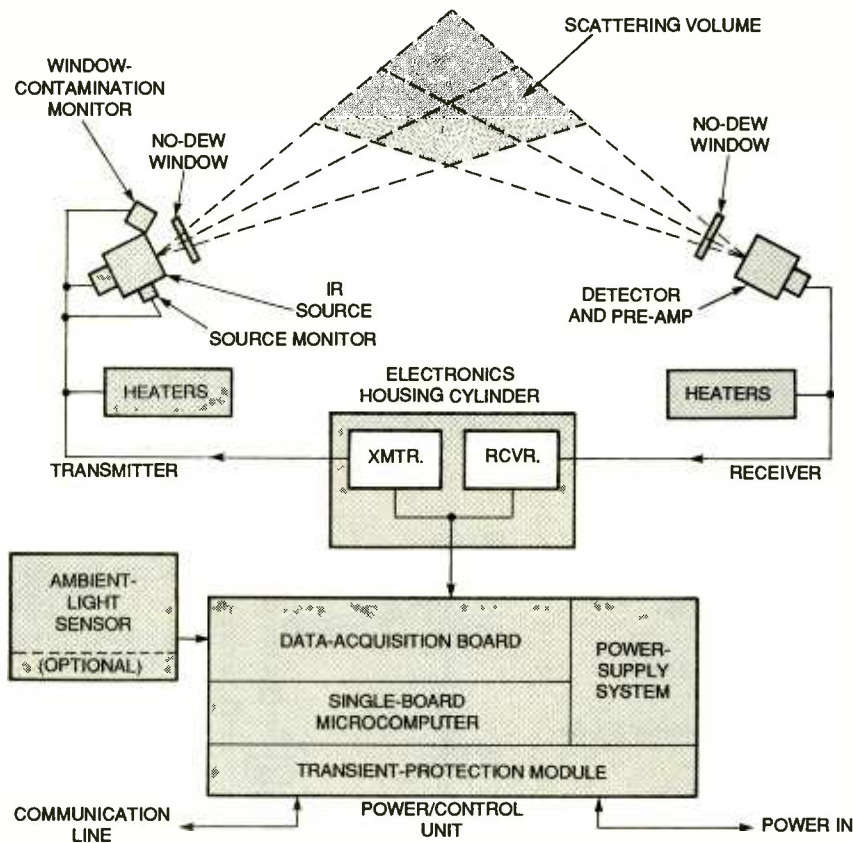

Fig. 2. Sensors of the type used in the Tennessee project are used in airports and elsewhere to keep track of visibility and other weather conditions. A block diagram of that sensor is shown here.

shoulder of the roadway are used to monitor the speed and number of vehicles passing by.

When conditions deteriorate below the pre-determined threshold levels, the Central Control Center could activate some or all of the ten variable-message signs (VMS) with predetermined messages. The signs feature three rows of 18-inch characters and are illuminated using LEDs and fiber optics. Speed limits on ten changeable speed-limit signs could be lowered as appropriate and other overhead and roadside warning signs with flashing lights could be turned on as needed.

If conditions deteriorate to the point it becomes necessary, the system will close the highway using six swing gates located on entrance ramps. Drivers could also be warned via one or more of the three highway-advisory-radio transmitters (HAR) covering that section of I-75. Officials could use the variable message signs to relay visibility-related messages to drivers.

Communications between the site control center and the system com-



Here is an HSS Visibility Sensor being calibrated prior to its installation on the highway.

For More Information

HSS, Inc.
1 Alfred Circle
Bedford, MA 01730

Georgia Tech Research Institute
Electro-Optical, Environmental, and
Materials Laboratory
Atlanta, GA 30322-0800

Special Research Office
Tennessee Dept. of Transportation
Suite 100, James K. Polk Building
Nashville, TN 37243-0350

ponents is done via buried fiber-optic cable links that are located in the I-75 right-of-way. Emergency power for the system is provided by standby propane-powered generators, and sensitive electronic equipment is supplied with a source of uninterrupted power.

The Tennessee system uses Digital Visibility Sensors supplied by HSS Inc. of Bedford, Massachusetts to measure daytime, nighttime, and twilight visual ranges. HSS visibility sensors, or combination visibility/precipitation sensors (called Present Weather Sensors), of that type are already used worldwide at airports and weather stations as well as on lighthouses, marine buoys, offshore oil rigs, and ships to monitor weather conditions.

A block diagram of a sensor is shown in Fig. 2. The sensor measures the atmospheric extinction coefficient (EXCO), a fundamental physical property of the atmosphere that determines if visibility is reduced due to the presence of fog, haze, rain, snow, drizzle, mist, and so forth.

The sensor's transmitter uses a high-powered gallium-aluminum-arsenide infrared-emitting diode (IRED) whose optical output power is monitored by a silicon photodiode. The IRED emits eye-safe, non-coherent infrared energy in an 80-nm band centered around a central wavelength of 880 nm. Light scattered by the fog, haze, etc. is detected by a silicon photodiode operating in the photovoltaic mode in the receiver.

This visibility sensor is a forward scatter meter (FSM) that measures the angular atmospheric scattering coefficient in a narrow range of angles between 30 degrees and 55 degrees. It operates on the "Loofah" principle, discovered by the British during World War II. The principle shows a constant relationship between the angular scattering and the total EXCO for all natural haze and fog conditions. The EXCO in turn is used to determine visibility range.

The two examples we've examined are not the only limited-visibility warning systems in existence or under development. In Europe, for example, "smart" highways that detect poor visibility conditions and warn drivers could be found in Holland, Germany, and Italy.

1990 was a Great Year for

Popular Electronics®

The twelve 1990 issues of *Popular Electronics* reveal many fascinating articles. There's a bonanza of build-it project plans, informative theory articles and timeless feature stories. Check out the partial list of titles packed into the 1990 issues and you'll agree that 1990 was a banner year. If you see an article about a project, theory topic or newsworthy feature, you can have that article, with the entire issue for only \$6.50. To get your 1990 issue(s) of *Popular Electronics*, place a ✓ in the box that indicates the month you want and complete the coupon below. Note that ordering six or more copies reduces the price per issue! Tear out this page, or make a photo copy of it, and mail or FAX it today! Just follow the directions below.

Popular Electronics 1990 Issues

TOPICS FROM THE PAST

Selected Projects

Audio Ambiance Ditherizer, **April**
 Bit Grabber for Parallel I/O Testing, **December**
 Car-Radio Silencer, **October**
 Cordless Test Probes, **January**
 CW and SSB, Add to a SW Receiver, **May**
 Digital Entry Switch, **November**
 Economy Portable SW Receiver, **August**
 Exhaust Monitor for Car, **June**
 Experimental AC Hum Sniffer, **September**
 Game Reaction Timer, **April**
 Headphone Output for Your CD Player, **July**
 Hot-Wire Glass Bottle Cutter, **December**
 Indoor Burglar Alarm, **December**
 IR-Trigged Sound-Effects Generator, **October**
 Lie Detector, Simple, **January**
 Microphone Preamp, Simplest, **March**
 Mobile Battery Charger, **March**
 NiCd Battery Tester, **August**
 Plasma Display, Custom, **February**
 Receiver Circuits You Can Build, **March**
 Remote-Control FAX Switch, **August**
 Serial Cable Tester, **January**
 Telephone Toll Totalizer, **August**
 Tesla's Lightning Generators, **September**
 The Lepton Candle, **October**
 Ultrasonic Morse-Code Transceivers, **July**
 Universal 3-Terminal Power Supply, **November**
 Video Titler, Super Simple, **September**
 Vision System for Robotic Toys, **March**
 VLF Receiver and Transmitter, **July**
 Water Leak Alarm, **January**

External Drive for Laptop, **June**
 First Electric Motor Project, **October**
 Ground Fault Technology, **November**
 Keeping Up with Pacemakers, **July**
 Living with Lightning, **October**
 Make Your Own Iron-on PC Patterns, **July**
 Old-time Radio Circuits, **March**
 Oliver Lodge: Radio's Forgotten Pioneer, **July**
 Restoring a Classic SW Receiver, **April**
 Solar Power, Experimenting with, **June**
 St. Elmo's Fire, **September**
 Surface Mount Technology, **November**
 Television Night, a Look Back, **July**
 Tune-in to Satellite Radio, **May**
 Using Appliances Overseas, **January**

Theory for Everyone

3-Terminal Voltage Regulators, **May**
 200,000-volt van de Graaff Generator, **October**
 All About Batteries, **August**
 All About Thermistors, **December**
 CCTV Installation Guide, **November**
 Connect Anything to Your Computer, **August**
 Designing Power-supply Circuits, **February**
 Digital Electronics Introduction, **April**
 Experiments in Electrophotography, **March**
 Fiber-Optic Communications, **April**
 Galvanometer, Build and Learn, **September**
 Lasers, All About, **September**
 Printer Technology, **October**
 Signal Generator Circuits Cookbook, **November**
 Stepping Motors Introduction, **March**
 Troubleshooting Computer Disk Drives, **May**
 Troubleshooting Your Printer, **December**
 Typing Practice Program, **August**
 Sideband Amplifiers, **January**
 Wimshurst Machine, **December**
 WW1 Long Island Spy Station, **December**

Special Features

Antenna Installation, **September**
 Capacitors, Choosing and Using, **June**
 Classic Amateur Receivers, **November**
 Drying Out Flood-Damaged Equipment, **January**
 Early Radio Transmitters, **May**

January	February	March	April	May	June	July	August	Sept.	Oct.	Nov.	Dec.
---------	----------	-------	-------	-----	------	------	--------	-------	------	------	------

✓ Check the issue(s) you want.
How to Determine Cost per Copy

Quantity	Price per copy		
	United States	Canada	Foreign
1-5	\$6.75 US	\$7.75 US	
6-12	5.75	6.75	\$8.50 US

Prices include handling and shipping costs. Prices subject to change. All Canada and foreign orders payable in U.S.A. funds only, via international money order, check drawn on a U.S. bank, or acceptable credit card (Visa, MasterCard) in U.S.A. funds. Allow 6-8 weeks delivery. Minimum foreign order—6 issues. Foreign orders may take longer. PE7

Visa MasterCard USA Bank Check US or International Money Order

Credit Card Number _____ Exp. Date ____/____
 (If used)
 Signature _____ Total No. of Copies _____
 Print Name _____ Total Amount \$ _____
 Address _____
 City _____ State _____ ZIP _____

Send orders to: CLAGGK, Inc. P.O. Box 4099, Farmingdale, NY 11735. No COD orders.
 Credit Card user may telephone or FAX order. Telephone 516-293-3751 or FAX 516-293-3115.

ANTIQUÉ RADIO

By Marc Ellis

The Tropicmaster Gets an Alignment

The April through July issues of this column were devoted to the restoration of an example of the Minerva Tropicmaster, a rugged, metal-cased broadcast/shortwave receiver that made a short-lived appearance just after the close of World War II. At the start of the series I didn't have much background on the set, guessing from its hefty construction that it might have been a military morale receiver designed just a bit too late to actually see action. Stuck with a canceled military contract,

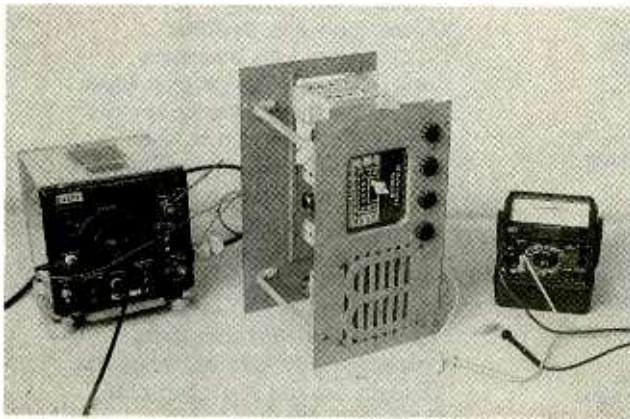

The alignment setup for the W117. A Navy-surplus "LM" acts as the signal generator; a Radio Shack FETVOM measures AVC voltage to indicate signal strength. Not visible is the all-important isolation transformer (see text).

I theorized, the manufacturers put the set on the consumer market (sans its military paint job) to help satisfy the public's pent-up postwar need for home appliances of all kinds.

Now that a few readers have responded with some information, I can tell you that my theory, though a good guess, was apparently not quite correct. But more on that after I report on the Minerva's realignment, which was the final

step of the restoration process.

After the rehabilitated set was reassembled and tested, as described in the July issue, it worked reasonably well. However, tuning on the broadcast band was unusually broad, suggesting that the IF might require some tweaking. Accordingly, I decided to go ahead and do a complete realignment on the set before putting the project to bed.

Last month, I wasn't in a position to do that work because I was busy moving into a larger home office and workshop. So instead I used the column to catch up on the backlog of reader mail. I almost didn't make it this month, either, because I was at the Dayton Hamvention promoting *The Radio Collector*, my newsletter for antique-radio enthusiasts, when I should have been working on this column.

However, thanks to an extension granted by **Popular Electronics'** sympathetic editor, I finished the work and am ready to talk about it. By the way, if you'd like to know more about *The Radio Collector*, an information sheet is yours for the asking. Write me at P.O. Box 1306, Evanston, IL 60204-1306.

SETTING UP FOR REALIGNMENT

In preparation for the realignment work, I powered the Tropicmaster through an isolation transformer and let it warm up for 20 minutes or so. Those who have been following the restoration to date know that the radio is an AC/DC

design. Without the transformer, its chassis has the potential of being "hot" to ground (depending on which way its AC plug is inserted into the outlet). The full AC-line voltage could easily short across a test probe's ground connection, or even across my body if some part of it was in contact with a damp concrete floor or other power-line ground.

Also warming up on the workbench was my trusty "LM" frequency meter. The LM is the U.S. Navy's version of the famous BC-221 meter used by the Signal Corps during World War II and for some time afterwards. In addition to its other uses, this unit is a signal generator of unusual stability and accuracy. Thanks to its built-in reference crystal, the set puts out a signal that is rarely more than a few hertz away from the indicated dial setting.

The LM or BC-221 might not have the nostalgic aura of a radio-service signal generator of the 1930's or 1940's, and it definitely isn't as convenient to use. But when you set one of those babies to a given frequency, you can be quite sure that's the frequency it's putting out. That's a lot more than you can say for most old service equipment. And remember, beauty is in the eye of the beholder!

Another necessity for the realignment process is a means of gauging the strength of the receiver's output signal. That is often an AC voltmeter (preferably a VTVM or other amplified instrument) connected across the speaker voice

coil. Using that type of indicator requires that the test signal be tone modulated so that there will be some audio for the voltmeter to measure. The LM does have a modulated mode (unlike most models of its BC-221 cousin), and the audio method is the one I tried first.

TROUBLE IN THE IF

After injecting a modulated 455-kHz (the IF frequency) signal into the Tropicmaster into the mixer grid as recommended in the service notes, I found that I couldn't get a measurable audio signal at the speaker voice coil except at very high signal levels. That was unusual and corroborated my feeling that the radio really needed to be realigned.

Rather than going with the strong signal, which was probably causing the automatic volume control to desensitize the set, I decided to change the method of measurement. Hooking up my Radio Shack FETVOM (the solid-state equivalent of a vacuum-tube voltmeter) across the set's AVC line, I was able to monitor the negative DC grid-bias voltage present there. The stronger the incoming signal, the greater the bias.

That type of hookup is a little more difficult to make, particularly if you don't have a schematic (luckily, I did). But it is a more sensitive method of indicating signal strength, and has the further advantage of not requiring a modulated test signal. Now I was getting a decent reading with just a moderately strong signal and could proceed with the alignment.

The input and output trimmers of the first IF transformer peaked nicely, providing a gratifying increase in signal strength.

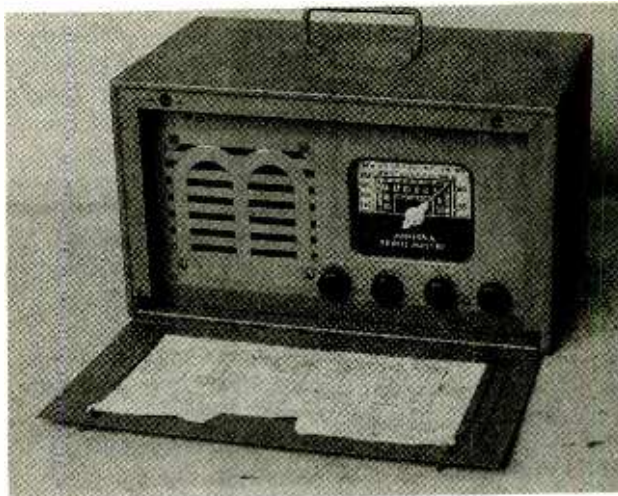

Here's the Minerva back in its cabinet and ready for the display shelf. The schematic inside the door is courtesy of reader Paul Douglas.

However, the second IF transformer was unresponsive to adjustment; no amount of "trimmer twiddling" made much of a difference in the signal. It almost seemed as if the transformer had an open winding, but I was able to rule out that possibility with some voltage and continuity tests.

Apparently both trimmers on that transformer were so mistuned that no adjustment position of a single one would result in a measurable peak. A stronger test signal would be needed to produce detectable results, so I disconnected the signal generator from the mixer grid and, instead, injected its signal directly into the grid of the IF-amplifier tube, a 6SK7. I also screwed both trimmers of the problem IF transformer all the way in so that at least they'd both be starting from equivalent settings.

Proceeding to adjust one of the trimmers through its range, I was pleased to discover a measurable (and strong) peak. Adjusting the other one, I found that the peak was now increasing to such a high value that the LM's output had to

be reduced in order to complete the adjustment. With the problem transformer now in reasonable adjustment, I reconnected the generator to the mixer grid, reduced its output to the minimum value that would give a definite indication, and fine-tuned the IF adjustment by re-peaking all four trimmers.

FINISHING THE ALIGNMENT

Apparently the second IF transformer had been worked on by one of those legendary "screwdriver mechanics." Those are the guys who play with a radio's adjustment trimmers without much idea of what they are doing—sometime attempting to screw them down tight because they appear to be loose!

Alignment of the Tropicmaster's "front end" was straightforward. As specified by the manufacturer, the signal generator was connected across the antenna and ground terminals in series with a 200-pF "dummy antenna" for broadcast-band adjustments, switching to a 400-ohm "dummy antenna" for shortwave adjustments.

The set's oscillator trim-

mers were peaked at dial (and signal generator) settings of 1600 kHz (broadcast band) and 18 MHz (short-wave band); the RF trimmers were peaked at 1400 kHz (broadcast) and 18 MHz (shortwave). An additional broadcast-band paddler needed to be peaked at 600 kHz. Those adjustments all went without a hitch—they had drifted only a little bit, over the years, from their optimum settings.

Hooked up to the antenna once more, the Minerva performed admirably. The broad tuning problem originally noticed on the broadcast band had disappeared, and the dial was alive with both broadcast and shortwave signals. It was time to put the set back in its cabinet and set it on a display shelf.

MINERVA LORE

Several times during the course of the Minerva restoration, I asked readers with any background information on the set to contact me. Because the radio was on the consumer market for only a short period of time, it isn't a really common piece. I didn't get an overwhelming response, but there were a few interesting letters.

Reader Paul Douglas (Seattle, WA) bought his W117 Tropicmaster in the summer of 1946 at the 32nd Infantry PX in Seoul, Korea. It was the successor to two previous sets he had used in the service. The first one, a tiny Silvertone he'd taken with him from home, was destroyed on a troop train. Its replacement, a Japanese set purchased in downtown Seoul, came to grief when the shaft of its tuning capacitor snapped. So it wasn't surprising that Paul was attracted by the Tropicmaster's heavy, sturdy

3 NEW BOOKS for the Project Builder

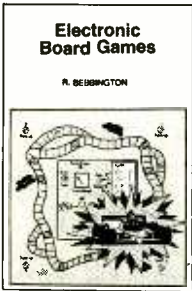

BP350—ELECTRONIC BOARD GAMES.....\$6.00

Twenty novel electronic board games that you can build from the plans in this book. Whether you are interested in motor racing, searching for buried treasure on a desert island or for gold in Fort Knox, spinning the wheel of fortune, or doing a musical quiz—there is something for you to build and enjoy!

PCP119—ELECTRONIC MUSIC AND MIDI PROJECTS.....\$14.95

Save cash by building the MIDI gadgets you need. Want a MIDI THRU box, program change pedal, Metronome, analog echo unit, MIDI patchbay or switcher? Over 16 practical and very useful music and MIDI projects—all in this book! The projects are explained in detail with full instructions on assembly.

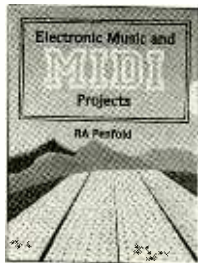

BP301—ANTENNAS FOR VHF AND UHF.....\$6.00

From installing a TV or FM antenna to setting up a multi-antenna array for shortwave listening or amateur radio, this book explains the basics of VHF and UHF antenna operation and installation. The text describes in easy-to-understand terms the essential information about how antennas works, the advantages of different antenna types, and how to get the best performance from an antenna.

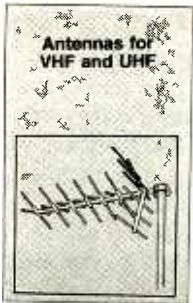

Mail to: **Electronic Technology Today, Inc.**
P.O. Box 240 • Massapequa Park, NY 11762-0240

Shipping Charges in USA & Canada

\$0.01 to \$5.00.....\$2.00	\$30.01 to \$40.00.....\$6.00
\$5.01 to \$10.00.....\$3.00	\$40.01 to \$50.00.....\$7.00
\$10.01 to \$20.00.....\$4.00	\$50.01 and above.....\$8.50
\$20.01 to \$30.00.....\$5.00	

Sorry, no orders accepted outside of USA and Canada. All payments must be in U.S. funds only.

Number of books ordered.

Total price of books.....	\$	_____
Shipping (see chart).....	\$	_____
Subtotal.....	\$	_____
Sales Tax (NYS only).....	\$	_____
Total enclosed.....	\$	_____

Name _____
 Address _____
 City _____ State _____ ZIP _____

Please allow 6-8 weeks for delivery.

ET04

construction and powerful appearance, not to mention its shortwave coverage.

Paul solved the mystery of what had been installed in the empty frame on my Minerva's inside front cover. It was indeed (as I'd guessed) the set's schematic along with a time-zone map. Paul recently discovered the original schematic inserted in the pages of "Radio for Beginners," a military training manual he'd picked up overseas, and was kind enough to send it along.

The schematic, which fits perfectly into my frame, is dated June 19, 1945. I suppose the time-zone map would have been slipped in over it, to be removed when access to the technical information was needed. It's interesting that the schematic shows a change in the push-pull output tubes from 25L6's to 50L6's. Mine are the original 25L6's—although I mistakenly reported them as 50L6's in the original article in this series (April, 1995).

Reader *Roy Reid* (Calgary, Canada) was inspired by the series to dig out a couple of Minerva sets that he'd purchased as part of a large lot. One was the W117 (which had been inventoried as a "Navy WWII metal Tropic Master") and the other was a W119, a 6-tube AC-DC radio in a conventional wood cabinet.

There are no markings on the W117 to verify that it was a Navy set, the latter identification apparently having been a guess based on the battleship-gray color.

Inside the W117's sliding door was a folded and fragile schematic which, after being photocopied and cut out, fit nicely into the frame on the front cover. It bears the same date and ID number (110-A) as the one Paul Douglas

sent me—but does not show the 25L6-to-50L6 modification. The front panel of Roy's set bears a colored "M" logo at the lower left, something my own set does not have.

I received some Tropic-master news from yet another Canadian reader—*Cyril R. Courtney* of Newfoundland. Cyril's set is complete, though rusty, and he hopes to restore it. The version he has is equipped with the 50L6 output tubes.

Finally, I was very pleased to get an interesting phone call from Julian Martin, who was my boss on the original (*Ziff-Davis Publications*) *Popular Electronics* magazine. Julian, now in charge of special projects for Gernsback Publications, is the person who brought me on board as antique-radio columnist for *Hands-on Electronics*, our predecessor magazine. (*Hands-on Electronics* was re-named **Popular Electronics** after Gernsback purchased the title from Ziff-Davis a few years ago.)

It turns out that Julian actually worked on Minerva's production line during his high school years. He tells us that the firm was located in New York City (lower Manhattan) and began producing the W117 towards the end of World War II.

According to Julian, the set was made as a military morale set and never had an o.d. paint job. It was mainly aimed at the PX market—which certainly corroborates what we learned from Paul.

That about wraps up our coverage of this radio. But if anyone else has information to share on the W117, I'd be delighted to hear from you and will discuss your letter in a future edition of this column.

5 BOOKS FOR ONLY \$4.95

WHEN YOU JOIN THE **Electronics Book Club®**

VALUES TO \$178.75

The leading source of information for electronics hobbyists for over 30 years!

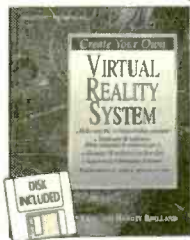

3376514-XX \$44.95
Counts as 2/Hardcover

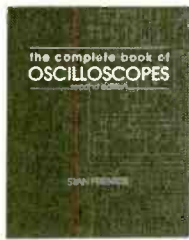

3825P \$19.95



0156778 \$44.95
Hardcover



4112H \$34.95
Hardcover

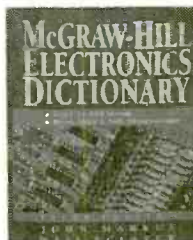

0404348-XX \$49.50
Counts as 2/Hardcover



4139P \$16.95

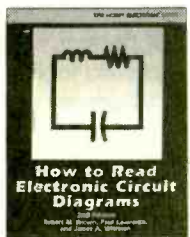

2880P \$15.95

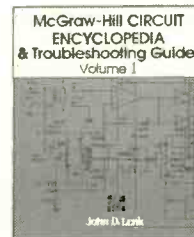
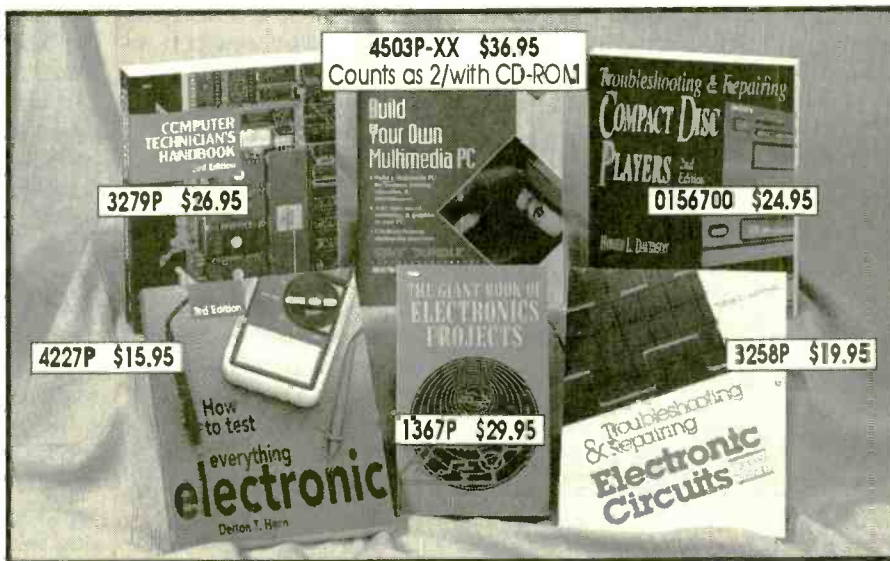

0376034-XX \$59.50
Counts as 2/Hardcover

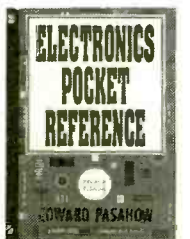

0487375 \$24.95

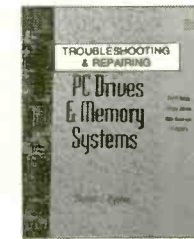

4491P \$24.95



3711P \$19.95



2613P \$19.95

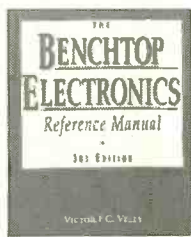

0673764-XX \$54.95
Counts as 2/Hardcover



3627P \$19.95



3795P \$19.95

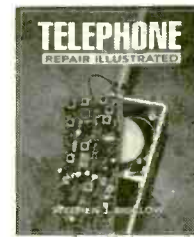

4179H \$28.95
Hardcover

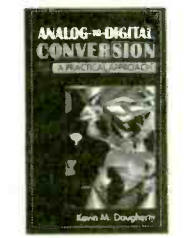

0156751-XX \$55.00
Counts as 2/Hardcover

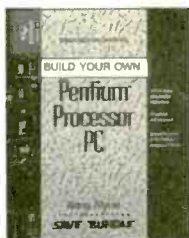

0501637 \$32.95
Hardcover

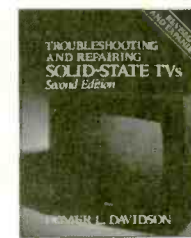

3700H \$36.95
Hardcover

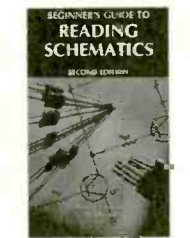

3632P \$10.95

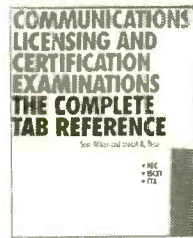

0708223-XX \$44.95
Counts as 2/Hardcover

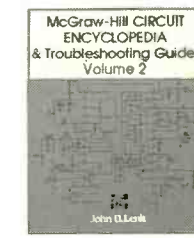

0376107-XX \$59.50
Counts as 2/Hardcover

As a member of the ELECTRONICS BOOK CLUB . . . you'll enjoy receiving Club bulletins every 3-4 weeks containing exciting offers on the latest books in the field at savings of up to 50% off the regular publishers' prices. If you want the Main Selection, do nothing and it will be shipped automatically. If you want another book, or no book at all, simply return the reply form to us by the date specified. You'll have at least 10 days to decide. If you ever receive a book you don't want due to late delivery of the bulletin, you can return it at our expense. Your only obligation is to purchase 3 more books during the next 12 months, after which you may cancel your membership at any time. And you'll be eligible for FREE BOOKS through our Bonus Book Program.

A shipping/handling charge and sales tax will be added to all orders. All books are softcover unless otherwise noted. If you select a book that counts as 2 choices, write the book number in one box and XX in the next. (Publishers' Prices Shown) ©1995 EBC PE995

If card is missing, write to: Electronics Book Club, A Division of McGraw-Hill, Inc., P.O. Box 549, Blacklick, OH 43004-9918

COMPUTER BITS

By Jeff Holtzman

Disk and File Utilities

Disk and file utilities are easy to come by; good disk and file utilities are not. This month, I would like to share some thoughts on what makes good ones—and bad ones. Maybe by pointing out the good and bad points of several offerings, we can arrive at the specs for how a good one would work. Then, perhaps some enterprising programmer will go off and make one!



Even in the era of the GUI, power users and technical users still prefer command-line operations. Symantec's Norton Commander is a command-line powerhouse. Versions for DOS and OS/2 are still available.

THE IDEAL UTILITY

Before we look at some real-world utilities, perhaps we should start with my views on what makes an ideal utility. The first question is Windows or DOS? Sometimes it's easier to do things in Windows, sometimes in DOS. However, DOS utilities are easily transportable in a way that Windows utilities tend not to be. With that in mind, I'd like to see carbon-copy versions of the same program for both environments. Unless specified otherwise, the remaining remarks apply to programs for both environments.

The program should be lightweight (no more than 150K), and should depend

on no overlays or DLLs. The only exception would be a program written in Visual Basic, which would be allowed use (only!) of VBRUN300.DLL.

The program should at all times allow two panels to be viewed on-screen. At any time, either panel could contain a collapsible tree-structured view of a disk drive, a listing of files in the current directory in either long or short formats, with a multitude of sorting options, or a view of the file currently highlighted in the opposite window. There should be a simple mechanism for rotating a panel through the various display options, a simple method for zooming a panel to full-screen view, and a simple method for disabling display of either panel or both.

In the file-list display, the user should be able to tag, retag, and untag groups of files manually, by file spec, by modification status, and by time and date, and subsequently perform copy, delete, zip, etc. operations on all tagged files.

Built-in file-viewing formats should include all versions of Paradox, dBase, and Microsoft Access; Excel and 1-2-3; ASCII, CSV, Hex, Word, and WordPerfect; optionally BMP, ICO, PCX, GIF and JPG. To conserve space, formatting of text and spreadsheet files need not be displayed. All viewers should be read-only, except the ASCII and hex viewers, which should allow files to be edited. The program should make a best guess as to file format, but provide a simple means for

the user to specify view format. Also, the program should never hang on what it might consider an invalid format.

The program should contain hooks to allow external viewers to be integrated. Built-in viewers could be updated through a defined mechanism, and relinked to the "kernel" application. Thus users could build tools that have just the viewers they need, and third-party vendors could supply enhanced and updated viewers as file formats evolve. Extensive addition of third-party viewers (and possibly other extensions) might force file size beyond the desired maximum, but that's up to the user.

The application's navigation keys should be fully customizable. In addition, the program should provide several key sets that follow *de-facto* standards; it should provide both function-key and Ctrl- or Alt-key sequences for initiating commands.

If space allows, the following might be useful additions: A file-synchronization utility that will make the directories displayed in the two panels identical. A LapLink-like capability for transferring files by serial or parallel port. Built-in support for PkZip files, including the ability to operate on archives in the same way as disk drives (i.e., copy, move, display, delete components of an archive). Fast ASCII-text-file searching and indexing should be provided. And last but not least, there should be a macro facility.

(Continued on page 79)

CIRCUIT CIRCUS

By Charles D. Rakes

Handy Hobbyist Circuits

This visit, we're going to stir the pot and pull out a number of simple circuits that you can use in either a present or future project. We hope that at least one of them will fulfill a need you might have at some time.

SOLDERING-IRON STANDBY

With the increasing complexity of today's projects, a hobbyist might find that his or her soldering iron has to stay on for a long time. That's not too good for most units. For that reason, our first circuit (see Fig. 1) is a soldering-iron standby that can help you lengthen the life of your iron's element and tip by keeping it constantly ready, but not really "burning."

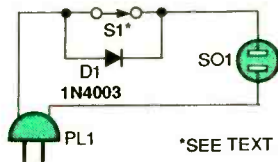

Fig. 1. Extend the life of your soldering iron with this standby circuit.

The two-terminal AC plug, PL1, should be plugged into a standard 117-volt AC outlet. Then, the soldering iron can be plugged into SO1. Switch S1, the small, leaf-operated, snap-action unit, has to be placed on the soldering-iron stand and positioned so that the iron's handle, when placed in the holder, could operate the switch. The normally closed contacts of the switch are open when the soldering iron is in the holder, allowing current to flow through D1, the 1N4003 diode, to

PARTS LIST FOR THE SOLDERING-IRON STANDBY (Fig. 1)

D1—1N4003 1-amp silicon diode
PL1—AC plug, two-terminal
SO1—AC socket, two-terminal
S1—Lever switch, snap-action
Power cord, wire, solder, etc.

the iron's element. That keeps the iron warm and ready. When the iron is removed from the holder, S1 closes, applying full power to the iron.

LAMP-LIFE EXTENDER

Our next entry (see Fig. 2) contains a 7805 5-volt regulator in an incandescent-lamp life-extender circuit. The cold resistance of an incandescent lamp is normally very low compared to its operating resistance. Each time such a lamp is turned on, the initial current is several times greater than its rated operating current. That continual shock shortens the lamp's life.

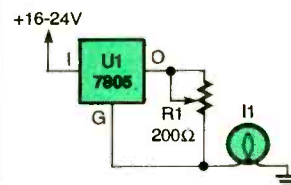

Fig. 2. This lamp-life extender should keep your incandescent lamps from burning out too quickly.

PARTS LIST FOR THE LAMP-LIFE EXTENDER (Fig. 2)

U1—7805 5-volt regulator, integrated circuit
R1—200-ohm, 2-watt potentiometer
I1—Incandescent lamp (see text)
Wire, solder, etc.

The life-extender circuit will work with any incandescent lamp that operates at

a voltage of 1½ to 12 volts and a current of 1 amp or less. Look up the lamp's normal operating current and, using an ammeter, set R1 so that the normal operating current flows to the lamp. Now, each time the lamp is switched on, the initial current will be limited to its pre-set value. That electronic tranquilizer effect should add many hours to the lamp's life.

TOUCH CONTROL

Our next circuit (see Fig. 3) places a high-input-impedance power hexFET, Q1, at the heart of the touch-turn-on lamp circuit. Each time the touch contacts are bridged, lamp I1 turns on. To make the circuit easy to use, make sure to place the touch-contact points close together.

The lamp used for I1 can be any 12-volt unit with an operating current of 1 amp or less. However, you don't need to use a lamp as the load of the circuit. Anything

from an alarm sounder to an optocoupler can be substituted.

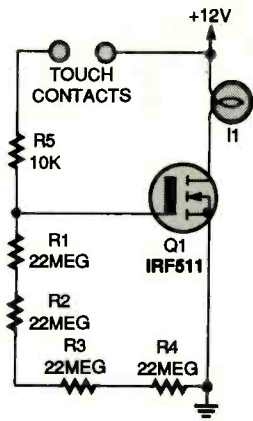

Fig. 3. Build this circuit and control things with a mere touch.

TAMPER ALARM

Here's a neat little tamper-alarm circuit (see Fig. 4). The silicon-controlled rectifier, SCR1, operates as a memory device to indicate a security breach in a room, desk drawer, safe, etc.

Switch S1 can be a mechanical or magnetic

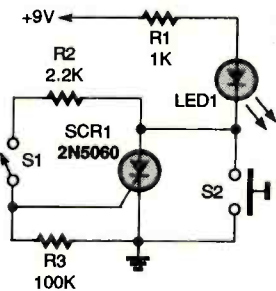

Fig. 4. Need some security? Why not protect an area from snoops with this tamper alarm.

switch. Position S1 in an object that you want to keep protected, making sure the switch will close when the object is tampered with. When S1 closes, SCR1 turns on, lighting LED1. Pressing S2 resets the circuit.

The trick is in installing the tamper circuit so that it will not be easily seen by an intruder. Because the best way to hide something is to place it in plain view, you might want to replace the indicator LED with an IR LED.

PARTS LIST FOR THE TOUCH CONTROL (Fig. 3)

- Q1—IRF511 hexFET transistor
- R1—R4—22-megohm, ¼-watt, 5% resistor
- R5—10,000-ohm, ¼-watt, 5% resistor
- I1—Lamp, 12-volt (see text)
- Touch contacts made of copper or brass, wire, solder, etc.

PARTS LIST FOR THE TAMPER ALARM (Fig. 4)

RESISTORS

(All resistors are ¼-watt, 5% units.)

- R1—1000-ohm
- R2—2200-ohm
- R3—100,000-ohm

ADDITIONAL PARTS AND MATERIALS

- SCR1—2N5060 silicon-controlled rectifier, 0.8-amp, 30-volt
- LED1—Light-emitting diode, any color or IR (see text)
- S1—SPST switch, normally open
- S2—Pushbutton switch, normally open
- Wire, solder, etc.

That way, the IR LED's status can be checked with an IR test card or a simple IR-detector circuit.

TWO-VOLT REFERENCE

Zener diodes that operate below the 3- or 4-volt level do not perform as well as higher-voltage Zeners, and are not normally used for low-voltage references.

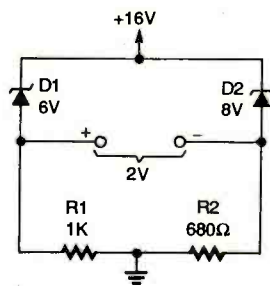

Fig. 5. This two-Zener, two-volt reference is much more stable than a circuit using only one Zener diode.

PARTS LIST FOR THE TWO-VOLT REFERENCE (Fig. 5)

- D1—Zener diode, 6-volt
- D2—Zener diode, 8-volt
- R1—1000-ohm, ¼-watt, 5% resistor
- R2—680-ohm, ¼-watt, 5% resistor
- Wire, solder, etc.

due to temperature variations are almost completely canceled out with the two-Zener circuit, making it a more accurate reference source than one with a single Zener. Other low-reference-voltage sources can be created by substituting different-valued Zeners for D1 and D2.

SHORT DETECTOR

Our next item (see Fig. 6) is a five-input short detector circuit. It can be used to check out long runs of a two- to five-wire cable for shorts between any of the wires.

An LM741 op-amp IC, U1, is connected in a comparator circuit. The inverting input (pin 2) of U1 is connected to a +9-volt source and a series of 6 resistors, while the noninverting input (pin 3) of the op-amp is connected to an adjustable voltage-divider circuit.

To use the circuit, potentiometer R10 should be used

The 2-volt reference shown in Fig. 5 uses two higher-voltage Zeners, D1 and D2, to obtain a stable, operating reference voltage. Any possible voltage changes

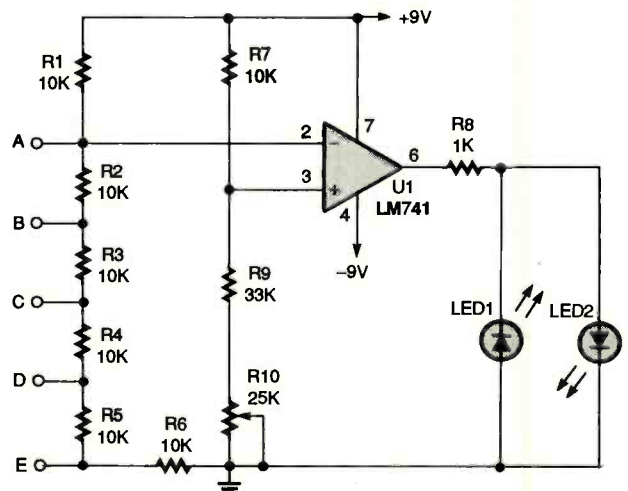

Fig. 6. Attaching a long, multiconductor cable to this circuit will let you know if the conductors short out somewhere along the line.

to set the voltage at pin 3 to a slightly more negative voltage than that at pin 2; you'll know when that is done, as U1's output will swing low, lighting LED1. Make that adjustment slowly until LED1 just barely turns

PARTS LIST FOR THE SHORT DETECTOR (Fig. 6)

RESISTORS

(All fixed resistors are 1/4-watt, 5% units.)

R1-R7—10,000-ohm

R8—1000-ohm

R9—33,000-ohm

R10—25,000-ohm potentiometer

ADDITIONAL PARTS AND MATERIALS

U1—LM741 op-amp, integrated circuit

LED1, LED2—Light-emitting diode, any color

Wire, solder, etc.

PARTS LIST FOR THE IMPEDANCE CONVERTER (Fig. 7)

SEMICONDUCTORS

U1—LM741 op-amp, integrated circuit

Q1—2N3904 NPN transistor

Q2—2N3906 PNP transistor

ADDITIONAL PARTS AND MATERIALS

R1—680-ohm, 1/4-watt, 5% resistor

Wire, solder, etc.

on. Then connect one end of a cable to points A-E. When any of resistors R2-R6 are shorted out, the voltage at pin 2 will go negative in respect to pin 3. That will make the op-amp's output go positive, which will light LED2, indicating a short in the cable.

IMPEDANCE CONVERTER

Our last circuit (see Fig. 7) is a high-input-impedance to low-output-impedance converter circuit with unity voltage gain. In the circuit, an LM741 op-amp, U1, is connected in a voltage-follower circuit that drives a complementary, transistor-emitter-follower circuit. The output of the circuit can be used to drive low-current lamps, relays, speakers, etc.

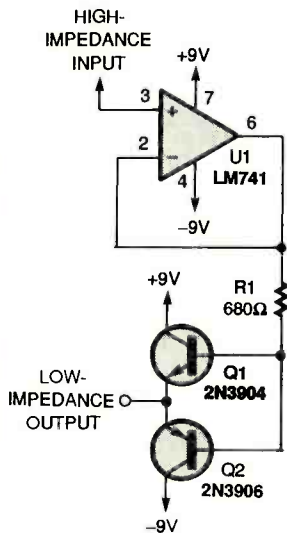
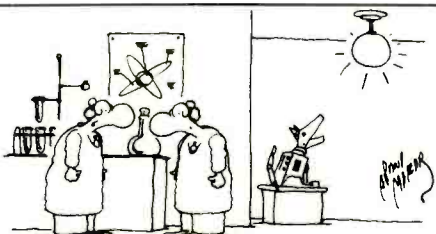

Fig. 7. Convert a high input impedance to a low output one with this simple circuit.

Well, fellow circuiters, that about does it for this gathering. See you here again next month. ■



"How long has he been howling at the hall light?"

From Not-Working to Networking!

Troubleshooting Local-Area Networks!

Now, complete for the first time in one detailed booklet!

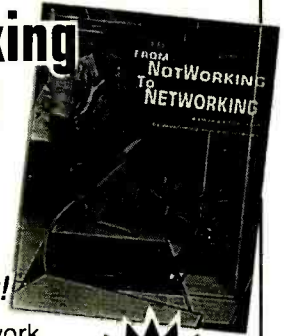

ONLY \$5.00

Gain a fuller knowledge of network fundamentals and how they developed from the early days of main frames, from XNS to Ethernet technology, the OSI stack for interconnecting different computers, basic and specialized test instruments, etc. Several tough LAN case histories brings you from theory to the practical side of troubleshooting.

CLAGGK Inc., Reprint Bookstore
P.O. Box 4099, Farmingdale, NY 11735

Please rush my copy of "From Not-Working to Networking." I enclosed payment of \$5.50 which includes shipping charges.

Name _____

Address _____

City _____

State _____

ZIP _____

Sorry, no orders accepted outside of United States and Canada. All Payments must be in U.S. funds. Send check or money order payable to CLAGGK Inc.—do not send cash or stamps. New York State residents add applicable sales tax. Allow 6 to 8 weeks for delivery. RBS02

Coil Design and Construction Manual

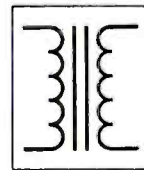

YOU CAN WIND YOUR OWN COILS?

There's no trick to it except knowing what you are doing. In a unique, 106-page book you can become expert in winding RF, IF, audio and power coils, chokes and transformers. Practically every type of coil is discussed and necessary calculations are given

with the mathematical data simplified for use by anyone. Get your copy today!

Mail coupon to:

Electronics Technology Today, Inc.

P.O. Box 240 • Massapequa Park, NY 11762-0240

Please send me my copy of *Coil Design and Construction Manual* (BP160). I enclose a check or money order for \$8.45 to cover the book's cost and shipping-and-handling expenses. NY state residents must add local sales tax.

Name _____

Address _____

City _____

State _____

ZIP _____

All orders must be paid in U.S. funds only. Sorry, no orders accepted outside of USA and Canada. Please allow 6-8 weeks for delivery.

ELECTRONICS MARKET PLACE

ANTIQUE RADIO CLASSIFIED Free Sample!

Antique Radio's
Largest Circulation Monthly.
Articles, Ads & Classifieds.
6-Month Trial: \$17.95. 1-Yr: \$34.95 (\$51.95-1st Class).
A.R.C., P.O. Box 802-L14, Carlisle, MA 01741
Phone: (508) 371-0512 VISA/MC Fax: (508) 371-7129

BEST BY MAIL

Rates: Write National, Box 5, Sarasota, FL 34230

COMPUTERS & SOFTWARE

DOES BUYING A computer have you baffled?? Get "Buying A Computer Made Easy!" Proven system guaranteed! Send \$8.00 today! PC Prescriptions, Ste. 134-(PE), 18 Concordia Center, Cranbury, NJ 08512.

FREE DISK CATALOG!! Inexpensive, Quality IBM Shareware. (ASP) MOM 'N' POP'S SOFTWARE, PO Box 15003-E, Springhill, FL 34609-0111. 1-904-688-9108.

EDUCATION & INSTRUCTION

HIGH SCHOOL DIPLOMA At Home, Accredited, Fast, "Failure-Proof" 1-800-470-4723, American Academy, 12651 S. Dixie Highway, Miami, FL 33156.

MONEYMAKING OPPORTUNITIES

MAKE GOOD MONEY working at home. Opportunities include clerical, electronic board assembly, sewing, and more. For info. send long SASE and \$1.00 to: Homeworkers, PO Box 66235, Roseville, MI 48066.

MEXICO TRADE DIRECTORY \$15.00 Postpaid. Box 661, Dallas, GA 30132.

ASTONISHING FORTUNES — TAX-forfeited land!! Complete guide \$12.00: SOUTHEX, PO Box 5918, Brandon, MS 39047-5918.

Be a PC repair expert!

Home study. Learn PC repairs, troubleshooting, installation, upgrading, servicing. For free career literature, call now: 800-223-4542.

Name _____ Age _____

Address _____

City _____ State _____ Zip _____

The School of PC Repair, Dept. JJK341, PCDI
6065 Roswell Road, Atlanta, Georgia 30328



EDUCATION/INSTRUCTION

BECOME an electrician. Approved home study. Free career literature. P.C.D.I., Atlanta, Georgia. 1 (800) 362-7070 Dept. TEK341.

LEARN PC assembly language. Disk \$5.00, book \$18.00. ZIPFAST, Box 12238, Lexington, KY 40581-2238.

BUSINESS OPPORTUNITIES

EASY work! Excellent pay! Assemble products at home. Call toll free 1 (800) 467-5566 ext. 5730.

START your own technical venture! Don Lancaster's newly updated **Incredible Secret Money Machine II** tells how. We now have autographed copies of the Guru's underground classic for \$18.50. SYNERGETICS PRESS, Box 809-C, Thatcher, AZ 85552. (520) 428-4073. Visa/MC.

Learn VCR repair!

Home study. Learn high-profit repairs without investing in high tech instruments. Free career literature: 800-223-4542.

Name _____ Age _____

Address _____

City _____ State _____ Zip _____

The School of VCR Repair, Dept. VRK 341
PCDI, 6065 Roswell Rd., Atlanta, GA 30328



FOR SALE

CABLE test chips. Jerrold, Tocom, S.A., Zenith. Puts cable boxes into full service mode! \$29.95 to \$59.95. 1 (800) 452-7090, (310) 922-0841.

THE Case Against Patents. Thoroughly tested and proven alternatives that work in the real world. \$28.50. SYNERGETICS PRESS, Box 809-C, Thatcher, AZ 85552. (520) 428-4073. Visa/MC.

T.V. notch filters, free brochure. MICROTHINC, Box 63/6025, Margate, FL 33063. (305) 752-9202.

SECRET cable descramblers! Build your own descrambler for less than \$12.00 in seven easy steps! Radio Shack parts list and free descrambling methods that cost nothing to try, included. Send \$10.00 to: INFORMATION FACTORY, PO Box 666, Seabrook, TX 77586. For COD's (713) 922-3512 any time!

300 Experimenters Circuits — Complete in 6 practical books using diodes, relays, FET's, LED's, IC 555's, and IC CA3130's for building blocks. Only \$33.00 plus \$6.00 for shipping. USA and Canada only. US funds. ETT, INC., PO Box 240, Massapequa Park, NY 11762-0240.

CABLE descramblers. Bargain headquarters, below wholesale prices. Absolutely the lowest prices! Money-back guarantee. Nobody beats us! RP ELECTRONICS, 1 (800) 304-3604.

CABLE TV equipment & accessories. Wholesalers welcome! 30 day moneyback guarantee! Free catalog! PERFORMANCE ELECTRONICS, INC., 1 (800) 815-1512.

RESISTORS \$1.00 a dozen. Catalog \$1.00, foreign add \$1.00. ZIPFAST, Box 12238, Lexington, KY 40581-2238.

ELECTRONIC sales, installation of Intruder ID security systems for home, apartment, or business, call (812) 295-4240.

UNIVERSAL descrambler. No cable box required. Works on most systems through your VCR. Also carry test chips, filters, etc. Call for prices. J.V. ELECTRONICS, (716) 342-7629 or 1 (800) 604-8777 orders only!

Printed circuit boards - etched, drilled, tin plated. Single sided \$1.25/sq. inch. CHELCO ELECTRONICS, 61 Water Street, Mayville, NY 14757. 1 (800) 388-8521. Fax (716) 753-3220.

CABLE Descrambler and test turn-on kits available for most makes and models. No catalog, no 800 number equals your lowest prices. Call others, then compare our prices! We pay cash for unwanted cable boxes. No Florida sales. (305) 425-0751.

INVENTIONS

FREE invention package: DAVISON & ASSOCIATES offers customized development, patenting, and licensing for new products and ideas. Proven results: 1 (800) 677-6382.

BUY BONDS

MASTERCARD AND VISA are now accepted for payment of your advertising. Simply complete the Classified Ad order form and we will bill you.

Dear Classified Advertiser:

Effective with the January 1996, issue the Electronics Market Place will be merged with the Market Center Classified. To order new advertising use the form in the Market Center Classified section. For information contact our New York Advertising Department.

Sincerely,

Larry Steckler, EHF, CET
Publisher, Editor-in-Chief

LS/ce

PLANS & KITS

60 Solderless Breadboard Projects in two easy-to-read pocket books. Complete with circuit descriptions, schematics, parts layouts, component listings, etc. Both books (BP107 & BP113) only \$11.99 plus \$4.00 for shipping. USA and Canada only. US funds. **ETT, INC.**, PO Box 240, Massapequa Park, NY 11762-0240.

SURVEILLANCE/countersurveillance, bugging/phone tapping detector, telephone/fax encryption, vehicle tracking, covert video, transmitter kit, and more... **A.B. ELECTRONICS**, 1 (800) U-ANTI-BUG.

CRYSTAL set Handbook — Visit antiquity by building the radios your grandfather built. Assemble a "Quaker Oats" rig, wind coils that work and make it look like the 1920s! Only \$10.95 plus \$4.00 for shipping and handling. **CLAGGK INC.**, PO Box 4099, Farmingdale, NY 11735. US funds only! USA and Canada — no foreign orders.

FIBER optics experimenters parts, supplies and tools: Fiber, cable, connectors, splices, detectors, lasers, kits, plans, newsletter. Send \$2.00 for catalog. **LIGHTLINE ENGINEERING**, PO Box 24, Mullica Hill, NJ 08062.

ANARCHY Online: Controversial and unusual information on line. Hackers/crackers/phreaks welcome. Teinet: anarchy-online.com Modem: (214) 289-8328.

LASER light show. For home and car, visual audio outputs. Plans \$5.00, P.O. Box 1412, Alta Loma, CA 91701.

ELECTRONIC GAMES

BP69—A number of interesting electronic game projects using IC's are presented. Includes 19 different projects ranging from a simple coin flipper, to a competitive reaction game, to electronic roulette, a combination lock game, a game timer and more. To order BP69 send \$8.00 (includes s&h) in the US and Canada to **Electronic Technology Today Inc.**, P.O. Box 240, Massapequa Park, NY 11762-0240. US funds only. Use US bank check or International Money Order. Allow 6-8 weeks for delivery. MA07



Earthquakes seem to move everyone closer together.

Earthquakes. Floods. Hurricanes. Fires. Wherever tragedy strikes, The Salvation Army is among the first to arrive. Offering hope to those in need. Please give, so when we're needed we'll be ready to move.

THE SALVATION ARMY
Changing the World One Life at a Time.



Popular Electronics®

REPRINT BOOKSTORE

- | | |
|---|---|
| <input type="checkbox"/> 225 Popular Electronics (1995 back issues) \$5.00
Write in issues desired _____ | <input type="checkbox"/> 211 Radio-Electronics (1991 back issues) \$5.00
Write in issues desired _____ |
| <input type="checkbox"/> 224 Popular Electronics (1994 back issues) \$5.00
Write in issues desired _____ | <input type="checkbox"/> 210 Radio-Electronics (1990 back issues) \$5.00
Write in issues desired _____ |
| <input type="checkbox"/> 223 Popular Electronics (1993 back issues) \$5.00
Write in issues desired _____ | |
| <input type="checkbox"/> 222 Popular Electronics (1992 back issues) \$5.00
Write in issues desired _____ | |
| <input type="checkbox"/> 221 Popular Electronics (1991 back issues, Jan., Mar. not available) \$5.00
Write in issues desired _____ | |
| <input type="checkbox"/> 220 Popular Electronics (1990 back issues) \$5.00
Write in issues desired _____ | |
| <input type="checkbox"/> EH94S Experimenters Handbook Summer Edition (1994) \$5.00 | |
| <input type="checkbox"/> EH94W Experimenters Handbook Winter Edition (1994) \$5.00 | |
| <input type="checkbox"/> EH94 Experimenters Handbook (1994) \$5.00 | |
| <input type="checkbox"/> EH93 Experimenters Handbook (1993) \$5.00 | |
| <input type="checkbox"/> EH92 Experimenters Handbook (1992) \$5.00 | |
| <input type="checkbox"/> EH90 Experimenters Handbook (1990) \$5.00 | |
| <input type="checkbox"/> HH94S Hobbyist Handbook Spring Edition (1994) \$5.00 | |
| <input type="checkbox"/> HH94F Hobbyist Handbook Fall Edition (1994) \$5.00 | |
| <input type="checkbox"/> HH93 Hobbyist Handbook (1993) \$5.00 | |
| <input type="checkbox"/> HH92 Hobbyist Handbook (1992) \$5.00 | |
| <input type="checkbox"/> HH91 Hobbyist Handbook (1991) \$5.00 | |
| <input type="checkbox"/> HH90 Hobbyist Handbook (1990) \$5.00 | |
| <input type="checkbox"/> GIZ Gizmo—The Consumers Guide to Electronics \$5.00 | |
| <input type="checkbox"/> Radiocraft 1993 Projects for Hobbyists \$5.00 | |
| <input type="checkbox"/> 215 Electronics Now (1995 back issues) \$5.00
Write in issues desired _____ | |
| <input type="checkbox"/> 214 Electronics Now (1994 back issues) \$5.00
Write in issues desired _____ | |
| <input type="checkbox"/> 213 Radio-Electronics/Electronics Now (1993 back issues) \$5.00
Write in issues desired _____ | |
| <input type="checkbox"/> 212 Radio-Electronics (1992 back issues) \$5.00 | |
| <input type="checkbox"/> 174 Electronics Comics (The Best of) \$2.00 | |
| <input type="checkbox"/> 173 From Not-Working to Networking Troubleshooting Local-Area Networks \$5.00 | |
| <input type="checkbox"/> 172 33 Bench-Tested Circuits \$2.00 | |
| <input type="checkbox"/> 171 36 Time Tested Circuits \$2.00 | |
| <input type="checkbox"/> 170 High-Voltage Projects for Fun and Science Book 1 \$4.00 | |
| <input type="checkbox"/> 170A High-Voltage Projects for Fun and Science Book 2 \$4.00 | |
| <input type="checkbox"/> 169 Think Tank (133 Circuits) \$3.50 | |
| <input type="checkbox"/> 169A Think Tank Vol. 2 \$3.00 | |
| <input type="checkbox"/> 168 Fact Cards (#34-66) \$3.00 | |
| <input type="checkbox"/> 168C Fact Cards (#67-99) \$3.00 | |
| <input type="checkbox"/> 168D Fact Cards (#100-132) \$3.00 | |
| <input type="checkbox"/> 167 Designing With IC's \$4.00 | |
| <input type="checkbox"/> 166 Collected Works of Mohammed Ulyses Fips(62 pages, April Fools Collection) \$5.00 | |
| <input type="checkbox"/> 165 How to Repair CD Disc Players \$5.00 | |
| <input type="checkbox"/> 164 Modern Electrics (April 1908) \$3.00 | |
| <input type="checkbox"/> 163 Receiving Satellite TV \$5.00 | |
| <input type="checkbox"/> 162 Build Your Own Satellite TV Receiver \$5.00 | |
| <input type="checkbox"/> 161 Descrambling (Feb. 1984) \$4.00 | |
| <input type="checkbox"/> 160 New Ideas - 42 Circuits \$3.50 | |
| <input type="checkbox"/> 159 Low Frequency Receiving Techniques Building and using VLF Antennas \$5.00 | |
| <input type="checkbox"/> 158 Electro Importing Co. Catalog (Circa 1918) \$5.95 | |
| <input type="checkbox"/> 157 All About Kits \$2.00 | |
| <input type="checkbox"/> 156 How To Make PC Boards \$2.00 | |
| <input type="checkbox"/> 154 How To Repair VCR's \$3.50 | |

REPRINTS REPRINTS

To order any of the items indicated above, check off the ones you want. Complete the order form below, include your payment, check or money order (DO NOT SEND CASH), payable to and mail to **Claggk Inc.**, Reprint Department, P.O. Box 4099, Farmingdale, NY 11735.

Please allow 4-6 weeks for delivery. No COD's! To place a credit card order by phone, Visa or Mastercard only.

CALL: 516-293-3751.

To use your Visa or Mastercard, complete the following:

Bill my Visa Mastercard

Card No. _____

Exp. Date _____

Signature _____

MAIL TO: Claggk Inc.

Reprint Bookstore, P.O. Box 4099, Farmingdale NY 11735

All payments must be in U.S. funds

SHIPPING CHARGES IN USA & CANADA

\$0.01 to \$5.00	\$2.00	\$30.01 to 40.00	\$6.00
\$5.01 to \$10.00	\$3.00	\$40.01 to 50.00	\$7.00
\$10.01 to 20.00	\$4.00	\$50.01 and above	\$8.50
\$20.01 to 30.00	\$5.00		

SORRY — We only ship to USA & Canada

Total price of merchandise \$ _____

Shipping Charge (see chart) \$ _____

Subtotal \$ _____

Sales Tax (New York State Residents only) \$ _____

Name _____ Total Enclosed \$ _____

Address _____

City _____ State _____ Zip _____

RBSO1

DX LISTENING

By Don Jensen

Radio From Eastern Europe

Ethnic music is one of world band radio's main attractions, observes *Passport To World Band Radio*, the respected shortwave annual. And *Passport* calls "The Skylark," *Radio Romania International's* long-running program, "a showcase of some of the finest ethnic music to come out of any part of Europe." In addition, bits of Romanian music, the rich ethnic sounds of exotic instruments like the pan-pipes and cimbalons, are scattered within *Radio Romania International's* daily program schedule.

ter in Geneva, Switzerland, and then by shortwave to New York. It was then fed to the U.S. AM radio networks for rebroadcast to an American audience.

Romania got its own shortwave station, transmitting on about 9,260 kHz, less than a year later, on Jan. 1, 1940. Called Radio Bucharest, the Romanian SW voice aired an hour of international programming, in English, French, German, and Italian, each day. After WWII, under a communist regime, Radio Bucharest became one of the regular shortwave voices from behind the Iron Curtain, broadcasting, by 1957, in 11 languages.

There were, of course, drastic programming changes in post-communist Romania. The first, and most apparent to SWs, was the change in the station's name in December 1989, to *Radio Romania International*. Now, the station says its policy is to present "a fair and objective image of realities" in today's Romania. The international service broadcasts about 13,000 hours annually, composed of 55 programs and 35 hours of air time daily in 15 languages.

Try tuning *Radio Romania International* during its 0200-UTC time slot to North America. Frequencies to try include 6,155, 9,510, 9,570, 11,830, and 11,940 kHz. "The Skylark," notes *Passport*, is aired during the Thursday-night program block. Or you might try 9,690, 9,750, 11,810, or 11,940 kHz at 1900 UTC, or 7,225, 9,690, 9,750, or 11,940 kHz at 2100 UTC, Thursdays.

You can contact the station's English Department by writing *Radio Romania International*, P.O. Box 111, Bucharest 70756, Romania. You can fax the station by international telephone: (40) (1) 312-9262.

BALKAN UPDATE

Several readers have asked about shortwave broadcasting in the war-torn Balkan area. Not surprisingly, the broadcasting picture is very fluid in that troubled corner of the world these days. But here's at least part of the shortwave picture as I've been able to piece it together at the time of this writing.

Radio Yugoslavia, the international shortwave service from Belgrade, is reported in English on 11,835 kHz at 1300 UTC, and on 6,100 kHz at 1930 and 2200 UTC. English broadcasts to North America are scheduled for 0100 and 0200 UTC on 6,195 kHz; also at 0100 on 9,580 kHz.

Nikola Ivanovic, director of *Radio Yugoslavia*, has been quoted as complaining that SW broadcasting "biggies" such as Germany's *Deutsche Welle* and *Radio France International* and "not-so-biggies" like *Adventist World Radio* and Albania's *Radio Tirana* have all jumped on *Radio Yugoslavia's* frequencies. Ivanovic, apparently, sees that as something of a plot against his country, claiming an increase in interference "precisely when the international community began hinting at a policy U-turn towards our country . . ."

Although not in English,



Here's a Romanian-language QSL card from the Cold-War era. Today the station is known as *Radio Romania International*.

American radio listeners first heard authentic Romanian folk music more than a half-century ago when, in 1939, the unofficial Romanian Radio Society produced a special broadcast for the World's Fair in New York. The technology involved was cumbersome. The musical program produced in Bucharest was sent by land-line wire to the League of Nations transmit-

Radio Belgrade's domestic shortwave service operates on 7,200 kHz, according to European reports.

Until early this year, *Serb Republic Radio* was operated by the Bosnian Serbs from Bijeljina in north-eastern Bosnia-Herzegovina. Reportedly that transmitter is no longer on the air, but unconfirmed reports say those broadcasts are sometimes transmitted on the same 6,100-kHz frequency used at other times by *Radio Yugoslavia*.

Radio Bosnia-Herzegovina, with programming originating from Sarajevo supposedly, is reported broadcasting again at times on 7,108 kHz. Previously, there were reports of English programming at 0930 UTC on 7,115 kHz.

Croatian Radio from Zagreb has been logged on 13,640 and 13,830 kHz, with English programming at 1300 and 2200 UTC.

Although not broadcast transmissions per se, data in "Contact," the publication of the World DX Club in England, reports that the International Red Cross in Bosnian Bihac, has SW communications links on 4,050 kHz during the Central European evening hours, and on 14,475 and 14,490 kHz in the daytime. UN Headquarters in Sarajevo communicates on 4,923, 5,084, and 9,004 kHz. However, hearing those transmissions in North America presumably would be extremely difficult.

IN THE MAIL

Your questions and comments on SWling are

CREDITS: Brian Alexander, PA; Mark Anderson, MI; Harold Frodge, MI; Rufus Jordan, PA; Mark Meece, OH; Ed Newbury, NE; Ed Rausch, NJ; Charles Rippel, VA; Errol Urbelis, NY; North American SW Association, 45 Wildflower Road, Levittown, PA 19057

always welcome. And how about sending along a photo of you and your shortwave-listening setup? Write me at "DX Listening," **Popular Electronics**, 500-B Bi-County Blvd., Farmingdale, NY 11735

First, a letter from Steven Bates, Taylors, SC, asks for information on "sources of shortwave sets, costs, and general reviews of the equipment.

"That would be of great value to me. I'd like to purchase a low-cost shortwave set, but I don't know where to start."

I think there might be a number of first-time readers of this column who are in the same boat. How can you choose a shortwave receiver and be reasonably confident that you're getting good value? I've always found the comprehensive and reliable shortwave-equipment reviews in *Passport To World Band Radio* to be especially helpful. The 1996 edition of that annual volume should be in the larger bookstores this fall.

Paul E. Saenz, Trenton, NJ, writes to say that most American shortwave listeners probably think that all SW stations in the Spanish-speaking Americas broadcast nothing but popular Latin rhythms, salsa, merengues, and the rest.

"But," he says, "I've come across a South American station that has cultural programs and classical music. It helps if you know Spanish, but anyone can enjoy the music. *Radio Nacional de Colombia* has turned up on 4,955 kHz, about 0100 UTC. In Spanish it identifies as the International Channel—*Canal Internacional*—of the Colombian National Radio. The station asks for reports to P.O. Box 93994, Bogota, Colombia."

Thanks, Paul, and you

might also want to try *Radio Nacional de Ecuador's* Spanish-language cultural programming, which is relayed by *HCJB*, the widely heard *Voice of the Andes* shortwave outlet in Quito, Ecuador. You can tune that on 15,115 kHz at 1900 UTC.

DOWN THE DIAL

Here are some shortwave goodies to tune for. As a reminder, UTC, international broadcasting's widely-used world-time reference, is four hours ahead of Eastern Daylight Time, 5 hours ahead of CDT, 6 hours ahead of MDT, and 7 hours ahead of PDT.

BELGIUM—6,030 kHz. *Radio Vlaanderen International* broadcasts in French and Dutch around 2230 UTC.

FINLAND—11,7735 kHz. *Radio Finland* airs its English language "Nordic Report" at 1230 UTC. The program is a joint production of the Finnish, Swedish, and Norwegian shortwave services.

GUATEMALA—5,981 kHz. *Adventist World Radio's* Central American voice, *Union Radio*, has been noted until 0100 UTC sign off, identifying in Spanish as *La Voz de Esperanza*.

INDIA—6,165 kHz. *All India Radio*, Delhi, was logged at 1220 UTC with Hindi music, followed by news at 1230 UTC.

ISRAEL—15,640 kHz. *Kol Israel* has announced that programs such as the "Calling All Listeners" "Letterbox" and "DX Corner," noted after 1400 UTC, are in trouble because of funding cutbacks. The station seeks letters of support from SWLs.

PHILIPPINES—9,505 kHz. *Radio Veritas* has been logged in English at 2305 UTC with popular music and identification.

SOMALIA—6,870 kHz. *Radio Mogadishu*, in Arabic and Somali languages,

signs on at 0330 UTC with Islamic religious programming, speeches, and chants.

SUDAN—9,200 kHz. *Radio Omdurman* broadcasts on that frequency in English and Arabic. It has been noted with English news at 1900 UTC, followed by Arabic programming.

THAILAND—6,035 kHz. English-language programming, including identification and news, from the *Voice of America* relay station near Bangkok, is reported at 2240 UTC. ■

COMPUTER BITS

(Continued from page 72)

BACK TO THE REAL WORLD

The closest I've seen to those specs are a pair of essentially orphaned DOS programs. One, called *Magellan*, had a loyal following in the late 1980s and early 1990s, but Lotus dropped the program long ago. Thus, while still useful, its viewers can't handle modern file formats such as *PkZip 2.0*.

The other, called the *Norton Commander*, is not completely dead, but *Symantec/Norton* hasn't upgraded it in a while. Nonetheless, *NC* does have a pseudo-installable viewer architecture, and there are some shareware authors who have taken up the challenge. However, *NC's* belly has expanded in middle age; through a set of marginal extensions (e.g., *MCI Mail* support), the current version of the program takes a great deal more disk space than it should. If that kind of thing appeals to you, let *Symantec* know. *DOS* may be dead—but the command-line has plenty of life left! ■

HAM RADIO

By Joseph J. Carr, K4IPV

Some Receiver Accessories

For the past two months we've discussed receiver specifications in this column. Those specs are extremely important, and can make the difference between a well-performing receiver and one that is either marginal, or a real problem child. But if your unit's specs are not up to snuff, all is not lost. This month we are going to look at some receiver accessories that can enhance—or degrade—your receiver's performance . . . depending on how you use them.

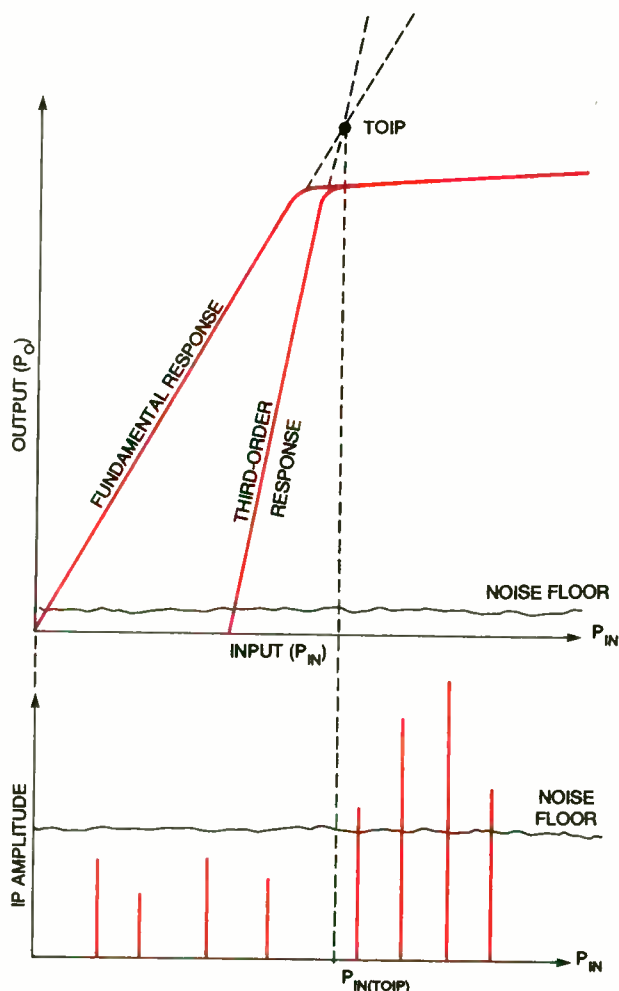

Fig. 1. These graphs show the relationship between the third-order intercept point (TOIP) and the intermodulation products.

PROBLEMS AND SOLUTIONS

Several problems are likely to rear their heads with respect to your receiver, especially if you have a low-cost model. First, sensitivity might suffer, especially on the upper bands. That was a real problem with low-cost ham and general-coverage receivers in the past. Second, the front-end selectivity might be nil, allowing overload, image responses, and so forth. Finally, the receiver might tend to overload all too easily, causing intermodulation products, desensitization, and other problems.

Nearly all of those problems can be overcome, but there are right ways and wrong ways in each case. One problem faced by many hams is that their receivers are part of a transmitter-receiver combination unit, or "transceiver." In those cases, there might be little that can be done unless the receiver has an auxiliary separate antenna input (some do). But one thing that can be done (and should be!) is to use an antenna tuning unit, or ATU, between the antenna and the transceiver.

There are two reasons why an ATU is desirable. First, if the transmitter is producing harmonics, parasitic oscillations, or other spurious output signals, the ATU might filter them out. Be a little careful, however, because some simple "line flattener" ATUs are actually high-pass filters, not band-pass filters. Second, the tuning or filtering will also

eliminate, or at least attenuate, strong local signals that could overload the front-end of the receiver.

Another neat accessory is the low-pass filter used for TVI suppression. Those filters are typically installed between the ATU and the transmitter. Such filters typically have a steep attenuation slope above a cut-off frequency in the 32- to 40-MHz range. They will eliminate harmonics and other transmitter products that interfere with TV and other services, but they also eliminate those other services that might interfere with receiver operation. (Aren't reciprocal circuits wonderful? They work in both directions equally well!)

One nice little accessory you should be aware of is the Palomar PA-360. That unit includes a 20-dB wide-band amplifier, a 30-MHz low-pass filter (LPF), a 3-MHz high-pass filter (HPF), and, of all things, a 20-dB attenuator (more on that in a moment). All of those functions can be used independently or together, as needed.

The PA-360 can be used as a preamplifier with 20-dB gain well into the VHF region, but if you want to limit the operation to the HF-region it can be used in conjunction with the 30-MHz LPF. Then, only signals below 30 MHz will be applied to the internal amplifier.

If there is a problem with AM broadcast-band interference, use the 3-MHz HPF. It will pass only signals greater than 3 MHz, so AM broadcast-band signals

(0.54–1.7 MHz) will be severely attenuated.

But why do you suppose Palomar put a 20-dB attenuator in the circuit? Because they're smart, that's why! Recall our discussion of the intermodulation products problem and the third-order intercept point last month? When strong signals mix in the front-end of a receiver they will drive the output toward the saturation level (i.e. the 1-dB compression point). When that happens, all kinds of spurious signals will be generated in, and received by, the receiver. Those "ghost signals" don't really exist, but appear to because of receiver problems.

Another problem, desensitization, also occurs. In desensitization, a strong off-channel signal reduces the level of the desired signal because of the compression-point phenomenon.

If those problems occur, then attenuating all input signals will back the receiver away from the compression point, restoring its ability to handle both the desired signal and the undesired signal. Consider Fig. 1. The upper graph shows the output-vs.-input relationship for a receiver or preamplifier. Recall from last month that the third-order response outputs, which produce spurious signals at $2f_1 \pm f_2$ and $2f_2 \pm f_1$, increase more rapidly than the fundamental (f_1 and f_2) outputs. At input signal levels below the third-order intercept point (TOIP), i.e. $P_{in(tolip)}$ in Fig. 1, the intermodulation products (I_p) are below the receiver noise floor, so they don't produce any problems. But above that critical point, the spurious I_p s begin to pop up above the receiver noise floor... creating reception problems. That's why the front-

end attenuator is included, and is needed! It will reduce all signals enough to back the aggregate input-signal level away from the critical point.

PRESELECTORS

Another useful receiver accessory is the preselector. A preselector might or might not have a pre-amplifier built in, but it is tunable to specific frequencies. The preselector improves the receiver's dynamic performance by screening out strong off-band signals that cause intermodulation and desensitization problems. Getting rid of them before they hit the front-end of the receiver is "worth a lotta gold." Many popular models, including one by Palomar and one by MFJ Enterprises, have the built-in attenuators, so they will perform as described in the discussion above.

Note that preamplifiers are not needed in every situation. When used inappropriately, a perfectly wonderful preamp will deteriorate the performance of the receiver it's intended to help. So when should you use a preamp? The rules are quite simple:

First, if the receiver has a poor noise figure (especially a VHF receiver), using a low-noise pre-amplifier (the preamp's noise figure should be less than 3 dB) will improve overall performance. Second, if the receiver has low sensitivity, then a pre-amplifier or amplifying preselector might work wonders, especially if the amplifier noise figure is less than the receiver noise figure. Finally, use a preamplifier only if its addition does not bring any normally received signals above the point where the TOIP is exceeded.



THE MOST
**AN IMPORTANT PART
OF YOUR PHOTOCOPIER
ISN'T PART OF
YOUR PHOTOCOPIER**

Having a machine may not permit you to photocopy books, journals, newsletters and magazines. The Copyright Clearance Center CAN. Contact us to find out how you too can COPY RIGHT!SM

COPYRIGHT CLEARANCE CENTER

222 Rosewood Drive, Danvers, MA 01923 ☐ Tel. (508) 744-3350 ☐ Fax (508) 741-2318

© 1993 Copyright Clearance Center

COMING NEXT MONTH
In the OCTOBER 1995 issue of

Popular Electronics[®]

Ever since the invention of the tape recorder, some people have heard mysterious voices in their recordings. Some say that those voices are from the dead communicating from the "afterlife," others feel that they are created through psychokinesis, and many consider them to be out-and-out hoaxes. Popular Electronics will examine the mystery of Electronic Voice Phenomena, and describe the techniques and experiments researchers have used to record "ghost" voices. We'll also show you how you can duplicate those experiments.

PLUS...

Build the Faux Fax Scanner: Turn your Fax machine into a high-resolution scanner for your personal computer.

Using a Spectrum Analyzer: See the radio spectrum at a glance with this valuable addition to any radio set up.

And: Outstanding columns and departments like Gizmo, Think Tank, DX Listening, Scanner Scene, Multimedia Watch, Circuit Circus, and a whole lot more!

On Sale August 15, 1995

Pick Up Popular Electronics at your favorite Newsstand, Bookstore, Convenience Store, or Supermarket

SCANNER SCENE

By Marc Saxon

Monitoring Beeper Messages



Why rely on your imagination when you can intercept those wild and crazy beeper messages with the Universal M-400 Decoder.

It's often said that we scanner owners are a curious lot. Show us a strange signal, and we won't rest until we can figure out what it's all about. That is true. But we don't expect the answers to jump out at us. Part of the enjoyment of our hobby is the sheer pleasure we receive from solving those minor mysteries.

One of the amazing tools that we have at our disposal to help in doing so is the *Universal M-400 Decoder*. You might not be familiar with the device, but if you wonder about the information concealed by those odd-sounding digital paging (beeper) signals, you should be.

As mentioned here last month, the 152.03- to 152.84-MHz band is usually rich with such non-voice signals. They're also plentiful elsewhere, such as between 454.025 and 454.625 MHz, and between 929.0125 and 931.9875 MHz.

Stations on those frequencies pump out data

bursts containing messages directed to specific beepers. Some of those messages are instructions to do nothing more than make a beeping sound. Other, more sophisticated messages include a call-back phone number. The ones of obvious interest are the alphanumeric messages, which consist of complete texts.

Some of those messages are absolutely wild and beyond imagination. Of course, if you had a Universal M-400 at your shack, you wouldn't need your imagination. All of the messages sent would appear in plain text on the unit's self-contained, two-line, LCD readout. The device has an 8000-character buffer, and stored data can be scrolled for later review. Or, it can be output to a printer via the unit's standard parallel port.

Digital-radio paging systems can use three different data-transmission formats, known as POCSAG, Super POCSAG, and GOLAY. Stations often send out successive data bursts using two of those formats. The M-400 is designed to decode any of the three formats, but only one at a time. That is, it doesn't automatically switch formats should the station change during a transmission.

In addition to decoding the paging formats, the M-400 can also decode CTCSS (so-called "PL") tones and DCS codes, as well as DTMF digits. It also can decode ACARS, plus many of

the RTTY formats used in high-frequency communications.

The M-400 might work satisfactorily on many scanners using no more than a connection to the set's external speaker output. You can then connect an external speaker to the M-400. In all cases, the best results will be obtained by connecting the M-400 to a scanner's low-level audio source, such as the "REC-OUT" connection, or, alternately, internally to the detector output (instructions are provided with the M-400).

The unit sells for about \$400. More information on the decoder can be obtained from Universal Radio, Inc., 6830 Americana Parkway, Reynoldsburg, OH 43068. The phone number is 614-866-4267.

HANDY ANDY

Andy Texidor of Louisiana wrote in to say that he has an idea that other owners of the popular Radio Shack PRO-2035 might find useful. Andy points out that he uses some of the radio's 100 monitor channels to set aside and store certain high-interest frequencies that he likes to either monitor over long periods of time or else slowly hand-scan using the rotary tuning dial.

Toward that end, Andy deliberately deposits those frequencies in consecutive monitor channel slots. Typical examples are the ten 46-MHz cordless-telephone channels, which he says are

a nuisance to scan and explore in the search mode. With his method, he can rotate the tuning knob in either direction and conveniently check out each channel manually on a concentrated basis.

He also included several of his favorite federal, local law-enforcement, voice pager, and other channels. In all, he has dedicated only 25 of the 100 channels for that purpose. That still leaves plenty of channels for search-discovery storage purposes.

We kind of liked his idea, and thought you'd like it too. Thanks, Andy!

FAR OUT

Russian space efforts aboard the orbiting MIR station have been in the news of late because they're being coordinated with our own space program. That means it's worth thinking about those matters in terms of your interest in monitoring.

The MIR has been reported with FM voice transmissions on 143.625 MHz, and telemetry on 192.00 and 922.70 MHz. Ham transmissions are on 145.55 MHz. Other Russian FM voice channels noticed in use aboard their manned spacecraft include 121.75 and 142.417 MHz. Look for additional telemetry transmissions from the Russians on 165.00, 166.00, and 180.00 MHz.

NEW BANDS TO WATCH

The FCC is going to allow wireline telephone companies to hold licenses in the 800-MHz Specialized Mobile Radio (SMR) service and in the subscriber-based 220-222-MHz land-mobile (commercial 220-MHz) services.

The SMR service was created 21 years ago, and the 220-MHz band was set up

in 1991. The FCC had prohibited telephone companies from entering those services in order to allow them to become established by their own groups of competing pioneer licensees.

The Budget Act of 1993 suggested that the FCC should review those prohibitions. After that review, the FCC decided to repeal the restrictions, as well as the FCC ban on common-carrier dispatch service.

Because of that, we will soon begin to hear new mobile-phone, voice- and digital-paging, dispatching, and other services opening up on additional 800-MHz channels. And if you thought nothing much was happening between 220 and 222 MHz, just wait! There soon will be plenty of new things to hear.

MAKE THE SCENE

Please continue sending your letters to our column. Your wonderful support and input is what keeps us tops! Send your frequency information, questions, hints, and ideas to *Scanner Scene*, **Popular Electronics**, 500-B Bi-County Blvd., Farmingdale, NY 11735. ■



One tree can make
3,000,000 matches.



One match can burn
3,000,000 trees.



A Public Service of The Magazine
& The Advertising Council

MULTIMEDIA WATCH

(Continued from page 25)

all for less than \$100. Best of all, though, is that it gives the user excellent Ultra-Sound sound quality without sacrificing any SoundBlaster compatibility that the existing FM synthesis card might have. When an UltraSound is the only sound card installed, emulation software must be run to provide SoundBlaster support, which can lead to incompatibility problems.

The UltraSound ACE also features a unique RAM-based wavetable system that allows users to edit any of the existing instrument and sound-effects patches. Users can also create new sounds to supplement the standard General MIDI patch set of 192 instruments.

New this month from Synergy Interactive Corporation are *Gadget* and *L-Zone*. The *Gadget* mystery adventure takes place on a locomotive speeding through a bizarre, retro-future world. Clues are provided by different settings and other passengers. The player must put together a bunch of gadgets to solve the mystery. The \$79.99 game provides up to 7 hours of adventure for each passage through it.

L-Zone takes place in an automated city built by a mad scientist. Huge buildings have rooms full of idling machines, yet no one stirs but you. Once *L-Zone* awakes, though, you must clear all the traps set for you, pass through all the zones, and find the path to planet Green. *L-Zone* sells for \$69.99.

New from LucasArts is *Dark Forces*, an action-filled, first-person, shoot-em-up adventure that takes place in the Star Wars Uni-

verse. Similar to id's *Doom* or *Heretic*, but with its own unique game engine, *Dark Forces* lets you pick up a blaster and go on missions to thwart the Evil Empire.

E-Media has already shipped its premier issue of *Go Digital Interactive Magazine*, a CD-ROM based quarterly. It covers the convergence of entertainment and new media, along with the latest developments in multimedia. But *Go Digital* has more of an adult nature to it than most multimedia information sources—it's sort of like a multimedia *Playboy* magazine. *Go Digital* has a suggested retail price of \$14.95 per issue, or \$39.95 for a 1-year subscription.

I've mentioned in the past how compilations of games on one CD-ROM are becoming more and more popular. *Power-GameIII* from Activision consists of three best-selling games on one disc. The disc contains *Super Tetriz*, *Spectre*, and *F-15 Strike Eagle*. The disc will have a suggested retail price of \$39.95.

Last this month, and on more of a productive note, are two products from Microsoft. *Publisher 2.0* on CD-ROM includes a special-occasions design pack (that's available as a separate product on diskette), additional clip art and templates, and more. *Publisher* makes it easy for inexperienced users to create professional looking documents. *Publisher 2.0* on CD-ROM will sell for around \$99.95. *Microsoft Works* on CD-ROM helps users run their homes and small businesses. *Works* includes software for word processing, spreadsheets and charting, database storage, modem communications, graphics, and much more, all for only \$99.95. ■

ELECTRONICS LIBRARY

The Ultimate Scanner (Cheek^{3!})

by Bill Cheek

This successor to Volumes 1 and 2 of Bill Cheek's *Scanner Modification Handbook* picks up where they left off, adding channels, extending frequency bands, enhancing sensitivity, and improving control—in short, it helps readers to optimize everything. A wealth of step-by-step instructions and specially prepared photos, charts, diagrams, and schematics instruct readers on how to turn their scanners into "The Ultimate Scanner," complete with wires, dials, knobs, switches, and meters that never appeared on the manufacturer's original

and to have total control over everything that comes out of their sets' speakers.

The book leads the reader into the next generation of scanning. It describes the scanning hobby's entry into the information and computing era, where automation adds fun, channels, and entirely new functionality to radio monitoring. It also provides modifications for expanded memory, cellular coverage, computer interfaces, SCA, and more.

The Ultimate Scanner (Cheek^{3!}) is available for \$29.95 plus \$4 shipping and handling (California residents must add \$2.32 tax) from Index Publishing Group, Inc., 3368 Governor Drive, Suite 273F, San Diego, CA 92122; Tel. 800-546-6707; E-mail: indexboox@aol.com.

CIRCLE 85 ON FREE INFORMATION CARD

MECHANICAL DEVICES FOR THE ELECTRONICS EXPERIMENTER

by Britt Rorabaugh

Aimed at robotics enthusiasts as well as general electronics hobbyists, this book tackles a neglected subject area—the mechanics that are essential to many electronics projects. It explains how to design, build, adapt, and use many types of mechanical devices. Its emphasis is on electromechanical equipment that can be used for motion and positioning in robotics. With the help of abundant illustrations, the book describes in detail how to design robot-propulsion systems, make homemade components for pneumatic systems, design simple hydraulic systems and motor controller circuits, select motors for particular applications, design and build solenoids and vacuum actuators, and design gear trains and cams.



Plenty of practical and theoretical information is included, along with simple explanations of the measuring units used by engineers, concise definitions of principles such as friction and inertia, and an explanation of electromechanical forces and how to harness them. The book also shows readers how to modify automotive and other mechanical parts for use in electronics experiments. The projects presented encourage readers to improve their skills and flex their imaginations.

Mechanical Devices for the Electronics Experimenter costs \$18.95 and is published by Tab Books Inc., Blue Ridge Summit, PA 17294-0850; Tel. 1-800-233-1128.

CIRCLE 86 ON FREE INFORMATION CARD

PLAYING MUDS ON THE INTERNET

by Rawn Shah and James Romine

Multiuser Dimension (MUD) games, or MUDs, are text-driven, interactive role-playing games based on fantastic, Tolkein-esque characters such as elves, warriors, dragons, and dungeons. It's relatively easy to get into a MUD game on the Internet, but with as many as 100 players from around the world and thousands of "rooms" to get lost in, you'll probably need some help to avoid instant

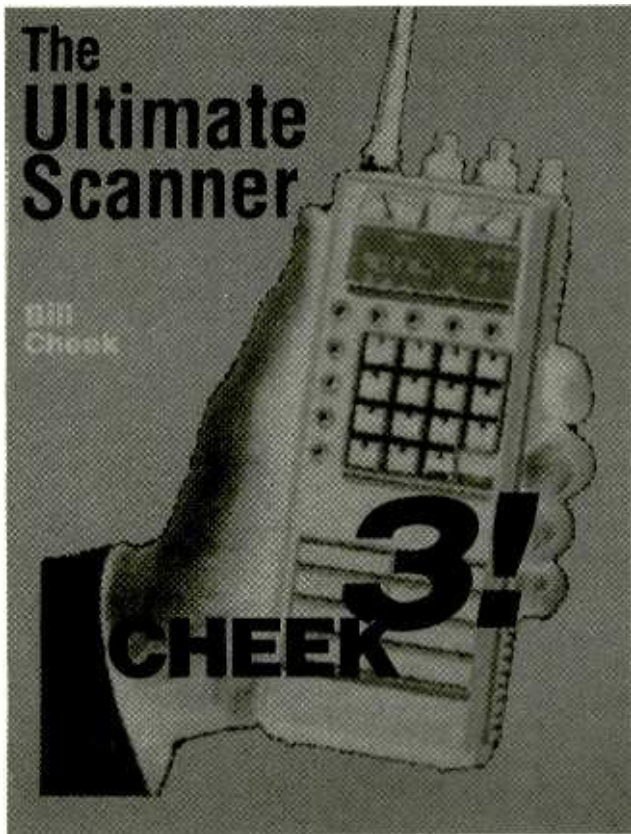

plans. The modifications presented allow hobbyists to cover all the bands and all the channels that they wish to receive,

death and survive to play on.

This book provides all the information you need to stay alive, outfox and dethrone experienced MUDers, and perhaps even win the game. It reveals the lore as well as the intricate customs and commands needed to get by in the imaginary worlds of MUDs. The book shows you where to find MUD games and how to join them, describes several MUDs in depth (including maps), provides hints and strategies for winning, warns you of the dangers that lie ahead, and offers tips on how to stay alive. Exploring all the varieties of MUDs—from hack-and-slash Aber-

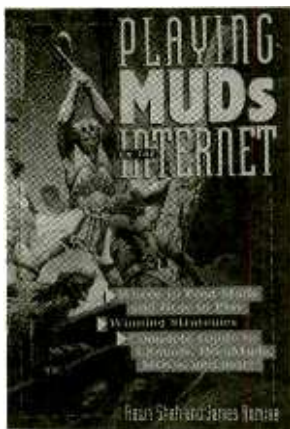

Diku-, and LPMUDs to role-playing MOOs, MUCKs, and TinyMUDs—the book gives readers the knowledge that experienced game players are unwilling to share, and puts the newcomer onto the path of online adventures.

Playing MUDs on the Internet costs \$16.95 and is published by John Wiley & Sons, Inc., 605 Third Avenue, New York, NY 10158-0012; Tel. 1-800-CALL-WILEY.

CIRCLE 87 ON FREE INFORMATION CARD

1995 MICROVIDEO CATALOG

from *Supercircuits*

This 38-page catalog is filled with innovative, microvideo products. The miniature cameras and transmitters have been used for investigations by local and network news programs. They can also be used by homeowners who want extra security, engineers who are looking for



cost-effective solutions, and hobbyists interested in exploring the world of microvideo, as well as for government, corporate, and military applications.

The catalog features a wide variety of microcameras, video transceivers/transmitters, amplifiers, antennas, VCRs, complete surveillance systems, and monitors and mini-monitors. Accessories include lenses, enclosures, and mounting brackets. The devices can be used in computer imaging, robotics, radio control, surveillance, and teleconferencing.

The 1995 Microvideo Catalog is free upon request from *Supercircuits*, 13552 Research Blvd. #B, Austin, TX 78750; Tel. 1-800-335-9777.

CIRCLE 88 ON FREE INFORMATION CARD

INNOVATION: Award-Winning Industrial Design

from *Industrial Designers Society of America*

This oversized, vividly illustrated book celebrates the 1991 through 1993 Gold, Silver, and Bronze winners of the Industrial Design Excellence Awards (IDEA), which are sponsored by

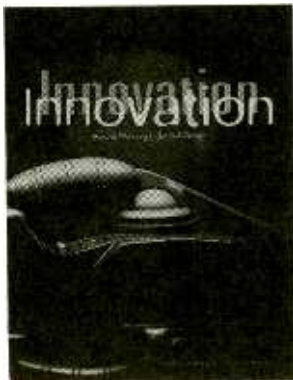

the Industrial Designers Society of America and *Business Week* magazine. While good looks are certainly considered, the products must also be cost-effective to manufacture, use less materials, and function better. Award-winning products run the gamut from toothbrushes to automobiles.

The book is organized in three sections: Designing for the Consumer, Designing for Industry, and Environmental and Packaging Design. Detailed text outlines the design objectives and solutions and results in terms of the product's success on the market, profitability for the client, impact on the environment, and benefits to the user. More than 500 photographs are accompanied by schematic drawings and conceptual sketches.

Innovation: Award-Winning Industrial Design costs \$45 and is published by PBC International, One School Street, Glen Cove, NY 11542; Tel. 1-800-527-2826 (in NY: 516-676-2727).

CIRCLE 89 ON FREE INFORMATION CARD

FPGA WORKOUT: Beginning Exercises with the Intel FLEXlogic FPGA

by David E. Van den Bout, Ph.D.

Field-programmable gate arrays, or FPGAs, provide a complete TTL parts cabinet within a single chip. Each FPGA chip contains thousands of digital gates that can be interconnected by internal switches to build a wide variety of circuits. The switches can be reprogrammed at any time to make the FPGA perform a completely different function.

This book shows readers how to build a low-cost (about \$100) FPGA development system and use it to explore digital-logic design techniques. Readers are encouraged to sharpen their digital-design skills by actually building circuits to see how they work. Each chapter presents working examples of logic circuits that the reader can load into an FPGA and experiment with.

The book starts by presenting logic design using discrete TTL

chips and then shows the advantages of working with a single-chip FPGA for a variety of combinational and sequential circuits. The last four chapters of the book show how to build a complete 4-bit microcomputer in a single FPGA.

Some digital-logic design theory is presented, but the overall emphasis is on practical learn-



ing by doing. Readers should have a basic knowledge of binary arithmetic and elementary logic operations.

FPGA Workout: Beginning Exercises with the Intel FLEXlogic FPGA costs \$19.95 and is published by XESS Corporation, Department PLE1, 2608 Sweetgum Drive, Apex, NC 27502; Tel. 919-387-1302 or 1-800-549-9377; E-mail: devb@vnet.net.

CIRCLE 90 ON FREE INFORMATION CARD

PHOTOSHOP F/X: Mac Edition

by Cathy Abes

Intended to inspire computer artists, this book features dozens of full-color case studies and two galleries of full-page images that display the broad range of computer-generated art that can be produced using Adobe Photoshop. Beginning with an overview of tools and techniques, it explains how professionals use Photoshop to turn a simple image into a rich, complex work of art. The focus is on exploiting Photoshop 3.0's new features, applying special effects with third-party filters that run within Photoshop, and using stand-alone programs with Photoshop. The book shows how to use filters, create

custom filters, and use advanced masking for special effects. It reveals which filters are preferred by top Photoshop artists, and how they use them. Each chapter uses case studies to show the wide range of effects that can be produced with a little ingenuity and experimentation.

The "Step-by-Step Gallery" consists of images accompanied by extensive tutorials that show each work in progress and describe the specific techniques developed and used by each artist. The gallery section showcases compositions from



award-winning artists who have produced notable work for major movies, national magazines, and book and CD covers, and now have had their work exhibited in major art galleries.

The included CD-ROM disc features a "virtual artist"—an animation that reenacts the creation of two pieces of art that appear in the book. The disc also contains a free copy of popular tools, filters, and image collections, as well as full-featured interactive demonstrations of Specular Collage, Infini-D, and Andromeda 3D Filter from Series II.

The book's Online Companion, located on Ventana Online's World Wide Web site, includes an archive of filters, tools, and utilities that can be downloaded for use in Photoshop; a digest of questions and answers posted on Internet-based mailing lists; and hot-links to various pieces of art found on the Internet.

Photoshop f/x costs \$39.95 for the book, CD-ROM, and Online Companion. It is published by Ventana Press, P. O. Box 2468, Chapel Hill, NC

27515; Tel. 1-800-743-5369 or 919-942-0220;

Fax: 919-942-1140.

CIRCLE 91 ON FREE INFORMATION CARD

POCKET PCREF

by Thomas J. Glover & Millie M. Young

POCKET REF

by Thomas J. Glover

These two pocket-size handbooks from Jensen Tools are packed with reference information on a broad range of technical subjects. Each is about the size of a 3 x 5 inch card and less than a half-inch thick, so they tuck easily into a pocket or briefcase.

The *Pocket PCRef* (order #939B010) is a reference book of computer information, with an emphasis on PC hardware. It presents 320 pages of tables and charts on video standards, keyboard scan codes, floppy and hard-drive specifications, printer codes, CPU processor types, ASCII codes, trademarks, DOS commands, and more.

The *Pocket Ref* (order #939B005) is more general. It contains 480 pages of tables,



diagrams, conversions, and constants in such categories as carpentry and construction, glues, solvents, paints and finishes, hardware, pipe and plumbing, tools, electrical (wire, motors, and frames), automotive, electronics, weights and measures, welding, and more. It also features a section on trade names and trademarks, a ten-year calendar, and blank pages for personal notations.

The *Pocket Ref* and *Pocket PCRef* cost \$9.95 and \$14.95, respectively, and are available from Jensen Tools Inc., 7815 South 46th Street, Phoenix, AZ 85044-5399; Tel. 800-426-1194.

CIRCLE 92 ON FREE INFORMATION CARD

THE MICROCONTROLLER IDEA BOOK:

Circuits, Programs & Applications featuring the 8052-BASIC Single-Chip Computer

by Jan Axelson

This book presents practical designs based on the 8052-BASIC microcontroller, whose on-chip BASIC-52 programming language makes it easy to write, run, and test programs. The chip uses a standard, popular architecture, and special commands can be used to store programs in EPROM, or other nonvolatile memory, for use in data loggers, controllers, and other microcontroller projects. The 8052-BASIC microcontroller is ideal for designs



that require computer intelligence but don't need the disk drives, keyboard, and full-screen display of a desktop computer. Designs, including circuits and programs, are provided for data loggers, controllers, and other microcontroller-based projects.

The book includes the real-world details needed to get the projects up and running. It offers complete circuit schematics, parts lists, design theory, construction and debugging tips, and example programs. The book also explains how to enhance the basic designs by adding keypads, switches, relays, displays, sensors, clock/calendars, motor controls, wireless links, and other types of input/output interfaces.

The *Microcontroller Idea Book* is available for \$31.95 plus \$3 shipping from Lakeview

Research, 2209 Winnebago Street, Madison, WI 53704; Tel. 608-241-5824.

CIRCLE 93 ON FREE INFORMATION CARD

ULTIMATE UNAUTHORIZED NINTENDO SUPER NES GAME STRATEGIES '95 Edition

by Jason Rich

This revised and updated version of the popular guide to Super NES games is presented in a new format that gives readers descriptions and winning hints for more than 200 games. It also offers full descriptions of the latest hits, such as *The Lion King*, *Beavis and Butthead*, and *Super Punch Out*, as well as a preview of *Donkey Kong Land* for the Super Game Boy. The book helps gamers and parents to preview the games before buying them by categorizing and rating hundreds of games.

The book is packed with all the inside tips, tricks, and strategies needed to put every Nintendo player on the winning track. Nine Mario games are covered, including the Super Mario All-Stars. The book offers 126 "Mini Hints," arranged alphabetically, for games such as *Jurassic Park*, *Doomsday Warrior*, *Home Alone*, *MLBPA Baseball*, and others. Also, dozens of Game Genie Codes are



included.

Ultimate Unauthorized Nintendo Super NES Game Strategies, '95 Edition, costs \$10.95 and is published by Random House Electronic Publishing, Hahn Road, Westminster, MD 21157; Tel. 800-733-3000 or 410-848-1900, extension 3000.

CIRCLE 94 ON FREE INFORMATION CARD

HANDS-ON REPORT
 (Continued from page 27)

mounted on ball bearings that
 to electronics couple the
 ments to an 8-conductor
 runs from the weather-
 weather computer tested.
 Once all gives set-
 assembled. The meters
 the weather speed and
 Calibrated before
 ting take another
 eo

Everything is cali-
 sors must be
 and indoor sen-
 s from all of the
 st pass through an
 re building. It's easiest
 igh of PVC pipe through
 ide wall, pass the cables
 gh it, and insulate and
 weatherproof the outside. The pipe
 should be angled down toward the
 outside so that water will not seep
 inside.

The wind boom should ideally be
 mounted far away from any obstruc-
 tions that could interfere with wind
 flow. But our home installation has to
 be on a mast on the roof, which is still
 partially blocked by tall trees. Oh well,
 at least measurements of the wind hit-
 ting the house will be accurate. The
 boom must be mounted and aligned
 so that when the wind vane points
 south, the display shows north. (The
 vane always points into the wind.) An
 8-conductor cable runs from the
 boom to the computer indoors.

The rain-gauge sensor is basically a
 small two-sided flip-flop water ladle
 magnetically connected to a reed
 switch. A screened funnel assembly
 mounted over the ladle directs rainfall
 into the ladle and causes it to toggle
 back and forth as each side fills and
 spill its water into the base below. The
 rate that the ladle toggles lets the
 weather computer know the rate at
 which rain is falling and how much
 has fallen over any given period of
 time. The rain-gauge sensor should
 ideally be mounted level and in a lo-
 cation that is blocked from cross
 winds. Of course it should not be

blocked from above so that full rainfall
 can be collected. It should be in an
 accessible location so that leaves
 and other debris caught in the
 screened funnel can be removed
 periodically. A 2-wire cable runs from
 that sensor to the computer that is
 located indoors.

The temperature sensors are facto-
 ry sealed in stainless steel cylinders
 attached to long 3-conductor cables.
 The outdoor temperature sensor
 should be mounted away from direct
 sunlight and wind, but ventilated, and
 where snow and ice is not likely to
 collect. The humidity-sensor boards
 install in ventilated plastic enclosures.
 The outdoor humidity sensor should
 be blocked from rain and direct sun-
 light, preferably under the eaves of a
 roof. The 3-conductor cable from that
 sensor also runs to the computer in-
 doors.

The indoor temperature and hu-
 midity sensors are easy to install. How-
 ever, the temperature sensor should
 obviously be mounted away from
 heat sources such as sunlight, radi-
 ators, and heating ducts. The humidity
 sensor should be mounted on a wall
 away from sources of heat, and
 should obviously not be near sources
 of moisture such as a bathroom or
 kitchen.

**An Impressive Conversation
 Piece.** Nobody can walk into a room
 and not ask what the Heathkit Ad-
 vanced Weather Computer is. It is
 very noticeable with its white-on-blue
 fluorescent display. It is also quite
 useful and informative to just about
 anybody breathing. If it were only
 \$100, everybody would buy one. But
 the best toys always come at a price,
 and this is one of the best. But even
 better, it is not a toy, but a valuable
 and fun tool.

For more information on the Heath-
 kit ID-5001 Advanced Weather Com-
 puter, contact the Heath Company
 directly at the address given below, or
 circle no. 119 on the Free Information
 Card. ■

For More Information

Heath Company
 Benton Harbor, MI 49022
 Tel. 1-800-253-0570

**Electronic
 Security**

2 for 1
 SALE!



**Mini Long Range FM Voice
 Transmitter (3 mi) Ultra Sensitive** -
 with fine tune, range control, more! Detects
 even whispers! FMX1 Kit and Plans.....~~\$49.50~~

**Tiny Telephone
 FM Transmitter** 
 (3 mi) - automatically operates when phone is
 used. Crystal clear clarity with fine tune and
 range control. TELX-1 Kit and Plans.....~~\$49.50~~

Both Easy-to-Build Kits Above only \$49.50!

**Extended Play
 Telephone**



Recording System - \$129.50
 - Automatic - Crystal Clear - Easy to Use -
 Connects to Any Phone - Automatically controls
 and records both sides of the conversation on our
 extended play recorder. Caution - check local
 laws as some states require an alerting beeper.
 TAP20X Ready-to-Use System only \$129.50

FREE CATALOG with order - or send \$1.00 P&H
INFORMATION UNLIMITED MC, VISA, Check, Cash or C.O.D.
 Send or Fax Orders to: Dept pe16
 PO Box 719, Amherst, NH 03031
 Orders: 800-221-1705 FAX 603-672-5406 Tel 603-673-4730

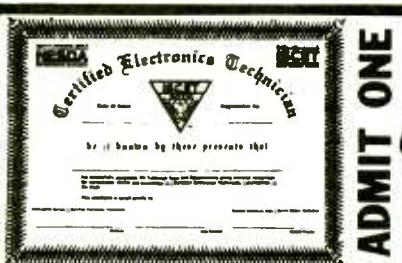

**Your Ticket To
 SUCCESS**

Over 28,000 technicians have gained admit-
 tance worldwide as certified professionals.
 Let your ticket start opening doors for you.

ISCT offers Journeyman certification in
 Consumer Electronics, Industrial, Medical,
 Communications, Radar, Computer and
 Video. For more information, contact the
 International Society of Certified Electro-
 nics Technicians, 2708 West Berry Street,
 Fort Worth, TX 76109; (817) 921-9101.

Name _____
 Address _____
 City _____
 State _____ Zip _____
 Send material about ISCT and
 becoming certified.
 Send one "Study Guide for the
 Associate Level CET Test." En-
 closed is \$10 (inc. postage).

September 1995, Popular Electronics 87

It started in America!

The creators are the masters in manufacturing the finest video products...

You probably don't associate VCR's with American technology. Fact is, video recording has its origins in America and it was 3M that brought video recording out of the lab and into your living room. Today, 3M video tape is the choice of all the major networks. No other tape company has ever won an Oscar or an Emmy. 3M Black Watch tape follows in this tradition—service and quality go hand in hand. Here are three Black Watch products you should be using at home!

Clean up! With constant playing and using of degrading dry or wet cleaners, the output of your video tapes has slowly diminished to an unacceptable level and the VCR plays as if it has a head cold! The culprit is most likely clogged and dirty video and/or audio heads. The 3M Black Watch™ Head Cleaner Videocassette uses a patented magnetic tape-based cleaning formation to remove head clogging debris. No foreign substances such as cloth, plastics or messy liquids and no harsh abrasive materials are present. The cleaner's usable life is 400 cleanings or more!

It's easy to use. Place the 3M Black Watch™ Head Cleaner Videocassette in the VCR and press the Play button. A pre-recorded message will appear clearly on your screen and an audible tone is heard, telling you that the cleaning process is now completed. No guess work; you never over clean! Priced at \$19.95.

For the VCR! Once your VCR's record and playback heads are cured, and the unit plays like new, consider using the finest videocassette you can buy—the 3M Black Watch™ T120 Hi Pro VHS 4410 Videocassette. The 4410 is the highest performing videocassette available today for use with all standard format VHS recording hardware!

Here's what you hear and see....A sharp, clear picture—brightest ever colors—freedom from streaks, flashes and snow—outstanding high-fidelity audio reproduction—optimum camcorder performance—maintains recording integrity. 3M Black Watch™ video tape is 100% laser inspected to guarantee surface smoothness and drop-out free performance. Priced at \$8.00

You saw it here first! 3M Black Watch™ 0900 8mm video tape cassette loaded into your Hi Band camcorder delivers the finest picture and sound possible in the 8mm format. Extremely fine particles of pure iron alloyed with nickel and cobalt deliver a video performance exceeding 400 lines of horizontal resolution. You get the advantage of an exceptional video image with superior audio re-



For the clearest pictures you ever record!

production. This means your Hi 8 format camcorder will produce the best video and audio definition possible. With the 3M Black Watch™ 8mm cassette, the recording capability and performance of your camcorder will be significantly enhanced. Priced at \$14.95.

Clagg Inc. — 3M VHS Special Offer
P.O. Box 4099,
Farmingdale,
New York 11735

Yes, I like your offer and here is my order for 3M Black Watch™ products!

- ___ 3M Black Watch™ 0900 Hi Band-120 8mm Cassette (\$14.95 each) \$ _____
- ___ 3M Black Watch™ T120 Hi Pro VHS 4410 Videocassette (\$8.00 each) \$ _____
- ___ 3M Black Watch™ Head Cleaner Videocassette (\$19.95 each) \$ _____

Shipping and handling per order **\$4.00**

Total Amount in U.S. Funds only \$ _____

New York residents add local sales tax. Canadians **add \$6.00** per order. No foreign orders. Do not send cash.

Bill my VISA MasterCard
Card No. _____
Expire Date ___/___/___
Signature _____
Name (Please print) _____
Address _____
City _____ State _____ ZIP _____

THINK TANK
continued from page 32)

...atively, you
...gates that
...equiv.

MOTOR CONTROL

I have a
6) I use for c
and other AC
have less than
power and lack
centrifugal startin
works by controlling
effective voltage in
circuit and governs b
starting and varying lo
conditions.

A ramp voltage is developed across capacitor C1. The voltage across C1 will vary the delay in turning on the SCR1. The amplitude of that voltage is controlled manually by R8 for adjusting the motor speed, and by a pre-adjusted potentiometer, R9, to provide governing action (R9 should be adjusted to provide maximum regulation). The level of the ramp relative to the firing voltage of Q1 is set by R12.

The value of R1 must be chosen to accommodate the load; a lower value might be more satisfactory for a larger motor. Transformer T1 can be wound with a primary of 25 turns of 26-gauge wire and a secondary of 200 turns. Alternatively, any small transformer having a turns ratio of approximately 1:10 will do.

—Robert Crooker, NS
Canada
The circuit formed by C1, R3, R6, R8, and R12 is tricky to follow at first. It should be mentioned that TR1 must be chosen to match the current draw of the load, and U1 must be selected to match TR1.

GET THE LATEST ADVANCES IN ELECTRONICS

SUBSCRIBE TO—

Electronics NOW

ENJOY THE WORLD OF ELECTRONICS EACH MONTH!

Subscribe to the best informed electronics magazine—the one that brings you the latest high-tech construction projects, feature articles on new technology, practical troubleshooting techniques, circuit design fundamentals, and much more.

Electronics Now looks to the future and shows you what new video, audio and computer products are on the horizon. You'll find helpful, monthly departments such as Video News, Equipment Reports, Hardware Hacker, Audio Update, Drawing Board, Computer Connections, New Products, and more. All designed to give you instruction, tips, and fun.

Electronics Now gives you exciting articles like:

- Buyer's Guide to Digital Oscilloscopes
- Build A Scanner Converter
- Single-Chip Voice Recorder
- Build A MIDI Interface for your PC
- Troubleshoot Microprocessor Circuits
- Build A High-Power Amplifier for your Car
- Add Music On Hold to your Phone
- All About Binaural Recording
- VGA-to-NTSC Converter



FOR FAST SERVICE CALL OUR TOLL-FREE NUMBER!

1-800-999-7139

DON'T DELAY — SUBSCRIBE TODAY!

If you prefer, just fill out the order card in this magazine and mail it in today.

7PJ56

VCR Cross Reference

**NOW Find the right Part
for your VCR**



With the

ISCET VCR CROSS REFERENCE

This 119-page reference contains both model and part-number cross-references updated to include 1994 units.

VCR's are made in a few factories from which hundreds of different brand names and model numbers identify cosmetically-changed identical and near-identical manufactured units. Interchangeable parts are very common. An exact replacement part may be available only a few minutes away from you even though the manufacturer supplier is out-of-stock. You may be able to cannibalize scrap units at no cost!

The ISCET VCR Cross Reference is pre-punched for standard loose-leaf binding. . . \$38.00 plus \$3.00 for shipping for each Reference.

**Clagg Inc.
VCR CROSS REFERENCE OFFER
P.O. Box 4099
Farmingdale, New York 11735-0793**

Name _____
Business _____
Address _____
City _____
State _____ Zip _____
Phone _____

Enclose \$38.00 for the Fifth Edition of the ISCET VCR Cross Reference and \$3.00 for shipping for each Reference.

The total amount of my order is \$ _____
Check enclosed—do not send cash.
or please charge my credit card.

Visa MasterCard Exp. Date ___/___/___

Card No. _____

Signature _____

New York State residents must add applicable local sales tax to total. US funds only. Use US bank check or International Money Order. CB02

ELECTRONIC ORACLE

(Continued from page 48)

capacitors, making sure that C1 and C4 are oriented properly. Depending on the style of capacitor that you use for C4, you might have to mount it upright.

If you build the circuit on perforated board, be sure to place C1 as close to B1 as possible. Also, C2 should be placed as close to pin 14 of the 4013 as possible. Try to cross the hookup wires as little as possible because any induced glitches can bother the flip-flops.

The cheat-circuitry points (C, Y, and N) are made out of the screws that mount the board to the enclosure. For that reason, the board should be mounted to the inside bottom of the enclosure; a metal enclosure is *not* suitable. Three of the board's corners have holes to insert and solder wires; the other ends of the wires are soldered to lugs and placed under the mounting screws as represented in Fig. 3 and shown in the internal view (Fig. 4). The holes in the PC board for the mounting screws are also provided with copper pads in the pattern shown in Fig. 2. Because of that, if you are using metal spacers that make good electrical contact, the wires and lugs can be omitted.

To enhance the total effect of the Electronic Oracle, the author drilled an extra hole in the top panel of the prototype and labeled it MIC. Doing the same might convince some of your victims (friends) that the Oracle could indeed actually hear the questions being asked. You should also label the LEDs YES and NO.

Using the Device. To let the Oracle work its magic, honestly, turn the device on and ask a question. Then press S2 and release it; there will be a short delay after the switch is released, after which either the "yes" or "no" LED will light.

Now, for cheating (don't feel too bad, you'll get over the guilt when you see how much fun it really is); as you hold down S2, simply use your fingers to bridge the "common" screw to either the "yes" or "no" screw on the bottom of the unit to obtain whichever response you desire. Then, release S2 while maintaining contact



Fig. 4. As this internal view shows, a wire with a lug is connected to the three cheat points to ensure a electrical connection.

with the screws until the desired lights. If you cannot get the cheat function to respond, it is likely that the mounting screws are not making adequate electrical contact with the PC board.

If you wish to decrease the chances of being "found out," you can drill more holes and use them to install as many dummy screws as you like (just be sure that none of the extra screws make contact with the underside of the PC board). Also, keep your finger movements underneath the unit inconspicuous and, if possible, out of sight.

So, the next time you have a get-together that becomes a little dull, bring out the Electronic Oracle. You'll have a great time watching everyone's puzzled expression as the Oracle treats you especially well. ■



Enter A World Of Excitement with a Subscription to

Popular Electronics®

Get the latest electronic technology and information monthly!

Now you can subscribe to the magazine that plugs you into the exciting world of electronics. With every issue of Popular Electronics you'll find a wide variety of electronics projects to build and enjoy, and feature articles that inform and entertain.

Popular Electronics brings you feature articles on technology, computers, test gear, and more—all designed to keep you tuned into the latest developments in electronics. So if you love to build fascinating projects, just fill out the subscription form below to subscribe to Popular Electronics. . . It's a power-house of fun for the electronics enthusiast.

EXCITING MONTHLY FEATURES LIKE:

- CONSTRUCTION**—Exciting projects that range from simple radios to working robots
- FEATURES**—Learn about new technology, see how to troubleshoot all types of electronics gear, refresh your knowledge of basic electronics theory, see how components work and how to use them in your own designs, and much more
- PRODUCT REVIEWS**—Get in depth, hands-on reviews of all types of hobby gear, and learn about the latest and the greatest in consumer electronics in our no-holds-barred Gizmo section
- SPECIAL COLUMNS**—Think Tank, Circuit Circus, Computer Bits, DX Listening, Antique Radio, Scanner Scene, Amateur Radio, Multimedia Watch, and more

PLUS: ALL OUR GREAT DEPARTMENTS!

You'll get 12 exciting and informative issues of Popular Electronics for only \$18.95. That's a savings of \$23.05 off the regular single copy price. Subscribe to Popular Electronics today! Just fill out the subscription order form below.



FOR FASTER SERVICE CALL TODAY

1-800-827-0383

(7:30AM-8:30PM) EASTERN STANDARD TIME

Popular Electronics® SUBSCRIPTION ORDER FORM

APEJ5

P.O. Box 338, Mt. Morris IL. 61054

YES! I want to subscribe to Popular Electronics for 1 Full year (12 Issues) for only \$18.95. That's a savings of \$23.05 off the newsstand price.

(Basic Subscription Rate—1 yr/\$21.95)

Payment Enclosed Bill me later

Please charge my: Visa Mastercard

Acct. #

Signature _____

Exp. Date _____

PLEASE PRINT BELOW:

NAME _____

ADDRESS _____

CITY _____

STATE _____

ZIP _____

Allow 6 to 8 weeks for delivery of first issue. U.S. Funds only.

In Canada add \$6.68 Postage (Includes G.S.T.).

All Other Foreign add \$7.50 Postage.

MAY THE SOURCE BE WITH YOU

Don't let the dark forces of ignorance defeat you. Right in this galaxy, you can tap into the source -- the free Consumer Information Catalog. It lists free and low-cost government publications on cosmic topics such as federal benefits, jobs, health, housing,



educating your children, cars, and much, much more. So dispel the darkness and send for the source. Write today to Pueblo, Colorado for the free Consumer Information Catalog. Just send your name and address to:

Consumer Information Center
Department Source
Pueblo, Colorado 81009

DTMF DECODER/LOGGER

(Continued from page 40)

both sides for cold solder joints and solder bridges. When you're sure everything seems okay, carefully insert U1, U2, and U3 into their sockets, making sure that they are oriented properly.

The PC board was designed to mount directly into a 3- x 4- x 2-inch plastic enclosure available from Digi-Key (part no. SR232G-ND). However, any box will do, provided it has the space for the PC board, display, and the parts of the switches that protrude into the enclosure. Cut a rectangular hole in the lid of the enclosure for the display to show through, and four holes below that for the three push-button switches, and the toggle switch.

Label the enclosure (using dry-transfer lettering or paper labels) as follows: S1—POWER; S2—CLEAR; S3—SHIFT BACK; and S4—SHIFT FWD. After you use dry-transfer lettering, it's a good idea to spray clear enamel on the surface for protection; give the enamel plenty of time to dry.

Mount the switches to the enclosure, being careful not to disrupt the lettering. The display should be mounted underneath the top side of the enclosure and positioned so that all characters will show through the rectangular hole in the case (when the module is upright, the ribbon cable will be at the top). The author used RTV silicon adhesive to mount the display to the case because it will not crack with any flexing of the plastic enclosure (epoxy will).

Mount the PC board to the bottom half of the enclosure with screws, and solder the four twisted pairs of wires you cut earlier to their appropriate switches and pads (see Fig. 4). Cut a small slot in the seam of the enclosure for the phone cord to exit. Tie a knot in the phone cord to be used as a strain relief and run the cord out the slot.

Operation. Attach a fresh 9-volt battery to the battery snap. Then, adjust trimmer-potentiometer R6 to its full clockwise position, and apply power. If all is well, a logo will appear on the display and remain there momentarily, then the display will clear itself. If that does not happen, remove power

and examine the board for errors. While viewing the logo, you can adjust R6 to set the contrast of the display to your liking.

Plug the phone cord of the DTMF Decoder/Logger into any phone jack on the line and use a touch-tone phone (on the same line) to begin entering numbers. As you do that, you will see those characters displayed on the LCD module. As the display fills up with new characters, it will start scrolling the old characters off the left hand side of the display. If you pause more than 10 seconds between entries, the next number entered will cause the display to clear, and the new character will be placed at the far left side of the display as if you had cycled the power switch or cleared the memory. That is for appearance only—all previously entered numbers are still held in memory.

At any time, you can press the SHIFT BACK button to scroll backwards and see all numbers that were previously entered (even though they had disappeared from the display). Pressing or holding down the SHIFT FWD button will return you back to the most recent entries, and the CLEAR button will erase all numbers stored in memory.

The memory will hold up to 240 characters, including the blank spaces between groups of numbers. When the memory fills up, the oldest entries will be overwritten by the new ones. Because the EEPROM uses its own dedicated address pointer, the scrolling action will automatically halt upon reaching the beginning or end of memory even if the memory is full. Also, all new touch-tone entries will always be added to the end of memory regardless of the portion of memory being viewed at that particular time.

Because the memory is stored in a non-volatile EEPROM, the DTMF Decoder/Logger can be turned off and still retain all data. When the unit is turned back on, the display automatically jumps to the end of memory and shows a blank screen. Use the SHIFT BACK button to scroll back and see all entries previously stored in memory.

And remember, you're not limited to just logging numbers dialed on a phone line you connect to. By feeding the input of a radio to the DTMF Decoder/Logger, who knows what numbers you'll capture and log! ■

MESSAGE STOPPER
(Continued from page 58)

connected from the phone line and continues to play the out-going message after the 5-second delay time

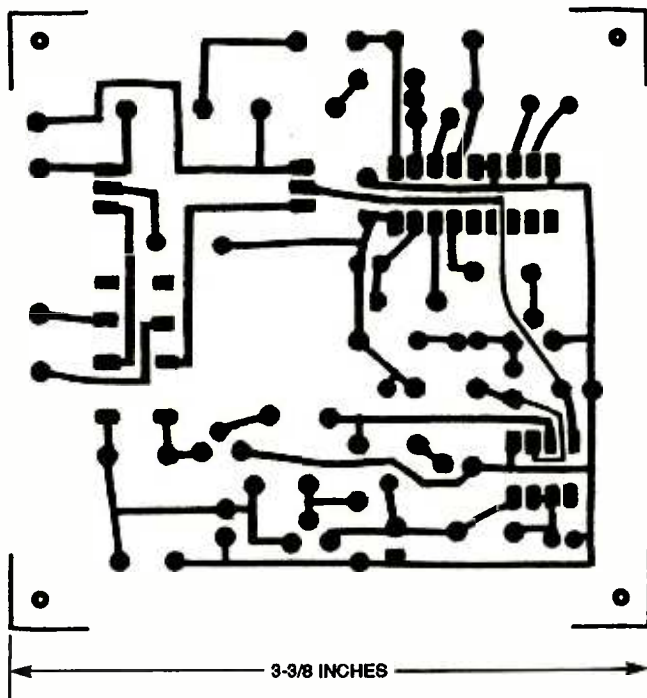

Fig. 2. If you'd like to build the Message Stopper on a printed-circuit board, use this template to etch your own.

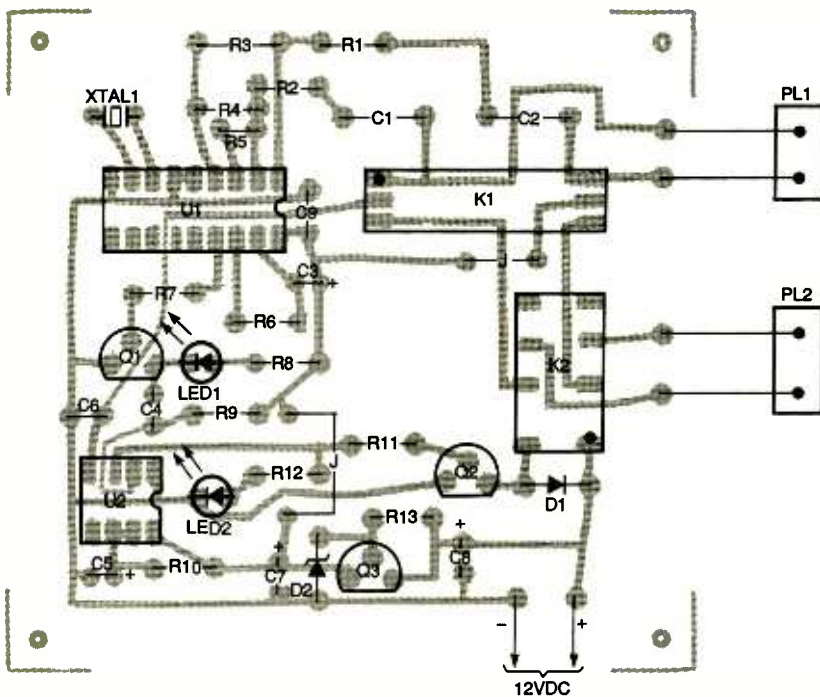
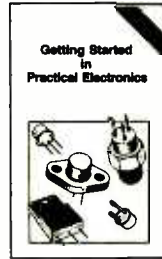

Fig. 3. Use this parts-placement diagram as a guide when installing the components on the board.

immediately, and will automatically reset for the next call. In the unlikely event that the answering machine doesn't detect that it has been dis-

expires, simply lengthen the project's delay time to equal that of the answering machine's out-going message and beep. ■

You can Build Gadgets!
Here are 3 reasons why!



BP345—GETTING STARTED IN PRACTICAL ELECTRONICS \$5.95

If you are looking into launching an exciting hobby activity, this text provides minimum essentials for the builder and 30 easy-to-build fun projects every experimenter should toy with. Printed-circuit board designs are included to give your project a professional appearance.

BP349—PRACTICAL OPTO-ELECTRONIC PROJECTS \$5.95

If you shun opto-electronic projects for lack of knowledge, this is the book for you. A bit of introductory theory comes first and then a number of practical projects which utilize a range of opto devices, from a filament bulb to modern infrared sensors and emitters—all are easy to build.



BP363—PRACTICAL ELECTRONIC MUSIC PROJECTS \$5.95

The text contains a goodly number of practical music projects most often requested by musicians. All the projects are relatively low-in-cost to build and all use standard, readily-available components that you can buy. The project categories are guitar, general music and MIDI.



Mail to:
Electronic Technology Today, Inc.
P.O. Box 240
Massapequa Park, NY 11762-0240

Shipping Charges in USA & Canada

\$0.01 to \$5.00.....\$2.00	\$30.01 to \$40.00.....\$6.00
\$5.01 to \$10.00.....\$3.00	\$40.01 to \$50.00.....\$7.00
\$10.01 to \$20.00.....\$4.00	\$50.01 and above.....\$8.50
\$20.01 to \$30.00.....\$5.00	

Sorry, no orders accepted outside of USA and Canada. All payments must be in U.S. funds only.

Number of books ordered.

Total price of books.....	\$ _____
Shipping (see chart)	\$ _____
Subtotal	\$ _____
Sales Tax (NYS only).....	\$ _____
Total enclosed	\$ _____

Name _____
Address _____
City _____ State _____ ZIP _____

Please allow 6-8 weeks for delivery.

ELECTRONICS ON A BUDGET

(Continued from page 50)

nated to the library specifically for resale. At one such recent sale, I purchased a set of five Intel data books for a mere \$2 each; a 1000% savings!

Another source of cheap books is used-book stores (although you should not even bother with the ones that sell mostly paperbacks). Further, check out the remainder or close-out sections of new-book stores. You could often pick up textbooks there for \$3 to \$5. Keep an eye out for older electronics and science books as they are sometimes more useful than current popular texts.

Another source for books is your local college or university. I've made friends with the staff at the electrical engineering department, and they have been more than willing to lend me any books I needed to aid in my self-studies.

Magazines like **Popular Electronics** are still my favorite source of information. They contain up-to-date information and give you a chance to find out what others are working on. All-in-all, magazines will always be the largest and cheapest single source of helpful data on a number of different subjects. They're well worth the few dollars a month they cost.

Computers. Many of you might be involved with electronics, and not computers, but the reality is the two of them go hand-in-hand. Computer hardware is available more and more through the methods outlined earlier. For example, I once paid \$2 apiece for four 1-MEG SIMMs. Believe it or not, someone had been using them for keychains! To this day, they are still in my computer system, and working perfectly!

Motherboards and hard drives were once big-ticket items. Now that they have come down in price, people are upgrading. That leaves all the older, unappreciated items left floating around, which means they could be picked up at rock-bottom prices. If your needs are more basic, and you don't intend to experiment with multimedia or anything else that needs top-of-the-line equipment, older gear could be perfectly useable. A 386 40-MHz motherboard could run

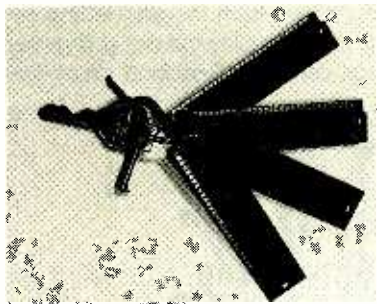

The deal of the century! These SIMMs were being used as a key chain yet were perfectly useable.

you as little as \$50, and a 386/16 costs about \$25! Five years ago, those boards ran for \$1000 and more. Talk about depreciation!

Saving Money With Microcontrollers. When I first started into electronics I was buying one IC after another. I would end up using 10 to 20 digital ICs for one simple project. If you figure an average price of \$1.20 per IC, it could add up to \$24 just for the logic chips, let alone the additional parts.

But that was then; I have now discovered the "future" of electronics: the microcontroller. That tiny marvel is essentially a complete computer on a single chip. Using software commands, the microcontroller could be made to function like a circuit consisting of as many as 30 discrete ICs. Add a few support components, and *Voilà!*, you have a project that would otherwise be out of reach in terms of complexity and cost for the average hobbyist.

Of course, to use microprocessors you have to make an initial investment of both money and time. The money part comes from the fact that you need to buy a programmer to use them; one could easily set you back \$100, or even more. The time investment is in learning assembly language, which for me represented a huge hurdle. But it is all worth it; you could easily save enough in a project or two to justify the expense of the programmer.

We've shown you various ways to keep your hobby going on a budget, and not be considered too much of a cheapskate! Of course, these are just some ideas to get you started. As you become more resourceful, you are sure to find many others. ■

SPACE WINGS

(Continued from page 56)

tremely thin and very sticky. You might not be able to find suitable tape at your local stationery store. It therefore might be worth your while to buy both the Muscle Wire and the wing base, if not the entire kit, from the source given in the Parts List.

Remove one end of the Muscle Wire from the board. Bend the wing base into a Y as shown in Fig. 6A, with the lower pieces of double-sided tape facing each other (see Fig. 6B). Attach it to the end of the PC board so that the Y-shaped base splits off about 1/4-inch above the top edge of the board (see Fig. 6C).

Stretch the Muscle Wire across the top of the wing base and reattach it to the board as shown in Fig. 7A. Remember that the wire should go from one side of the board to the other, cutting across the base diagonally. Tighten the wire in position so that the ends of the Y-shaped base point up as shown. Cut the wing material diagonally as shown in Fig. 7B, and cut the corners off the wings as shown. The corner cuts should be on the shorter side of each triangle.

Adhere the wings to the wing base as shown in Fig. 7C, leaving a 1/8-inch space between them as shown in Fig. 7D. Apply power and let the wings flap for awhile, and then readjust the Muscle Wire. The wings should open and close to the angles shown in Fig. 7E. When you are sure the wings are flapping properly, further secure the wing base to the board with clear tape, as shown in 7F.

If you intend to operate Space Wings continuously, you should use a 3-volt DC, 200-milliampere power adapter in place of the batteries. Note that exceeding 200 milliamperes could overheat the wire and reduce its operating lifetime.

Pick a Location. Space Wings is most impressive when it is placed in direct sunlight where its reflective wings create a light show of their own. It looks like some kind of electronic bug kept from flying away by a heavy battery pack. Just keep in mind that the Space Wings project is fragile and should be placed where it can not be easily damaged. ■

Market Center TM

Paperback Books

GREAT BOOKS AT BUDGET PRICES

100 RADIO HOOKUPS
—#7—\$3.00

First published in May, 1923 this popular booklet went into reprint editions nine times. It is packed with circuits, theory, antenna installation and tips on consumer radio receivers that were popular in the early 1920's. Antique radio buffs and those inquisitive about the early days of radio will find this booklet an exciting, invaluable and excellent reference into the minds of early-day radio listeners. Sorry, we cannot honor the original 25-cent cover price.

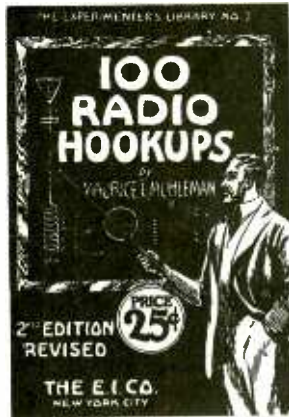

INTERNATIONAL RADIO STATIONS GUIDE—BP255
—\$9.95

Provides the casual listener, amateur radio DXer and the professional radio monitor with an essential reference work designed as a guide for listening to the complex radio bands. Includes coverage on Listening to Shortwave Radio, ITU Country Codes, Worldwide Radio Stations, European Long Wave and Medium Wave Stations, Broadcasts in English and more.

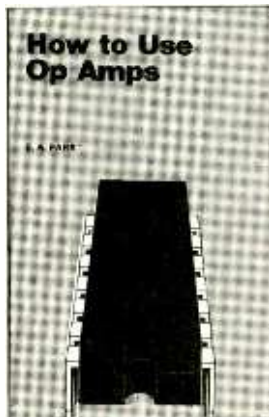
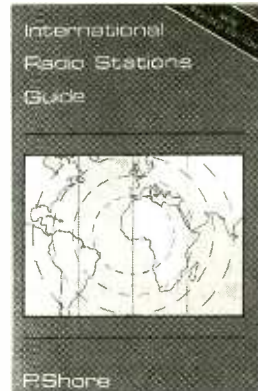

HOW TO USE OP AMPS
—BP88—\$5.95

The engineer's best friend is the op amp. This basic building block is found in many circuits, analog and digital alike. The op amp finds many useful purposes such as: oscillators, inverters, isolators, high- and low-filters, notch and band-pass filters, noise generator, power supplies, audio, MIDI, and much more. Prepared as a designer's guide, some limited math is used, however engineers and hobbyists alike find it a useful text for their design needs.



WIRELESS & ELECTRICAL CYCLOPEDIA
—ETT1—\$5.75

A slice of history. This early electronics catalog was issued in 1918. It consists of 176 pages that document the early history of electricity, radio and electronics. It was the "bible" of the electrical experimenter of the period. Take a look at history and see how far we have come. And by the way, don't try to order any of the radio parts and receivers shown, it's very unlikely that it will be available.

ELECTRONIC TECHNOLOGY TODAY INC.
P.O. BOX 240, Massapequa, NY 11762-0240

Name _____
Address _____
City _____ State _____ Zip _____

SHIPPING CHARGES IN USA AND CANADA

\$0.01 to \$5.00	\$2.00
\$5.01 to \$10.00	\$3.00
\$10.01 to 20.00	\$4.00
\$20.01 to 30.00	\$5.00
\$30.01 to 40.00	\$6.00
\$40.01 to 50.00	\$7.00
\$50.01 and above	\$8.50

SORRY No orders accepted outside of USA & Canada

Number of books ordered

Total price of merchandise	\$ _____
Shipping (see chart)	\$ _____
Subtotal	\$ _____
Sales Tax (NYS only)	\$ _____
Total Enclosed	\$ _____

All payments must be in U.S. funds!

ET01

ACE COMMUNICATIONS



Get instant tech information FREE from your Fax or Computer!

You can obtain specs, freq. info, software and more from our automated services. For fax facts, call from your stand alone fax machine and follow the voice prompts. Use the BBS from your modem of fax/modem equipped computer. Dial 317-849-8683 for fax back service, or dial 317-579-2045 for our computer bulletin board service.

Total Coverage Radios

TRIDENT
TR1200XLT
AM Broadcast to
Microwave 1000 Scan
Channels \$389.00

500KHz to 1300MHz coverage in a programmable hand held. Ten scan banks, ten search banks. Lockout on search and scan. AM plus narrow and broadcast FM. Priority, hold, delay and selectable search increments. Cell Lock. Permanent memory. 4 AA ni-cads and wall plus cig charger included along with belt clip, case, ant. & earphone. Size: 6 7/8 x 1 3/4 x 2 1/2. Wt 12 oz. Fax fact document # 205



TRIDENT
TR4500 \$449
2016 Channels
1 to 1300MHz
Computer Control
62 Scan Banks, 16
Search Banks, 35 Channels

per second. Patented Computer control for logging and spectrum display. AM, NFM, WFM, & BFO for CW/SSB. Priority bank, delay/hold and selectable search. Cell Lock Permanent memory. DC or AC with adaptors. Mtng Brkt & Antenna included. Size: 2 1/4H x 5 5/8W x 6 1/2D. Wt. 1lb. Fax fact #305



TRIDENT
TR980 \$279.00
125 Channels
5 MHz to
999MHz

Most Economical receiver in its class, offers AM, NFM Wide FM, modes. 5KHz increments. Delay & hold & Search. Cell Lock NiCads, chgr & whip ant. Size: 5 7/8H x 1 1/2W x 2 D. Wt 14oz.



Continuous Coverage



Three new Bearcat units offer expanded coverage and more memory than before. The 890 offers 200 channels, base/mobile operation, VFO tuning, service search, weather alert, search and store, and more. The 2500 hand held has 400 channels, fast scan and more. The Bearcat 8500 has 500 channels in 20 banks, VFO, auto store, alpha numeric display, 10 priority channels, aux tape output jacks, and coverage to 1.3 Gigahertz.

- Bearcat 2500XLTA hand held.....\$349.95
 - Bearcat 8500XLTC mobile.....\$389.95
 - Bearcat 890XLTB mobile.....\$259.95
- 25-1300MHz, 500 ch. in 8500, 400 in 2500. 890 has 200 ch. & 29-950MHz. All cell locked. Features include turbo scan, VFO, search and store, Priority, LCD display, and more. Fax Facts 474, 475, 476



Mobile Scanners

TRIDENT
TR2C
Police & CB
\$69.95

Scans police pre-programmed by state channel plus the CB channel of your choice. Also has Mobile Repeater and Weather. Extra cost option of CB and laser detectors built in. Compact size allows for dash or visor mounting. Mtng hardware and power connectors included. Size: 5 5/8 x 4 7/8 x 1 3/4. Wt: 1.5lbs. Fax fact #580



- Bearcat 700AX 50Ch w/800..... \$159.95
- Bearcat 350A 50 Ch H/L/U..... \$119.95
- Bearcat 560XLJ 16 Ch H/L/U..... \$ 89.95
- Bearcat 760XM100Ch H/L/U/Air/800 \$219.95
- Bearcat T2 state/state scan..... \$144.95

Shortwave Radios

- Sangean ATS-818CS..... \$219.95
- Sangean ATS-818..... \$184.95
- Sangean ATS-803A..... \$169.95
- Sangean ATS-808..... \$179.95
- Sangean ATS-606..... \$149.95
- Sangean ATS-606P..... \$169.95
- Sangean ATS-800..... \$89.95
- Grundig YB400..... \$219.00
- Grundig Satellit 700..... \$399.00



Hand Held Scanners

- Bearcat 200XLTN**
\$209.95 200 Channels 800 MHz
Ten scan banks plus search. Covers 29-54, 118-174, 406-512 and 806-956MHz (with cell lock). Features scan, search, delay, 10 priorities, mem backup, lockout, WX search, keylock. Includes NiCad & Chgr. Size: 1 3/8 x 2 11/16 x 7 1/2.
- Bearcat 120XLTL 100Ch H/L/U..... \$149.95
 - Bearcat 150XLTL 100Ch H/L/U/8..... \$199.95
 - Bearcat 220XLTL 200 Ch H/L/U/8.... \$249.95
- Coverage of above hand helds is: 29-54, 136-174, 406-512, and 800MHz band as indicated. Fax facts #475



Table Top Scanners

- Bearcat 855XLTE 50 Ch w/800..... \$159.95
- Bearcat 142XLM 10Ch H/L/U..... \$ 73.95
- Bearcat 147XLJ 16 Ch H/L/U/8..... \$ 89.95
- Bearcat 172XM 20Ch H/L/U/Air..... \$124.95
- Bearcat 145 16Ch H/L/U..... \$ 79.95

Accessories & Etc.

- Mag Mount Mobile Ant MA100..... \$ 19.95
- Base Ant. 25-1000MHz AS300..... \$ 59.95
- Pre-Amp .1-1500MHz GW2..... \$ 89.00
- Wide Coverage Antenna..... \$ 119.95
- Base Discone Ant DA300..... \$ 89.00
- External Speaker MS190/opt. amp... \$ 19.95
- Old Scanner Repair, all brands..... \$ CALL
- Extended Warranties..... \$ CALL
- Frequency Info FaxFact/Modem..... \$ FREE
- On Glass Mobile Antenna..... \$ 32.95

2 Way Radios

VHF hi band programmable mobiles as low as \$299.95. Call for quotes or Fax Fact #775

TRIDENT Winner of the 1994 INNOVATIONS Design & Engineering Honors, Electronic Industries Association. Trident TR2400 Total Coverage Receiver

Trident TR2400: 100KHz to 2060MHz. Ten scan banks of 100 channels each, ten search banks. Tuning increments as low as 1KHz. Beat Freq. Oscillator for SSB and CW modes. Search lockout and store. VFO tuning knob. Permanent memory. Bank lock and linking. Attenuator switch. Backlit LCD. 1 Yr Warranty. AM/NFM/WFM. Selectable increments. Delay, Hold, Priority. 5 7/8H x 1 1/2D x 2W. Wt 14 oz. \$499.00



Toll Free, 24 Hours! 800-445-7717 Fax Orders 800-448-1084 Fax Facts 317-849-8683
Computer BBS Modem & Fax/Modem, 317-579-2045. Toll Free Tech Support, Dial 800-874-3468
International Fax: en Espanol, en Francais, und auf Deutsch, or just fax in plain English to: 317-849-8794

ACE Communications 6975 Hillsdale Court, Indianapolis, IN 46250
Service & Support hours: Mon.-Fri. 9AM to 6PM, Sat. 10-4 EST. Mastercard, Visa, Checks, Approved P.O.'s & COD (add \$5.50) & AMEX, Discover. Prices, specifications and availability subject to change. Flat rate ground shipping and handling charge only \$6.95 per unit. Express Air only \$9.95, for most units, to most locations. One week trial, no returns accepted two weeks after original receipt without substantial restocking charge. All units carry full factory warranty. Indiana residents add 5 per cent sales tax.



FLY IT! ONLY \$9.95

RAINBOW KITS

The 10GHz transmitter is back...

The "ZAPPER II"

Rainbow's new amateur radio transmitter.

With it's new and improved design it will not only test your radar detector... BUT it's tuned to the amateur radio band.

- While your out on American highways personally test yours and your fellow travelers radar detectors.

The "ZAPPER II" is a 10.450 GHz to 10.550 CW oscillator. It has a code key jack installed for those who want to send Morse code.

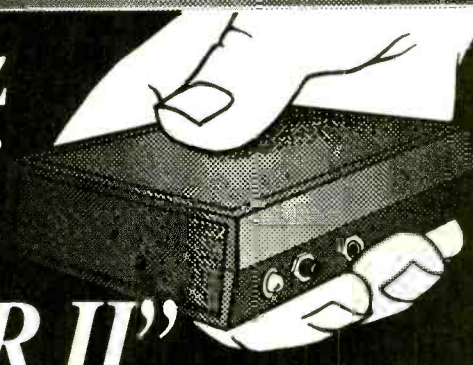

PHONE TRANSMITTER

Small but mighty, it fits anywhere. Phone line powered, never needs batteries. Transmits both sides of a phone conversation loud and clear, wireless, to any FM radio at great distances. Variable tunes from 70MHz to 130MHz FM. You can also use it as a speaker phone. SIZE: 1.25" x 6".

TEL-B1 KIT \$12.95 BUILT \$29.95



FM STEREO TRANSMITTER

Own your own FM radio station. Any stereo signal you plug into the FMST-100 will be transmitted to any FM radio tuneable from 76 to 108MHz FM. Transmit a wireless link through an auditorium, from your car to your camper, listen to your CD's while mowing the lawn, Play music on one channel sing on the other. Clarity is excellent, approx. 40dB stereo separation. Length of antenna determines the distance of transmission. Complete with stereo input level controls & crystal for stereo separation. 9v battery operation. SIZE: 1.5" x 2.5" x 3"

FMST-100 KIT \$29.95 / Cabinet \$8.95

BUILT \$49⁹⁵
KIT \$39⁹⁵



A stand alone D.T.M.F decoder display unit

Connects to any phone, scanner, or amateur radio.

DECODES ANY DTMF SIGNALS

- Decodes digits 0 thru 9, #, *, A, B, C on a 2 line 16 character LCD display.
- Use the scroll switch to display all 490 digits last stored in its memory bank
- * See what numbers people are calling on your phone?
- * Is someone hiding the numbers they are calling by using another credit card?
- * See the hidden phone numbers in your software.
- * Great for telephone installers
- * Who's using secret codes on the air waves. The DTMF DECODER can grab them from the air. Power requirement 9v DC. SIZE: 3.5" x 4" x 1"
- * Decode the thousand of secret numbers sent over your scanner daily,

COMPLETE WITH BLACK ANODIZED CABINET

DTMF-DIS KIT \$119⁹⁵ / BUILT \$159⁹⁵

TV NOTCH

FOR CHANNELS 2 thru 22 ONLY

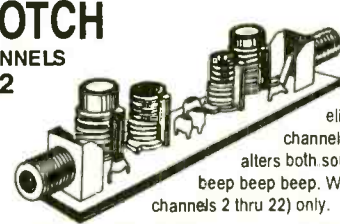

FILTERS

Our TV filters eliminate unwanted TV channels or interference that alters both sound and video with a beep beep beep. Works on cable channels 2 thru 22) only.

NOTE: All TV Filter Kits are sold for educational purposes only. You must obtain permission from your local cable company before using these filters on your cable system.

DF-222

KIT \$14.95



This Manual contains schematics, parts lists & P.C. board layouts for many of the Rainbow Kits. Use your own parts to construct our kits.

KIT BOOK

\$14.95 \$9.95 with the purchase of any kit.



WIRELESS FM MICROPHONE

Small but mighty this little jewel will out perform most units many times its price. It really

stomps out a signal. The WM-1 kit is a buffered wireless mike that operates from 80MHz to 120MHz FM, the frequency of any broadcast FM radio. Includes a mini-electret mike. 6 to 12v DC. SIZE: 1.25" x 1"

WM-1 KIT \$14.95

Please add sufficient postage First lb \$5.00 Canada \$7.00 Additional LB. Add \$1.00 US FUNDS ONLY We will accept telephone orders for Visa or Mastercard



To Order Call 317-291-7262



ELECTRONIC RAINBOW INC

6254 LaPas Trail • Indianapolis, IN 46268
FAX 317-291-7269

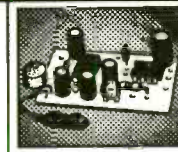

SUPER SNOOPER BIG EAR

Listen through walls, hear conversations across the room. Add a parabolic reflector and hear blocks away. The BIG EAR can be hidden about anywhere. Makes an ultra sensitive intercom. Can be used as a 1.5W AMP. We supply a mini-electret mike in the kit. Power requirement 6 to 12v DC. SIZE: 1" x .75"

AA-1 KIT \$10.95 BUILT \$29.95

ALL ELECTRONICS CORP.

QUALITY PARTS • DISCOUNT PRICES • FAST SERVICE • HUGE SELECTION

JUMBO LEDs

Liton # LTL 327C - 8MM
Ideal for eye-catching indicators and displays. A recent quantity purchase of these BIG, 8mm diameter, red diffused LEDs enables us to provide some very special pricing. The leads on these devices are 0.325" long with plenty of room for soldering.



5 for \$1⁰⁰ CAT# LED-23
100 for \$ 15.00
1000 for \$ 120.00

VIDEO SWITCHING CENTER



Gemini # SC1600
Special purchase of these video signal switching centers allows us to sell them for 65% to 75% less than their original price. Enables five signal input to be switched to your TV or three signal inputs to be switched to your VCR. Watch one channel while recording another. F connectors on input. Use with antenna, CATV, VCR, laser disc, game or computer. 6.37" X 4.7" X 1.58". Brand-new, individually boxed, includes instructions.

CAT# SC-1600 **\$8⁰⁰** each

6 FOOT VIDEO HOOK-UP CABLE



High quality 6' video patch cables. Belden # 9104 "Duobond" dual shielded RG-59 cable with heavy-duty F connectors hex-crimped onto each end. Large quantity available.

\$1⁰⁰ each
CAT# VHU-6S
10 for \$7.50 • 100 for \$60.00

INCREDIBLE SAVINGS! 30' CABLE



Originally made to connect Digital Audio Tape machine to a remote controller, this "snake" cable consists of four separate 9 conductor plus drain wire, foil-shielded cables in one jacket. The conductors are stranded 24 AWG wire. Each end of each smaller cable is terminated with DB-9P connectors. The cable is well-made and quite flexible for its size. Snake cable nominal O.D. is 0.52". Interior cable O.D. is 0.15". The outer jacket can be slit and removed if only the 9 conductor cable is required. DB-9 connectors include thumbscrew hold-downs. If you are using multiconductor shielded cable this is a great deal.



\$5⁵⁰ each

2 for \$10.00

CAT# CBL-3

7 Vdc MOTOR

Matsushita # MMX- 7AC O 8A
1.25" diameter x 1.25" high motor. Prepped with 1.61" diameter flywheel, pulley and fiber glass mounting board.



CAT# DCM-54

\$1⁰⁰ each

10 for \$9.00
100 for \$80.00

"HI-8" VIDEO CASSETTE (USED)

8 mm Video Camcorder Users!.

SONY Hi-8
Top quality, metal particle 120 minute video cassettes. Used for a short time, then bulk-erased. Each cassette has its own plastic storage box. Satisfaction Guaranteed.



\$3⁰⁰ each

10 for \$28.00
100 for \$250.00

CAT # VCU-8

9 VOLT 60 MA SOLAR PANEL

These 6" X 6" glass enclosed photovoltaic panels produce 9 Vdc at 60 mA. Ideal for charging batteries and powering small devices. Put two or more together for more current and voltage. Includes metal connectors and instructions for soldering directly to panel.



CAT # SPL-960

\$5²⁵ each

640 X 480 LCD PANELS WITH BUILT-IN DIGITIZER

Two sizes available, both originally designed for laptop computer/note pad. Built-in digitizer to be used with a stylus for hand written notations. Onboard drivers operate on 5 vdc (logic) and 18 vdc (LCD). Full documentation on both units.

SHARP LM64P90

Built-in CCFT backlight. Overall dimensions: 10.19" x 7" x 0.35" Viewing area: 7.88" X 6" Dot size: 0.27mm X 0.27mm. White dots on black background. CAT # LCD-31

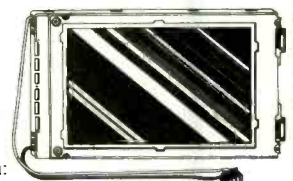

\$40⁰⁰

SHARP LM64194F

Overall dimensions: 8" x 5.75" Viewing area: 6" X 4.5". Dot size: 0.21mm X 0.21mm Black dots on white background. CAT # LCD-32

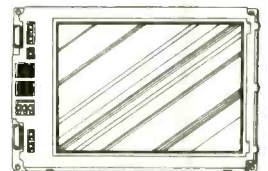

\$40⁰⁰

MANUFACTURERS - We Purchase EXCESS INVENTORIES... Call, Write or Fax YOUR LIST.

CALL, WRITE
or FAX For A
Free 64 Page
CATALOG.
Outside the U.S.A.
send \$2.00 postage.

ORDER TOLL FREE **1-800-826-5432**

MAIL ORDERS TO:
ALL ELECTRONICS CORP.
P.O. BOX 567
VAN NUYS, CA 91408-0567

FAX (818) 781-2653
INFO (818) 904-0524

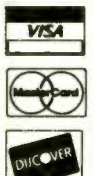

NO MINIMUM ORDER • All Orders Can Be Charged to Visa, Mastercard or Discover • Checks and Money Orders Accepted by Mail • Orders Delivered in the State of California must include California State Sales Tax • NO C.O.D • Shipping and Handling \$5.00 for the 48 Continental United States • ALL OTHERS including Alaska, Hawaii, P.R. and Canada Must Pay Full Shipping • Quantities Limited • Prices Subject to change without notice.

CIRCLE 28 ON FREE INFORMATION CARD

Check Out These Deals From CIRCUIT SPECIALISTS!

Circuit Specialist's Positive Photo Resist Pre-Sensitized Printed Circuit Boards



These pre-sensitized printed circuit boards are ideal for small production runs. They provide high resolution and excellent line width control. High sensitive positive resist coated on 1oz. copper foil allows you to go direct from your computer plot or artwork layout. No need to reverse art.

Single-Sided, 1oz. Copper Foil on Paper Phenolic Substrate

CAT NO	DESCRIPTION	PRICE EACH		
		1	10	50
PP101RE	100mm x 150mm/3.91" x 5.91"	\$2.55	\$1.90	\$1.70
PP114RE	114mm x 185mm/4.6" x 6.6"	2.98	2.45	1.98
PP152RE	150mm x 250mm/5.91" x 9.84"	5.40	3.98	3.60
PP153RE	150mm x 300mm/5.91" x 11.81"	6.15	4.48	4.10

Single-Sided, 1oz. Copper Foil on Fiberglass Substrate

CAT NO	DESCRIPTION	PRICE EACH		
		1	10	50
GS101RE	100mm x 150mm/3.91" x 5.91"	\$ 3.90	\$2.98	\$2.60
GS114RE	114mm x 185mm/4.6" x 6.6"	4.80	3.49	3.20
GS152RE	150mm x 250mm/5.91" x 9.84"	8.69	5.98	5.78
GS153RE	150mm x 300mm/5.91" x 11.81"	10.20	7.20	6.80

Double-Sided, 1oz. Copper Foil on Fiberglass Substrate

CAT NO	DESCRIPTION	PRICE EACH		
		1	10	50
GD101RE	100mm x 150mm/3.91" x 5.91"	\$ 5.07	\$3.68	\$3.38
GD114RE	114mm x 185mm/4.6" x 6.6"	5.95	4.29	3.99
GD152RE	150mm x 250mm/5.91" x 9.84"	10.47	7.39	6.98
GD153RE	150mm x 300mm/5.91" x 11.81"	11.95	8.69	8.30

Etching Chemicals/Ferric Chloride

A dry concentrate that mixes with water to make 1 pint of etchant, enough to etch 400 sq. inches of 1oz board.



CAT NO	DESCRIPTION	PRICE EACH	
		1	5
ER-3RE	Makes 1 pint	\$3.50	\$2.75



Developer

This product is used as the developer on our positive photo-resist printed circuit boards. Includes instructions, 50 gram package, mixes with water, makes 1 quart.

CAT NO	DESCRIPTION	PRICE EACH		
		1	10	25
POSDEVRE	Positive Developer	\$.95	\$.80	\$.50

Etching Tank



REDUCES ETCHING TIME!

This attractive injection moulded designed tank is ideal for etching your PCBs. It includes a thermostatically controlled glass heater, electric agitator and PCB hanging accessories. Measuring graduations are included. Maximum PCB size is 160mm x 250mm or 200mm x 250mm w/o heater. Typical etching time is 4 minutes.

CAT NO	DESCRIPTION	PRICE
ET10RE	Etch Tank System	\$52.00

QUANTITY PRICING DOES NOT APPLY TO MIXED ITEMS!

Electronic Soldering System

Here's the ideal solution when Temperature Control is required. Easy to use slide control allows user to set system from 300°F to 840°F. Voltage to iron from control unit is 24V. Iron heating power is 48W. Replaceable 5.3mm tip is standard. Replacement irons and tips are available.

CAT NO	DESCRIPTION	PRICE EACH	
		1	5
SL10RE	Temperature Controlled Soldering Iron	\$56.00	\$50.00
SL24VRE	Spare 24V Soldering Iron	10.50	7.50



Electronic Soldering System AS LOW with LED Display AS \$75.00

Deluxe temperature controlled system with LED display for maximum accuracy. Temperature is adjustable from 160°-480°C (320°-900°F). Iron heating power is 48 Watts. Runs on 24V from controller unit. Replacement irons and tips are available. Tip size is 5.3mm.

CAT NO	DESCRIPTION	PRICE EACH	
		1	5
SL30RE	Deluxe Soldering System	\$86.00	\$75.00
SL24VRE	w/LED Spare 24V Soldering Iron for SL10 or SL30	10.50	7.50



Replacement Tip



Replacement Tips for SL10/SL30

We now offer a variety of replacement tips for the SL10/SL30 soldering stations.

CAT NO	DESCRIPTION	PRICE EACH	
		1	5
821RE	1/32" Pencil Tip	\$1.39	\$1.19
822RE	1/32" Pencil Tip	1.39	1.19
823RE	1/64" Pencil Tip	1.39	1.19
824RE	1/16" Chisel Tip	1.49	1.29
825RE	1/8" Chisel Tip	1.49	1.29
826RE	3/64" Chisel Tip	1.49	1.29
827RE	3/64" Pencil Tip	1.59	1.39

RECEIVE YOUR FREE COPY OF OUR 100 PAGE CATALOG!

It's chock full of all types of electronic equipment and supplies. We've got I.C.'s, capacitors, resistors, pots, inductors, test equipment, bread-boarding supplies, PC supplies, industrial computers, data acquisition products, personal computers and computer parts, plus much, much more. FAX us your name and address or call 800-528-1417, ext. 5 and leave a message on our catalog request line.

CIRCUIT SPECIALISTS, SINCE 1971

800-528-1417
602-464-2485
602-464-5824 (FAX)

WE ACCEPT:

**VISA, Mastercard, Discover Card
& American Express**



New and Pre-Owned Test Equipment

Substantial **SAVINGS** on New & Pre-Owned B+K Precision, Fluke, Hewlett-Packard, Goldstar, Leader, Tektronix, and more ...



GoldStar Precision

New Oscilloscope Specials

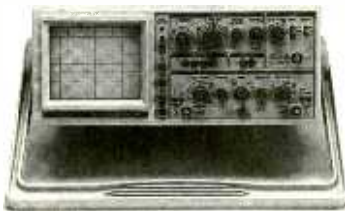

FREE SHIPPING!
ON ALL GOLDSTAR EQUIPMENT
ANYWHERE IN THE U.S.
Excluding AK & HI

SUPER SALE!

Model OS-9100P → **\$999.00**
Full 100 MHz Bandwidth!

Model OS-904RD - 40 MHz Bandwidth → **\$699.00**
On-Screen Measuring Cursors & Readout!

- TV Synchronization Trigger
- Dual-Channel, High Sensitivity
- Calibrated Delayed Sweep
- Two Probes Included
- 2 Year Warranty

**WE BUY
SURPLUS EQUIPMENT!**

Professional Quality Digital Storage Oscilloscopes at Affordable Prices!

Transmit and Receive Data with Standard RS-232C Interface

- Includes FREE Comprehensive Communication Software
- Waveform Save, Calculation, and Print
- Dual Channel, Delayed Sweep, TV Synchronization Trigger
- 20 MS/s Sampling Rate, Two Save Memories
- Switch Between Analog and Digital Modes
- CRT Readout Including Measurement Cursors
- Includes Two Probes, 2 Year Warranty.

Bandwidth	20 MHz	40 MHz	60 MHz
Model	OS-3020	OS-3040	OS-3060
SALE Price	\$1,199.00	\$1,599.00	\$1,899.00

Full line of Oscilloscopes, RF, Video & Audio Test Equipment, Power Supplies, Meters, Probes and Accessories.

TOLL FREE 1-800-99-METER

1-800-996-3837



Pre-Owned Oscilloscope Specials

Tektronix 465	100 MHz	\$589.00
Tektronix 465B	100 MHz	\$689.00
Tektronix 475	200 MHz	\$749.00
Tektronix 475A	250 MHz	\$849.00

- Professionally Refurbished
- Calibrated to Original Specifications
- Dual Channel, Calibrated Delayed Sweep
- 90 Day Warranty



BK PRECISION
MAXTEC INTERNATIONAL CORP.

NTSC Generator with RGB
Model 1249A \$569.00

- NTSC Color Bars $\pm 5^\circ$ and ± 5 IEEE Units
- Ch. 3, 4, and IF Outputs Crystal Controlled
- Calibrated 1 Vp-p or Variable Composite Video Output
- RGB Outputs on BNC or 9-pin D Connector
- Composite, Vertical, and Horizontal Sync. Outputs
- Interlaced or Progressive Scan
- 1 Year Warranty

Hand-Held Parts Tester Model 815 \$99.00

- Large 0.8" digits, 26 User Ranges
- Tests Transistor hFE and Leakage Icc
- Checks SCR's, Diodes, LED's, Caps, and Resistors
- Tests Batteries Under Actual Load Conditions
- 1 Year Warranty

Variable 1-150VAC Isolation Transformer
Model 1653 \$299.00

- Metered Display of Voltage or Current
- 2 Amp. Continuous Output
- Eliminate Shock Hazard while servicing "Hot-Chassis" Equipment

FOTRONIC CORPORATION

P.O. BOX 708
Medford, MA 02155

(617) 665-1400

FAX (617) 665-0780



100-LE
 AC/DC Voltages
 Cont. Tester-
 Buzzer
 3-1/2 Digit LCD
 Low Battery
 Indicator
 Battery Test
 #990087
\$19⁹⁵



150-LE
 Transistor
 Battery Test
 DC Current
 10 Amp
 #990122
\$29⁹⁵



200-LE
 Freq. Counter
 up to 20MHz
 Capacitance
 from 1pF to 20uF
 Transistor
 AC/DC Current
 10 Amp
 #990123
\$49⁹⁵



400-LE
 Inductance
 resolution of 1uH
 Freq. Counter
 up to 20MHz
 Cap. from
 1pF to 200uF
 AC/DC Current
 Transistor
 Duty %
 20 Amp
 #990124
\$79⁹⁵

STANDARD FEATURES: ▲ AC/DC Voltages ▲ DC Current ▲ Resistance
 ▲ Continuity Tester Buzzer ▲ Diode Test
 ▲ 10M ohm Input Imp. ▲ Accuracy +/- 0.5% RDG

Protective Meter Cases for 100-300LE990088 ..\$4.95
 Protective Meter Case for 400LE990094 ..\$4.95

THE ULTIMATE METER

Popular Electronics (reviewed 5/93)
 "Not only does the Kelvin 94 boast a lot of features...the features go the extra distance."
 "If we had to run into a burning building to do some emergency trouble-shooting and could carry only one piece of equipment, the Kelvin 94 would be it!"

★ True RMS, LCR, Hz, dBm ★ 0.1% Accuracy ★



12 INSTRUMENTS IN ONE!
 DC Voltmeter,
 AC Voltmeter,
 Ohmmeter,
 AC Current,
 DC Current,
 Diode Tester,
 Audible Cont.
 Tester, dBm,
 Freq. Counter,
 Capac. Meter,
 Inductance
 Meter,
 Logic Probe
 #990111
\$199⁹⁵

Protek MODEL B-803



2MHz Sweep Function Generator

- ★ Output Frequency of 0.02Hz to 2MHz on 7 ranges
 - ★ Output: sine, triangle, square, pulse, ramp or slewed sine wave
 - ★ 4 digit frequency counter
 - ★ With sync output (TTL), VCF, DC offset, variable symmetry
 - ★ Square wave rise time: 100ns or less
- #720129 **\$299⁹⁵**

Protek MODEL P-3502C



20MHz "Afford-A-Scope"

- ★ 2 Channels
 - ★ Built-in component tester for resistors, capacitors, and diodes
 - ★ 6" CRT with internal graticule
 - ★ TV trigger
 - ★ CH2 Invert
 - ★ 2-Axis input
 - ★ Includes 2 probes
 - ★ 2-Yr. warranty
- #720085 **\$385**

Protek MODEL P-3003



Regulated DC Power Supply

- ★ 0-30V, CV; 0 to 3A, CC
 - ★ 2 Separate LED displays (green for voltage, red for current)
 - ★ Constant voltage & constant current operation
 - ★ Fully isolated outputs allow series or parallel operation
 - ★ Includes (1) set of test leads & operation manual
 - ★ Overload protected
 - ★ 2-Yr. warranty
- #690038 **\$225**

ALFA ELECTRONICS

HIGH QUALITY TEST EQUIPMENT
BEST PRICE



DMM 89 \$199.95
Most Advanced DMM
All Purpose & Communication
-80.7 to 81.4 dBm with 4Ω -1200Ω
20 reference impedances
True RMS
Frequency counter: 0.01Hz-10MHz
Capacitance: 1pF-50,000μF
Measure AC volt to 20kHz
5000 counts, 0.1% accuracy
Auto/manual range, fast bar graph
Min/Max/Ave/DH/Relative/Zoom
Auto power off
Input warning
Volt, amp, ohm, logic, diode, continuity
Ruggedized case
Rubber holster included



DMM 2360 \$119.95
DMM+LCR Meter
Very Versatile DMM
Inductance: 1μH-40H
Capacitance: 1pF-40μF
Frequency: 1Hz - 4MHz
Temperature: -40-302 °F
TTL Logic Test: 20MHz
Diode, Continuity
Volt, Amp, Ohm
3999 count display
Peak Hold
Auto power off
Ruggedized case
Temperature probe included
Rubber Holster \$8.00



DMM 20 \$74.95
Inductance: 1μH-40H
Capacitance: 1pF-200μF
Frequency: 1Hz-20MHz
Volt, amp, ohm, diode,
20 Amp AC/DC current
Transistor HFE
Continuity, duty %
Peak hold/Max
Ruggedized case
Rubber holster \$8.00

Fluke Multimeter
Fluke 12 \$84.95
Holster C-10 \$10
Fluke 70 II \$67.5
Fluke 73 II \$94
Fluke 75 II \$129
Holster C-70 \$16
Fluke 77 II \$149
Fluke 79 II \$169
Fluke 29 II \$169
Fluke 83 \$225
Fluke 85 \$259
Fluke 87 \$287
Fluke 97
Scope Meter \$1785

Full line of DMMs,
economy, compact,
ruggedized, solar cell,
automotive, heavy
duty, industrial,
starts from \$15.95



LCR Meter 131D \$229.95
Most Advanced LCR
Dual display: L/Q or C/D
Inductance: 0.1μH-1000H
Capacitance: 0.1pF-10,000μF
Impedance: 1mΩ-10MΩ
0.7% basic accuracy
Auto/manual range
Dissipation factor & Q factor
Serial & parallel mode
Relative mode for comparison
and to remove parasitics
Statistics, tolerance,
Best for design, incoming
testing & production
SMD and chip component
test probe \$25.00



LCR Meter 814 \$189.95
Best Resolution LCR
Inductance: 0.1μH-200H
Capacitance: 0.1pF-20,000μF
Resistance: 1mΩ-20MΩ
1% basic accuracy
Dissipation factor indicates leakage
in capacitor and Q factor in inductor
Zero adjustment to reduce parasitics
Best for high frequency RF
SMD and chip component test probe
\$25.00
LIMITED QUANTITY SPECIAL
DIGITAL LCR METER \$74.95
0.1pF, 1μH, 10mΩ resolution

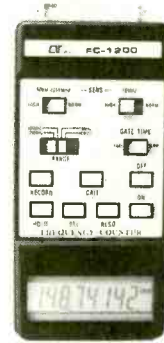

Frequency Counter FC-1200 \$129.95
Frequency: 0.1Hz-1.25GHz
Display: 8 digit LCD
Period: 0.1μs-0.1s
Records Max/Min/Average
Data hold, relative mode
Telescoping antenna \$8.00
Deluxe case \$5.00
Also Available:
AC/DC clamp meter, Light meter,
Thermometer, pH meter, High
voltage probe, Digital caliper,
Anemometer, Electronic scale,
Force gauge, Tachometer,
Stroboscope, Humidity & EMF
adapter, Sound level meter,
Frequency counter, SWR/field
strength/power meter, Dip meter

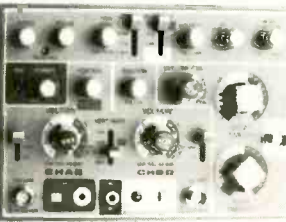

20 MHz Oscilloscope with Delay Sweep PS-205 \$429.95
Dual Trace, Component test, 6" CRT, X-Y Operation, TV Sync, Z-Modulation, CH2 Output, Graticule Illum, 2 probes each has x1, x10 switch. Best price with delay sweep.
PS-200 20 MHz DUAL TRACE \$339.95
PS-400 40 MHz DUAL TRACE \$494.95
PS-405 40 MHz DELAY SWEEP \$569.95
PS-805 60 MHz DELAY SWEEP \$769.95
Scope Probe: 60MHz x1, x10 \$15, 100MHz x1, x10 \$22
250MHz x1, x10 \$29, 250MHz x100 \$39

Digital Storage Scope
DS-203 20MHz, 10M Sample/sec \$729.95
DS-303 30MHz, 20M Sample/sec \$849.95
DS-303P with RS-232 interface \$1,049.95
Switchable between digital and analog modes
2 K word per channel storage
8 bit vertical resolution (25 Level/div)
Expanded Timebase 10ms/div - 0.5 s/div
Refresh, Roll, Save all, Save CH2, Pre-Trig
Plotter control

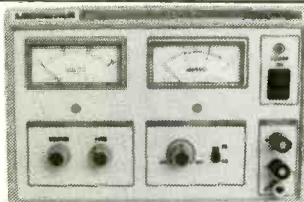

DC Power Supply PS-303 \$159.00
0-30 VDC, 0-3A output
Constant voltage & constant current mode
0.02% + 2mV line regulation
0.02% + 3mV load regulation
1 mVrms noise and ripple
Short circuit and overload protected
PS-8200 with digital voltmeter \$179.00
Also available: 30V/5A, 60V/3A, 60V/5A
16V/10A, 30V/10A



DC Power Supply Triple Output PS-8202 \$499.95
Two 0-30 VDC, 0-3A outputs
One fixed 5VDC, 3A output
Capable of independent or tracking operation
Constant voltage and constant current mode
Four digital meters for volt and current display
Excellent regulation and low ripple
Short circuit and overload protected
Also available: 30V/5A triple output \$549.95
Dual tracking 30V/3A, 30V/5A, 60V/3A, 60V/5A

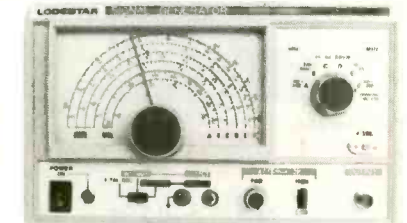

RF SIGNAL GENERATOR SG-4160B \$119.00
100 kHz-150MHz sinewave in 8 ranges
RF Output 100mVrms to 35 MHz
Internal 1kHz, External 50Hz-20kHz
AM modulation
Audio output 1 kHz, 1 Vrms

AUDIO GENERATOR AG-2601A \$119.00
10Hz - 1MHz in 5 ranges
Output: 0-8Vrms sinewave
0-10Vp-p squarewave
Synchronization: ±3% of oscillation frequency per Vrms
Output distortion:
0.05% 500Hz - 50kHz
0.5 % 50Hz - 500kHz
Output impedance: 600 ohm

FUNCTION GENERATOR FG-2100A \$169.95
0.2 Hz - 2 MHz in 7 ranges
Sine, square, triangle, pulse and ramp
Output: 5mV-20Vp-p
1% distortion, DC offset ± 10V
VCF: 0-10V control frequency to 1000:1



RF SIGNAL GEN./COUNTER SG-4162 AD \$229.95
Generates RF signal same as SG-4160B
8 digit frequency counter 1Hz - 150 MHz for internal and external source Sensitivity <50mV

AUDIO GEN./COUNTER AG-2603AD \$229.95
Generates audio signal same as AG-2601A
8 digit frequency counter 1Hz-150MHz for internal and external sources Sensitivity <50mV

FUNCTION GEN./COUNTER FG-2102AD \$229.95
Generates signal same as FG-2100A
Frequency counter 4 digits
Feature TTL and CMOS output
SWEEP FUNCTION GEN./COUNTER \$329.95
0.5Hz to 5 MHz in 7 ranges
Sweep: Linear 10:1/Log 10:1 20ms to 2s
AM Modulation
Gated Burst, Voltage Control Generator
Generator Control Voltage & 8 digit counter
1Hz-10MHz for internal & external sources

ALFA ELECTRONICS

741 Alexander Rd., Princeton, NJ 08540

(800) 526-2532/(609) 520-2002 15 DAY MONEY BACK GUARANTEE. 1 YEAR WARRANTY

FAX:(609) 520-2007

CALL OR WRITE FOR FREE CATALOG AND BEST OFFER.

Visa, Master Card, American Express, COD, Purchase Order Welcome

CIRCLE 26 ON FREE INFORMATION CARD

Are Cable Companies Sucking You Dry?



All Major
Brands!

FREE
Catalog!

Take a Bite out of High Rental Fees
with your own

Converters & Descramblers



Everquest • Panasonic • Jerrold • Zenith • Pioneer
Scientific Atlanta • Oak • Eagle • Hamlin • Tocom



Order
Toll-Free **1 800 624-1150**

Call today for a FREE catalog!

MD Electronics

875 S. 72 Street • Omaha, NE 68114



CALL TOLL FREE
 1-800-292-7711
 1-800-445-3201 (Can)

C&S SALES

EXCELLENCE IN SERVICE

**WRITE FOR
 FREE CATALOG**



**Line Tracker
 MV-963
 \$52.95**
 (Infra-red Sensor)
 The robot follows
 a black line
 on white paper
 Preassembled PCB



**Dual-Display
 LCR Meter
 w/ Stat Functions
 B+K Model 878
 \$239.95**
 Auto/manual range
 Many features
 with Q factor
 High Accuracy

Electronic Tool Kit Model TK-1000
 A professional organizer tool kit at affordable prices. No student should be without this unique tool kit that holds all the tools you need.
\$39.95

Including:
 Diagonal Cutter
 Long Nose Pliers
 6" Wire Stripper
 Solder 60/40
 6" Screwdriver
 6" Phillips Driver
 Safety Goggles
 IC Puller
 3pc Nut Drivers
 Iron 25W
 Iron Stand
 Solder Wick
 Desoldering Pump
 5 pc Solder Ease Kit
 6pc Precision Screwdrivers



**Robotic Arm
 Y-01
 \$49.95**
 (Wired Control)
 Movement grabs
 & releases,
 lifts & lowers,
 pivots from side to side



**Stereo Cassette Player
 Kit
 Model
 TR-18K
 \$16.95**
 Headphones
 Included



**Digital
 Multimeter
 EDM-83B
 \$175.00**
 Almost every
 feature available
 Bargain of the
 decade



**Elenco
 LCR + DMM
 LCM-1950
 \$79**
 12 Functions
 Freq to 4MHz
 Inductance
 Capacitance



**Digital
 Capacitance
 Meter
 CM-1555
 \$49.95**
 Measures capacitors
 from .1pf to 20,000µf



**Digital
 LCR Meter
 LCR-680
 \$79.95**
 3-1/2 Digit
 LCD Display
 Inductance
 1µH to 20MΩ



**Function Generator
 GF-8026
 \$239**
 In/Ext
 Operation
 Sine, Square, Triangle, Pulse
 Ramp, 2 to 2MHz, Freq Ctr



**3-3/4 Digit Multimeter
 BK-390
 \$139.00**
 0.1% DCV accy
 Analog bar graph
 Auto/manual ranging
 Capacitance meas
 Temperature probe



**Digital
 Multimeter Kit
 w/ Training Course
 M-2665K
 \$49.95**
 Full function 34 ranges
 Ideal school project



**Frequency Counter
 F-1225
 \$225.00**
 8 Digit LED display
 Wide meas range
 High sensitivity
 Data hold function
 Input impedance 1MΩ or 50Ω
 10:1 input attenuation function

**Fluke Multimeters
 (All Models Available Call)**

Scopemeters	70 Series
Model 97 \$1,795	Model 7011 \$69.95
10 Series	Model 7311 \$97.50
Model 10 \$62.95	Model 7711 \$149
Model 12 \$84.95	Model 7911 \$175
20 Series	80 Series
Model 2911 \$175	Model 87 \$289



**Triple Power
 Supply
 XP-620
 By Elenco
 \$75.00**
 3 fully regulated supplies; 1.5-15V @ 1A, -1.5 to -15V @ 1A or 3-30V @ 1A & 5V @ 3A Kit XP-620K \$49.95



**Quad Power
 Supply
 XP-581
 By Elenco
 \$79.95**
 Four supplies in one unit; 2-20V @ 2.5A, 5V @ 3A, -5V @ .5A and 12V @ 1A. All regulated and short protected



**High Current DC
 Power Supply
 BK-1686 \$169.95**
 3 to 14 VDC Output
 12A @ 13.8V
 For servicing high
 power car stereos,
 camcorders, ham radios, etc.
 Connect 2 or more in parallel



**Wide Band
 Signal
 Generators
 SG-9000
 \$124.95**
 RF Frequency 100K-450MHz
 AM modulation of 1KHz Variable
 SG-9500 150MHz \$239.00

**Telephone Kit
 PT-223K
 \$14.95**
 Available
 Assembled
 PT-223
 \$15.95



**Function Generator
 Blox
 #9600
 By
 Elenco
 \$29.95**
 Kit \$28.95
 Sine, Triangle, Square Wave



**Learn to Build & Program
 Computers with this Kit**



**MM-8000
 By Elenco
 \$129.00**

From scratch you build a complete system. Our Micro-Master trainer teaches you to write into RAMs, ROMs and run a 8085 microprocessor, which uses similar machine language as IBM PC.

**Digital/Analog Trainer
 Complete Mini-Lab For Building,
 Testing, Prototyping Analog and Digital**



**By Elenco
 in U.S.A.**
 XK-525
 \$159.95
 Kit
 XK-525K
 \$129.95

**AM/FM Transistor
 Radio Kit
 with Training Course
 Model AM/FM 108
 \$29.95**
 14 Transistor, 5 Diodes
 Easy to build because
 schematic is printed on the PCB
 Makes a great school project
 Model AM-550 AM Only \$17.95

**Telephone Line
 Analyzer**
 Kit TT-400K \$19.95
 Assembled TT-400 \$26.95



WE WILL NOT BE UNDERSOLD
 UPS SHIPPING: 48 STATES 5%
 IL RES 7.5% TAX (\$3 min \$10 max)
 OTHERS CALL

C&S SALES INC.
 1245 ROSEWOOD, DEERFIELD, IL 60015
 FAX: 708-520-0085 (708) 541-0710



**15 DAY MONEY BACK
 GUARANTEE
 FULL FACTORY WARRANTY**
 PRICES SUBJECT TO CHANGE WITHOUT NOTICE

**FREE PROBES
WITH ALL
SCOPES**

**ELENCO ♦ HITACHI ♦ B+K
SCOPES
AT GUARANTEED LOWEST PRICES**

**WRITE FOR
FREE
CATALOG**

QUALITY - ELENCO OSCILLOSCOPES

2-YEAR WARRANTY

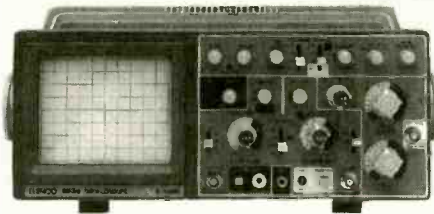

60MHz

S-1360 \$775

Delayed Sweep

S-1365 \$849

Cursor Readout

- ♦ Voltage, Time
- ♦ Frequency differences displayed on CRT

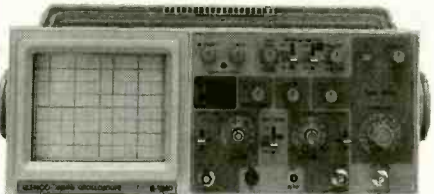

40MHz

S-1340 \$495

2- Channel

S-1345 \$575

Delayed Sweep

- ♦ Beam Find
- ♦ Component Tester



25MHz

S-1325 \$349

2- Channel

S-1330 \$449

Delayed Sweep

- ♦ Beam Find
- ♦ Component Tester

Dependable Equipment at Affordable Prices

B+K 20MHz

2 Channel

Model 2120 \$389.00



Delayed Sweep

Model 2125 \$539.95

40MHz DUAL -TRACE

Model 1541B \$749.95

- 1mV/div sensitivity
- Video sync separators
- Z axis input
- Single sweep
- V mode-displays 2 signals unrelated in frequency

60MHz DUAL-TRACE

Model 2160

\$949.95

- 1mV/div sensitivity
- Sweep to 5ns/div
- Dual time base
- Signal delay line
- Component tester
- V mode-displays 2 signals unrelated in frequency

100MHz THREE-TRACE

Model 2190

\$1,379.95

- 1mV/div sensitivity
- Sweeps to 2ns/div
- Dual time base
- Signal delay line
- 19kV accelerating voltage
- Calibrated delay time multiplier

**20MHz ANALOG with
DIGITAL STORAGE**

Model 2522A \$869.95

- 20MHz analog bandwidth
- 20MS/s sampling rate
- 2k memory per channel
- 20MHz equivalent time sampling

HITACHI POPULAR SERIES

V-212 - 20MHz, 2 Channel	\$425.00
V-222 - 20MHz, DC Offset	\$695.00
V-422 - 40MHz, Dual Trace	\$849.00
V-522 - 50MHz, Dual Trace	\$975.00
V-523 - 50MHz, Delayed Sweep	\$995.00
V-525 - 50MHz, w/ Cursor	\$1,069.00

HITACHI COMPACT SERIES SCOPES

V-660 - 60MHz, Dual Trace	\$1,375.00
V-665A - 60MHz, DT, w/cursor	\$1,449.00
V-1060 - 100MHz, Dual Trace	\$1,549.00
V-1065A - 100MHz, DT, w/cursor	\$1,695.00
V-1085 - 100MHz, QT, w/cursor	\$2,125.00
VC-6045A - 100MHz, Digital Stor	CALL
VC-6025A - 50MHz, Digital Stor	CALL

**Elenco DS-203 20MHz, 10MS/s
Digital Storage Oscilloscope**



\$749

2K Word Per Channel • Plotter Output
8 Bit Vert. Resolution • 2048 Pts Hcr.
Resolution • Much More.....

FLUKE SCPEMETERS

A handheld instrument that combines a 50MHz, 25MS/s dual channel digital storage oscilloscope with feature-packed 3000 count digital multimeter.



Model 93 - \$1,225

Model 95 - \$1,549

Model 97 - \$1,795

- Autoset, automatically sets voltage, time & trigger
- Multimeter display; 3-2/3 digits (>3000 counts)
- True RMS volts; AC or AC+DC up to 600V

C&S SALES INC.

1245 ROSEWOOD, DEERFIELD, IL 60015
FAX: 708-520-0085 (708) 541-0710

CALL TOLL FREE

1-800-292-7711

1-800-445-3201 (Can)



**15 DAY MONEY BACK GUARANTEE
FULL FACTORY WARRANTY
ALL PRODUCTS ARE FACTORY NEW**

PRICES SUBJECT TO CHANGE WITHOUT NOTICE

CIRCLE 132 ON FREE INFORMATION CARD

EARN MORE MONEY!

Be an FCC LICENSED ELECTRONIC TECHNICIAN!



No costly school. No commuting to class. The Original Home-Study course prepares you for the "FCC Commercial Radio-telephone License." This valuable license is your professional "ticket" to thousands of exciting jobs in Communications, Radio-TV, Microwave, Maritime, Radar, Avionics and more...even start your own business! You don't need a college degree to qualify, but you do need an FCC License.

No Need to Quit Your Job or Go To School
This proven course is easy, fast and low cost! **GUARANTEED PASS**—You get your FCC License or money refunded. **Send for FREE facts now. MAIL COUPON TODAY!**

Or, Call 1-800-932-4268 Ext. 240

COMMAND PRODUCTIONS

FCC LICENSE TRAINING, Dept. 240
P.O. Box 2824, San Francisco, CA 94126
Please rush FREE details immediately!

NAME _____
ADDRESS _____
CITY _____ STATE _____ ZIP _____



Are you overpaying . . .
. . . your cable company?

You are if . . . 
. . . you are leasing their equipment.

- Forest Electronics, Inc. offers a complete line of New Cable Decoders and Converters that are fully Compatible with your cable system.
- All systems come with: Remote Control, & Parental Guidance Feature. Volume Control is also available.
- All Equipment is fully guaranteed & comes with a 30 day money back option.

For More Information Call Us 24 Hours a Day At:

800-332-1996

FAX: 708-860-9048

Digital Storage Oscilloscope For \$169.95 ???

And much, much more!

O-Scope I turns PC-ATs into DSO, spectrum analyzer, frequency counter, DVM. DC-50KHz

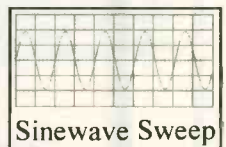

Actual O-Scope Signal Traces

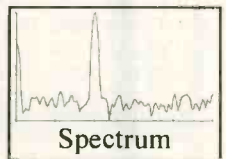

For Orders and Inquiries Call: 1-800-980-9806
For Technical Assistance: 1-713-777-0401

Allison Technology Corporation
8343 Carvel, Houston, TX 77036
FAX and BBS 1-713-777-4746



NATIONS LARGEST RECEIVER OUTLET SUMMER SUPER SALE!!!

AOR

- AR2700¹⁻³ \$399.95
- AR8000¹⁻³ \$599.95
- AR3000A¹⁻³ \$1029
- SDU5000A/I \$997.95



GRUNDIG

- YB305 **NEW** \$137.95
- YB400 **HOT** \$179.95
- SAT700 **Special** \$388.95



LOWE

- HF150 **Compact** \$579.95
- HF225E **Europa** \$999.95

SANGEAN

- ATS202 \$99.95
- ATS606P w/Ant60 \$169.95
- ATS808 \$137.95
- ATS818 \$147.95



REALISTIC

- PRO62 (CALL) \$239.95
- PRO2035 (CALL) \$359.95

Bearcat SALE!!!

- BC3000XLT 25-550/760-1300MHz⁽¹⁾ \$
- Scan 100ch/sec, search 300ch/sec, 400 memory channels, 20 x 20 banks.
- LIST \$499.95 **EEB \$369.95**



- BC9000XLT 25-550/760-1300MHz⁽¹⁾
- Alpha numeric LCD on all 500 memory ch. Scan 100 ch/sec, search 300 ch/sec, data skip, attenuator 15dB, COR recorder control.
- LIST \$769.95 **EEB \$389.95**



- BCT-7 All Band 26-956MHz⁽¹⁾
- A must for the frequent highway travelers. 7135 pre-programmed chs., search by state & service. Police, HP, DOT, Fire, News, WX, CB, plus 100 User memories, scan 100 ch/sec.
- LIST \$319.95 **EEB \$169.95**



Other BEARCAT Scanners...

- BC120XLT \$129.95 BC760XLT⁽¹⁻²⁾ \$199.95
- SC150Y/B⁽¹⁾ \$169.95 BC860XLT⁽¹⁾ \$169.95
- BC148XLT-1⁽¹⁾ \$99.95 BC890XLT⁽¹⁻²⁾ \$229.95
- BC220XLT⁽¹⁾ \$224.95

- (1) Cellular Block (not restorable)
- (2) Cellular Block, but can be restored
- (3) Un-Blocked O.K. to qualified buyers (Govt., Export, etc.)

Check out EEB's NEW BBS!!!
Dial us up, Check us out!
Tech Info, Used-Demo Specials, MORE!
1 - 703 - 938 - 3781

JOIN THE OPTO/AOR REVOLUTION!!!

• OPTO Electronics and AOR are revolutionizing the scanner world.

The new Scout 40 version 3.1 and the AOR AR2700/AR8000 scanners gives you the intercept power in your hands, that just a few years ago could only be a dream. Imagine having your scanner hop on a signal the instant someone presses the mic button. The Scout will reaction tune your AOR scanner in a blink of an eye to any locally generated signal.



• **WHERE** is the Scout most effective? Sporting events, car races, air shows, NEWS gatherings, accident scenes, air ports, railroads, marinas, fast food drive-thrus, many more applications. Everywhere you turn today there's a walkie-talkie in use. Listen in, it's your world.

• **WHO** needs the Scout/AOR System? NEWS service, local TV/Radio stations, Police, DEA, Air ports, anyone that wants to know what is being transmitted in the immediate area, plus thousands of scanner listeners, FBI, Law enforcement, SWAT team, and surveillance.

- **WHAT** do you need? 1. Scout 40 version 3.1
- 2. AOR AR2700/AR8000 3. Input jack, modification to scanner
- 4. Interconnect cable. 5. Scout 40 V3.0 requires CB-AR cable \$49.00

SAVE up to \$300
OFF list price

EEB SPECIAL PACKAGE DEAL

- **AR2700**, Scout 40 version 3.1, Mod to AR2700, cable, (regular discount price \$899.90)...**Package Deal \$839.95**
- **AR8000**, Scout 40 version 3.1, Mod to AR8000, cable, (regular discount price \$1090)...**Package Deal \$1039.95**

EEB will install jack and wire in scanner, assure that your AOR warranty is good for one year and completely check out your system on our lab prior to shipping.
FREE with system purchase.

FREE AR2700/AR8000 Modification (\$50 value)

• AR2700	list \$499.95	EEB \$399.95
• AR8000	list \$799.95	EEB \$599.95
• MODS		EEB \$50.00
• Cable CB RT		EEB \$20.00
• SCOUT 40 v3.1 list	\$449.95	EEB \$419.95

Special SONY Summer SALE!!!

• ICFSW55 •

"Among the best performers in compact portables, audio quality among the best, a superior performer in it's size class". (IBS Passport)

- 150kHz - 30MHz, 76 - 108MHz • AM, FM, CW, LSB, USB
- 125 station memory preset • Factory preset name tuning provides easy access to popular SWL stations • Direct keyboard entry • World clock rotary tuning dial for roaming the dial • Power 6VDC, or 4AA (not incl.) AC adaptor is included.



Limited Time... **\$319.95**
3 year Extended Warranty \$39.95

Other SONY's at Special Summer Prices

- ICFSW7600G \$179.95 • ICFSW100 \$344.95
- ICFSW77 \$459.95 • ICFSW30 \$104.95
- ICF2010 \$344.95 • ICFSW33 \$159.95

WJ HF1000 World's Ultimate Receiver

\$3799

Opt. Preselector HF1000D \$649.00



GE SUPERADIO II

Puts the fun back into AM Radio!!!

Everyone needs a good AM/FM DX radio. Great audio, large ferrite antenna, 4 I.F. stages.

\$59.95



DRAKE R8A

Improved and upgraded version of the world famous R8.

- Improved Ergonomics
- Dynamic range (+100dB)
- 3rd OIP +20dBm
- Increase memory to 440 ch.
- Scar 40 ch/sec.



It's time to trade-in your R8, call for Quote.
R8A \$1085.00

95 Catalog...**FREE**
96 Pages, SWL, Scanners, Antennas, Books, Lots more.



FREE in the U.S., 3rd class (4 weeks) \$2 1st class (1 week), \$2 Can/Mex, \$5 elsewhere.

ELECTRONIC EQUIPMENT BANK
323 MILL Street NE
Vienna, VA 22180

*We accept VISA, MasterCard, and American Express/Discover

ORDERS: 800-368-3270
Local Tech: 703-938-3350
FAX: 703-938-6911

*We ship via UPS, Federal Express, and Mail

- Sorry, no COD's
- Free Catalog in USA
- Prices Subject to change
- Prices do not include freight
- Returns subject to restock fee up to 20%

MIRACLES NEVER CEASE



MICRO TX2000 KIT

\$59⁹⁵

- SMALLEST 120 MW FM VOICE/PHONE TRANSMITTER
- SMALL SIZE 1-7/16" x 2 1/32"
- 88-110MHz ON ANY BROADCAST RECEIVER
- ROCK SOLID TUNING, DOESN'T DRIFT
- 5 MIN. ASSEM., HEAR A WHISPER UP TO 2 MILES
- SMT PARTS PREASSEMBLED
- INCLUDES TXMTR, MIC, ANTENNA, BATTERY CLIP, TUNING TOOL, AND INSTRUCTIONS

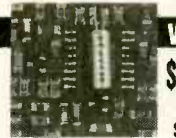

VOICE SCRAMBLER/DESCRAMBLER KIT

\$69⁹⁵

2 FOR \$129.95

- WORLDS SMALLEST AUDIO SCRAM/DESCRAM.
- TALK IN PRIVACY ON AUDIO, SPKR. OR MIC LINE
- HEAR THOSE GARBLED SCANNER VOICES
- SMALL SIZE 1"x7/8"x1/4"
- CRYSTAL CONTROLLED DIGITAL SPEECH INVERSION
- 7-15 VOLT DC SUPPLY
- LOUD HALF WATT AUDIO AMPLIFIER
- EXCELLENT AUDIO QUALITY
- INCLUDES FULL DOCUMENTATION
- DUPEX SCRAMBLE & DESCRAMBLE AT THE SAME TIME

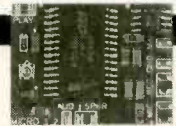

MICRO 1.2 VOICE RECORDER

\$69⁹⁵

- SMALL SIZE 1-1/4"x15/16"x1/4"
- HUNDREDS OF APPLICATIONS
- EXCELLENT AUDIO QUALITY
- 60 SECONDS REC/PLAY
- 8 OHM SPEAKER OUTPUT
- 7-15 VOLT DC SUPPLY
- 100 YEAR MEMORY WITHOUT POWER
- INCLUDES MIC, SWITCHES AND FULL DOCUMENTATION



MICRO 2B VOICE RECORDER

\$109⁹⁵

MICRO 2B FEATURES

- SAME AS 1.2 PLUS:
- MULTI MESSAGES (UP TO 600 MEM.)
- SMALL SIZE 1-5/16"x1-5/8"x1/8"
- VARIABLE AUTO PLAY TIMER
- 5 VOLT KEY OUT DURING PLAYBACK

ORDER BY PHONE OR MAIL
IN U.S.A. ADD \$5 FOR S&H

C.O.D. CHARGES APPLY
NYS RESIDENTS ADD SALES TAX

VFC400 VHF/UHF FM VOICE TRANSMITTER KIT



ONLY
\$99⁹⁵

NEW

- SMALLEST 400 MILLIWATT VOICE TRANSMITTER ANYWHERE! (1.5" x .56")
- RECEIVE ON ANY SCANNER OR VHF/UHF SURVEILLANCE RECEIVER
- RELIABLE CRYSTAL CONTROL OSCILLATOR
- 5 MILE RANGE (OR BETTER!)
- SUPER SENSITIVE OP-AMP PICKS UP SOUNDS AT WHISPER LEVEL
- LINE LEVEL AUDIO INPUT FOR DATA, STATION ID, OR INTERFACE TO OUR POPULAR VOICE RECORDERS
- SIMPLE 5 MINUTE ASSEMBLY, ALL CHIP COMPONENTS ARE PRE-ASSEMBLED
- CUSTOM FREQUENCIES AVAILABLE FOR LAW ENFORCEMENT
- INCLUDES TRANSMITTER, CRYSTAL, BATTERY HOLDER, MICROPHONE, ANTENNA, & INSTRUCTIONS
- CHANNEL A) 146.565 MHZ B) 149.000 MHZ (SELECT ONE WHEN ORDERING)

MICRO-4 MULTI-MESSAGE VOICE RECORDER

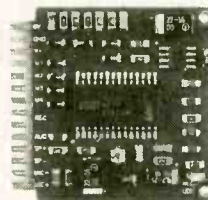

- EXACT SOUND REPRODUCTION
- SMALL SIZE 1-3/4" x 1-5/8"
- NEW EDGE CARD DESIGN IS STANDARD. 100 SPACING
- 4 MESSAGE MAX. UP TO 20 SECONDS
- LED INDICATES RECORDING IN PROGRESS
- 6 VOLT INPUT ONLY DRAWS .5 uA STANDBY
- 7-13.8 VOLT REGULATED INPUT @ 30ma
- 8 OHM 50 MILLIWATT SPEAKER OUTPUT
- LINE LEVEL AUDIO OUTPUT (VARIABLE)
- FULLY ASSEMBLED (NOT A KIT)
- 100 S OF APPLICATIONS, ALARMS, PRODUCT DISPLAY, NOTE PAD, HAM, CB, MUSEUMS, ETC
- SWITCHES, MICROPHONE, & INSTRUCTIONS INCLUDED

NEW

ONLY **\$89⁹⁵**

COMING SOON



AGRELO ENGINEERING

1145 CATALYN STREET
SCHENECTADY, NY 12303

MICRO-3

RECYCLE UP TO 4.5 MINUTES
UP TO 1800 MESSAGES (NO DIODES)
MESSAGE CUEING (FAST FORWARD)

TECH. FAX: 518-381-1058

TO ORDER: CALL 1-(800)-588 4300



TECH. SUPPORT: 518-381-1057

SHOW TIME CABLE

Your Cable Connection
To The Stars!

Order your **FREE**
catalog today!

1-800-643-4258



STARGATE SST

- Converters & Descramblers
- All Makes & Models
- Quantity Discounts
- 30-day Money Back Guarantee
- Best Warranties

Show Time Cable
643 N 98th St STE 260
Omaha, NE 68114

COD • MasterCard • Visa • Amex • Discover

Motion Control System

\$249.95

Includes Stepper Controller Card, 12VCT Transformer, (2) 4 Phase Stepper Motors,
Easy to use I.B.M Software! Connects to any I.B.M. Compatible LPT Port (1,2,3)...

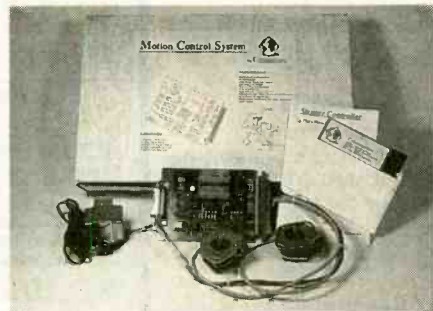

* Nothing more to Buy!

- * Easy Installation 15 minutes or Less!
- * No Tools Required!
- * Design Robots, Plotters, Laser Systems!
- * Drives (2), 4 Phase Stepping Motors!
- * Bi-Directional 8 Bit Read and Write Port!
- * Board Addressable, 16 Possible Choices!
- * Fits in Standard 19" inch Card Rack!
- * With Additional Cards Control 32 Motors on 1 LPT Printer Port!
- * Features Include: Variable Speed, Step, Range, Direction, and On/Off Control!
- * Free QBasic & Gwbasic Source Code \$ 59.95 value! *

Send Check or M.O. to:

CYBERMATION

"Intelligent Controllers"

1943 Sunny Crest Dr., Suite 288,
Fullerton, CA 92635

Call Us Today!

Tel (714) 879-2000

Visa/Master Charge Accepted

* Add \$12.00 S&H; CA residents please add sales tax *

There's No Easier Way to TROUBLESHOOT AND REPAIR Your Electronics!



It's easy, fast and rewarding to do it yourself with the Electronics Repair Manual!

- TVs VCRs
- Hi-Fi Stereo Amplifiers
- Turntables
- Speakers
- Shortwave Radios
- Camcorders
- Tape Decks
- CD Players
- Walkmans
- AM & FM Receivers
- PC Systems
- Automobile Sound Systems
- PC Peripherals
- Telephone Systems
- Fax Machines
- Electronic Home Appliances



Electronics Repair Manual

- Electronic Repair Basics
- Tools and Test Equipment
- Troubleshooting and Maintenance
- Specific Repair Instructions
- Schematic Diagrams
- Component/Manufacturer Indices

- 900-PAGE, MODULAR FORMAT MANUAL
- TROUBLE ANALYSIS FLOWCHARTS
- SCHEMATIC DIAGRAMS
- HANDS-ON, DETAILED, TROUBLESHOOTING INSTRUCTIONS
- "HOW TO" PRIMER FOR TEST EQUIPMENT SUCH AS OSCILLOSCOPES, FREQUENCY COUNTERS, AND VIDEO ANALYZERS
- SAFETY PRECAUTION CHECKLISTS
- COMPREHENSIVE REPLACEMENT PARTS LISTS
- PREVENTIVE MAINTENANCE TECHNIQUES
- DIRECTORY OF MANUFACTURERS

30 Day Free Trial Order Form

Yes, Please rush me my copy of Electronics Repair Manual for only \$59.95 (I may take \$10 off the price when I enclose my check or credit card authorization with my order within the next 30 days. Plus, I get free shipping and handling!) I understand that if I am not satisfied I may return the book within 30 days for a full 100% refund of the purchase price.

My payment of \$59.95 is enclosed (\$49.95 when ordering with-in the next 30 days.)

VISA **MasterCard** Check enclosed.

Optional express delivery (available in U.S. only). Enclose an additional \$10.00 and we'll guarantee delivery within 5 business days from receipt of your order (prepaid orders only).

_____|_____|_____|_____|_____|_____|_____|_____|_____|_____|
Credit card no.

_____|_____|_____|_____|_____|_____|_____|_____|_____|_____|
Expiration Date Daytime phone no.

Signature _____

Bill me later for \$59.95 plus \$6.50 shipping and handling, subject to credit approval. Signature and phone number required to process your order. P.O. Box addresses must be prepaid.

Mr./Mrs./Ms. _____

Company _____

Address _____

City _____ State _____ Zip _____

Shipping and handling to Canada, \$10 (U.S. currency); Overseas, \$15 (foreign orders must be prepaid); CT residents add 4% sales tax. Supplements will be sent 4-5 times a year on a fully-guaranteed, 30-day trial basis. They may be cancelled at any time.

MAIL TO: WEKA Publishing, Inc. 31180
1077 Bridgeport Avenue, Shelton, Connecticut 06484

1-800-222-WEKA FAX: 1-203-944-3663

Keep Your Skills Up-to-Date!

The Electronics Repair Manual will be a valuable reference for years to come. Supplements, each containing 140 pages, add new repair projects, valuable insights into new technologies, diagnostic and repair techniques, and more schematic diagrams into your manual. Just \$30 each plus shipping and handling. Supplements are sent 4-5 times a year and are fully guaranteed. Return any supplements you don't want within 30-days and owe nothing. Cancel anytime.

September 1995, Popular Electronics

INSTEK Test & Measuring Instruments

20 MHZ, 2-Channel, OSCILLOSCOPE

- model #OS-622B
- 20MHz, Dual Channel
- High Sensitivity 1mV/DIV
- TV Synchronization
- Z axis input
- ALT Triggering Function
- Hold Off Function
- Trigger Level Lock Function
- CH 1 Output
- Includes Probes (x1, x10)
- 2 Year Warranty

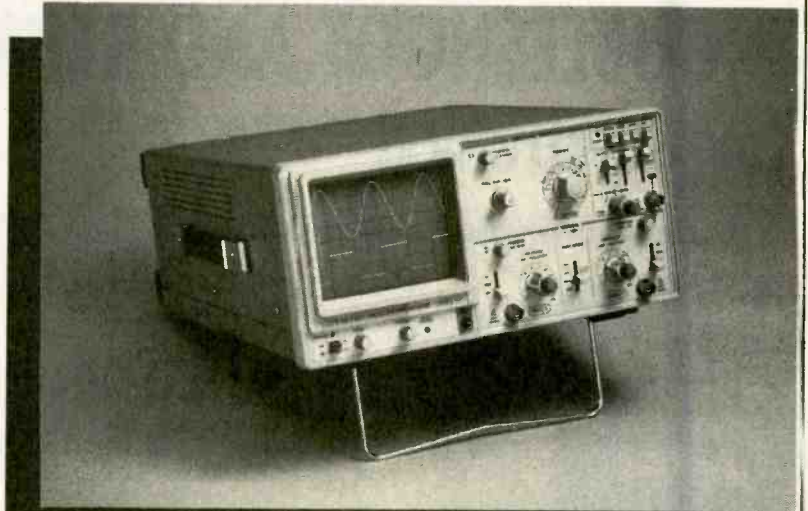

Regular \$499.00 Sale \$389.95

PRINT™ 

Products International



800-638-2020



Test Instruments, Equipment, Tools & Supplies For Electronic Production, Maintenance & Service
8931 Brookville Road, Silver Spring, MD, 20910 * 800-638-2020 * Fax 800-545-0058

CIRCLE 162 ON FREE INFORMATION CARD

Learn MICROCONTROLLERS EMBEDDED SYSTEMS and PROGRAMMING with the New AES-10

The AES-10... a complete learning system, a complete embedded control system. Extensive manuals guide you through your 8051 development project. Assembly, BASIC, and C programmable. All hardware details, complete schematics. Learn to program the LCD, keypad, digital and analog I/Os. The entire board is software reconfigurable for your applications. Everything you need, nothing extra required.

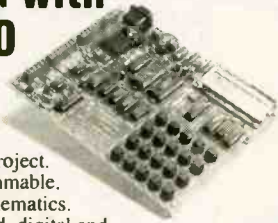

80C32 Computer/Microcontroller board with:

- 32K Byte ROM, 32K Byte RAM • 2 by 16 Liquid Crystal Display • 4 by 5 Keypad • Two serial ports • 5 interrupt sources • 3 timers • A/D, D/A, PWM and digital I/O • Built in Logic Probe • Power supply (can also be battery operated) • Extended Intel BASIC and AES Monitor in ROM • RS-232 cable to connect to PC for programming • 8051/52 DOS Cross Assembler • Program disks with well documented examples • User's Manual, Language Manual, and Text (over 400 pages).

AES-10 \$285 Complete
Money Back Guarantee

Free Info Pack, M/C Visa
714 - 550-8094
Fax 714 - 550-9941

AES
Advanced Educational Systems

CALL 1 - 800 - 730-3232

970 W. 17th St., Santa Ana, California, 92706 USA

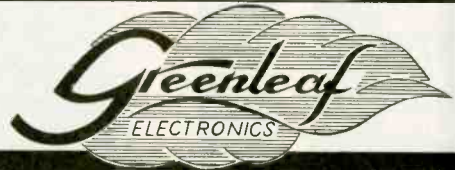

CABLE TV Converters & Descramblers

Compatible with
**Jerrold, Scientific Atlanta,
Pioneer, Oak, & Hamlin
Equipment**

BRAND NEW!

6-MONTH GUARANTEE

LOWEST PRICES

Volume Control & Parental Lockout Available

Greenleaf Electronics

1-800-742-2567

NO ILLINOIS SALES

It is not the intent of Greenleaf Electronics to defraud any pay television operator and we will not assist any company or individual in doing the same.

**PE MARKET CENTER
CLASSIFIEDS**

PLANS-KITS-SCHEMATICS

BUILD — FIVE-digit, ohms, capacitance, frequency, pulse, multimeter. Board and instructions \$9.95. Bagnall Electronics, 179 May, Fairfield, CT 06430.

ALL-IN-ONE catalog. AM/FM/ham/spy, transmitters, amplifiers, receivers. Voice scramblers/disguisers, audio, TV, Tesla coils, plans, "secret" books, kits, imports, exports and more. Start your own licensed or unlicensed radio station, 60 full pages for \$1.00. **PAN-COM INTERNATIONAL**, PO Box 130-H9, Paradise, CA 95967.

FM STEREO TRANSMITTER kit broadcasts any audio signal to FM stereo radios throughout your home. Uses unique BA1404 IC. Complete kit: PC board/components — \$24.00. **Visa/MC. TENT-ROXIX**, 3605 Broken Arrow, Coeur d'Alene, ID 83814. (208) 664-2312.

HOBBYIST CIRCUITS — Remote room monitor, tone decoder, long distance circuit control. Simple unusual experiments for the novice. **CATALOG** \$2.00 — Garrett Plans, PO Box 155, Jamesburg, NJ 08831.

SURVEILLANCE TRANSMITTER kits. 65 to 305 MHz. **Quick & Easy.** Partially assembled units. Five minutes completion. 110-volt duplex receptacle, room battery types, and telephone. Counter-surveillance. Catalog: \$2.00. **SHEFFIELD ELECTRONICS**, PO Box 377940-B, Chicago, IL 60637-7940.

CRYSTAL SET Handbook — Visit antiquity by building the radios your grandfather built. Assemble a "Quaker Oats" rig, wind coils that work and make it look like the 1920s! Only \$10.95 plus \$4.00 for shipping and handling. **CLAGGK Inc.**, PO Box 4099, Farmingdale, NY 11735. US funds only! USA and Canada — no foreign orders.

CIRCUITS! CIRCUITS! The very best in plans, kits, schematics, and books. Too many to list. Satisfaction guaranteed! Send for free listing. **HOBBYTECH**, Dept. PE1, 1748 SE Alder, Hillsboro, OR 97123.

YOU WON'T be caught flashing with **SILENT SAM**. Patented vehicle turn signal reminder warns when not to. See PE's Apr. '95 Hands-On Report. Call toll free 1 (800) 398-5605 Visa/MC. Kit w/case \$15.00, \$22/\$27.00 wired models, plus \$2.50 P&H. Flyer. 1627 Basil Dr., Columbus, OH 43227.

NIGHT VISION kits. And brand name U.S. and foreign units. Complete kits include all necessary components to build your own night vision scope. **SAVE \$.** U.S. **Military Intensifiers, I.R.**, foreign and more. Call or write: **NENVIS INC.**, 320 Main Street, Box 1088, Sturbridge, MA 01566. Or (508) 347-7238 10-4pm EST.

FASCINATING ELECTRONIC devices! Tazer! Dazer! Super spy microphone! Vocal truth detector! Universal IC tester! Radar and laser jammers! Surveillance! Countermeasures! Ultrasonic! Tesla! High voltage! More! Plans & kits catalog \$2.00. **QUANTUM RESEARCH**, 17919 — 77th Avenue, Edmonton, Alberta, Canada T5T 2S1.

HEATH COMPANY is selling photocopies of most Heathkit manuals. Only authorized source for copyright manuals. Phone: (616) 925-5899, 8-4 ET.

DIRECTIONAL MICROPHONE! Inexpensive to make but can professionally record the faintest sound from a distance. Send \$5.00: Freedom Enterprise, PO Box 69059, Edmonton, Alberta T6U-1A0.

REPAIRS-SERVICES

TEST EQUIPMENT REPAIR, including power supplies. **REPAIR** of citizen band, two way radio, both base and mobile, scanners call (812) 295-4240.

CABLE TV DESCRAMBLERS



We Carry A Full Line of Premium Descramblers And Converters Compatible With:

- **JERROLD™** (Add-ons and Combos)
- **GENERAL INSTRUMENTS™**
- **SCIENTIFIC ATLANTA™**
- **PIONEER™**
- **TOCOM™**
- **ZENITH™**
- **HAMLIN™**
- **OAK™** (all except Sigma)



GUARANTEED TO WORK OR YOUR MONEY BACK!
BEST PRICES FREE CATALOG
Please have the **MAKE & MODEL #** of your area's cable box ready when you call!

ALLSTAR ELECTRONICS HOURS 9-6 M-F 10-3 Sat EST
1-800-782-7214

It is not the intent of Allstar Electronics to defraud any pay TV operator. Anyone implying theft of service will be denied assistance. All brand names are registered trademarks of their respective owners and are used for reference only. 110-64 Queens Blvd., #465, Forest Hills, NY 11375. NO NYS SALES!

BUGGED??

EAVESDROPPING is unbelievably widespread! Electronic Devices with amazing capabilities can be monitoring your telephone and room conversations **RIGHT NOW!** Are you sure you're safe? **FREE CATALOG** tells you **FAST!** Includes Free Bonus details on fantastic opportunities now open in Counter-Surveillance field. Exciting, immensely interesting and **EXTREMELY** profitable (up to \$250/hr) full/part-time income. Call Now! **1-800-732-5000**

Satellite-TV
SAVE 40% - 60%
800-334-8455
218-739-5231 Int'l
218-739-4879 Fax
Skyvision®
1048 FRONTIER DRIVE • FERGUS FALLS, MN 56537

FREE Buyer's Guide

Prototype it..... FAST!

with ProtoQuick 8051 or 28

- Complete single board computers
- Up to 32K EPROM and 8K RAM
- 12 bit in parallel through serial bus
- RS232 C serial port w/ 0825 core
- 0db 555 or EPROM w/ source code
- Assembled - ready to run - 5v. only
- MS-DOS cross assembler included

ProtoQuick 28 and 8051
\$99.00 each

Software Science
3710 Huntington Road
Cincinnati, OH 45244 USA
(513) 561-2060

Run prototype applications of experimental hardware from the serial port - **WITHOUT PROGRAMMING!**

SURVEILLANCE
& COUNTERSURVEILLANCE Electronic Devices

Hidden Video Cameras • Electronic Kits • Voice Changers
Bug and Phone Tap Detectors • Shotgun Mics • Micro Recorders
• Vehicle Tracking • Locksmithing • AND MORE!

Extra Long Play Telephone Recorders • Silently Tapes **\$125.00** and up
Incoming/Outgoing Phone calls automatically...

SDY FOR CATALOG SEND \$5.00 TO... P.O. Box 337,
OUTLET Buffalo, NY 14226 (716) 691-3476 • (716) 695-8660

September 1995, Popular Electronics

Electronics made Easy with UCANDO



UCANDO's unique computer animation makes learning electronics fast and easy. These videos will...allow you to learn at your own pace...help you remember more of what you learn ... give you years of quality use... become a valuable source of reference material...make your understanding of electronics complete ... and help you build your future today. **Call today and see how UCANDO is...**

"Changing The Way The World Learns Electronics."

New Release!!!

VT102 Introduction to VCR Repair ...	\$44.95
VT103 VCR Maintenance & Repair ...	\$29.95
VT201 Direct Current	\$44.95
VT202 Alternating Current	\$44.95
VT203 Semiconductors	\$44.95
VT204 Power Supplies	\$44.95
VT205 Amplifiers	\$44.95

VT405 TV Part 2 "The Front End" \$44.95

VT206 Oscillators	\$44.95	VT401 AM Radio	\$44.95
VT301 Digital 1	\$44.95	VT402 FM Radio Part 1	\$44.95
VT302 Digital 2	\$44.95	VT403 FM Radio Part 2	\$44.95
VT303 Digital 3	\$44.95	VT404 TV Part 1 "Intro to TV"	\$44.95
VT304 Digital 4	\$44.95	VT501 Fiber Optics	\$44.95
VT305 Digital 5	\$44.95		
VT306 Digital 6	\$44.95		

SAVE!!! Buy any 6 videos for only \$240 ... SAVE MORE!!! Buy any 12 videos for only \$450

MONEY BACK GUARANTEE! Call for details.



Call toll-free 1-800-678-6113

or mail check or money order to:

UCANDO Videos, P.O. Box 928, Greenville, OH 45331

FREE Shipping ... FREE Catalog

CIRCLE 136 ON FREE INFORMATION CARD



Cable TV Descramblers * Converters

Absolutely The Lowest Prices!

All Major Brands * #1 In Customer Service
30 Day Money Guarantee - 2 Year Warranty
Call For Price Quote. Please Have Make And Model
Number Ready When You Call.

Frequent Buyer And Quantity Discounts

1-800-203-7077

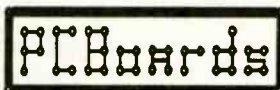
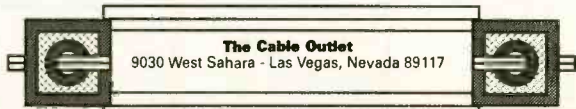

PCB Artwork Made Easy!

PRINTED CIRCUIT DESIGN SOFTWARE
for
Layout - Autorouting - Schematic

- * Supports all Video Modes including SVGA
- * Copper Flooding for Ground Areas
- * Mirror Imaging for Laser Output
- * Circuit Simulation Programs available
- * **NEW - WINDOWS**™ versions
- * **NEW - DOS** versions
- * **FREE** - Heat Transfer Film with Order
- * Great for All Printed Circuit Projects

Download Demos from BBS (205)933-2954

PCBoards Layout Only ... \$99.00

Layout for Windows™ starts at ... \$149.00

Call or Write for Full Product Line, Prices & Demo Packages

PCBoards
2110 14th Ave. South
Birmingham, AL 35205

(800) 473-7227
Fax (205) 933-2954
Phone (205) 933-1122

IF You Service Electronics

MCM ElectronicsSM Is The Only Source You'll Ever Need



- Wide selection, fast delivery and competitive prices
- Test Equipment, Semiconductors, Chemicals, Tools, TV/VCR Parts
- Over 21,000 Items Stocked and Ready To Ship Within 24 Hours
- Free 332 Page Catalog
- Toll Free Tech Line For Technical Assistance

We understand the needs of todays service professional. For over 15 years our deep inventories have enabled competitive pricing and rapid delivery. Call today for your free catalog and you'll discover... MCM is your #1 source.

MCM IS AN
RCM 
PREMIER
DISTRIBUTOR

FREE CATALOG

Call Toll Free:
1-800-543-4330



MCM ELECTRONICSSM
650 CONGRESS PARK DR.
CENTERVILLE, OH 45459-4072
A PREMIER Company

Hours: M-P 7a.m. - 9p.m., Sat. 9a.m. - 6p.m. EST



GET FAST DELIVERY FROM OUR DISTRIBUTION CENTERS NEAR DAYTON, OH AND RENO, NV!

CIRCLE 152 ON FREE INFORMATION CARD

Low Cost CAD Software for the IBM PC and Compatibles Now In WindowsTM

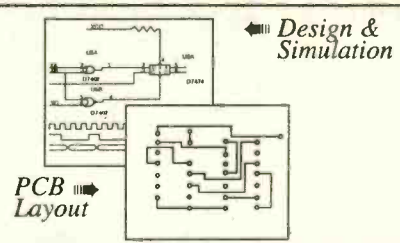







- Easy to use schematic entry program (SuperCAD) for circuit diagrams, only \$149. Includes netlisting, bill of materials, extensive parts libraries, More parts, and automatic wiring available in enhanced CAD package (SuperCAD+) for only \$249.
- Powerful, event-driven digital simulator (SuperSIM) allows you to check logic circuitry quickly before actually wiring it up. Works directly within the SuperCAD editor from a pull-down menu and displays results in "logic analyzer" display window. Starting at \$149 this is the lowest cost simulator on the market. Support for PALs, a larger library, and a separate interactive logic viewer are available in full-featured SuperSIM+ for only \$399. Library parts include TTL, CMOS and ECL devices.
- Circuit board artwork editor and autorouter programs (SuperPCB), starting at \$149. Produce high quality artwork directly on dot matrix or laser printers. You can do boards up to 16 layers including surface mount. Includes Gerber and Excellon file output. Autorouter accepts netlists and placement data directly from the SuperCAD schematic editor.
- Low cost combination packages with schematics and PCB design: 2-layer for \$399, 16-layer for \$649.
- DOS version available.

Write or call for free demo disks:
MENTAL AUTOMATION^{INC.} 
5415 - 136th Place S.E.
Bellevue, WA 98006
(206) 641-2141
BBS (206) 641-2846

CONTROL MEASURE INPUT

RELAYS • LIGHTS • MOTORS
TEMPERATURE • PRESSURE • LIGHT LEVELS • HUMIDITY
SWITCH POSITIONS • THERMOSTATS • LIQUID LEVELS

<p>MODEL 30 \$79</p>  <ul style="list-style-type: none"> • PLUGS INTO PC BUS • 24 LINES DIGITAL I/O • 8 CHANNEL • 8 BIT A/D IN • 12 BIT COUNTER • UP TO 14K SMP/SEC 	<p>MODEL 45 \$189</p>  <ul style="list-style-type: none"> • RS-232 INTERFACE • 8 DIGITAL I/O • 8 ANALOG INPUTS • 2 ANALOG OUTPUTS • 2 COUNTERS-24 BIT
<p>MODEL 100 \$279</p>  <ul style="list-style-type: none"> • 12 BIT 100 KHZ A/D • 4 ANALOG OUTPUTS • 3 TIMER COUNTERS • 24 DIGITAL I/O 	<p>MODEL 150-02 \$179</p>  <ul style="list-style-type: none"> • RS-232 INTERFACE • TRMS, 20 AMPS • 12 BIT A/D • OPTO-ISOLATED • COMPLETE DMM
<p>MODEL 40 \$99</p>  <ul style="list-style-type: none"> • RS-232 INTERFACE • 28 LINES DIGITAL I/O • 8 ANALOG INPUTS • PWM OUTPUT 	<p>MODEL 70 \$239</p>  <ul style="list-style-type: none"> • RS-232 INTERFACE • 16 BIT A/D • 5.5 DIGIT • UP TO 60 SMP/SEC

Prairie Digital, Inc.
PHONE 608-643-8599 • FAX 608-643-6754
846 SEVENTEENTH STREET • PRAIRIE DU SAC, WISCONSIN 53578

CIRCLE 47 ON FREE INFORMATION CARD

September 1995, Popular Electronics

FM TRANSMITTERS ELECTRONIC KITS AND MORE!

**SATISFACTION
GUARANTEED!**

WE ACCEPT VISA, MC, MO, CO
SHIPPING & HANDLING EXTRA



BUY WITH CONFIDENCE FROM XANDI
• 30-DAY REFUND POLICY
• TECH SUPPORT NUMBER (602-894-0992)

- Tunes 88-108 MHz.
- Powerful 2 stage audio amplifier.
- Sensitive, picks up sounds at the level of a whisper.
- Up to 1 mile range.
- Requires 9V battery. (Not incl.)



SUPER-MINIATURE FM TRANSMITTER
Super small FM transmitter. Use with any FM broadcast receiver. Easy to assemble, all chip (SMT) parts are pre-assembled to the circuit board.

XST500 (E-Z) Kit \$44.95

- Miniature photo battery mounts right on circuit board. (Included)
- Tunes 88-108 MHz.
- Up to 1/2 mile range.
- Sensitive 2 stage audio amplifier, picks up sounds at the level of a whisper.



MICRO-MINIATURE FM TRANSMITTER
Including the battery, this is the Worlds smallest FM transmitter. Use with any FM broadcast receiver. Easy to assemble, uses pre-assembled circuit board.

XWB1000 E-Z KIT \$49.95

- Up to 1/2 mile range.
- Miniature photo battery mounts right on circuit board.
- Transmits at 143 MHz.
- Amazing audio sensitivity, picks up sounds at the level of a whisper.



CRYSTAL CONTROLLED FM TRANSMITTER
Including the battery, this is the Worlds smallest crystal controlled FM transmitter. Transmits to any scanner type receiver. Easy to assemble, uses pre-assembled circuit board.

XTL1000 E-Z KIT \$69.95

- Smallest Phone transmitter anywhere!
- Tunes 88-108 MHz.
- No batteries required, powered by phone line.
- Up to 1/4 mile range.
- Attach to phone line anywhere in house.



SUPER-MINIATURE PHONE TRANSMITTER
Worlds smallest FM phone transmitter. Use with any FM broadcast receiver. Easy to assemble, all chip components are pre-assembled to the circuit board.

XSP250 (E-Z) Kit \$34.95

- Dial your phone from anywhere and listen to the sounds inside your home.
- Two digit Touch Tone code for secure operation.



TELEPHONE SNOOP

The latest in home or office security. Call home from anywhere, enter a two digit security code, and hear the sounds in your home. Automatically turns on without ringing the phone, verifies code, then activates for one and a half minutes.

XPS-CASE KIT \$13.95

XPS1000 (C) KIT \$49.95

- Transmits a continuous beeping tone.
- Adjustable from 88 to 108 MHz.
- Up to 1 mile range.
- Works with any FM broadcast receiver.



TRACKING TRANSMITTER

Only 0.7 by 2.4 inches, the XTR100 operates at voltages of 3 to 18 Volts and is ideal for use in locating lost model rockets, bicycles, automobiles, games of hide and seek, and contests.

XTR100 (C) Kit \$33.95

- Uses sensitive microwave transistor amplifier.
- Covers 1 to 2,000 MHz.
- Compact hand held unit.
- Includes miniature loud speaker for audio indication of detected signals.



SUPER SENSITIVE BUG DETECTOR

When the XBD200 intercepts a signal in the 1 to 2,000 MHz range, it emits a growl that increases to a high pitched squeal as the signal strength increases.

XBD200 (C) Kit \$49.95

- Use with any FM broadcast receiver.
- Hear every sound in an entire house!
- Up to 1 mile range
- Powerful 2 stage audio amplifier.



MINIATURE FM TRANSMITTER

The XFM100 has a super sensitive microphone and is capable of picking up sounds at the level of a whisper and transmitting them to any FM broadcast receiver.

XFM100 (C) Kit \$32.95

- Digital voice changing: male to female, female to male, adult to child, child to adult.
- Anonymity on any call.
- Button for normal operation.
- 16 levels of voice masking.



VOICE CHANGING TELEPHONE

STOP THOSE ANNOYING TELEPHONE CALLS!
Sound older and tougher when you want to. Not a kit. Fully assembled. Single phone operation only.

TRANSITION 2000 \$89.95

- Digital voice changing: male to female, female to male, adult to child, child to adult.
- Use with any modular phone.
- 16 levels of voice masking.
- Connects between handset and phone.



VOICE CHANGING ACCESSORY

STOP THOSE ANNOYING TELEPHONE CALLS!
Sound older and tougher when you want to. Not a kit. Fully assembled. Use with single or multi-line phones.

TRANSITION 2001 \$59.95

- Uninterrupted coverage of 800 to 950 MHz.
- Works with any scanner that can receive 400 to 550 MHz.



800-950 MHz SCANNER CONVERTER KIT

If your scanner can receive 400-550 MHz, just add the XLC900 for uninterrupted 800-950 MHz coverage. It converts all 800-950 MHz signals down to 400-550 MHz so your scanner can receive them! Add our custom case kit for that "Professional" look.

XLC-CASE KIT \$13.95

XLC900 (C) KIT \$49.95

- Transmit high quality stereo to any FM stereo receiver.
- Built-in output level monitor for quick and easy tuning.
- Ideal for use with personal CD player.



FM STEREO TRANSMITTER

Transmit full-bodied Hi Fi stereo to any FM stereo receiver. Separate left and right inputs and gain controls. Includes an output booster stage for greater range.

XFS-CASE KIT \$13.95

XFS108 (C) KIT \$41.95

XANDI ELECTRONICS, INC.
1270 E Broadway Rd. # 113, Tempe AZ 85282

TOLL FREE ORDER LINE
1-800-336-7389
ASK FOR FREE CATALOG OF OUR PRODUCTS

SEND MAIL XANDI ELECTRONICS
ORDERS TO: BOX 25647
TEMPE, AZ 85285-5647

CIRCLE 134 ON FREE INFORMATION CARD

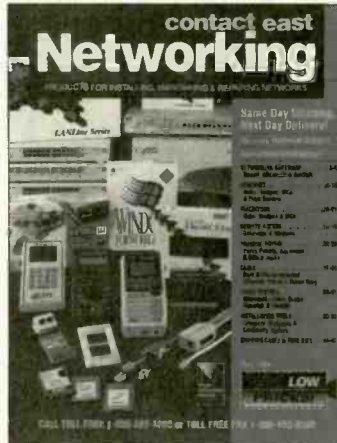

FREE CATALOG TEST EQUIPMENT AND TOOLS FOR VOICE & DATA NETWORK PROFESSIONALS

Packed with hundreds of quality brand name products for installing, testing, & maintaining networks. A full selection of network analyzers, interface cards, hubs & concentrators, cable testers, tool kits, crimping tools, connectors, adapters, software and much more. Full color photos with detailed descriptions.

In a hurry to receive your catalog?
Call (800) 282-1800
Contact East, Inc., Dept. R535
335 Willow St., No. Andover, MA 01845

New!
Pocket Cube™ with Filter
Would you like to wireless command a rental cable box into FULL service?
Smallest cube on the market just under 1" x 2"!
Simply clip it onto a 9V battery for 10sec!
Only \$69.⁹⁵!
(plus \$8 S&H)
30 Day Warranty!

Quantity discounts available.
Dealers Welcome!
Test chips also available.
**Order Toll Free
1-800-417-6689**
Tue, Thu, Sat & Sun, 10AM-9PM et.
If busy please keep trying.
VISA, MC, MO & CO

IEC, P O Box 80762, Atlanta, GA 30366
Pocket Cube is a test generator ONLY.
Do not use these devices without authorization from your local cable company.
No GA & TN sales.

CABLE DIRECT CONVERTERS DESCRAMBLERS VIDEO STABILIZERS FILTERS



**100%
MONEY BACK
GUARANTEE!**

30 DAY FREE TRIAL
FREE Cable TV Catalog.

Now you can tune-in your favorite cable TV programming and **SAVE \$100'S - EVEN \$1000'S** on premium CABLE TV EQUIPMENT.

MODERN ELECTRONICS
1-800-906-6664
2125 E. 156TH CIRCLE • OMAHA, NE 68130

September 1995, Popular Electronics

CIRCLE 154 ON FREE INFORMATION CARD

2 Chan. Digital Storage Scope



mission technology Inc.
P.O. Box 3016
Teaneck, NJ 07666

PC Parallel Port Scope / Recorder Input to 20Msample/sec-16 bit output



\$369 + ship & tax
NJ residents
VISA / Mastercard
Tel 800 880 7688
Fax 201 837 6597

Features:

- Rear Connection to Parallel Port
- Windows 3.1 VGA based
- 1 M Ω Input Resistance
- 8-bit Multiplexed Input
- Triggered with AC or DC Coupling
- Scope or Real Time Rec. Mode
- 16 freq. ranges in scope mode
- User definable sampling interval from 0.055 sec to 8 hrs per sample in recorder mode with 16000 sample buffer per chan.
- Printer Cable is included
- Store results to Disk or Print
- Built-in DC, RMS, PK to PK and Frequency Meter
- 10 gain ranges: 5v/dv to 5mv/dv
- 16-bit user-defined output in response to input signal setpoints
- Auto ranging in scope mode
- 1MHz amplifier bandwidth
- Easy installation / Auto port detect.
- Made in USA

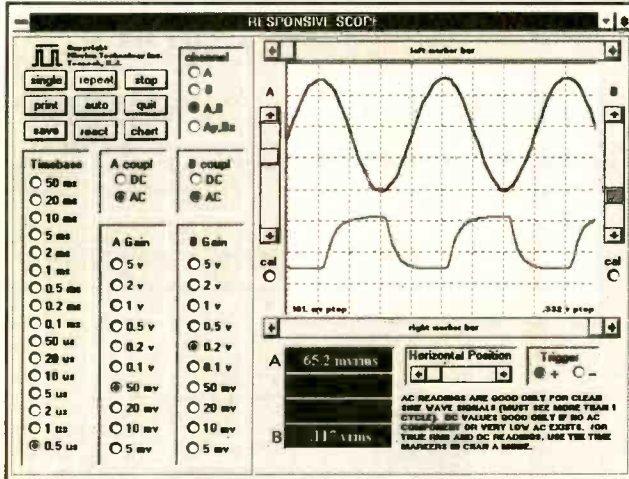

Actual scope screen for 500 KHz signals

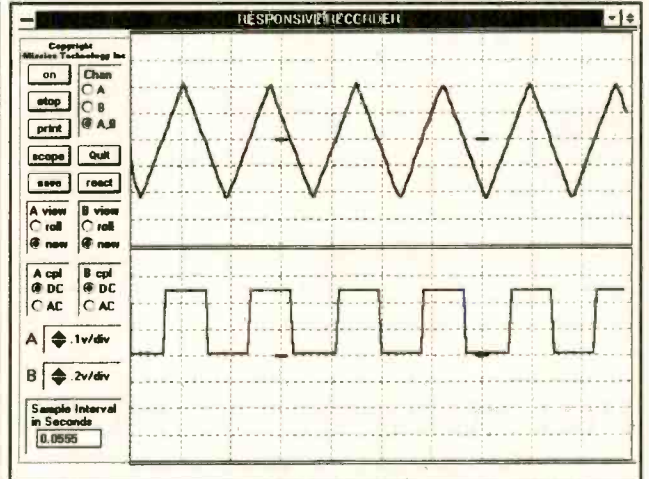

Actual recorder screen for 0.5 Hz signals

Make your projects speak for themselves... Ours do!

DIGITAL VOICE RECORDERS

- Record up to 218 seconds
- 1 to 8 messages
- High quality speech 12 bit
- Switch-closure actuation
- Sample rates up to 20KHz
- On-board backup
- Direct speaker output
- Wide operating range
- Small size 2.6" X 2.6"
- Made in U.S.A.

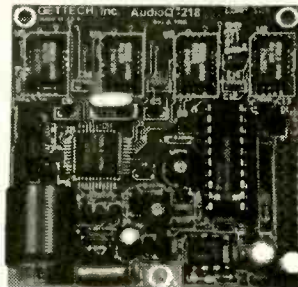

MODEL AudioQ™-218

Call or write for more information.
OEM price and delivery available
Custom designs and enclosures
Single unit price \$149.00 plus s+h
Quantity pricing as low as \$99.00

GETTECH Inc.

402 Riley Road, New Windsor, NY 12553
(914) 564-5347

Specifications and price subject to change.

CABLE T.V. EQUIPMENT

Friendly, Knowledgeable Service



**ORDERS CALL:
1-800-361-4586**



- All Equipment New
- Convertors & Descramblers
- 30 Day Money Back Guarentee
- 6 Month Warranty
- Visa, MC, C.O.D. Welcome

KDE ELECTRONICS, INC.

P.O. Box 1494
Addison, IL 60101

Info. 708-889-0281 HRS: Mon-Fri, 9-6 CST
Fax 708-889-0283 Sat, 9-3 CST

CABLE TV DESCRAMBLER KITS

Universal-New Product

This Product includes all the Parts, PC Board, Complete Schematic with Functional Guide. Generates Sync for most Video Applications.

\$79.95



Tri-Mode Descrambler

This product includes all the parts PC Board and AC Adaptor. NO Enclosure included.

\$59.95

SB-3 Descrambler

This Product includes all the Parts, PC Board and AC Adaptor. Enclosure is not included.

\$44.95



Call Toll Free 1-800-886-8699

M & G Electronics, P.O. Box 3310, No. Attleboro Mass. 02761

Anyone implying theft of Cable service will be denied assistance.

NO MASSACHUSETTS SALES!

PUT YOUR PC TO WORK!

THIS IS THE MACHINE YOU'VE BEEN WAITING FOR!

Imagine using your computer to turn 3D CAD drawings into actual working parts! Machine and drill printed circuits directly from blank material. Fabricate intricate mechanical components from raw plastic or aluminum. Route wood to make signs or "digitally" carve three dimensional art objects AND MORE! Sound interesting? You bet it is and with your creativity the sky's the limit! The NEURACTOR CNC-4+, 5 & 6 Desktop Manufacturing Systems may be just the edge you need! Utilizing patent pending technology the ROBOMAX and NEURACTOR CNC kits provide you with machining resolution of .001". All mechanical components are pre-fabricated, pre-machined, plated and painted. The CNC-4+ machines an area approximately 18"x18"x4.6" and includes four 83 oz/in CY-MOTORS. The CNC-5 & 6 (42"x42"x4.6" and 66"x42"x4.6" respectively) include four 125 oz/in CY-MOTORS. Interface card, 5 amp power supply, 10 pitch steel lead screws, 4 proprietary Slide Block actuator mechanisms, 4 aluminum linear actuator channels, polished steel guide-rods, toolholder bracket, hardware, etc., are included with each unit. (You provide Dremel(tm) Tool or flex-shaft router and work surface.) It's a complete kit! All you do is put it together, calibrate it and TURN IT LOOSE! IF THAT'S NOT EXCITING ENOUGH, WE'RE THROWING IN A FREE, FULL-FEATURED 3D CAD/CAM SOFTWARE PACKAGE WITH EACH UNIT! CNC-4+ is \$595 + 24.95 S/H, CNC-5 is \$895 + 57.95 S/H, CNC-6 is \$995 + 69.95 S/H. ROBOMAX(tm) Vertical MiniMill is \$695 + 49.95 S/H. Order now or call about our complete line of supplies & accessories! MICRO-DRILLS, FLEX-SHAFTS, MILLS & BITS, ETCHERS, CHEMICALS, BLANK BOARDS, ETC. Allow 4 weeks min. for delivery. CALL NOW!

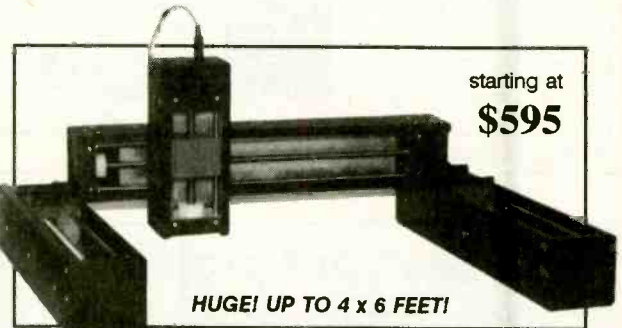
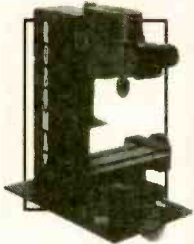

HUGE! UP TO 4 x 6 FEET!

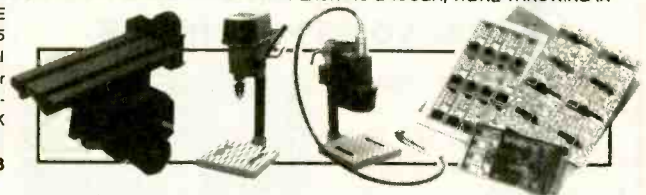

U.S. CYBERLAB, 14786 Slate Gap Rd., West Fork, AR 72774 (501) 839-8293

September 1995, Popular Electronics

RCA NOW USA
DSS AVAILABLE

SHARPER PICTURE - CLEARER SOUND - GREATER CHOICE

Introducing the RCA brand DSS™ (Digital Satellite System) the ultimate digital entertainment experience. The advanced digital compression technology delivers broadcast pictures with laser disc precision accuracy and CD-quality sound clarity. All from a small 18" dish that can be easily installed on your home or property.

\$699.00
 U.S. CURRENCY

+S&H AND RECEIVE 1 MONTH FREE **USSB** HBO

TRI STAR SATELLITE
 1-800-929-2485

HOW FAR YOU GO DEPENDS ON WHERE YOU GET YOUR START.

1-800-854-CLUB

The Positive Place For Kids.

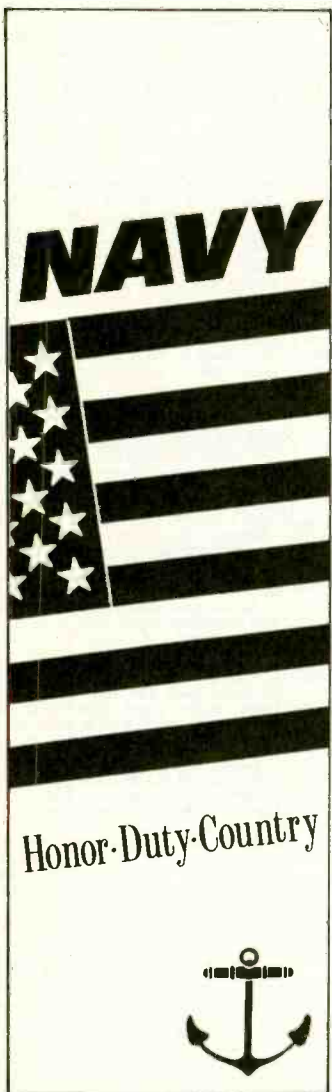

New Jensen Catalog

⇒ *Inch/Metric Tools, Tool Kits*
 ⇒ *Telecom/LAN Accessories*
 ⇒ *Diagnostic Products*
 ⇒ *Test Equipment from the Major Manufacturers*

Call for Free Copy **800-426-1194**

JENSEN TOOLS INC.
 7815 S. 46th St., Phoenix, AZ

CIRCLE 153 ON FREE INFORMATION CARD

BLACK FEATHER ELECTRONICS

3 1/2 Digit LCD Panel Meter	Stepper Motor Controller Kit	Camcorder Video Tape
		
<p>Features: 200mV full scale input 9VDC operation. Decimal point selectable. 13mm digit height, auto polarity indication, zero reading for 0 volt input. Measures 2.67" x 1.73" x 0.28" above panel thickness, 0.57" overall thickness. LCD size: 1.83" x 0.8". Has many useful applications and is easy to install. CAT# PM-1 \$17.00 each</p>	<p>This kit allows you to adjust the speed and direction of a stepper motor. You can move the motor in one step increments or rotate it at a constant speed. Visual indicators show the sequence of motion. Includes stepper motor, pc board, parts and instructions. (12vdc power source not included.) CAT# SMK-1 \$25.00 each</p>	<p>HI-8 120 MINUTE TAPE (used) They were recorded on once and played only a few times. Made by a major brand name manufacturer. Professional series metal tapes. Includes plastic jewel box. CAT# CCT-1 \$3.00 each 10 or more - 2.80 each</p>

1-800-526-3717
 645 Temple 78 ▲ Long Beach ▲ California 90814
 ▲ (310) 434-5641 ▲ FAX (310) 434-9142 ▲

1. California residents must include sales tax.
 2. Checks and money order accepted.
 3. Quantities limited - prices subject to change.

Black Feather ELECTRONICS

SOLAR ELECTRIC PANELS

POWERGLASS™
\$79.95
 350 mA at 14.5 VDC
 17.5" x 16.0" x 1.25"
 3.8 lbs.

POWERGLASS™ PLUS
\$169.95
 1.0 A at 14.5 VDC
 17.5" x 16.0" x 1.25"
 4 lbs.

These affordable solar panels generate useful electric power without noise, pollution, fuel costs, or electric bills. Stop buying and throwing away batteries. Start using Solar Photovoltaic Electric Panels from SECO.

To order call 1-800-700-1867
Visa /Master Card Accepted

NEW TOOL

Hot-Aero
 Miniature Heatgun
 For Heat-Shrink Tubing



Uses most adjustable flame lighters • Shrinks tubing in seconds, will not burn tubing nor components • Compact, shirt-pocket size for toolboxes • Safety-valve mouthpiece • Simple & easy to use

- Completely portable • No moving parts • Patented air-injector turbocharges the flame, producing a precise 1/2 inch diameter, super-hot air-stream and no carbon soot mess
- Unbreakable & built to last a lifetime • Heats-up instantly & cools-down in seconds • Made with precision & top-quality materials; Hardened stainless steel, Heat-resistant nylon, Polyurethane recoil tubing • Professional • Rugged • Limited lifetime warranty • Satisfaction guaranteed

Limited Time, Introductory Price \$14.95

If you solder wire connections together, you will love this tool! Now using heat-shrink tubing with the Hot-Aero is faster, easier and more convenient than tape or big, loud electric heatguns.

Send check/money-order (\$3.00 S/H) to: 

Rose Research & Development
 P.O. Box 12212 **1-800-606-9044**
 Santa Rosa, CA 95406 **Free Color Brochure**

The Pocket Programmer

\$129.95



The portable programmer that uses the printer port of your PC instead of an internal card.

Easy to use software that programs E(E)prom, Flash & Dallas Ram. 27(C)/28(C)(F)/29(C)(F)/25 series from 16K to 8 Megabit with a 32 pin socket. Adapters available for MCU's 874X, 875X, Pic, 40-Pin X 16 & Serial Eprom's, PLCC, 5-Gang and Eprom Emulator to 32K X 8.

Same Name, Address & Phone # for 13 Years.... Isn't it Amazing?

Intronics, Inc.
 Box 13723 / 612 Newton St.
 Edwardsville, KS 66113 Add \$4.75 COD
 Tel. (913) 422-2094 Add \$4.00 Shipping
 Fax (913) 441-1623 Visa / Master Charge

September 1995, Popular Electronics

Tap into a World of...

FREE ELECTRICITY

Our 150+ page **Self-Reliance Catalog** IS JUST LOADED WITH DC to AC ENERGY INDEPENDENCE ...

We offer:

Solar, Wind & Hydroelectric energy systems. True Sine Wave DC to AC Inverters. Electric Boat & Car kits. Portable power packs. Solar Lighting & Cooling systems. Solar Pool Heaters. Solar Battery chargers. Solar Books & Toys. DC Appliances. Active & Passive Solar Air & Water Heating Systems. Composting Toilets. Hydroponic, Fish-Farming, Solarium & Greenhouse Systems. Water Testing, Treatment, & Pumping Systems. Emergency Food & H₂O Kits. High Efficiency AC/DC Refrigeration + More...

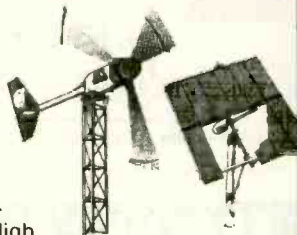

A LOT OF INFORMATION FOR ONLY \$6.75 ...

SEND CHECK or MO TO:

Self-Reliance Company Inc.
P.O. Box 306, Florissant, MO 63032

TOP SECRET

CONSUMERTRONICS
2011 Crescent Dr., P.O. Drawer 537
Alamogordo, NM 88310

Voice: (505) 439-1776, 439-8551

8AM - 7PM MST, Mon - Sat

Fax: (505) 434-0234, 434-1778 (orders only; if you get voice, enter *11 #11 any time); 24-hr

Free Tech Support (relates directly to your order or prospective order): Tues. and Thurs. only.

10% OFF on orders \$100+. 15% OFF over \$200+. Add \$5 total SH (US, Canada). All items in stock. VISA, MC, Card OK. No CODs or "bill me's". New Catalog (200+ offers) \$2 w/ order. \$5 w/ (check or MO). NO handling. Since 1971. As seen on CBS "60 Minutes", "Forbes", etc. By John Williams - former Lockheed Senior Engineer, NMSU CS Professor, DOD Electronic Weapons Engineer, NIH Health Physicist. Wanted: 7 MAC HX, PC486, better - buy, trade.

*All software supports all IBM-PC compatible x86 systems (8086 - Pentium)

OFF-THE-SHELF HARDWARE

Van Eck Systems ♦ Data Card Reader/Writers ♦ ATM2 ♦ RF-EM Radar/Ultrasonic/IR Detectors/Receivers ♦ Xmitter/Jammer/Blasters ♦ Security/Surveillance ♦ EM Lab/Weaponry/Countermeasures ♦ Neurophonic/Rife/Hieronymus Resonant Crystal Radionics ♦ Voice Disguisers ♦ Phone Color Boxes ♦ DTMF Decoders ♦ Lineman's Handsets ♦ Bug & Tap Detector/Blaster ♦ Carjack/Kidnap Follower ♦ Hearing Assistant ♦ Shriek Module ♦ TENS ♦ 6th Sense Communicator ♦ Subliminal Mixer/Amp ♦ Levitator ♦ Vortex Generator ♦ Noise Cancelling System ♦ Ultrasensitive Sound Light/RF/EMF Detectors ♦ Electronic Downer ♦ Laser ♦ Bacteria Detection Kit - more! See our New Catalog!

SPECIAL PROJECTS

We design/build/obtain/repair/modify/maintain/consult on any device/system/process/project - electrical/electronic/phone/computer/mechanical/optical/automotive for business/personal/invention need. Confidentiality guaranteed. Describe and include \$30 pre-engineering fee (does not obligate you). Time and cost estimates in 7-10 days.

The HACKER FILES

Compilation of 100s of the best articles written (in ASCII) by top hackers & phreakers. Covers every major topic in hackerdom! 3 HD Disks* \$39.

COMPUTER PHREAKING

Describes in detail how computers penetrate each other, and how VIRUSES, TROJAN HORSES, WORMS, etc are implemented. Dozens of computer crime and abuse methods and countermeasures. Includes disk filled with hacker text files and utilities, and the legendary FLU-SHOT+ protection system (Ed. Choice, PC Magazine). BBS advice, password defaults, glossary - much more! Manual + Disks* \$39.

Beyond VAN ECK PHREAKING

Eavesdropping on TV and computer video signals using an ordinary TV described in detail. Includes security industry reports. Range up to 1 KM. Plans include both the Consumertronics and the original Top Secret Van Eck designs! \$29.

CELLPHONE MODS

See our Catalog for our infamous cellphone modification guide (\$69) - detailed, comprehensive, covers all makes - 10 times more info than competitor's "guide". (Do Special Projects (above) for up-to-date hardware/software).

VOICE MAIL HACKING

How Voice Mail Box (VMB) systems are used and the specific ways they are hacked. Includes ASPEN, MESSAGE CENTER, BIX, GENESIS, EZ, SYDNEY, PHONE MAIL, AUDIX, CINDY, CENTGRAM, SPERRY LINK, RSPV, etc. Absolutely required for all users, sysops and security personnel! \$29.

PBX HACKING

1,000s of PBXs are hacked to the tune of \$ Billions/yr! While "VOICE MAIL HACKING" details how VMSs are hacked for "phun" and profit - including VMS methods for hacking PBXs themselves - "PBX HACKING" addresses ALL issues relating to PBX hacking, including countermeasures! Can your business or agency afford a \$90,000 phone fraud loss (the average loss due to hacked PBXs)? As described in Forbes Magazine. \$29.

PHREAKING CALLER ID & ANI

Details on how they work and dozens of effective ways of defeating Caller ID, ANI, *69, *57, and Call Blocking and *67. Also describes Caller ID, Orange, Belge, Cheese and CF Boxes, ESS, SS7, 9-9-11, various CLASS services: CWA, NON PUB, CA, CAMA, DNR, 800-ECR, Diverters, Extenders, Centrex - more. \$29.

Beyond PHONE COLOR BOXES

Dozens phone color boxes described - many circuits. Plus Call Forwarding, Conferencing, Phreak History, Glossary, Diverters, Extenders, Loops, REMOBS, Bridging Heads & Cans, Optocom, 3rd Party and many other non-box methods - more. \$39.

ROBOFONE AUTODIALER

Powerful, versatile, menu-driven "Wargames" autodialer lets you dial any quantity (up to 10K) or mix of local/long distance numbers in any order, over any length of time, whether busy or answered (your choice) and log the times, commands and results to monitor, printer and/or disk. Quick-dial directory of up to 600 numbers. BUSY redial options. Direct modem command and control. All Result Codes, including VVOICE and RINGING. Optional shell to terminal program upon CONNECT. Exit to menu or DOS (for batching). Manual + Disk* \$29.

Bold for educational purpose only

STOPPING POWER METERS

As reported on CBS "60 Minutes": How certain devices can slow down - even stop - watt-hour meters - while loads draw full power! Device simply plugs into one outlet and normal loads into other outlets. Also describes meter creep, overload droop, etc. Plans \$29. I.Q. MANUAL: External magnetic ways (applied to the meter itself) to slow down and stop watt-hour meters while drawing full loads. Plans. \$19. KW-HR METERS: How watt-hour meters work, calibration, error modes (many), ANSI Standards, etc. Demand and Polyphase Meters. Experimental results to slow and stop meters by others. \$19. Any 2. \$38. All 3. \$59.

AUTOMATIC TELLER MACHINES

ATM crimes, abuses, vulnerabilities and defeats exposed! 100+ methods detailed, include: Physical, Reg. E, cipher, PIN compromise, card counterfeiting, magnetic stripe, false front, TEMPEST, Van Eck, tapping, spoofing, inside job, super-cool, vibration, pulse, high voltage - others. Case histories, lab, countermeasures, detailed security checklist, labeled internal photos, figures. ATMs contain up to \$250,000 in cash! Recent \$350,000 ATM crime spree still unsolved! \$39.

CREDIT CARD SCAMS

Cardholders, merchants, banks suffer \$ Billions in losses annually because of credit card fraud. Describes every known means of credit card fraud and scams. Protect yourself! \$29.

CONS, SCAMS & SWINDLES

Cons & scams and related swindles fleece Americans of \$100+ Billion per year! The most comprehensive survival manual on cons & scams of all kinds - from the classic to hi-tech. Details on 100s and their many variations, and countermeasures. Protect yourself! \$39.

STEALTH TECHNOLOGY

Police radar is fascinating! It also has error rates of 10-20%! Every known error mode - stealth method and material used to minimize radar reflections - lactic and strategy to fight unjust radar tickets (that cost you \$100s in insurance and risk cancellation) - methods to detect and jam signals - fully described! \$29.

SECRET & SURVIVAL RADIO

Optimum survival and security radio equipment, methods, freq allocations and voice/data scrambling/encoding. Includes small receivers/transmitters, telemetry, antenna optimizations, remote monitoring and control, security, surveillance, and ultrasonic, fiber-optic and infrared commo. 70+ circuit plans, tables. \$29.

HIGH VOLTAGE DEVICES

HV devices plans: Stun Gun, Taser, Prod, Cans, Flasher, Blaster, Zapper, Audio/RF Radar Jammer, Jacob's Ladder, Plasma & Van de Graaff Guns, Fence Charger, Gelger Counter, Ozone Gen., Fish Stunner, Plant Stim. Kirlian, more! All plans for only \$29.

UNDER ATTACK!

Electromagnetic interference and Electronic Weapon Attacks cause: Cancer, birth defects, and profound psychological, neurological, cardiovascular and immune system disorders! Destructive to people, animals, plants, equipment! Includes ACTUAL CASES OF EM ATTACKS (we investigated)! Includes how to verify and pinpoint CMI and electronic attack sources, and specific countermeasures. \$29. EM BRAINBLASTER: Tutorial and plans for powerful ELECTROMAGNETIC WEAPONS and LAB DEVICES. Optimum circuits, legs, waveforms, duty cycles, intensities. Thorough. \$29. Both \$49.

RADIONICS MANUAL

Exciting electrical, electronic, electromagnetic therapeutic, diagnostic & preventive devices (mostly experimental). History, descriptions, plans (dozens), availabilities of Radionics Devices from early to modern. Whole health cost \$ Hundreds, electricity costs pennies! \$29. HEAL THYSELF: Plans for 3 major electronic therapeutic devices of types approved by FDA. \$19. Both \$39.

CRYPTANALYSIS TECHNIQUES

Five powerful menu-driven crypto programs (in .COM and .BAS source code) to analyze, decrypt "secure" ciphertexts. Worked-out examples. Recommended by prestigious "Computers & Security," Manual + Disk* \$29.

By an ORDER of the MAGNITUDE

The most comprehensive, hard-hitting, hi-tech survival book ever written! Topics include electronics, computers, energy, weapons, concealment, revenge, alarms, etc to survive today's dangerous world. We all face increasingly financially and physically brutal times! Field-expertise use of technology in various threat and conflict environments and scenarios. \$49.

ROCKET'S RED GLARE

How to design and build solid-propellant amateur and survival rockets, Emphasis on formulation, manufacture, installation of propellants, motors, igniters, etc. Includes list of commonly available materials, and the design of launch pads and test beds and their electronics. \$29. FIREWORKS: Small fireworks (M-80s, blockbusters, cherry bombs), slow rockets, volcanos, fountains, sparklers and safety fuses are made and colored. Simple, cheap, common ingredients. \$9. Both \$36.

SAVVY DRIVING

Detailed, comprehensive manual describes 100+ tactical and strategic driving tips. Includes how to avoid and evade criminals, avoid and evade head-on collisions and other accidents, properly react to accidents, emergencies and police pullovers, avoid tickets, minimize insurance premiums and loss risk, prepare for trips and optimize routes and long-distance driving, optimize parking, more. For all drivers - beginners to pros. \$29.

ULTIMATE SUCCESS MANUAL

Underpaid, overworked, harassed or abused? Victim of office politics? Stuck in a dead-end job? Can't find a good job? Expect to be laid off, fired or transferred soon? The ultimate no-holds-barred, looking-after-#1 Machiavellian techniques to find, obtain, optimize and keep top jobs, pay and benefits. THE RULES OF THE GAME FOR A GAME WITHOUT RULES! From resume to CEO. \$29.



CABLE TV

Universal Descrambler
NEW PRODUCT



UNIVERSAL 5000 \$199.95

Our fully assembled product is factory tested and **GUARANTEED** to work on your system.

MODEL 4000 KIT \$ 79.95

The 4000 KIT comes with all the electronic parts and our Cad designed PC board. We provide parts list, full schematic, wiring diagram and tutorial.

MODEL 4000A Enclosure \$ 44.95

The 4000A Enc. Package will provide the hobbyist, who has our 4000 Kit, a custom enclosure, AC adaptor and finish accessories to enclose their kit.

MODEL 4000 And 5000 Features

- The latest in Video Amplification Technology.
- New clocking circuits to stabilize color and picture performance.
- The most advanced picture locking circuitry.
- Inverted Video Option is available.
- NO CONVERTER BOX is necessary.

The Halcyon Group 1-800-664-6999

AMERICAN RELIANCE

AMREL Offers Lowest Prices & Best Warranties on DC Power Supplies ANYWHERE!

3 YEAR WARRANTY



3 YEAR WARRANTY



AMREL Offers Superior Analog Power Supplies Starting as Low as \$149.00

- Low Output noise rating less than 0.3mV.
- Line/load regulation rated at low 0.01% + 1mV.
- Transient response time of 50µ Sec.
- Overload protection, and Output enable/disable.
- Coarse and fine voltage/current adjustment.
- Auto series/parallel operations for triple output supplies.

AMREL Offers Features And Prices on Digital Power Supplies That The Competition Can't Beat!

- Microprocessor controlled.
- User friendly keypad data entry.
- Low output noise rating less than 1mV.
- Line/Load regulation rated less than 2mV.
- Output enable/disable and Power off memory.
- Optional RS-232 interface capability.

Model	LPS-101	LPS-102	LPS-103	LPS-104	LPS-105	LPS-106	LPS-301	LPS-302	LPS-303	LPS-304	LPS-305
Rating	30V/1A	30V/2A	30V/3A	+30V/1A -30V/1A 3-6.5V/3A	+30V/3A -30V/3A 3-6.5V/3A	60V/1A	15V/2A(H) 30V/1A(L)	15V/4A(H) 30V/2A(L)	30V/3A	+30V/1A -30V/1A 5V/2A	+30V/2.5A -30V/2.5A 3.3-5V/3A
List Price	\$195	\$225	\$295	\$395	\$495	\$245	\$249	\$299	\$469	\$349	\$599
Sale Price	\$149	\$179	\$199	\$375	\$469	\$219	\$199	\$285	\$350	\$379	\$569

PR INT™
Products International Inc.



Call: 1-800-638-2020



8931 Brookville Road • Silver Spring, Maryland 20910 • Fax: 800-545-0058

CIRCLE 46 ON FREE INFORMATION CARD

BREAST CANCER BEGINS EVEN SMALLER THAN THIS. THAT'S WHY YOU NEED A YEARLY MAMMOGRAM, ESPECIALLY AS YOU GET OLDER. MAMMOGRAMS CAN DETECT LUMPS TOO SMALL FOR YOU TO FEEL AND EARLY DETECTION MAY SAVE YOUR LIFE, SO CALL 1-800-ACS-2345.

GET A MAMMOGRAM. EARLY DETECTION IS THE BEST PROTECTION.

DC/CAD introducing...

THE TERMINATOR

Super High Density Router
(Complete with Schematic & PCB EDITOR)

Features the following powerful algorithm & capability:

- Rip - up and Retry
 - Pre-routing of SMT components
 - Real-Time via minimization
 - Real-Time clean up passes
 - User defined strategies
 - Window 3.0 capability as DOS Task
 - 1-mil Autoplacer and Autopanning
 - Two-way Gerber and DXF
 - Automatic Ground Plane w/ Cross-Hatching
 - Complete w/ Schematic & Dolly Libraries
 - Optional simulation capability & protected mode for 386 users
- * PCB LAYOUT SERVICE AT LOW COST *

Call for DC/CAD - \$95 (available for students only) normal price range \$295 - \$2500

LEASE PROGRAM & SITE LICENSE AVAILABLE



Design Computation

1771 State Highway 34
Farmingdale, NJ 07727
(908) 681 - 7700 • (908) 681 - 8733 (FAX)

"DC/CAD... The focal point of future CAD market"

Radiotelephone - Radiotelegraph

FCC Commercial License

Why Take Chances?

Discover how easy it is to pass the exams. Study with the most current materials available. Our Homestudy Guides, Audio, Video or PC "Q&A" pools make it so fast, easy and inexpensive. No college or experience needed. The new commercial FCC exams have been revised, covering updated Aviation, Marine, Radar, Microwave, New Rules & Regs, Digital Circuitry & more. We feature the Popular "Complete Electronic Career Guide" 1000's of satisfied customers. **Guarantee to pass or money back.** Send for **FREE DETAILS** or call **1-800-800-7588**

WPT Publications
4701 N.E. 47th Street
Vancouver, WA 98661

Name _____

Address _____

City _____ St. _____ Zip _____

1-800-800-7588

September 1995, Popular Electronics

Weeder Technologies

FREE
catalog and construction plans
for any of these kits (limit two)
Call 513-752-0279

Pro-Kit™

P.O. Box 421, Batavia, OH 45103

Educational Kits for the Serious Hobbyist

Caller Block

Connects between your telephone and its wall jack, and prevents the phone from ringing unless the calling party is one which you've entered into memory using your touch-tone phone. Your answering machine can handle all other calls. Change between two separate directories of callers with a simple flip of a switch. \$48.00

Telephone Caller ID

Connects to telephone wall jack. Shows the telephone number of the calling party along with the time of day the call was received, on a 16x1 character LCD display. Stores the info from the last five calls in memory. Complete stand alone, no computer interface needed. \$52.50

Telephone Call Restrictor

Connects to telephone wall jack. Disables all phones on the line if attempting to either: dial a number that has been stored in memory "Block Mode" or, dial a number that has not been stored in memory "Allow Mode". Use touch-tone phone to enter telephone numbers into memory, and choose mode. Program from any phone on the line using your password. \$35.00

50 MHz Frequency Counter

Reads frequency from 1Hz to 50MHz and displays it on a 16x1 character LCD display. Auto-range feature provides floating decimal point and automatically affixes the correct suffix (Hz, KHz, or MHz). Microcontroller based, very few additional components. \$48.50

Telephone Scrambler

Scrambles your voice before sending it over the telephone line, and descrambles it on the other end. Connects between your telephone and wall jack. No modifications are required to your telephone. Full duplex operation. \$43.00

IR Remote Control Receiver

Learns and records the data patterns emitted by standard infrared remote controls used by TVs, VCRs, Stereos, etc. Lets you control all your electronic projects with your TV remote. Seven individual I/O pins can be assigned to any button on your remote, and can be configured for either "toggle" or "momentary" action. \$32.00

Vocal Filter

An audio device which can be used with a home component stereo system, to filter out the main vocal sound track from standard stereo recordings (CD, tape, record or FM), leaving the background music to sing along with. Produce your own karaoke tapes. \$40.00

DTMF Decoder/Logger

Keep track of all numbers dialed or entered from any phone on your line. Connects to your telephone wall jack. Decodes all 16 touch-tones and displays them on an LCD display. Holds the last 240 digits in a nonvolatile memory. Scroll through and view all telephone numbers dialed, credit card numbers entered, etc. \$54.50

CABLE TV CHANNELS

EQUIPMENT **Direct!**
GUARANTEED

SAVE \$1000's
The Nationwide source for cable TV equipment.
"BUY WHERE THE DEALERS BUY."

FREE TV Cable Descramblers, Converters and Magic Box Catalog. Open Every Day!

FREE YOUR VCR TAPES CAN PLAY AS CLEAR AS DAY!
Eliminates copy protection on any tape.

UNJAM NOW WITH Video Decoder
Copy any rental/bought tape
Power Cord and RC Plugs Included

2 Year Warranty
CALL NOW!
Member Better Business Bureau

MEGA ELECTRONICS
1-800-676-6342 VISA • MC • COD

FREE 30 DAY TRIAL



PE MARKET CENTER CLASSIFIEDS

Quality Microwave TV Antennas

WIRELESS CABLE - IFTS - MMDS - Amateur TV
Ultra High Gain 50db(+) • Tuneable 1.9 to 2.7 GHz.

- 55-Channel Dish System \$199.95
- 36-Channel Dish System \$149.95
- 20-Channel Dish System \$124.95
- Optional Commercial Grid Antenna (not shown) Add \$50.00
- Yagi Antennas, Components, Custom Tuning Available
- Call or write (SASE) for "FREE" Catalog

PHILLIPS-TECH ELECTRONICS
Dish System P.O. Box 8533 • Scottsdale, AZ 85252
LIFETIME WARRANTY (602) 947-7700 (\$3.00 Credit all phone orders)
MasterCard • Visa • American Express • COD's • Quantity Pricing

TEST EQUIPMENT

SURPLUS ELECTRONIC test equipment for sale at deep discounts. Write, phone, or fax to request the current list. Jim Stevenson, 3401 Sunny Slope Road, Bridgewater, NJ 08807. Phone: (908) 722-6157, Fax: (908) 722-6391.

MUSIC & ACCESSORIES

LOUDSPEAKER COMPONENTS, Car amplifiers, woofers, midranges, tweeters, crossover components, CD players, equalizers, custom built loudspeaker and subwoofer systems, DJ mixers, and more!!! Call 1 (800) AUDIO-28 for **FREE CATALOG!!!**

BUSINESS OPPORTUNITIES

START your own technical venture! Don Lancaster's newly updated **Incredible Secret Money Machine II** tells how. We now have autographed copies of the Guru's underground classic for \$18.50. **SYNERGETICS PRESS**, Box 809-C, Thatcher, AZ 85552. (520) 428-4073. Visa/MC.

GREAT EXTRA income! Assemble craft products at home. Easy/fun! Program guaranteed! Call: 1 (800) 377-6000 ex7930.

SMALL BUSINESS "Government" loans available nationwide! It's easy when you know how — Call NIC: 1 (800) 226-3601, BF7930.

MAKE \$75,000 to \$250,000 YEARLY. Repairing all kinds IBM monitors. Successful home based business, anywhere. Telephone required. Details: USA \$3.00 cash (no checks), Dealerships: Canada-all foreign countries: \$85.00 for application-brochure. Randall Display, Box 2168H, Van Nuys, CA 91404.

GET SERIOUS! A wealth of information to make you wealthy. Money, PO Box 69059, Edmonton, Alberta T6V 1A0.

EDUCATION

LEARN IBM PC ASSEMBLY LANGUAGE. Disk \$5.00. Book \$18.00. ZIPFAST, Box 12238, Lexington, KY 40581-2238.

MISCELLANEOUS ELECTRONICS FOR SALE

THE CASE Against Patents. Thoroughly tested and proven alternatives that work in the real world. \$28.50. **SYNERGETICS PRESS**, Box 809-C, Thatcher, AZ 85552. (520) 428-4073. Visa/MC.

TURBO CHARGE your amplifier. Guide to increase wattage of existing power amplifiers. Send \$7.50 for complete book. JAM Electronics, 7391 St. Hwy 78, Gratiot, WI 53541.

REMOTE CONTROL miniature encoded transmitters and receivers. Send for free catalog to: Inventive Solutions, PO Box 8, Stratford, NY 13470.

FREE BUY/Sell listing searches. **FREE** 2 month listing. Used/surplus/antique equipment/parts/books. **Communications/Computer/Electronics BBS.** Modem: (201) 993-0811 (8/N/1/ANSI) or Suite 111, 103 Washington, Morristown, NJ 07960.

COMPONENTS

HUGE SELECTION of electronic components. Best prices available on capacitors, resistors, IC's, diodes, transistors, and more. Send for free catalog. Fastronics, 2312D Crestview, Suite 112-PE1, Hudson, WI 54016.

AUDIO-VIDEO-LASERS

LASERS, LIGHTSHOWS, Holography. Lowest prices. For free catalog write: Midwest Laser Products, PO Box 2187, Bridgeview, IL 60455. Or call: (708) 460-9595.

SILICON-CONTROLLED RECTIFIER PROJECTS

1586T—From TAB Books. A treasure trove of exciting projects using SCR's and other low-cost thyristor devices for power-control applications. Includes a sophisticated burglar-alarm system, an SCR-based smoke-alarm system, a remote-control garage-door opener, and a high-tech light dimmer that uses the output from your stereo to modulate the intensity of your lights. And then there are 20 more. To order—ask for book 1586T, and include your check for \$12.95 (includes s&h) in US and Canada, and order from — Electronic Technology Today Inc., P.O. Box 240, Massapequa Park, NY 11762-0240. US funds only, use US bank check or International money order. Allow 6-8 weeks for delivery.



MA09

EPROM+ PROGRAMMING SYSTEM USES PARALLEL PORT

EPROMS (24, 28, 32 & 40 PIN*)+27C AND 25XXX
1702*, 2708, TMS2716*, 32, 32A, 64, 64A, 128, 128A
256, 512, 513, 011, 010, 101, 1001, 1000, 1024, 210, 020
2001, 220, 2048, 4001/2, 040, 080, 240, 4096, 68764/66
FLASH EPROMS 28F256, 28F512, 28F010
28F020, 29C257, 29C010, 29C040, 29F010, 29F040
EEPROMS & NVRAMS (18, 24 & 28 PIN-CXX)
2210, 2212, 2804, 2816, 2816A, 2817, 2864, 2865
28256, 28C010, DS1220, DS1225, DS1230
SERIAL EPROMS* (8 & 14 PIN PLUS CXX)
ER1400, M58657, 2401, 02, 04, 08, 16, 32, 65, 2444
59C11, 80011A, 9306, 46, 56, 66, 8572, 82, 92, 168/9 XX
BIPOLAR PROMS* (16 THROUGH 24 PINS)
74SXXX AND 82SXXX FAMILY
MICROCONTROLLERS* 8741, 42, 48, 49, 8751
C51, 52, C52, 87C5XXX, 87C75X, 89C5X, 68705
68HC705, 68HC711E9, PIC16CXX, TMS7742
*ADAPTER REQUIRED - DIAGRAMS INCLUDED

SOFTWARE - READ, VERIFY, PROGRAM, COPY
DISK FILE LOAD/SAVE, CHECKSUM, FULL
SCREEN BUFFER EDITOR W/20 COMMANDS
READS HEX, S-RECORD AND BINARY FILES
FAST-DEVICES PROGRAM IN UNDER 20 SEC
RUGGED (9"X6"X3") ENCLOSURE W/HANDLE
MADE IN USA - 1 YEAR WARRANTY

ANDROMEDA RESEARCH, P.O. BOX 222, MILFORD, OH 45150
(513) 831-9708 FAX (513) 831-7562



SYSTEM INCLUDES:
PROGRAMMING UNIT
PRINTER PORT CABLE
POWER PACK, MANUAL
AND SOFTWARE.

\$289

ADD \$5.00 SHIPPING
\$5.00 C.O.D.
VISA/MASTERCARD

HOME AUTOMATION

Largest Selection of HOME AUTOMATION
products in the World!

Browse us on the WEB!
<http://www.techmail.com/smarthome>

Hundreds of hard-to-find automation, X10, and wireless
control products. Computer control of your home, security
systems, surveillance cameras, infra red audio/video control,
HVAC, pet care automation, wiring supplies, and much more!

HOME AUTOMATION SYSTEMS, Inc.
151 Kalmus Drive, Ste L4, Costa Mesa, CA 92626
Questions 714-708-0610 FAX 714-708-0614

800-SMART-HOME

800-762-7846

**Home Automation
Systems, Inc.**



Call 24hrs for FREE
64 page Color Catalog

**Over 500
unique products!**

PE MARKET CENTER CLASSIFIEDS

MISCELLANEOUS ELECTRONICS WANTED

I'M LOOKING to buy a Realistic DX-150 5-Band
shortwave receiver. Will pay big cash (409)
299-1897.

SATELLITE EQUIPMENT

SATELLITE RADIO BOOK AND GUIDE. New
book covers all audio services, SCPC, subcar-
riers, FM squared, facsimile, press services,
weather services. Simple how-to-receive instruc-
tions. \$16.95 plus \$3.00 Priority Mail. UNIVER-
SAL ELECTRONICS, 4555 Groves Road, #12,
Columbus, OH 43232. (614) 866-4605.

VIDEOCYpher II descrambling manual. Schematics,
video and audio. Explains DES, EPROM,
CloneMaster, Pay-per-view (HBO, Cinemax,
Showtime, Adult, etc.) \$16.95, \$2.00 postage.
Schematics for Videocypher Plus, \$20.00. Schematics
for Videocypher 032, \$15.00. Collection of
software to copy and alter EPROM codes, \$25.00.
VCI Plus EPROM, binary and source code,
\$30.00. CABLETRONICS, Box 30502PE, Beth-
esda, MD 20824.

SECURITY

HI-TECH. ELECTRONICS, The best for less,
(spy, security, laser), catalog \$5.00 postage: F & P
Enterprises, Box 51272, Palo Alto, CA 94303-A.

PUBLICATIONS

HISTORIC AND Classic hardware support mag-
azine. *The Computer Journal* provides how-to
information on keeping S-100, Kaypro, Z80, 6809,
CP/M, and PC/XT systems running. Over TEN
years of hardware, software projects. 6 issues
\$24.00. Free sample. 1 (800) 424-8825. TCJ, PO
Box 535, Lincoln, CA 95648.

\$139* Laser LightShow



Draw with a laser beam! Animation,
text, music & more! Includes galvos, servo
amp, oscillators, software listing, analog &
digital computer interfaces. Call for details



Computerized Motors \$39*

Includes: 2 Stepper motors,
computer interface, 32 page training manual, &
software listing. Expandable system! Up to 12
motors, up to 3 amps per phase. Call for details

* Add \$6 for shipping. Computer with parallel printer port.
Assembly, Power supply, & Laser are required

Call or fax for **FREE FLYER**

SVS
Light &
Motion
in kit form

1273 Industrial Pky, West Bldg. 460
PO Box 55125
Hayward CA 94545-0125

Voice **510-582-6602**
Fax **510-582-6603**

NEW EASY PC

BRITISH
DESIGN
AWARD

SCHEMATIC and PCB C.A.D

ONLY **\$195**

Includes

- MGA, CGA, EGA & VGA compatible.
- Design large multi layer boards.
- One level pull down menu and quick keys for fast layout.
- Dot matrix, laser, plotter, Gerber & N.C. drill output.
- 6 Month Free update
Free Demo

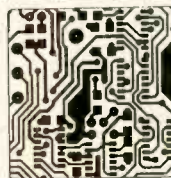

7840 ANGEL RIDGE ROAD
ATHENS, OHIO 45701
(614) 592-1810

Visa & MasterCard Accepted

PROGRAMMERS

- 1349 DATA I/O CHIPLABS 4800
- 799 DATA I/O CHIPLABS 3200
- 579 EETOOLS ALLMAX
- 249 XELTEK SUPERPRO (R)
- 599 LOGICAL DEVICES 3000
- 599 ADVANTECH PC-UPROG
- 269 SUNSHINE UNIVERSAL
- 449 TUP-300 HILO SYSTEMS
- 449 JDR MCT-EMUF
- 539 TUP-400 HILO
- 429 NEEDHAMS EMP-20
- 679 NEEDHAMS SA-20
- 139 EETOOLS 1 GANG
- 199 EETOOLS 4 GANG
- 49 SUNSHINE 1 GANG
- 99 SUNSHINE 4 GANG
- 169 SUNSHINE 8 GANG
- 349 SUNSHINE 16 GANG

GENERAL DEVICE INSTRUMENTS
(408) 241-7376 Fax 241-6375 BBS 983-1234

Save Big \$ and watch what you want!

Cable TV Descramblers

Converters * Filters * Accessories

30 day Free Trial - NO RISK!
Unbeatable wholesale prices!
Affordable extended warranty
1 Year Warranty on all products

Free
Catalog

Call the cable professionals!

Credit Cards Welcome!

1-800-379-3976

We'll beat anyone's price!

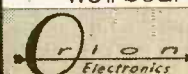

Prices starting
as low as \$99!

USE POPULAR ELECTRONICS CLASSIFIEDS

READ BY BUYERS OF ELECTRONIC EQUIPMENT ACCESSORIES AND PARTS

INSTRUCTIONS FOR PLACING YOUR AD

HOW TO WRITE YOUR AD

TYPE or **PRINT** your classified ad copy **CLEARLY** (not in all capitals) using the form below. If you wish to place more than one ad, use a separate sheet for each additional one (a photo copy of this form will work as well). Place a category number in the space at the top of the order form (special categories are available). If you do not specify a category, we will place your ad under miscellaneous or whatever section we deem most appropriate.

We cannot bill for classified ads. **PAYMENT IN FULL MUST ACCOMPANY YOUR ORDER.** We do permit repeat ads or multiple ads in the same issue, but, in all cases, full payment must accompany your order.

WHAT WE DO

The first word and company name of each ad are set in bold caps at no extra charge. No special positioning, centering, dots, extra space, etc. can be accommodated.

RATES

Our classified ad rate is \$1.75 per word. Minimum charge is \$26.25 per ad per insertion (15 words). Any words that you want set in bold are each .40 extra. Indicate bold words by underlining. Words normally written in all caps and accepted abbreviations are not charged anything additional. State abbreviations must be post office 2-letter abbreviations. A phone number is one word.

If you use a **Box number** you must include your permanent address and phone number for our files. **ADS SUBMITTED WITHOUT THIS INFORMATION WILL NOT BE ACCEPTED.**

For firms or individuals offering Commercial products or Services. **Minimum 15 Words.** 5% discount for same ad in 6 issues within one year; 10% discount for same ad in 12 issues. **Boldface** (not available as all caps), add .40 per word additional. **Entire ad in boldface**, add 20%. **Tint screen behind entire ad**, add 25%. **Tint screen plus all boldface ad**, add 45%. **Expanded type ad**, add \$2.25 per word.

General Information: A copy of your ad must be in our hands by the 13th of the fourth month preceding the date of issue (i.e. Sept issue copy must be received by May 13th). When normal closing date falls on Saturday, Sunday or Holiday, issue closes on preceding work day. Send for the classified brochure.

DEADLINES

Ads not received by our closing date will run in the next issue. For example, ads received by November 13 will appear in the March issue that is on sale January 17. **POPULAR ELECTRONICS** is published monthly. No cancellations permitted after the closing date. No copy changes can be made after we have typeset your ad. **NO REFUNDS**, advertising credit only. No phone orders.

CONTENT

All classified advertising in **POPULAR ELECTRONICS** is limited to electronics items only. All ads are subject to the publishers approval. **WE RESERVE THE RIGHT TO REJECT OR EDIT ALL ADS.**

AD RATES: \$1.75 per word. Minimum \$26.25

Send you ad payments to:

POPULAR ELECTRONICS 500 Bi-County Blvd, Farmingdale, NY 11735-3931

CATEGORIES

100 - Antique Electronics	270 - Computer Equipment Wanted	450 - Ham Gear Wanted	630 - Repairs-Services
130 - Audio-Video Lasers	300 - Computer Hardware	480 - Miscellaneous Electronics For Sale	660 - Satellite Equipment
160 - Business Opportunities	330 - Computer Software	510 - Miscellaneous Electronics Wanted	690 - Security
190 - Cable TV	360 - Education	540 - Music & Accessories	710 - Telephone
210 - CB-Scanners	390 - FAX	570 - Plans-Kits-Schematics	720 - Test Equipment
240 - Components	420 - Ham Gear For Sale	600 - Publications	730 - Wanted

CLASSIFIED AD COPY ORDER FORM

Place this ad in Category # _____

Special Category \$20.00 Additional _____

1 - \$26.25	2 - \$26.25	3 - \$26.25	4 - \$26.25	29 - \$50.75	30 - \$52.50	31 - \$54.25	32 - \$56.00
5 - \$26.25	6 - \$26.25	7 - \$26.25	8 - \$26.25	33 - \$57.75	34 - \$59.50	35 - \$61.25	36 - \$63.00
9 - \$26.25	10 - \$26.25	11 - \$26.25	12 - \$26.25	37 - \$64.75	38 - \$66.50	39 - \$68.25	40 - \$70.00
13 - \$26.25	14 - \$26.25	15 - \$26.25	16 - \$28.00	Total words _____		\$1.75 per word = \$ _____	
17 - \$29.75	18 - \$31.50	19 - \$33.25	20 - \$35.00	Bold Face _____		\$0.40 per word = \$ _____	
21 - \$36.75	22 - \$38.50	23 - \$40.25	24 - \$42.00	Special Heading _____		\$20.00 = \$ _____	
25 - \$43.75	26 - \$45.50	27 - \$47.25	28 - \$49.00	Other _____		= \$ _____	

Total classified ad payment \$ _____ enclosed

TOTAL COST OF AD \$ _____

Check Mastercard Visa

Card # _____ Expiration Date ____/____/____

Signature _____

Name _____ Phone _____

Address _____ City State Zip _____

September 1995, Popular Electronics

IMPROVE YOUR IMAGE!

WITH OUR VIDEO STABILIZERS

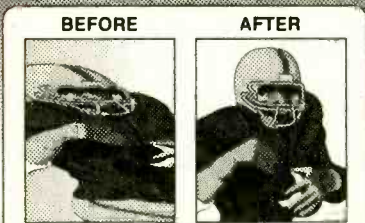

SUPER VHS MODEL AVAILABLE!

The clearest picture possible playing back movies. **GUARANTEE** to eliminate copy protection.

- No Rolls/Jitters/Flickers/Fading
- Works on all TV's, VCR's Beta & Cable
- Gold Video Connectors & Cables Included
- 2 Year Warranty
- Money Back Guarantee



VISION ELECTRONICS

1-800-562-2252

2125 S. 156TH CIRCLE • OMAHA, NE 68133

CABLE TV DESCRAMBLERS

Best Wholesale Prices in the U.S.A.!

	1-4	5-9	10-19	20-49	50+
<i>For Jerrold Systems</i>					
TNT+	59	55	49	45	40
Stealth+	55	49	44	39	34
FTB3	49	39	35	32	30
<i>For Scientific Atlanta Systems</i>					
M80	69	62	55	45	40
SA3	55	45	40	36	33
<i>For Pioneer Systems</i>					
Super-PIO+	69	62	55	45	40
<i>Panasonic Converter</i>					
TZPC1003	75	67	62	59	57

1-800-818-9688

U.S. Cable TV Inc. M-F: 9-6 EST

4100 N.Powerline Rd., Bldg.F4 Pompano Beach, FL 33073

U.S. Cable will only sell the cable equipment to authorized cable subscribers. It is illegal to operate this equipment without paying for the basic and the premium services. U.S. Cable will not sell to anyone who will not comply with Federal and State laws. *No Florida Sales.*

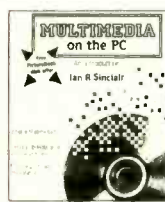

MULTIMEDIA on the PC!

What is Multimedia? What can it do for you? It can do lots of nice things! This 184-page book helps you create your own multimedia presentation.

Multimedia applications by people like you can revolutionize educational and business applications as well as bring more FUN, FUN, FUN into your leisure computer activities.

Mail coupon to:

Electronics Technology Today, Inc.
P.O. Box 240
Massapequa Park, NY 11762-0240

Please send me my copy of *Multimedia on the PC* (PCP120). I enclose a check or money order for \$18.95 to cover the book's cost and shipping-and-handling expenses. NY state resident must add local sales tax.

Name _____
Address _____
City _____ State _____ Zip _____

All orders must be paid in U.S. funds only. Sorry, no orders accepted outside of USA and Canada. Please allow 6-8 weeks for delivery. MA02

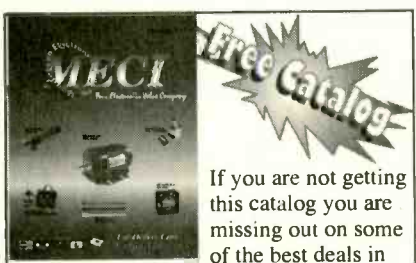

If you are not getting this catalog you are missing out on some of the best deals in electronics today! We have thousands of items ranging from unique, hard-to-find parts to standard production components. Call, write, or fax today to start your free subscription to the most unique catalog in the industry, filled with super values on surplus electronic and hobbyist type items. If you have a friend who would like to receive our catalog, send us their name and address and we will gladly forward them a complementary 100 page catalog.

Why pay more? Call today.

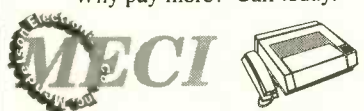

340 East First Street Dayton, Ohio 45404 Fax Order Line 1-800-344-6324

Order Toll-Free
1-800-344-4465

CIRCLE 149 ON FREE INFORMATION CARD

SURVEILLANCE

FM TRANSMITTERS MINI (KITS)

- 3-VOLT FM XMTR, up to 300 ft. indoors, 1500 ft. outdoors
- PHONE XMTR, range to 500 ft., uses phone-line power
- Sound-Activated XMTR, range to 500 ft.
- 2-STAGE XMTR, 9-Volt, very powerful

All above require simple soldering at 2 to 4 places. **\$29.95** ea.**

TELE FM WIRELESS MONITORING SYSTEM. (Kit) **\$99.00***

TELE CALL FORWARDER. Transfers incoming calls. **\$99.00***

CALLER ID. Registers incoming number. **\$99.00***

TEL REGISTER WITH PRINTER. Records dialed number, duration, and prints record. **\$139.00***

12-HOUR LONG-PLAY RECORDER. Modified Panasonic. Records 6 hrs. on each side of 120 tape (supplied). Compatible with VOX and Tel Rec Adapter. **\$119.00***

VOX VOICE-ACTIVATED SWITCH. Makes recorder self-activating with voices or other sounds. **\$28.50****

TELE RECORDING ADAPTER. Records incoming and outgoing calls. **\$28.50****

TELEPHONE SCRAMBLERS. Over 4,000 separate codes. **\$199.00***

VOICE CHANGER. Changes man's voice to lady's and vice versa. **\$49.00***

For Shipping & Handling add *\$5.00 and **\$2.00 per item. Colo. residents add sales tax. Mail Order, VISA, M/C, COD's o.k. Inquire for dealer prices. Free catalog.

MUCH, MUCH MORE — OUR 25TH YEAR!
TOLL FREE 1-800-926-2488

A.M.C. SALES, INC.
193 Vaquero Dr., Boulder, CO 80303
Tel: (303) 499-5405, Fax: (303) 494-4924
Mon.-Fri. 8 a.m.-5 p.m. Mtn. Time

CIRCLE 140 ON FREE INFORMATION CARD

September 1995, Popular Electronics

The Electronics Industry is looking for a lot of good people!

Here is your chance to get in on the ground floor as an Associate CET. Is your job title "Electronics Service Technician?" Would you like to have that title? You can prove you qualify for the title with a CET Associate Certificate. It can be your career door-opener and begin your rapid advancement!

A technician or student of electronics with less than a total of four years of basic experience may take the Associate Level Exam. The exam is the basic electronics portion of the full-credit CET exam. The 75-question, multiple-choice test covers basic electronics, math, DC and AC circuits, transistors and semiconductors, instruments, measurements and troubleshooting. A successful Associate CET will receive a wall certificate valid for four years and is eligible to join ISCET as an Associate Member. ISCET is the International Society of Certified Electronics Technicians.

The ISCET Computer-Aided Associate-Level Study Guide prepares you for the Associate CET Certificate by randomly selecting sample questions with appropriate diagrams, provides multiple-choice answers, grades the test and provides a summary of your strong and weak points.

CLAGGK INC. - CET Computer-Aided Study Guide Offer
PO Box 4099, Farmingdale, New York 11735

Yes, I want to step up to a career in servicing. Here is my order for the CET Computer-Aided Study Guide on a 3.5 diskette.

Bill my VISA MasterCard Expire Date / /
 USA Bank Check US or International Money Order

Card No. _____

Signature _____

Name (Please Print) _____

Address _____

City _____ State _____ Zip _____

New York residents add local sales taxes. Canadians add \$6.00 per order. No foreign orders. Do not send cash. Checks drawn on US Bank and International Money Orders in US funds only. Credit card users may telephone or FAX orders. Telephone 516-293-3751 or FAX 516-293-3115. Price subject to change. Allow 6 to 8 weeks for delivery.

CB05

Proof Positive that you are a Certified Electronics Technician



A New Computer Software Program — ISCET Computer-Aided Associate-Level Study Guide

Prepare yourself for the 75-question CET Associate Examination. Model examinations provide the technician with a study program and introduction to the actual examinations. The model examinations are automatically graded in decimal numbers and bar graphs that can be outputted on your printer. The questions for each exam are selected randomly from a loaded data base—no two exams are exactly the same. When you answer a question, the correct answer is displayed and an explanation is given. From the print-outs you will determine whether you need more practice and in which topic areas, or if you are ready to take the real test and continue to promote your electronics career today!

❖ ATTENTION CABLE VIEWERS ❖

CABLE VIEWERS. . . get back to your BASIC Cable Needs

Call 800-577-8775

For information regarding all of your BASIC cable needs.



**BASIC
ELECTRICAL
SUPPLY &
WAREHOUSING
CORPORATION**

5 GOOD REASONS TO BUY OUR FAR SUPERIOR PRODUCT

- ❖ PRICE
- ❖ EFFICIENT SALES AND SERVICE
- ❖ WE SPECIALIZE IN 5, 10 LOT PRICING
- ❖ ALL FUNCTIONS (COMPATIBLE WITH ALL MAJOR BRANDS)
- ❖ ANY SIZE ORDER FILLED WITH SAME DAY SHIPPING

We handle NEW equipment ONLY - Don't trust last years OBSOLETE and UNSOLD stock!
COMPETITIVE PRICING—DEALERS WELCOME

HOURS: Monday-Saturday 9-5 C.S.T.

It is not the intent of B.E.S.W. to defraud any pay television operator and we will not assist any company or individual in doing the same.
*Refer to sales personnel for specifications.

P.O. Box 8180 ■ Bartlett, IL 60103 ■ 800-577-8775

PE MARKET CENTER CLASSIFIEDS

CABLE TV

"BULLET" BUSTER. Protect your cable box against the infamous cable "bullet." The "Bullet" Buster acts as an electronic shield. Installs in-line in seconds. Don't wait until it's too late! \$19.95 + \$3.00 S&H. Visa/MC. **ELECTROMAN**, Box 24474, New Orleans, LA 70184. (504) 482-3017.

CABLE — SAFE. Guarantee cable privacy. The one way valve for your cable TV signal. Cable signals come in, but they don't go out! \$29.95, + \$3.00 S&H. Visa/MC. **ELECTROMAN**, Box 24474, New Orleans, LA 70184. (504) 482-3017.

DESCRAMBLER SCHEMATICS REVEALED. A powerful guide to descrambling schemes. \$10.00. Visa/MC. **ELECTROMAN**, Box 24474, New Orleans, LA 70184. (504) 482-3017.

CABLE UNSCRAMBLED. Everything you want to know about cable, but are afraid to ask. \$10.00. Visa/MC. **ELECTROMAN**, Box 24474, New Orleans, LA 70184. (504) 482-3017.

UNIVERSAL DESCRAMBLER. Unscramble signals using your VCR as the tuner. Works with virtually any system, this is the only one you need. Declare cable box independence! \$129.95 + \$5.00 S&H. Visa/MC. **ELECTROMAN**, Box 24474, New Orleans, LA 70184. (504) 482-3017.

ATTN. CABLE box owners. Get your Bullet and ID stopper before it's too late. Send \$20.50 to R.R. Enterprise, Box 3532, Easton, PA 18043.

CABLE DESCRAMBLING, New secret manual. Build your own descramblers for cable and subscription TV. Instructions, schematics for SSAVI, gated sync, sinewave, some free methods (HBO, Cinemax, Showtime, UHF, Adult) \$12.95, \$2.00 postage. **CABLETRONICS**, Box 30502PE, Bethesda, MD 20824.

Cable Test Aids

Orders only 1-800-452-7090 Information (310)902-0841
*Test chips for JERROLD, TOCOM, ZENITH, S.A. & more. Puts cable boxes in full service mode. Easy installation. Zenith only \$39.95. Most others under \$50ea. Quantity prices available. FAX: (310)902-0851
No Co. sales. Not for use in cable co. owned equip. For use as a test aid only.*

CABLE TV DESCRAMBLERS

Never rent again! Save \$100's on premium Cable TV Descramblers & Converters compatible with Jerrold, Scientific Atlanta, Zenith, Pioneer, Tecom and More! Get your best prices and call us last! Please have the MAKE & MODEL # of your area's cable box ready.
GUARANTEED TO WORK IN YOUR AREA!
1 year warranty and 30 day money back guarantee!
Allstar Electronics 1-800-782-7214

CABLE DESCRAMBLER! Build for UNDER \$12.00 with 7 Radio Shack parts! Instructions \$8.00: F.A.S.T., Box 369-EP, Pt. Salerno, FL 34992-0369.

CATV TEST chips as low as \$8.95 for testing converter boxes in full service modes. Jerrold, Tocom, Scientific Atlanta, Pioneer BA5XXX — BA67XX cubes clears E2—E5. Micro Masters, 1 (800) 360-7654.

UNIVERSAL DESCRAMBLER No cable box required. Works on most systems through your VCR. Also carry test chips, filters, etc. Call for prices. J.V. Electronics (716) 342-7629 or 1 (800) 604-8777 orders only!

Parts Express™



Parts Express is proud to announce that we now stock the NTE line of replacement semiconductors. NTE has been

supplying the electronics industry with top notch replacement parts for over 15 years. All NTE products meet or exceed industry specifications and offer an exclusive 2 year manufacturer warranty. We also offer a complete line of parts for the service repair industry. Test equipment, loudspeakers, video and audio heads, magnetrons,



belts, idler assemblies, tools, soldering equipment, just to name some of the 12,000 items we stock. Ask about our new dealer program for resellers. Call toll free for a copy of our FREE 212 page catalog. **Source Code: POM**

**CALL TOLL FREE
1-800-338-0531**

Parts Express 340 E First St. Dayton, Ohio 45402-1257
Phone: 513-222-0173 Fax: 513-222-4644

CIRCLE 148 ON FREE INFORMATION CARD

ADVERTISING INDEX

POPULAR ELECTRONICS magazine does not assume any responsibility for errors that may appear in the index below.

Free Information No.	Page	—	Intronics	Page		
25	Ace Communications	96	—	ISCET	87	
—	Agrelo Engineering	108	153	Jensen Tools	117	
26	Alfa Electronics	102	—	KDE Electronics	115	
28	All Electronics	98	38	Kelvin Electronics	101	
—	Allen Engineering	110	—	M&G Electronics	116	
—	Allison Technology	106	152	MCM Electronics	113	
—	Allstar Electronics	111, 125	—	MD Electronics	103	
140	AMC Sales	123	—	Mega Electronics	120	
—	Andromeda Research	121	149	Mendelsohn's	123	
—	Antique Radio Classified	76	—	Mental Automation	113	
—	Basic Electrical Supply	125	42	MicroCode Engineering	5	
—	Black Feather	117	—	Mission Technology	115	
—	C&C Specialties	125	—	Modern Electronics	114	
132	C&S Sales	104	14	Mouser Electronics	3	
—	Circuit Specialties	99	16	Nat'l Electronic Wholesalers	4	
—	CLAGGK, Inc.	75, 88	—	NRI Schools	51	
—	CLAGGK, Inc.	90, 124	—	Ohio Automation	121	
—	Cleveland Inst. of Electronics	23, 35	43	Optoelectronics	CV4	
—	Command Productions	106	—	Orion Electronics	121	
—	Comtrad Industries	8, 13, 17	148	Parts Express	125	
—	Consumertronics	118	—	PC Boards	112	
154	Contact East	114	—	Phillips Tech	120	
15	Cook's Institute of Elec. Eng.	31	47	Prairie Digital Inc.	113	
—	Copyright Clearance Center	81	46	Print	119	
—	Cybermation	108	162	Print	110	
160	Davis Instruments	3	—	Rose Research & Development	117	
—	Design Computation	119	—	RP Enterprises	112	
—	EDE Spy Outlet	111	—	The School of PC Repair	76	
—	Electronic Equipment Bank	107	—	The School of VCR Repair	76	
147	Electronic Rainbow	97	—	SECO	117	
—	Electronics Tech. Today	CV3, 68, 75	—	Self-Reliance Co. Inc.	118	
—	Electronics Tech. Today	77, 93	—	Show Time	108	
—	Electronics Tech. Today	95, 120	—	Silicon Valley Surplus	121	
13	Foley-Belsaw Institute	3	—	Skyvision Inc.	111	
—	Forest Electronics	106	—	Software Science	111	
—	Fotronic Corporation	100	—	Tab Books	29, 71	
—	General Device Instruments	121	—	Tri Star Satellite Systems	116	
—	Get-Tech Inc.	118	136	UCANDO Videos	112	
—	Grantham College of Engineering	27	—	US Cable (Zentek)	123	
—	Great Southern Security	111	—	US Cyberlab	116	
—	Greenleaf Electronics Inc.	110	—	Vision Electronics	123	
—	Halcyon Group	118	168	Wavetek Corp.	7	
—	Home Automation Systems	121	—	Weeder Technologies	120	
—	I.E.C.	114	—	Weka Publishing	109	
—	Information Unlimited	87	—	WPT Publications	119	
126	169	Interactive Image Technologies	CV2	134	Xandi Electronics	114

ADVERTISING SALES OFFICE

Gernsback Publications, Inc.
500-B Bi-County Blvd.
Farmingdale, NY 11735
1-(516) 293-3000

Larry Steckler, EHF/CET
 President

Christina Estrada
 Assistant to the President

For Advertising ONLY
516-293-3000
Fax 1-516-293-3115

Larry Steckler
 publisher

Arline Fishman
 advertising director

Denise Mullen
 advertising assistant

Kelly Twist
 credit manager

**Subscription/
 Customer Service/
 Order Entry**
 1-800-827-0383
 7:30 AM - 8:30 PM EST

ADVERTISING SALES OFFICES EAST/SOUTHEAST

Stanley Levitan
 Eastern Sales
 1 Overlook Ave.
 Great Neck, NY 11021
 1-516-487-9357, 1-516-293-3000
 Fax 1-516-487-8402

MIDWEST/Texas/Arkansas/ Oklahoma, Colorado, Arizona

Ralph Bergen
 Midwest Sales
 One Northfield Plaza, Suite 300
 Northfield, IL 60093-1214
 1-708-446-1444
 Fax 1-708-559-0562

PACIFIC COAST/Mountain States

Anita Bartman
 Hutch Looney & Assoc., Inc.
 6310 San Vicente Blvd.
 Suite 360
 Los Angeles, CA 90048
 1-213-931-3444
 Fax 1-213-931-7309

Electronics Paperback Books

How to Use Op Amps



□ **BP88—How to Use OpAmps...\$5.95.** A designer's guide that covers operational amplifiers. Serving as both a source book of circuits and a reference book for design calculations. The text is non-mathematical and easy to understand by most readers.

30 Solderless Breadboard Projects - Book 2



□ **BP113—30 Solderless Breadboard Projects-Book 2...\$5.95.** Companion to BP107. Presented in exactly the same style using "Verobloc" breadboards. All the breadboard projects in this book are based on CMOS logic integrated circuits.

An Introduction to IC Components

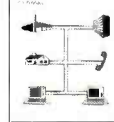

□ **BP177—Introduction to Computer Communications...\$5.95.** Details on types of modems and their suitability for specific application, plus details of connecting various computers to modems, and modems to the telephone system.

Electronic Board Games



□ **BP350—Electronic Board Games...\$6.00.** Twenty novel electronic board games that you can build from the plans in this book. Some games are motor racing, searching for buried treasure or for gold in Fort Knox. — there is something for you to build and enjoy!

Beginner's Guide to Digital Techniques



□ **BP61—Beginners Guide to Digital Techniques...\$5.00.** Covers the basics of digital techniques—decimal, binary, octal and hexadecimal numbering systems are covered plus insights on weighted and non-weighted binary-coded-decimal codes and alphanumeric codes. The basic building blocks of circuit logic, the common AND, OR, NAND, NOR and EXCLUSIVE-OR gates and bi-stables are thoroughly covered.

A Beginner's Guide to Modern Electronic Components



□ **BP285—A Beginners Guide to Modern Electronics Components...\$6.50.** It is easy for newcomers to electronics to become confused. There are a great many different types of components available often with numerous variations of each type. This book presents the reader with a vast amount of invaluable parts information to enable the right component to be selected every time for repairs and projects.

Practical MIDI Handbook



□ **PCP103—Practical MIDI Handbook...\$9.95.** The Musical Instrument Digital Interface (MIDI) is surrounded by a great deal of misunderstanding. This book is aimed at musicians and technicians who want to explore the vast capabilities of MIDI. It covers MIDI-based equipment you can use: keyboards, drum machines, sequencers, effects units, mixers, drum pads guitars. There's also a section on computer music.

Electronic Music and MIDI Projects



□ **PCP119—Electronic Music and MIDI Projects...\$14.95.** Save cash by building the MIDI gadgets you need. Want a MIDI Thru box, program change pedal, Metronome, analog echo unit? Over 16 practical and very useful music and MIDI projects.

Design and Make Your Own PCB's



□ **BP121—How to Design and Make Your Own PCB's...\$5.75.** Simple methods for copying printed-circuit board designs from magazines and books on to copper. Covers all aspects of simple PCB construction as comprehensively as possible.

IC 555 Projects



□ **BP44—IC 555 Projects...\$5.95.** Every so often a device appears that is so useful that one wonders how life went on before without it. The 555 timer integrated-circuit chip is one such device. Included are basic and general circuits used by most hobbyists.

Electronic Data Book

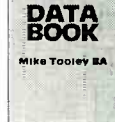

□ **PCP109—Everyday Electronics Data Book...\$10.00.** An invaluable source of electronics information—the text contains sections that deal with the underlying theory of electronic circuits and a wide range of practical electronic uses for everyone.

Antennas for VHF and UHF



□ **BP301—Antennas for VHF and UHF...\$6.00.** From installing a TV or FM antenna to setting up a multi-antenna array for shortwave listening or amateur radio, this book explains the basics of VHF and UHF antenna operation and installation. The text describes in easy-to-understand terms the essential information about how antennas work, the advantages of different antenna types, and how to get the best performance.

Loudspeakers for Musicians



□ **BP297—Loudspeakers for Musicians...\$6.25.** Contains all the information that a working musician needs to know about loudspeakers; the different types, how they work, the most suitable for different instruments, for cabaret work, and for vocals. It gives tips on constructing cabinets, wiring up, available fittings, finishing and how to connect multi-speaker arrays, etc. Includes ten enclosure designs with plans.

Electronic Power Supply Handbook



□ **PCP110—Electronic Power Supply Handbook...\$10.95.** All types of power supplies used for electronics purposes are covered in detail, starting with cells and batteries and extending by way of rectified supplies and linear stabilizers to modern switch-mode systems. IC switch-mode regulators, DC-converters and inverters. The devices, their operating principles and typical circuits, are dealt with in detail.

From Atoms to Amperes



□ **BP254—From Atoms to Amperes...\$6.50.** Explains in crystal-clear terms the fundamentals behind the whole of electricity and electronics. Really helps you to understand the basis of the complex subject perhaps for the first time ever.

Practical Digital Electronics Handbook



□ **PCP101—Practical Digital Electronics Handbook...\$9.95.** An introduction to digital circuits, logic gates, bi-stables, timers, micro-processors, memory and I/O devices. A special feature of the book is the section on digital test gear projects.

An Introduction to the Electromagnetic Wave

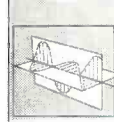

□ **BP315—Introduction to the Electromagnetic Wave...\$5.95.** A fundamental and easy-to-understand approach to a complicated theory topic. The beginner requires no more than elementary mathematics and basic knowledge of electronics.

Essential Theory for the Electronics Hobbyist



□ **#228—Essential Theory for the Hobbyist...\$5.25.** Supplies to the hobbyist background knowledge tailored to the specific requirements of the hobbyist. Relevant material is presented in a readable manner with minimum mathematics.

TEST EQUIPMENT SPECIALS

- **BP239—Getting the Most from Your Multimeter...\$5.95**
Covers analog and digital gear, component and gear testing.
- **BP267—How to Use Oscilloscopes & Other Testing Equipment...\$6.95**
Get with the next step to proficient troubleshooting.
- **PCP111—Electronic Test Equipment Handbook...\$13.95**
The all-purpose, all-pro handbook that covers basics to in-circuit testing.

SUBSTITUTION GUIDES FOR HOBBYISTS

- **BP85—International Transistor Equivalents Guide...\$7.50**
The ultimate guide to replacing foreign and domestic transistors.
- **BP108—International Diode Equivalents Guide...\$5.95**
Rectifiers, Zeners, LEDs, OCIs, diacs, triacs...all hobby types.
- **BP140—Digital Equivalents and Pin Connectors...\$12.50**
A master reference for builders who design projects.

ELECTRONIC TECHNOLOGY TODAY INC.
P.O. BOX 240, Massapequa, NY 11762-0240

Name _____
Address _____
City _____ State _____ Zip _____
PE6

SHIPPING CHARGES IN USA AND CANADA	
\$0.01 to \$5.00	\$2.00
\$5.01 to \$10.00	\$3.00
\$10.01 to 20.00	\$4.00
\$20.01 to 30.00	\$5.00
\$30.01 to 40.00	\$6.00
\$40.01 to 50.00	\$7.00
\$50.01 and above	\$8.50

SORRY No orders accepted outside of USA & Canada

Total price of merchandise	\$ _____
Shipping (see chart)	\$ _____
Subtotal	\$ _____
Sales Tax (NYS only)	\$ _____
Total Enclosed	\$ _____

Number of books ordered

All payments must be in U.S. funds!



You Won't

Miss a Thing

With

SCOUT™

Reaction Tune

The SCOUT™ Has Taken Tuning Your Receiver To a New Dimension

Featuring Automatic Tuning of your AR8000 and AR2700 with the Optoelectronics Exclusive, Reaction Tune (Pat.Pend.). Any frequency captured by the Scout will instantly tune the receiver. Imagine the possibilities! End the frustration of seeing two-way communications without being able to pick up the frequency on your portable scanner. Attach the Scout and AR8000/2700 to your belt and capture up to 400 frequencies and 255 hits per frequency. Or mount the Scout and AR8000/2700 in your car and cruise your way into the future of scanning. A simple interface cable will connect you to a whole new dimension of scanning.

The Scout's unique Memory Tune (Pat.Pend.) feature allows you to capture frequencies, log into memory and tune your AR8000/2700 at a later time. A distinctive double beep will inform you when the Scout has captured a new frequency, while a single beep indicates a frequency that has already been recorded. For discreet monitoring, a pager style vibrator will inform you of any hits the Scout captures.

The Scout will also Reaction Tune and Memory Tune Icom CI-V receivers: (R7000, R7100, and R9000) and (Pro 2005/6 equipped with OS456, Pro 2035 equipped with OS535). Download the Scout frequencies to a PC with the Scout Utility Disk and CX-12AR (optional), then compare them to the Spectrum CD-ROM/PerCon FCC Database (optional).

Act Now!! Let the Scout Reaction Tune you into The World of Scanning

SCOUT™ \$449



*Scanner not included



Features

- Automatically tunes these receivers with Reaction Tune (Pat.Pend.): CI-V receivers (ICOM's R7000, R7100, and R9000) (Pro 2005/2006 equipped with OS456, Pro 2035 equipped with OS535) or AOR models (AR2700 and AR8000)
- Records and saves 400 unique frequencies
- Records 255 hits on each frequency in memory
- Digital Filter and AutoCapture (Pat.Pend.)
- 10MHz-1.4GHz single frequency range
- View frequencies in RECALL mode
- 10 digit LCD with EL Backlight
- 16 Segment RF signal strength bargraph
- CX-12AR Computer Interface (optional)
- PC Utility Disk for downloading memory to PC
- Rapid charge NiCads with 10 hour discharge time
- Scout Spectrum CD-ROM/PerCon FCC database (optional)
- AC Adaptor/Charger
- DB 32 VHF/UHF mini-antenna shown with Scout (optional)
- Distinctive Beeper/Vibrator indicate frequency hits

At right: Scout shown with CLIPMATE™. A handy windshield mount for Scout, for quick access and visibility.

CLIPMATE™ \$25.00



OPTOELECTRONICS®

5821 NE 14th Avenue • Ft. Lauderdale, FL 33334

Contact Factory for shipping prices. Visa, Master Card, & C.O.D.(cash or money order only)

All prices and specifications are subject to change without notice or obligation

MADE IN THE U.S.A.

ORDER LINE
800-327-5912
Tel:305/ 771-2050
Fax:305/ 771-2052

CIRCLE 43 ON FREE INFORMATION CARD