





# Design and Verify Circuits. Fast.

DOS and Windows & Mac versions available

## Electronics Workbench®

**NEW** Version 3

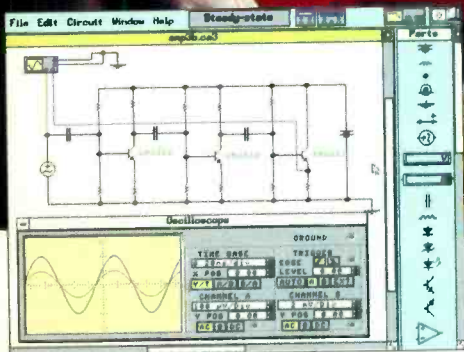

### Analog Module includes:

- complete control over all component values
- ideal *and* real-world models for active components
- resistors, capacitors, inductors, transformers, relays, diodes, Zener diodes, LEDs, BJTs, opamps, bulbs, fuses, JFETs, and MOSFETs
- manual, time-delay, voltage-controlled and current-controlled switches
- independent, voltage-controlled and current-controlled sources
- multimeter
- function generator (1 Hz to 1 GHz)
- dual-trace oscilloscope (1 Hz to 1 GHz)
- Bode plotter (1 mHz to 10 GHz)
- SPICE simulation of transient and steady-state response

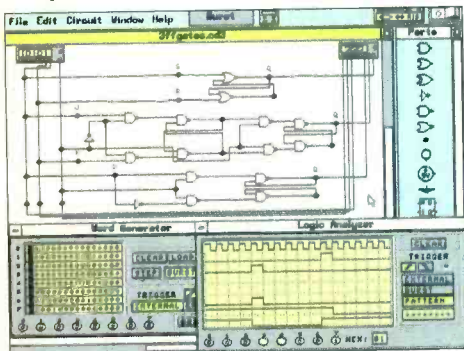

### Digital Module includes:

- fast simulation of ideal components
- AND, OR, XOR, NOT, NAND and NOR gates
- RS, JK and D flip-flops
- LED probes, half-adders, switches and seven-segment displays
- word generator (16 eight-bit words)
- logic analyzer (eight-channel)
- logic converter (converts among gates, truth table and Boolean representations)

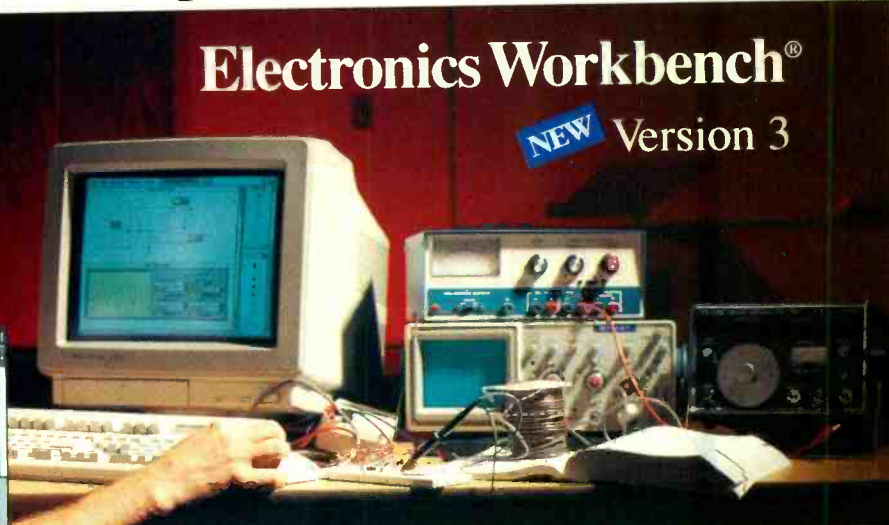

## Complement Your Test Bench

Here's why Electronics Workbench belongs on *your* test bench: Wires route themselves. Connections are always perfect. And the simulated components and test instruments work just like the real thing. The instruments are indestructible and the parts bin holds an unlimited supply of each component. The result: thousands of electronics professionals and hobbyists save precious time and money. **Over 90% would recommend it to their friends and colleagues.** Electronics Workbench: the ideal, affordable tool to design and verify your analog and digital circuits before you breadboard.

And now the best is even better - Electronics Workbench Version 3.0 is here. It simulates more and bigger circuits, and sets the standard for ease of use. Guaranteed!

### **NEW** Features in Version 3

- new components include JFETs, MOSFETs, voltage-controlled and current-controlled sources and manual, time-delay, voltage-controlled and current-controlled switches
- real-world models for opamps, BJTs, JFETs, MOSFETs and diodes - over 100 models available
- MS-DOS version now supports up to 16 MB of RAM for simulation of bigger circuits
- new Microsoft® Windows™ version available
- technical support now also available on CompuServe®

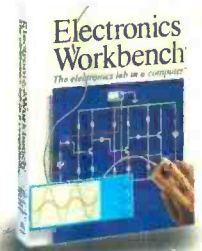

**Just \$299!**

## Electronics Workbench®

*The electronics lab in a computer™*

**Call: 800 263-5552**

INTERACTIVE IMAGE TECHNOLOGIES LTD.  
908 Niagara Falls Blvd. #068, North Tonawanda, NY 14120-2060  
Telephone: (416) 361-0333 FAX: (416) 368-5799

\*30-day money-back guarantee.

Prices in U.S. dollars, shipping \$15. Offer valid in U.S. and Canada only. All trademarks are the property of their respective owners.

CIRCLE 166 ON FREE INFORMATION CARD



# Popular Electronics®

THE MAGAZINE FOR THE ELECTRONICS ACTIVIST!

## CONSTRUCTION ARTICLES

<b>BUILD THE MICRO MESSENGER</b> .....	Scott Edwards	31
<i>Put your thoughts into words with this scrolling-sign display</i>		
<b>BUILD THE SMARTCHARGER</b> .....	Anthony J. Caristi	64
<i>Take full advantage of the new rechargeable alkaline batteries with this easy-to-build recharger</i>		
<b>BUILD THE SCANNER SILENCER</b> .....	Brian Pfliler	73
<i>Get rid of scanner feedback with this great addition to your radio shack</i>		

## FEATURE ARTICLES

<b>A GUIDE TO BETTER SOLDERING</b> .....	Karl T. Thurber, Jr.	37
<i>Improve your technique with this primer on the art, craft, and science of soldering</i>		
<b>AC OR DC?</b> .....	James P. Rybak	42
<i>How the battle between Westinghouse and Edison shaped the history of electrical power generation</i>		
<b>AN INTRODUCTION TO REACTANCE</b> .....	Paul Coxwell	69
<i>Learn how inductive and capacitive circuits work, and how to analyze them</i>		

## PRODUCT REVIEWS

<b>HANDS-ON-REPORT</b> .....		18
<i>Elenco Electronics Microprocessor Trainer</i>		
<b>GIZMO</b> .....		49
<i>Whole-house audio/video systems, and how to install them</i>		

## COLUMNS

<b>MULTIMEDIA WATCH</b> .....	Marc Spiwak	4
<i>Logitech CyberMan, Gravis UltraSound, and more</i>		
<b>ANTIQUE RADIO</b> .....	Marc Ellis	21
<i>Answering the mail</i>		
<b>THINK TANK</b> .....	John Yacono	24
<i>Education and alarms</i>		
<b>COMPUTER BITS</b> .....	Jeff Holtzman	76
<i>A new Windows shell</i>		
<b>CIRCUIT CIRCUS</b> .....	Charles D. Rakes	81
<i>Fun with game circuits</i>		
<b>DX LISTENING</b> .....	Don Jensen	84
<i>Radio St. Helena Day</i>		
<b>HAM RADIO</b> .....	Joseph J. Carr	86
<i>Spectrum-analysis software, preamplifier oscillation, and more</i>		
<b>SCANNER SCENE</b> .....	Marc Saxon	88
<i>Some easy-to-remember frequencies</i>		

## DEPARTMENTS

<b>EDITORIAL</b> .....	Carl Laron	2
<b>LETTERS</b> .....		3
<b>ELECTRONICS LIBRARY</b> .....		8
<b>NEW PRODUCTS</b> .....		12
<b>ELECTRONICS MARKET PLACE</b> .....		78
<b>POPULAR ELECTRONICS MARKET CENTER</b> .....		95
<b>ADVERTISER'S INDEX</b> .....		126
<b>FREE INFORMATION CARD</b> .....		127

Popular Electronics (ISSN 1042-170X) Published monthly by Gernsback Publications, Inc., 500-B Bi-County Boulevard, Farmingdale, NY 11735. Second-Class postage paid at Farmingdale, NY and at additional mailing offices. One-year, twelve issues, subscription rate U.S. and possessions \$21.95, Canada \$28.84 (includes G.S.T. Canadian Goods and Services Tax Registration No. R125166280), all other countries \$29.45. Subscription orders payable in U.S. funds only. International Postal Money Order, or check drawn on a U.S. bank. U.S. single copy price \$3.50. © 1994 by Gernsback Publications, Inc. All rights reserved. Hands-on Electronics and Gizmo trademarks are registered in U.S. and Canada by Gernsback Publications, Inc. Popular Electronics trademark is registered in U.S. and Canada by Electronics Technology Today, Inc. and is licensed to Gernsback Publications, Inc. Printed in U.S.A.

Postmaster: Please send address changes to Popular Electronics, Subscription Dept., P.O. Box 338, Mount Morris, IL 61054-9932.

A stamped self-addressed envelope must accompany all submitted manuscripts and/or artwork or photographs if their return is desired should they be rejected. We disclaim any responsibility for the loss or damage of manuscripts and/or artwork or photographs while in our possession or otherwise.

As a service to readers, Popular Electronics publishes available plans or information relating to newsworthy products, techniques, and scientific and technological developments. Because of possible variances in the quality and condition of materials and workmanship used by readers, Popular Electronics disclaims any responsibility for the safe and proper functioning of reader-built projects based upon or from plans or information published in this magazine.

**Larry Steckler**

*EHF, CET  
Editor-In-Chief and Publisher*

## EDITORIAL DEPARTMENT

**Carl Laron**

*Editor*

**Robert A. Young**

*Associate Editor*

**John J. Yacono**

*Associate Editor*

**Teri Scaduto**

*Assistant Editor*

**Evelyn Rose**

*Editorial Assistant*

**Marc Spiwak**

*Editorial Associate*

**Joseph J. Carr, K4IPV**

**Marc Ellis**

**Len Feldman**

**Jeffrey K. Holtzman**

**Don Jensen**

**Charles D. Rakes**

**Marc Saxon**

*Contributing Editors*

## PRODUCTION DEPARTMENT

**Ruby M. Yee**

*Production Director*

**Karen S. Brown**

*Production Manager*

**Kathy Campbell**

*Production Assistant*

## ART DEPARTMENT

**Andre Duzant**

*Art Director*

**Russell C. Truelson**

*Illustrator*

**Jacqueline P. Cheeseboro**

*Circulation Director*

**Michele Torriilo**

*P-E Bookstore*

## BUSINESS AND EDITORIAL OFFICES

Gernsback Publications, Inc.  
500-B Bi-County Blvd  
Farmingdale, NY 11735  
1-516-293-3000  
Fax: 1-516-293-3115

President: **Larry Steckler**

**Subscription  
Customer Service/Order Entry**

1-800-827-0383  
7:30 AM - 8:30 PM EST

## Advertising Sales offices listed on page 126

Cover by Loewy Design,  
Photo Illustration by Jack Harris, Visual Logic

Composition by  
Mates Graphics



Since some of the equipment and circuitry described in POPULAR ELECTRONICS may relate to or be covered by U.S. patents, POPULAR ELECTRONICS disclaims any liability for the infringement of such patents by the making, using, or selling of any such equipment or circuitry, and suggests that anyone interested in such projects consult a patent attorney.

## YOU CAN'T PLEASE EVERYONE

Sometimes you just can't win. A letter I received recently essentially trashed virtually everything about this magazine. The writer did not like our advertising ("too much"), consumer and computer coverage, our covers, and more. But one of his complaints really got my goat. That complaint involved projects using microcontrollers, or other relatively expensive (\$18 by his definition) or hard-to-get parts.

Electronics is an ever-changing technology. Once upon a time, the only active components were vacuum tubes. Those gave way to transistors and other discrete semiconductors, and from those, integrated circuits of greater and greater complexity evolved. Microcontrollers and other LSI (large-scale integration) components are an extension of that evolution. They make possible projects that otherwise would be prohibitively expensive and complex to build. For example, try putting together the scrolling sign featured in this issue using discrete components. What's more, if you do not want to buy a pre-programmed controller, we always make the code available on our BBS or through the mail.

As for exotic parts, for the most part we insist on at least two sources for hard-to-get components. There are exceptions, of course, such as with the Universal Noise Reduction System in the July, 1994 issue. The availability of a key IC in that project was limited by copyright restrictions; however the source for the IC was selling it at a rather reasonable price. Why publish articles with hard-to-find parts? As with the example cited above, often there is no other way to present the project at all. It is a trade-off we must sometimes make, and we think that it serves the majority of our readers.

Don't get me wrong, there will always be a fair measure of simpler construction projects in this magazine. Each month, Circuit Circus and Think Tank present 6-12 projects built around basic, largely generic components. We also try to include some feature articles and projects that focus on more basic components in each issue. It's all part of our pledge to present a balanced view of the world of electronics.

**Carl Laron**  
Editor



# LETTERS

## CLOCK CORRECTIONS

There are a few corrections to the "Build a Digital Clock" article that ran in the July 1994 issue. To begin with, the 7-segment displays should be of the common-cathode type. In Figure 2, a short was inadvertently drawn across 10-ohm power resistor R30; that short should be removed. In the same figure, U12-a has an unlabeled pin going to +9 volts; that should be labeled pin 16. Also, pin 2 of U12-a (not shown) should be connected to pin 14 of U12-b.—Editor

## PROJECT SCORES AN A +

I am writing concerning John Yacono's article, "Build a Remote-Control Relay Station" (*Popular Electronics*, May 1994). I'd like to commend the author on that ingenious piece of equipment.

As of this writing, I am finishing up my first year in a two-year junior-college electronics program. Part of my final grade for this semester was to write a technical report and give an oral presentation to my classmates on anything dealing with electronics. I chose to build and do my report on the remote-control relay station for two reasons. First, it had a lot of solid-state components that I had been studying about and, second, the room where my TV and VCR are located is extremely long and is subjected to intense sunlight until about 10:00 AM.

I built the device and it worked the first time I applied power. My tech report was given an A+, and my oral presentation received a 99. Both of my instructors were highly impressed with the projects simplicity and versatility, and during my presentation they learned a few things about TV and VCR remote-control devices—namely, how they encode and transmit information. Two upper-classmen are also going to build the device for their own use.

P.J.V.  
Coeur d'Alene, ID

## HAVES & NEEDS

I'm looking for an operator's manual for an EICO DC wide-

band oscilloscope, Model 460. I'll gladly pay for any copying and postage costs. Thank you in advance.

RAY BERKOSKI  
General Delivery  
APO AE 09601

I'm searching for owner's manuals and schematics for an Allied Radio Electronics Stereophonic AM/FM Receiver, Model A-380, and a Model A-2515 Communications Receiver from the same company. I will be glad to pay any postage and copying expenses. Thank you.

WILLIE C. MARTIN, KE6DKH  
43528 Gadsden Ave, Apt. 306  
Lancaster, CA 93534

I have a General Electric Radio, Model G-167, serial number 0194. According to its information plate, it consumes 180

watts of power, runs off a 105/125-volt 25-cycle power source, and was made in Canada. I am looking for a schematic diagram and possibly an owner's manual for the radio, as I would like to restore it. Anyone who can be of assistance is welcome to contact me. I am willing to reimburse any shipping and handling charges.

Thank you.  
RON NIEUWENHUIS  
R.R. #1  
Gowanstown, Ontario  
Canada, N0G 1Y0

I recently acquired a DuMont 190 oscilloscope. The vertical-deflection amplifier output stage is defective. If anybody has schematics or service manuals for this scope, I will pay the necessary costs for photocopies and postage. A user

manual would also be useful because this is my first scope and I have no papers on it.

I would also like to get in touch with people who build tube hi-fi equipment.

Thanks!  
THOMAS DUNKER, LB2ZE  
P. O. Box 2811  
7002 Trondheim  
Norway

I have been a **Popular Electronics** reader for some time now. I am looking for the schematics, calibration, and repair data for a Heathkit color bar and dot generator model IG-62 and an EICO model 324 signal generator. I will be grateful if any of your readers can help. I will gladly pay all costs.  
SEPALA AMARASENA  
100 Sepulveda Blvd.  
Suite 300, WCMD  
El Segundo, CA 90245

Heathkit Heathkit Heathkit Heathkit Heathkit

## Camcorder Servicing

Now, a Quality, Affordable, and Value-Packed Course

The best course of its kind, it teaches you how to service the hottest new consumer electronics product—the camcorder. You also get one of the best, feature-packed camcorders available today.



### What You'll Learn:

Obviously this course teaches how to fix dirty video heads, jammed tapes, worn rubber belts or rollers, dirty contacts, etc. But unlike others, Heathkit's course goes far beyond the routine, into the theories of light, optics, color, electron shades, image transducers, plus how electronic signals are recorded onto magnetic media and played back again.

You will delve into, test, and troubleshoot the sophisticated electronic circuitry of one of the most technically advanced camcorders ever. With Heathkit behind you, you can't fail. Beyond maintenance and repair, this course empowers you with the knowledge and skills to get the most out of your own camcorder.

Compare this course with any others. You'll find that Heathkit offers you 2 to 3 times more value and better quality. Among the many additional courses available are TV, VCR, PC Servicing, Electron

•Heathkit •455 Riverview Drive •Benton Harbor, MI 49023-1288

For a Full-Line Catalog of Electronics and Computer Courses, call 1-800-44-HEATH

When calling, please mention this code: 107-1027

CIRCLE 155 ON FREE INFORMATION CARD

# MULTIMEDIA WATCH

By Marc Spiwak

## CyberMan at Your Command

This month I've got a mixture of hardware and software. Also, just to let you know, I've got a loaner Mac (a Performa 600) for about three months. I'm a PC man and don't get to play with Macs very often, so this is somewhat of a treat—or at least a change from my PC. The Performa 600 is about as fast as a 486 SX, so it's not nearly as fast as my 50-MHz PC. However, I am mostly interested in seeing how the Mac handles multimedia applications in general, and not so much in how fast it does them.



*CyberMan, from Logitech, offers new dimensions in game control.*

I have to say that a Mac really is very easy to set up and use. Without much Mac experience, I had no trouble setting it up and was quickly able to get things done with it. I don't think the same could be said of a Mac user trying to

get things done on a PC. Anyway, I'm going to be comparing some multimedia applications that I have for both Mac and PC platforms, and I'll discuss what I find in a future column.

### CYBERMAN.

I'm going to be looking at some new—and some bizarre—mouse/joystick substitutes during the next few months. One that I'd like to tell you about this month is the very unusual *CyberMan* from Logitech. *CyberMan* is sort of like a cross between a mouse, a joystick, and a trackball, with a few additional functions thrown in.

*CyberMan* offers three-dimensional control for every axis, including pitch, yaw, and roll. A stationary base with plenty of room to support your hand also supports a mouse-like assembly that is free to slide around within a square-shaped recess in the base. The mouse-like part has three buttons on top; the two outside buttons perform the same functions as on a regular mouse, and the middle button defaults to a left-mouse-button "double click." *CyberMan* is a little bit like a trackball in that its base doesn't move.

The mouse-like top performs X- and Y-axis movements just like a regular mouse. But if you push down on the entire assembly, you can control the Z-axis in the downward direction for times when you might have to "squat

down." Likewise, if you lift up on the assembly, you move along the Z-axis in the upward direction for times when you might have to "jump." Twisting the assembly counterclockwise or clockwise controls yaw, allowing you to look, or turn, left or right. Roll occurs when you bend the assembly left or right: this lets you to move left or right or perhaps do a mid-air roll in a flight game. Pitch occurs when you bend the assembly forward or backward, which might move you forward or backward or raise or lower a plane's nose.

As if all that control wasn't enough, Logitech threw in one last feature: tactile feedback. If you either install two AA batteries or connect an optional AC adapter, *CyberMan* will vibrate at certain times (if you get shot at, for example) provided that the software you're using supports the feature. The feature is more bizarre than useful I think, but at least it invigorates your hand every so often.

Special *CyberMan* functions (tactile feedback, pitch, yaw, etc.) must be built into the software you're using, or else *CyberMan* performs only the same functions as a regular mouse or joystick (more or less). A demo version of an amazing game called *Doom* is supplied with *CyberMan*. This version of the game provides full *CyberMan* support. In the game you are a commando on a mission to kill



everything that exists on Mars. CyberMan lets you move in any direction and it vibrates when you're fired at.

Limited versions of Doom are actually distributed as shareware, and the idea is that you'll be impressed enough to buy the full-function game. The idea is right on target, as Doom has become one of the hottest games in town. Even the shareware version of this game (which just has fewer levels, but no less functionality) will blow your mind; the sound effects are wild and intense. If you've never played Doom, get your hands on a copy today.

Two other CyberMan-supporting games included are *Shadow Caster* and *The Terminator Rampage*. They are similar to Doom in the way they play, but they don't come close to the realism of Doom. Another program called *Body Adventure* is a fairly interesting multimedia adventure into the human body that doesn't benefit at all from the CyberMan. It was thrown in as a substitute for another game that wasn't ready to be shipped with the CyberMan.

A free serial port is required to use CyberMan. Software for the CyberMan makes it easy to use side by side with your regular mouse, provided you have a free serial port. If you don't have a free serial port, CyberMan will have to replace your mouse. That's not a problem because CyberMan works in DOS and Windows, although it does take some getting used to as a mouse substitute.

CyberMan has a list price of \$129, but I've already seen it for sale at close to half that amount. I prefer to use my mouse for most

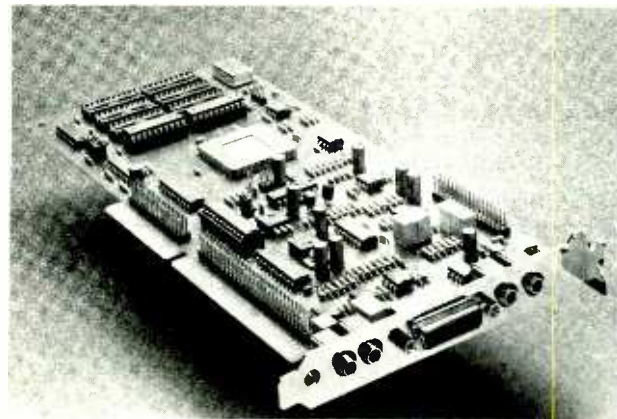

*The Gravis UltraSound is an inexpensive route to 16-bit wave-table synthesis sound.*

mouse-like functions, but I'd rather use the CyberMan for certain games. If unusual controllers interest you, or if you think you have an application that would benefit from this very different controller, you'll want to get your hands on CyberMan.

#### **GRAVIS ULTRASOUND.**

I like to cover products that are as new as possible, but sometimes I receive demo products that deserve mention even though they aren't so new. The *UltraSound* 16-bit stereo sound card from Advanced Gravis, while not new at all, is an excellent sound card available at very reasonable prices—\$199 list and around \$130 on the street. The *UltraSound's* low cost should not be confused with low performance, however, as this card features wave-table synthesis and puts out some of the best sound available at any price—especially for MIDI applications.

One drawback with the *UltraSound* is that it's not the easiest card to set up in a PC. While I don't recommend the card for people unfamiliar with the intricacies of a PC, it's an inexpensive jewel of a sound card for people with higher PC knowledge. Because the card does not

directly emulate a Sound Blaster, emulation software included with it must be run to provide Sound Blaster support. That was more of a concern when the card was new on the market, but most new games provide direct *UltraSound* support for some of the best sound effects you'll hear any-

where. Windows sound is fully supported.

A speed-compensating joystick port is built into the card. That kind of game port is a must for anyone with a fast PC, simply because the standard PC game port is too slow for today's PCs. A speed-compensating port will double your game-playing skills overnight. The speed-compensating port is available in a separate game-controller card from Gravis, but having this feature built into the sound card saves an expansion slot.

By itself the *UltraSound* is capable of 16-bit CD-quality audio playback, and only 8-bit recording. An optional daughter card adds 16-bit recording capability to the *UltraSound*. The daughter card mounts directly to the *UltraSound* board and it re-

## 3M breadboards for less dough.

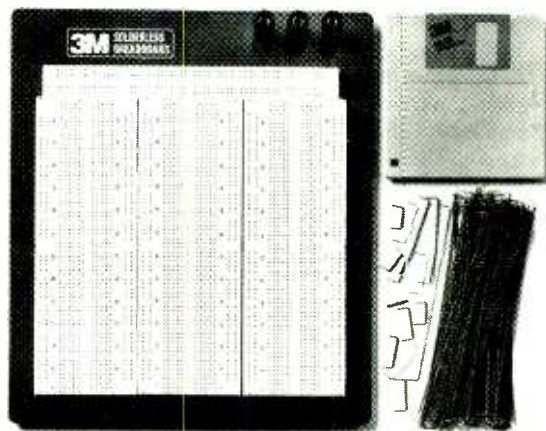

Lower prices, plus jumper wires and a diskette. No wonder interest is rising.

Remember, 3M Breadboards carry a lifetime warranty. For more information, call 1 (800) 328-0016, ext. 103.

© 3M 1994

**3M** Reliability

CIRCLE 164 ON FREE INFORMATION CARD

quires a unique IRQ and a DMA (different than those used by the UltraSound). The add-on provides full mixer support for UltraSound cards that lack it—cards prior to version 3.7. The software bundled with the upgrade is an excellent addition to any audio hacker's collection. One drawback, though, is that the daughter card blocks an adjacent adapter-card socket. It also covers a connector on the UltraSound that's meant for a CD-ROM drive-card upgrade.

The UltraSound is to be replaced by the time you read this by a new card (the *UltraSound MAX*) that will have the daughter-card capabilities built-in, among other new features. I'll be checking out the new card very soon and I'll let you know what I think.

## NEW STUFF

I've been playing with two great CD-ROM's from Spectrum Holobyte: *Tetris Gold* and *Iron Helix*. *Tetris Gold* contains every version of Tetris ever produced for DOS, Windows, and the Mac. That includes Tetris Classic, Wordtris, Super Tetris, and more. Any Tetris fan will surely want this disc in their collection. *Iron Helix* for Windows, an enhancement of the original Mac version, is a fantastic interactive science-fiction adventure. The game takes place in a cold-war future where a deadly biological weapon threatens the entire galaxy. Your job is, of course, to save it. This is one of the neatest CD-ROM-based games I've seen as far as graphics are concerned.

*Mad Dog McCree*, available through IBM EduQuest, is an arcade-type shoot-em-up game with good live-action video. You play the "Stranger" who just en-

tered town and must save the town from Mad Dog and his men. Readers who grew up playing old-west shooting games at the arcades will really get a kick out of this game.

Microsoft sent me some of their new CD-ROM's, including the 1994 editions of *Cinemanía* and *Encarta*. *Cinemanía* is an entertaining interactive movie guide. This disc will hold anyone's interest—anyone who likes movies that is, and who doesn't like movies? This disc makes it easy to search for movie information by title, topic, cast, category, and so on. Thousands of movies are reviewed on this disc. The disc also contains video clips, music, dialog, photos, and the complete text of several prominent printed movie guides. This

## Where to Get it

Advanced Gravis  
1790 Midway Ln.  
Bellingham, WA 98226

Capstone/IntraCorp, Inc.  
Airport Corporate Center  
7200 Corporate Center Drive,  
Suite 500  
Miami, FL 33126  
Tel. 800-591-5900

New Multimedia Schoolhouse  
P.O. Box 390  
69 Westchester Ave.  
Pound Ridge, NY 10576  
Tel. 800-672-6002

IBM EduQuest  
4111 Northside Parkway  
Atlanta, GA 30327  
Tel. 800-758-HOME

id Software  
P. O. Box 538  
Dallas, TX 75221  
Tel. 800-IDGAMES

Logitech  
6505 Kaiser Drive  
Fremont, CA 94555  
Tel. 510-795-8500

Microsoft Corporation  
One Microsoft Way  
Redmond, WA 98052-6399  
Tel. 206-882-8080

Spectrum Holobyte, Inc.  
2490 Mariner Square Loop  
Alameda, CA 94501  
Tel. 800-695-GAME

disc is the perfect companion for any home-video collector.

Encarta is a great multimedia encyclopedia that includes video, pictures, sounds, music, readings, animations, and more. With the complete text of the 29-volume *Funk & Wagnall's* encyclopedia, and thousands of articles exclusive to Encarta at your fingertips, information on any topic is available in seconds.

If you like Schubert, in particular *The Trout Quartet*, check out Microsoft's *Multimedia Schubert, The Trout Quartet*. This illustrated, interactive musical exploration offers a unique way to study this piece of music bit by bit.

*King Arthur's Magic Castle* from New Media Schoolhouse is a place for children to explore a medieval castle or Merlin's magic-tower workshop, joust against menacing knights on brave steeds, or crawl through a maze of prizes and surprises in the *Dungeon of Peril*. For jousting, you get to choose your opponent and your horse. When exploring the castle, you can click on any part of the castle or the surrounding area to learn more about its function. The descriptions are spoken. Clicking on items in Merlin's tower activates animation sequences. In the *Dungeon of Peril*, you collect an inventory of items that prove to be useful as you proceed through a maze.

Capstone has come out with a neat set of kids' games on CD-ROM. The set consists of the games *Trolls* and *An American Tail*. If anything describes the *Trolls* set of games, it's the phrase "ultra-cute." All of its screens are filled with bright colors, fun animation, and interesting game scenarios. In classic 2-D arcade-game

style (like *Donkey Kong* or *Mario Brothers*) you help a troll zip around collecting "good stuff" (balloons, yo-yos, and such) and avoid bad things (like naughty clowns and bad dice). There are seven lands (game themes) to visit—Fable Land, Candyland, Toyland, Sodaland, Board Game Land, Fairground Land, and Medialand.

*An American Tail* is an interesting blend of adventure game and live animation. The object is to help Fievel Mousekewitz through a series of adventures in turn-of-the-century New York and the wild West to reach his family. Each screen is animated, but words appear on the screen instead of being heard. The user helps Fievel respond by selecting from a list of choices. This one's hours of fun for kids who can read. ■



One tree can make  
3,000,000 matches.



One match can burn  
3,000,000 trees.



A Public Service of This Magazine  
© The Advertising Council



## Introducing a New Era In Technical Training.

World College, an affiliate of the Cleveland Institute of Electronics, was created to provide a four year, independent study, technical degree program to individuals seeking a higher education. The Bachelor of Electronics Engineering Technology Degree, offered by World College, prepares students for high-paying careers in electronics, telecommunications, electrical power, computer and control systems. World College's curriculum is taught in an effective, time-proven, independent study environment. With World College's flexible study schedule, students have the opportunity to work or spend time with their family without having to worry about rigid scheduling residential colleges offer.

## A Quality Education with a Flexible Schedule.

In a world heavily dependent on electronic equipment, people who understand electronics will have no problem putting their knowledge to work... in high-paying careers. The staff and faculty of World College have invested over ten years developing, what we believe to be, the finest independent-study, baccalaureate degree program available. World College's mission is to instill in each student the knowledge, education, and training that employers are seeking for the many technical positions available today. It's a program created to provide the best education and training possible with a flexible schedule to match your busy lifestyle.



World College is currently seeking approval to confer the Bachelor Degree from the Virginia Council of Higher Education.

# Earn A Bachelor of Electronic Engineering Technology Degree from



**WORLD COLLEGE**  
*Bringing Technology Home!*

Lake Shores Plaza  
5193 Shore Drive, Suite 113  
Virginia Beach, VA 23455-2500

## Send For Your Free Course Catalog.

Take the first step towards a new start in life. Send for World College's Free Independent Course Catalog today and discover how easy and affordable it is to get started on your **Bachelor Degree**.

World College is affiliated with



## Complete the Entire Degree Program Under One Roof. Yours!

Only World College offers an independent study, four year technical degree which can be completed through one school. All lab equipment\*, parts, and software are included in your tuition and the program's 300-plus laboratory experiments can be completed in your own home.

## You Pay Only For Time Actually Used.

World College not only provides a means to earn a Bachelor Degree while fulfilling current obligations, but there are no restrictions on how fast you can complete the program. At World College, you pay tuition only for the actual upper-level semesters it takes to graduate. The quicker you complete the program, the less you pay in tuition. It's an effective way to keep you motivated in order to complete the course and move on to a better paying position as quickly as possible.

Currently not available in Ohio.  
\* Student must have access to a personal computer system.

**YES!** Please send me World College's Free Course Catalog detailing the full curriculum.

Name: \_\_\_\_\_

Address: \_\_\_\_\_

Apt: \_\_\_\_\_

City: \_\_\_\_\_

State: \_\_\_\_\_ Zip: \_\_\_\_\_

Phone: ( \_\_\_\_\_ ) \_\_\_\_\_

Age: \_\_\_\_\_

Return to: **WAH12**  
World College  
Lake Shores Plaza  
5193 Shore Drive, Suite 113  
Virginia Beach, VA 23455-2500

# ELECTRONICS LIBRARY

## A DOS User's Guide to the Internet E-Mail, Netnews, and File Transfer with UUCP

by James Gardner

Bringing the riches of the Internet and the power of advanced UNIX communications software to MS-DOS users, this book provides detailed, hands-on instructions on how to access the Internet using the bundled UUCP software for DOS from MKS. The included software package, MKS UUCP from Mor-tice Kern Systems, lets DOS users sample various compatible Internet sites. Discount offers from three service providers encourage readers to "test drive" the services described in the book.

send and receive information between the home office and traveling business people. In addition, the book offers an overview and history of the Internet, a review of Internet mailing lists and new groups, and a discussion of "netiquette."

*A DOS User's Guide to the Internet: E-Mail, Netnews, and File Transfer with UUCP, including diskette, costs \$34.95 and is published by PTR Prentice Hall, 113 Sylvan Avenue, Route 9W, Englewood Cliffs, NJ 07632; Tel. 515-284-6751; Fax: 515-284-2607.*

**CIRCLE 99 ON FREE INFORMATION CARD**

## 1994 AMATEUR RADIO MAIL ORDER CATALOG & RESOURCE DIRECTORY

from Resource Solutions

This 260-page book combines a catalog of the latest amateur-radio gear and a resource directory filled with valuable facts and articles. Designed to keep hams up to date on who's who in the mail-order business, the catalog contains more than 1650 listings of amateur-radio products from reputable vendors and manufacturers. Many of the 216 categories in the fourth edition of this catalog are new or revised, and every address and phone number has been verified. Categories include everything from bumper stickers, calendars, and ham-equipped bed-and-breakfast inns to antennas to meet any need, test gear, and computer-to-rig-interfaces. The resource directory lists catalogs, radio clubs around the world, bulletin board systems, books, museums, standards associations, worldwide QRP organizations, foreign amateur-radio magazines, and DX hot lines and help lines. How-to articles cover

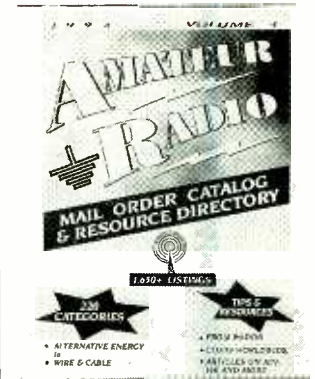

getting your amateur-radio license, finding amateur-radio satellites, soldering, and ATV. Other articles discuss technical terminology, laser-printer tips, 160-meter antennas, and cable-television interference.

*The 1994 Amateur Radio Mail Order Catalog & Resource Directory is available from Resource Solutions, 6050 Peachtree Parkway, Suite 340-228, Norcross, GA 30092; Tel. 404-448-9836; Fax: 404-242-9147.*

**CIRCLE 90 ON FREE INFORMATION CARD**

## THE PIRATE RADIO DIRECTORY, Sixth Edition—1994

by Andrew Yoder and George Zeller

Since the beginning of broadcasting, there have been unlicensed, "pirate" radio stations, and their numbers are rapidly increasing every year. Although they are illegal in North America, such pirate stations often provide some of the most interesting, and amusing, programming on the airwaves. Unfortunately, the erratic and sporadic nature of pirate transmissions make them difficult to tune in.

This book details how to find clandestine stations on the shortwave bands, including broadcasts originating from or-

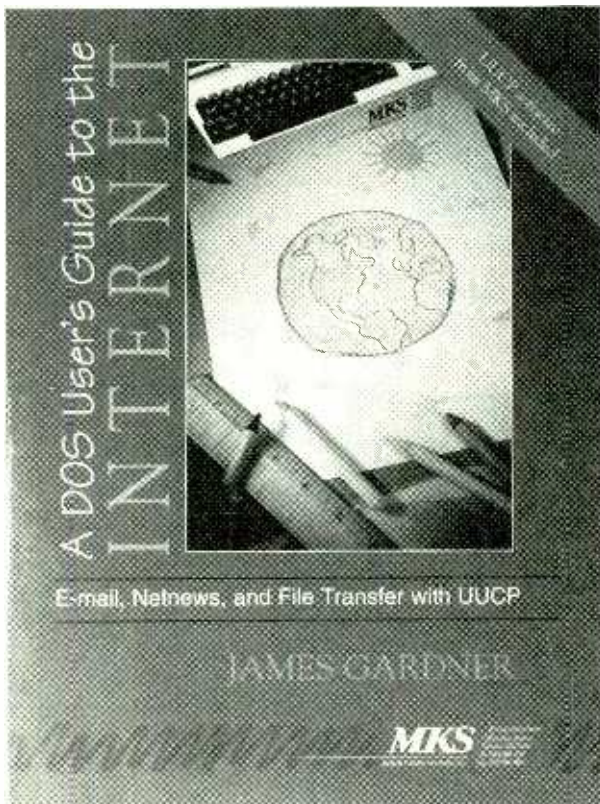

Using easy-to-follow examples, the book explains how to send and receive electronic mail across the Internet, how to receive and reply to any of the thousands of news groups on the Internet, how to transfer files over the Internet, and how to



# Get **3** PROFESSIONAL BOOKS for only **\$9.95**

when you join the **ELECTRONICS ENGINEERS' BOOK CLUB®**

Values to \$150.00

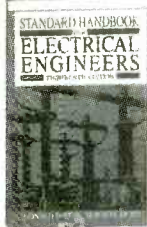

020984H-XXX \$110.50  
Counts as 3

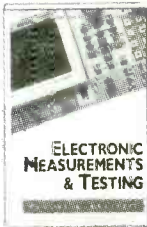

003951H \$40.00



2962P \$18.95  
Softcover



0494347H \$50.00



070964H-XX \$70.00  
Counts as 2

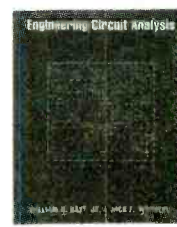

027410XH-XX \$69.44  
Counts as 2

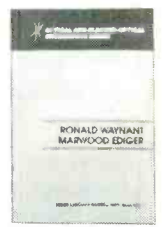

0686637H-XX \$89.50  
Counts as 2

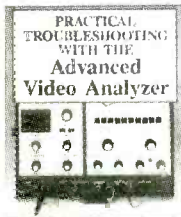

4358P \$24.95  
Softcover



031716H \$50.00

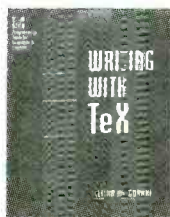

0252076P \$29.95  
Softcover



9255H-XXX \$105.50  
Counts as 3



0696217H \$50.00

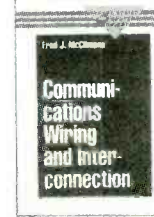

044847H-XX \$40.00  
Counts as 2

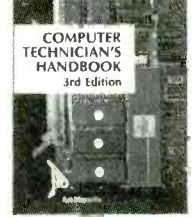

3279P \$26.95  
Softcover

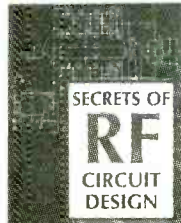

3710P \$19.95  
Softcover



0164223H-XX \$60.00  
Counts as 2

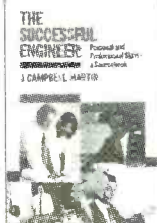

0407258P \$30.59  
Softcover

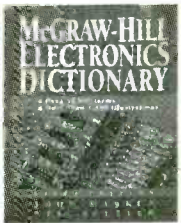

0404348H \$49.50



028977H \$49.00



041525GH-XX \$61.52  
Counts as 2

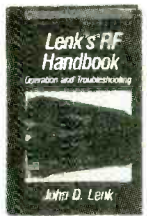

037504H \$39.50



4228H \$32.95

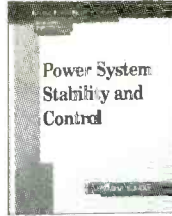

035958XH-XXX \$95.00  
Counts as 3

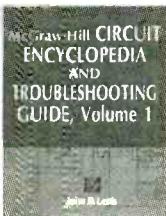

037603H-XX \$59.50  
Counts as 2



2672H \$49.50

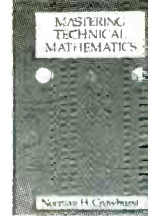

3430H-XX \$39.95  
Counts as 2

## As a member of the Electronics Engineers' Book Club . . .

. . . you'll enjoy receiving Club bulletins every 3-4 weeks containing exciting offers on the latest books in the field at savings of up to 50% off of regular publishers' prices. If you want the Main Selection do nothing and it will be shipped automatically. If you want another book, or no book at all, simply return the reply form to us by the date specified. You'll have at least 10 days to decide. And you'll be eligible for **FREE BOOKS** through the Bonus Book Program. Your only obligation is to purchase 3 more books during the next 2 years, after which you may cancel your membership at any time.

All books are hardcover unless otherwise noted. Publishers' prices shown. ©1994 EEBC

A shipping/handling charge & sales tax will be added to all orders.

If you select a book that counts as 2 choices, write the book number in one box and XX in the next. If you select a Counts as 3 choice, write the book number in one box and XXX in the next 2 boxes.

If coupon is missing, write to:  
Electronics Engineers' Book Club, Blue Ridge Summit, PA 17294-0860

## ELECTRONICS ENGINEERS' BOOK CLUB

Blue Ridge Summit, PA 17294-0860

**YES!** Please send me the book(s) listed below for just \$9.95, plus shipping/handling & tax. Enroll me as a member of the **Electronics Engineers' Book Club** according to the terms outlined in this ad. If not satisfied, I may return the book(s) within ten days and have my membership cancelled.

--	--	--

If you select a book that counts as 2 choices, write the book number in one box and XX in the next. If you select a Counts as 3 choice, write the book number in one box and XXX in the next 2 boxes.

Name \_\_\_\_\_

Address \_\_\_\_\_

City/State \_\_\_\_\_

Zip \_\_\_\_\_ Phone \_\_\_\_\_

Valid for new members only, subject to acceptance by EEBC. Canada *must* remit in U.S. funds drawn on U.S. banks. Applicants outside the U.S. and Canada will receive special ordering instructions. A shipping/handling charge & sales tax will be added to all orders.

PIIF994



**THE  
PIRATE RADIO  
DIRECTORY**  
by Andrew Yoder  
and George Zeller



Sixth Edition • 1994



ganizations like the California Marijuana Growers Cooperative, businesses such as Friendly Freddy's Budget Burials, and even from someone in a leaky bathtub somewhere off the coast of North America. The book includes a witty introduction to pirate radio that explains how you can hear and QSL those stations on shortwave. The station section reviews dozens of pirate broadcasters who were active on shortwave last year, with details about their programming styles, relays, QSL addresses, and more. The book also includes a complete index of stations that have appeared in previous editions of the book.

*The Pirate Radio Directory costs \$12.95 (plus \$2 shipping and handling; \$3 foreign) and is published by Tiare Publications, P.O. Box 493, Lake Geneva, WI 53147.*

**CIRCLE 91 ON FREE INFORMATION CARD**

**THE MODERN POWER SUPPLY AND BATTERY CHARGER CIRCUIT ENCYCLOPEDIA**

by Rudolf F. Graf

This book provides readers with quick, easy access to more than 250 ready-to-use power-supply

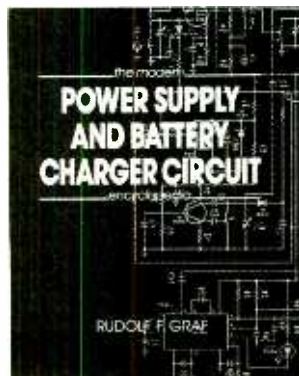

and battery-charger circuit designs that represent up-to-the-minute circuit technology. It presents a selection of circuits that span the entire range of power supplies—fixed, high-voltage, variable, and more—as well as power-supply monitors and protection circuits. The battery-charger circuits are suitable for use with batteries of different voltages and chemistries. All of the circuits are arranged by applications for easy reference, and appear in their original form to prevent transcription errors. Each entry includes a schematic and a brief description of how the circuit actually works. For those who require more detailed information, listings of the original source for each circuit appear in the back of the book.

*The Modern Power Supply and Battery Charger Circuit Encyclopedia costs \$10.95 and is published by Tab Books Inc., Blue Ridge Summit, PA 17294-0850; Tel. 800-233-1128.*

**CIRCLE 98 ON FREE INFORMATION CARD**

**BASIC ELECTRONICS THEORY WITH PROJECTS & EXPERIMENTS; 4th Edition**

by Delton T. Horn

Updated to keep pace with the rapidly growing field of electronics, the fourth edition of this book contains almost all of the material found in earlier editions, and a significant amount of new material. The sections on personal computers and troubleshooting have been expanded, and new chapters on TV's and VCR's have been added. Also new to this edition are discussions of computerized test equipment, laser diodes, VMOS transistors, logic-family interfacing, new computer microprocessors, Digital Audio Tape, and high-definition TV.

This combination introductory textbook and one-volume reference source functions as a complete, self-paced electronics course for hobbyists, students, and beginning-level technicians. Its focus is on the basics and some of the more important specialized areas of today's electronics. The book begins

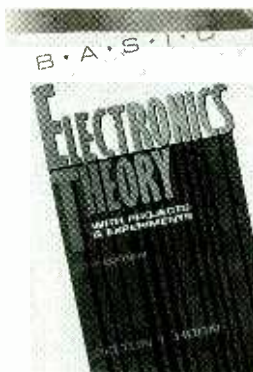

with an introduction to those aspects of atomic physics and electrical theory that are relevant to electronics, and goes on to cover common electronic components, basic circuit types, and applications of modern electronics. To enhance the learning process with hands-on experience, several practical, do-it-yourself experiments are included. Tests at the end of each chapter help readers gauge their progress.

*Basic Electronics Theory with Projects & Experiments costs \$24.95 and is published by Tab Books Inc., Blue Ridge Summit, PA 17294-0850; Tel. 800-233-1128.*

**CIRCLE 98 ON FREE INFORMATION CARD**

**A CONCISE INTRODUCTION TO MICROSOFT WORKS FOR WINDOWS**

by P.R.M. Oliver and N. Kantaris

Written with the novice user in mind, this book explains how to come to grips with Microsoft Works for Windows, with the least amount of time and trou-

**A Concise Introduction to Microsoft Works for Windows**

P.R.M. OLIVER & N. KANTARIS

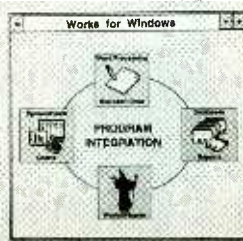

ble. All functions and keyboard commands are detailed in the book. It is formatted in self-contained chapters, beginning with a look at how Works fits into the general Windows environment.

The book goes on to explain how to use the word processor to advantage to type, edit, enhance, print, and save documents; how to use Draw to handle graphics within documents; and how to build up simple spreadsheet examples and then edit, save, print, and retrieve them. The book shows how to generate, edit, and print single and multiple types of graphs. It also explains how to set up, sort, and search a database-management system, and how to use it to create top-quality printed reports.

*A Concise Introduction to Microsoft Works for Windows (order number BP343) is available for \$7.95 plus \$2.50 shipping and handling from Electronics Technology Today Inc., P.O. Box 240, Massapequa Park, NY 11762-0240.*

**CIRCLE 97 ON FREE INFORMATION CARD**

**WINDOWS NT PROGRAMMING HANDBOOK**

by Herbert Schildt

For those who would like to get started with applications development under Windows NT, this comprehensive volume can replace stacks of overly technical, confusing documentation and manuals. Opening with an overview of Windows NT and programming basics, the book then discusses such fundamentals as messages, bitmaps, menus, graphics, dialog boxes, and controls. The book also covers several functions unique to Windows NT, including consoles and multithread programming, as well as special conversion notes to help those programmers porting older 16-bit Windows applications to NT.

*Windows NT Programming Handbook costs \$29.95 and is published by Osborne McGraw-Hill, 2600 Tenth Street, Berkeley, CA 94710; Tel. 510-549-6600; Fax: 510-549-6603.*

**CIRCLE 92 ON FREE INFORMATION CARD**



# READERS: TELL US

## WHAT YOU THINK ABOUT THIS ISSUE

**A**re you interested in helping us make this magazine as good for you as it can be? Then be one of the first to join the 1994 *Popular Electronics Reader Council*. Twice a year you'll be asked to complete a detailed questionnaire. It will tell us about the things in this magazine that are important to you and give us the information we need to make this your best possible reading.

If you would like to be considered for this special *Popular Electronics* project, take a few minutes to answer the questions on this page and return it to us.

While we cannot accept everyone, we will randomly select our participants, giving each one of you an equal chance of being selected.

Please mail the completed questionnaire no later than November 30, 1994, to:

**Total Recall Research Group**  
**Box 4079**  
**Farmingdale, NY 11735-9622**

Thank you, and I am looking forward to hearing from you!

*Larry Steckler,*  
*Editor-in-Chief*

1. **Where did you get this magazine?**  
 Subscription  Newsstand
2. **Are you:**  
 Male  Female
3. **How old are you:**  
 I am \_\_\_\_\_ years old
- 4a. **Highest education achieved?**  
 Attended technical school   
 Graduated technical school   
 Attended College   
 Graduated College   
 Earned PhD
- 4b. **Do you**  
 Hold FCC license   
 Hold other license, Certif.
5. **What is your total household income?**  
 Total household income, before taxes is \$ \_\_\_\_\_
6. **Name the article in this issue that you liked the best.**  
 \_\_\_\_\_
7. **Name the article in this issue that you liked the least.**  
 \_\_\_\_\_
8. **Name the department or regular column in this issue that you liked the best.**  
 \_\_\_\_\_
- 8a. **Name the department or regular column in this issue that you liked the least.**  
 \_\_\_\_\_
9. **Do you earn your living working in the electronics industry?**  
 Yes  No
10. **If you were the editor, would you make the articles:**  
 More complex   
 Simpler   
 Longer   
 Shorter   
 More build it   
 Less build it   
 More how to   
 Less how to
11. **What articles would you publish?**  
 \_\_\_\_\_  
 \_\_\_\_\_  
 \_\_\_\_\_
12. **What new columns would you add?**  
 \_\_\_\_\_  
 \_\_\_\_\_  
 \_\_\_\_\_
13. **What else would you change?**  
 Use a separate sheet for your comments. Please give as much detail as possible.

**Name** \_\_\_\_\_  
**Address** \_\_\_\_\_  
**City** \_\_\_\_\_  
**State, Zip** \_\_\_\_\_

# NEW PRODUCTS

## Palm-Sized World-Band Receiver

Whether you take frequent business trips, are planning a globe-trotting vacation, or prefer "arm-chair travelling" from the comfort of your own home, Sony's ICF-SW100S world-band receiver can help you keep up with news and events from around the world or around your town. The rugged, battery-powered receiver weighs just eight ounces, making it easy to take on the road. The ICF-SW100S can receive long-, medium-, and short-wave signals, as well as FM stereo. Its active antenna for shortwave reception helps pick up the clearest signal even in environments that typically have poor reception.



The receiver provides accurate information about time, broadcasting stations, and frequencies. Once the user inputs the local time, the built-in world clock can display the correct time of 24 major cities around the world. An LCD readout displays the names of broadcasting stations and their frequency numbers. Up to 50 different frequencies can be stored in the receivers memory, so the user can preset several different frequencies for each station and call up the most suitable one depending on the

time or the season. The receiver's stand-by function has two timer settings so that favorite programs won't be missed.

The ICF-SW100S world-band radio receiver, complete with AC adapter, has a suggested retail price of \$449.95. For more information, contact Sony, 1 Sony Drive, Park Ridge, NJ 07656.

**CIRCLE 100 ON FREE INFORMATION CARD**

## "INFORMATION SUPERHIGHWAY" TELEPHONE

*U.S. Order's PhonePlus* is a multiservice telephone that lets people pay bills, shop from catalogs, and conduct banking transactions without leaving their homes. The device is a speakerphone that has 256K memory, a 32-bit Motorola 68000 CPU, a full alphanumeric keyboard, and encrypted credit-card and ATM reader, Caller ID name and number display capability, personal-organizer functions, a 4-line by 20-character display with eight application "softkeys," and one-touch visual access to advanced telephone services such as Call Forward, Return Call, and Three-Way Calling. Personal-organizer functions include a visual and audible reminder for dates, appointments, and events; an integrated directory with autodial and storage for up to 250 names, addresses, and phone numbers; a call timer; and an available data back-up service.

PhonePlus users have password-protected access to services such as BankPlus and ShopPlus, which have a one-time activation charge and a monthly fee of less than \$15. BankPlus is an electronic bill-payment service that also allows users to review their account activity and transfer funds by running their ATM cards through the built-in magnetic stripe reader. With ShopPlus, users can order from any catalog in print, and will receive a cash bonus with each PhonePlus transaction.



EmailPlus and InfoPlus will be added in the fourth quarter of 1994. EmailPlus will allow consumers to send e-mail notes through the Internet and to transmit faxes without using a PC or fax machine. InfoPlus will provide one-button access to sports scores, weather reports, stock-market reports, news, horoscopes, and trivia.

The PhonePlus telephone has a suggested retail price of less than \$200. For more information, contact US Order, 13873 Park Center Road, Suite 230, Herndon, VA 22071; Tel: 703-834-9480; Fax: 703-834-9668.

**CIRCLE 101 ON FREE INFORMATION CARD**

## OYSTER HANDHELD THERMOMETERS

Available for Type J, K, or T thermocouple inputs, *Extech's Model 43134* handheld thermometers feature an exclusive "Oyster"-design case. The rugged, impact-resistant Oyster case offers a half-inch LCD readout, an adjustable flip-up cover, and automatic shutoff when the cover is closed. The thermometers offer fast response times (0.25 seconds) and are accurate to 0.25% of the reading plus one digit. Measuring ranges are -60-1999°F for Type K, -60-1400°F for Type J, and -150-400°F for Type T. Each unit measures 3.7 x 4.2 x 2 inches and runs on a 9-volt battery or an optional AC adaptor. They can be used on the benchtop or for handheld applications, and the included



# Be a computer programmer!

Only NRI gives you hands-on training with the latest programming tools:

- A 486sx computer with Super VGA color monitor, 200 meg hard drive
- Windows
- Visual Basic
- Power C
- QBasic
- DOS
- And much more!

**NEW!**  
Super VGA  
Color Monitor,  
200 Meg  
Hard Drive!

Only NRI at-home training gives you real-world programming skills in three in-demand languages: QBasic, C, and Visual Basic, today's hot new language designed for writing popular Windows applications. Best of all, you get hands-on training with a powerful Intel-based 486sx computer system, complete with Super VGA color monitor, 200 meg hard drive, Windows, and professional programming software you keep!



and clients demand...including programs designed for use in a Windows environment!

Only NRI gives you first-hand programming experience with a state-of-the-art Intel-based 486sx computer system, complete with Super VGA color monitor, 200 meg hard disk drive, a full megabyte of RAM, 1.44 meg 3.5" floppy drive, mouse, and more — all yours to train with and keep!

Plus you explore the extraordinary capabilities of three in-demand programming languages. You learn to design, code, run, debug, and document programs in QBasic, C, and Visual Basic. Best of all, since Visual Basic is specifically designed for creating Windows applications, you learn to generate fully functioning Windows programs, complete with text boxes, command buttons, and other sophisticated graphical interface elements.

NRI's step-by-step lessons and hands-on programming projects help you first master the design concepts used every day by successful PC programmers. Then, with the support of your experienced NRI instructor, you quickly move on to learn programming in three of today's hottest languages.

By the time you complete your course, you have a clear understanding of programming methods, languages, and techniques... and you're ready to handle any programming task with confidence.

## NRI, the leader in at-home computer training, shows you how to take advantage of today's newest programming opportunities

Get in on the ground floor of computer programming one of today's fastest-growing career fields. The Bureau of Labor Statistics forecasts that job opportunities for programmers will increase much faster than average over the next 10 years, with as many as 400,000 new jobs opening up by 2005.

And the fastest-growing segment of programming jobs will be PC programming, fueled by the phenomenal popularity of Windows, the efficient power of C, and the ascent of exciting new languages like QBasic and Visual Basic.

Now, with NRI at-home training, you can get the new skills you need to build a top-paying career — even a full- or part-time business of your own — in this high-growth, high-opportunity field.

Get hands-on experience with today's programming tools: a powerful 486sx computer, Super VGA color monitor, 200 meg hard drive, Windows, Visual Basic, and more — all yours to keep!

Right from the start, NRI's unique Discovery Learning Method gets you actively involved in the challenge of real-world programming. Step by step, you learn to create the kinds of full-featured, powerful programs today's employers

## No previous experience necessary

Train with NRI, and immediately start getting the money-making job skills you need to be a computer programmer — no matter what your previous background.

## Send today for your FREE catalog

See how NRI at-home training gives you the programming know-how, the computer, and the software you need to get started in this top-paying field. Send today for your FREE catalog!

If the coupon is missing, write to us at the NRI School of Computer Programming, McGraw-Hill Continuing Education Center, 4401 Connecticut Avenue, NW, Washington, DC 20008.

IBM PC/AT is a registered trademark of the IBM Corporation. Windows, QBasic, and Visual Basic are trademarks of Microsoft Corporation. Intel Inside logo is a registered trademark of Intel, Inc.

**FREE CATALOG! CALL 1-800-321-4634**

**NRI Schools**

McGraw-Hill Continuing Education Center  
4401 Connecticut Avenue, N.W., Washington, DC 20008

Check one FREE catalog only

- COMPUTER PROGRAMMING
- PC Applications Specialist
- Programming in C++ with Windows

**Other Computer Career Courses**

- Microcomputer Servicing
- Desktop Publishing
- Bookkeeping and Accounting
- Multimedia Specialist

For career courses  
 approved under GI Bill,  
check for details

Name \_\_\_\_\_ (please print) Age \_\_\_\_\_

Address \_\_\_\_\_

City/State/Zip \_\_\_\_\_ Accredited Member, National Home Study Council 5413-0994





neckstrap allows hands-free operation. A bead-wire temperature probe is also included.

The Type J Model 43134J costs \$89; Type K Model 43134K and Type T Model 43134T each cost \$99. For further information, contact Extech Instruments Corporation, 335 Bear Hill Road, Waltham, MA 02154; Tel. 617-890-7440; Fax: 617-890-7864.

**CIRCLE 102 ON FREE INFORMATION CARD**

## DIGITAL MULTIMETER

The DM383 digital multimeter from *Universal Enterprises, Inc. (UEI)* measures up to 1000 VDC, 750 VAC, AC/DC current, resistance, diodes, and continuity. Its 200-mA range allows measurement of most flame safeguard systems. The DM383 offers a 0.91-inch, 2000-count LCD readout and a color-coded front panel. Other features include auto-polarity, data-hold, overrange indicator, low-battery indicator, an audible continuity buzzer, and a diode-check function. The digital multimeter was designed to meet UL and IEC safety standards and to withstand a 10-foot drop. A unique "boot" that allows the user to

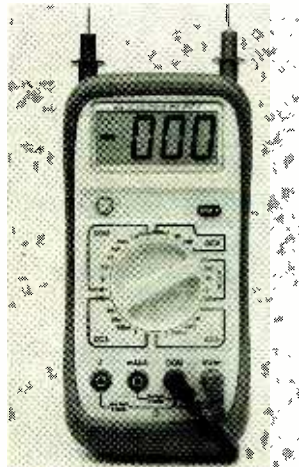

hang the DMM or position it on a flat surface with an adjustable tilt stand also serves as a probe and lead holder. Probes snap into the boot and leads wrap neatly around it for storage.

The DM383 digital multimeter has a suggested trade price of \$49.95. For additional information, contact UEI, 5500 SW Arctic Drive, Beaverton, OR 97005; Tel. 503-644-8723.

**CIRCLE 103 ON FREE INFORMATION CARD**

## WEATHER FAX PC INTERFACE

Available in kit form or fully assembled and tested, A & A Engineering's Weather Fax PC-compatible interface connects between the speaker of a satellite receiver (137 MHz or 1.69 GHz) or a HF SSB shortwave receiver and the computer's standard parallel printer port. Once connected, it will process HF ad satellite weather fax.

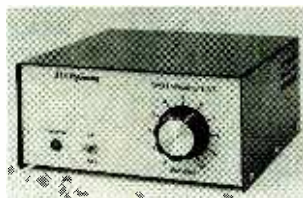

The interface consists of a satellite fax demodulator, a HF fax demodulator, a digitizer, a printer port, and a triple-output power supply. An optional 20-LED tuning indicator is available. The aluminum enclosure is pre-punched, painted, and lettered.

The included software will run on any PC/XT/AT/PS1/PS2-compatible computer with at least 640K of RAM and one floppy drive, parallel port, and a VGA display. To keep up with the satellite data stream in terms of real-time imaging, a 10-MHz 286 system or better is required.

The WSH Weather Fax interface costs \$159.95 in kit form or \$189.95 complete. The 20-LED tuning option adds \$40 to the price. U.S. shipping charges are \$6.50. For more information, contact A & A Engineering, 2521 West LaPalma, Unit K, Anaheim, CA 92801; Tel. 714-952-2114.

**CIRCLE 104 ON FREE INFORMATION CARD**

## 12-VOLT SOLDERING IRON

The Antex MLXS soldering iron from M.M. Newman Corporation is an industrial-grade, 25-watt iron that connects to any automotive or marine 12-volt battery to provide safe soldering without butane or flames. Two alligator clips connect to the battery terminals, and a 15-foot cord provides mobility. The heating element is located under the tip for optimum thermal efficiency, and heats up to 800°F in less than two minutes. The MLXS comes complete with a tip, solder, and a plastic carrying case.



The Antex MLXS 12-volt soldering iron has a list price of \$31.95. For additional information, contact M.M. Newman Corporation, 24 Tioga Way, P.O. Box 615, Marblehead, MA 01945; Tel. 617-631-7100; Fax: 617-631-8887.

**CIRCLE 105 ON FREE INFORMATION CARD**

## INTELLIGENT CELLULAR/DATA LINK

*ORA Electronics' Intelligent Data Equipment Adaptor (I.D.E.A.)* allows any modem or fax machine to be connected to a portable cellular phone, automatically sending data or faxes as easily as by standard phone lines. The microprocessor-controlled system generates a dial tone, controls the functions of the cellular phone, and provides a standard RJ-11 interface for modem or fax connections. The system is completely transparent to the modem or fax machine and works with all popular communications and fax software packages. It does not require additional software and can be used with any modem-equipped computer or fax machine with an RJ-11 interface. The I.D.E.A. is powered by a 9-volt battery. To extend battery life, a built-in power-management feature shuts off the unit when not in use.

The system is available for most popular portable cellular

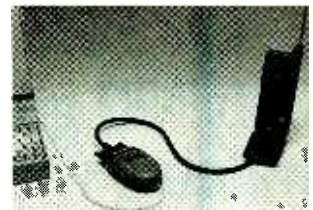

phones, including those built by AT&T, Motorola, NEC, OKI, and others. It comes with a phone-specific adaptor cable, a modular telephone cord, a 9-volt battery, and a user's guide. The modular design allows it to be used with other models of portable cellular phones by attaching an optional cellular-phone adaptor cable.

Suggested retail prices for the I.D.E.A. intelligent cellular/data link start at \$249.95, depending on the phone model. For more information, contact ORA Electronics, 9410 Owensmouth Avenue, Chatsworth, CA 91311; Tel. 818-772-2700.

**CIRCLE 106 ON FREE INFORMATION CARD**

## MOBILE ELECTRONIC CROSSOVER

The XM-5e mobile electronic crossover from *Coustic* provides a high degree of system flexibility, control, and fidelity. The two/three-way crossover uses an exclusive high-fidelity crossover slope technology said to provide dramatic improvements in staging and imaging abilities. The high-pass section uses an adjustable slope of 6 or 18 dB per octave, which allows the user to better tailor the response of the speaker. The low-pass section uses a fixed 18-dB slope to minimize the unwanted high-frequency content of the subwoofer while maintaining optimum phase and amplitude response characteristics.

The XM-5e offers subwoofer-enhancement features called Bass Drive and Bass Shaper. With Bass Drive, a remotely

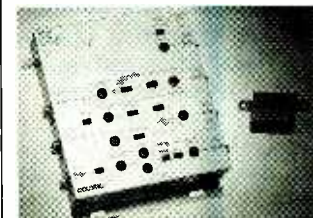



operated subwoofer level control allows the user to dial in the extra bass level needed to overcome the masking effects of road noise. The Bass Shaper allows the user to "customize" the sound of any woofer/enclosure combination with two controls for boosting any frequency from 25 to 250 Hz from zero to 12 dB. The XM-5e also offers a flexible bandpass section for three-way system designs, as well as a rear channel to enhance sound-stage ambiance. Other features of the crossover include a pulse-width modulated switching power supply, a frequency multiplier, and gold-plated RCA connectors for all inputs and outputs.

The XM-5e mobile electronic crossover has a suggested retail price of \$249.95. For further information, contact Coustic, 4260 Charter Street, Vernon, CA 90058-2596; Tel. 213-582-2832 or 800-227-8879; Fax: 213-582-4328.

**CIRCLE 107 ON FREE INFORMATION CARD**

## WEATHER RADIOS

Bad weather can be more than an inconvenience; Tornadoes, hurricanes, or floods can threaten your home or even your life.

Two *Radio Shack Weatheradios* can keep you posted as to National Weather Service broadcasts throughout the United States. The radios monitor local forecasts, storm warnings, and traveler's advisories issued by the National Weather Service, 24 hours a day. Both the desktop and the portable, pocket-sized models feature an alert mode that sounds an alarm whenever the local weather station broadcasts a special signal indicating a weather emergency. If you are away from your Weatheradio, an alert lock provides a continuous tone to indicate that a weather bulletin was issued while you were out of hearing range. The desktop model operates on AC power with 9-volt battery backup (not included) for uninterrupted listening during a power failure. The pocket model uses three



"AA" batteries. Both models have built-in antennas.

The Weatheradios with alert mode are priced from \$29.95 at Radio Shack stores nationwide. For additional information, contact Radio Shack, 700 One Tandy Center, Fort Worth, TX 76102; Tel. 817-390-3300.

**CIRCLE 108 ON FREE INFORMATION CARD**

## TRUE-RMS BENCHTOP DIGITAL MULTIMETER

For use in electronics service and production tests, *Wavetek's Model BDM40* 4½-digit, true-RMS digital multimeter features AC and DC voltage measurement in six ranges to 20 megohms and a diode test

range. The true-RMS measuring circuit is pushbutton selectable for AC or AC plus DC coupling to assure accurate measurements. All functions and ranges are selected using interlocking front-panel push-buttons. For user safety and convenience, input jacks are boldly labeled and the 2-amp jack is fully fused.



The Model BDM40 digital multimeter, complete with test leads, power cord, and a comprehensive instruction manual, costs \$429. For further information, contact Wavetek Corporation, 9045 Balboa Avenue, San Diego, CA 92123; Tel. 619-279-2955.

**CIRCLE 109 ON FREE INFORMATION CARD**

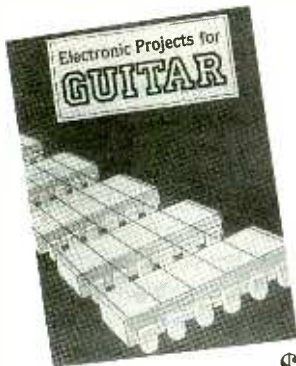

Whether you wish to save money, boldly go where no guitarist has gone before or simply have fun building electronic gadgets designed for your musical pleasure, then read

## Electronic Projects for GUITAR

**\$12<sup>95</sup>**

Some of the add-on guitar gadgets you can build are:

**Preamplifier • Headphone Amplifier • Soft Distortion Effects Unit • Compressor • Auto-waa • Waa-waa Pedal • Phaser • Dual Tracking Effects • Distortion Unit • Expander • Dynamic Treble Booster • Direct Injection Box • Dynamic Tremelo • Thin Distortion Unit • and Guitar Tuner.**

Anyone with some previous electronic project building experience should have no problem assembling the projects.

ELECTRONICS TECHNOLOGY TODAY INC.  
P.O. Box 240, Massapequa Park, NY 11762-0240

Yes, send my copy of ELECTRONIC PROJECTS FOR GUITAR by RA Penfold to the address at right. I am enclosing \$12.95 plus \$2.95 for shipping charges in USA and Canada. All payments must be made in US funds. Sorry, no orders accepted outside of USA and Canada. New York State residents add local sales tax. Allow 6-8 weeks for delivery.

Check enclosed

Please charge my  Visa  MasterCard

Signature \_\_\_\_\_

Account No. \_\_\_\_\_ Expir. Date \_\_\_\_\_

Name \_\_\_\_\_

Address \_\_\_\_\_

City \_\_\_\_\_ State \_\_\_\_\_ ZIP \_\_\_\_\_

## Satellite Images On Your PC



## PC HF Facsimile 7.0 \$99

SSC has interfaces and software to allow you to receive vivid satellite images on an IBM PC computer. Just plug the interface into the serial port of a PC and into the audio output of a shortwave receiver. The package includes the interface, manuals, schedules and software. SSC also makes systems for reception with VHF scanners. Call or write for our free catalog. Visa and MASTERCARD accepted

## Software Systems Consulting

615 S. El Camino Real, San Clemente, CA 92672  
Tel: (714)-498-5784 Fax: (714)-498-0568

## Invest a stamp. . . . . . Save a bundle

For the price of a stamp, you can get the federal government's free **Consumer Information Catalog**. It lists more than 200 free or low-cost publications. Send your name and address to: Consumer Information Center, Department SB, Pueblo, Colorado 81009



## ELENCO MM-8000 MICROPROCESSOR TRAINER



CIRCLE 119 ON FREE INFORMATION CARD

*Learn how microprocessors work by building a computer from the ground up.*

It can't be disputed that today, in order for someone to claim that they're proficient in the field of electronics, a general knowledge of microprocessors is a must. Microprocessors are found in more and more gadgets each day, and anyone considering a career in circuit design—or even just servicing—absolutely must be familiar with microprocessors.

Sometimes microprocessors end up in embedded applications such as in digital car stereos and microwave ovens. (Those microprocessors coordinate user inputs from switches on the device's front panel and inputs from various sensors inside the device.) Other times, microprocessors are used in more general-purpose computers that can perform many different tasks depending on the instructions they're given. Of course, their versatility and popularity are what make learning about them important.

There are lots of different ways to learn about microprocessors, and many people turn to magazines like

this one to learn what they can about them. However, the best way to learn about anything is with hands-on experience, and some of the best hands-on experience you can get with microprocessors is with the *Micro-Master MM-8000 Microprocessor Trainer Kit* from Elenco Electronics, Inc. (150 West Carpenter Avenue, Wheeling, IL 60090-6062; Tel. 708-541-3800).

**The MM-8000.** The MM-8000 is a complete computer system that you build from scratch. It teaches you how to write to RAM and ROM, and how to run an 8085 microprocessor. In these days of cheap 486 PC's, it's easy to forget that the Intel 8085 started it all when it was used in the first 4.77-MHz IBM PC's. The 8088 was later used in the "faster" XT's, then came the 286, the 386, the 486, and now the "586," or more precisely the Pentium.

The "lowly" 8085 performed many a task on many a desktop in its day, and you'd be surprised how many 8085's are still in use. In fact, while you wouldn't want an 8085 in a new computer, they're more than powerful

enough for a microprocessor trainer. An 8085 can provide a great deal of insight into how the more complicated microprocessors in the lineup work. It's actually the ideal microprocessor for such an application.

The MM-8000 lets you write instructions for the 8085 microprocessor and store them in permanent memory. You learn about input and output ports, timers, how to scan displays and keyboards, and you eventually learn how to write machine-language programs. In addition to the 8085 microprocessor, the MM-8000 houses a 2816 EEPROM (electrically erasable, programmable read-only memory) and an 8156 2048-bit (2K) static RAM (random-access memory). The finished unit, which includes a built-in 5-volt power supply and a 28-key keyboard, is housed in a rugged black plastic case. Two empty DIP sockets on the board provide direct access to the I/O ports for various purposes. Also included are eight LED data-bus indicators, eight data switches, four control switches, and two 7-segment LED displays. A thick, well-written



# Be today's complete drafter.



**N**ow with NRI, you can get in on the ground floor of CAD, the new revolution in drafting!

Transforming rough sketches and calculations into accurate working drawings, drafters have always been the key link in the chain of creative people who envision, design, and build the world's products. And today, thanks to the computer revolution, a career in drafting offers more job security — and opportunity — than ever before.

It's true! People with computer-aided drafting (CAD) skills are achieving breakthrough success on design teams in all areas of business and industry. In fact, employment experts predict that manufacturers will hire some 300,000 of these computer-savvy drafters over the next decade!

Now, with NRI at-home training, you can get the hands-on skills and equipment you need for a fast start as today's *complete* drafter, equally comfortable with both manual and computer-aided drafting techniques.

## Only NRI gives you an AT-compatible computer and CAD software you train with and keep

Working with a full array of drafting tools, you first master the techniques required to create detailed drawings by hand. Then, with a firm foundation in traditional methods, you move on to do the same kinds of drawings with greater speed and accuracy — using the high-powered PC and software also included with your course.

Only NRI gives you this priceless, practical experience ... with a complete computer system that's yours to train with and keep! You learn to create precision drawings using a fully IBM PC/AT-compatible system that includes a full meg of RAM, hard disk drive, high-density floppy drive, mouse, and 14" monitor. But that's just the beginning.

## AutoSketch CAD software turns your computer into a high-tech drafting tool

Using your AutoSketch CAD software, you learn to draft objects with a variety of computer-generated drawing tools — from lines, arcs, and circles to fillets, ellipses, and pattern fill areas. And, once you've discovered how to draw an object, you learn how to quickly stretch it, scale it, copy it, rotate it at any angle, or change its dimensions.

You find out how fast and easy it is to manipulate your work with a single keystroke — moving or adding features such as wheels, doorways, and circuitry on your mechanical, architectural, and electrical drawings.

## NRI Discovery Learning Method means no experience necessary

NRI's unique training method helps you learn by doing as you build a complete understanding of today's revolutionary drafting techniques.

Bite-size lessons expand your knowledge one step at a time while hands-on Discovery Learning projects give you practical drafting experience. You learn at home, at your own pace, guided by your personal NRI instructor from the basics of drafting to more advanced computer techniques.

Soon you have the skills and confidence you need to draft detailed renderings of sprockets, homes,

circuit boards — indeed, virtually anything you'll be called on to produce on the job — at the drafting table or your computer terminal.

## Send today for your FREE NRI catalog

Whether you want to change careers, advance on the job, or make good money in a business of your own, you can count on NRI hands-on training to give you the fast start you need to succeed. Send today for your free catalog describing NRI's new course in Computer-Aided Drafting.

If the coupon is missing, write to NRI Schools, McGraw-Hill Continuing Education Center, 4401 Connecticut Avenue, NW, Washington, DC 20008.

AutoSketch is a registered trademark of Autodesk, Inc., makers of AutoCAD®. IBM, PC, and AT are registered trademarks of IBM Corp.

## Send Today For FREE Catalog!

### **NRI Schools**

McGraw-Hill Continuing Education Center  
4401 Connecticut Avenue, NW  
Washington, DC 20008

- Check one FREE catalog only
- COMPUTER-AIDED DRAFTING**
- Computer Programming
- Microcomputer Servicing
- Desktop Publishing and Design
- Home Inspection
- Programming in C++ with Windows

NAME (please print) AGE

ADDRESS

CITY

STATE ZIP 18-0994

Accredited Member, National Home Study Council

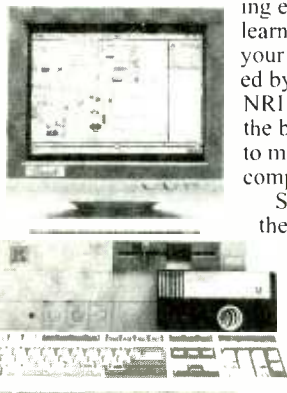

# Earn Your B.S. Degree in ELECTRONICS or COMPUTERS



## By Studying at Home

Grantham College of Engineering, now in our 44th year, is highly experienced in "distance education"—teaching by correspondence—through printed materials, computer materials, fax, and phone.

No commuting to class. Study at your own pace, while continuing on your present job. Learn from easy-to-understand but complete and thorough lesson materials, with additional help from our instructors.

Our Computer B.S. Degree Program includes courses in BASIC, PASCAL and C languages — as well as Assembly Language, MS DOS, CADD, Robotics, and much more.

Our Electronics B.S. Degree Program includes courses in Solid-State Circuit Analysis and Design, Control Systems, Analog/Digital Communications, Microwave Engr, and much more.

An important part of being prepared to *move up* is holding the right college degree, and the absolutely necessary part is knowing your field. Grantham can help you both ways—to learn more and to earn your degree in the process.

Write or phone for our free catalog. Toll free, 1-800-955-2527, or see mailing address below.

Accredited by  
the Accrediting Commission of the  
National Home Study Council

**GRANTHAM**  
*College of Engineering*  
Grantham College Road  
Slidell, LA 70460

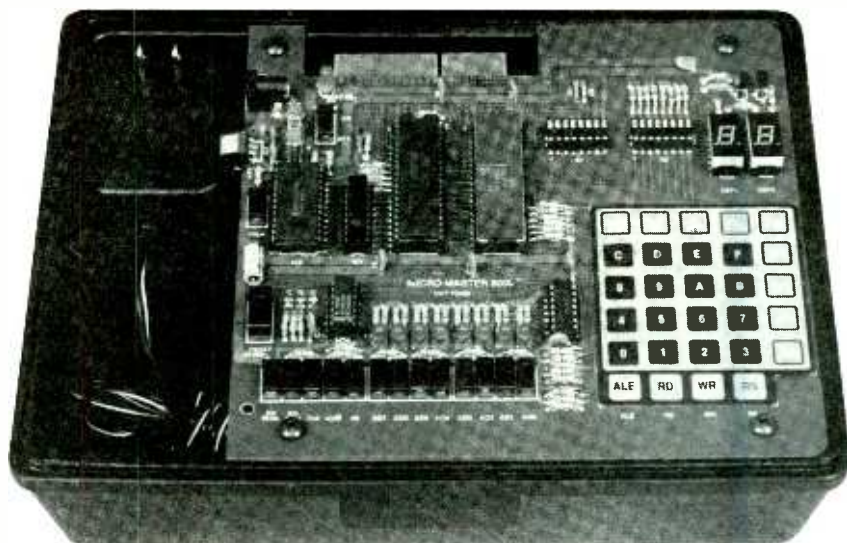

*The keypad connects to the microprocessor, the microprocessor connects to the memory. Put all the pieces together and you end up with a working computer!*

lesson/instruction manual and AC power pack completes the package—at a very reasonable price of \$129.95.

**A Hands-On Approach.** What we found most interesting about the MM-8000 is its very effective hands-on approach that makes it easy to understand how microprocessors work. All you need to build the MM-8000 is basic assembly tools—a soldering iron, desoldering tool, needle-nose pliers, cutters, screwdrivers—and some experience building electronic kits, particularly ones containing IC's. A handful of IC's must be soldered onto a PC board, including two 40-pin chips, and careful soldering is a must. Anyone with no prior soldering experience should not learn how to do it with this kit. You'll also need many evenings of quiet concentration to fully understand the MM-8000, although the actual assembly time is only a few hours. What you don't need to build the MM-8000 is any prior knowledge of microprocessors or computers—that's what you learn by building it.

The operating theory behind the MM-8000 computer is discussed before any assembly begins. A page of soldering tips is also included in the lesson manual although, as we said before, one should already know how to solder before building this kit. The MM-8000 must be built in steps according to instructions. That's because each section of the circuit is explained, built, and tested, before con-

tinuing with the next. Certain jumpers are soldered in place in one step, only to be removed in another after their job is done. (A jumper's job is usually to let you manually test a feature that will later be controlled by the microprocessor.)

This step-by-step assembly technique is what makes understanding computer circuitry so easy and entertaining. For example, first the power-supply/distribution circuitry is discussed, installed, and tested. Next, memory is installed and manually tested. During testing, a section is operated manually so that the builder knows exactly what the microprocessor will have to do to perform the same task. This assembly process also increases the chances of finding and fixing any problems.

By the time all the parts are installed, the builder has an intricate knowledge of the MM-8000's circuitry and the 8085's complete instruction set. After that, more and more complex routines are covered until complete programs are up and running.

Anyone seriously interested in microprocessors and computers, and how they work, should look into this \$129.00 educational bargain. The MM-8000 is an excellent way to obtain the hands-on experience that's so often lacking in theory-oriented microprocessor-training courses. If you'd like more information about it, contact Elenco Electronics at the address given earlier in this article, or circle No. 119 on the Free Information Card. ■



# ANTIQUUE RADIO

By Marc Ellis

## Mailbag Time!

It has been many months since we've had the opportunity to give our readers the floor. I really hadn't intended to let so much time go by without a mailbag column. What probably threw us off schedule was my having broken into the crystal-set series earlier this year for a couple of impromptu columns on the Antique Wireless Association annual conference. Having interrupted the series once, I really hated to do it again.

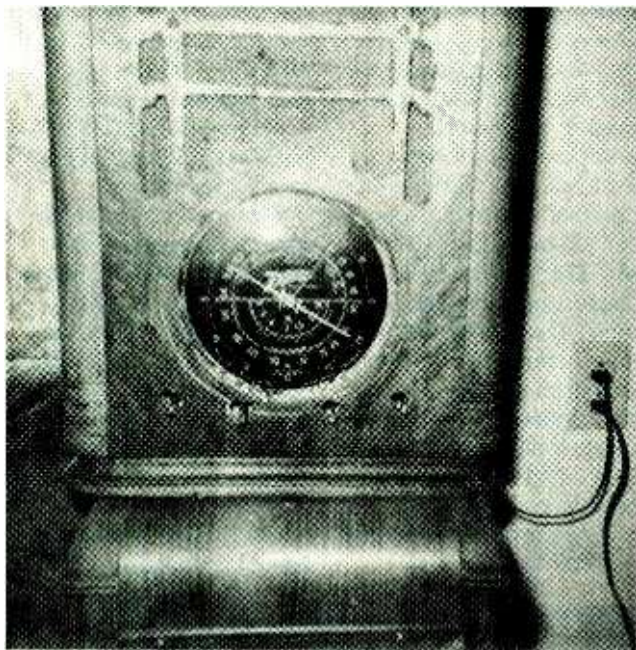

Can anyone help Ivan Smith (see text) find the knobs he needs to complete this Zenith 5D127?

Last month's column, however, saw the wrap-up of the crystal-set project. At that time we were also able to cover most of the letters that had come in with comments relating to it. So let's go right on this month and work our way through the rest of the mail.

But before we get started, I'd like to take this

opportunity to talk about how I handle communications from readers. First of all, let me assure you that every piece of mail I receive is valued and carefully read. Time does not permit me to respond personally to the many comments, questions, and requests for information that I receive each year. However, I do try to mention almost every letter I receive in the column, passing along the comments and requests for help to the readership at large.

Over the years, many helpful readers have responded to such letters—taking it upon themselves to send information and advice to those requiring it. To those generous souls, I'd like to pass along a hearty "thank you" on behalf of the folks who have benefited from your knowledge and resources. You are a credit to our hobby!

To those of you who've written me and are waiting for acknowledgment, please be patient! I wish it were possible to mention every letter in the month it was received, but the reality is that sometimes several months will pass before I have an opportunity to devote a column or two to the mail.

Now, without further ado, let's get started—beginning with those all-important requests for schematics, information, and parts.

### WANTED: HALLICRAFTERS HELP

Tom Byers (1640 Timber Ridge Dr., Sedalia, MO 65301) seeks service data for a Hallicrafters S-40, as

well as knobs for the band switch and BFO. An S-40 bandswitch knob is also needed by *Marvin E. Leisy* (5556 Beverly Ave. NE, Tacoma, WA 98422). By the way, if you need a schematic for a Majestic 90-B, Marvin has one and will send it to you for copying and mailing costs. Lucky scavenger *Chris Burke* (E.N.D. Auto Repair, 2801 Route 88, Point Pleasant, NJ 08742) found an SX-24 Sky-rider Defiant in someone's garbage and is looking for schematics and service information.

*Andre Pelletier* (C.P. 1508, Fermont, Quebec, Canada G0E 1J0) needs an owners and/or service manual for an HT-40, and will gladly pay the cost of copying. *Bob Schaum* (R.D. #1, Box 1339, Carbondale, PA 18407) needs alignment data and a schematic for an S-16 Super Skyrider; he could also use some advice on correcting a low-sensitivity problem on the top two bands. How about some service info on the SX-100 for *Thomas Perepluk* (220 Beaverglen Close, Fort McMurray, Alberta, Canada T9H-2V3)? Finally, *Arturo Ortiz Pina* (AV Juarez 1006-A, Cal. Centro, Pachuca, Hidalgo, Mexico c.p. 42060) is restoring an S-38 and an HT-40 and would like to get his hands on schematics for both.

### WANTED: SCHEMATICS AND MANUALS

Schematics and/or service information for the following radio models are needed by the readers indicated:

Zenith Trans-Oceanic

Chassis -5H 40 (uses 1U4, 1L6, 1U4, 1U5 3V4); *Philipp Kotsias* (Kifisias 39, 151 23 Maroyi, Athens, Greece). Westinghouse radio/phone J904 with radio chassis V-2502-2 and power-supply/audio chassis P725891; *Frances L. Munsch* (22300 Mobile St., Woodland hills, CA 91303-2426). Deforest Crosley Type 7D 832, Model A 67615; *Herb Turner* (Site 121, Comp 2 RR 1, Sorrento, BC, Canada V0E 2W0). Blaupunkt TYP2500USA, Ser. G824852; *Jim Ferrara* (10 Eagle View Ct., Monsey, NY 10952).

Operating manuals and, if possible, schematics for the following pieces of test equipment are needed by the indicated readers:

Heathkit IT-3120 Transistor Tester, Hickock 600A Tube Tester, Knight F-135 Signal Tracer, Knight F-119 Capacitor Checker, Sprayberry Academy of Radio 18 range VOM w/capacitor and resistor substitution boxes; *Ron Neely II* (2500 S. Rockport Rd., #403, Bloomington, IN 47403). Heathkit Signal Tracer Model T 2; *Jack Malone* (917 Torchwood Dr., Deland, FL 32724).

*Craig Colboth* (41190 N. Greenbay Rd., Zion, IL 60099) needs a schematic for a 1930's Echophone, but first he requires assistance in identifying the model number of that radio. It's a six-tube AC-operated cathedral-style set. The brass dial escutcheon is decorated with a graphic of a woman seated on our planet, and bears the legend: "Echophone—Echoes of the World."

#### WANTED: PARTS AND INFO

*Albert J. Kelly* (Amcor International Investigative Service, 7141 Marsden St., Philadelphia, PA 19135) is restoring an RCA Victor 45-RPM Victrola Model 45-EY-2.

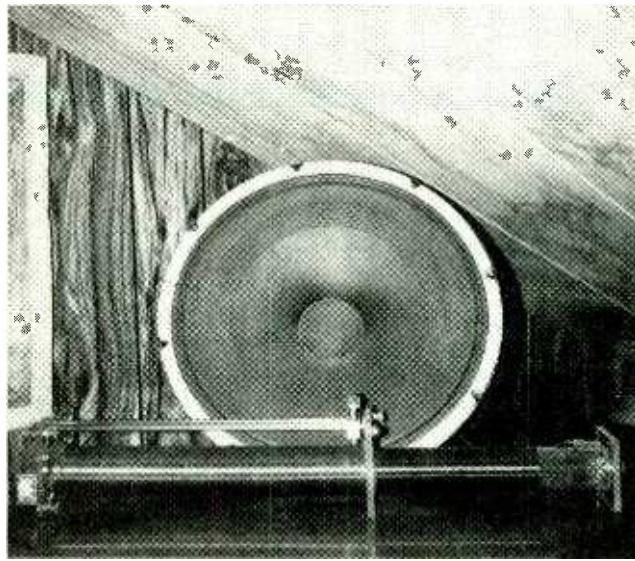

*James Knight's crystal set, which uses a carefully designed inductance coil (foreground), has been continuously driving a 14-inch speaker at comfortable room volume for 26 years.*

He's looking for a set of tubes (35W4, 50B5, 12AV6), a new stylus (possibly a complete cartridge and stylus assembly), a schematic, and information on adjusting the changer. *Albert* would also like to know more about the history and manufacture date of that unit.

*Larry Fritz* (19899 Wayne Rd., Livonia, MI 48152) seeks an inexpensive source of antique telephones and parts, 1890-1920 vintage. *Roy Randall* (130 Palm Ave. #18, Jupiter, FL 33477-5133) needs a power transformer (Part #3-140) for a Sprague TO-6A Tel-Ohmike capacitor analyzer. *Ivan W. Smith* (HC72 Box 288, Glen Morgan, WV 258437-9714) sends a photo of his Zenith 5D127, which plainly would be improved by a set of knobs. *Ivan* is also looking for schematics and operating instructions for RCA WO-91A and Dumont 224-A oscilloscopes. Can anyone help?

From New Zealand comes an appeal for the pushbutton station and tone selector assemblies, as well as the white plastic volume and tuning knobs,

for a Zenith shutter-dial set. Owner *Ross Paton* (56 Glengarry Rd., Auckland 7, New Zealand) tells us that the model-number label is missing, but the five-character model number starts with 9S3, and the tube complement is as follows: 6S7 (2), 6L7, 6J5 (2), 6F5, 6F6, 5Y4, 6U5. He could also use service information and a BFO/Q-multiplier coil for a Hammarlund HQ100. Readers needing service information on Phillips radios are invited to write to *Ross*, as he has quite a bit of data on hand.

*R. Morrison* (1597 Maquina Ave., Comox, BC,

Canada V9N 7B9) has forwarded many schematics to readers who requested them, but now he could use some help! Needed is a schematic for a Trio (Kenwood) 9R-4 receiver. The model was apparently made for sale in Japan, so not much service information has found its way onto this continent.

#### MISCELLANEOUS HAVES/NEEDS

*Bob Zinck* (118 Doull Ave., Halifax, NS, Canada, B3N 1Y9) has schematics for the following mostly 1950's-era Heathkit equipment (space permits mentioning only the model number): O-8, V-6, GD-1A, QM-1, C-3, T-3, SG-7, TC-1, TS-2, PS-2, IB-1B, AG-8, AO-1, SQ-1, AF-1, IM-1, AV-2, A-7, A-8, W-2M, WA-P1, BR-1, AR-1, FM-2, MI-11A, MI-41. Also available: Hewlett-Packard 401-B, 400-D, 200-AB. Send \$1.00 per diagram for postage/copying.

If you need a radio schematic, chances are *Alvin Sydnor* (806 Meetinghouse Rd., Boothwyn, PA 19061) has it. Though retired from his service business, he held onto his collection of over 3,000 factory service manuals and schematics. Send a large SASE with your request. *Al* is also interested in hooking up with (or establishing) an antique-radio



*Taking a drive down Radio Road in Tuckerton, NJ, reader Folkerts discovered what appear to be remnants of the original World-War-I-era German station.*



club serving southeastern Pennsylvania and southern Delaware. Contact him if you have information.

*Dr. O. A. Rinn* (4402 Vance Jackson Blvd., San Antonio, TX 78230), at least as of several months ago, was looking for someone to restore his "Sorbor" battery-operated receiver (uses five type 32's and two type 30's) to working condition. And *James H. Lundsted* (211 SE Ridgeview Dr., Lee's Summit, MO 64063), again as of several months ago, was looking for reasonable offers on a Hallicrafters SX-111 Mark I ham-bands-only receiver. He'd like to place that radio in the hands of someone who would appreciate it.

### THIS 'N THAT

In a very interesting letter too lengthy to quote in detail, *Don Lambert* (Auburn, IN) tells us that the recent NBS crystal-set series reminded him of his experiences building experimental crystal sets just before he was drafted into the army in 1944. Those were times of shortages and rationing, and Don had to "make do" for the parts he needed. For example, he recalls disassembling surplus transformers to salvage wire for winding coils.

Speaking of crystal sets, *James Knight* (Tulloma, TN) sent along a shot of one he built that drives a 14-inch speaker to comfortable volume when receiving a 250-watt station several miles away. And using an indoor antenna at that! James' radio has been operating more-or-less continuously for the last 26 years.

Just as this column was being "put to bed," we received a final NBS crystal-set note. *John Nix* (Foley, MN) tells us that the knurled binding-post nuts that the

original 1920's constructors salvaged from No. 6 dry cells can be purchased in some hardware stores.

*George Rath* (Labour Market Services, 5th Floor, Phase IV, Place du Portage, Hull, P.Q., Canada, K1A 0J9) is trying to locate Neil Carleton, formerly of Ottawa, Ontario. Neil holds the SWL call letters VE3DX2ZD. These "pseudo call letters" are similar to the "WPE" calls once issued by the original **Popular Electronics** magazine in the 1950's and 60's (and, in fact, may have actually been assigned by **Popular Electronics**). In any case, please contact George if you know how to get in touch with Neil.

In the November 1992 column, we mentioned a radio installation quietly built by the German government at Tuckerton, NJ just before our entry into World War I. It is thought that the order for the *Lusitania* sinking might have been given through that station. The station was confiscated by the our government and, after the war, was acquired by RCA.

After operating a short-wave transmitting facility at Tuckerton for decades, RCA sold the site to a developer in the late 1960's. Though no transmissions have been made from that location in many years, the street that originally gave access to the old station is still known as "Radio Road."

Last November, *W. Folkerts* (North Palm Beach, FL) had a chance to drive down Radio Road while visiting some relatives who live in Tuckerton. He discovered that three giant concrete blocks—possibly anchors for guy wires—were still standing near the station site. Mr. Folkerts sent us some nice shots of the blocks, and I'm including one here. ■

## SURVEILLANCE & SECURITY

### FM TRANSMITTERS MINIATURE (KITS)

- 3-VOLT FM XMTR, up to 300 ft. indoors, 1500 ft. outdoors
- PHONE XMTR, range to 500 ft., uses phone-line power
- Sound-Activated XMTR, range to 500 ft.
- 2-STAGE XMTR, 9-Volt, very powerful

All above require simple soldering at 2 to 4 places. Broadcast on std FM band. Assemble in less than 5 minutes. Any of the above **\$29.95\*\***

**TELE CALL FORWARDER.** Transfers incoming calls to any number you select. **\$99.00\***

**CALLER ID.** Registers incoming number and stores to 50 numbers. **\$99.00\***

**TEL REGISTER WITH PRINTER.** Records dialed number, duration, and prints record. 16-digit display with security lock control. Stores up to 40 calls. **\$149.00\***

**TEL REGISTER W/O PRINTER.** Records dialed number and time. 16-digit display. Holds up to 145 numbers in memory. **\$99.00\***

**12-HOUR LONG-PLAY RECORDER.** Modified Panasonic. Records 6 hrs. on each side of 120 tape (supplied). Compatible with VOX and Tel Rec Adapter. **\$119.00\***

**VOX VOICE-ACTIVATED SWITCH.** Makes recorder self-activating with voices or other sounds. Great for radios and scanners. Provisions for external mike and/or patch cord. **\$28.50\*\***

**TELEPHONE RECORDING ADAPTER.** Records incoming and outgoing calls. Use of handset controls recorder and records both sides of conversation. **\$28.50\***

**TELEPHONE SCRAMBLERS.** Over 51,000 separate codes; impossible to break code. Assures utmost privacy. **\$295.00\***

**VOICE CHANGER.** Changes man's voice to lady's and vice versa. 4 separate settings. Ideal for disguising voice. **\$29.95\*\***

### RF BUG DETECTORS, AND MUCH MORE

For Shipping and Handling add \*\$5.00 and \*\*\$2.00 per item. Colo. residents add sales tax. Mail Order. VISA, M/C, COD's o.k. Inquire for dealer prices. Free catalog

**TOLL FREE 1-800-926-2488**

### A.M.C. SALES, INC.

193 Vaquero Drive  
Boulder, CO 80303  
Tel: (303) 499-5405  
Fax: (303) 494-4924

Mon-Fri 8 a.m. - 5 p.m. Mtn. Time

CIRCLE 151 ON FREE INFORMATION CARD

# THINK TANK

By John J. Yacono

## Education and Alarms

This month I'll continue to present letters on interesting alarm circuits, but first I'd like to follow up on something cut from last month's column. As you might recall, last month I discussed an educational course for beginners in electronics. I did that to help beginners and to bring up the topic of technical education.

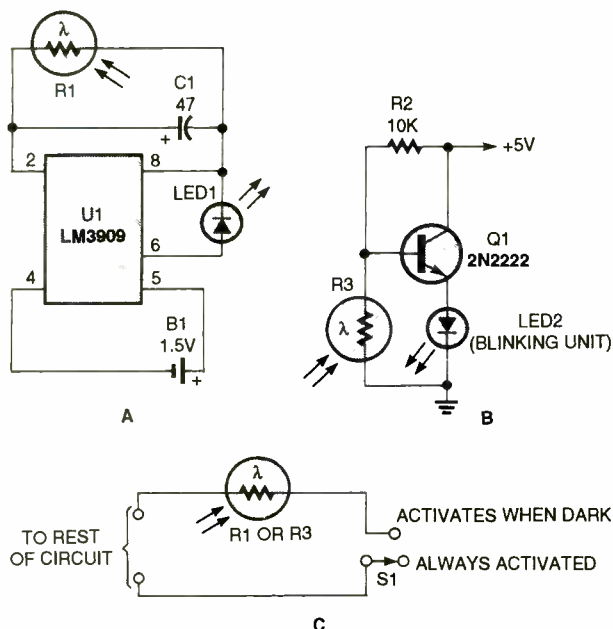

Fig. 1. The most inexpensive car alarm is no alarm at all, as the false alarms in A and B show. The circuit in A requires only 1.5-volts to operate, while the one in B requires more voltage, but fewer parts. In C we show a modification of the circuits for selectable daylight use.

You see, I'm very distressed over the numerous reports in electronics trade journals that our youth can't cut the technical mustard. According to the reports, some American high-tech firms are having a heck of a time filling their more advanced positions from within America. I do not want to enter the debate over whether there's an education problem or

companies are looking to save money by hiring overseas help. My point is that even if those reports are a tiny bit true, they should scare us.

I'm not so young that I can't remember the time when hiring from overseas would have been unheard of. When it was accepted, without debate, that our youth would be the technical leaders of tomorrow. Now, our own companies are looking elsewhere for talent; that's a big change in attitude to be just a simple economic trend.

Not being one who simply complains about the weather, I want to help change this destructive trend in whatever way I can. For that, I need to hear more from teachers and amateur electronics and science groups out there.

Write and tell me what you'd like to see here in the coming months, what circuits your participants have built, etc. If I receive enough submissions from a given school or group, perhaps I can devote a column to their work. Perhaps we can work out the makings of an electronics fair fashioned after science-fair competitions. I can even work up some course material and present it here to help educators. Nothing would make me happier than to hear from you and do what I can to help out, so please write to me at the address given at the end of this article.

Let's now turn our attention to this month's correspondences. I think you'll like the alarm circuits they contain.

### POOR MAN'S ALARM

Looking for an inexpensive vehicle-alarm simulator that's portable and can easily fool anybody? Then you can use either the circuit presented in Fig. 1A or the one in Fig. 1B. Although they are fake alarms, they give people the impression that there is indeed an alarm system installed in the vehicle.

Both circuits use a cadmium-sulfide photocell and they are activated (the LED's start blinking) when the surrounding environment is dark. You can also have the LED's blink in daylight by inserting a miniature on/off switch in series with the photocell (see Fig. 1C.) That approach, however, is not recommended since the glow of an LED is not very visible in bright light.

My personal favorite is the circuit presented in Fig. 1A. It operates on a single 1.5-volt AA battery, which can last for more than two months in continuous operation. In the circuit of Fig. 1B, the transistor is used as a switch. It switches on a blinking LED when no light hits the surface of the photocell.

Nothing is too critical in the circuits, and all materials are readily available from Radio Shack. It does not take more than a few minutes to set those circuits up and you can even use your imagination to add a realistic appearance to them. For example, I have assembled the circuit of Fig. 1A on the back of a ten-key matrix keypad that I purchased from All Electronics for a little over a dollar. My



project now truly resembles a real alarm. In a friend's version, I added one green and one yellow LED in addition to the original red one (all connected in parallel, of course.)

Well dear John, I hope that those projects meet the requirements of your column and that they deserve a book.

—Georgios Kilizirakis, Astoria, NY

In fact both circuits deserve a book, mainly because they perform a useful function in a very simple way. I like the fact that you used the often-overlooked blinking LED in the second design. I wish I had a dime for every circuit I've seen that contained a driver to blink an LED instead of taking the easy, less-expensive way out and just using a blinking unit. Of course, a driver is needed for your first circuit to power the LED off such a meager supply.

### DOOR AJAR UNIT

I came up with a circuit to help a friend who owned

a meat market. He wanted a short tone to sound when the front door was opened to announce a customer.

The door had a standard magnetic alarm switch (normally closed when near its magnet), so I used it as shown in Fig. 2A. When the door and switch are opened, the base of Q1 goes high, applying power to the 555 oscillator/timer. The IC is wired as a power-up one-shot and sounds the piezo sounder for about 1/2 a second. The circuit will not sound when the door is closed.

With the values shown, the circuit draws only 0.3 mA with the door closed and 11 mA when sounding. I used a 12-volt plug-in supply for power, but a 9-volt battery can be used if less volume is acceptable. By replacing the sounder with a relay and driver transistor (see Fig. 2B), the circuit can be used to sound a standard doorbell. That arrangement, however, requires that the supply be heavy enough to handle the relay's coil current.

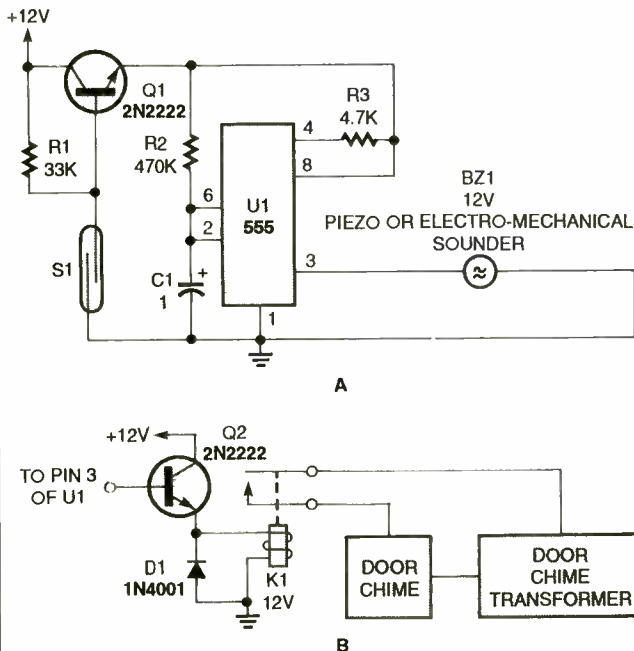

Fig. 2. This simple sounder (A) makes a good door annunciator. If the buzzer is replaced with the circuit in B, the annunciator can be made more pleasant to the ear.

# Electronic Security

2 for 1 SALE!



**Mini Long Range FM Voice Transmitter (3 mi) Ultra Sensitive** - with fine tune, range control, more! Detects even whispers! FMX1 Kit and Plans.....~~\$49.50~~

**Tiny Telephone FM Transmitter** (3 mi) - automatically operates when phone is used. Crystal clear clarity with fine tune and range control. TELX-1 Kit and Plans.....~~\$49.50~~

Both Easy-to-Build Kits Above only **\$49.50!**

---

**Extended Play Telephone Recording System - \$129.50**

- Automatic - Crystal Clear - Easy to Use - Connects to Any Phone - Automatically controls and records both sides of the conversation on our extended play recorder. Caution - check local laws as some states require an alerting beeper. TAP20X Ready-to-Use System ..... only **\$129.50**



FREE CATALOG with order - or send \$1.00 P&H  
MC, VISA, Check, Cash or C.O.D.  
Send or Fax Orders to: Dept pe16  
PO Box 719, Amherst, NH 03031  
Orders: 800-221-1705 FAX 603-672-5406 Tel 603-673-4730

## TANDY

### NATIONAL PARTS

**HAS THE PARTS FOR YOUR HOME AUTOMATION NEEDS!!**

**\* RECORD / PLAYBACK ICs \***

**UP TO 20 SECONDS OF SOUND**

CRYSTALS
LEDs
SEMI-

WIRE/CABLE
RESISTORS

POWER STRIPS
SWITCHES

CONNECTORS

and much more....

NO MINIMUMS

ORDER TOLL FREE

1-800-322-3690

ASK FOR OPERATOR # 731

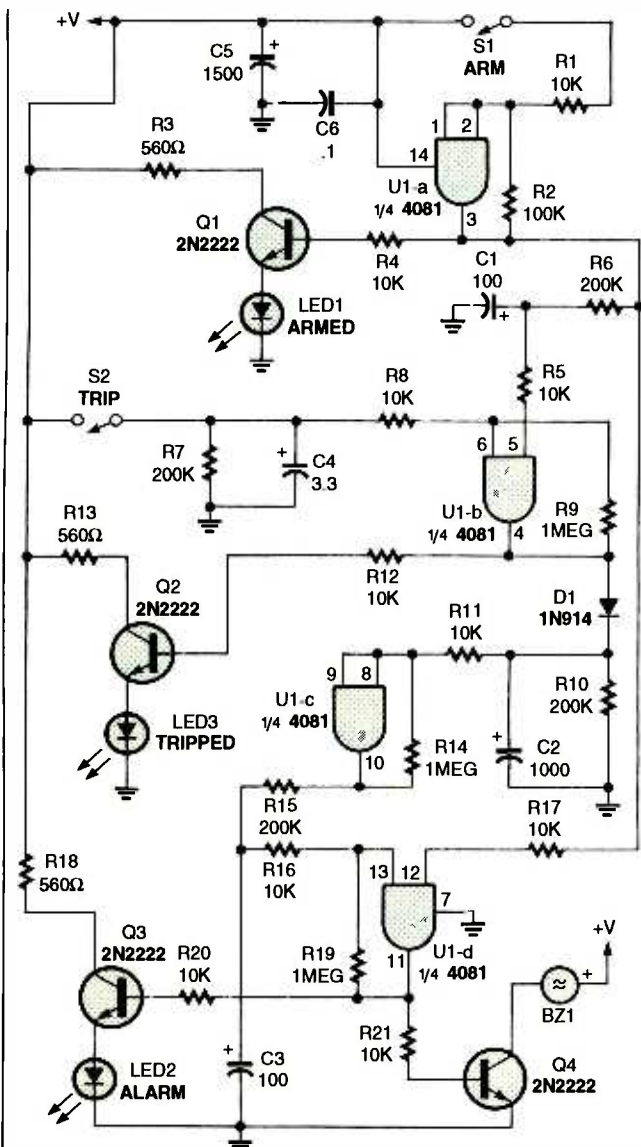

Fig. 3. If you want an alarm with all the standard features (exit entry delay, automatic reset, status indicators, etc.) then this circuit is worth a look. For all its features, it only uses one simple IC.

—Ed Baumgarten, Stewardson, IL

Thanks for sharing that circuit with us. Remember folks to select the transistor in Fig. 2B to handle the relay's coil current, and the relay contacts should be rated for whatever they activate.

**LOGICAL CHOICE**

Here is an alarm circuit that I built around a single 4081 (CMOS) quad AND gate (see Fig. 3). It offers an exit and entry delay (around 20 seconds), and will automatically reset 2 minutes after tripping, provided that the trip input is not left high.

The arming switch must go high to arm or low to disarm. After arming, U1-a begins to charge C1 via R6. Around 20 seconds later (after the exit delay), C1 has a sufficient charge to produce a high at the pin-5 input of U1-b. Also, when the circuit is armed, Q1 is turned on to indicate arming, and one input of U1-d is brought high.

After the exit delay times out, if the trip input opens, it causes an output on gate U1-b. Transistor Q2 is turned on, lighting the trip indicator (LED3). C2 instantly charges, and the output of U1-c goes high. At that

point, C3 begins charging to provide the entry delay.

After 20 seconds, C3 has sufficient charge to produce a high at pin 13 of U1-d. That forces U1-d's output high, turning Q3 and Q4 on, which activate the alarm indicator (LED2) and sounder (BZ1), respectively. If disarmed after a trip pulse, but before the 20-second entry delay times out, pin 12 of U1-d goes low, so the gate's output does not go high and there's no alarm.

Components C2 and R10 hold U1-c on for around 2 minutes and 20 seconds to provide the 2-minute alarm. After C2's charge drops below 1/2 the supply voltage, U1-c's output goes low, awaiting another trip pulse to set it off again.

Resistors R2, R9, R14, and R19 give the gates some snap when changing states. Capacitor C5 holds enough charge after power down to let all timing capacitors discharge before the supply drops. That prevents damage to the gates.

I hope that you at **Popular Electronics** enjoy putting this one together, I sure did.

—Douglas Miller, Alliance, OH

A very professional circuit. Anyone trying out the circuit should remember that electrolytic capacitors are not accurate timing components. Their tolerance is high and, more importantly, their leakage current drains charge off during charging cycles. That makes their charge times hard to predict, so expect some variation in the time periods you experience.

**ALARM-CLOCK ADAPTER**

This simple but very useful circuit (see Fig. 4) consists of a few inexpensive parts

(Continued on page 92)

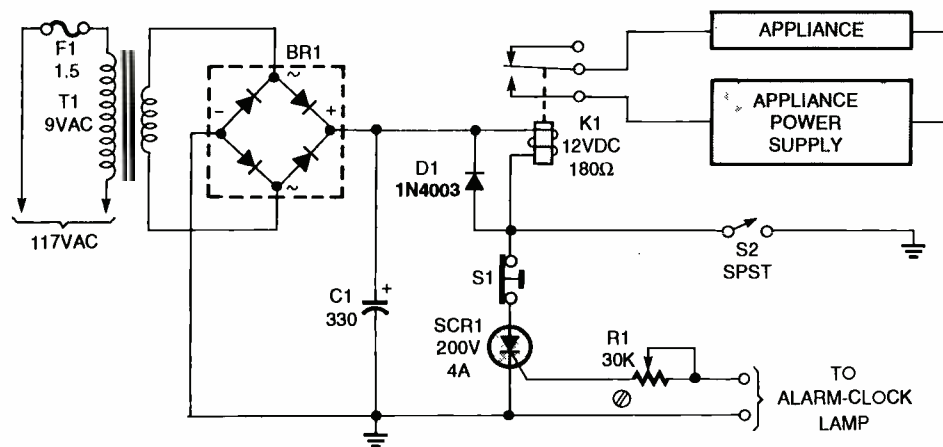

Fig. 4. Turn your alarm clock into a specialized timer with this simple circuit. The clock used with the circuit should be the kind that turns on a little lamp when the alarm is activated.



## Just like these Fully Trained Electronics Professionals



"Thanks to CIE I have tripled my previous salary, and I am now in a challenging and rewarding new field where only the sky is the limit."

Daniel Wade Reynolds  
Industrial Electrician  
Ore-Ida Foods



"CIE was recommended to me by my boss. It was appealing since I could study at my own pace at home and during business travel."

Dan Parks  
Marketing Manager/Consumer Products  
Analog Devices, Inc.



"I loved the flexibility CIE offered. It was the only way I could continue both school and my demanding job."

Britt A. Hanks  
Director of Engineering  
Petroleum Helicopters, Inc.



"I liked the way the school was set up with laboratory assignments to enforce conceptual learning. The thing which impressed me the most about CIE's curriculum is the way they show application for all the theory that is presented."

Daniel N. Parkman  
Missile Electro-Mechanical Technician  
U.S. Air Force



"Completing the course gave me the ability to efficiently troubleshoot modern microprocessor based audio and video systems and enjoy a sense of job security."

Tony Reynolds  
Service Manager/Technician  
Threshold Audio & Video

# Graduate with an Associate Degree from CIE!

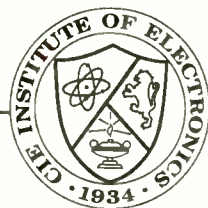

CIE is the best educational value you can receive if you want to learn about electronics, and earn a good income with that knowledge. CIE's reputation as the world leader in home study electronics is based solely on the success of our graduates. And we've earned our reputation with an unconditional commitment to provide our students with the very best electronics training.

Just ask any of the 150,000-plus graduates of the Cleveland Institute of Electronics who are working in high-paying positions with aerospace, computer, medical, automotive and communications firms throughout the world. They'll tell you success didn't come easy...but it did come...thanks to their CIE training. And today, a career in electronics offers more rewards than ever before.

### CIE'S COMMITTED TO BEING THE BEST...IN ONE AREA...ELECTRONICS.

CIE isn't another be-everything-to-everyone school. CIE teaches only one subject and we believe we're the best at what we do. Also, CIE is accredited by the National Home Study Council. And with more than 1,000 graduates each year, we're the largest home study school specializing exclusively in electronics. CIE has been training career-minded students for nearly sixty years and we're the best at our subject...  
**ELECTRONICS... IT'S THE ONLY SUBJECT WE TEACH!**

### CIE PROVIDES A LEARNING METHOD SO GOOD IT'S PATENTED.

CIE's AUTO-PROGRAMMED® lessons are a proven learning method for building valuable electronics

career skills. Each lesson is designed to take you step-by-step and principle-by-principle. And while all of CIE's lessons are designed for independent study, CIE's instructors are personally available to assist you with just a toll free call. The result is practical training... the kind of experience you can put to work in today's marketplace.

### LEARN BY DOING...WITH STATE-OF-THE-ART EQUIPMENT AND TRAINING.

CIE pioneered the first Electronics Laboratory

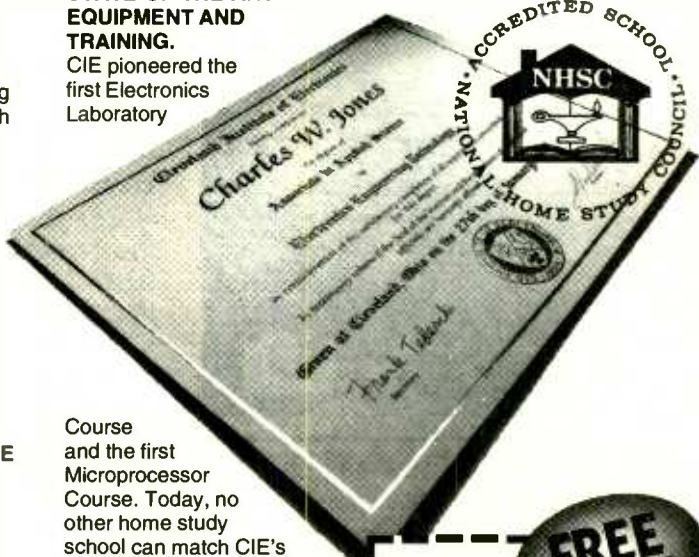

Course and the first Microprocessor Course. Today, no other home study school can match CIE's state-of-the-art equipment and training. And all your laboratory equipment, books and lessons are included in your tuition. It's all yours to use while you study and for on-the-job after you graduate.

### PERSONALIZED TRAINING...TO MATCH YOUR BACKGROUND.

While some of our students have a working knowledge of electronics others are just starting out. That's why CIE has developed twelve career courses and an A.A.S. Degree program to choose from. So, even if you're not sure which electronics career is best for you, CIE can get you started with core lessons applicable to all areas in

electronics. And every CIE Course earns credit towards the completion of your Associate in Applied Science Degree. So you can work toward your degree in stages or as fast as you wish. In fact, CIE is the only school that actually rewards you for fast study, which can save you money.



**YES!** I want to get started. Send me my CIE course catalog including details about the Associate Degree Program. (For your convenience, CIE will have a representative contact you - there is no obligation.)

Please Print Clearly

AH58

Name \_\_\_\_\_

Address \_\_\_\_\_

City \_\_\_\_\_

State \_\_\_\_\_ Zip \_\_\_\_\_ Age \_\_\_\_\_

Phone No. \_\_\_\_\_

Check box for G.I. Bill Benefits.

Veteran

Active Duty

Cleveland Institute of Electronics, Inc.  
1776 East 17th Street  
Cleveland, OH 44114

A School of Thousands.  
A Class of One. Since 1934.

Send for CIE's FREE Course Catalog and See How We Can Help Your Career Too!

# GET THE LATEST ADVANCES IN ELECTRONICS

SUBSCRIBE TO—

# Electronics NOW<sup>®</sup>



## ENJOY THE WORLD OF ELECTRONICS EACH MONTH!

Subscribe to the best informed electronics magazine—the one that brings you the latest high-tech construction projects, feature articles on new technology, practical troubleshooting techniques, circuit design fundamentals, and much more.

**Electronics Now** looks to the future and shows you what new video, audio and computer products are on the horizon. You'll find helpful, monthly departments such as Video News, Equipment Reports, Hardware Hacker, Audio Update, Drawing Board, Computer Connections, New Products, and more. All designed to give you instruction, tips, and fun.

## Electronics Now gives you exciting articles like:

- Buyer's Guide to Digital Oscilloscopes
- Build A Scanner Converter
- Single-Chip Voice Recorder
- Build A MIDI Interface for your PC
- Troubleshoot Microprocessor Circuits
- Build A High-Power Amplifier for your Car
- Add Music On Hold to your Phone
- All About Binaural Recording
- VGA-to-NTSC Converter



FOR FAST SERVICE CALL OUR TOLL-FREE NUMBER!

# 1-800-999-7139

## DON'T DELAY — SUBSCRIBE TODAY!

If you prefer, just fill out the order card in this magazine and mail it in today.



# Build The

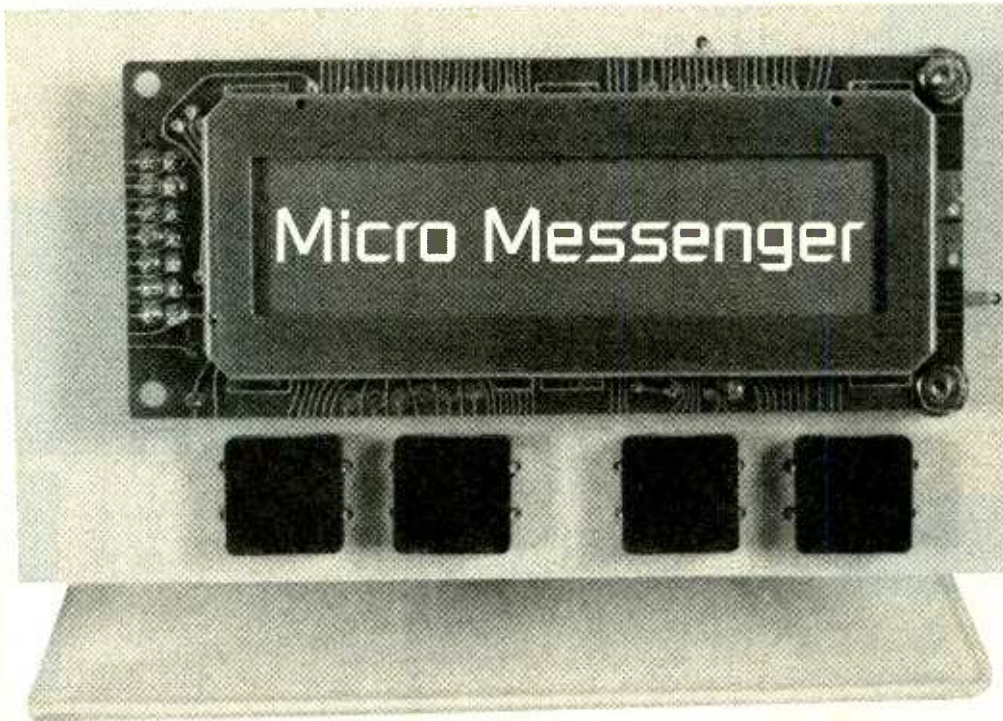

BY SCOTT EDWARDS

*Put your thoughts into words  
and share them with the world using this scrolling marquee-like display.*

**H**ere's a project to help you communicate. It's not a phone, fax, radio, pager, or satellite dish. It's a sign. A very small electronic sign. Dubbed the *Micro Messenger*, it combines a sharp liquid-crystal display (LCD) with an inexpensive microprocessor to produce the world's smallest scrolling sign. It can be programmed via the front-mounted pushbuttons, or through a temporary serial connection to a PC. Once the Micro Messenger is programmed, it will broadcast your opinions, tell your jokes, or just startle passersby for days using just a single 9-volt battery.

The Micro Messenger is easy to build. As an added bonus, you'll gain experience with LCD's, custom microprocessors, surface-mount components, RS-232 communications, and electronic assembly. Using the Micro Messenger will probably improve your spelling, too.

**Circuit Description.** Figure 1 is a schematic diagram of the Micro Mes-

senger, which consists of a power supply, microcontroller, LCD module, and various resistors, switches, and connectors. Because most of the device's operation depends on U2, we'll start the circuit description with that microcontroller—a PIC16C54 made by Microchip, Inc.

The PIC16C54 is an inexpensive computer-on-a-chip that is often used in PC peripherals, such as mice and trackballs, or control systems like antilock brakes. Like other computers, its operation is determined by a set of program instructions that reside in internal read-only memory (ROM). Once programmed, it cannot be erased.

As computers go, the PIC is not very powerful, having only 32 bytes of random-access memory (RAM) and enough ROM for up to 512 instructions. It has a limited instruction set that allows a program to input and output data through its two ports; do simple arithmetic, like addition and subtraction; compare values and make IF/THEN decisions; and perform logical

operations such as AND, OR, and NOT (inversion).

The PIC occupies the middle ground between full-blown microprocessors (like the ones in desktop computers) and logic IC's (like the 74xx or 4xxx series chips). It is called a microcontroller rather than a microprocessor because it is essentially self-sufficient. It doesn't need external RAM, ROM, or peripheral chips in order to do its job; those features are built in. The PIC's job in the Micro Messenger is to read inputs from switches S1 through S4 and the serial port (J1), and display them on the LCD.

Driving the LCD is not too different from driving a printer. The PIC must follow a strict format for communicating with, initializing, and controlling the LCD. Control codes tell the LCD to turn its cursor on or off, clear the screen, shift data left or right, and use a particular font.

Figure 2 is a flow chart of the Micro Messenger's PIC program. It begins by checking to see whether a computer is connected to the serial port. If a

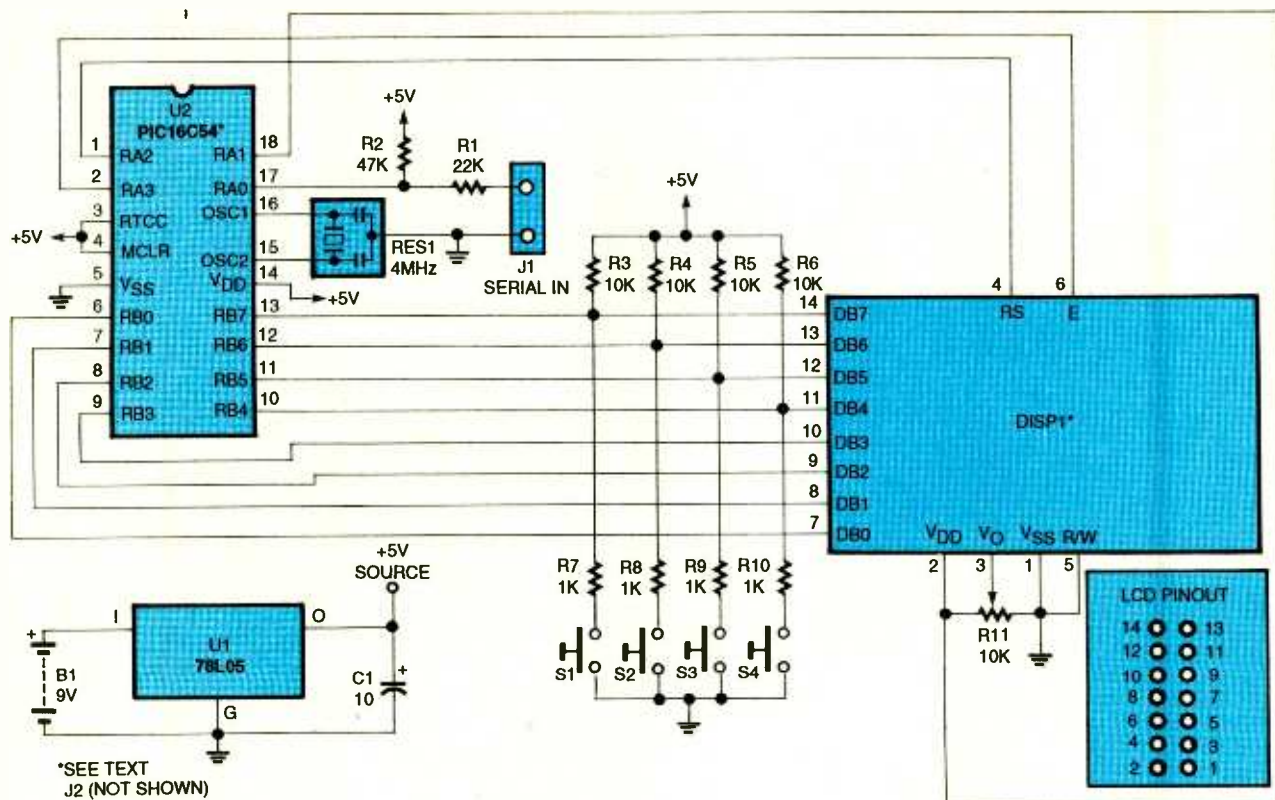

Fig. 1. The Micro Messenger consists of a power supply (U1, C1), microcontroller (U2, RES1), LCD module, and various resistors, switches, and connectors.

computer is connected to the serial port, the program assumes that you want to enter your message through the computer. If not, it prepares to accept a message through the buttons.

The program handles serial input by receiving one byte (equivalent to a character of text) at a time, displaying it on the LCD, and checking to see whether the maximum number of characters (70) has been received. If so, it begins scrolling the display, ignoring any further input. If not, it prepares to receive the next character.

Handling manual input is more complicated. The program initially displays a capital letter A in the center of the LCD screen. If you click S4, the display changes to B. Holding S4 down causes the display to rapidly scan through B, C, D, E, etc., until you release the button. If you press S1, you get the opposite result; the program progresses backwards through the characters. Arcade-game fans may recognize that style of "typing." It's the way that many games use a joystick or pair of buttons to let the high-scorer add his or her name to its "hall-of-fame list."

Once you have the letter you want

displayed, clicking S2 causes the display to shift to the left, letting you pick the next letter. If you want to change a previously entered letter, pressing S3 moves the display to the right. Each time the display is advanced, the program checks to determine whether the maximum message length has been reached. If it has, the program stops accepting input and begins scrolling the display.

### Some Questions and Answers.

Now that you know how U2 works, you may have some questions about Fig. 1. For Example:

- I thought that receiving RS-232 signals required special components to shift the voltage levels and interpret the bits. How come this circuit has just a couple of resistors?

That's possible because an RS-232 computer port sends one bit at a time by switching a voltage between -10 and +10 volts relative to ground. A -10-volt signal represents a high bit (1), while +10 volts represents a low bit (0). Most computers use two peripheral chips to receive that signal; the first changes the ±10-volt signal to standard 5-volt levels and inverts it

so that +5 volts represents 1, and 0 volts represents 0. The second chip collects the single-bit bits, and outputs them eight (one byte) at a time to the microprocessor.

The Micro Messenger takes a no-frills approach to do the same job. Resistor R1 limits the amount of current allowed to flow through the RS-232 connection, while diodes inside the PIC limit the voltage to 5-volt logic levels. The PIC program takes care of inverting the bits and arranging them into bytes. Resistor R2 (see Fig. 1) helps the PIC determine whether or not a computer is connected. If no computer is connected, R2 holds the serial input pin at 0 volts; if one is connected, the RS-232 resting state of +10 volts puts a high on the serial input pin, telling the PIC to expect serial input.

- The eight pins of port RB go from the PIC to the LCD, probably carrying bytes of data. How can the switches use the same pins without messing up the LCD?

The PIC is able to change the functions of its pins from input to output and vice-versa. To read the switches, the PIC disables the LCD by putting a



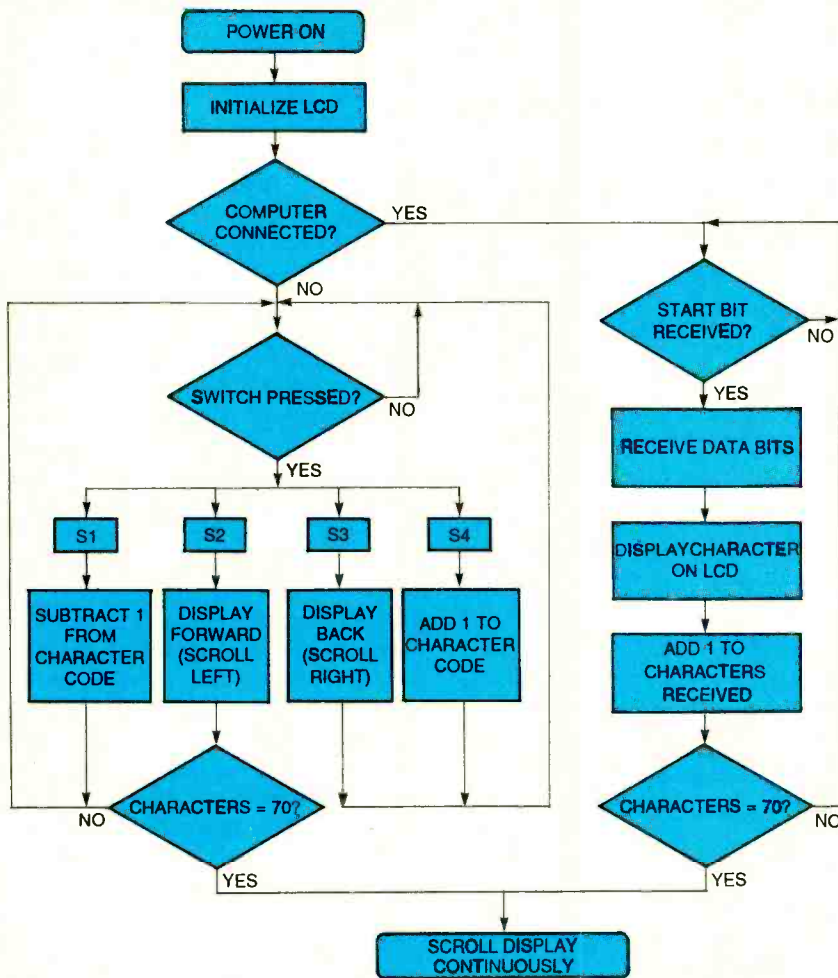

Fig. 2. This flow chart of the PIC program shows that the PIC begins by checking to see whether a computer is connected to the serial port. If a computer is connected to the serial port, the program assumes that you want to enter your message through the computer. If not, it prepares to accept a message through the buttons.

low on the enable line, and then puts the pins of port RB into the input mode. If no switch is pressed, 10k resistors (R3 through R6) hold pins RB4 through RB7 at +5 volts (high). When you press a switch, the corresponding pin of RB sees resistances of 10k to +5 volts and 1k to ground. The two resistors form a voltage divider, delivering about half a volt to the pin:  $1k / (1k + 10k) \times 5 \text{ volts} = 0.45 \text{ volts}$ , which is low enough to be seen as a 0.

To talk to the LCD, the PIC puts the pins of port RB into output mode and puts a high on the LCD enable pin. If a switch is pressed while the PIC is transferring data to the LCD, a high on the corresponding PIC output pin has to push 5 mA of current through the 1k resistor (5 volts/1k) to ground. The PIC can supply up to 20 mA per pin, so that's not a problem. The PIC merely "overpowers" the switch input.

• What does RES1 do?

The ceramic resonator (RES1) performs a similar function to quartz crystals (which control timing in watches and frequency in transmitters); it is less precise but more rugged than its quartz counterpart. The resonator controls the speed of a clock oscillator that's built into the PIC, which, in turn, determines the rate at which the PIC executes instructions. The PIC executes an instruction every fourth clock cycle, so with a clock speed of 4 MHz, the PIC carries out 1-million instructions per second.

The PIC clock can be programmed to operate with a resistor and capacitor pair to set the clock speed. However, receiving RS-232 signals requires fairly precise timing, so a ceramic resonator was used in the circuit. A quartz crystal would also work, but could be larger and more fragile.

**Construction.** The author's prototype of the Micro Messenger was built on a printed-circuit board, measuring about 4 by 2 $\frac{3}{16}$  inches. A template of that printed-circuit board is shown in Fig. 3. Once you have etched your board, verified there are no shorts between traces or broken

## PARTS LIST FOR THE MICRO MESSENGER

### SEMICONDUCTORS

- U1—78L05 100-mA, 5-volt voltage regulator IC (Digi-Key AN78L05)
- U2—Programmed PIC16C54 microcontroller (see text)
- DISP1—16 × 1 LCD module based on the Hitachi 44780 controller circuit (see text)

### RESISTORS

- (All fixed resistors are ¼-watt, 5% units, unless otherwise noted.)
- R1—22,000-ohm
  - R2—47,000-ohm
  - R3—R6—10,000-ohm, ¼-watt, surface mount
  - R7—R10—1000-ohm
  - R11—10,000-ohm miniature, PC-mount, trimmer potentiometer

### ADDITIONAL PARTS AND MATERIALS

- C1—10-µF, 16-WVDC, axial-lead electrolytic capacitor
  - RES1—4-MHz ceramic resonator (Digi-Key PX400)
  - J1—4-pin section of single-row stake header material (0.100 inch spacing, Digi-Key WM4002)
  - J2—14-pin section dual-row stake header material (0.100 inch by 0.200 inch spacing, Digi-Key S2072-14-ND), see text
  - S1—S4—N.O. momentary contact pushbutton switch (Digi-Key P8034S)
  - B1—9-volt transistor-radio battery
- Printed-circuit materials, enclosure, 9-volt battery holder and connector, 4-contact IDC receptacle (0.100-inch spacing, Digi-Key A1902-ND), female DB-9 connector, 4 × 5-inch acrylic photo frame, hot glue, ¼-inch diameter standoff tubing, ½ inch, 2-56 machine screws and nuts, solder, tools, wire, solder, hardware, etc.

**Note:** The programmed PIC16C54 is available for \$10 postpaid (check or money order) from Scott Edwards, 964 Cactus Wren Lane, Sierra Vista, AZ 85635. Arizona residents add 6.5% sales tax.

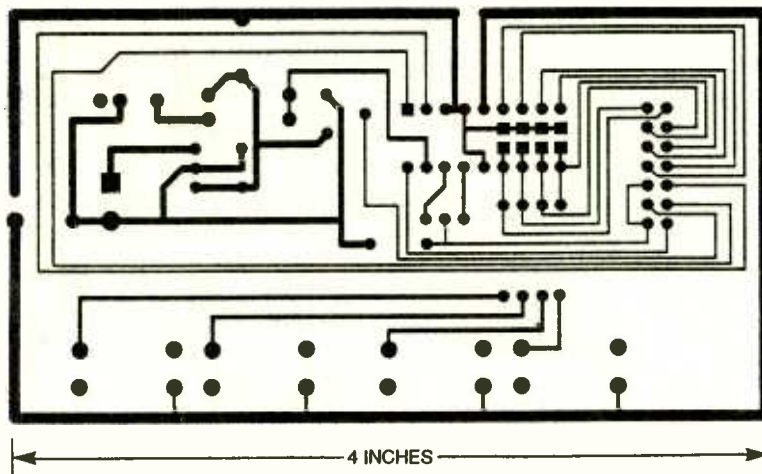
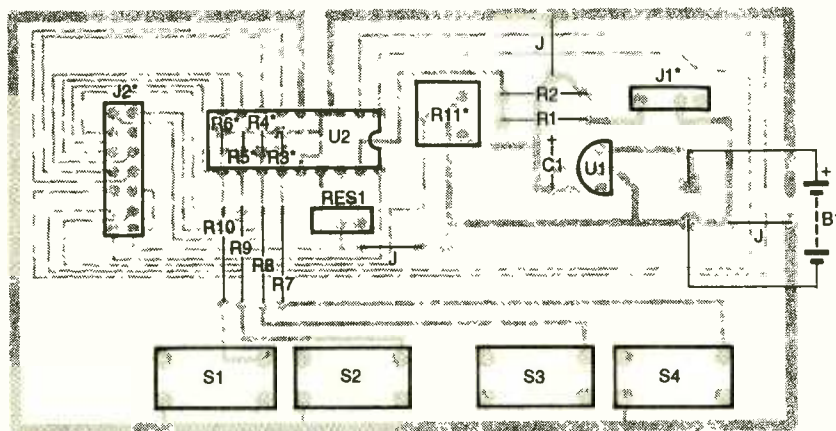

Fig. 3. The author's prototype of the Micro Messenger was built on a printed-circuit board, measuring about 4 by 2 $\frac{3}{16}$  inches. A template of that printed-circuit board is shown here.



\*SEE TEXT

Fig. 4. Once you have etched your board, verified there are no shorts between traces or broken lands, and obtained all the parts listed in the Parts List, install them in the positions indicated in this parts-placement diagram.

lands, and obtained all the parts listed in the Parts List, construction can begin. An ohmmeter can be used to make continuity checks for land breaks. When drilling the board, be sure to use as fine and sharp a bit as possible. An oversize or dull bit may remove the pads entirely—so be careful.

The pin headers, J1 and J2, require some minor surgery before installation. Note that J2, the LCD socket, is not shown in the schematic (Fig. 1). Begin with J1, the serial-port header. Break off a four-pin piece of the single-row header material—a pair of wire cutters can be used for that; just snip the plastic at the notch between adjacent pins. Then use a pair of needle-nose pliers to pull the square metal posts completely out of the plastic block. The plastic may separate into

two pieces. If it does, discard one piece. Now push three of the four posts back into the remaining block, leaving the blank one space from the end. Don't push the posts into the block very far; just until their ends are flush with the surface of the block.

Insert the modified header through the component side of the circuit board at the position indicated in Fig. 4. The pins should protrude from the foil side and the block should be flush to the board on the component side. Solder the pins carefully.

Next you'll perform a variation on the same trick for J2. Break or cut off a 14-pin section of dual-row header. A fine saw does the neatest job. Take a look at the header pins. They protrude approximately  $\frac{1}{4}$  inch from one side of the plastic block, and  $\frac{1}{8}$  inch from the other side. Using needle nose

pliers, push each stake further through the block until the short end protrudes only about  $\frac{1}{16}$  inch. That's just enough to stick through the circuit board and make a solder joint. The idea is to extend the pins' reach above the circuit board enough to mount the LCD over the other components. If you can find headers with pins longer than 0.5 inch overall, you can skip that step.

Once it's modified, mount J2 so that the long ends of the pins stick up on the component side of the board; just the opposite of J1. The trimmer potentiometer, R11, is mounted on the foil side of the board. Just push its pins through the board and solder it in place. Be careful not to touch the part's plastic body with the soldering iron.

Next install U1, all of the resistors other than R3 through R6, the switches, C1, and the wire jumpers where indicated in Fig. 4. Note that the tall components—U1, C1, and RES1—all must be bent flat to the board. The resonator's case should point toward U2's mounting area. When you are finished, connect a 9-volt battery connector to the board, apply power, and check the voltage across pins 5 and 14 of U2's still-vacant pads. If it reads something other than 5 volts, remove power and recheck your work. Do not install U2 until you measure 5 volts across those pins.

A pre-programmed PIC16C54 (U2) is available from the source given in the Parts List. If you have the ability and equipment to program your own PIC, the listing is available on the Gernsback BBS (516-293-2283, 8-N-1).

Before installing U2, make sure that you, your tools, and your work area are static safe. That means wearing cotton clothes and a ground strap, using a grounded soldering iron, and working on a wood or metal benchtop or a static-free pad. Although U2 is not particularly sensitive to static, it's better to be safe than sorry. Be sure to orient U2 correctly; pin 1 should be at the top of the board.

Before soldering U2 in place, lightly tin the square pads beneath U2. The surface-mount resistors go here. You want a fairly thin coating, one that just barely bulges above the pad. To install the resistors, pick one up with a pair of tweezers. Heat one of the pads with your soldering iron until the tin-



ning melts. Press one end of the resistor against that pad, while aligning the other end with the opposite pad. Let the first pad cool a moment, then touch your iron to the other pad and the end of the resistor. Then the joint should flow together. If needed, you may touch up the joint with a bit more solder. Repeat the process with the other three surface-mount resistors, then install U2.

Finally, we come to the LCD module. Note the LCD module, DISP1, is a surplus unit that is available with slight variations from several parts dealers. The one used in the prototype is the 16 x 1 Hitachi LCD from Timeline, Inc. (23605 Telo Avenue, Torrance, CA 90505; Tel. 800-233-9977), priced at \$8.33 (with a minimum \$25 order requirement). An equivalent device (tested to work in the circuit) is the Densitron 4012 available (as part no. 25-210 (\$9.95) from Hosfelt Electronics (2700 Sunset Boulevard, Steubenville, OH 43952; Tel. 800-524-6464). No minimum for credit card orders. Another source is B.G. Micro (P.O. Box 280298, Dallas, TX, 75228; Tel. 214-271-5546). Their DMC16207H (at \$5.99) works, but requires a negative bias voltage as described in the sidebar. The DMC20171 (at \$9.95) also requires a negative bias voltage, but provides a jumbo display, 6 inches wide with 0.42-inch characters. B.G. Micro has a \$10 minimum order requirement.

Install the LCD module. The module has two rows of seven holes each that match the pins of J2. Fit the LCD to the pins, and then look to see whether any of the components on the circuit board are interfering with the fit. If they are, press them flatter to the board or adjust them as necessary to accommodate the display. Capacitor C1 is the most likely potential problem.

Before soldering the LCD into position, cut two pieces of 1/4-inch diameter standoff tubing to a length of 1/4 inch. Put a drop of glue (or hot glue) into each standoff and push 1/2-inch, 2-56 machine screws headfirst into the glue. Make sure that the threaded ends stick straight up. Set them aside on wax paper or any other glue-resistant surface. When they are set, push the threaded ends of the screws through the LCD's right-hand mounting holes and secure them with nuts. Apply a dab of glue to the other end of each standoff and install the LCD

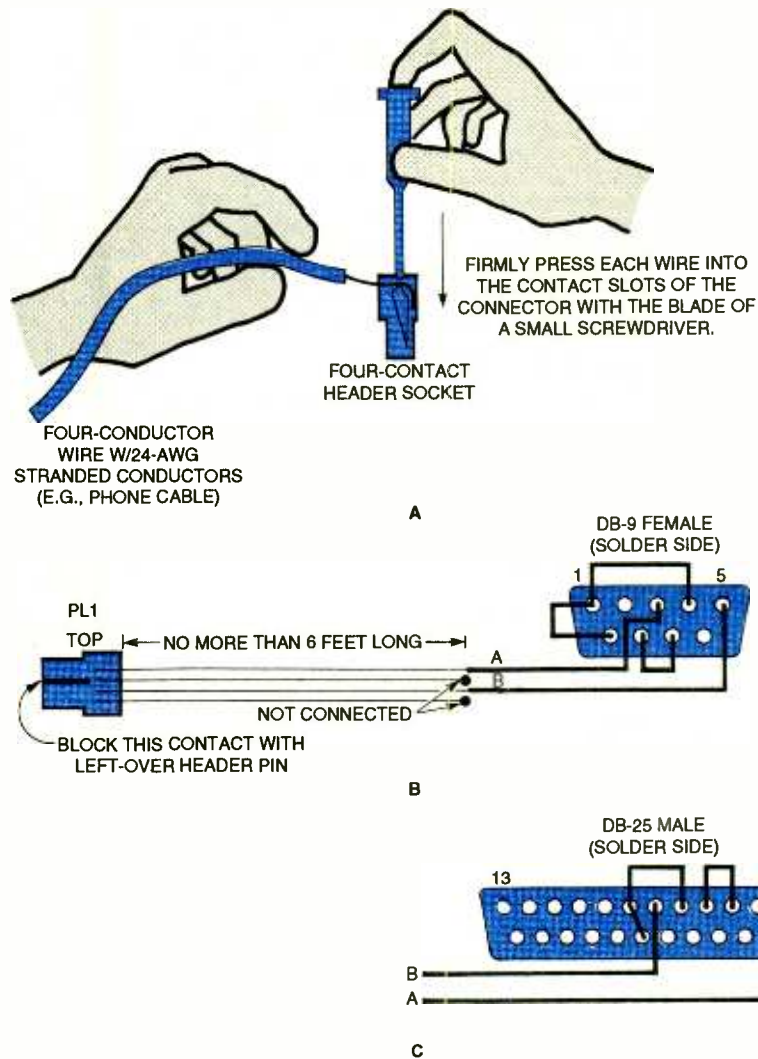

Fig. 5. If you plan to use the Micro Messenger with a computer, use this diagram (and the instructions in the text) to prepare the necessary interconnecting cable.

on its mounting pins. Press the sticky standoffs securely against the circuit board and solder the LCD into place.

Apart from connecting a 9-volt battery and (if desired) a power switch, you are done. The only issue that remains is a case for your project. I cut a 4- x 5-inch acrylic photo frame to size, drilled holes for J1, R11, and the power leads, and hot-glued the circuit board to the front of the frame. The clear plastic protects the foil side of the board from fingers, but shows

off my handiwork. You can follow my lead, or dream up an entirely different mounting scheme.

If you plan to use the Micro Messenger with a computer, Fig. 5 shows how to make the cable. The interconnecting cable was made from a 6-foot length of 4-conductor stranded 24 AWG cabling (e.g., modular telephone-station wire), a 4-contact header socket, and a DB-9 or DB-25 connector. Begin by firmly pressing each wire into the contact slots (as

#### LISTING 1

```
OPEN "com1:2400,N,8,1" FOR OUTPUT AS #1
CLS
PRINT : PRINT : PRINT
PRINT "Type your message below; 70 characters maximum. "
PRINT
PRINT ".....10.....20.....30.....40.....50.....60.....70"
LINE INPUT ; "": AS
PRINT #1, AS
CLOSE : END
```

## SURPLUS LCD BARGAINS

One of the most important skills an electronics hobbyist can develop is scrounging—the ability to recognize and use parts bargains. The Micro Messenger project is a prime example. Its LCD module can be quite expensive, up to almost \$40 from some new-parts suppliers. The surplus sources specified in the Parts List sell it for less than \$10; that's quite a difference.

Surplus buyers not only save money, they get an education, too. In the case of the Micro Messenger, the author found that the variety of LCDs using the same basic controller is staggering. Most work with the Micro Messenger chip, but a few do not. If you're the adventurous type and want to use a different LCD than the ones specified in the article, here are some guidelines:

The controller must be a Hitachi 44780, which interprets the commands that the Micro Messenger PIC sends to the LCD. If it's not a 44780, chances are the LCD won't respond correctly. (Don't worry if your LCD has additional letters and numbers to the part designation, like HD44780A00. It's still a 44780.)

In addition to the controller, the LCD should have at least one additional driver chip, either a Hitachi 44100 or an OKI 5259. At least one popular 16×1 LCD display, the Optrex 16187, lacks an extra controller IC. Without it, the LCD behaves like a two-line device with the lines arranged side-by-side. That results in scrambled text from the Micro Messenger. (Here again, additional characters in the part number are OK: HD44100H or M5259.)

Two-line displays (16×2) are generally a safe bet. They usually have both the 44780 and 44100/5259 to support their two-line display. Since the Micro Messenger is programmed to use the top part of the second line to display the descenders of letters like g, p, and y, the extra space isn't too noticeable.

Backlighting is optional. A backlit display will work fine without power to the backlight. If you do want to use the

backlight, find out from the surplus dealer what type it is; electroluminescent (EL) or LED. If it's EL, find out whether the dealer has the inverter needed to convert a 5-volt supply to the 100 VAC/400 Hz required by the backlight. Do not connect the backlight to household AC power! That's not only dangerous, it's ineffective. The 60-Hz AC line won't light the panel properly. If the backlight is an LED, you'll see connections marked A and K for anode and cathode. Connect the anode to the +5-volt supply through a 220-ohm resistor and ground the cathode.

Different pin arrangements are common. As built, the Micro Messenger uses a two-row header to connect to the 14 pins on the LCD module. Many LCDs have their pins arranged in a single row along the top or bottom of the display. There's normally a mark to identify pin 1. To use that type of display, you'll need to use wire or ribbon cable to make the connection. Just make sure to observe the staggered arrangement of the two rows on the printed-circuit board. Unlike a 14-pin IC, whose pins are numbered 1–7 on one side and 8–14 on the other, these pins are numbered 1, 3, 5, 7, 9, 11, 13 along one edge and 2, 4, 6, 8, 10, 14 along the other.

Some LCDs require a negative supply. The LCD used in the project requires a low-biasing voltage at pin 3 ( $V_o$ ) to control the contrast of the screen. At room temperature, R11 is adjusted to set the bias at about 0.5 volts DC. Some LCDs intended for use at extreme temperatures require a negative biasing voltage. For example, the Optrex DMC16207H and DMC20171 require –3- to –4-volt DC bias. The easiest way to supply that bias voltage is to disconnect R11 from the +5-volt supply. Connect a second 9-volt battery to the circuit. Ground the positive terminal and connect the negative terminal to the ungrounded terminal of R11. You can now adjust R11 to supply negative bias. ■

shown in Fig. 5A) of the header with the blade of a small screwdriver. Afterward block the contact-position indicated in Fig. 5B with the header pin that was left over from the board-mounted assembly, and snip off the excess. That way you'll have a socket that will only fit one way; the right way. Next connect the female DB-9 connector to the other end of the cable, and finally make the jumper connections between the connector pins, as shown. Figure 5C shows how to connect a DB-25 connector to the cable instead of the DB-9.

**Operation.** Connect a 9-volt battery to the circuit and adjust R11 until you see a capital letter A in the center of the LCD screen. At that point, you are ready to enter a message. Manual operation of the Micro Messenger is pretty well described in the circuit description above, but here are a few hints. To enter a space character, or move rapidly around the character set, press and hold S1 and S4 at the same time. The characters "space," capital "A," lowercase "a," and the number "0" will scroll by on the screen. Let the buttons go when you see the

character you want. That helps speed up the two-thumb typing process.

If your message is shorter than 70 characters, put a space on the screen, then press and hold S2. That will enter a string of spaces to pad the rest of the 70-character memory. Feel free to explore the character set of the LCD; there are many pleasant surprises. For example, past the lower-case Roman alphabet are Japanese Kana characters, Greek letters, and special symbols. Even if you don't have a particular need for those characters, you can throw a few in to give your messages an international flavor.

Using the Micro Messenger with a computer is almost as easy. With the Messenger turned off, connect the cable between the Micro Messenger and the computer's serial port. Turn the computer on and boot your terminal software. Set it for 2400 baud, eight data bits, no parity, with one stop bit. Afterward, turn on the Micro Messenger and type in your message. When the Micro Messenger has received 70 characters, it will begin scrolling. As with manually entered messages, you may pad the message with spaces to reach the 70-character point. If you don't have a terminal program, enter and run the BASIC program in the Listing 1, and use it to download messages to the Micro Messenger.

Once you have programmed the Micro Messenger, you can take off the programming connector. Doing that won't disturb the Micro Messenger's memory once your message has begun scrolling.

**Conclusion.** Now that you have this powerful new means of communication, what do you want to say? I have a theory that the first million or so cellular phone calls were exactly the same, "Hi Joe. Guess where I'm calling from—my car!" If you want to avoid that trap with your Micro Messenger, try quoting song lyrics. Mine frequently says, "I wish I were in Dixie, away, away" or "She's filing her nails while they're dragging the lake." (Not too many readers can identify that second song. I'll wager.) If you are really stuck for ideas, you could always leave practical messages like "Gone to lunch, back by 1:00." Whatever you decide to say, have fun! ■



**T**here's nothing too difficult about soldering. Many failed construction projects suffer from nothing more than poor soldering. However, it doesn't take much time to learn good soldering techniques, nor does good soldering require expensive tools. If you stick to a few guidelines, you'll consistently produce good, permanent electronic connections.

This article presents some tips to help your electronic projects look and work better through improved soldering. The tips include discussions of solder, flux, soldering tools and accessories, the role of cleanliness, preparing connections, knowing what a good soldering job looks like, avoiding component damage, desoldering techniques, and common soldering problems. The article also covers handling special soldering jobs and practicing good soldering techniques.

**The Solder.** Solder is a tin-lead fusible alloy, although small amounts of other metals such as antimony, bismuth, or silver may be included to enhance its characteristics or make it suitable for a special purpose. Solder flows at a fairly low temperature, around 360–370°F. Because of its relatively low melting point, solder can form a metallic union or "joint" of two metals at a temperature well below their own melting points. So solder can easily be melted by home-workshop soldering irons, guns, and pencils to make connections between metals.

Solder is usually identified by its tin-to-lead composition. If you look at a solder roll, you will probably find the figures 40/60, 50/50, 60/40, or 63/37. Those are the ratios of tin-to-lead, given in percent. Solder with a higher tin content melts at a lower temperature, and is usually desirable.

Since solder adhesion depends on a solvent or metallurgical action, the process breaks down if the solder itself is of poor quality, or of the wrong composition. When tin is added to lead, the melting point of the lead decreases along a known composition/temperature line (see Fig. 1). When lead is added to tin, the melting point of the tin is lowered along another such composition/temperature line. The intersection of these two lines is known as the "eutectic" point.

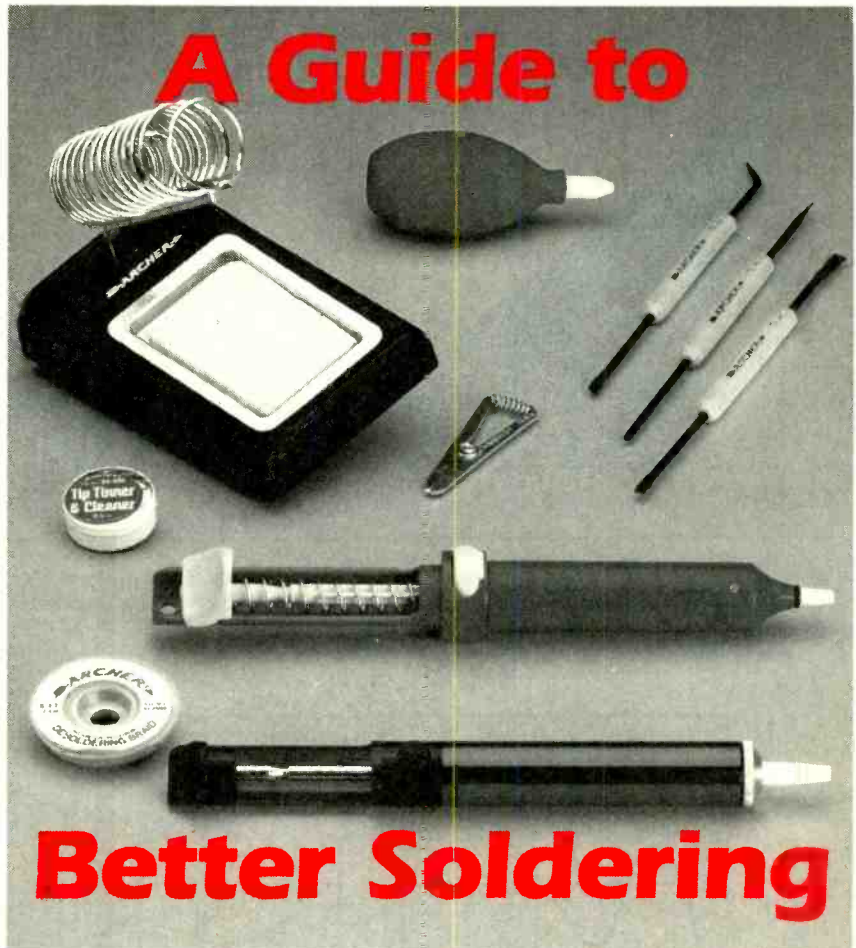

*Here's all you'll ever need to know about the art, craft, and science of soldering.*

BY KARL T. THURBER, JR.

The so-called "eutectic alloy" of 63% tin and 37% lead has a melting, or eutectic, temperature of 361°F. That composition is the standard for electronic purposes, being approximated by 60/40 solder, and has a pronounced melting point. Other solder compositions have a flexible or plastic range running from the 361°F eutectic temperature up to the melting points of either pure lead (621°F), or pure tin (450°F).

Solders with a 63/37 or 60/40 composition are the most free-flowing kinds and are particularly good for working on delicate printed-circuit boards. That is especially the case if you use solder in thin, 16- or 18-gauge wire form; avoid thicker solders, which are difficult to control in terms of quantity and usually don't flow quickly enough.

Another important quality is

strength. A nice looking solder connection is worthless if it won't take a little stress and strain. Since tin is a more active metallic solvent than lead, the quality of the joint is very closely related to its tin content. Taking a look at Fig. 2, note that solder with less than about 30% tin content is inferior in stress-handling ability. The alloy quality curve reaches its peak with about 60% tin, which approximately corresponds to the composition of the eutectic alloy we described.

**Use the Right Flux.** Most solder contains flux inside its core, so the flux is automatically applied when you heat the solder. When it flows over the connection, it removes oxides from the metal surfaces. Any oxides are suspended in the flux, allowing good metal-to-metal contact to promote the metallurgical process. The action

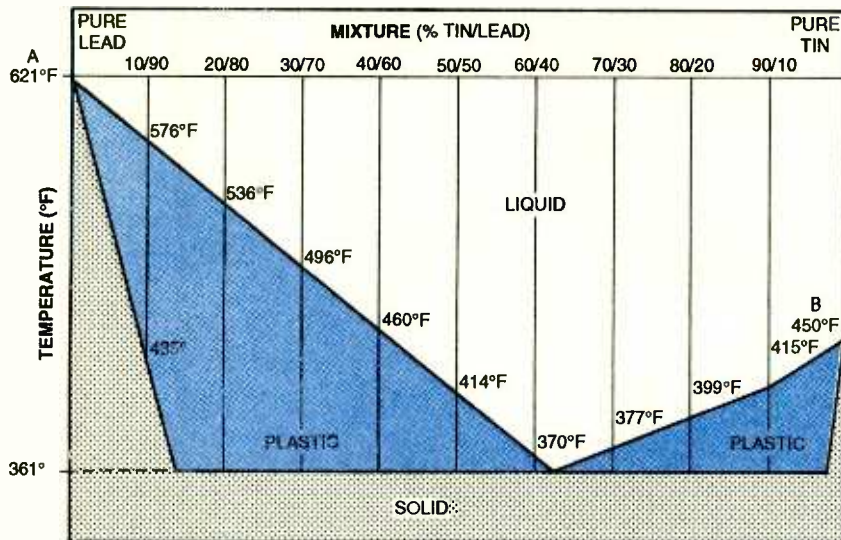

Fig. 1. When tin is added to lead, the melting point of the lead decreases along a known composition-temperature line. Likewise, when lead is added to tin, the melting point of the tin is lowered along another composition-temperature line. The intersection of these two lines is known as the eutectic point.

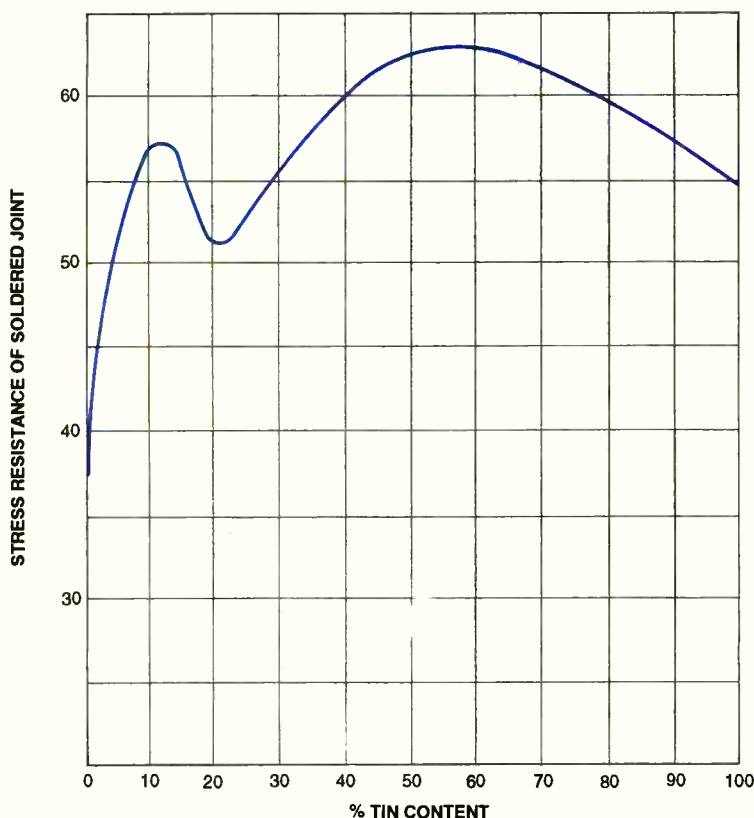

Fig. 2. Shown here is the change in joining quality of tin-lead solders with an increase in tin content, based on the resistance of the joint to stress. As shown, solder with less than about 30% tin content is inferior in its ability to take stress.

of the flux is known as "wetting the metal;" after soldering is complete, the oxides lie inert on the surface of the solder joint.

There are three basic types of soldering fluxes: organic acid or chlo-

ride, organic, and resin or rosin. Resin flux is the only kind that's usable in electronics construction and repair work. In that category, the safest and most reliable type of flux is pure rosin with no additives, rather than "active-

rosin" fluxes. Active fluxes can cause salt migrations, called "dendrites," between pathways on the PC board. Later, that can cause "phantom failures" in electronic equipment.

Organic-acid and chloride-salt fluxes are highly corrosive since they attract moisture. They have no place in electronics. Using acid or salt type fluxes is almost sure to lead to circuit problems. So, read the label closely to ensure that what you have isn't an organic-acid type.

**Use the Right Tools.** The state of the soldering art has progressed over the years, along with the rest of the electronics field, and has spawned many new tools and aids. There now are a large number of soldering and desoldering tools available for general and special applications, including soldering irons, guns, pistols, and variations on these tools. As a rule, irons and pencils are light- and medium-duty tools; guns are for medium- to heavy-duty work, while pistols are available in light, medium, or heavy-duty models.

Looking first at the iron, it's usually low in cost, keeps a fairly uniform temperature, and doesn't have to be turned on each time you solder a connection. Irons vary in size and heat capacity from about 15 to 500 or more watts, but an iron of 20-30 watts is all you need for most electronics work. A 15-watt pencil iron is good for PC boards and tight places. A 100-watt-plus iron is good for heavy-duty electrical work, but not for working on PC boards.

Arguably, the tip is the most important part of the iron; the size of the tip greatly affects the initial heating and heat-recovery times. Tips are made of various types of metal, though coated copper is generally used. A simple, straight tip with two flat faces (like a wedge) is most often used for general-purpose irons. Very slim, pointed tips are frequently used for delicate PC-board work. Several tip-face styles usually are available for most popular irons.

Depending on what you're working on, you might find a soldering gun suitable. Although a gun must be activated each time it's picked up, a gun heats quickly, often has a dual heat selection, and doesn't need a stand. A gun has a noteworthy advantage



over an iron: fast heating. It has a built-in transformer that provides high current directly to the tip, causing the tip to come up to full heat almost instantaneously.

However, that feature is a two-edged sword: some users complain that a gun is hard to handle, heavy, and fatiguing to use. A gun is typically more useful for repairs and when only a few connections must be made.

With the features of both a soldering iron and a soldering gun, a soldering pistol might be more advantageous. It combines a gun-type heating element and step-down transformer with the iron's soldering tip, so it heats almost instantaneously.

One of the most useful soldering tools of recent years is the rechargeable cordless soldering iron. It allows completely portable operation—it is not tied down to an AC source like a conventional iron, gun, or pistol. The typical cordless unit has a self-contained, rechargeable battery that yields from 100 to 175 solder joints per charge. The tip usually comes up to operating temperature in 5 to 8 seconds.

Many units have batteries that can be brought up to a full charge in an hour or so after completely discharging. The more advanced models allow for continuous charging when not in use, and have LED indicators that indicate when charging is complete; others can be left plugged in at all times, and can't be overcharged.

Many multipurpose units have provisions for interchangeable tips and other accessories, including small PC-board drills. Wahl has a novel PC mini-drill attachment for their ISO-TIP rechargeable iron; it temporarily replaces the tip of the iron, and obtains power from the unit's battery pack.

**Accessories.** We'll assume you're equipped with appropriate electronic workbench tools, such as needle-nose pliers, screwdrivers, knives, wire strippers, and the like, in addition to a suitable soldering iron or gun. Besides these, many other soldering accessories and gadgets can make building and repair work a great deal easier.

Some soldering accessories you'll find useful are a brush, scraper, probes, and spare tips. A clip-on heat



*This Wahl Quick Charge ISO-TIP iron recharges completely in 3 to 4½ hours and can't be overcharged. A fully charged unit can make up to 125 electrical joints per charge. The kit contains the cordless soldering iron, wall plug transformer, two tips, and instructions. (Photo courtesy Wahl Clipper Corporation.)*

sink to protect delicate components is a must, although it need not be a commercially manufactured item. You could use a paper clip, a clamp, or pliers to grip components that need protection from excessive heat.

Something to clean up the iron and keep its tip shiny is a must. That can be a sponge, rag, or washcloth. An illuminated magnifier is handy for examining connections, working with small components, and performing delicate PC board repairs.

Anyone who has had the experience of having a hot soldering iron inadvertently come in contact with a component, PC board, or cabinet, thereby causing heat damage, will want to use an iron holder to keep the iron in a safe place. Some iron holders even have built-in sponges for tip cleaning.

**Keep the Soldering Tool Clean.** If

there's a basic rule about soldering, it is: keep it clean! The tip itself must be clean, with its surface lightly coated with solder to prevent its deterioration from oxidation. That is called tinning, and it facilitates transfer of heat from the tip to the connection. You should clean and tin the tip of the soldering tool with solder after purchase.

Wear on the tip is not due to erosion or to the flux. Instead, it's due to the effect of the molten solder on it. Some manufacturers coat their copper tips with iron; this makes them less efficient for heat transfer, but it increases their lifetime. Besides the tip, the terminals and components to be joined must also be clean. "Well cleaned is already half soldered," is what old hands say.

The tip should be cleaned frequently during lengthy soldering sessions. This can be done by lightly running a wash cloth or rag across its surface, particularly when it is only moderately hot. Don't let the cloth remain in contact with the tip for an extended period, or it will char or even catch fire. Specially treated cleaning pads and sponges can also be used.



*This Wahl butane-powered soldering iron and torch is for heavy-duty electrical jobs—not for delicate PC-board work. Ideal for hobbyists and technicians, especially in outdoor applications, the cordless and refillable iron features an aluminum body and even-flow valve for a uniform flame. (Photo courtesy Wahl Clipper Corporation.)*

Don't be concerned if the tip becomes pitted since this is a result of normal soldering action. You can lightly file the iron's tip to remove the black spots of oxidation, and then re-tin it. If your iron has a detachable tip, you should periodically dismantle it from the heating element, to prevent its permanently bonding itself in place. Some builders like to store the heating element and handle with the tip removed.

**Prepare the Connection and Solder.** For solder to properly adhere to a connection, the metals must be clean and free of all nonmetallic matter. While rosin flux removes oxides from metal surfaces, it won't remove grease, dirt, or other foreign matter. If need be, you must do that yourself with a brush or cloth. You can clean a dirty lug or component lead with a small steel-bristle brush designed for the purpose, and you can use a strip of emery cloth or a file to remove stubborn particles. You also can use a solvent such as alcohol.

Once the components and terminals to be soldered are clean, they should be connected together to form a good mechanical and electrical joint before soldering. However, don't always rely just on solder to physically hold the work together. If parts fit too loosely, a weak joint will be the result, or even no joint at all if the gap is too wide for the solder to bridge.

The iron or gun should be hot enough to allow soldering to proceed quickly, but not so hot that the solder "burns" and free flux on the tip forms black flakes. If your iron or gun is adjustable, try different settings to determine which is best.

Now, to solder the connection. The idea is to apply the tip to the connection and almost simultaneously apply the solder to the junction between the tip and the connection. You want a small amount of solder to flow between the iron tip and the wire or component, which aids in transferring heat to the connection. The connection becomes hot enough for the solder to flow onto it, forming a solder fillet between all of the parts.

When soldering, place the tip of the soldering iron directly against the connection to be soldered, and at the same time apply the solder to the point where the iron touches the two

pieces of metal. Allow the connection to be heated enough so that the solder melts quickly and spreads evenly and almost immediately to every part of the connection.

Keep the soldering iron against the connection long enough to "cook out" any flux residue, but not so long that the solder "burns up." The time for the entire operation should be very short, just a matter of seconds. Don't let the solder run down the tip, or try to heat up the whole area first. Apply just enough solder to fill the gaps, and no more. Why? Excess solder will flow into places where it's not needed, or where it can cause a short.

To complete the process, remove the solder first, then the tip, being careful not to allow the connection to move while the solder is solidifying. Resist cooling the joint by blowing on it and also overcome the temptation to "test" the physical connection prematurely. If you do, you'll set up tiny fractures within the joint, seriously weakening it. Note, too, that you should clip excess leads before soldering, not afterwards—doing so afterwards weakens the connection.

## Names and Numbers

Elenco Electronics, Inc. (150 W. Carpenter Ave., Wheeling, IL 60090; Tel. 708-541-3800) offers a number of electronic kits including the SP-1 Soldering Practice Kit, several analog and digital multimeters, a diode/transistor tester, a combination AM/FM radio kit and training course, power supplies, and several other educational kits particularly suited to beginners.

Radio Shack Corporation (1500 One Tandy Center, Fort Worth, TX 76102; Tel. 817-390-3011) sells through its more than 7000 stores a good selection of soldering and desoldering tools and accessories. Necessary test equipment, including several multimeters, also are offered.

Solder-It Company (P.O. Box 20100, Cleveland, OH 44120; Tel. 261-721-3700) markets a variety of specialty soldering pastes and tools. Their products aim to make soldering coaxial-cable fittings, aluminum tubing, antenna set screws, and other often difficult-to-solder materials less troublesome.

Wahl Clipper Corporation (2900 Locust Street, Sterling, IL 61081; Tel. 815-625-6525) sells a variety of soldering and desoldering tools. They feature the ISO-TIP line of cordless rechargeable soldering irons and accessories, including PC-board mini-drill attachments.

It's best not to use water to clean any solder joint that uses a rosin flux, as it can cause a corrosive chemical reaction. The rosin residues can be left in place with no danger of corrosion, or they can be removed with a rag or a brush and special solvents.

**How Good Soldering Looks.** What does a good solder connection look like? A good connection is one where the solder has uniformly flowed over all the surfaces to be connected, following their contours. The connection appears bright, shiny, and smooth, with all wires in it appearing well soldered. However, if the connection is rough, grainy, or flaky looking, or if the solder formed into little round blobs, or has ridges or sharp points, redo it. Take the time to visually check the connection with those points in mind.

If the joint is a "cold" connection, caused either by insufficient heat, a wire moving, or foreign matter (such as oxides) getting into the connection, the cure is simple and direct: re-heat the joint and apply a little more solder. If that would place too much solder on the joint, you will have to remove the solder (as we'll describe shortly) before trying again.

**Avoid Component Damage.** Place heat sinks on the leads of particularly heat-sensitive components such as transistors, integrated circuits, small capacitors, diodes, and the like, to divert heat from them. Also keep in mind that components such as integrated circuits and field-effect transistors, can be destroyed by static or stray electricity. For that reason, many of these devices are furnished with the leads jumpered or shorted together by a ring of fine wire or special conductive foam. Leave the short on the leads as long as possible to prevent damage during handling.

**Know How to Desolder.** It's tricky to repair a mistake on a PC board without damaging the board and its components. The board is delicate: the base material can be charred or melted, and the metal foil can be pulled up from the base and broken if you're not careful. If you replace a component, use as little heat as possible. Excessive heat can damage it, adjacent components, and the board itself.



For correcting mistakes and for PC board repairs, you'll need a low-heat desoldering tool, bulb, station, or wick. A soft wire brush and illuminated magnifying glass might also be handy. Most of these inexpensive items are available in desoldering tool sets from Radio Shack and other electronics suppliers. It's worthwhile to have the proper desoldering tools, since a construction mistake and a messy, inept attempt at PC-board repair can ruin a whole project in a twinkling.

**Nasty Problems.** Most electronic kits returned to the factory for repair don't have anything wrong with them except bad solder connections. The biggest problems arise from poor soldering techniques, resulting either in cold, ineffective solder joints or massive blobs of solder running across contacts and terminals shorting them out. Many of these problems can be traced to not applying the right amount of heat to a joint, moving it too soon, using too much solder and not watching where it flows, applying the soldering iron tip to the solder rather than to the joint, and working with dirty soldering tools.

Problems due to cold solder joints are difficult to diagnose. They tend to blend into regular electronic malfunctions, making them difficult to spot. They can appear as open, intermittent, high-resistance, or even apparently normal connections. They can trick you into suspecting other components, such as resistors, transistors, capacitors, and IC's.

If you're having problems with an electronic project, closely examine all solder connections for dull, loose, or flaky joints and for "solder bridges" between adjacent components. A good magnifying glass and a sharp eye helps spot them. Usually, reapplying heat to all connections will solve most such problems.

**Special Solder Jobs.** Some metals are just not solderable (at least in their natural states); they don't have an affinity for conventional solder. Therefore, you need to first consider the metal or materials to be soldered—some of the problem ones being magnesium, chromium, tantalum, silicon, and aluminum.

That doesn't mean it's impossible to

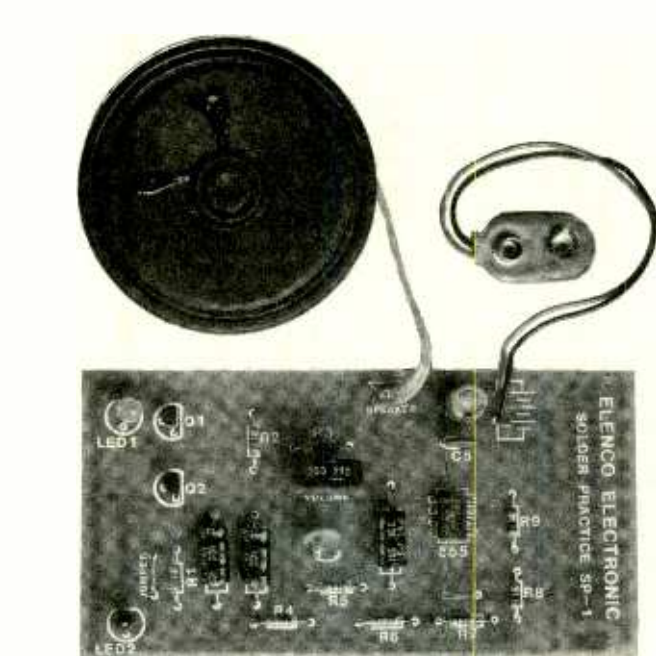

*The Elenco Electronics SP-1 Soldering Practice Kit is designed for the beginner, being a simple and inexpensive project that exposes you to proper soldering techniques. (Photo courtesy Elenco Electronics, Inc.)*

solder to them; it's just more difficult. Aluminum and other metals can be soldered, for example, if you use a special flux. To solder some of the difficult metals, they must be plated with a solderable metal.

Solder-It Co., markets a variety of specialty soldering pastes and tools to handle some of the difficult metals. The main product offered is The Solder Kit. The kit contains the necessary fluxes for silver, aluminum, copper, and pot metal (for zinc die cast and white metals), plus a pencil butane soldering torch. The \$59 kit includes four solder-paste syringes, a refillable butane pencil, and a vinyl storage pouch.

The special fluxes are packaged in special no-mess applicator syringes for one-hand-free soldering. Professional results, including neat, clean soldered joints and excellent electrical conductivity, and continuity, are results claimed by the manufacturer for its products.

Sometimes, especially in heavy outdoor projects, you need soldering tools heavier than the small, low-power guns and irons we have focused on here. Wahl, for instance, makes a butane-powered soldering iron and torch, the Model 7980, for heavy-duty use by hobbyists and

technicians, and so it's especially useful for big outdoor jobs. As an iron, it offers up to 100 minutes of continuous soldering per refill; adjustable tip temperatures range up to 1067°F. Used as a torch, the unit provides up to 60 seconds of continuous flame per refill; adjustable temperatures up to 2372°F can be obtained. The Wahl unit is \$47.

**Practice Makes Perfect** Do you need some electronic soldering practice before digging into a real project? The February 1994 issue of **Popular Electronics** favorably reviewed the Elenco Electronics SP-1 Soldering Practice Kit. Designed for the beginner, it's a simple and inexpensive (\$8.25) project that exposes him or her to various soldering techniques. While the project's warbling alarm and flashing LED's might not be something you really need, it may be perfect for the first-time electronics builder. The kit is like any other electronic kit, but the SP-1 manual places more emphasis on learning and practicing proper soldering techniques than it does on the circuit itself.

That's really all there is to good soldering. With a little practice and keeping these few guidelines in mind, you can do a professional soldering job each and every time. ■

**T**homas A. Edison is quoted as saying: "My personal desire would be to prohibit entirely the use of alternating currents. They are as unnecessary as they are dangerous." His futile attempts to have the establishment of alternating current (AC) power systems outlawed seemed to be centered around the issue of "safety." It is likely, however, that not all his motives were altruistic.

While Edison did have a great fear of high voltages, he also had a major business interest in the development and manufacture of direct-current (DC) generation-and-distribution systems. Not surprisingly, he attempted to use his popularity as the greatest scientific celebrity of the late 19th century to rally public support against the competition posed by George Westinghouse's high-voltage alternating-current system.

### **The History of Electrical Generation.**

Thales of Miletus rubbed a piece of amber with a cloth in the sixth century B.C. and found that the amber would then attract light pieces of matter. From that time until

*In the late nineteenth century, George Westinghouse and Thomas Edison took opposing sides in the spirited debate to determine whether AC*

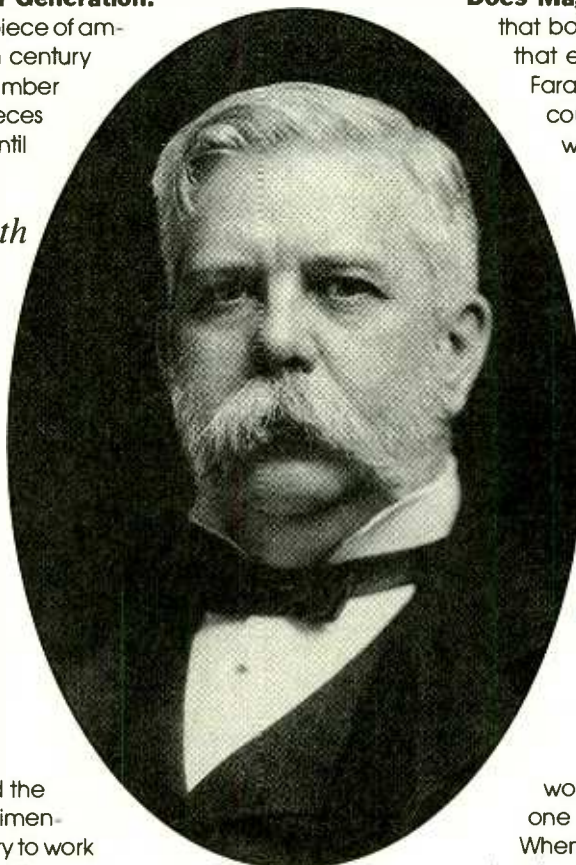

Alessandro Volta produced the first battery in 1800, experimenters only had static electricity to work with. Rotating static-electricity generators developed in the 17th century were used to charge Leyden jars (capacitors), but they could only provide current flow for very brief periods while they discharged.

Volta's batteries produced a unidirectional flow of electrons, but were expensive and could not produce substantial currents for extended time periods. That mattered little, however, as electricity was merely a poorly understood scientific curiosity in 1800.

A major scientific breakthrough was made in 1820 when Hans Christian Oersted noticed that a battery current flowing through a wire caused a nearby compass needle to deflect. His discovery established that electricity and magnetism are somehow related.

Andre Marie Ampere, upon learning of Oersted's observation, conducted experiments that resulted in his finding that

closely spaced, current-carrying parallel wires either attract or repel each other depending on whether the currents flow in the same or in opposite directions. He determined that the magnitude of the attractive or repulsive force is directly proportional to the product of the two currents and inversely proportional to the square of the distance separating the wires. Ampere also discovered that a current flowing through a spiral wire or solenoid produces the same type of magnetic field as does a bar magnet.

Francois Jean Dominique Arago soon discovered that an iron core greatly increases the strength of the magnetic field produced by current flow through a solenoid. He also found that some residual magnetization remains in the iron core after the current flow stops.

**Does Magnetism Produce Electricity?** Knowing that both Oersted and Ampere had established that electricity produces magnetism, Michael Faraday attempted in 1831 to see if magnetism could be used to produce electricity. He wound two separate coils on a block of

# LABOR

wood and then made a current flow through one coil.

When the current through the one coil was started or stopped, and only then, a galvanometer connected to the second coil indicated the momentary flow of current. Suspecting that the changing magnetic field was responsible, Faraday then showed that this "mutual induction" effect, as he called it, was much more pronounced when the two coils were wound on an iron ring (see Fig. 1). He had discovered the principle of "transformer action."

Faraday discovered another important electrical principle shortly thereafter. He found that a current can be made to flow by moving a conductor through a magnetic field. In Faraday's experiment, current flowed between the axis and rim of a copper disk that was rotating between the poles of a strong horseshoe magnet. These two observations would be crucial in the development of electrical generators, motors, transformers, and other energy-conversion systems.

Joseph Henry, working simultaneously and independently in the United States, also discovered the principle of mutual



induction. In addition, he discovered that the ratio of the number of turns on the two coils determined the magnitudes of the voltage and current in the second winding relative to the corresponding values in the first winding.

It was now known that electricity produces magnetism and that, conversely, magnetism produces electricity. Some ten years earlier, Faraday and Ampere each had independently found that a current-carrying conductor can be made to rotate in the fields produced by bar magnets.

**Necessary Principles Now Known.** In 1831, all the scientific principles needed for the development of large-scale electrical generators, transformers, and motors had been established. It would be many years, however, before the advantages of using such devices would be fully realized and the practical problems associated with building them would be solved.

Faraday's rotating disk was capable of producing only very small voltages. The greatest attention, therefore, was soon directed toward developing the other principle he had

The voltage generated and, hence, the current flowing through a connected load vary sinusoidally with each revolution of the coil. That is precisely the output produced by the alternators or AC generators used today. What was wanted in those days, however, was a voltage that was constant with time like that produced by a battery. No one at that time knew of a use for "alternating" voltages.

**Direct Current Produced.** A "split-ring commutator" was developed in 1832 by Hippolyte Pixii in France to provide unidirectional current from a generator. He connected the ends of the rotating coil to the opposite sides of a metal slip ring that had been split lengthwise to form two half-cylinders (see Fig. 3). The two segments of the split slip ring were insulated from each other and each was connected to the ends of the coil that rotated in the magnetic field. The stationary brushes were positioned so that as the voltage generated by the coil changed polarity, the section of the split-ring com-

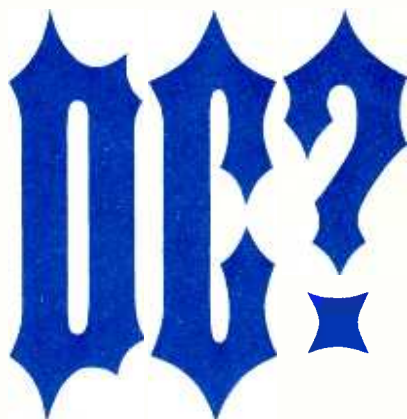

*power systems  
were safe  
enough to  
supplant  
those  
using DC.*

**BY JAMES P. RYBAK**

discovered for producing voltages: induction.

Changing the magnetic field around a conductor is accomplished rather easily by wrapping a coil of wire around a cylindrical "armature" and then rotating that armature in a magnetic field. The voltage generated is proportional to the strength of the magnetic field, the speed of the armature's rotation, and the length of the wire comprising the rotating coil. Increasing any one of these quantities will increase the voltage produced.

One important problem to be overcome was that of maintaining continuous electrical contact with the rotating coil of wire. The solution devised was to connect the ends of the coil to "slip rings" that rotate with the coil and that rub against stationary "brushes" to make the needed electrical contact (see Fig. 2).

The voltage produced by rotating a coil in a magnetic field is not constant. The angle that the magnetic field makes with the plane of the coil changes as the coil rotates. That results in a change in both the magnitude and polarity of the voltage produced.

mutator coming into contact with each brush also changed.

This commutator action caused the voltage delivered to the load to always have the same polarity although it was still not constant in magnitude. Nonetheless, a DC generator had been achieved. Later DC-generator designs had additional coils spaced symmetrically around the armature with each connected to its own pair of commutator segments. These produced more nearly constant DC voltages.

Other improvements in the operation of the DC generator soon were made by a number of experimenters. It was noticed that increasing the number of loops of wire on the rotating coil resulted in greater voltage output. A larger diameter wire allowed greater currents to be delivered to the load. Positioning a number of separate coils around the rotating cylindrical armature and segmenting the slip-ring commutator into a corresponding number of segment pairs provided a DC output that was more nearly constant in magnitude.

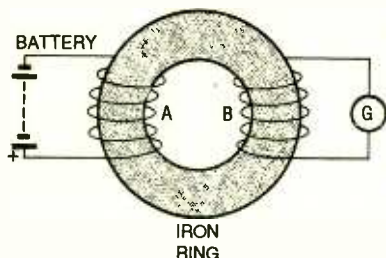

Fig. 1. Faraday discovered the "transformer effect" when he observed that causing a current to start or stop in coil A produced a momentary deflection of the galvanometer connected to coil B.

The horseshoe magnet that had provided the magnetic field through which the armature coils rotated was soon replaced by a battery. Much greater magnetic field strengths and, hence, greater generator output now could be obtained.

In 1866, it was discovered that the residual magnetism of the electromagnet's iron core produces a small output from a generator even if the battery is not connected. Connecting the electromagnet's own coil to the output terminals of the generator slightly strengthens the magnetic field produced by the electromagnet. That, in turn, increases the output of the generator. The increased generator output further strengthens the magnetic field and results in the generator output being further increased.

This "bootstrapping" action quickly results in the generator reaching full output. Generators operating on this principle became known as being "self-excited" and the windings on the electromagnet became known as the "field" windings.

**Generators Go Commercial.** The first major commercial use for machine-produced electricity came in the early 1870's when DC generators began to replace the costly batteries used in industrial-electroplating processes. In addition to never needing replacement, the generators provided a more constant voltage than did batteries. Other commercial uses for generators quickly followed.

Generator-powered electric-arc outdoor lighting was developed simultaneously in both the United States and Europe in the late 1870's. The first carbon-arc lights were inefficient and had a relatively short lifetime, but pro-

duced significantly greater amounts of light than gas lamps.

Arc-lamps required high currents at relatively low DC voltages. Typically, as many as 65 lamps were connected in series in circuits operating at up to 3500 volts. The light produced by these arc-lamps, however, was too intense to be used indoors.

**Edison's Contributions.** Thomas Alva Edison developed his first commercially successful incandescent lamp in 1879. He then designed several types of DC generators to power his lighting systems in factories, public buildings, and steamships.

In 1882, the newly formed Edison Electric Illuminating Company of New

voltage, the power mains had to handle very large currents.

The design of the underground distribution systems presented numerous problems. The high currents necessitated that both large conductor cross-section areas and short conductor lengths be used to keep the voltage drops from being excessive.

Soon, Edison improved the load capacity of his distribution systems somewhat by connecting the outputs of two 125 volt generators in series. He used a three-wire distribution system to deliver the correct 125 volt electric potential to each lamp. The generating stations, however, still had to be located relatively close to where the power was to be used.

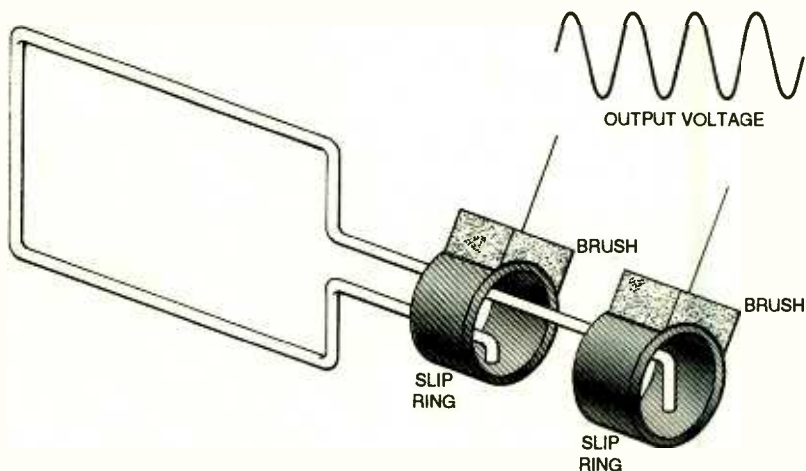

Fig. 2. The "slip-ring" and "brush" made possible the development of rotating electrical generators.

York began building a central power-distribution system to provide indoor incandescent lighting for the main business district of the city. Six "jumbo" generators, each capable of powering twelve-hundred 100-watt lamps, were built by the Edison Machine Works and used together with more than fourteen miles of underground power mains.

Edison had designed his incandescent lamps to operate at a voltage ranging from 110 to 125 volts DC. That was considered to be the maximum safe voltage for use inside commercial buildings and homes. The voltage produced by the power generating stations, was therefore 125 volts since parallel operation of the lamps was desired and no efficient way to reduce higher DC voltages was available. As a result of this low utilization

The DC power-generating and distribution systems designed and produced by Edison were quickly adopted by hundreds of cities, both large and small, throughout the United States. Because of the limitations of the distribution networks, these Edison systems were characterized by the use of numerous small central generating plants.

The success of the incandescent lamps manufactured by the Edison Lamp Company increased the demand for electrical power. Ironically, this increased demand helped hasten the demise of the municipal DC generation and distribution systems Edison had developed.

The short distribution systems necessitated by the low utilization voltage and high currents meant that the central power stations had to be built in



dense population areas where the cost of real estate was high. In addition, the actions of overseas copper cartels in the late 1880's dramatically increased the cost of that metal, which was required in great amounts for the distribution systems (see Fig. 4). Direct-current systems were at a distinct cost disadvantage compared with the alternating-current systems George Westinghouse was beginning to develop.

### Alternating-Current Generators.

The first true AC generators capable of producing significant amounts of power were built in the 1850's and 1860's. The builders recognized that AC generators (or alternators) had the advantage of inherently simpler design

that company built a 200-volt alternator capable of powering 5000 incandescent lamps.

The advantages of electrical transmission at high voltages became apparent to many in the late 1870's. It was estimated, for example, that copper conductors 3 inches in diameter would be needed to transmit the electrical equivalent of 1000 horsepower a distance of 30 miles. Increasing the potential to 80,000 volts, however, would permit 21,000 electrical horsepower to be transmitted 300 miles using only 1/2-inch diameter copper wires.

Low-voltage alternating current, on the other hand, provided no advantages in overcoming distribution problems, however. So what was ap-

a high-voltage pulse was produced across the terminals of the secondary winding.

A number of people recognized that the induction coil might be modified to produce a continuous high-voltage output when connected to an AC generator. It was Lucien Gaulard and John D. Gibbs, however, who were the first to produce a convincing demonstration.

These two engineers constructed a modest but highly successful display at the 1883 electrical exhibition at Westminster Aquarium in London. They clearly showed that the use of what they called "secondary generators" (today we would call them "transformers") would enable electrical-energy producers to supply AC energy to a distribution system at the most economical potential, while permitting the users to obtain that energy at the potential that best suited their needs.

In 1884, Gaulard and Gibbs installed an electrical transmission line with secondary generators to supply AC power to arc lamps and incandescent lighting at a number of passenger stations of the London Metropolitan Railway. That same year, they produced another impressive demonstration at the Turin (Italy) Exhibition. For that, they built a transmission line with secondary generators that powered electric lights from the line's origin at Turin to the terminus at Lanzo, some 25 miles away.

Gaulard and Gibbs' secondary generators were configured much like an induction coil. A bundle of straight soft-iron wires was used to form an "open" core around which the primary and secondary windings were wrapped. Pulling in or pushing out the core controlled the voltage produced at the secondary terminals. The fact that the primary windings were connected in series severely limited the degree to which the secondary voltages could be independently varied.

The demonstration caught the attention of three Hungarian engineers (Max Deri, Otto Blathy, and Karl Zipernowsky) who were in attendance at the Exhibition. The three visitors immediately concluded that a better secondary generator design was possible. In only a few weeks after returning home, the Hungarians produced their

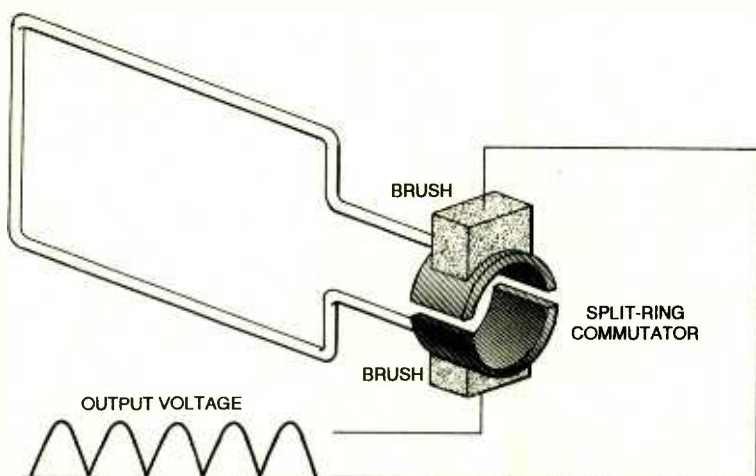

Fig. 3. The "split-ring commutator" made the generation of a pulsating, unidirectional flow of electricity from a coil rotating in a magnetic field possible.

due to their lack of a commutator.

Creating a demand for AC power met with little success initially. Interest in AC power increased, however, when it was found in the 1870's that arc-lamps functioned better when operated from AC rather than from DC voltages.

Ganz and Company was established in Budapest in 1880 and became one of the European pioneers in the development of alternating-current systems. Their first major contribution was a 60-volt, 2800-ampere alternator capable of operating 1600 of the incandescent lamps developed by Joseph Swan in England.

The Ferranti Company began building AC equipment in England at approximately the same time. In 1883,

parently needed were high-voltage AC generation and distribution systems coupled with the yet-to-be-invented transformer.

**The Transformer Evolves.** The transformer has as its ancestor the induction coil, which experimenters have used since the 1830's to generate high-voltage pulses. The induction coil of that time had a bundle of iron wires as a core over which a primary coil, consisting of a few turns of heavy-gauge insulated wire, was wound. A secondary coil, consisting of many turns of fine, insulated wire was wound over the primary coil. A battery connected to the primary winding caused a large current to flow. When this current was abruptly interrupted,

first 1400-watt "transformer," as they called it, with iron wires forming a "closed" core. Seventy-five of these transformers with their primary windings connected in parallel were used in conjunction with 1067 of Edison's incandescent lamps to light the 1885 Hungarian National Exhibition in Budapest.

### Westinghouse Likes What He Sees.

Despite the shortcomings of the Gaulard and Gibbs design, their demonstration at Turin earned for them the gold medal and cash prize awarded by the Exhibition's organizers. George Westinghouse was impressed with what he saw at the Exhibition and purchased the American patent rights to the Gaulard and Gibbs equipment. He had several of the secondary generators immediately shipped to Pittsburgh for study.

Westinghouse, already famous for the invention of the railway air brake, had recognized the opportunities offered by electrical power. A year earlier he had assembled a group of the best "electricians" available to develop commercially profitable electrical products. To this group he now added a man who had worked with Gaulard and Gibbs. With both the patents and the technical knowledge that the Gaulard and Gibbs enterprise had developed, Westinghouse began manufacturing transformers.

The Westinghouse transformers used stacks of thin, T-shaped plates of soft iron for the magnetic circuit rather than the bundles of iron wire Gaulard and Gibbs had used. Connecting the transformers' primary windings in parallel was recognized from the onset by the Westinghouse engineers as far superior to a series connection.

**AC Competes with DC.** The first experimental Westinghouse AC distribution system was installed at Great Barrington, Massachusetts during the winter of 1885-86. The system served only about 150 incandescent street and store lights, but was so successful, Westinghouse began to manufacture and sell AC equipment for powering incandescent lighting. By November of 1886, Westinghouse had installed his first commercial AC-distribution system in Buffalo, New York and had orders for twenty-seven additional systems.

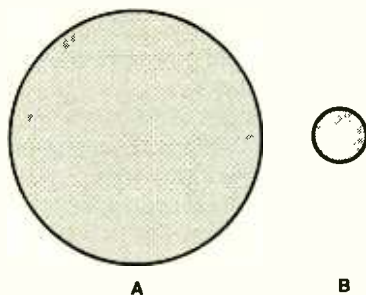

Fig. 4. The relative amounts of copper required by Edison's 220-volt three-wire DC distribution system and Westinghouse's 1000-volt AC distribution system are indicated here by circles A and B, respectively.

Initially, Westinghouse used AC generators built by Siemens and Halske in Germany. Later, the Westinghouse firm would manufacture its own alternators.

Thomas Edison quickly became aware of the Westinghouse successes. Of concern to Edison was the fact that the Westinghouse AC-generation and -distribution systems not only provided reliable service, but were more economical to install than were Edison's own DC systems.

Power in the Westinghouse AC systems was usually distributed at a potential of 1000 volts in contrast with the 240 volts used in the Edison DC systems. Transformers then stepped-down the potential to the 50 volts needed to power specially designed incandescent lamps.

The high voltage used in the AC distribution systems allowed the use of small conductors because of the proportionately lower current levels needed for a given amount of power. The large copper conductors needed for Edison's low-voltage distribution systems, together with the small area over which each of his generating plants could provide service before voltage drops became excessive, put the DC systems at a substantial cost disadvantage.

There was really no way that the cost of installing a DC system could be reduced. The voltage drops dictated by Ohm's Law and the cost of copper were outside of Edison's control. Clearly, other tactics would have to be used if Edison was to avoid the threat of financial ruin posed by Westinghouse's AC systems.

Edison knew that he needed to have public support if his DC systems

were to survive. If Edison could convince the public that AC systems posed unacceptable safety risks, it might be possible to get them outlawed.

**AC Called "Damnable."** Harold P. Brown, a virtually unknown electrical consultant and inventor, joined the battle against AC systems in May of 1888 when he wrote a letter to the *New York Evening Post* in which he claimed that, from a safety standpoint, alternating current should be described by "no adjective less forcible than damnable." Brown, who had no formal schooling in electricity, claimed that the danger due to electrocution lay not in the amount of voltage present, but in whether the current flow was "wavy or pulsating" (AC) as opposed to "continuous" (DC).

### Books and Articles

"The Comparative Value of the Alternating Transformer and Continuous Current Systems for Central Station Lighting," by F. B. Badt, *The Electrical Engineer*, July, 1888, pp. 305-308.

"Experiments with Electric Currents on Dogs," by Harold P. Brown, *The Electrical World*, August 11, 1888, pp. 72-73.

"The New Instrument of Execution," by Harold P. Brown, *The North American Review*, vol. 149, November, 1889, pp. 586-593.

*A Streak of Luck*, by Robert Coniot, Sea-view Books, New York, 1979.

"The Dangers of Electric Lighting," by Thomas A. Edison, *The North American Review*, vol. 149, November, 1889, pp. 625-634.

"Transformer Invented 75 Years Ago," by A. A. Halacsy and G. H. von Fuchs, *Electrical Engineering*, June, 1961, pp. 404-407.

*The Rise of the Electrical Industry During the Nineteenth Century*, by Malcolm MacLaren, Princeton Univ. Press, Princeton, NJ, 1943.

"The Damnable Alternating Current," by Terry S. Reynolds and Theodore Bernstein, *Proceedings of the IEEE*, vol. 64, September, 1976, pp. 1339-1343.

"Alternating Current Versus Direct Current," by Lewis B. Stillwell, *Electrical Engineering*, May, 1934, pp. 708-710.

"A Reply to Mr. Edison," by George Westinghouse, Jr., *The North American Review*, vol. 149, December, 1889, pp. 653-664.



Chicago had already severely restricted the use of AC for power distribution and Brown urged that the New York City Board of Electrical Control adopt similar regulations. Brown's recommendation that no AC-distribution networks be allowed with potentials exceeding 300 volts would have eliminated the economic advantages AC held over DC.

Brown then went to the West Orange, New Jersey laboratory of Thomas Edison to obtain the use of specialized equipment needed to conduct experiments he hoped would confirm his assertions concerning the dangers of AC. Edison had not known Brown previously, but agreed to the latter's request, obviously hoping that Brown would be successful.

Brown's plan was to show that AC was more dangerous than DC by subjecting live dogs to electric shocks of both types. The series of experiments he conducted in the summer of 1888 was both inhumane and somewhat macabre, at least by today's standards.

The gruesome details of Brown's experiments are best left undiscussed here, but his conclusions concerning the relative dangers of AC and DC are important. Brown claimed that dogs subjected to direct current shocks as great as 1420 volts "yelped but (were) unhurt," while those to which AC shocks of as little as 200 volts (and less) were applied died "without a struggle."

Frederick Peterson, a medical doctor who assisted Brown with the experiments and then performed autopsies on many of the dogs that died, proposed an explanation concerning the apparently greater lethal effect of AC. In essence, he felt that a DC voltage produces a damaging shock to the body only twice; once when the circuit is first closed and once again when the circuit is opened. No shock, he claimed, occurs with DC during the interval between those events.

Dr. Peterson maintained that AC produces a damaging shock to the body each time the current changes direction; *i.e.*, twice each cycle. The effects of ohmic heating produced in the body by both AC and DC current were apparently not taken into account, or else were considered unimportant, by Peterson.

**A New Mode of Execution.** The next stage in the verbal battle between the proponents and opponents of AC developed almost immediately as the State of New York undertook a search to find a means of executing criminals that would be more humane than hanging. Edison suggested that electricity, specifically alternating current, be used. Edison's recommendation was supported by Elihu Thomson who headed the Thomson-Houston Company, a major manufacturer of alternating-current equipment.

Edison opposed the principle of capital punishment, but felt that, if executions were to be conducted, electrocution would be the most painless method. George Westinghouse opposed the electrocution of criminals because he feared adverse public reaction to his alternating-current systems.

The New York State Legislature enacted legislation calling for the electrocution of criminals convicted of committing capital crimes on or after January 1, 1889. The type of electricity was not specified, but the Legislature requested that the New York Medico-Legal Society determine the best way to carry out the new law. The chairman of the commission established by the Society was Dr. Frederick Peterson who utilized (not surprisingly) the services of Harold Brown in his work.

The two men prepared a report for the Medico-Legal Society based on additional experiments in which animals, including two calves and a horse, were electrocuted. Most of the experiments took place at Edison's West Orange, New Jersey laboratory. The much publicized report recommended (not surprisingly) that alternating current be used to execute criminals.

Brown then was given the responsibility of purchasing the equipment for performing executions by electrocution at New York's Auburn, Sing Sing, and Clinton penitentiaries. As Brown was convinced of the greater lethal power of AC, he wanted to purchase three Westinghouse alternators. George Westinghouse, not wanting his alternators associated with death, refused to sell Brown the machines. Brown, however, finally did obtain the Westinghouse alternators on the used-equipment market.

Westinghouse knew full well that Peterson and Brown's work was threatening the public's acceptance of alternating current. He challenged the conclusions drawn by Brown and Peterson as well as their objectivity. Westinghouse also suggested that Brown was deliberately serving the business interests of Edison for pay. Westinghouse urged that an unbiased person independently investigate the relative dangers of AC and DC.

Brown responded by challenging Westinghouse to a contest best described as a game of electrical "chicken." The proposal was that Brown would submit himself to DC electrical shocks while Westinghouse would be given AC electrical shocks. The voltages would be increased in 50 volt increments between successive shocks. The contest would continue until one of the men cried "enough" and publicly admitted the error of his position concerning the relative dangers of AC and DC.

Wisely, Westinghouse declined Brown's challenge. The contest, at best, would have proven nothing scientifically and, at worst, could have resulted in serious injury or death to one or both of the men.

Probably relieved that Westinghouse had declined the challenge, Brown nonetheless tried to use the refusal to his advantage. Brown reminded the public that Westinghouse was "willing to endanger the public, but not himself," with alternating current. The fact that Westinghouse used direct current in his own home did not go unnoticed or unmentioned by Brown.

**Edison is Heard From.** Thomas A. Edison became more directly involved in the controversy in November of 1889 when he wrote an article entitled "The Dangers of Electric Lighting," which appeared in a widely read magazine of the day. In that article, Edison stated that DC at a potential not exceeding 200 volts is "harmless, and can be passed through the human body without producing uncomfortable sensations." He also claimed that alternating current of 1000 volts and greater (such as Westinghouse's distribution systems used) "through any living body means instantaneous death."

The "father" of the incandescent lamp and the person generally recognized by the public as the greatest expert concerning things electrical was adamant in his stand. He maintained that "There is no plea which will justify the use of high-tension and alternating currents, either in a scientific or a commercial sense."

Edison urged that DC be restricted to no more than 700 volts (well above the voltages used in his DC distribution systems) while stating: "As for alternating current, it is difficult for me to name a safe pressure." He went on to say: "My personal desire would be to prohibit entirely the use of alternating currents. They are as unnecessary as they are dangerous."

George Westinghouse lost no time in responding to Edison's claims. In an article entitled "A Response to Mr. Edison" published in the same magazine, Westinghouse convincingly refuted Edison's principal assertions concerning the dangers of AC.

Westinghouse challenged Edison's claim that DC "can be passed through the human body without producing uncomfortable sensations" quite dramatically. He invited the readers to place a thick piece of beef between a metal pan and a metal grid, both of which make contact with the beef and are connected to the two wires of one of Edison's residential DC electrical systems. Westinghouse assured the readers: "I have witnessed the roasting of a large piece of beef by a direct continuous current of less than one hundred volts within two minutes."

In reference to the lethal effects of AC on dogs, Westinghouse claimed knowledge of an experiment in which: "A continuous current of 304 volts was applied (to a dog) for thirty seconds, and then an alternating current of 100 volts for sixty-five seconds; yet the dog was unhurt." Westinghouse further attacked the validity of Brown's experiments on dogs by claiming that the "alternating current" used in these experiments wasn't true AC, but was actually DC made alternating using a "polechanger" that produced a dangerously high voltage transient by partially discharging the field magnets of the generator.

Unlike Edison's DC system, wherein the wiring in buildings was connected directly to the distribution system, the

step-down transformer used in the AC systems isolated the customer's wiring from the distribution system. This, claimed Westinghouse, made the use of AC far safer than using DC. Furthermore, the 50-volt potential used for lighting in his AC systems enabled the use of lamps that were "far more durable and give a better light, with much greater economy, than the 100- or 110-volt (DC) lamps" according to Westinghouse.

**A Law is Sought.** Edison and the other advocates of DC made their final major attack on AC by attempting to have high-voltage distribution systems outlawed legislatively. When a bill to outlaw any electrical potential exceeding 800 volts was proposed in Virginia, a committee of 15 state senators was appointed to hold public hearings.

Edison testified at the hearings, but his deafness made it frequently necessary for the questions to be repeated. As a result, his testimony was both disjointed and unconvincing.

The proponents of AC had several expert witnesses who were able to explain the advantages of alternating current eloquently and in terms that were both convincing and soothing to the senators. As a result, the proposed bill was defeated.

Legislation to prevent the use of alternating current was introduced in numerous other locations in the United States and Canada, but the results were the same. The advantages of AC were recognized and officially sanctioned.

**Edison's Control Slips.** Edison had a brilliant mind for inventing but he lacked the interest and ability to manage the finances of his, by now numerous and large, manufacturing companies. Edison had accepted payments in stock and bonds, rather than in cash, from many electric-utility companies who purchased his equipment. He also had allocated more cash to operate his research laboratory and to pay his personal salary than the manufacturing operations could comfortably afford. Business was thriving, but the cash needed to expand the companies was lacking.

By 1889, a wholesale corporate restructuring of the Edison companies

was needed. A syndicate of U.S. and foreign bankers supplied the funds needed to combine Edison's diverse corporations into the Edison General Electric Company. Edison was given over one million dollars in cash, but now held only a relatively small percentage of the stock in the new company. He received a salary and a research budget, but they, together with the control of the Company's destiny, now were determined by the new corporate directors, not by Edison himself.

Edison soon began putting all his time and energy into the development of a magnetic technique to concentrate low-grade iron ore. Setback after setback could not convince him that the project was doomed. When investors refused to put more money into what was clearly becoming a hopeless cause, Edison sold off large blocks of his stock to raise the necessary cash. His holdings in the Edison General Electric Company soon were reduced to nearly nothing.

Lacking both an AC system and up-to-date DC streetcar motors to market, the Edison General Electric Company was being outpaced by its competitors. When the Company's managers tried to steer Edison's efforts away from his mining folly and toward the development of a competitive AC power system, he stubbornly replied "The use of alternating current instead of direct current is unworthy of practical men." Edison, once the brilliant pioneer of electrical equipment, was now out of touch with the industry that people identified with his name.

By 1892, the Edison General Electric Company's directors and bankers knew that it was necessary to act decisively. Without Edison's knowledge, a merger with the Thomson-Houston Company was negotiated. Thomson-Houston was already a leader in the manufacture of AC equipment and wanted to increase its position in electric lighting.

The new company was to be called simply "General Electric." Edison was deeply shocked that his name no longer would be part of the Company's identity. General Electric soon became a world leader in developing equipment that produced and utilized the alternating current its forerunner, Edison, detested. ■



# GIZMO®

A CHRONICLE OF CONSUMER ELECTRONICS

## Living the Good Life

### A Look at the World of Whole-House Entertainment

There's a hot new trend in consumer electronics—but you won't find it at your local Circuit City or Nobody Beats The Wiz store. In fact, you might not even be aware that it exists outside the pages of glossy magazines depicting the homes—and the audio/video systems—of the mega-rich.

We're talking about custom installation (a.k.a., whole-house entertainment or custom design): the process of incorporating home electronic equipment into the architectural and interior design of a room, several rooms, a house, or an entire residence (including the house, outdoor living spaces, "out buildings" such as guest cottages or garages). The electronics need not be limited to audio and video; custom designs can incorporate telephone and security systems, as well as lighting, heating and cooling systems, and even appliances if you wish.

In this Gizmo special issue, we examine custom installations from several different perspectives. First, we answer some frequently asked questions: What type of systems are available? Who designs and installs those systems? How much does it all cost? And could custom design and installation represent a new career choice for you?

Next, we take you on tours of two distinctly different installation sites. One is a luxury home built from the ground up by a team of professionals to be a showcase for whole-house entertainment, security, and communications. The other is a retrofit of a modest existing home, an installation that we designed and installed completely on our own. Also included are hands-on reviews of the equipment that was used in our own installation.



#### WHAT IS CUSTOM INSTALLATION?

Many tasks fall under the general heading "custom installation." A custom installer might be called-in just to install some in-wall speakers. But a more typical custom-design/installation assignment might be to create a home theater in one room—designing a system that includes several audio and video sources, surround-sound decoding, and all the necessary speakers. Although it's possible to buy all that gear retail, a professional custom installer will help ensure not only that the system is properly connected and calibrated, but that the homeowner knows how to use it, and that it complements the decor of the room.

At the high end of the custom-installation spectrum are jobs that entail distributing the audio and video outputs from that main system to various zones located throughout the house and property, and even integrating communications and security equipment.

Let's take a look at how much use a typical family might get from just such a whole-house system over the course of a summer evening.

#### GEE WHIZ-ARDRY

It's 6:00 pm, and the Smith family just got home from work, school, and day care. Mom is watching a cooking show on The Learning Channel (source: cable TV) on the small TV in the kitchen as she prepares dinner, while Dad catches up with world events on "All Things Considered" (source: FM radio) in the study. Meanwhile, their teenage son listens to Smashing Pumpkins (source: CD player) while splashing around in the pool with some friends, and his little sister is kept occupied with a tape of *Barney* (source: VCR) in the family room.

After dinner, Dad listens to classical music (source: CD player) as he cleans the kitchen, while Mom clears up some paperwork in the study with her favorite radio station playing. Their son is closeted in his room doing homework while watching MTV (source: cable TV), and their daughter falls asleep to the soothing sounds of her favorite Rafi tape (source: tape deck).

Later, chores completed and baby tucked in, the rest of the family gathers in the family room to watch a laserdisc movie on their home-theater system.

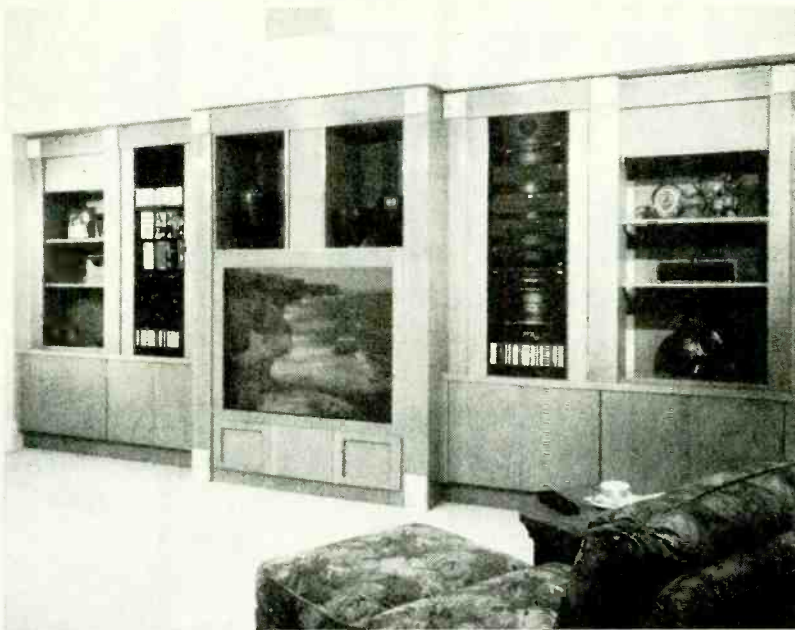

A custom installation usually includes a home-theater, like this one and the one shown on page 49, both designed by Behrens Audio Video of Jacksonville, Florida.

You might think that the above scenario closely resembles a typical evening in your own home, but keep in mind that in the Smith home all of the source components are neatly, centrally located in one spot—the family-room entertainment center. Each of the other zones—kitchen, bedrooms, and even the back yard—is equipped with only a pair of speakers, perhaps a television set, and a wall-mounted pad that controls the functions of the source components.

There are other differences between the Smith house and a typical home. For instance, if the phone rang at the Smiths', all audio/video sources would temporarily mute until the call was picked up; then only the zone in which the call was received would remain muted until the call was ended. If the doorbell rang, the chime could be heard in all zones. A surveillance camera mounted at the front door would allow the homeowner to view the visitor on a TV in any zone, while a built-in intercom would allow two-way conversation between the homeowner and the guest. Other surveillance cameras would allow parents to keep an eye on the kids in the pool or the baby in the nursery.

The Smith family's whole-house system can also turn on or off lights, heating, air conditioning, and appliances at specified

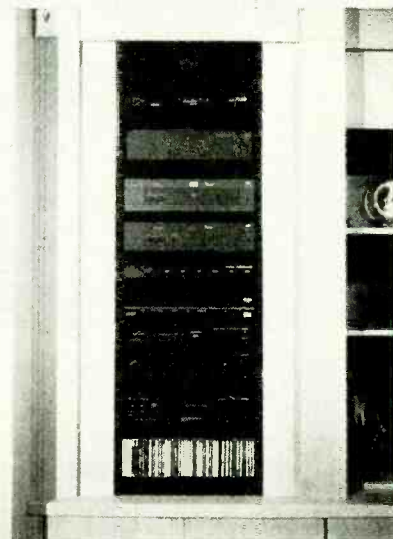

Custom cabinetry stores source components, as well as a CD collection, with a minimum of clutter.

times. It can even, at the push of *one* button, dim the family-room lighting, lower black-out shades at every window and skylight in the room, roll out a projection-TV screen, and turn on all the components needed to watch a movie on laser disc, complete with surround sound.

#### HOW DOES IT WORK?

At the heart of any whole-house custom installation is a component, or group of components, that provides multi-source, multi-room operation; in other words, it allows different entertainment sources to be enjoyed in different locations at the same time. The main audio and video

components are wired directly to that multi-room controller. The source and control units are typically located in the family or media room, although it is possible to keep the controller in a separate, less obtrusive spot. Also hard-wired to the multi-room controller, but mounted in other rooms (or "zones"), are keypad controllers and speakers that allow remote control of some functions of several audio and video components. Each keypad controller features an infrared eye that allows the functions to be accessed using a hand-held remote.

Although multi-room controllers are now being produced by a number of manufacturers, most are not available directly to consumers, but only through dealers and installers. One of those is Square D's Elan Home Electronics Network, a modular system that can include whole-house music and video distribution, paging, security cameras, and more. In fact, the Smith family's system described above closely resembles an actual installation built around the top-of-the-line Elan Series HD. That system is covered in detail elsewhere in Gizmo.

Regardless of size and complexity, all custom installations have two things in common: aesthetics and ergonomics. Each system is designed to merge seamlessly with the decor of the home, and with the lifestyle of the homeowner. No matter how sophisticated the system, control of each and every component must be simple enough for every member of the family to operate. Before a single piece of equipment is brought onto the site of a custom installation, the family's listening and viewing needs and preferences—present and future—are considered, as are their decorating tastes. The components should not overwhelm the house, and using them should not overwhelm the homeowners. All functions should be obvious, almost second nature to the users.

Achieving those results is an exercise in problem-solving that demands knowledge of several disciplines, including electronics, construction, carpentry, and home design. In other words, for most homeowners it's time to call in a pro.

#### WHO DOES CUSTOM INSTALLATIONS?

That professional is a specialized home contractor, called a custom installer or custom designer, who offers several related services. Using his (or her) familiarity with the technologies and products currently available, along with extensive input from the client, he designs the entire system. He determines what capabilities it will offer, what equipment will be used, where each piece will be placed, how it will all be connected, and how it can be expanded in the future. He (or his compa-



ny) then performs the actual installation, from pre-wiring the home to fine-tuning each piece of equipment. If the installation requires custom cabinetry, the custom installer either does the work himself, sub-contracts it, or supervises the craftsman hired by the client. The installation is not considered complete until all the finish work is done, and all the components are operating smoothly.

Even then, the job is not necessarily over. Customer service is a vital part of the job, and clients often require technical help until they get accustomed to using a new system. Also, as new components are added, the custom installer will often be called back to integrate them into the whole-house system (resulting in lucrative repeat business for the installer).

Because whole-house systems are usually, though not necessarily, installed during new construction or major renovations, the custom installer must work closely with architects, builders, and interior designers, during all stages of design, building, and finish work. A custom installer should be hired at the same time as those other professionals—in fact, many architects and builders now recommend that their clients hire a custom installer with whom they've worked in the past.

In the absence of such a recommendation, where can you find a custom installer? We tried looking in the Yellow Pages under "Audio-Video," "Custom Installers," "Electronics," and "Home Improvements," before we struck gold under the heading "Stereophonic & High Fidelity Equip.—Dlrs." Judging by the ads and the multi-line listings, most high-end audio dealers in our area provide custom installations of audio and video equipment, although none specifically mentioned that the dealer installed whole-house systems.

Instead of letting your fingers do the walking, try calling 800-CEDIA-30. That's the toll-free number for the Custom Electronic Design and Installation Association, or CEDIA, a nationwide trade association of companies that specialize in planning and installing electronic systems for the home. CEDIA provides consumers with referrals to custom-installation specialists nationwide. (See the box for more information about CEDIA.)

#### HIRING A CUSTOM INSTALLER

Once you've found a few potential custom-installation firms, the interviewing and hiring process is the same as for any other home contractor. Make sure the firm that is experienced and insured, and request references from other customers. If possible, visit the sites of previous installations, and speak to the homeowners about their experience with the installer. Ask if the installer provides service calls,

#### CEDIA

Established in 1989, CEDIA is a not-for-profit corporation that is controlled by its members—more than 300 custom-installation firms—who elect officers and board members annually. Although active membership is restricted to established, insured businesses with at least two years experience in custom installation, manufacturers and their sales organizations can join CEDIA as non-voting associate members. Approximately 200 manufacturers and vendors currently hold associate memberships. Publishers, software, and technology companies participate as affiliate members.

CEDIA members are at the forefront of the custom-installation industry. The organization itself provides support and assistance to its members and a guiding hand to the evolving industry.

As is the case with any new and growing field, there's a flip side to the excitement and profits generated as new products and technologies are introduced. Rapid changes make it difficult for consumers, manufacturers, and installers to keep pace and make informed decisions. Consumers need to know that the custom-installation field exists, and to define what they want to gain from it. Manufacturers need to know what consumers want. Installers need to know what manufacturers are producing, and how to sell it to consumers. Further complicating matters is the lack of established standards.

Part of CEDIA's varied agenda is to address and attempt to resolve those issues by setting standards, establishing relationships with similar industries, and through education. For instance, seeking to play an active role in setting national standards for the design and installation of low-voltage electrical products, CEDIA joined the National Fire Protection Association, which determines the National Electrical Code and influences the design and materials used in many household products, including consumer electronics. CEDIA's Systems Integration Council is charged with establishing cross-disci-

pline ties in several areas, with the goal of setting standards for the integration of various residential electronic systems. Besides establishing relationships with professional and trade associations in such industries as security, lighting, and HVAC, the Council is concentrating on establishing an educational curriculum of systems integration courses, and providing CEDIA members with technical information relevant to systems integration.

In addition, CEDIA's Home Entertainment Council (HEC) was established to define "standards of excellence" for residential audio/video-system design that it hopes will become industry benchmarks. The HEC's standards committee has the task of developing and promoting standards in several areas, including component-design parameters and ergonomics, component interfaces and integration, system-design procedures and practices, language and method of system documentation, methods of system preparation and installation, methods for system maintenance and troubleshooting, and business practices. Once those standards have been developed, the Home Entertainment Council will use them as the basis of educational-training seminars for CEDIA members.

Education is paramount to CEDIA, which increases public awareness through advertising and publicity, and coordinates technical meetings and educational programs for members. The organization also runs a national bulletin-board system for members. Furthermore, CEDIA is actively compiling a library of information to help educate installers, manufacturers, and consumers. Much of that information is garnered from annual polls of members, which are used to monitor industry trends and growth patterns, as well as to profile customers and their spending patterns.

For more information about CEDIA, write to 8335 Allison Pointe Trail, Indianapolis, IN 46250, or call 800-CEDIA30. ■

warranties, operating instructions, and customer service.

The prospective custom installer should have some questions of his own, and he should *listen* to your answers. Those questions should include: In what rooms do you want to provide audio? Video? How seriously do you listen to music? Where would you like the main components to be placed? Which rooms are prime listening areas, and which require only "background" music? Which of the components that you already own would you like incorporated in the whole-house system? How much can you comfortably spend on the system? Every family member who will be

using the system should be present during the interview.

As is the case with any home contractor, the custom installer works for the client. The installer should be able to make knowledgeable recommendations about the type of equipment to buy, where to place it, etc., but those recommendations should be based in part on the answers to the above questions—and all final decisions rest with the client.

There are other similarities between custom installers, general contractors, and interior designers. All charge their customers for materials, labor, and designing and/or supervising subcontracted work.

Materials costs are often offset to some degree by discounts offered to professionals by manufacturers. Also, like interior designers, custom installers are able to purchase goods that are not available to the retail consumer at any price.

### WHAT DOES IT COST?

Prices for custom installations vary widely—from less than \$100 to well over \$100,000—depending primarily upon the complexity of the job and the amount and quality of gear purchased. At the low end, a customer might call in a pro to sort out the tangled mess of an existing audio/video “system,” rewiring the components correctly and teaching the client how to use all the components to their fullest. Another small job might be to simply install a pair of in-wall speakers with volume control. Near the high end, you have homes like the one featured elsewhere in this section, in which the whole-house audio/video/telephone/security system cost a whopping \$150,000!

Most jobs fall somewhere inbetween. For instance, another Elan system provides telephone paging, whole-house audio and video distribution, and doorbell integration with prices starting at a reasonable \$2500 when installed in new construction.

According to a poll of CEDIA members conducted by Leibowitz/Roher Marketing, Inc., just over half the respondents said their average job was priced over \$10,000, with 16% saying their average installations were higher than \$20,000. Big-ticket jobs are more common in California, where one third of respondents reported average job prices of \$20,000 or more and 58% said that their largest installation in 1992 was more than \$100,000. Installations in the central region of the U.S. tend to be a bit smaller and generally less costly.

At Audio/Video Entertainment, a custom-installation firm based in Orange County, California, a “typical” job is done during the construction of a new home, and involves setting up a home theater and equipping two or three rooms with remote access to audio and video. The price usually falls between \$7000 and \$20,000. That broad range is due largely to differences in the quality of the equipment being used, and how much of it must be purchased new.

### CAN'T I DO IT MYSELF?

Custom installation of a whole-house entertainment system is not a job we'd advise the average person to tackle. If however, you are knowledgeable about consumer-electronics products and electronics in general, have experience in wiring and electrical work, are comfortable using power tools for home repairs, and have the free time to put all those skills to

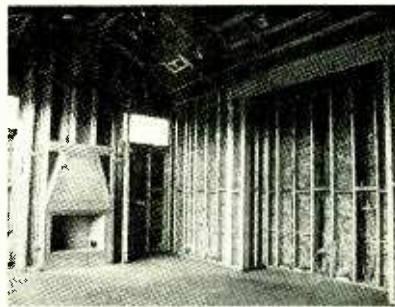

**Whole-house audio/video systems are most often installed during new construction or major remodeling.**

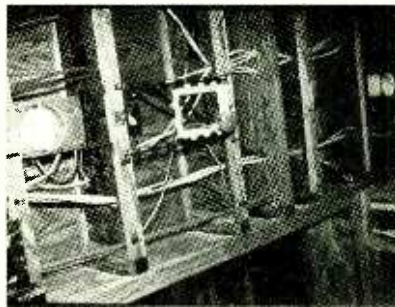

**When the walls are open, running wires is a relatively simple task.**

use, there are several ways to go about installing your own whole-house audio-video system.

The simplest way to achieve a small-scale multi-room system is to use a commercially available A/V receiver with multi-room control capabilities. Such units are available from several manufacturers, including Onkyo and Luxman.

We took a different route for our whole-house entertainment system. Using Audioaccess' MRX multi-room receiver and remote-access keypads, Multiplex Technologies' ChannelPlus video-distribution system, and Sonance in-wall speakers, we designed and installed a five-zone, whole-house system in a home that will never be featured on “Lifestyles of the Rich and Famous.” It's not a job for the novice do-it-yourselfer, and it isn't inexpensive. But for the electronics hobbyist, it's do-able. And for the avid audio-/videophile, the prices won't seem too far out of line.

### OPPORTUNITIES ABOUND

If you find the thought of designing and implementing your own system intriguing, perhaps you're ready to consider a career in custom design and installation. It's a fast-growing field, and the demand for professional, qualified, educated installers is keeping pace.

Sean Fields, owner of Audio/Video Entertainment and a member of the Board of Directors of CEDIA, has a couple of suggestions on how to get started. First, you might apprentice with an established company, perhaps moonlighting part-time at

first. “A lot of companies are growing and looking for part-time help that can become full time as growth continues,” he said. As for the electronics hobbyist, the person who goes home and tinkers because he has a passion for it, that is “. . . just the kind of employee I like.”

If you can't connect with an established custom-installation firm in your area, learn by doing, but be sure to practice on your own home—it's better to make mistakes there than on your first paying job! Once you have a successful installation under your belt, show it off as much as possible. Create a demand among your friends, and you may just have your next job.

Sean Fields also points out that, as installations are becoming “more interactive, more centralized, and . . . [we're using] new products and technologies that weren't around a year ago,” the competition to create those new products is heated. Equipment manufacturers are looking for creative, knowledgeable product designers. According to Fields, both manufacturers and installation firms have a “demand for people who really know electronics, and know the importance of quality.”

### GETTING STARTED: TWO CASE HISTORIES

An audiophile friend of ours—one who built his own stereo components as a hobby—put himself through college back in the early days (before home theater, let alone whole-house entertainment), by designing and installing audio and video systems. His best sales technique? Offer to throw the satisfied client a party at which he could show off the new system. Invariably, a couple of his friends or colleagues would want an even better system installed in his home! One-upmanship proved a very profitable selling tool.

In Chicago last summer for the Consumer Electronics Show, we struck up a conversation with the two guys sitting at the next table in our favorite Mexican restaurant. They were from the Minneapolis/St. Paul area, also in town for CES. We asked if they were manufacturers or buyers, and learned that they had recently—and unexpectedly—become custom installers of whole-house entertainment systems.

It seems that they were the guys who were called in to help out every time one of their friends bought a new computer or piece of software. They did such a good job on the computer stuff that they started getting calls to hook up TV's, VCR's, and audio equipment, and before they knew it, they were in business. They traveled to Chicago to learn what equipment was being offered, and what other installers were up to.

*(Continued on page 60)*



# Desert Dream House

## Take a Tour of the Elan Showcase Home

Before we even pulled into the circular flagstone driveway with its center fountain, before we stepped into the marble-floored entrance hall with its views of the sunken living room, built-in pool, and cabanas beyond, we had high expectations of the Elan Showcase Home. After all, we'd been clued in that the 5465-square-foot Mediterranean-style home (add another 1740 square feet for the two cabanas), located in the exclusive Sierra Vista Ranch Estates just 15 minutes from the Las Vegas Strip, was just down the street from Wayne Newton's compound and two doors down from Robert Goulet's home. We also knew that the home represented the collaborative effort of a team of pros—including the builder, interior designers, a custom audio/video installer, and a system manufacturer—aiming to “create the ultimate environment for a distributed audio/video/telephone system.”

We weren't disappointed. Even without the electronics, the house is impressive, with its spacious, open design; gourmet kitchen; master suite with separate sitting area and opulent bathroom; library with floor-to-ceiling cherry bookcases, family room with bar and three-way fireplace, and three other bedrooms, each with private bath. And let's not forget the yard, with its covered patio, 70-foot pool, and two cabana/guest houses!

### THE ELECTRONIC INFRASTRUCTURE

The electronics, however, are just as impressive, and go a long way toward making the house a luxurious place to live. *Square D's Elan Series HD* system provides multi-source distribution of audio, video, and telephone throughout 14 separate zones, some with subzones. Remote operation is achieved through in-wall keypads in each zone as well as by handheld remote controls.

At the heart of the system are two *Series HD Master Control Units*. Each modular unit houses plug-in cards that are chosen by the designer to coincide with the functions required of the system. Depending on how the cards are configured, each Master Control Unit allows the homeowner to watch or listen to up to 10 sources in as many as 20 zones. Each zone can control the volume, bass, treble, and basic control functions for any source listened to in that zone.

In addition to audio-input and -output



cards, the Showcase Home uses two *Low-Voltage Relay Cards*, each controlling up to six dry-contact relays. Those cards allow the homeowner to operate lights, motorized curtains and video screens, and other devices, using the system's handheld remote.

A *Telephone Interface Card* integrates the home's telephone and communications systems, adds features to standard touch-tone phones, and provides security. With that card installed, standard phones can be used for whole-house paging, room-to-room communication, off-hook signal, and call hold. The telephone interface card also allows the user to activate speakers placed outside the front and back doors, for indoor/outdoor communication, and to control a relay to operate a door or gate latch. A three-tone door bell chimes when the front doorbell is pressed; two tones for the back doorbell. Both front and back doorbells, as well as incoming phone calls, are heard over the Elan speakers,

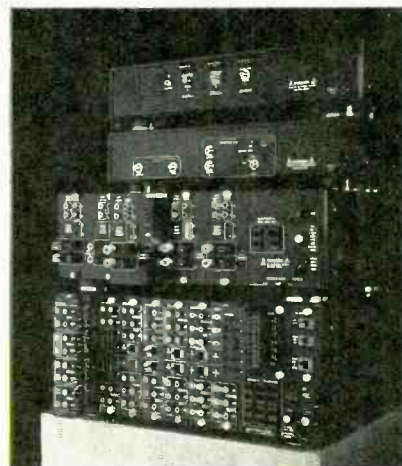

The modular configuration of the units allow the system designer to select plug-in cards for the master control and audio-distribution amplifier cards, allowing a high degree of flexibility and expandability.

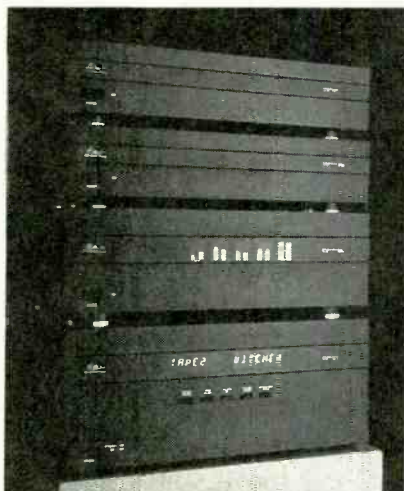

The control components used in the Elan Series HD installation include, from top to bottom, a camera modulator, a video-distribution amplifier, a multi-zone audio amplifier, and a master control unit.

momentarily interrupting the audio program so ensure that the rings are heard throughout the house.

Elan's modular *Multi-Zone Audio Amplifier* amplifies and distributes the controlled, unamplified output from the Master Control Unit. Its five card slots can accommodate any combination of the 50-watts-per-channel *Zone Amp Stereo Card*, the 100-watt *Zone Amp Monaural Card*, and the 100-watt *Zone Amp Monaural Subwoofer Card*.

The *Video Distribution Amplifier* sends high-quality video signals throughout the house via a two-coax wiring system. The unit amplifies and distributes cable-TV signals, and off air signals, to as many as eight rooms. Three *Video Distribution Amplifiers* are used in the Showcase Home, for security as well as television viewing.

The home's surveillance system also features five *CAM 1010* flush-mount cam-





When the video screen of the family-room home-theater system is retracted into the upper cabinet, a picture window with a view of the pool is uncovered.

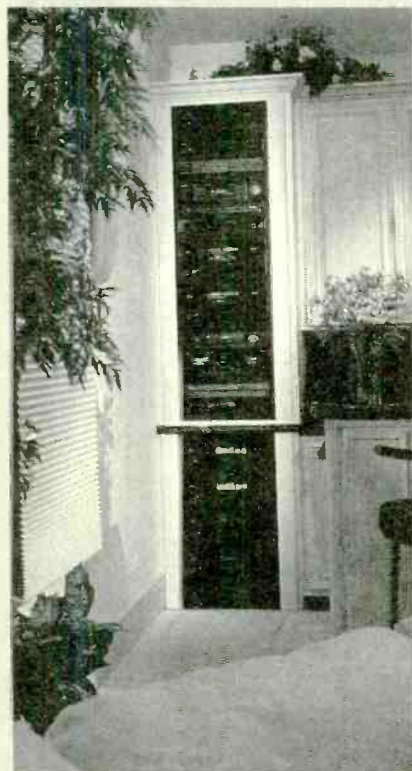

The control and source components that comprise "command central" for the whole-house system are mounted unobtrusively in a rack next to the family-room bar.

eras, two digital modulators, and two three-channel modulators, all from Elan. The system allows the homeowner to monitor rooms and outdoor areas from any TV in the home.

#### TAKING THE TOUR

Let's take a condensed tour of the Elan Showcase House, starting in the media room, where the control and source equipment is all discretely housed in a floor-to-ceiling rack built into a custom cabinet behind the bar. At center stage is a custom entertainment center built around a picture window, and nicely framing a view of the pool. Cabinets on the sides of the window each hold a 27-inch monitor and one of the

surround-sound system's front-channel speakers; the center-channel speaker was installed in a cabinet below the window. The cabinet that bridges the top of the window holds the 100-inch video screen. The subwoofer is tucked almost invisibly into the kick plate of the bar, and two pairs of Elan 1100 "serious listening" speakers top off the sound system.

When it's time to watch a movie, just press a button on the Elan handheld remote control. The lights dim, the motorized black-out blinds roll down, the video screen drops from the cabinet, an Auton lift lowers a Mitsubishi 1202 video projector from the ceiling, and the laserdisc player and VCR are powered up.

In the master suite, the main room is visually divided into a sitting area and a sunken sleeping area by the bed's headboard. The sitting room is intended for serious music listening on a system that is separate from the whole-house electronics. It includes Kinergetics' KCD 55T CD transport and matching KDP 100 D-A converter/preamp, and Unity Audio's Professional Application Reference Monitor (PARM) five-piece speaker system. Two Cary 100-watt, mono, tube amps drive the satellites and a Bryston 4B amplifier drives the subwoofer.

Next, we'll step down into the sleeping area, with its picture window overlooking the pool, 52-inch rear-projection TV, two in-wall and two "in-headboard" speakers, and gas fireplace. A handheld remote controls the draperies, lights, room temperature, and more.

The master bath, built completely in



The view from the master bed encompasses a remote-controlled gas fireplace, a rear-projection TV, and the backyard deck and pool.



## ELAN SHOWCASE HOUSE ZONE/ COMPONENT LISTING

### ZONE 1: DINING ROOM

- 2 Elan 1100 Speakers
- 1 Elan Keypad

### ZONE 2: STUDY/OFFICE

- 2 Elan 1100 Speakers
- 1 Elan Keypad

### ZONE 3: LIVING ROOM AND POWDER- ROOM SUBZONE

- 4 Elan 1100 Speakers
- 2 Elan Keypads

### ZONE 4: MASTER BEDROOM AND SITTING-ROOM SUBZONE

- 2 Elan 1100 Speakers
- 2 Elan 1000 Speakers
- 1 Elan Keypad
- 1 52-inch RCA TV
- 1 RCA laserdisc/five-CD player
- 1 ProScan VCR
- 1 Denon AVR-3000 receiver
- 1 Elan Audio Distribution system

### ZONE 5: MASTER-BATHROOM, STEAM- BATH, AND WALK-IN CLOSET SUBZONES

- 2 Elan 1000 Speakers
- 2 Elan Keypads
- 1 20-inch ProScan TV system
- 2 Infinity ERS 500 speakers
- 2 ELAN Classic speakers
- 2 Elan volume controls

### ZONE 6: KITCHEN

- 2 Elan 1000 Speakers
- 1 Elan Keypad
- 1 13-inch RCA TV

### ZONE 7: CABANA 1

- 2 Elan 1000 Speakers
- 1 Elan keypad
- 1 35-inch ProScan TV
- 1 Denon 5-CD carousel

### ZONE 8: CABANA 2

- 2 Elan 1000 Speakers
- 1 Elan keypad
- 1 52-inch ProScan projection TV
- 1 RCA Video Acoustics speaker system
- 1 RCA laserdisc/five-CD player
- 1 Denon dual auto-reverse cassette deck
- 1 Denon AVR 3000 receiver

### ZONE 9: PATIO AND POOL BATHROOM

- 4 Elan outdoor speakers
- 2 Elan keypads
- 1 35-inch RCA console TV (on casters)
- 2 Elan Classic outdoor speakers
- 1 Elan volume control

### ZONE 10: MEDIA ROOM

- 3 Wallspeaker Technologies Series II loudspeakers
- 1 DCS custom 18-inch JBL Theater subwoofer
- 4 Elan 1100 speakers
- 5 Elan 100-watt amplifiers
- 1 Soundcraftsmen PM860 600-watt mono amplifier
- 1 Lexicon CP-1 digital surround-sound processor
- 1 Audio Control Richter Scale III
- 1 RCA LDR-500 laserdisc/5-CD player
- 1 ProScan PSVRS81 VHS HiFi 4-head VCR
- 1 Denon DRW 840 dual auto-reverse cassette deck
- 1 Stewart Filmscreen 84-inch Videomatte 2000 electronic screen
- 1 Mitsubishi 1202 video projector
- 2 ProScan PS27151 27-inch Invar monitors
- 2 Denon TU-680 NAB AM/FM tuners
- 1 NSM 100-disc CD changer

### ZONE 11: MAID'S QUARTERS AND LAUNDRY-ROOM SUBZONE

- 2 ELAN 1000 speakers
- 2 Elan Classic outdoor speakers
- 2 Elan keypads
- 2 Elan volume controls
- 1 20-inch RCA TV with FM stereo
- 1 RCA VCR

### ZONE 12: GARAGE

- 2 Elan Classic speakers
- 1 Elan keypad

### ZONE 13: BEDROOM 2 (GUEST ROOM)

- 2 Elan Classic speakers
- 1 Elan keypad
- 1 13-inch RCA TV

### ZONE 14: BEDROOM 3 (NURSERY)

- 2 Elan 1000 speakers
- 1 Elan keypad
- 1 ELAN camera

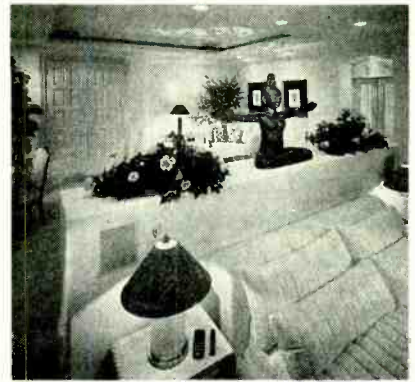

**In-wall speakers and a keypad controller are mounted in the headboard in the master bedroom.**

kitchen, guest room, maid's room, and the two cabanas all have TV's for viewing any of the available video sources. The baby's room is equipped to receive and control audio, and an Elan CCTV camera monitors the room.

Outside, the covered patio features four outdoor speakers. The north and south yards are monitored by two CCTV cameras. The front entrance is protected by a CCTV camera and a door speaker at the front gate, which can be opened and closed through the Elan system using a button on the telephone. Another camera and speaker are mounted at the front door.

### CREDIT WHERE CREDIT'S DUE

The Elan Showcase Home was designed by Stephen Ball AIA & Associates, Inc., a Brentwood California-based architectural firm that specializes in the design and development of high-end residential renovations and new custom homes. The actual construction was handled by Matthews Development Co., under the supervision of the husband-and-wife team of Bob and Adele Matthews. Two Las Vegas interior designers—Marteen Moore of Designs by Marteen and Jeff Hicks of Interior Design Consultants tackled the challenge of designing an interior around a custom-installed audio/video/telephone system.

That whole-house electronics system was designed by Don Calley, owner of Las Vegas-based Image and Sound. Mr. Calley is a founding member of CEDIA, and his client list includes Jerry Lewis and Robert Goulet. The actual system was designed around Square D's Elan Series HD Home Electronics Network, with additional components from Thomson Consumer Electronics, Infinity, Denon, Mitsubishi, NSM, Soundcraftsmen, Lexicon, Stewart, and Audio Control. (See the box for a listing of the components used in each zone.) The motorized black-out shades were provided by Bautex USA, the mounting racks by Middle Atlantic Products, and the central lighting-control system by Lutron NeTwork. ■

marble, features an enclosed area with a waterfall, a Jacuzzi tub, his' and her's showers, and a steam/mist system. Of course, it has its own set of speakers, a control keypad, and a 20-inch television. In fact, the steam room has its own speak-

ers and volume control, as does the master bedroom's walk-in closet!

The living room, formal dining room, and library each feature in-wall speakers and keypad controls to control any of the audio sources. In addition to audio, the

# Just Do-It-Yourself

## How we installed our own whole-house audio/video system

Our do-it-yourself whole-house entertainment installation won't make it to the glossy pages of *Audio/Video Interiors*. Unlike most magazine-featured installations, ours did not require a second mortgage. However, it did increase our viewing and listening options and reduce component clutter.

The five-zone installation is based on two main components. The audio portion is controlled by the *Audioaccess MRX Multi-Room Controller*, which provides up to six zones with independent control over source and listening volume. The video-distribution chores are handled by *Multiplex Technology's ChannelPlus Multi-Room Video Distribution System 9020*, which can deliver video signals from three different sources to as many as eight locations. The house has no formal media room, so we placed the controllers and the

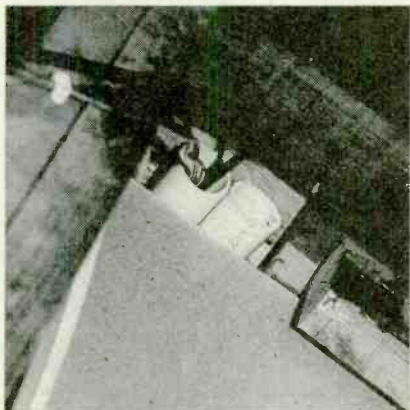

PVC pipes, installed inside the walls during a previous kitchen remodeling, run from the basement to a crawlspace under the eaves, providing a handy conduit for wires and cables.

source components in the living room. The four audio keypad controllers were mounted in the kitchen/dining area, the main office, the bedroom, and outside on the deck.

Two of the most important attributes of a good whole-house installation are flexibility and expandability. Although five zones were sufficient for our installation site, a modest, five-room Cape Cod-style home, the system can grow as the need arises. Should we decide at some future date to add a family room, dormer-out for more upstairs space, or convert the garage

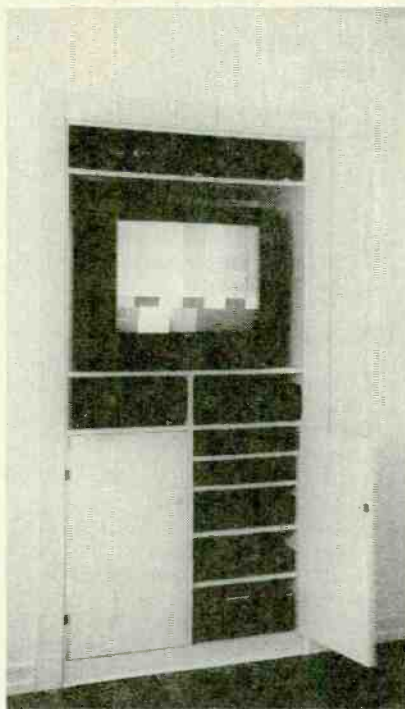

Recessed into an adjacent room, the entertainment center houses the source components as well as the MRX and ChannelPlus audio and video distribution controllers, without taking up any floor space in the small living room.

to office space, the entertainment system can keep pace. It can also easily handle the equipment upgrades that are sure to occur.

Although we installed a pair of *Sonance S3500* in-wall speakers in the dining area in all other zones, we used our existing speakers. For source components as well, we made do with what was on hand—our

budget didn't allow any upgrades at the time. When we do purchase new gear, however, it can be easily incorporated into our whole-house setup.

The MRX and ChannelPlus controllers are described in full detail elsewhere in this issue of *Gizmo*. You might want to read about them now, or wait until you've finished following our step-by-step installation. The Sonance speakers will be discussed next month.

### LAYING THE GROUNDWORK

We actually began this project more than a year before we unpacked the audio and video controllers. Our first design hurdle was immediately apparent: How could we install a system without ripping out walls in every room? When a system is being retrofitted into an existing house, the job is twice as difficult. It's much easier to snake wires between wall studs *before* the sheetrock, let alone the paint or wallpaper, goes up.

We managed to circumvent that problem to some extent with advance planning. Last year, during a kitchen renovation, we took advantage of the temporarily open walls and had the contractor run two 2-inch PVC-pipe conduits from the unfinished basement to a crawl space under the eaves. Even though at that time our whole-house entertainment system was only a half-baked idea in the back of our minds, we knew that we were sure to need a way to install wiring throughout the house.

Even if an audio/video distribution system isn't in your family's foreseeable future, plan for it if you're having any remodeling work done around your home.

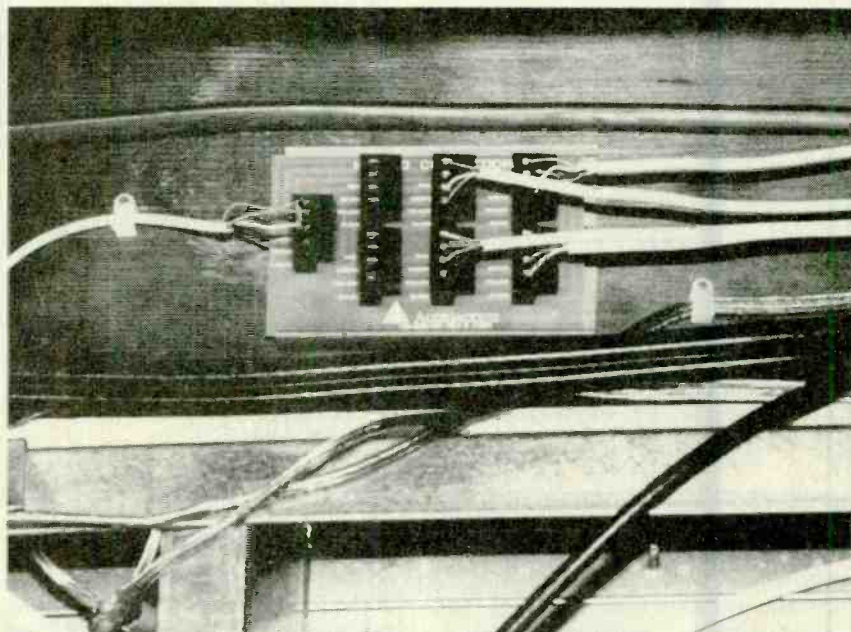

The termination boards supplied with the MRX control unit can be mounted out of sight—in our case, tucked away in the basement—eliminating unsightly tangles of wires in the entertainment center.



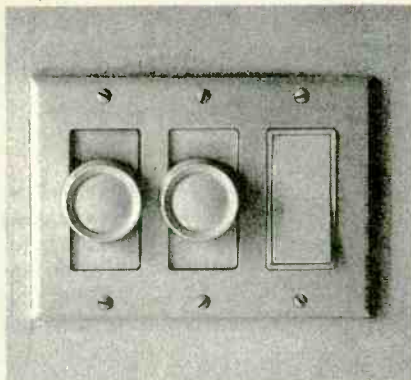

The separate ceiling-fan dimmer and speed controls (center and right) were replaced with one combined light-and-fan control unit to make room for the MRX keypad controller.

Asking your contractor to run some PVC piping through walls that are already open will add almost nothing to the price of the job at hand.

### PLACEMENT PLANNING

With our pre-planning, we started out somewhat ahead of the game, as far as retrofit installations go. We already had a way to string wires throughout the house without breaking into the walls. We also had an entertainment center in the living room that could comfortably and attractively house all the source components and controllers. Next, we had to decide how many zones we needed, and precisely how to wire them.

The living room, of course, was the main zone (MRX Zone 6). The kitchen/dining area was designated Zone 1, and, figuring that we'd probably want to play the same music in the kitchen and out on the deck during summer barbecues, we decided to make the backyard Zone 2. We designated the home office as Zone 3, and the bedroom Zone 4. Then we determined the best locations for the keypad controllers, and where needed, new speakers.

Because the installations were virtually the same for each zone, we'll go into detail on only one room. We chose the kitchen

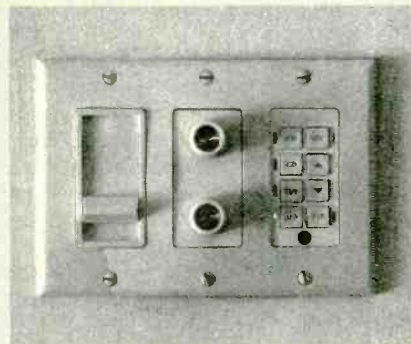

In the completed keypad installation, the controls for the kitchen lights and ceiling fan share the space with the MRX keypad controller.

because that zone includes both audio and video distribution, and required the installation of the Sonance in-wall speakers.

### WHOLE-HOUSE AUDIO

We began our installation with the MRX multi-room audio controller, which was given a prominent position in the living-room entertainment center. Because airflow is somewhat restricted where it is installed, we added a fan behind the controller to ensure that it would not overheat. The MRX runs hot for two reasons. First, it is never really off. Even when all zones are turned off, the controller remains awake, monitoring the keypads. Second, the MRX is really six stereo amplifiers packed in one comparatively compact package. Although it is equipped with a thermostatically controlled fan that is set to turn on when the amplifier heatsink rises to about 150°F, additional cooling is required when the MRX is mounted in an enclosed space.

The wiring for the MRX can be kept

put board. The remaining termination board is for the keypad controllers. Because there was no need to clutter up the entertainment-center wiring any further, we attached that to a floor joist in the basement. It connects to the MRX via standard 4-conductor telephone wire, and feeds to each keypad the same way. Although all our keypads were run right to the termination board, they can be daisy-chained as well.

The termination boards are easy to install: First, a plastic channel is fastened to the mounting location. Then the boards are simply snapped into position. The boards have a practical advantage besides just keeping the wiring neater. They allow a whole-house audio system to be essentially fully wired without requiring the MRX controller to be on site. That keeps the MRX safe from construction dirt and damage. When construction is complete, the unit can be put in place and attached to the wiring in a matter of minutes.

The keypad controllers are designed to

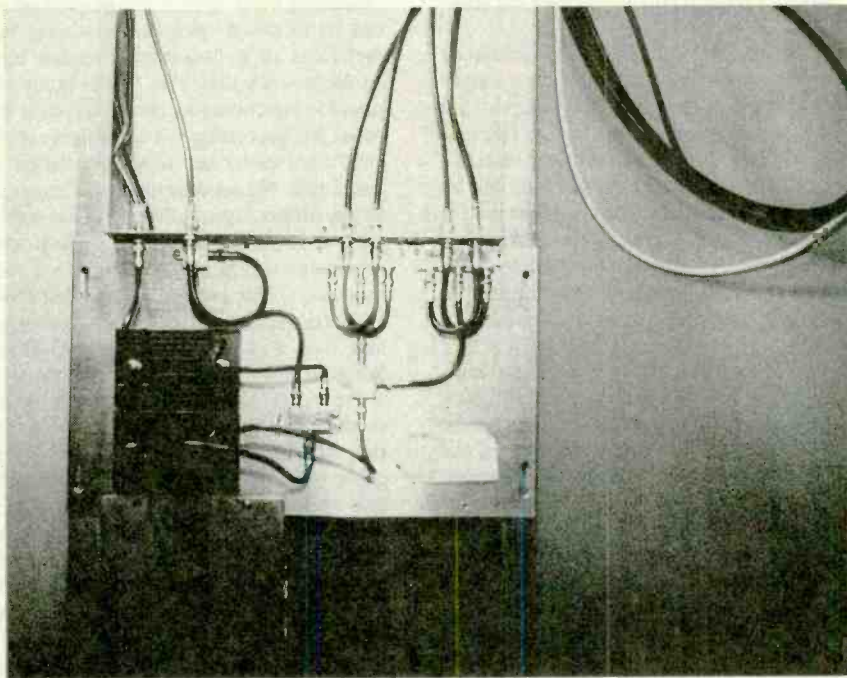

The ChannelPlus coax cable panel distributes high-quality signals to all TV's in the house.

neat thanks to separate wire-termination boards. They connect to the MRX via ribbon cables or wiring harnesses, and can be mounted to make the wiring most convenient. For example the speaker-wire termination board was mounted on the floor of the entertainment center. A wiring harness neatly connects it to the MRX. The wires to all five sets of speakers go through the floor into the basement, and then through-out the house.

Two other termination boards were centrally mounted in the entertainment center: the audio-input board and the preamp-out-

be mounted in standard electrical junction boxes. In new construction, a new junction box can be installed in a matter of minutes. For retrofit installations, things are more difficult. First, of course, you have to cut open the wall to install a box. Then you have to worry about possible obstructions inside the wall that would make it impossible to snake wiring through. In retrofit installations, it is more likely that you will be forced to compromise on the location of the keypad.

For our Zone 1 installation, we took advantage of an existing three-gang junc-

tion box. The box originally held two dimmer knobs (for the recessed kitchen lights and the ceiling-fan light) and a fan switch. We replaced the two separate fan controls with a combined fan-speed/dimmer switch. That left an open box for the keypad control. The junction box was deep enough that everything fit without too much effort.

That technique won't always work, of course. The alternative would have been to open the wall to get access to the box, install a new or larger box, and rewire. In either case, you will have to snake wires through the walls. A standard electrician's fish tape is essential.

## SPEAKERS

With the keypad installed, we were half way to having audio in our kitchen/dining area. The second half of the job was installing a pair of Sonance S3500 in-wall speakers. Although this was our first in-wall speaker installation, the mounting kits provided by Sonance smoothed the way. The hardest part was getting the wires to the speakers.

The location of a pair of speakers has an important affect on the way they sound. However, not everyone is willing to put speakers where they sound best. Because of aesthetic considerations, we installed the Sonance speakers in anything but an ideal location. Instead of being installed at ear level, the speakers are mounted up near the ceiling. A pivoting tweeter in the S3500 permits the sound to be directed to the listening area and compensates for poor placement.

We chose to mount the speakers horizontally rather than vertically. It's slightly more difficult because the cutout has to be almost perfectly centered between the studs. With careful measuring, however, it's a small obstacle.

Two potential problems threatened to make wiring difficult. First, the wall is insulated, which makes snaking wires difficult (at least for us). Second, the wall has a diagonal "hurricane brace" running through it. We got around both problems by running wires up to the attic and then down through the wall, using the pre-installed PVC conduit.

A template supplied with the speakers makes it easy to mark the speaker location so that the proper holes can be cut. We first opened up pilot holes in the sheetrock to ensure that there were no obstacles in our chosen location. Following a tip in the Sonance installation instruction sheet, we held the sheetrock saw at an angle when cutting out the pilot holes. The intent was to make the hole smaller on the inside than on the outside. Then, if the location proves to be no good, the plug can be re-inserted and patched easily. Luckily, we found no obstacles on our first try.

The Sonance S3500 speakers are equipped with *Flex-bar* brackets that make installation simple. The speaker is simply angled into the hole, and the screws are tightened down. That sandwiches the sheetrock between the Flex-bar brackets and the speaker baffle.

With the keypad and speakers installed, our kitchen and dining area officially became Zone 1. We could now listen to CD's, the radio, tapes, or television audio, in hi-fi stereo, as we cooked, ate, and relaxed in the room that's considered the hub of the house. We particularly enjoyed the addition of stereo sound to our small kitchen TV—and the ability to mute that sound during commercials.

## VIDEO THROUGHOUT THE HOUSE

We mounted the *ChannelPlus Model 3100 Coaxial Cable Panel* in the basement. The *ChannelPlus Modulator* was tucked away behind the closed doors of the entertainment center.

The coaxial-cable panel mounts easily to framing studs spaced 16 inches apart. It can be mounted virtually anywhere, but preferably in an accessible location near an AC power outlet. (We had to bring AC power to our chosen location.) Because the panel has preconfigured amplifiers, splitters, combiners, and taps, installation is simplified: No measurements are required to get proper signal strength at the cable outlets. For inexperienced installers, that eliminates mistakes. For pros, it's a real time-saver. Our previously installed PVC conduits made the wiring a much simpler task than it otherwise would have been. We used RG-6 cable for all cable runs.

Next, we installed the *ChannelPlus* modulator. One length of RG-6 cable carries the modulator output to the coaxial cable panel. There, the modulator output—which contains the outputs of our satellite receiver, VCR, and front-door camera on channels 23, 25, and 27, respectively—is combined with the signals from our TV antenna, and then distributed to the other outputs.

The most difficult part of the modulator installation was getting the outputs tuned to the right frequency. Not all TV's allow their automatic fine tuning to be turned off, and each TV behaves a little differently. At first, we were unable to get perfect audio and video at all TV's. On some TV's, the picture would tear, on others the sound would be filled with an annoying buzz. On others, everything was perfect. We were finally able to get things working properly by measuring the modulator output with a frequency counter, and tuning for the correct center frequency for our desired channel. Now, watching our desired source is simple for everyone in the family. There's no need to throw A/B switches or do anything special. ■

# Audio Everywhere

**MRX MULTI-ROOM CONTROLLER.** From Audioaccess, 26046 Eden Landing Road, Suite 5, Hayward, CA 94545; Tel. 415-293-0183; Fax: 415-293-0189; Approximate retail prices: \$4000; Keypads: \$250 each; Handheld Remotes: \$90 each.

Aiming to provide an "easy-to-install, compact, cost-effective" means to bring "whole-house entertainment control to a wider audience than ever before," *Audioaccess* designed the *MRX Multi-Room Controller*. The AM/FM stereo hi-fi receiver is equipped with six 40-watt-per-channel stereo amplifiers to provide up to six remote zones with independent control of audio-source selection and volume level. Each of those zones—except the one where the MRX itself is installed—must be equipped with an *Audioaccess* keypad control. Of course, speakers are another requirement.

The MRX controller can be used with virtually any brand of CD player/changer, tape player, VCR, and other source equipment. (Bang and Olufsen and Studer Revox components are not compatible with the MRX.) The sources are controlled with infrared signals, which are "memorized" by the MRX. The components can also be controlled from the MRX's front panel.

That front panel provides simple and straightforward direct control of the main zone and remote control of all other zones. A row of ten large, square buttons dominates the center of the front panel. They include four tuner controls (TUNE UP, TUNE DOWN, AM/FM, and MODE.) Four tuning modes are available: manual and auto mono and stereo. In either of the manual modes, each push of the tuning buttons increases or decreases the frequency one step. In the auto modes, each push puts the receiver into its search mode, where it scans for the next station with adequate signal strength.

The next five square buttons are used for source selection—TUNER, CD, TAPE, AUX, and VIDEO. Used alone, and pressed once, they select the source for the main zone; pressed once in combination with the ROOM button, they select sources for remote zones. Each of the source-selection buttons can also command up to three functions of its source component—the same three functions that can be activated via the remote keypads.

The final square button in the row is MUTE. Used alone, it mutes the current audio source in the main zone. It can also mute the remote zones.





The row of square buttons is flanked by the volume knob on the right side and the LCD readout on the left. The display provides tuner information, including frequency, signal strength, stereo/mono, and preset number. (Up to six stations can be assigned preset numbers.) The LCD indicates the zone name when the ROOM button is used. During programming, the display also shows different programming menus, including the zone-programming menu for zone names, volume settings, bass settings, treble settings, all-on settings, and lockout settings. Below the display are the infrared input window, tuner preset buttons 1 through 6, and the store button, which is used to store tuner presets, zone settings, and IR commands.

Rounding out the front-panel controls are buttons used for remote control of other zones. The ROOM button selects a zone and permits its status to be changed. When the ROOM button is pressed, the zone name appears in the display. An LED lights in the source button that corresponds to the source that is on in that zone, and the display shows the source name and volume level. While the zone name appears on the display, that zone can be turned on or off, a different source can be selected, and its volume adjusted.

The MRX main unit is a somewhat oversized component that measures about 5½ × 17 × 15-inches and weighs about 35 pounds. However, as long as a cooling fan is added, it can fit neatly in most entertainment centers or racks. Put the emphasis on "neatly." Almost everything is wired to printed-circuit boards included in the MRX Terminator Kit. Each termination board connects to the main unit via a four-foot cable, so they can be mounted to make wiring convenient.

The kit includes separate termination boards for audio inputs, preamp outputs,

and speaker outputs. The speaker-output board is equipped with a cable harness for connection to the MRX, and the preamp-output board connects with a supplied 26-pin ribbon cable. The source equipment is connected to the audio-input board, which connects to the controller via a supplied 20-pin ribbon cable. The board includes jacks for CD, tape, video, and auxiliary inputs. In addition, TAPE OUT will send the selected source to a tape recorder or other device, and LOOP THRU allows a second board to be connected so that sources can be shared with other equipment or to connect additional MRX's.

The use of termination boards is ideal when the MRX is being installed in new construction, or during a major renova-

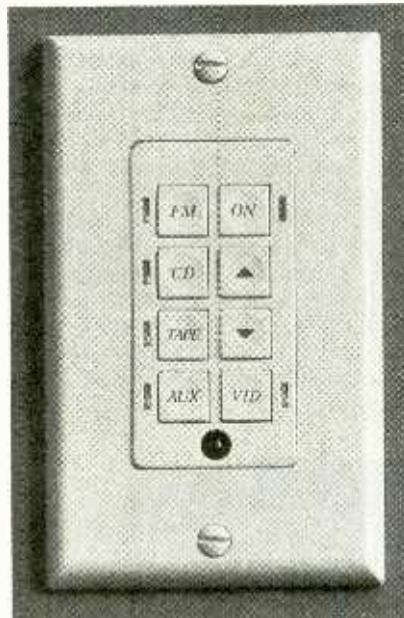

The MRX keypad controller fits into a standard "Decora"-style wall box, and provides finger-tip control of up to six audio sources.

tion. The termination board can be hidden behind an access panel in a wall, and all necessary wiring run through the walls before sheetrock is installed. In-wall speakers and the keypad controllers would also be installed at that stage. Neither the MRX unit nor any of the source equipment need be on site until construction is complete. Once the pre-wiring is in place, all that's required for the final setup is to connect the source components and any free-standing speakers. Although the MRX Terminator Kit is included with the controller, it can be ordered separately for pre-wiring purposes. A separate termination board is also available for keypad connection; alternately, the keypads can be wired directly to the MRX controller.

In the remote zones, the keypad is the user interface for the MRX. The keypad, which fits in a standard junction box, has eight pushbuttons and six LED status indicators. Each keypad contains DIP switches so that it can be assigned to a given zone. Multiple keypads can be used in a zone for convenience. In that case, they can both be set to the same zone and are simply wired in parallel.

The keypad also has an infrared "eye" so it can be operated with an infrared remote control. The keypad can send the infrared signals back to the MRX, but it doesn't act like an infrared repeater. The MRX can control your CD player remotely, but not with your CD-player's remote control.

When the keypad ON button is pressed, that zone comes on. It defaults to the tuner mode, and to the programmed turn-on volume. The volume up and down keys will change the volume, if desired. Pressing the FM button changes the tuner to the next station in the preset memory. Only six memory presets are available—our only substantial complaint with the MRX. If the FM button is pressed and held until its status LED blinks, the tuner will enter its search mode.

The other source-selection buttons (CD, TAPE, AUX, and VID) operate the same way. The first press selects the source and turns the source on. A subsequent press sends a command to the source. Pressing and holding the button sends a different command to the source. The CD button, for example, could be programmed to send next-track and next-disc commands. The TAPE button might send an auto music search command and a reverse-direction command.

The MRX controller has an infrared learning remote controller built in. When the MRX receives an input from a keypad or its front panel, it transmits any necessary infrared signals to output jacks on the rear panel. Infrared emitters connected to those jacks transmit the signals to the equipment to be controlled. ■

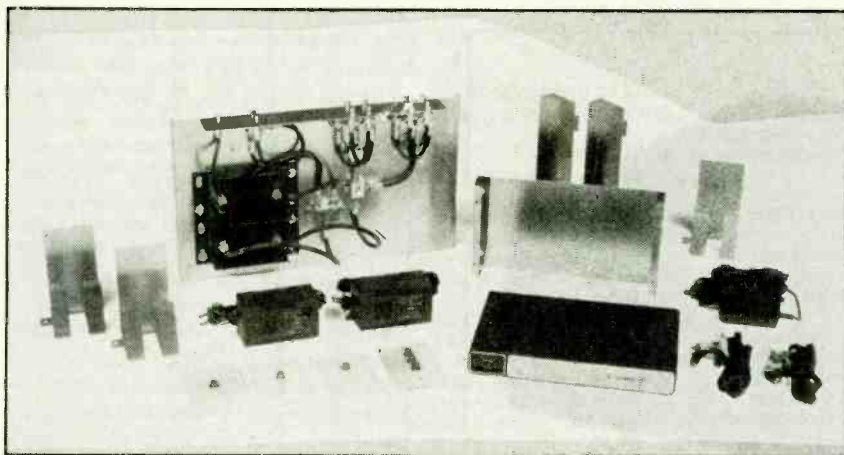

## Video on Demand

**CHANNEL PLUS 9020 MULTI-ROOM VIDEO DISTRIBUTION SYSTEM.** From Multiplex Technology, Inc., 3200 East Birch Street, Brea, CA 92621. Tel. 714-996-4100. Price: \$1405.00.

The days when a family would gather in one room around the television set are gone forever. Today's typical family watches more TV than ever, but they watch it scattered throughout the house, each watching something different. Now there's a way to ensure that all TV's receive a quality signal: the *ChannelPlus 9020 Video Distribution System*.

The 9020 contains everything that's required to distribute TV signals throughout a house. Plus, it has the capability of accepting video signals from up to three different sources, and distributing them on unused TV channels. For example, signals from your satellite receiver might be distributed on channel 24 on all TV's throughout the house, and your laserdisc-player's output might be on channel 27.

The 9020 includes a 3-channel modulator, connectors, terminators, attenuators, wall plates, and a coaxial-cable panel that contains amplifiers, splitters, and taps on a base plate. About the only thing to add is coaxial cable and junction boxes for the cable outlets.

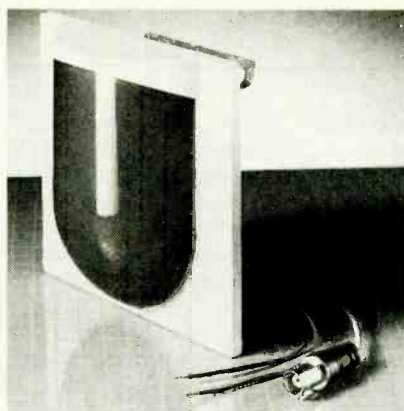

The ChannelPlus in-wall camera provides superior image resolution in low-light conditions.

The coaxial-cable panel is the heart of the distribution system. It accepts input from a TV antenna or cable, and up to two modulators. Its mounting holes are designed for easy mounting to the framing studs of a wall. It should be mounted in a central, accessible location because cables from each set in the house are "home run" back to the panel. That provides for the best signal at each set, and guarantees that adequate signal is available.

Four of the eight outputs are designed to supply cable runs between 30 and 90 feet long. The remaining four are designed for cable runs between 90 and 150 feet. An additional amplifier can be added to service more TV's or longer cable runs.

Either a hyperband or UHF modulator

is supplied with the 9020. Because we are not cable-TV subscribers, we chose the UHF modulator, which can output signals on UHF channels 14-62. Once installed, the modulator helps to make the system extremely easy to operate. Only one cable needs to be run to each TV. Sources are selected simply by changing the channel. For example, the satellite receiver might be found on Channel 24, the VCR on channel 26, and the front-door camera on channel 28. The frequency of the modulators are set by rotating thumb wheels behind a removable front panel. They are reminiscent of the channel-setting controls on early VCR's. An output-level control is provided so that the signal level of the house-generated channels can be set to match those from cable or terrestrial broadcasts.

Once the system was tuned properly—which was more difficult to accomplish than we expected—the performance at every TV in the house was outstanding. The only drawback is that the modulator transmits only a mono signal. An MTS stereo modulator is available, however, as is a digitally tuned modulator that should make the setup task easier.

Now, instead of falling asleep on the couch watching satellite TV, we can fall asleep in the bedroom. We can even keep tabs on who's at the front door by turning on our TV's picture-in-picture. ■

## THE GOOD LIFE

(Continued from page 52)

### GET EDUCATED!

They were on the right track. It's vital to learn everything you can about the field. Reading magazines like this one is a start, but Sean Fields suggests that you also take advantage of some of the classes offered by CEDIA. Regional seminars are offered throughout the year, and are open to members and non-members (at a higher cost). Manufacturers also offer training courses specific to their own products, usually held at their main offices. However, manufacturer's training programs are often coordinated with CEDIA's regional classes, allowing the manufacturers to reach more people with the closer, more affordable programs. Current information on regional seminars is available from CEDIA.

If you'd prefer to go the total-immersion route, consider attending CEDIA's 1994 Fall Management Conference and Trade Expo, to be held in Dallas on September 8-11, 1994. Although the agenda has not yet been finalized as we go to press, several workshops and manufacturers' seminars will be offered, as well as a series of educational panels focusing on both the basics and the evolving nature of the custom-installation industry. ■

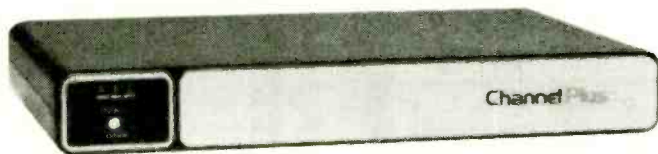

The ChannelPlus Modulator accepts up to three video inputs, and distributes them on unused TV channels.



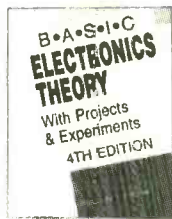

4261H-XX \$35.00  
Counts as 2/Hardcover

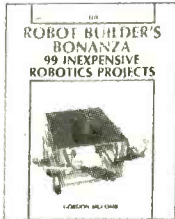

2800P \$17.95

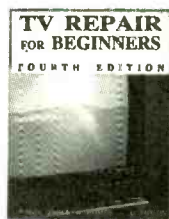

3627P \$19.95



2724P \$17.95

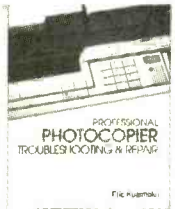

4331H \$29.95  
Hardcover



3671P \$18.95

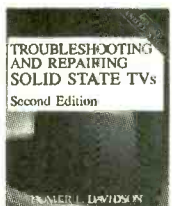

3700H-XX \$36.95  
Counts as 2/Hardcover



3765P \$19.95

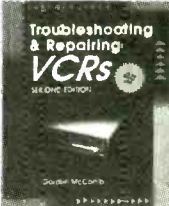

3777H \$32.95  
Hardcover



4360H-XX \$34.95  
Counts as 2/Hardcover

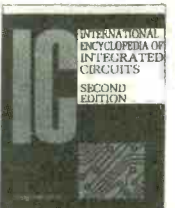

3802H-XXX \$84.95  
Counts as 3/Hardcover

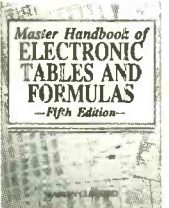

3730P \$22.95

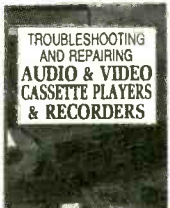

3795P \$19.95



3711P \$19.95

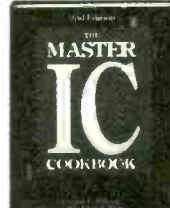

3550H-XX \$34.95  
Counts as 2/Hardcover

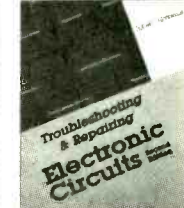

3258P \$19.95

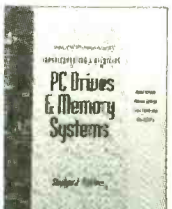

4491H-XX \$39.95  
Counts as 2/Hardcover

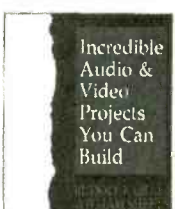

4325H-XX \$39.95  
Counts as 2/Hardcover



0487375P \$24.95

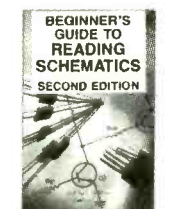

3632P \$10.95

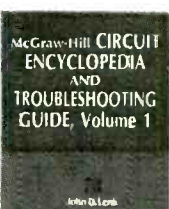

0376026H-XX \$39.50  
Counts as 2/Hardcover



4139P \$14.95



2613P \$19.95

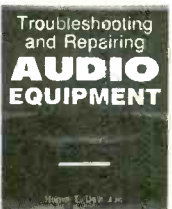

4112H-XX \$29.95  
Counts as 2/Hardcover

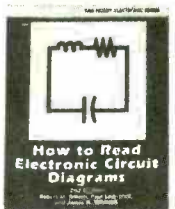

2880P \$15.95

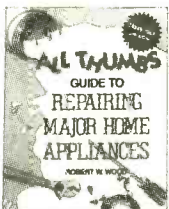

4061P \$9.95



4122H-XX \$36.95  
Counts as 2/Hardcover



4256P \$24.95



4227P \$15.95



1367P \$29.95

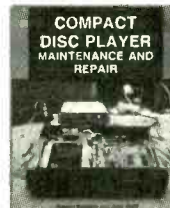

2790P \$17.95

# Select any 5 books for only \$4<sup>95</sup>

(values  
up to  
\$140.75)

## when you join the Electronics Book Club®



### As a member of the Electronics Book Club . . .

. . . you'll enjoy receiving Club bulletins every 3-4 weeks containing exciting offers on the latest books in the field at savings of up to 50% off of regular publishers' prices. If you want the Main Selection do nothing and it will be shipped automatically. If you want another book, or no book at all, simply return the reply form to us by the date specified. You'll have at least 10 days to decide. And you'll be eligible for **FREE BOOKS** through the Bonus Book Program. Your only obligation is to purchase 3 more books during the next 12 months, after which you may cancel your membership at any time.

A shipping/handling charge and sales tax will be added to all orders. All books are softcover unless otherwise noted. (Publishers' prices shown) If you select a book that counts as 2 choices, write the book number in one box and XX in the next. If you select a book that counts as 3 choices, write the book number in one box and XXX in the next. ©1994 Electronics Book Club PE994

If card is missing, write to: Electronics Book Club, Blue Ridge Summit, PA 17294-0810

### Your most complete and comprehensive source for the finest electronics books.



# Build the Smart Charger

*Is the high cost of replacement batteries affecting your limited household budget? If so, get with the rechargeable revolution*

BY ANTHONY J. CARISTI

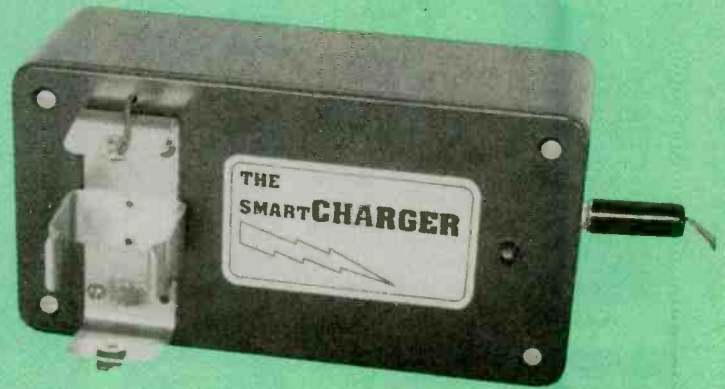

**D**o you shudder at the cost of batteries every time you need to buy replacements? Would you like to cut the cost of operating your portable equipment by a factor of 5 to 1 or more? If so, the *SmartCharger* described in this article is for you. With the help of the Smartcharger, you can take advantage of a new type of alkaline battery that can be recycled, instead of thrown away. That considerably cuts the cost of operating your portable radio, cassette player, or almost any battery-operated device.

That's possible because a quiet revolution has taken place in the primary (dry-cell) battery industry. The Rayovac Corp. has developed and patented a rechargeable alkaline battery, called Renewal, which is available in AAA, AA, C, and D sizes. Ordinary alkaline batteries cannot be successfully recharged due to the buildup of gases, the possibility of internal shorting and leakage, and other problems. Before Renewal, battery users could only dream of recharging their alkaline cells. Many have tried, unsuccessfully of course, to charge alkaline cells using either home-made or commercially available chargers.

## **Alkaline vs. NiCd Cells.**

Rechargeable alkaline batteries have several important advantages over their NiCd counterparts. In addition to initially costing less, they offer two to three times more energy-storage capacity in any given size, and offer a higher terminal voltage than NiCd's—1.5 volts versus 1.2 volts. Also, alkaline cells retain their full charge

for up to 5 years in storage. In contrast, NiCd's have a self-discharge rate of about 1% or more per day, depending on the ambient temperature. That is why a device that is used sporadically often seems to have dead NiCd's when you thought they were charged. Because of the self-discharge characteristic, NiCd batteries must be left on trickle charge or recharged just prior to use; and a full charge can take as much as 16 hours to complete.

Another advantage of alkaline over NiCd units is the ability of the alkaline cell to function at lower operating temperatures. That characteristic could be important for those who must operate portable equipment in very cold climates.

Finally, NiCd batteries are not environment friendly. They are highly toxic and their contents are classified as hazardous waste by the EPA. By comparison, Renewal cells are 99.975% mercury free, contain no cadmium, and use recycled cardboard and plastic packaging.

**The New Technology.** The rechargeable alkaline battery is a zinc/manganese-dioxide system designed with enhanced electrochemical and mechanical construction that eliminates the problems inherent in ordinary alkaline batteries. One problem with non-rechargeable alkaline cells is the tendency of the outer cathode to separate from the steel jacket, rendering the battery useless. Further, attempting to charge such batteries can generate hydro-

gen gas, which can create over-pressurization resulting in leakage and possible bursting.

In addition, chemical reactions within an ordinary alkaline battery can form conductive paths within the unit, resulting in a shorted cell. Successful, repeated charge/discharge cycling of an alkaline battery requires that the manganese dioxide contained in the electrolyte not be allowed to form manganese trioxide during discharge. That chemical reaction is not reversible during the recharge process. Rayovac's rechargeable alkaline batteries do not suffer any of those problems.

**Performance.** New rechargeable alkaline batteries have virtually the same discharge capacity as regular alkaline units. Once fully discharged and recharged, they have a capacity that's slightly less than that of new units. Thereafter, each charge/discharge cycle results in decreasing capacity. However, after 25 full charge/discharge cycles have been completed, the rechargeable alkaline battery's capacity equals that of a consumer-grade NiCd cell. Shallow discharge cycles (25% or less) of the new alkaline units allow 100 or more recharges before its capacity is reduced to that of NiCd units.

Figure 1 illustrates the typical cumulative number of hours of use available from a rechargeable AA-size alkaline battery when powering a load, perhaps an electronic game or toy. Initially, an ordinary alkaline cell permits about 4 hours of use before it



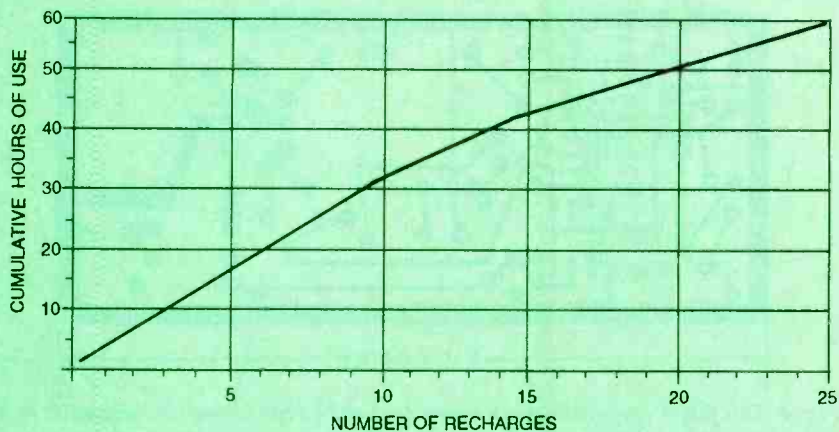

Fig. 1. Shown here is the typical cumulative number of hours of use available from a rechargeable AA-size alkaline battery powering a load.

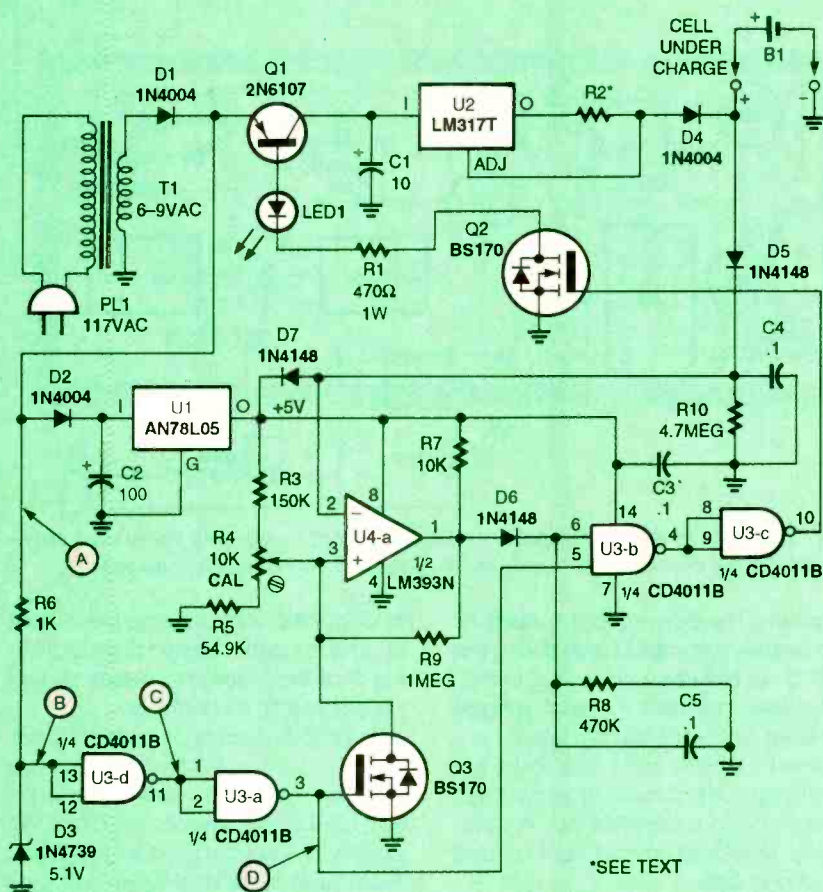

Fig. 2. The Smartcharger is comprised mainly of four chips—an AN78L05 5-volt, 100-mA regulator (U1), an LM317T 1-amp adjustable-voltage regulator (U2), a CD4011BE quad 2-input NAND gate (U3), and an LM393N dual voltage comparator (U4). The value and rating of R2 is selected as described in text.

must be discarded. However, a rechargeable cell can provide almost 60 hours of use at the 25th recycle, and still have some life.

**Recharging Fundamentals.** Rechargeable alkaline batteries cannot be properly charged using an ordinary charger. Such chargers supply a

continuous charging current whether or not the battery is fully charged. However, proper charging can be accomplished via the Smartcharger. The Smartcharger is designed deliver a series of discrete charging-current pulses to the battery, while continuously monitoring its condition.

The Smartcharger, using analog

and digital-logic circuitry, samples the battery's terminal voltage 60 times per second (during the time between the discrete charging pulses). The constant-monitoring system used in the Smartcharger prevents overcharge, which can damage and/or reduce the performance of the battery. When the battery's terminal voltage reaches the theoretical maximum charge of 1.65 volts, the charging-current pulses are automatically terminated.

**How It Works.** A schematic diagram of the Smartcharger is shown in Fig. 2. The Smartcharger receives power from a common AC wall transformer that provides 6- to 9-volts rms, at about 1/4 to 1/2 amp; the transformer's current rating depends on the size of the cell under charge. Diode D1, used as a half-wave rectifier, provides a pulsating DC output that is used to power the circuit and provide charging current to charge the battery. Resistor R6 and Zener diode D3 shape and limit the pulsating DC to produce a 5-volt, 60-Hz trapezoidal pulse train that is used to drive the associated logic circuitry.

Diode D2 is used to isolate the pulsating-DC output of D1 from filter capacitor C2. The voltage across C2 is fed to the input of U1, a fixed 5-volt regulator that is used to power the analog and digital sections of the circuit.

The pulsating-DC output of D1 is also fed to the emitter of Q1 (a 2N6107 PNP transistor), which is operated as a switch and controlled by Q2. The output of Q1, at its collector, is fed to the input of U2, an LM317 adjustable-voltage regulator that is configured as a current regulator. Resistor R2 is placed between the adjust and output terminals of U2; that maintains a fixed 1.2-volt reference voltage between those two terminals. Because of the U2/R2 arrangement, only a minimal current flows through D4, regardless of the input voltage or load resistance. The output of U2 feeds pulsating DC to the battery under charge.

Refer to the waveform diagrams shown in Fig. 3. The waveform in Fig. 3A is the 60-Hz, half-wave-rectified output of D1 (at point A of Fig. 2). The waveform in Fig. 3B (point B in Fig. 2) is the clipped waveform (which is regulated to about 5 volts by Zener diode

D3) that is fed to the input of U3-d (¼ of a CD4011 quad NAND gate), which is configured as an inverter. The output of U3-d (shown in Fig. 3C) is fed to U3-a (also connected as an inverter) at point C. The output of U3-a (illustrated in Fig. 3D) is the inverse of U3-d's output waveform. The final waveform, Fig. 3E, represents the current pulses (0.2- or 0.4-amp peak) fed to the battery under charge. Note that all waveforms are synchronized with the 60-Hz, power-line frequency.

The battery's terminal voltage (less the diode drop of D5) appears across R7 and at the inverting input (-) at pin 2 of U4, an LM393N dual voltage comparator. The non-inverting (+) input of U4 at pin 3 is fed a voltage derived from a resistive string composed of R3-R5, which is connected between the 5-volt regulated-supply rail and ground. The output of U4 assumes a logic-1 (5-volt) state when the battery's terminal voltage drops below the threshold set by R4, indicating that the battery needs recharging.

When the battery is fully charged, its voltage hovers above the reference voltage established at pin 3 of U4, causing the output of U4 at pin 1 to go to zero. That characteristic allows U4 to be used to monitor the battery-recharging process. The comparator circuit is designed to have about a 0.1-volt input-voltage hysteresis, as provided by R9. That increases circuit stability and allows the charging current to flow only when the battery's terminal voltage is below the threshold value by a certain amount.

In order to meet the criteria set by the rechargeable alkaline cell's man-

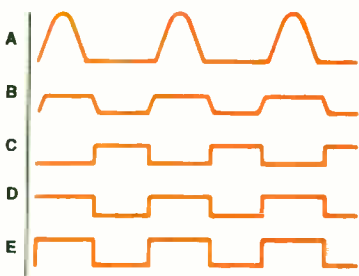

Fig. 3. These are the waveforms that should appear at specified points in the circuit. (See the text for details.) A is the 60-Hz, half-wave-rectified output of D1; B is the clipped waveform that's fed to U3-d; C is the output of U3-d; D is the output of U3-a; and E, represents the current fed to the battery under charge.

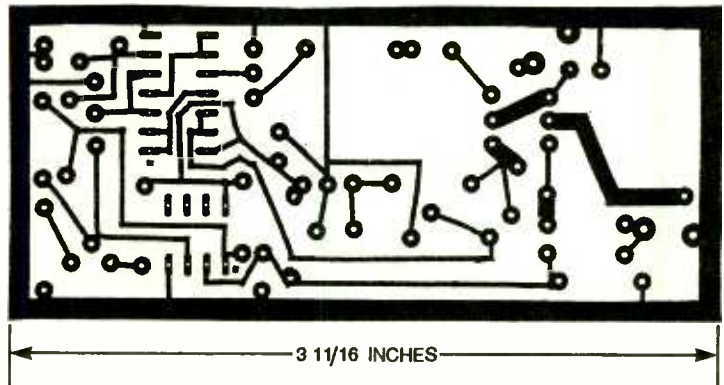

Fig. 4. This full-size template of the author's printed-circuit layout can be used to etch your own board or you can purchase one from the source given in the Parts List.

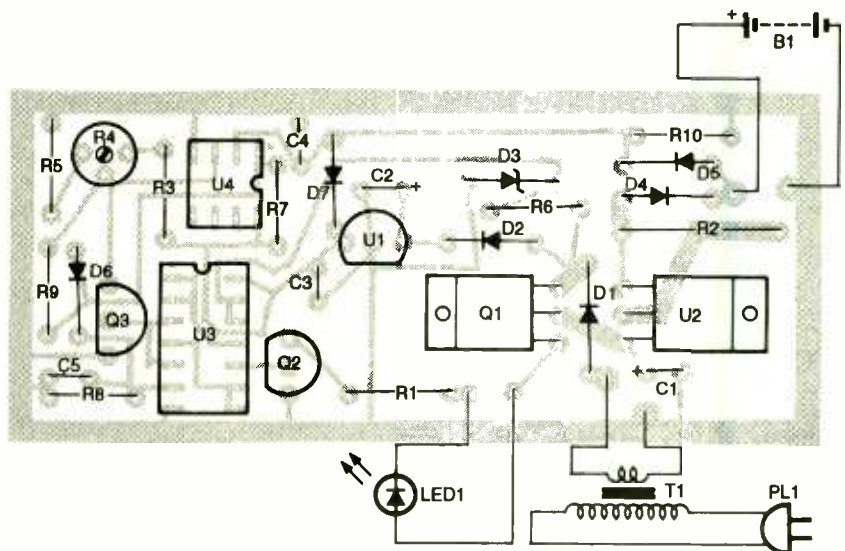

Fig. 5. Guided by this parts-placement diagram, carefully assemble the printed-circuit board, paying close attention to the orientation of all the polarized components.

ufacturer, the open-circuit voltage of the battery is sampled only during the idle time between charging pulses. When the battery's terminal voltage reaches 1.65 volts, the battery is considered fully charged; therefore the charging current must be terminated. That function is handled by an automatic shut-down circuit built around U3-b and U3-c.

Transistor Q3 (an N-channel enhancement mode MOSFET) is driven by the output of U3-a. Each time Q3 is turned on, the positive input of U4 is pulled low, inhibiting it during the charging-pulse time. That, in turn, causes the output of U4 to go to zero during the time that charging current is applied to the battery. When the output of U3-a goes low, Q3 cuts off and U4 is free to measure the terminal voltage of the battery. If that voltage is below 1.65 volts, pin 1 of U4 is pulled high via R7. That causes C5 to charge

to about 4.8 volts, causing the output of U3-b to go to a logic-1 state, signifying that the charging pulses should be applied to the battery.

The high output of U4 applied to pin 6 of U3-b, plus the simultaneous positive transition of waveform D (at pin 3 of U3-a) applied to pin 5 of U3-b, causes its output at pin 4 to go to zero. That signal is inverted by U3-c to produce a logic-1 output at pin 10, which is then applied to the gate of Q2. With Q2 activated, Q1 is biased on, allowing charging current to flow to U2 and the battery.

Light-emitting diode LED1, which is placed in series with Q1's base and is illuminated by Q1's base current, provides a visual indication of the charger's operation. That LED glows constantly as the battery is being charged. As long as C5 remains charged, current pulses will continue to be applied to the battery. When



the battery approaches full charge, pin 1 of U4 goes to zero. The time constant established by the values of R8 and C5 allow the input voltage of U3b at pin 5 to decay to zero, cutting off the drive current to Q2 and extinguishing LED1.

In actual operation, the number of charging pulses delivered to the battery is 60 per second when the battery is in a state of low or partial charge. As the battery approaches full charge, the number of pulses decreases, eventually diminishing to just a few pulses per minute. If the Smartcharger is left in operation, the pulses delivered to the battery eventually cease, thereby protecting the battery from overcharging.

Note that the charging circuit is designed to monitor a single cell. If more than one battery is to be charged at once, the main circuit (minus the wall transformer) must be duplicated for each additional battery. A single transformer is all that's needed to feed all of the charging circuits simultaneously, so long as it can deliver the necessary current.

For one AA or AAA cell, a ¼-amp unit is required; a C or D cell requires a ½-amp unit. For a multiple-battery charging station, the transformer rating must be ¼ or ½ amp times the maximum number of cells on charge. For instance, for a multiple-AA or -AAA unit, the transformer must be capable of delivering ¼n amps; where n is the number of cells to be charged.

**Construction.** The author's prototype of the Smartcharger was built on a printed-circuit board measuring about 3¼ by 1½ inches. A full-size template of that printed-circuit layout is shown in Fig. 4. You can etch your own printed-circuit board or one can be obtained from the source given in the Parts List.

Figure 5 shows the parts-placement diagram for the author's printed-circuit layout. When assembling the board, note the orientation of all the polarized components. It is important that none of them is inadvertently misoriented; doing so could result in an inoperative circuit and possible component damage. It is recommended that sockets be used for the DIP IC's. That allows the circuit to easily be serviced should it ever need it. It is very difficult to separate a sol-

dered-in multi-pin device from a PC board without damaging either the board or the chip.

Be sure to use the correct-value resistor for R2, which determines the volume of charge current. For AA and AAA cells, the proper charge current is 200 mA; thus, R2 can be two 3-ohm, 1-watt resistors connected in series, or a fixed value of 6.2 ohms. For C and D cells, the charging current is 400 mA; so R2 should be a 3-ohm, 2-watt unit. The Smartcharger can be configured for all cell sizes by adding a single-pole double-throw (SPDT) switch to the circuit to allow a resistance of 3 or 6 ohms to be placed in the circuit as needed to select the proper charging current. Figure 6 shows how to alter the circuit for that purpose.

The accuracy and stability of the circuit relies on the temperature coefficient of the voltage-divider string composed of R3, R4, and R5. For that reason you should use only metal-film resistors and a cermet potentiometer as specified in the Parts List. Ordinary carbon components are not be stable enough for the circuit, and should not be used.

Transistors Q1 and U2 do not require heat sinking, and are placed on the circuit board with the metal tab facing down. Be careful not to inadvertently interchange those two components, and do not allow any metal part of either component to short to anything else. Be sure to place LED1 in a location where it can be readily seen during charging operations.

Power for the author's unit was provided by a 6- to 9-volt AC, ¼- or ½-amp plug-in wall transformer, depending on the size of the cell to be charged, as previously discussed. A plug-and-jack arrangement was then used for connections between the transformer and circuit board.

Battery holders for the size cells to be charged (AAA, AA, C, and D) are available from a wide range of sources, including Digi-Key Corp. and Radio Shack to name a few. Remember, the Smartcharger can charge only one cell at a time, so if the battery holder that you get is designed for two or more cells, it must be modified to accommodate a single cell. A case in point is Radio Shack's #270-398 "AAA" battery holder, which is designed to hold two AAA units.

Since only one cell compartment is

## PARTS LIST FOR THE SMARTCHARGER

### SEMICONDUCTORS

- U1—AN78L05 5-volt, 100-mA, fixed-voltage regulator, integrated circuit
- U2—LM317T 1-amp, adjustable-voltage regulator, integrated circuit
- U3—CD4011BE quad, 2-input NAND-gate, integrated circuit
- U4—LN393N dual, voltage-comparator, integrated circuit
- Q1—2N6107 general-purpose PNP silicon transistor
- Q2, Q3—BS170 N-channel, enhancement-mode MOSFET
- D1, D2, D4—1N4004, or equivalent, 1-amp, 400-PIV, silicon diode
- D3—1N4739 5.1-volt, 1-watt, Zener diode
- D5—D7—1N4148 general-purpose silicon diode
- LED1—Light-emitting diode, 2-volt, 20-mA

### RESISTORS

(All fixed resistors are ¼-watt, 5% carbon units, unless otherwise noted.)

- R1—470-ohm, 1-watt
- R2—See text
- R3—150,000-ohm, 1% metal-film
- R4—10,000-ohm PC mount, cermet potentiometer
- R5—54900-ohm, 1% metal film
- R6—1000-ohm
- R7—10,000-ohm
- R8—470,000-ohm
- R9—1-megohm
- R10—4.7-megohm

### CAPACITORS

- C1—10-µF, 25-WVDC, radial-lead electrolytic
- C2—100-µF, 25-WVDC, radial-lead electrolytic
- C3—C5—0.1-µF, ceramic-disc

### ADDITIONAL PARTS AND MATERIALS

- T1—6- to 9-volt rms AC wall transformer (see text)
- B1—See text
- PL1—Part of T1 (see text)
- Printed-circuit materials, enclosure, IC sockets, optional plug and jack (see text), battery holder(s) and connector(s), wire, solder, etc.

**Note:** The following parts are available from A. Caristi, 69 White Pond Road, Waldwick, NJ 07463: a printed-circuit board, \$10.95; U1, \$2.00; U2, \$2.50; U3, \$2.25; U4, \$2.95; Q1, \$2.25; Q2, \$2.75; Q3, \$2.75; set of 2 metal-film resistors, \$1.25. Please add \$4.00 postage/handling. New Jersey residents please add appropriate sales tax.

required, the other compartment must be shorted by connecting a wire from the positive terminal to the negative terminal. Be sure to observe proper polarity when wiring the battery holder to the Smartcharger. Use a sample rechargeable cell and DC voltmeter to be sure. If the connections are reversed, the circuit will not work.

When the circuit is completely assembled, examine your work very carefully for bad solder joints and shorts, especially between adjacent IC pins and circuit traces. It is much easier to correct problems at this stage than later if the circuit does not work.

**Checkout.** Checking out the Smartcharger requires an accurate digital voltmeter, and a Renewal rechargeable alkaline cell that is fully or partially charged. Note: Do not insert the battery in its holder until instructed to do so. An oscilloscope is not necessary, but may come in handy if you need to troubleshoot the circuit. With no battery in the holder, apply power to the circuit and measure the DC voltage across C2. It should read 8 to 15 volts, depending on the transformer voltage.

Then, measure the output of U1; it should be somewhere between 4.75 and 5.25 volts. Afterward, measure the pulsating DC voltage at pins 12 and 13 of U3; an indication of about 2 or 3 volts is normal. If you don't get the correct reading, disconnect power, troubleshoot the circuit, and repair the fault before proceeding. Once the proper voltages have been measured, proceed with the checkout. With the power turned off, place a rechargeable cell into the battery holder and set R4 to mid position. Connect the DC voltmeter across the battery; you should get a reading somewhere between 1 and 1.6 volts.

Next apply power to the circuit and observe the meter reading and the LED. If the battery is in a state of partial charge, the LED will light and the battery voltage will increase as it accepts the charge. Adjust R4 very slowly to bring the meter reading to about 1.6 volts, if possible. If the battery is in a very low state of charge, you may have to wait until sufficient recharging time has lapsed to restore battery voltage level.

As the battery recharges further, note that the LED begins to flash off and on. Wait until enough time occurs between flashes so that the voltmeter is able to measure battery voltage when the LED is extinguished. Each time the LED pulses on, note that battery voltage increases by about 0.3 volts. When you can measure battery voltage between charging pulses (LED off), very carefully adjust R4 for a battery terminal voltage of at least 1.62 volts, but not more than 1.65 volts,

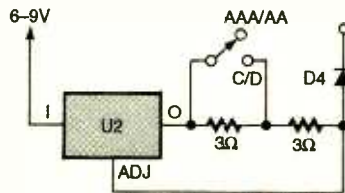
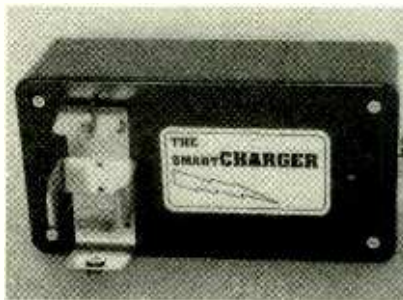

Fig. 6. The Smartcharger can be modified to accommodate all battery sizes by replacing R2 with two 3-ohm units.



Here is the author's prototype of the Smartcharger alkaline-battery recharger. As described in the article, select your cell holder to accommodate the cell type you will be recharging.

when the LED is off. That adjustment is very important to avoid any possibility of overcharging the battery while ensuring that the battery reaches full recharge. When the battery approaches full charge, the LED's flash rate diminishes, eventually going out for minutes or even hours between flashes.

If you do not obtain the results described, try charging a new cell. If that doesn't work, disconnect power to the circuit and review Fig. 5 to verify that all of the components are of the correct values and are properly oriented. Make sure that Q1 and U2 have not been inadvertently interchanged, and that they are positioned on the board with proper orientation. If all appears okay, but the circuit still does

not operate properly, try new chips for U3 and U4.

If that does not eliminate the fault, use an oscilloscope to display and measure the pulse trains and logic levels throughout the circuit. Check the signals at points A, B, C, and D indicated in Fig. 2 and compare them with the corresponding waveforms shown in Fig. 3. Temporarily remove Q3 from the circuit and verify that the voltage at pin 3 of U4, varies from about 1.3 to 1.5 volts as R4 is adjusted. If not, check the values of R3, R4, and R5. If the fault still has not been found, check the operation of Q1 and U2 by temporarily connecting the drain of Q2 to ground while monitoring the battery voltage and observing the LED. Grounding the drain of Q2 should cause LED1 to light while increasing the battery's terminal voltage to 1.6 volts or more. If necessary replace Q1 and/or U2.

**Use.** Best battery life will be obtained if the alkaline cells are not severely discharged. Any battery that is discharged to the point where its terminal voltage is extremely low may not be capable of being rejuvenated by the Smartcharger. When battery-operated equipment exhibits erratic or sluggish operation, it's best to remove the batteries immediately and place them on charge. The charging time will depend on the state of the cells. AAA and AA cells require 3 or more hours of charging; C and D cells may require overnight charging. There is no danger of damaging the cells if the Smartcharger is left on for extended periods of time.

It would be a good idea to keep a spare set of batteries on hand so that the exhausted cells can be placed on charge while the freshly charged ones are placed in service. The charged alkaline cells have an excellent storage life, and will not self-discharge to any great extent after being charged.

When the capacity of the cells is too low after repeated charge/discharge cycles, they should be replaced. That should not occur until after 25 or more cycles have taken place. Even then, such cells can still find use in very intermittent and non-critical service applications, such as in a spare flashlight or perhaps a portable radio. ■



**S**imple resistive circuits are fairly easy to understand, but circuits with capacitors and inductors, known collectively as reactive components, are more elusive. This article will attempt to shed light on reactive circuits by comparing them to resistive ones.

Let's start by examining the simple resistive circuit shown in Fig. 1A. When DC is supplied by the battery, the current developed can be determined by using Ohm's Law, the battery voltage ( $E$ ), and the resistor's value ( $R$ ). When an AC source is used (Fig. 1B), the instantaneous value of current flowing through the resistor varies with the alternating output voltage of the generator. Ohm's Law applies to the circuit just as it does to the DC circuit; peak current can be calculated from the generator's peak voltage, and rms current from the rms voltage. The graph of one cycle of AC (Fig. 1C) shows that when the voltage reaches a peak, the current also peaks; when the voltage crosses the zero line, so does the current. The two waveforms are said to be in phase, and this condition occurs in any circuit that contains pure resistance with no reactive components.

**Inductance.** The first reactive element we shall examine is inductance. The basic laws of electromagnetism tell us that whenever current flows through a conductor, a magnetic field is developed around that conductor. Similarly, whenever a conductor passes through a magnetic field, or a magnetic field cuts through a conductor, a current is induced in that conductor.

Figure 2A shows a coil wired into a simple DC circuit. When the switch is operated to connect the battery, current starts to flow through the windings of the coil. As the current builds up, a magnetic field expands from each turn of the coil and cuts across neighboring turns. That expanding field induces a separate current in the coil in the opposite direction to the energiz-

# An Introduction

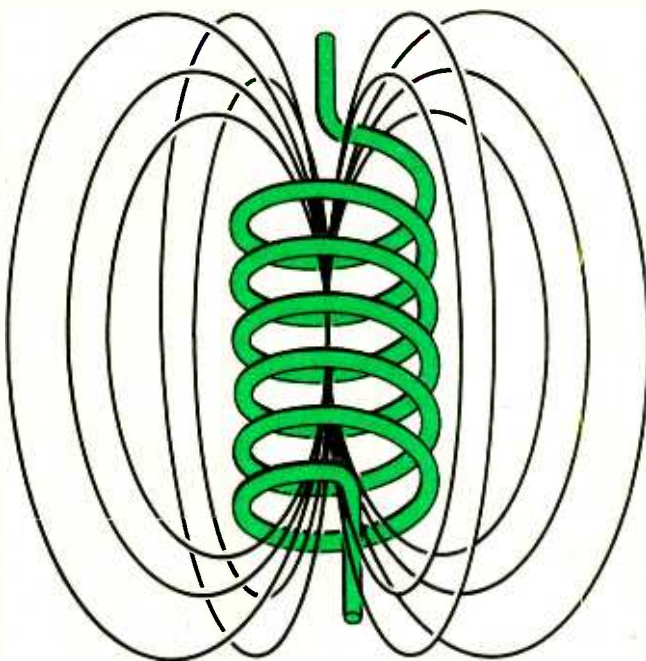

# to Reactance

*Take a step beyond resistive-circuit analysis.*

BY PAUL COXWELL

ing current from the battery. The induced current, known as counter-EMF (or electro-motive force), can never be as great as the original current, but since it is of opposite polarity, it restricts the rate at which current in the coil can increase. When the field around each turn of wire stops expanding, there is no longer any induced counter-EMF, so the final value of current is limited only by the resistance of the circuit (just  $R$  if we disregard the tiny resistance in the coil's windings). It is important to realize that the time constant is affected not only by the inductor itself, but also by the resistance of the circuit to which it is connected.

The build-up of current follows an exponential curve, as shown in Fig. 2B. The period between the application of power and the current reaching 63.2% of its maximum value is called the circuit's time constant. The time constant's value in seconds can be calculated by dividing the inductance in henries by the circuit resistance, in ohms. For most practical purposes, the current is considered to have reached its maximum value after a period equal to five times the constant.

Several factors affect the inductance of a coil: It can be increased by adding more turns, using an iron core, reducing the spacing between adjacent turns, and altering the coil's overall diameter. For example, if a 10-henry coil is used with a circuit resistance of 50

ohms, the time constant is 0.2 second. Current through the coil would reach 63.2% of its final value after 0.2 second, and would be considered to have reached maximum (over 99%) after approximately 1 second. If the coil was changed to one of 20 henries by adding more turns, the time constant would be increased to 0.4 second. Current would now reach its maximum value 2 seconds after power was applied.

Assume now that the switch in Fig. 2 is moved back to its original position, connecting the coil to the resistor. Even though the battery is disconnected, current will still flow for a short time. With the energizing current removed, the magnetic field around each loop of the coil starts to collapse, and in doing so generates EMF within the inductor. It is that induced EMF that attempts to maintain current flow. After one time constant, the current will have dropped to 36.8% of its maximum value (i.e., 63.2% toward zero), and is considered to be zero after five time constants.

The result of connecting an inductive circuit to an AC voltage source (as in Fig. 3A) is shown in Fig. 3B. The voltage starts to rise from zero at the be-

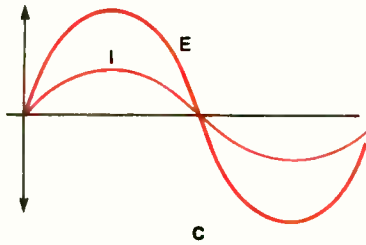
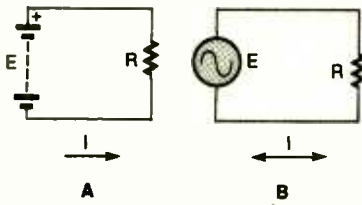

Fig. 1. DC resistive circuits (A) and AC resistive circuits (B) both obey a simple version of Ohm's Law. So in a resistive AC circuit, current and voltage vary in step with one another (C).

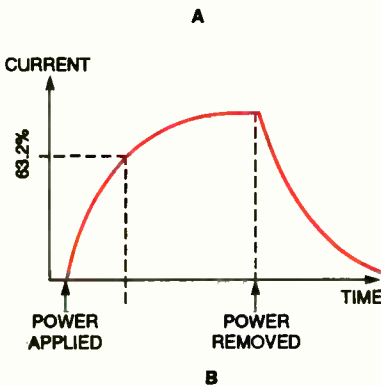
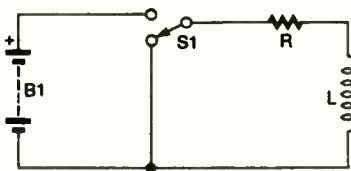

Fig. 2. The inductor in the circuit shown in A causes current to lag behind the applied voltage, as shown in B.

ginning of a cycle, but as you might guess, the circuit current does not rise instantaneously as it would in a purely resistive circuit. The voltage will have passed its positive peak and dropped toward zero before the inductance allows the current to reach its peak value. In other words, the instantaneously current flowing in the circuit is less than what would be calculated from the resistance of the coil wire alone.

The opposition to current flow due to the inductor's induced EMF is called inductive reactance, denoted  $X_L$ , and is measured in ohms. If the frequency of the applied AC is reduced, the coil

current will reach a higher value before the voltage waveform passes its peak and drops toward zero, so inductive reactance is directly proportional to the applied frequency as follows:

$$X_L = 2\pi fL$$

The formula assumes that the value of inductance (L) is given in henrys and the frequency (f) in cycles-per-second, or hertz.

In a theoretical circuit consisting of pure inductance, with no resistance, the current lags behind the voltage by exactly 90 degrees: When voltage is maximum, current is minimum, and vice versa. Since there is no resistance, the current in the circuit can be determined by substituting  $X_L$  for R in the Ohm's Law equation.

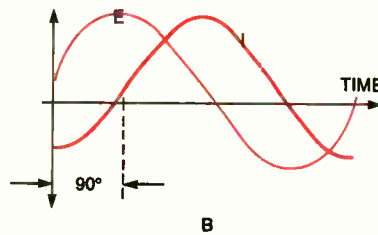
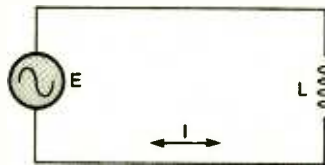

Fig. 3. In a purely inductive AC circuit (A), the current waveform lags behind the voltage waveform by 90 degrees (B).

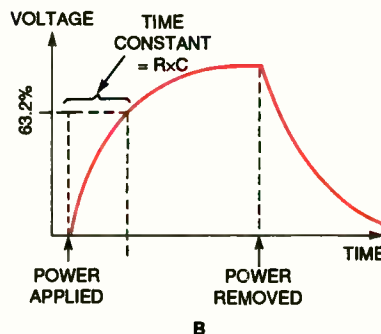
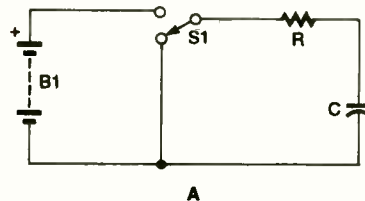

Fig. 4. The charging action of the capacitor in A causes voltage to lag behind current, as shown in B.

**Capacitance.** The electrically speaking, the opposite of inductance is capacitance. Let's discuss how current flows through a capacitor as it charges from a DC source (shown in Fig. 4A). When the switch is closed, the current immediately rises to a value set by the limiting resistor (R). Electrons flow from the negative pole of the battery to one plate of the capacitor to give it a negative charge, while at the same time, electrons are drawn from the other plate to the positive battery pole. The current gradually drops as the plates charge, and in an ideal capacitor the current would be zero when the plates were charged to capacity.

At the instant that current is applied, there is no voltage across the capacitor (see Fig. 4B). As charge accumulates on the plates and the charging current drops, the capacitor's voltage rises. The plotted curve of the voltage rise is exponential, and is identical in shape to the curve shown earlier for the rise of current in an inductor.

The capacitive time constant is defined as the period between the application of charging current and the point at which the capacitor voltage reaches 63.2% of the supply voltage. It is equal to the product of the capacitance and overall circuit resistance. With the capacitance specified in farads and resistance in ohms, the result will be in seconds. Once again, the circuit is considered to have reached its final values, with the capacitor fully charged, after approximately five time constants.

When the circuit is switched to discharge the capacitor, both the current and voltage decrease gradually, as would be expected. After a period equal to one time constant, the capacitor voltage will be 36.8% of its full value, and after five such periods the capacitor is considered to be fully discharged.

Figure 5A shows the capacitor in an AC circuit. Notice that the relationship between current and voltage in a purely capacitive circuit, as reflected in the graph in Fig. 5B, is exactly opposite to that in an inductive circuit—the current leads the voltage by 90 degrees. Whereas the inductor opposes changes in circuit current by generating a counter EMF, the capacitor opposes changes in voltage by storing and releasing electrons from



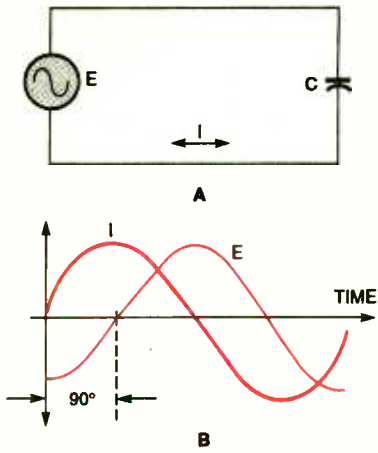

Fig. 5. In a purely capacitive AC circuit (A), the current waveform leads the voltage waveform by 90 degrees (B).

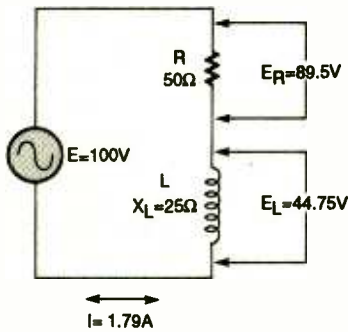

Fig. 6. Voltages in RL circuits like this one, or in RC circuits, are not in phase and cannot be added directly.

its plates. However, the overall effect on current flow is similar: the effect is greater than can be accounted for by resistance alone.

The opposition to current flow in a capacitor is called capacitive reactance,  $X_C$ , and is also measured in ohms. As the frequency of the applied AC is reduced, the capacitor will have longer to charge before the supply polarity changes, so the overall current will be lower. Capacitive reactance is therefore inversely proportional to frequency, as indicated by:

$$X_C = 1/(2\pi fC)$$

where the frequency ( $f$ ) is in hertz, and the capacitance ( $C$ ) is in farads. Note that is the exact opposite of inductive reactance.

**Phase Angle and Vectors.** The effects of pure capacitance or inductance can be understood quite simply by remembering that they cause current and voltage to be 90 degrees out-of-phase. However, the situation becomes more complex when both

reactive components and resistance are combined, which is the case in any practical circuit.

Look at the circuit of Fig. 6 as we proceed. The components in the circuit shown are in series, so the current flow must be the same through both of them. The resistor has a value of 50 ohms, and we have assumed that the inductor has an inductive reactance of 25 ohms at the frequency in use.

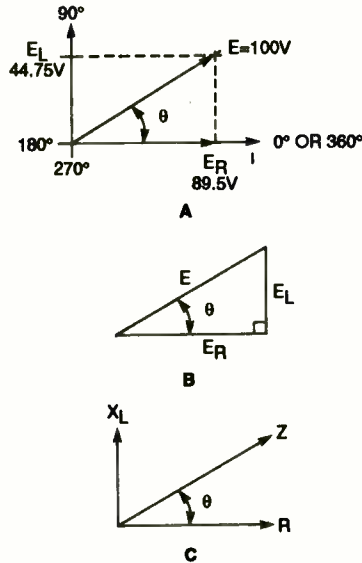

Fig. 7. Vectors can be used to show the relationship between voltages in a reactive circuit (A). By rearranging vectors (B), one can see their geometric relationship. Vectors can also be used to describe circuit impedance (C), too.

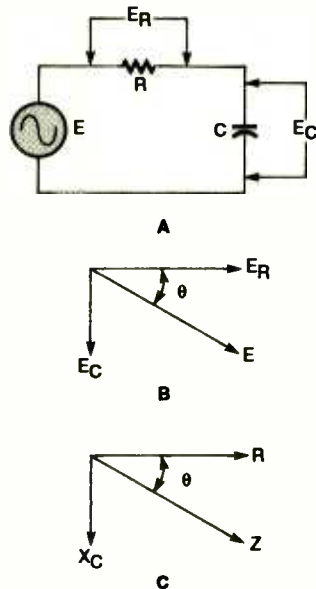

Fig. 8. A capacitive AC circuit (A) falls prey to vector analysis for its voltages (B) and impedance (C) just like an inductive circuit.

The current flow is 1.79 amps, and the voltage drops measured across the resistor and inductor are 89.5V and 44.75V, respectively. At first sight, the voltages shown may appear to be incorrect, because together they total more than the supply voltage of 100 volts. That apparent discrepancy, however, is caused by the fact that the voltage across the resistor is out of phase with that across the inductor.

The voltage and current in the resistive portion of the circuit are in phase with each other. In the inductive portion of the circuit, the voltage leads the current by 90 degrees. Since the current at all points in a series circuit must be of the same phase, it follows that  $E_R$  and  $E_L$  are out of phase.

One way to represent current and voltage in circuits like that is to use vectors—arrows that start at the origin of a coordinate system and point in a particular direction (see Fig. 7A). The size of an arrow indicates the magnitude of whatever the arrow represents—the bigger the arrow, the larger the value. The angle an arrow makes with the X-axis indicates its phase in degrees. The positive X-axis will be zero degrees, and the degrees increase as you move in a counterclockwise direction.

Because the current in the series circuit of Fig. 6 flows through both components with the same phase, we will use the current vector as the zero-degree reference. In other words, the current vector will lie on the X-axis. Voltage  $E_R$  is in phase with the current, so its vector will be placed on that axis, too.

The voltage across the coil,  $E_L$ , is 90 degrees ahead of the current, so its vector points straight up (90 degrees) from the X-axis. Because each vector is drawn to scale, we can draw the source-voltage vector ( $E$ ) by starting it at the origin and ending it at the maximum values of  $E_L$  and  $E_R$  as shown. The angle of vector  $E$  (which is  $\theta$ ) is the phase between the current and source voltage, and its length indicates the voltage's magnitude.

The basic vector diagram can be rearranged to form a right triangle, with the hypotenuse representing the longest vector (see Fig. 7B). Pythagoras' Theorem can be used to calculate any vector when the other two are known, as follows:

$$E = \sqrt{E_R^2 + E_L^2}$$

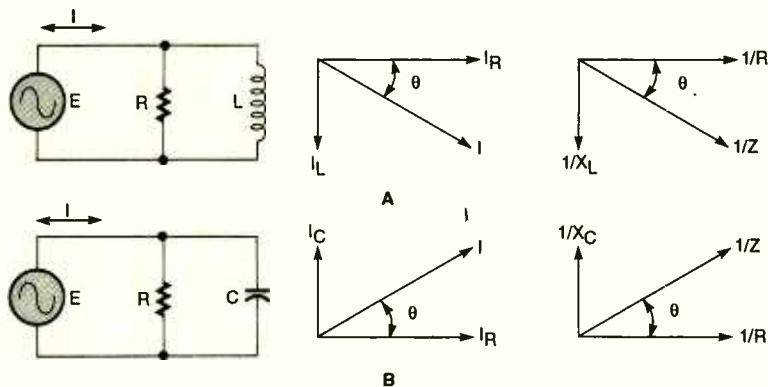

Fig. 9. Vectors can be used to analyze parallel inductive (A) and capacitive (B) circuits, but current flow, not voltage, is the property of import. Also, the only inverse of the impedance vectors are examined.

so scale drawings are not needed to determine magnitudes.

Vector representation also allows us to use trigonometric functions to determine voltages when we know only one voltage and a phase angle, or to determine a phase angle when we know only two voltages. For our example these relationships are:

$$\begin{aligned} \sin \theta &= E_L/E \\ \cos \theta &= E_R/E \\ \tan \theta &= E_L/E_R \end{aligned}$$

From any of these relations, we can determine that the phase difference between the current and the supply voltage in our example is 26.56 degrees.

A little experimentation with different values for  $E_L$  and  $E_R$  will reveal some useful tips to remember. Whenever a circuit is purely resistive, the phase angle is zero, because current and voltage are in phase. As the inductive reactance increases, the phase angle becomes greater, until it reaches 45 degrees when resistance and reactance are equal in value. By the time a circuit contains pure reactance, with no resistance, the phase angle has increased to 90 degrees.

Since the current flow is the same through all components in a series circuit, it follows that the voltage drop across any component in that circuit is proportional to the resistance or inductive reactance of that component. In other words, if we draw vectors for the resistance and reactance of the circuit, they would be proportional to the ones we've drawn for the voltages (see Fig. 7C). The resistance,  $R$ , would be at 0 degrees and inductive the reactance,  $X_L$ , at 90 degrees.

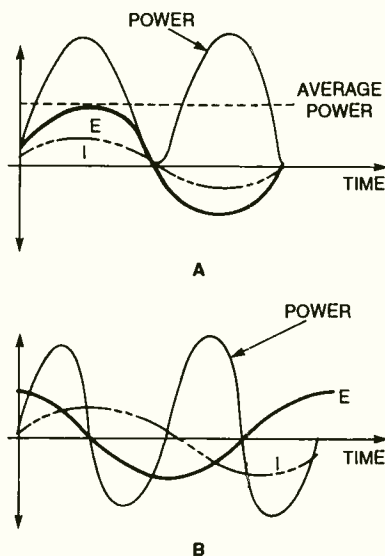

Fig. 10. While power dissipation in a resistive circuit has a non-zero average value (A), in a reactive circuit there is no average or net power loss (B).

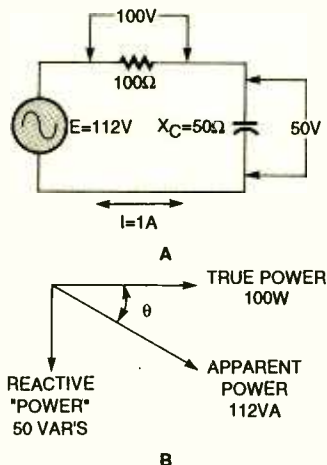

Fig. 11. In a reactive circuit, the true power dissipated in its resistance and the reactive power supplied to its reactance vectorially sum to produce an apparent power vector, even though reactive power is returned to the circuit.

The combined effect of resistance and reactance is called impedance, which is represented by the symbol  $Z$ . It is that value that must be used to calculate the current in a reactive circuit when the supply voltage is known; just dividing the source voltage by the resistance plus the reactance will yield an incorrect answer, since the voltages involved are not in phase.

The series RC circuit in Fig. 8A is described by the vector diagrams in Figs. 8B and 8C. Once again, the current is used as the zero-degree reference point, with  $E_R$  at 0 degrees since it is in phase with the current. Recall that in a capacitor, the voltage lags 90 degrees behind the current, so its voltage vector ( $E_C$ ) is drawn downward. The phase angle of such a circuit is sometimes given a negative value, although it is just as acceptable to specify "leading" or "lagging" instead. All the same trigonometric equations and the Pythagorean Theorem can be applied to the vectors.

**Parallel-Circuit Vectors.** Parallel circuits containing capacitors and inductors can also be analyzed with vector diagrams. However, the vectors used are current vectors since the voltages across each component must be equal and in phase with each other.

Figure 9A shows a parallel RL circuit and its resulting vector diagrams. Once again the vector for the resistor is placed at zero degrees. It is now a simple matter to plot the vector for the coil's current,  $I_L$ . The current in an inductor lags the voltage by 90 degrees, so the vector is drawn downward.

Figure 9B shows the vector diagram for a parallel RC circuit. Notice that the capacitive and inductive vectors for parallel circuits are drawn the opposite way to those for series circuits. That is simply because we are examining current, not voltage.

Just as the resistance of a parallel resistor network is always less than the value of the smallest resistor, so the impedance of a parallel RC or RL circuit is smaller than both the individual resistance and reactance. Vectors can be used to determine parallel circuit impedance, but the reciprocal values of  $R$ ,  $X$ , and  $Z$  must be used. That makes impedance calculations a lit-

(Continued on page 94)



# Build The Scanner Silencer

*This simple carrier-operated switching circuit eliminates the squealing and howling feedback that's caused by scanner-transceiver interaction*

BY BRIAN PLILER

**A**re you tired of having to turn down the volume of your scanner before transmitting on your rig because of squealing and howling feedback that occurs when you forget? If so, then maybe you should consider building the *Scanner Silencer* described in this article. The Scanner Silencer is basically a carrier-operated-relay (COR) that detects RF energy whenever your transceiver is keyed up. When RF is detected, the circuit instantly mutes scanner audio, effectively eliminating the squealing and howling feedback that would normally occur.

The unit works with both AM and FM transceivers running approximately 4- to 10-watts of RF output power. That allows it to be used by citizens-band (CB) radio operators in the 27-MHz CB band as well as by licensed amateur-radio operators in the 10-meter amateur band.

**About the Circuit.** A schematic diagram of the Scanner Silencer is shown in Fig. 1. Audio from the scanner is connected to the Scanner Silencer through PL1, a plug that is simply inserted into the scanner's external speaker jack. Through PL1, the scanner's audio output is connected to the wiper or moving contact of K1-a. The normally-closed contact of K1-a is connected to a panel-mounted jack, J1. A common extension speaker is plugged into J1. The normally-open contact of K1-a is connected to resistor R4.

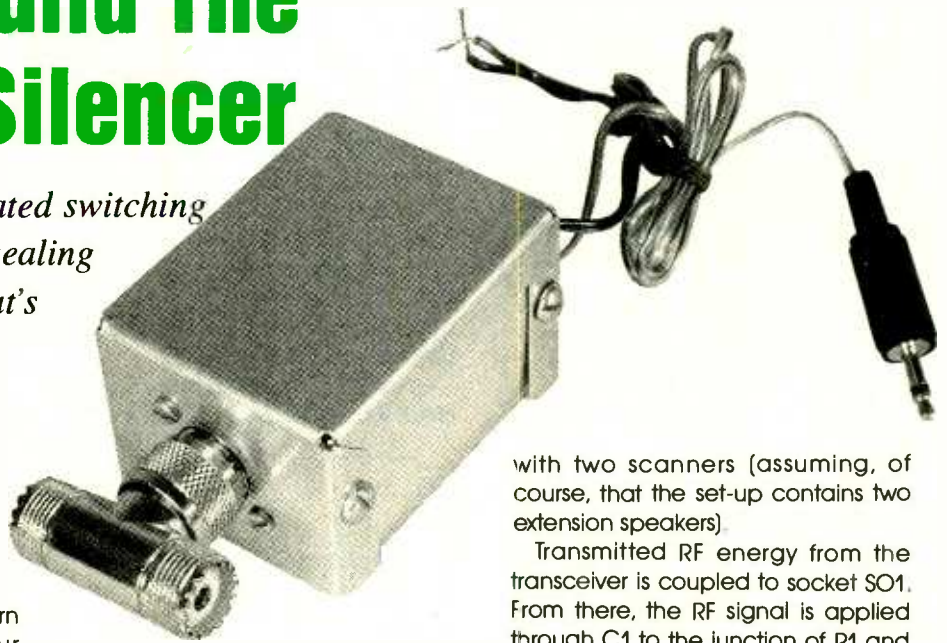

As long as you are not transmitting, scanner audio can be heard through the extension speaker. But the moment that you transmit, the relay energizes and the scanner audio is removed (muted) from the extension speaker and grounded through resistor R4. Resistor R4 absorbs the scanner audio while you are transmitting to prevent possible damage to the scanner's audio amplifier section. The R4 wattage should be chosen so that it can absorb the full audio-output power of the scanner without overheating. The K1-b contacts of the relay are not used in the prototype, since the Scanner Silencer was originally intended for use with a single scanner. However, provisions have been made on the Scanner Silencer's printed-circuit board to allow the unit to be used

with two scanners (assuming, of course, that the set-up contains two extension speakers).

Transmitted RF energy from the transceiver is coupled to socket SO1. From there, the RF signal is applied through C1 to the junction of R1 and R2. Resistor R1 sets the input impedance of the circuit to approximately 4.7k, while R2 is used to limit current flow through D1 and D2. Resistor R2 also helps to isolate the diodes from the antenna feedline to prevent the diodes from generating harmonic interference.

Diodes D1 and D2, along with capacitor C2, form a voltage-doubler circuit that converts the RF energy into a DC voltage. That DC voltage is used to turn on transistor Q1, which, in turn, energizes K1. Diode D3 is used to protect transistor Q1 from possible damage when the magnetic field around the relay collapses.

**Assembly.** The prototype unit was assembled on a small printed-circuit board, measuring about 2 $\frac{1}{16}$  by 1 $\frac{1}{16}$

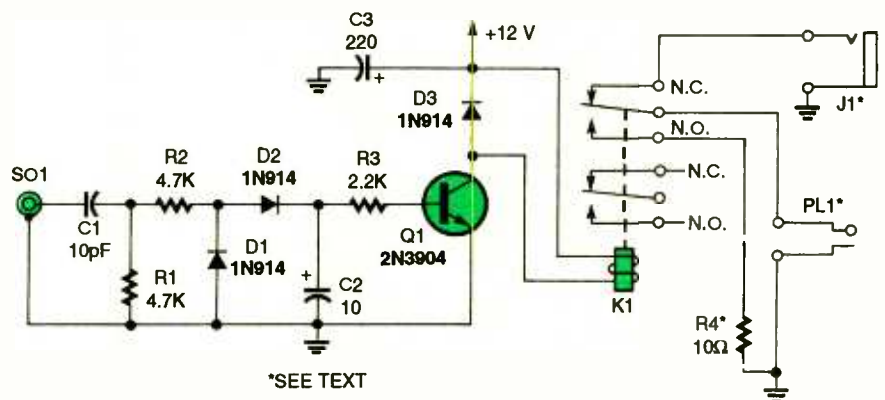

Fig. 1. The Scanner Silencer is nothing more than a carrier-operated relay. When an RF signal is detected, the circuit turns on, removing the connected scanner's audio from an external speaker to prevent feedback.

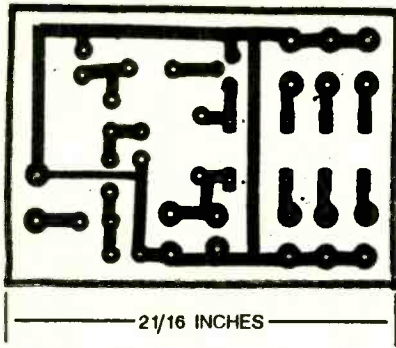

Fig. 2. The Scanner Silencer's was assembled on a small printed-circuit board, measuring about 2 1/16 by 1 7/16 inches. A full-size template of its printed-circuit board is shown here.

have etched your board and obtained all of the components listed in the Parts List, construction can begin.

A parts-placement diagram for the printed-circuit layout is shown in Fig. 3. As usual, it is recommended that you install the passive components first, followed by the semiconductors. After all board-mounted components have been installed, it is time to prepare the enclosure by drilling three holes in suitable locations. Note that a metal (aluminum) enclosure must be used to house the circuit.

Since SO1 is the most difficult to handle, it would be a good idea to deal

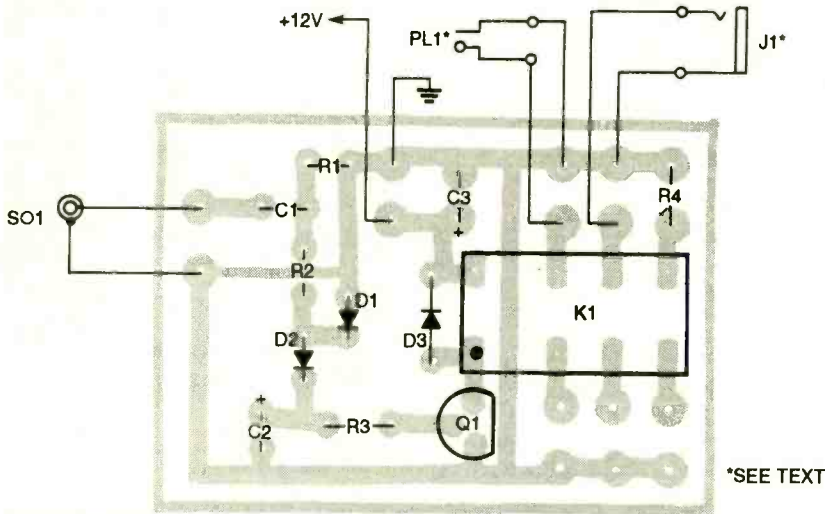

Fig. 3. Once you have etched your board and obtained all of the components listed in the Parts List, assemble your unit using this parts-placement diagram as a guide.

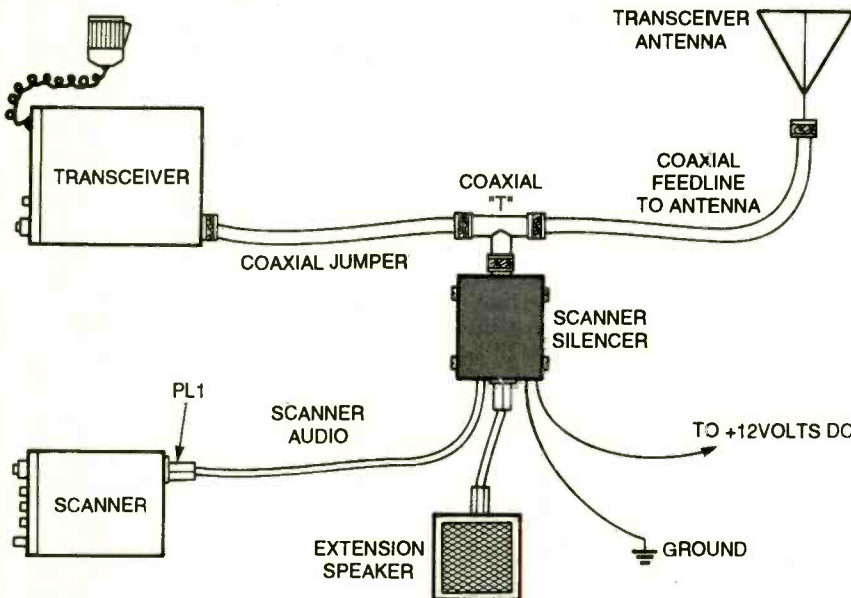

Fig. 4. This illustration outlines how to properly insert the Scanner Silencer into your scanner/transceiver system.

inches. A full-size template for the Scanner Silencer's printed-circuit board is shown in Fig. 2. Once you

with it first. Before drilling any holes in the enclosure, make certain that the enclosure is clamped securely to your

## PARTS LIST FOR THE SCANNER SILENCER

### SEMICONDUCTORS

- Q1—2N3904 general-purpose NPN silicon transistor
- D1—D3—1N914 general-purpose silicon diode

### RESISTORS

- (All resistors are 1/4-watt, 5% units, unless otherwise noted.)
- R1, R2—4700-ohm
- R3—2200-ohm
- R4—10-ohm (see text)

### CAPACITORS

- C1—10-pF ceramic-disc
- C2—10-μF 35-WVDC, electrolytic
- C3—220-μF, 35-WVDC, electrolytic

### ADDITIONAL PARTS AND MATERIALS

- SO1—Chassis mount SO-239 connector (Radio Shack #278-201 or similar)
- PL1—See text
- J1—See text
- K1—12-volt DPDT sensitive-coil relay with 1 amp contacts (ITT #RZ-12 or similar)
- Printed-circuit materials, metal enclosure (Radio Shack #270-235 or similar), coaxial T-connector (Radio Shack #278-198 or similar) rubber grommet, PL-259 connector (see text), wire, solder, hardware, etc.

work surface. Do not try to hold the box while drilling!

Begin by drilling a hole—starting with a relatively small bit (about 1/8 inch in diameter) and then slowly working up—of sufficient size to allow the threaded portion of SO1 to pass through the enclosure. Do not try using a large bit first, you risk tearing or warping the aluminum. After drilling the hole, mount SO1 to the enclosure.

After mounting SO1, drill the appropriate size mounting hole for J1. Drill another hole near the J1 hole. That hole is used to pass the power, ground, and audio-input wires for PL1. Note: PL1 must be selected to mate with the external speaker jack on your scanner. Place a rubber grommet into the hole, route the power, ground, and audio input wires into the enclosure, and solder the wires to the board at the appropriate locations.

Now connect J1 to the board using short lengths of wire. Next, again using short lengths of wire, make the appro-

(Continued on page 91)



Enter A World Of Excitement with a Subscription to

# Popular Electronics®

Get the latest electronic technology and information monthly!

Now you can subscribe to the magazine that plugs you into the exciting world of electronics. With every issue of Popular Electronics you'll find a wide variety of electronics projects you can build and enjoy.

Popular Electronics brings you informative new product and literature listings, feature articles on test equipment and tools—all designed to keep you tuned in to the latest developments in electronics. So if you love to build fascinating electronics, just fill out the subscription form below to subscribe to Popular Electronics... It's a power-house of fun for the electronics enthusiast.

## EXCITING MONTHLY FEATURES LIKE:

- CONSTRUCTION**—Building projects from crystal sets to electronic roulette
- FEATURES**—Educational training on digital electronics, Ohm's Law, Antennas, Communications, Antique Radio, Simplified Theory
- HANDS-ON-REPORTS**—User test comments on new and unusual consumer products
- SPECIAL COLUMNS**—Think Tank, Circuit Circus, Computer Bits, DX Listening, Antique Radio, Scanner Scene, Amateur Radio

## PLUS: ALL OUR GREAT DEPARTMENTS!

You'll get 12 exciting and informative issues of Popular Electronics for only \$18.95. That's a savings of \$23.05 off the regular single copy price. Subscribe to Popular Electronics today! Just fill out the subscription order form below.



FOR FASTER SERVICE CALL TODAY

**1-800-827-0383**

(7:30AM-8:30PM) EASTERN STANDARD TIME

## Popular Electronics® SUBSCRIPTION ORDER FORM

APEJ4

P.O. Box 338, Mt. Morris IL. 61054

**YES!** I want to subscribe to Popular Electronics for 1 Full year (12 Issues) for only \$18.95. That's a savings of \$23.05 off the newstand price.  
(Basic Subscription Rate—1 yr/\$21.95)

Payment Enclosed     Bill me later  
Please charge my:     Visa     Mastercard

Acct. #

Signature \_\_\_\_\_

Exp. Date \_\_\_\_\_

PLEASE PRINT BELOW:

NAME \_\_\_\_\_

ADDRESS \_\_\_\_\_

CITY \_\_\_\_\_ STATE \_\_\_\_\_ ZIP \_\_\_\_\_

Allow 6 to 8 weeks for delivery of first issue. U.S. Funds only.  
In Canada add \$6.68 Postage (Includes G.S.T.). All Other Foreign add \$7.50 Postage.

# COMPUTER BITS

By Jeff Holtzman

## FrontRunner

It is commonly thought that there are two types of people in the world: Those who like command-line interfaces (DOS) and those who like GUIs (Windows). Actually, there is a third category; those who like both. If you count yourself among the latter, you are going to love a new

them. That's a superior approach to that used by some totally Windows-based DOS command-line emulators, for several reasons. First is that with FrontRunner, you can use your own DOS shell, be it 4DOS, NDOS, COMMAND, or what have you. By using your own shell, you have guaranteed compatibility and no quirks in the use of commands.

You can't say that about DashBoard's command-line interpreter. But there are lots of other things that help FrontRunner pull out in front of the pack. For one, it gives a "scroll-back" or history capability. If you've ever wished you could scroll back through a long directory or text-file listing, FrontRunner gives you a Windows-based means of doing so. The program can capture as many as 16,000

lines in the history buffer. Using a mouse and the Windows scrollbar, you're free to peruse the buffer. And if you get the urge to cut and paste some of that text into another application—Windows or DOS—just drag the mouse pointer through the desired text, select Copy, switch to the other application, and select Paste. (Yes, I know that there are numerous scroll-back utilities for DOS. But I've yet to find one that works reliably under Windows. Furthermore, FrontRunner is currently the only program that allows DOS/DOS cut-and-paste.)

There are even cooler ways of doing things like that. You're probably familiar with DOS command-line redirection. For example, if you type DIR C:\CDIR.TXT, you'll get a text file with a listing of the contents of your hard drive's root directory. Then you might import that file into some application (e.g., your word processor). FrontRunner gives you a cleaner way. Just type DIR C:\ \$CLIP, and the listing will be copied to the Windows clipboard. Just switch to the other application, and select Paste.

I love FrontRunner's ability to interact with the Windows clipboard from both the DOS and Windows side. But that's not the only trick this pony knows. You can launch both DOS and Windows programs from the command line. Sometimes it's faster to just type NOTEPAD than to search through dozens of program groups and icons. In addition, you can launch a Windows program simply by typing in the name of an associated data file. For example, change to your budget directory, type BUDGET94.XLS and Excel will launch with that file loaded and ready to go.

There are other features as well. You can open multiple DOS windows simultaneously. You can direct text-only output to a special text window, essentially a simple text editor. You can define multiple launch-bar configurations, loading and unloading them at will. Each launch bar can be configured to appear along one edge of the FrontRunner window, or totally detached from it. You can search through the history buffer for a specific text string; you can also save the buffer to disk, or print it.

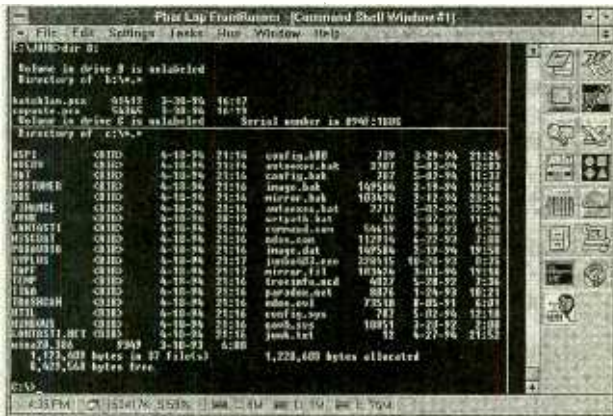

FrontRunner, a new Windows shell from Phar Lap Software, combines the best of the DOS and Windows worlds.

product called FrontRunner (\$139), by Phar Lap Software, Inc. (60 Aberdeen Avenue, Cambridge, MA 02138; Tel. 800-292-9622, or 617-661-1510). I was skeptical at first (you get that way after ten years of reviewing computer products and technologies), but it took less than an hour of playing with this product to make it my primary Windows shell—in the process, giving up what had until then been a good friend; HP's DashBoard.

In a word, FrontRunner gives you the best of both command-line and GUI worlds. It works by "encapsulating" the DOS command-line prompt in a Windows shell, and providing tight integration and communication between

product called FrontRunner (\$139), by Phar Lap Software, Inc. (60 Aberdeen Avenue, Cambridge, MA 02138; Tel. 800-292-9622, or 617-661-1510). I was skeptical at first (you get that way after ten years of reviewing computer products and technologies), but it took less than an hour of playing with this product to make it my primary Windows shell—in the process, giving up what had until then been a good friend; HP's DashBoard.

In a word, FrontRunner gives you the best of both command-line and GUI worlds. It works by "encapsulating" the DOS command-line prompt in a Windows shell, and providing tight integration and communication between

product called FrontRunner (\$139), by Phar Lap Software, Inc. (60 Aberdeen Avenue, Cambridge, MA 02138; Tel. 800-292-9622, or 617-661-1510). I was skeptical at first (you get that way after ten years of reviewing computer products and technologies), but it took less than an hour of playing with this product to make it my primary Windows shell—in the process, giving up what had until then been a good friend; HP's DashBoard.

In a word, FrontRunner gives you the best of both command-line and GUI worlds. It works by "encapsulating" the DOS command-line prompt in a Windows shell, and providing tight integration and communication between



Phar Lap has used the DOS/Windows communications capability in some ingenious ways. For example, the package also includes a pretty good file-find utility that runs from DOS, but prompts you for information about what to search for and where, via a Windows dialog box. Then it goes off searching, in the background, while you do something else. Nice. (Phar Lap should turn the mouse pointer into an hourglass while it's searching to let you know what's going on.)

In fact, you can provide Windows-like front ends for your DOS utilities using FrontRunner's enhanced batch-file commands. Those features only work from a FrontRunner DOS box running under Windows; in other words, they won't work if Windows is not loaded.

## WINDOWS CAPABILITIES

From a Windows point of view, FrontRunner provides many of the functions that we've come to expect from a Program Manager replacement, including an icon bar for quick access to your favorite applications, and a full-featured, highly-customizable status bar that can display time (but not date), free memory and system resources, free disk space on one or more drives, current clipboard contents, and more. The only thing lacking in this regard is a quick printer switcher (like DashBoard's). However, a little "spelunking" on CompuServe produced a more-than-serviceable shareware utility, PrintSwitch 1.8a, by Michael Haschka (73027,3307).

FrontRunner's main-menu bar contains one menu that lists active tasks, and allows you switch among them. Another menu allows

you to run programs via your program manager groups, which are presented as text-only listings, not as icons. A related feature is a highly capable group and icon manager, which allows you to add, copy, delete, and move program icons and groups. Ironically, the group manager does present groups in icon form, but a bug prevents multiline icon titles from displaying properly.

One anomaly is that you can append text to the clipboard via a batch-language command, but not interactively using the mouse. My only other complaint is that the launch-bar configuration is not quite as versatile as DashBoard's. In particular, icons can be displayed as icon only, or with a two-line caption. In my opinion, that wastes too much screen real estate; I'd prefer a one-line option, and the ability to customize the font.

I found one bug in the early release that I received. When using something other than COMMAND.COM (I use 4DOS) as the primary DOS shell, the history buffer did not work correctly. Running 4DOS under COMMAND provided a work-around; Phar Lap is looking into the problem.

If you're interested in FrontRunner, but would like to try before you buy, Phar Lap has developed a "lite" version; call the company for details. If you're a Windows C programmer, the package also includes a programming interface and documentation that allows you to build your own command-line and status-bar utilities.

I loved DashBoard, but FrontRunner is my new favorite. If version 1 is this good, I can't wait to see version 2!

# 3 NEW BOOKS for the Project Builder

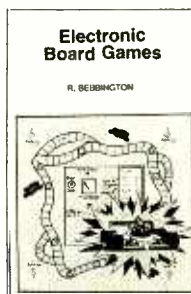

**BP350—ELECTRONIC BOARD GAMES ..... \$6.00**

Twenty novel electronic board games that you can build from the plans in this book. Whether you are interested in motor racing, searching for buried treasure on a desert island or for gold in Fort Knox, spinning the wheel of fortune, or doing a musical quiz—there is something for you to build and enjoy!

**PCP119—ELECTRONIC MUSIC AND MIDI PROJECTS ..... \$14.95**

Save cash by building the MIDI gadgets you need. Want a MIDI THRU box, program change pedal, Metronome, analog echo unit, MIDI patchbay or switcher? Over 16 practical and very useful music and MIDI projects—all in this book! The projects are explained in detail with full instructions on assembly.

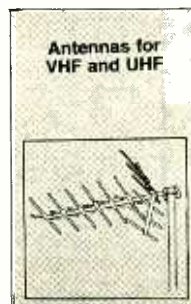
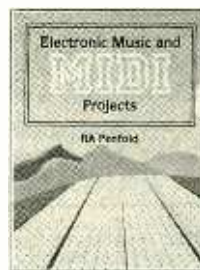

**BP301—ANTENNAS FOR VHF AND UHF ..... \$6.00**

From installing a TV or FM antenna to setting up a multi-antenna array for shortwave listening or amateur radio, this book explains the basics of VHF and UHF antenna operation and installation. The text describes in easy-to-understand terms the essential information about how antennas work, the advantages of different antenna types, and how to get the best performance from an antenna.

Mail to: **Electronic Technology Today, Inc.**  
P.O. Box 240 • Massapequa Park, NY 11762-0240

### Shipping Charges in USA & Canada

\$0.01 to \$5.00 .....	\$1.50	\$30.01 to \$40.00 .....	\$5.50
\$5.01 to \$10.00 .....	\$2.50	\$40.01 to \$50.00 .....	\$6.50
\$10.01 to \$20.00 .....	\$3.50	\$50.01 and above .....	\$8.00
\$20.01 to \$30.00 .....	\$4.50		

Sorry, no orders accepted outside of USA and Canada. All payments must be in U.S. funds only.

Number of books ordered.

Total price of books .....	\$ _____
Shipping (see chart) .....	\$ _____
Subtotal .....	\$ _____
Sales Tax (NYS only) .....	\$ _____
Total enclosed .....	\$ _____

Name \_\_\_\_\_

Address \_\_\_\_\_

City \_\_\_\_\_ State \_\_\_\_\_ ZIP \_\_\_\_\_

Please allow 6-8 weeks for delivery.

# ELECTRONICS MARKET PLACE

## FOR SALE

**CABLE** test chips. Jerrold, Tocom, S.A., Zenith. Put cable boxes into full service model! \$29.95 to \$59.95. 1 (800) 452-7090, (310) 902-0841.

**CABLE descramblers** and test turn-on kits available for most makes and models. We also carry bullet stoppers. No catalog, no 800 number equals your lowest prices. Call others, then compare our prices! Cash paid for cable equipment. No Florida sales. (305) 425-0751.

**THE Case Against Patents.** Thoroughly tested and proven alternatives that work in the real world. \$28.50. SYNERGETICS PRESS, Box 809-C, Thatcher, AZ 85552. (602) 428-4073. Visa/MC.

## TELEVISION VIDEOS

**INEXPENSIVE, proven, colorbar generator alternative!** Crosshatch, dot matrix, and more on high grade VHS. 30 minutes. Only \$23.95. DLD DISTRIBUTORS, 429 Cessna Road, Concord, NC 28025.

## INVENTIONS

**FREE Invention package: DAIVSON & ASSOCIATES** offers customized development, patenting, and licensing for new products and ideas. Proven results: 1 (800) 677-6382.

### CLASSIFIED AD ORDER FORM

To run your own classified ad, put one word on each of the lines below and send this form along with your check to:

**Popular Electronics Classified Ads**, 500-B Bi-County Boulevard, Farmingdale, N.Y. 11735

**PLEASE INDICATE** in which category of classified advertising you wish your ad to appear. For special headings, there is a surcharge of \$11.00.

( ) Plans/Kits ( ) Business Opportunities ( ) For Sale  
( ) Education/Instruction ( ) Wanted ( ) Satellite Television

Special Category: \$11.00

#### PLEASE PRINT EACH WORD SEPARATELY, IN BLOCK LETTERS.

(No refunds or credits for typesetting errors can be made unless you clearly print or type your copy.) Rates indicated are for standard style classified ads only. See below for additional charges for special ads. **Minimum: 15 words.**

1	2	3	4	5
6	7	8	9	10
11	12	13	14	15 (\$23.25)
16 (\$24.80)	17 (\$26.35)	18 (\$27.90)	19 (\$29.45)	20 (\$31.00)
21 (\$32.55)	22 (\$34.10)	23 (\$35.65)	24 (\$37.20)	25 (\$38.75)
26 (\$40.30)	27 (\$41.85)	28 (\$43.40)	29 (\$44.95)	30 (\$46.50)
31 (\$48.05)	32 (\$49.60)	33 (\$51.15)	34 (\$52.70)	35 (\$54.25)

We accept MasterCard and Visa for payment of orders. If you wish to use your credit card to pay for your ad fill in the following additional information (Sorry, no telephone orders can be accepted):

Card Number

Expiration Date

PRINT NAME

SIGNATURE

**IF YOU USE A BOX NUMBER YOU MUST INCLUDE YOUR PERMANENT ADDRESS AND PHONE NUMBER FOR OUR FILES. ADS SUBMITTED WITHOUT THIS INFORMATION WILL NOT BE ACCEPTED.**

**CLASSIFIED COMMERCIAL RATE:** (for firms or individuals offering commercial products or services) \$1.55 per word prepaid (no charge for ZIP code)...**MINIMUM 15 WORDS.** 5% discount for same ad in 6 issues within one year; 10% discount for 12 issues within one year if prepaid not applicable on credit card orders. **NON-COMMERCIAL RATE:** (for individuals who want to buy or sell a personal item) \$1.25 per word, prepaid....no minimum. **ONLY FIRST WORD AND NAME** set in bold caps at no extra charge. Additional bold face (not available as all caps) **30¢ per word additional.** Entire ad in boldface, \$1.85 per word. **TINT SCREEN BEHIND ENTIRE AD: \$1.90 per word. TINT SCREEN BEHIND ENTIRE AD PLUS ALL BOLD FACE AD: \$2.25 per word. EXPANDED TYPE AD: \$2.05 per word prepaid.** Entire ad in boldface, \$2.45 per word. **TINT SCREEN BEHIND ENTIRE EXPANDED TYPE AD: \$2.55 per word. TINT SCREEN BEHIND ENTIRE EXPANDED TYPE AD PLUS ALL BOLD FACE AD: \$2.95 per word. DISPLAY ADS: 1" x 2 1/4" — \$205.00; 2" x 2 1/4" — \$410.00; 3" x 2 1/4" — \$615.00.** **General Information:** Frequency rates and prepayment discounts are available. **ALL COPY SUBJECT TO PUBLISHERS APPROVAL. ADVERTISEMENTS USING P.O. BOX ADDRESS WILL NOT BE ACCEPTED UNTIL ADVERTISER SUPPLIES PUBLISHER WITH PERMANENT ADDRESS AND PHONE NUMBER.** Copy to be in our hands on the 18th of the fourth month preceding the date of issue (i.e., Sept. issue copy must be received by May 18th). When normal closing date falls on Saturday, Sunday or Holiday, issue closes on preceding work day. Send for the classified brochure. Circle Number 49 on the Free Information Card.

## ★ 1994 CATALOG ★ OF THE WORLD'S MOST FAMOUS CB ANTENNAS & ACCESSORIES

— FIRESTIK ANTENNA —  
2614 E. Adams · Phoenix, AZ 85034  
Write or Call, 602-273-7151

**GREAT idea!** We do documentation right! **PAT DOCUMENT SERVICES**, PO Box 200, Ellisville, MS 39437. (601) 477-3875.

**CABLE TV converters/descramblers** 2 year warranties on Jerrold, Zenith, Tocom, Scientific Atlanta. We service most converters. Money back guarantee. **NATIONAL CABLE SERVICES** (219) 935-4128.

**PRINTED** circuit boards — etched, drilled, tin plated. Single sided \$1.25/sq. inch. Free shipping. **CHELCO ELECTRONICS**, 61 Water Street, Mayville, NY 14757. 1 (800) 388-8521.

## CB RADIO OWNERS!

We specialize in a wide variety of technical information, parts and services for CB radios. 10-Meter and FM conversion kits, repair books, plans, high-performance accessories. Thousands of satisfied customers since 1976! Catalog \$3.

**CBC INTERNATIONAL, INC.**  
P.O. BOX 31500PE, PHOENIX, AZ 85046

**OSCILLOSCOPE** simulator program for IBM PC MS-DOS compatibles is \$20.00. Free literature. **SCOPE**, 21555 Doneswood, Waukesha, WI 53186.

**PROTECT** yourself and cash in on crime, security devices catalog and special offer, \$5.00, write **GEMINI ENTERPRISES**, PO Box 1558, Bristol, CT 06011-1558.

**CAR** stereo amplifiers, woofer boxes, speakers, equalizers. Free catalog. **L.H. ENG**, 8362 Pines Blvd., Suite 422PE, Pembroke Pines, FL 33024.

**SECRET cable descramblers!** Build your own descrambler for less than \$12.00 in seven easy steps! **Radio Shack** parts list and free descrambling methods that cost nothing to try, included. Send \$10.00 to: **INFORMATION FACTORY**, PO Box 669, Seabrook, TX 77586. For COD's (713) 922-3512 any time!

**300 Experimenters Circuits** — Complete in 6 practical books using diodes, relays, FET's, LED's, IC 555's, and IC CA3130's for building blocks. Only \$33.00 plus \$5.50 for shipping. USA and Canada only. US funds. **ETT, INC.**, PO Box 240, Massapequa Park, NY 11762-0240.



## SATELLITE TELEVISION

LEARN how to buy satellite systems at wholesale prices. Kingviper \$629.00, Tracker 10 plus \$769.00, Monterey 95 \$1,099.00. Get free subscription of Onsat and Satellite TV Week. \$29.95, SATTRONICS, Box 832P, N. Highlands, CA 95660.

## BUSINESS OPPORTUNITIES

MAKE \$75,000.00 to \$250,000.00 yearly. Learn IBM monitors repairs (solutions most brands). New home based business program. Software available. Information: USA-Canada \$3.00 cash (no checks), Dealers wanted worldwide (\$35.00) US funds. RANDALL DISPLAY, PO Box 2168-H, Van Nuys, CA 91404, USA.

EASY work! Excellent pay! Assemble products at home. Call toll free 1 (800) 467-5566 ext. 5730.

START your own technical venture! Don Lancaster's newly updated Incredible Secret Money Machine II tells how. We now have autographed copies of the Guru's underground classic for \$18.50. SYNERGETICS PRESS, Box 809-C, Thatcher, AZ 85552. (602) 428-4073. Visa/MC.

# TODAY'S THE DAY

Stop Smoking.



American Heart Association

# HOME FIRE SAFETY. ACT ON IT!



FOR FREE HOME FIRE SAFETY TIPS, WRITE:

United States  
Fire Administration  
P.O. Box 70274  
Washington, DC 20024



## Learn VCR repair!

Home study. Learn high-profit repairs without investing in high-tech instruments. FREE BOOKLET: 800-223-4542.

Name \_\_\_\_\_ Age \_\_\_\_\_  
Address \_\_\_\_\_  
City \_\_\_\_\_ State \_\_\_\_\_ Zip \_\_\_\_\_  
The School of VCR Repair, Dept. VRK341  
6065 Roswell Road, Atlanta, Georgia 30328



## EDUCATION/INSTRUCTION

ELECTRONIC engineering. 8 volumes complete. \$109.95. No prior knowledge required. Free brochure. BANNER TECHNICAL BOOKS, 1203 Grant Avenue, Rockford, IL 61103.

VCR Repairs You Can Do. Save\$. Make\$. 403-page textbook used by national correspondence schools. \$Back-guarantee. Over 40,000 sold. 704 illustrations + tool. Mail \$24.95 to WORTHINGTON PUBLISHING, Box 16691N, Tampa, FL 33687-6691.

BECOME an electronics engineer! Money for college available. Call (609) 266-2887 ext. 112 for recorded message.

BECOME an amateur radio operator ham. Information how \$3.00 D&S INT., PO Box 73560, Metairie, LA 70033-3560.

DIGITAL electronics, learn at home or college for digital computers, full color illustrations 360 pages. Send \$29.95 to PJ ENTERPRISES, 26551 Sparks St., Highland, CA 92346.

ELECTRICITY Electronics training series used by US military. 24 volumes, other courses available. Free info: FEDERAL TECHNICAL PUBLISHERS, Box 1218 E, Glen Lake, MN 55345.

## PLANS & KITS

60 Solderless Breadboard Projects in two easy-to-read pocket books. Complete with circuit descriptions, schematics, parts layouts, component listings, etc. Both books (BP107 & BP113) only \$11.90 plus \$3.50 for shipping. USA and Canada only. US funds. ETT, INC., PO Box 240, Massapequa Park, NY 11762-0240.

SCHEMATIC design program, Free brochure. Write Dept. P, SCHEME-ADDICT, 8622 W. 44th Place, Wheat Ridge, CO 80033.

LASER plans. Build your own laser. Diagrams, construction tips, part sources. \$6.00. Satisfaction guaranteed. K. HARRIS, PO Box 290729, Phelan, CA 92329.

THE Anarchist's BBS: A resource for controversial and unusual information. Lots of "how to" data. Call (214) 289-8328.

TWINKLING musical flower kit. Send \$10.00 to MCPALMO ENTERPRISES, 5608 Hamilton Manor Drive 5, Hyattsville, MD 20782. (301) 559-7044. Be unforgettable.

SURVEILLANCE/Countersurveillance, bugging/phone tapping detector, telephone/fax encryption, vehicle tracking, covert video, transmitters kit, and more...A.B. ELECTRONICS, (718) 253-3637.

MASTERCARD AND VISA are now accepted for payment of your advertising. Simply complete the Classified Ad order form and we will bill you.

THIS IS A BOLDFACE EXPANDED-TYPE AD WITH A TINT SCREEN. See how it jumps out on the page. To order your ad in this format calculate the cost at \$2.70 per word.

# BUY BONDS

NU-TEK ELECTRONICS Video Stabilizer

\$49.95

FREE Catalog

CABLE TV EQUIPMENT



1-800-228-7404



NEW PICTURE IN PICTURE Stereo

PIP WORKS ON ALL TV'S. 181 CHANNEL CAPABILITY. REMOTE CONTROL. 4 SOURCE INPUTS



3250 Hatch Cedar Park TX 78613

## ANTIQUE RADIO CLASSIFIED

Free Sample!

Antique Radio's  
Largest Circulation Monthly.  
Articles, Ads & Classifieds.  
6-Month Trial: \$16.95. 1-Yr: \$31.95 (\$47.95-1st Class).  
A.R.C., P.O. Box 802-L12, Carlisle, MA 01741



## Be a computer repair expert!

Professional-level home study. Learn PC repairs, troubleshooting, upgrading, servicing, installation. Open your own business; be a more valuable employee. Free career literature.

Send or call:  
800-223-4542



Name \_\_\_\_\_ Age \_\_\_\_\_

Address \_\_\_\_\_ Phone (\_\_\_\_) \_\_\_\_\_

City \_\_\_\_\_ State \_\_\_\_\_ Zip \_\_\_\_\_

The School of PC Repair

PCDI, 6065 Roswell Road  
Dept. JJK341 Atlanta, Georgia 30328

## BEST BY MAIL

Rates: Write National, Box 5, Sarasota, FL 34230

FINANCIAL

VISA/MASTERCARD GUARANTEED! ALSO SUPER-LOW INTEREST CARDS. (312) 918-4078.

EARN \$500-\$1000 WEEKLY stuffing envelopes. For details—Rush \$1.00 with SASE to: KAPPaONE, PO Box 220, Clarion, PA 16214.

OF INTEREST TO ALL

MODERN DAY REVIVAL? Eternal Security? Send for FREE Bible Studies. Light, St. Maries, ID 83861.

WE MAKE NAME and Address RUBBER STAMPS \$8.00. Specialized Business Address with Logo \$14.00. Same day service. Stamp Connection, Box 556-P, Grover Beach, CA 93483. 805-481-7843 Fax. 805-481-5189.

HOW TO BUY FEDERAL surplus property. Simple instructions. \$1.00: DECY, Box 1294, Severna Park, MD 21146.

FREE ELECTRONICS PARTS, I've been getting them for years. I'll show you how. Call: 1-800-200-0396.

# Electronic Paperbacks at Special Prices

**BP325—A CONCISE USER'S GUIDE TO WINDOWS 3.1 . . . . \$7.95.** Come to grips with Windows 3.1 in the shortest and most effective way. Learn how to manipulate Windows screens and DOS by Windows graphics interface. Master its word processor, Paintbrush and data base along with Notepad, Macro Recorder, PIF Editor, and Calculator.

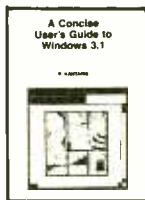

**BP311—AN INTRODUCTION TO SCANNERS AND SCANNING . . . . \$7.95.** Radio scanners have opened a realm of exciting radio listening. Understand radio wave propagation, types of transmissions, antennas, band assignments—the straight dope on what to hear and where to hear it! Comes complete with index, glossary of important terminology.



**BP287—A REFERENCE GUIDE TO PRACTICAL ELECTRONICS TERMS . . . . \$8.95.** More than just a dictionary of practical electronics terms, the book goes a step further in getting down to fundamentals. A reference volume that can be read casually by a reader seeking knowledge.

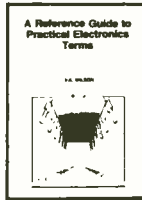

**BP248—TEST EQUIPMENT CONSTRUCTION . . . . \$5.95.** Details construction of simple, inexpensive, but extremely useful test equipment. AF Gen, Test Bench Ampl, Audio Millivoltmeter, Transistor Tester and six more.



**BP267—HOW TO USE OSCILLOSCOPES AND OTHER TEST EQUIPMENT . . . . \$6.95.** Mastering the oscilloscope is not really too difficult. This book explains all the standard controls and functions. Other equipment is also described.



**BP265—MORE ADVANCED USES OF THE MULTI-METER . . . . \$5.95.** Use these techniques to test and analyze the performance of a variety of components. Also see how to build add-ons to extend multi-meter capabilities.



**BP256—INTRO TO LOUDSPEAKERS AND ENCLOSURE DESIGN . . . . \$5.95.** We explore the variety of enclosure and speaker designs in use today, so the reader can understand the principles involved.

**BP298—A CONCISE INTRODUCTION TO THE MACINTOSH SYSTEM AND FINDER . . . . \$6.25.** If you have one of the popular Macintosh range of computers, this book is designed to help you get the most from it. Although the Mac's WIMP user interface is designed to be easy to use, much of it only becomes clear when it is explained in simple terms. All Macintosh computers are covered including the new "Classic" range.



**BP299—PRACTICAL ELECTRONIC FILTERS . . . . \$6.95.** Presents a dozen filter-based practical projects with applications in and around the home or in the constructor's workshop. Complete construction details are included.



**BP249—MORE ADVANCED TEST EQUIPMENT CONSTRUCTION . . . . \$6.95.** Eleven more test equipment construction projects. They include a digital voltmeter, capacitance meter, current tracer, etc.



**BP308—PREAMPLIFIER AND FILTER CIRCUITS . . . . \$6.95.** Provides circuits and background info for a range of pre-amplifiers, plus tone controls, filters, mixers and more. All are high-performance circuits that can be built at a reasonable cost.



**BP245—DIGITAL AUDIO PROJECTS . . . . \$5.95.** Practical circuits to build and experiment with. Includes A/D converter, input amplifier, digital delay line, compander, echo effect and more.



**BP247—MORE ADVANCED MIDI PROJECTS . . . . \$5.95.** Circuits included are a MIDI indicator, THRU box, merge unit, code generator, pedal, programmer, channelizer, and analyzer.



**BP257—INTRO TO AMATEUR RADIO . . . . \$6.95.** Amateur Radio is a unique and fascinating hobby. This book gives the newcomer a comprehensive and easy to understand guide to the subject.

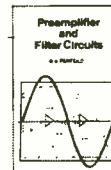

**PCP115—ELECTRONIC PROJECTS FOR HOME SECURITY . . . . \$10.00.** 25 projects ranging from a single-door protection circuit that can be completed in an hour or two, to a sophisticated multi-channel security system. Each project is described in detail with circuit diagrams, explanations of how it works, instructions for building and testing, and how to adapt circuits to meet special requirements.



**BP303—UNDERSTANDING PC SOFTWARE . . . . \$6.95.** This book will help you understand the basics of various types of business software in common use. Types of software covered include word processors, spelling checkers, graphics programs, desktop publishing, databases, spreadsheets and utilities.



**BP251—COMPUTER HOBBYISTS HANDBOOK . . . . \$8.95.** A wrapup of everything the computer hobbyist needs to know in one easy to use volume. Provides a range of useful reference material in a single source.



**BP238—GETTING THE MOST FROM YOUR MULTIMETER . . . . \$5.95.** Covers basics of analog and digital meters. Methods of component testing includes transistors, thyristors, resistors, capacitors and other active and passive devices.

**BP190—ADVANCED ELECTRONIC SECURITY PROJECTS . . . . \$5.95.** Includes a passive infra-red detector, a fiber-optic loop alarm, computer-based alarms and an unusual form of ultrasonic intruder detector.

**BP235—POWER SELECTOR GUIDE . . . . \$10.00** Complete guide to semiconductor power devices. More than 1000 power handling devices are included. They are tabulated in alpha-numeric sequence, by technical specs includes power diodes, Thyristors, Triacs, Power Transistors and FET's.

**BP234—TRANSISTOR SELECTOR GUIDE . . . . \$10.00.** Companion volume to BP235. Book covers more than 1400 JEDEC, JIS, and brand-specific devices. Also contains listing by case type, and electronic parameters. Includes Darlingtons transistors, high-voltage devices, high-current devices, high power devices.

**BP117—PRACTICAL ELECTRONIC BUILDING BLOCKS—Book 1 . . . . \$5.75.** Oscillators, Timers, Noise Generators, Rectifiers, Comparators, Triggers and more.

**BP195—INTRODUCTION TO SATELLITE TV . . . . \$9.95.** A definitive introduction to the subject written for the professional engineer, electronics enthusiast, or others who want to know more before they buy. 6 x 10 in.

**BP179—ELECTRONIC CIRCUITS FOR THE COMPUTER CONTROL OF ROBOTS . . . . \$7.50.** Data and circuits for interfacing the computer to the robot's motors and sensors

**BP97—IC PROJECTS FOR BEGINNERS . . . . \$5.50.** Power supplies, radio and audio circuits, oscillators, timers, switches, and more. If you can use a soldering iron you can build these devices.

**RADIO—100 RADIO HOOKUPS . . . . \$3.00.** Reprint of 1924 booklet presents radio circuits of the era including regenerative, neutrodyne, reflex & more.

**BP42—SIMPLE LED CIRCUITS . . . . \$5.50.** A large selection of simple applications for this simple electronic component.

**BP122—AUDIO AMPLIFIER CONSTRUCTION . . . . \$5.75.** Construction details for preamps and power amplifiers up through a 100-watt DC-coupled FET amplifier.

**BP92—CRYSTAL SET CONSTRUCTION . . . . \$5.50.** Everything you need to know about building crystal radio receivers.

**BP255—INTERNATIONAL RADIO STATIONS GUIDE . . . . \$7.95.** Provides the casual listener, amateur radio DXer and the professional radio monitor with an essential reference work designed to guide him or her around the more than ever complex radio bands.

## CHECK OFF THE BOOKS YOU WANT

**ELECTRONIC TECHNOLOGY TODAY INC.**  
P.O. Box 240, Massapequa Park, NY 11762-0240

**SHIPPING CHARGES IN USA AND CANADA**

**SORRY No orders accepted outside of USA & Canada**

Number of books ordered

Name \_\_\_\_\_  
Address \_\_\_\_\_  
City \_\_\_\_\_ State \_\_\_\_\_ Zip \_\_\_\_\_

\$0.01 to \$5.00 . . . . \$1.50  
\$5.01 to \$10.00 . . . . \$2.50  
\$10.01 to 20.00 . . . . \$3.50  
\$20.01 to 30.00 . . . . \$4.50  
\$30.01 to 40.00 . . . . \$5.50  
\$40.01 to 50.00 . . . . \$6.50  
\$50.01 and above . . . . \$8.00

Total price of merchandise . . . \$ \_\_\_\_\_  
Shipping (see chart at left) . . . \$ \_\_\_\_\_  
Subtotal . . . . \$ \_\_\_\_\_  
Sales Tax (NY State only) . . . \$ \_\_\_\_\_  
Total Enclosed . . . . \$ \_\_\_\_\_

All payments must be in U.S. funds

PE994



# CIRCUIT CIRCUS

By Charles D. Rakes

## Game Circuits

**O**n a return flight from Las Vegas, I mentally put together a few circuit ideas for this visit. I'll "bet" you know what kind of circuits we're going to share.

The prime component for each of our gaming circuits is the versatile 4017 CMOS decade counter/divider IC. This easy-going little chip can count up to ten and turn on a LED indicating the number of input clock pulses. Another good feature is the IC's low cost of about half-a-buck each from just about any parts supplier.

### COIN TOSS

Our simplest entry (see Fig. 1) places the 4017 IC in a coin-toss or decision-making circuit. No, this isn't

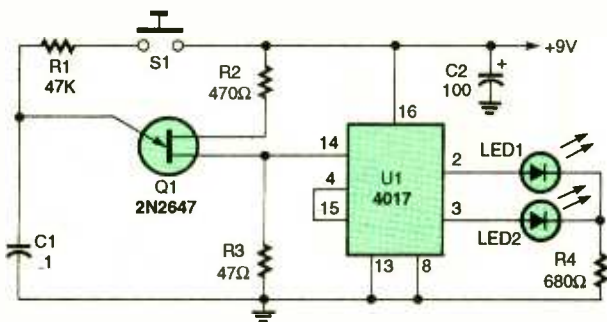

Fig. 1. Our coin-toss (or decision-making) circuit may not be high-tech, but hopefully it will serve as a good circuit for the beginner.

high-tech gaming, but it is an easy starting point for our circuit adventure.

Integrated circuit U1 is connected in a two-stage counter circuit that counts "one-two" over and over as long as clock pulses enter pin 14 of the 4017. When the clock pulses stop, one of the LED's will remain on, indicating the last even or odd count. Designate one LED as "heads" and the

other as "tails" and you have an electronic coin flipper.

The coin flipper's clock has a 2N2647 unijunction transistor in an RC relaxation oscillator. The values of R1 and C1 set the oscillator's frequency. If you like a fast oscillation between the two LED's, lower the value of R1; to slow the rate, increase the value of R1.

To operate the circuit, press S1 for a brief period of time and release. Only one of the LED's will remain on.

### CRAPS

Our next entry (see Fig. 2) uses a couple of 4017 IC's in a two-die craps circuit. Two

gates of a 4093 quad, 2-input NAND, Schmitt-trigger CMOS IC are connected in astable-oscillator circuits as clocks for the two 4017 IC's. Each of the 4017 IC's have six LED's connected to its first six outputs. As the clock pulses enter pin 14 of the 4017's, the IC's count from one to six over and over as long as the clock pulses are present. When S1 and/or S2 are released one of the LED's in each circuit will remain on indicating a number from one to six.

The circuit is set up so you can roll the dice together by pressing S1 and S2 at the same time, or roll each die one at a time. The

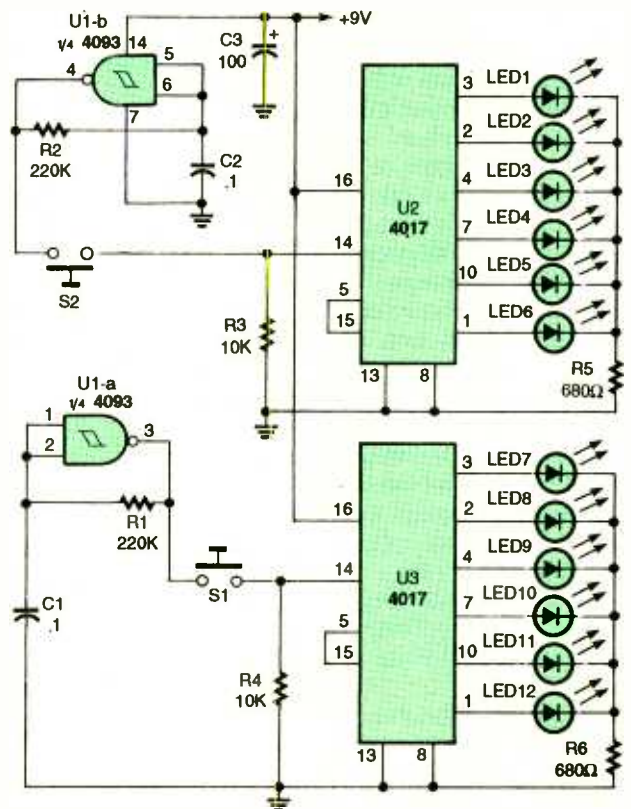

Fig. 2. This craps circuit is set up so you can roll the dice together by pressing S1 and S2 at the same time or roll each die one at a time. The rolling speed is set by the values of R1, C1, R2, and C2.

## PARTS LIST FOR THE ELECTRONIC COIN TOSS (Fig. 1)

### SEMICONDUCTORS

U1—4017 decade-counter, integrated circuit  
 Q1—2N2647, or similar type unijunction transistor  
 LED1, LED2—Light-emitting diode, any color

### RESISTORS

(All fixed resistors are 1/4-watt, 5% units unless otherwise indicated.)

R1—47,000-ohm  
 R2—470-ohm  
 R3—47-ohm  
 R4—680-ohm

### CAPACITORS

C1—0.1- $\mu$ F, ceramic-disc  
 C2—100- $\mu$ F, 25-WVDC, electrolytic

### ADDITIONAL PARTS AND MATERIALS

S1—Normally open, pushbutton switch  
 IC socket, perfboard, solder, wire, etc.

rolling speed is set by the values of R1, C1, R2, and C2. Increasing any component value will lower the associated oscillator's frequency, and lowering a value will raise the oscillator's frequency.

## TWENTY-ONE

A simplified version of the card game 21 is shown in Fig. 3. Even though the odds are not the same as in the card game of 21, our electronic version is still a lot of fun to play. In a standard deck of cards, there are sixteen cards that count as 10: the 10 card, the Jack, the Queen, and the King of each suit. The Ace can count as a one or eleven. Our game can only display two cards that count ten for each deal of the cards. The Ace can be set to count as one or eleven as in the card game of 21. The circuit only shows one hand of 21. Double the circuit for two players.

Two 2N2647 unijunction transistors serve as the clock generators for the two 4017 IC's. A single "Deal" push-button switch, S1, operates both clock generators at the same time. Diodes D1 and D2 isolate the two

clock circuits, allowing S1 to operate both.

The 4017 counter/readout circuits are identical in circuitry and operation. As long as clock pulses enter

## PARTS LIST FOR THE ELECTRONIC CRAPS (Fig. 2)

### SEMICONDUCTORS

U1—4093 quad, 2-input, NAND, Schmitt-trigger, integrated circuit  
 U2, U3—4017 decade-counter, integrated circuit  
 LED1—LED12—Light-emitting diode, any color

### RESISTORS

(All fixed resistors are 1/4-watt, 5% units unless otherwise indicated.)

R1, R2—220,000-ohm  
 R3, R4—10,000-ohm  
 R5, R6—680-ohm

### CAPACITORS

C1, C2—0.1- $\mu$ F, ceramic-disc  
 C3—100- $\mu$ F, 25-WVDC, electrolytic

### ADDITIONAL PARTS AND MATERIALS

S1, S2—Normally open, pushbutton switch  
 IC sockets, perfboard, solder, wire, etc.

pin 14 of each 4017, the IC's count from one to ten over and over until the clock pulses stop. When S1 is released, the clock pulses stop and one LED from each IC remains on to indicate a card with a number

value of one (one or eleven) to ten.

The position of switches S2 and S3 determine whether the number-one ("Ace") output of the 4017's count as an eleven or a one. Both S2 and S3 may

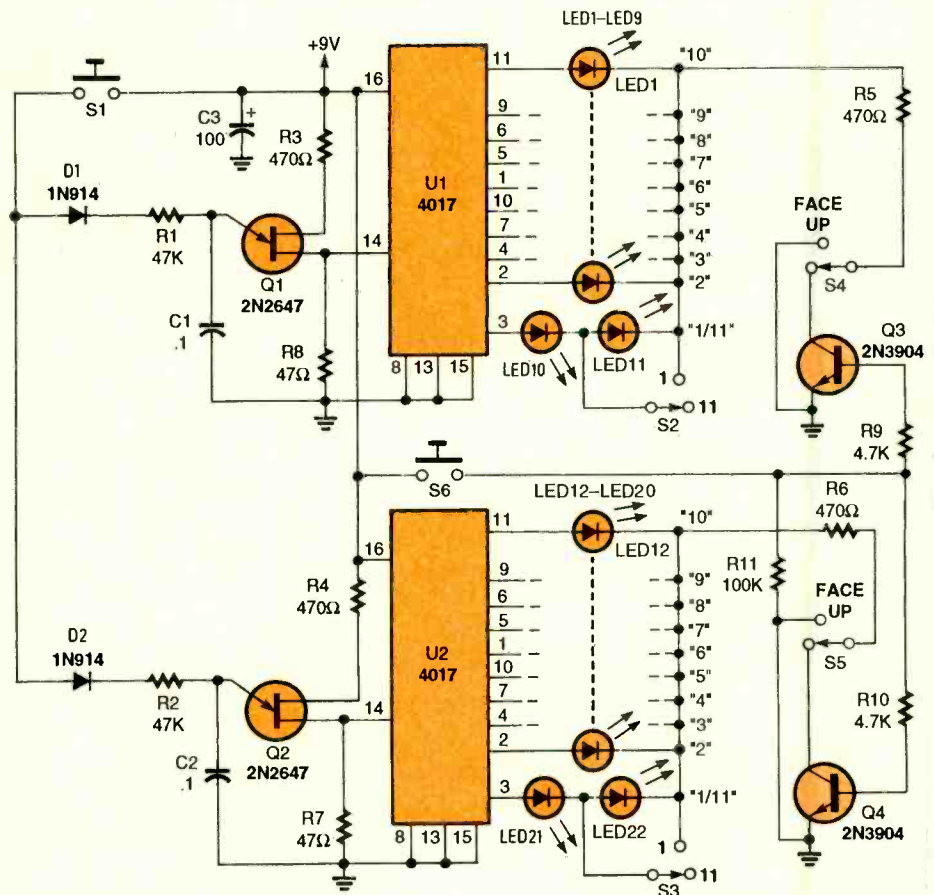

Fig. 3. Even though the odds for this simplified version of the card game 21 are not the same as the real thing, our electronic version is still a lot of fun to play.



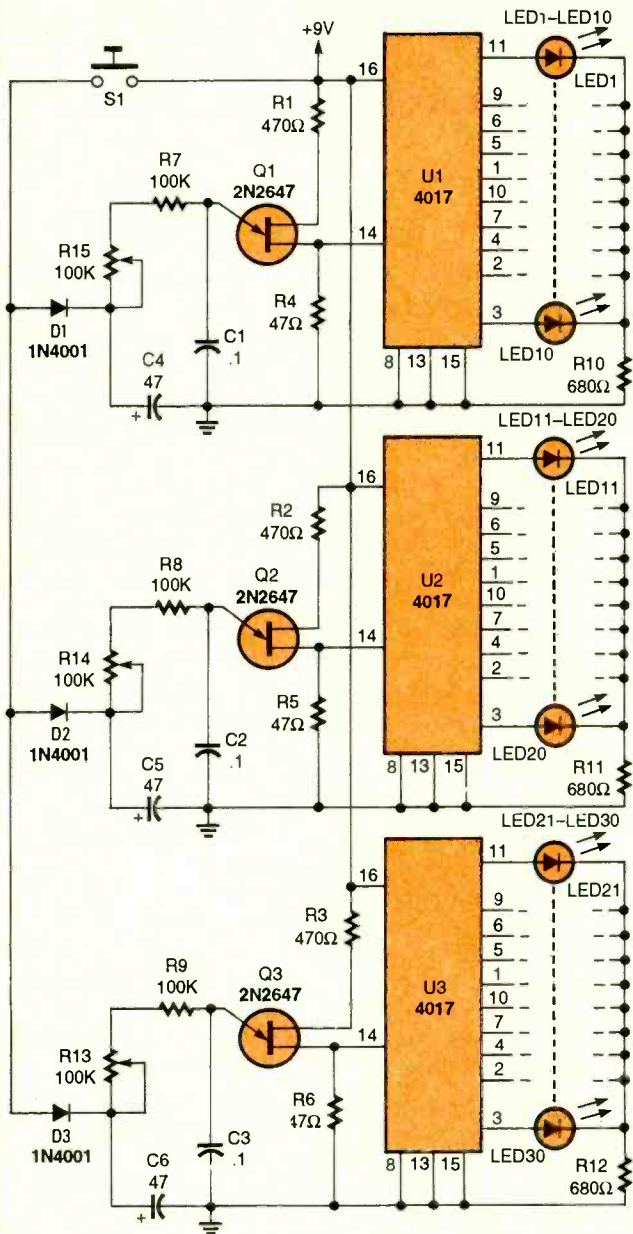

Fig. 4. Our one-arm bandit is made up of three clock circuits and three counter/readout circuits all activated by roll switch S1.

be switched in either position before or after the cards are played.

The cards may be played either face up or face down. When switches S4 and S5 are in the position shown in Fig. 3, the cards are dealt face down. Transistor's Q3 and Q4 are turned off in this position and no current can flow through the LED's. Pressing S6 turns both transistors on, lighting the LED's.

The circuit may be modi-

fied to allow additional cards to be dealt by adding additional clock and readout circuits. A separate deal switch (S1) for each additional card circuit will be needed to keep the extra card(s) as an option.

### ONE-ARM BANDIT

Our last entry into the gaming caper this visit is an electronic version of the one-arm bandit. Ours is a much simpler machine than the ones found in the

## PARTS LIST FOR THE ELECTRONIC TWENTY-ONE (Fig. 3)

### SEMICONDUCTORS

U1, U2—4017 decade-counter, integrated circuit  
 Q1, Q2—2N2647 or similar unijunction transistor  
 Q3, Q4—2N3904 NPN transistor  
 D1, D2—1N914 silicon signal diode  
 LED1-LED22—Light-emitting diode, any color

### RESISTORS

(All fixed resistors are 1/4-watt, 5% units unless otherwise indicated.)  
 R1, R2—47,000-ohm  
 R3-R6—470-ohm  
 R7, R8—47-ohm  
 R9, R10—4700-ohm  
 R11—100,000-ohm

### CAPACITORS

C1, C2—0.1- $\mu$ F, ceramic-disc  
 C3—100- $\mu$ F, 25-WVDC, electrolytic

### ADDITIONAL PARTS AND MATERIALS

S1, S6—Normally open pushbutton switch. S2-S5—SPDT toggle switch  
 IC sockets, perfboard, solder, wire, etc.

## PARTS LIST FOR THE ELECTRONIC ONE-ARM BANDIT (Fig. 4)

### SEMICONDUCTORS

U1-U3—4017 decade counter, integrated circuit  
 Q1-Q3—2N2647 or similar unijunction transistor  
 D1-D3—1N4001 1-amp, silicon diode  
 LED1-LED30—Light-emitting diode, any color

### RESISTORS

(All fixed resistors are 1/4-watt, 5% units unless otherwise indicated.)  
 R1-R3—470-ohm  
 R4-R6—47-ohm  
 R7-R9—100,000-ohm  
 R10-R12—680-ohm  
 R13-R15—100,000-ohm potentiometer

### CAPACITORS

C1-C3—0.1- $\mu$ F, ceramic-disc  
 C4-C6—47- $\mu$ F, 16-WVDC, electrolytic

### ADDITIONAL PARTS AND MATERIALS

S1—Normally open, pushbutton switch  
 IC sockets, perfboard, solder, wire, knobs, etc.

gambling casinos. Mechanical casino bandits use rotating drums driven by stepper motors that are computer controlled. That allows the bandits to be programmed to pay out a specific percentage of the take to customers.

Take a look at the circuit diagram in Fig. 4 and you will see that our one-arm

bandit circuit is made up of three clock circuits and three counter/readout circuits. A single roll switch, S1, turns on all three clocks at the same time. When S1 is closed, capacitors C4, C5, and C6 are charged through D31, D32, and D33 to about 8 volts. After S1 is released, the three clocks  
*(Continued on page 92)*

# DX LISTENING

By Don Jensen

## Radio St. Helena Day

There was good reason when, in 1815, Great Britain chose to exile Napoleon Bonaparte to the island of St. Helena. Napoleon had been a mighty thorn in the paw of the British lion and the English government. Once they'd finally got their hands on "Old Boney," they wanted to stash him safely away in some out-of-the-way corner of the empire. St. Helena, in the remote South Atlantic, certainly fit the bill.



This verification card was sent by Radio St. Helena for its 1992 special broadcast.

In 1990, shortwave listeners were delighted when a couple of Swedish DX'ers arranged with St. Helena authorities for a special transmission from that remote island, which has no regular SW broadcasts. Its success led the station to repeat the one-day-only single-sideband transmissions in 1992 and 1993. The odds are good that Radio Helena will do it again in this October.

St. Helena, together with the South Atlantic islands of Ascension and Tristan Da Cunha, form one of the oldest British colonies. While Ascension has an airport,

the only access to the other two islands is by sea. St. Helena, about midway between Brazil and southern Africa, is served by just one ship, the RMS St. Helena, which operates between Cardiff, Wales, and Cape Town, South Africa.

The island's only significant export seems to be St. Helena's commemorative postage stamps, which are prized by collectors. It is forced to import food, medical supplies, and practically everything else. It is entirely dependent on Great Britain for its funding. However, the island has a local AM radio station, *Radio St. Helena*, which broadcasts to the local population of some 6,800.

Several years ago, Jan Tuner and John Eckwall, two top Swedish DX'ers, persuaded Radio Helena to transmit the special broadcast for SWLs, relaying the medium-wave AM signal on an existing 1.5-kilowatt, SSB communications transmitter owned by Cable and Wireless. That program was heard quite widely in the U.S., Canada, Europe, and elsewhere. The mail response delighted station manager Tony Leo and his staff of three so much that Radio St. Helena Day (as the special broadcasts were dubbed) have been repeated annually.

I have no confirmation, at this writing, but according to preliminary plans, this year's broadcast may be heard on Friday, October 14. Based on last year's schedule, I'd suggest tuning on that day, beginning at around 2000 UTC, and perhaps for several hours

afterward, on 11,092.5 kHz. "Being as isolated as we are," Leo said after the 1993 broadcast, "it was a thrill to have calls from so many of you, backed up by faxes and letters, stating, so genuinely, how happy you were to have received our broadcast."

Radio St. Helena issues a very attractive verification card for correct reports, which can be sent, with a \$1 bill for return postage, to Radio St. Helena, The Castle, Jamestown, St. Helena, via Ascension Island, South Atlantic Ocean. Also, you can call the station by international telephone if you wish. The number is 011 290 4669. Check your phone book for international dialing instructions.

### FAVORITE FREQUENCY

Readers of Edwin Southwell's "Radio World" column in *Contact*, the monthly bulletin of the World DX Club in Great Britain, recently offered their answers to this hypothetical question: If, for some reason, you could only receive one shortwave frequency, which would it be, and why?

WDXC member Keith Mellor said his choice was 9,410 kHz, because "it is a reliable frequency for the *British Broadcasting Corporation's* highly regarded World Service. But," he went on to note, "according to the 1994 edition of *Passport to World Band Radio*, 9,650 kHz is used by 18 different stations broadcasting from 21 different countries, with six broadcasters in English, so a receiver on this frequency could provide varied listening."



Keith's letter sent me scurrying to my copy of *Passport* (which, incidentally, is available at most major book stores) to check that out. He's right. It is a busy channel, with 18 SW stations scheduled here at various hours of the day, with programming in English and a number of other languages.

On 9,650 kHz, there's *Radio Canada International*, broadcasting from Canada and, at other times, from a relay station in Portugal. There's *Radio Denmark* broadcasting from a Norwegian transmitter, and *Radio France International* relayed from Japan. At various hours of the day and night, *Deutsche Welle* programming is aired by German transmitters, and relayed by others in Portugal, Malta, and Rwanda in Africa.

The list goes on: *Adventist World Radio* from Guam, *Radio TV Guineene* from Guinea, *Radio Nederlnad*, *Radio Korea*, *Radio Pyongyang*, *Radio Norway*, *Vatican Radio*, *Swiss Radio International* and *Radio Exterior Espana* from Spain.

There is *Trans World Radio* from Monaco and Swaziland, Russia's *Golos Rossii*, South Africa's *Channel Africa*, *Radio Free Europe/Radio Liberty* broadcast from transmitters in Germany, and *Voice of America* programming relayed by stations in Greece, Morocco, Greece, and Great Britain. Varied listen-

\*Credits: Jerry Berg, MA; David Clark, Ont., Richard D'Angelo, PA; William Davenport, TN; Jim Ducharme, MA; William Flynn, OR; Marie Lamb, NY; William McGuire, NY; Marine Papas, SD; Ed Rausch, NJ; Doug Robertson, CA; North American SW Association, Levittown, PA; Ontario DX Association, Willowdale, Ont., Canada; World DX Club, Northampton, England.

ing possibilities on 9,650 kHz? Indeed!

How about you? What's your favorite SW frequency and why? Drop me a line with your answers. The address is *DX Listening*, **Popular Electronics**, 500-B Bi-County Blvd., Farmingdale, NY 11735.

### HAPPENINGS

Some interesting SW developments, noted by Canadian DX'er Roger Chambers, writing in *DX Ontario*, the bulletin of the Ontario DX Association.

The *Australian Broadcasting Corporation's* home-service, shortwave VLW outlets in Perth, and the VLM and VLW stations in Brisbane have left the air for good. Those domestic SW outlets, intended for Aussie listeners in the "outback," offered separate programming from the international service of Radio Australia.

Increased medium-wave, FM, and satellite communications made those SW stations, with their aging transmitters from the late 1930's and 1940's, redundant, the ABC indicated. As Chambers wrote, "Farewell, old friends!"

He also noted, favorably, the programs of traditional Colombian music aired by *Radio Difusora Nacional Colombia*. "It features a varied mix of popular and folk music," he wrote, "the best Latin music on SW except for Cuba and some of the stations on the shortwave *tropical bands*, where difficult reception may make it hard to enjoy the music." Chambers says it is heard well at about 1830 UTC on 11,785 kHz.

Speaking of Cuban music, one of my favorites is *Radio Rebelde*, the Cuban shortwave alternative to the international broadcasts of *Radio Havana Cuba*. *Radio Rebelde*, whose name

dates way back to the beginnings of the Castro regime, also happens to be one of the easier stations to hear on the 60-meter tropical band.

Look for *Radio Rebelde* on 5,025 kHz, at around 0200 UTC. Programming is in Spanish but the music is super! The station's address, by the way, is *Radio Rebelde*, Apartado 6277, Havana 6, Cuba.

### DOWN THE DIAL

Here are some of the stations that are being reported lately:

**CROATIA**—5,985 kHz. *Croatian Radio* has English news, after identification at 2200 UTC—also noted on parallel 5,920 kHz. Another brief newscast in English is heard on both frequencies shortly after 0700 UTC.

**LEBANON**—6,450 kHz. The *Voice of Lebanon* has been

logged here signing on at 0355 UTC with an interval signal, "Colonel Bogey" march, and a choral anthem.

**PAKISTAN**—15,675 kHz. *Radio Pakistan* has slow-speed English-language news bulletins on this frequency until 1630 UTC.

**SINGAPORE**—9,530 kHz. *Radio Singapore International's* new 150-kilowatt powerhouse transmitter is putting in a nice signal. English is noted during the 1100 to 1300 UTC period.

**Tanzania**—5,050 kHz. *Radio Tanzania* in Dar es Salaam is heard at 0400 UTC, with English-language news, easy-listening music, and identification.

**ZAMBIA**—7,234 kHz. *Radio Zambia* is not an easy catch. But it has been heard in English until sign off, with a choral anthem, shortly after 2200 UTC. ■

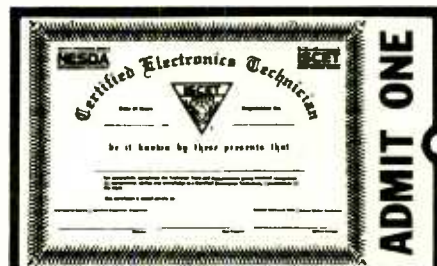

## Your Ticket To SUCCESS

Over 28,000 technicians have gained admittance worldwide as certified professionals. **Let your ticket start opening doors for you.**

ISCET offers Journeyman certification in Consumer Electronics, Industrial, Medical, Communications, Radar, Computer and Video. For more information, contact the **International Society of Certified Electronics Technicians, 2708 West Berry Street, Fort Worth, TX 76109; (817) 921-9101.**

Name \_\_\_\_\_  
 Address \_\_\_\_\_  
 City \_\_\_\_\_  
 State \_\_\_\_\_ Zip \_\_\_\_\_

Send material about ISCET and becoming certified.

Send one "Study Guide for the Associate Level CET Test." Enclosed is \$10 (inc. postage).

# HAM RADIO

By Joseph J. Carr, K4IPV

## Preamplifier Oscillations

This month we are going to look at two different topics: oscillations in broadband receiver preamplifiers and a new software package that allows you to look at a radio-signal's spectrum.

### PREAMPLIFIER OSCILLATIONS

A number of readers have written to me about the MAR-1 preamplifier circuit that was published in this column (November 1993 and March 1994) and elsewhere in *Popular Electronics*. The MAR-1 device offers 15 to 18 dB of gain,

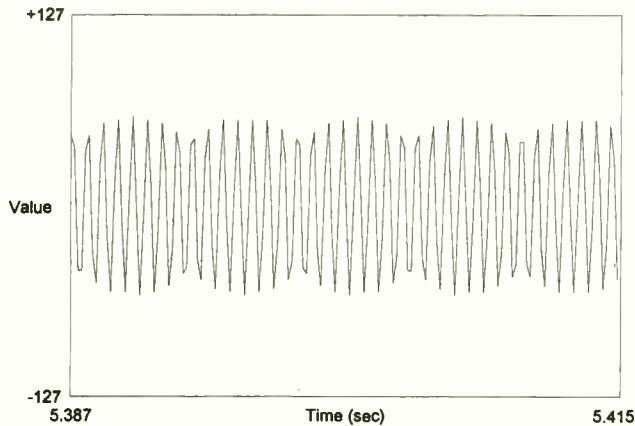

Fig. 1. Here is a time-domain view of the audio output from a receiver tuned to an RTTY signal that has a 800-Hz, mark-space separation.

with a decent 5-dB noise figure, and operates from DC to 1000 MHz. The MAR-6 is similar, but has a 2.9-dB noise figure and operates from DC to 2000 MHz. A lot of readers built the preamplifier, and reported good results. Two readers, however, reported oscillations rather than amplification. Given the MAR-1 and MAR-6 devices are almost unconditionally stable (not quite, but almost), that surprised me. So, what to do?

I went to the workbench and tried a few things that I hoped would help me figure out what went wrong. When I used perfboard rather than the printed-circuit board used in my article, made the leads too long, and deleted the power-supply decoupling capacitor, I achieved oscillations. In another case, when I used an RF choke in the DC power-supply line that had a resonant frequency well within the bandpass of the MAR-1 and left the input unterminated, oscillations were achieved.

Those conditions are pretty easily avoided. In the first case, tightening up the perfboard layout or using a properly designed printed-circuit board will eliminate the oscillations or at least make them highly unlikely.

### SPECTRA PLUS SOFTWARE

Pioneer Hill Software (24460 Mason Rd., Poulsbo, WA, 98370; Tel. 206-697-3472) offers a software package that allows you to look at the spectrum of a radio signal, or any other audio signal for that

matter. The software can be used for passband monitoring, signal identification and tuning, notch-filter/passband-filter adjustments, and anything else where the bandpass spectrum of the signal is important.

The spectrum of a signal is a plot of the individual frequency components that make up the signal displayed on an amplitude-vs.-frequency plot. Most of us are familiar with time-domain plots of radio signals—the kind of signal displays that normally appear on oscilloscopes. Figure 1 shows the basic time-domain display of a radioteletype (RTTY) signal with an 800-Hz mark-space separation. That plot was taken from the Spectra Plus Time Series View mode, and printed on my laser printer.

Figure 2 shows the same signal displayed in the Spectrum View mode. Note that the signal is now broken into its main components with their amplitudes shown along the vertical axis and their frequencies shown along

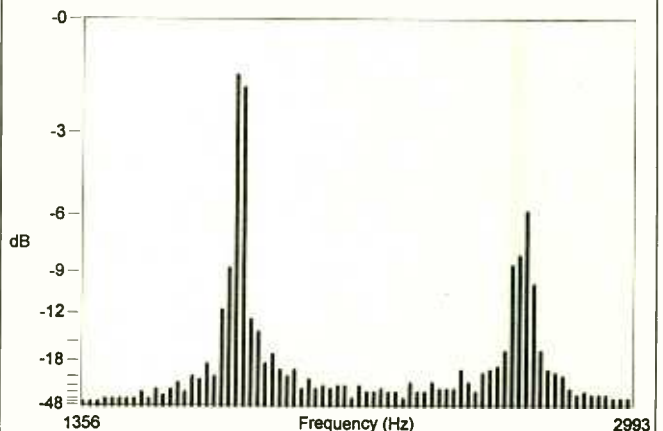

Fig. 2. This is a spectrum plot of the same 800-Hz RTTY signal, plotting amplitude vs. frequency.



the horizontal axis. The mark and space signals, along with their respective sidebands, are clearly shown.

For the sake of comparison, Fig. 3 shows a CW signal that was generated using my electronic-keyer set to produce a chain of "dots." Note that the spectrum represents only one central frequency with its associated sidebands. Those sidebands, by the way, are why you need a 250- to 500-Hz, or wider, filter for CW reception. Although we normally think of CW as being on a single frequency, and as such

screen, however, it was a great-looking presentation. Users with a compatible color printer should experience no problems, however.

The spectrogram mode is especially favored by people looking for "whistlers" (see "The Sky Chorus" by Gary Eggleston, **Popular Electronics**, July 1993, page 46), i.e., those natural radio signals traversing the Earth's magnetosphere from lightning strikes in other parts of the world. Whistler hunters often record the signals on a cassette tape; some later do a

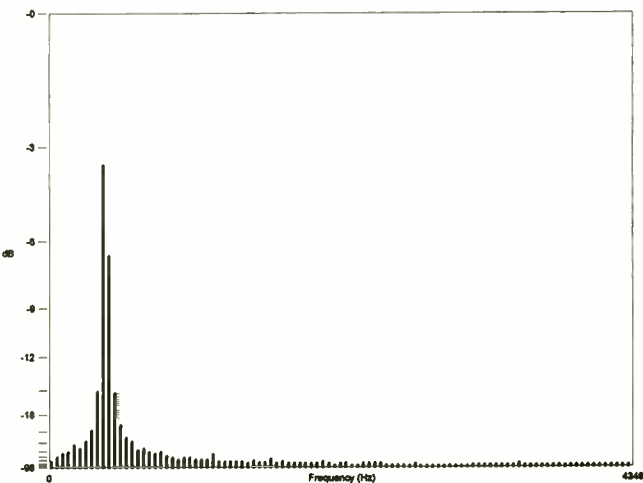

Fig. 3. For the sake of comparison, here is a Spectrum plot of a CW signal (string of dots) generated using my electronic-keyer.

would produce a single spike and no sidebands, the act of pulsing the signal (making "dots") spreads the spectrum out a bit. Also, even a sine wave will have minor sidebands unless it is totally pure—which just doesn't happen.

Spectra Plus also makes a spectrogram, which rotates the spectrum so that the frequency appears along the vertical axis and time appears along the horizontal axis. That allows us to see a time history of the received signal. I couldn't reproduce it for you because it comes out in color, and my printer wouldn't reproduce color. On the VGA

spectrogram on the signal to take measurements and make identification.

There is also another mode, the 3-D View mode, which places the time along the vertical axis, the frequency along the horizontal axis, and the amplitude along the Z-axis. What's a "Z-axis?" The Z-axis is the dimension that gives the image an out of the screen (towards the viewer) appearance. The Spectra Plus software (priced at \$179) is a useful adjunct to ham radio operators, as well as shortwave listeners, whistler hunters, and amateur-science buffs.

A smaller cousin of the

program, Spectra Vision (\$89) is available from the same source. Both software packages require a 386 or 486 computer and Windows 3.1. To get the signals into the computer for Spectra Plus or Spectra Vision to analyze, you'll need a Windows compatible sound card. I've seen some off-brand sound cards at relatively low prices; even the 8-bit SoundBlaster at less than \$100 will do nicely. I used a SoundBlaster 16-bit ASP to make recordings with my copy of Spectra Plus.

calculates the length of a high-frequency antenna and its key elements. It uses a scroll bar to set the frequency, and a menu bar to select the type of antenna. When an antenna type is selected, a schematic of that antenna appears on the screen.

Also available are "Loops for Windows" (\$20), and "Antlers for VHF/UHF" (\$20). All three programs can be purchased at one time for \$40. The programs can be ordered from me at P.O. Box 1099, Falls Church, VA, 22041. ■

### ANTLERS FOR WINDOWS

A new version of Antlers, the antenna-length calculator software is now available. The new software, "Antlers for Windows" (priced at \$30 postpaid),

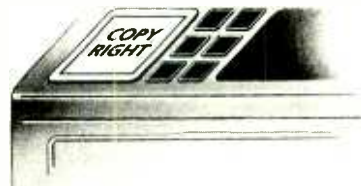

## THE MOST AN IMPORTANT PART OF YOUR PHOTOCOPIER ISN'T PART OF YOUR PHOTOCOPIER

Having a machine may not permit you to photocopy books, journals, newsletters and magazines. The Copyright Clearance Center CAN. Contact us to find out how you too can COPY RIGHT!<sup>SM</sup>

### COPYRIGHT CLEARANCE CENTER

222 Rosewood Drive, Danvers, MA 01923 □ Tel. (508) 744-3350 □ Fax (508) 741-2318

© 1993 Copyright Clearance Center

# SCANNER SCENE

By Marc Saxon

**W**e got a chance to look at the new *Radio Shack PRO-51* handheld scanner, and are pleased to report that it should find a comfortable niche with serious monitoring enthusiasts. The PRO-51 covers 29–54, 137–174, 406–512, and 806–956 MHz, less the two 800-MHz cellular bands. It also covers the 108–137-MHz aeronautical band.



The Radio Shack PRO-51, a new 200-channel handheld scanner, is ideal for the serious monitoring enthusiast.

The PRO-51 deals with that coverage in 200 memory channels, formatted as 10 bands of 20 channels each. In addition, there are 10 monitor memories that allow for the temporary storage of frequencies discovered during a search.

A service-search feature lets the user check through all aeronautical, fire, maritime, and NOAA weather channels when the proper button for each service is pressed on the keypad. The PRO-51 has "Hyperscan," which means that it scans at 50 channels per second and searches at a peppy 100 channels per second.

The IF frequencies are 450 kHz and 10.8 MHz. Sensitivity at 20 dB S/N is 0.5  $\mu$ V from 29 to 54 and 406 to 512 MHz; 0.6  $\mu$ V from 137 to 174 MHz, 0.7  $\mu$ V in the 800-MHz band, and 1.3  $\mu$ V from 108 to 137 MHz.

The PRO-51 is fitted with a BNC connector, so it can be used with any antenna. A rubberized whip is furnished. Power comes from four "AA" batteries or a 9VDC adapter. The PRO-51 will retain programmed information for as long as three days without batteries or other power.

This is a good-looking scanner that performs like a champ. Check out the PRO-51 at any Radio Shack store.

## SO EASY TO REMEMBER

In past issues, we've mentioned that 123.45 MHz has become an informal and unauthorized chit-chat fre-

quency for airline pilots. That hasn't made everybody happy, particularly those stations licensed to operate there. They complain that it's cluttered with pilots wisecracking about their lives, jobs, and problems.

The 122.75-MHz frequency was set aside by the FCC for interplane communications, but only private pilots use that frequency. Instead, 123.45 MHz was selected because the sequential run of numbers from one to five made it easy to remember. Military pilots have their own offbeat and unofficial UHF-band chit-chat frequencies, also based on memory gimmicks. Most people don't know about them, and they can produce some worthwhile monitoring. So we'll pass them along here.

Taking a page from the airline pilots, military pilots using their 225–400-MHz UHF band picked the sequential run of numbers from two to five as a memory trigger. Therefore, 234.5 MHz became an unofficial interplane frequency.

Military pilots have come up with a couple of other easy-to-recall frequencies, based on firearms. If a person were asked to name two famous and historic rifles, he might pick the Winchester 30–30 and the Remington .30–06. So, if you hear one pilot tell another to switch to Winchester, or Winchester .30–30, that's your clue to direct your scanner to 303.0 MHz. Likewise, pilot instructions to



change frequency to Remington, or Remington .30-6, means that the contact is going to turn up on 300.6 MHz. Monitoring 234.5, 300.6, and 303.0 MHz might produce off-the-cuff commentary from military pilots that is funny and insightful, and isn't to be heard on the more formal circuits. The same goes for 123.45 MHz.

### JEEPERS BEEPERS

An inquiry from Charles W. Hollinshead, of Fayetteville, Pennsylvania, asks about the data and CW signals he hears on 157.74 MHz. That frequency is used

voice and non-voice beeper service to the general public use 35.20-35.66, 43.20-43.66, 152.03-152.24, 454.025-464.65, and 459.025-459.65 MHz. There are also frequencies above 929 MHz in use.

### FROM READERS

In the midtown area of New York City, a large, private, merchants' security patrol operates. The patrol's armed, uniformed personnel carry two-way radios and conduct their operations in a very professional manner, reports Bill In-coronato, of Queens, New

York. Bill tells us that this patrol is deployed primarily in the area around Grand Central Station, and he wonders if it's possible to find out their frequency. The highly visible security patrol is run by Grand Central Partners, Inc. They operate on 461.575, 464.675, and 469.675 MHz. From the Lone Star state (that's Texas, podner), Martin G. wants us to pass along some of the better statewide frequencies that he can monitor. How about the Texas Rangers on 155.505 MHz? The Texas Highway Patrol dispatchers use 155.46 MHz in most areas. Intercity po-

lice communications are on 154.95 and 155.37 MHz. Texas Fish and Game law-enforcement activities can be monitored on 151.31, 151.355, and 151.415 MHz. Various state prisons have discrete channels assigned, but common to all facilities are frequencies such as 153.905, 453.30, 453.45, and 453.525 MHz. The State Alcohol and Beverage Commission operations include 154.905, 155.595, and 156.06 MHz. That should be enough to keep any scanner perking. The Sunset Limited is the Amtrak passenger train that runs between Los Angeles and New Orleans. Scannist Peggy Marton takes that train from time to time and reports that during the western portion of the trip, the train manager can be seen using a handheld

transceiver. Peggy figures that if she knew the frequency, she could listen in. Our suggestion is to scan 160.44, 160.455, 160.65, and 160.74 MHz. All are in use aboard the Sunset Limited.

### KEEP THOSE CARDS AND LETTERS COMING IN

Let's hear from you with questions, comments, and loggings. Write to *Scanner Scene*, **Popular Electronics**, 500-B Bi-County Blvd., Farmingdale, NY 11735.



"Hey, it does find golf balls."



Beeperes are intended to receive data or voice one-way paging signals.

by businesses to send one-way paging messages to their employees' beepers. The CW signal is the FCC callsign of the station being copied, and several might share the frequency in any given area. Some beeper systems use data transmission, but others use voice messages.

Other frequencies used by businesses for voice or non-voice paging include 152.48, 154.625, 158.46, 462.75-462.925, and 465.00 MHz. Medical voice and non-voice pagers use 35.64, 35.68, 152.01, 157.45, 163.25, and 453.025-453.175 MHz. Companies that furnish

York. Bill tells us that this patrol is deployed primarily in the area around Grand Central Station, and he wonders if it's possible to find out their frequency.

The highly visible security patrol is run by Grand Central Partners, Inc. They operate on 461.575, 464.675, and 469.675 MHz.

From the Lone Star state (that's Texas, podner), Martin G. wants us to pass along some of the better statewide frequencies that he can monitor.

How about the Texas Rangers on 155.505 MHz? The Texas Highway Patrol dispatchers use 155.46 MHz in most areas. Intercity po-

NEXT MONTH

In the October, 1994

## Popular Electronics®

Strike back at crime by reading and heeding two articles in the October 1994 Issue!

- **Build a Home Security System**—Featured packed, commercial-quality system includes multiple zones, emergency auto-dialing, adjustable entry and exit delays, and much more!
- **Auto Security System**—Foil carjackers, muggers and thieves with this automotive remote control. Disable your car, flash your lights, sound your horn, and more; all at a safe distance.
- **Also:** Jammed packed with Gizmo, Think Tank, DX Listening, Scanner Scene, Ham Radio, and a heck of a lot more!

On Sale  
August 16, 1994  
Watch for it!

Pick up *Popular Electronics* at your favorite Newsstand, Bookstore, Convenience Store or Supermarket

# FACTCARDS



**Jampacked with information at your fingertips**

■ ALL YOU NEED to know about electronics from transistor packaging to substitution and replacement guides. FACTCARDS numbers 34 through 66 are now available. These beautifully-printed cards measure a full three-by-five inches and are printed in two colors. They cover a wide range of subjects from Triac circuit/replacement guides to flip-flops, Schmitt triggers, Thyristor circuits, Opto-Isolator/Coupler selection and replacement. All are clearly explained with typical circuit applications.

■ WANT TO EXPAND your knowledge of electronics? Do it the easy way

by studying the Electronics Fact Cards. Do you travel to and from your job each day? Drop a handful of cards in your pocket before you leave, and the bus becomes a schoolroom! At home, you can build some of the projects and not only have fun building and using them, but learn how they work at the same time.

■ YOU'LL BE AMAZED both at how rapidly you learn with these cards, and how easy it is to understand. These new cards are available right now. Don't miss out. Send your check or money order today.

## FACTCARDS—Facts at your fingertips for Experimenters and Project Builders!

- Please send one copy of FACTCARDS at \$3.50. Shipping \$1.00 (U.S. and Canada only).
- Please send \_\_\_\_\_ copies of FACTCARDS. Total cost is sum of copy price and First Class postage and handling cost multiplied by number of card sets ordered.
- New York residents add sales tax to total cost of each order.  
Please print Allow 6-8 weeks for the material to arrive.

(Name) \_\_\_\_\_

(Street Address) \_\_\_\_\_

(City) \_\_\_\_\_

(State) \_\_\_\_\_

(Zip) \_\_\_\_\_

Detach and mail today:  
CLAGGK Inc.  
P.O. Box 4099  
Farmingdale, NY 11735

All Payment must be in U.S. Funds!

# NOW Find the Right Part for Your VCR!



with the

## IS CET VCR CROSS REFERENCE

**NEW!** The Fourth Edition is contained on a diskette for IBM PC AT/XT compatibles, DOS 2.1 or higher. The disk software allows technicians to search by manufacturer for model numbers and description of part numbers. A parts editing sequence gives an on-screen view of all substitutes for parts entered. With the diskette, the technician can update files by adding model and parts

*The 320-page, Fourth Edition of the VCR Cross Reference contains both model and part number cross references. Over 1300 new parts and 360 new models have been added.*

VCR's are made in a few factories from which hundreds of different brand names and model numbers identify cosmetically-changed identical and near-identical manufactured units. Interchangeable parts are very common. An exact replacement part may be available only a few minutes away from you even though the original brand-name supplier is out of stock. Also, you may be able to cannibalize scrap units at no cost.

crosses of future models. The Fourth Edition can be printed on pages completely from the diskette.

The IS CET VCR Cross Reference, Fourth Edition, is on 8 1/2 x 11-in., pre-punched pages and sells for **\$36.00**. The 3 1/2 inch diskette sells for **\$69.95** and you can view listings from a monitor or printed page.

**Only \$36.00 for pages  
\$69.95 diskette**

**Claggk Inc.  
VCR CROSS REFERENCE OFFER  
P.O. Box 4099  
Farmingdale, New York 11735**

Name \_\_\_\_\_  
Business \_\_\_\_\_  
Address \_\_\_\_\_  
City \_\_\_\_\_  
State \_\_\_\_\_ Zip \_\_\_\_\_  
Phone \_\_\_\_\_

Enclosed \$36.00 for the IS CET VCR Cross Reference, Fourth Edition.

Enclosed \$69.95 for the diskette containing the IS CET VCR Cross Reference, Fourth Edition. Please specify:

5 1/4 Diskettes (2) 3 1/2 Diskette (1)

Include \$3.00 for shipping each Cross Reference (Pages or Diskette)

The total amount of my order is \$ \_\_\_\_\_

Check enclosed—do not send cash.

Visa  MasterCard Exp. Date \_\_/\_\_/\_\_

Signature \_\_\_\_\_

New York State residents must add applicable local sales tax to total.



## SCANNER SILENCER

(Continued from page 74)

ropriate connections between SO1 and the printed-circuit board, as shown in Fig. 3. Once all the connections between the board and the off-board components have been made, mount the finished board in the enclosure. (The author used double-sided foam tape to accomplish that task in the prototype).

Before applying power to the circuit, make absolutely certain that all the circuit connections are insulated from the metal enclosure. Pay extra attention to the wire that connects between C1 and SO1; a shorted connection in that area could permanently damage your transceiver.

**Hook-Up and Use.** Figure 4 outlines how to properly insert the Scanner Silencer into your scanner/transceiver system. First attach a coaxial T-connector to SO1 of the Scanner Silencer as shown. Disconnect the antenna feedline from your transceiver and connect it instead to one of the female T-connector sockets. Then using a short coaxial jumper made of 50-ohm cable (such as RG58 or similar with PL-259 connectors on both ends), connect your transceiver to the empty T-connector socket. Next insert PL1 into the external speaker jack on your scanner and then plug an extension speaker into jack J1 on the Scanner Silencer.

With your scanner tuned to an active frequency, scanner audio should be heard through the extension speaker. Now connect the Scanner Silencer to a fused 12-volt DC source and key your transceiver; the scanner audio should be muted instantly. Now un-key your transceiver; scanner audio should once again be heard through the extension speaker. (When testing the project for proper operation, it is suggested that you use an RF dummy load in place of your transceiver's antenna so as not to create interference to others.

While the Scanner Silencer was intended to automatically mute a scanner, it can just as easily be used to automatically mute a portable radio while transmitting. Or, it could even be adapted for use as an on-the-air indicator. ■



From the Lab  
to your  
Living Room!

## Does your VCR have a "Head Cold?"

Probably not! However, through constant playing and using of degrading dry or wet cleaners, the output of your video tapes has slowly diminished to an unacceptable level and the VCR plays as if it has a head cold! The culprit is most likely clogged and dirty video and/or audio heads.

The **3M Black Watch™ Head Cleaner Videocassette** uses a patented magnetic tape-based cleaning formation to remove head clogging debris. No foreign substances such as cloth, plastics or messy liquids and no harsh abrasive materials are present. The cleaner's usable life is 400 cleanings or more! It's easy to use. Place the **3M Black Watch™ Head Cleaner Videocassette** in the VCR and press the Play button. A pre-recorded message appears clearly on your screen and an audible tone is heard, telling you that the cleaning process is now completed. No guess work, you never over clean!

**3M Black Watch™ Head Cleaner Videocassette** **S**VHS **VHS**.....\$19.95

Once your VCR's head cold is cured, and the unit plays like new, consider using the finest videocassette you can buy—the **3M Black Watch™ T120 HI Pro VHS 4410 Videocassette**. The 4410 is the highest performing videocassette available today for use with all standard format VHS recording hardware!

Here's what you hear and see....A sharp, clear picture—brightest colors—freedom from streaks, flashes and snow—outstanding high-fidelity audio reproduction—optimum camcorder performance—maintains recording integrity. **3M Black Watch™** video tape is 100% laser inspected to guarantee surface smoothness and drop-out free performance.

**3M Black Watch™ T120 HI Pro VHS 4410 Videocassette** **VHS**.....\$8.00

### CLAGGK INC. — 3M VHS Special Offer P.O. Box 4099, Farmingdale, New York 11735

Yes, I like your offer and here is my order for 3M Black Watch™ products!

___ 3M Black Watch™ Head Cleaner Videocassette	(\$19.95 each)	_____ \$
___ 3M Black Watch™ T120 HI Pro VHS 4410 Videocassette	(\$8.00 each)	\$ _____
Shipping and handling per order		\$ <b>4.00</b>
Total Amount in U.S. Funds only		\$ _____

New York State residents add local sales tax. Canadians add \$6.00 per order. No foreign orders. Do not send cash.

Bill my  VISA  MasterCard Expire Date \_\_\_/\_\_\_/\_\_\_

Card No. \_\_\_\_\_

Signature \_\_\_\_\_

Name (Please print) \_\_\_\_\_

Address \_\_\_\_\_

City \_\_\_\_\_ State \_\_\_\_\_ ZIP \_\_\_\_\_

# From Not-Working to Networking!

## Troubleshooting Local-Area Networks!

Now, complete for the first time in one detailed booklet!

Gain a fuller knowledge of network fundamentals and how they developed from the early days of main frames, from XNS to Ethernet technology, the OSI stack for interconnecting different computers, basic and specialized test instruments, etc. Several tough LAN case histories bring from theory to the practical side of troubleshooting.

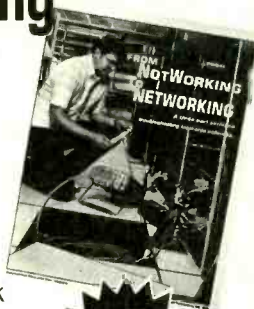

ONLY \$5.00

CLAGGK Inc., Reprint Bookstore  
P.O. Box 4099, Farmingdale, NY 11735

Please rush my copy of "From Not-Working to Networking." I enclosed payment of \$5.00 which includes shipping charges.

Name \_\_\_\_\_

Address \_\_\_\_\_

City \_\_\_\_\_ State \_\_\_\_\_ ZIP \_\_\_\_\_

Sorry, no orders excepted outside of United States and Canada. All Payments must be in U.S. funds. Send check or money order payable to CLAGGK Inc.—do not send cash or stamps. New York State residents add applicable sales tax.

“  
I'm afraid  
if I don't get  
a good education  
I will end up  
living the rest of  
my life  
with my mother.”

Joel Regimbal  
5th grade

America needs more schools  
that encourage our children to fulfill  
their promise.

**KEEP THE PROMISE.**

For information on how you can  
help change the schools in your  
community, call 1 800-96-PROMISE.



Education Excellence Partnership

## THINK TANK

(Continued from page 26)

and it can turn on coffee-makers, lights, or even audio equipment. To make it work, you'll need an alarm clock that has an internal light that comes on when the alarm is activated. The supply voltage to the light from the clock should be around 8–10 volts.

Start by taking apart the alarm clock and splicing into the positive and negative supply of the light. By the way, it's not necessary to unhook the bulb. Hook the supply from the lamp to a power jack for which you have a mating plug.

Once the alarm clock turns on at the predetermined time, it sends a signal to the gate of the SCR, forcing it into conduction. The SCR completes the negative supply to K1, which turns on the appliance of choice. (Make sure that the SCR that you use can handle the relay's coil current.) Diode D1 shorts-out the spike voltage of the relay coil.

Switch S1 is a single-pole, single-throw, normally closed pushbutton switch that, when pressed, opens the circuit, stopping the SCR from conducting until another signal is present at the gate again. The alarm clock must be off to allow reset.

Switch S2 is a manual on/off switch for when you wish to use the appliance normally. Resistor R1 controls the gate current to the SCR. If the incoming signal from the lamp in the clock is higher than 10 volts, then increase R1. Device BR1 is a full-wave bridge rectifier, and C1 filters the DC ripple to stabilize the circuit, which never hurts.

Compare the relay-contact current rating to the

appliance's current draw to insure safe operation. I used a heavy-duty relay and the circuit turns on a whole entertainment center for me in the morning!

—Anthony C. Stonerock,  
Bellefontaine, OH

I used to have my stereo on one of those motorized timers so it would wake me up in the morning. Of course, I didn't have the fun of building it, and it probably cost more than yours.

Interested readers, for safety, be sure to insulate any AC connections properly (with wire nuts, etc.) and mechanically secure all connections.

Well it's time for us to part again. Until next time, please write to *Think Tank*, Popular Electronics, 500-B Bi-County Blvd., Farmingdale, NY 11735. If your work appears here, a book will be your reward. ■

## CIRCUIT CIRCUS

(Continued from page 83)

run, taking energy from the three charged capacitors. As the capacitors discharge, the three clocks begin to slow down producing the effect of the drums in a mechanical bandit slowing to a stop.

The 4017's ten output LED's may be numbered or designated as apples, cherries, bells, wild cards, or anything you like to make the game more interesting. Additional logic circuitry may be added to the 4017 outputs to sound an alert or turn on a light when any three numbers or output items match.

The three potentiometers, R12, R13, and R14, may be varied for each roll to change the clock's frequency and the roll rate.

That's all for now; see you next month. ■



# Popular Electronics

The HDTV Revolution

Philoflash Power System

The Exciting World of Ham Radio

Shaky!

600 Listening

Plans for the world's zaniest plaything—September 1989

# Get the one you missed!

# Popular Electronics

Popular Electronics back issues are available although quantities of some issues are nearly exhausted. Here's an opportunity to complete your collection, or obtain a selected back issue you cannot find elsewhere. This offer is valid only when using the coupon on this page or a photo copy.

## Special Back Issue Offer!

Please circle the issue(s) ordered!

	Jan.	Feb.	Mar.	Apr.	May	June	July	Aug.	Sep.	Oct.	Nov.	Dec.	
1987	1	2	3	4	5	6	7	8	9	10	11	12	
1988	1	1987-1988 back issues not available										23	24
1989	25	26	27	28	29	30	31	32	33	34	35	36	
1990	37	38	39	40	41	42	43	44	45	46	47	48	
1991	—	49	—	50	51	52	53	54	55	56	57	58	
1992	59	60	61	62	63	64	65	66	67	68	69	70	
1993	71	72	73										

Note: Issues prior to November 1988 are "Hands-on Electronics"—the predecessor of Popular Electronics.

## How to determine cost!

Quantity	Price per copy		
	United States	Canada	Foreign
1-5	\$6.50 US	\$6.50 US	*
6-11	5.50	5.75	\$8.00 US
12-23	5.00	5.25	7.50
24 and more	4.50	4.75	7.00

Prices include handling and shipping. Prices subject to change. All orders payable in U.S.A. funds only, via international money order, check drawn on a U.S.A. bank, or acceptable credit card (Visa, MasterCard) in U.S.A. funds. Allow 6-8 weeks delivery. Foreign orders may take longer. \*Minimum foreign order—6 issues.

Visa     
  MasterCard     
  USA Bank Check     
  US or Int. Money Order

[Note: Credit Card minimum order is \$15.00.]

Credit Card Number \_\_\_\_\_ Exp. Date \_\_\_\_/\_\_\_\_/\_\_\_\_

Signature \_\_\_\_\_

Name \_\_\_\_\_

Address \_\_\_\_\_

City \_\_\_\_\_ State \_\_\_\_\_ ZIP \_\_\_\_\_

Send Orders To: CLAGGK, Inc., P.O. Box 4099, Farmingdale, NY 11735. Sorry, no telephone orders.

# Popular Electronics

Square-Tesla Coil

Spheric Level Monitor

Build the Tesla Coil that went square!

August 1989

# Popular Electronics

Build Your Own Dice-Roulette Game

Lucky Lotto Selector

A Real Socket

Send Payment on This Issue

Cord Buster

Madison's Hobby

Your Hobby and the IRS

Ham Radio

Take a chance on our Dice-Roulette project—April 1989



Trees are the basic building blocks of the rain forest. Countless other forms of life depend on them for survival.

## RAIN FOREST RESCUE: TO HELP STOP THE DESTRUCTION

Every minute, an area of rain forest the size of 10 city blocks is destroyed. Once 8 million square miles of rain forest circled the globe. Now, a little over 3 million. 96,000 acres of rain forest are being burned and bulldozed every day.

Rain forests directly affect our weather. 70% of the plants found to have anti-cancer properties come from rain forests. They're home to more than half of the world's plant and animal species. Many of the songbirds in our own backyard winter in the rain forest.

Join The National Arbor Day Foundation and support Rain Forest Rescue to help stop the destruction. When you join, the Foundation will preserve threatened rain forest in your name. Help us help stop the destruction. Before it's too late.

To contribute to Rain Forest Rescue, call  
**1-800-222-5312**

 **The National  
Arbor Day Foundation**

## INTRODUCTION TO REACTANCE

*(Continued from page 72)*

tie more complex for parallel circuits. All the trigonometric functions previously mentioned are just as applicable to the parallel circuit, so long as care is taken to get the vectors drawn correctly in the first place. Mathematically, for Fig. 9A:

$$I = \sqrt{I_R^2 + I_C^2} \quad 1/Z = \sqrt{(1/R)^2 + (1/X_C)^2}$$

and for Fig. 9B:

$$I = \sqrt{I_R^2 + I_L^2} \quad 1/Z = \sqrt{(1/R)^2 + (1/X_L)^2}$$

**Power.** The power consumption of a purely resistive AC circuit is easy to determine: Simply calculate the product of the rms current and rms voltage to obtain average power. Figure 11A shows a graphical way in which instantaneous power consumption can be calculated by plotting current and voltage on the same axes and then performing successive multiplications to plot the power curve.

The same principle can be applied to the reactive circuit (see Fig. 11B). Recall that in a circuit containing just pure inductance, current lags voltage by 90 degrees. Plotting the power curve for this circuit yields an alternating waveform that is centered on zero. In other words, the net power consumption of an inductive circuit is nil.

That may seem a little confusing, so let's discuss why. During the positive portion of the waveform, the inductor takes energy and stores it in the form of a magnetic field. During the negative portions of the curve, the field collapses and the coil returns energy to the circuit. A similar situation occurs with pure capacitance, except that the capacitor stores energy as an electrostatic field and the current/voltage phase relationship is reversed.

As resistance is introduced to a circuit, the phase angle becomes less than 90 degrees and the power curve will shift to a more positive value, showing that the circuit is taking more energy than it is returning. However, the capacitive or inductive part of the circuit still stores and releases energy and consumes no power whatsoever—the power loss is due entirely to the resistance. Remember this basic rule: Only the resistive part of a circuit consumes power.

Take the circuit in Figure 11A as an example. Using the Pythagorean theorem, the resistance of 100 ohms and capacitive reactance of 50 ohms gives a combined impedance ( $Z$ ) of approximately 112 ohms as follows:

$$\begin{aligned} Z &= \sqrt{100^2 + 50^2} \\ &= \sqrt{10,000 + 2500} \\ &= \sqrt{12,500} \\ &= 111.8 \end{aligned}$$

By Ohm's law, that would allow a current of about 1 amp to flow in the circuit. The voltage drop across the resistor will be 100 volts, so the "true power" dissipated by that resistor will be 100 watts.

We know that the capacitive part of the circuit consumes no power, and yet multiplying the source voltage by circuit current yields an answer of 112 watts. The difference is accounted for, once again, by the difference in phase between the various voltages. As opposed to true power, the figure obtained by multiplying the source voltage and current is known as "apparent power," and it is specified as 112VA or 112 volt-amperes. The true power of the circuit can never be greater than the apparent power, and the ratio of true power in watts to apparent power in volt-amps is called the power factor.

A vector diagram can again be used to analyze the power factor. If the phase angle of the circuit is known, the power factor can be calculated directly by taking the cosine of that angle. In the circuit shown, that figure is the same as the ratio of  $E_R$  to source voltage. There are always several ways to obtain the power factor, depending upon the available data. In a purely resistive circuit, the true power is the same as the apparent power, so the power factor is 1. In a purely inductive or capacitive circuit the true power is 0, no matter what the apparent power, so the power factor is 0. Power factor is a very important consideration in heavy industrial power distribution, since cables must be able to handle the apparent-power load. ■

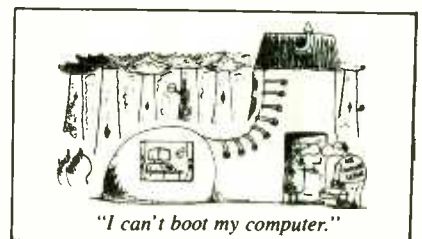



# Market Center<sup>TM</sup>

## MACHINE YOUR DREAM!

### THIS IS THE MACHINE YOU'VE BEEN WAITING FOR!

Have you ever dreamed of manufacturing and marketing your own products? If so, the Neuractor CNC-4 Desktop Manufacturing System may be just the edge you need! This fourth-generation CNC machining center can automatically drill, mill and route three-dimensional products in wood, plastic and light metals DIRECTLY FROM YOUR CAD DRAWINGS! You've seen the rapid-prototyping and "Santa Claus" machines that cost thousands of dollars, but did you know that as an electronic technician you can build one yourself from this inexpensive kit? Utilizing patent pending technology the Neuractor CNC-4 kit provides you with everything you need to machine products in three dimensions with a resolution of .001". All mechanical components are pre-fabricated, pre-machined, plated and painted. Includes four 83 oz/in CY-MOTORS, interface card, 5 amp power supply, 10 pitch steel lead screws, 4 proprietary Slide Block actuator mechanisms, 4 aluminum linear actuator channels, polished steel guide-rods, Dremel bracket, hardware, etc. (You provide Dremel or flex-shaft router and work surface.) It's a complete kit! All you do is put

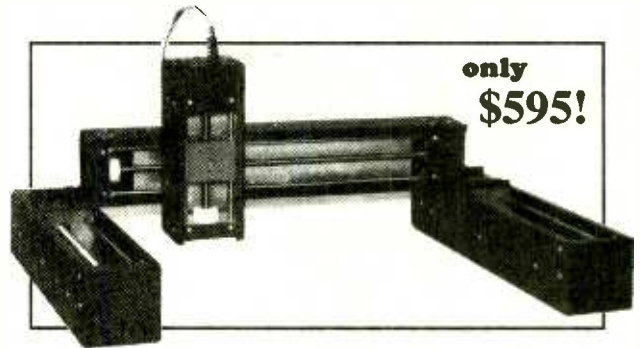

only  
**\$595!**

it together and calibrate it! Using 32 screw-type micro-calibrators, you calibrate your machine and then TURN IT LOOSE! Designed to be used with a Dremel MotoTool(tm), or flex-shaft router for more cutting power, the Neuractor translates your 3D CAD files directly into actual working parts! IF THAT'S NOT EXCITING ENOUGH, WE'RE THROWING IN A FREE, FULL-FEATURED 3D CAD/CAM SOFTWARE PACKAGE WITH EACH UNIT! Imagine using your new Neuractor to experiment with different product designs and concepts BEFORE taking the business plunge! By working out your product's design and Desktop Manufacturing processes, you can virtually automate the "proof-of-concept" phase of your projects! Built-in fonts for custom sign-making and panel engraving, 18"x18"x4.6" cutter travel for crafts, electronics, and printed circuit board drilling, not to mention model-making, mold-making, and painting. These are but a few opportunity areas others are already exploring with their Neuractors. You build it, you calibrate it, you customize it for your applications! Don't miss out on your chance to cash-in on your own at-home business! Get started by ordering your own Neuractor CNC-4 today! ACT NOW! Kit \$595 +\$24.95 UPS S/H. Allow 4-8 wks for delivery. U.S. CYBERLAB, 14786 S at Gate Rd., West Fork, AR 72774 (501) 839-8293



## CABLE TV DESCRAMBLER KITS

### "New & Improved Version"

#### Universal Descrambler

Includes all the parts and an etched & Drilled PC Board. Not included is AC adaptor or enclosure.....\$69.00

#### Tri-Mode Descrambler

Includes all the parts and an etched & drilled PC board & AC adaptor. Not included is the enclosure.....\$49.00

#### SB-3 Descrambler

Includes all the parts & an etched & drilled PC board & AC adaptor. Not included is the enclosure.....\$39.00

**Call Toll Free 1-800-886-8699**

**Visa, MasterCard & COD.**

**M & G Electronics, Inc. 2 Aborn Street, Providence, RI. 02903**

*It is not the intent of M & G Electronics, Inc. to assist any individual to defraud any pay TV operator or to violate any state or federal laws regarding the use of the descrambler kits. You must understand the kits being purchased for educational and or experimental use only.*

# B & S SALES

Call (313) 566-7248 • FAX (313) 566-7258 24 hrs.

Hours: Monday through Friday 8 am to 6 pm EST  
51756 Van Dyke St. #330, Shelby Township, MI 48316

WE SPECIALIZE IN QUANTITY PRICING 5, 10, 20 LOTS

*Make Your Best Deal!*

**\$ SALE**  
**Y RENT**

**\$ SALE**  
**Y RENT**

<u>JERROLD</u>	<u>SA</u>	<u>PIONEER</u>	<u>HAMLIN</u>	<u>TOCOM</u>	<u>ZENITH</u>
DRX-3-DIC	8590	BA 6110	CR 6600-3M	5507 VIP	1600
DPBB	8580	BA 5135	CR 6000-3M	5503 VIP	
DPV-5,7	8570				
	8550				

**NEW PAN**  
**PIONEER**  
**GREEN E LITE**  
BA 5000 > SERIES  
BA 6000

**NEW PAN**  
**SA-8500 SERIES**  
**(BUT ALL BASE BAND)**  
**THE PREMIER**

**NEW PAN**  
**JERROLD**  
**PINK PAN**

## PANASONIC TZ — PC 1453G2

By far the best basic converter on the market today. 550 MHz (1 to 99) parental control, sleep timer, remote batteries, contrast and remote control range.

*Superior to all other converters*

**NO MICHIGAN SALES**

**MINI TVT:**  
**THE 1/4 POUNDER**  
**LITTLE 4x4**  
**SECOND ONLY TO TVT**  
**GOLD IN POPULARITY**

**OWN YOUR OWN**  
SA-3  
M-80  
**SAVE \$**

**NEW REMOTE CONTROL AS**  
**SWITCH FOR DUAL SYSTEMS**  
**(WITHOUT LEAVING THE**  
**COMFORT OF YOUR CHAIR)**

**TVT GOLD ORIGINAL**  
**FOR MOST**  
**JERROLD SYSTEMS,**  
**LEADING SELLER**  
**OF ALL PANS**

**TNT**  
**MLD**  
**OWN YOUR OWN**  
**SAVE \$**

**FILTERS**  
**POST & NEG**  
**SUBCONTRACTORS**  
**& DEALERS**  
**ONLY QUANTITY**

We are now offering a 6-month warranty. In order for warranty to be in effect, this form must be signed and returned.  
**FOR VCR, SECOND, THIRD, ETC. HOOK-UPS.**

Yes, I agree all units are to be used or resold in compliance with Federal and State laws.

Signature \_\_\_\_\_ Date \_\_\_\_\_

Name \_\_\_\_\_ Phone No. ( ) \_\_\_\_\_  
Address \_\_\_\_\_  
City \_\_\_\_\_ State \_\_\_\_\_ Zip \_\_\_\_\_  
It is not the intent of B & S Sales to defraud any pay television operator and we will not assist any company or individual in doing the same.

CIRCLE 137 ON FREE INFORMATION CARD





**Get instant tech information FREE from your Fax or Computer!**

You can obtain specs, freq. info, software and more from our automated services. For fax facts, call from your stand alone fax machine and follow the voice prompts. Use the BBS from your modem of fax/modem equipped computer. Dial 317-849-8683 for fax back service, or dial 317-579-2045 for our computer bulletin board service.

## Total Coverage Radios

### TRIDENT

**TR1200XLT**  
AM Broadcast to  
Microwave 1000 Scan  
Channels \$389.00



500KHz to 1300MHz coverage in a programmable hand held. Ten scan banks, ten search banks. Lockout on search and scan. AM plus narrow and broadcast FM. Priority, hold, delay and selectable search increments. Cell Lock. Permanent memory. 4 AA ni-cads and wall plus cig charger included along with belt clip, case, ant. & earphone. Size: 6 7/8 x 1 3/4 x 2 1/2. Wt 12 oz. Fax fact document # 205

### TRIDENT

**TR4500 \$449**  
2016 Channels  
1 to 1300MHz  
Computer Control



62 Scan Banks, 16 Search Banks, 35 Channels per second. Patented Computer control for logging and spectrum display. AM, NFM, WFM, & BFO for CW/SSB. Priority bank, delay/hold and selectable search. Cell Lock Permanent memory. DC or AC with adaptors. Mtng Brkt & Antenna included. Size: 2 1/4H x 5 5/8W x 6 1/2D. Wt. 11lb. Fax fact #305

### TRIDENT

**TR980 \$279.00**  
125 Channels  
5MHz to  
999MHz



Most Economical receiver in its class, offers AM, NFM Wide FM, modes. 5KHz increments. Delay & hold & Search. Cell Lock NiCads, chgr & whip ant. Size: 5 7/8H x 1 1/2W x 2 D. Wt 14oz.

## Continuous Coverage



Three new Bearcat units offer expanded coverage and more memory than before. The 890 offers 200 channels, base/mobile operation, VFO tuning, service search, weather alert, search and store, and more. The 2500 hand held has 400 channels, fast scan and more. The Bearcat 8500 has 500 channels in 20 banks, VFO, auto store, alpha numeric display, 10 priority channels, aux tape output jacks, and coverage to 1.3 Gigahertz.

- Bearcat 2500XLT hand held.....\$349.95
  - Bearcat 8500XLTC mobile.....\$389.95
  - Bearcat 890XLTB mobile.....\$259.95
- 25-1300MHz, 500 ch. in 8500, 400 in 2500. 890 has 200 ch & 29-956MHz. All cell locked. Features include turbo scan, VFO, search and store, Priority, LCD display, and more. Fax Facts #74,475,476

## Mobile Scanners

**TRIDENT**  
TR2C  
Police & CB  
\$69.95



Scans police programmed by state channel plus the CB channel of your choice. Also has Mobile Repeater and Weather. Extra cost option of CB and laser detectors built in. Compact size allows for dash or visor mounting. Mtng hardware and power connectors included. Size: 5 5/8 x 4 7/8 x 1 3/4. Wt: 1.5lbs. Fax fact #580

- Bearcat 700AX 50Ch w/800..... \$159.95
- Bearcat 350A 50 Ch H/L/U..... \$119.95
- Bearcat 560XLJ 16 Ch H/L/U..... \$ 89.95
- Bearcat 760XM100Ch H/L/U/Air/800 \$219.95
- Bearcat T2 state/state scan..... \$144.95

## Shortwave Radios

- Sangean ATS-818CS..... \$219.95
- Sangean ATS-818..... \$184.95
- Sangean ATS-803A..... \$169.95
- Sangean ATS-808..... \$179.95
- Sangean ATS-606..... \$149.95
- Sangean ATS-606P..... \$169.95
- Sangean ATS-800..... \$89.95
- Grundig YB400..... \$219.00
- Grundig Satellit 700..... \$399.00



## Hand Held Scanners

### Bearcat 200XLTN

**\$209.95 200 Channels 800 MHz**  
Ten scan banks plus search. Covers 29-54, 118-174, 406-512 and 806-956MHz (with cell lock). Features: search, delay, 10 priorities, mem backup, lockout, WX search, keylock. Includes NiCad & Chgr. Size: 1 3/8 x 2 11/16 x 7 1/2.



- Bearcat 120XL TJ 100Ch H/L/U..... \$149.95
- Bearcat 150XL TJ 100Ch H/L/U/8..... \$199.95
- Bearcat 220XL TJ 200 Ch H/L/U/8.... \$249.95

Coverage of above hand holds is: 29-54, 136-174, 406-512, and 800MHz band as indicated. Fax facts #475

## Table Top Scanners

- Bearcat 855XLTE 50 Ch w/800..... \$159.95
- Bearcat 142XLM 10Ch H/L/U..... \$ 73.95
- Bearcat 147XLJ 16 Ch H/L/U..... \$ 89.95
- Bearcat 172XM 20Ch H/L/U/Air..... \$124.95
- Bearcat 145 16Ch H/L/U..... \$ 79.95

## Accessories & Etc.

- Mag Mount Mobile Ant MA100..... \$ 19.95
- Base Ant. 25-1000MHz AS300..... \$ 59.95
- Pre-Amp .1-1500MHz GW2..... \$ 89.00
- Wide Coverage Antenna..... \$119.95
- Base Discone Ant DA300..... \$ 89.00
- External Speaker MS190/opt. amp.... \$ 19.95
- Old Scanner Repair, all brands..... \$ CALL
- Extended Warranties..... \$ CALL
- Frequency Info FaxFact/Modem..... \$ FREE
- On Glass Mobile Antenna..... \$ 32.95

## 2 Way Radios

VHF hi band programmable mobiles as low as \$299.95. Call for quotes or Fax Fact #775

**TRIDENT Winner of the 1994 INNOVATIONS Design & Engineering Honors, Electronic Industries Association. Trident TR2400 Total Coverage Receiver**

Trident TR2400: 100KHz to 2060MHz. Ten scan banks of 100 channels each, ten search banks. Tuning increments as low as 1KHz. Beat Freq. Oscillator for SSB and CW modes. Search lockout and store. VFO tuning knob. Permanent memory. Bank lock and linking. Attenuator switch. Backlit LCD. 1 Yr Warranty. AM/NFM/WFM. Selectable increments. Delay, Hold, Priority. 5 7/8H x 1 1/2D x 2W. Wt 14 oz. \$499.00

**Toll Free, 24 Hours! 800-445-7717 Fax Orders 800-448-1084 Fax Facts 317-849-8683**

Computer BBS Modem & Fax/Modem, 317-579-2045. Toll Free Tech Support, Dial 800-874-3468

International Fax: en Espanol, en Francais, und auf Deutsch, or just fax in plain English to: 317-849-8794

**ACE Communications 6975 Hillsdale Court, Indianapolis, IN 46250**

Service & Support hours: Mon.-Fri. 9AM to 6PM, Sat. 10-4 EST. Mastercard, Visa, Checks, Approved P.O.'s & COD (add \$5.50) & AMEX, Discover. Prices, specifications and availability subject to change. Flat rate ground shipping and handling charge only \$6.95 per unit. Express Air only \$9.95, for most units, to most locations. One week trial, no returns accepted two weeks after original receipt without substantial restocking charge. All units carry full factory warranty. Indiana residents add 5 per cent sales tax.

**FLY IT! ONLY \$9.95**



**CALL TOLL FREE**  
**1-800-292-7711**  
**1-800-445-3201 (Can)**

# C&S SALES

## EXCELLENCE IN SERVICE

**WRITE FOR  
 FREE CATALOG**



**Line Tracker  
 MV-963  
 \$52.95**  
 (Infra-red Sensor)  
 The robot follows  
 a black line  
 on white paper  
 Preassembled PCB



**Dual-Display  
 LCR Meter  
 w/ Stat Functions  
 B+K Model 878  
 \$239.95**  
 Auto/manual range  
 Many features  
 with Q factor  
 High Accuracy

**Electronic Tool Kit Model TK-1000**  
 A professional organizer tool kit at affordable prices. No student should be without this unique tool kit that holds all the tools you need.  
**\$39.95**

Including:  
 Diagonal Cutter  
 Long Nose Pliers  
 6" Wire Stripper  
 Solder 60/40  
 6" Screwdriver  
 6" Phillips Driver  
 Safety Goggles  
 IC Puller  
 3pc Nut Drivers  
 Iron 25W  
 Iron Stand  
 Solder Wick  
 Desoldering Pump  
 5 pc Solder Ease Kit  
 6pc Precision Screwdrivers



**Robotic Arm  
 Y-01  
 \$49.95**  
 (Wired Control)  
 Movement grabs  
 & releases,  
 lifts & lowers,  
 pivots from side to side



**Stereo Cassette Player  
 Kit  
 Model  
 TR-18K  
 \$16.95**  
 Headphones  
 Included



**Digital  
 Multimeter  
 EDM-83B  
 \$175.00**  
 Almost every  
 feature available  
 Bargain of  
 the decade



**Digital  
 Multimeter  
 DVM-638  
 \$39.95**  
 11 Functions  
 with case



**Digital  
 Capacitance  
 Meter  
 CM-1555  
 \$49.95**  
 Measures capacitors  
 from .1pf to 20,000µf



**Digital  
 LCR Meter  
 LCR-680  
 \$79.95**  
 3-1/2 Digit  
 LCD Display  
 Inductance  
 1uH to 20MΩ



**Function  
 Generator  
 FG-801  
 \$149.95**  
 Square,  
 Triangle  
 Sine wave  
 Freq range



**3-3/4 Digit Multimeter  
 BK-390  
 \$139.00**  
 0.1% DCV accy  
 Analog bar graph  
 Auto/manual ranging  
 Capacitance meas  
 Temperature probe



**Digital  
 Multimeter Kit  
 w/ Training Course  
 M-2665K  
 \$49.95**  
 Full function 34 ranges  
 Ideal school project  
**M-2661 (Assembled) \$55.00**



**Frequency Counter  
 F-1225  
 \$225.00**  
 8 Digit LED display  
 Wide meas range  
 High sensitivity  
 Data hold function  
 Input impedance 1MΩ or 50Ω  
 10:1 input attenuation function

**Fluke Multimeters  
 (All Models Available Call)**  
**Scopemeters**  
 Model 97 \$1,795  
**10 Series**  
 Model 10 \$62.95  
 Model 12 \$84.95  
**20 Series**  
 Model 291L \$175

**70 Series**  
 Model 701L \$69.95  
 Model 731L \$97.50  
 Model 771L \$149  
 Model 791L \$175  
**80 Series**  
 Model 87 \$289



**Triple Power  
 Supply  
 XP-620  
 By Elenco  
 \$75.00**

3 fully regulated supplies; 1.5-15V @ 1A, -1.5 to -15V @ 1A or 3-30V @ 1A & 5V @ 3A Kit XP-620K \$49.95



**Quad Power  
 Supply  
 XP-581  
 By Elenco  
 \$79.95**

Four supplies in one unit; 2-20V @ 2.5A, 5V @ 3A, -5V @ .5A and 12V @ 1A. All regulated and short protected



**High Current DC  
 Power Supply  
 BK-1686 \$169.95**  
 3 to 14 VDC Output  
 12A @ 13.8V  
 For servicing high  
 power car stereos,  
 camcorders, ham radios, etc.  
 Connect 2 or more in parallel



**Wide Band  
 Signal  
 Generators  
 SG-9000  
 \$124.95**  
 RF Frequency 100K-450MHz  
 AM modulation of 1KHz Variable  
**SG-9500 150MHz \$239.00**

**Telephone Kit  
 PT-223K  
 \$14.95**  
 Available  
 Assembled  
 PT-223  
 \$15.95



**Function Generator  
 Blox  
 #9600  
 By  
 Elenco  
 \$29.95**  
 Kit \$26.95  
 Sine, Triangle, Square Wave



**Learn to Build & Program  
 Computers with this Kit**



**MM-8000  
 By Elenco  
 \$129.00**

From scratch you build a complete system. Our Micro-Master trainer teaches you to write into RAMs, ROMs and run a 8085 microprocessor, which uses similar machine language as IBM PC.

**Digital/Analog Trainer  
 Complete Mini-Lab For Building,  
 Testing, Prototyping Analog and Digital**



**By Elenco  
 in U.S.A.**  
 XK-525  
**\$159.95**  
 Kit  
 XK-525K  
**\$129.95**

**AM/FM Transistor  
 Radio Kit  
 with Training Course  
 Model AM/FM 108  
 \$27.95**  
 14 Transistor, 5 Diodes  
 Easy to build because  
 schematic is printed on the PCB  
 Makes a great school project  
 Model AM-550 AM Only \$17.95

**Telephone Line  
 Analyzer  
 Kit TT-400K \$19.95  
 Assembled TT-400 \$25.95**



**WE WILL NOT BE UNDERSOLD**  
 UPS SHIPPING: 48 STATES 5%  
 IL RES 7.5% TAX (\$3 min \$10 max)  
 OTHERS CALL

**C&S SALES INC.**  
 1245 ROSEWOOD, DEERFIELD, IL 60015  
 FAX: 708-520-0085 (708) 541-0710



**15 DAY MONEY BACK  
 GUARANTEE**  
**FULL FACTORY WARRANTY**  
 PRICES SUBJECT TO CHANGE WITHOUT NOTICE



**FREE PROBES  
WITH ALL  
SCOPES**

**ELENCO ♦ HITACHI ♦ B+K  
SCOPES  
AT GUARANTEED LOWEST PRICES**

**WRITE FOR  
FREE  
CATALOG**

**QUALITY - ELENCO OSCILLOSCOPES**

**2-YEAR WARRANTY**

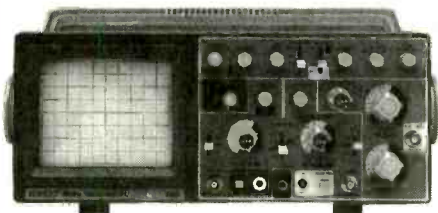

**60MHz**

**S-1360 \$775**

Delayed Sweep

**S-1365 \$849**

Cursor Readout

- Voltage, Time
- Frequency differences displayed on CRT

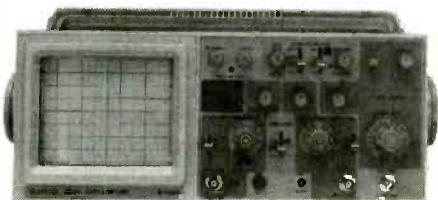

**40MHz**

**S-1340 \$495**

2- Channel

**S-1345 \$575**

Delayed Sweep

- Beam Find
- Component Tester



**25MHz**

**S-1325 \$349**

2- Channel

**S-1330 \$449**

Delayed Sweep

- Beam Find
- Component Tester

*Dependable Equipment at Affordable Prices*

**B+K 20MHz**

2 Channel

**Model 2120 \$389.00**



Delayed Sweep

**Model 2125 \$539.95**

**40MHz DUAL -TRACE**

**Model 1541B \$749.95**

- 1mV/div sensitivity
- Video sync separators
- Z axis input
- Single sweep
- V mode-displays 2 signals unrelated in frequency

**60MHz DUAL-TRACE**

**Model 2160 \$949.95**

- 1mV/div sensitivity
- Sweep to 5ns/div
- Dual time base
- Signal delay line
- Component tester
- V mode-displays 2 signals unrelated in frequency

**100MHz THREE-TRACE**

**Model 2190 \$1,379.95**

- 1mV/div sensitivity
- Sweeps to 2ns/div
- Dual time base
- Signal delay line
- 19kV accelerating voltage
- Calibrated delay time multiplier

**20MHz ANALOG with DIGITAL STORAGE**

**Model 2522A \$869.95**

- 20MHz analog bandwidth
- 20MS/s sampling rate
- 2k memory per channel
- 20MHz equivalent time sampling

**HITACHI POPULAR SERIES**

V-212 - 20MHz, 2 Channel	\$425.00
V-222 - 20MHz, DC Offset	\$695.00
V-422 - 40MHz, Dual Trace	\$849.00
V-522 - 50MHz, Dual Trace	\$975.00
V-523 - 50MHz, Delayed Sweep	\$995.00
V-525 - 50MHz, w/ Cursor	\$1,069.00

**HITACHI COMPACT SERIES SCOPES**

V-660 - 60MHz, Dual Trace	\$1,375.00
V-665A - 60MHz, DT, w/cursor	\$1,449.00
V-1060 - 100MHz, Dual Trace	\$1,549.00
V-1065A - 100MHz, DT, w/cursor	\$1,695.00
V-1085 - 100MHz, QT, w/cursor	\$2,125.00
VC-6045A - 100MHz, Digital Stor	CALL
VC-6025A - 50MHz, Digital Stor	CALL

**Elenco DS-203 20MHz, 10MS/s Digital Storage Oscilloscope**

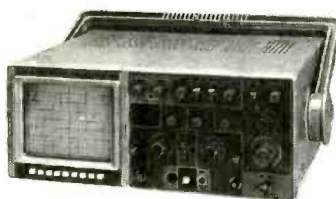

**\$749**

2K Word Per Channel • Plotter Output  
8 Bit Vert. Resolution • 2048 Pts Hor. Resolution • Much More.....

**FLUKE SCOPEMETERS**

A handheld instrument that combines a 50MHz, 25MS/s dual channel digital storage oscilloscope with feature-packed 3000 count digital multimeter.



**Model 93 - \$1,225**  
**Model 95 - \$1,549**  
**Model 97 - \$1,795**

- Autoset, automatically sets voltage, time & trigger
- Multimeter display; 3-2/3 digits (>3000 counts)
- True RMS volts; AC or AC+DC up to 600V

**C&S SALES INC.**

1245 ROSEWOOD DEERFIELD IL 60015  
FAX: 708-520-0085 (708) 541-0710

**CALL TOLL FREE**

**1-800-292-7711**

**1-800-445-3201 (Can)**



**15 DAY MONEY BACK GUARANTEE  
FULL FACTORY WARRANTY  
ALL PRODUCTS ARE FACTORY NEW**

PRICES SUBJECT TO CHANGE WITHOUT NOTICE

CIRCLE 32 ON FREE INFORMATION CARD



# LATEST TECHNOLOGY

- DESCRAMBLERS
- CONVERTERS
- COMBINATION UNITS

**WE'LL BEAT ANY PRICE!**

## LATEST DESCRAMBLER MODELS

Add On Descrambler for all JERROLD Systems (Except Base Band) Guaranteed to Work Anywhere Coast to Coast (Model JD-3)

~~\$425~~  
**\$89** 6-10  
**\$119** 1-5

Add On Descrambler For All PIONEER Systems. Guaranteed to Work Anywhere Coast to Coast. (Model PD-3)

~~\$125~~  
**\$89** 6-10  
**\$119** 1-5

Add On Descrambler For All SCIENTIFIC ATLANTA Systems (Except 8570, 8590, 8600). Guaranteed to Work Anywhere Coast to Coast. (Model SAD-3)

**\$89** 6-10  
**\$119** 1-5



**BRAND NEW 1 YEAR WARRANTY**

### SCIENTIFIC ATLANTA 8580

- Features
- Wireless Remote Control
  - Favorite Channel Recall
  - Parental Lockout

**\$259** 6-10

**BRAND NEW 1 YEAR WARRANTY**

**\$289** 1-5

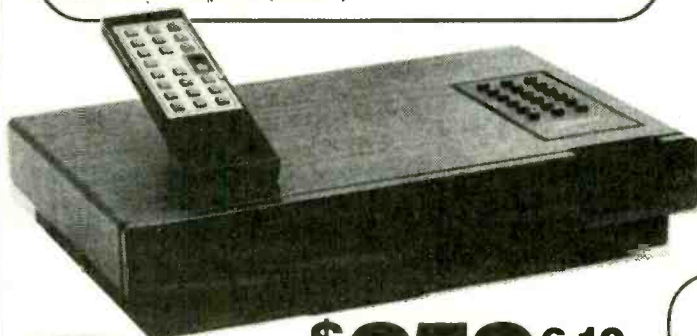

### ZENITH

#### Features

- Wireless Remote Control
- 550MHz (99 Channel) capacity
- Volume Control
- Parental Lock-Cut
- Programmable Favorite Channel Memory

**\$259** 6-10

**\$289** 1-5

## ADD ON DESCRAMBLERS

	1-5	6-10
FTB-3	49.00	39.00
TVT OR TBI	55.00	47.00
SA-3	59.00	49.00
KN12-3	59.00	49.00
MLD1200-3	49.00	39.00

## CONVERTERS

	1-5	6-10
PANASONIC 1453G	79.00	69.00
JERROLD DQN7-3	75.00	65.00
STARGATE 2001	75.00	65.00

Call for other models



**DPV7 & DBB7  
8590 & 8600**  
Call for availability & prices

**JP VIDEO**

1470 OLD COUNTRY ROAD,  
SUITE 315 - P.E.  
PLAINVIEW, NY 11803  
NO NY SALES

**FREE COLOR CATALOG!**  
**1-800-950-9145**



# Simply A Superior 1.3 GHz Spectrum Analyzer

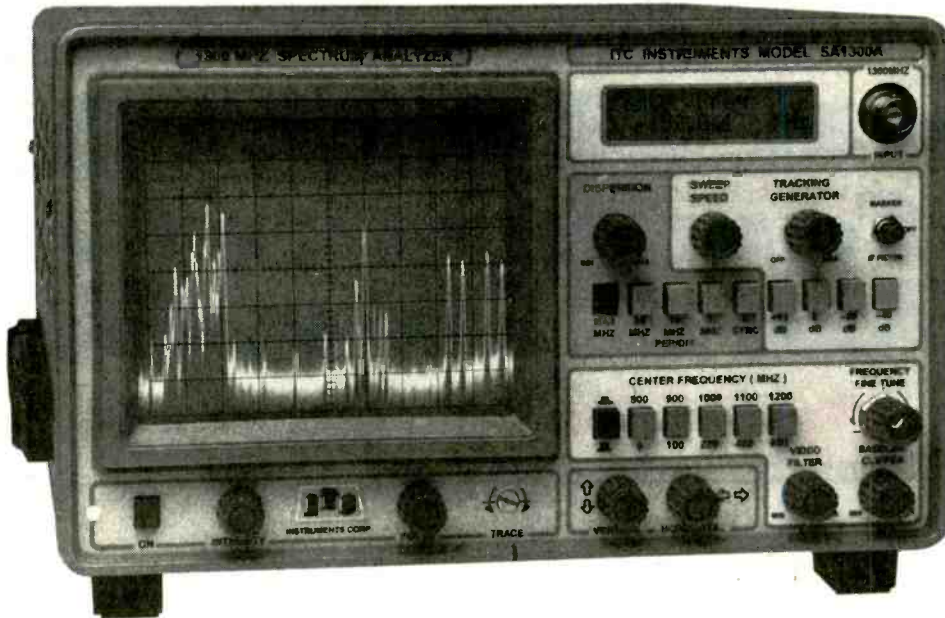

**1-1300 MHz *In One Sweep* \$1,895.**

**MADE IN USA** -10KHz Resolution Band Width -7 Digit Center Frequency Display

**MARINE, TWO-WAY, HAM, AM FM SW BROADCAST RADIO - CATV, SATELLITE. SYS., SURVEILLANCE  
TUNE DUPLEXERS, AMPS, FILTERS, SECURITY TRANS, & RECEIVERS - EMI, RFI, FCC, TESTING**

## EXCLUSIVE DISPERSION ZOOM

ITC SA Series exclusive Dispersion Zoom lets you zoom in on **any Center Frequency** signal, from any one of five calibrated Dispersion positions. Preset at >140 MHz, 50MHz, 10MHz 1MHz and zero MHz per division. The SA1300A displays greater than 1300 MHz on the screen at one time yet allows instant zoom to any Dispersion Scan Width as low as zero MHz per div. Allowing for total control over all **Dispersion Scan Widths** settings.

## 80 dB ON SCREEN

130 dB total Dynamic range **110 dBm Sensitivity**. At Narrow and Wide Band Width settings. Performance you would expect only from a \$10,000 Analyzer.

## ULTIMATE *LOW COST* ANALYZER

ITC Spectrum Analyzers are the best performance to price ratio Analyzers on the market today. No other low cost Analyzer comes close to the Superior performance and quality of an ITC Analyzer. **Total flexibility and ease of operation.** SA1300A gives you full control over the Resolution Band Width and Freq. Span widths. Plus Vertical Position, Baseline Clipper, Sweep Speed, Video Filter, 4 Input Attenuator settings, 10 Frequency Select settings.

## MODEL SA1800B 1800 MHz

Covers 1-1300 MHz and 850-1850 MHz In one sweep. Ideal for Satellite service. The **SA1800B** has the same general specifications as the model SA1300A.

## INTRODUCTORY OFFER

**SA1300A & OPT.s 1, 3, 6  
ONLY \$1895.00** note 1

**SA1800B & OPT.s 1, 3, 6  
ONLY \$2295.00** note 1  
\$1995.00 Opt. 1, 6 ONLY

SA1300A	\$1595.00
SA1800B	\$1895.00
OPT. 1 50MHz MARKER	\$200.00
OPT. 3 +/- 5KHz Res B.W	\$350.00
OPT. 5 1000 MHz Tracking Generator	\$250.00
OPT. 6 7 Digit Center Frequency Display	\$300.00

Note 1: Introductory Price for limited time only.

**TAKE ADVANTAGE  
CALL 1-800-566-1818**

To: Order - For information & Special Intro. Offer  
Terms MC, VISA, AE, Check, COD, PO (OAC), LC, Transfer

**DISTRIBUTED BY: ADVANTAGE INSTRUMENTS CORP.**

3817 S. CARSON ST. # 818 CARSON CITY NV. 89701

1-800-566-1818 702-885-0234 FAX 702-885-7600

PRICES & SPECIFICATIONS SUBJECT TO CHANGE WITHOUT NOTICE OR OBLIGATION. F.O.B. CARSON CITY NV. NV. RESIDENTS ADD SALES TAX. 101

CIRCLE 138 ON FREE INFORMATION CARD

**OPTOELECTRONICS**

# Setting New Standards

IN THE WORLD OF

## Communications, Test & Surveillance

**Further • Better • Faster**



**Model 3000A \$329.**

World's most highly advanced hand held counter.

- Digital Filter: Reduces false counts - no loss of sensitivity
- Digital Auto Capture - auto hold & store; works even near strong RF Fields
- Stores and recalls frequencies
- 5-6 hour battery operation
- Fast - 950 million counts per second for high resolution - 250 MHz direct count
- 10 Hz to 3 GHz
- Ultra sensitive bargraph w/ 16 segment display
- Multi-Function Counter with Frequency, Period, Ratio and Time Interval
- Optional  $\pm 2$  PPM TCXO - \$100.

**Model M1 \$229.**

Full Range Pocket Sized Counter

- Digital Filter
- Digital Auto Capture - Auto Hold
- Stores & Recalls Frequencies
- 4-5 hr. battery operation
- 10 Hz to 2.8 GHz
- 10 digit LCD with EL backlight

**Model 8040 \$679.**

Multi-Function Bench/Portable Counter Measures Frequency Period, Ratio, Time Interval and Average.

- Digital Filtering to eliminate false counts
- Auto Capture/Auto Hold
- 16 Segment Signal Strength Bargraph
- Dual 50 Ohm and 1 Meg Ohm input amplifiers with AC/DC Coupling,  $\pm$  Polarity, Triggers Level Adj., Low Pass Filter and Attenuator
- .05PPM, 0-50°C Oversized Time Base Option
- Internal/External Clock Input
- RS-232 Serial Computer Interface

**8 0 0 • 3 2 7 • 5 9 1 2**

(305) 771-2050 • FAX (305) 771-2052 • 5821 NE 14th Ave. Ft. Lauderdale FL 33334

CIRCLE 43 ON FREE INFORMATION CARD





**Model DC440 Decoder \$259.**

- 50 Sub-Audible (CTCSS) tones
- 106 Digital (DCS) Codes
- 16 Touch Tone (DTMF) characters/126 character recall
- Serial Data Interface
- Update older service monitors
- Ideal for testing two way radios
- Tone log software available
- Exceptional 2x16 character backlit display
- Small size - 1.8" x 4.5" x 4" deep



**Model 3300 MiniCounter \$129.**

- Super Compact
- 10 digit LCD - longer battery life
- 1 MHz to 250 MHz direct count for high resolution (1 Hz/Second)
- Maximized Sensitivity
- Hold Switch to lock display
- Ni-Cad plugs into board - no soldering to change outpack



**Model CF-802 \$149.**

835 MHz ± 10 MHz filter/amplifier. 10 times the pick-up distance when used with our counters or R-10.

**Model R-10 \$359.**

The R-10 is a unique FM Communication Test Receiver with security and surveillance applications. 30 MHz to 2 GHz. Measures deviation and relative signal strength. Demodulates FM

**Model APS104 \$995.**

Tunable band pass filter covers 10 MHz to 1,000 MHz. Tunes continuously over more than 5 octaves. Increase pickup distance 10 times. Ultimate Security Sweeper.



**MADE IN THE U.S.A**  
CIRCLE 43 ON FREE INFORMATION CARD

5% Ship/Handling (Max \$10 U.S. & Canada, 15% outside continental U.S. Visa Master Card, C.O.D., Cash or Money Orders only. All specifications and prices are subject to change without notice or obligation.

**AMERICAN  
RADIO  
HISTORY**



# ALL ELECTRONICS CORP.

QUALITY PARTS • DISCOUNT PRICES • FAST SHIPPING

## JUMBO SAVINGS! JUMBO LEDs

Liton # LTL 327C - 8MM  
Ideal for eye-catching indicators and displays. A recent quantity purchase of these BIG, 8mm diameter, red diffused LEDs enables us to provide some very special pricing. The leads on these devices have been trimmed to 0.325", leaving plenty of room for soldering. Normally these parts would sell for more than twice our price.



CAT #  
LED-23

5 for \$ 1.00

100 for \$15.00  
1000 for \$120.00

## SPECIAL QUANTITY PURCHASE!

### TWO AA CELL BATTERY HOLDER

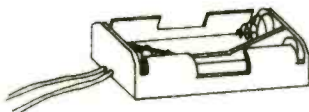

Flexible black plastic holder for two AA batteries. 5.5" long red and black leads. 2.25" X 1.17" X 0.5".

CAT #BH-2AA

2 for \$ 1.00

100 for \$35.00  
1000 for \$250.00

### LASER TUBE

Siemens# LGR 7659



1 mW helium-neon laser tube. 22.5 mm diameter X 146 mm long. 1.7 mrad beam divergence. 7 kV start voltage. 1kV operating voltage. 3.5 mA current.

CAT# LT-1

\$ 25.00 each

## 4 POSITION SCREW CLAMP TERMINAL STRIP

Four position, dual screw terminal strip for surface mounting. Screw-clamp terminals accept up to AWG 16 wire. Black thermoplastic housing. UL listed. Terminals and mounting holes are on



CAT# TER-41

4 for \$ 1.00

100 for \$20.00

## 12 Vdc 90 DEGREE GEAR MOTOR

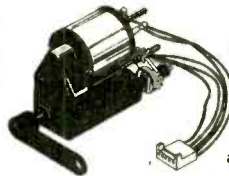

Originally built for electric automobile mirror adjusters, these small 12 vdc gear motor assemblies have quite a bit of torque. Though they only rotate 90 degrees at a rate of about 1 RPM, they could be quite useful for animation

or robotics applications where 360 degree rotation isn't required. There is also a variable resistor attached to the back of the shaft which was used as a position sensor. The overall dimensions of the assembly are 1.95" X 1.25". Attached to the 1/8" diameter final drive shaft is a 1.92"

CAT# DCM-49

\$ 6.00 each

## 640 X 480 LCD DISPLAY

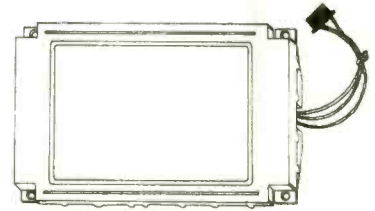

Sharp # LM64P70

Brand new 640 X 480 dot LCD flat panel display with on board high speed drivers and built-in CCFT backlight (inverter not included). Logic voltage: 5 Vdc. LCD driver voltage: -16.2 Vdc. Viewing area 6.8" X 5.1". Overall module size: 10.1" X 6.23" X 0.33". These displays sold for over \$300.00 new. Includes specs and hook-up information.

CAT# LCD-17

\$ 45.00 each

## 9 Vdc @ 200 ma. WALL TRANSFORMER

### SPECIAL!



CAT#  
DCTX-9200

Three prong grounded plug. 6 foot long cord terminates to three color-coded pigtail leads.

100 for \$180.00

\$ 2.00 each

## VACUUM FLUORESCENT DISPLAY

Futaba # M202SD08GL

Two rows of 20 characters displayed in a 5 X 7 dot matrix. Bright green 5mm X 3.5mm characters. On board CPU, driver and DC-DC converter simplifies hook-up and interfacing. Operates on 5 Vdc. Displays 215 different characters including alphanumeric and other symbols. ASCII configuration. Module overall dimensions: 6.1" X 1.7" X 0.7" thick.

These displays were modified somewhat from original specifications and we do not know the exact nature of the modifications. They work fine in the test mode, but we don't know if the original interface is the same. We supply a data/ hook-up sheet for the pre-modified device which, hopefully, provides most of the information necessary to use the display.

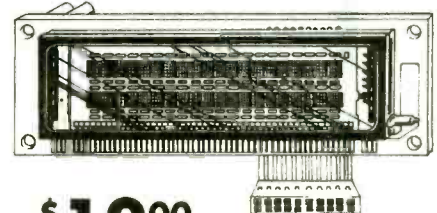

\$ 12.00 each

CAT# VFM-2

MANUFACTURERS - We Purchase EXCESS INVENTORIES... CALL, WRITE OR FAX YOUR LIST

CALL, WRITE or FAX For A Free 64 Page CATALOG Outside the U.S.A. send \$2.00 postage

ORDER TOLL FREE 1-800-826-5432

MAIL ORDERS TO:  
ALL ELECTRONICS CORP  
P.O. Box 567  
Van Nuys, CA 91408

FAX (818) 781-2653  
INFO (818) 904-0524



Minimum Order \$10.00 • All Orders Can Be Charged To Visa, Mastercard Or Discover Card • Checks and Money Orders Accepted By Mail • California, Add Sales Tax • No C.O.D. • Shipping And Handling \$4.00 for the 48 Continental United States • All Others Including Alaska, Hawaii, P.R. and Canada Must Pay Full Shipping • Quantities Limited • Prices Subject to change without notice.

CIRCLE 28 ON FREE INFORMATION CARD





**Forest  
Electronics  
Inc.**

**Are you overpaying . . .  
. . . your cable company?**

**You are if . . .**

**. . . you are leasing their  
equipment.**

- Forest Electronic, Inc. offers a complete line of New Cable Equipment that is fully Compatible with your cable system.
- All systems come with: Remote Control, & Parental Guidance Feature. Volume Control is also available.
- All Equipment is fully guaranteed & comes with a 30 day money back option.

For More Information Call Us At:

**800-332-1996**

FAX: 708-860-9048

Tap into a World of...

## FREE ELECTRICITY

Our 150+ page *Self-Reliance Catalog*  
IS JUST LOADED WITH DC to AC  
ENERGY INDEPENDENCE ...

We offer:

- Solar, Wind & Hydroelectric energy systems. True Sine Wave DC to AC Inverters.
- Electric Boat & Car kits.
- Portable power packs.
- Solar Lighting & Cooling systems. Solar Pool Heaters.
- Solar Battery chargers. Solar Books & Toys. DC Appliances.
- Active & Passive Solar Air & Water Heating Systems.
- Composting Toilets. Hydroponic, Fish-Farming, Solarium & Greenhouse Systems. Water Testing, Treatment, & Pumping Systems.
- Emergency Food & H<sub>2</sub>O Kits. High Efficiency AC/DC Refrigeration + More...



A LOT OF INFORMATION FOR ONLY \$5.75 ...

SEND CHECK or MO TO:

*Self-Reliance Company Inc.*

**P.O. Box 306, Florissant, MO 63032**

# WE'VE GOT IT!

Service • Selection • Value

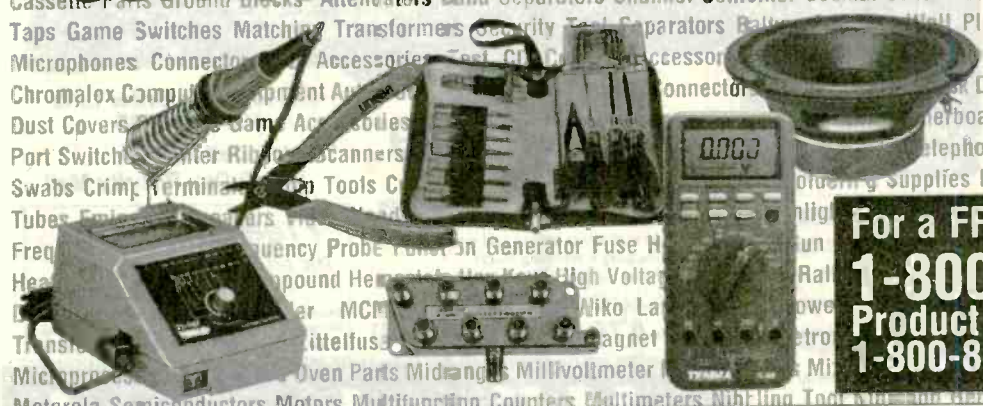

For a FREE Catalog...  
**1-800-543-4330**  
Product questions...  
**1-800-824-TECH (8324)**

MCM ELECTRONICS is your one stop shop for all of your electronics needs. Stocked and ready to ship within 24 hours are over 21,000 different items including test equipment, semiconductors, repair parts, speaker components, amateur radio accessories, computer products and much more. Call today for your free 288 page catalog and you will discover ...

**When you need it, WE'VE GOT IT !**

**MCM ELECTRONICS**  
650 CONGRESS PARK DR.  
CENTERTVILLE, OH 45459-4072  
A PREMIER Company



Serving you coast to coast. Distribution facilities in Dayton, OH and Reno NV!

CIRCLE 145 ON FREE INFORMATION CARD



Reg. \$45.95  
**Sale \$29.00\***  
 Item # X2600 ▶

**Affordable  
 Auto-Ranging**

- Automatic AC/DC Mode Selection
- C voltage 0.2V to 1000V in 5 ranges
- AC voltage 2V to 700V in 4 ranges
- DC and AC current 200mA and 10A
- Audible continuity check & Diode Tester
- Yellow Case
- 1 Year Warranty



**Fast Camcorder  
 Battery Charger**

**Works With:**  
 Sony, Canon, Hitachi, RCA, Panasonic, JVC, and Victor batteries with 1000mAh to 2400mAh capacity.

- Auto Conditioning
- 1 Hour Charge for 1000mAh
- AC & DC Car Adapter
- 1 Year Warranty

Reg. \$59.95  
**Sale \$32.00\***

Item #  
**X5000**



Reg. \$54.95  
**Sale \$39.00\***  
 Item # X3910

**Versatile DMM  
 w/ Capacitance**

- Large LCD Display
- DCV accuracy 0.5%
- Diode test, continuity check with buzzer sound
- Transistor hFE test
- All ranges overload protected
- Rugged case, drop proof
- Capacitance measurement 1pF-20µF in 5 ranges
- Resistance measurement up to 200M
- Auto power off
- Yellow Case
- 1 Year Warranty



Item # **X6000** **Shoreline**  
 INSTRUMENTS  
**Automotive Meter with  
 Auto-Ranging DMM**

- RPM, Dwell, Frequency, Temp. (°C & °F)
- AC/DC Voltage & Current (10A - µA)
- Continuity Beeper, Ohms
- **Standard Accessories**
- Multi-tip Probe Set, Large Alligator Clips, Temp. Probe, Rubber Boot, Inductive Pick-Up
- 9V Batt. - 1 Year Warranty

Reg. \$159.95  
**Sale \$130.00\***

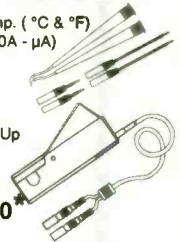

Model Close Out  
 Reg. \$59.95  
**Sale \$24.00\***  
 Item # X3800 ▶

**Full Range DMM**

- 5 DCV ranges ±0.5%
- 5 ACV ranges ±0.8%
- 7 DCA ranges ±0.5%
- 7 ACA ranges ±1%
- 6 OHM ranges ±0.8%
- Diode Tester
- Trans. Tester
- Continuity Buzzer
- Highly Visible Yellow Color
- 1 Year Warranty



Reg. \$39.95  
**Sale \$29.00\***  
 Item# X1000 ▼

**Shoreline**  
 INSTRUMENTS

- 2000 Count Digital Display
- 11 Ranges - AC/DC V, mA, Ω
- Diode Tester and Continuity Beeper
- Auto Shut-off
- Alligator Clip for Easy Measuring
- 1 Year Warranty
- Attractive Gray Case



Orders Only Please  
**800-597-5929**

24 hours a Day

or send Check or Money order

- \* CA customers please add Sales Tax
- \* Shipping & Handling \$4.00
- \* Prices Subject to Change

Technical Support /Product Line  
**800-470-WIND (9463)**

24 Hour Fax Order Line  
 408-987-7735

\* Quick Delivery via  
 U.S. 2-Day Priority Mail

**Free Shipping**  
 for all Fax Orders  
 & Mail-in Orders

Include: Name, Add., Ph#, Card#, Exp. Date, Item #  
 For Mail-in orders please mail check or money order to the address below. For Info Call 800-470-WIND

**Auto-Range DMM  
 w/Capacitance**

- CPU controlled with auto power off function
- 3.75 digit jumbo LCD (max reading 3999)
- 42 segment high speed bar graph
- Full auto-ranging measurement
- Offset adjustment
- Data hold and data memory
- MIN/MAX hold function
- Auto capacitance measurement 1pF to 40µF in 5 ranges
- Auto frequency measurement up to 1 MHz in 5 ranges
- Safety design according to IEC Publication 348
- 1 Year Warranty

Reg. \$105.95  
**Sale \$89.00\***  
 Item # X3500



**Windward**  
 Products

*We Stand Behind our Products  
 Satisfaction Guaranteed*

P.O. Box 378, Moffett Field, CA. 94035



# B<sup>2</sup> Spice v.1.1

**BIG News!! - B<sup>2</sup> LOGIC v 3.0 IS HERE!!! - BIG News!!**

## ANALOG & DIGITAL Circuit Design & Simulation for Microsoft Windows™ and the Macintosh™

**NEW  
RELEASE**

# B<sup>2</sup> Logic® v.3.0

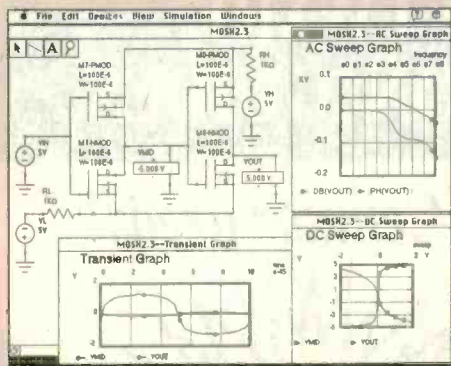

### What is B<sup>2</sup> Logic 3.0?

B<sup>2</sup> Logic v.2.2 + EDIF File Format Output + Enhanced PLD Sim. Cap. + New Devices (inc. binary-to-seven segment decoder and one shot) + Print Across Mult. Pgs. + Subcircuit Probing + Table For Sim. Results + Model Primitives with User Def. Prop. + Mult. Document Interface in Microsoft Windows + Rotate Comp. + Check For Fan-Out Violations + More Accurate Power Calc. + Check For Max PulseWidth Violation + more!

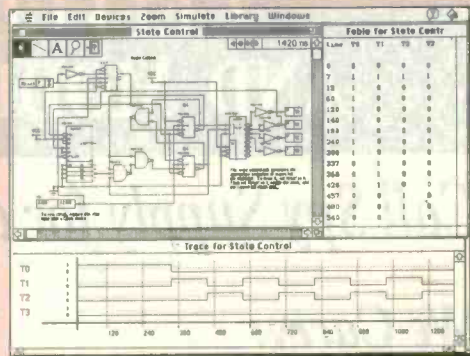

**NEW  
RELEASE**

### TRANSIENT, DC & AC ANALYSES

**B<sup>2</sup> Logic v.3.0... Check it out!!!**

**"Using B<sup>2</sup> Logic ... my students have been able to learn more, and go much further than ever before."**

-Professor F.S. Hill, Jr. University of Massachusetts, Amherst

**B<sup>2</sup> Spice is "a very good moderately priced program."** - Professor Anthony Seigman, Stanford University

### • INTEGRATED SCHEMATIC CAPTURE & SIMULATION •

Now in use at over **75** major universities and leading corporations around the world.  
(University of Michigan, Stanford, University of Illinois, NASA, Bell Labs... to name a few)

- Program prices start at \$149.00/ea.
- University & Student Pricing Available
- Dealer Inquiries Welcome
- VISA/Mastercard Accepted

## Beige Bag Software

2000 Hogback Rd, Ste 2 • Ann Arbor, MI • 48105  
Ph: (313) 971-4227 • Fax: (313) 971-3632

CIRCLE 141 ON FREE INFORMATION CARD

Serving the public since 1981

## XANDI ELECTRONICS

201 E Southern # 205, Tempe AZ 85282 - 5140

**SATISFACTION  
GUARANTEED!**

**BUY WITH CONFIDENCE FROM XANDI**

- 30-DAY REFUND POLICY
- TECH SUPDRT NUMBER  
(602-894-0992)

- Smallest FM transmitter anywhere!
- Tunes 88-108 MHz.
- Powerful 2 stage audio amplifier.
- Sensitive, picks up sounds! at the level of a whisper.
- Up to 1 mile range.

**SUPER-MINIATURE FM TRANSMITTER**  
World's smallest FM transmitter. Use with any FM broadcast receiver. Easy to assemble, all chip (SMT) parts are pre-assembled to the circuit board.

**XST500 (E-Z) Kit ..... \$44.95**

- Smallest Phone transmitter anywhere!
- Tunes 88-108 MHz.
- No batteries required, powered by phone line.
- Up to 1/4 mile range.
- Attach to phone line anywhere in house, even inside phone.

**SUPER-MINIATURE PHONE TRANSMITTER**  
World's smallest FM phone transmitter. Use with any FM broadcast receiver. Easy to assemble, all chip components are pre-assembled to the circuit board.

**XSP250 (E-Z) Kit ..... \$34.95**

- Uses sensitive microwave transistor amplifier.
- Covers 1 to 2,000 MHz.
- Compact hand held unit.
- Includes miniature loud speaker for audio indication of detected signals.

**SUPER SENSITIVE BUG DETECTOR**  
When the XBD200 intercepts a signal in the 1 to 2,000 MHz range, it emits a growl that increases to a high pitched squeal as the signal strength increases.

**XBD200 (C) Kit ..... \$49.95**

- Transmit high quality stereo to any FM stereo receiver.
- Built-in output level monitor for quick and easy tuning.
- Ideal for use with personal CD player.

**FM STEREO TRANSMITTER**  
Transmit full-bodied Hi Fi Stereo to any FM stereo receiver. Separate left and right inputs and gain controls. Includes an output booster stage for greater range.

**XFS-CASE KIT ..... \$13.95**  
**XFS108 (C) KIT ..... \$41.95**

- Dial your phone from anywhere and listen to the sounds inside your home.
- Two digit Touch Tone code for secure operation.

**TELEPHONE SNOOP**  
The latest in home or office security. Call home from anywhere, enter a two digit security code, and hear the sounds in your home. Automatically turns on without ringing the phone, verifies code, then activates for one and a half minutes.

**XPS-CASE KIT ..... \$13.95**  
**XPS1000 (C) KIT ..... \$49.95**

- Transmits a continuous beeping tone.
- Adjustable from 88 to 108 MHz.
- Up to 1 mile range.
- Works with any FM broadcast receiver.

**TRACKING TRANSMITTER**  
Only 0.7 by 2.4 inches, the XTR100 operates at voltages of 3 to 18 Volts and is ideal for use in locating lost model rockets, bicycles, automobiles, games of hide and seek, and contests.

**XTR100 (C) Kit ..... \$33.95**

- Works with any FM broadcast receiver.
- Turns off when phone is not in use to extend battery life.
- Adjustable from 88 to 108 MHz.
- Up to 1 mile range.

**LONG RANGE PHONE TRANSMITTER**  
Similar to our very popular XSP250, the XT1100 is battery powered for greater range. It plugs into any phone jack and transmits both sides of conversations on that line.

**XTT100 (C) Kit ..... \$32.95**

- Use with any FM broadcast receiver.
- Hear every sound in an entire house!
- Up to 1 mile range
- Powerful 2 stage audio amplifier.

**MINIATURE FM TRANSMITTER**  
The XFM100 has a super sensitive microphone and is capable of picking up sounds at the level of a whisper and transmitting them to any FM broadcast receiver.

**XFM100 (C) Kit ..... \$32.95**

- Digital voice changing: male to female, female to male, adult to child, child to adult.
- Anonymity on any call.
- Button for normal operation
- 16 levels of voice masking.

**VOICE CHANGING TELEPHONE**  
STOP THOSE ANNOYING TELEPHONE CALLS! Sound older and tougher when you want to. Not a kit. Fully assembled. Single phone operation only.

**TRANSITION 2000 ..... \$89.95**

- Digital voice changing: male to female, female to male, adult to child, child to adult.
- Use with any modular phone.
- 16 levels of voice masking.
- Connects between handset and phone.

**VOICE CHANGING ACCESSORY**  
STOP THOSE ANNOYING TELEPHONE CALLS! Sound older and tougher when you want to. Not a kit. Fully assembled. Use with single or multi-line phones.

**TRANSITION 2001 ..... \$59.95**

- Uninterrupted coverage of 800 to 950 MHz.
- Works with any scanner that can receive 400 to 550 MHz.

**800-950 MHz SCANNER CONVERTER KIT**  
If your scanner can receive 400-550 MHz, just add the XLC900 for uninterrupted 800-950 MHz coverage. It converts all 800-950 MHz signals down to 400-550 MHz so your scanner can receive them! Add our custom case kit for that "Professional" look.

**XLC-CASE KIT ..... \$13.95**  
**XLC900 (C) KIT ..... \$49.95**

- Works with most any scanner.
- 10 TO 1000 MHz.
- 10 dB typical gain.
- 3 dB typical noise figure.

**10 - 1000 MHz AMPLIFIER**  
Designed to help scanners with poor sensitivity pull in those weak signals. Includes OFF/BYPASS switch for returning to normal operation and front panel gain control. Add our custom case kit for that "Professional" look.

**XLA-CASE KIT ..... \$13.95**  
**XLA1000 (C) KIT ..... \$24.95**

WE ACCEPT VISA, MC, MO, COD  
SHIPPING & HANDLING EXTRA

**TOLL FREE ORDER LINE**  
**1-800-336-7389**  
ASK FOR FREE CATALOG OF OUR PRODUCTS

SEND MAIL XANDI ELECTRONICS  
ORDERS TO: BOX 25647  
TEMPE, AZ 85285-5647

CIRCLE 134 ON FREE INFORMATION CARD

www.americanradiohistory.com



# CELLULAR SOFTWARE AND MODIFICATION GUIDES

*Call Spy Supply for all of your Cellular needs!*

**We Carry:**

## CELLULAR SOFTWARE

(We have the software to do New Motorola Phones)

## CELLULAR CABLES

(For the Motorola, Panasonic, and Nokia Phones)

## CELLULAR MODIFICATION GUIDES

(Covers all cellular manufacturers)

## CELLULAR PHONES

(We carry a complete line of cellular phones)

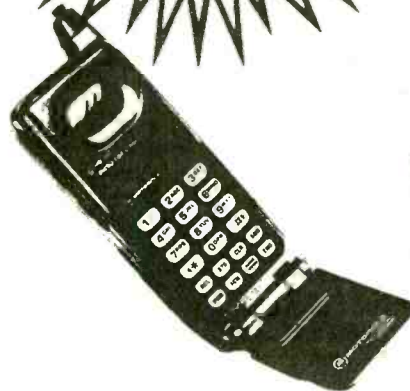

## FREE TECHNICAL SUPPORT!

We now offer Cellular Phones cloned with your existing number! Buy a handheld, transportable or car mounted phone ready to go and have only one monthly bill!

### ***Don't Get Ripped Off!***

Before you buy our competitor's manual, call and ask if they offer **FREE TECHNICAL SUPPORT**

### **SPY SUPPLY**

Find out why the  
CIA - FBI - DEA -  
SECRET SERVICE  
Have ordered from our catalog  
To receive yours, send \$5.00 to:

### **SPY SUPPLY**

1212 Boylston St. #120  
Chestnut Hill, MA 02167

**SPY SUPPLY, 1212 Boylston St. #120, Chestnut Hill, MA 02167**

**(617) 327-7272**

*Sold for educational purposes only*



**KELVIN**  
ELECTRONICS  
10 HUB DRIVE, MELVILLE, NY 11747

(800) 645-9212  
(516) 756-1750  
(516) 756-1763/FAX

Established 1945  
M/C & VISA \$20 Minimum Order  
KELVIN CATALOG #3  
Stock No. 650412



150 LE - Student 200 LE - Technician 300 LE - Auto-Range 400 LE - Engineer

**Standard Features** • AC & DC VOLTAGES • DC CURRENT  
• RESISTANCE • CONTINUITY TESTER - Buzzer • DIODE TEST  
• 10M ohm INPUT IMPEDANCE • ACCURACY +/- 0.5% RDG

<b>TRANSISTOR BATTERY TEST</b> <b>DC CURRENT</b> 10 Amp	<b>FREQ COUNTER</b> up to 20MHz <b>CAPACITANCE</b> from 1pF to 20uF <b>TRANSISTOR</b> AC/DC CURRENT 10 Amp	<b>AUTO RANGE</b> with 3200 counts <b>AC CURRENT</b> <b>DC CURRENT</b> <b>ANALOG BAR</b> 10 Amp	<b>INDUCTANCE</b> Resolution 1uH <b>FREQ COUNTER</b> up to 20MHz <b>CAPACITANCE</b> from 1pF to 200uF <b>AC/DC CURRENT</b> <b>TRANSISTOR DUTY %</b> 20 Amp
<b>150 LE</b> Stock # 990122 <b>\$29<sup>95</sup></b>	<b>200 LE</b> Stock # 990123 <b>\$49<sup>95</sup></b>	<b>300 LE</b> Stock # 990125 <b>\$49<sup>95</sup></b>	<b>400 LE</b> Stock # 990124 <b>\$79<sup>95</sup></b>

**KELVIN 100 Basic**  
# 990087 **\$19<sup>95</sup>**

- AC & DC VOLTAGES
- DC CURRENT
- RESISTANCE
- 3 1/2 Digit LCD
- CONTINUITY TEST
- -Buzzer
- LOW BATTERY INDICATOR
- DIODE TEST • BATTERY TEST



**CAPACITANCE KELVIN METER**  
**250 LE \$59<sup>95</sup>**  
# 990126

- 0.5% ACCURACY
- RANGES: 20mF, 200uF, 20uF, 2uF, 200nF, 20nF, 200pF, 20pF
- Zero Adjust
- Safety Test Leads
- Test Socket for Plug-in Components



Designed to meet IEC-348 & UL-1244 safety specifications.

**Protective Cases**  
For Models 100 Basic, 150LE, 200LE, 300LE  
..... \$4.<sup>95</sup> (#990088)  
Case For Model 400LE ..... \$9.<sup>95</sup> (#990116)

**2 Year Warranty (Parts & Labor)**

# The Ultimate Meter

## TRUE RMS - LCR - Hz - dBm

Popular Electronics (Reviewed - May 1993)

"Not only does the Kelvin 94 boast alot of features ... the features go the extra distance."

"If we had to run into a burning building to do some emergency trouble-shooting and could carry in only one piece of equipment, the Kelvin 94 would be it!"

### 12 INSTRUMENTS IN ONE -

DC VOLTMETER, AC VOLTMETER, OHMMETER, AC CURRENT, DC CURRENT, DIODE TESTER, AUDIBLE CONTINUITY TESTER, dBm, FREQ COUNTER, CAPACITANCE METER, INDUCTANCE METER, LOGIC PROBE

- 0.1% ACCURACY ON DC VOLTAGES
- TRUE RMS ON AC VOLTAGES & CURRENT
- FREQUENCY COUNTER TO 20 MHz
- LARGE EASY-TO-READ 3 3/4 DIGIT LCD DISPLAY
- AUTO SLEEP & AUTO POWER OFF BUILT-IN TO SAVE BATTERY LIFE with Bypass
- SHOCK RESISTANT HEAVY DUTY CASE WITH YELLOW RUBBER HOLSTER & TILT STAND
- WATER RESISTANT SEALED CASE
- 30 DAY MONEY BACK SATISFACTION GUARANTEE

**\$199<sup>95</sup>** MODEL 94 #990111

COMES COMPLETE WITH YELLOW HOLSTER, PROBES, BATTERY, FUSE, STAND

**0.1% ACCURACY on DC Voltages** Water Resistant

**Freq Counter to 20 MHz**

**Protective Cases for Model 94**  
Regular Padded Zippered ..... \$9.<sup>95</sup> (#990116)  
Deluxe Padded Zippered ..... \$14.<sup>95</sup> (#990115)

Meter is designed in accordance with safety requirements specified in IEC-348, UL-1244 VDE-0411.

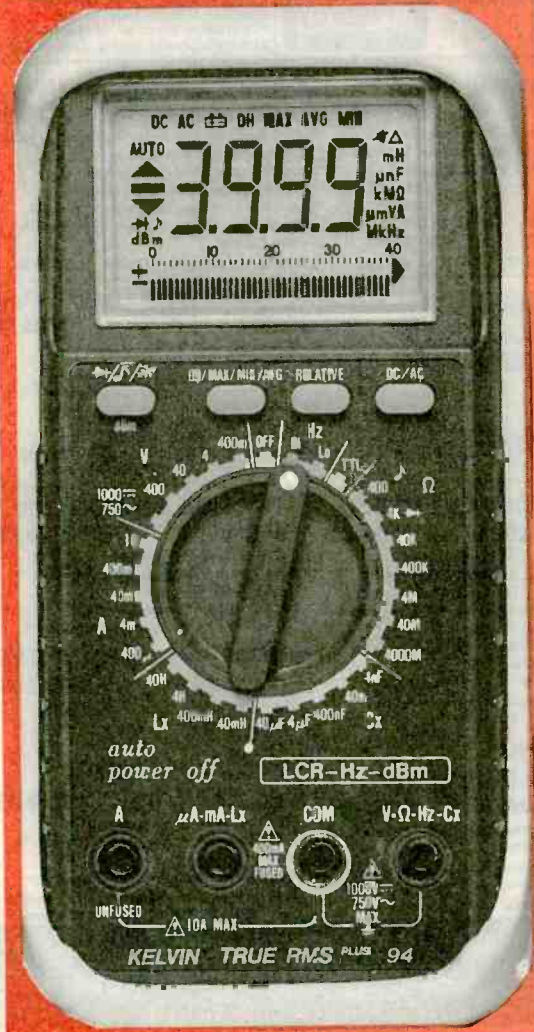

CIRCLE 38 ON FREE INFORMATION CARD

www.americanradiohistory.com

September 1994, Popular Electronics



# ALFA ELECTRONICS

HIGH QUALITY TEST EQUIPMENT  
BEST PRICE



## DMM 89 \$199.95

**Most Advanced DMM**  
All Purpose & Communication  
-80.7 to 81.4 dBm with 4Ω -1200Ω  
20 reference impedances  
True RMS  
Frequency counter: 0.01Hz-10MHz  
Capacitance: 1pF-50,000μF  
Measure AC volt to 20kHz  
5000 counts, 0.1% accuracy  
Auto/manual range, fast bar graph  
Min/Max/Ave/DH/Relative/Zoom  
Auto power off  
Volt, amp, ohm, logic, diode, continuity  
Ruggedized case  
Rubber holster included



## DMM 2360 \$119.95

**DMM+LCR Meter**  
**Very Versatile DMM**  
Inductance: 1μH-40H  
Capacitance: 1pF-40μF  
Frequency: 1Hz - 4MHz  
Temperature: -40-302 °F  
TTL Logic Test: 20MHz  
Diode, Continuity  
Volt, Amp, Ohm  
3999 count display  
Peak Hold  
Auto power off  
Ruggedized case.  
Rubber Holster \$8.00  
Temperature probe \$7.00

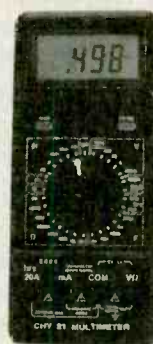

## DMM 21 \$74.95

Inductance: 1μH-40H  
Capacitance: 1pF-200 F  
Frequency: 1Hz-1MHz  
Volt, amp, ohm, diode, continuity  
3999 count display  
TTL logic, HFE  
Peak hold  
Ruggedized case  
Rubber holster \$8.00  
  
Full line of DMMs, economy, compact, ruggedized, solar cell, automotive, heavy duty, industrial, starts from \$15.95

Fluke Multimeter  
Fluke 12 \$84.95  
Holster C-10 \$10  
Fluke 70 II \$67.5  
Fluke 73 II \$94  
Fluke 75 II \$129  
Holster C-70 \$16  
Fluke 77 II \$149  
Fluke 79 II \$169  
Fluke 29 II \$169  
  
Fluke 83 \$225  
Fluke 85 \$259  
Fluke 87 \$287  
Fluke 97  
Scope Meter \$1785



## LCR Meter 131D \$229.95

**Most Advanced LCR**  
Dual display: LQ or CD  
Inductance: 0.1μH-1000H  
Capacitance: 0.1pF-10,000μF  
Impedance: 1mΩ-10MΩ  
0.7% basic accuracy  
Dissipation factor & Q factor  
Serial & parallel mode  
Relative mode for comparison and to remove parasitics  
Statistics, tolerance,  
Best for design, incoming testing & production  
SMD and chip component test probe \$25.00



## LCR Meter 814 \$189.95

**Best Resolution LCR**  
Inductance: 0.1μH-200H  
Capacitance: 0.1pF-20,000μF  
Resistance: 1mΩ-20MΩ  
1% basic accuracy  
Dissipation factor Indicates leakage in capacitor and Q factor in inductor  
Zero adjustment to reduce parasitics from test fixture  
Best for high frequency RF and surface mount components.  
SMD and chip component test probe \$25.00, Deluxe carrying case \$5.00

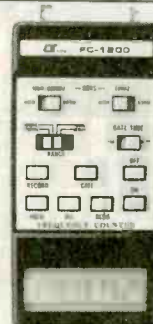

## Frequency Counter FC-1200 \$129.95

Frequency: 0.1Hz-1.25GHz  
Display: 8 digit LCD  
Period: 0.1μs-0.1s  
Records Max/Min/Average  
Data hold, relative mode  
Telescoping antenna \$8.00  
Deluxe case \$5.00  
  
Also Available:  
AC/DC clamp meter, Light meter, Thermometer, pH meter, High voltage probe, Digital caliper, Anemometer, Electronic scale, Force gauge, Tachometer, Stroboscope, Humidity & EMF adapter, Sound level meter, Frequency counter, SWR/field strength/power meter, Dip meter

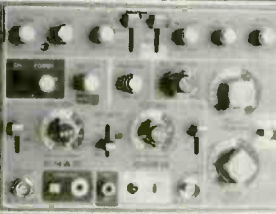

## 20 MHz Oscilloscope with Delay Sweep PS-205 \$429.95

Dual Trace, Component test, 8" CRT, X-Y Operation, TV Sync, Z-Modulation, CH2 Output, Graficule IIlum, 2 probes each has x1, x10 switch. Best price with delay sweep.  
PS-200 20 MHz DUAL TRACE \$339.95  
PS-400 40 MHz DUAL TRACE \$494.95  
PS-405 40 MHz DELAY SWEEP \$589.95  
PS-605 60 MHz DELAY SWEEP \$769.95  
Scope Probe: 60MHz x1, x10 \$13, 100MHz x1, x10 \$22

## 20 MHz Digital Storage Oscilloscope DS-203 \$729.95

Switchable between digital and analog modes  
2 K word per channel storage  
Sampling rate: 10 M sample /sec  
8 bit vertical resolution (25 Level/div)  
Expanded Timebase 10ms/div - 0.5 s/div.  
Refresh, Roll, Save all, Save CH2, Pre-Ting  
Plotter Control  
250MHz x1, x10 \$29, 250MHz x100 \$39

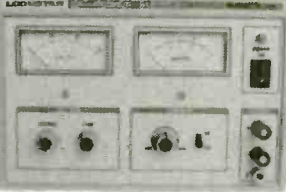

**DC Power Supply PS-303 \$159.00**  
0-30 VDC, 0-3A output  
Constant voltage & constant current mode  
0.02% + 2mV line regulation  
0.02% + 3mV load regulation  
1 mVrms noise and ripple  
Short circuit and overload protected  
PS-8200 with digital voltmeter \$179.00  
Also available: 30V/5A, 60V/3A, 60V/5A, 16V/10A, 30V/10A

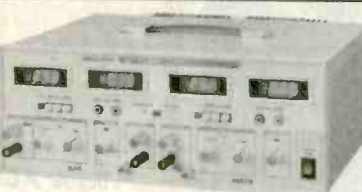

**DC Power Supply Triple Output PS-8202 \$499.95**  
Two 0-30 VDC, 0-3A outputs  
One fixed 5VDC, 3A output  
Capable of independent or tracking operation  
Constant voltage and constant current mode  
Four digital meters for volt and current display  
Excellent regulation and low ripple  
Short circuit and overload protected  
Also available: 30V/5A triple output \$549.95  
Dual tracking 30V/5A, 30V/5A, 60V/3A, 60V/5A

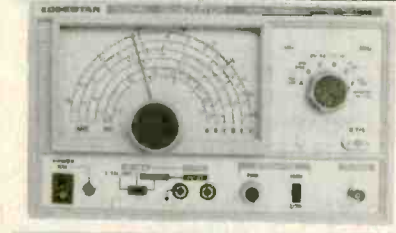

**RF SIGNAL GENERATOR SG-4160B \$119.00**  
100 kHz-150MHz sinewave in 6 ranges  
RF Output 100mVrms to 35 MHz  
Internal 1kHz, External 50Hz-20kHz  
AM modulation  
Audio output 1 kHz, 1 Vrms

**AUDIO GENERATOR AG-2601A \$119.00**  
10Hz - 1MHz in 5 ranges  
Output 0-8Vrms sinewave  
0-10Vp-p squarewave  
Synchronization: ±3% of oscillation frequency per Vrms  
Output distortion:  
0.05% 500Hz - 50kHz  
0.5 % 50Hz - 500kHz  
Output impedance: 600 ohm

**FUNCTION GENERATOR FG-2100A \$169.95**  
0.2 Hz - 2 MHz in 7 ranges  
Sine, square, triangle, pulse and ramp  
Output 5mV-20Vp-p  
1% distortion, DC offset ± 10V  
VCF: 0-10V control frequency to 1000:1



**RF SIGNAL GEN./COUNTER SG-4162 AD \$229.95**  
Generates RF signal same as SG-4160B  
Frequency counter 1Hz - 150 MHz for internal and external source  
Sensitivity <50mV

**AUDIO GEN./COUNTER AG-2603AD \$229.95**  
Generates audio signal same as AG-2601A  
Frequency counter 1Hz-150MHz for internal and external sources  
Sensitivity <50mV

**FUNCTION GEN./COUNTER FG-2102AD \$229.95**  
Generates signal same as FG-2100A  
Frequency counter 4 digits  
Feature TTL and CMOS output  
  
**SWEEP FUNCTION GEN./COUNTER \$329.95**  
0.5Hz to 5 MHz in 7 ranges  
Sweep: Linear 10:1/Log 10:1 20ms to 2s  
AM Modulation  
Gated Burst, Voltage Control Generator  
Generator Control Voltage & 6 digit counter  
1Hz-10MHz for internal & external sources

# ALFA ELECTRONICS

741 Alexander Rd., Princeton, NJ 08540

(800) 526-2532/(609) 520-2002

FAX: (609) 520-2007

Visa, Master Card, American Express, COD, Purchase Order Welcome

15 DAY MONEY BACK GUARANTEE, 1 YEAR WARRANTY

CALL OR WRITE FOR FREE CATALOG AND BEST OFFER

CIRCLE 26 ON FREE INFORMATION CARD



# Are Cable Companies Sucking You Dry?



**FREE  
Catalog!**

**All Major  
Brands!**

Take a Bite out of High Rental Fees  
with your own

## Converters & Descramblers



Everquest • Panasonic • Jerrold • Zenith • Pioneer  
Scientific Atlanta • Oak • Eagle • Hamlin • Tocom



Order  
Toll-Free **1 800 624-1150**

Call today for a FREE catalog!

# MD Electronics

875 S. 72 Street • Omaha, NE 68114



AMERICAN RELIANCE

Introducing the AMREL Analog and Digital Power Supplies...

EITHER CHOICE PLACES MORE FEATURES ON YOUR BENCH—SAVES YOU MONEY!

3 YEAR WARRANTY



**AMREL LPS-100 Series—For Performance That Sets New Industry Standards!**

- Low Output noise rating less than 0.3mV.
- Line/load regulation rated at low 0.01% + 1mV.
- Transient response time of 50µ Sec.
- Overload protection.
- Output enable/disable
- Coarse and fine voltage/current adjustment.
- Auto series/parallel operations for triple output supplies.
- 3 year full warranty—not 1 or 2 years.

2 YEAR WARRANTY



**AMREL LPS-300 Series—Offer Features And Prices That The Competition Can't Beat!**

- Microprocessor controlled.
- User friendly keypad data entry.
- Low output noise rating less than 1mV.
- Line/Load regulation rated less than 2mV.
- Output enable/disable and Power—off memory.
- 2 year warranty.
- Optional RS-232 interface capability.

Model	LPS-101	LPS-102	LPS-103	LPS-104	LPS-105	LPS-106	LPS-301	LPS-302	LPS-303	LPS-304	LPS-305
Rating	30V/1A	30V/2A	30V/3A	+30V/1A -30V/1A 3-6.5V/3A	+30V/3A -30V/3A 3-6.5V/3A	60V/1A	15V/2A(H) 30V/1A(L)	15V/4A(H) 30V/2A(L)	30V/3A	+30V/1A -30V/1A 5V/2A	+30V/2.5A -30V/2.5A 3.3-5V/3A
Retail Price	\$195	\$225	\$295	\$395	\$495	\$245	\$249	\$299	\$369	\$399	\$599

**PR INT**<sup>TM</sup>  
Product International, Inc.



Call For Sale Price: **1-800-638-2020**



8931 Brookville Road • Silver Spring, Maryland 20910 • Fax: 800-545-0058 •

CIRCLE 46 ON FREE INFORMATION CARD

**AFFORDABLE DATA ACQUISITION**



**MODEL 30 ..... \$79.00**

- PLUGS INTO PC BUSS
- 24 LINES DIGITAL I/O
- 8 CHANNEL 8 BIT A/D IN
- 12 BIT COUNTER
- UP TO 14K SMP/SEC



**MODEL 45 ..... \$189**

- RS-232 INTERFACE
- 8 DIGITAL I/O
- 8 ANALOG INPUTS
- 2 ANALOG OUTPUTS
- 2 COUNTERS-24 BIT



**MODEL 70 ..... \$239**

- RS-232 INTERFACE
- 16 BIT A/D
- 5.5 DIGIT
- UP TO 60 SMP/SEC



**MODEL 150-02 .. \$179**

- RS-232 INTERFACE
- TRMS, 20 AMPS
- 12 BIT A/D
- OPTO-ISOLATED
- CHANGE RANGES, AC/DC, VIA RS-232

**Prairie Digital, Inc.**

846 17th Street • Industrial Park • Prairie du Sac, WI 53578  
(608) 643-8599 • FAX: (608) 643-6754

CIRCLE 47 ON FREE INFORMATION CARD



**CABLE TV Converters & Descramblers**

Compatible with  
**Jerrold, Scientific Atlanta,  
Pioneer, Oak, & Hamlin  
Equipment**

**BRAND NEW!**

**90-DAY GUARANTEE**

**LOWEST PRICES**

*Volume Control & Parental Lockout Available*

**Greenleaf Electronics**

**1-800-742-2567**

**NO ILLINOIS SALES**

It is not the intent of Greenleaf Electronics to defraud any pay television operator and we will not assist any company or individual in doing the same.



# Don't Despair...REPAIR!

Here's how to troubleshoot and repair your electronics successfully!



## You Can Be Your Own Repair Expert!

For VCRs, camcorders, audio equipment, TV equipment, computer hardware, office equipment, home appliances, automobile electronics, and outdoor equipment.

- Pinpoint and analyze problems quickly.
- Successfully complete repairs with hands-on troubleshooting instructions.
- Become skilled understanding flowcharts and schematic diagrams.
- Confidently use test equipment such as oscilloscopes, frequency counters, and video analyzers.
- Keep your equipment in top condition with effective preventive maintenance techniques.

## Continue to Broaden Your Repair Expertise!

You'll receive quarterly supplements, up to 160 pages, with new step-by-step repair and maintenance instructions, valuable schematics and new repair techniques. Learn how to repair a growing variety of appliances with hands-on repair projects that will keep you up-to-date with later models and technology. You'll be thrilled with your ability to repair a growing list of electronic equipment! Supplements may be returned or cancelled at any time.

**SAVE \$10**

Call our toll-free number,  
pay by credit card, and mention  
this ad. We'll deduct \$10!  
We'll also waive  
shipping and handling.

**Order today for your 30-day, no-risk  
review of The Electronics Repair Manual.**

**For Faster Service Call TOLL-FREE  
1-800-222-WEKA  
Or Fax To: 1-203-622-4187**

CIRCLE 133 ON FREE INFORMATION CARD

## One Source For All Your Repair Needs!

Better organized than a magazine, more current than a book.

- 900-page manual
- easy-to-follow, detailed instructions
- trouble analysis flowcharts
- safety precaution checklists
- comprehensive replacement parts list
- directory of manufacturers



**Order  
your copy  
today!**

### MONEYBACK GUARANTEE

There's no risk in trying the **ELECTRONICS REPAIR MANUAL** to see if it's right for you. If you are not delighted, simply return the manual after the 30-day trial period and receive a prompt refund.



97 Indian Field Rd.  
Greenwich, CT 06830

**YES!** Please rush me a copy of the new Electronics Repair Manual for only \$59.95 + \$5.50 shipping and handling. I understand that if I am not satisfied I may return the manual within 30 days for a complete refund. Supplements are sent quarterly for 25¢ per page (never more than \$30) and may be returned or cancelled at any time.

My payment is enclosed     Bill me later  
 Charge my     Visa     MasterCard

Acct. No. \_\_\_\_\_ Exp. Date \_\_\_\_\_

Signature \_\_\_\_\_

Phone (    ) \_\_\_\_\_ Signature and phone number are required for all orders.

Name \_\_\_\_\_

Address \_\_\_\_\_

City \_\_\_\_\_ State \_\_\_\_\_ Zip \_\_\_\_\_

All payments must be in U.S. funds. Canada add \$10. All other countries add \$15. CT residents add 6% sales tax.

Mail to: WEKA Publishing, 97 Indian Field Rd.,  
Greenwich, CT 06830

400085

## CABLE CONVERTER SPECIALS

	1	5	10+
<b>Sigma 550</b> NEW — 86 channel O & I compatible Last channel recall — lightning protection 1 year warranty	<b>99.95</b>	<b>75.00</b>	<b>70.00</b>
<b>Timeless 550 P/C</b> Same as above, different manufacturer with parental lockout. HRC switchable 1 year warranty	<b>99.95</b>	<b>75.00</b>	<b>70.00</b>
<b>Northcoast Excell</b> American manufactured!! 70 channel Fine tuning — Standard HRC tuning through remote, sleep timer. Green LED w/dimmer Parental lockout. Deluxe! A/B twinline available. . .	<b>109.95</b>	<b>85.00</b>	<b>75.00</b>



### United Electronic Supply

P.O. Box 1206-RE  
Elgin, IL 60121

**708-697-0600**

No Illinois Sales

### NEW ITEM

Zenith Universal Remotes  
Fully Programmable  
New Program / Learn Type  
Combines both functions  
for  
VCR / Cable / TV / Stereo  
All in remote.

As low as **\$19.95**

Hours: Mon - Fri: 8:30 — 5:00 pm CST

24 Hour Answering Machine for orders

## TONY TALLI'S ORIGINAL TELEVIEW DISTRIBUTORS

WHERE OUR VALUED CUSTOMERS'

*BUSINESS*

IS HONESTLY APPRECIATED

**OUR PRICES**

**1 800 847 3773**

*Call Us Today*

**90 DAY + GUARANTEE**

**SCIENTIFIC ATLANTA**

**JERROLD PIONEER**

**OAK HAMLIN**



**HRS. M - F 9-4 PST NO NV. SALES**

## Learn MICROCONTROLLERS and EMBEDDED SYSTEMS with the AES-10



The AES-10... a complete learning system, a complete embedded control system. Extensive manuals guide you through your 8051 development project. Assembly, BASIC, and C programming. All hardware details, complete schematics. Learn to program the LCD, keypad, digital and analog I/Os for your applications.

### 80C32 Computer/Microcontroller board with:

- 32K ROM, 32K RAM
- 2 by 16 Liquid Crystal Display
- 4 by 5 Keypad
- Digital, A/D, D/A, and PWM, I/O
- Built in Logic Probe
- Power supply, (can also be battery operated)
- Extended AES BASIC and AES Monitor in ROM
  - Built-in routines for LCD, Keypad, A/D, D/A and Digital I/O ports
  - See 80C32 registers while you Step
  - See all memory locations and data on LCD
  - See memory contents in dec, hex, and binary
- RS-232 cable to connect to PC for programming
- 8051/52 DOS Cross Assembler
- Program disks with well documented examples
- User's Manual, Language Manual, and Text

**AES**  
Advanced Educational Systems

1407 North Batavia Street, Orange, California 92667, USA

\$365, Money Back Guarantee  
Free Brochure, M/C Visa  
800 - 730-3232  
714 - 744-0981  
Fax 714 - 744-2693



# CABLE TV DESCRAMBLERS

Best Prices in the U.S.A. Guaranteed to Work!

**WE WILL BEAT ANY PRICE!**

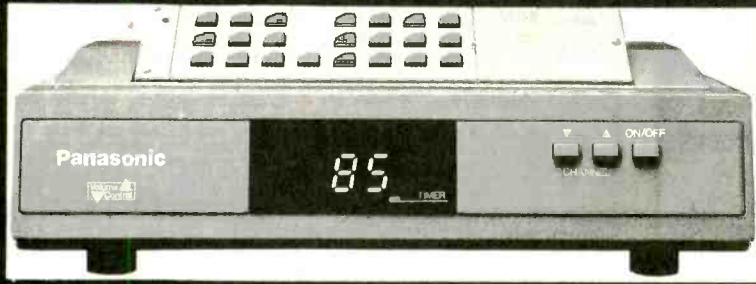

JERROLD PANASONIC SCIENTIFIC ATLANTA PIONEER

**The Newest & the Latest**

DMTB-A - all Jerrold Impulse & Starcom series  
 SA3-DFA - all Sci. Atlantas incl. 8536/+, 8580, Drop-field  
 PN-3A - all Pioneer systems

ALSO FTB3, SA3, TZPC145G

FAST SHIPMENTS FREE CATALOG 30 DAY MONEY BACK GUARANTEE

**1-800-772-6244** M-F: 9-6 EST

U.S. Cable TV, Inc. Dept.: KPE084

4100 N. Powerline Rd, Bldg. F-4 Pompano Beach FL 33073

NO FLORIDA SALES!

## HARNESS THE POWER OF THE SUN

SOLAR ILLUMINATION & POWER SYSTEM  
 PRODUCT CATALOG IS PACKED WITH  
 THE EQUIPMENT NEEDED TO TURN  
 THE SUN'S ENERGY TO ELECTRICAL POWER

CATALOG PROVIDES:

INTRODUCTION TO SOLAR POWER,  
 BASIC SOLAR POWER SYSTEMS DESIGN  
 & PROCUREMENT, SOLAR MODULES,  
 TRACKERS, CHARGE REGULATORS,  
 BATTERIES, DC TO AC INVERTERS,  
 SOLAR POWER WATER PUMPING SYSTEM,  
 SOLAR WATER HEATING SYSTEM,  
 SOLAR LIGHTING, COMPLETE ELECTRICAL  
 GENERATING SOLAR POWER KITS FOR  
 HOME, RV'S, BOATS, PLUS MANY MORE  
 ITEMS.

ALL THIS INFORMATION FOR ONLY \$5.50

SEND CHECK OR MO TO:

SOLAR ILLUMINATION & POWER SYSTEM INC.

P.O. BOX 557826 MIAMI, FL 33255

### SHORTWAVE HEADQUARTERS PRESENTS 10-Band Shortwave Receiver only \$34.95!

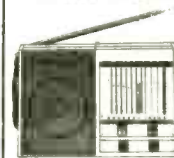

MW/FM/LW7 INTERNATIONAL  
 Shortwave Bands:

MW - 522-1620 KHz	FM 88-108 MHz
LW - 150-280 KHz	Shortwaves:
SW1 - 49 Meters = 5.85-6.25 MHz	
SW2 - 41 Meters = 7.10-7.55 MHz	
SW3 - 31 Meters = 9.50-9.95 MHz	
SW4 - 25 Meters = 11.50-12.00 MHz	
SW5 - 19 Meters = 15.10-15.70 MHz	
SW6 - 16 Meters = 17.50-18.00 MHz	
SW7 - 13 Meters = 21.35-22.00 MHz	

Features include: LED Signal Indicator,  
 Telescoping Antenna, Deluxe Carrying Case, Money Back Guarantee!  
 Send \$34.95 plus \$2.45 S&H  
 to SHORTWAVE HEADQUARTERS  
 1790 Edison St., Green Bay, WI 54302

#### Coil Design and Construction Manual

R. S. SAMAL



## YOU CAN WIND YOUR OWN COILS?

There's no trick to it except knowing what you are doing. In a unique, 106-page book you can become expert in winding RF, IF, audio and power coils, chokes and transformers. Practically every type of coil is discussed and necessary calculations are given

with the mathematical data simplified for use by anyone. Get your copy today!

Mail coupon to:

**Electronics Technology Today, Inc.**  
 P.O. Box 240 • Massapequa Park, NY 11762-0240

Please send me my copy of *Coil Design and Construction Manual* (BP160). I enclose a check or money order for \$8.45 to cover the book's cost and shipping-and-handling expenses. NY state residents must add local sales tax.

Name \_\_\_\_\_

Address \_\_\_\_\_

City \_\_\_\_\_ State \_\_\_\_\_ ZIP \_\_\_\_\_

All orders must be paid in U.S. funds only. Sorry, no orders accepted outside of USA and Canada. Please allow 6-8 weeks for delivery.

Make your projects speak for themselves...  
 Ours do!

### DIGITAL VOICE RECORDERS

- Record up to 218 seconds
- 1 to 8 messages
- High quality speech 12 bit
- Switch-closure actuation
- Sample rates up to 20Khz
- On-board backup
- Direct speaker output
- Wide operating range
- Small size 2.6" X 2.6"
- Made in U.S.A.

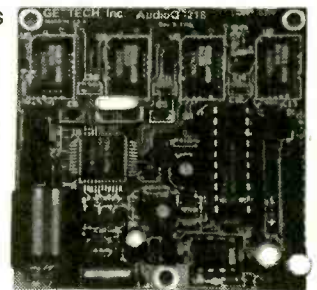

MODEL AudioQ™-218

Call or write for more information

OEM price and delivery available

Custom designs and enclosures

Single unit price \$149.00 plus s+h

Quantity pricing as low as \$99.00

**GETTECH**, Inc.

402 Riley Road, New Windsor, NY 12553

(914) 564-5347

Specifications and price subject to change.



# Double Your Income! Own your own computer repair business or add computer repair to your existing business.

TechServ can put you into your own computer repair business quickly, economically and efficiently. Research indicates that during a recession, computer repair businesses will grow at twice the rate of hardware sales. TechServ's complete support program gives you the opportunity to be a part of this fast growing industry.

## • Proven Marketing Plan

## • Recognition

Nationally recognized trademarks and logos give you immediate recognition as a professional computer repair specialist in your area.

## • Training

- Level 1 286/386/486/586  
Troubleshooting, upgrades, advanced diagnostics
- Level 2 Networking/Novel/Unix/Multi-user/  
Multi-tasking configuration/Installation/  
Maintenance. Prepare for C.N.E.  
(Certified Network Engineer) test

## • Parts and Board Repair

Single source for OEM/generic parts and board repair. Order 7 days a week/24 hours a day. \$45 million in parts in stock, ready to ship any where, overnight if required.

## • Documentation

We provide manuals, documentation and advanced diagnostic software.

## • New Hardware

We provide new hardware for IBM, Compaq, Apple and compatibles at huge discounts. Custom build your own systems.

## Over 300 dealers worldwide

Find out why the Wall Street Journal and Fortune Magazine call computer repair the business opportunity of the 1990s.

**Call TechServ at (212) 967-1865**

or fill out coupon below and mail to:

**techserv** AUTHORIZED DEALER  
SM

**America's largest chain of independent,  
licensed computer repair centers**

253 West 28th Street, New York, NY 10001

NAME			
ADDRESS			
CITY	STATE	ZIP	
TELEPHONE	[PE 2/93]		

CIRCLE 130 ON FREE INFORMATION CARD



## CONSUMERTRONICS

2011 Crescent Dr., P.O. Drawer 537  
Alamogordo, NM 88310

Voice: (505) 434-0234, 434-1778;  
8AM - 8PM MST, Mon-Sat

Fax: (505) 434-0234 (orders only; if you get  
answering machine, any time enter #111);  
24-hour, 7 days/week

Free Tech Support (must relate directly to your  
order or prospective order): Tues. and Thurs. only.

Add \$5 total SH (US, Canada). All items in stock. VISA,  
MCARD OK (\$29 min.). No CODs or "bill me's". New Catalog  
(150+ offers) is \$2 w/order, \$4 w/o (no free catalog).

In business since 1971. As seen on TV, etc. John Williams - former  
Lockheed Senior Engineer, NUSI Computer Science Professor, Navy, Air Force Weapons Engineer, NIH Health Physicist.

\*All software supports all IBM-PC compatible  
x86 systems (8086 - Pentium)

## Off-The-Shelf Hardware

Van Eck Systems, Automated Tempest Module, KK Radar  
Emitter, Carjacking Follower, Personal Body Alarm,  
Voice Disguiser, Hearing Assistant, Shriek Module, EM  
Countermeasure, Omnimax TENS, 6th Sense Communicator,  
many nifty Phone Boxes, Bumper Beeper, Subliminal  
Mixer/Amp, Super MW0, Rifle Device, Neurophone,  
Hieronymus Machine, Magnetometer, Data Card  
Reader/Writers, Dwelling Security System, Levitator,  
Vortex Generator, Ultrasonic Jammer & Receiver,  
Long-Range Eavesdropper, Noise Cancellation System,  
Unknown Presence Detector, Electronic Downer, Automatic  
Pet Feeder, Stealth Palm - more! See our Catalog.

## CELLPHONE MODIFICATIONS

See our Catalog for our infamous cellphone modification  
guide (\$69) - detailed, comprehensive, covers all makes -  
10 times more info than competitor's "guides". (Do Special  
Projects (below) for up-to-date hardware/software)

## SPECIAL PROJECTS

We design, build, repair, modify, maintain and/or consult  
on any device, system, process or project - electrical,  
electronic, computer, phone, mechanical, optical, automotive,  
invention prototyping. Confidentiality guaranteed.  
Describe and include \$25 pre-engineering fee (does not  
obligate you). Time and cost estimates in 7-10 days.

## VOICE MAIL HACKING

How Voice Mail Box (VMB) systems are used and the  
specific ways they are hacked. Includes ASPEN, MESSAGE  
CENTER, BIX, GENESIS, EZ, SYDNEY, PHONE  
MAIL, AUDIX, CINDY, CENTAGRAM, SPERRY LINK,  
RSVP, etc. Absolutely required for all users, sysops and  
security personnel \$29.

## PBX HACKING

While "VOICE MAIL HACKING" details how VMBs are  
hacked for "hobby" and profit - including VMS methods  
for hacking PBXs themselves - "PBX HACKING" addresses  
ALL ISSUES relating to PBX hacking, including  
countermeasures! Can your business or agency afford a  
\$90,000 phone fraud loss (the average loss due to  
hacked PBXs)? As described in Forbes Magazine, \$39.

## PHREAKING CALLER ID & ANI

Details on how they work and dozens of effective ways  
of defeating Caller ID, ANI, \*69, \*57, and Call Blocking  
& \*67. Also describes Caller ID, Orange, Beige,  
Cheese and CF Boxes, ESS, SS7, E-911, various  
CLASS services, CNA, NON PUB DA, CAMA, DNR,  
800-ECR, Diversers, LD Extenders, Centrex - more, \$29.

## PHONE COLOR BOXES

As designed by Phone Phreaks! 13 phone color boxes  
described. Dozens of circuits, simulator programs. Plus  
call-forwarding, conferencing, phreak history, 50 useful  
and legal phone circuit plans - more, \$29.

## ROBOFONE AUTODIALER

Powerful, versatile, menu-driven "Wargames" autodialer  
lets you dial any quantity (up to 10K) or mix of lo-  
cating distance numbers in any order, over any length  
of time, whether busy or answered (your choice) and  
log the times, commands and results to monitor, printer  
and/or disk. Quick-dial directory of up to 600 numbers.  
BUSY redial options. Direct modem command and control.  
All Result Codes, including VOICE and RINGING.  
Optional shell to terminal program upon CONNNECT. Exit  
to menu or DOS (for batching). Manual + Disk\* \$29.

## COMPUTER PHREAKING

TRADIAN HORSES, VIRUSES, WORMS, etc. and  
countermeasures. Includes disk with 360K of hacker  
text files and utilities, and legendary FLUSHOT+ protection  
system (Editor Choice, PC Magazine). Dozens of  
computer crime and abuse methods and countermeasures.  
How systems are penetrated. BBS advice, password  
defeats, glossary - much more! Manuals +  
Disks\* \$39.

## BEYOND VAN ECK PHREAKING

Eavesdropping on TV and computer video signals using  
an ordinary TV! Includes security industry reports. Range  
up to 1 KM. Plans include both the Consumertronics and  
the original Top Secret Van Eck designs! \$29.

## CRYPTANALYSIS TECHNIQUES

Five powerful menu-driven crypto programs (in COM  
and their .BAS sources) to analyze, decrypt "secure" cipher-  
texts. Worked-out examples. Recommended in pres-  
tigious "Computers & Security". Manual + Disk\* \$29.

## By an ORDER of the MAGNITUDE

The most comprehensive, hard-hitting, hi-tech survival  
book ever written! Topics include electronics,  
computer, ever, weapons, concealment, revenge,  
alarms, etc. to survive today's dangerous world. We all  
face increasingly financially and physically brutal times!  
Field-expedient use of technology in various threat and  
conflict environments and scenarios. \$49.

## STOPPING POWER METERS

As reported on CBS "60 MINUTES": How certain de-  
vices can slow down - even stop - watt-hour meters -  
while loads draw full power! Device simply plugs into  
one outlet and normal loads into other outlets. Also de-  
scribes meter creep, overload droop, etc. Plans \$29.  
I.G. MANUAL: External magnetic ways (applied to the  
meter itself) to slow down and stop watt-hour meters  
while drawing full loads. Plans \$19. KW-HR  
METERS: How watt-hour meters work, calibration,  
error modes (many), ANSI Standards, etc. Demand and  
Polyphase Meters. Experimental results to slow and  
stop meters by others. \$19. Any 2, \$38. All 3, \$59.

## AUTOMATIC TELLER MACHINES

ATM crimes, abuses, vulnerabilities and defeats ex-  
posed! 100+ methods detailed, include: Physical, Reg-  
E, cipher, PIN compromise, card counterfeiting, mag-  
netic stripe, false front, TEMPEST, Van Eck, tapping,  
spoofing, inside job, super-cook, vibration, pulse, high  
voltage - others. Case histories, law, countermeasures,  
detailed security checklist, labeled instant photos, fig-  
ures. ATMs contain up to \$250,000 in cash! Recent  
\$350,000 ATM crime scores still unsolved! \$39.

## CREDIT CARD SCAMS

Cardholders, merchants, banks suffer \$ billions in  
losses annually because of credit card fraud. Describes  
every known means of credit card fraud and scams.  
Protect yourself! \$29.

## CONS & SCAMS

Cons & scams fleece Americans of \$100+ Billion per  
year! The most comprehensive survival manual on cons &  
scams of all kinds - from the classic to hi-tech. De-  
tails on 100s and their many variations. Protect your-  
self! \$29.

## HIGH VOLTAGE DEVICES

HV devices plans: Stun Gun, Laser, Prod, Game,  
Flasher, Blaster, Zapper, Audio/Radar Jammer,  
Jacob's Ladder, Plasma & Van de Graaff Guns, Fence  
Charger, Gelger Counter, Ozon Gun, Fish Stunner,  
Plant Stim., Kirlian, more! Shocking! \$29.

## UNDER ATTACK!

Electromagnetic Interference and Electronic Weapon  
Attacks cause: Cancer, birth defects, and profound psy-  
chological, neurological, cardiovascular and immune  
system disorders! Destructive to people, animals,  
plants, equipment! Includes ACTUAL CASES OF EM AT-  
TACKS ON PEOPLE (we investigated!) Includes how to  
verify and pinpoint EMI and electronic attack sources,  
and specific countermeasures. \$29. EM BRAIN-  
BLASTER! Tutorial and plans for powerful  
ELECTROMAGNETIC WEAPONS and LAB DEVICES.  
Optimum circuits, freqs, waveforms, duty cycles, inter-  
stities. Thorough. \$29. Both \$49.

## RADIONICS MANUAL

Extensive, electrical, electronic and electromagnetic therapeu-  
tic, diagnostic and preventive devices (mostly ex-  
perimental). History, descriptions, plans (dozens), avail-  
abilities of Radionics Devices from early to modern.  
While drugs cost \$ hundreds, electricity costs pennies!  
\$29. HEAL YOURSELF! Plans for 3 major elec-  
tronic therapeutic devices of types approved by FDA.  
\$19. Both \$39.

## HARD DRIVE MANUAL

Covers all hard drive and controller implementations  
(emphasis on PCs). How to select, interface, initialize,  
set up, use, maintain, troubleshoot and repair them.  
How to protect them from mistakes, sabotage, prying  
eyes and sticky fingers. How to recover damaged and  
lost files. How to prevent crashes. Includes software re-  
views. Loaded with information, advice, tips. \$29.  
DISK SERVICE MANUAL! Maintain, trouble-  
shoot, repair, adjust, align floppies without special  
equipment or software. 3.5x5.25x8", PCXTAT386/  
486, Apple, Commodore, etc systems. All floppies need  
occasional upkeep. \$29. DISK DRIVE TUTO-  
RIALS! Theory, practical facts on floppy drives, disks,  
including many tips, recommendations, formatting, inter-  
facing FDC, etc. \$24. Any 2, \$49. All 3, \$69.

## SOFTWARE PROTECTION SYSTEM

Unique system that highly discourages costly software  
piracy while not interfering with legit archival copies. No  
known way to defeat. No special equipment required.  
Simple and automatic to install on your distributed soft-  
ware. Compatible with all copy-prevention systems.  
Manual + Disk\* \$59.

## STEALTH TECHNOLOGY

Police radar is fascinating! It also has error rates of 10-  
20%! Every known error mode - stealth method and ma-  
terial used to minimize radar reflections - tactic and  
strategy to fight unjust radar tickets (that cost you  
\$100s in insurance and risk cancellation) - methods to  
detect and jam signals - fully described! \$29.

## SECRET & SURVIVAL RADIO

Optimum survival and security radio equipment, meth-  
ods, freq allocations and voice/data scrambling/encod-  
ing. Includes small receivers/transmitters, telemetry, an-  
tenna optimizations, remote monitoring and control, se-  
curity, surveillance, and ultrasonic, fiber-optic and mi-  
cro-com. 70+ circuit plans, tables. \$29.

## ULTIMATE SUCCESS MANUAL

Underpaid? Harassed? Stuck in a dead-end job? Can't find a  
good job? Expect to be laid off, fired or transferred soon?  
The ultimate no-holds-barred, looking-after-#1  
Machiavellian techniques to find, obtain, optimize and  
keep top jobs, pay and benefits. THE RULES OF THE  
GAME FOR A GAME WITHOUT RULES! From first re-  
sume to CEO. \$29.

## ROCKET'S RED GLARE

How to design and build solid-propellant amateur and  
survival rockets. Emphasis on formulation, manufacture,  
installation of propellants, motors, igniters, etc. Includes  
list of commonly available materials, and the design of  
launch pads and test beds and their electronics. \$29.

Please Order Today! (505) 434-0234  
Good for educational purposes only.



DC/CAD

introducing...

# THE TERMINATOR

Super High Density Router  
(Complete with Schematic & PCB EDITOR)

Features the following powerful algorithm & capability:

- Rip - up and Retry
  - Pre-routing of SMT components
  - Real-Time via minimization
  - Real-Time clean up passes
  - User defined strategies
  - Window 3.0 capability as DOS Task
  - 1-mil Autoplacer and Autopanning
  - Two-way Gerber and DXF
  - Automatic Ground Plane w/ Cross-Hatching
  - Complete w/ Schematic & Dolly Libraries
  - Optional simulation capability & protected mode for 386 users
- \* PCB LAYOUT SERVICE AT LOW COST \*

Call for  
**DC/CAD - \$95**  
(available for students only)  
normal price range  
\$295 - \$2500

LEASE PROGRAM & SITE LICENSE AVAILABLE



Design  
Computation

1771 State Highway 34  
Farmingdale, NJ 07727  
(908) 681 - 7700 • (908) 681 - 8733 (FAX)

" DC/CAD ... The focal point of future CAD market "

# GENUINE ELECTRONICS, INC

## CABLE TV AND ELECTRONIC EQUIPMENT

Genuine Electronics, Inc can help you  
with virtually any electronic need:

- \* Cable TV Descramblers/Converters
- \* Bullet Protectors
- \* Immunizers
- \* Voice-Mail Systems
- \* Digital On-Hold Announcers
- \* Laser Pens

90-Day Guarantee & Lowest Prices!

Call  
GENUINE ELECTRONICS, INC  
**1-800-833-2915**

# INSTEK Test & Measuring Instruments

## DC POWER SUPPLIES PR-Middle Series (Analog/Digital)

ISO 9002  
CERTIFICATION  
#934163



MODEL #PR6030D (Digital)  
Regular \$500.00  
Sale \$399.95

MODEL #PR6030 (Analog)  
Regular \$379.00  
Sale \$299.95

- Continuous or Dynamic load for internal selectable
- Low ripple and noise
- 0.01% high regulation
- Overload and Reverse polarity protection
- Constant voltage and constant current modes
- 3½ Digits 0.5" LED display (Digital type only)

	Model	Output Volts (V)	Output Amps (A)	Weight (kg)
Analog	PR-6030	0~60	0~3	11.5
Digital	PR-6030D	0~60	0~3	11.5



Products International

Test Instruments, Equipment and Tools, Training and Supplies for Electronic Maintenance and Repair  
8931 Brookville Road • Silver Spring, Maryland 20910 • 800-638-2020 • Fax 800-545-0058



TOLL FREE  
800-638-2020

NEW 84 PAGE CATALOG!!!  
Call Today For Your FREE Copy  
Of The 1994 Print Test  
Equipment Catalog!

CIRCLE 143 ON FREE INFORMATION CARD

September 1994, Popular Electronics

### OPTO INPUT



This board has 8 opto isolaters and interfaces to the Parallel I/O boards or the 8748 board via 16 pin dip ribbon cables. It has a screw terminal block to connect to external devices. Input voltage range is 4 to 15 volts AC or DC. Outputs are TTL levels. Size 3.4" by 4.6". Order # 91-305A \$49.95

### RELAY OUTPUT



This board has 8 DIP Relays, and interfaces to the Parallel I/O boards or the 8748 board via 16 pin dip ribbon cables. It has a screw terminal block to connect to external devices. Contacts are 500ma and 10 watts max. Inputs are LS-TTL. Size 3.4" by 4.6". Order # 91-300A \$69.95

### PARALLEL I/O



This board is IBM PC,XT,AT compatible. It has 6 eight bit I/O ports, via two 8255 I/O chips. Ports are programmable for input or output and are TTL level. Will interface with up to 6 Opto input and Relay output boards via ribbon cables. Dip switch sets I/O address. Plugs into bus, uses 1/2 slot. Order # 86-108A \$89.95

### A-D CONVERTER



IBM comp. 8 bit A-D board. 16 channel 0-5 or more volts. Designed to measure temperature, voltage or other slow changing inputs. Connects via 16 pin ribbon cables. Also has 3 TTL inputs & 3 outputs. Order # 87-016A \$99.95

### UNIVERSAL I/O



This IBM compatible has three 8255's that make 9 eight bit I/O ports and also has 16 analog inputs (0-5 volts) It also has a prototyping area. The I/O ports are designed to work with the Opto Input and Relay output boards. Order # 83-064A \$199.95

### 8748 CONTROLLER



This board is designed to interface with the Opto input & Relay output boards. It uses the 8748 or 8749 single chip controllers (chip is extra). This board has 3 eight bit I/O ports, 6 Mhz crystal, power on reset and a prototype area. Size 3.4" by 4.6". Order # 92-148A \$49.95

### FREE DISK

With order of \$89.95 or more. This is a one time offer. Disk has Basic I/O programs, 8748 Assm., Utilities and Text files.

### HOURS

10am to 4pm Pacific time.  
Monday through Friday.  
(702) 267-2704

### ACCESSORIES

8748 Chip \$12.95  
8748 Programmer \$CALL  
Ribbon cable 3 Ft. \$5.00  
Disk with Basic I/O programs,  
8748 Assembler, Text files &  
Utilities.  
\$10.00 or FREE with an order of  
\$89.95 or more (one time offer).

### Thank You !

I want to thank all my customers for over 13 years of success.

This ad is my new catalog. All boards come with Users Manual. Knowledge of computer workings is necessary.



**John Bell**  
1381 Saratoga St.  
Minden, NV 89423  
(702) 267-2704

To Order: Send check or money order to John Bell 1381 Saratoga St. Minden, NV 89423. Add \$4.00 for UPS Ground or \$6.00 for UPS Blue shipping. For COD add \$4.00. Include shipping address and phone number. I don't take credit cards. For cash COD, PO's call 702 267-2704 10am to 4pm Pacific time Monday through Friday.

CIRCLE 142 ON FREE INFORMATION CARD

## DIGI-FIELD

### FIELD STRENGTH METER

**\$139.95** Plus \$6.50 s/h

Are you worried about electromagnetic radiation, TV cox distribution loss, poor antenna performance, or EMU/RFI? The DIGI-FIELD field strength meter will put you at ease. With its frequency response of DC up to 12 GHz, it readily detects potential electromagnetic radiation hazards. It is an excellent tool for measuring TV cox distribution loss. In addition DIGI-FIELD can easily find 60-Hz AC-line interference, as well as RFI/EMI instrumentation disrupting set-ups. Sensitivity: @ 100 MHz Model "A" 150 nano Watts. Model "B" 2 nano watts.

To order call - (800) FIELD 58 (343-5358)  
I.C. Engineering 16350 Ventura Blvd.  
Suite 125, Encino, CA 91436 PH (818) 345-1692 • 818-345-0517 Fax

### Model 1010 Synthesized Digital Sweep/Function Generator \$289

- .1 Hz to 8 MHz sawtooth and ramp
- DC to 8 MHz square and sine wave
- AM and FM modulation
- ±25 ppm frequency accuracy
- Log or linear frequency sweeping with automatic or user programmed markers
- Programmable Pulse width and repetition rate. Programmable burst mode.
- 10 year nonvolatile memory storage of up to 100 user programmable setups

Options: RS-232 remote, 22 ppm accuracy, rechargeable battery operation, 30 day trial, 1 year factory parts and labor price and availability subject to change w/o notice.

**Videospectra**  
P.O. Box 755 Agoura, CA 91301  
(818) 889-9072 (800) 835-8335  
FAX (818) 889-9085

VISA MasterCard

## Infiniter™ Laser Pointer

Attracts the attention of your audience

**\$68** Black or Silver  
**\$88** Gold  
2 "AAA" Batteries included  
1 year warranty

FDA APPROVAL PATENTED

For:  
\*Conferences  
\*Presentations  
\*Marketing Sales  
\*Lawyers \*Doctors  
\*Real Estate Brokers  
\*Lectures \*Teachers  
\*Executives \*Engineers  
\*Scientists \*Inspections

Please Call 800-520-8435  
**Quarton USA, LTD. CO.**  
7042 Alamo Downs Parkway, Suite 250,  
San Antonio, Texas 78238-4518  
Tel: (210)520-8430 Fax: (210)520-8433

## Home Automation Enthusiasts

DIRECT WIRE TO FACEPLATE OR SOFT TOUCH BUTTONS!

LEARNING REMOTE

UNIVERSAL REMOTE

X-10 OR CUSTOM REMOTE

Remote Expansion Board

Remote Interface Board

MORE! MORE!

Authorized Distributor:  
**JAVANCO INC.**  
501 12th Avenue South  
Nashville, TN 37203  
(800) 528-2626 Sales Only  
(615) 244-4444 Information

Call for our catalog, filled with your electronic needs! Quantity discounts available.  
Remote Interface Board & complete instructions only \$29.99  
RIB Kit (all parts assembled for \$39.99) Order Code #RIB-001  
New Introducing REB, The Remote Expansion Board \$29.99  
REB Links up to eight RIB's on one parallel port. Order Code #RFB-001  
\* RIB is an interface. Remote control not included.

## Universal Programmers

Largest Selection In The World  
Also Buy, Sell & Program  
**GDI** Plus Never Undersold!

- \$1399 DATA I/O CHIPLABS 4800
- \$ 849 DATA I/O CHIPLABS 3200
- \$ 579 EETOOLS ALLMAX
- \$ 479 EETOOLS PROMAX
- \$ 479 XELTEK SUPERPRO II
- \$ 350 XELTEK SUPERPRO (R)
- \$ 499 LOGICAL DEVICES 3000
- \$ 499 ADVANTECH PC-UPROG
- \$ 429 NEEDHAMS EMP-20
- \$ 779 DATAMAN S4
- \$ 499 AMERICAN RELIANCE 9860
- \$ 699 NEEDHAMS SA-20 S/ALONE
- \$ 139 EETOOLS 1 GANG
- \$ 199 EETOOLS 4 GANG
- \$ 159 SUNSHINE 4 GANG
- \$ 399 SUNSHINE 8 GANG
- \$2499 STAG PP42 8 GANG S/ALONE

General Device Instruments  
(408) 241-7376 Fax 241-6375

CALL FOR DEVICE LISTS





## EPROM+ PROGRAMMING SYSTEM USES PARALLEL PORT

**EPROMS** (24,28,32 & 40 PIN\*) PLUS 27CXXX  
1702\*, 2708, TMS2716\*, 32,32A, 64,64A, 128,128A  
256,512,513,011,010,101,1001,1000,1024,210,020  
2001,220,204R,4001,040,240,4096,25X5,68764/66  
**FLASH EPROMS** 28F256, 28F512, 28F010  
28F020, 29C257, 29C010, 29F010  
**EEPROMS & NVRAMS** (18,24 & 28 PIN+CXX)  
2210,2212,2804,2816,2816A,2817,2864,2865,28256  
28C010, DS1220, DS1225, DS1230  
**SERIAL EPROMS\*** (8 & 14 PIN PLUS CXX)  
ER1400,MS8657,2401,02,04,08,16,2444,59C11  
9306,46,56,66,8572,82,92  
**BIPOLAR PROMS\*** (16 THROUGH 24 PINS)  
74SXXX AND 82SXXX FAMILY  
**MICROCONTROLLERS\*** 8741, 42, 48, 49, 8751  
C51,8752,87C52,87C5XXX,87C751,87C752,68705  
68HC705, 68HC711E9, PIC16C5X, TMS7742  
\*ADAPTER REQ'D - DIAGRAMS INCLUDED

**SOFTWARE** - READ,VERIFY,PROGRAM,COPY  
DISK FILE LOAD/SAVE, CHECKSUM, FULL  
SCREEN BUFFER EDITOR W/20 COMMANDS  
**READS** HEX, S-RECORD AND BINARY FILES  
**FAST-DEVICES** PROGRAM IN UNDER 60 SEC  
**RUGGED** (8"X7"X3")ENCLOSURE W/HANDLE  
**MADE IN USA** - 1 YEAR WARRANTY

**ANDROMEDA RESEARCH, P.O. BOX 222, MILFORD, OH 45150**  
(513) 831-9708 FAX (513) 831-7562



**SYSTEM INCLUDES:**  
PROGRAMMING UNIT  
PRINTER PORT CABLE  
POWER PACK, MANUAL  
AND SOFTWARE.

# \$289

ADD \$5.00 SHIPPING  
\$5.00 C.O.D.  
VISA/MASTERCARD



## AUTOMATE YOUR HOME

Hundreds of hard-to-find home automation and wireless control products. Computer control of your home, security systems, surveillance cameras, audio/video control, HVAC, pet care automation and much more. Easy do-it-yourself installation on most products. Affordable, systems start at about \$20.



Largest Selection of X10 Compatible Products in the World

Call for our Free 56 page Color Catalog

**800-FOR-XTEN (800-367-9836)**

**HOME AUTOMATION SYSTEMS, INC.**

151 Kalmus Dr., Ste M6, Dept. PE1, Costa Mesa, CA 92626

Questions 714-708-0610 Fax 714-708-0614

## PE MARKET CENTER CLASSIFIEDS

### MISCELLANEOUS ELECTRONICS FOR SALE

**ADD EXCITING** surround sound to your stereo system, **decoder** includes audio patch cables, requires second stereo amplifier. Only \$39.95 plus S&H, fully guaranteed, 1 (800) 768-7530.

**The Case Against Patents.** Thoroughly tested and proven alternatives that work in the real world. \$28.50. **SYNERGETICS PRESS**, Box 809-C, Thatcher, AZ 85552. (602) 428-4073. Visa/MC.

**NEW SURPLUS ELECTRONIC PARTS.** Call or fax anytime for catalog #P11. Voice 1(800) 290-2694. Fax (916) 823-0643. **CCSNOW ELECTRONICS.**

### Prototype it..... FAST!

with ProtoQuick 8051 or Z8  
• Complete single board computers  
• Up to 32K EPROMs and 64K RAM  
• 12 sq. in. plated-through proto area  
• RS232 C serial port w/ DB25 conn.  
• Chip eye in EPROM w/ source code  
• Assembly ready to run - \$c. only  
• MS-DOS cross-assembler included

**ProtoQuick Z8 and 8051**  
**\$99.00** each

Software Support  
2750 Roundstone Road  
Channahon, IL 61614  
(513) 561-2060

Run prototype applications or experimental hardware from the serial port - WITHOUT PROGRAMMING!

### Satellite-TV

**SAVE 40% - 60%**  
**800-334-6455**  
**218-738-5231 Int'l**  
**218-738-4879 Fax**

**FREE Catalog**

**Skysation Inc.®**  
1048 FRONTIER DRIVE • FERGUS FALLS, MN 56527

**YOU CAN**

### SATELLITE EQUIPMENT

**VIDEOCIPHER II** Descrambling manual. Schematics, video and audio, \$18.95. Software, \$25.00. Videocipher II 032, \$15.00. Videocipher II Plus, \$20.00. VCII Plus software, \$30.00. Cabletronics, Box 30502PE, Bethesda, MD 20824.

**SAVE \$\$\$ TROUBLESHOOTING** your satellite system yourself! Simplified manual \$14.95: T. Dee, POB 858, Fleischmanns, NY 12430.

### REPAIRS-SERVICES

**WOOFER ROT?** Quality re-coning, refoaming, restorations and parts for all speakers. World's largest speaker catalog, 200 pages \$10.00. Tri-State Loudspeaker, 650 Franklin, Aliquippa, PA 15001. (412) 375-9203.

### PUBLICATIONS

**FREE PROGRAMS**, games, information from local computer bulletin boards. "A Guide to Computer BBSing," 87 pages explains, \$11.95. Imprint Publications, 35775 Schmid #103, New Baltimore, MI 48047.

**LOWEST PRICES** on underground information including **Phreaking, Hacking, Cellular**, scanners, explosives, etc. Send SASE for free catalog. S.R. Thomas, PO Box 861, No. Branford, CT 06471.

### COMPUTER SOFTWARE

**ADVENTURER'S IBM CGA** games: **GUN-FIGHTERS, DINOSAURS, SPACEF, and BIKINI MURDER** for \$7.50 each or all \$15.00 plus shipping. (308) 532-8546.

**CIRCUIT BOARD** trace program for MS-Windows. Draw trace patterns quickly. Send \$20.00 to **SYTEC**, 223 Cambridge Road, Cherry Hill, NJ 08034.

**LOTTERY PROGRAM** for MS-Windows. Increase probability, don't pick in the dark. Send \$10.00 to **SYTEC**, 223 Cambridge Road, Cherry Hill, NJ 08034.

**SHAREWARE SOFTWARE** — Many titles never seen before. Call via modem (615) 837-0342.

**PC-SCHEMATICS V4.6**, schematics, layouts, PCB's (1-.05 ctrs), DOS/VGA, Epson Dot Matrix & HP Jets (8x11 & 8x14), full edit **TECHNICAL GRAPHICS**, 702 Hilton Ave., Baltimore, MD 21228. (410) 747-4184.

**IBM SOFTWARE** for the hobbyist or pro. \$2.00 per disk. Free catalog. F. Petersen, PO Box 2234, New Hyde Park, NY 11040.

### CB-SCANNERS

**RCI-2950 MODIFICATION** Manual \$20.00 pre-paid money order, \$25.50 COD. Scott, PO Box 510408, St. Louis, MO 63151-0408. (314) 846-0252.

### Quality Microwave TV Antennas

**WIRELESS CABLE - IFTS - MMDS - Amateur TV**  
Ultra High Gain 50db (+) - Tunable 1.9 to 2.7 Ghz.  
• 55-Channel Dish System \$199.95  
• 36-Channel Dish System \$149.95  
• 20-Channel Dish System \$124.95  
• Optional Commercial Bird Antenna (not shown) Add \$50.00  
• Yagi Antennas, Components, Custom Tuning Available  
• Call or write (SASE) for "FREE" Catalog

### PHILLIPS-TECH ELECTRONICS

P.O. Box 8533 • Scottsdale, AZ 85252  
(602) 947-7700 (\$3.00 Credit all phone orders)  
MasterCard • Visa • American Express • COD's • Quantity Pricing

**VIDEO GAME** training videos for NES, Super NES and SEGA Genesis, tools, parts, schematics. Send SASE for free catalog. **Irate Systems**, 2562 East Glade Ave., Mesa, AZ 85204-6208.

**FIBER OPTICS EXPERIMENTERS PARTS AND SUPPLIES:** fiber, cable, connectors, splices, detectors, lasers, kits, plans, newsletter. Send \$2.00 for catalog, Lightline Engineering, PO Box 24, Mullica Hill, NJ 08062.

**VIDEO GAME** system player all cables 20 game cartridge all in working order \$200.00. Dave (914) 562-2805.

**SAMS PHOTOFACTS** #1000-#1420 \$3,000.00, #1421-#1581 \$1,600.00, #1582-#1754 \$1,700.00, #1755-#1928 \$1,700.00, #1929-#2291 \$3,000.00. Dave (914) 562-2805.



# PE MARKET CENTER CLASSIFIEDS

**Cable Test Aids**  
 Orders only Information  
 1-800-452-7090 (310)902-0841

Test chips for JERROLD, TOCOM, ZENITH, S.A. & more. Puts cable boxes in full service mode. Easy installation. Zenith only \$39.95. Most others under \$50 ea. FAX: (310)902-0831. Quantity prices available. No Cx. sales. Not for use in cable co. rented equip. For use as a test aid only.

## CABLE TV

**"BULLET" BUSTER.** Protect your cable box against the infamous cable "bullet." The "Bullet" Buster acts as an electronic shield. Installs in-line in seconds. Don't wait until it's too late! \$19.95 + \$3.00 S&H. **Electroman**, Box 24474, New Orleans, LA 70184. (504) 482-3017.

**CBTV DOCTOR** Stop the Bullet and ID signal in cable lines. Send \$20.00 to: R.R. Enterprise, PO Box 3532, Easton, PA 18043.

**CABLE UNSCRAMBLED.** Everything you want to know, but are afraid to ask. \$10.00. **Electroman**, Box 24474, New Orleans, LA 70184. (504) 482-3017.

**CABLE — SAFE.** Guarantee cable privacy. The one way valve for your cable TV signal. \$29.95, + \$3.00 S&H. **Electroman**, Box 24474, New Orleans, LA 70184. (504) 482-3017.

**DESCRAMBLER SCHEMATICS REVEALED.** A powerful guide to descrambling schemes. \$10.00. **ELECTROMAN**, Box 24474, New Orleans, LA 70184. (504) 482-3017.

**CABLE TV DESCRAMBLERS.** All major brands. Have make/model used in your area when calling. 1 (800) 327-3407. For a free catalog write K D Video, PO Box 29538, Minneapolis, MN 55429.

**RAW UNITS** Oak RTC 56 \$35.00, Tocom 5503A \$35.00, SA 8500 310 \$50.00, 8580, 8600 call, JSX Dic \$20.00, Zenith PZ1 \$90.00. Call (414) 554-8618.

**BUILD — FIVE-digit**, ohms, capacitance, frequency, pulse, multimeter. Board and instructions \$9.95. **Bagnall Electronics**, 179 May, Fairfield, CT 06430.

**ALL-IN-ONE catalog.** AM/FM/ham/spy, transmitters, amplifiers, receivers. Voice scramblers/disguisers, audio, TV, Tesla coils, plans, "secret" books, kits, imports, exports and more. Start your own licensed or unlicensed radio station, 60 full pages for \$1.00. **PAN-COM INTERNATIONAL**, PO Box 130-H9, Paradise, CA 95967.

## BUGGED??

**EAVESDROPPING** is unbelievably widespread! Electronic Devices with amazing capabilities can be monitoring your telephone and room conversations **RIGHT NOW!** Are you sure you're safe? **FREE CATALOG tells you fast!** Includes Free Bonus details on fantastic opportunities now open in Counter-Surveillance field. Exciting, immensely interesting and **EXTREMELY** profitable (up to \$250/hr) full/part-time income. Call Now! **1-800-732-5000**

**FM STEREO TRANSMITTER** kit broadcasts any audio signal to FM stereo radios throughout your home. Uses unique BA1404 IC. Complete kit: PC board/components — \$24.00. Visa/MC. **TENTRONIX**, 3605 Broken Arrow, Coeur d'Alene, ID 83814. (208) 664-2312.

**TIRED OF IRONING??** Prototype service for hobbyists & engineers. Single/small quantity ss PCB's. No setup fee. \$10.00 minimum, most boards \$25.00. We scan magazine artwork free! Get out your back issues! **FIRST PROTO**, (407) 392-8677.

**SILENT SAM.** Patented vehicle turn signal reminder. Outshines others. Brief, timely alerting signal doesn't bug you. Kit complete w/case \$15.00. Visa/MC. 1 (800) 398-5605 literature. Also, \$22.00/\$27.00 wired models. **Silent Sam**, 1627 Basil Dr., Columbus, OH 43227.

**HOBBYIST CIRCUITS** — Remote room monitor, tone decoder, long distance circuit control and more. Simple experiments for the beginner. **CATALOG \$2.00** — Garrett Plans, Box 155, Jamesburg, NJ 08831.

**SURVEILLANCE TRANSMITTER** kits. 65 to 305 MHz. **Quick & Easy.** Partially assembled units. Five minutes completion. 110-volt duplex receptacle, room battery types, and telephone. Counter-surveillance. Catalog: \$2.00. **SHEFFIELD ELECTRONICS**, PO Box 377940-B, Chicago, IL 60637-7940.

**WAVEFORM VIEWER.** square sine other on monitor TV RF sweep applications filter circuits book \$19.95. **Waveform Viewer**, PO Box 142042, Gainesville, FL 32614-2042.

**!! BROADCAST & SURVEILLANCE !!**

70-120MHz FM Transmitters & RF Amplifiers  
 RF Power/SWR Meters, Stereo Generator, DC Power Supplies, Audio Limiters, Electronic & RF Components, Plans, Kits, and more! Send \$2 for complete information, get \$2 discount on first order.

**Progressive Concepts** 1434 N. MILLS AVENUE, B CLAREMONT, CA 91711  
 (909) 626-4969

## PLANS-KITS-SCHEMATICS

**PROJECTS.** \$2.00 gets flyer, 100 piece grab bag. **Lynn Johnson Electronics**, Box 51268, San Jose, CA 95151-1268.

**MINI-FM transmitter.** Buy parts at Radio Shack. Complete plans \$3.00. **Lynn Johnson Electronics**, Box 51268, San Jose, CA 95151-1268.

**ELECTRIC DOG DOOR,** entrancing LED clock, cool rocket launcher, computer clocks, awesome phones, plans, kits and more. **FREE CATALOG, CAMPBELL ENTERPRISES**, 27955 Terrace PE9, North Olmsted, OH 44070.

**THE ONLY CATALOG NEEDED!** Kits, plans, surveillance, test, radios, more! Part locating. Best prices! Send \$1.50 (refundable) **NEUTRONICS**, 4 Croydon Ct., Englishtown, NJ 07726.

**CABLE DESCRAMBLERS** Build your own, SSAVI, gated sync, sinewave. \$14.95. **Cabletronics**, Box 30502PE, Bethesda, MD 20824.

**SURVEILLANCE & COUNTERSURVEILLANCE** Electronic Devices.

Bugging/Phone Tapping Detectors • Caller ID • Covert Video • Phone Scramblers • Voice Changers • Shotgun Mics • Vehicle Tracking • Transmitter Kits • Locksmithing • AND MORE!

7-Hour Telephone Recording System  
 Tapes phone calls automatically. \$125.00

**FOR CATALOG SEND \$5.00 TO...**  
**P.O. Box 337, Buffalo, NY 14226 (716) 691-3476**

## MUSIC & ACCESSORIES

**MUSICAL INSTRUMENTS**, discount prices, free catalog. **Freeport Music**, 41A Shore Drive, Huntington Bay, NY 11743.

## BUILDING BLOCK FOR YOUR CONTROL & MONITORING NETWORK SYSTEMS

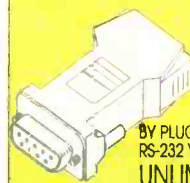

**DINEX**  
 DISTRIBUTED INTELLIGENT NETWORK CONTROLLER

BY PLUGGING DINEX INTO YOUR PC RS-232 YOU CAN CONNECT ALMOST UNLIMITED I/O.

**DIO-STD-SM \$69.95**  
 5 TTL DIGITAL I/O

**ADFC-SM \$96.65**  
 4 CHANNEL 8 BIT 0-5V A/D  
 1 CHANNEL FREQ INPUT

**D-M232-SM \$79.95**  
 RS-232 TO 485 INTELLIGENT CONVERTER

LIMITED TIME

**INTRODUCTORY OFFER:**

**\$199.95/kit** +S/H

**P/N SM-KIT** including:  
 DIO-STD-SM/ADFC-SM/D-M232-SM. POWER ADAPTER. NETWORK PHONE LINE SOFTWARE. DEVICE DRIVER, AND UTILITY. OVER \$450 VALUE.

**ALSO AVAILABLE:**  
 8 CH. 12BIT A/D, 12 BIT D/A STEPPER MOTOR SERVO, DISPLAY, CODE INPUT, NETWORK CONTROLLER...ETC.

PLS CONTACT FACTORY FOR DETAIL.  
 TO ORDER CALL:  
**I/O CONTROLS CORPORATION** 15 DAYS MONEY BACK GUARANTEE  
 1359 W. FOOTHILL BLVD., AZUSA, CA 91702  
**(818) 812-5333 FAX: (818) 812-5332**

**Dumont Model 190** two channel, 190 MHz solid state, delayed timebase, modular construction, built to military specs, includes 225 page manual, 30 money-back guarantee. Your cost:

**Hewlett-Packard Model 180A** two channel solid state, 50 MHz delayed timebase, Remanufactured, original cost was over \$6,000. Your cost:

**\$250**

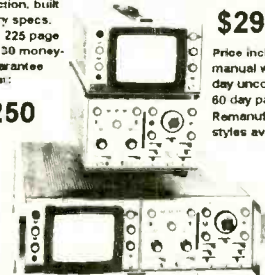

**\$290**

Price includes 225 page service manual with schematics, 30 day unconditional guarantee, 60 day parts and labor. Remanufactured. Two cabinet styles available.

**VIDEOSPECTRA** P.O. Box 755 Agoura, CA 91301  
**(800) 835-8335**

**BE A GOOD NEIGHBOR**

Volunteer.

**American Heart Association**



# Electronics made Easy with UCANDO



**Complete Course in Basic Electronics**  
Includes 6 one hour videos and 6 workbooks. Everything you need to learn basic electronics. You will learn about Direct Current, Alternating Current, Semiconductor devices, Power supplies, Amplifiers, and Oscillators. These videos are **100% computer animated**, they make learning electronics easy and fun. Don't waste any more of your valuable time reading and re-reading the same material to try and understand these simple concepts when you can **"see it happen."** These videos will ... teach you more in less time ... allow you to learn at your own pace ... help you remember more of what you learn ... give you years of quality use ... become a valuable source of reference material ... make your understanding of electronics more complete ... and help you build your future today. **Your future is too important to gamble with**, so order your course in Basic Electronics Today.

**Call Now ...** ask about our other popular UCANDO videos in Digital, AM Radio, FM Radio, and Fiber Optics. These videos are currently being used by Tech-Schools, CET's, Military branches, Ham Operators, Industries, and are sold in six foreign countries. After you have seen your first UCANDO video you will understand why UCANDO is .....

## "Changing The Way The World Learns Electronics".

Part 1 DC .....	\$44.95
Part 2 AC .....	\$44.95
Part 3 Semiconductors ....	\$44.95
Part 4 Power Supplies .....	\$44.95
Part 5 Amplifiers .....	\$44.95
Part 6 Oscillators .....	\$44.95
<b>SAVE ... buy all six for only \$240</b>	

**Call toll free 1-800-678-6113**

CIRCLE 136 ON FREE INFORMATION CARD

# SMALL MIRACLES



## NEW MICRO TX2000 KIT

**\$59<sup>95</sup>**

- SMALLEST 120 MW FM VOICE/PHONE TRANSMITTER
- 88-110mhz ON ANY BROADCAST RECEIVER
- ROCK SOLID TUNING, DOESN'T DRIFT
- 5 MIN. ASSEM., HEAR A WHISPER UP TO 2 MILES
- SMT PARTS PREASSEMBLED
- INCLUDES TXMTR, MIC, ANTENNA, BATTERY CLIP, TUNING TOOL, AND INSTRUCTIONS

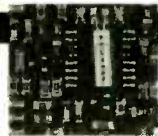

## VOICE SCRAMBLER/DESCRAMBLER KIT

**\$69<sup>95</sup>**

**2 FOR \$129.95**

- WORLDS SMALLEST AUDIO SCRAM./DESCRAM.
- TALK IN PRIVACY ON AUDIO, SPKR. OR MIC LINE
- HEAR THOSE GARBLED SCANNER VOICES
- SMALL SIZE 1 1/2" x 1 1/4"
- CRYSTAL CONTROLLED DIGITAL SPEECH INVERSION
- 7-15 VOLT DC SUPPLY
- LOUD HALF WATT AUDIO AMPLIFIER
- EXCELLENT AUDIO QUALITY
- INCLUDES FULL DOCUMENTATION
- DUPLEX SCRAMBLE & DESCRAMBLE AT THE SAME TIME

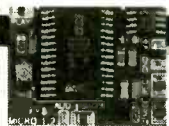

## MICRO 1.2 VOICE RECORDER

**\$69<sup>95</sup>**

- SMALL SIZE 1-1/4"x15/16"x1/4"
- HUNDREDS OF APPLICATIONS
- EXCELLENT AUDIO QUALITY
- 60 SECONDS REC/PLAY
- 8 OHM SPEAKER OUTPUT
- 7-15 VOLT DC SUPPLY
- 100 YEAR MEMORY WITHOUT POWER
- INCLUDES MIC, SWITCHES AND FULL DOCUMENTATION



## MICRO 2B VOICE RECORDER

**\$109<sup>95</sup>**

- SAME AS 1.2 PLUS:
- MULTI MESSAGES (UP TO 600 MEM.)
- SMALL SIZE 1-5/16"x1-3/8"x1/8"
- VARIABLE AUTO PLAY TIMER
- 5 VOLT KEY OUT DURING PLAYBACK

ORDER BY PHONE OR MAIL  
IN U.S.A. ADD \$5 FOR S&H  
C.O.D. CHARGES APPLY  
NYS RESIDENTS ADD 7% SALES TAX  
TECH. SUPPORT: 518-381-1057  
TECH. FAX: 518-381-1058



1145 CATALYN STREET  
SCHENECTADY, NY 12303

**TO ORDER: CALL 1-(800)-588 4300**



## CABLE TV



## NEW Release Universal II

## DESCRAMBLER **COD**

### Advanced Performance:

- Color, Picture Quality and Stability
- New PC Board Design
- Latest Technology Components

**FREE In-House Technical Support**

**Universal II Kit 4000 \$74.95**

Includes our new silk-screened, etched, drilled PC board plus the electronic components.

**Kit Enclosure Pak 4000A \$39.95**

Includes custom enclosure, AC adaptor, nuts screws, knobs, momentary switch.

**1-800-664-6999**



### No Florida Sales!

It is not the intent of The Halcyon Group to defraud any part tv operator and we will not assist anyone in doing the same. Kits should be used for educational purposes only.



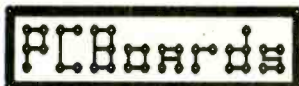

# PCB Artwork Made Easy!

PRINTED CIRCUIT DESIGN SOFTWARE  
for

## Layout - Autorouting - Schematic

- Supports all Video Modes including Super VGA
- Copper Flooding for Building Ground Areas
- Gerber and Excellon Output
- Mirror Imaging for Laser Printer Output
- Autorouter and Schematic Programs
- Circuit Simulation Software Available
- NEW! - **WINDOWS**™ Versions
- NEW! - **DOS Versions** - PCBoards & PCRoute
- FREE - Heat Transfer Film with Order

Download Demos from BBS (205)933-2954

**PCBoards Layout Only \$99**

**Windows**™ Layout starts at **\$149**

Call or Write for Full Product Line, Prices & Demo Packages

PCBoards  
2110 14th Ave. South  
Birmingham, AL 35205

(800)473-7227  
Fax (205)933-2954  
Phone (205)933-1122

# EARN MORE MONEY!

## Be an FCC LICENSED ELECTRONIC TECHNICIAN!



Earn up to  
\$60 an hour  
and more!

Learn at home in spare time.  
No previous experience needed!

No costly school. No commuting to class. The Original Home-Study course prepares you for the "FCC Commercial Radiotelephone License." This valuable license is your professional "ticket" to thousands of exciting jobs in Communications, Radio-TV, Microwave, Maritime, Radar, Avionics and more...even start your own business! You don't need a college degree to qualify, but you do need an FCC License.

**No Need to Quit Your Job or Go To School**  
This proven course is easy, fast and low cost! **GUARANTEED PASS**—You get your FCC License or money refunded. **Send for FREE facts now. MAIL COUPON TODAY!**

Or, Call 1-800-932-4268 Ext. 240

### COMMAND PRODUCTIONS

FCC LICENSE TRAINING, Dept. 240  
P.O. Box 2824, San Francisco, CA 94126  
Please rush FREE details immediately!

NAME \_\_\_\_\_  
ADDRESS \_\_\_\_\_  
CITY \_\_\_\_\_ STATE \_\_\_\_\_ ZIP \_\_\_\_\_

## FOTRONIC

### QUALITY ELECTRONIC TEST EQUIPMENT

Sales • Service

- Specialists in - Fluke, Hewlett Packard, Tektronix

- NIST Traceable/Mil Spec 45662A Calibration Available

We buy surplus  
Electronic Equipment  
FAX your list!!!

#### TECHNICAL SUPPORT

#### Oscilloscope Specials

Tek 465	100 MHZ	\$489.00
Tek 465B	100 MHZ	\$589.00
Tek 475	200 MHZ	\$649.00
Tek 475A	250 MHZ	\$749.00

ALL EQUIPMENT SOLD WITH WARRANTY

For more GREAT VALUES Call, Write, or FAX  
P.O. Box 708, Medford, MA 02155

(617) 391-6858 FAX (617) 391-6903

**CABLE TV CHANNELS**  
EQUIPMENT **GUARANTEED**

→ The nationwide source for cable TV equipment.

**FREE 30 DAY TRIAL**

"BUY WHERE THE DEALERS BUY."

**FREE** TV Cable Descramblers and Converters Catalog. Open Every Day!

**MEGA ELECTRONICS**  
VISA • MC C.O.D. **1-800-676-6342** SAVE 1000's

21 South Main Street, Winter Garden, FL 34787

**YOUR VCR TAPES**  
CAN PLAY AS

**CLEAR AS DAY!**

Why put up with Inconsistent Color, Flashes, Streaking and Interference!

**UNJAM NOW WITH INTELESTAR**

- Easy Connections
- Eliminates "Jamming"
- Copy any tape
- RC Plugs Included







**STAR ELECTRONICS**  
**1-800-282-4336**

**\$59.95**

- 30 Day Money Back Guarantee
- 2 year warranty

**PROFESSIONAL SURVEILLANCE EQUIPMENT**  
Used By Law Enforcement Agencies

VHF-FM CRYSTAL CONTROLLED TRANSMITTERS  
A - 139MHz, B - 139.970 MHz, C - 149 MHz, D - 149.450 MHz  
All kits assemble in less than 5 mins.

					
SD-200 Smoke Detector Camera w/Audio 400 lines .03 lux 10-14 VDC \$330	CX-102 Miniature Camera w/Audio 240 lines 2 lux 7-14 VDC \$235	AD-700 Mic Range: up to 5 Mile Power: 750MW \$247	AD-600 Mic Range: up to 5 Mile Power: 15MW \$125	AD-500 Tel. Range: up to 5 Mile Power: 15MW \$115	AD-400 Mic Range: up to 2.5 Mile Power: 400MW \$155

We sell a variety of cameras, bug detectors, night vision equipment, video transmitters, time lapse recorders, remote video monitoring systems, and many more...

**A&D ELECTRONICS**  
P.O. Box 601, Monsey, NY 10952  
914-356-7541 • Fax 914-356-7505  
Call for FREE catalog. Credit Cards accepted

**ALPHA CABLE**  
**MAGIC BOX**

Don't waste your money on outdated technology

The Alpha Cable Box offers you leading edge technology to connect to the world's best cable TV programming. Now you can own the multi-video box of the future.

Free Catalog.  
"Buy where the dealers buy"

Star Electronics **1-800-282-4336**

**THE POCKET PROGRAMMER**

**The Pocket Programmer**

The portable Eeprom programmer that uses the printer port of your PC instead of an internal card. The software has 24 easy to use functions and programs 27/25/28/68764 & Cmos from 16K (2K x 8)—2M (256K x 8) Eeproms (32 pin socket, UpGradeable to 8Meg). Adapters available for MCU's, 40-Pin Eeproms, 5-Gang and Eeprom Emulator to 32K x 8.

**\$129.95**

INTRONICS, INC.  
Box 13723  
Edwardsville, KS 66113  
(913) 422-2094

Add \$3.00 for shipping.  
Add \$3.75 for COD.  
Visa/Master Charge

**Surface Mount Chip Component Prototyping Kits—**  
Only **\$49.95**

INDIVIDUAL VALUES AVAILABLE

CC-1 Capacitor Kit contains 365 pieces, 5 ea. of every 10% value from 1pf to 33µf. CR-1 Resistor Kit contains 1540 pieces; 10 ea. of every 5% value from 10Ω to 10 megΩ. Sizes are 0805 and 1206. Each kit is ONLY \$49.95 and available for Immediate One Day Delivery!

Order by toll-free phone, FAX, or mail. We accept VISA, MC, COD, or Pre-paid orders. Company PO's accepted with approved credit. Call for free detailed brochure.

**COMMUNICATIONS SPECIALISTS, INC.**  
426 West Taft Ave. • Orange, CA 92665-4296  
Local (714) 998-3021 • FAX (714) 974-3420

**Entire USA 1-800-854-0547**

**CABLE DIRECT**

Now you can tune-in to your favorite cable TV programming and SAVE 100's—EVEN \$1000's on premium

**CABLE TV EQUIPMENT**  
Converters • Descramblers • Filters

FREE Cable TV Catalog

**MODERN ELECTRONICS**  
**1-800-906-6664**  
100% MONEY BACK GUARANTEE! • 30 DAY FREE TRIAL!

**\$129 Laser Light Show**

This kit displays animation, text, drawings, & music! Includes 2 Galvos, VCO, Computer Interface, Manual & Software listing. Works from parallel printer port.

**Computerized Motors \$39\***  
Includes: 2 Stepper or 4 DC servo motors, Computer interface kit, 32 page training manual & Software listing. Works from parallel printer port.  
\* Add \$5 for shipping. Computer and Laser not included.

Call for **FREE** Flyer

**SVS** Light & Motion in kit form

1273 Industrial Pky. W#460  
P O Box 55125  
Hayward CA 94545-0125  
**510-582-6602**

**MARYMAC**  
The New Realistic®  
**PRO-43 Scanner**

**Radio Shack**  
PHONES

Our 18th year of DISCOUNTS  
**Toll Free 800-231-3680**  
PRO-43 List \$349.95  
Our Delivered Price \$288.00  
**IF ON SALE, WE ARE CHEAPER!**  
We discount everything in the RS catalog

22511 Katy Fwy.  
Katy (Houston), TX 77450  
1-713-392-0747 FAX 713-574-4567

**Smart Battery Charger**

JUN 87 QST  
BY WARREN DION N1BBH

FOR GEL-CELLS or LEAD ACID BATTERIES.  
Features: Precision temperature tracking voltage reference & three mode charging sequence. Standard kit is for 12V @ 1/2 or 1 Amp, user selectable. Can be connected to the battery indefinitely, will not overcharge. Weighs 2 pounds and measures 4"W x 5 1/2"D x 2 1/2"H. Finished enclosure included in kit.

Complete Kit Only ..... \$59.95  
Assembled & Tested ..... \$79.95

CA Residents add 7.75% sales tax. S&H: \$5.00 (insured). Foreign orders add 20%. For more info or price list; send legal size SASE (52¢) to:

**A&A Engineering**  
2521 W. La Palma #K • Anaheim, CA 92801  
(714) 952-2114 • FAX: (714) 952-3280



# MAY THE SOURCE BE WITH YOU

Don't let the dark forces of ignorance defeat you. Right in this galaxy, you can tap into the source -- the free CONSUMER INFORMATION CATALOG. It lists more than 200 free and low-cost



government publications on a variety of important topics. So dispel the darkness and send for the source. Just send your name and address to:

**Consumer Information Center  
Department Source  
Pueblo, Colorado  
81009**

## NEW EASY PC

BRITISH DESIGN AWARD

SCHEMATIC and PCB C.A.D

ONLY

\$195

Includes

- MGA, CGA, EGA & VGA compatible.
- Design large multi layer boards.
- One level pull down menu and quick keys for fast layout.
- Dot matrix, laser, plotter, Gerber & N.C. drill output.
- 6 Month Free update  
Free Demo

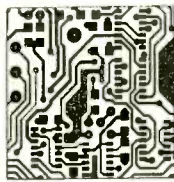

7840 ANGEL RIDGE ROAD  
ATHENS, OHIO 45701  
(614) 592-1810

Visa & MasterCard Accepted

## PE MARKET CENTER CLASSIFIEDS

### BUSINESS OPPORTUNITIES

**EASY WORK!** Excellent pay! Assemble products at home. Call toll free 1 (800) 467-5566 ext. 5192.

**GREAT EXTRA** income! Assemble products at home. Easy and fun to do. Guaranteed! 1 (800) 377-6000 ex7930.

**FREE 900#'S.** Computerized equipment managers and brokers wanted. Unlimited income potential. For information call (914) 573-2067.

**START** your own technical venture! Don Lancaster's newly updated **Incredible Secret Money Machine II** tells how. We now have autographed copies of the Guru's underground classic for \$18.50. **SYNERGETICS PRESS**, Box 809-C, Thatcher, AZ 85552. (602) 428-4073. Visa/MC.

**FREE INFORMATION** about earning some extra money. Send a SASE to: **GREEN ENTERPRISES**, PO Box 136, Still River, MA 01467.

**TOP PAY!** Get the electronics job you want! Learn employment strategy from technical recruiter. Earn more and get ahead. Must for students. Results guaranteed. \$5.00. Lou Garcia, 8306 Mills Drive, Suite 115, Miami, FL 33014. Attn: Tech Tips.

Radiotelephone - Radiotelegraph

## FCC Commercial License

### Why Take Chances?

Discover how easy it is to pass the exams. Study with the most current materials available. Our **Homestudy Guides**, Audio, Video or PC "Q&A" pools make it so fast, easy and inexpensive. No college or experience needed. The new commercial FCC exams have been revised, covering updated Aviation, Marine, Radar, Microwave, New Rules & Regs, Digital Circuitry & more. We feature the Popular "Complete Electronic Career Guide" 1000's of satisfied customers **Guarantee** to pass or money back. Send for **FREE DETAILS** or call **1-800-800-7588**

WPT Publications  
7015 N.E. 61st Ave Dept. 10  
Vancouver, WA 98661

Name \_\_\_\_\_

Address \_\_\_\_\_

City \_\_\_\_\_ St. \_\_\_\_\_ Zip \_\_\_\_\_

**1-800-800-7588**



If you are not getting this catalog you are missing out on some of the best deals in electronics today! We have thousands of items ranging from unique, hard-to-find parts to standard production components. Call, write, or fax today to start your free subscription to the most unique catalog in the industry, filled with super values on surplus electronic and hobbyist type items. If you have a friend who would like to receive our catalog, send us their name and address and we will gladly forward them a complementary 68 page catalog.

Why pay more? Call today.



340 East First Street Fax Order Line  
Dayton, Ohio 45404 1-800-344-6324

**Order Toll-Free  
1-800-344-4465**

CIRCLE 144 ON FREE INFORMATION CARD

## You Need Tree City USA

City trees add the soft touch of nature to our busy lives. Support Tree City USA where you live. For your free booklet, write: Tree City USA, The National Arbor Day Foundation, Nebraska City, NE 68410.

**The National Arbor Day Foundation**



# ADVERTISING INDEX

POPULAR ELECTRONICS magazine does not assume any responsibility for errors that may appear in the index below.

Free Information No.	Page	—	ISCET .....	85
164	3M Electrical/Electronic Products	5	138 ITC Instruments	101
—	A&A Engineering	124	142 John Bell	118
—	A&D Electronics	124	— JP Video	100
25	Ace Communications	97	38 Kelvin Electronics	109
—	Agrelo Engineering	122	— M&G Electronics	95
26	Alfa Electronics	110	— Marymac Industries Inc.	124
28	All Electronics	104	145 MCM Electronics	105
—	Allen Engineering	114	— MD Electronics	111
151	AMC Sales	23	— Mega Electronics	124
—	Andromeda Research	120	144 Mendelson's	125
—	Antique Radio Classified	79	— Modern Electronics	124
137	B&S Sales	96	— NRI Schools	15, 23
141	Beige Bag	107	— Nu-Tek Electronics	79
—	CBC International Inc.	78	— Ohio Automation	125
—	C&C Specialties	121	43 Optoelectronics	102, 103
32	C&S Sales	98	— PC Boards	123
—	CLAGGK Inc.	90, 91, 92	— Phillips Tech	120
—	CLAGGK Video	CV4	47 Prairie Digital Inc.	112
—	Cleveland Inst. of Electronics	29	46 Print	112
—	Command Productions	123	143 Print	117
—	Communication Specialists	124	— Progressive Concepts	121
140	CompCo	118	— Quarton USA	118
—	Consumertronics	116	— The School of PC Repair	79
—	Copyright Clearance Center	87	— The School of VCR Repair	79
—	Design Computation	117	— Self-Reliance Co. Inc.	105
—	EDE	121	— Short Wave Headquarters	115
—	EIA	CV3	— Silicon Valley Surplus	124
—	Electronics Technology Today	17, 80	— Skyvision (Small)	120
—	Firestick II	78	— Software Science	120
—	Foley Belsaw	119	— Software Systems Consulting	17
—	Forest Electronics	105	— Solar Illumination & Power Sys.	115
—	Fotronics	123	— Spy Supply	108
—	General Device Instruments	118	— TAB Books	9, 63
—	Genuine Electronics	117	— Tandy National Parts	25
—	Get-Tech Inc.	115	130 Tech Serv	116
—	Grantham College of Engineering	20	— Tele View Distributors	114
—	Great Southern Security	121	136 UCANDO Videos	122
—	Greenleaf Electronics Inc.	112	— United Electronic Supply	114
—	Halcyon Group	122	— US Cable (Zentek)	115
155	Heath Company	3	— US Cyberlab	95
—	Home Automation Systems	120	— Video Spectra	118, 121
—	I.C. Engineering	118	133 Weka Publishing	113
—	I/O Controls Corp.	121	— Windward Electronics	106
—	Information Unlimited	25	— World College (Div. of CIE)	8
166	Interactive Image Technologies	CV2	— WPT Publications	125
—	Intronics	124	134 Xandi Electronics	107

## ADVERTISING SALES OFFICE

**Gernsback Publications, Inc.**  
500-B Bi-County Blvd.  
Farmingdale, NY 11735  
1-(516) 293-3000

**Larry Steckler, EHF/CET**  
President

**Christina Estrada**  
Assistant to the President

**For Advertising ONLY**  
516-293-3000  
Fax 1-516-293-3115

**Larry Steckler**  
publisher

**Arline Fishman**  
advertising director

**Denise Mullen**  
advertising assistant

**Kelly Twist**  
credit manager

**Subscription/  
Customer Service/  
Order Entry**  
1-800-827-0383  
7:30 AM - 8:30 PM EST

## ADVERTISING SALES OFFICES EAST/SOUTHEAST

**Stanley Levitan**  
Eastern Sales  
1 Overlook Ave.  
Great Neck, NY 11021  
1-516-487-9357, 1-516-293-3000  
Fax 1-516-487-8402

**MIDWEST/Texas/Arkansas/  
Oklahoma, Colorado, Arizona**

**Ralph Bergen**  
Midwest Sales  
One Northfield Plaza, Suite 300  
Northfield, IL 60093-1214  
1-708-446-1444  
Fax 1-708-559-0562

## PACIFIC COAST/Mountain States

**Mike Brooks**  
Hutch Looney & Assoc., Inc.  
1800 North Highland Avenue  
Suite 717  
Hollywood, CA 90028  
1-213-462-2700  
Fax 1-213-463-0544



# What Do These Prestigious Companies Have In Common?

## Aerovox®

DC Film and RFI Suppression Capacitors, Aluminum Electrolytic and AC Oil Capacitors, EMI Filters

## AMP

Electrical/Electronic Connectors, IC Sockets, PCB Switches

## AMRAD Engineering, Inc.

Motor Run Capacitors, HID Lighting Capacitors, Power Factor Correction Capacitors



Miniature and Subminiature Coaxial Connectors and Cable Assemblies.

## AVX CORPORATION

MLC, Tantalum and Thin Film Capacitors, Resistors, Networks, Integrated Passive Components, Trimmers, Oscillators, Resonators, Filters, Piezo Devices, and Connectors

## BERG ELECTRONICS

High Density and Industry Standard Connectors/Subsystems

## CAROL

Electronic and Electrical Wire and Cable and Power Supply Cords

## COLE FLEX

Tubing, Conduits, Hose, Sleeveings, Splices, Insulation and Cable Harness Products, Power Cords and Cordsets

## Communications Instruments, Inc.

CII Midtex  
Relays and Solenoids

## COOPER

**Bussmann**  
Fuses, Fuseholders, Fuse Blocks, and Fuse Accessories

## CORNELL DUBILIER

Capacitors-Aluminum Electrolytics, Mica, AC Oil, Film, MICA Paper and Relays



**Dale Electronics, Inc.**

Resistors, Networks, Oscillators, Displays, Inductors, Thermistors, Connectors, & Transformers

## DANTONA INDUSTRIES, INC.

Batteries: Computer, Cordless Phone, Laptop, Scanner, Alarm and Medical  
Antennas: Cordless Phone and Scanner

## DEARBORN WIRE AND CABLE L.P.



## EAT•N

Eaton Corporation, Commercial & Military Controls Operation  
Switches, Relays, Displays and Keyboards



Quartz Crystals, Clock Oscillators, Surface Mount Products, Programmable Devices

## GERNSBACK

PUBLICATION  
*Popular Electronics*  
Electronics Now Magazine

## GUARDIAN

Relays and Solenoids

## KEMET

Electronics Corporation

Multilayer Ceramic and Solid Tantalum Capacitors

## KOA SPEER

Resistors, SMT Tantalum Capacitors Inductors, Resistor Networks, SMT Thermistors

## MALLORY

North American Capacitor Company  
Tantalums, Aluminums, Sonalaters® Ceramics, Films and AC's

## M•tron

Quartz Crystal  
Hybrid Oscillators

## muRata®

Fixed Ceramic Capacitors, Variable Capacitors and Resistors, Crystal Oscillators, Ceramic Filters, Resonators, EMI Filters, Hybrid Circuits and more.

## Panasonic Industrial Company

Resistors, Resistor Networks, Ceramic, Film, Electrolytic, Double Layer Capacitors, Potentiometers, Switches, Inductors, Filters, Resonators, Varistors, Thermistors

## Philips Components

Philips Electronics North America Corporation

Resistors, Ferrite Components  
Aluminum Electrolytic, Film & Ceramic Capacitors

They sell through distributors.  
They belong to the E.I.A.  
They belong on your vendor list.

## Quam

Loudspeakers and Commercial Sound Products

## ROHM

Rohm Electronics Division  
Resistors, Ceramic Capacitors, Transistors/Diodes, Opto Components and IC's

## SELECTA

Switches, Relays, Terminals, Indicator/Pilot Lights, LED Indicators, Test Clips, Test Leads, Cable Ties and Heat Shrinkable Tubing

## SPRAGUE

Tantalum Capacitors, Wet & Foil Capacitors, Resistor Networks, Resistor Capacitor Networks, Filters

## Switchcraft

A Raytheon Company  
Switches, Connectors, Jacks, Plugs, Jackfields & Audio Accessories, Cable Assemblies

Leadership in electronics is not just a matter of designing products better and manufacturing them better, but also of marketing them better. And the sponsors of this message understand that better service to customers requires effectively involving distributors as part of their marketing teams.

Distributor involvement means lower prices, quicker deliveries, better service over-all. The Buyer wins...the Seller wins.

Distributors help achieve marketing leadership. So does the manufacturer's involvement in the Components Group of the Electronic Industries Association. EIA fosters better industry relations, coherent industry standards, and the sharing of ideas, which helps one another and serves customers better.

In choosing your component supplier, look for the marks of leadership--

- availability through distribution
- membership in E.I.A.



Our 70th Anniversary Year

Electronic Industries Association/Components Group  
2001 Pennsylvania Avenue, N.W.,  
11th Floor  
Washington, D.C. 20006  
Phone: (202) 457-4930  
Fax: (202) 457-4985

Committed to the competitiveness of the American electronics producer

# Countersurveillance

**Never before has so much professional information on the art of detecting and eliminating electronic snooping devices—and how to defend against experienced information thieves—been placed in one VHS video. If you are a Fortune 500 CEO, an executive in any hi-tech industry, or a novice seeking entry into an honorable, rewarding field of work in countersurveillance, you must view this video presentation again and again.**

*Wake up!* You may be the victim of stolen words—precious ideas that would have made you very wealthy! Yes, professionals, even rank amateurs, may be listening to your most private conversations.

*Wake up!* If you are not the victim, then you are surrounded by countless victims who need your help if you know how to discover telephone taps, locate bugs, or "sweep" a room clean.

There is a thriving professional service steeped in high-tech techniques that you can become a part of! But first, you must know and understand Countersurveillance Technology. Your very first insight into this highly rewarding field is made possible by a video VHS presentation that you cannot view on broadcast television, satellite, or cable. It presents an informative program prepared by professionals in the field who know their industry, its techniques, kinks and loopholes. Men who can tell you more in 45 minutes in a straightforward, exclusive talk than was ever attempted before.

## Foiling Information Thieves

Discover the targets professional snoopers seek out! The prey are stock brokers, arbitrage firms, manufacturers, high-tech companies, any competitive industry, or even small businesses in the same community. The valuable information they filch may be marketing strategies, customer lists, product formulas, manufacturing techniques, even advertising plans. Information thieves eavesdrop on court decisions, bidding information, financial data. The list is unlimited in the mind of man—especially if he is a thief!

You know that the Russians secretly installed countless microphones in the concrete work of the American Embassy building in Moscow. They converted



**CALL NOW!**

**1-516-293-3751**

**HAVE YOUR  
VISA or MC CARD  
AVAILABLE**

what was to be an embassy and private residence into the most sophisticated recording studio the world had ever known. The building had to be torn down in order to remove all the bugs.

## Stolen Information

The open taps from where the information pours out may be from FAX's, computer communications, telephone calls, and everyday business meetings and lunchtime encounters. Businessmen need counselling on how to eliminate this information drain. Basic telephone use coupled with the user's understanding that someone may be listening or recording vital data and information greatly reduces the opportunity for others to purloin meaningful information.

The professional discussions seen on the TV screen in your home reveals how to detect and disable wiretaps, midget radio-frequency transmitters, and other bugs, plus when to use disinformation to confuse the unwanted listener, and the technique of voice scrambling telephone communications. In fact, do you know how to look for a bug, where to look for a bug, and what to do when you find it?

Bugs of a very small size are easy to build and they can be placed quickly in a matter of seconds, in any object or room. Today you may have used a telephone handset that was bugged. It probably contained three bugs. One was a phony bug to fool you into believing you found a bug and secured the telephone. The second bug placates the investigator when he finds the real thing! And the third bug is found only by the professional, who continued to search just in case there were more bugs.

The professional is not without his tools. Special equipment has been designed so that the professional can sweep a room so that he can detect voice-activated (VOX) and remote-activated bugs. Some of this equipment can be operated by novices, others require a trained countersurveillance professional.

The professionals viewed on your television screen reveal information on the latest technological advances like laser-beam snoopers that are installed hundreds of feet away from the room they snoop on. The professionals disclose that computers yield information too easily.

This advertisement was not written by a countersurveillance professional, but by a beginner whose only experience came from viewing the video tape in the privacy of his home. After you review the video carefully and understand its contents, you have taken the first important step in either acquiring professional help with your surveillance problems, or you may very well consider a career as a countersurveillance professional.

## The Dollars You Save

To obtain the information contained in the video VHS cassette, you would attend a professional seminar costing \$350-750 and possibly pay hundreds of dollars more if you had to travel to a distant city to attend. Now, for only \$49.95 (plus \$4.00 P&H) you can view *Countersurveillance Techniques* at home and take refresher views often. To obtain your copy, complete the coupon or call.

**CLAGGK INC. PE**  
**P.O. Box 4099 • Farmingdale, NY 11735**

Please rush my copy of the Countersurveillance Techniques Video VHS Cassette for a total cost of \$53.95 each (which includes \$1.00 postage and handling)

No. of Cassettes ordered \_\_\_\_\_  
Amount of payment \$ \_\_\_\_\_  
Sales tax (N.Y.S. only) \_\_\_\_\_  
Total enclosed \_\_\_\_\_  
Bill me  VISA  MasterCard  
Card No. \_\_\_\_\_  
Expire Date \_\_\_\_ / \_\_\_\_  
Signature \_\_\_\_\_  
Name \_\_\_\_\_  
Address \_\_\_\_\_  
City \_\_\_\_\_ State \_\_\_\_\_ ZIP \_\_\_\_\_

All payments in U.S.A. funds. Canadians add \$1.00 per VHS cassette. No foreign orders.